



**HAL**  
open science

# Concentration and fractionation by membranes of spent brewer's yeast protein hydrolysate

Gabriela Vollet Marson

► **To cite this version:**

Gabriela Vollet Marson. Concentration and fractionation by membranes of spent brewer's yeast protein hydrolysate. Chemical and Process Engineering. Université Montpellier; Universidade estadual de Campinas (Brésil), 2020. English. NNT : 2020MONTG015 . tel-03847839

**HAL Id: tel-03847839**

**<https://theses.hal.science/tel-03847839v1>**

Submitted on 10 Nov 2022

**HAL** is a multi-disciplinary open access archive for the deposit and dissemination of scientific research documents, whether they are published or not. The documents may come from teaching and research institutions in France or abroad, or from public or private research centers.

L'archive ouverte pluridisciplinaire **HAL**, est destinée au dépôt et à la diffusion de documents scientifiques de niveau recherche, publiés ou non, émanant des établissements d'enseignement et de recherche français ou étrangers, des laboratoires publics ou privés.

# THÈSE POUR OBTENIR LE GRADE DE DOCTEUR DE L'UNIVERSITÉ DE MONTPELLIER

En génie des procédés et en génie alimentaire

École doctorale GAIA / Faculté de Génie Alimentaire

Unité de recherche : Institut Européen des Membranes

En partenariat international avec l'Université de l'État de Campinas (UNICAMP), Brésil

## Concentration et fractionnement par membranes d'hydrolysats protéiques de levure résiduelle de bière

Présentée par **Gabriela VOLLET MARSON**  
Le 11 septembre 2020

Sous la direction de Marie-Pierre BELLEVILLE  
et Miriam Dupas HUBINGER

Devant le jury composé de

Rénato FROIDEVAUX, Professeur, INRAE/ Université de Lille

Marco DI LUCCIO, Professeur, EQA/ UFPR

Dominique CHEVALIER-LUCIA, Professeur, IATE/ Université de Montpellier (Président du jury)

Agnes de Paula SCHEER, Professeur, FEQ/ UFPR

Guilherme MIRANDA TAVARES, Professeur, FEA/ UNICAMP

Rapporteur

Rapporteur

Examineur

Examineur

Examineur



UNIVERSITÉ  
DE MONTPELLIER



UNICAMP/ UNIVERSITÉ DE MONTPELLIER  
Faculty of Food Engineering/ GAIA Doctoral School

**Gabriela VOLLET MARSON**

**Concentration and fractionation by membranes of spent  
brewer's yeast protein hydrolysates**

**Concentration et fractionnement par membranes  
d'hydrolysats protéiques de levure résiduelle de bière**

**Concentração e fracionamento por membranas de  
hidrolisados proteicos de levedura residual cervejeira**

Campinas  
2020

**Gabriela VOLLET MARSON**

**Concentration and fractionation by membranes of spent brewer's yeast  
protein hydrolysates**

**Concentration et fractionnement par membranes d'hydrolysats  
protéiques de levure résiduelle de bière**

**Concentração e fracionamento por membranas de hidrolisados proteicos  
de levedura residual cervejeira**

Thesis presented to the Faculty of Food Engineering of the University of Campinas and Doctoral School GAIA of Université de Montpellier in partial fulfillment of the requirements for the degree of Doctor in Food Engineering and Process Engineering under the double-diploma agreement between Unicamp and Université de Montpellier.

Thèse présentée à Faculté de Génie Alimentaire de l'UNICAMP et à l'Ecole Doctorale GAIA de l'Université de Montpellier dans le cadre des conditions pour l'obtention du titre de Docteur en Génie Alimentaire et Génie des Procédés, comme défini dans l'accord de cotutelle entre UNICAMP et Université de Montpellier.

Tese apresentada à Faculdade de Engenharia de Alimentos da Universidade Estadual de Campinas e à Escola Doutoral GAIA da Universidade de Montpellier como parte dos requisitos para a obtenção do título de Doutor em Engenharia de Alimentos e em Engenharia de Processos, no âmbito do acordo de Cotutela firmado entre a Unicamp e a Université de Montpellier.

**Supervisors/Thesis Directors: Prof. PhD Miriam Dupas Hubinger and Prof. PhD Marie-Pierre Belleville**

Campinas  
2020

Ficha catalográfica  
Universidade Estadual de Campinas  
Biblioteca da Faculdade de Engenharia de Alimentos  
Claudia Aparecida Romano - CRB 8/5816

M359c Marson, Gabriela Vollet, 1991-  
Concentration and fractionation by membranes of spent brewer's yeast protein hydrolysates / Gabriela Vollet Marson. – Campinas, SP : [s.n.], 2020.

Orientadores: Miriam Dupas Hubinger e Marie-Pierre Marcelle Belleville.  
Coorientador: Mariana Teixeira da Costa Machado.

Tese (doutorado) – Universidade Estadual de Campinas, Faculdade de Engenharia de Alimentos.

Em cotutela com: Université de Montpellier (France).

1. Hidrólise enzimática. 2. Ultrafiltração. 3. Peptídeos bioativos. 4. Fracionamento de peptídeo. 5. *Saccharomyces*. I. Hubinger, Miriam Dupas. II. Belleville, Marie-Pierre Marcelle. III. Machado, Mariana Teixeira da Costa. IV. Universidade Estadual de Campinas. Faculdade de Engenharia de Alimentos. VI. Título.

Informações para Biblioteca Digital

**Título em outro idioma:** Concentração e fracionamento por membranas de hidrolisados proteicos de levedura residual cervejeira

**Palavras-chave em inglês:**

Enzymatic hydrolysis

Ultrafiltration

Bioactive peptides

Peptide fractionation

*Saccharomyces*

**Área de concentração:** Engenharia de Alimentos

**Titulação:** Doutora em Engenharia de Alimentos

**Banca examinadora:**

Dominique Chevalier-Lucia

Rénato Froidevaux

Agnes de Paula Scheer

Marco di Luccio

Guilherme Miranda Tavares

**Data de defesa:** 11-09-2020

**Programa de Pós-Graduação:** Engenharia de Alimentos

**Identificação e informações acadêmicas do(a) aluno(a)**

- ORCID do autor: <https://orcid.org/0000-0001-7733-1666>

- Currículo Lattes do autor: <http://lattes.cnpq.br/3909285916318798>

## **ACCEPTANCE LETTER**

Below are the members of the jury of the public dissertation defense session for the title of PhD in Food Engineering and Process Engineering, presented by the student Gabriela VOLLET MARSON at September 11th 2020 at the School of Food Engineering - UNICAMP, in Campinas/SP.

**Prof. PhD Rénato Froidevaux**  
INRAE/Université de Lille

**Prof. PhD Dominique Chevalier-Lucia**  
IATE/Université de Montpellier

**Prof. PhD Agnes de Paula Scheer**  
FEQ/UFPR

**Prof. PhD Marco di Luccio**  
EQA/UFSC

**Prof. PhD Guilherme Miranda Tavares**  
FEA/UNICAMP

Acceptance letter, signed by the members of the jury, as registered in SIGA Thesis Flow System, in FEA post-graduate studies Office (UNICAMP) as well as in ADUM System and GAIA Doctoral School Office (Université de Montpellier).

# Acknowledgements

This work was carried out with the support of the São Paulo Research Foundation (FAPESP) [grant numbers #2016/18465-8 and #2018/04067-6], FAEPEX (UNICAMP) [#2422/16; 519.292], the National Council for Scientific and Technological Development - Brazil (CNPq) and the Committee for Improvement of Higher Education Personnel - Brazil (CAPES) [Financing Code 001].

I would like to thank Prozyn and Novozymes for the kind supply of enzymes; Pedro Moura from Haus Bier Brewing (São José dos Campos, Brazil) and Jérôme Panine from Brasserie la Singulière (Sète, France) for donating spent brewer's yeasts.

I am indebted to my doctoral advisors, Prof. Miriam Dupas Hubinger and Prof. Marie-Pierre Belleville, for all conviviality and for sharing your knowledge with me. This work was also developed with the unlimited support of Prof. Ruann Janser Soares de Castro, Prof. Mariana Teixeira da Costa Machado and Stella Lacour. It has been such a great pleasure to work alongside all of you.

I would like to pay my special regards to all professors and teachers involved in my education; to the whole team of researchers, technicians, professors, students and other workers in the Food Engineering Department and the Laboratory of Food Processing Engineering at UNICAMP and Institut Européen des Membranes; to Armando Silveiro, for his thorough revision of the English wording of my papers; to my colleagues, with whom I have worked during this special period, who have continuously uplifted my days; to my dear friends, who have shared with me all decisive moments; and to all those who have contributed in any way to this work.

I am deeply grateful to my parents, Isabel Cristina and Marco Antonio, who have always encouraged me to study and broaden my knowledge all over the world, who have

trusted my instincts and done their best to give me opportunities that allowed me to follow my dreams. I wish to thank my dear brother, Marco Antonio, who has always inspired me to be a better person and has always given me strength to go further. Finally, my acknowledgements to my godfather, Fernando Henrique, and my godmother, Cléo, who have stimulated my interest in science and my curiosity, believed in my potential and supported my decisions without any hesitation.

To all of you, my endless gratitude.



# Abstract

The valorisation of agro-industrial by-products and the search for alternative sources of protein to produce peptides are of great importance. This work proposes the development of a process enabling the production of fractions rich in bioactive peptides from the by-product from brewing called “spent brewer’s yeast”. The motivation of this subject of research is based on the increasing demand to reuse agro-industrial by-products such as spent yeasts and on the production bioactive peptides using clean and efficient technologies. Spent brewer’s yeast slurry was collected after maturation and was submitted to cell wall disruption methods. Autolysis, glass bead milling and enzymatic hydrolysis using Brauzyn<sup>®</sup> were compared, and enzymatic hydrolysis presented a higher protein recovery and improved antioxidant activity. A simultaneous cell wall disruption and peptide production was proposed using a mixture design employing Brauzyn<sup>®</sup>, Protamex<sup>™</sup> and Alcalase<sup>™</sup> (pH 7.0, 50 °C, 2000 U g<sup>-1</sup> for 2 h), being able to reduce steps during the processing of spent brewer’s yeast. Protein hydrolysates characteristics varied with the proportion of enzymes used, changing the extent of the release of hydrophobic residues, the degree of hydrolysis, antioxidant properties, browning extent and yield of solids and peptides. Membrane separation of the complex protein hydrolysate was studied firstly using polymeric membranes of regenerated cellulose and polyethersulfone and then in ceramic ones. A smaller susceptibility to fouling was observed for more hydrophilic surfaces, and at higher feed pH values. Results confirmed that the main foulants during ultrafiltration of spent brewer’s yeast protein hydrolysate are peptides that adsorb easily onto the membrane surface. Fractionation using ceramic membranes of 50-1 kg mol<sup>-1</sup> of molecular weight

cut-off was able to separate multi-active peptides from total sugars and ribonucleic acids. Spent brewer's yeast peptides presented antioxidant activity by different mechanisms, in vitro anti-diabetic activity (inhibition of  $\alpha$ -glucosidase and  $\alpha$ -amylase) and anti-Alzheimer activity (inhibition of acetylcholinesterase). Sequential processing of spent brewer's yeast using enzymatic and membrane separation technologies was able to recover peptides with multiple bio-activities from an underused by-product from brewing. Fractions produced represent an alternative as peptide-rich ingredients in the food and pharmaceutical industries.

Keywords: Enzymatic proteolysis; yeast hydrolysates; ultrafiltration; peptide fractionation; bioactive peptides; *Saccharomyces* sp.; yeast peptides; biomass.

# Resumé

La valorisation des sous-produits agro-industriels et la recherche de sources alternatives de protéines pour la production de peptides sont d'une grande importance. Ce travail propose le développement d'un procédé capable d'obtenir des fractions riches en peptides bioactifs à partir du sous-produit de brasserie appelé «levure résiduelle de bière». Ces travaux de recherche sont motivés par la nécessité de valorisation des sous-produits agro-industriels et la demande croissante de peptides bioactifs produits par des technologies vertes et efficaces. La suspension de levure résiduelle de bière a été recueillie après maturation puis soumise à différents traitements de rupture de la paroi cellulaire. L'autolyse, le broyage par billes de verre et l'hydrolyse enzymatique utilisant Brauzyn<sup>®</sup> ont été comparés, et l'hydrolyse enzymatique a permis une récupération plus importante des protéines avec une activité antioxydante plus élevée. Une rupture de la paroi cellulaire simultanée à la production de peptides a été proposée grâce à un plan de mélanges en utilisant Brauzyn<sup>®</sup>, Protamex<sup>™</sup> et Alcalase<sup>™</sup> (pH 7,0, 50 °C, 2000 U g<sup>-1</sup> pendant 2 h). Cette procédure a permis de réduire le nombre d'étapes requises pour le traitement des levures résiduelles de bière. Il a été montré que les caractéristiques des hydrolysats obtenus (la quantité de résidus hydrophobes libérés, le degré d'hydrolyse, les propriétés antioxydantes, l'évolution du brunissement et le rendement en solides) sont fonction de la proportion en enzymes utilisées. Le fractionnement par techniques membranaires de l'hydrolysat protéique a d'abord été étudié en utilisant des membranes polymères en cellulose régénérée et en polyéthersulfone, et ensuite avec des membranes céramiques. Les phénomènes de colmatage sont moins importants lorsque les surfaces sont hydrophiles et lorsque la valeur du pH de l'alimentation est élevée. Les résultats

ont confirmé que les principaux éléments colmatants de l'hydrolysate de protéines de levure résiduelle de bière sont les peptides qui s'absorbent facilement à la surface des membranes. Le fractionnement en cascade avec des membranes céramiques de 50 à 1 kg mol<sup>-1</sup> de seuil de coupure a permis de séparer des peptides multi-bioactifs des sucres totaux et des acides ribonucléiques. Les peptides de levure résiduelle de bière ont présenté des activités antioxydantes impliquant différents mécanismes d'action, une activité anti-diabétique (inhibition de l' $\alpha$ -glucosidase et de l' $\alpha$ -amylase) et une activité anti-Alzheimer (inhibition de l'acétylcholinestérase). Le traitement séquentiel de la levure résiduelle de bière couplant des technologies d'hydrolyse enzymatique et les techniques de séparation par membranes a permis de récupérer des peptides ayant de multiples bio-activités à partir d'un résidu sous-utilisé du brassage. Les fractions produites représentent une alternative en tant qu'ingrédients riches en peptides pour des applications en industries alimentaires et pharmaceutiques.

Mots-clés: Hydrolyse enzymatique ; hydrolysats de levure ; ultrafiltration ; fractionnement de peptides ; peptides bio-actifs ; *Saccharomyces* sp. ; peptides de levure ; biomasse.

# Resumo

A valorização de subprodutos agroindustriais e a busca de fontes alternativas de proteínas para a produção de peptídeos são de grande importância. Este trabalho propõe o desenvolvimento de um processo capaz de obter frações ricas em peptídeos bioativos a partir do subproduto da fabricação de cerveja denominado “levedura residual cervejeira”. A motivação deste tema de pesquisa baseia-se na crescente demanda pela reutilização de subprodutos agroindustriais e na produção de peptídeos bioativos usando tecnologias limpas e eficientes. A levedura residual cervejeira foi coletada após a maturação da cerveja e submetida a métodos de rompimento da parede celular. A autólise, a ruptura com esferas de vidro e a hidrólise enzimática usando Brauzyn<sup>®</sup> foram comparadas, e a hidrólise enzimática apresentou maior recuperação de proteínas e maior atividade antioxidante. Um processo para promover simultaneamente a ruptura da parede celular e a produção de peptídeos foi proposto usando um plano de misturas empregando Brauzyn<sup>®</sup>, Protamex<sup>™</sup> e Alcalase<sup>™</sup> (pH 7,0, 50 °C, 2000 U g<sup>-1</sup> por 2 h), reduzindo o número de etapas necessárias para processamento de levedura residual cervejeira. As características dos hidrolisados proteicos foram moduladas pela proporção de enzimas utilizada, alterando a quantidade de resíduos hidrofóbicos liberados, o grau de hidrólise, as propriedades antioxidantes, ao grau de escurecimento e o rendimento de sólidos e peptídeos. A separação por membranas do hidrolisado proteico de composição complexa foi estudada primeiramente utilizando membranas poliméricas de celulose regenerada e poliétersulfona e então com membranas cerâmicas. Observou-se uma menor suscetibilidade à incrustação em superfícies hidrofílicas e para valores de pH da alimentação mais altos. Os resultados confirmaram que os principais compostos do

hidrolisado de proteína de levedura residual cervejeira responsáveis pela incrustação são peptídeos, que se adsorvem facilmente à superfície da membrana. O fracionamento em várias etapas usando membranas cerâmicas de 50 a 1 kg mol<sup>-1</sup> de massa molecular de corte foi capaz de separar peptídeos bioativos dos açúcares totais e dos ácidos ribonucleicos. Os peptídeos de levedura cervejeira apresentaram atividade antioxidante por diferentes mecanismos, atividade antidiabética (inibição da  $\alpha$ -glucosidase e  $\alpha$ -amilase) e atividade anti-Alzheimer (inibição da acetilcolinesterase). O processamento sequencial de levedura residual cervejeira usando hidrólise enzimática e tecnologia de separação por membranas foi capaz de recuperar peptídeos com múltiplas atividades biológicas, de um resíduo subutilizado, proveniente da fabricação de cerveja. As frações produzidas representam uma alternativa como ingredientes ricos em peptídeos para aplicação nas indústrias alimentícia e farmacêutica.

Palavras-chave: Hidrólise enzimática; hidrolisados de levedura; ultrafiltração; fracionamento de peptídeos; peptídeos bioativos; *Saccharomyces* sp.; peptídeos de levedura; biomassa.

# Contents

<b>1</b>	<b>Synthèse des travaux</b>	<b>16</b>
<b>2</b>	<b>Introduction and objectives</b>	<b>21</b>
2.1	Introduction . . . . .	21
2.2	Objectives . . . . .	23
2.2.1	Main objectives . . . . .	23
2.2.2	Specific objectives . . . . .	23
2.3	Thesis structure . . . . .	24
<b>3</b>	<b>Review 1: Spent brewer's yeast</b>	<b>26</b>
<b>4</b>	<b>Review 2: Membrane fractionation of yeast peptides</b>	<b>49</b>
<b>5</b>	<b>Article 1: Rupture of yeast cell wall</b>	<b>68</b>
<b>6</b>	<b>Article 2: Protein hydrolysis</b>	<b>81</b>
<b>7</b>	<b>Article 3: Membrane fouling in polymeric membranes</b>	<b>94</b>
<b>8</b>	<b>Article 4: Peptides fractionation in ceramic membranes</b>	<b>135</b>
<b>9</b>	<b>General Discussion</b>	<b>176</b>
<b>10</b>	<b>General Conclusions and Perspectives</b>	<b>181</b>
10.1	Conclusions . . . . .	181
10.2	Perspectives . . . . .	182

<b>References</b>	<b>184</b>
<b>A Report of performed activities and project progression</b>	<b>187</b>
<b>B Article 5: Microencapsulation</b>	<b>194</b>
<b>Annex – Reprinting permission for published articles</b>	<b>208</b>



# Chapter 1

## Synthèse des travaux

La prise en compte croissante de tous les aspects d'une économie durable et le souci d'améliorer la gestion des ressources naturelles ont orienté l'attention des chercheurs et des industriels vers la valorisation des sous-produits et résidus agro-industriels. Chaque année, d'énormes quantités de résidus organiques sont générées par les industries alimentaires et agro-industrielles. Habituellement, ces sous ou coproduits ont une valeur commerciale faible voire nulle et peuvent parfois représenter un coût pour l'industrie qui doit les éliminer correctement.

Afin d'améliorer la gestion de ces déchets, les scientifiques ont été amenés à développer des stratégies pour réutiliser et ajouter de la valeur à ces sous-produits qui peuvent notamment représenter de nouvelles sources de protéines d'origine non animales (NAYAK et al., 2019). Parmi ces déchets potentiels, la levure de bière résiduelle est un sous-produit peu coûteux, largement disponible et riche en nutriments qui devrait être considérée comme une matière première prometteuse à exploiter (PINTO et al., 2015; FERREIRA et al., 2010).

En effet, l'industrie brassicole est l'une des principales industries des boissons au monde, produisant en permanence de nombreux sous-produits agro-industriels dont la levure résiduelle de bière qui est produite à raison de 1,7 à 2,3 g par litre de bière fabriqué (KUMAR et al., 2016; PINTO et al., 2015; FERREIRA et al., 2010). Actuellement, son utilisation principale reste limitée à l'alimentation animale alors que ce sous-produit est disponible toute l'année et présente une valeur nutritive élevée (VIEIRA et al., 2016; MUSSATTO, 2009). Recueillie sous forme de suspension humide (85-97%), la levure de bière résiduelle est un résidu riche en matière organique, avec une

forte demande chimique en oxygène (DCO) ( $1308 \text{ mg g}^{-1}$ ). Plus de la moitié de sa composition (en matière sèche) correspond à des protéines, mais on trouve aussi des polysaccharides et de plus petites quantités d'acides ribonucléiques (ARN), de cendres, de fibres et de lipides (MATHIAS et al., 2015; MUSSATTO, 2009).

La production d'extraits de levures implique généralement en première étape, la rupture des cellules de levure pour libérer le contenu intra cellulaire. Cela est réalisé généralement par autolyse, par broyage avec des billes de verre et, plus récemment, par hydrolyse enzymatique. Si l'objectif est l'obtention de peptides à partir de levure, une seconde étape d'hydrolyse enzymatique est réalisée. Quelle que soit la stratégie d'extraction et de traitement mise en œuvre, les extraits de levure et les hydrolysats de protéines obtenus contiennent, outre des fractions de protéines et de peptides de tailles et de propriétés physicochimiques (charge, hydrophobicité) différentes, d'autres composés dont la présence peut être problématique.

En effet, l'un des principaux défis liés à l'utilisation de matières premières telles que les levures de bière résiduelles est la teneur élevée en ARN des produits obtenus. Or chez l'homme, l'ARN est métabolisé en acide urique et peut conduire à la formation de calculs rénaux ou à l'apparition de symptômes de la goutte (ABOU-ZEID et al., 1995). Les molécules d'ARN sont généralement extraites en même temps que les protéines (HALÁSZ et al., 1991) et il est nécessaire de prévoir en aval de l'extraction, des étapes de séparation et purification plus ou moins complexes (NAZIR et al., 2019; AMORIM et al., 2016).

Les fractions de protéines et les peptides d'intérêt obtenues doivent présenter un niveau de pureté minimum pour permettre leur utilisation en tant qu'ingrédients ou nutraceutiques (LAMMI et al., 2019; PHONGTHAI et al., 2018). La qualité du produit final dépend de la capacité de la technologie de séparation mise en œuvre, à discriminer les petites différences existantes entre les composés du mélange et ainsi parfaire la séparation (POULIOT et al., 1999). De plus, un autre élément clé de la transformation des sous-produits agro-industriels est le coût des opérations qui doit être minimisé pour assurer la rentabilité du procédé (EMIN et al., 2018). Les techniques de séparation membranaire dont l'ultrafiltration ont été utilisées avec succès pour le fractionnement des molécules de haute valeur ajoutée (molécules bioactives) (BUKUSOGLU et al., 2020). Elles sont économiquement rentables, elles permettent une séparation efficace

avec des rendements élevés et la mise à l'échelle tout comme le nettoyage des équipements sont simples (ROSLAN et al., 2018; XU et al., 2018; SAXENA et al., 2009).

Bien que la valorisation de la levure de bière résiduelle présente des intérêts économiques, environnementaux et technologiques, (développement d'ingrédients innovants pour les industries alimentaires, biotechnologiques et pharmaceutiques, élimination et réduction des déchets permettant la promotion d'une économie durable et la diminution de l'impact environnemental de la production de bière), seules quelques études ont été publiées sur le sujet. Peu d'informations sont disponibles concernant l'hydrolyse enzymatique et le fractionnement membranaire des levures et des sous-produits de levure. Cette thèse vise à étudier et développer un procédé de valorisation de la levure de bière à l'aide de deux technologies efficaces et performantes : l'hydrolyse enzymatique et les techniques de séparation membranaire.

Le présent mémoire est divisé en 10 chapitres dont cette présentation synthétique en français constitue le premier chapitre. Le chapitre 2 présente le contexte et la problématique abordée par la thèse, ses objectifs ainsi que la structure de la thèse. Les chapitres 3 à 8 correspondent à des articles de synthèse ou de résultats publiés ou soumis à des revues scientifiques de rang A dans le domaine de l'ingénierie alimentaire et des procédés. Le chapitre 3 est la reproduction d'un article de synthèse rédigé sur invitation et publié par le «World Journal of Microbiology and Biotechnology» de Springer Nature. Il présente l'importance de la levure de bière résiduelle, ses caractéristiques, ainsi que plusieurs stratégies de transformation visant à augmenter la VA de ce sous-produit de brassage et les applications actuelles et innovantes des produits obtenus. Le chapitre 4 explore les concepts fondamentaux de la technologie de séparation membranaire appliquée à la récupération des peptides des sous-produits agro-industriels et les particularités de la séparation des hydrolysats de protéines de levure. Cet article a été soumis à la revue «Membranes» de Multidisciplinary Digital Publishing Institute (MDPI).

Le chapitre 5 est consacré à l'étude de la rupture de la paroi cellulaire de la levure résiduelle de bière, et compare les performances de méthodes conventionnelles avec l'hydrolyse enzymatique à l'aide d'une préparation enzymatique commerciale appelée Brauzyn<sup>®</sup>. C'est la reproduction d'un article publié dans la revue Elsevier «Process Biochemistry», en 2019. Les conditions de traitement de l'hydrolyse enzymatique ont

été étudiées à l'aide d'un plan d'expériences, qui a mis en évidence que la rupture enzymatique avec Brauzyn<sup>®</sup> est possible à des concentrations en solides élevées, sans dilution du sous-produit, à pH 5,5 et 60 °C. Par rapport aux méthodes conventionnelles (autolyse et broyage avec des billes de verre), la rupture enzymatique des cellules à l'aide de Brauzyn<sup>®</sup> a été plus efficace en termes de rendement et elle permet de conserver l'activité antioxydante de l'extrait de levure obtenu. La production de peptides à partir de l'extrait de levure a été évaluée par protéolyse séquentielle, elle a permis d'améliorer les propriétés antioxydantes des hydrolysats et d'augmenter la récupération des solides, en particulier lorsque l'enzyme Alcalase<sup>™</sup> était utilisée. Des essais ont été réalisés avec plusieurs types de levures de bières et des différences ont été mises en évidence. La paroi cellulaire des levures réutilisées pendant le brassage (repitching) sont plus réfractaires à la rupture de que celles des levures qui n'ont pas été réutilisées. Des changements dans le degré d'hydrolyse, la libération de solides, le degré de brunissement des échantillons et les propriétés antioxydantes ont également été observés pour les différentes enzymes utilisées.

Le couplage des étapes de rupture cellulaire et d'hydrolyse des protéines a été étudié et les résultats, rapportés dans le chapitre 6, ont été aussi publiés dans la revue «Process Biochemistry» d'Elsevier, en 2020. Cette stratégie de réduction des étapes de transformation de la levure résiduelle de bière en peptides a été conduite à l'aide d'un plan de mélanges en utilisant les préparations enzymatiques commerciales Brauzyn<sup>®</sup>, Protamex<sup>™</sup> et Alcalase<sup>™</sup> (pH 7,0, 50 °C, 2000 U g<sup>-1</sup> pendant 2 h). Il a été montré que les caractéristiques des hydrolysats obtenus (la quantité de résidus hydrophobes libérés, le degré d'hydrolyse, les propriétés antioxydantes, l'évolution du brunissement et le rendement en solides et en peptides) variaient selon la proportion d'enzymes utilisées. Le fractionnement de l'hydrolysats de protéines de levure résiduelle de bière a été étudié, à l'échelle laboratoire, dans une cellule de filtration équipée de membranes polymère de cellulose régénérée et de polyethersulfone.

L'étude des mécanismes de colmatage est rapportée dans le chapitre 7, qui a fait l'objet d'un article soumis à la revue «Separation and Purification Technology» d'Elsevier, en 2020. Il a été observé que la rétention des peptides est plus élevée avec la membrane de polyethersulfone à pH 5. A pH 8, l'adsorption des composés protéiques est plus faible et ce, quelle que soit le type de membrane utilisé. Il a été confirmé que les propriétés

morphologiques et physico-chimiques telles que l'hydrophilie et la rugosité des membranes polymères jouent un rôle important dans leur sensibilité au colmatage.

Une étude de fractionnement en cascade à l'aide de membranes céramiques et l'évaluation des propriétés multi-bioactives par rapport à la syndrome métabolique des différentes fractions récupérées ont été réalisées et les résultats obtenus sont présentés dans le chapitre 8, soumis également pour publication à «Separation and Purification Technology» d'Elsevier, en 2020. Les filtrations successives sur des membranes de seuil de coupure allant de 50 à 1 kg mol<sup>-1</sup> ont permis d'améliorer la pureté des fractions de peptides à la fois par rapport à la quantité de sucres totaux ou d'ARN. Il a été possible d'obtenir des fractions enrichies en peptides présentant des caractéristiques différentes tant en termes de distributions de poids moléculaires, de propriétés antioxydantes, de capacité d'inhibition des enzymes impliquées dans la digestion des glucides ( $\alpha$ -amylase et  $\alpha$ -glucosidase) et d'une enzyme impliquée dans le développement de la maladie d'Alzheimer (acétylcholinestérase).

Les chapitres 9 et 10 correspondent à la discussion générale, reprenant les résultats de tous les chapitres précédents et aux conclusions/perspectives de ce travail consacré au traitement de la levure résiduelle de bière.

Les résultats et des connaissances présentés dans ce mémoire indiquent que les processus séquentiels basés sur l'hydrolyse enzymatique et la séparation membranaire sont capables de produire des fractions riches en peptides à partir de levure résiduelle de bière et donc ce sous-produit peut être considéré comme une source alternative de protéines pour la production de peptides. Le procédé développé peut être applicable pour la réutilisation et la transformation d'autres déchets de biomasse ou à base de levure de composition complexe.

L'annexe A résume brièvement toutes les activités annexes effectuées pendant le doctorat. L'annexe B est la reproduction d'une publication publiée au journal d'Elsevier «Food Research International», en 2020 qui concerne des travaux réalisés en parallèle des travaux de thèse. Il s'agit d'une étude dédiée au traitement et à l'application des débris de cellules de levure de bière (qui sont générés lors de la production d'hydrolysats de protéines) comme matériau de paroi innovant pour la micro encapsulation. Enfin, les annexes suivantes concernent les autorisations de réimpression pour les articles publiés.

## Chapter 2

# Introduction and objectives

### 2.1 Introduction

A worldwide concern with the proper management of natural resources and the increasing consideration of all aspects of a sustainable economy has turned the attention to the handling of agro-industrial by-products and residues. Every year, huge amounts of organic residues are generated by the food and agro-industrial industries. Habitually, these materials have a low or no commercial value and sometimes can even represent a cost to the industry to be correctly handled and disposed. This scenario has driven scientists to develop strategies to reuse and add-value to these by-products (NAYAK et al., 2019).

The brewing industry is one of the main beverage industries in the world, continuously producing abundant agro-industrial sub and by-products. The spent brewer's yeast is the second most representative by-product from brewing, produced in the ratio of 1.7 to 2.3 g per litre of beer produced (FERREIRA et al., 2010; KUMAR et al., 2016; PINTO et al., 2015). Currently, its main application is still limited to animal feed even though this by-product is available throughout the year and presents high nutritional value (VIEIRA et al., 2016; MUSSATTO, 2009). Collected from the brewing industry as a moist slurry (85-97%), it is a organic-matter-rich residue, with a high chemical oxygen demand (COD) (1308 mg g<sup>-1</sup>). More than half of its composition (in dry matter) corresponds to proteins, followed by polysaccharides and smaller amounts of ribonucleic acids (RNA), ash, fibres and lipids are found (MATHIAS et al., 2015; MUSSATTO, 2009).

The production of extracts from yeasts commonly involve a first step responsible for the disruption of the yeast cells, releasing all compounds. This is typically done through autolysis, glass bead milling, and more recently, by enzymatic hydrolysis. If the intent is to obtain peptides from yeast, a second processing step to promote protein hydrolysis is envisaged, also done by enzymatic hydrolysis. Independently of the extraction and processing strategy, yeast extracts and protein hydrolysates consist of mixtures of several compounds. Protein fractions and peptides of different sizes and minor differences on their physicochemical properties (charge, hydrophobicity) are generated. Furthermore, one of the main challenges involving the use of yeast-based raw materials besides its very complex composition is the high RNA content, which in humans are metabolised into uric acid and may progress to kidney stones or gout (ABOU-ZEID et al., 1995). RNA molecules are usually extracted with proteins, and the decrease of RNA content of yeast protein hydrolysates is often left to the separation step (HALÁSZ et al., 1991). For all those reasons, complex downstream processing follows yeast extraction (NAZIR et al., 2019; AMORIM et al., 2016).

The quality of the end-product is dependent on a separation technology that is able to discriminate the small differences between the mixture components (POULIOT et al., 1999). Moreover, an efficient and low cost protein separation is a key component on agro-industrial by-products processing (EMIN et al., 2018). Membrane technology has been successfully used for the fractionation of high value molecules because it is cost-effective, enables high product yields, high separation efficiency, simple scale-up and equipment cleaning (ROSLAN et al., 2018; XU et al., 2018; SAXENA et al., 2009). Protein fractions and peptides of interest need to be separated from the other components of a protein hydrolysate and should achieve a minimum purity level that allows its application as an ingredients or nutraceutical (LAMMI et al., 2019; PHONGTHAI et al., 2018). Membrane separation technologies can be considered a solution; ultrafiltration for example, allow the recovery of enriched bioactive fractions after fractionation (BUKUSOGLU et al., 2020).

Many approaches are available to further process potential agroindustrial by-products into value-added products, but great interest on new protein and peptide sources from non-animal origin have been reported (NAYAK et al., 2019). Spent brewer's yeast is a low-cost, widely available and poorly reused by-product of nutrient-rich composition that should be considered as a promising raw material to be exploited (PINTO et al.,

2015; FERREIRA et al., 2010). Valorisation of SBY is of economical, environmental and technological interests, with many possible innovative applications in food, biotechnology and pharmaceutical industries. This would reduce waste disposal, help to promote a sustainable economy and decrease the environmental impact of beer production.

Despite the potential of this by-product, only a few studies are available about the processing technologies able to turn spent brewer's yeast into value-added products and ingredients. Even less information is available concerning enzymatic hydrolysis and membrane fractionation of both yeast materials and yeast by-products. In the extraction sphere, information such as enzyme choice, hydrolysis conditions, particularities involving yeast materials composition during hydrolysis, how to produce protein hydrolysates in a more efficient way and the development of processes adapted to different yeasts, lack in the literature. On the membrane separation domain, very limited information is available on process design, process strategy, factors influencing the separation and on strategies to separate proteins from complex food hydrolysates. This thesis aimed to address all of these gaps, with the focus on the production of bioactive peptides from the spent brewer's yeast by-product.

In this context, this thesis aimed to develop a process and investigate the valorisation of spent brewer's yeast through the recovery of peptides using two very efficient and performing technologies: enzymatic hydrolysis and membrane separation.

## **2.2 Objectives**

### **2.2.1 Main objectives**

The objective of this work was to add-value to spent brewer's yeast by-product, focused on the production of value-added products rich in protein compounds. The potential of the spent brewer's yeast as a novel source of peptides was explored using enzymatic hydrolysis and membrane separation technology.

### **2.2.2 Specific objectives**

- Study the rupture of spent brewer's yeast cells and verify the potential of enzymatic hydrolysis to promote cells disruption;



- Develop an enzymatic method to produce peptides from spent brewer's yeast by-product;
- Study the fractionation of spent brewer's yeast protein hydrolysate using membrane separation technology;
  - Study the concentration and fractionation of spent brewer's yeast protein hydrolysate in laboratory-scale module using polymeric membranes of ultra and nanofiltration, regarding retention of compounds and fouling;
  - Study the multi-stage fractionation of spent brewer's yeast protein hydrolysate in a pseudo tangential laboratory-scale module using ceramic membranes of ultra and nanofiltration for the production of bioactive peptide fractions;
- Study the full valorisation of spent brewer's yeast material, including polysaccharide-rich yeast cell debris, obtained during protein hydrolysate production;

## 2.3 Thesis structure

This PhD thesis is divided in 10 chapters. Chapter 1 includes a synthesis of the thesis in French. Chapter 2 presents the contextualisation and problematic approached by the thesis, its objectives and the presentation of thesis structure.

Chapters 3 to 8 correspond to review or full length articles published or submitted to respected scientific journals on food and processing engineering.

State-of-the-art and review articles on spent brewer's yeast processing and membrane separation technology are presented in Chapter 3 and 4, respectively. Chapter 3 presents the importance of spent brewer's yeast, its characteristics, several processing strategies to add-value to this brewing by-product and current and innovative applications of the products obtained. This article was an invited review published by Springer's "World Journal of Microbiology and Biotechnology". Chapter 4 explores the fundamental concepts involving membrane separation technology applied to the recovery of peptides from agro-industrial by-products and the particularities involving the separation of yeast protein hydrolysates. This review paper was submitted to Multidisciplinary Digital Publishing Institute (MDPI) journal "Membranes".

Chapter 5 presents a study about the rupture of the spent yeast cell wall, that compared conventional methods to enzymatic hydrolysis using commercial enzymes, published in Elsevier's journal "Process Biochemistry", in 2019.

Simultaneous spent brewer's yeast cell disruption and peptide production using enzymatic hydrolysis with the production of an antioxidant protein hydrolysate is the subject of the article published in Elsevier's journal "Process Biochemistry", in 2020, as presented in Chapter 6.

The separation of spent brewer's yeast protein hydrolysate using commercial polymeric membranes and corresponding fouling underlying mechanisms were explored in Chapter 7, that presents an article submitted to Elsevier's "Separation and Purification Technology", in 2020.

A study including spent brewer's yeast peptides fractionation using ceramic membranes and the evaluation of their multi-bioactive properties against the metabolic syndrome were presented in Chapter 8, submitted to Elsevier's "Separation and Purification Technology", in 2020.

Chapters 9 and 10 correspond to the general discussion including results from all previous chapters and conclusions/perspectives on spent brewer's yeast processing, respectively.

Appendix A include a brief report of all performed activities during the PhD.

A full valorisation of spent brewer's yeast material was envisaged during this thesis project, and a processing strategy to apply spent brewer's yeast cell debris (which are generated during protein hydrolysate production) as an innovative carrier material for microencapsulation is presented in Appendix B. This study was published by Elsevier's Journal "Food Research International", 2020.

Annexes present reprinting permissions for published articles.

## Chapter 3

# Review 1: Spent brewer's yeast

**Spent brewer's yeast as a source of high added value molecules: a systematic review  
on its characteristics, processing and potential applications**

Gabriela Vollet Marson<sup>a,b</sup>, Ruann Janser Soares de Castro<sup>c</sup>, Marie-Pierre Belleville<sup>a</sup>,  
Miriam Dupas Hubinger<sup>b</sup>

<sup>a</sup>Institut Européen des Membranes (IEM), Université de Montpellier, CNRS, ENSCM, UM, CC 047, 2,  
Place Eugène Bataillon, 34095, Montpellier, Occitanie, France.

<sup>b</sup>Department of Food Engineering (DEA), School of Food Engineering (FEA), University of Campinas  
(UNICAMP), R. Monteiro Lobato, 80, 13083-862, Campinas, São Paulo, Brazil.

<sup>c</sup>Department of Food Science (DCA), School of Food Engineering (FEA), University of Campinas  
(UNICAMP), R. Monteiro Lobato, 80, 13083-862, Campinas, São Paulo, Brazil.

Results of this chapter were published in the Springer Nature's Journal "World Journal  
of Microbiology and Biotechnology", 36, Article number: 95, 2020.

ISSN: 0959-3993

DOI: <https://doi.org/10.1007/s11274-020-02866-7>



# Spent brewer's yeast as a source of high added value molecules: a systematic review on its characteristics, processing and potential applications

Gabriela Vollet Marson<sup>1,2</sup> · Ruann Janser Soares de Castro<sup>3</sup> · Marie-Pierre Belleville<sup>1</sup> · Miriam Dupas Hubinger<sup>2</sup>

Received: 1 April 2020 / Accepted: 8 June 2020  
© Springer Nature B.V. 2020

## Abstract

Development of new strategies to add-value to agro-industrial by-products are of environmental and economical importance. Innovative and low-cost sources of protein and bioactive peptides have been explored worldwide. Spent brewer's yeast (SBY) is the second most relevant by-product from the brewing industry, and despite its nutritional (about 50% protein, dry weight) and technological potential, it is still underused or needs to be disposed of. SBY cells need to be disrupted to release intracellular and cell wall proteins. This procedure has been performed using autolysis, glass bead milling, enzymatic hydrolysis and ultrasound processing. Enzymatic treatment is usually performed without prior purification and is a challenging process, which involves multiple factors, but has been successfully used as a strategy to add value to agro-industrial by-products. Scope and approach: in this review, we particularly focused on enzymatic hydrolysis as a strategy to promote SBY valorisation, illustrating the state-of-the-art processes used to produce protein extracts from this material as well as exploring fundamental concepts related to the particularities of yeast cell disruption and protein hydrolysis. Furthermore, innovative applications of value-added yeast by-products in food, biotechnological and pharmaceutical industries are presented and discussed. Key findings and conclusions: the discovery of valuable compounds found in spent yeasts as well as the development of new processing methodologies have been widening the possibilities of reuse and transformation of SBY as an ingredient and innovative matrix. Once released, yeast proteins and peptides may be applied as an innovative non-animal protein source or a functional and bioactive ingredient.

**Keywords** Alternative sources of protein · Autolysis · Beer by-products · Enzymatic hydrolysis · *Saccharomyces* sp. · Yeast peptides

## Beer by-products into perspective: general aspects

Beer is one of the most consumed beverages in the world, with a global production of approximately 1.9 billion hL in 2018. The world's beer market is growing slowly (about 1.4% in 2018), mostly represented by an increase in consumption reported in China. China, Europe and America play an important role in both production and consumption of beer. Brazil is one of the world's largest beer producers and consumers, representing the third world's largest beer

market (Ziener and McNally 2019). According to the World Health Organization (2014), in 2010, beer represented 60% of Brazil's alcohol consumption.

Beer is a beverage consisting essentially of barley malt, water, hops and yeasts. Barley might be partially replaced with unmalted cereals such as corn, rice, wheat, oats or sorghum, called adjuncts. This procedure is adopted because of either economic reasons (as in the case of corn) or the intention to produce beers with distinctive organoleptic characteristics (such as wheat, necessary in Weiss-type beers) (Ambrosi et al. 2014; Mussatto 2009).

Briefly, the brewing process is made up of 10 steps. Figure 1 shows a general scheme of the brewing process and the steps in which the main by-products are formed (Mussatto 2009). During milling, malt is ground to make its particles accessible to water. Next, mashing and lautering are

✉ Gabriela Vollet Marson  
gabriela.vollet@gmail.com

Extended author information available on the last page of the article

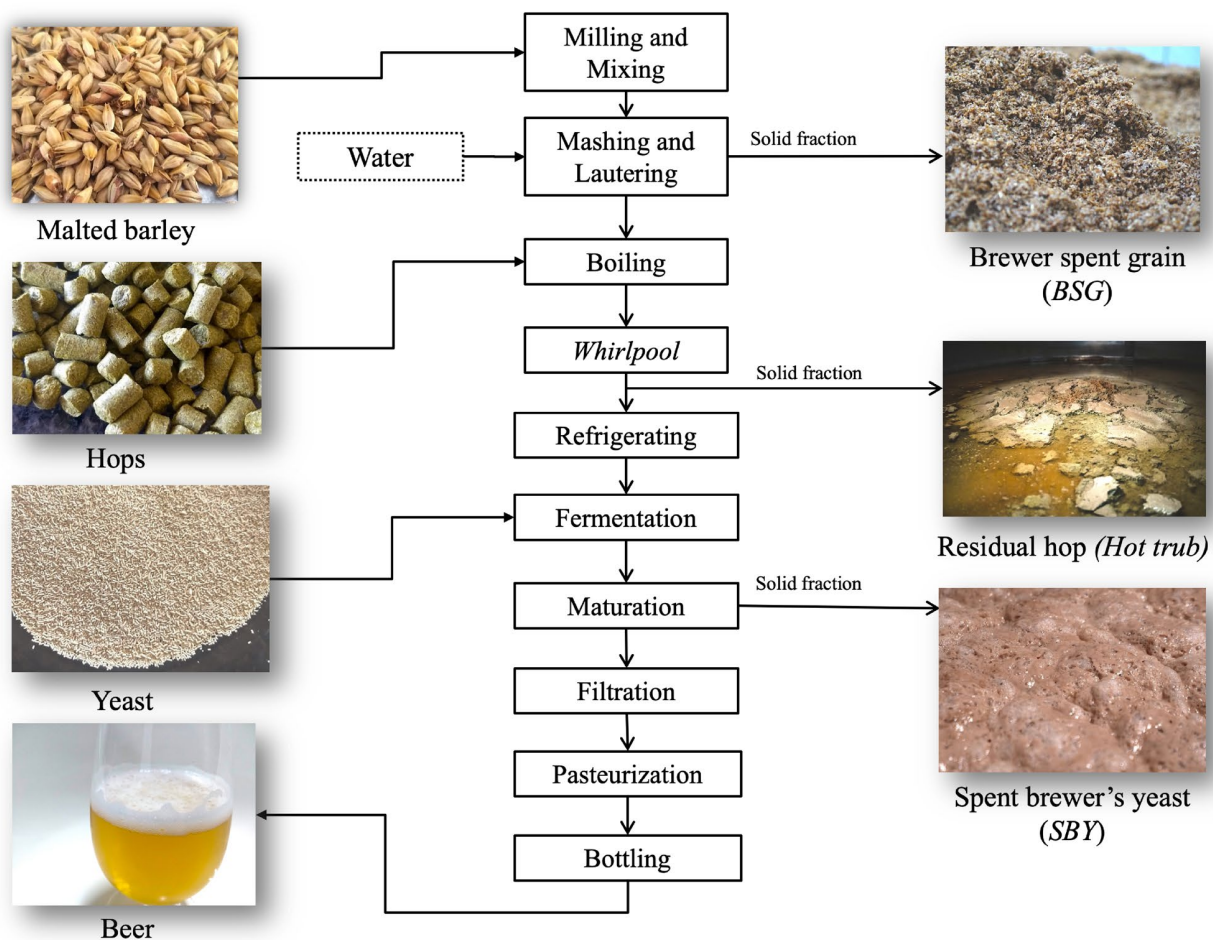

Fig. 1 Schematic representation of beer processing and main by-products generated. Adapted from Mussatto (2009)

performed when water is heated (78 °C), activating endogenous malt enzymes. These enzymes start the process of hydrolysis, particularly that of complex carbohydrates. Grain husks form a natural filtration bed that promotes the separation of wort from solids. Finally, to complete the extraction of sugars, the grains are washed with hot water (78 °C) until the filtrate has about 2% solid concentration, resulting in the brewer's wort. At this stage, the solid by-product *brewers' spent grain* (BSG) is generated, and it is the largest amount of waste generated from beer processing (140–200 g L<sup>-1</sup>). Then, the boiling step begins; the wort is boiled for a period of approximately 90 min and the hops are added. During this step, the wort is concentrated and sterilized, the enzymes are inactivated, the hop compounds are extracted and some proteins coagulate. In the *whirlpool* stage, some aggregated proteins, hops and other solids are separated. In this phase, residual hops (*hot trub*) are formed in a ratio of 1 to 4 g L<sup>-1</sup>. The wort is then cooled down to prevent oxidation when fermentation conditions are reached and yeasts are added, which initiates the fermentation process. Sugars are

converted to ethyl alcohol and carbon dioxide and several other secondary compounds are produced. This step usually takes 3 to 15 days to be completed, depending on beer type. Some of the yeasts and other particles settle at the bottom of the fermentation tank or float to the surface, forming the second largest residue produced, the spent brewer's yeast (SBY) in the ratio of 1.7 to 2.3 g L<sup>-1</sup> (Ferreira et al. 2010; Kumar and Chandrasekaran 2016; Pinto et al. 2015). Finally, the "green" beer goes on to maturation. This step occurs at low temperatures, allowing flavour development and insolubilisation/deposition of proteins and polyphenols. Turbidity precursors are separated from the raw beer, which is then filtered, pasteurized and bottled (Mathias et al. 2015; Ambrosi et al. 2014; Huang et al. 2012).

Among the three by-products, BSG is the most abundant side stream from the brewing industry. Most of the spent grain generated is reused either as animal feed, compost, fertiliser or sent to landfills. This by-product is rich in polysaccharides, is considered as a source of fermentable sugars, and contains a higher amount of proteins than many similar

agro-industrial residues. Therefore, it is a potential ingredient for protein production (Ravindran et al. 2019; Qin et al. 2018). Indeed, a number of studies have investigated more efficient protein recovery methods from BSG and a number of applications have been reported, such as value-added protein-rich and carbohydrates-rich ingredients (Qin et al. 2018). Recently, the vermicomposting of BSG by *Eisenia fetida* was studied in order to convert this residue into a soil conditioner (Budroni et al. 2020; Saba et al. 2019). On the other hand, SBY and hot trub are still mostly underutilized or discarded because there are limited processes available that can handle their higher complexity and particularities. There is an unexplored potential to find new applications to them, which could reduce the disposal amount of such by-products, thus decreasing their environmental impact. Transforming them into value-added ingredients depends on the development of insightful, sustainable and economically-viable processing technologies that take into account their characteristics and constraints.

Although recycling of brewing yeasts in a new fermentation cycle (in a process known as “repitching”) is a common practice, the number of reuses is limited to maintain beverage quality. Excessive repitching can result in negative effects on fermentation performance and on sensorial profile, accumulation of haze-causing substances and undesirable secondary fermentation compounds. The number of times a specific culture can be repitched depends on the brewing fitness of the yeast population: their physiological state and

fermentation performance in the previously defined brewing conditions. Measurement of yeast viability before fermentation can be checked to determine if further repitching is advised (Kalayu 2019). Even when repitching practices are performed, a great amount of SBY (a low-value brewing by-product with high organic load) is produced.

SBY is a low-cost, poorly reused by-product of nutrient-rich composition available in large amounts that could be used in more noble applications. This would reduce waste disposal, help to promote a sustainable economy and decrease the environmental impact of beer production. Thus, the aim of this review is to present the up-to-date applications for SBY and the related processing technologies that could turn SBY into value-added products and ingredients.

## Potential of spent yeast as an alternative source of protein

### Nutritional composition

SBY slurry is a moist (85–97%), organic-matter-rich residue, with a high chemical oxygen demand (COD, 1308 mg g<sup>-1</sup>) (Mathias et al. 2015). The final pH value of SBY is approximately 5.9 i.e., it is higher than the pH value of beer (between 4.2 and 4.5) (Mathias et al. 2015). Table 1 shows the ranges of macronutrients of both non-treated SBY (collected from the brewing industry) and yeast

**Table 1** Macronutrient composition in non-treated and yeast extracts of spent brewer's yeast (SBY) produced by mechanical rupture [ultrasound (US) and glass bead milling], autolysis and enzymatic hydrolysis

Macronutrients (g 100 g <sup>-1</sup> , d.w.)	SBY slurry/biomass non-treated <sup>A</sup>	SBY obtained by mechanical rupture (US and glass beads) <sup>B</sup>	SBY autolysate <sup>C</sup>	SBY enzymatic hydrolysate <sup>D</sup>
Total nitrogen	7.3–10.5	7.0–14.2	3.1–6.8	1.5–12.0
Protein nitrogen	41–49	43–78	18–45	9.3–69.0
Free amino nitrogen	0.2–0.4	2.6–16.5	3.8–45.1	28–35
Ribonucleic acids	1.9–7.5	2.2–7.5	4.0–8.0	5.6
Total sugars	22–54	8.3–51.7	12.3–48.0	3.0–48
Fibers	6.6–36.2	3.1–12.2	nd	nd
Insoluble fibers	< 2.6	0.5–2.6	nd	nd
Soluble fibers	< 9.6	2.7–9.6	nd	nd
Lipids	< 3.9	0.02–6.5	0.5–1.3	0.2–1.0
Ashes	1.7–8.5	0.2–14.0	13	3.0–22.0

All composition data are expressed in dry weight (d.w.). Because protein content is determined using various analytical techniques and calculations, we presented only protein nitrogen data (considering original conversion factors) and the corresponding total nitrogen content. The use of yeast extract as a growth medium or a flavouring ingredient needs a precise differentiation between free and bound amino acids; thus, free amino content was included. References: <sup>A</sup>Marson et al. (2020), Marson et al. (2019), Bertolo et al. (2019), Pinto et al. (2015), Mathias et al. (2015), Vieira et al. (2013), Kanauchi et al. (2005), and Caballero-Córdoba and Sgarbieri (2000); <sup>B</sup>Jacob et al. (2019c), Bertolo et al. (2019), Vieira et al. (2016b), Vieira et al. (2016a), Pancrazio et al. (2016), Vieira et al. (2013), Caballero-Córdoba and Sgarbieri (2000), Caballero-Córdoba et al. (1997) and Pacheco et al. (1997); <sup>C</sup>Bertolo et al. (2019), Jacob et al. (2019c), Vieira et al. (2013) and Tangüler and Erten (2008); <sup>D</sup>Marson et al. (2020), Marson et al. (2019), Podpora et al. (2016), Amorim et al. (2016a) and Chae et al. (2001)

nd not determined

extracts, obtained after processing. SBY is rich in carbohydrates and proteins (40–50% dry weight, each) with lower amounts of ash, fibers, ribonucleic acids (RNAs) and lipids (Mathias et al. 2015; Mussatto 2009; Caballero-Córdoba and Sgarbieri 2000). After processing, protein, ash and free amino nitrogen contents are usually increased.

Tables 2 and 3, respectively, show the amino acid profile and the detailed content of vitamins and minerals of the yeast extracts. Spent yeast from brewing processes is reported as an excellent source of proteins with high biological value proteins with a well-balanced amino acids profile that meets Food and Agriculture Organization of the United Nations (FAO) and World Health Organization (WHO) recommendations (Jacob et al. 2019a). In SBY, acidic amino acids (glutamic acid and aspartic acid) and the essential amino acids leucine and lysine are the most abundant, while sulfur-containing amino acids, such as methionine and cysteine, are the least (Jung et al. 2012, 2011; Lee et al. 2009; Pacheco et al. 1997; Halász and Lásztity 1991b). Amino acid composition may vary greatly with processing (Table 2). Spent yeasts contain significant amounts of tyramine, a derivative of tyrosine metabolism (Jach et al. 2015). With a high

**Table 2** Amino acid profile of spent brewer's yeast (SBY) extracts

Amino acids [g (100 g <sub>protein</sub> ) <sup>-1</sup> , d.w.]	SBY extract
Alanine	4.2–26.6
Arginine	0.3–11.3
Aspartic acid	4.1–11.6
Cysteine	0.3–0.7
Glutamic acid	0.6–15
Asparagine	4.9–12
Glutamine	7.7–18.0
Glycine	2.9–4.9
Histidine	1.3–7.3
Isoleucine	2.8–5.6
Leucine	4.1–8.8
Lysine	4.1–8.8
Methionine	0.9–2.5
Phenylalanine	2.5–5.3
Proline	2.8–4.5
Serine	2.8–6.1
Threonine	0.2–6.2
Tyrosine	0.4–4.7
Valine	0.7–6.2
Tryptophan	0.7–1.4

References: Podpora et al. (2016), Amorim et al. (2016a), Chae et al. (2001), Caballero-Córdoba and Sgarbieri (2000), Caballero-Córdoba et al. (1997) and Pacheco et al. (1997)

**Table 3** Micronutrient compositions of spent brewer's yeast (SBY) extracts: mineral and vitamin content ranges

Micronutrients [mg (100 g) <sup>-1</sup> , d.w.]	SBY extract
<b>Minerals</b>	
Phosphorus (P)	1.0–3214
Potassium (K)	0.7–9148
Calcium (Ca)	0.4–27.1
Magnesium (Mg)	0.2–696
Sodium (Na)	0.5–1228
Iron (Fe)	0.1–12.0
Manganese (Mn)	0.6–15.9
Aluminium (Al)	0.5–1.0
Chromium (Cr)	0.01–9.6
Cobalt (Co)	0.03–0.07
Molybdenum (Mo)	< 0.003
Zinc (Zn)	4.6–22.6
Copper (Cu)	0.4–7.8
Selenium (Se)	0.03–24.2
Lead (Pb)	9.7
Nickel (Ni)	7.2
Lithium (Li)	5.9
Vanadium (V)	0.6
Cadmium (Cd)	0.3
Silicon (Si)	90–118
Boron (B)	0.5–0.6
Barium (Ba)	0.3
Strontium (Sr)	1.0–1.1
<b>Vitamins</b>	
Thiamine (B1)	5.2–7.1
Riboflavin (B2)	1.2–2.4
Nicotinic acid (B3)	68–104
Panthenic acid (B5)	15.7–20.3
Pyridoxine (B6)	3.1–55.1
Biotin (B7)	114–139
Folic acid (B9)	1.4–5.0
Cobalamin (B12)	0.12–0.33

References: Jacob et al. (2019c), Vieira et al. (2016b), Amorim et al. (2016a) and Caballero-Córdoba et al. (1997)

mineral content (up to 8.5%, d.w.), SBY contains relevant amounts of zinc and selenium with magnesium, potassium and phosphorus being the most abundant. Complex B vitamins are also present in important quantities (Huige 2006; Lewis and Young 2001). Less than 4% of yeast composition consists of lipids. Saturated fatty acids account for more than half of the lipidic composition of SBY, followed by mono-unsaturated and then polyunsaturated fatty acids (Caballero-Córdoba et al. 1997).

Chemical and nutritional composition of SBY is affected by its biodiversity: strain, operating conditions (of fermentation and the overall beer processing), how many times the

yeast is reutilized (repitching), when it is collected and how the yeast extract is produced. The main yeast strains used for beer production are *Saccharomyces cerevisiae* and *Saccharomyces pastorianus*, but several non-*Saccharomyces* strains are also available. Recently, Jacob et al. (2019b) reported that the composition of yeast extracts was affected by different yeast strains (*S. cerevisiae*, *S. pastorianus*, *Saccharomycodes ludwigii*, *Saccharomycopsis fibuligera*, *Brettanomyces bruxellensis* and *Torulaspora delbrueckii*) for beers produced under the same conditions. Antioxidant properties were also dependent on which spent yeast was used in the brewing process. The influence of yeast strain on other biological or functional properties was not reported. Other recent studies assessed the effect of repitching, yeast strain and rupturing/extraction methods on final product composition (Marson et al. 2019; Mathias et al. 2015; Vieira et al. 2013). Therefore, the manufacturing industry needs to be robust enough to be able to take into account all these variations that are inherent in the brewing process (Jacob et al. 2019b; Marson et al. 2019).

Spent yeasts from alcohol distilleries (*S. cerevisiae*) can also be a potential by-product to process since they are also produced in large quantities in Brazil and in other ethanol-producing countries. They have a very similar overall composition but with higher RNA, ash and lipid contents. Those differences are due to the strain and fermentation conditions in use, which are different from those of brewing (Steckelberg et al. 2013; Yamada et al. 2010).

### Challenges facing yeast-products processing

*Saccharomyces cerevisiae* extracts, including SBY, are considered safe (generally recognized as safe, GRAS; Jung et al. 2010; Chae et al. 2001). However, toxicity of yeast extracts and products depends on the method of protein extraction and processing. Some evidence of liver toxicity has been found for a yeast protein concentrate prepared with sodium perchlorate (Caballero-Córdoba and Sgarbieri 2000). On the other hand, yeast hydrolysate obtained from cultivated *S. cerevisiae* IFO 2346 cells hydrolysed with bromelain was investigated as a supplement for rats, but it showed no evidence of toxicity. Previous research has been conducted on both acute (single oral dose of 5000 mg kg<sup>-1</sup>) and subacute (dose of 1000 mg kg<sup>-1</sup> day<sup>-1</sup>, for 14 days) toxicity of yeast hydrolysate samples with molecular weight fractions of 10–30 kg mol<sup>-1</sup> (Jung et al. 2010). Vieira et al. (2016c) also reported no cytotoxic effects of SBY autolysates after exposure in Caco-2 cells, in a concentration range of 0.5–3.0 mg<sub>peptides</sub> mL<sup>-1</sup>. Chronic toxicity studies are still needed to evaluate further effects.

Some studies on the virulence of *S. cerevisiae* reported that, in high-risk immuno-compromised or critically ill patients (in intensive care, with intravascular catheters and in

previous antibiotic therapy), some strains have the ability to translocate across the gastrointestinal mucosa and progress to an infection (Enache-Angoulvant and Hennequin 2005). Although invasive *Saccharomyces* sp. infections remain rare, workers that handle viable yeast cells (winemakers, bakers, pharmaceutical industry workers, researchers, etc.) should follow proper hygiene practices (Posteraro et al. 2018). In processed yeast products, after cell disruption or degradation, cells are not viable anymore, and the risk of opportunistic infection does not exist.

The inclusion of yeast in food products is usually limited by the high amount of nucleic acids (7–12% dry weight) present, mainly ribonucleic acid, which in humans is metabolized to uric acid and may progress to kidney stones or gout (Rajendran 2012; Huige 2006; Caballero-Córdoba and Sgarbieri 2000; Halász and Lásztity 1991b). The total content of nucleic acids in yeast products should be reduced to a final concentration of 1–3% (dry weight) before they can be used without the risk of increasing uric acid levels in blood and tissues in humans (Abou-Zeid et al. 1995). Nucleic acid content is higher when protein content and yeast growth rate are higher (Mathias et al. 2015; Vieira et al. 2013). In this context, processing is of great importance. After processing, nucleic acid content can be reduced by the action of enzymes, precipitation or formation of complexes with other molecules (Halász and Lásztity 1991b). Also, after hydrolysis by RNases, RNA can be converted into flavouring molecules (Ferreira et al. 2010; Tangüler and Erten 2008; Huige 2006; Halász and Lásztity 1991b). Other processes, such as fractionation and purification by membranes or chromatography techniques, can promote the reduction and separation of nucleic acids from the protein-rich fraction (Marson et al. 2020).

### Processing of SBY

SBY is essentially constituted of yeast cells. It is a perishable by-product that requires proper hygiene standards and practices during brewing, as well as handling and storage prior to yeast extract production. Contamination of spent yeasts by bacteria or other microorganisms has been reported (Barrette et al. 1999). The first step in yeast processing is to stabilize the material (Marson et al. 2020). Thermal treatments are the most commonly used, even though they might cause up to 58% losses in vitamin B2 content and 23% losses in vitamin B1 content, depending on heating conditions (Varga and Maráz 2002).

In addition to high nucleic acid content, which limits the use of yeast as food, yeast cells may also have low digestibility and a bitter taste when not processed. The thick cell walls of yeasts are resistant to digestive enzymes (Vilela et al. 2000). Such cell walls give yeast physical protection



and elasticity, allowing SBY cells to maintain their shape. The cell wall consists predominantly of polysaccharides (85%, dry weight) and proteins (5 to 15%, dry weight) (Harrison 2011; Halász and Lásztity 1991b). Mannoproteins are glycosylated proteins found in the yeast cell wall, being responsible for the permeability and porosity of the cell, while  $\beta$ -glucans and chitin promote its mechanical rigidity (Paramera et al. 2014). Although glucose and mannose are the major components of the polysaccharide fraction, *N*-acetyl glucosamine is also found in small amounts (Halász and Lásztity 1991b). Thus, cell disruption is essential for the extraction of intracellular components and the proteins of the cell wall itself (Middelberg 1995).

Because spent yeasts from brewing have a bitter aroma when commercially produced as an extract or ingredient in foods, they can be subjected to a pretreatment called “debittering” to remove unwanted resins and tannins (In et al. 2005; Nand 1987) such as humulones and isohumulones (Shotipruk et al. 2005). These compounds, originally present in hops, are adsorbed on the yeast cell wall surface during fermentation and are responsible for the intense bitter taste of SBY products (Shotipruk et al. 2005; Nand 1987). The “debittering” process can be performed through successive washes with basic solutions, solvents or using adsorbents (In et al. 2005; Reed and Nagodawithana 1991; Nand 1987). The production of yeast extracts needs to overcome three major obstacles, namely yeast cell wall strength, which prevents yeast compounds from being released and transformed, as well as the high nucleic acid content and the bitter aroma of yeasts, all of which limit their application as ingredients. Spent yeast processing needs to handle those particular characteristics of yeast while creating a final ingredient that presents suitable technological, nutritional, functional, bioactive and sensorial properties. The next sections present processing technologies developed to disrupt the yeast cell wall and to produce yeast protein hydrolysates. The release of yeast compounds results in a complex pool of molecules of interest that need to be separated from the other compounds to ensure their specific application purpose.

### Disruption of the yeast cell wall by physical and chemical methods

Disruption of the cell wall can occur through physical, chemical and enzymatic methods. Depending on the method of choice, there is a considerable impact on amino acid composition and yeast extract quality (Jacob et al. 2019a; Marson et al. 2019).

In physical processes, the destruction of the wall structure is carried out in a non-specific manner, involving, for example, agitation with glass beads, cavitation by high pressure or ultrasound and thermolysis (Jacob et al. 2019a; Liu et al. 2016, 2013; Harrison 2011; Middelberg 1995). Because of

the amount of friction that is created during these processes, energy is greatly spent to keep the product temperature from rising (Asenjo and Dunnill 1981). The most common method involves glass bead agitation, sometimes referred to as milling. It allows to maintain the characteristics of the yeast intracellular components (including enzymes) stable if the temperature is kept low. Also, the process can be scaled up (Halász and Lásztity 1991a). The ultrasound technique, despite its effectiveness, still requires a large amount of energy, usually for a long period of time, which leads to the formation of high temperature outbursts. Molecules of interest might be deteriorated as a result of the formation of free radicals and other unsought chemical changes (Yusaf and Al-Juboori 2014; Bzducha-Wróbel et al. 2014).

Chemical disruption is performed using bases, acids, surfactants, detergents and solvents (Suwanapong et al. 2013; Harrison 2011; Middelberg 1995). Chemical methods act by permeabilizing chemical compounds from outside the cell wall, which allows intracellular products to pass through it. These methods can have great complexity during operation, limited potential for scaling up, low efficiency and low economic viability. In addition, chemical treatments can degrade compounds with biological properties and even introduce contaminants into the system, resulting in difficulties and the need for further processing steps (Liu et al. 2016).

### Disruption of the yeast cell wall by enzymatic hydrolysis

Enzymatic processes occur in a predominantly targeted way (Middelberg 1995). Yeast autolysis, widely used by the industry to produce yeast extract, is classified as an enzymatic method, even though it is induced by adding chemicals or changing the temperature. Solvents (e.g. ethyl acetate) and salts (NaCl) are often added to increase efficiency. In autolysis, endogenous yeast enzymes are activated and degrade the cell wall from the inside out, causing rupture (Middelberg 1995). In a recent study that compared three processes in the disruption of SBY cells, autolysis was the most effective (98% of nitrogen released from the cells) (Jacob et al. 2019a). However, this process is not yet deeply understood and poorly controlled and the autolytic properties of the strain are decisive and can make the autolysis process non-viable (Jacob et al. 2019a; Marson et al. 2019; Bzducha-Wróbel et al. 2014). The addition of exogenous enzymes (mainly proteases) is also an option, as it releases components from the wall in a more controlled and efficient manner and the process can be easily scaled up (Bzducha-Wróbel et al. 2014; Halász and Lásztity 1991b; Asenjo and Dunnill 1981). Long hours of autolysis often result in losses of important components (e.g., antioxidants, polyphenols and vitamins)

(Jacob et al. 2019c). Smaller concentrations of glutamic acid in autolysates (in comparison to mechanical disruption methods) have been reported recently. It can be hypothesised that glutamic acid takes part in a reaction catalysed by the enzyme glutamate decarboxylase, which is naturally present in yeast. As a result, a neuroactive compound known as  $\gamma$ -aminobutyric acid (GABA; Jacob et al. 2019a) is produced. In this case, losses in glutamic acid are advantageous because GABA can be applied in the pharmaceutical industry.

The disruption of yeast cell walls by enzymatic hydrolysis can be performed with different objectives involving carbohydrases, RNAses and mainly, proteases. Proteolytic hydrolysis is the most efficient method of solubilising, exposing and releasing yeast peptides (Marson et al. 2019; Chae et al. 2001), and this technology is widely used to improve and increase the functional, biological and nutritional properties of food proteins in various matrices (Phongthai et al. 2018; de Castro and Sato 2014; Yuan et al. 2008).

Enzymatic hydrolysis has been used independently or combined with traditional methods such as autolysis and mechanical rupture. Amorim et al. (2016a), for example, used autolysis, hydrolysis with a *Cynara cardunculus* extract as well as series of ultra and nanofiltration to obtain SBY yeast ingredients with different characteristics while Marson et al. (2020) developed a process, using commercial enzymes, to disrupt and hydrolyse yeast protein simultaneously. Proteolytic hydrolysis may not only disrupt the cell wall, causing the release of compounds, but also modify the existing proteins. Solubilization and modification of compounds inside and on the cell wall can be performed during or after cell wall disintegration.

The characteristics of the peptides released by the enzymatic treatment vary with the specificity and type of enzyme (Phongthai et al. 2018; de la Hoz et al. 2014), and the effectiveness of hydrolysis depends directly on the composition of the matrix to be hydrolysed and on the process variables (de Castro and Sato 2015). Optimization and development of the protein hydrolysis of yeast and yeast by-products has been performed for different purposes and using several strategies. Tables 4, 5 and 6 show the treatments and processing conditions used in the cell wall rupture, and in the release and modification of the biochemical components of yeasts. Every hydrolysis process was specially developed: to produce yeast extracts for nutritional purposes (Jacob et al. 2019a, c; Amorim et al. 2016b; Tangüler and Erten 2008); to promote the release of flavour-related 5'-nucleotides (Xie et al. 2017; Cui et al. 2016; Chae et al. 2001); to release peptides with ACE-I activity (Amorim et al. 2019b; Vieira et al. 2017a; Mirzaei et al. 2015; Kanauchi et al. 2005), antioxidant activity (Marson et al. 2020, 2019; Podpora et al. 2016), iron-chelating ability (de la Hoz et al. 2014); or to release specific peptide sequences (Jung et al. 2011).

For SBY, a yield of 5% of peptides with angiotensin-converting enzyme inhibitory activity (ACE-I) was reported after hydrolysis with Alcalase<sup>TM</sup> and subsequent purification (Kanauchi et al. 2005). In another study, Alcalase<sup>TM</sup>, Neutrase, Protamex<sup>TM</sup>, Flavourzyme<sup>TM</sup> and ficin were used to release a peptide (*Cyclo-His-Pro*) from SBY. The hydrolysate obtained from Flavourzyme<sup>TM</sup>, an enzyme with exo and endoprotease activities, showed the highest recovery of the peptide analysed in a previous study ( $674.0 \mu\text{g g}^{-1}$ ) (Jung et al. 2011). Chae et al. (2001) reported the use of Protamex<sup>TM</sup> and two enzymes with exo and endoprotease activities, Flavourzyme<sup>TM</sup> and Protein FN, to obtain yeast extract. The authors found that the dosage of exoprotease affected protein recovery, the degree of hydrolysis and sensorial characteristics to a greater extent than the dosage of endoprotease. The combined treatment of Protamex<sup>TM</sup> and Flavourzyme<sup>TM</sup> resulted in the greatest recovery of solids (50%) (Chae et al. 2001). Alcalase<sup>TM</sup> and Protex 51FP were used to hydrolyse residual yeast from sugarcane processing. Using Alcalase<sup>TM</sup> resulted in extracts with a higher degree of hydrolysis (de la Hoz et al. 2014). As for the hydrolysis of cultivated cells of *S. cerevisiae*, bromelain (Kim et al. 2009, 2004; Yu et al. 2002) is normally used.

Thus, so far, Alcalase<sup>TM</sup>, Protamex<sup>TM</sup> and Flavourzyme<sup>TM</sup> were the enzymes that obtained the highest yield and the greatest functional or biological activity for SBY during hydrolysis, as reported in recently published studies (Marson et al. 2020, 2019; de la Hoz et al. 2014; Jung et al. 2011). Alcalase<sup>TM</sup> is a serine endoprotease, while the last two are mixtures of endo and exoproteases. The pH value of action of the enzymes usually ranges from 5.0 to 8.0. The adequate temperature range of the enzymes is quite wide, with maximum activity achieved at temperatures of 40–60 °C (Nielsen and Olsen 2002). Indeed, these and other enzymes specially designed for yeast were tested for the proteolytic hydrolysis of SBY, and these tests showed different characteristics for them (Marson et al. 2020, 2019). A recent study has reported the production of an antioxidant SBY enzymatic hydrolysate with an optimised mixture of enzymes using a mixture design. It indicated synergistic effects of the simultaneous use of Brauzyn<sup>®</sup>, Protamex<sup>TM</sup> and Alcalase<sup>TM</sup> (Marson et al. 2020). A response surface methodology was used to maximize the production of ACE-I peptides from SBY using the *C. cardunculus* extract (Amorim et al. 2019b).

After enzymatic treatments are performed, broken yeast cells are separated by centrifugation, which results in two fractions (Lobo-Alfonso et al. 2010). Often referred to as yeast extract, the soluble fraction consists of yeast cell compounds, which can be processed in subsequent steps for the purpose of concentration, purification and fractionation, depending on the application intended for the ingredient (Nagodawithana et al. 2010). A yeast extract usually presents a reduced content of nucleic acids and polysaccharides,

**Table 4** Treatments and conditions used for solubilization of components and rupture of yeast cell wall: Part 1

Substrate	Treatment	[S] (%)	Enzyme	E:S (%)	T (°C)	pH	t (h)	Obs.	Inactivation	Centrifugation	DH (%)	References
Commercially dried yeast	Enzymatic hydrolysis	10 to 40	Papain	0.5	55	-	3 - 34	1% added NaCl	100 °C/20 min	8000 × g for 20 min at 4 °C	10-37	Cui et al. (2016)
Baker's yeast	Enzymatic hydrolysis	18 and 28	Papain, Alcalase <sup>TM</sup>	0.1	55	-	6-48	100 rpm	95 °C/15 min	10,000 × g for 25 min °C	5-55 ± 0.6	Xie et al. (2017)
SBY ( <i>S. pastorianus</i> ) reused 3 to 6 times	Debittering, mechanical rupture using glass beads	-	-	-	-	-	-	-	-	11,000 × g for 30 min at 4 °C	-	Vieira et al. (2013, 2016b)
SBY ( <i>S. pastorianus</i> )	Mechanical rupture using glass beads and autolysis (200 rpm, 20-50 °C, 1-7 h)	-	-	-	-	-	-	-	90 °C/15 min	10,000 × g/10 min	-	Vieira et al. (2017a)
SBY	Debittering and enzymatic hydrolysis	-	Alcalase <sup>TM</sup>	-	50	7.5-8.5	12	-	-	10,000 × g/20 min at 4 °C	-	Kanauchi et al. (2005)
SBY	Enzymatic hydrolysis	8	Neutrase, Alcalase <sup>TM</sup> , Protamex <sup>TM</sup> , Flavourzyme <sup>TM</sup> , Ficin	1	50	7.0-8.0	48	-	90 °C/5 min	10,000 × g/20 min	-	Jung et al. (2011)

All spaces marked with “-” indicate that these data were not disclosed in the original papers

SBY spent brewer's yeast, [S] substrate concentration in (m/m), E:S enzyme:substrate ratio (considering protein content), in (m/m), T temperature of treatment, t duration of treatment, Obs. relevant observations related to the treatment, Inactivation conditions of enzyme inactivation, Centrifugation centrifugation conditions of the treated materials, DH degree of hydrolysis

<sup>A</sup>Percentage defined while considering the solids content

**Table 5** Treatments and conditions used for solubilization of components and rupture of yeast cell wall: Part 2

Substrate	Treatment	[S] (%)	Enzyme	E:S (%)	T (°C)	pH	t (h)	Obs.	Inactivation	Centrifugation	DH (%)	References
Dried cells of <i>SBY</i> ( <i>Saccharomyces</i> sp.)	Thermal treatment (pH 6.5, 95 °C/5 min) and enzymatic hydrolysis	20 <sup>A</sup>	Flavourzyme™ and Protamex™	0.6 e 2.0	50	6.5	12	200 rpm	95 °C/5 min	10,000 × g/20 min at 4 °C	40–60	Chae et al. (2001)
<i>SBY</i> ( <i>S. pastorianus</i> reused 4 times)	Protein FN Autolysis (at 70 °C/4 h) and enzymatic hydrolysis	0.5	–	0–8	55	5.2	0–8	–	–	UF, NF	–	Amorim et al. (2016a, 2019b)
<i>SBY</i> (from Lager beer) reused 4 times	<i>Debittering</i> and autolysis at pH 6.0, 45–60 °C/8–72 h	0.15% <sup>B</sup>	–	–	–	–	–	–	80 °C/30 min	11,000 × g/10 min at 4 °C	–	Tangüler and Erten (2008)
<i>SBY</i> (12–15% dry weight)	<i>Debittering</i> , clarification and enzymatic hydrolysis	–	Papain	–	50–60	–	24	Constant mixing	–	–	High	Podpora et al. (2016)
<i>SBY</i> ( <i>S. cerevisiae</i> TUM 68)	Mechanical rupture using glass beads, sonication (400 W, 20 kHz, 30 min), autolysis (24 h, 50 °C)	–	–	–	–	–	–	Added NaCl and ethyl acetate	–	10,000 × g/20 min at 4 °C	–	Jacob et al. (2019a, c)

All spaces marked with “-” indicate that these data were not disclosed in the original papers

*SBY* spent brewer's yeast, [S] substrate concentration (m/m), E:S enzyme:substrate ratio (considering protein content, m/m), T temperature of treatment, t duration of treatment, Obs. relevant observations related to the treatment, Inactivation conditions of enzyme inactivation, Centrifugation centrifugation conditions of the treated materials, DH degree of hydrolysis

<sup>A</sup>Percentage defined considering the solids content

<sup>B</sup>Percentage defined while considering (m/v)

**Table 6** Treatments and conditions used for solubilization of components and rupture of yeast cell wall: Part 3

Substrate	Treatment	[S] (%)	Enzyme	E:S (%)	T (°C)	pH	t (h)	Obs.	Inactivation	Centrifugation	DH (%)	References
Yeast ( <i>S. cerevisiae</i> )	Autolysis (pH 5.5 °C/96 h, 120 rpm)	-	-	-	-	-	-	120 rpm	85 °C/15 min	11,000 ×/10 min	49	Mirzaei et al. (2015)
Sugar cane yeast extract	Sonication (600 W, 20 kHz, 10 min) and enzymatic hydrolysis	2.5%	Trypsin, chymotrypsin	0.1	37	7.8	5	-	-	-	18–19	
	Enzymatic hydrolysis	10	Alcalase™	1.4	55	8.0	-	-	-	-	16.6	de la Hoz et al. (2014)
SBY ( <i>S. pastorianus</i> )	Autolysis: mechanical rupture using glass beads, enzymatic hydrolysis	50–100% of SBY	Viscozyme L	2.0	51	4.4	-	-	-	-	15.8	
			Protex 51FP	1.6	50	7.6	-	-	-	-	9.7	
			Braunzyt®, Alcalase™, Flavourzyme™	0.5–10	60–80	5.5–7.5	max 1 h	700 rpm	90 °C/30 min	15,300 ×/30 min at 4 °C	4–50	Marson et al. (2019)
SBY ( <i>S. pastorianus</i> )	Enzymatic hydrolysis	12% (d.w.)	Braunzyt®, Alcalase™, Protamex™	2000 U g <sup>-1</sup>	50	7.0	2 h	500 rpm	95 °C/15 min	15,300 ×/30 min at 4 °C	8–33	Marson et al. (2020)

All spaces marked with “-” indicate that these data were not disclosed in the original papers

SBY spent brewer's yeast, [S] substrate concentration (m/m), E:S enzyme:substrate ratio (considering protein content, m/m), T temperature of treatment, t duration of treatment, Obs. relevant observations related to the treatment, Inactivation conditions of enzyme inactivation, Centrifugation centrifugation conditions of the treated materials, DH degree of hydrolysis

depending on the disruption treatment of choice (Kollar et al. 1992; Halász and Lásztity 1991a). The precipitated material, which is mostly insoluble in water, has potential as a carrier material for microencapsulation and as an emulsifying agent, since it is mainly composed of proteins and carbohydrates from the yeast cell wall. Mannoproteins and  $\beta$ -glucans are extracted from this fraction, through washing and precipitation steps, with yields of 4% and 10%, respectively (Melo et al. 2015; Araújo et al. 2014).

### Current and potential applications of the processed spent yeast from brewing

In-depth knowledge of the rich macro and micronutrient composition of SBY, combined with the development of application-focused processes, are the key to extend the scope of application of this important brewing by-product and well as other yeast by-products. The next sections present up-to-date foreseen applications of SBY as an innovative ingredient in the food and pharmaceutical industries.

### Uses of yeast biomass for human and animal nutrition: alternative source of proteins, bioplexes and vitamins

Among all possible applications, SBY is commonly used as feed for protein supplementation. As studies and technology progress, SBY feed supplements are investigated not only for their protein and vitamin-rich composition, but also for their bioactive effects in animals (Shurson 2018).

A yeast extract from hydrolysed cells of the IFO 2346 strain of *S. cerevisiae* was used to enrich pet food and showed anti-obesity effects in dogs (Kim et al. 2012). Supplementation of vitamin and mineral premix with brewer's yeast (1% to 5%) in broiler diets reverted negative bone effects (diminished tibia ash amounts) in vitamin/mineral depleted diets (Sacakli et al. 2013).

Disrupted yeast cells from *S. cerevisiae*, *Candida utilis* and *Kluyveromyces marxianus* have been evaluated as sustainable protein sources for fish feed. A previous study proposed a sustainable way of cultivating yeast in ligno-cellulosic non-food biomass from forestry and agricultural industries, which resulted in a low-cost product. After cell disruption and processing to improve protein digestibility, those protein-rich yeast materials were used in aquaculture as feed, with various immunological and health benefits (Øverland and Skrede 2017).

Proteins from brewing yeasts have high biological quality, which makes SBY a sustainable alternative source of proteins, as well as a non-allergenic option for vegans/vegetarians. Because it comes from a by-product, it is also a better choice in comparison to higher-cost proteins from

plants or animals (Bertolo et al. 2019). The digestibility of yeast proteins before and after disruption methods has been investigated recently and indicated high digestibility when processed (> 95%), comparable to that of textured soy protein (Bertolo et al. 2019).

Yeast cells are researched as a vehicle to human mineral supplementation, in the form of bioplexes. *Saccharomyces cerevisiae* yeast cells have been reported to accumulate and readily adsorb minerals ( $\text{Cr}^{3+}$ ,  $\text{Se}^{4+}$ ,  $\text{Mg}^{2+}$ ,  $\text{Cu}^{2+}$ ,  $\text{Cd}^{2+}$ ,  $\text{Zn}^{2+}$ ,  $\text{Mn}^{2+}$ ,  $\text{Ca}^{2+}$ ,  $\text{Fe}^{3+}$ ) in amounts that exceed their physiological demand (Błażej and Duszkievicz-Reinhard 2004; Stehlik-Tomas et al. 2004; Park et al. 2003; Varga and Maráz 2002; Pacheco et al. 1999). The concentration of these microelements needs to be carefully selected before use to prevent them from being toxic to cells. The content of cations adsorbed by cell wall proteins (mainly mannoproteins) is proportional to the total surface area of the yeast cell. Cation content is also dependent on yeast strain, properties of cell morphology, composition and physiological state of yeast cells (Błażej and Duszkievicz-Reinhard 2004; Varga and Maráz 2002). The presence of phosphorylated mannans in the cell wall, cell size, thickness of the mannoprotein layer and the presence of free carboxyl, hydroxyl, phosphate and hydrosulfide groups in the surface proteins influence this bioaccumulation phenomena (Błażej and Duszkievicz-Reinhard 2004; Park et al. 2003). For the production of bioplexes, *Saccharomyces* sp. is cultivated in a medium supplemented with the cation of interest, and the enrichment of biomass takes place in two steps. Firstly, the adsorption in the cell wall occurs rapidly; it is referred to as biosorption. The second phase, chemisorption, is energy consuming and happens at a lower rate, resulting in the active transport of cations from the cell wall to the cytoplasmic membrane and then to the cell interior.

Magnesium ions were enriched 3-fold above the physiological demand in *Saccharomyces* sp. Authors reported that the mechanism of cation binding of  $\text{Mg}^{2+}$  with yeast cells was chemisorption followed by accumulation inside the cell, forming bioplexes (Błażej and Duszkievicz-Reinhard 2004). The effect of enrichment of yeast (*S. cerevisiae*) with chromium, selenium and zinc did not influence the content and stability of complex B vitamins, but the iron-enriched yeast resulted in losses in vitamin B2 (Varga and Maráz 2002). Varga and Maráz (2002) also found that those four microelements were mainly present in yeast as undissolved, bound compounds. It is important to emphasize that the greater the viability of yeast cells, the higher the degree of cation binding (Błażej and Duszkievicz-Reinhard 2004).

SBY may present low viability, specially if it has been repitched several times, but  $\text{Ca}^{2+}$  binding in a SBY protein concentrate is possible (Pacheco et al. 1999). Although the binding of several cations has still not been evaluated for spent yeasts, this may be a potential application, cations

may be either readily adsorbed by the cell wall proteins or released inside the body. Humans can easily assimilate bioplexes (Błażej and Duszkiewicz-Reinhard 2004). They deliver minerals along with the proteins they are bound to, and penetrate the intestinal wall. Bioplexes are also less susceptible to the formation of complexes with compounds such as phytic acids, commonly found in plants, which limit body absorption. The presence of other compounds of interest in yeasts, namely  $\beta$ -glucans, along with their high protein content and complex B vitamins, makes them an even more appealing vehicle for minerals supplementation.

Yeasts may also produce vitamins when grown in specific mediums. *Saccharomyces* sp. was reported to produce ergosterol, a precursor of vitamin D2 (ergocalciferol) that can be extracted from the lipid fraction of cell walls (Kollar et al. 1992). Genetically engineered *S. cerevisiae* was capable of producing minor amounts of L-ascorbic acid from L-galactose (Stahmann 2019).

### Yeast extracts: from medium supplementation to flavouring compounds

The nutrient-rich composition of yeast extracts may be used to boost nutrient supply, thus improving the fermentation performance of various microorganisms, including the fermentation of *Saccharomyces* sp. in beer production (Jacob et al. 2019b). An SBY enzymatic hydrolysate produced with Alcalase™ was used as a nitrogen source to enhance the succinic acid production by *Actinobacillus succinogenes* (Chen et al. 2011).

Yeasts are able to synthesize a myriad of flavour molecules such as alcohols and terpenoids, used in food flavouring. Naturally, during fermentation, some of those compounds are produced. Yeast flavour depends on a delicate balance among peptides, nucleotides (guanosine monophosphate and inosine monophosphate), carbohydrates and free amino acids. There is great interest in using yeast extracts as flavouring agents in foods (Rakowska et al. 2017; Pérez-Torrado et al. 2015).

When the envisaged application for SBY is the production of a flavouring yeast extract, the method chosen for disruption and processing of SBY is of great importance. The concentration of free amino acids in the extract plays a major role in the flavouring potency of the ingredient. Leucine, isoleucine, valine, histidine, proline, cysteine and glutamine greatly influence the aroma of the product. A recent study compared the amino acid composition of yeast extracts produced by mechanical disruption (by glass beads and ultrasound) and autolysis, and the latter resulted in a higher release of those target amino acids (Jacob et al. 2019a). Enzymatic hydrolysis with proper exogenous enzymes, such as RNAses, also promotes the release of 5'-nucleotides (Xie et al. 2017; Vieira et al. 2013; Chae et al. 2001) and results

in high quality yeast extracts that are suitable as flavouring ingredients.

### Yeast proteins as non-synthetic food emulsifiers and functional ingredients

The use of SBY materials as a sustainable and technologically viable option to synthetic emulsifiers has been investigated lately. The emulsifying ability of cell wall components is often attributed to mannoproteins and  $\beta$ -D-glucans that have technological properties acting as water holding, thickening, emulsifying and stabilizing agents (Araújo et al. 2014; Kollar et al. 1992).

Mannoproteins extracted from SBY (*Saccharomyces uvarum*) showed potential as stabilizers and emulsifying agents when used in the formulation of mayonnaise (substituting xanthan gum) with no negative effects on the sensory attributes of the product (Araújo et al. 2014). Mannoproteins also demonstrated the ability to emulsify and stabilize French salad dressings, while improving their nutritional composition and sensorial acceptance (Melo et al. 2015). Use of inactivated high-pressure homogenized baker's yeast dispersion for low-fat dressings indicated the potential of yeast biomass as an alternative emulsifier (Fernandez et al. 2012).

Gel stabilizing properties of an SBY extract produced by mechanical disruption using glass beads were detected in cooked hams. The addition of 1% of yeast extract resulted in increased hardness, chewiness, sliceability and water-holding capacity, in addition to the incorporation of amino acids and proteins with high biological value, with no sensorial differences detected in comparison to controls (Pancrazio et al. 2016). The substitution of meat by yeast extract (distillery spent yeast *Saccharomyces* sp.) up to 1.5% in Frankfurt type sausages did not result in any sensorial changes (aroma, flavour and texture) (Yamada et al. 2010).

Non-treated and ultrasound-treated SBY cells were reported to have emulsifying properties in model emulsions, but autolysed samples presented very poor emulsifying properties (Bertolo et al. 2019). Foaming ability and stability were also assessed, but lower values were found for autolysed samples. The water-holding properties of yeast cells worsened after the disruption treatments (autolysis and ultrasound), but the ultrasound treatment improved significantly the oil-holding capacity of the yeast biomass. The solubility of yeast ingredients was studied, and it was found that disruption processes and addition of salts can improve yeast proteins solubility (Bertolo et al. 2019).

Yeast materials have been also studied as new carrier agents for microencapsulation because of their interesting composition and functional properties (gel formation, stabilization, emulsification). Cells of *S. cerevisiae* after chemical treatment showed good encapsulation yields of chlorogenic

acid, a natural hydrophilic antioxidant (Paramera et al. 2014; Shi et al. 2010).

Those results suggest that further research is necessary to improve the processing and incorporation of SBY and yeast-based products as functional additives in the food industry.

### Yeast enzymes

Yeasts contain several enzymes with hydrolytic activity. Enzymatic extracts of SBY or cultivated *S. cerevisiae* cells were already employed alone (with low or medium protein conversion) or in combination with exogenous enzymes to produce protein hydrolysates (Vieira and Ferreira 2017; Vieira et al. 2017a, b, 2016a; Martínez-Alvarez et al. 2008). The SBY protein extract is usually produced by disruption of yeast cells using glass beads under refrigerating temperatures to minimize enzyme denaturation and loss of hydrolytic capacity. The reported activity of SBY proteases extract ranges from 0.2 to 1.0 U mL<sup>-1</sup> at pH 6.0, and they have already been used to produce hydrolysates from by-products of sardine cannery and spent grains from brewing (BSG, Vieira and Ferreira 2017; Vieira et al. 2017a, b, 2016a). A full characterisation of SBY proteases are still not available, but Fukal et al. (1986) reported that SBY proteinases contain sulfhydryl and metallo-proteinases with thermostability up to 50 °C and activity at pH values as low as 3.

The potential of SBY as a source of invertase (EC 3.2.1.26) is yet to be evaluated, but *S. cerevisiae* is a known source, and invertase has been extracted from baker's yeast by autolysis and ultrafiltration (> 20 kDa membranes) with an activity higher than 4.0  $\mu\text{kat mg}_{\text{protein}}^{-1}$  (Pérez-Torrado et al. 2015; Kollar et al. 1992).

### SBY polyphenols

Yeasts are known to possess the ability to absorb polyphenols during fermentation processes or when grown in media containing high levels of those compounds (León-González et al. 2018; Rizzo et al. 2006). Some polyphenols from hops (humulones, iso-humulones, lupulones, chalcones and flavones) and malt are delivered to the medium during brewing and are adsorbed to different extent by yeast cells. According to the literature, total polyphenol content in SBY ranges from 1.2 to 375 mg of gallic acid equivalents g<sup>-1</sup> (d.w.) (Jacob et al. 2019c; Vieira et al. 2016b; Podpora et al. 2016). A detailed study on polyphenols profile of SBY demonstrated the potential of SBY as a source of bioactive polyphenols such as (+)-catechin, gallic acid, protocatechuic acid, *p*-coumaric acid, ferulic acid, *trans*-ferulic acid, rutin, naringin, quercetin and kaempferol (León-González et al. 2018; Vieira et al. 2016b). Bryant and Cohen (2015) measured hop acid profiles of spent yeast and reported that the concentration of hop acids in spent yeasts was much

higher than in respective beers. Hop acids in spent yeasts were mainly represented by  $\alpha$ -acids (humulones) and  $\beta$ -acids (lupulones). Five-fold higher total hop acid content in craft SBY samples in comparison to multinational SBY samples were detected. This result is probably related to the fact that craft beer formulations typically employs higher levels of hops than those used in multinational industries. Although the mechanisms underlying yeast adsorption of hop acids is still not elucidated, authors have hypothesised that hop acids were probably located in the cell wall or cell membrane and were mostly associated with dead yeast cells (Bryant and Cohen 2015).

### $\gamma$ -Aminobutyric acid (GABA) and kynurenic acid production

$\gamma$ -Aminobutyric acid (GABA) is a neuroactive non-protein amino acid that is reported to have bioactive activities (Diana et al. 2014). This compound is involved in the metabolic Krebs cycle in plants, and in vertebrates, it is an important inhibitory neurotransmitter that reduces neuronal excitability throughout the nervous system. Changes in GABA concentrations in the brain and in GABA synthesis pathways are related to many mental and psychiatric disorders (Huntington's disease, Parkinson's disease, senile dementia, seizures, Alzheimer's disease, stiff person syndrome and schizophrenia). Effects against hypertension, kidney diseases, diabetes and cancers were also reported (Diana et al. 2014). GABA may be synthesized from L-glutamic acid or its salts via the glutamic acid decarboxylase enzyme (GAD; EC 4.1.1.15) with vitamin B6 (pyridoxal phosphate) as a cofactor. It is found in plants, animals, microorganisms and foods, and it is even synthesized by the gut microbiota (Yilmaz and Gökmen 2020). The discovery of new high-GABA producing strains for high performance biotechnological production is of great interest. Recent studies have been investigating new microorganisms and biotechnological processes that are able to produce GABA (Diana et al. 2014). During autolysis of SBY, GABA may be produced because GAD as well as great amounts of glutamic acid and vitamin B6 naturally occur in SBY (Table 2) (Masuda et al. 2008). Jacob et al. (2019b) found 2-fold higher concentrations of GABA by *S. cerevisiae* (TUM 68) with the addition of glucose and monosodium glutamate by autolysis (pH 6.0, 37 °C for 72 h), but further studies are still needed to confirm the feasibility of the commercial use of this technology. The concentration of GABA in the yeast extract was 10 mg g<sup>-1</sup> (d.w.) (Jacob et al. 2019a). In tea, one of the most important food sources of GABA, the concentration ranges from 50 to 2000  $\mu\text{g g}^{-1}$  (d.w.).

The essential amino acid tryptophan is mainly metabolised through the kynurenine pathway. Some changes in this pathway, ultimately resulting in imbalances in tryptophan



and kynurenines, is related to the pathogenesis of some disfunctions, such as Alzheimer's disease, Huntington's disease, dementia complex, acquired immune deficiency syndrome and schizophrenia (Chen and Guillemin 2009). For instance, quinolinic acid, a derivative from the kynurenine pathway, is an important factor of Alzheimer's disease neuronal damage pathogenesis (Guillemin and Brew 2002). The neurotoxicity caused by quinolinic acid can be limited by kynurenic acid, its antagonist (Chen and Guillemin 2009). Kynurenic acid is also an inhibitor of the  $\alpha$ -7 nicotinic acetylcholine receptor and an antioxidant compound. Antagonists or agonists of nicotinic acetylcholine receptors are considered a therapeutic strategy to Alzheimer's disease, because the interactions between those receptors and amyloid beta peptides are changed (Lombardo and Maskos 2015). So far, the content of tryptophan derivatives, among them kynurenic acid, has been determined in fermented foods and plants. Kynurenic acid was detected in fermented products (cheese, yoghurt, beer, wine) as well as in cacao powder, which presents the highest content, about  $4500 \mu\text{g kg}^{-1}$  (d.w.) (Yılmaz and Gökmen 2018). The synthesis of kynurenine and kynurenic acid by *S. cerevisiae* and *S. pastorianus* was confirmed during beer fermentation, summing up  $0.02\text{--}0.05 \mu\text{g g}^{-1}$  (d.w.) or  $17\text{--}52 \mu\text{g L}^{-1}$  (Yılmaz and Gökmen 2020, 2019). Their presence in SBY was still neither investigated nor reported, but it is a possibility. The discovery of those neuroactive tryptophan derivatives is still very recent and their production/detection in spent yeasts from brewing has still not been investigated.

### Bioactive peptides

Some peptides in food that can exert functions in addition to their basic nutritional benefits are defined as bioactive peptides. Although they usually present biological properties to a lesser extent than synthetic drugs, they are less likely to accumulate in the body and have side effects (Li-Chan 2015). Several studies have been published reporting beneficial effects to the organism of protein hydrolysates and peptides from spent grains (BSG), SBY, barley and non-processed *S. cerevisiae*. There are studies reporting antioxidant activity (McCarthy et al. 2013), anti-inflammatory effects (Connolly et al. 2015, 2014; McCarthy et al. 2013) and effects against type II diabetes and hypertension (Connolly et al. 2014) of BSG hydrolysates. Evidence has also been reported for antimicrobial, antioxidant, and antihypertensive activities and effects of barley grain protein fractions on diabetes ( $\alpha$ -amylase inhibitory activity) (McClellan et al. 2014; Ortiz-Martinez et al. 2014; Xia et al. 2012; Alu'datt et al. 2012).

Tables 7 and 8 show the up-to-date biological activities discovered in yeast hydrolysates detected by in vitro and in vivo tests. The investigation of biological properties of

yeast hydrolysates is recent, with the majority of articles published in the last 10 years. The most studied yeast material as a bioactive source of peptides is cultivated non-residual yeast. Protein hydrolysates from *S. cerevisiae* showed beneficial effects on indicators of stress. Near to control levels of epinephrine and norepinephrine were found for rats after the ingestion of yeast extract for 8 days prior to a 48 h stress period (Kim et al. 2003). This yeast extract was reported to present immunomodular effects, by activating macrophage and interleukin-6 production (1.9-fold when given to rats at  $2 \text{ g/kg/day}$ ). Rats bone marrow cells significantly proliferated 2.1-fold more than the control group (Yu et al. 2002). Cultivated yeast protein hydrolysates also were reported to decrease fat accumulation in rats. The alteration of the activity of enzymes involved in lipid regulation was evaluated. Rats fed with a high-fat diet supplemented with 0.5–1% yeast extract have shown decreased body weight gain, serum triglycerides and low-density lipoprotein cholesterol concentrations. Also, the yeast supplementation seemed to inhibit the activity of both hepatic glucose-6-phosphate dehydrogenase and malic enzymes (Jung et al. 2012; Kim et al. 2004). In another study, the anti-obesity activity of yeast hydrolysates was investigated through changes in the expression of neuropeptides Y and cocaine and amphetamine-regulated transcript, compared with a control group. Authors reported that the ingestion of yeast decreased body weight gain, and increased the expression of the mRNA of cocaine and amphetamine-regulated transcript, a neuropeptide with regulatory functions on feed intake and energy balance (Park et al. 2013). The anti-obesity effect of yeast hydrolysate consumption was confirmed in beagle dogs, for which a significant weight reduction was observed (Kim et al. 2012).

Weight reduction and decreased abdominal fat accumulation as a result of consumption of yeast hydrolysate were reported in a human study (Jung et al. 2014). Residual yeast peptides from sugarcane processing were able to bind iron (de la Hoz et al. 2014). The consumption of a *S. cerevisiae*-based fermentate in a randomised, double-blind and placebo-controlled trial reduced the incidence of cold and flu-like symptoms in a healthy population, regardless of vaccination history (Moyad et al. 2010). SBY protein hydrolysates showed blood pressure lowering effects (ACE-I, Amorim et al. 2019a; Vieira et al. 2017a; Kanauchi et al. 2005), anti-ulcer and antiproliferative activity (Amorim et al. 2016b), antioxidant activity (Marson et al. 2020, 2019; Jung et al. 2011) and effects against type II diabetes (Jung et al. 2011). The expression of biological activities in SBY are probably represented not only by peptides, but also by vitamins, phenolic components and enzymes (Jacob et al. 2019b).

Several studies have investigated the hydrolysis of purified matrices and their activity. It is extremely important to consider the use of complex matrices as a substrate for

**Table 7** Yeast hydrolysates: biological activities reported in tests in vitro and in vivo: Part 1

Substrate	Treatment	Antioxidant and biological reported activity	Peptide fractionation	References
SBY	Autolysis and enzymatic hydrolysis with <i>Cynara cardunculus</i> extract	Protective effect on the gastric mucosa of rats against lesions caused by ethanol (cytoprotective action) and cytotoxic effect against leukemic cells.	Mainly < 3 kg mol <sup>-1</sup> (membrane separation: UF, RO and NF)	Amorim et al. (2016b)
SBY and baking yeast	Sequential hydrolysis using glutaminase, Corolase PN-L, Alcalase <sup>TM</sup> , Flavourzyme <sup>TM</sup> and trypsin	Anti-inflammatory activity in stimulated human blood cells	Hydrophobic subfractions of glycopeptides < 6–8 kg mol <sup>-1</sup> (dialysis and ion exchange chromatography)	Williams et al. (2016)
SBY	Autolysis and enzymatic hydrolysis with <i>Cynara cardunculus</i> extract	Antioxidant activity: ORAC: 3–7 mM <sub>TE</sub> mg <sup>-1</sup> sample; ACE-I: IC <sub>50</sub> 84–259 μg <sub>sample</sub> mL <sup>-1</sup> ; reduction of systolic blood pressure (< 3 kg mol <sup>-1</sup> peptides) in vivo	UF fractionation (10 and 3 kg mol <sup>-1</sup> )	Amorim et al. (2019a)
SBY	Mechanical rupture using glass beads	Antioxidant activities: FRAP (261 ± 14 mg <sub>TE</sub> 100 g <sup>-1</sup> extract (d.w.)), DPPH (59.7 ± 2.5 mg <sub>TE</sub> 100 g <sup>-1</sup> extract (d.w.)) and FRP (127.6 ± 1.0 mg <sub>TE</sub> 100 g <sup>-1</sup> extract (d.w.))	Non-purified/fractionated	Vieira et al. (2016b)
SBY	Enzymatic hydrolysis using papain	Antioxidant activity: ABTS (461.5–506.9 mmol <sub>TE</sub> 100 mg <sup>-1</sup> extract)	Non-purified/fractionated	Podpora et al. (2016)
SBY ( <i>S. pastorianus</i> )	Mechanical rupture using glass beads and autolysis	Antioxidant activity: FRAP (199 μmol <sub>TE</sub> mL <sup>-1</sup> extract); ACE-I: IC <sub>50</sub> 481 μg <sub>peptides</sub> mL <sup>-1</sup> extract)	Non-purified/fractionated	Vieira et al. (2017a)
SBY ( <i>S. pastorianus</i> )	Enzymatic hydrolysis with Flavourzyme <sup>TM</sup> , Alcalase <sup>TM</sup> , Protamex <sup>TM</sup> and Brauzyt <sup>®</sup>	Antioxidant activities: FRAP (5–25 μmol <sub>TE</sub> g <sup>-1</sup> extract), DPPH (17–50 μmol <sub>TE</sub> g <sup>-1</sup> extract)	Non-purified/fractionated	Marson et al. (2019)

SBY spent brewer's yeast, FRAP ferric reducing ability of plasma, DPPH free radical 2,2-diphenyl-1-picrylhydrazyl (DPPH) scavenging activity, FRP ferrocyanide reduction potential, ABTS radical 2,2'-azino-bis(3-ethylbenzothiazoline-6-sulfonic acid) scavenging capacity (ABTS), TE TROLOX equivalents (water-soluble analog of vitamin E), ACE-I inhibitory activity of the angiotensin-converting enzyme, IC<sub>50</sub> sample concentration at which enzyme activity is inhibited by 50%, UF ultrafiltration, RO reverse osmosis, NF nanofiltration, d.w. dry weight

**Table 8** Yeast hydrolysates: biological activities reported in tests in vitro and in vivo: Part 2

Substrate	Treatment	Antioxidant and biological reported activity	Peptide fractionation	References
SBY	Enzymatic hydrolysis with Alcalase™	ACE-I: IC <sub>50</sub> of all fractions 88% in vitro	< 5 kg mol <sup>-1</sup> liquid chromatography	Kanauchi et al. (2005)
SBY	Enzymatic hydrolysis with 5 proteases, Flavourzyme™ (tests in vivo)	Antioxidant activities: ABTS: 66.5% of scavenging activity at 1.5 mg mL <sup>-1</sup> ; DPPH: 59.9% of scavenging activity at 2.5 mg mL <sup>-1</sup> ; improved insulin sensitivity in rats	Concentration by UF (20X) (< 10 kg mol <sup>-1</sup> )	Jung et al. (2011)
SBY ( <i>S. pastorianus</i> )	Simultaneous enzymatic hydrolysis with Alcalase™, Protamex™ and Brauzyne®	Antioxidant activities: FRAP (5–7 μmol <sub>TE</sub> mg <sup>-1</sup> extract, DPPH (9–16 μmol <sub>TE</sub> mg <sup>-1</sup> extract), ORAC (85–500 μmol <sub>TE</sub> mg <sup>-1</sup> extract)	UF fractionation (10 and 30 kg mol <sup>-1</sup> and electrophoresis)	Marson et al. (2020)
Yeast ( <i>S. cerevisiae</i> )	Sonication and enzymatic hydrolysis with trypsin	Antioxidant activities: ABTS (4653.36 ± 5.0 μmol <sub>TE</sub> mg <sup>-1</sup> protein (d.w.)), DPPH (179.24 ± 4.8 μmol <sub>TE</sub> mg <sup>-1</sup> protein (d.w.)) and ACE-I: IC <sub>50</sub> of all fractions 0.84 ± 0.01 mg mL <sup>-1</sup> in vitro	UF fractionation (3, 5 and 10 kg mol <sup>-1</sup> ) Highest activity of peptide with 1057.45 kg mol <sup>-1</sup> (reversed-phase chromatography)	Mirzaei et al. (2015)
Sugarcane yeast extract ( <i>S. cerevisiae</i> )	Enzymatic hydrolysis with Alcalase™, Viscozyme L and Protex 51FP	Iron chelating ability (iron solubility 34–41%; iron binding capacity 21–26%)	< 5 kg mol <sup>-1</sup> (UF)	de la Hoz et al. (2014)
Yeast ( <i>S. cerevisiae</i> )	Enzymatic hydrolysis with bromelain	Reduction of weight and abdominal fat accumulation in obese adults <sup>1</sup> ; anti-obesogenic activity in rats <sup>2,3</sup> ; anti-stress effect in rats <sup>4</sup> ; promotion of bone mass growth in rats <sup>5</sup>	< 10 kg mol <sup>-1</sup> (UF)	Jung et al. (2014) <sup>1</sup> , Park et al. (2013) <sup>2</sup> , Jung et al. (2012) <sup>3</sup> , Lee et al. (2009), Kim et al. (2003) <sup>4</sup> , and Lee et al. (2011) <sup>5</sup>

SBY spent brewer's yeast. DPPH free radical 2,2-diphenyl-1-picrylhydrazyl (DPPH) scavenging activity. ABTS radical 2,2'-azino-bis(3-ethylbenzothiazoline-6-sulfonic acid) scavenging capacity (ABTS). TE TROLOX equivalents (water-soluble analog of vitamin E). ACE-I inhibitory activity of the angiotensin-converting enzyme, IC<sub>50</sub> sample concentration at which enzyme activity is inhibited by 50%. UF ultrafiltration, d.w. dry weight

hydrolysis, and evaluate the potential for production of bio-active peptides from commercially relevant food by-products (Li-Chan 2015; Ortiz-Chao and Jauregi 2007), such as SBY (Marson et al. 2020; Xie et al. 2017; Mirzaei et al. 2015). Several studies have suggested that the biological activity of protein fractions depends on the sequence of peptides and their hydrophobicity (Phongthai et al. 2018), and the antioxidant activity is correlated with some other activities, such as antihypertensive activity (Zhang 2016; Garcia-Mora et al. 2015; Esteve et al. 2015; Ortiz-Chao and Jauregi 2007). Because of the usually complex composition of SBY extracts, fractionation and purification are necessary to separate compounds of interest (such as peptides) from the mixture. The peptides with the highest reported activities are often those with a molecular weight smaller than  $10 \text{ kg mol}^{-1}$ ; therefore, fractionation using chromatography or membrane technology is a very common practice in the production of peptides (Tables 7, 8).

SBY peptides with ACE-I activity and molecular weight smaller than  $3 \text{ kg mol}^{-1}$  maintained their activity following in vitro gastrointestinal digestion. More studies are needed to further investigate the effects of SBY on human health, but the potential of SBY-based products in medicine and health is encouraging.

## Conclusions and perspectives

Spent yeasts from brewing are a nutritional rich by-product with a lot of potential to be processed into value-added ingredients and products for the food and pharmaceutical industries. Several technologies to transform SBY are already available and should be developed considering the intended use of SBY for maximum yield and performance. Valorisation of SBY is of economical, environmental and technological interests, and the products developed using this material are already showing promising results. Yeast processing perspectives involve application-focused process development considering yeast variability, pilot and industrial scaling up needs, investigation of susceptibility to gastrointestinal digestion and bioaccessibility of SBY peptides and other compounds in humans, further characterisation of molecules extracted/synthesised by SBY and economical studies.

**Acknowledgements** This work was supported by FAPESP (São Paulo Research Foundation, Grant Numbers #2016/18465-8, #2018/04067-6) and CNPq (Brazilian National Council for Scientific and Technological Development, Grant Number 306461-2017-0). The authors are also thankful to Food Engineering Doctoral Program of UNICAMP (Brazil), GAIA Doctoral School, Institut Européen des Membranes (Université de Montpellier, France), Tiago Afonso Marena, Martin Hartinger and Philipp Hartinger from Brauerei Stierberg (Stierberg, Germany).

**Author contributions** All authors contributed to the idea and concept of the study. Literature search and data analysis was performed by GVM. The first draft of the manuscript was written by GVM and all authors reviewed and commented on previous versions of the manuscript. Funding acquisition, resources and supervision were done by M-PB and MDH. All authors read and approved the final manuscript.

**Data availability** Data sharing not applicable to this article as no datasets were generated or analysed during the current study.

## Compliance with ethical standards

**Conflict of interest** The authors declare that they have no conflicts of interest.

## References

- Abou-Zeid A, Jalaluddin AK, Abulnaja KO (1995) On methods for reduction of nucleic acids content in a single-cell protein from gas oil. *Bioresour Technol* 52(1):21–24. [https://doi.org/10.1016/0960-8524\(95\)99782-Q](https://doi.org/10.1016/0960-8524(95)99782-Q)
- Alu'datt MH, Ereifej K, Abu-Zaiton A, Alrababah M, Almajwal A, Rababah T, Yang W (2012) Anti-oxidant, anti-diabetic, and anti-hypertensive effects of extracted phenolics and hydrolyzed peptides from barley protein fractions. *Int J Food Prop* 15(4):781–795. <https://doi.org/10.1080/10942912.2010.503357>
- Ambrosi A, Cardozo NSM, Tessaro IC (2014) Membrane separation processes for the beer industry: a review and state of the art. *Food Bioprocess Technol* 7(4):921–936. <https://doi.org/10.1007/s11947-014-1275-0>
- Amorim M, Pereira JO, Gomes D, Pereira CD, Pinheiro H, Pintado M (2016a) Nutritional ingredients from spent brewer's yeast obtained by hydrolysis and selective membrane filtration integrated in a pilot process. *J Food Eng* 185:42–47. <https://doi.org/10.1016/j.jfoodeng.2016.03.032>
- Amorim M, Marques C, Pereira J, Guardão L, Martins M, Osório H, Moura D, Calhau C, Pinheiro H, Pintado M (2019a) Antihypertensive effect of spent brewer yeast peptide. *Process Biochem* 76:213–218. <https://doi.org/10.1016/j.procbio.2018.10.004>
- Amorim M, Pinheiro H, Pintado M (2019b) Valorization of spent brewer's yeast: optimization of hydrolysis process towards the generation of stable ACE-inhibitory peptides. *LWT* 111:77–84. <https://doi.org/10.1016/j.lwt.2019.05.011>
- Amorim MM, Pereira JO, Monteiro KM, Ruiz AL, Carvalho JE, Pinheiro H, Pintado M (2016b) Antiulcer and antiproliferative properties of spent brewer's yeast peptide extracts for incorporation into foods. *Food Funct* 7:2331–2337. <https://doi.org/10.1039/C6FO00030D>
- de Araújo VBS, de Melo ANF, Costa AG, Castro-Gomez RH, Madruga MS, D'Souza EL, Magnani M (2014) Followed extraction of  $\beta$ -glucan and mannoprotein from spent brewer's yeast (*Saccharomyces uvarum*) and application of the obtained mannoprotein as a stabilizer in mayonnaise. *Innov Food Sci Emerg Technol* 23:164–170. <https://doi.org/10.1016/j.ifset.2013.12.013>
- Asenjo JA, Dunnill P (1981) The isolation of lytic enzymes from cytophaga and their application to the rupture of yeast cells. *Biotechnol Bioeng* 23(5):1045–1056. <https://doi.org/10.1002/bit.260230512>
- Barrette J, Champagne CP, Goulet J (1999) Development of bacterial contamination during production of yeast extracts. *Appl Environ Microbiol* 65(7):3261–3263. <https://doi.org/10.3390/fermentati on5020051>

- Bertolo AP, Biz AP, Kempka AP, Rigo E, Cavalheiro D (2019) Yeast (*Saccharomyces cerevisiae*): evaluation of cellular disruption processes, chemical composition, functional properties and digestibility. *J Food Sci Technol* 56(8):3697–3706. <https://doi.org/10.1007/s13197-019-03833-3>
- Błażej S, Duszkiwicz-Reinhard W (2004) Yeast cell biomass as a potential source of magnesium bioplexes—a review. *Pol J Food Nutr Sci* 54(3):223–232
- Bryant RWR, Cohen SD (2015) Characterization of hop acids in spent brewer's yeast from craft and multinational sources. *J Am Soc Brew Chem* 73(2):159–164. <https://doi.org/10.1094/ASBCJ-2015-0315-01>
- Budroni M, Mannazzu I, Zara S, Saba S, Pais A, Zara G (2020) Composition and functional profiling of the microbiota in the casts of *Eisenia fetida* during vermicomposting of brewers' spent grains. *Biotechnol Rep* 25:e00439. <https://doi.org/10.1016/j.btre.2020.e00439>
- Bzducha-Wróbel A, Błażej S, Kawarska A, Stasiak-Róžańska L, Gientka I, Majewska E (2014) Evaluation of the efficiency of different disruption methods on yeast cell wall preparation for  $\beta$ -glucan isolation. *Molecules* 19(12):20941–20961. <https://doi.org/10.3390/molecules191220941>
- Caballero-Córdoba GM, Sgarbieri VC (2000) Nutritional and toxicological evaluation of yeast (*Saccharomyces cerevisiae*) biomass and a yeast protein concentrate. *J Sci Food Agric* 80(3):341–351. [10.1002/1097-0010\(200002\)80:3<341::AID-JSFA533>3.0.CO;2-M](https://doi.org/10.1002/1097-0010(200002)80:3<341::AID-JSFA533>3.0.CO;2-M)
- Caballero-Córdoba GM, Pacheco MT, Sgarbieri VC (1997) Composição química da biomassa de levedura integral (*Saccharomyces* sp.) e determinação do valor nutritivo da proteína em células íntegras ou rompidas mecanicamente. *Food Sci Technol* 17(2):102–106. <https://doi.org/10.1590/S0101-2061199700200007>
- Chae HJ, Joo H, In MJ (2001) Utilization of brewer's yeast cells for the production of food-grade yeast extract. Part 1: effects of different enzymatic treatments on solid and protein recovery and flavor characteristics. *Bioresour Technol* 76(3):253–258. [https://doi.org/10.1016/S0960-8524\(00\)00102-4](https://doi.org/10.1016/S0960-8524(00)00102-4)
- Chen KQ, Li J, Ma JF, Jiang M, Wei P, Liu ZM, Ying HJ (2011) Succinic acid production by *Actinobacillus succinogenes* using hydrolysates of spent yeast cells and corn fiber. *Bioresour Technol* 102(2):1704–1708. <https://doi.org/10.1016/j.biortech.2010.08.011>
- Chen Y, Guillemin GJ (2009) Kynurenine pathway metabolites in humans: disease and healthy states. *Int J Tryptophan Res*. <https://doi.org/10.4137/IJTR.S2097>
- Connolly A, Piggott CO, FitzGerald RJ (2014) In vitro  $\alpha$ -glucosidase, angiotensin converting enzyme and dipeptidyl peptidase-IV inhibitory properties of brewers' spent grain protein hydrolysates. *Food Res Int* 56:100–107. <https://doi.org/10.1016/j.foodres.2013.12.021>
- Connolly A, O'Keeffe MB, Piggott CO, Nongonierma AB, FitzGerald RJ (2015) Generation and identification of angiotensin converting enzyme (ACE) inhibitory peptides from a brewers' spent grain protein isolate. *Food Chem* 176:64–71. <https://doi.org/10.1016/j.foodchem.2014.12.027>
- Cui C, Qian Y, Sun W, Zhao H (2016) Effects of high solid concentrations on the efficacy of enzymatic hydrolysis of yeast cells and the taste characteristics of the resulting hydrolysates. *Int J Food Sci Technol* 51(5):1298–1304. <https://doi.org/10.1111/ijfs.13084>
- de Castro RJS, Sato HH (2014) Functional properties and growth promotion of bifidobacteria and lactic acid bacteria strains by protein hydrolysates using a statistical mixture design. *Food Biosci* 7:19–30. <https://doi.org/10.1016/j.fbio.2014.05.004>
- de Castro RJS, Sato HH (2015) Biologically active peptides: processes for their generation, purification and identification and applications as natural additives in the food and pharmaceutical industries. *Food Res Int* 74:185–198. <https://doi.org/10.1016/j.foodres.2015.05.013>
- de la Hoz L, Ponezi AN, Milani RF, da Silva VSN, de Souza AS, Bertoldo-Pacheco MT (2014) Iron-binding properties of sugar cane yeast peptides. *Food Chem* 142:166–169. <https://doi.org/10.1016/j.foodchem.2013.06.133>
- de Mathias TRS, Alexandre VMF, Cammarota MC, Mello PPM, Sêrvulo EFC (2015) Characterization and determination of brewer's solid wastes composition. *J Inst Brew* 121(3):400–404. <https://doi.org/10.1002/jib.229>
- de Melo ANF, de Souza EL, de Araujo VBS, Magnani M (2015) Stability, nutritional and sensory characteristics of French salad dressing made with mannoprotein from spent brewer's yeast. *LWT* 62(1, Part 2):771–774. <https://doi.org/10.1016/j.lwt.2014.06.050>
- Diana M, Quílez J, Rafecas M (2014) Gamma-aminobutyric acid as a bioactive compound in foods: a review. *J Funct Foods* 10:407–420. <https://doi.org/10.1016/j.jff.2014.07.004>
- Enache-Angoulvant A, Hennequin C (2005) Invasive *Saccharomyces* infection: a comprehensive review. *Clin Infect Dis* 41(11):1559–1568. <https://doi.org/10.1086/497832>
- Esteve C, Marina ML, García MC (2015) Novel strategy for the revalorization of olive (*Olea europaea*) residues based on the extraction of bioactive peptides. *Food Chem* 167:272–280. <https://doi.org/10.1016/j.foodchem.2014.06.090>
- Fernandez VE, Palazolo GG, Bosisio NA, Martínez LM, Wagner JR (2012) Rheological properties and stability of low-in-fat dressings prepared with high-pressure homogenized yeast. *J Food Eng* 111(1):57–65. <https://doi.org/10.1016/j.jfoodeng.2012.01.029>
- Ferreira IMPLVO, Pinho O, Vieira E, Távarela JG (2010) Brewer's *saccharomyces* yeast biomass: characteristics and potential applications. *Trends Food Sci Technol* 21(2):77–84. <https://doi.org/10.1016/j.tifs.2009.10.008>
- Fukal L, Káš J, Rauch P (1986) Properties of yeast proteinases. *J Inst Brew* 92(4):357–359. <https://doi.org/10.1002/j.2050-0416.1986.tb04423.x>
- García-Mora P, Frias J, Nas EP, Zieliński H, Giménez-Bastida JA, Wiczkowski W, Zielińska D, Martínez-Villaluenga C (2015) Simultaneous release of peptides and phenolics with antioxidant, ACE-inhibitory and anti-inflammatory activities from pinto bean (*Phaseolus vulgaris* L. var. pinto) proteins by subtilisins. *J Funct Foods* 18:319–332. <https://doi.org/10.1016/j.jff.2015.07.010>
- Guillemin GJ, Brew BJ (2002) Implications of the kynurenine pathway and quinolinic acid in Alzheimer's disease. *Redox Rep* 7(4):199–206. <https://doi.org/10.1179/135100002125000550>
- Halász A, Lásztity R (1991a) Introduction. In: Halász A, Lásztity R (eds) Use of yeast biomass in food production. CRC Press, Boca Raton, pp 1–10
- Halász A, Lásztity R (1991b) Chemical composition and biochemistry of yeast biomass. In: Halász A, Lásztity R (eds) Use of yeast biomass in food production. CRC Press, Boca Raton, pp 23–41
- Harrison STL (2011) Cell disruption. In: Moo-Young M (ed) Comprehensive biotechnology, 2nd edn. Academic, Burlington, pp 619–640. <https://doi.org/10.1016/B978-0-08-088504-9.00127-6>
- Huang K, Gao JY, Ma S, Lu JJ (2012) Optimising separation process of protein and polysaccharide from spent brewer's yeast by ultrafiltration. *Int J Food Sci Technol* 47(6):1259–1264. <https://doi.org/10.1111/j.1365-2621.2012.02967.x>
- Huige NJ (2006) Chapter 18: brewery by-products and effluents. In: Stewart GG, Priest FG (eds) Handbook of brewing, 2nd edn. CRC Press, Boca Raton, pp 656–716
- In MJ, Kim DC, Chae HJ (2005) Downstream process for the production of yeast extract using brewer's yeast cells. *Biotechnol Bioprocess Eng* 10(1):85. <https://doi.org/10.1007/BF02931188>
- Jach ME, Serefko A, Sajnaga E, Kozak E, Poleszak E, Malm A (2015) Dietary supplements based on the yeast biomass. *Curr Top*

- Nutraceutical Res 13(2):83–88. <https://doi.org/10.1590/S1415-5273200000300005>
- Jacob FF, Hutzler M, Methner F-J (2019a) Comparison of various industrially applicable disruption methods to produce yeast extract using spent yeast from top-fermenting beer production: influence on amino acid and protein content. *Eur Food Res Technol* 245:95–109. <https://doi.org/10.1007/s00217-018-3143-z>
- Jacob FF, Striegel L, Rychlik M, Hutzler M, Methner F-J (2019b) Spent yeast from brewing processes: a biodiverse starting material for yeast extract production. *Fermentation* 5(2):51 (special Issue “Food Wastes: Feedstock for Value-Added Products”). <https://doi.org/10.3390/fermentation5020051>
- Jacob FF, Striegel L, Rychlik M, Hutzler M, Methner F-J (2019c) Yeast extract production using spent yeast from beer manufacture: influence of industrially applicable disruption methods on selected substance groups with biotechnological relevance. *Eur Food Res Technol* 245:1169–1182. <https://doi.org/10.1007/s00217-019-03237-9>
- Jung EY, Lee HS, Chang UJ, Bae SH, Kwon KH, Suh HJ (2010) Acute and subacute toxicity of yeast hydrolysate from *Saccharomyces cerevisiae*. *Food Chem Toxicol* 48(6):1677–1681. <https://doi.org/10.1016/j.fct.2010.03.044>
- Jung EY, Lee HS, Choi JW, Ra KS, Kim MR, Suh HJ (2011) Glucose tolerance and antioxidant activity of spent brewer's yeast hydrolysate with a high content of cyclo-his-pro (CHP). *J Food Sci* 76(2):C272–C278. <https://doi.org/10.1111/j.1750-3841.2010.01997.x>
- Jung EY, Hong YH, Kim JH, Park Y, Bae SH, Chang UJ, Suh HJ (2012) Effects of yeast hydrolysate on hepatic lipid metabolism in high-fat-diet-induced obese mice: yeast hydrolysate suppresses body fat accumulation by attenuating fatty acid synthesis. *Ann Nutr Metab* 61:89–94. <https://doi.org/10.1159/000338441>
- Jung EY, Cho MK, Hong YH, Kim JH, Park Y, Chang UJ, Suh HJ (2014) Yeast hydrolysate can reduce body weight and abdominal fat accumulation in obese adults. *Nutrition* 30(1):25–32. <https://doi.org/10.1016/j.nut.2013.02.009>
- Kalayu G (2019) Serial re-pitching: its effect on yeast physiology, fermentation performance, and product quality. *Ann Microbiol* 69:787–796. <https://doi.org/10.1007/s13213-019-01493-4>
- Kanauchi O, Igarashi K, Ogata R, Mitsuyama K, Andoh A (2005) A yeast extract high in bioactive peptides has a blood-pressure lowering effect in hypertensive model. *Curr Med Chem* 12(26):3085–3090. <https://doi.org/10.2174/092986705774933461>
- Kim JH, Jung EY, Hong YH, Bae SH, Kim JM, Noh DO, Nozaki T, Inoue T, Suh HJ (2012) Short communication: pet foods with yeast hydrolysate can reduce body weight and increase girth in beagle dogs. *Can J Anim Sci* 92(2):207–210. <https://doi.org/10.4141/cjas2011-123>
- Kim JM, Lee SW, Kim KM, Chang UJ, Song JC, Suh HJ (2003) Anti-stress effect and functionality of yeast hydrolysate SCP-20. *Eur Food Res Technol* 217(2):168–172. <https://doi.org/10.1007/s00217-003-0723-2>
- Kim JM, Kim S, Jung E, Bae SH, Suh HJ (2009) Yeast hydrolysate induces longitudinal bone growth and growth hormone release in rats. *Phytother Res* 23(5):731–736. <https://doi.org/10.1002/ptr.2720>
- Kim KM, Chang UJ, Kang DH, Kim JM, Choi YM, Suh HJ (2004) Yeast hydrolysate reduces body fat of dietary obese rats. *Phytother Res* 18(11):950–953. <https://doi.org/10.1002/ptr.1582>
- Kollar R, Sturdik E, Sajbidor J (1992) Complete fractionation of *Saccharomyces cerevisiae* biomass. *Urol Nurs* 6(3):225–237. <https://doi.org/10.1080/08905439209549836>
- Kumar RS, Chandrasekaran M (2016) Beverages. In: Chandrasekaran M (ed) Valorization of food processing by-products. CRC Press, Boca Raton, pp 589–614
- Lee H, Jung E, Bae SH, Kwon KH, Kim J, Suh HJ (2011) Stimulation of osteoblastic differentiation and mineralization in MC3T3 E1 cells by yeast hydrolysate. *Phytother Res* 25(5):716–723. <https://doi.org/10.1002/ptr.3328>
- Lee HS, Jung EY, Suh HJ (2009) Chemical composition and anti-stress effects of yeast hydrolysate. *J Med Food* 12(6):1281–1285. <https://doi.org/10.1089/jmf.2009.0098>
- León-González ME, Gómez-Mejía E, Rosales-Conrado N, Madrid-Albarrán Y (2018) Residual brewing yeast as a source of polyphenols: extraction, identification and quantification by chromatographic and chemometric tools. *Food Chem* 267:246–254. <https://doi.org/10.1016/j.foodchem.2017.06.141>
- Lewis MJ, Young TW (2001) *Brewing*, 2nd edn. Springer. <https://doi.org/10.1007/978-1-4615-0729-1>
- Li-Chan EC (2015) Bioactive peptides and protein hydrolysates: research trends and challenges for application as nutraceuticals and functional food ingredients. *Curr Opin Food Sci* 1:28–37. <https://doi.org/10.1016/j.cofs.2014.09.005>
- Liu D, Zeng XA, Sun DW, Han Z (2013) Disruption and protein release by ultrasonication of yeast cells. *Innov Food Sci Emerg Technol* 18:132–137. <https://doi.org/10.1016/j.ifset.2013.02.006>
- Liu D, Ding L, Sun J, Boussetta N, Vorobiev E (2016) Yeast cell disruption strategies for recovery of intracellular bio-active compounds—a review. *Innov Food Sci Emerg Technol* 36:181–192. <https://doi.org/10.1016/j.ifset.2016.06.017>
- Lobo-Alfonso J, Price P, Jayme D (2010) Chapter 4: benefits and limitations of protein hydrolysates as components of serum-free media for animal cell culture applications. In: Pasupuleti VK, Demain AL (eds) *Protein hydrolysates in biotechnology*, 1st edn. Springer, New York, pp 55–78. <https://doi.org/10.1007/978-1-4020-6674-0>
- Lombardo S, Maskos U (2015) Role of the nicotinic acetylcholine receptor in Alzheimer's disease pathology and treatment. *Neuropharmacology* 96:255–262. <https://doi.org/10.1016/j.neuropharm.2014.11.018>
- Marson GV, de Machado MTC, de Castro RJS, Hubinger MD (2019) Sequential hydrolysis of spent brewer's yeast improved its physico-chemical characteristics and antioxidant properties: a strategy to transform waste into added-value biomolecules. *Process Biochem* 84:91–102. <https://doi.org/10.1016/j.procbio.2019.06.018>
- Marson GV, de Castro RJS, de Machado MTC, Zandonadi FDS, de Barros HDFQ, Maróstica Júnior MR, Sussulini A, Hubinger MD (2020) Proteolytic enzymes positively modulated the physico-chemical and antioxidant properties of spent yeast protein hydrolysates. *Process Biochem* 91:34–45. <https://doi.org/10.1016/j.procbio.2019.11.030>
- Martínez-Alvarez O, Guimas L, Delannoy C, Fouchereau-Peron M (2008) Use of a commercial protease and yeasts to obtain CGRP-like molecules from saithe protein. *J Agric Food Chem* 56(17):7853–7859. <https://doi.org/10.1021/jf801393r>
- Masuda K, Feng Guo X, Uryu N, Hagiwara T, Watabe S (2008) Isolation of marine yeasts collected from the Pacific Ocean showing a high production of  $\gamma$ -aminobutyric acid. *Biosci Biotechnol Biochem* 72(12):3265–3272. <https://doi.org/10.1271/bbb.80544>
- McCarthy AL, O'Callaghan YC, Connolly A, Piggott CO, FitzGerald RJ, O'Brien NM (2013) In vitro antioxidant and anti-inflammatory effects of brewers' spent grain protein rich isolate and its associated hydrolysates. *Food Res Int* 50(1):205–212. <https://doi.org/10.1016/j.foodres.2012.10.022>
- McClellan S, Beggs LB, Welch RW (2014) Antimicrobial activity of antihypertensive food-derived peptides and selected alanine analogues. *Food Chem* 146:443–447. <https://doi.org/10.1016/j.foodchem.2013.09.094>

- Middelberg APJ (1995) Process-scale disruption of microorganisms. *Biotechnol Adv* 13(3):491–551. [https://doi.org/10.1016/0734-9750\(95\)02007-P](https://doi.org/10.1016/0734-9750(95)02007-P)
- Mirzaei M, Mirdamadi S, Ehsani MR, Aminlari M, Hosseini E (2015) Purification and identification of antioxidant and ACE-inhibitory peptide from *Saccharomyces cerevisiae* protein hydrolysate. *J Funct Foods* 19:259–268. <https://doi.org/10.1016/j.jff.2015.09.031>
- Moyad MA, Robinson LE, Zawada ET, Kittelsrud J, Chen DG, Reeves SG, Weaver S (2010) Immunogenic yeast-based fermentate for cold/flu-like symptoms in nonvaccinated individuals. *J Altern Complim Med* 16(2):213–218. <https://doi.org/10.1089/acm.2009.0310>
- Mussatto SI (2009) Biotechnological potential of brewing industry by-products. In: Nigam PSN, Pandey A (eds) *Biotechnology for agro-industrial residues utilisation: utilisation of agro-residues*, 1st edn. Springer, Dordrecht, pp 313–326. [https://doi.org/10.1007/978-1-4020-9942-7\\_16](https://doi.org/10.1007/978-1-4020-9942-7_16)
- Nagodawithana TW, Nelles L, Trivedi NB (2010) Chapter 11: protein hydrolysates as hypoallergenic, flavors and palatants for companion animals. In: Pasupuleti VK, Demain AL (eds) *Protein hydrolysates in biotechnology*, 1st edn. Springer, New York, pp 191–208. <https://doi.org/10.1007/978-1-4020-6674-0>
- Nand K (1987) Debitting of spent brewer's yeast for food purposes. *Food/Nahr* 31(2):127–131. <https://doi.org/10.1002/food.19870310208>
- Nielsen PM, Olsen HS (2002) Enzymic modification of food protein. In: Whitehurst RJ, Law BA (eds) *Enzymes in food technology*. Sheffield Academic Press, Sheffield, pp 109–143
- Ortiz-Chao PA, Jauregi P (2007) Enzymatic production of bioactive peptides from milk and whey proteins. In: Rastall R (ed) *Novel enzyme technology for food applications*, 1st edn. Woodhead Publishing, Cambridge, pp 160–182
- Ortiz-Martinez M, Winkler R, García-Lara S (2014) Preventive and therapeutic potential of peptides from cereals against cancer. *J Proteomics* 111:165–183. <https://doi.org/10.1016/j.jpro.2014.03.044>
- Øverland M, Skrede A (2017) Yeast derived from lignocellulosic biomass as a sustainable feed resource for use in aquaculture. *J Sci Food Agric* 97(3):733–742. <https://doi.org/10.1002/jsfa.8007>
- Pacheco MT, Caballero-Córdoba GM, Sgarbieri VC (1997) Composition and nutritive value of yeast biomass and yeast protein concentrates. *J Nutr Sci Vitaminol* 46(6):601–612. <https://doi.org/10.3177/jnsv.43.601>
- Pacheco MTB, Carraro F, Sgarbieri VC (1999) Study of calcium binding to different preparations of yeast (*Saccharomyces cerevisiae*) protein by using an ion selective electrode. *Food Chem* 66(2):249–252. [https://doi.org/10.1016/S0308-8146\(98\)00252-0](https://doi.org/10.1016/S0308-8146(98)00252-0)
- Pancrazio G, Cunha SC, de Pinho PG, Loureiro M, Meireles S, Ferreira IM, Pinho O (2016) Spent brewer's yeast extract as an ingredient in cooked hams. *Meat Sci* 121:382–389. <https://doi.org/10.1016/j.meatsci.2016.07.009>
- Paramera EI, Karathanos VT, Konteles SJ (2014) Chapter 23: yeast cells and yeast-based materials for microencapsulation. In: Gaonkar AG, Vasishth N, Khare AR, Sobel R (eds) *Microencapsulation in the food industry*, 1st edn. Academic, San Diego, pp 267–281. <https://doi.org/10.1016/B978-0-12-404568-2.00023-6>
- Park JK, Lee JW, Jung JY (2003) Cadmium uptake capacity of two strains of *Saccharomyces cerevisiae* cells. *Enzyme Microb Technol* 33(4):371–378. [https://doi.org/10.1016/S0141-0229\(03\)00133-9](https://doi.org/10.1016/S0141-0229(03)00133-9)
- Park Y, Kim JH, Lee HS, Jung EY, Lee H, Noh DO, Suh HJ (2013) Thermal stability of yeast hydrolysate as a novel anti-obesity material. *Food Chem* 136(2):316–321. <https://doi.org/10.1016/j.foodchem.2012.08.047>
- Pérez-Torrado R, Gamero E, Gómez-Pastor R, Garre E, Aranda A, Matallana E (2015) Yeast biomass, an optimised product with myriad applications in the food industry. *Trends Food Sci Technol* 46(2, Part A):167–175. <https://doi.org/10.1016/j.tifs.2015.10.008>
- Phongthai S, D'Amico S, Schoenlechner R, Homthawornchoo W, Rawdkuen S (2018) Fractionation and antioxidant properties of rice bran protein hydrolysates stimulated by in vitro gastrointestinal digestion. *Food Chem* 240:156–164. <https://doi.org/10.1016/j.foodchem.2017.07.080>
- Pinto M, Coelho E, Nunes A, ao TB, Coimbra MA (2015) Valuation of brewers spent yeast polysaccharides: A structural characterization approach. *Carbohydr Polym* 116(Supplement C):215–222. <https://doi.org/10.1016/j.carbpol.2014.03.010>
- Podpora B, Świdorski F, Sadowska A, Rakowska R, Wasiakzys G (2016) Spent brewer's yeast extracts as a new component of functional food. *Czech J Food Sci* 34(6):554–563. <https://doi.org/10.17221/419/2015-CJFS>
- Posteraro B, Quarant G, Posteraro P, Sanguinetti M (2018) Chapter 48: *Saccharomyces cerevisiae*. In: Liu D (ed) *Handbook of food-borne diseases*. CRC Press, Boca Raton, pp 509–520. <https://doi.org/10.1201/b22030>
- Qin F, Johansen AZ, Mussatto SI (2018) Evaluation of different pre-treatment strategies for protein extraction from brewer's spent grains. *Ind Crop Prod* 125:443–453. <https://doi.org/10.1016/j.indcrop.2018.09.017>
- Rajendran RMNR (2012) Enzymatic conversion of RNA from yeast extract to guanosine monophosphate (a flavoring agent). Master's Thesis, Chalmers University of Technology, Göteborg
- Rakowska R, Sadowska A, Dybkowska E, Świdorski F (2017) Spent yeast as natural source of functional food additives. *Ann Natl Inst Hyg* 68(2):115–121
- Ravindran R, Sarangapani C, Jaiswal S, Lu P, Cullen P, Bourke P, Jaiswal AK (2019) Improving enzymatic hydrolysis of brewer spent grain with nonthermal plasma. *Bioresour Technol* 282:520–524. <https://doi.org/10.1016/j.biortech.2019.03.071>
- Reed G, Nagodawithana TW (1991) Food and feed yeast. In: *Yeast technology*. Springer, Dordrecht, pp 413–440. <https://doi.org/10.1007/978-94-011-9771-7>
- Rizzo M, Ventrice D, Varone M, Sidari R, Caridi A (2006) HPLC determination of phenolics adsorbed on yeasts. *J Pharm Biomed Anal* 42(1):46–55. <https://doi.org/10.1016/j.jpba.2006.02.058>
- Saba S, Zara G, Bianco A, Garau M, Bononi M, Deroma M, Pais A, Budroni M (2019) Comparative analysis of vermicompost quality produced from brewers' spent grain and cow manure by the red earthworm *Eisenia fetida*. *Bioresour Technol* 293:122019. <https://doi.org/10.1016/j.biortech.2019.122019>
- Sacakli P, Koksall BH, Ergun A, Ozsoy B (2013) Usage of brewer's yeast (*Saccharomyces cerevisiae*) as a replacement of vitamin and trace mineral premix in broiler diets. *Rev Med Vet* 164(1):39–44
- Shi G, Rao L, Xie Q, Li J, Li B, Xiong X (2010) Characterization of yeast cells as a microencapsulation wall material by Fourier-transform infrared spectroscopy. *Vib Spectrosc* 53(2):289–295. <https://doi.org/10.1016/j.vibspec.2010.04.007>
- Shotipruk A, Kittianong P, Suphantharika M, Muangnapoh C (2005) Application of rotary microfiltration in debittering process of spent brewer's yeast. *Bioresour Technol* 96(17):1851–1859. <https://doi.org/10.1016/j.biortech.2005.01.035>
- Shurson G (2018) Yeast and yeast derivatives in feed additives and ingredients: sources, characteristics, animal responses, and quantification methods. *Anim Feed Sci Technol* 235:60–76. <https://doi.org/10.1016/j.anifeedsci.2017.11.010>
- Stahmann KP (2019) Vitamins and vitamin-like compounds: microbial production. In: Schmidt TM (ed) *Encyclopedia of microbiology*,

- 4th edn, Academic, Oxford, pp 569–580. <https://doi.org/10.1016/B978-0-12-809633-8.13017-1>
- Steckelberg C, Andrietta MDGS, Andrietta SR, Stupielloé ENA (2013) Yeast proteins originated from the production of Brazilian bioethanol quantification and content. *Int J Food Eng* 9(1):141–146. <https://doi.org/10.1515/ijfe-2012-0179>
- Stehlik-Tomas V, Zetić VG, Stanzer D, Grba S, Vahčić N (2004) Zinc, copper and manganese enrichment in yeast *Saccharomyces cerevisiae*. *Food Technol Biotechnol* 42(2):115–120
- Suwanapong S, Khongsay N, Laopaiboon L, Jaisil P, Laopaiboon P (2013) Dried spent yeast and its hydrolysate as nitrogen supplements for single batch and repeated-batch ethanol fermentation from sweet sorghum juice. *Energies* 6(3):1618–1631. <https://doi.org/10.3390/en6031618>
- Tangüler H, Erten H (2008) Utilisation of spent brewer's yeast for yeast extract production by autolysis: the effect of temperature. *Food Bioprod Process* 86(4):317–321. <https://doi.org/10.1016/j.fbp.2007.10.015>
- Varga E, Maráz A (2002) Yeast cells as sources of essential microelements and vitamins B1 and B2. *Acta Aliment* 31(4):393–405. <https://doi.org/10.1556/AAlim.31.2002.4.8>
- Vieira E, Brandão T, Ferreira IMPLVO (2013) Evaluation of brewer's spent yeast to produce flavor enhancer nucleotides: influence of serial repitching. *J Agric Food Chem* 61(37):8724–8729. <https://doi.org/10.1021/jf4021619>
- Vieira E, Teixeira J, Ferreira I (2016a) Valorization of brewers' spent grain and spent yeast through protein hydrolysates with antioxidant properties. *Eur Food Res Technol* 242:1975–1984. <https://doi.org/10.1007/s00217-016-2696-y>
- Vieira EF, Ferreira IM (2017) Antioxidant and antihypertensive hydrolysates obtained from by-products of cannery sardine and brewing industries. *Int J Food Prop* 20(3):662–673. <https://doi.org/10.1080/10942912.2016.1176036>
- Vieira EF, Carvalho J, Pinto E, Cunha S, Almeida AA, Ferreira IMPLVO (2016b) Nutritive value, antioxidant activity and phenolic compounds profile of brewer's spent yeast extract. *J Food Compos Anal* 52:44–51. <https://doi.org/10.1016/j.jfca.2016.07.006>
- Vieira EF, das Neves J, Vitorino R, Dias da Silva D, Carmo H, Ferreira IMPLVO (2016c) Impact of in vitro gastrointestinal digestion and transepithelial transport on antioxidant and ACE-inhibitory activities of brewer's spent yeast autolysate. *J Agric Food Chem* 64(39):7335–7341. <https://doi.org/10.1021/acs.jafc.6b02719>
- Vieira EF, Melo A, Ferreira IMPLVO (2017a) Autolysis of intracellular content of brewer's spent yeast to maximize ACE-inhibitory and antioxidant activities. *LWT* 82:255–259. <https://doi.org/10.1016/j.lwt.2017.04.046>
- Vieira EF, da Silva DD, Carmo H, Ferreira IM (2017b) Protective ability against oxidative stress of brewers' spent grain protein hydrolysates. *Food Chem* 228:602–609. <https://doi.org/10.1016/j.foodchem.2017.02.050>
- Vilela ESD, Sgarbieri VC, Alvim ID (2000) Determination of protein value of integral cells, total autolysate and yeast extract (*Saccharomyces* sp.). *Braz J Nutr* 13(3):185–192. <https://doi.org/10.1590/S1415-52732000000300005>
- Williams R, Dias DA, Jayasinghe N, Roessner U, Bennett LE (2016)  $\beta$ -Glucan-depleted, glycopeptide-rich extracts from brewer's and baker's yeast (*Saccharomyces cerevisiae*) lower interferon- $\gamma$  production by stimulated human blood cells in vitro. *Food Chem* 197:761–768. <https://doi.org/10.1016/j.foodchem.2015.11.015>
- Xia Y, Bamdad F, Gänzle M, Chen L (2012) Fractionation and characterization of antioxidant peptides derived from barley glutelin by enzymatic hydrolysis. *Food Chem*. <https://doi.org/10.1016/j.foodchem.2012.03.063>
- Xie J, Cui C, Ren J, Zhao M, Zhao L, Wang W (2017) High solid concentrations facilitate enzymatic hydrolysis of yeast cells. *Food Bioprod Process* 103:114–121. <https://doi.org/10.1016/j.fbp.2017.03.004>
- Yamada EA, Cipolli KMAVB, Harada MM, Sgarbieri VC (2010) Utilização de extrato de levedura (*Saccharomyces* sp.) de destilaria de álcool em salsicha. *Braz J Food Technol* 13(3):197–204. <https://doi.org/10.4260/BJFT2010130300026>
- Yu KW, Kim JM, Oh SH, Chang UJ, Suh HJ (2002) Physiological effects of yeast hydrolysate SCP-20. *Food Res Int* 35(9):879–884. [https://doi.org/10.1016/S0963-9969\(02\)00097-2](https://doi.org/10.1016/S0963-9969(02)00097-2)
- Yuan X, Gu X, Tang J (2008) Optimization of the production of *Momordica charantia* L. var. *abbreviata* ser. protein hydrolysates with hypoglycemic effect using alcalase. *Food Chem* 111(2):340–344. <https://doi.org/10.1016/j.foodchem.2008.03.070>
- Yusaf T, Al-Juboori RA (2014) Alternative methods of microorganism disruption for agricultural applications. *Appl Energy* 114:909–923. <https://doi.org/10.1016/j.apenergy.2013.08.085>
- Yılmaz C, Gökmen V (2018) Determination of tryptophan derivatives in kynurenine pathway in fermented foods using liquid chromatography tandem mass spectrometry. *Food Chem* 243:420–427. <https://doi.org/10.1016/j.foodchem.2017.10.004>
- Yılmaz C, Gökmen V (2019) Kinetic evaluation of the formation of tryptophan derivatives in the kynurenine pathway during wort fermentation using *Saccharomyces pastorianus* and *Saccharomyces cerevisiae*. *Food Chem* 297:124975. <https://doi.org/10.1016/j.foodchem.2019.124975>
- Yılmaz C, Gökmen V (2020) Neuroactive compounds in foods: occurrence, mechanism and potential health effects. *Food Res Int* 128:108744. <https://doi.org/10.1016/j.foodres.2019.108744>
- Zhang SB (2016) In vitro antithrombotic activities of peanut protein hydrolysates. *Food Chem* 202:1–8. <https://doi.org/10.1016/j.foodchem.2016.01.108>
- Ziener S, McNally J (2019) Beverage trends: beer (market survey). [https://www.braubeviale.de/en/news/press-releases/beverage-trends-beer-9j1b7cb\\_pireport](https://www.braubeviale.de/en/news/press-releases/beverage-trends-beer-9j1b7cb_pireport)

**Publisher's Note** Springer Nature remains neutral with regard to jurisdictional claims in published maps and institutional affiliations.

## Affiliations

Gabriela Vollet Marson<sup>1,2</sup>  · Ruann Janser Soares de Castro<sup>3</sup>  · Marie-Pierre Belleville<sup>1</sup>  ·  
Miriam Dupas Hubinger<sup>2</sup> 

Ruann Janser Soares de Castro  
ruann@unicamp.br

Marie-Pierre Belleville  
marie-pierre.belleville@umontpellier.fr

Miriam Dupas Hubinger  
mhuh@unicamp.br



- <sup>1</sup> Institut Européen des Membranes, Université de Montpellier, CNRS, ENSCM, UM, CC 047, 2 Place Eugène Bataillon, 34095 Montpellier, France
- <sup>2</sup> Present Address: Laboratory of Process Engineering, Department of Food Engineering, School of Food Engineering, UNICAMP, Rua Monteiro Lobato, 80, Campinas, SP 13083-862, Brazil
- <sup>3</sup> Department of Food Science, School of Food Engineering, UNICAMP, Rua Monteiro Lobato, 80, Campinas, SP 13083-862, Brazil

## Chapter 4

# Review 2: Membrane fractionation of yeast peptides

**Membrane separation technology for fractionation of spent brewer's yeast protein hydrolysates**

Gabriela Vollet Marson<sup>a,b</sup>, Marie-Pierre Belleville<sup>a</sup>, Stella Lacour<sup>a</sup>, Miriam Dupas Hubinger<sup>b</sup>

<sup>a</sup>Institut Européen des Membranes (IEM), Université de Montpellier, CNRS, ENSCM, UM, CC 047, 2, Place Eugène Bataillon, 34095, Montpellier cedex 5, Occitanie, France.

<sup>b</sup>Department of Food Engineering (DEA), School of Food Engineering (FEA), University of Campinas (UNICAMP), R. Monteiro Lobato, 80, 13083-862, Campinas, São Paulo, Brazil.

Results of this chapter were submitted in the Multidisciplinary Digital Publishing Institute's (MDPI) Journal "Membranes", 2020.

ISSN: 2077-0375



Review

# Membrane Fractionation of Protein Hydrolysates from By-Products: Recovery of Valuable Ingredients from Spent Yeasts

Gabriela Vollet Marson <sup>1,2,†,\*</sup> , Marie-Pierre Belleville <sup>1</sup> , Stella Lacour <sup>1</sup> and Miriam Dupas Hubinger <sup>2</sup> 

<sup>1</sup> Institut Européen des Membranes, IEM – UMR 5635, ENSCM, CNRS, Université de Montpellier, CC 047, Place Bataillon, 34095 Montpellier cedex 5, France.

<sup>2</sup> Department of Food Engineering, School of Food Engineering, UNICAMP, Rua Monteiro Lobato, 80, 13083-862, Campinas, SP, Brazil.

\* Correspondence: gabrielavollet@gmail.com

† Current address: Department of Food Engineering, School of Food Engineering, UNICAMP, Rua Monteiro Lobato, 80, 13083-862, Campinas, SP, Brazil.

Version October 5, 2020 submitted to Membranes

**Abstract:** Spent brewer's yeast (*Saccharomyces* sp.), the second most generated by-product from the brewing industry, contains bioactive and nutritional compounds with high added-value such as proteins (40-50%), polysaccharides, fibres and vitamins. Molecules of interest from agroindustrial by-products need to be extracted, separated, concentrated, and/or purified so that a minimum purity level is achieved, allowing its application. Enzymatic hydrolysis has been successfully used in the production of peptides and protein hydrolysates, releasing compounds at the expense of efficient downstream processes. Membrane technology is an important tool for the recovery of thermolabile and sensitive compounds from complex mixtures, with low energy consumption and high specificity. The integration of membrane techniques that promote the separation through sieving and charge-based mechanisms are of great interest to improve the purity of the recovered fractions. This review is specifically addressed to the application of membrane technologies for the recovery of peptides from yeast protein hydrolysates. Fundamental concepts and practical aspects relative to protein separation of agro-industrial protein hydrolysates by membranes will be described. Challenges and perspectives involving the recovery of peptides from yeast protein hydrolysates will be presented and thoroughly discussed.

**Keywords:** *Saccharomyces* sp.; protein hydrolysis; membrane separation technology; ultrafiltration; membrane-peptide interactions

## 1. Introduction

Membrane separation technologies have been successfully applied and can be considered as an integral part of the downstream processing of agroindustrial, food, pharmaceutical and biotechnological products. These industries annually produce huge amounts of by-products that not only have high chemical and oxygen demand but also require proper handling and disposal. For these reasons, these by-products represent a serious economical and environmental concern worldwide. In an attempt to address these issues and to promote a more sustainable economy, processing technologies are being developed to foster the reuse and recovery of potential high value-added compounds from those streams [1,2].

Separation processes for the treatment of bio-based by-products demand productive, efficient and sufficiently robust technologies to account for the intrinsic variability and sometimes fluctuating

29 availability of some by-products throughout the year. The treatment of agroindustrial by-products  
30 involves an elaborate approach because those materials have a complex composition and a high organic  
31 load, thus requiring specific extraction prior to separation [3]. Membrane processing technologies  
32 usually offer high throughput associated with very good product purity, thereby allowing an efficient  
33 wastewater treatment approach (to produce recycling water) as well as recovery of several valuable  
34 by-product components [2,4,5]. With these technologies, one can combine productivity with separation  
35 efficiency and reduce the number of processing steps. Different objectives can be achieved, such as  
36 clarification, fractionation, purification and concentration [6,7].

37 The brewing industry produces several tons of spent brewer's yeast (SBY) per year. As with  
38 other bio-based by-products, this residue has a high oxygen demand that needs to be managed  
39 properly [8]. The potential for re-utilisation and transformation of this material has been addressed  
40 by several authors in an attempt to reduce the environmental impact of beer production and to  
41 promote the valorisation of a nutrient-rich by-product. SBY consists of yeast cells collected after  
42 fermentation/maturation of beer and is quite rich in proteins (40-50%, d.w.), carbohydrates, vitamins,  
43 minerals and other compounds of interest for the food and pharmaceutical industries, such as  
44  $\beta$ -D-glucans, 5'nucleotides, complex B vitamins and bioactive peptides [9-11].

45 The release of peptides from SBY requires steps such as chemical or mechanical cell wall rupture  
46 and proteolytic hydrolysis to ensure cell wall disruption and transformation of proteins into peptides  
47 [12]. The resulting yeast extract contains several macro and micronutrients that need to be properly  
48 separated before they can be applied as new ingredients. Thus, aiming at a more purified product,  
49 with a higher protein content and fewer contaminants, the hydrolysate needs to be treated. Separation  
50 and fractionation of yeast proteins can be carried out by chromatographic methods [13,14], which have  
51 high selectivity but very high operating costs; moreover, they are not simple to scale up [15].

52 Sometimes, membrane separation processes are used before enzymatic hydrolysis with the  
53 objective of performing hydrolysis of specific fractions. Amorim *et al.* [16] ultrafiltered ( $10 \text{ kg mol}^{-1}$ ) an  
54 SBY autolysate before enzymatic hydrolysis with a *C. carduculus* extract. After hydrolysis, a  $3 \text{ kg mol}^{-1}$   
55 ultrafiltration step and reverse osmosis were carried out. Versatile and continuous separation and  
56 hydrolysis can be performed simultaneously in enzymatic membrane reactors. This procedure has  
57 been used for production of protein hydrolysates from fish, milk and other products [17,18]. Despite  
58 these applications, major use of membrane technologies is still in the downstream stages of separation  
59 of protein hydrolysates from complex matrices [16,19]. Membrane separation technology has been  
60 used to fractionate and concentrate protein hydrolysates of by-products with biological and functional  
61 properties [15,20-22], including SBY peptides [9,16,23].

62 Properties of peptides and proteins depend on their sequence and structure. Thus, their  
63 separation from mixtures of complex composition must be carried out by mild methods (low  
64 temperatures and pH value close to neutrality) with high selectivity, in order to maintain the  
65 structural and physicochemical characteristics of molecules, as ensured by many membrane separation  
66 technologies [24-26]. Separation performance is determined by membrane selectivity and permeate  
67 flux, which are dependent on operating conditions (temperature, pressure, process configuration,  
68 module characteristics, cleaning procedure), membrane properties (membrane material and structure,  
69 membrane pore size) and feed characteristics (pH, concentration, composition and physicochemical  
70 characteristics of feed components) [27,28]. The intended purpose of separation is also an important  
71 aspect of process design [2].

72 This review is a state-of-the-art of membrane processes applied to fractionation of protein  
73 hydrolysates from agro-industrial by-products, mainly from spent yeasts. The following section  
74 focus on the current strategies, challenges and solutions for the application of this technology to the  
75 downstream processing of protein hydrolysates. Then, the use of charge-based membrane separation  
76 techniques is presented. Finally, particularities involving the separation of SBY protein hydrolysates is  
77 discussed by taking into account engineering, technical and practical aspects of membrane processes.

## 78 2. Processing of Protein By-Products Using Pressure-Driven Membrane Operations

79 Figure 1 shows a schematic flow of potential unit operations involved in the transformation  
80 of agroindustrial and biotechnological by-products into value-added protein-rich ingredients. The  
81 transformation of by-products from biotechnological, food and agroindustrial processing begins with  
82 stabilisation of the material. This step is usually performed by thermal treatments that are able  
83 to inactivate endogenous enzymes that may alter the characteristics of the by-products until they  
84 are processed. Another important consideration is that the processing of by-products may not be  
85 performed in the same plant where the material is produced. For this reason, pre-treatments may be  
86 envisaged to ensure the microbiological safety of the material until further processing. Unit operations  
87 such as milling, drying, thermal treatments and conventional filtration can be used for this purpose [1].

88 The next step is to properly release proteins from the original structure of the material. The  
89 extraction step is usually essential for transformation of by-products because of their complex  
90 composition and the usually low initial availability of the compounds of interest. Protein extraction  
91 from food and biotechnological matrices is achieved by chemical extraction methods, ultrasound  
92 technology and, most often, enzymatic treatments. Extraction has been successfully applied for  
93 the recovery of value-added components from by-products at the expense of complex and efficient  
94 separation [1]. Following extraction, a complex pool of protein fractions and peptides is obtained in  
95 addition to many other original compounds of the material, such as polysaccharides, fibres, minerals,  
96 vitamins, nucleic acids, etc. The resulting extract usually needs to be treated to ensure higher  
97 performance in the next downstream processing stages. Several technologies are used for this purpose,  
98 namely centrifugation, protein precipitation, conventional filtration or use of adsorbents (activated  
99 carbon, diatomaceous earth) and MF membranes [3,4]. MF is largely employed to reduce microbial  
100 count and macromolecules such as non-hydrolysed proteins, lipids, fibres and other aggregates, while  
101 retaining suspended colloidal particles produced during fermentation and processing [29]. MF also  
102 contributes to the clarification of solutions prior to fractionation steps.

103 The recovery of compounds of interest will require one or more fractionation steps, usually  
104 achieved using UF, followed by purification or concentration steps, per requirement of the targeted  
105 ingredient, as shown in Figure 2. UF is the main pressure-driven process used in the processing  
106 of proteinaceous solutions because UF MWCOs fit the size range of proteins and their fractions  
107 [4,30]. Downstream processing of protein hydrolysates by a properly designed UF cascade and  
108 recycling loops is able to refine several bioactive peptide fractions at once, possibly improving their  
109 functional/biological activity by increasing peptide purity [3,29].

110 The first step of protein and peptide fractionation involves the use of higher MWCO UF  
111 membranes (500-50 kg mol<sup>-1</sup>), intended to reject intact/non-extracted proteins, fibres, polysaccharides  
112 and other macromolecules that were not removed in previous steps. One or more fractionation  
113 steps can be performed in this MWCO range. High molecular weight peptides with emulsifying  
114 and stabilising activities may be recovered in the first retentate fractions, as shown in Figure 2. The  
115 last permeate from the fractionation cascade at 500-50 kg mol<sup>-1</sup> goes on for further fractionation (UF  
116 membranes of MWCO of 50-1 kg mol<sup>-1</sup>, in order to recover bioactive peptides, which are ingredients  
117 rich in peptides or amino acids [3] (Figure 2).

118 Fractions of interest (permeate or retentate) from the fractionation cascade may be purified  
119 (decrease impurity concentration) and peptides can be even isolated, either due to application  
120 requirements (for example for pharmaceutical industry use) or for analytical purposes. Depending  
121 on the peptide mixture properties, peptides are isolated thanks to techniques based mainly on  
122 sieving (size-exclusion chromatography, low MWCO UF, NF), charge-based techniques (pH-induced  
123 precipitation, electrodialysis, ion-exchange chromatography - as discussed in section 3), techniques that  
124 detect differences in hydrophobic interactions (solvent precipitation, reversed-phase chromatography)  
125 or even affinity and special attribute molecular methods (affinity chromatography, immunoaffinity).  
126 While chromatographic methods are mainly used for analytical purposes, the NF membrane technique

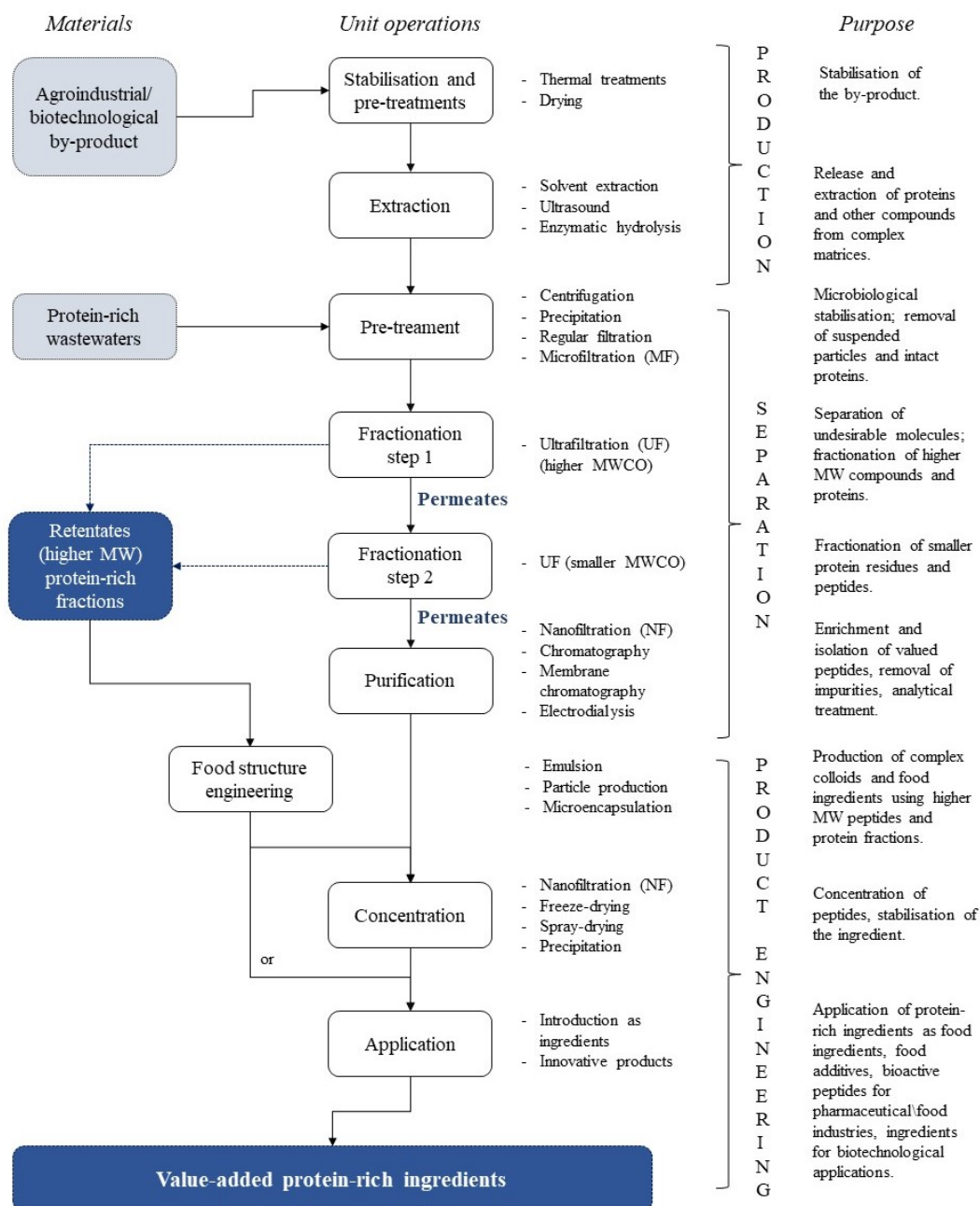
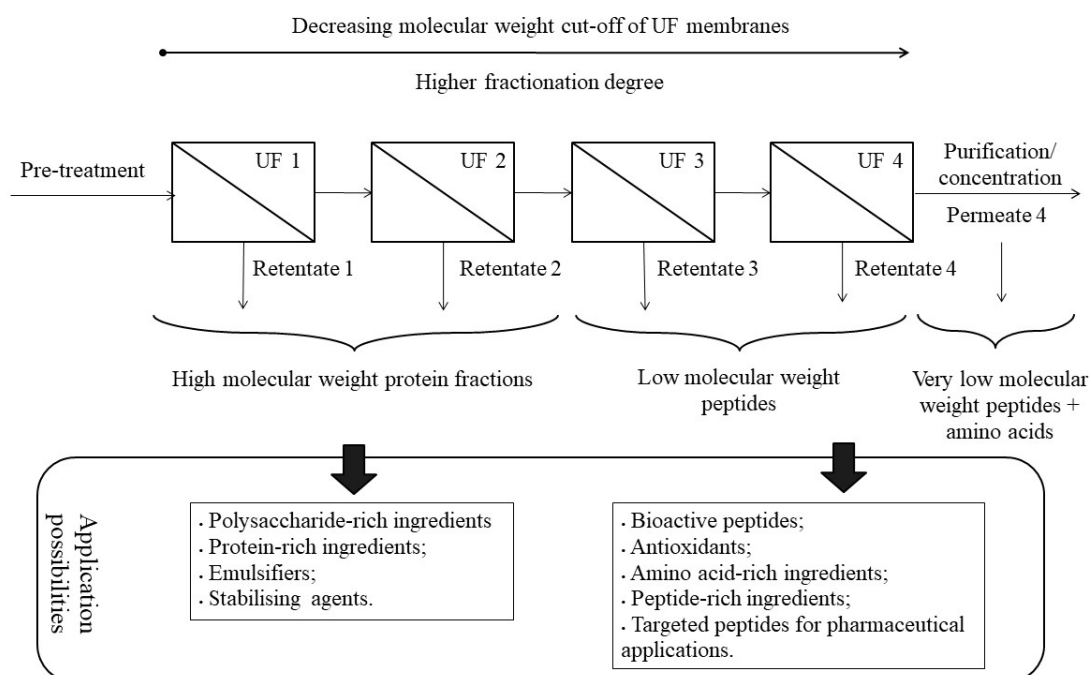

Figure 1. Strategy of processing of agroindustrial, food and biotechnological protein-rich by-products into value-added ingredients



**Figure 2.** Ultrafiltration (UF) fractionation cascades for the recovery of several protein and peptides-based ingredients, using 500-1 kg mol<sup>-1</sup> molecular weight cut-off membranes

127 is one of the industrial processes most frequently used to purify low molecular weight peptides,  
 128 employing membranes in the range of 100-1000 g mol<sup>-1</sup> [3,4].

129 The concentration step of the resulting streams is not mandatory but, depending on the  
 130 end-application of the ingredients, it is a recommended procedure. The use of bioactive peptides  
 131 or other isolated protein fractions is sometimes not practicable in small concentrations. Thermal or  
 132 chemical processes such as dehydration, rotary or vacuum evaporation and chemical precipitation  
 133 might be used but they are employed less and less because most bioactive peptides are thermolabile  
 134 and may be denatured while losing activity in the presence of chemicals and solvents. Instead, NF,  
 135 reverse osmosis and spray-drying are preferred technologies because they consume a smaller amount  
 136 of chemicals and energy [3,29]. Spray-drying may be successfully used to protect bioactive peptides  
 137 and extend their shelf-life when appropriate process parameters are employed and the characteristics  
 138 of each matrix are taken into account [29,31,32].

139 In sum, the design of an efficient fractionation process for peptide mixtures issued from enzymatic  
 140 hydrolysis requires knowledge of: (1) target peptide or protein fraction properties (amino acid sequence,  
 141 mass ratio, isoelectric point, hydrophobicity, bioactive properties), (2) rigorous characterisation of feed  
 142 composition and sensitivity of feed components to processing conditions and (3) presence of main  
 143 contaminants that may need to be separated from the target protein fractions [3].

#### 144 2.1. Membrane Fractionation of Protein Hydrolysates: Challenges, Limitations, Advantages and Solutions

145 Membrane separation processes offer several advantages; for example, low energy requirements  
 146 in comparison to conventional concentration processes, high selectivity, wide range of applications,  
 147 modular design, simplicity in continuous operation, integration and scaling up [2,4,25]. In the  
 148 context of protein hydrolysate separation, membrane processes are able to maintain protein stability  
 149 throughout the process, and a high resolution separation is possible at ambient/low temperatures.

150 They do not require the use of solvents and other chemicals [2,30]. Indeed, several biotechnological  
151 and pharmaceutical applications count on those advantages to obtain high-resolution fractions [4,5].

152 Membrane and process operations to conduct bio-separations may involve high costs, specially  
153 for establishing the installed membrane area (e.g., the price of new membranes and their modules).  
154 However, the value added to the recovered product is usually more significant. An increase of 8-10%  
155 in sales of membranes and modules for food processing and water treatment applications may lead to  
156 a gradual decrease of membrane technology costs [1,2].

157 Main limitations of the separation of protein-rich products by membranes are fouling and limited  
158 selectivity. Proteins are easy foulants because they have a complex molecular structure and multiple  
159 charged groups that readily interact with the membrane surface, water and ions, with the later  
160 affecting their real size and solubility [3,33]. Fouling control strategies are indispensable to maintain  
161 acceptable flux levels and ensure microbiologically safe membrane operations, minimising the growth  
162 of microorganisms and the formation of bio-films [2].

163 Several solutions are being investigated to improve mass transfer and limit fouling formation.  
164 Hydrodynamic management strategies include the use of different modules that ensure operation at  
165 turbulent regimes. Intelligent membrane cleaning methods are becoming more efficient with deeper  
166 knowledge of foulant complexity and composition. Operations such as back flushing and pulsing,  
167 and use of non-conventional technologies (pulsed electric fields and ultrasound) have been reported  
168 to improve cleaning and even mass transport in UF [1]. The application of electric fields with NaCl  
169 was able to completely clean a zirconium dioxide/titanium dioxide UF membrane of  $15 \text{ kg mol}^{-1}$   
170 MWCO fouled with whey model solutions [34]. Ultrasound technology has been used to enhance  
171 permeate flux, showing 10-20% enhancement for 1 MHz (whey UF at a transmembrane pressure  
172 smaller than 1.5 bar and  $0.28 \text{ m s}^{-1}$  cross-flow velocity). For ultrasound frequencies of 20-40 MHz,  
173 large bubbles result in the formation of shock-waves, and at ranges of 100-1000 MHz, although smaller  
174 bubbles are formed, high temperature foci can be an issue. The mechanisms involved in flux enhancing  
175 and the cleaning effects of ultrasound are yet not clear (higher turbulence vs sonication effects) [35].  
176 The development of new engineered membrane materials is also a prominent field in membrane  
177 technology. Surface modification is aimed at improving membrane resistance to protein adsorption  
178 and to increase permeation of hydrophobic membranes. The increase of surface hydrophilicity can  
179 effectively minimise protein adsorption, improve membrane permeability and prevent membrane  
180 fouling [2,5].

181 The understanding of critical flux and fouling phenomena can be used as a strategy to maintain  
182 high selectivity and mass throughput of UF and NF operations. Working within the limits of the  
183 pressure control region (low pressures, low volumetric reduction factors and feed concentrations) can  
184 reduce fouling and increase separation performance. After a determined concentration of solutes on  
185 the membrane surface (the mass transfer controlled region), higher productivity can only be achieved if  
186 there is an increase in the mass transfer coefficient [3,5,36]. The detailed investigation of mass transfer  
187 and thorough description of fouling mechanisms through theoretical and modelling studies have  
188 provided fundamental insights that are imperative to further improvements in membrane performance.  
189 Indeed, the investigation of fouling mechanisms and the development of flux prediction models  
190 through simulation and computer-based techniques are of great interest. So far, no model is universally  
191 applicable or satisfactory, but as simulation evolves, phenomena description and understanding, as  
192 well as technology maturity, also evolve. Recently, there has been a multi-objective optimisation  
193 of design and operational conditions to maximise product yield and purity for fractionation of fish  
194 by-product protein hydrolysates using UF and NF. The proposed modelling strategy included the  
195 implications of economical and environmental aspects in the optimisation of technical objectives, such  
196 as high purity and product yield [37]. Thus, efficient solutions to reduce fouling and increase selectivity  
197 and productivity of membrane processes are being developed [30,38].



### 198 3. Peptide Separation and Purification by Charge

199 The separation of peptides and protein fractions depend on their charge and interactions. In  
200 this context, charge-based membrane separations can be used as a next separation step after UF  
201 or as another separation strategy, depending on the envisaged separation outcome. Charge-based  
202 membrane separations depend on the conductivity of feed streams, which are usually low (food  
203 and biotechnology). These processes also have higher energy requirements than conventional  
204 membrane processes, and heat may be produced, depending on the technique, which could result in  
205 the degradation of molecules. Despite those limitations, charge-based membrane separation processes  
206 are aligned with the researchers' efforts to improve peptide refining and can replace chromatography,  
207 which is mostly used for analytical purposes [29]. Several simultaneous size and charge-based  
208 separation techniques are available, including high-performance tangential flow filtration (HPTFF),  
209 electrophoretic membrane contactor processes, membrane chromatography, electrically enhanced  
210 membrane filtration (EMF), UF using charged membranes, electro-ultrafiltration using pulsed fields,  
211 electro dialysis and electro dialysis using UF membranes (EDUF) [1,3,4]. Among them, one of the most  
212 promising techniques recently used for peptide separation is electro dialysis.

213 Electro dialysis is a membrane technology that employs ion-exchange membranes. Separation in  
214 electro dialysis processes is based on an electrical potential driving force. Species mobility depends  
215 not only on their electrophoretic mobility but also on sieving effects (as is the case of EDUF). The  
216 extent of mass flow depends on the electrophoretic mobility of peptides, on the presence of other  
217 charged components in the feed, and on the solution's pH. Because each species migrates at a specific  
218 rate, depending on the configuration previously selected, several outlet streams can be obtained  
219 simultaneously, and each of them is enriched in a specific peptide or species [4,39]. When porous  
220 membranes are employed in EDUF, they act as electrophoretic membrane contactors, in which  
221 separation occurs while taking into account charge and molecular weight peptide differences. This  
222 technology has been reported as a very selective one, capable of separating targeted peptides from  
223 complex mixtures [40]. Several studies explored the use of EDUF in the separation of bioactive peptides  
224 and other charged molecules of interest from complex mixtures and residues from sea food by-products  
225 [41,42].

226 The simultaneous separation of anionic and cationic peptides from a herring milt hydrolysate by  
227 EDUF using UF membranes of 50 and 20 kg mol<sup>-1</sup> MWCO was reported [41]. Peptide migration rates  
228 through the first membrane were 44 and 20 fold higher for anionic and cationic peptides, respectively,  
229 in comparison to the second membrane. EDUF at pH 7.0 allowed the separation of peptides with  
230 positively charged arginine and lysine in the cationic recovery compartments and peptides with  
231 negatively charged asparagine and glutamine in the anionic recovery fractions. Durand *et al.* [41]  
232 found that the anionic fraction obtained after the 50 kg mol<sup>-1</sup> MWCO membrane had the highest  
233 antioxidant activity whereas anti-inflammatory activities were higher in the cationic fractions collected  
234 after the first and second membranes. EDUF using 20 kg mol<sup>-1</sup> MWCO UF membranes enabled  
235 the separation of arginine-containing peptides in a defatted flaxseed protein hydrolysate, enhancing  
236 hypotension effects *in vivo* of fractions, since these effects have been associated with the presence of  
237 arginine in active peptides [43]. EDUF has recently been considered for large scale peptide production  
238 in substitution to several chromatographic operations. EDUF was exploited as a tool to ease the  
239 isolation of antihypertensive peptides from a protein hydrolysate of rapeseed protein isolate. An  
240 anionic peptide fraction with 44% negatively-charged amino acids and a cationic peptide fraction with  
241 28% positively-charged amino acids were recovered after 6 h of operation in an with EDUF process that  
242 employed 20 kg mol<sup>-1</sup> MWCO membranes. At a feed concentration of 1.7 mg of peptides per mL, the  
243 system could operate for 18 h without any indication of membrane fouling [44]. The sustainable aspect  
244 of EDUF was explored in the valorisation of the bovine cruor, i.e., the red cells fraction of the blood  
245 by-product from slaughterhouse processing. A positively charged antimicrobial peptide, obtained  
246 from hemoglobin, was enriched 24 fold using a 10 kg mol<sup>-1</sup> MWCO membrane [40]. Associated costs  
247 of producing peptides from EDUF technologies was reported to range from 0.3 to 0.5 Canadian dollars

per gram of peptides for an effective filtration area of 10 m<sup>2</sup> [43]. These results indicate a great potential of this technology in the field of recovery of peptides from by-products. Higher migration rates and production at larger scale are some of the perspectives of EDUF. However, these perspectives face three major challenges: understanding the underlying mechanisms of transport in complex matrices, finding ways to enhance peptide migration while keeping quality and reducing the high costs of this technology.

#### 4. Membrane Fractionation and Purification of Yeast Protein Hydrolysates: Recovery of Bioactive Peptides

##### 4.1. Challenges Involving Yeast-Products Separation by Membranes

Figure 3 shows how some membrane technologies can be used in the recovery of protein-rich fractions and peptides from yeast protein hydrolysates and which components are involved during processing. Cultivated and spent yeast protein hydrolysates are very complex matrices after disruption and enzymatic hydrolysis. Pre-treatments are usually capable of removing most of the high molecular weight compounds that may disturb protein and peptide fractionation performance, such as cell debris, non-hydrolysed proteins and other non-protein components (section 2), which are reported to hinder the resolution of analytical techniques, if they are not removed [9].

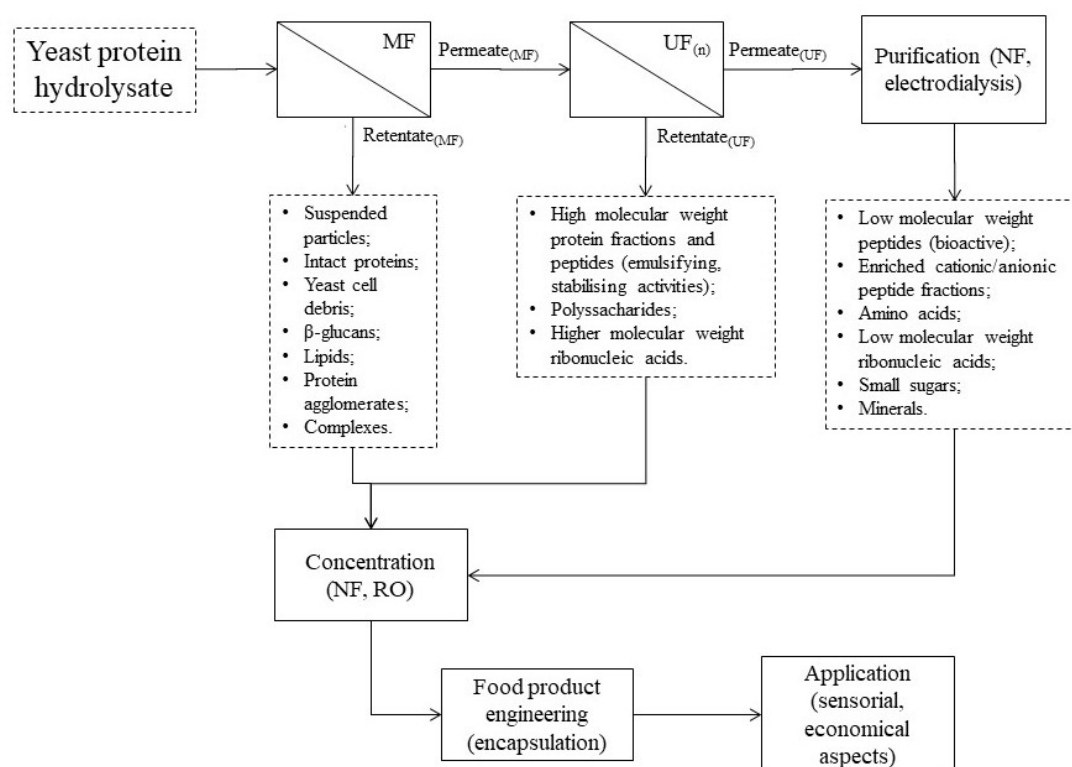

**Figure 3.** Use of membrane separation technology in the recovery of protein-rich ingredients and bioactive peptides from yeast protein hydrolysates and the main compounds recovered in fractions.

MF: microfiltration; UF: ultrafiltration; (n): number of ultrafiltration fractionation steps; NF: nanofiltration; RO: reverse osmosis.

Feed composition is one of the important factors to be considered in the design of an efficient separation process. Table 1 shows the composition of macronutrients of SBY protein hydrolysates produced via enzymatic processes. Proteins constitute the main compound present, followed by polysaccharides. Smaller amounts of ashes, lipids, minerals and vitamins are also found. Ribonucleic

268 acids are an important component of yeast products because they can limit product consumption  
 269 if they are found in high amounts in the end-product (>3%, d.w.). In humans, nucleic acids are  
 270 metabolised to uric acid, which can be involved in conditions such as kidney stones formation or gout  
 271 [45].

**Table 1.** Macronutrients composition in spent brewer's yeast protein hydrolysates produce using enzymatic hydrolysis.

Macronutrients (g 100 g <sup>-1</sup> , d.w.)	SBY enzymatic hydrolysate <sup>A</sup>
Total nitrogen	1.5-12.0
Protein nitrogen	9.3-69.0
Free amino nitrogen	28-35
Ribonucleic acids	5.6
Total sugars	3.0-48
Lipids	0.2-1.0
Ashes	3.0-22.0

All composition data are expressed in dry weight (d.w.). Because protein content is determined using various analytical techniques and calculations, we presented only protein nitrogen data (considering original conversion factors) and the corresponding total nitrogen content. References: <sup>A</sup>[9,12,16,46,47].

272 During peptide fractionation, the main reported foulants are protein fragments (which, depending  
 273 on the conditions, may form aggregates or complexes with ribonucleic acids (RNA) or polysaccharides),  
 274 fibres such as  $\beta$ -glucans and other polysaccharides complexes [16,45,48]. The recovery of  $\beta$ -glucans  
 275 might take place before peptide fractionation, because of the difference of molecular weight range of  
 276 those molecules. UF conditions using 100 kg mol<sup>-1</sup> MWCO membranes were optimised to recover  
 277 high molecular weight  $\beta$ -glucans from oat mill waste [49]. This strategy was still not reported for SBY  
 278 or other spent yeasts (from sugarcane and distilleries) but membrane technologies (MF and 10-100 kg  
 279 mol<sup>-1</sup> UF MWCO membranes) have been successfully employed in the recovery of  $\beta$ -glucans from  
 280 cereals, algae and mushrooms [50,51].

281 The pI of yeast proteins is around 4-5 [45], but there are no studies to date on the effect of pH in  
 282 the separation of spent yeast hydrolysates. Salt content in protein hydrolysates is not often determined  
 283 because the concentrations are usually not high compared to the other components. On the other hand,  
 284 in yeast hydrolysates salt content may be relevant depending on hydrolysate processing conditions,  
 285 because during autolysis salts can be added to increase the extent of cell rupture [45,52]. If there is a  
 286 high concentration of salts, which affect the ionic strength of the medium, it can probably alter mass  
 287 transport properties during membrane operations. Those particular composition details are necessary  
 288 to develop an adequate separation strategy capable of fractionating proteins from SBY.

289 The use of yeast as a food ingredient can be limited by its high content of RNA, which is often  
 290 extracted with protein molecules by conventional methods [45]. Processing strategies to promote the  
 291 decrease of RNA content in yeast products are usually limited to the extraction step. Chemical methods  
 292 are used to precipitate ribonucleic acids, but important amounts of proteins are precipitated as well.  
 293 Differences in RNA and protein structure and their charge suggest that the separation of RNA from  
 294 protein fractions in spent brewer yeast protein hydrolysates could be performed by using membrane  
 295 separation technologies. Recently, diluted torula yeast (mixture of heterogeneous RNA) solutions  
 296 have been separated in polyethersulfone and regenerated cellulose UF membranes. Experiments were  
 297 made in amicon cells of 4.1 cm<sup>2</sup> of effective filtration area, at room temperature and low pressure (0.06  
 298 to 0.90 bar). Adsorption of RNA in regenerated cellulose membranes was significant but this effect  
 299 was minimal in polyethersulfone. In polyethersulfone membranes of 300 kg mol<sup>-1</sup> MWCO, 95% of  
 300 RNA was permeated, while 50 and 100 kg mol<sup>-1</sup> MWCO membranes were able to reject most of the  
 301 RNA at low flux [53]. In another study, Manzano *et al.* [54] evaluated synthesised RNA transmission  
 302 in polyethersulfone UF membranes of 50, 100 and 300 kg mol<sup>-1</sup> MWCO. RNA structure (hairpin or  
 303 linear, with an equivalent number of nucleotides) affected the extent of transmission. This finding

304 was attributed to the effective size of the molecule, which depends on the molecule structure. RNA  
305 transmission at pH 7.5 was enhanced upon the addition of NaCl (100 mM), which is believed to affect  
306 molecule size and alter the ionic strength of the medium, causing electrostatic repulsion between the  
307 negatively-charged polyethersulfone membrane and negatively-charged RNA. Additional studies are  
308 required to explain RNA transmission mechanisms and to explore RNA separation in more complex  
309 matrices, such as in yeast extracts and protein hydrolysates of SBY.

310 In sum, there are various challenges involving membrane separation of yeast-based by-products  
311 such as SBY. The complex composition suggests that the choice and conditions of the membrane  
312 separation process should consider precise separation objectives. Several streams may be produced  
313 for the recovery of target compounds, and the maximum valorisation of these streams needs to occur  
314 whenever possible. The development of sustainable processes that take into account all the fractions  
315 generated and all spheres of the process is extremely important to maintain the environmental and  
316 economic viability of the technology, especially when the transformation of by-products is envisaged.  
317 The selection of the pre-treatment process, membrane, module, feed conditions (pH, concentration,  
318 ionic strength) and operational conditions is decisive to achieve maximum membrane performance  
319 during the filtration of spent yeasts protein hydrolysates.

#### 320 4.2. Strategy of Fractionation of SBY and Yeast Protein Hydrolysates

321 Tables 2 and 3 show the state-of-the-art of fractionation and concentration of protein hydrolysates  
322 from cultivated *Saccharomyces* sp. cells, spent yeasts from distilleries, sugar cane processing and  
323 brewing (SBY), and the respective discussion is presented in the following paragraphs.

324 The concentration of SBY proteins and polysaccharides was carried out with MF and UF  
325 polyethersulfone membranes (0.2  $\mu\text{m}$  and 5  $\text{kg mol}^{-1}$  MWCO) and yield of about 95% for both proteins  
326 and polysaccharides was obtained. The influence of yeast extract concentration, feed pH and operating  
327 pressure on the yield of polysaccharides and protein nitrogen was investigated using response surface  
328 methodology (Box-Behnken design). Optimised separation conditions were determined at the centre of  
329 the study ranges: 2.7% (m/m) feed concentration at pH 5.0 and 0.97 bar of operating pressure, but the  
330 study did not explain why these conditions were the optimal ones concerning mass transfer and SBY  
331 characteristics [48]. In several studies of the another research group, UF membranes of 30  $\text{kg mol}^{-1}$  and  
332 10  $\text{kg mol}^{-1}$  MWCO were used to fractionate a protein hydrolysate from cultivated *S. cerevisiae* before  
333 the freeze-dried yeast extracts were used in *in vitro* and *in vivo* determinations of anti-obesogenic and  
334 anti-stress activities of yeast peptides [55–61].

335 With the intent of creating innovative ingredients rich in polysaccharide and protein from SBY,  
336 series of ultra and nanofiltrations before and after hydrolysis (10 and 3  $\text{kg mol}^{-1}$  MWCO) were  
337 performed in a pilot system, resulting in four fractions. Proteins were mainly present in the higher  
338 molecular weight fractions while polysaccharides were mostly represented by simple sugars released  
339 by the autolysis process, in smaller molecular weight fractions. Minerals were fractionated as well:  
340 sodium concentration in the most concentrated fraction differed from 4 to 24 fold to others. Free amino  
341 acid profile also was changed by UF, thus indicating that the fractionation process can be developed to  
342 refine specific free amino acids. SBY amino acids such as glutamine, glutamic acid, arginine, alanine,  
343 tyrosine and valine were enriched in permeates of 3  $\text{kg mol}^{-1}$  MWCO membranes. Maximum total free  
344 amino acid content was concentrated by 55 fold [16].

**Table 2.** Fractionation of yeast (*Saccharomyces* sp.) protein hydrolysates: membrane technology and chromatography in the production of bioactive peptides

Yeast	Fractionation/Concentration	Peptide analytical techniques	Purpose	References
Sugarcane spent yeast ( <i>S. cerevisiae</i> )	Fractionation: UF cartridges (5 kg mol <sup>-1</sup> MWCO) and FPLC with IMAC-Fe(III) resin chromatography. Concentration by freeze-drying.	-	Iron-chelating peptides	[62]
Cultivated yeast ( <i>S. cerevisiae</i> )	Fractionation: UF cartridges (10 and 30 kg mol <sup>-1</sup> MWCO). Concentration by freeze-drying.	-	Peptides with anti-obesogenic and anti-stress properties	[55–61,63]
Cultivated yeast ( <i>S. cerevisiae</i> )	Fractionation: UF (10, 5 and 3 kg mol <sup>-1</sup> MWCO) and RP-HPLC (C <sub>18</sub> column). Concentration: freeze-drying.	MS (MALDI-TOF-TOF) for peptide sequencing	Peptides with antioxidant activity	[64]
Cultivated yeast ( <i>S. cerevisiae</i> )	Fractionation: Dialysis (6-8 kg mol <sup>-1</sup> MWCO) and RP-SPE cartridges (C <sub>18</sub> ). Concentration: vacuum-evaporation.	RP-HPLC (C <sub>18</sub> column)	Glyco-peptide with anti-inflammatory activity	[65]
Cultivated yeast ( <i>S. cerevisiae</i> K-7)	Fractionation: lab-scale UF (5 kg mol <sup>-1</sup> MWCO); SEC (Sephadex G-25) and RP-HPLC (C <sub>18</sub> column). Concentration: freeze-drying	LC-MS (peptide sequencing)	Anti-angiogenic peptides	[66]

UF: ultrafiltration; MWCO: molecular weight cut-off; FPLC: Fast Protein Liquid Chromatography; IMAC: Immobilised metal affinity chromatography; RP: reversed-phase; HPLC: high-performance liquid chromatography; SPE: solid phase extraction; SEC: size-exclusion chromatography; MS: mass spectrometry; MALDI: Matrix-assisted laser desorption/ionisation; TOF: Time-of-Flight; LC: liquid chromatography; ACE-I: inhibitory activity of the angiotensin-converting enzyme.

**Table 3.** Fractionation of protein hydrolysates from spent yeasts from brewing: membrane technology and chromatography in the obtention of bioactive peptides

Yeast	Fractionation/Concentration	Peptide analytical techniques	Purpose	References
SBY	Fractionation: adsorbing column (Amberlite XAD-2 resin), SEC (Sephadex G-25), RP-HPLC (C <sub>30</sub> column). Purification: gel filtration phase HPLC (Diol column)	LC/MS/MS (amino acid sequencing)	Peptides with ACE-I activity	Kanauchi <i>et al.</i> [13]
SBY	Fractionation: UF (10 kg mol <sup>-1</sup> MWCO). Concentration: acid precipitation, activated carbon adsorption.	HPLC (peptide profile)	Antioxidant and anti-diabetic peptides	Jung <i>et al.</i> [23]
SBY	Fractionation: UF module of effective permeation area of 7.4 m <sup>2</sup> (10 and 3 kg mol <sup>-1</sup> MWCO). Concentration: Reverse osmosis and freeze-drying.	RP-HPLC (C <sub>18</sub> column); MS (MALDI-TOF-TOF for amino acid sequencing)	Nutritional ingredient rich in protein and polysaccharides <sup>1</sup> ; peptides with antioxidant and ACE-I properties <sup>2</sup>	Amorim <i>et al.</i> [16] <sup>1</sup> ; Amorim <i>et al.</i> [67] <sup>2</sup>
SBY ( <i>S. pastorianus</i> )	Fractionation: NF in amicon cell (3 kg mol <sup>-1</sup> MWCO). Concentration: freeze-drying.	SEC (Superdex 200 and Superdex peptide 10/300GL)	Peptides with ACE-I activity	Amorim <i>et al.</i> [10]
SBY	Fractionation: MF and UF in hollow fibres with effective permeation area of 0.05 m <sup>2</sup> (0.2 μm and 10 kg mol <sup>-1</sup> MWCO).	-	Polysaccharide and protein-rich fractions	Huang <i>et al.</i> [48]
SBY ( <i>S. pastorianus</i> )	Fractionation: UF in flat sheet module of effective permeation area of 0.0016 m <sup>2</sup> (30 and 10 kg mol <sup>-1</sup> MWCO).	Electrophoresis (SDS-PAGE)	Antioxidant peptides	Marson <i>et al.</i> [9]

SBY: spent brewer's yeast; MF: microfiltration; UF: ultrafiltration; NF: nanofiltration; MWCO: molecular weight cut-off; RP: reversed-phase; HPLC: high-performance liquid chromatography; SEC: size-exclusion chromatography; MS: mass spectrometry; MALDI: Matrix-assisted laser desorption/ionisation; TOF: Time-of-Flight; LC: liquid chromatography; ACE-I: inhibitory activity of the angiotensin-converting enzyme; SDS-PAGE: sodium dodecyl sulfate-polyacrylamide gel electrophoresis.

345 Notably, UF (MWCO of 30-3 kg mol<sup>-1</sup>) is one of the main fractionation tools applied for the  
346 separation of yeast protein hydrolysates. The application of membrane technology for those products  
347 was reported in different scales (from the use of UF cartridges and amicon cells to pilot-scale  
348 systems with a highly effective permeation area). Chromatographic techniques based on sieving  
349 (Size-Exclusion Chromatography - SEC) and based on hydrophobicity of peptides (Reversed-Phase  
350 High-Performance Liquid Chromatography - RP-HPLC) are also very common to promote the  
351 fractionation of yeast protein hydrolysate for analytical purposes. A protein hydrolysate of cultivated  
352 *Saccharomyces cerevisiae* cell produced by using trypsin was fractionated by capillary reversed-phase  
353 liquid chromatography (RPLC) [14]. Jung *et al.* [23] studied several processes to concentrate SBY  
354 hydrolysates (acid precipitation, activated carbon, UF and a combination of these) and reported a  
355 better performance with UF (10 kg mol<sup>-1</sup> MWCO), allowing for a 20-fold concentration of a specific  
356 peptide (Cyclo-His-Pro) in comparison to its initial concentration. As shown in Tables 2 and 3,  
357 concentration of yeast hydrolysates is mainly performed by freeze-drying, but NF, RO - as well as  
358 conventional techniques (vacuum evaporation and precipitation) - have also been reported.

359 To summarise, the use of UF and NF in the fractionation and concentration of peptides and  
360 other components of yeast is increasing. In most studies, membrane technology is used simply as  
361 a tool, and the separation process is not explored in terms of process parameters. Mass transfer,  
362 fouling and concentration polarisation phenomena, effect of feed characteristics (composition, pH,  
363 ionic strength, concentration) and interactions between the membrane material and SBY hydrolysate  
364 still have not been reported. The study of the phenomena and the factors that influence the application  
365 of this technology to obtain peptides from SBY and other yeasts is important to ensure an efficient  
366 and cost-effective separation. Operational costs are a very relevant concern in the processing of  
367 by-products and waste streams with spent yeasts [1,8]. Further studies focused on the comprehension  
368 of fouling phenomena and mass transfer mechanisms are still needed to improve and extend the scope  
369 of membrane technology to the production of peptides from cultivated and spent yeasts.

## 370 5. Conclusions

371 The consistent application of membrane separation technologies on the recovery of value-added  
372 compounds such as bioactive peptides from agroindustrial and biotechnological by-products  
373 depends on the development of integrated processes adapted to the specificities of those materials.  
374 High-resolution fractions can be obtained if a well designed strategy is chosen - from by-product  
375 extraction to downstream processing and product engineering.

376 Peptide and protein fractionation should take into account the associated effects of feed, membrane  
377 and processing parameters so that maximum membrane performance is achieved and an economically  
378 viable recovery of peptides is possible. Integration of sieving and charge-based membrane techniques  
379 as well as the elucidation of underlying mechanisms of separation may improve the throughput of the  
380 technology, which is much required in bio-separations.

381 Several possibilities involve the recovery of value-added compounds from cultivated and spent  
382 yeasts. The production of fractions with high peptide content but with low content of RNA,  
383 polysaccharides and fibres poses a great challenge. The recovery of various fractions enriched  
384 in different high-added value components such as  $\beta$ -glucans, peptides for different applications,  
385 oligosaccharides, minerals and amino acids is possible for multiple fractionation processes and may  
386 increase the economical viability of yeast by-product processing.

387 **Author Contributions:** *Gabriela Vollet Marson*: Conceptualisation, Methodology, Formal Analysis, Investigation,  
388 Writing - Original Draft, Writing - Review & Editing, Visualisation, Funding Acquisition; *Marie-Pierre Belleville*:  
389 Conceptualisation, Writing - Review & Editing, Funding Acquisition, Supervision; *Stella Lacour*: Conceptualisation,  
390 Investigation, Writing - Review & Editing; *Miriam Dupas Hubinger*: Writing - Review & Editing, Funding  
391 Acquisition, Supervision, Project Administration.

392 **Funding:** This research was funded by FAPESP (São Paulo Research Foundation) [grant numbers #2016/18465-8,  
393 #2018/04067-6] <https://bv.fapesp.br/en/pesquisador/690998/gabriela-vollet-marson/>; National Council for  
394 Scientific and Technological Development - Brazil (CNPq), the Coordination for the Improvement of Higher

395 Education Personnel - Brazil (CAPES) - Financing Code 001 and by the European Membranes Institute (IEM)  
396 (Montpellier, France).

397 **Acknowledgments:** The authors are also thankful to the Food Engineering Doctoral Program of UNICAMP  
398 (Brazil), and GAIA Doctoral School and Institut Européen des Membranes (Université de Montpellier, France).

399 **Conflicts of Interest:** The authors declare no conflict of interest.

#### 400 Abbreviations

401 The following abbreviations are used in this manuscript:

402

SBY	Spent brewer's yeast
MF	Microfiltration
UF	Ultrafiltration
NF	Nanofiltration
RO	Reverse osmosis
MW	Molecular weight
MWCO	Molecular weight cut-off
HPTFF	High-performance tangential flow filtration
EMF	Electrically enhanced membrane filtration
EDUF	Electrodialysis using ultrafiltration membranes
RNA	Ribonucleic acids
403 FPLC	Fast Protein Liquid Chromatography
IMAC	Immobilised metal affinity chromatography
RP	Reversed-phase
HPLC	High-performance liquid chromatography
SPE	Solid phase extraction
SEC	Size-exclusion chromatography
MS	Mass spectrometry
MALDI	Matrix-assisted laser desorption/ionisation
TOF	Time-of-Flight
LC	Liquid chromatography
ACE-I	Inhibitory activity of the angiotensin-converting enzyme
SDS-PAGE	Sodium dodecyl sulfate-polyacrylamide gel electrophoresis

#### 404 References

- 405 1. Nazir, A.; Khan, K.; Maan, A.; Zia, R.; Giorno, L.; Schroën, K. Membrane separation technology for the  
406 recovery of nutraceuticals from food industrial streams. *Trends Food Sci. Technol.* **2019**, *86*, 426 – 438.  
407 doi:10.1016/j.tifs.2019.02.049.
- 408 2. Castro-Muñoz, R.; Barragán-Huerta, B.; Fíla, V.; Denis, P.C.; Ruby-Figueroa, R. Current Role of Membrane  
409 Technology: From the Treatment of Agro-Industrial by-Products up to the Valorization of Valuable  
410 Compounds. *Waste Biomass Valoriz.* **2018**, *9*, 513 – 529. doi:10.1007/s12649-017-0003-1.
- 411 3. Pouliot, Y.; Gauthier, S.F.; Groleau, P.E. Membrane-based fractionation and purification strategies for  
412 bioactive peptides. In *Nutraceutical proteins and peptides in health and disease*, 1st ed.; Mine, Y.; Shahidi, F.,  
413 Eds.; CRC Press: Boca Raton, USA, 2005; pp. 109–143. doi:10.1201/9781420028836.
- 414 4. Saxena, A.; Tripathi, B.P.; Kumar, M.; Shahi, V.K. Membrane-based techniques for the separation  
415 and purification of proteins: An overview. *Adv. Colloid Interface Sci.* **2009**, *145*, 1 – 22.  
416 doi:10.1016/j.cis.2008.07.004.
- 417 5. van Reis, R.; Zydney, A. Membrane separations in biotechnology. *Curr. Opin. Biotechnol.* **2001**, *12*, 208 –  
418 211. doi:10.1016/S0958-1669(00)00201-9.
- 419 6. Belleville, M.P.; Vaillant, F. Membrane technology for production of nutraceuticals. In *Functional Food*  
420 *Ingredients and Nutraceuticals: Processing Technologies*, 2 ed.; Shi, J., Ed.; CRC Press: Boca Raton, USA, 2016;  
421 pp. 217–234.



- 422 7. Ghosh, R. Chapter 18: Ultrafiltration-based Protein Bioseparation. In *Handbook of Membrane Separations: Chemical, Pharmaceutical, Food and Biotechnological Applications*, 1 ed.; Pabby, A.K.; Rizvi, S.S.H.; Sastre, A.M.,  
423 Eds.; CRC Press: Boca Raton, USA, 2009; pp. 497–512.
- 425 8. Mathias, T.R.d.S.; Alexandre, V.M.F.; Cammarota, M.C.; Mello, P.P.M.; Sérvulo, E.F.C. Characterization and  
426 determination of brewer's solid wastes composition. *J. Inst. Brew.* **2015**, *121*, 400–404. doi:10.1002/jib.229.
- 427 9. Marson, G.V.; de Castro, R.J.S.; da Costa Machado, M.T.; da Silva Zandonadi, F.; de Freitas Queiroz Barros,  
428 H.D.; Júnior, M.R.M.; Sussulini, A.; Hubinger, M.D. Proteolytic enzymes positively modulated the  
429 physicochemical and antioxidant properties of spent yeast protein hydrolysates. *Process Biochem.* **2020**,  
430 *91*, 34 – 45. doi:10.1016/j.procbio.2019.11.030.
- 431 10. Amorim, M.; Pinheiro, H.; Pintado, M. Valorization of spent brewer's yeast: Optimization of  
432 hydrolysis process towards the generation of stable ACE-inhibitory peptides. *LWT* **2019**, *111*, 77 – 84.  
433 doi:10.1016/j.lwt.2019.05.011.
- 434 11. Rakowska, R.; Sadowska, A.; Dybkowska, E.; Świdorski F. Spent yeast as natural source of functional food  
435 additives. *Ann. Natl. Inst. Hyg.* **2017**, *68*, 115–121. PMID: 28646828.
- 436 12. Chae, H.J.; Joo, H.; In, M.J. Utilization of brewer's yeast cells for the production of food-grade yeast extract.  
437 Part 1: effects of different enzymatic treatments on solid and protein recovery and flavor characteristics.  
438 *Bioresour. Technol.* **2001**, *76*, 253 – 258. doi:10.1016/S0960-8524(00)00102-4.
- 439 13. Kanauchi, O.; Igarashi, K.; Ogata, R.; Mitsuyama, K.; Andoh, A. A Yeast Extract High in Bioactive Peptides  
440 has a Blood-Pressure Lowering Effect in Hypertensive Model. *Curr. Med. Chem.* **2005**, *12*, 3085–3090.  
441 doi:10.2174/092986705774933461.
- 442 14. Bączek, T. Fractionation of peptides and identification of proteins from *Saccharomyces cerevisiae* in  
443 proteomics with the use of reversed-phase capillary liquid chromatography and pI-based approach.  
444 *J. Pharm. Biomed. Anal.* **2004**, *35*, 895 – 904. doi:10.1016/j.jpba.2004.02.032.
- 445 15. Ghosh, R.; Cui, Z.F. Protein purification by ultrafiltration with pre-treated membrane. *J. Membr. Sci.* **2000**,  
446 *167*, 47 – 53. doi:10.1016/S0376-7388(99)00275-6.
- 447 16. Amorim, M.; Pereira, J.O.; Gomes, D.; Pereira, C.D.; Pinheiro, H.; Pintado, M. Nutritional ingredients from  
448 spent brewer's yeast obtained by hydrolysis and selective membrane filtration integrated in a pilot process.  
449 *J. Food Eng.* **2016**, *185*, 42 – 47. doi:10.1016/j.jfoodeng.2016.03.032.
- 450 17. Huang, S.; Gong, Y.; Li, Y.; Ruan, S.; Roknul Azam, S.M.; Duan, Y.; Ye, X.; Ma, H. Preparation of  
451 ACE-inhibitory peptides from milk protein in continuous enzyme membrane reactor with gradient dilution  
452 feeding substrate. *Process Biochem.* **2020**, *92*, 130 – 137. doi:10.1016/j.procbio.2020.02.030.
- 453 18. Thuanthong, M.; De Gobba, C.; Sirinupong, N.; Youravong, W.; Otte, J. Purification and characterization  
454 of angiotensin-converting enzyme-inhibitory peptides from Nile tilapia (*Oreochromis niloticus*) skin  
455 gelatine produced by an enzymatic membrane reactor. *J. Funct. Foods* **2017**, *36*, 243 – 254.  
456 doi:10.1016/j.jff.2017.07.011.
- 457 19. Nielsen, P.M.; Olsen, H.S. Enzymic modification of food protein. In *Enzymes in Food Technology*; Whitehurst,  
458 R.J.; Law, B.A., Eds.; Sheffield Academic Press: Sheffield, 2002; pp. 109–143.
- 459 20. Emin, C.; Kurnia, E.; Katalia, I.; Ulbricht, M. Polyarylsulfone-based blend ultrafiltration membranes with  
460 combined size and charge selectivity for protein separation. *Sep. Purif. Technol.* **2018**, *193*, 127 – 138.  
461 doi:10.1016/j.seppur.2017.11.008.
- 462 21. Saidi, S.; Deratani, A.; Amar, R.B.; Belleville, M.P. Fractionation of a tuna dark muscle hydrolysate by a  
463 two-step membrane process. *Sep. Purif. Technol.* **2013**, *108*, 28 – 36. doi:10.1016/j.seppur.2013.01.048.
- 464 22. Chabeaud, A.; Vandanjon, L.; Bourseau, P.; Jaouen, P.; Guérard, F. Fractionation by ultrafiltration of a saithe  
465 protein hydrolysate (*Pollachius virens*): Effect of material and molecular weight cut-off on the membrane  
466 performances. *J. Food Eng.* **2009**, *91*, 408 – 414. doi:10.1016/j.jfoodeng.2008.09.018.
- 467 23. Jung, E.Y.; Lee, H.S.; Choi, J.W.; Ra, K.S.; Kim, M.R.; Suh, H.J. Glucose Tolerance and Antioxidant Activity  
468 of Spent Brewer's Yeast Hydrolysate with a High Content of Cyclo-His-Pro (CHP). *J. Food Sci.* **2011**,  
469 *76*, C272–C278. doi:10.1111/j.1750-3841.2010.01997.x.
- 470 24. Ortiz-Martinez, M.; Winkler, R.; García-Lara, S. Preventive and therapeutic potential of peptides from  
471 cereals against cancer. *J. Proteom.* **2014**, *111*, 165 – 183. doi:10.1016/j.jprot.2014.03.044.
- 472 25. Ambrosi, A.; Cardozo, N.S.M.; Tessaro, I.C. Membrane Separation Processes for the Beer Industry: a  
473 Review and State of the Art. *Food Bioprocess Technol.* **2014**, *7*, 921–936. doi:10.1007/s11947-014-1275-0.

- 474 26. Habert, A.C.; Borges, C.P.; Nobrega, R. Aspectos Gerais dos Processos com Membranas. In *Processos de*  
475 *Separação por Membranas*, 1 ed.; Habert, A.C.; Borges, C.P.; Nobrega, R., Eds.; E-papers: Rio de Janeiro,  
476 Brasil, 2006; pp. 9 – 24.
- 477 27. Cheryan, M. *Ultrafiltration and Microfiltration Handbook*, 2 ed.; CRC Press: Boca Raton, USA, 1998.
- 478 28. Mulder, M. *Basic Principles of Membrane Technology*, 1 ed.; Springer-Science + Business Media, B.V.:  
479 Dordrecht, Netherlands, 1991. doi:10.1007/978-94-017-0835-7.
- 480 29. Etzel, M.; Arunkumar, A. Chapter 6 - Novel Membrane Technologies for Protein Concentration and  
481 Fractionation. In *Innovative Food Processing Technologies*; Knoerzer, K.; Juliano, P.; Smithers, G., Eds.;  
482 Woodhead Publishing Series in Food Science, Technology and Nutrition, Woodhead Publishing, 2016; pp.  
483 151 – 175. doi:10.1016/B978-0-08-100294-0.00006-7.
- 484 30. Cui, Z.; Jiang, Y.; Field, R. Chapter 1 - Fundamentals of Pressure-Driven Membrane Separation Processes.  
485 In *Membrane Technology*; Cui, Z.; Muralidhara, H., Eds.; Butterworth-Heinemann: Oxford, 2010; pp. 1 – 18.  
486 doi:10.1016/B978-1-85617-632-3.00001-X.
- 487 31. Wang, Y.; Selomulya, C. Spray drying strategy for encapsulation of bioactive peptide powders for food  
488 applications. *Adv. Powder Technol.* **2020**, *31*, 409 – 415. doi:10.1016/j.appt.2019.10.034.
- 489 32. Kurozawa, L.E.; Park, K.J.; Hubinger, M.D. Effect of carrier agents on the physicochemical  
490 properties of a spray dried chicken meat protein hydrolysate. *J. Food Eng.* **2009**, *94*, 326 – 333.  
491 doi:10.1016/j.jfoodeng.2009.03.025.
- 492 33. Cui, Z. Protein separation using ultrafiltration — an example of multi-scale complex systems. *China*  
493 *Particuology* **2005**, *3*, 343 – 348. doi:10.1016/S1672-2515(07)60213-9.
- 494 34. Corbatón-Báguena, M.J.; Álvarez-Blanco, S.; Vincent-Vela, M.C.; Ortega-Navarro, E.; Pérez-Herranz, V.  
495 Application of electric fields to clean ultrafiltration membranes fouled with whey model solutions. *Sep.*  
496 *Purif. Technol.* **2016**, *159*, 92 – 99. doi:10.1016/j.seppur.2015.12.039.
- 497 35. Córdova, A.; Astudillo-Castro, C.; Ruby-Figueroa, R.; Valencia, P.; Soto, C. Recent advances and  
498 perspectives of ultrasound assisted membrane food processing. *Food Res. Int.* **2020**, *133*, 109163.  
499 doi:10.1016/j.foodres.2020.109163.
- 500 36. Baker, R.W. *Membrane Technology and Applications*, 2 ed.; John Wiley & Sons Ltd: Sussex, England, 2004.  
501 doi:10.1002/0470020393.
- 502 37. Abejón, R.; Abejón, A.; Belleville, M.P.; Sánchez-Marcano, J.; Garea, A.; Irabien, A. Multiobjective  
503 Optimization of Membrane Networks for Fractionation of Protein Hydrolysate from Fish By-Products. In  
504 *26th European Symposium on Computer Aided Process Engineering*; Kravanja, Z.; Bogataj, M., Eds.; Elsevier,  
505 2016; Vol. 38, *Computer Aided Chemical Engineering*, pp. 415 – 420. doi:10.1016/B978-0-444-63428-3.50074-6.
- 506 38. Persico, M.; Daigle, G.; Kadel, S.; Perreault, V.; Pellerin, G.; Thibodeau, J.; Bazinet, L. Predictive models for  
507 determination of peptide fouling based on the physicochemical characteristics of filtration membranes.  
508 *Sep. Purif. Technol.* **2020**, *240*, 116602. doi:10.1016/j.seppur.2020.116602.
- 509 39. Kolakowski, E. Analysis of Proteins, Peptides and Amino Acids in Foods. In *Methods of Analysis of Food*  
510 *Components and Additives*, 2nd ed.; Ötles, S., Ed.; Taylor & Francis Group: Boca Raton, USA, 2012; pp.  
511 79–114.
- 512 40. Przybylski, R.; Bazinet, L.; Firdaous, L.; Kouach, M.; Goossens, J.F.; Dhulster, P.; Nedjar, N. Harnessing  
513 slaughterhouse by-products: From wastes to high-added value natural food preservative. *Food Chem.* **2020**,  
514 *304*, 125448. doi:10.1016/j.foodchem.2019.125448.
- 515 41. Durand, R.; Pellerin, G.; Thibodeau, J.; Fraboulet, E.; Marette, A.; Bazinet, L. Screening for metabolic  
516 syndrome application of a herring by-product hydrolysate after its separation by electrodialysis with  
517 ultrafiltration membrane and identification of novel anti-inflammatory peptides. *Sep. Purif. Technol.* **2020**,  
518 *235*, 116205. doi:10.1016/j.seppur.2019.116205.
- 519 42. Suwal, S.; Roblet, C.; Doyen, A.; Amiot, J.; Beaulieu, L.; Legault, J.; Bazinet, L. Electrodialytic separation of  
520 peptides from snow crab by-product hydrolysate: Effect of cell configuration on peptide selectivity and  
521 local electric field. *Sep. Purif. Technol.* **2014**, *127*, 29 – 38. doi:10.1016/j.seppur.2014.02.018.
- 522 43. Marie, G.C.U.; Perreault, V.; Henaux, L.; Carnovale, V.; Aluko, R.E.; Marette, A.; Doyen, A.; Bazinet, L.  
523 Impact of a high hydrostatic pressure pretreatment on the separation of bioactive peptides from flaxseed  
524 protein hydrolysates by electrodialysis with ultrafiltration membranes. *Sep. Purif. Technol.* **2019**, *211*, 242 –  
525 251. doi:10.1016/j.seppur.2018.09.063.

- 526 44. He, R.; Girgih, A.T.; Rozoy, E.; Bazinet, L.; Ju, X.R.; Aluko, R.E. Selective separation and concentration  
527 of antihypertensive peptides from rapeseed protein hydrolysate by electro dialysis with ultrafiltration  
528 membranes. *Food Chem.* **2016**, *197*, 1008 – 1014. doi:10.1016/j.foodchem.2015.11.081.
- 529 45. Halász, A.; Lásztity, R. Chemical composition and biochemistry of yeast biomass. In *Use of yeast biomass in*  
530 *food production*; Halász, A.; Lásztity, R., Eds.; CRC Press: Boca Raton, USA, 1991; pp. 23–41.
- 531 46. Marson, G.V.; da Costa Machado, M.T.; de Castro, R.J.S.; Hubinger, M.D. Sequential hydrolysis  
532 of spent brewer's yeast improved its physico-chemical characteristics and antioxidant properties: A  
533 strategy to transform waste into added-value biomolecules. *Process Biochem.* **2019**, *84*, 91 – 102.  
534 doi:10.1016/j.procbio.2019.06.018.
- 535 47. Podpora, B.; Świdorski, F.; Sadowska, A.; Rakowska, R.; Wasiak-zys, G. Spent brewer's yeast extracts as a  
536 new component of functional food. *Czech J. Food Sci.* **2016**, *34*, 554–563. doi:10.17221/419/2015-CJFS.
- 537 48. Huang, K.; Gao, J.Y.; Ma, S.; Lu, J.J. Optimising separation process of protein and polysaccharide  
538 from spent brewer's yeast by ultrafiltration. *Int. J. Food Sci. Technol.* **2012**, *47*, 1259–1264.  
539 doi:10.1111/j.1365-2621.2012.02967.x.
- 540 49. Patsioura, A.; Galanakis, C.M.; Gekas, V. Ultrafiltration optimization for the recovery of  $\beta$ -glucan from oat  
541 mill waste. *J. Membr. Sci.* **2011**, *373*, 53 – 63. doi:10.1016/j.memsci.2011.02.032.
- 542 50. Morales, D.; Smiderle, F.R.; Piris, A.J.; Soler-Rivas, C.; Prodanov, M. Production of a  $\beta$ -D-glucan-rich  
543 extract from Shiitake mushrooms (*Lentinula edodes*) by an extraction/microfiltration/reverse osmosis  
544 (nanofiltration) process. *Innov. Food Sci. Emerg. Technol.* **2019**, *51*, 80 – 90. doi:10.1016/j.ifset.2018.04.003.
- 545 51. Zhu, F.; Du, B.; Xu, B. A critical review on production and industrial applications of beta-glucans. *Food*  
546 *Hydrocoll.* **2016**, *52*, 275 – 288. doi:10.1016/j.foodhyd.2015.07.003.
- 547 52. Jacob, F.F.; Striegel, L.; Rychlik, M.; Hutzler, M.; F-J., M. Yeast extract production using spent yeast from beer  
548 manufacture: influence of industrially applicable disruption methods on selected substance groups with  
549 biotechnological relevance. *Eur. Food Res. Technol.* **2019**, *245*, 1169–1182. doi:10.1007/s00217-019-03237-9.
- 550 53. Manzano, I.; Zydney, A.L. Quantitative study of RNA transmission through ultrafiltration membranes. *J.*  
551 *Membr. Sci.* **2017**, *544*, 272 – 277. doi:10.1016/j.memsci.2017.09.042.
- 552 54. Manzano, I.; Vezeau, G.; Salis, H.; Zydney, A.L. RNA size and 3-dimensional structure determine  
553 ultrafiltration behavior of small RNA molecules. *Sep. Purif. Technol.* **2020**, *237*, 116372.  
554 doi:10.1016/j.seppur.2019.116372.
- 555 55. Jung, E.Y.; Cho, M.K.; Hong, Y.H.; Kim, J.H.; Park, Y.; Chang, U.J.; Suh, H.J. Yeast hydrolysate  
556 can reduce body weight and abdominal fat accumulation in obese adults. *Nutr.* **2014**, *30*, 25 – 32.  
557 doi:10.1016/j.nut.2013.02.009.
- 558 56. Park, Y.; Kim, J.H.; Lee, H.S.; Jung, E.Y.; Lee, H.; Noh, D.O.; Suh, H.J. Thermal stability of yeast hydrolysate  
559 as a novel anti-obesity material. *Food Chem.* **2013**, *136*, 316 – 321. doi:10.1016/j.foodchem.2012.08.047.
- 560 57. Jung, E.Y.; Hong, Y.H.; Kim, J.H.; Park, Y.; Bae, S.H.; Chang, U.J.; Suh, H.J. Effects of Yeast Hydrolysate  
561 on Hepatic Lipid Metabolism in High-Fat-Diet-Induced Obese Mice: Yeast Hydrolysate Suppresses  
562 Body Fat Accumulation by Attenuating Fatty Acid Synthesis. *Ann. Nutr. Metab.* **2012**, *61*, 89 – 94.  
563 doi:10.1159/000338441.
- 564 58. Kim, J.H.; Jung, E.Y.; Hong, Y.H.; Bae, S.H.; Kim, J.M.; Noh, D.O.; Nozaki, T.; Inoue, T.; Suh, H.J. Short  
565 Communication: Pet foods with yeast hydrolysate can reduce body weight and increase girth in beagle  
566 dogs. *Can. J. Anim. Sci.* **2012**, *92*, 207–210. doi:10.4141/cjas2011-123.
- 567 59. Lee, H.; Jung, E.; Bae, S.H.; Kwon, K.H.; Kim, J.; Suh, H.J. Stimulation of osteoblastic differentiation  
568 and mineralization in MC3T3 E1 cells by yeast hydrolysate. *Phytother. Res.* **2011**, *25*, 716–723.  
569 doi:10.1002/ptr.3328.
- 570 60. Lee, H.S.; Jung, E.Y.; Suh, H.J. Chemical Composition and Anti-Stress Effects of Yeast Hydrolysate. *J. Med.*  
571 *Food* **2009**, *12*, 1281–1285. PMID: 20041782, doi:10.1089/jmf.2009.0098.
- 572 61. Kim, J.M.; Kim, S.; Jung, E.; Bae, S.H.; Suh, H.J. Yeast hydrolysate induces longitudinal bone growth and  
573 growth hormone release in rats. *Phytother. Res.* **2009**, *23*, 731–736. doi:10.1002/ptr.2720.
- 574 62. de la Hoz, L.; Ponezi, A.N.; Milani, R.F.; da Silva, V.S.N.; de Souza, A.S.; Bertoldo-Pacheco,  
575 M.T. Iron-binding properties of sugar cane yeast peptides. *Food Chem.* **2014**, *142*, 166 – 169.  
576 doi:10.1016/j.foodchem.2013.06.133.
- 577 63. Kim, J.M.; Lee, S.W.; Kim, K.M.; Chang, U.J.; Song, J.C.; Suh, H.J. Anti-stress effect and functionality of  
578 yeast hydrolysate SCP-20. *Eur. Food Res. Technol.* **2003**, *217*, 168–172. doi:10.1007/s00217-003-0723-2.

- 579 64. Mirzaei, M.; Mirdamadi, S.; Ehsani, M.R.; Aminlari, M.; Hosseini, E. Purification and identification of  
580 antioxidant and ACE-inhibitory peptide from *Saccharomyces cerevisiae* protein hydrolysate. *J. Funct. Foods*  
581 **2015**, *19*, 259 – 268. doi:10.1016/j.jff.2015.09.031.
- 582 65. Williams, R.; Dias, D.A.; Jayasinghe, N.; Roessner, U.; Bennett, L.E.  $\beta$ -glucan-depleted, glycopeptide-rich  
583 extracts from Brewer's and Baker's yeast (*Saccharomyces cerevisiae*) lower interferon- $\gamma$  production by  
584 stimulated human blood cells in vitro. *Food Chem.* **2016**, *197*, 761 – 768. doi:10.1016/j.foodchem.2015.11.015.
- 585 66. Jeong, S.C.; Lee, D.H.; Lee, J.S. Production and characterization of an anti-angiogenic agent from  
586 *Saccharomyces cerevisiae* K-7. *J. Microbiol. Biotechnol.* **2006**, *16*, 1904 – 1911.
- 587 67. Amorim, M.; Marques, C.; Pereira, J.; Guardão, L.; Martins, M.; Osório, H.; Moura, D.; Calhau, C.; Pinheiro,  
588 H.; Pintado, M. Antihypertensive effect of spent brewer yeast peptide. *Process Biochem.* **2019**, *76*, 213 – 218.  
589 doi:10.1016/j.procbio.2018.10.004.

590 © 2020 by the authors. Submitted to *Membranes* for possible open access publication  
591 under the terms and conditions of the Creative Commons Attribution (CC BY) license  
592 (<http://creativecommons.org/licenses/by/4.0/>).

## Chapter 5

### Article 1: Rupture of yeast cell wall

**Sequential hydrolysis of spent brewer's yeast improved its physico-chemical characteristics and antioxidant properties: A strategy to transform waste into added-value biomolecules**

Gabriela Vollet Marson<sup>a</sup>, Mariana Teixeira da Costa Machado<sup>b</sup>, Ruann Janser Soares de Castro<sup>c</sup>, Miriam Dupas Hubinger<sup>a</sup>

<sup>a</sup>Department of Food Engineering (DEA), School of Food Engineering (FEA), University of Campinas (UNICAMP), R. Monteiro Lobato, 80, 13083-862, Campinas, São Paulo, Brazil.

<sup>b</sup>Department of Food Technology, Federal Rural University of Rio de Janeiro, BR 465, km 7, 23890-000, Seropédica, Rio de Janeiro, Brazil.

<sup>c</sup>Department of Food Science (DCA), School of Food Engineering (FEA), University of Campinas (UNICAMP), R. Monteiro Lobato, 80, 13083-862, Campinas, São Paulo, Brazil.

Results of this chapter were published in the Elsevier's Journal "Process Biochemistry", Vol. 84, p. 91-102, 2019.

ISSN: 1359-5113

DOI: <https://doi.org/10.1016/j.procbio.2019.06.018>



Contents lists available at ScienceDirect

Process Biochemistry

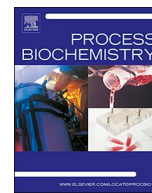
journal homepage: [www.elsevier.com/locate/procbio](http://www.elsevier.com/locate/procbio)

## Sequential hydrolysis of spent brewer's yeast improved its physico-chemical characteristics and antioxidant properties: A strategy to transform waste into added-value biomolecules

Gabriela Vollet Marson<sup>a,\*</sup>, Mariana Teixeira da Costa Machado<sup>b</sup>, Ruann Janser Soares de Castro<sup>c</sup>, Miriam Dupas Hubinger<sup>a</sup>

<sup>a</sup> Department of Food Engineering, School of Food Engineering, UNICAMP, Rua Monteiro Lobato, 80, 13083-862 Campinas, SP, Brazil

<sup>b</sup> Department of Food Technology, Federal Rural University of Rio de Janeiro, Rodovia BR 465, km 7, 23890-000 Seropédica, RJ, Brazil

<sup>c</sup> Department of Food Science, School of Food Engineering, UNICAMP, Rua Monteiro, 80, 13083-862 Campinas, SP, Brazil

### ARTICLE INFO

#### Keywords:

Food waste recovery  
Food proteolysis  
Yeast cell wall  
Antioxidant peptides  
*Saccharomyces pastorianus*  
Autolysis

### ABSTRACT

The spent brewer's yeast (SBY) is a promising raw material due to its high content of proteins, but cells must be disrupted to release yeast compounds. Our work aimed to study the rupturing of SBY cell wall comparing conventional methods (autolysis and mechanical rupture) with enzymatic hydrolysis using proteolytic enzymes (Brauzyne<sup>®</sup>, Alcalase<sup>™</sup>, Protamex<sup>™</sup> and Flavourzyme<sup>™</sup>). The susceptibility to rupture of different SBY by-products (repitched and non-repitched) and the effect of sequential enzymatic hydrolysis after rupture were also investigated. The hydrolysate produced at pH 5.5, 100% substrate concentration, 10% enzyme/substrate ratio and 60 °C resulted in maximized yield and enhanced antioxidant properties. Yeast compounds were more efficiently released after enzymatic hydrolysis, resulting in increases of 50% in crude protein, 83% in protein recovery and 63% in antioxidant properties. Repitched yeast took 3.5 longer to achieve the same degree of hydrolysis of non-repitched SBY. Sequential hydrolysis using Brauzyne<sup>®</sup> and Alcalase<sup>™</sup> resulted in maximum solid recovery and antioxidant properties. An effective approach for the recovery of proteins and peptides of SBY while reducing environmental impact of beer production was presented. Additionally, we demonstrated that a process to reuse SBY must contemplate yeasts differences and their susceptibility to breakdown to be successfully implemented.

### 1. Introduction

Agricultural and food industries generate relevant amounts of organic residues as a result of raw materials processing [1]. The bigger percentage (26%) of food wastes comes from the drink industry [2]. Beer is one of the most consumed beverages in the world, with a production of 191 million kL in 2016 [3]. As a consequence, the brewing industry continuously produce abundant agro-industrial residues, such as brewer spent grain, spent yeast and hot trub [4,5]. Despite the increasing importance that has been given to the sustainable use and management of natural resources, these sub and by-products are habitually underutilized, displaying low or no commercial value. Correct handling and disposal of those waste materials can be expensive, representing a considerable cost to the industry [1].

The spent brewer's yeast (SBY) is the second major by-product of the brewing industry [6]. Currently, SBY main application is still limited to

animal feed [7] even though this by-product is available throughout the year and presents high nutritional value, notably a high protein content – around 50% [6–8]. Thus, it may be considered as a promising raw material to be exploited. Many approaches are available to further process potential agroindustrial by-products into value-added products, but great interest on new protein and peptide sources from non-animal origin have been reported [1,9–12].

Protein and peptide-enriched ingredients can be successfully obtained through enzymatic hydrolysis of agroindustrial waste [13]. Protein hydrolysates from brewery by-products, mainly from brewer spent grain, have been studied for their functional and biological properties. Extensive studies on the choice of enzyme and process conditions to obtain brewer spent grain hydrolysates and protein isolates with specific characteristics were reported, investigating heat stability, emulsification and foaming properties, *in vitro* antioxidant and anti-inflammatory activities, as well as cell culture effects following *in*

\* Corresponding author. Present Address: Institut Européen des Membranes, Université de Montpellier, CNRS, ENSCM, UM, CC 047, 2 Place Eugène Bataillon, 34095 Montpellier, France.

E-mail address: [gabriela.vollet@gmail.com](mailto:gabriela.vollet@gmail.com) (G.V. Marson).

<https://doi.org/10.1016/j.procbio.2019.06.018>

Received 5 March 2019; Received in revised form 16 May 2019; Accepted 20 June 2019

Available online 21 June 2019

1359-5113/ © 2019 Elsevier Ltd. All rights reserved.

*in vitro* digestion [14–17]. On the other hand, protein hydrolysates from spent yeast are still underexploited [8,18], probably related to SBY complex composition and high nucleic acids content [8,19]. Yeast protein hydrolysates from pure *Saccharomyces cerevisiae* and *Kluyveromyces marxianus* cells were reported to present antioxidant and anti-hypertensive activities [20,21]. Recently both of these activities were found in a SBY protein hydrolysate produced with an aqueous extract of *Cynara cardunculus* [22,23].

The SBY is mainly composed by exhausted yeast cells, which are protected by a thick and rigid cell wall. Yeast biomass in the brewery industry is often reused up to 6 times, in a process called serial repitching, that results in changes in the physico-chemical composition and other characteristics of yeasts [5,24]. Yeast cells must be ruptured prior to processing, in order to assure the release of cell wall, as well as intracellular compounds [25,26]. The aim of this procedure is to increase the availability of chemical compounds in the next processing steps. For instance, if the interest is to produce a protein hydrolysate, after rupture, proteins can be readily accessed by enzymes. The rupture of the yeast cell wall is also interesting from a nutritional point of view. Although yeasts are rich protein sources, soluble fiber and minerals, in non-treated whole cells nutrients are less digestible [27]. Compared to spent yeasts from distilleries, for example, SBY presents better nutritional properties such as increased protein digestibility and growth-promoting capacity, both determined *in vivo*. The effect of rupturing the cell walls can greatly improve this scenario [27].

Yeast cell rupture had been studied mainly using autolysis and mechanical rupture processes [18,28–30]. Autolysis is induced by temperature at specific pH conditions and cell breakdown is achieved from within, by active endogenous enzymes [31]. The autolytic process is still not fully understood, poorly controlled and it depends on the autolytic properties of yeast strains, which may turn the process non-viable [32,33]. Mechanical rupture usually employs glass beads in high velocity, promoting cell rupture by friction [19,24,26].

Enzymatic hydrolysis using exogenous enzymes can also be used for yeast cell rupture, while offering higher process specificity than that of conventional processes [13]. Appropriate selection of process conditions and control of the progress of hydrolysis may result in hydrolysates of superior sensorial quality and improved functional and biological properties [8,33,34]. The use of commercial enzyme pools to promote the enzymatic production of bioactive peptides from complex feedstock mixtures are a prospective alternative to provide ingredients with increased bioactivity at reduced cost [35]. The release of molecules and nutrients from SBY has been successfully done through enzymatic hydrolysis [13,36,37], but studies focus mainly on increased yield of protein and the maximization of its recovery with limited or no information about the quality of the hydrolysate such as functional and biological properties.

Food wastes are characterized by their complex and variable composition, high moisture content, biological instability and organic loading. The successful production of bio-products from food wastes relies on the extensive study of their composition, selection of adequate processing parameters and an optimization that accounts for both the variability of the input waste material and process configuration [1]. Technologies that promote the reuse of such relevant agro-industrial by-products should be developed from both economic and environmental standpoints [7]. In this context, we developed an approach to transform SBY into a value-added product rich in proteins and peptides using enzymatic hydrolysis. For this, an investigation of the efficiency of various yeast cell wall rupture strategies was proposed. We particularly targeted the application of one commercial enzyme (Brauzyne<sup>®</sup>) to break the cell wall and release cell components. An experimental design assessed the effects of pH, substrate concentration, enzyme/substrate (E:S) ratio and temperature on the release of solids and protein, color changes and antioxidant properties. Also, a validation of the enzymatic process was proposed testing different suppliers and repitched yeast residues. Finally, ruptured yeast material was further

hydrolyzed with proteases in an attempt to enhance its antioxidant properties.

## 2. Material and methods

### 2.1. Reagents

Folin Ciocalteu phenol reagent, 2,4,6-tripyridyl-s-triazine (TPTZ), bovine serum albumine (BSA) (electrophoretic grade), 2,2-diphenyl-1-picryl-hydrazyl (DPPH) and 6-hydroxy-2,5,7,8-tetramethylchroman-2-carboxylic acid (TROLOX) were purchased from Sigma-Aldrich. Absolute ethanol, iron III chloride hexahydrate, trichloroacetic acid (TCA), sodium carbonate, L-tyrosine, casein and all other reagents were of analytical grade.

### 2.2. Enzymes

Four proteases were used in this study: Brauzyne<sup>®</sup> 100 L (Prozyn, Brazil), Alcalase<sup>™</sup> 2.4 L FG (Novozymes, Denmark), Protamex<sup>™</sup> (Novozymes, Denmark) and Flavourzyme<sup>™</sup> 1000 L (Novozymes, Denmark). Protease activity was checked using casein as substrate, following Sigma's non-specific protease assay [38] at 37 °C and pH 7.5. Results were reported in terms of enzymatic units (as defined by the method) per mg of pure enzyme with a maximum standard deviation of 15%. Protease activity of Alcalase (3002 U) was higher than the measured activity of Protamex (571 U), Brauzyne (171 U) and Flavourzyme (98 U) by 5, 17 and 31 times, respectively.

### 2.3. SBY samples

SBY (*Saccharomyces pastorianus*) from Lager Pilsner beer production (*saflager W-34/70*, Fermentis, France) was supplied by Haus Bier (São José dos Campos, Brazil) without repitching and was denominated as SBYL. For the validation of the rupture method, two more SBY raw materials (*S. pastorianus*) from Lager Pilsner beer production (*Diamond*, Lallemand, Canada) were also supplied by Haus Bier (São José dos Campos, Brazil), with serial repitching of 5 times and without repitching and were denominated as SBYD-R and SBYD-N, respectively. All yeasts were collected after 11 days of beer maturation and kept frozen in polypropylene bottles until further processing.

### 2.4. Experimental procedure

The study was divided in three parts, as shown in Fig. 1. Firstly, process conditions by enzymatic hydrolysis using Brauzyne<sup>®</sup> were determined, in a screening factorial plan. Then, one chosen condition for hydrolysis with Brauzyne<sup>®</sup> was compared with the two most common conventional methods used for yeast cell wall rupture: autolysis and mechanical rupture by glass beads. The extent of cell yeast compounds released by each of the methods was measured in terms of protein and total solids yield after centrifugation and an evaluation of antioxidant properties in the ruptured materials was made.

In a second step, the best method of cell wall rupturing was validated for the waste material of repitched cells (SBYR) against non-repitched (SBYN) cells of the same yeast strain and beer production. Comparison of non-repitched yeasts of different suppliers was also done.

Finally, aiming at the production of a protein hydrolysate with enhanced antioxidant properties, sequential hydrolysis was done in the ruptured material (ERM) using three other proteases in addition of Brauzyne<sup>®</sup>. In this step, the effect of centrifuging the ruptured material before the second step hydrolysis was investigated.

#### 2.4.1. Determination of hydrolysis conditions with Brauzyne<sup>®</sup> using an statistical design

Cell wall hydrolysis was performed using Brauzyne<sup>®</sup> 100 L, which is a

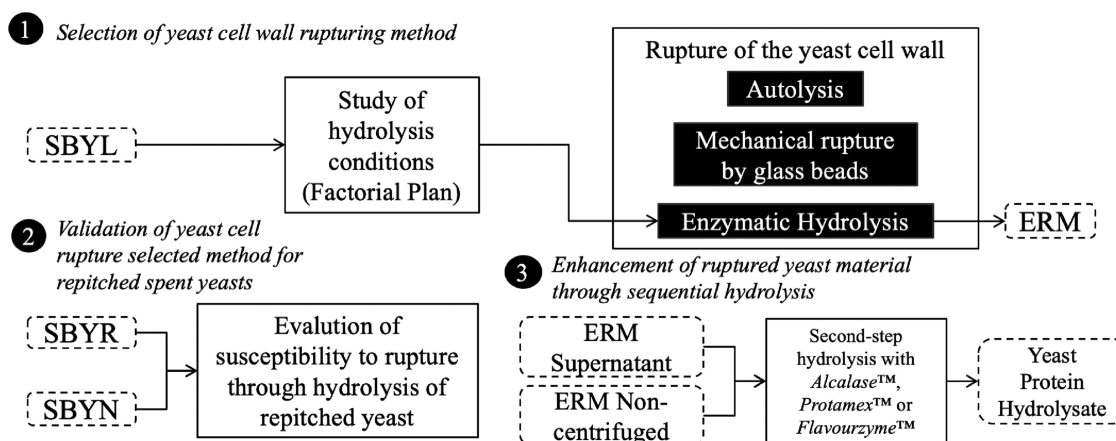

Fig. 1. Schematic representation of the study design: rupture of the yeast cell wall and production of a protein hydrolysate from spent brewer's yeast (SBY) by sequential protein hydrolysis.

Table 1

Coded and uncoded () levels of the factors ( $x$ ) in the fractional factorial design  $2^{4-1}$  used to access the process of enzymatic rupture of spent brewer's yeast (SBY) cell wall: evaluation of the pH, substrate concentration, enzyme and substrate mass ratio and temperature.

Runs	pH $x_1$	[substrate] <sup>a</sup> $x_2$	E:S <sup>b</sup> $x_3$	$T$ (°C) $x_4$
1	-1 (5.5)	-1 (50%)	-1 (0.5%)	-1 (60 °C)
2	1 (7.5)	-1 (50%)	-1 (0.5%)	1 (80 °C)
3	-1 (5.5)	1 (100%)	-1 (0.5%)	1 (80 °C)
4	1 (7.5)	1 (100%)	-1 (0.5%)	-1 (60 °C)
5	-1 (5.5)	-1 (50%)	1 (10%)	1 (80 °C)
6	1 (7.5)	-1 (50%)	1 (10%)	-1 (60 °C)
7	-1 (5.5)	1 (100%)	1 (10%)	-1 (60 °C)
8	1 (7.5)	1 (100%)	1 (10%)	1 (80 °C)
9	0 (6.5)	0 (75%)	0 (5.25%)	0 (70 °C)
10	0 (6.5)	0 (75%)	0 (5.25%)	0 (70 °C)
11	0 (6.5)	0 (75%)	0 (5.25%)	0 (70 °C)

<sup>a</sup> Substrate concentration expressed in %, v/v, considering a dilution in distilled water.

<sup>b</sup> Enzyme/substrate (E:S) ratio expressed in %, m/m, taking into account crude protein content in the matrix.

commercial plant protease preparation designated for the rupturing of yeast cell walls. This study was done in SBYL non-repitched spent cells. The determination of variables that exert relevant impact on the process of hydrolysis is of great value when there is interest in the properties of a hydrolysate [39]. Thus, a screening statistical design was chosen to establish the process conditions for the production of a SBY hydrolysate with antioxidant properties and maximum protein and solids yield. A fractional factorial design of 4 factors was set up to study the hydrolysis conditions of the yeast cell wall rupture. All experiments were performed accordingly to the experimental design presented in Table 1, which displays the coded and real levels for each one the variables. In sum, 11 runs were carried out, with 3 replicates at the center point for curvature effect verification. Alias relations for the chosen factorial design were:  $A = BCD$ ;  $B = ACD$ ;  $C = ABD$ ;  $D = ABC$ ;  $AB = CD$ ;  $AC = BD$ ;  $AD = BC$ , meaning that all two-way interactions are confounded with each other and main interactions are confounded with three-way ones. The four independent variables used in this study were pH ( $x_1$ ), substrate concentration (% v/v) ( $x_2$ ), E:S ratio (% m/m) ( $x_3$ ) and temperature (°C) ( $x_4$ ). Enzyme dosage was determined on a yeast crude protein content (CP) basis and dilution was calculated as substrate/water ratio (m/m). Dependent variables were total solids (TS), soluble solids (SS), protein recovery (PR), crude protein content in supernatant fraction (CP in SF), degree of hydrolysis, DPPH radical scavenging activity, iron reducing ability of the samples (FRAP

activity), Browning Index (BI),  $L^*$  color parameter and overall change in color ( $\Delta E$ ). Experiments were performed randomly in order to limit any possible biases that may arise. Under one selected condition (experiment 7), the validity of the experimental design was confirmed.

All enzymatic treatments were performed on a 50 mL jacketed beaker coupled with a controlled water bath and automatic titrator (T-50, Mettler Toledo, Switzerland) for pH control. Solutions were magnetically stirred at 700 rpm. Hydrolysis time was defined for each condition after evaluating the kinetics of hydrolysis and stopped when the base consumption vs. time curve was flat (Section 2.5.2). Inactivation was done at 90 °C for 30 min as suggested by the enzyme supplier. One control for each condition was prepared as described by the factorial design but without the addition of enzyme.

#### 2.4.2. Selection of yeast cell wall rupturing method

The enzymatically ruptured material (ERM), in one condition determined in Section 2.4.1 that resulted in the best yield of proteins and physico-chemical properties, was selected and compared to autolysis and mechanical rupture by glass beads. Comparison among methods was also done in SBYL non-repitched spent cells.

Rupture by autolysis was induced by temperature (50 °C) at pH 6 for 24 h under magnetic stirring of 700 rpm. Process was stopped by heating at 80 °C for 30 min and the suspension was immediately cooled down (ice bath) [30].

Glass beads of different sizes (2.64, 2.96 and 3.86 mm in diameter) in the ratio of 1:2 (beads:suspension) were used in the mechanical rupture test, performed at 4 °C with 10 high speed intermittent vortex homogenizations of 1 min [24]. Control experiments followed the same procedure but did not contain glass beads.

Ruptured materials obtained from the three methodologies were centrifuged after the treatments (Allegra 25R, Beckman Coulter, United States) at 15,300 × g for 30 min at 4 °C resulting in the hydrolysate (supernatant fraction – SF) and in non-soluble cell debris (precipitate fraction).

#### 2.4.3. Validation of yeast cell wall rupture method for repitched yeast

The effect of serial repitching of spent yeast on the degree of hydrolysis with Brauzyne<sup>®</sup> was studied using SBYD-R and SBYD-N, at the same hydrolysis conditions defined by the factorial plan, as described previously, using an automatic titrator (Section 2.4.1).

#### 2.4.4. Production of SBY protein hydrolysate through sequential hydrolysis

Ruptured material obtained from treatment with Brauzyne<sup>®</sup> (ERM), with a degree of hydrolysis of 25%, was further independently hydrolyzed with proteases after and before centrifugation (Alcalase<sup>™</sup>, Protamex<sup>™</sup> and Flavourzyme<sup>™</sup>) using the same equipments of the first



step hydrolysis (Section 2.4.1). All hydrolysis went on for 40 min at pH value of 7.5 and 50 °C respecting their reported optimum range [40], and 0.5% enzyme dosage which was also determined on a CP content basis. Controls were prepared without the addition of enzyme. Afterwards, the obtained protein hydrolysate was centrifuged as previously described (Section 2.4.2), resulting in the SBY protein hydrolysate and a precipitate fraction.

## 2.5. Analytical procedure

### 2.5.1. Physico-chemical composition

Total solid content (TS) (% m/m) was determined gravimetrically at 105 °C for 12 h using an incubator (C-HT 515, Fanem, Brazil) and soluble solids (SS) (°BRIX) were determined in a refractometer (N-1 alpha, Atago, Japan) [41]. Ash was determined [41] as well as total sugars [42]. The density of the non-treated material was determined using a pycnometer with a thermometer, after a calibration with ultra pure water. Crude protein content (CP) was measured by the Dumas method [43] in an element analyser CHNS-O (Flash 2000, Thermo Fisher Scientific, Netherlands) considering a nitrogen conversion factor of 5.5 for spent yeasts [44,45] in a dry weight basis. Protein content of supernatant and precipitate of hydrolysates was determined in order to calculate the protein recovery (PR) (Eq. (1)), which is a measure of how much protein is migrating from the precipitate to the supernatant after the treatment. Furthermore, the extent of rupture was monitored by comparing the content of CP, TS and SS of the supernatant fraction after each treatment compared to the supernatant fraction of the controls [30,46].

$$PR(\%) = \frac{MP_S}{MP} = \frac{x_S \cdot M_S}{x_S \cdot M_S + x_P \cdot M_P} \times 100 \quad (1)$$

where  $MP_S$  is the mass of protein in the supernatant fraction (g),  $MP$  is the total mass of protein in the matrix (g),  $x_S$  is the CP in the supernatant fraction ( $g_{\text{protein}}/g_{\text{supernatant}}$ ),  $x_P$  is the CP in the precipitate fraction ( $g_{\text{protein}}/g_{\text{precipitate}}$ ),  $M_S$  is the mass of supernatant after centrifugation (g) and  $M_P$  is the mass of precipitate after centrifugation (g).

### 2.5.2. Degree of hydrolysis

The progress of all hydrolysis experiments was evaluated through the measurement of the degree of hydrolysis by the pH-STAT technique [47] in an automatic titrator (T-50, Mettler Toledo, Switzerland). Using this method, all hydrolysis occurs at constant pH and temperature (water bath MA126/BD, Marconi, Brazil) and the amount of base consumed to keep the pH constant is correlated with the amount of cleaved peptide bonds from which the degree of hydrolysis is calculated (%), when compared to the total number of bonds. The sum of millimoles of individual amino acids per gram of protein ( $h_{\text{total}}$ ) considered was  $7.5 \text{ meq g}^{-1}$ , calculated with amino acid composition data from SBY [48].

### 2.5.3. Browning Index and overall change in color

Color of experiment's supernatants was measured in an UV-Vis spectrophotometer in reflectance mode with D65 illuminant (model UltraScan, Hunterlab, United States). Results were expressed as the Browning Index (BI) which was calculated using the color parameters of the CIELab scale, where  $L^*$  represents the luminosity ( $L = 0$  corresponds to the darkest black and  $L = 100$  to the brightest white),  $a^*$  represents the green (-)/red (+) colors and  $b^*$  the blue (-)/yellow (+) colors. This index is a measurement of brown color development for non-enzymatic reactions, such as that caused by the Maillard Reaction [49–51], and is calculated by Eqs. (2) and (3).

$$x = \frac{a^* + (1.75 \cdot L^*)}{(5.65 \cdot L^*) + a^* - (3.01 \cdot b^*)} \quad (2)$$

$$BI = \frac{x - 0.31}{0.17} \times 100 \quad (3)$$

The difference between two colors was calculated to study the magnitude of color changes between the hydrolysates and the non-treated yeast sample. Overall change in color ( $\Delta E$ ) was defined as presented in Eq. (4), according to the first formula for the Euclidean distance between two points in the CIE -  $L^*a^*b^*$  space [52]. Experimental data indicates that an unexperienced observer can notice a color difference when the  $\Delta E$  value is bigger than 2 [52].

$$\Delta E = [(L_{\text{control}}^* - L_{\text{sample}}^*)^2 + (a_{\text{control}}^* - a_{\text{sample}}^*)^2 + (b_{\text{control}}^* - b_{\text{sample}}^*)^2]^{\frac{1}{2}} \quad (4)$$

When included in the factorial design, color parameters were transformed in reduction percentage in relation to the controls for the  $L^*$  parameter and percentage of increase for the  $\Delta E$ , in order to check the evolution of color after the treatment, against the control.

### 2.5.4. Antioxidant properties

Antioxidant properties of the samples were determined by two different antioxidant methodologies: FRAP and DPPH, at a standardized protein content and pH 7.5. The ferric reducing ability of plasma (FRAP assay) was performed as described by Benzie and Strain [53] and the changes proposed by Rufino et al. [54]. The 1,1-diphenyl-1-picrylhydrazyl radical-scavenging capacity assay (DPPH) [55] was determined using ethanol as solvent and 4 h reaction time in the dark (determined after testing the yeast samples). Standard curves of TROLOX were prepared for each one of the methods and results were expressed as TROLOX equivalents, in  $\mu\text{mol}_{\text{TE}} \text{g}^{-1}$ .

## 2.6. Statistical analysis

All experiments were studied in duplicate and all analysis were performed at least in triplicate. Results were expressed as average values  $\pm$  standard deviation and were submitted to analysis of variance (ANOVA) one and two way and comparison of means by Tukey HSD test. ANOVA assumptions were checked through analysis of the residues, data distribution (Ryan-Joiner's and Shapiro Wilk's tests) and homogeneity of variances (Bartlett's and Levene's tests). Correlations between data were determined by Pearson test followed by paired Student test. Differences were considered significant at a level of 5% for all statistical analysis.

Data from the experimental design were expressed in percentage of variation of hydrolysates in comparison to controls for all responses. Multiple regression analysis considered the confidence level of 5%. ANOVA and multiple regression assumptions were checked as described previously. If considered significant, a regression model was assumed to describe relationships between response ( $Y$ ) and experimental factors ( $x_1, x_2, x_3$  and  $x_4$ ) (Table 1) as presented in Eq. (5).

$$Y = \beta_0 + \sum_{i=1}^n \beta_i x_i \quad (5)$$

where  $x_i$  are coded independent variables,  $i$  take the value from 1 to the number of factors ( $n$ ), which is 4,  $\beta_0$  is the constant or intercept term,  $\beta_i$  represents the linear coefficient of main factors. Interactions between factors were not considered because of the resolution (IV) of the chosen factorial plan.

## 3. Results and discussion

### 3.1. Influence of enzymatic hydrolysis conditions in the performance of rupture

#### 3.1.1. Solids and protein yield

TS in samples was higher than in the controls (not enzymatically treated) by 37% in average, for all runs. SS increased from 12% to 100% in comparison to the controls and CP content from 27% to 64%. PR increased from 32% to 100% after the hydrolysis. A rise in TS and

**Table 2**

Regression coefficients for the prediction of evaluated dependent variables of experimental design for the study of yeast cell wall rupture: soluble solids (SS), crude protein content in supernatant fraction (CP in SF), degree of hydrolysis (DH), 1,1-diphenyl-1-picrylhydrazyl radical-scavenging activity (DPPH), ferric reducing capacity (FRAP), Browning Index (BI),  $L^*$  color parameter ( $L^*$ ) and overall change in color ( $\Delta E$ ).

Regression coefficients	SS	CP in SF	DH	DPPH	FRAP	BI	$L^{*a}$	$\Delta E^b$
Curvature	NS	6.1	-21.2	18.2	NS	NS	36.3	63.8
Mean/interaction ( $\beta_0$ )	34.5	43.4	27.6	6.3	74.5	21.1	26.8	48.1
pH (linear) ( $\beta_1$ )	-9.6	-3.8	-17.3	NS	NS	<b>19.9</b>	1.7	NS
[substrate] (linear) ( $\beta_2$ )	-10.7	NS	-10.5	NS	NS	NS	5.8	NS
E:S (linear) ( $\beta_3$ )	<b>18.0</b>	<b>9.3</b>	13.3	<b>38.0</b>	<b>45.3</b>	NS	<b>30.6</b>	<b>38.1</b>
Temperature (linear) ( $\beta_4$ )	8.7	5.6	10.5	-13.3	-27.6	NS	-8.1	NS

Enzyme/substrate (E:S) ratio expressed in %, m/m, taking into account crude protein content in the matrix. NS: non-significant effects. Interaction effects ( $\beta_{ij}$ ) were not added in this table because they are confounded by each other. Most important factor for each dependent variable is highlighted in bold.

<sup>a</sup> The  $L^*$  parameter represents the reduction percentage in relation to the controls.

<sup>b</sup> The  $\Delta E$  is expressed as the increased percentage in relation to the controls.

PR in all hydrolysates was evident after comparison with the controls. As expected, a strong correlation between TS in the hydrolysates and SS was found (Pearson coefficient of 0.96;  $p = 0.004$ ), indicating that more material was becoming soluble after the hydrolysis treatment.

Inverse correlations were found between PR and total and soluble solids in the controls (Pearson coefficients of -0.85 and -0.91, respectively,  $p = 0.000$  for both). It may indicate that the higher the total solids content in the supernatant fraction of controls, the smaller the PR. It is an expected behavior because if the solids content in the supernatant is already high, there would be less material available to migrate from the precipitate to the supernatant fraction. This is not true for the hydrolysates because the enzymes can release proteins that were not initially available, further validating the release of these components after the enzymatic treatment. Those results indicate that the enzymatic hydrolysis step was able to promote the rupture of the cell wall and the release of cellular compounds when compared to the non-hydrolyzed control samples, as observed in other papers [13,45].

Table 2 shows the regression coefficients for all the modelled responses. These values indicate the influence of each factor on a response. SS were greatly affected by all factors studied and the regression model was able to explain 98.6% of total variation (Table 2). Higher enzyme/substrate ratio and temperature as well as smaller pH value and substrate concentration resulted in a higher increase of SS in comparison to the respective controls. The same trends observed for pH, E:S and temperature were found by the regression model for the increase in CP after the hydrolysis treatment (with a curvature coefficient of 6.1), which also presented a high correlation coefficient of 99.2%. In Fig. 2 plots of observed versus predicted values for SS (a) and CP in SF (b) confirmed their prediction capability. TS and PR were not influenced by the hydrolysis conditions in the range evaluated and thus data could not be modelled for these responses.

Overall, dependent variables related to the yield of solids and

proteins in the hydrolysates, such as SS and CP in SF, were maximized when a higher E:S ratio and temperature were used along with low pH values and low substrate concentrations. A higher E:S ratio probably increased the rate of the reaction between enzyme and substrate within the evaluated E:S levels of the experimental plan because more enzyme is available for the same amount of substrate, and then more protein can be hydrolyzed. Brauzyn<sup>®</sup> is a vegetable protease preparation for yeast cell hydrolysis which presents both endo and exoactivities and is not specific, being able to break a wide range of proteins. The positive effect of low substrate concentration on yield is in agreement with the E:S effect, because with lower substrate concentrations, the enzymes can more efficiently access the proteins to promote their hydrolysis [56]. Higher temperatures and low pH values were also able to increase the yield, probably because Brauzyn<sup>®</sup> is active at high temperatures, having its optimum temperature ranging from 65 and 80 °C and acting at acidic pH values (from 3.5) [57].

Finally, the hydrolysate produced at pH 5.5, 50% of substrate dilution, 10% E:S ratio and 80 °C resulted in the highest solid and protein yield. At this condition, increases of 2.5, 2 and 1.6 fold were detected for the content of TS, SS and CP, respectively, compared to the control.

### 3.1.2. Degree of hydrolysis

The hydrolysis process was ceased once the base consumption has reached an equilibrium, verified continuously throughout the hydrolysis, using the pH-STAT technique (Section 2.5.2). Kinetics of hydrolysis for the central points of the experimental design are displayed in Fig. 3, where the plateau of base consumption is demonstrated.

As shown for SS and CP contents, which measured the yield of released compounds, the degree of hydrolysis was maximized for higher E:S and temperature and smaller pH values and substrate concentrations. Similar results were obtained for other protein hydrolysates [34,58]. This further confirms that those factors influenced the rate of

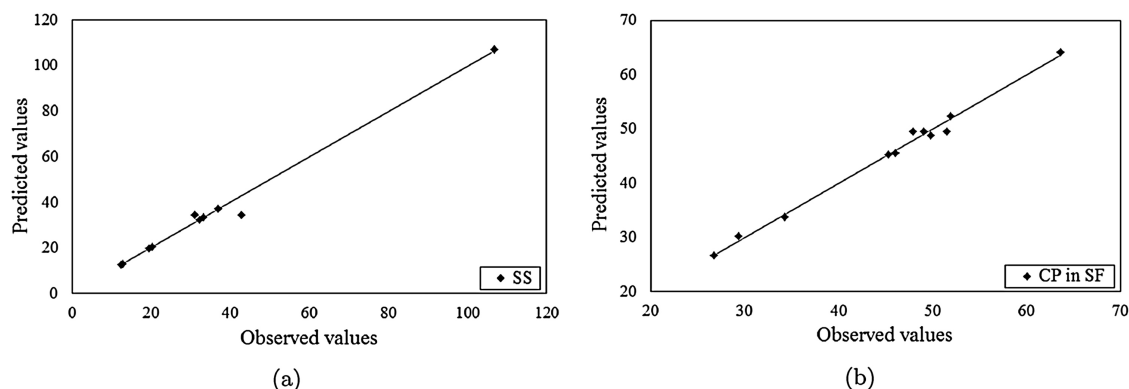

**Fig. 2.** Prediction of fitted line plots between experimental and predicted values for the rupture of the yeast cell wall by enzymatic hydrolysis regarding (a) Soluble Solids (SS) and (b) Crude protein content in supernatant (CP in SF).

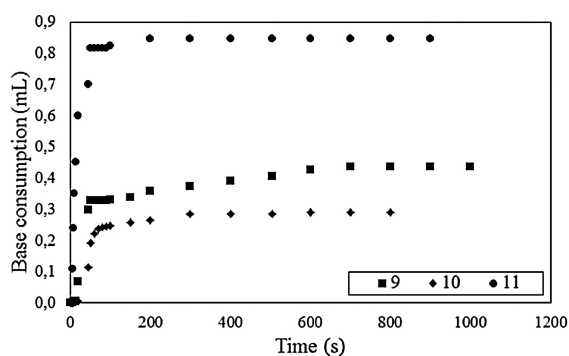

Fig. 3. Kinetics of hydrolysis with Brauzyne® for the central points of the fractional factorial plan (runs 9, 10 and 11): volume consumed of base (mL) versus time of hydrolysis (s).

enzymatic reaction, releasing more peptides. The more important effect was pH, followed by E:S, substrate concentration and temperature as indicated in Table 2, considering a curvature coefficient of  $-21.2$ . This model was able to explain 99.7% of the variance of data.

Higher degree of hydrolysis was also achieved for the hydrolysate which presented the higher solids and protein yield, as expected. For this run, the degree of hydrolysis increased by 100% in comparison to control. For the other hydrolysates, the degree of hydrolysis varied from 4% to 24%.

### 3.1.3. Antioxidant properties

Ferric reducing ability of samples (FRAP assay) ( $R^2 = 0.938$ ) and the capacity to scavenge the DPPH radical (DPPH assay) (curvature coefficient of 18.2 and  $R^2 = 0.974$ ) were enhanced when E:S ratio was higher and for lower hydrolysis temperatures, as presented in Table 2. Antioxidant activity was affected by higher E:S ratios, as did the solid and protein yield and degree of hydrolysis results. Similar results were found for shrimp waste protein hydrolysate using Alcalase™ [58,59], and were explained by the higher peptide concentration and higher DH in the extract obtained at higher E:S conditions. In this study, protein concentration of the experiments was standardized before antioxidant capacity measurements. This means that the increased antioxidant capacity is not due to a difference in peptide concentration, but to their physico-chemical properties that apparently change their antioxidant properties.

Antioxidant properties of SBY hydrolysates were negatively affected by high temperatures within the evaluated range. Rafi et al. [60] reported higher antioxidant activity of Alcalase™-produced lead tree seed hydrolysate with higher temperatures up to a limit (58 °C) after which it decreased. The higher temperature – higher antioxidant activity effect was explained by the higher yield obtained in that condition, and thus the rise in the antioxidant activity was, again, explained by the greater peptide concentration in the extracts. The negative effect of the temperature factor on the antioxidant properties was evidenced for both methodologies (DPPH and FRAP), strongly suggesting that temperature may degrade antioxidant compounds.

DPPH scavenging activity has decreased or did not change for the experiments with 0.5% of E:S ratio (runs 1–4, Fig. 4a) and values ranged from 16.2 to 35.4  $\mu\text{mol}_{\text{TE}} \text{g}^{-1}$  in the hydrolysates. FRAP activity was higher for all samples compared to the respective controls, and ranged from 5 to 12  $\mu\text{mol}_{\text{TE}} \text{g}^{-1}$  (Fig. 4b). The hydrolysate that presented higher antioxidant properties considering the two methodologies was the one produced at pH 5.5, 100% of substrate dilution, 10% E:S ratio and 60 °C.

Hydrolyzed proteins from numerous sources have been found to possess antioxidant properties [58,61]. Specifically, SBY extract has shown scavenging activity by DPPH and ABTS radicals as well as ferric reducing activity (FRAP) [18,20,37]. Our results were higher than those

obtained for debittered and mechanically disrupted *S. pastorianus* SBY by approximately 1.2 and 11 fold for FRAP and DPPH activities, respectively [18].

A weak positive correlation between DPPH and FRAP antioxidant values was found (Pearson coefficient of 0.67,  $p = 0.000$ ). As observed in Fig. 4, hydrolysates presented a similar trend of antioxidant capacity for both methods, with the greatest difference between control and hydrolysate being 177% and 60%, for FRAP and DPPH assays, respectively. This effect may be explained by the hydrolysate greater iron reducing power than ability to capture the DPPH organic radical. Antioxidants may act by multiple mechanisms and respond differently to oxidants, specially in reaction systems of complex composition [62]. The FRAP assay reflects the ability to maintain a redox status in the medium, based upon the ferric ion. The reaction mechanism is entirely due to electron transfer. DPPH radicals are mainly neutralized by direct reduction via electron transfer but radical quenching via hydrogen atom transfer may contribute to the measured antioxidant result [62]. Moreover, steric accessibility is a major determinant in the DPPH assay reaction, smaller molecules having higher apparent antioxidant capacities. These results confirm that the yeast hydrolysates present antioxidant capacity by electron transfer. The differences observed between both methods are probably caused by the size of peptides, that after the rupture stage, are not sufficiently small to neutralize the DPPH radical. Interference of molecules of distinct nature with reducing ability, such as polyphenols and sugars, may also contribute to the greater FRAP values [8].

### 3.1.4. Color changes

Three color parameters were studied in the enzymatically ruptured materials. The  $L^*$  parameter was influenced by all 4 factors, with a more important effect caused by E:S and temperature (curvature term 36.3,  $R^2 = 99.9\%$ ). Table 2 shows that a higher E:S, substrate concentration and pH result in a higher reduction of  $L^*$  in comparison to the controls and that a higher temperature results in a smaller reduction. The greater the reduction in the  $L^*$  color parameter, the darker becomes the sample.

The  $\Delta E$  results (Table 2) indicate that a higher concentration of enzyme in the reactional volume caused a higher change in color (curvature term 63.8,  $R^2 = 77.6\%$ ), what is in agreement with the darkening of the samples shown by the change in the  $L^*$  parameter. More amino acids are released because of the higher degree of hydrolysis and higher solid and protein yield that are achieved in this condition, and thus more substrate is available for the Maillard reaction, causing a higher change in color.

The formation of compounds responsible for the brown color, detected by the BI, and by the darkening of the samples ( $L^*$  reduction) may be an indicative of the presence of Maillard Reaction Products (MRPs) in the samples [51,63]. When the pH is alkaline, the temperature is higher or there is more substrate, samples are darker because the Maillard reaction is favored [64]. Indeed, in their basic form, the reactivity of free amines is enhanced [51]. BI values in the hydrolysates increased in all controls, in comparison with the non-treated samples and small changes were observed among the hydrolysates considering the different hydrolysis process conditions. Brown color development happened mainly due to heating (in the controls) indicating that it was not greatly affected by the enzymatic hydrolysis. Even though, when the material was hydrolyzed, a higher shift in color was observed ( $\Delta E$  data).

In sum, color parameters were affected by the hydrolysis conditions, specially by the E:S ratio. More enzyme resulted in darker samples. Although the investigation of color changes in protein hydrolysates is barely reported, similar trends were found in MRPs of a fish protein hydrolysate with added ribose. Yang et al. [65] discovered that high substrate concentration and pH remarkably increased the BI for this material.

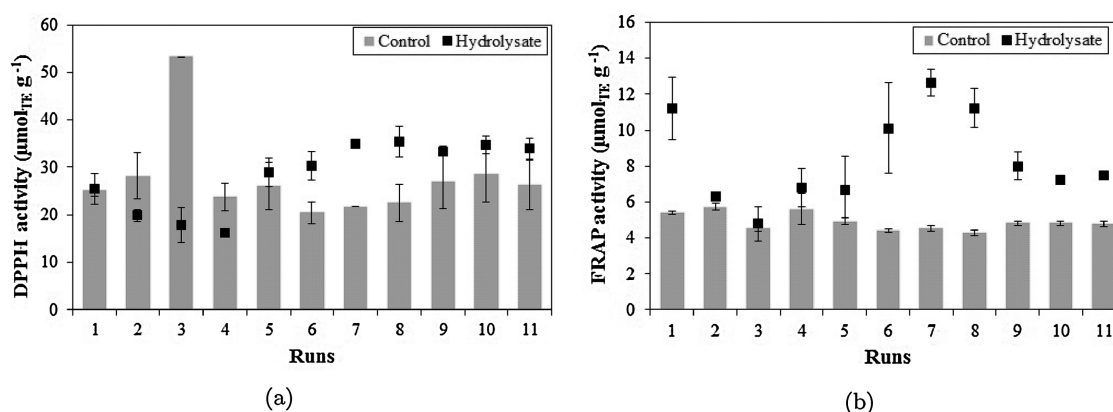

Fig. 4. Antioxidant capacity changes for the different hydrolysis conditions using Brauzyne<sup>®</sup> for the enzymatic rupture of the yeast cell wall: DPPH radical scavenging activity (DPPH) (a) and ferric reducing ability of samples (FRAP) (b) of hydrolysates and respective controls for all runs of the fractional factorial design.

### 3.1.5. Choice of hydrolysis conditions

The aim of a fractional design is to determine the most influential factors on specific characteristics of the hydrolysate. Among the evaluated hydrolysis conditions, the most relevant effects were the pH of the solution and the amount of enzyme added, represented as the proportion of enzyme per amount of substrate, the E:S ratio. Based on the observed results and the discussion above, the most adequate hydrolysis parameters were chosen to proceed with the comparison of rupture methods. Thus, the hydrolysate produced at pH 5.5, no substrate dilution, 10% of E:S ratio and 60 °C was chosen. This hydrolysate resulted in excellent protein and solids yield along with the higher antioxidant capacity, measured by both methodologies. pH and temperature chosen were in accordance with suggested conditions by the enzyme manufacturer [57]. Based on the experimental design done to determine the influence of hydrolysis conditions on the properties of the SBY ruptured material, as well as previous study results (data not shown), it was defined that the substrate would not be diluted prior to enzymatic rupture. Indeed, recent studies have shown that yeast cells may be more susceptible to deform and rupture under enzymatic treatments in high solid concentrations [66,67].

### 3.2. Comparison of cell rupture methods

Non-diluted SBYL yeast slurry, with 12% of solids (Table 4) was ruptured by autolysis, mechanical rupture using glass beads and hydrolysis on the conditions determined previously (Section 3.1.5). Ruptured materials were compared regarding protein and solids yield and antioxidant properties of the samples. Results for total solids in supernatant (TS in SF), soluble solids (SS), crude protein in the supernatant fraction (CP in SF) and protein recovery (PR) are presented in Fig. 5 for all methods.

From a  $12.0 \pm 0.2\%$  TS and  $41.2 \pm 0.2\%$  CP yeast slurry, a  $15.6 \pm 0.1\%$  TS and  $36.2 \pm 0.1\%$  CP autolysate was obtained (measurements before centrifugation). Following autolysis, a rise of 30% in TS was observed, indicating the evaporation of water during this heat treatment (50 °C for 24 h). On the other hand, a 12% decrease of crude protein content in yeast slurry was found. After autolysis, protein content may be lower due to protein degradation and reaction with other compounds although solid content may rise, caused by a concentration effect [68]. Extracts obtained by autolysis at the same conditions used in this work were reported to have less than 18% of protein referred to w/w dry yeast cell [24]. In relation to non-treated yeast, autolysis promoted an increase of about 22% of TS in SF, 20% of SS (Fig. 5a), 10% of CP in SF, 11% of PR (Fig. 5b) and a 20% decrease of CP in precipitate. A considerable increase in the amount of TS released into liquid yeast extract after autolysis was also reported [30]. Although these results suggest the release of intracellular compounds by this

treatment, a decrease of 26% and 37% in antioxidant properties by FRAP and DPPH, respectively, was found when compared to the non-treated yeast (Table 3). SBY contains vacuole proteases such as serine, aspartyl and metalloproteases which may become active at pH 6. Indeed, these proteases from ruptured yeast extracts can be used to obtain hydrolysates [7,8].

No differences on supernatants between control and samples obtained by mechanical rupture method were found in relation to CP, TS and antioxidant properties by FRAP and DPPH. A slight increase in SS compared to the control was found (Fig. 5a) and also some decrease of TS in precipitate. In another work, more than 95% of the repitched *S. pastorianus* cell walls were ruptured by a mechanical process with 0.6 mm glass beads following the same procedure used in this paper, but only solubility of protein was evaluated and experiments were done with 5 times smaller glass beads [24]. Same results were achieved for debittered SBY (*Saccharomyces* sp.) using 0.6–1 mm diameter glass beads, in a mill at 2400 rpm [48]. A high recovery of lipids was reported for 120 min of mechanical cell rupture using 3.3 mm of diameter glass beads and the proportion of 0.5 g of *Candida* sp. biomass in 10 mL of water and 5 g of glass beads. In that same work, cell rupture efficiency was very low in 5 min treatment [69]. Yeast composition, species and type, stage of fermentation/maturation at which it is removed, the number of times that it is reused as well as brewery constituents and process conditions might influence greatly the cell's susceptibility to rupture [5]. Furthermore, the apparatus and the size of the recipient where the mechanical rupture takes place may also influence the results [26,70].

Hydrolysis of SBYL by Brauzyne<sup>®</sup> at pH 5.5, 60 °C, no dilution and 10% E:S ratio (m/m) (ERM) resulted in an increase in supernatant of 40% in TS, 38% in SS (Fig. 5a), 50% in CP content, 83% in PR (Fig. 5b) and 62% and 64% in antioxidant properties by FRAP and DPPH (Table 3). As expected, a decrease of 25% and 9% in CP and TS in precipitate were found to be caused by the migration of this components from the precipitate to the supernatant fraction. Although this enzyme was never used for rupturing yeast cell wall, the hydrolysate obtained in these process conditions showed the greatest results in terms of yield and quality when compared to the conventional methods of yeast cell rupture. These results strongly suggest that enzymatic hydrolysis with Brauzyne<sup>®</sup> promoted the release of intracellular content and caused cell wall breakdown. Autolysis and enzymatic hydrolysis with Alcalase<sup>™</sup> have been used to release SBY cell components and results also evinced that the enzymatic hydrolysis was more effective [36]. When yeasts are hydrolyzed, enzymes cleave the bonds of the yeast cell wall compounds resulting in their fragmentation and solubilization. The cell wall debris, mainly composed of carbohydrates, is insoluble and becomes suspended, being recovered in the precipitate fraction [37] (Section 3.3).

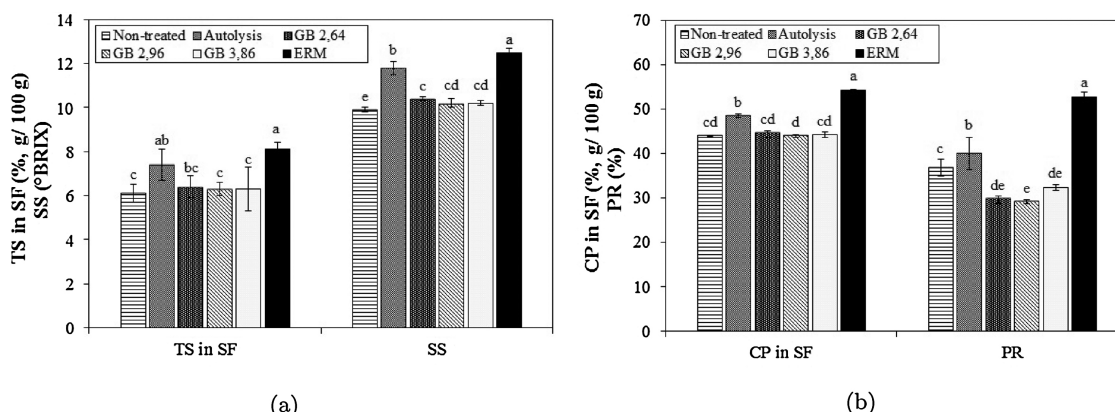

Fig. 5. Comparison of solids and protein yield among rupture methods (non-treated, autolysates, mechanically ruptured samples using glass beads (GB) of 2.64; 2.96 and 3.86 mm of diameter and enzymatically ruptured material (ERM) using Brauzyn<sup>®</sup>): total solids content in the supernatant fraction (TS in SF) and soluble solids (SS) (a) and crude protein content in the supernatant fraction (CP in SF) and protein recovery (PR) (b).

Table 3

Antioxidant properties by ferric reducing ability (FRAP) and DPPH radical scavenging and Browning Index (BI) values for spent brewer's yeast Lager Pilsen residue (SBYL) non-treated, ruptured by autolysis, mechanical rupture with glass beads (GB) and hydrolysis with Brauzyn<sup>®</sup> (ERM).

Treatment	FRAP	DPPH	BI
Non-treated	9.7 ± 0.4 <sup>b</sup>	28.1 ± 1.7 <sup>c</sup>	65.8 ± 1.5 <sup>d</sup>
Autolysis	7.4 ± 0.4 <sup>c</sup>	17.7 ± 0.7 <sup>e</sup>	141.0 ± 3.6 <sup>c</sup>
GB 2.64	9.7 ± 0.3 <sup>b</sup>	29.2 ± 0.6 <sup>c</sup>	8.9 ± 1.5 <sup>b</sup>
GB 2.96	10.2 ± 1.1 <sup>b</sup>	28.4 ± 0.8 <sup>c</sup>	9.7 ± 1.3 <sup>b</sup>
GB 3.86	10.7 ± 0.7 <sup>b</sup>	28.2 ± 0.7 <sup>c</sup>	8.8 ± 1.3 <sup>b</sup>
ERM	12.6 ± 0.7 <sup>a</sup>	35.2 ± 0.6 <sup>a</sup>	186.0 ± 12.9 <sup>a</sup>

Different letters in the same column indicate statistically significant differences ( $p < 0.05$ ) among treatments. FRAP: antioxidant properties by ferric reducing ability of plasma ( $\mu\text{mol}_{\text{TE}} \text{g}^{-1}$ ); DPPH: antioxidant properties by 1,1-diphenyl-1-picrylhydrazyl radical-scavenging capacity assay ( $\mu\text{mol}_{\text{TE}} \text{g}^{-1}$ ); BI: Browning Index (%). GB 2.64, GB 2.96 and GB 3.86: mechanical rupture treatment using 2.64, 2.96 and 3.96 mm diameter glass beads, respectively.

As already discussed, Maillard reaction may play a role during heat treatments. The greater the BI value, greater the amount of advanced MRPs [71]. On the two treatments involving temperature, 50 °C for autolysis and 60 °C for hydrolysis, it can be observed in Table 3 that BI was from 2 to 3 times higher than it was in the non-treated material. These results suggest that MRPs may have been produced during autolysis and hydrolysis. Indeed, there are carbohydrates and a large amount of proteins for the reaction to happen. As hydrolysis progresses, more proteins become available and the reaction may happen with greater intensity [51,63].

### 3.3. Physico-chemical characteristics of SBYL and ruptured material

SBYL raw material (*S. pastorianus*) with a density of  $1.089 \pm 0.002 \text{ g mL}^{-1}$  presented a high content of CP and total sugars (Table 4) which is in accordance with centesimal composition of spent yeasts outlined by other authors. SBYL CP content was within the reported range (35.2% to 49.4%) [5,24,45]. Both higher (8.6%) and smaller (5.9%) ash contents were reported and total carbohydrates ranged from 21.5% to 45.6% [4,5,45]. Those perceived changes are probably related to intrinsic characteristics of yeast and brewing conditions [5].

Comparing the composition of the original material (SBYL) against its supernatant fraction (SBYL SF), it can be observed that CP is mostly present on the supernatant (Table 4). There is a loss of 14% in total sugars of the SF comparing to the non-centrifuged material. Yeast cell wall contains only approximately 8% protein and is mainly composed

Table 4

Proximal composition and antioxidant capacity of spent brewer's yeast samples: non-treated (SBYL), supernatant fraction (SF) of non-treated yeast and supernatant fraction of ruptured material by hydrolysis (ERM).

	SBYL	SBYL SF	ERM SF
<i>Physicochemical properties</i>			
TS (%)	12.0 ± 0.2	6.1 ± 0.6 <sup>a</sup>	8.1 ± 0.4 <sup>b</sup>
CP (%)	41.2 ± 0.2	44.0 ± 0.1 <sup>a</sup>	54.3 ± 0.1 <sup>b</sup>
Total sugars (%)	37.8 ± 0.3	32.6 ± 0.6 <sup>a</sup>	40.9 ± 2.6 <sup>b</sup>
Ashes (%)	4.9 ± 0.2	11.5 ± 0.1 <sup>a</sup>	8.9 ± 0.0 <sup>b</sup>
<i>Antioxidant properties</i>			
DPPH <sup>*</sup>	N/A	28.1 ± 1.7 <sup>a</sup>	34.9 ± 0.5 <sup>b</sup>
FRAP <sup>*</sup>	N/A	9.9 ± 0.4 <sup>a</sup>	12.6 ± 0.7 <sup>b</sup>

SBYL: Lager Pilsner SBYL; ERM: ruptured material by hydrolysis with Brauzyn<sup>®</sup>; TS: total solids; SF: supernatant fraction.

\* Antioxidant properties by 1,1-diphenyl-1-picrylhydrazyl radical-scavenging capacity (DPPH) and ferric reducing ability of samples (FRAP) in  $\mu\text{mol}_{\text{TE}} \text{g}^{-1}$ . N/A, not applicable.

of carbohydrates such as oligosaccharides, beta glucans, and chitin [72]. The cell wall fraction is mostly insoluble; therefore, it stays suspended in the yeast protein solution and probably the majority of it is in the precipitate fraction [37].

A decrease of total sugars and a rise of ashes on yeast extract's SF was also reported [8]. After enzymatic rupture, ERM soluble fraction showed a rise of 33% in TS, 23% in CP, 25% in total sugars while the ash content decreased 23%. This behavior is expected because after cell rupture, intracellular and cell wall components are released and become more soluble, causing a rise in the amount of those macronutrients in the SF.

The antioxidant capacity of ERM and the non-treated material was characterized by the two methodologies: DPPH and FRAP. All antioxidant capacities measured at pH 7.5 increased 1.2 times in the ERM in comparison with the non-treated spent yeast.

### 3.4. Validation of yeast cell wall rupture method for repitched yeast

Many different yeast strains and cultivars are available for beer production, because each one may result in a different flavor profile. They are chosen considering brewing conditions, beer style and the desired characteristics of the end-product. Apart from the different characteristics of the various strains and cultivars, brewing yeast physico-chemical characteristics may be changed after they are repitched (with a complement of fresh yeast or not) [27]. Successive reuse of cells in repeated cycles of fermentation along with high alcohol concentration contributes to changes in cell wall and nutritional composition of

residual yeasts [19,73]. Repitched yeasts are even more exhausted in terms of its cell components accompanied by a thickening of the cell wall as they are recycled over and over. The response of different yeast cells to rupture and to proteolytic treatments may differ greatly according to their characteristics (strain, cultivar, if they are recycled or not) [27] and thus, the interest of studying different yeast types, which was not reported up to date.

In this context, a method for SBY rupture must be suitable to a variety of residues available in the brewing industry. For that reason, after the choice of a method for rupturing SBY, we proposed to evaluate the susceptibility to hydrolysis of different spent yeasts. First, two non-repitched yeasts of the same strain, but from different suppliers (SBYL and SBYD-N) were compared. Then, the effect of repitching on yeasts from the same supplier (SBYD-R and SBYD-N) was carried out. Differences on the degree of hydrolysis of samples after hydrolysis with Brauzyn<sup>®</sup> were verified.

When comparing non-repitched yeast (*S. pastorianus*) from different suppliers (Fermentis and Lallemand), SBYL samples resulted in 18.5% higher DH than SBYD-N samples, hydrolyzed by Brauzyn<sup>®</sup>. It seems that SBY (*S. pastorianus*) material from Fermentis was more easily ruptured than the one from Lallemand, both used at the same brewing conditions.

The effect of serial repitching of *S. pastorianus* from Lallemand (SBYD-R and SBYD-N) showed that non-repitched yeast samples were more easily hydrolyzed than the repitched ones, probably because of the thickening of the cell wall caused by yeast reuse. At the same hydrolysis conditions (pH, temperature, E:S and substrate concentration), SBYD-N samples took 3.5 times longer to achieve the same DH. After a sequential hydrolysis step using Alcalase<sup>™</sup>, a hydrolysate with the same DH attained with Brauzyn<sup>®</sup> in the case of non-repitched cells, could be achieved (data not shown). If the interest of SBY reuse is to obtain food protein hydrolysates, the sequential step of specific proteolysis using other enzymes seems to be enough to efficiently promote cell lysis and peptide production, following the Brauzyn<sup>®</sup> treatment. In sum, these results indicate that changes in the hydrolysis process should be done in order to adapt the process to different yeasts, so that proper release of cell components could be attained.

### 3.5. Sequential enzymatic hydrolysis

Because enzymatic hydrolysis was the selected method for SBY wall rupture, the ruptured material obtained through enzymatic hydrolysis with Brauzyn<sup>®</sup> (ERM) was used as substrate (supernatant fraction or non-centrifuged) for the sequential hydrolysis study with Alcalase<sup>™</sup>, Protamex<sup>™</sup> and Flavourzyme<sup>™</sup>. We aimed to check if antioxidant properties were improved by a sequential hydrolysis step.

TS in SF increased in average 10% in relation to control for both supernatants and non-centrifuged matrices. Hydrolysis with Protamex<sup>™</sup> using non-centrifuged ERM was the only enzymatic treatment that resulted in a rise in SS. CP in SF on all further hydrolyzed samples was kept constant in comparison to the control (ERM). These results suggest that a second step of hydrolysis does not considerably increase the yield of solids and proteins, in comparison with the ruptured material (ERM) obtained by hydrolysis with Brauzyn<sup>®</sup>.

A degree of hydrolysis approximately 2 times higher was found for non-centrifuged samples in comparison with supernatants for all enzymes (Fig. 6a). This may be attributed to the fact that non-treated samples contained more substrate available for the hydrolysis. Degree of hydrolysis of samples after second hydrolysis ranged from 31% to 52%, the highest value being achieved for the hydrolysate produced with Alcalase<sup>™</sup>. Alcalase<sup>™</sup> is a serine endoprotease from *Bacillus licheniformis* [74]. Protamex<sup>™</sup>, also from *Bacillus* sp. origin, is a peptidase complex and has been reported to have both endo and exoprotease activities, as does Flavourzyme<sup>™</sup>, a fungal complex from *Aspergillus oryzae* [75–77]. As previously stated, Brauzyn<sup>®</sup> is a protease from vegetal origin and presents both endo and exoactivities, as does

Protamex<sup>™</sup> and Flavourzyme<sup>™</sup> [57]. Among the three enzymes chosen for the sequential hydrolysis step, only Alcalase<sup>™</sup> presented just endoprotease activity and maybe this difference in enzymatic action contributed to the higher degree of hydrolysis achieved with this enzyme in comparison to the others (Fig. 6a).

A small decrease in antioxidant properties by the FRAP method was found for all hydrolysis on ERM supernatants (Fig. 6b). On the other hand, when non-centrifuged material was hydrolyzed, a rise in FRAP was found, specially for Flavourzyme and Alcalase<sup>™</sup>, which also presented the highest degree of hydrolysis, resulting in a rise of 45% and 51% in antioxidant capacity related to control. Indeed, a positive correlation between these two parameters was found for hydrolysates obtained from non-centrifuged ERM (Pearson coefficient of 0.95,  $p = 0.02$ ). In barley glutelin, beans and silkworm (*Bombyx mori* L.) pupa protein hydrolysates, antioxidant capacity was also higher for hydrolysates produced by Alcalase<sup>™</sup> [59,78,79]. Alcalase seems to produce antioxidant peptides because of its broad specificity and preferential breakdown of hydrophobic amino acids [80]. Great variation in the antioxidant capacity of protein hydrolysates is often reported, because it depends on hydrolysis conditions, substrate, enzyme specificity and degree of hydrolysis [78]. In general, methods that measure the antioxidant properties of food solutions and extracts are not specific for a particular group of compounds, instead, they give a value that expresses the antioxidant capacity of all the components in the extract [81]. Although peptide-rich extract results end-up varying greatly with the matrix composition, chosen radical system or mechanism used, data can be correlated to another biological properties and hydrophobicity of peptides [35,79].

Finally, the evolution of the BI parameters in this sequential hydrolysis step was investigated. Highest BI values were found for hydrolysates produced from non-centrifuged ERM, the one from Alcalase<sup>™</sup> presenting the highest degree of browning ( $254 \pm 20\%$ ), 2 times superior than the BI of the control, the ERM ( $128 \pm 13\%$ ). A positive correlation between the degree of hydrolysis and BI (Pearson coefficient of 0.82,  $p = 0.01$ ) suggested that the more cleaved the proteins, more important was the darkening of the hydrolysates. Because of its endoprotease characteristic, Alcalase<sup>™</sup> is able to produce very little protein fragments [40], which may be readily used in the Maillard reaction, causing the color change displayed by the BI.

## 4. Conclusions

The experimental design that evaluated the process conditions for the enzymatic rupture of yeast cell wall using Brauzyn<sup>®</sup> indicated a positive influence of higher E:S ratio and smaller pH on the solids and protein yield. High temperature values resulted in the reduction of the antioxidant properties of the hydrolysate. Once compared to cell rupture methods, enzymatic hydrolysis promoted a more efficient release of solids and protein and cell wall breakdown than both autolysis and mechanical rupture, resulting in the ruptured material with the highest antioxidant capacity.

Repitched yeast was more resistant to enzymatic rupture than non-repitched ones, as expected. Differences among yeast suppliers for the same strain and beer type were also found. These results suggest that the effective disruption of the yeast cell wall is dependent on the yeast supplier, beer type, and if the yeast is reused.

The protein hydrolysate obtained by sequential hydrolysis using Brauzyn<sup>®</sup> and Alcalase<sup>™</sup> resulted in the material with the highest antioxidant properties and total solids content. Probably, for repitched SBY, the sequential step would not only serve to cleave the released proteins and transform them into peptides, but also to finish disrupting the cell wall, increasing the release of yeast compounds.

This study proposed an approach for the recovery of an important by-product of the brewing industry, reducing the environmental impact of its disposal. SBY protein hydrolysates constitute a valuable source of protein and peptides, that may find use in the food industry as a

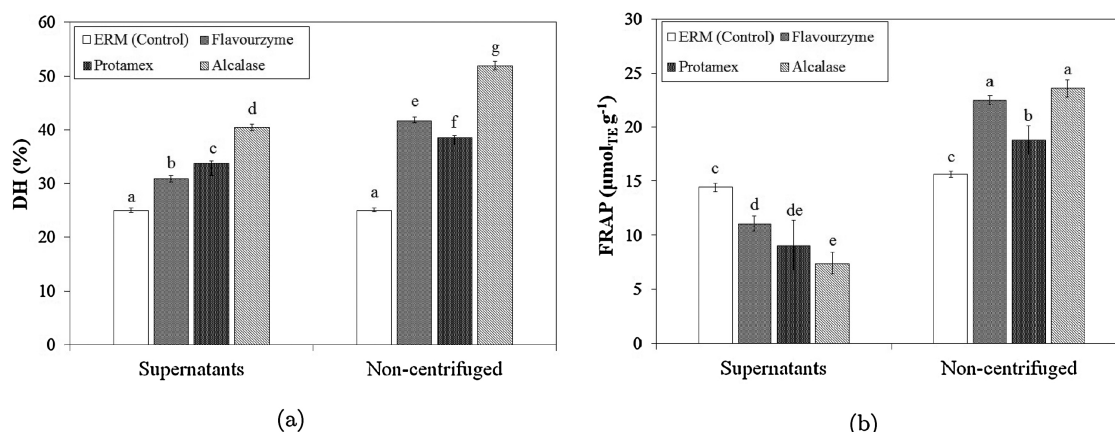

Fig. 6. Effect of a second step hydrolysis on the degree of hydrolysis (DH) (a) and ferric reducing ability (FRAP) (b) of hydrolysates and respective control (ERM): evaluation of the influence of centrifugation before the second hydrolysis (supernatants or non-centrifuged) and the use of three different enzymes (Flavourzyme™, Protamex™ and Alcalase™).

peptide-rich ingredient with antioxidant properties.

#### List of abbreviations

SBY	spent brewer's yeast
TROLOX	6-hydroxy-2,5,7,8-tetramethylchroman-2-carboxylic acid
SBYL	spent brewer's yeast ( <i>Saccharomyces pastorianus</i> ) from Lager Pilsner beer production without repitching (yeast supplier: Fermentis)
SBYD-N	spent brewer's yeast ( <i>Saccharomyces pastorianus</i> ) from Lager Pilsner beer production without repitching (yeast supplier: Lallemand)
SBYD-R	spent brewer's yeast ( <i>Saccharomyces pastorianus</i> ) from Lager Pilsner beer production repitched 5 times (yeast supplier: Fermentis)
ERM	ruptured yeast material, obtained by enzymatic hydrolysis with Brauzyn®
SF	supernatant fraction
TS	total solids
SS	soluble solids
CP	crude protein content
PR	protein recovery
MP <sub>S</sub>	protein mass in the hydrolysate's supernatant
MP	protein mass in the original substrate
x <sub>S</sub>	protein content in the hydrolysate's supernatant
x <sub>P</sub>	protein content in the hydrolysate's precipitate
M <sub>S</sub>	hydrolysate's supernatant mass
M <sub>P</sub>	hydrolysate's precipitate mass
E:S	enzyme:substrate ratio
DH	degree of hydrolysis
BI	Browning Index
ΔE	overall change in color
FRAP	antioxidant properties measured by the ferric reducing ability of plasma assay
DPPH	antioxidant properties measured by the 1,1-diphenyl-1-picrylhydrazyl radical-scavenging capacity assay

#### Conflict of interest

None declared.

#### Acknowledgements

This work was supported by FAPESP (São Paulo Research Foundation) [grant numbers #2016/18465-8, #2018/04067-6 and

#2011/51707-1] and FAEPEX (UNICAMP) [#2422/16; 519.292]. The authors thank Prozyn and Novozymes for the kind supply of enzymes; Pedro Moura (Haus Beer Brewery) for donating SBYs. Funding sources had no involvement in any steps of this research.

#### References

- [1] A. Nayak, B. Bhushan, An overview of the recent trends on the waste valorization techniques for food wastes, *J. Environ. Manage.* 233 (2019) 352–370.
- [2] A. Baiano, Recovery of biomolecules from food wastes – a review, *Molecules* 19 (2014) 14821–14842.
- [3] Kirin Holdings Company, Kirin beer university report global beer production by country in 2016, (2017) URL: [https://www.kirinholdings.co.jp/english/news/2017/0810\\_01.html](https://www.kirinholdings.co.jp/english/news/2017/0810_01.html), (accessed 01.09.18).
- [4] M.T.B. Pacheco, G.M. Caballero-Córdoba, V.C. Sgarbieri, Composition and nutritive value of yeast biomass and yeast protein concentrates, *J. Nutr. Sci. Vitaminol.* 43 (1997) 601–612.
- [5] T.R.d.S. Mathias, V.M.F. Alexandre, M.C. Cammarota, P.P.M. Mello, E.F.C. Sérvulo, Characterization and determination of brewer's solid wastes composition, *J. Inst. Brewing* 121 (2015) 400–404.
- [6] S.I. Mussatto, Biotechnological potential of brewing industry by-products, in: P. Singh nee' Nigam, A. Pandey (Eds.), *Biotechnology for Agro-Industrial Residues Utilisation: Utilisation of Agro-Residues*, Springer Netherlands, Dordrecht, 2009, pp. 313–326, [https://doi.org/10.1007/978-1-4020-9942-7\\_16](https://doi.org/10.1007/978-1-4020-9942-7_16).
- [7] E. Vieira, J. Teixeira, I.M. Ferreira, Valorization of brewers' spent grain and spent yeast through protein hydrolysates with antioxidant properties, *Eur. Food Res. Technol.* 242 (2016) 1975–1984.
- [8] B. Podpora, F. Świdorski, A. Sadowska, R. Rakowska, G. Wasiak-zys, Spent brewer's yeast extracts as a new component of functional food, *Czech J. Food Sci.* 34 (2016) 554–563.
- [9] Y.-J. Jeon, H.-G. Byun, S.-K. Kim, Improvement of functional properties of cod frame protein hydrolysates using ultrafiltration membranes, *Process Biochem.* 35 (1999) 471–478.
- [10] I. Ferreira, O. Pinho, E. Vieira, J. Tavela, Brewer's *Saccharomyces* yeast biomass: characteristics and potential applications, *Trends Food Sci. Technol.* 21 (2010) 77–84.
- [11] R.S. Kumar, M. Chandrasekaran, Beverages, in: M. Chandrasekaran (Ed.), *Valorization of Food Processing By-Products*, CRC Press, Boca Raton, 2016, pp. 589–614.
- [12] M. Pinto, E. Coelho, A. Nunes, T.B. ao, M.A. Coimbra, Valuation of brewers spent yeast polysaccharides: a structural characterization approach, *Carbohydr. Polym.* 116 (2015) 215–222.
- [13] H.J. Chae, H. Joo, M.-J. In, Utilization of brewer's yeast cells for the production of food-grade yeast extract. Part 1: Effects of different enzymatic treatments on solid and protein recovery and flavor characteristics, *Bioresour. Technol.* 76 (2001) 253–258.
- [14] A. Connolly, C.O. Piggott, R.J. FitzGerald, Technofunctional properties of a brewers' spent grain protein-enriched isolate and its associated enzymatic hydrolysates, *LWT Food Sci. Technol.* 59 (2014) 1061–1067.
- [15] A.L. McCarthy, Y.C. O'Callaghan, A. Connolly, C.O. Piggott, R.J. FitzGerald, N.M. O'Brien, In vitro antioxidant and anti-inflammatory effects of brewers' spent grain protein rich isolate and its associated hydrolysates, *Food Res. Int.* 50 (2013) 205–212.
- [16] A.L. McCarthy, Y.C. O'Callaghan, A. Connolly, C.O. Piggott, R.J. FitzGerald, N.M. O'Brien, Brewers' spent grain (BSG) protein hydrolysates decrease hydrogen peroxide (H<sub>2</sub>O<sub>2</sub>)-induced oxidative stress and concanavalin-A (con-A) stimulated IFN-γ production in cell culture, *Food Funct.* 4 (2013) 1709–1716.

- [17] A.L. McCarthy, Y.C. O'Callaghan, A. Connolly, C.O. Piggott, R.J. FitzGerald, N.M. O'Brien, A study of the ability of bioactive extracts from brewers' spent grain to enhance the antioxidant and immunomodulatory potential of food formulations following *in vitro* digestion, *Int. J. Food Sci. Nutr.* 66 (2015) 230–235.
- [18] E.F. Vieira, J. Carvalho, E. Pinto, S. Cunha, A.A. Almeida, I.M. Ferreira, Nutritive value, antioxidant activity and phenolic compounds profile of brewer's spent yeast extract, *J. Food Compos. Anal.* 52 (2016) 44–51.
- [19] A. Halász, R. Lásztity, Chemical composition and biochemistry of yeast biomass, in: A. Halász, R. Lásztity (Eds.), *Use of Yeast Biomass in Food Production*, CRC Press, Boca Raton, USA, 1991, pp. 23–41.
- [20] M. Mirzaei, S. Mirdamadi, M.R. Ehsani, M. Aminlari, E. Hosseini, Purification and identification of antioxidant and ACE-inhibitory peptide from *Saccharomyces cerevisiae* protein hydrolysate, *J. Funct. Foods* 19 (2015) 259–268.
- [21] M. Mirzaei, S. Mirdamadi, M.R. Ehsani, M. Aminlari, Production of antioxidant and ACE-inhibitory peptides from *Kluyveromyces marxianus* protein hydrolysates: purification and molecular docking, *J. Food Drug Anal.* 26 (2018) 696–705.
- [22] M. Amorim, C. Marques, J.O. Pereira, L. Guardão, M.J. Martins, H. Osório, D. Moura, C. Calhau, H. Pinheiro, M. Pintado, Antihypertensive effect of spent brewer yeast peptide, *Process Biochem.* 76 (2019) 213–218.
- [23] M. Amorim, J.O. Pereira, D. Gomes, C.D. Pereira, H. Pinheiro, M. Pintado, Nutritional ingredients from spent brewer's yeast obtained by hydrolysis and selective membrane filtration integrated in a pilot process, *J. Food Eng.* 185 (2016) 42–47.
- [24] E. Vieira, T. Brandão, I.M. Ferreira, Evaluation of brewer's spent yeast to produce flavor enhancer nucleotides: influence of serial repitching, *J. Agric. Food Chem.* 61 (2013) 8724–8729 PMID: 24004163.
- [25] D. Liu, X.-A. Zeng, D.-W. Sun, Z. Han, Disruption and protein release by ultrasonication of yeast cells, *Innov. Food Sci. Emerg. Technol.* 18 (2013) 132–137.
- [26] R. Lovitt, M. Jones, S. Collins, G. Coss, C. Yau, C. Attouch, Disruption of bakers' yeast using a disrupter of simple and novel geometry, *Process Biochem.* 36 (2000) 415–421.
- [27] E.A. Yamada, V.C. Sgarbieri, Yeast (*Saccharomyces cerevisiae*) protein concentrate: preparation, chemical composition, and nutritional and functional properties, *J. Agric. Food Chem.* 53 (2005) 3931–3936 PMID: 15884819.
- [28] E.F. Vieira, A. Melo, I.M. Ferreira, Autolysis of intracellular content of brewer's spent yeast to maximize ACE-inhibitory and antioxidant activities, *LWT Food Sci. Technol.* 82 (2017) 255–259.
- [29] G. Pancrazio, S.C. Cunha, P.G. de Pinho, M. Loureiro, S. Meireles, I.M. Ferreira, O. Pinho, Spent brewer's yeast extract as an ingredient in cooked hams, *Meat Sci.* 121 (2016) 382–389.
- [30] H. Tangler, H. Erten, Utilisation of spent brewer's yeast for yeast extract production by autolysis: the effect of temperature, *Food Bioprod. Process.* 86 (2008) 317–321.
- [31] A.P.J. Middelberg, Process-scale disruption of microorganisms, *Biotechnol. Adv.* 13 (1995) 491–551.
- [32] A. Bzducha-Wróbel, S. Błażej, A. Kawarska, L. Stasiak-Różańska, I. Gientka, E. Majewska, Evaluation of the efficiency of different disruption methods on yeast cell wall preparation for  $\beta$ -glucan isolation, *Molecules* 19 (2014) 20941–20961.
- [33] S. Harrison, *Cell disruption*, in: M. Moo-Young (Ed.), *Comprehensive Biotechnology*, 2nd ed., Academic Press, Burlington, 2011, pp. 619–640, <https://doi.org/10.1016/B978-0-08-088504-9.00127-6>.
- [34] A. Noman, Y. Xu, W.Q. AL-Bukhaiti, S.M. Abed, A.H. Ali, A.H. Ramadhan, W. Xia, Influence of enzymatic hydrolysis conditions on the degree of hydrolysis and functional properties of protein hydrolysate obtained from Chinese sturgeon (*Acipenser sinensis*) by using papain enzyme, *Process Biochem.* 67 (2018) 19–28.
- [35] P.A. Ortiz-Chao, P. Jauregi, Enzymatic production of bioactive peptides from milk and whey proteins, in: R. Rastall (Ed.), *Novel Enzyme Technology for Food Applications*, 1st ed., Woodhead Publishing, Cambridge, England, 2007, pp. 160–182.
- [36] M. Jiang, K. Chen, Z. Liu, P. Wei, H. Ying, H. Chang, Succinic acid production by *Actinobacillus succinogenes* using spent brewer's yeast hydrolysate as a nitrogen source, *Appl. Biochem. Biotechnol.* 160 (2010) 244–254.
- [37] E.Y. Jung, H.-S. Lee, J.W. Choi, K.S. Ra, M.-R. Kim, H.J. Suh, Glucose tolerance and antioxidant activity of spent brewer's yeast hydrolysate with a high content of Cyclo-His-Pro (CHP), *J. Food Sci.* 76 (2011) C272–C278.
- [38] C. Cupp-Enyard, Sigma's non-specific protease activity assay – casein as a substrate, *J. Visual. Exp.* 19 (2008) 899.
- [39] R.J.S. de Castro, H.H. Sato, A response surface approach on optimization of hydrolysis parameters for the production of egg white protein hydrolysates with antioxidant activities, *Biocatal. Agric. Biotechnol.* 4 (2015) 55–62.
- [40] P.M. Nielsen, H.S. Olsen, Enzymic modification of food protein, in: R.J. Whitehurst, B.A. Law (Eds.), *Enzymes in Food Technology*, Sheffield Academic Press, Sheffield, 2002, pp. 109–143.
- [41] AOAC, *Official Methods of Analysis of the Association of Official Analytical Chemists*, 18th ed., (2006) Gaithersburg, MD, USA.
- [42] E. Fournier, Colorimetric quantification of carbohydrates, in: R.E. Wrolstad (Ed.), *Current Protocols in Food Analytical Chemistry*, John Wiley & Sons, Inc., 2001, pp. 1–8, <https://doi.org/10.1002/0471142913.fae0101s00>.
- [43] R.E. Wrolstad, T.E. Acree, E.A. Decker, M.H. Penner, D.S. Reid, S.J. Schwartz, C.F. Shoemaker, D. Smith, P. Sporns, *Measurements of Protein Content*, John Wiley & Sons, Inc., 2005, pp. 73–121, <https://doi.org/10.1002/0471709085.ch3>.
- [44] G. Reed, T.W. Nagodawithana, *Food and Feed Yeast*, Springer, Dordrecht, 1991, pp. 413–440, <https://doi.org/10.1007/978-94-011-9771-7>.
- [45] G.M. Caballero-Córdoba, V.C. Sgarbieri, Nutritional and toxicological evaluation of yeast (*Saccharomyces cerevisiae*) biomass and a yeast protein concentrate, *J. Sci. Food Agric.* 80 (2000) 341–351.
- [46] M.T.B. Pacheco, V.C. Sgarbieri, Hydrophilic and rheological properties of brewer's yeast protein concentrates, *J. Food Sci.* 63 (1998) 238–243.
- [47] M.A.N. del Toro, F.L. García-Carreño, Evaluation of the progress of protein hydrolysis, in: R.E. Wrolstad (Ed.), *Handbook of Food Analytical Chemistry: Water, Proteins, Enzymes, Lipids, and Carbohydrates*, John Wiley & Sons, Inc., 2005, <https://doi.org/10.1002/0471709085.p.B2.2>.
- [48] G.M. Caballero-Córdoba, M.T.B. Pacheco, V.C. Sgarbieri, Composição química da biomassa de levedura integral (*Saccharomyces* sp.) e determinação do valor nutricional da proteína em células íntegras ou rompidas mecanicamente, *Food Sci. Technol.* 17 (1997) 102–106.
- [49] M.-J. In, D.C. Kim, H.J. Chae, Downstream process for the production of yeast extract using brewer's yeast cells, *Biotechnol. Bioprocess Eng.* 10 (2005) 85.
- [50] M. Yu, S. He, M. Tang, Z. Zhang, Y. Zhu, H. Sun, Antioxidant activity and sensory characteristics of Maillard reaction products derived from different peptide fractions of soybean meal hydrolysate, *Food Chem.* 243 (2018) 249–257.
- [51] R. Song, P. Yang, R. Wei, G. Ruan, Antioxidative, antibacterial, and food functional properties of the half-fin anchovy hydrolysates-glucose conjugates formed via Maillard reaction, *Molecules* 21 (2016).
- [52] W.S. Mokrzycki, M. Tatol, Colour difference Delta E – a survey, *Mach. Graph. Vis.* 20 (2011) 383–412 (accessed 20 October 2018).
- [53] I.F. Benzie, J. Strain, The ferric reducing ability of plasma (FRAP) as a measure of "Antioxidant Power": the frap assay, *Anal. Biochem.* 239 (1996) 70–76.
- [54] M.S.M. Rufino, R.E. Alves, E.S. Brito, J. Mancini Filho, A.V.B. Moreira, Metodologia científica: determinação da atividade antioxidante total em frutas no sistema  $\beta$ -caroteno/ácido linoleico, EMBRAPA, Fortaleza, 2006 Technical Report.
- [55] T.J. Herald, P. Gadgil, M. Tilley, High-throughput micro plate assays for screening flavonoid content and DPPH-scavenging activity in sorghum bran and flour, *J. Sci. Food Agric.* 92 (2012) 2326–2331.
- [56] C.I. Butré, P.A. Wierenga, H. Gruppen, Influence of water availability on the enzymatic hydrolysis of proteins, *Process Biochem.* 49 (2014) 1903–1912.
- [57] Prozyn S/A, Brauzyn™ 100 L Product Sheet, Special Food, 2009.
- [58] R. Sowmya, T.M. Ravikumar, R. Vivek, K. Rathinaraj, N.M. Sachindra, Optimization of enzymatic hydrolysis of shrimp waste for recovery of antioxidant activity rich protein isolate, *J. Food Sci. Technol.* 51 (2014) 3199–3207.
- [59] R. Yang, X. Zhao, Z. Kuang, M. Ye, G. Luo, G. Xiao, S. Liao, L. Li, Z. Xiong, Optimization of antioxidant peptide production in the hydrolysis of silkworm (*Bombyx mori* L.) pupa protein using response surface methodology, *J. Food Agric. Environ.* 11 (2013) 952–956.
- [60] N. Rafi, N. Halim, A.M. Amin, N. Sarbon, Response surface optimization of enzymatic hydrolysis conditions of lead tree (*Leucaena leucocephala*) seed hydrolysate, *Int. Food Res. J.* 22 (2015) 1015–1023.
- [61] B.H. Sarmadi, A. Ismail, Antioxidative peptides from food proteins: a review, *Peptides* 31 (2010) 1949–1956.
- [62] R.L. Prior, X. Wu, K. Schaich, Standardized methods for the determination of antioxidant capacity and phenolics in foods and dietary supplements, *J. Agric. Food Chem.* 53 (2005) 4290–4302.
- [63] J.M. Kim, K.S. Ra, H.J. Suh, Hydrolysis of onion and kinetics of non-enzymatic browning of its hydrolysate, *Food Sci. Technol. Int.* 10 (2004) 41–44.
- [64] G.R. Walter, M.S. Feather, *The Maillard Reaction in Foods and Nutrition*, volume 215 – ACS Symposium Series, American Chemical Society, Washington, USA, 1983, <https://doi.org/10.1021/bk-1983-0215>.
- [65] S.-Y. Yang, S.-W. Kim, Y. Kim, S.-H. Lee, H. Jeon, K.-W. Lee, Optimization of Maillard reaction with ribose for enhancing anti-allergy effect of fish protein hydrolysates using response surface methodology, *Food Chem.* 176 (2015) 420–425.
- [66] J. Xie, C. Cui, J. Ren, M. Zhao, L. Zhao, W. Wang, High solid concentrations facilitate enzymatic hydrolysis of yeast cells, *Food Bioprod. Process.* 103 (2017) 114–121.
- [67] C. Cui, Y. Qian, W. Sun, H. Zhao, Effects of high solid concentrations on the efficacy of enzymatic hydrolysis of yeast cells and the taste characteristics of the resulting hydrolysates, *Int. J. Food Sci. Technol.* 51 (2016) 1298–1304.
- [68] H.A. El-Enshasy, Chapter 9 – filamentous fungal cultures – process characteristics, products, and applications, in: S.-T. Yang (Ed.), *Bioprocessing for Value-Added Products from Renewable Resources*, Elsevier, Amsterdam, 2007, pp. 225–261, <https://doi.org/10.1016/B978-0-44452114-9/50010-4>.
- [69] S.H. Duarte, P.d. Santos, M. Michelon, S.M.d.P. Oliveira, J. Martínez, F. Maugeri, Recovery of yeast lipids using different cell disruption techniques and supercritical CO<sub>2</sub> extraction, *Biochem. Eng. J.* 125 (2017) 230–237.
- [70] M. Ricci-Silva, M. Vitolo, J.A. ao Neto, Protein and glucose 6-phosphate dehydrogenase releasing from baker's yeast cells disrupted by a vertical bead mill, *Process Biochem.* 35 (2000) 831–835.
- [71] L. Miranda, C. Rakovski, L. Were, Effect of Maillard reaction products on oxidation products in ground chicken breast, *Meat Sci.* 90 (2012) 352–360.
- [72] G. Rumsey, S. Hughes, R. Smith, J. Kinsella, K. Shetty, Digestibility and energy values of intact, disrupted and extracts from brewer's dried yeast fed to rainbow trout (*Oncorhynchus mykiss*), *Anim. Feed Sci. Technol.* 33 (1991) 185–193.
- [73] P. Saini, A. Beniwal, A. Kokkilgadda, S. Vij, Response and tolerance of yeast to changing environmental stress during ethanol fermentation, *Process Biochem.* 72 (2018) 1–12.
- [74] Novozymes S/A, Alcalase™ Product Sheet, Special Food, 2002.
- [75] Novozymes S/A, Protamex™ Product Sheet, Special Food, 2002.



- [76] Novozymes S/A, Flavourzyme™ Product Sheet, Special Food, 2002.
- [77] C.M. Silva, R.A. dos Santos da Fonseca, C. Prentice, Comparing the hydrolysis degree of industrialization byproducts of Withemouth croaker (*Micropogonias furnieri*) using microbial enzymes, *Int. Food Res. J. Malay.* 21 (2014) 1757–1761.
- [78] Y. Xia, F. Bamdad, M. Gänzle, L. Chen, Fractionation and characterization of antioxidant peptides derived from barley glutelin by enzymatic hydrolysis, *Food Chem.* 134 (2012) 1509–1518.
- [79] P. Garcia-Mora, J. Frias, E. Peñas, H. Zieliński, J.A. Giménez-Bastida, W. Wiczkowski, D. Zielińska, C. Martínez-Villaluenga, Simultaneous release of peptides and phenolics with antioxidant, ACE-inhibitory and anti-inflammatory activities from pinto bean (*Phaseolus vulgaris* L. var. pinto) proteins by subtilisins, *J. Funct. Foods* 18 (2015) 319–332.
- [80] R. Gupta, Q. Beg, P. Lorenz, Bacterial alkaline proteases: molecular approaches and industrial applications, *Appl. Microbiol. Biotechnol.* 59 (2002) 15–32.
- [81] A. Moure, H. Domínguez, J.C. Parajó, Antioxidant properties of ultrafiltration-recovered soy protein fractions from industrial effluents and their hydrolysates, *Process Biochem.* 41 (2006) 447–456.

## Chapter 6

### Article 2: Protein hydrolysis

**Proteolytic enzymes positively modulated the physicochemical and antioxidant properties of spent yeast protein hydrolysates**

Gabriela Vollet Marson<sup>a</sup>, Ruann Janser Soares de Castro<sup>b</sup>, Mariana Teixeira da Costa Machado<sup>c</sup>, Flávia da Silva Zandonadi<sup>d</sup>, Helena Dias de Freitas Queiroz Barros<sup>e</sup>, Mário Roberto Maróstica Júnior<sup>e</sup>, Alessandra Sussulini<sup>d</sup>, Miriam Dupas Hubinger<sup>a</sup>

<sup>a</sup>Department of Food Engineering (DEA), School of Food Engineering (FEA), University of Campinas (UNICAMP), R. Monteiro Lobato, 80, 13083-862, Campinas, São Paulo, Brazil.

<sup>b</sup>Department of Food Science (DCA), School of Food Engineering (FEA), University of Campinas (UNICAMP), R. Monteiro Lobato, 80, 13083-862, Campinas, São Paulo, Brazil.

<sup>c</sup>Department of Food Technology, Federal Rural University of Rio de Janeiro, BR 465, km 7, 23890-000, Seropédica, Rio de Janeiro, Brazil.

<sup>d</sup>Department of Analytical Chemistry, Institute of Chemistry (IQ), University of Campinas (UNICAMP), 13083-970, Campinas, São Paulo, Brazil.

<sup>e</sup>Department of Food and Nutrition (DEPAN), School of Food Engineering (FEA), University of Campinas (UNICAMP), R. Monteiro Lobato, 80, 13083-862, Campinas, São Paulo, Brazil.

Results of this chapter were published in the Elsevier's Journal "Process Biochemistry",

Vol. 91, p. 34-45, 2020.

ISSN: 1359-5113

DOI: <https://doi.org/10.1016/j.procbio.2019.11.030>



Contents lists available at ScienceDirect

## Process Biochemistry

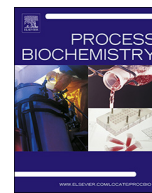
journal homepage: [www.elsevier.com/locate/procbio](http://www.elsevier.com/locate/procbio)

## Proteolytic enzymes positively modulated the physicochemical and antioxidant properties of spent yeast protein hydrolysates

Gabriela Vollet Marson<sup>a,\*</sup>, Ruann Janser Soares de Castro<sup>b</sup>, Mariana Teixeira da Costa Machado<sup>c</sup>, Flávia da Silva Zandonadi<sup>d</sup>, Helena Dias de Freitas Queiroz Barros<sup>e</sup>, Mário Roberto Maróstica Júnior<sup>e</sup>, Alessandra Sussulini<sup>d</sup>, Miriam Dupas Hubinger<sup>a</sup>

<sup>a</sup> Department of Food Engineering, School of Food Engineering, UNICAMP, Rua Monteiro Lobato, 80, 13083-862, Campinas, SP, Brazil

<sup>b</sup> Department of Food Science, School of Food Engineering, UNICAMP, Rua Monteiro Lobato, 80, 13083-862, Campinas, SP, Brazil

<sup>c</sup> Department of Food Technology, Federal Rural University of Rio de Janeiro, Rodovia BR 465, km 7, 23890-000, Seropédica, RJ, Brazil

<sup>d</sup> Department of Analytical Chemistry, Institute of Chemistry, University of Campinas, 13083-970, Campinas, SP, Brazil

<sup>e</sup> Department of Food and Nutrition, School of Food Engineering, UNICAMP, Rua Monteiro Lobato, 80, 13083-862, Campinas, SP, Brazil

## ARTICLE INFO

## Keywords:

Food protein hydrolysates  
Mixture design  
*Saccharomyces* sp.  
membrane fractionation  
hydrophobic peptides

## ABSTRACT

The spent brewer yeast (SBY) is a by-product with great potential for the production of peptides. Protein hydrolysates of SBY with improved physicochemical and antioxidant properties were produced by a system containing mixtures of proteases (Alcalase™, Brauzyn® and Protamex™). The amount of solids and crude proteins recovered from the raw material after the protein hydrolysis was, in average, 57% and 70% (w/w), respectively. Hydrolysis resulted in intermediate degrees of hydrolysis (15%), promoting the release of hydrophobic residues (8% higher related to the control) with antioxidant properties. The presence of all three enzymes influenced the degree of hydrolysis but the darkening and browning of the hydrolysates were mainly affected by Protamex™. Most of the hydrolyzed proteins presented a molecular weight (MW) of 35 kg mol<sup>-1</sup>, as confirmed after membrane separation and electrophoresis. The membrane fractionation step using 30 kg mol<sup>-1</sup> membranes effectively produced peptide-enriched fractions of 30–35 kg mol<sup>-1</sup>. In addition, it was possible to correlate the degree of hydrolysis, solids release, color parameters L\*, Browning Index and antioxidant properties by FRAP and DPPH in function of the hydrolysis conditions, showing the potential use of SBY protein hydrolysates as a source of peptides in value-added functional foods.

### 1. Introduction

About 400 thousand tons of spent brewer's yeast (SBY) are produced each year by the brewing industry [1]. A good source of protein, SBY is still currently used as inexpensive animal feed or has to be disposed as biological waste [2–4]. On account of the increasing concern about the sustainable use and management of natural resources as well as higher transportation costs and severe waste disposal regulations, alternative uses for SBY and other agro-industrial by-products are being studied [5,6]. In addition to its economical relevance, this by-product is a valuable source of nutrients and is recognized as safe [4]. SBY presents a high protein content (45%–60%), carbohydrates (35%–15%) as well as vitamins (complex B), minerals, dietary fibers and RNA [2,7,8]. It is a source of high-quality proteins, with amounts of all essential amino acids that meet or exceed FAO (Food and Agriculture Organization of

the United Nations) amino acids ingestion recommendations [9,2]. During beer production, yeasts are imposed to stressful conditions (high alcohol concentration and successive reuse of cells), turning the cell wall into a resistant structure which must be ruptured in order to release the yeast compounds [10,11]. Enzymatic hydrolysis can efficiently break down the cells while releasing bioactive peptides [11–13]. Indeed, our research group reported recently a more efficient release of compounds following the disruption of the yeast cell wall by enzymatic hydrolysis in comparison to conventional methods such as autolysis and mechanical rupture using glass beads [6].

Peptides are molecules of 2 to 50 amino acids, whereas a larger chain of more than 50 generally is referred to as a protein [14]. Once released from the parent protein, peptides contribute to physico-chemical, biological and organoleptic properties of foods due to the action of enzymes during food processing or gastrointestinal digestion

\* Corresponding author. Present Address: Institut Européen des Membranes, Université de Montpellier, CNRS, ENSCM, UM, CC 047, 2 Place Eugène Bataillon, 34095, Montpellier, France.

E-mail address: [gabrielaivollet@gmail.com](mailto:gabrielaivollet@gmail.com) (G.V. Marson).

<https://doi.org/10.1016/j.procbio.2019.11.030>

Received 28 June 2019; Received in revised form 17 November 2019; Accepted 22 November 2019

Available online 28 November 2019

1359-5113/ © 2019 Elsevier Ltd. All rights reserved.

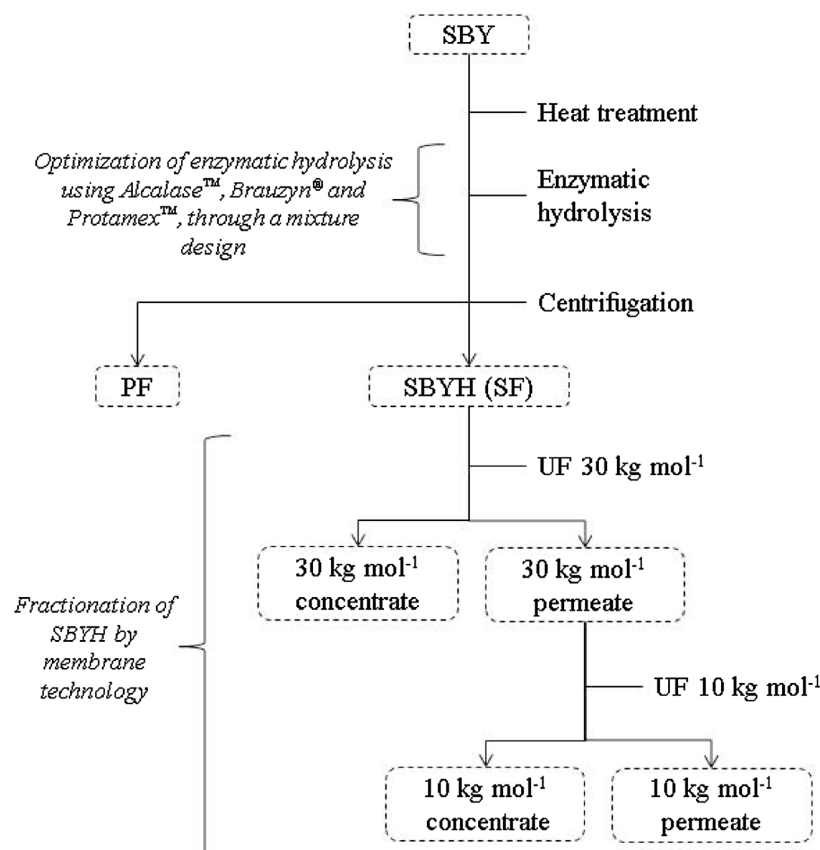

Fig. 1. Schematic diagram of the experimental procedure for the production of fractionated spent brewer's yeast hydrolysate (SBYH) using enzymatic hydrolysis and ultrafiltration (UF) membranes of 30 and 10 kg mol<sup>-1</sup> molecular weight cut-off.

[15,16]. Bioactive peptides may be generated from protein-rich materials under controlled enzymatic conditions with commercial enzymes [15], potentially resulting in reduced allergenicity, improved solubility and digestibility and functionality [2,17]. The characteristics and properties of the released peptides hinge on the processing conditions as well as on the specificity of the chosen enzymes for that purpose [7,16,3]. Biological activity effects of protein hydrolysates have been reported to depend on their peptide sequence, size and hydrophobicity [18]. Yeast hydrolysates have been reported to have antioxidant properties [3] and to have a high proportion of hydrophobic and basic residues [7], which are an indicative of antihypertensive and antioxidant properties, which can also be correlated with other biological effects [19,20].

Protein hydrolysates obtained from by-products consist of a complex mixture of peptides with different molecular weights (MW) and amino acids composition, among other biomolecules. Separation steps are required in order to obtain more purified fractions with the desired characteristics for particular applications [13,16]. Membrane separation technologies have been successfully employed in the fractionation and concentration of protein hydrolysates from food industry by-products, mostly from meat and plants [18,4].

The motivation for using yeast as a source of peptides is based on the enormous availability of this raw material, the environmental concern involving its disposal as well as its high biological protein quality and composition [11,7]. Moreover, even though recent papers have reported that yeast is considered as a potential source of bioactive peptides [19], studies have not proposed the optimization of hydrolysis neither evaluated the choice of enzyme on the qualitative properties of the hydrolysates. We propose a mixture design to access the effects of enzyme combinations on the production of spent brewer's yeast hydrolysates and to evaluate their properties. Mixture design is a

statistical optimization tool where different proportions of some component are accessed for individual, antagonist or synergistic effects on the chosen responses. Using the prediction models and mixture contour plots, the most adequate mixtures of the studied component can be determined, using a limited number of assays [21,22]. Based on this context, the objective of our study was to optimize the enzymatic hydrolysis by a mixture design, aiming the recovery of SBY hydrolysate fractions enriched in antioxidant and hydrophobic peptides. First, the enzyme choice and their proportions were optimized considering SBY protein hydrolysate characteristics and then, SBY peptide-enriched fractions obtained by membrane fractionation were characterized by electrophoresis.

## 2. Material and Methods

### 2.1. Reagents

Azocasein, bovine serum albumine (electrophoretic grade), 6-hydroxy-2,5,7,8-tetra-methylchroman-2-carboxylic acid (TROLOX), 2,2-diphenyl-1-picrylhydrazyl (DPPH), iron III chloride hexahydrate, iron II sulfate heptahydrate, trichloroacetic acid (TCA), 2,4,6-tris(2-pyridyl)-s-triazine (TPTZ), Tris(hydroxymethyl)aminomethane, Tris-HCl, glycine, Sodium dodecyl sulfate (SDS), Dithiothreitol (DTT), fluorescein and 2,2'-azobis (2-methylpropio-namidine) dihydrochloride (AAPH) were purchased from Sigma-Aldrich (Steinheim, Germany). Acrylamide/Bis-acrylamide (30% solution), N, N, N', N'-Tetra-methylethylenediamine, and ammonium persulfate were obtained from Biorad (Hercules, United States). Other reagents were of analytical grade.

2.2. Enzymes

Three commercial proteases were used in this study: Brauzyn® 100 L (Prozyn, Brazil), which is a vegetable protease specific for yeast cell wall hydrolysis, Protamex™ (Novozymes, Denmark) and Alcalase™ 2.4 L FG (Novozymes, Denmark). Protease activity was checked using azo-casein as substrate [23], following modifications [21], at pH 7.0 and 50°C. Protease activity results were reported in U, where one unit of enzymatic activity was defined as the amount of enzyme required to increase the absorbance at 428 nm by 0.01 under the assay conditions [21].

2.3. Production of spent brewer's yeast hydrolysate

SBY (*Saccharomyces pastorianus*) from Lager Pilsen beer production (Diamond Lager, Lallemand, Canada) was collected after 11 days of beer maturation at Haus Bier Brewery (São José dos Campos, Brazil), without any repitching. The pH value of the collected material was 6.1 ± 0.1. SBY was kept at 2°C until it was homogenized and pre-treated (section 2.3.1). The experimental procedure for the production of the spent brewer's yeast hydrolysate (SBYH) is described in Figure 1.

2.3.1. SBY pre-treatment

SBY was submitted to a heat pre-treatment which consisted in heating yeast slurry in a stainless steel batch reactor at 70 ± 0.2°C, with mechanical stirring of 1000 rpm for an hour, followed by an ice bath [24].

2.3.2. Protein hydrolysis procedure

Yeast slurry following the heat treatment consisted of 12.3 ± 0.1% of total solids and 40.8 ± 0.1% of crude protein. The pH value of the non-diluted SBY was adjusted using 2 M NaOH to reach pH 7.0. The suspension was incubated for 10 minutes at hydrolysis temperature (50°C). Then, the reaction was initiated by the addition of enzymes in the proportions (enzyme:substrate ratio, U g<sub>protein</sub><sup>-1</sup>) determined for each experiment by the mixture design (section 2.3.3), as presented in Table 1, to give a final enzyme:substrate ratio of 2000 U g<sub>protein</sub><sup>-1</sup>. Temperature and pH of hydrolysis were determined considering the ranges of action of the enzymes so they could act simultaneously. All hydrolysis experiments were performed in 100 mL jacketed beakers under agitation (500 rpm) for 2 h. The pH control was done by an automatic titrator (T50, Mettler Toledo, Switzerland) and the temperature control was assured by a water bath (MA126/BD, Marconi, Brazil). Controls were prepared for each experiment, following the same conditions but no enzymes were added. After 2 h of hydrolysis, enzymes were inactivated by heating (95°C for 15 min). Reaction mixture was centrifuged at 15,300 × g for 30 min at 4°C (Allegra 25R, Beckman Coulter, United States). The cell debris were separated from the hydrolysate by centrifugation, resulting in the precipitate fraction (PF) and the supernatant, the spent brewer's yeast protein hydrolysate (SBYH). The pH value of samples was verified, corrected if necessary (pH 7.0) and they were kept at -20°C until further analysis.

2.3.3. Statistical mixture design

Optimization of SBY protein hydrolysis was performed using a three component augmented simplex centroid mixture design to investigate the presence of synergistic or antagonist effects of a blend of proteases: Alcalase™ (x<sub>1</sub>), Brauzyn® (x<sub>2</sub>) and Protamex™ (x<sub>3</sub>); to obtain hydrolysates with maximum antioxidant activity. Six levels of each component were studied, namely: 0, 1/6, 1/3, 1/2, 2/3 and 1 (Table 1). The responses of the mixture design were expressed in terms of difference of the hydrolysate to the respective control. Finally, the experimental values were compared to the predicted ones in order to validate the models using the conditions of run 7 (Table 1) resulting in non-significant differences (p < 0.05).

In a mixture design, the components of a mixture are not just levels

**Table 1** Coded levels of the simplex centroid mixture design matrix for the study of enzymatic hydrolysis of SBY; proportions of the enzymes (x<sub>1</sub>: Alcalase™; x<sub>2</sub>: Brauzyn®; x<sub>3</sub>: Protamex™) in terms of enzyme:substrate ratio (U g<sub>protein</sub><sup>-1</sup>) and response values for physico-chemical and antioxidant properties

Runs	x < ce: inf > 1 < /ce: inf >	x < ce: inf > 2 < /ce: inf >	x < ce: inf > 3 < /ce: inf >	Total solids in precipitate (%)	Degree of hydrolysis (%)	L* color parameter	Browning Index	FRAP <sup>a</sup>	DPPH <sup>a</sup>	ORAC <sup>a</sup>
1	1	0	0	27.4±0.2 <sup>ABCD</sup>	10.9±0.5 <sup>C</sup>	7.51±0.32 <sup>A</sup>	101±5 <sup>G</sup>	5.59±0.32 <sup>AB</sup>	10.78±0.46 <sup>C</sup>	485.6±24.1 <sup>A</sup>
2	0	1	0	25.9±0.2 <sup>D</sup>	9.0±0.5 <sup>CD</sup>	5.18±0.08 <sup>B</sup>	132±5 <sup>F</sup>	6.03±0.11 <sup>AB</sup>	15.35±0.86 <sup>AB</sup>	461.6±28.2 <sup>A</sup>
3	0	0	1	28.1±0.4 <sup>AB</sup>	15.3±0.5 <sup>B</sup>	4.64±0.03 <sup>CD</sup>	250±8 <sup>A</sup>	5.83±0.23 <sup>AB</sup>	9.93±0.14 <sup>C</sup>	374.5±22.3 <sup>B</sup>
4	1/2	1/2	0	26.4±0.9 <sup>CD</sup>	8.2±0.5 <sup>D</sup>	4.42±0.03 <sup>D</sup>	248±8 <sup>A</sup>	5.65±0.19 <sup>AB</sup>	14.54±0.04 <sup>AB</sup>	498.6±35.1 <sup>A</sup>
5	1/2	0	1/2	26.4±1.0 <sup>CD</sup>	15.6±0.5 <sup>B</sup>	4.85±0.03 <sup>C</sup>	232±3 <sup>B</sup>	5.52±0.08 <sup>AB</sup>	14.71±0.44 <sup>AB</sup>	195.8±4.4 <sup>D</sup>
6	0	1/2	1/2	27.8±0.1 <sup>ABC</sup>	33.1±0.5 <sup>A</sup>	4.65±0.03 <sup>CD</sup>	218±4 <sup>C</sup>	6.41±0.81 <sup>A</sup>	14.54±0.52 <sup>AB</sup>	149.7±15.0 <sup>DE</sup>
7	1/3	1/3	1/3	26.3±0.3 <sup>CD</sup>	14.1±0.5 <sup>B</sup>	4.65±0.04 <sup>CD</sup>	135±5 <sup>F</sup>	6.26±0.25 <sup>AB</sup>	16.50±0.69 <sup>A</sup>	84.8±2.2 <sup>F</sup>
8	2/3	1/6	1/6	27.±0.6 <sup>ABCD</sup>	15.2±0.5 <sup>B</sup>	4.40±0.03 <sup>D</sup>	140±3 <sup>F</sup>	6.02±0.16 <sup>AB</sup>	15.44±0.37 <sup>AB</sup>	339.2±43.9 <sup>BC</sup>
9	1/6	2/3	1/6	27.4±0.3 <sup>ABCD</sup>	16.2±0.5 <sup>B</sup>	4.50±0.04 <sup>D</sup>	184±4 <sup>E</sup>	5.87±0.08 <sup>AB</sup>	16.17±0.15 <sup>A</sup>	387.4±13.8 <sup>B</sup>
10	1/6	1/6	2/3	26.5±1.0 <sup>BCD</sup>	15.7±0.5 <sup>B</sup>	3.93±0.03 <sup>E</sup>	206±5 <sup>F</sup>	7.56±0.16 <sup>C</sup>	14.90±1.42 <sup>AB</sup>	367.4±21.5 <sup>B</sup>
Control	-	-	-	28.7±0.4 <sup>A</sup>	0.1±0.1 <sup>E</sup>	7.52±0.45 <sup>A</sup>	198±3 <sup>D</sup>	5.48±0.24 <sup>B</sup>	13.75±0.13 <sup>B</sup>	293.2±12.9 <sup>C</sup>

Control samples were prepared in the same conditions (temperature, pH, and agitation) but without the addition of the enzymes. Total solids results were expressed in wet basis. <sup>a</sup>Antioxidant properties measured by Ferric Reducing Ability of Plasma assay (FRAP), 1,1-diphenyl-1-picrylhydrazyl radical-scavenging capacity assay (DPPH) and oxygen radical absorbance capacity assay (ORAC) were expressed as TROLOX equivalents, in μmol·FE·g<sup>-1</sup>. The results of the dependent variables are presented as the mean (minimum n = 3) ± standard deviation. Different capital letters in the same column indicate statistical difference (p < 0.05).

of factors, but the proportions of the mixture such that the sum of them is 1 ( $0 \leq x_i \leq 1$ ). Regression models (quadratic or special cubic) present the dependence of each response on the proportions of Alcalase™ ( $x_1$ ), Brauzyne® ( $x_2$ ) and Protamex™ ( $x_3$ ), within a probability higher than 95%. Equation (1) presents the special cubic model and the quadratic model (without the third term), where  $Y$  is the predicted response,  $x_i$ ,  $x_j$  and  $x_l$  are coded independent variables,  $i$  takes the value from 1 to the number of components of the system ( $k$ ), which is 3,  $\beta_i$  is the regression coefficient for each linear effect term,  $\beta_{ij}$  represents the binary and  $\beta_{ijl}$  the ternary interaction effect terms and  $\epsilon$  is the error term. For a final adjusted model, non-significant interactions were disregarded.

$$Y = \sum_{i=1}^k \beta_i x_i + \sum_{i < j}^k \beta_{ij} x_i x_j + \sum_{i < j < l}^k \beta_{ijl} x_i x_j x_l + \epsilon \quad (1)$$

#### 2.4. Membrane fractionation of SBYH

UF experiments were performed after the conditioning and compacting of the membranes, in a jacketed stainless steel dead-end cell (effective permeation area of 0.0016 m<sup>2</sup>). Briefly, SBYH (12 g<sub>protein</sub> L<sup>-1</sup>) at pH 8.0 was ultrafiltered in 30 kg mol<sup>-1</sup> molecular weight cut-off (MWCO) membrane and then the permeate was further fractionated in a 10 kg mol<sup>-1</sup> MWCO membrane (Figure 1). All experiments were performed in a magnetically stirred cell (600 rpm), at 50°C and 5.0 ± 0.2 bar.

#### 2.5. Proximate composition

Total solid's content (% m/m) was determined gravimetrically at 105°C for 12 h using an incubator (C-HT 515, Fanem, Brazil) and soluble solids (grams of dissolved soluble solids per grams of wet sample) were determined by a refractometer (N-1 alpha, ATAGO, Japan) [25] at 25°C. Ashes and fibers were determined [25] as well as total sugars [26] and total titratable acidity [25]. RNA was extracted [27] and determined based on the calculation presented by [28]. Crude protein content was determined by the Dumas method [29] in an element analyser CHNS-O (Flash 2000, ThermoScientific, USA). A nitrogen conversion factor of 5.5 was considered because of the high content of non-protein nitrogen in yeast [7]. Protein recovery (PR) was calculated using Equation (2), where MP<sub>S</sub> is the mass of protein in the supernatant fraction (g), MP is the total mass of protein in the matrix (g),  $x_S$  is the CP in the supernatant fraction ( $g_{\text{protein}}/g_{\text{supernatant}}$ ),  $x_P$  is the CP in the precipitate fraction ( $g_{\text{protein}}/g_{\text{precipitate}}$ ),  $M_S$  is the mass of supernatant (g) and  $M_P$  is the mass of precipitate, both after centrifugation (g).

$$\text{PR}(\%) = \frac{\text{MP}_S}{\text{MP}} = \frac{x_S \cdot M_S}{x_S \cdot M_S + x_P \cdot M_P} \times 100 \quad (2)$$

#### 2.6. Determination of the degree of hydrolysis

Progress of all hydrolysis experiments was evaluated measuring the degree of hydrolysis (DH) by the pH-STAT technique [30] in an automatic titrator (T-50, Mettler Toledo, Switzerland). Using this method, all hydrolysis occurs at constant pH and temperature, which is corrected continuously during the experiment by the addition of 1 M NaOH (1.10 to 4.65 mL). The amount of base used is correlated to the amount of peptide bonds cleaved by the enzymatic treatment. The DH was calculated following the equation (3), considering  $B$  (mL), which is the volume of base consumed,  $N_B$ , the normality of the base,  $\alpha$ , the degree of dissociation of the  $\alpha$ -amino groups related with the pK of the amino groups at pH 7 and 50°C,  $M_{\text{protein}}$  (g), the amount of protein in the reaction mixture and  $h_{\text{total}}$ , which corresponds to the sum of millimoles of individual amino acids per gram of protein and was calculated as 7.5 meq g<sup>-1</sup> [31].

$$\text{DH}(\%) = \frac{B \times N_B}{\alpha \times M_{\text{protein}} \times h_{\text{total}}} \times 100 \quad (3)$$

#### 2.7. Hydrophobicity measurements

Protein hydrophobicity of SBYHs was measured via surface tension measurements, considering the approach presented by [32]. Multiple measurements via camera were made of a sample's drop of 6  $\mu$ L in contact with air for 2000 s in a tensiometer (Teclis, Tracker, France), on pendant drop mode. Six replicates were performed for each sample at 25°C and pH 7.0. Results were expressed as mN m<sup>-1</sup>.

#### 2.8. Determination of antioxidant properties

Antioxidant properties of SBYHs were determined by three *in vitro* methodologies. Sample's ability to capture an organic radical (DPPH), to reduce iron (FRAP) and to capture the peroxy radical (ORAC) were investigated. The 1,1-diphenyl-1-picrylhydrazyl radical-scavenging capacity assay (DPPH) was determined as described by [33] but using ethanol PA as the solvent and 4h reaction time in the dark (determined after testing of the yeast samples). The Ferric Reducing Ability of Plasma assay (FRAP) was performed as described by [34] with modifications [35]. The Oxygen Radical Absorbance Capacity Assay (ORAC) was determined [36] using a BioTek Synergy HT Microplate Reader (Winooski, USA) coupled to the data software program Gen5™ 2.0. Protein concentration and pH (7.0 ± 0.1) in samples were standardized before the antioxidant measurements so that antioxidant differences were not due to different peptide concentration or pH, but due to its biochemical characteristics [20]. TROLOX, a water-soluble analogue of tocopherol, was used as standard in all determinations. Results were expressed as TROLOX equivalents, in  $\mu\text{mol}_{\text{TE}} \text{g}^{-1}$ .

#### 2.9. Color

Color changes in samples SBYHs were measured in an UV-Vis spectrophotometer in reflectance mode using D65 illuminant (model UltraScan, Hunterlab, United States). Results were expressed considering the CIELab scale where L\* represents the luminosity (L = 0 corresponds to the darkest black and L = 100 to the brightest white), a\* represents the green (-)/red (+) colors and b\* the blue (-)/yellow (+) colors. The Browning Index (BI) was calculated using Equations (4) and (5) [37,38]. It measures the shift towards a more brown color, used to describe non-enzymatic color development, such as those caused by the Maillard Reaction [39,38].

$$x = \frac{a^* + (1.75 \cdot L^*)}{(5.65 \cdot L^*) + a^* - (3.01 \cdot b^*)} \quad (4)$$

$$\text{BI} = \frac{x - 0.31}{0.17} \times 100 \quad (5)$$

##### 2.9.1. Particle size

Estimation of particle size and particle size distribution in the yeast materials without previous dilution were determined by the angular variation in the intensity of scattered light, as a laser beam passes through the sample (Mastersizer 2000, Malvern Instruments Ltd., UK), with water as dispersant. Mean diameter of particles was expressed as the volume weighted mean,  $D_{[4.3]}$  and the span.

##### 2.9.2. Gel electrophoresis

Samples (3 mL) were resuspended in 1 mL 10% TCA in acetone with 20 mM DTT (2:1, v/v). Proteins were precipitated for at least 45 min at -20°C, and centrifuged (10,000 × g for 20 min at 4°C), recovered by precipitation, and washed four times with 70% cold ethanol. Protein pellets were air-dried, solubilized and sonicated for 5 min in 200  $\mu$ L 40 mM DTT, 1 mM EDTA, 1 mM PMSF, 10 mM Tris-HCl pH 8.0 buffer.

Protein concentration was determined [40] and 260  $\mu\text{g}$  of protein samples were purified (2-D Clean-Up kit, GE Healthcare) and stored at  $-20^\circ\text{C}$ . SDS-PAGE was performed using a 12% polyacrilamide gel in resolving buffer (Tris-HCl (pH 8.8, 1.5 M), SDS (0.4%)) and a 5% polyacrilamide gel in stacking buffer (Tris-HCl (pH 6.8, 0.5 M), SDS (0.4%)). Samples (30 and 60  $\mu\text{g}$  of protein) were prepared with Laemmli buffer and gel was run at 200 V for 4 h in buffer (pH 8.4, 192 mM glycine, 25 mM Tris-HCl and 0.1% SDS) in an Hoefer system (GE Healthcare).

### 2.10. Statistical analysis

All experiments were done in duplicate and analysis at least in triplicate. Results were expressed as average values  $\pm$  standard deviation and were submitted to analysis of variance (ANOVA) and comparison of means by Tukey HSD test. Differences were considered significant at a level of 5% ( $p < 0.05$ ). ANOVA assumptions were checked through analysis of the residues and data distribution through Ryan Joiner's, Multiple Comparisons and Levene's tests. Correlations were determined by Pearson test followed by paired Student t test. Mixture design ANOVA, regression models, plots and contourplots were generated using Statistica<sup>®</sup> 10 software (Statsoft Inc., USA).

## 3. Results and Discussion

### 3.1. Characterization and effect of pre-treatment on proximate composition and physico-chemical properties of SBY

Physico-chemical and proximate composition data of non-treated spent brewer's yeast (SBY) and pre-treated spent brewer's yeast (SBY<sub>PT</sub>) are presented in Table 2. SBY raw material collected from Lager Pilsen beer production consists mainly of protein (41%) and total sugars (43%) with lesser amounts of ash (7%), fiber (7%) and nucleic acids (2%) (Table 2) which is in general agreement with previously published results for spent yeasts [41,8,2,24,42,31,43–45].

Spent yeast collected after the fermentation of beer is a slurry that can expand when heated. This effect was reported to be caused by the release of carbon dioxide by still-active cells before the enzymatic treatment [46]. This blown-up effect is adverse in enzymatic hydrolysis processes, since added enzymes could be trapped in the foam. Unable to access proteins in the solution, the efficiency of the enzymes is decreased. A thermal pre-treatment of the raw material was proposed in

**Table 2**

Proximate composition data of non-treated spent brewer's yeast (SBY), pre-treated spent brewer's yeast (SBY<sub>PT</sub>), supernatant fraction of the substrate (SBY<sub>s</sub>) and spent brewer's yeast protein hydrolysate (SBYH<sub>s</sub>)

Analyses	SBY	SBY <sub>PT</sub>	SBY <sub>s</sub>	SBYH <sub>s</sub>
Total solids (%)	12.7 $\pm$ 0.1 <sup>a</sup>	16.5 $\pm$ 0.1 <sup>b</sup>	5.32 $\pm$ 0.07 <sup>A</sup>	6.79 $\pm$ 0.08 <sup>B</sup>
Crude protein (%)	40.7 $\pm$ 0.1 <sup>a</sup>	41.0 $\pm$ 0.2 <sup>a</sup>	41.45 $\pm$ 0.04 <sup>A</sup>	53.15 $\pm$ 0.01 <sup>B</sup>
RNA (%)	1.9 $\pm$ 0.1 <sup>a</sup>	1.7 $\pm$ 0.1 <sup>a</sup>	4.36 $\pm$ 0.09 <sup>A</sup>	5.59 $\pm$ 0.13 <sup>B</sup>
Total sugars (%)	43.5 $\pm$ 2.4 <sup>a</sup>	40.3 $\pm$ 4.0 <sup>a</sup>	43.68 $\pm$ 6.56 <sup>A</sup>	31.37 $\pm$ 1.00 <sup>B</sup>
Ash (%)	7.0 $\pm$ 0.1 <sup>a</sup>	6.5 $\pm$ 0.1 <sup>b</sup>	13.04 $\pm$ 0.56 <sup>A</sup>	10.51 $\pm$ 0.24 <sup>B</sup>
Fiber (%)	6.6 $\pm$ 0.1 <sup>a</sup>	5.6 $\pm$ 0.5 <sup>b</sup>	nd	1.02 $\pm$ 0.04
Lipids* (%)	< 1	< 5	nd	nd
pH	6.06 $\pm$ 0.01 <sup>a</sup>	6.24 $\pm$ 0.09 <sup>b</sup>	6.33 $\pm$ 0.01 <sup>A</sup>	7.06 $\pm$ 0.01 <sup>B</sup>
Titrate acids	8.2 $\pm$ 0.1 <sup>a</sup>	6.9 $\pm$ 0.2 <sup>b</sup>	17.28 $\pm$ 0.64 <sup>A</sup>	8.21 $\pm$ 0.08 <sup>B</sup>

Total solids results were expressed in wet basis and titrate acids in grams of citric acid per gram of dry matter. All other proximate composition data is in dry basis.

\* Determined by difference from total composition (proteins, total sugars, RNA, fiber and ash). Nd: amount was not determined because it was below methodology detection range; N/A: not applicable. Different letters in the same line indicate statistical difference ( $p < 0.05$ ); small letters comparing non-treated (SBY) and pre-treated SBY (SBY<sub>PT</sub>) and capital letters comparing the supernatant fractions before (SBY<sub>s</sub>) and after the protein hydrolysis (SBYH<sub>s</sub>).

order to decrease foaming, evaporate the excess of alcohol in the residue, inactivate autolytic endogenous enzymes, standardize the material and finally, to potentially increase protein exposure for the subsequent hydrolysis procedure.

Heat treated samples presented 30% higher total solids content, a concentration effect due to evaporation, but very similar overall proximate composition as the non-treated SBY (Table 2). The lower titrate acids content is probably related to the higher pH. Average particle's size diameter of the pre-treated material was  $59.6 \pm 5.3 \mu\text{m}$ , 40% higher than the non-treated SBY, probably caused by the aggregation of components after heating. The particle size distribution, measured by the span, was the same before and after the pre-treatment ( $13.5 \pm 0.9$ ). This indicates a degree of polydispersion of the particles' size, explained by the high degree of complexity of the composition of the material.

Heat treatment of raw materials preceding the production of protein hydrolysates has been reported with the intent of denaturing proteins and unfolding polypeptide chains to ease enzyme's access to cleavage sites [24,18]. Indeed, [18] reported an increased yield of total solids of 13% for some fractions of soy protein hydrolysates with antioxidant capacity followed by heating at temperature conditions higher than the average denaturing temperature of proteins in the matrix.

### 3.2. Effect of proteases on the production and characteristics of spent brewer's yeast hydrolysates

Agroindustrial by-products may contain a wide variety of biological compounds which can interact with each other during processing, and changes may happen due to simple heating. Because of these effects, for each run proposed by the mixture design, a control without added enzyme was prepared. The existence and the extent of the enzyme interactions on the yield and biochemical characteristics of SBY hydrolysates were studied by the mixture design considering the differences caused by the enzymatic treatments in comparison with non-hydrolyzed controls. Apart that, in all experiments, the enzymatic activity per g of protein in the samples was kept constant ( $2000 \text{ U g}_{\text{protein}}^{-1}$ ), so that the amount of enzyme added on each experiment was adjusted considering their enzymatic activity. The protease activity of Alcalase<sup>™</sup> ( $595 \pm 25 \text{ U mL}^{-1}$ ) was 8 times higher than that of Protamex<sup>™</sup> ( $79.0 \pm 3.8 \text{ U mL}^{-1}$ ) and 29 times higher than that of Brauzyn<sup>®</sup> ( $20.5 \pm 1.4 \text{ U mL}^{-1}$ ).

#### 3.2.1. Protein and solids yield

The yield of protein and solids of hydrolyzed and control samples is presented in Figure 2. Hydrolysis resulted in increase of protein recovery (PR), ranging from 24% (non-treated) to 42% (hydrolysate) and a 21% higher concentration of crude protein in the supernatant fraction of SBY when compared to an average control sample, as shown in Figure 2a. Hydrolysates presented 35% and 22% higher levels of total and soluble solids, respectively (Figure 2b). A decrease in total solids and crude protein in the precipitate fraction after hydrolysis of 7% and 9% was also found, supporting that the enzymatic treatment promoted the release of proteins and peptides, resulting in the solubilization of SBY proteins. Other authors have associated the recovery of solid and proteins with the release of proteins [2]. Although hydrolysates were very different from the non-hydrolyzed SBY, no effect of the mixture of enzymes was found, except for the reduction of total solids content in the precipitate fraction between each hydrolysate and its control. As presented Figure 3a, a higher reduction in the total solids in the precipitate fraction is observed in the hydrolysates produced by a mixture of enzymes, with a strong synergistic effect between Alcalase<sup>™</sup> and Brauzyn<sup>®</sup>, indicating that more protein is migrating to the soluble fraction when these enzymes are used. A high percentage of variance was explained by the model (Table 3) suggesting a good fit. In Table 1 the absolute values of total solids in the precipitate fraction for each experiment as well as the average for the control is also shown.

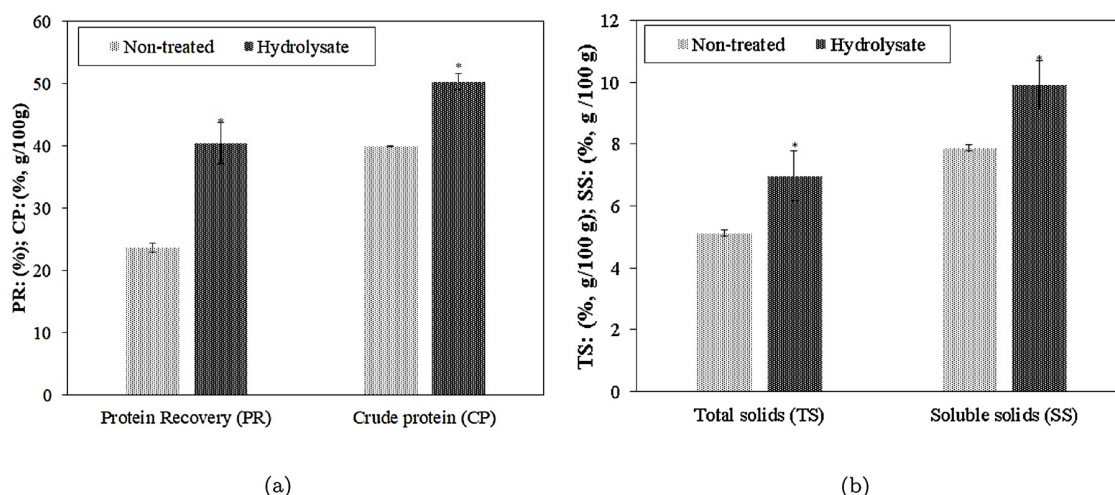

Fig. 2. Overall variation of (a) protein recovery (%), crude protein content (%), (b) total solids (% in wet basis) and soluble solids (% in wet basis) for hydrolysates and controls.

### 3.2.2. Degree of hydrolysis

Constant hydrolysis conditions were employed in order to compare the efficacy of the enzymes in the production of SBY hydrolysate. Degree of hydrolysis ranged from 8.3% to 33.0% for the different enzyme proportions (Table 1), indicating that different mixtures of the enzymes resulted in hydrolysates of different degrees of hydrolysis for the same enzymatic activity. Maximum degree of hydrolysis was achieved with equal amounts of Protamex™ and Brauzyn®. On the other hand, the use of Alcalase™ and Brauzyn® either alone or combined, resulted in the hydrolysates with smaller degree of hydrolysis, not exceeding 10%. Indeed, observing the results (Table 1) and the mixture contour plot for the degree of hydrolysis (Figure 3b), it becomes evident that when Protamex™ and Brauzyn® were used together, up to 75% higher values of degree of hydrolysis were achieved. The quadratic model was able to explain 81% of the variance of the data. The synergistic effect of Protamex™ and Brauzyn® to spent brewer's yeast protein cleavage is probably related to the specificity of those enzymes. For instance, Protamex™ is a protease complex from *Bacillus licheniformis* and *Bacillus amyloliquefaciens*. It may be classified as both serine and metalloendopeptidase but is reported to have exopeptidase activity [47]. This enzyme has been reported to be used for the hydrolysis of spent yeast, either alone or in combination with Flavourzyme™ [3,2]. Brauzyn® is a vegetable protease preparation designed for yeast cell wall hydrolysis [48] but until now, its use in brewer yeast has not yet been reported. Its main component is papain, a cysteine protease from *Carica papaya*. Papain has broad specificity with a preference for aminoacids containing a bulky non-polar side chain and exhibits endopeptidase, amidase and esterase activities [49]. Brauzyn® is reported by the manufacturer to possess both endo and exopeptidase activities. Finally, Alcalase™ is produced by bacterial fermentation using a selected strain of *Bacillus licheniformis*, and its main enzyme component is *Subtilisin Carlsberg*. It is a serine protease (according to the nature of its catalytic site) and it acts as an endopeptidase (selectivity they exhibit for a peptide bond in a particular position in the polypeptide chain) [47]. This enzyme is highly efficient and much described in literature for the enzymatic treatment of different matrices. Hydrolysates were produced using this enzyme for spent brewer's yeast [3,11], spent yeast from sugar industry [46,7] and baker's yeast, in sequence with other enzymes [50].

These results indicate that different types of enzymes allowed maximizing the degree of hydrolysis that could not be achieved by Alcalase™ and Brauzyn® alone. In Table 1 it is possible to observe that when those two enzymes are used either separately (runs 1 and 2) or together (run 4), the maximum degree of hydrolysis achieved is 11%.

When they are combined with Protamex™, an enzyme with a exopeptidase activity, degrees of hydrolysis of at least 14% are achieved. It has been reported that when an exoprotease is used in combination with endoprotease, higher degree of hydrolysis hydrolysates may be obtained resulting in small non-bitter peptides [2,3]. The degree of hydrolysis of Alcalase™ and Brauzyn® alone (runs 1 and 2) were lower than the one with only Protamex™ (run 3). Similar results were recently reported for flaxseed hydrolysates, when an exoprotease (Flavourzyme™) resulted in higher degree of hydrolysis values in comparison with papain, but the effect of their combinations was not evaluated [51]. They explained the poorer performance of papain in achieving higher degree of hydrolysis due to the high specificity of this enzyme in comparison to the others. In this work, the protein hydrolysis of SBY using enzymes with predominantly endopeptidase activity (Brauzyn® and Alcalase™) was more efficient once combined with Protamex™. This reinforces the importance of studying enzyme combinations in the production and modulation of peptides properties.

### 3.2.3. Hydrophobicity

Enzymatic hydrolysis greatly affected the hydrophobicity of the hydrolysates, expressed by the surface tension values (Figure 4). The hydrophobicity of proteins plays a key role in the biological activities and technological properties of proteins (solubility, and aggregation tendency) which are of interest in the pharmaceutical and food industries [32,12]. The correlation between surface tension and hydrophobicity denotes that the decrease in the surface tension is accompanied by an increase in the relative hydrophobicity of proteins, which is an indicative of the level of non-polar amino acids in the sample [32]. The determination of the surface tension by a tensiometer is a physical, non-invasive and accurate measure that does not depend on the affinity of proteins with dyes [32]. The bigger the decrease in surface tension, higher is the hydrophobic character of the peptides. The hydrophobicity of the peptides increased from 4% to 16% after the enzymatic hydrolysis when compared to the control samples, as shown in Figure 4.

In this work, the hydrolysate which presented the highest rise in hydrophobicity was the one produced only with Alcalase™ (run 1) followed by run number 5, produced with equal amounts of Alcalase™ and Protamex™. Alcalase™ is known to produce more bitter and hydrophobic peptides from various matrices when compared with enzymes with exoprotease activity such as Flavourzyme™ and Protamex™ [52,53,3]. This effect may be linked to the tendency of this enzyme to hydrolyze hydrophobic amino acid residues [54]. Indeed, bitterness development in food hydrolysates is thought to be related to the presence of hydrophobic amino acid residues, usually kept inside of a



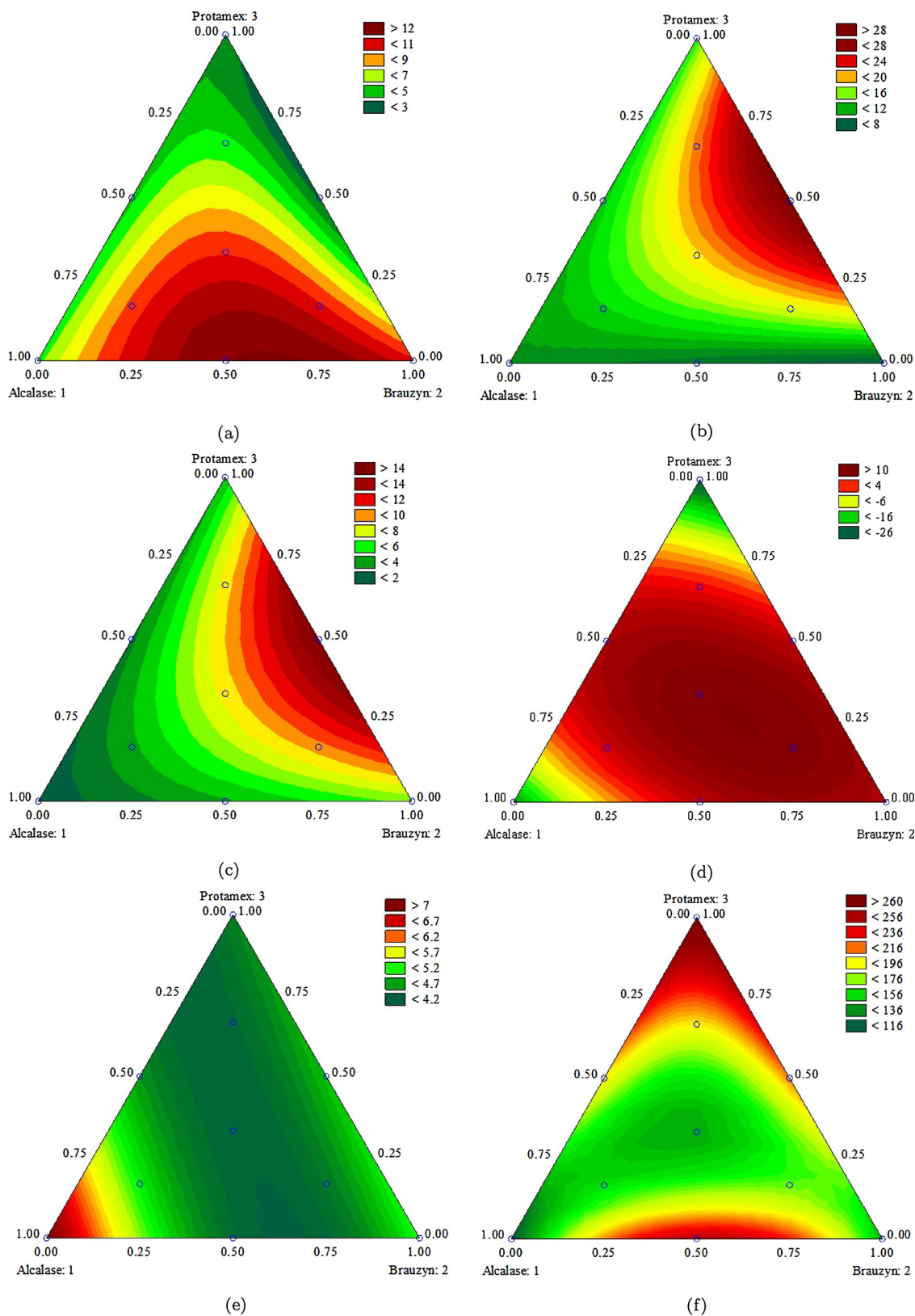
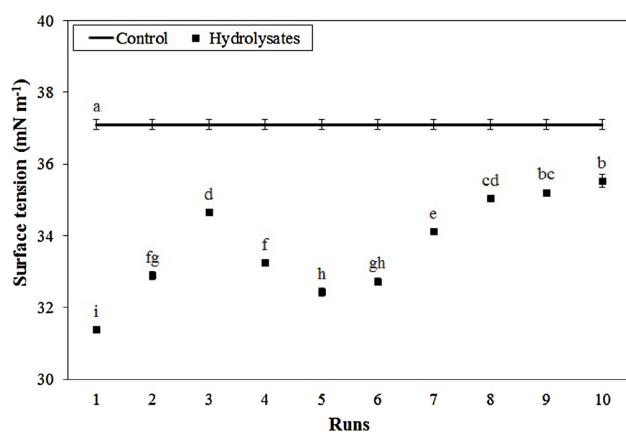

Fig. 3. Mixture contour plots for reduction in total solids in the precipitate fraction (a), degree of hydrolysis (b), variation in the antioxidant activity measured by FRAP (c) and DPPH (d) between hydrolysates and non-hydrolyzed control, color parameter L\* (e) and Browning Index (f).

**Table 3**

Analysis of variance (ANOVA) for all dependent variables of the mixture design: models, regression coefficients, probability values and coded reduced models

Source of variation	Sum of squares	Degrees of freedom	Mean of squares	F <sub>calculated</sub> / F <sub>tabulated</sub>	R <sup>2</sup>	p-value
<b>Reduction in total solids in the precipitate fraction</b>						
Regression	107.01	5	21.40	21.74 / 6.00	0.96	< 0.005
Residual	3.94	4	0.98			
Total	110.95	9				
Special cubic model: $Y = 5.7x_1 + 10.2x_2 + 3.7x_3 + 20.1x_1x_2 - 16.7x_2x_3 + 81.0x_1x_2x_3$						
<b>Degree of hydrolysis</b>						
Regression	344.90	3	114.97	8.31 / 4.10	0.81	< 0.01
Residual	83.00	6	13.83			
Total	427.90	9	47.54			
Quadratic model: $Y = 10.8x_1 + 7.9x_2 + 14.4x_3 + 69.9x_2x_3$						
<b>L* parameter</b>						
Regression	7.74	4	1.94	10.79 / 4.77	0.90	< 0.01
Residual	0.90	5	0.18			
Total	8.64	9	0.96			
Quadratic model: $Y = 7.3x_1 + 5.2x_2 + 4.5x_3 - 7.8x_1x_2 - 5.3x_1x_3$						
<b>Browning Index</b>						
Regression	23402	4	5851	9.85 / 4.77	0.89	< 0.01
Residual	2968	5	594			
Total	26370	9				
Special cubic model: $Y = 112.8x_1 + 144.0x_2 + 277.4x_3 + 475.7x_1x_2 - 2428.6x_1x_2x_3$						
<b>FRAP</b>						
Regression	154.08	3	51.36	4.25 / 4.10	0.68	< 0.05
Residual	72.53	6	12.09			
Total	226.61	9	25.18			
Quadratic model: $Y = 1.4x_1 + 6.3x_2 + 4.2x_3 + 40.1x_2x_3$						
<b>DPPH</b>						
Regression	2185.13	5	437.03	20.64 / 6.00	0.96	< 0.01
Residual	84.70	4	21.17			
Total	2269.83	9	252.20			
Special cubic model: $Y = -21.2x_1 + 10.6x_2 - 27.9x_3 + 59.0x_1x_2 + 144.7x_1x_3 + 70.4x_1x_2x_3$						



**Fig. 4.** Surface tension values for each run of the mixture design against the non-hydrolyzed sample. Different letters indicate statistical difference ( $p < 0.05$ ).

macromolecule structure, such as high MW peptides or intact food proteins. However, following a hydrolysis treatment, more hydrophobic oligopeptides may be exposed [52]. For the current study, no correlation between hydrophobicity and degree of hydrolysis of the hydrolysates was found. The exposure of these non-polar residues depends on the structure of protein and peptides, on the interactions involving other components of the mixture, and positive correlations between those two parameters are not always found [53].

### 3.2.4. Color change in the hydrolysates

As presented in Table 2, both SBY and SBY<sub>PT</sub> are rich in proteins and total carbohydrates, which can be involved in the Maillard reaction and even become more available as an enzymatic treatment takes place. Thermal-induced reactions like the Maillard reaction are implicated in the formation of flavor molecules as peptides and amino acids are released during an enzymatic process, possibly resulting in antioxidant components [55]. Recently, [55] discovered that peptides or other low MW compounds may be ionically linked to bigger melanoidins structure and finally contribute to antioxidant activity in high MW melanoidins. Similarly, antioxidant properties of soybean meal hydrolysates could be enhanced by Maillard reaction [39].

Color parameters L\* and Browning Index were influenced by the mixture of enzymes employed in the proteolysis of SBY (Table 1). A quadratic and special cubic model, respectively, were able to explain a high percentage of the data (Table 3). A darker coloured hydrolysate, expressed by a more pronounced L\* reduction, was produced by Protamex™ alone or in combination with the other enzymes (runs 3, and 5 to 9) (Table 1). Alcalase™ seemed to result in clearer hydrolysates when used alone (Figure 3e). L\* was also negatively correlated with protein recovery (Pearson coefficient = 72.4;  $p = 0.000$ ) indicating that a darker colored hydrolysate was obtained for the samples with higher protein recovery in the supernatant. This may be related to the higher content of amino acids available for the Maillard Reaction, reflected into the darkening of the samples [38]. Following the same trend, hydrolysates exhibited a more pronounced brown color when Protamex™ was used alone or in combination with Brauzyn® or when Alcalase™ in the proportion of at least 1/2, as presented in Figure 3f and Table 1. The equal combination of Brauzyn® and Alcalase™ also resulted in a higher Browning Index (Figure 3f). These data may suggest that the amount of darker compounds, probably Maillard reaction products, was affected by the mixture of enzymes chosen for the SBYH production and could be successfully predicted through those models. The presence of Protamex™ seemed to play a role in the color development of the hydrolysates as it influenced the degree of hydrolysis.

### 3.2.5. Antioxidant properties of the hydrolysates

Antioxidant properties of the hydrolysates varied greatly among runs and were differently affected by the mixture of enzymes (Table 1). Model summary and analysis of variance results for the antioxidant activities measured by FRAP and DPPH compared to control are shown in Table 3. Linear and quadratic terms showed a significant effect in FRAP and DPPH ( $p < 0.05$ ) with a cubic term significant for DPPH ( $p < 0.05$ ). The combined use of Alcalase™ and Protamex™ increased the DPPH in comparison to control (Figure 3d). Whether for FRAP, the interaction between Brauzyn® and Protamex™ was the one which resulted in an increase in FRAP values (Figure 3c). The interaction between the three enzymes was specially very important for the enhancement of DPPH antioxidant properties of SBYH. Higher coefficient of regression ( $R^2$ ) as well as a valid analysis of variance indicated that the models were appropriate (Table 3).

The antioxidant activity measured by FRAP did not change in comparison to the non-hydrolyzed control for most of the hydrolysates. An increase of 15% and 36% in FRAP antioxidant activity was found only for runs 6 and 10, indicating a positive interaction of Brauzyn® and Protamex™, as shown in Figure 3d. The ability to scavenge the DPPH radical was strongly affected by the use of mixtures of the three enzymes (Table 3).

Among the hydrolysates, those produced with equal proportions of the enzymes (run 7) and that with 67% of Brauzyn®, 16% of Protamex™ and 16% of Alcalase™ (run 9) exhibited the highest DPPH values when compared to control (Table 1). The hydrolysates produced only with Alcalase™ (run 1) or Protamex™ (run 3), exhibited the lowest DPPH antioxidant capacity, decreased by 22% and 28% in comparison to the control, respectively (Table 1). An association between hydrophobic peptides and their DPPH free radical scavenging activity was previously

reported but it could have been influenced by the different protein concentration in the hydrolysates [12]. In this work no correlations between hydrophobicity and antioxidant capacity were found. Even though, we have shown that both the degree of hydrolysis and hydrophobicity were greatly affected by the specificity of the enzymes present in the mixture ( $2000 \text{ U g}_{\text{protein}}^{-1}$  for all runs) through mechanisms not yet elucidated. The ability of samples to inhibit the peroxy radical was measured by ORAC and was greater for the hydrolysates produced by Alcalase™ and Brauzyn® (Table 1), but a model could not be fitted. ORAC values were negatively correlated with the degree of hydrolysis (Pearson coefficient = 0.626;  $p_{\text{value}} = 0.000$ ), indicating that a SBY of a higher degree of hydrolysis may result in lower ORAC values. Thus, the observed changes in hydrophobicity, degree of hydrolysis as well as in the antioxidant capacity are probably dependent on enzyme-peptide bond specificity [21].

All samples were tested on the same protein concentration so that differences were due to the characteristics of proteins and not because of concentration effects [20]. Correlation data between all three antioxidant methodologies was not significant since they have very different mechanisms, as previously reported for other matrices [21]. Antioxidant activity in protein hydrolysates may depend on the type, and structure of the peptides, their amino acid composition, the specificity of the proteases used [3,21] and on the composition of the by-product [41]. The effect of SBYH to reduce iron was positively correlated with total solids (Pearson coefficient = 0.855;  $p_{\text{value}} = 0.034$ ) and soluble solids content (Pearson coefficient = 0.813;  $p_{\text{value}} = 0.000$ ) in the hydrolysates. These results, along with the high FRAP values of the control sample, give evidence that the FRAP antioxidant activity may be also due to the presence of other components of the SBY composition, apart from proteins. Indeed, *Saccharomyces* sp. can adsorb phenolic compounds from the medium, possibly changing its antioxidant properties [56]. A noticeable high antioxidant activity was recently related to the high levels of soluble residues of polyphenolic compounds remaining after sieving, derived from the hops and barley, used in the brewing process [41]. A part of the observed antioxidant properties of SBYH might be due to other components than proteins such as Maillard reaction products (section 3.2.4) or phenolics. Nevertheless, all SBYH possessed antioxidant properties measured by FRAP, DPPH and ORAC assays that were influenced by the mixture of enzymes. This result is an indicative of the contribution of peptides to the observed *in vitro* antioxidant activity, suggesting that different peptides are produced by each of the mixture of the enzymes.

In order to determine the accuracy of the fitted models obtained for the responses discussed in this work, experimental data for run 7 were found within a 90% confidence level of the predicted range, thereby confirming the validity of the models for the evaluated responses.

### 3.3. Characterization of the hydrolysate

The results of the mixture design indicate that the choice of enzymes and their proportions greatly influence the physico-chemical and antioxidant activities of the obtained SBY hydrolysates. Depending on the interest of the SBY hydrolysate, different enzyme combinations must be chosen using the proposed models (section 3.2), taking into account the desired characteristics that are more relevant for a specific application. For instance, the degree of hydrolysis can be maximized by an equal mixture of and Brauzyn® and Protamex™ (run 6). This hydrolysate also presented a high hydrophobicity and brown color development and average antioxidant properties. If the intent is to maximize the antioxidant capacity of the hydrolysate, the runs 4, 7, 9 and 10 could be chosen. In this work we aimed to generate hydrophobic peptides with potential biological activities, and in this case, maximum antioxidant activity, hydrophobicity and yield were prioritized. For this reason, we chose to proceed to the membrane fractionation and characterization of the hydrolysate produced with equal amounts of the three enzymes (run 7). In that condition, a high DPPH antioxidant activity hydrolysate with

an average hydrophobicity, maximum protein and solids recovery, a degree of hydrolysis of 14%, and low brown color development, was obtained.

The proximate composition of this hydrolysate (SBYH<sub>s</sub>) was compared to the supernatant fraction of non-treated spent brewer's yeast, after centrifugation (SBY<sub>s</sub>) (Table 2). The levels of total solids, crude protein and RNA were higher in the hydrolysate (SBYH<sub>s</sub>) when compared to the non-treated material (SBY<sub>s</sub>) by 22% respectively. After cell rupture and chemical treatment, [44] also reported an increase in RNA content in spent yeast from an ethanol distillery. Total sugars and ash content decreased by 28% and 19% after hydrolysis. Complex sugars are an important part of the yeast wall composition, representing more than 50% of the dry weight [42]. During the enzymatic treatment, proteins are cleaved, yeast wall and intracellular compounds are released. After centrifugation, polysaccharides may not be soluble and stay onto the precipitate fraction while proteins tend to migrate to the supernatant fraction (data not shown). No previous literature reports seem to exist on the surface tension of SBY supernatant fraction ( $40.7 \pm 0.6 \text{ mN m}^{-1}$ ), but the hydrolysis seemed to decrease it considerably ( $34.1 \pm 0.1 \text{ mN m}^{-1}$ ), indicating a rise in the hydrophobicity of the material (Section 3.2.3).

The titratable acidity of the supernatant fraction of the non-treated material (SBY<sub>s</sub>) was about two fold higher than both the non-centrifuged samples (non-treated and pre-treated) and the protein hydrolysate. These difference could be explained by the centrifugation step and the effect of hydrolysis on this parameter. From one side, the difference between the supernatant (SBY<sub>s</sub>) and the non-centrifuged (SBY and SBY<sub>PT</sub>) samples was probably due to an effect of acidic compounds concentration on the soluble fraction. When separated from the other components of the yeast, there may be a concentration of the acids present in addition to eliminating a potential buffering effect of the particles present in the precipitate. From the other side, the difference between the supernatant (SBY<sub>s</sub>) and the supernatant's hydrolysate (SBYH<sub>s</sub>) samples is probably due to the release of intracellular compounds that may exert buffering effects. After the yeast cell lysis due to hydrolysis, for instance, it may occur the release of intracellular materials with higher pH leading to a reduction of the observed titratable acidity [8].

The amount of solids and crude proteins recovered from the raw material after the protein hydrolysis was, in average, 57% and 70% (w/w), respectively. [2] reported similar solids percentage recovery but 23% smaller protein yield for its best enzymatic treatment of SBY (*Saccharomyces* sp.) using Protamex™ and Flavourzyme™. The solids and protein mass yield of SBY hydrolysate may change with the characteristics of collected raw material as well as particularities of processing equipment and handling. The material evaluated in this work was slightly concentrated (4% difference in humidity) after the heat treatment and after centrifugation, the mass yield of spent brewer's yeast hydrolysate varied from 64% to 76%.

### 3.4. Peptide fractionation and characterization

The electrophoresis results of the supernatant fraction of SBY (1) (non-hydrolyzed); SBY protein hydrolysate (2); and fractionated hydrolyzed fractions of the protein hydrolysate in 30 and 10  $\text{kg mol}^{-1}$  MWCO membranes (3, 4, 5) are presented in Figure 5. Roughly eight main stained bands were visible in the SBY non-hydrolyzed supernatant, with molecules of MWs ranging from 20 to 50  $\text{kg mol}^{-1}$ . Non-hydrolyzed yeast had to be centrifuged and further purified in order to remove yeast cell debris, complex carbohydrates and other non-protein materials. During this process, some higher MW proteins may have been lost. Even though, when comparing SBY supernatant before and after hydrolysis (samples 1 and 2), we confirm that the enzymatic treatment effectively cleaved SBY proteins, presented by the partial or complete disappearance of higher MW molecules (35–50  $\text{kg mol}^{-1}$ ), observed in the non-hydrolyzed SBY samples, and the appearance of new

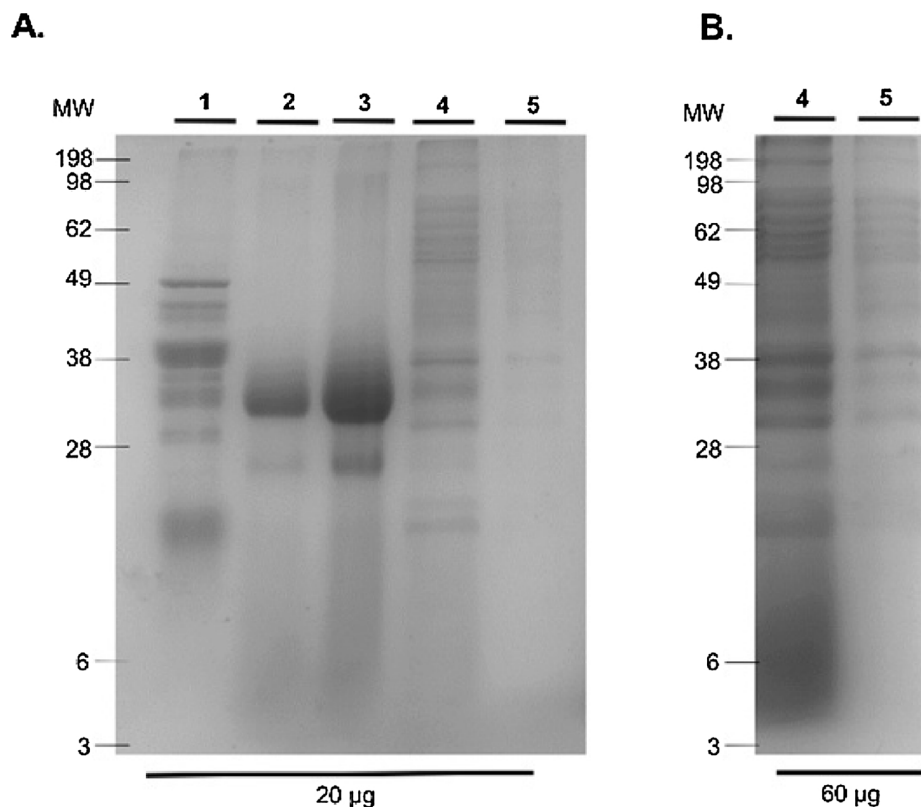

**Fig. 5.** SDS-PAGE separation of proteins and peptides from standards of molecular weight (MW) from 3 to 198 kg mol<sup>-1</sup> and samples (1-5), stained with Coomassie Blue where (A) 1-supernatant fraction of spent brewer's yeast; 2-spent brewer's yeast hydrolysate; 3-protein hydrolysate retentate of 30 kg mol<sup>-1</sup> molecular weight cut-off membrane, (A and B) 4-protein hydrolysate retentate of 10 kg mol<sup>-1</sup> molecular weight cut-off membrane and 5-protein hydrolysate permeate of 10 kg mol<sup>-1</sup> molecular weight cut-off membrane.

bands of smaller MW (smaller than 20 kg mol<sup>-1</sup>). Two main bands in the hydrolysate were observed, one blurry around 30 kg mol<sup>-1</sup> and another around 25 kg mol<sup>-1</sup>.

The fraction retained by the 30 kg mol<sup>-1</sup> MWCO membrane (sample 3) showed a concentration of the protein fractions around that size, when compared to the non-fractionated protein hydrolysate. In the second fractionation step, using 10 kg mol<sup>-1</sup> MWCO membrane, bands are resolved more clearly, probably because samples 4 and 5 were more pure, being possible to see a larger range of protein fractions and peptides (Figure 5). Molecules of higher size are still detected in fractionated samples, indicating that higher MW molecules go through the 30 kg mol<sup>-1</sup> MWCO membrane. On the other hand, the faint bands present in the 10 kg mol<sup>-1</sup> MWCO permeate indicate that these molecules are mostly retained in the second fractionation step. Indeed, in samples 4 and 5, we were able to effectively resolve the bands separation (Figure 5a), suggesting that the fractionation step successfully removed most of the protein fractions higher than 30 kg mol<sup>-1</sup> bands, previously observed in the non-fractionated samples in higher concentration.

#### 4. Conclusions

This study seems to be the first to investigate the influence of a mixture of proteases using a mixture plan on the production of hydrophobic and antioxidant protein hydrolysates of SBY. This work demonstrated that the enzyme choice modulated the degree of hydrolysis, the release of solids, the darkening and browning of samples, the ferric reducing ability and DPPH scavenging capacity of the hydrolysates. Depending on the considered product outcome, a different mixture of enzymes should be selected. The presence of the enzyme Protamex™ combined with Brauzyn® seemed to maximize the degree of hydrolysis and FRAP values. Protamex™ alone or in high proportions resulted in the darker, more brown hydrolysates but equal proportions of the three enzymes resulted in maximum DPPH scavenging activity. A two-step

fractionation was able to separate the SBY peptides, resulting in a concentrated fraction of about 30 kg mol<sup>-1</sup> peptides and another with peptides smaller than 35 kg mol<sup>-1</sup>. Studies are in progress to investigate the applications of SBY peptides including further separation, characterization as well as a thorough investigation of their bioactivities and technological properties.

#### Abbreviations

SBY: spent brewer's yeast; SBYH: spent brewer's yeast hydrolysate; SBY<sub>PT</sub>: pre-treated spent brewer's yeast; SBY<sub>S</sub>: supernatant fraction of non-treated spent brewer's yeast; SBYH<sub>S</sub>: supernatant fraction of hydrolyzed spent brewer's yeast; RNA: ribonucleic acid; TROLOX: 6-hydroxy-2,5,7,8-tetramethylchroman-2-carboxylic acid; SF: supernatant fraction; PF: precipitate fraction; MWCO: molecular weight cut-off; UF: ultrafiltration; TS: total solids; SS: soluble solids; CP: crude protein content; PR: protein recovery; E:S: enzyme:substrate ratio; DH: degree of hydrolysis; BI: Browning Index; ΔE: overall change in color; FRAP: antioxidant properties measured by the Ferric Reducing Ability of Plasma assay; DPPH: antioxidant properties measured by the 1,1-diphenyl-1-picrylhydrazyl radical-scavenging capacity assay; ORAC: antioxidant properties measured by the oxygen radical absorbance capacity assay; D<sub>[4,3]</sub>: volume weighted mean; SDS-PAGE: sodium dodecyl sulfate polyacrylamide gel electrophoresis; MW: molecular weight; Tukey HSD: Tukey's Honest Significant Difference test; ANOVA: analysis of variance.

#### Declaration of interests

None.

#### Acknowledgements

This work was supported by FAPESP (Sao Paulo Research

Foundation) [grant numbers #2006/03263-9, #2007/54520-4, #2009/50593-2, #2009/50591-0, EMU#2009/ 54137-1, #2011/06083-0, #2011/51707-1, #2015/24351-2, #2015/50333-1, #2016/18465-8, #2017/04231-8 and #2018/04067-6], FAEPEX (UNICAMP) [#2422/16; 519.292] and CNPq [#403328/2016-0, #301108/2016-1]. The authors thank Prozyn and Novozymes for the kind supply of enzymes; Pedro Moura for donating SBYS. Funding sources had no involvement in any steps of this research.

## Appendix A. Supplementary Data

Supplementary data associated with this article can be found, in the online version, at <https://doi.org/10.1016/j.procbio.2019.11.030>.

## References

- [1] Kirin Holdings Company Limited, Kirin Beer University Report on Global Beer Production by Country in 2016, 2017. URL: <https://www.kirinholdings.co.jp/english/news/2017/0810.01.html>.
- [2] H.J. Chae, H. Joo, M.-J. In, Utilization of brewer's yeast cells for the production of food-grade yeast extract. Part I: effects of different enzymatic treatments on solid and protein recovery and flavor characteristics, *Bioresour. Technol.* 76 (2001) 253–258.
- [3] E.Y. Jung, H.-S. Lee, J.W. Choi, K.S. Ra, M.-R. Kim, H.J. Suh, Glucose tolerance and antioxidant activity of spent brewer's yeast hydrolysate with a high content of Cyclo-His-Pro (CHP), *J. Food Sci.* 76 (2011) C272–C278.
- [4] M. Amorim, J.O. Pereira, D. Gomes, C.D. Pereira, H. Pinheiro, M. Pintado, Nutritional ingredients from spent brewer's yeast obtained by hydrolysis and selective membrane filtration integrated in a pilot process, *J. Food Eng.* 185 (2016) 42–47.
- [5] R. Ravindran, A.K. Jaiswal, Exploitation of food industry waste for high-value products, *Trends Biotechnol.* 34 (2016) 58–69.
- [6] G.V. Marson, M.T. da Costa Machado, R.J.S. de Castro, M.D. Hubinger, Sequential hydrolysis of spent brewer's yeast improved its physico-chemical characteristics and antioxidant properties: A strategy to transform waste into added-value biomolecules, *Process Biochemistry* 84 (2019) 91–102.
- [7] L. de la Hoz, A.N. Ponezi, R.F. Milani, V.S.N. da Silva, A.S. de Souza, M.T. Bertoldo-Pacheco, Iron-binding properties of sugar cane yeast peptides, *Food Chem.* 142 (2014) 166–169.
- [8] T.R.d.S. Mathias, V.M.F. Alexandre, M.C. Cammarota, P.P.M. Mello, E.F.C. Sérvulo, Characterization and determination of brewer's solid wastes composition, *J. Inst. Brew.* 121 (2015) 400–404.
- [9] G.M. Caballero-Córdoba, V.C. Sgarbieri, Nutritional and toxicological evaluation of yeast (*Saccharomyces cerevisiae*) biomass and a yeast protein concentrate, *J. Sci. Food Agric.* 80 (2000) 341–351.
- [10] T. Yusuf, Experimental study of microorganism disruption using shear stress, *Biochem. Eng. J.* 79 (2013) 7–14.
- [11] O. Kanauchi, K. Igarashi, R. Ogata, K. Mitsuyama, A. Andoh, A yeast extract high in bioactive peptides has a blood-pressure lowering effect in hypertensive model, *Curr. Med. Chem.* 12 (2005) 3085–3090.
- [12] Y. Xia, F. Bamdad, M. Gänzle, L. Chen, Fractionation and characterization of antioxidant peptides derived from barley glutelin by enzymatic hydrolysis, *Food Chem.* 134 (2012) 1509–1518.
- [13] R. Durand, E. Fraboulet, A. Marette, L. Bazinet, Simultaneous double cationic and anionic molecule separation from herring milt hydrolysate and impact on resulting fraction bioactivities, *Sep. Purif. Technol.* 210 (2019) 431–441.
- [14] I. Iupac, Compendium of Chemical Terminology, 2nd ed., Blackwell Scientific Publications, Oxford, UK, 1997 doi:<https://doi.org/10.1351/goldbook>.
- [15] F. Toldrá, M. Reig, M.-C. Aristoy, L. Mora, Generation of bioactive peptides during food processing, *Food Chem.* 267 (2018) 395–404.
- [16] B. Hernández-Ledesma, D. Martínez-Maqueda, B. Miralles, L. Amigo, J.A. Gómez-Ruiz, Peptides, in: M.L. Nolle, Leo, F. Toldrá (Eds.), *Food Analysis by HPLC*, 3 ed., CRC Press, Boca Raton, USA, 2013, pp. 69–96.
- [17] R.J.S. de Castro, V.G. Cason, H.H. Sato, Binary mixture of proteases increases the antioxidant properties of white bean (*Phaseolus vulgaris* L.) protein-derived peptides obtained by enzymatic hydrolysis, *Biocatal. Agric. Biotechnol.* 10 (2017) 291–297.
- [18] S. Ranamukhaarachchi, L. Meissner, C. Moresoli, Production of antioxidant soy protein hydrolysates by sequential ultrafiltration and nanofiltration, *J. Membr. Sci.* 429 (2013) 81–87.
- [19] M. Mirzaei, S. Mirdamadi, M.R. Ehsani, M. Aminlari, E. Hosseini, Purification and identification of antioxidant and ACE-inhibitory peptide from *Saccharomyces cerevisiae* protein hydrolysate, *J. Funct. Foods* 19 (2015) 259–268.
- [20] C. Esteve, M.L. Marina, M.C. García, Novel strategy for the revalorization of olive (*Olea europaea*) residues based on the extraction of bioactive peptides, *Food Chem.* 167 (2015) 272–280.
- [21] R.J.S. de Castro, H.H. Sato, A response surface approach on optimization of hydrolysis parameters for the production of egg white protein hydrolysates with antioxidant activities, *Biocatal. Agric. Biotechnol.* 4 (2015) 55–62.
- [22] W. Pan, C.T. Nomura, J.P. Nakas, Estimation of inhibitory effects of hemicellulosic wood hydrolysate inhibitors on PHA production by *Burkholderia cepacia* ATCC 17759 using response surface methodology, *Bioresour. Technol.* 125 (2012) 275–282.
- [23] J. Charney, R.M.A. Tomarelli, A colorimetric method for the determination of the proteolytic activity of duodenal juice, *J. Biol. Chem.* 170 (1947) 501–505.
- [24] K. Huang, J.-Y. Gao, S. Ma, J.-J. Lu, Optimising separation process of protein and polysaccharide from spent brewer's yeast by ultrafiltration, *Int. J. Food Sci. Technol.* 47 (2012) 1259–1264.
- [25] AOAC, Official Methods of Analysis of the Association of Official Analytical Chemists, 18th ed, Gaithersburg, MD, USA, 2006.
- [26] E. Fournier, Colorimetric quantification of carbohydrates, in: R.E. Wrolstad (Ed.), *Current Protocols in Food Analytical Chemistry*, John Wiley & Sons, Inc, 2001, pp. 1–8 doi:<https://doi.org/10.1002/0471142913.fae0101s00>.
- [27] J.M. Webb, H.L. Levy, A sensitive method for the determination of deoxyribonucleic acid in tissues and microorganisms, *J. Biol. Chem.* 213 (1955) 107–117.
- [28] P. Sceni, G.G. Palazolo, M. del Carmen Vasallo, M.C. Puppo, M.A. Otero, J.R. Wagner, Thermal and surface behavior of yeast protein fractions from *Saccharomyces cerevisiae*, *LWT Food Sci. Technol.* 42 (2009) 1098–1106.
- [29] R.E. Wrolstad, T.E. Acree, E.A. Decker, M.H. Penner, D.S. Reid, S.J. Schwartz, C.F. Shoemaker, D. Smith, P. Sporns, Measurements of protein content, in: *Handbook of Food Analytical Chemistry*, John Wiley & Sons, Inc., doi:<https://doi.org/10.1002/0471709085.ch3>, 2005, pp. 73–121.
- [30] M.A.N. del Toro, F.L. García-Carre no, Evaluation of the progress of protein hydrolysis, in: R.E. Wrolstad (Ed.), *Handbook of Food Analytical Chemistry: Water, Proteins, Enzymes, Lipids, and Carbohydrates*, John Wiley & Sons, Inc, 2005p. B2.2. doi:<https://doi.org/10.1002/0471142913.fab0202s10>.
- [31] M.T.B. Pacheco, G.M. Caballero-Córdoba, V.C. Sgarbieri, Composition and nutritive value of yeast biomass and yeast protein concentrates, *J. of Nutr. Sci. Vitaminol.* 43 (1997) 601–612.
- [32] S. Amrhein, K.C. Bauer, L. Galm, J. Hubbuch, Non-invasive high throughput approach for protein hydrophobicity determination based on surface tension, *Biotechnol. Bioeng.* 112 (2015) 2485–2494.
- [33] T.J. Herald, P. Gadgil, M. Tilley, High-throughput micro plate assays for screening flavonoid content and DPPH-scavenging activity in sorghum bran and flour, *J. Sci. Food Agric.* 92 (2012) 2326–2331.
- [34] I.F. Benzie, J.J. Strain, The ferric reducing ability of plasma (FRAP) as a measure of Antioxidant Power: The FRAP assay, *Anal. Biochem.* 239 (1996) 70–76.
- [35] M.S.M. Rufino, R.E. Alves, E.S. Brito, S.M. Morais, C.d.G. Sampaio, J. Péprez-Jiménez, F.D. Saura-Calixto, Metodologia científica: determinação ao da atividade antioxidante total em frutas pelo método de redução ao do ferro, (FRAP), Technical Report, EMBRAPA, Fortaleza, (2006), p. 125 URL: <http://ainfo.cnptia.embrapa.br/digital/bitstream/CNPAT-2010/11964/1/cot-125.pdf>, number.
- [36] B. Ou, T. Chang, D. Huang, R.L. Prior, Determination of total antioxidant capacity by oxygen radical absorbance capacity (ORAC) using fluorescein as the fluorescence probe: First Action 2012.23, *J. AOAC Int.* 96 (2013) 1372–1376.
- [37] M.P. Buera, R.D. Lozano, C. Petriella, Definition of colour in the non enzymatic browning process, *Die Farbe.* 32/33 (1985) 316–326.
- [38] R. Hirschler, Chapter 10 - whiteness, yellowness, and browning in food colorimetry: A critical review, in: J.L. Caivano, M. del Pilar Buera (Eds.), *Color in Food: Technological and Psychophysical Aspects*, 1 ed., CRC Press, Boca Raton, USA, 2012, pp. 93–103 doi:<https://doi.org/10.1201/b11878>.
- [39] M. Yu, S. He, M. Tang, Z. Zhang, Y. Zhu, H. Sun, Antioxidant activity and sensory characteristics of Maillard reaction products derived from different peptide fractions of soybean meal hydrolysate, *Food Chem.* 243 (2018) 249–257.
- [40] M.M. Bradford, A rapid and sensitive method for the quantitation of microgram quantities of protein utilizing the principle of protein-dye binding, *Anal. Biochem.* 72 (1976) 248–254.
- [41] B. Podpora, F. Świdorski, A. Sadowska, R. Rakowska, G. Wasiak-zys, Spent brewer's yeast extracts as a new component of functional food, *Czech J. Food Sci.* 34 (2016) 554–563.
- [42] M. Pinto, E. Coelho, A. Nunes, T. Brand ao, M.A. Coimbra, Valuation of brewers spent yeast polysaccharides: A structural characterization approach, *Carbohydr. Polym.* 116 (2015) 215–222.
- [43] T.W. Nagodawithana, L. Nelles, N.B. Trivedi, Chapter 11: Protein hydrolysates as hypoallergenic, flavors and palatants for companion animals, in: V.K. Pasupuleti, A.L. Demain (Eds.), *Protein Hydrolysates in Biotechnology*, 1 ed., Springer Science + Business Media, New York, USA, 2010, pp. 191–208 doi:<https://doi.org/10.1007/978-1-4020-6674-0>.
- [44] E.A. Yamada, V.C. Sgarbieri, Yeast (*Saccharomyces cerevisiae*) protein concentrate: Preparation, chemical composition, and nutritional and functional properties, *J. Agric. Food Chem.* 53 (2005) 3931–3936.
- [45] H. Tangüler, H. Erten, Utilisation of spent brewer's yeast for yeast extract production by autolysis: The effect of temperature, *Food Bioprod. Process.* 86 (2008) 317–321.
- [46] J. Xie, C. Cui, J. Ren, M. Zhao, L. Zhao, W. Wang, High solid concentrations facilitate enzymatic hydrolysis of yeast cells, *Food Bioprod. Process.* 103 (2017) 114–121.
- [47] Novozymes S/A, Alcalase™, Flavourzyme™ and Protamex™ Product Sheet, 2002. Numbers: 2001-08281-02; 2001-08282-02; 2001-08284-02.
- [48] Prozyn S/A, Brauzyn \* 100 L Product Sheet, 2009. Special Food.
- [49] A.C. Storer, R. Ménard, Chapter 419 - Papain, in: N.D. Rawlings, G. Salvesen (Eds.), *Handbook of Proteolytic Enzymes*, 3rd ed., Academic Press, 2013, pp. 1858–1861 doi:<https://doi.org/10.1016/B978-0-12-382219-2.00418-X>.
- [50] R. Williams, D.A. Dias, N. Jayasinghe, U. Roessner, L.E. Bennett, β, *Food Chem.* 197 (2016) 761–768.
- [51] M. Karamać, A. Kosińska-Cagnazzo, A. Kulczyk, Use of different proteases to obtain flaxseed protein hydrolysates with antioxidant activity, *Int. J. of Mol. Sci.* 17 (2016) 1–13.

- [52] H. Hou, B. Li, X. Zhao, Z. Zhang, P. Li, Optimization of enzymatic hydrolysis of alaska pollock frame for preparing protein hydrolysates with low-bitterness, *LWT Food Sci. Technol.* 44 (2011) 421–428.
- [53] J.A. do Evangelho, N.L. Vanier, V.Z. Pinto, J.J.D. Berrios, A.R.G. Dias, E. da Rosa Zavareze, Black bean (*Phaseolus vulgaris* L.) protein hydrolysates: Physicochemical and functional properties, *Food Chem.* 214 (2017) 460–467.
- [54] P. Meinschmidt, D. Sussmann, U. Schweiggert-Weisz, P. Eisner, Enzymatic treatment of soy protein isolates: Effects on the potential allergenicity, techno-functionality, and sensory properties, *Food Sci. Nutr.* 4 (2016) 11–23.
- [55] D. Tagliacuzzi, E. Verzelloni, A. Conte, Effect of dietary melanoidins on lipid peroxidation during simulated gastric digestion: Their possible role in the prevention of oxidative damage, *J. Agric. Food. Chem.* 58 (2010) 2513–2519.
- [56] M. Rizzo, D. Ventrice, M. Varone, R. Sidari, A. Caridi, HPLC determination of phenolics adsorbed on yeasts, *J. Pharm. Biomed. Anal.* 42 (2006) 46–55.

## Chapter 7

# Article 3: Membrane fouling in polymeric membranes

**Ultrafiltration performance of spent brewer's yeast protein hydrolysate: impact of pH and membrane material on fouling**

Gabriela Vollet Marson<sup>a,e</sup>, Débora Tamires Vitor Pereira<sup>b</sup>, Mariana Teixeira da Costa Machado<sup>c</sup>, Marco di Luccio<sup>d</sup>, Julian Martínez<sup>b</sup>, Marie-Pierre Belleville<sup>e</sup>, Miriam Dupas Hubinger<sup>a</sup>

<sup>a</sup>Laboratory of Process Engineering, Department of Food Engineering (DEA), School of Food Engineering (FEA), University of Campinas (UNICAMP), R. Monteiro Lobato, 80, 13083-862, Campinas, São Paulo, Brazil.

<sup>b</sup>Laboratory of High Pressure in Food Engineering, Department of Food Engineering (DEA), School of Food Engineering (FEA), University of Campinas (UNICAMP), R. Monteiro Lobato, 80, 13083-862, Campinas, São Paulo, Brazil.

<sup>c</sup>Department of Food Technology, Federal Rural University of Rio de Janeiro, BR 465, km 7, 23890-000, Seropédica, Rio de Janeiro, Brazil.

<sup>d</sup>Department of Chemical and Food Engineering, Federal University of Santa Catarina, 88040-970, Florianópolis, Santa Catarina, Brazil.

<sup>e</sup>Institut Européen des Membranes (IEM), Université de Montpellier, CNRS, ENSCM, UM, CC 047, 2, Place Eugène Bataillon, 34095, Montpellier, Occitanie, France.

Results of this chapter were submitted in the Elsevier's Journal "Separation & Purification Technology", 2020.

ISSN: 1383-5866

## Ultrafiltration performance of spent brewer's yeast protein hydrolysate: impact of pH and membrane material on fouling

Gabriela Vollet Marson<sup>a,e,1,\*</sup>, Débora Tamires Vitor Pereira<sup>b</sup>, Mariana Teixeira da Costa Machado<sup>c</sup>, Marco Di Luccio<sup>d</sup>, Julian Martínez<sup>b</sup>, Marie-Pierre Belleville<sup>e</sup>, Miriam Dupas Hubinger<sup>a</sup>

<sup>a</sup>Laboratory of Process Engineering, Department of Food Engineering, School of Food Engineering, UNICAMP, Rua Monteiro Lobato, 80, 13083-862, Campinas, SP, Brazil

<sup>b</sup>Laboratory of High Pressure in Food Engineering, Department of Food Engineering, School of Food Engineering, UNICAMP, Rua Monteiro Lobato, 80, 13083-862, Campinas, SP, Brazil

<sup>c</sup>Department of Food Technology, Federal Rural University of Rio de Janeiro, Rodovia BR 465, km 7, 23890-000 Seropédica, RJ, Brazil

<sup>d</sup>Laboratory of Membrane Processes, Department of Chemical and Food Engineering, Federal University of Santa Catarina, 88040-970 Florianópolis, SC, Brazil

<sup>e</sup>Institut Européen des Membranes, Université de Montpellier, CNRS, ENSCM, UM, CC 047, 2 Place Eugène Bataillon, 34095 Montpellier, France

---

### Abstract

Spent brewer's yeast is a major by-product from the brewing industry. Because of its availability and high protein content, this by-product has been considered as an interesting source of bioactive peptides. The aim of our work was to investigate membrane performance (flux, selectivity) and fouling involved in ultrafiltration (UF) of spent brewer's yeast protein hydrolysate. UF experiments were carried out with regenerated cellulose (RC) and polyethersulfone (PES) membranes of 30 kDa molecular weight cut-off at different pH values (5 and 8). The PES membrane at pH 5 was able to retain 48% of total solids and 78% of peptides, i.e., the highest retention among all conditions tested. Ribonucleic acids were mainly found in the permeate (about 60%), being separated from the peptide rich fraction with the RC membrane at pH 8. The protein hydrolysate at pH 8 showed less susceptibility to the adsorption of proteins onto the membrane surface in static conditions as well as smaller resistance to mass transfer. The smaller permeate flux decline was obtained for the



RC membrane at pH 8 ( $18.6 \pm 2.7 \text{ kg m}^{-2} \text{ h}^{-1}$ ). In the PES membrane, there were smaller changes in roughness, membrane hydrophobicity and wettability after static adsorption and UF. Similarities in the zeta potential of membranes and feed solution suggest that foulants aggregate in the surface of membranes by weak physical adsorption. Peptides were confirmed by FT-IR analysis as the main foulants in the UF of spent brewer's yeast protein hydrolysate in both membrane materials. The present results showed that UF of spent brewer's yeast hydrolysate should be carried out using hydrophilic membranes at pH 8 to prevent fouling and decrease its effects on membrane performance. The material and pH of spent brewer's yeast feed solution influenced the susceptibility to fouling and ultrafiltration performance, and thus, these parameters should be closely defined according to the intended objective of the separation.

*Keywords:* Hydrophobicity, Yeast ribonucleic acids, Membrane-protein interactions, Brewing by-products, Membrane wettability

---

## 1. Introduction

Increasing interest in the sustainable use and management of natural resources has driven scientists to search for technologies to transform industrial by-products into value-added products [1]. Several food industry residues, which are typically underused or inappropriately

---

*Abbreviations:* SBY: spent brewer's yeast; UF: ultrafiltration; MWCO: molecular weight cut-off; RC: regenerated cellulose; PES: polyethersulfone; pI: isoelectric point; WRD: water flux reduction; RPD: reduction of the mean pore diameter; UH030: flat sheet membrane of a molecular weight cut-off of 30 kDa, made of polyethersulfone; UC030: flat sheet membrane of a molecular weight cut-off of 30 kDa, made of regenerated cellulose; AFM: atomic force microscopy; FT-IR: Fourier-transform infrared spectroscopy; RNA: ribonucleic acids.

\*Corresponding author

*Email address:* gabrielavollet@gmail.com (Gabriela Vollet Marson)

<sup>1</sup>Present Address: Laboratory of Process Engineering, Department of Food Engineering, School of Food Engineering, UNICAMP, Rua Monteiro Lobato, 80, 13083-862, Campinas, SP, Brazil.

5 disposed of, can potentially become high-quality ingredients after processing.

6 The brewing industry continuously produces abundant agroindustrial by-products, e.g.,  
7 brewer's spent grain, spent brewer's yeast (SBY) and hot trub. The second major by-  
8 product from the brewing industry is SBY, which has great potential as a source of protein  
9 and bioactive peptides (50% consists of protein, d.w.) [2, 3, 4]. Processing of spent yeasts  
10 usually involves yeast cell disruption and protein hydrolysis. Extraction methods, such  
11 as autolysis, glass bead milling and enzymatic hydrolysis, are often successfully employed  
12 at the expense of complex downstream processing [5, 6]. Size of hydrolysed proteins is  
13 an important factor in producing bioactive peptides. For this reason, hydrolysates must  
14 often be fractionated to provide ingredients whose required functionality and bioactivity are  
15 enhanced in a more purified form [7, 8]. Protein hydrolysates consist of mixtures of protein  
16 fractions and peptides of several sizes, with minor differences in terms of physicochemical  
17 properties (charge, hydrophobicity). Therefore, they require a separation technology that is  
18 able to discriminate them [9]. Efficient and low-cost protein separation is of great interest  
19 to the pharmaceutical, biotechnological and food processing industries [10].

20 Fractionation and purification of proteins and peptides can be achieved through column  
21 chromatography, which presents high selectivity and also high costs for scale up [11]. Mem-  
22 brane technology has been used lately for fractionation of high value molecules because it is  
23 cost-effective and enables high product yields, high separation efficiency, simple scale-up and  
24 equipment cleaning [12, 13, 14]. One of the main challenges facing yeast extract separation  
25 lies in the complex composition of such extracts and high ribonucleic acids (RNA) content.

26 In humans, RNA are metabolised to uric acid, which can then progress to gout or kidney  
27 stones, and thus should be separated from the yeast final ingredient [15]. RNA molecules  
28 are usually extracted with proteins, and the objective to decrease of RNA content of yeast  
29 protein hydrolysates is often left to the separation step [15]. Only a few studies so far have  
30 exploited the separation of SBY hydrolysates by membrane technologies. Some have focused  
31 on the production of polysaccharide-rich and protein-rich fractions [6, 16], while others have  
32 focused on the separation of peptide-rich fractions [4].

33 Membrane fouling is a critical aspect of membrane separation technology. Many efforts  
34 have been made in order to study this phenomenon and overcome fouling-induced perfor-  
35 mance losses [13, 17]. The pH value of feed and protein concentration, along with membrane  
36 material and operating variables, greatly affect fouling and separation efficiency. For this  
37 reason, they need to be studied further for complex matrices [18, 19], such as SBY. Studies  
38 need to be conducted on both membrane performance (water and hydrolysate fluxes) and  
39 fouling resistance (membrane surface analysis, hydrophilicity and membrane-material inter-  
40 actions), to ensure the suitability and economic viability of ultrafiltration (UF) for a specific  
41 application [13, 20].

42 To date, there are no studies about fouling and mass transfer concerning membrane  
43 separation of yeast protein hydrolysates. Recent interest in the recovery of peptides and  
44 several other compounds from SBY extracts and hydrolysates has created an important  
45 demand for efficient downstream processing, adapted to the specificities of this complex  
46 by-product. In this research, we have investigated the UF of SBY protein hydrolysates

47 using food-grade commercial flat sheet membranes with the intent of studying mass transfer  
48 phenomena and fouling. The impact of feed composition, pH and membrane material on  
49 UF performance and fouling was evaluated, by exploring membrane-feed interactions and  
50 the existing relations between fractions and membrane characteristics.

## 51 2. Material and Methods

### 52 2.1. Materials

#### 53 2.1.1. Reagents

54 Sodium hydroxyde, hydrochloric acid, RNA from *S. cerevisiae* yeast and trichloroacetic  
55 acid were purchased from Sigma-Aldrich (Steinheim, Germany) and all other reagents were of  
56 analytical grade. Proteases used in this study were: Brauzyn<sup>®</sup> 100 L (Prozyn, Brazil), which  
57 is a vegetable protease specific for yeast cell wall hydrolysis, Protamex<sup>™</sup>, from *Bacillus* sp.  
58 (Novozymes, Denmark) and Alcalase<sup>™</sup> 2.4 L FG, from *Bacillus licheniformis* (Novozymes,  
59 Denmark).

#### 60 2.1.2. Spent brewer's yeast (SBY) hydrolysate

61 SBY from Lager Pilsen beer production (*Saccharomyces pastorianus*, Diamond, Lalle-  
62 mand, Canada) collected after 11 days of beer maturation without repitching (Haus Bier  
63 Brewery, São José dos Campos, Brazil) was used for the production of the protein hy-  
64 drolysate. The procedure developed in a previous study of our research group was followed,  
65 using the same proportion of three enzymes (Brauzyn<sup>®</sup>, Protamex<sup>™</sup> and Alcalase<sup>™</sup>) [4].  
66 The SBY hydrolysate consisted of 6.8% dry matter, 53% (d.w.) crude protein, 5.6% (d.w.)  
67 RNA, 31% (d.w.) total sugars, 1% (d.w.) fibre and 11% (d.w.) ash. Hydrolysate yield from

68 non-treated SBY was 64-76% (m/m) [4].

### 69 2.1.3. Membranes

70 The membrane experiments used commercial flat sheet membranes with a molecular  
71 weight cut-off (MWCO) of 30 kDa, made of polyethersulfone (PES) (UH030) and regener-  
72 ated cellulose (RC) (UC030) from Mycrodyn-Nadir (Germany) were used in the membrane  
73 experiments (Table 1).

Membrane	UH030	UC030
MWCO <sup>a</sup> (kDa)	30	30
Material <sup>a</sup>	PES	RC
Maximum temperature <sup>a</sup> (°C)	95	55
Maximum pH range <sup>a</sup>	0 - 14	1 - 11
Initial water flux <sup>b</sup> (kg m <sup>-2</sup> h <sup>-1</sup> )	419 ± 107	1007 ± 206

Table 1: Characteristics of UF membranes made of regenerated cellulose (RC) and polyethersulfone (PES) of 30 kDa MWCO.

MWCO: molecular weight cut-off; <sup>a</sup>Manufacturer data. <sup>b</sup>Initial water flux measured in the conditions evaluated in this work (5.0 ± 0.2 bar of transmembrane pressure, 600 rpm and 50 °C) in a stirred dead-end module for flat sheet membranes.

## 74 2.2. Static adsorption tests

### 75 2.2.1. Experimental procedure

76 Figure 1 shows the experimental strategy and a detailed schema of static adsorption  
77 procedure in UF membranes. Membranes were conditioned prior to adsorption experiments.  
78 Firstly, the membranes were fully soaked in distilled water at room temperature (20-25 °C)  
79 for 12 h in glass plates. Then, they were placed in the UF system, which was filled with  
80 distilled water, and pressure was gradually increased up to 5 bar. This procedure ensures no  
81 changes occur in membrane hydraulic resistance throughout the process [21]. Then, initial  
82 water flux ( $J_0$ ) was determined at 5.0 ± 0.2 bar of transmembrane pressure, 600 rpm and

83 50 °C (Table 1).

84 Static adsorption tests were performed as described by Chabeaud *et al.* (2009) [22], with  
 85 some modifications. Briefly, conditioned membranes were soaked in an SBY hydrolysate  
 86 solution diluted to 30 g<sub>protein</sub> L<sup>-1</sup> for 12 h at 2 °C. Membranes were rinsed with distilled  
 87 water and water flux after adsorption ( $J_A$ ) was measured in operating conditions ( $5 \pm 0.2$   
 88 bar of transmembrane pressure, 600 rpm and 50 °C). Membranes were kept in a desiccator  
 89 at room temperature until surface analyses.

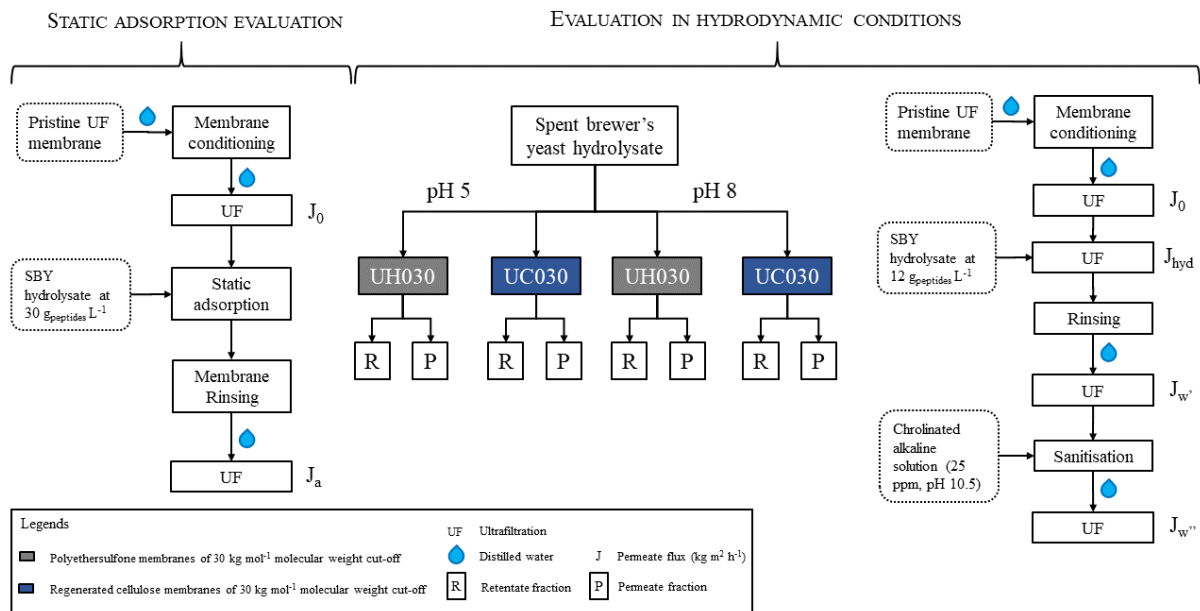

Figure 1: Experimental strategy to evaluate membrane performance during ultrafiltration of spent brewer's yeast (SBY) hydrolysate at static and hydrodynamic conditions.

### 90 2.2.2. Water flux reduction and reduction of mean pore diameter

91 Adsorption results were evaluated in terms of water flux reduction (WRD) and reduction  
 92 of the mean pore diameter (RPD). Both parameters quantify the extent of adsorption and  
 93 are complementary [22]. While the WRD is the percentage difference in pure water flux of

94 the membrane before ( $J_0$ ) and after static contact with the hydrolysate followed by water  
95 rinsing ( $J_a$ ) (Equation 1) [23], reduction in pore radius in RPD occurs by adsorption of  
96 hydrolysate particles on the pore walls (Equation 2) [24].

$$WRD (\%) = 1 - \frac{J_a}{J_0} \quad (1)$$

$$RPD (\%) = 1 - \left( \frac{J_a}{J_0} \right)^{0.25} \quad (2)$$

### 97 2.3. Fractionation of SBY hydrolysate

#### 98 2.3.1. Experimental procedure

99 All membranes were conditioned prior to the experiments and initial water flux was  
100 determined as described in section 2.2.1 (initial water flux data available in Table 1). UF  
101 experiments were performed in a 200 mL capacity jacketed stainless steel dead-end cell  
102 (effective permeation area of 0.0016 m<sup>2</sup>), pressurised with gaseous nitrogen. The cell was  
103 stirred at 600 rpm (Magnetic stirrer IKA RH Basic, Germany) using a magnetic bar of  
104 25 mm. UF was performed until a volumetric concentration factor of 4 (ratio of initial  
105 feed volume to final retentate volume). Figure 2 show a schematic representation of the  
106 UF system, in dead-end mode. The jacketed membrane module was connected to a water  
107 bath (MA126/BD, Marconi, Brazil) to control the temperature of the system during UF.  
108 Before each experiment, the feed was kept in the cell for temperature conditioning for 10  
109 min. Operating conditions were based on those established by Chabeaud *et al.* (2009) [22]  
110 (feed concentration of SBY hydrolysate: 1% dry matter and 12 g<sub>peptide</sub> L<sup>-1</sup>, 5.0 ± 0.2 bar

111 of transmembrane pressure and 50 °C) in order to efficiently assess the influence of material  
 112 and pH on separation performance. SBY hydrolysate dynamic viscosity at 50 °C was 0.0008  
 113 Pa s. Feed pH (initially at pH 7) was adjusted with NaOH 1 mol L<sup>-1</sup> or HCl 1 mol L<sup>-1</sup>  
 114 solutions to pH 5 or 8. A sanitisation procedure was carried out after membrane rinsing  
 115 and hydrolysate filtration at  $3.0 \pm 0.2$  bar for 30 min with a chlorinated alkaline solution  
 116 (25 ppm, pH 10.5), to prevent not only bio-film formation on the membranes, but also  
 117 microbiological development until further analyses [19]. Permeate flux was measured using  
 118 an in-line balance (Shimadzu UX4200H, Japan).

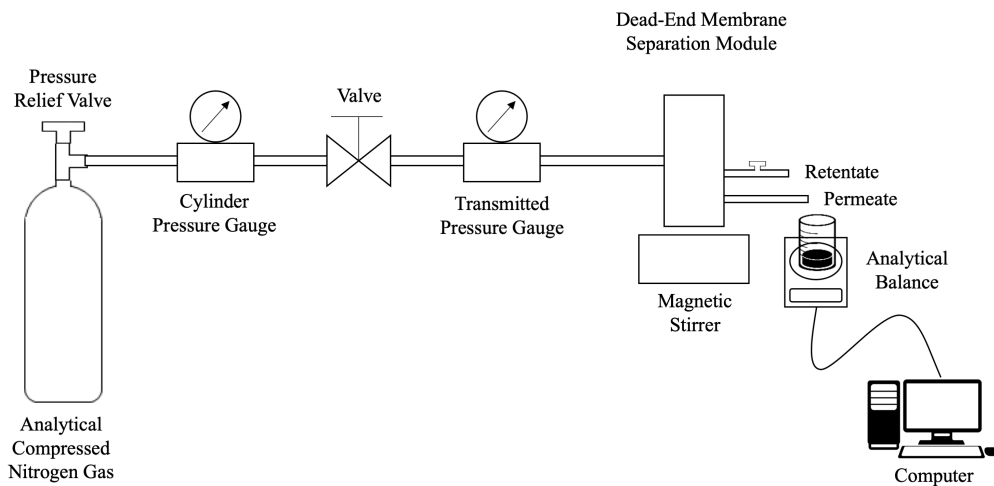

Figure 2: UF laboratory unit system (a) and dead-end membrane separation module and its components

### 119 2.3.2. Permeate flux and retention

120 At an instant  $t$ , permeate mass flux was calculated according to Equation 3, where  $J_p$  is  
 121 the massic flux of the permeate ( $\text{kg m}^{-2} \text{h}^{-1}$ );  $m_p$  is permeate mass (kg);  $\Delta t$  is the period of  
 122 time (h) (1 min) and  $A_p$  is the effective permeation area ( $\text{m}^2$ ).



$$J_p = \frac{\Delta m_p}{\Delta t A_p} \quad (3)$$

123 Retention coefficients ( $RC$ ) of total solids and peptides were calculated by Equation 4,  
124 as the ratio of the concentrations of solute in the permeate ( $C_p$ ) and in the feed ( $C_f$ ).

$$RC (\%) = \left( 1 - \left( \frac{C_p}{C_f} \right) \right) \times 100 \quad (4)$$

### 125 2.3.3. Membrane hydraulic resistances

126 Mass transfer resistances were evaluated using the resistance-in-series model. Resistances  
127 were conceptually separated into intrinsic membrane resistance and the resistances relative  
128 to the fluid layers (concentration polarisation in the boundary layer and fouling) [25, 26].  
129 Darcy's model is presented in Equation 5, where  $R$  represents the membrane hydraulic  
130 resistance ( $\text{m}^2 \text{kg}^{-1}$ ),  $\Delta P$  is the transmembrane pressure (Pa),  $\mu$  is the dynamic viscosity  
131 (Pa s) and  $J$  is the permeate flux ( $\text{kg m}^{-2} \text{h}^{-1}$ ).

$$J = \frac{\Delta P}{\mu R} \quad (5)$$

132 The intrinsic membrane resistance is calculated while considering the water dynamic  
133 viscosity in the experimental conditions ( $\mu_w$ ) and the initial water flux ( $J_0$ ), as shown in  
134 Equation 6. Similarly, total membrane resistance considers the hydrolysate dynamic viscos-  
135 ity in the same conditions ( $\mu_{hyd}$ ) and the permeate flux of the hydrolysate ( $J_{hyd}$ ) (Equation  
136 7).

$$R_M = \frac{\Delta P}{\mu_w J_0} \quad (6)$$

$$R_T = \frac{\Delta P}{\mu_{hyd} J_{hyd}} \quad (7)$$

137 The permeate flux of water after rinsing ( $J_{w'}$ ) was measured after hydrolysate UF and  
 138 simple water rinsing of the membrane. The same membrane was sanitised using the pro-  
 139 cedure described in section 2.3.1, and the water permeate flux after sanitisation ( $J_{w''}$ ) was  
 140 measured as well. Both fluxes were used for calculation of the regeneration rate (section  
 141 2.3.4). Water fluxes measured before and after SBY hydrolysate filtration were used to cal-  
 142 culate the resistances relative to fouling, which are shown in a schematic form in Figure 1.  
 143  $R_I$  accounts for the residual part of total resistance that is not eliminated by water rinsing,  
 144 which represents irreversible fouling (Equation 8) and  $R_{pl}$  represents the part of  $R_T$  (includ-  
 145 ing what is adsorbed) that can be eliminated by rinsing the sample with water (Equation  
 146 9).

$$R_I = \frac{\Delta P}{\mu_w J_{w'}} - R_M \quad (8)$$

$$R_{pl} = R_T - R_M - R_I \quad (9)$$

## 147 2.3.4. Membrane regeneration rates

148 Water flux data at different stages of separation were determined in order to assess mem-  
149 brane behaviour in water, and enabled the calculation of membrane regeneration [27, 17],  
150 after water rinsing ( $RR_r$ ) (Equation 10) and after the sanitising procedure ( $RR_s$ ) (Equation  
151 11).

$$RR_r = \frac{J_{w'}}{J_0} \times 100 \quad (10)$$

$$RR_s = \frac{J_{w''}}{J_0} \times 100 \quad (11)$$

## 152 2.4. Physico-chemical analyses

153 Dry matter (% , m/m) in the feed, permeate and retentate fractions was determined  
154 gravimetrically at 105 °C for 12 h using an incubator (C-HT 515, Fanem, Brazil) [28].  
155 Dissolved solids in samples ( $\text{g } 100 \text{ g}_{\text{solution}}^{-1}$ ) were quantified by a refractometer (N-1 alpha,  
156 ATAGO, Japan), at  $22 \pm 2$  °C [28]. Peptide concentration ( $\text{g L}_{\text{solution}}^{-1}$ ) was measured  
157 by far-UV absorbance at 205 nm (2800, Unico, United States) using quartz cuvettes [29].  
158 Ribonucleic acid content (RNA) was determined in dried samples using trichloroacetic acid  
159 hydrolysis (1 mL of acid per 15 mg of dried sample) followed by absorbance determination. A  
160 standard curve using RNA from *S. cerevisiae* at 260 nm was used, and results were expressed  
161 in  $\text{g L}_{\text{solution}}^{-1}$  [30, 31, 32].

## 162 2.5. Membrane surface characterisation

163 Pristine and treated membranes (after adsorption and fractionation processes) were main-  
164 tained for at least 24 h in a desiccator before analysis. All membranes were characterised  
165 to establish some of their morphological, physico-chemical properties and susceptibility to  
166 fouling.

### 167 2.5.1. Surface roughness

168 Surface topology analysis of the membranes was performed in an atomic force microscope  
169 (Alto Probe CP, Park Scientific Instruments, Korea). Three-dimensional images of  $10 \times 10$   
170  $\mu\text{m}$  in the same sample area, and three different regions of each membrane were analysed,  
171 in non-contact mode. Average surface roughness ( $R_a$ ), root mean square roughness ( $RMS$ )  
172 and surface area ( $SA$ ) were calculated using the software Gwyddion 2.53 (Czech Metrology  
173 Institute, Czech Republic).  $RMS$  and  $R_a$  results were expressed in nm.

### 174 2.5.2. Surface hydrophilicity

175 Surface hydrophilicity was determined by calculating membrane and liquid interfacial free  
176 energy, based on contact angle and roughness data. Contact angle ( $\theta$ ) of membrane samples  
177 was determined using the sessile drop method in a tensiometer (Teclis, Tracker, France). A  
178 water drop of  $2 \mu\text{L}$  was deposited on the surface of each sample by a motor-driven micro  
179 syringe. All results were performed at  $20 \pm 3 \text{ }^\circ\text{C}$  after 30 s of contact between droplet  
180 and membrane surface. Six replicates were determined for each sample. Membrane-liquid  
181 interfacial free energy ( $-\Delta G_{ML}$ ) was calculated using a modified Young-Dupré equation as  
182 described previously [33] (Equation 12). The effect of membrane surface roughness (de-

183 terminated in section 2.5.1) on contact angle measurement was accounted for through the  
184 roughness area parameter ( $RAP = 1 + SAD$ ), which is equal to one plus the ratio of the  
185 actual membrane superficial area ( $SA$ ) to its geometric area [34]. The greater the actual  
186 membrane surface area (roughness taken into account), the stronger the membrane-feed in-  
187 teractions are likely to be [35]. Equation 12 also considers the water contact angle value  
188 ( $\theta_{water}$ ) and the surface tension of water ( $\gamma_{water}$ , which is  $72.8 \text{ mN m}^{-1}$  at  $20 \text{ }^\circ\text{C}$ ). A larger  
189 value of  $-\Delta G_{ML}$  suggests a more wettable surface [36].

$$-\Delta G_{ML} (\%) = \gamma_{water} \left(1 + \frac{\cos \theta}{RAP}\right) \quad (12)$$

### 190 2.5.3. Functional groups on the surface of membranes

191 Investigation of functional groups and molecular structures on the surface of membranes,  
192 before and after UF, was performed using Fourier-transform infrared spectroscopy (FT-IR) in  
193 attenuated total reflectance mode (ATR, ory model PRO450-S) in an infrared spectrometer  
194 (JASCO Model FT/IR-6100 type A, Japan). For data acquisition, a zinc selenide crystal  
195 (ZnSe) was used (incidence angle of  $45^\circ$ ), from  $4000$  to  $500 \text{ cm}^{-1}$ , with a  $4 \text{ cm}^{-1}$  resolution and  
196  $2 \text{ mm/sec}$  of scanning speed, generating about 1800 data points per sample. Each sample  
197 was analysed in triplicate.

### 198 2.5.4. Zeta potential of membranes

199 The zeta potential ( $\zeta_m$ ) of the membranes was determined by an electrokinetic analyser  
200 (SurPass, Anton Paar GmbH, Austria) at pH values ranging from 2 to 9, in order to inves-  
201 tigate the extent of the interaction between membrane and feed solution and its effect on

202 fouling. A 2 g L<sup>-1</sup> NaOH solution was used to induce the shift in pH during measurement;  
203 the electrolyte solution employed was KCl (1 mmol L<sup>-1</sup>).

## 204 2.6. Characterisation of SBY fractions

### 205 2.6.1. Zeta potential of suspensions

206 Electrophoretic mobility of molecules in the SBY hydrolysate was determined by Laser  
207 Doppler Velocimetry (LDV), using a Zetasizer NanoZS dynamic light scattering instrument  
208 (Malvern Instruments, United Kingdom). Zeta potential ( $\zeta_s$ ) was calculated by the Henry's  
209 equation considering the Smoluchowski approximation ( $f(ka) = 1.5$ ), as presented in Equa-  
210 tion 13, where  $E_M$  is electrophoretic mobility (m<sup>2</sup> s<sup>-1</sup> mV<sup>-1</sup>),  $\eta$  is viscosity (kg m<sup>-1</sup> s<sup>-1</sup>),  $\epsilon$  is  
211 the dielectric constant (kg m mV<sup>-2</sup> s<sup>-2</sup>) and  $f(ka)$  is Henry's function (dimensionless) [37].  
212 Six replicates were carried out for each sample without any dilution at 25 °C after 30 s of  
213 temperature conditioning, at the sample's pH (5 or 8). Disposable folded capillary cells  
214 made of polystyrene latex (model DTS1070, Malvern Instruments, United Kingdom) were  
215 used. Conductivity of samples ranged from 1.8 to 3.7 mS cm<sup>-1</sup>.

$$\zeta (mV) = \frac{E_M 3 \eta}{2 \epsilon f(ka)} \quad (13)$$

### 216 2.6.2. Surface tension

217 Protein hydrophobicity was measured via surface tension (the more hydrophobic the  
218 protein, the greater the depression in surface tension) [38]. Surface tension was measured  
219 optically; several photographs were taken of a 6  $\mu$ L drop of sample in contact with air for  
220 2000 s, using a camera in a tensiometer (Teclis, Tracker, France), in pendant drop mode.

221 The temperature of the samples ( $25 \pm 1$  °C) was kept constant during the analysis (TE-2005,  
222 Tecnal, Brazil). Six replicates were determined for each sample, and results were expressed  
223 as  $\text{mN m}^{-1}$ .

### 224 *2.7. Statistical analysis*

225 Experiments were performed in duplicate and all analyses were determined at least in  
226 triplicate. Results were expressed as average values  $\pm$  standard deviation and were submitted  
227 to one-way and two-way analysis of variance (ANOVA), followed by the comparison of means  
228 by Tukey's HSD test. ANOVA assumptions were checked through analysis of the residuals,  
229 data distribution (Ryan-Joiner's and Shapiro Wilk's tests) and homogeneity of variances  
230 (Bartlett's and Levene's tests). Differences were considered significant at a level of 5% for  
231 all statistical analyses. Correlations between variables were determined by Pearson's test  
232 followed by paired Student's t test.

## 233 **3. Results and Discussion**

### 234 *3.1. UF performance in the separation of the SBY protein hydrolysate*

#### 235 *3.1.1. Permeate flux and hydraulic resistances*

236 Initial water flux data is shown in Table 1. Water flux of the membranes varied greatly  
237 for the two study materials. RC membrane presented an initial water flux 2.4 times higher  
238 than that of PES in the conditions evaluated in this research ( $5 \pm 0.2$  bar of transmem-  
239 brane pressure, 600 rpm and 50 °C). Several factors related to the characteristics of the  
240 material (composition, morphology, hydrophilicity, roughness) affect water flux in polymeric  
241 membranes. In the literature, higher water permeation of the RC membrane in comparison

242 to the PES membrane is often attributed to a higher hydrophobicity of this material [35].  
243 Morphology may also play an important role in initial water flux. Indeed, membranes of the  
244 same material (PES) were reported to have very different initial water flux values, probably  
245 because of morphological differences between membranes from different suppliers [39].

246 Figure 3 shows the influence of membrane material on the UF separation of SBY hy-  
247 drolysate at pH 5 and 8 in the PES and RC membranes. Small differences were seen  
248 between both materials. Figure 3b shows higher flux values achieved at pH 8 and confirms  
249 that no significant differences between membrane materials were found in this condition.  
250 The change of feed pH value from 5 to 8, for the RC membrane, resulted in an increase in  
251 permeate flux by 39%. Among the tested conditions, the smallest flux was found at pH 5  
252 when using the UH030 membrane ( $13.6 \pm 0.4 \text{ kg m}^{-2} \text{ h}^{-1}$ ), while the highest flux ( $18.6 \pm 2.7$   
253  $\text{kg m}^{-2} \text{ h}^{-1}$ ) was found for the UC030 with a feed pH value of 8.

254 There was a rapid decrease in permeate flux with increased concentration at the beginning  
255 of filtration for all membranes (Figure 3a). This finding suggests the setup of concentration  
256 polarisation and fouling. A gel layer formed probably by yeast hydrolysate proteins is  
257 formed on the surface of both RC and PES membranes, creating a resistance to transport.  
258 Once these phenomena are established, permeate flux changes very little with increasing  
259 concentration (Figure 3b), suggesting an external deposition, which confirms that a layer is  
260 formed on the surface of the membrane. This type of fouling prevents internal pore clogging.  
261 These features are very interesting for industrial use, because higher concentration factors  
262 can be used with very little risk of a complete clogging of the membrane [40].



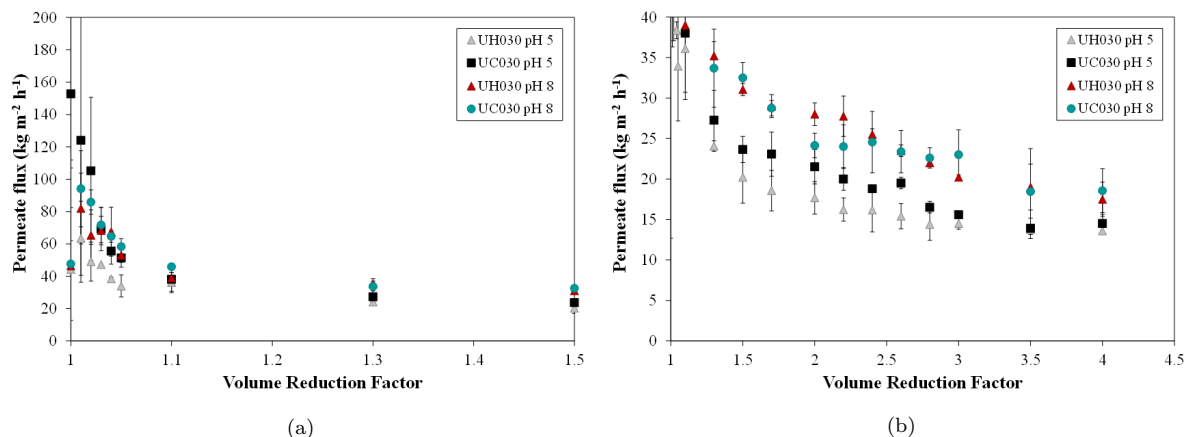

Figure 3: Permeate flux at pH 5 and 8 for polyethersulfone (UH030) and regenerated cellulose (UC030) membrane during the UF of SBY hydrolysate in the beginning of filtration (a) and in the end (b)

The coefficient of variation of mass balances ( $\text{Feed} = \text{Retentate} + \text{Permeate}$ ) was smaller than 15%.

263 Table 2 shows regeneration rates after rinsing and sanitisation using chlorinated alka-  
 264 line solution for all membranes tested. The sanitisation procedure involving a very mild  
 265 treatment with chlorinated water in small alkali concentration, adapted to food industry  
 266 requirements, was able to recover more than 68% of the initial water flux in the RC mem-  
 267 brane. However, for PES, recovery was smaller ( $<41\%$ ). Thus, the sanitisation procedure  
 268 was not able to regenerate either membrane, indicating that chemical cleaning was required.  
 269 Chemical cleaning of fouled membranes is a common practice in the UF separation of food  
 270 materials [19]. The use of concentrated alkaline solutions ( $1$  to  $10$   $\text{g L}^{-1}$ ) for regenera-  
 271 tion of PES membranes after UF of fish hydrolysates was very effective (more than 95%)  
 272 [27, 22]. However, contact with concentrated chemicals can damage the membrane structure  
 273 and chemical composition, possibly causing deterioration of membrane integrity [19]. For  
 274 this reason, recent studies prefer to evaluate membrane anti-fouling ability through water  
 275 washing efficiency [13].

Membrane	$RR_r$	$RR_s$
UH030 pH 5	$16 \pm 1^c$	$35 \pm 6^d$
UH030 pH 8	$30 \pm 1^a$	$41 \pm 2^c$
UC030 pH 5	$22 \pm 3^b$	$68 \pm 4^b$
UC030 pH 8	$34 \pm 9^a$	$95 \pm 10^a$

Table 2: Regeneration rates after rinsing ( $RR_r$ ) and after sanitisation procedure ( $RR_s$ ) of membranes of MWCO of 30 kDa made of polyethersulfone (UH030) and regenerated cellulose (UC030) in the UF of SBY hydrolysate at pH 5 or 8.

Different letters in the same column indicate significant differences (5% level) in regeneration rates.

276 Figure 4 shows that total resistance as well as the distribution of resistance types for each  
 277 membrane material varied with the pH of the feed solution. Intrinsic membrane resistance  
 278 of the PES and RC membranes was of the same order of magnitude, and was slightly  
 279 higher (58%) for PES. This parameter is complex and mainly dependent on membranes  
 280 structure (pore size, distribution, tortuosity, porosity). From feed pH 5 to pH 8, total and  
 281 irreversible resistance values decreased about 20% and 50%, on average, for both membranes,  
 282 indicating an influence of pH on hydraulic resistances and probably on fouling formation as  
 283 well. The  $R_{pl}$  resistance was not different for each pH in the PES membrane, but in the RC  
 284 membrane,  $R_{pl}$  was 20% smaller when feed pH was 8. In sum, the RC membrane and the  
 285 SBY hydrolysate at pH 8 presented the smallest overall resistance to flux.

### 286 3.1.2. Fractions characteristics

287 Table 3 shows the concentrations and retention coefficients for PES and RC membranes  
 288 at pH 5 and 8. The retention coefficients ranged from 22% to 48% for dry matter and from  
 289 22% to 57% for dissolved solids. Maximum retention was achieved when using the PES  
 290 membrane at pH 5, resulting in the retention of 48% of total solids and 57% of dissolved  
 291 solids. At this pH, this membrane was able to retain 78% of total protein, compared to about

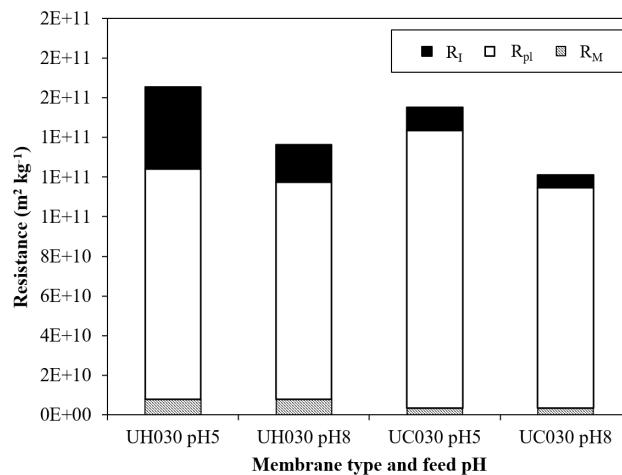

Figure 4: Total hydraulic resistance of the membranes studied and its components (b):  $R_M$ , the intrinsic hydraulic resistance of the membrane,  $R_{pl}$ , the resistance related to the polarised layer and  $R_I$ , the part of resistance not recovered after water rinsing.

292 60% for the RC membrane, at any pH value. For the RC membrane, retention of peptides  
 293 was 50% at most and, for this membrane, pH had a very small effect on the retention of all  
 294 components.

295 The concentration of RNA after UF in a RC membrane with a MWCO of 30 kDa is  
 296 shown in Table 3. RNA concentration is higher in the permeate than in the retentate.  
 297 Mass balance confirms this finding, indicating that most of RNA mass (60%) is found in  
 298 the permeate. Previous treatments used in the production of the protein hydrolysate (heat  
 299 treatment, enzymatic hydrolysis and centrifugation) [4] may be responsible either for holding  
 300 up higher molecular weight RNA or by promoting the hydrolysis of RNA molecules into small  
 301 nucleic acid residues, which then are transmitted to the permeate fraction when ultrafiltered  
 302 in 30 kDa MWCO membrane. The decrease of RNA content in yeast-based products is one  
 303 of the main challenges facing the application of these products, and it is usually achieved  
 304 by using chemical methods that require several precipitation steps to separate nucleic acids

305 from proteins. Some recent studies evaluated the retention of heterogeneous mixtures of  
306 RNA from yeast using membrane technology, but there is no investigation, to date, about  
307 the separation of RNA from hydrolysates or complex matrices (containing components other  
308 than RNA) was carried out [15, 41]. Previous studies have reported that most intact RNA  
309 was rejected by using PES and RC membranes with MWCO of 50 and 100 kDa. Manzano *et*  
310 *al.* (2017) [41] investigated RNA transmission of pure *Torula* yeast solution using PES and  
311 RC membranes of 300, 100 and 50 kDa at pH 7.5; they reported an important effect of RNA  
312 adsorption on RC membranes that did not occur with PES membranes. For this reason,  
313 we evaluated the transmission of RNA naturally present in SBY in the RC membrane at  
314 pH 8. At this pH, the solubility of nucleic acids is maximised [15]. However, as discussed  
315 previously, the RNA from the SBY protein hydrolysate was not retained by the membrane  
316 because it had been either hydrolysed or retained in previous extract preparation steps (such  
317 as during centrifugation).

<i>Fraction</i>	<i>Feed</i>	<i>Retentate</i>	<i>Permeate</i>	<i>Retentate</i>	<i>Permeate</i>	<i>Feed</i>	<i>Retentate</i>	<i>Permeate</i>	<i>Retentate</i>	<i>Permeate</i>
<i>Membrane/pH</i>	<i>pH 5</i>	<i>UH030 pH 5</i>	<i>pH 5</i>	<i>UC030 pH 5</i>	<i>pH 5</i>	<i>pH 8</i>	<i>UH030 pH 8</i>	<i>pH 8</i>	<i>UC030 pH 8</i>	<i>pH 8</i>
Dry matter	1.07	1.72	0.56	1.71	0.80	1.05	2.13	0.68	1.80	0.80
$RC_{\text{dry matter}}$		0.48		0.25			0.35		0.22	
Dissolved solids	2.2	2.8	1.0	3.0	1.4	1.9	3.3	1.2	3.0	1.5
$RC_{\text{dissolved solids}}$		0.57		0.39			0.37		0.22	
Peptide content	12.9	22.1	2.9	20.9	5.4	11.7	21.2	4.1	18.5	5.1
$RC_{\text{peptides}}$		0.78		0.58			0.65		0.57	
RNA content	nd	nd	nd	nd	nd	2.38	nd	nd	2.31	2.42

Table 3: Dry matter, dissolved solids, peptide content and ribonucleic acids (RNA) content of fractions obtained in the fractionation of spent brewer's yeast hydrolysate using membranes of a molecular weight cut-off of 30 kDa made of polyethersulfone (UH030) and regenerated cellulose (UC030) and corresponding retention coefficients (RC).

Standard deviations for all data were smaller than 5% for dry matter, dissolved solids and RNA content; for peptide content standard deviations were smaller than 15%. Dry matter and dissolved solids data in g per 100 g of wet sample; RNA and peptide content in g per L of wet sample; nd: not determined due to insufficient sample amount.

Surface tension data was used as an indirect measure of hydrophobicity of peptides present in the protein hydrolysate [38]. Surface tension values of SBY hydrolysate at pH 5 and 8 were 42 and 47 mN m<sup>-1</sup>, respectively. There were small changes in the surface tension of the fractions, with values ranging from 41 to 50 mN m<sup>-1</sup> (Figure 5a). Retentate fractions presented higher hydrophobicity (5 to 8% smaller surface tension values) than both the feed and the permeate fractions, but this effect did not seem to depend either on pH or on membrane material. The relation between surface tension and peptide content of the samples was confirmed by inverse correlations between these two parameters, and this result was found for all membrane materials and pH conditions (Pearson coefficient = 0.82-0.99;  $p < 0.02$ ). A higher concentration of peptides in the fractions resulted in a more important depression in surface tension, suggesting that hydrophobic peptides were concentrated during the UF experiments. At pH 5, this correlation was stronger (Pearson coefficient = 0.97-0.99;  $p < 0.02$ ) than at pH 8 (Pearson coefficient = 0.82-0.89;  $p < 0.02$ ). This result can be explained by the higher retention of peptides that is achieved in this condition.

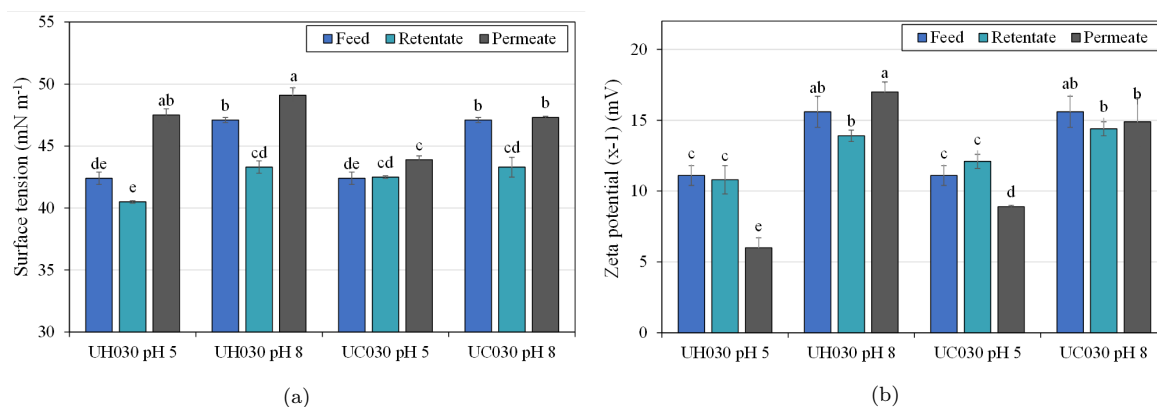

Figure 5: Surface tension (a) and zeta-potential of membrane fractions ( $\zeta_s$ ) (b) submitted to ultrafiltration in polyethersulfone (UH030) and regenerated cellulose (UC030) membranes with molecular weight cut-off (MWCO) of 30 kDa at different feed pH values.

332 The zeta potential of suspended particles and macromolecules is a measure of net charge  
333 of ions in the boundary of the dispersive layer of particles. The magnitude of this parameter is  
334 related to the degree of electrostatic repulsion or attraction among particles of a suspension.  
335 Figure 5b shows the zeta potential of suspended particles ( $\zeta_s$ ) in fractionated samples by  
336 the PES and RC membranes. UF with the PES or RC membranes, for the same pH value,  
337 did not affect the separation of charged groups. On the other hand, the feed pH used in  
338 the UF of SBY influenced the zeta potential of the fractions. At pH 5, the zeta potential  
339 of the permeate fractions for both the PES and RC membranes was decreased, whereas  
340 there were no differences between fractions at pH 8. This also could be due to the higher  
341 retention of compounds detected at pH 5 for the PES membrane. Positive correlations  
342 between dry matter and dissolved solids contents and zeta potential were found at pH 5,  
343 regardless of membrane material (Pearson coefficient<sub>dry matter</sub> = 0.80-0.90;  $p < 0.03$ ; Pearson  
344 coefficient<sub>dissolved solids</sub> = 0.93-0.98;  $p < 0.04$ ). When more solids were present in the fractions,  
345 a higher zeta potential magnitude was found for this condition. At higher pH, the net charge  
346 surrounding the suspended particles of SBY is also higher. This is a common phenomenon,  
347 explained by the effect of pH of the media on the net charge of protein molecules and thus  
348 their respective solubility. Ionisable amino acid residues of proteins, notably those exposed  
349 on the surface of proteins, are affected by pH. At the isoelectric point of most amino acids, the  
350 net charge of the protein is zero, while at higher and lower pH values the net charge becomes  
351 more negative or positive, respectively. This happens because of the gain or loss of protons  
352 by these residues ( $H^+$ ) that changes electrostatic interactions among the proteins themselves

353 and between the proteins and the solvent [42, 43]. It should be noted that the zeta potential  
354 of complex solutions is a quantification of the net charge considering the contribution of  
355 all charged compounds present in the matrix. Protein solubility and interactions in food  
356 systems such as SBY are very complex because of the presence of several ions. Moreover,  
357 SBY hydrolysates usually contain minerals that could alter the ionic strength of the medium,  
358 also affecting the interactions and net charge of proteins or other charged molecules [43].

### 359 *3.2. Membrane characteristics and susceptibility to fouling*

360 The characteristics of the surface of pristine membranes are presented in Table 4. The  
361 hydrophobic characteristic of the PES material ( $63^\circ$ ) in comparison to RC ( $21^\circ$ ) is confirmed  
362 by the contact angle values. RC membranes are more hydrophilic and wettable than PES  
363 membranes (much smaller contact angle and higher  $-\Delta G_{ML}$ ). Differences in pristine mem-  
364 brane roughness were not detected. PES membranes are more hydrophobic because they  
365 contain hydrophobic aromatic groups whereas the RC material presents mostly hydroxyl  
366 groups, which gives the material hydrophilic characteristics [44, 19]. Also, surface hydra-  
367 tion plays a relevant role in enhancing anti-fouling properties (represented by  $-\Delta G_{ML}$ ). An  
368 effective physical and thermodynamic barrier is formed when the membrane surface has  
369 great surface hydration ability, resulting in a tightly bound water layer (preventing protein  
370 penetration and adsorption, both responsible for promoting fouling and loss of membrane  
371 performance in terms of flux) [17].

372 The hydrophobic nature of PES in comparison with RC exacerbates the susceptibility  
373 of proteins to fouling as a result of membrane-foulant hydrophobic interactions [13]. Be-



374 cause of these interactions, both intrinsic and irreversible resistances are higher for the PES  
375 membrane in comparison to the RC. The latter membrane presented very small irreversible  
376 resistance and higher permeate fluxes. In the literature, it has been reported that mem-  
377 brane chemical composition, surface properties and hydrophilicity affect membrane fouling  
378 in different extents [45, 13, 17, 22]. Cellulose membranes with enhanced hydrophilicity are  
379 reported to show better mitigation of fouling caused by proteins and microorganisms when  
380 compared to polyvinylidene fluoride and PES membranes [45]. PES membranes were found  
381 to be less permeable to protein hydrolysates (in comparison to those made of polysulphone  
382 and other materials) because of their stronger hydrophobic nature [22].

383 In the present research, adsorption tests were conducted to provide further insights into  
384 the fouling mechanisms involved. Figure 6 shows the extent of adsorption of the PES mem-  
385 brane at pH 5 and 8. Neither water flux reduction (WRD) nor reduction of the mean pore  
386 diameter (RPD) occurred for the RC membrane treated with SBY hydrolysate at both pH  
387 values, which indicates that this material has a very low tendency for protein adsorption.  
388 The most important static hydrolysate adsorption was found for the UH030 membrane com-  
389 bined with feed pH value of 5, condition for which the retention of solids and peptides was  
390 maximum and the regeneration rates after rinsing and sanitisation were smaller. Similar  
391 results were reported in the literature: there was higher adsorption at a pH close to the  
392 isoelectric point (pI, around 5.0) of bovine serum albumin and  $\gamma$ -globulin on RC and PES  
393 membranes with a MWCO of 30 kDa was found [44].

394 Table 4 shows the evolution of roughness and contact angles after UF experiments. There

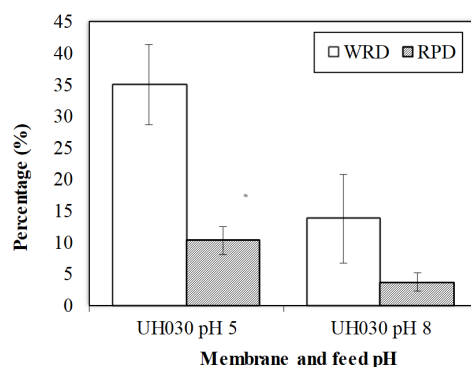

Figure 6: Extent of static adsorption on polyethersulfone (UH030) membranes of MWCO of 30 kDa at pH 5 and 8: water flux reduction (WRD) and reduction of the mean pore diameter (RPD).

UC030 membrane at pH 5 and 8 did not show any adsorption effects in the evaluated conditions ( $30 \text{ g}_{\text{protein}} \text{ L}^{-1}$  for 12 h at  $2 \text{ }^\circ\text{C}$ ).

395 was a decrease in roughness after 12 h static adsorption, for all conditions. When the  
396 hydrolysate solution was at pH 5, the decrease in  $RMS$  and  $R_a$  was even more important  
397 (38% for RC and 35% for PES). When UF was carried out, the roughness of the membranes  
398 did not change, possibly because of hydrodynamic effects of fluid velocity in the stirred  
399 dead-end cell, which removed weakly adsorbed proteins on the surface. Following the same  
400 trend, contact angle after 12 h static adsorption increased ( $>30\%$ ) for all membranes tested  
401 (Table 4), suggesting an accumulation of hydrophobic components on the surface of the  
402 membranes. The contact angles after sanitisation, compared to the corresponding pristine  
403 membranes, indicated an increased hydrophobicity in RC membranes, whereas no differences  
404 were found in PES membranes. At feed pH 8, a contact angle 24% smaller was found for  
405 the RC membranes. The same tendency is seen in the membrane-liquid interfacial free  
406 energy ( $-\Delta G_{ML}$ ) values, an indicator of membrane wettability that considers both surface  
407 hydrophobicity and roughness aspects of membranes, shown in Figure 7a. RC membranes  
408 have shown a smaller hydrophilicity after SBY UF and sanitisation in comparison to pristine

409 membranes or after adsorption. These data indicate that fouling caused more pronounced  
 410 changes in the roughness and surface hydrophilicity of RC membranes with MWCO of 30 kDa  
 411 compared to PES. More hydrophilic RC membranes may establish more strong interactions  
 412 (ionic and hydrogen bond) with foulants, resulting in the adhesion of molecules on the surface  
 413 of the RC membrane. Although this effect affects contact angle values (more responsive), it  
 414 did not significantly change the flux of permeate.

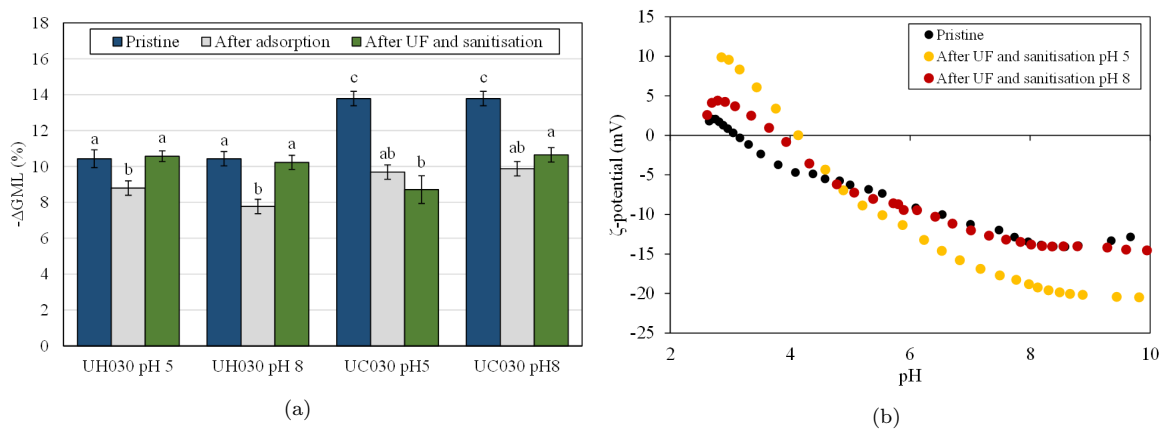

Figure 7: Membrane-liquid interfacial free energy ( $-\Delta G_{ML}$ ) of polyethersulfone (UH030) and regenerated cellulose (UC030) membranes with molecular weight cut-off of 30 kDa at pH 5 and 8 (a) and  $\zeta$ -potential of membrane ( $\zeta_m$ ) UH030 before and after hydrolysate and sanitisation (b).

415 In the context of membrane separation processes, the zeta potential is associated with  
 416 the prediction of how the suspension may interact with the surface of the membranes, and  
 417 with the actual possibility of formation of films or agglomerates [46]. Table 4 shows the  
 418 zeta potential of pristine membranes ( $\zeta_m$ ) used in the study. The RC membrane presented  
 419 a zeta potential value of higher magnitude. For a higher pH value (8), the surface charge  
 420 of the membranes increased, as did the zeta potential of the feed ( $\zeta_s$ ). At a pH 5, the zeta  
 421 potential of the feed was  $-11.1 \pm 0.7$  mV and at pH 8,  $-15.6 \pm 1.1$  mV. While the  $\zeta_s$  had a  
 422 modest increase in magnitude with increased pH in fractions,  $\zeta_m$  increased 2 and 4 fold in the

<i>Fractions</i>	<b>pH 5</b>	<b>pH 8</b>	<b>pH5</b>	<b>pH8</b>
	<b>PES</b>		<b>RC</b>	
<i><math>-\Delta G_{ML}</math> [%]</i>				
Pristine	$10 \pm 1^A$	$10 \pm 1^A$	$14 \pm 1^B$	$14 \pm 1^B$
<i><math>\zeta_m</math> [mV]</i>				
Pristine	$-4 \pm 1^A$	$-15 \pm 2^A$	$-18 \pm 1^B$	$-29 \pm 2^B$
<i>RMS [nm]</i>				
Pristine	$106 \pm 40^a$	$106 \pm 40^a$	$89 \pm 30^a$	$89 \pm 30^a$
After adsorption	$69 \pm 13^b$	$95 \pm 23^b$	$55 \pm 12^b$	$62 \pm 14^b$
After UF and sanitisation	$86 \pm 18^a$	$137 \pm 47^a$	$119 \pm 43^a$	$143 \pm 37^a$
After UF	nd	nd	nd	$129 \pm 13^a$
<i><math>R_a</math> [nm]</i>				
Pristine	$79 \pm 27^a$	$79 \pm 27^a$	$71 \pm 26^a$	$71 \pm 26^a$
After adsorption	$54 \pm 10^b$	$68 \pm 8^b$	$43 \pm 9^b$	$46 \pm 15^b$
After UF and sanitisation	$67 \pm 18^a$	$113 \pm 43^a$	$97 \pm 41^a$	$116 \pm 33^a$
After UF	nd	nd	nd	$104 \pm 16^a$
<i>Contact angle (<math>\theta</math>) [°]</i>				
Pristine	$63 \pm 4^b$	$63 \pm 4^b$	$21 \pm 1^b$	$21 \pm 1^c$
After adsorption	$77 \pm 4^a$	$85 \pm 2^a$	$69 \pm 5^a$	$68 \pm 4^a$
After UF and sanitisation	$61 \pm 2^b$	$64 \pm 3^b$	$78 \pm 7^c$	$59 \pm 5^b$
After UF	nd	nd	nd	$23 \pm 1^c$

Table 4: Surface characteristics of pristine membranes made of polyethersulfone (PES) and regenerated cellulose (RC) of 30 kDa molecular weight cut-off at pH 5 and 8: membrane-liquid interfacial free energy ( $-\Delta G_{ML}$ ), zeta-potential of the membranes surface  $\zeta_m$ , evolution of roughness (represented by  $RMS$  and  $R_a$ ), and contact angle ( $\theta$ ), at pH 5 and 8.

Different lowercase superscript letters in the same column indicate significant differences between pristine, after adsorption, after UF and sanitisation and, when applicable, after UF membranes (5% level); Different uppercase superscript letters in the same row indicate significant differences (5% level). Roughness values expressed by root mean square roughness ( $RMS$ ) and average surface roughness ( $R_a$ ). nd: not determined.

423 RC and PES membranes, respectively. The extent of interactions between SBY hydrolysate  
424 compounds and membrane surface seems to depend on feed pH. Figure 7b shows the zeta  
425 potential of the PES membrane surface before and after UF. After UF, at a feed pH 8,  
426 the charge of the membrane surface is very similar to that of the pristine membrane. The  
427 zeta potential of membranes after UF gets more negative at feed pH 5, which could indicate

428 the deposition of feed materials onto the surface. The same trend was observed for the RC  
429 membrane to a smaller extent: the RC membrane, after UF at pH 5 and sanitisation, showed  
430 an increase in zeta potential magnitude by 17% compared to 94% in PES. The membranes  
431 also became even more negative after static conditions in comparison to hydrodynamic UF  
432 (data not shown). This finding agrees with the data on roughness and contact angle data,  
433 which showed higher variations after static adsorption tests. Increased magnitude of the  
434 zeta potential of membranes following UF was reported to be due to increased fouling [35].  
435 Proteins adhere to the surface of membranes leading to the formation of gel layers, that  
436 increase the resistance to mass transport. Indeed, these results suggest that proteins were  
437 adsorbed on the surface of the membrane by a physical adsorption mechanism rather than  
438 by a chemical one. Electrostatic interactions were not as important because both  $\zeta_m$  and  
439  $\zeta_s$  were negative and had similar absolute values. Interactions between RNA molecules and  
440 membranes when feed pH was 8 were also small probably because of the negative charge of  
441 RNA at this pH value [41]. Previous studies using various pH values reported that protein  
442 binding capacity was strongly dependent on both the solution pH and membrane charge [14].  
443 Protein fouling is modulated by membrane-foulant and foulant-foulant interactions, which  
444 are changed by the pH of the media [47]. In fact, higher zeta potential values of fractions  
445 at pH 8 indicate higher repulsive electrostatic interactions of SBY components, which could  
446 minimise fouling.

447 Changes in the main functional groups on the surface of the membranes after UF and  
448 adsorption were investigated using FT-IR analysis. Figures 8a and 8b respectively show

449 the FT-IR spectra of pristine membranes, after adsorption and after UF experiments and  
450 sanitisation at pH 5 and 8, for both PES and RC membranes. Figure 8a shows that the  
451 band located between  $1200\text{ cm}^{-1}$  and  $1275\text{ cm}^{-1}$ , attributed to the vibration of the aromatic  
452 ether bond (C-O-C), is the most characteristic band of the polyethersulfone material. C=C  
453 stretching bands in aromatic rings are seen at  $1485\text{ cm}^{-1}$ , which are present in the PES  
454 structure but not in the RC membranes. The two bands at about  $2920$  and  $2870\text{ cm}^{-1}$ , that  
455 correspond to the vibration of C-H bonds in  $-\text{CH}_3$  and  $-\text{CH}_2$ , and that of  $1485\text{ cm}^{-1}$ , assigned  
456 to C-C bond stretching, are related to PES chemical structure as well as other carbon  
457 containing materials [48]. Other absorption bands of PES are superposed with protein and  
458 peptide functional groups [49].

459 Bands in the  $1000\text{-}1235\text{ cm}^{-1}$  region, corresponding to the C-O single bond stretching  
460 modes, are reported in cellulose membranes; they are usually the highest peak, which is  
461 characteristic of the saccharide structure [50, 49, 51, 52] (Figure 8b). The band at about  
462  $895\text{ cm}^{-1}$  indicates the existence of  $\beta$ -glycosidic groups, present in the cellulose structure  
463 [51, 52]. The bands seen in the  $3100\text{-}3500\text{ cm}^{-1}$  range, because of the O-H stretching of  
464 hydroxyl groups, only seen in cellulose [51]. The H-O-H bending, characterised by the  $1640$   
465  $\text{cm}^{-1}$  peak, is usually related to bound water [49, 51].

466 Membranes after UF and sanitisation or adsorption showed very similar FT-IR spectra  
467 to the one of the respective pristine membrane with slightly shifted or new absorption bands.  
468 Decreases in peak heights at characteristic membrane material bands are an indication of  
469 masking of the original membrane surface, suggesting the deposition of compounds [35]. An

470 important decrease in RC characteristic peaks in the 900-1200  $\text{cm}^{-1}$ , range indicated the  
471 deposition of organic compounds onto the surface of the membranes (bands around 900  $\text{cm}^{-1}$   
472 and 1053  $\text{cm}^{-1}$  are related to the C-O stretching and C-H vibration) [52]. Similarly, the ob-  
473 served decrease of the PES characteristic peaks intensity was attributed to the accumulation  
474 of molecules onto the surface of the membranes. The decrease of materials' characteristic  
475 peaks was slightly higher after adsorption than after UF and sanitisation. This result agrees  
476 with the regeneration rates and resistance calculations discussed in the previous sections,  
477 i.e., sanitisation was able to partially regenerate the membranes, decreasing fouling on the  
478 surface of the membranes.

479 The presence of protein/peptide molecules in the FT-IR spectra involve multiple peaks,  
480 such as the amide I band, due to C=O vibration, close to 1656  $\text{cm}^{-1}$ , and the amide II  
481 band, due to vibration of C-N and N-H, close to 1577 and 1535  $\text{cm}^{-1}$  [53, 54]. Peaks at the  
482 3300-3600  $\text{cm}^{-1}$  range, due to the  $\text{NH}_2$  stretch of the amine group, are overlapped by the  
483 O-H stretching vibration [51]. The peak around 3000  $\text{cm}^{-1}$  is also characteristic of amides.  
484 The characteristic bands of aromatic secondary amines and sulphones are found at 1320 and  
485 1150  $\text{cm}^{-1}$ . In the PES membrane, the presence of proteins as foulants can be observed in the  
486 higher peak in the 1535  $\text{cm}^{-1}$  region. The same result was found in the RC membrane, which  
487 showed an increase in the 1577  $\text{cm}^{-1}$  peak after treatments. To confirm these assumptions,  
488 one RC membrane was analysed directly after filtration of the SBY hydrolysate, and its  
489 spectra is shown in Figure 8b. For this membrane that was neither rinsed nor sanitised, the  
490 characteristic peaks of amides at 1656 and 1640  $\text{cm}^{-1}$  were clearly higher than the ones seen

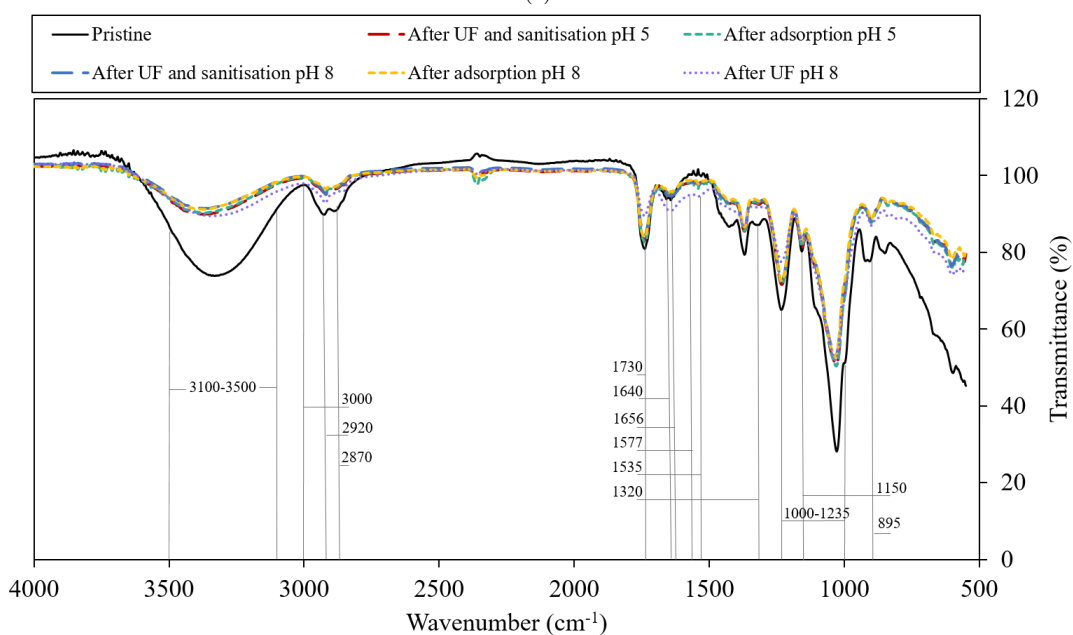
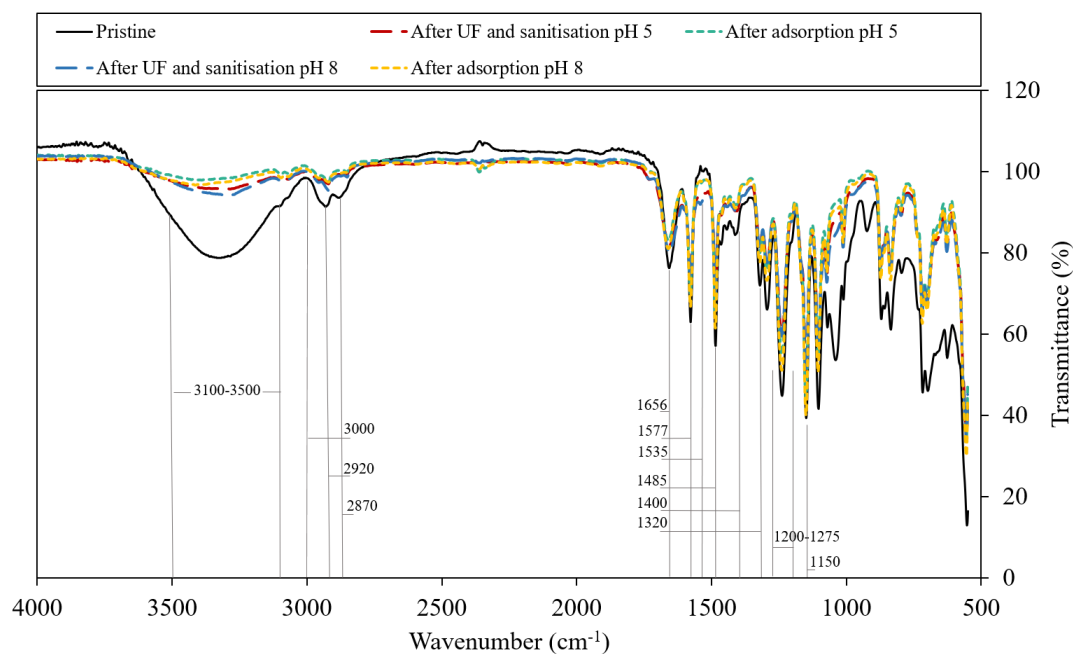

Figure 8: FT-IR spectra of pristine, after static adsorption, ultrafiltration and sanitisation in membranes with molecular weight cut-off of 30 kDa, made of polyethersulfone (a) and regenerated cellulose (b).



491 in pristine membranes.

492 The presence of other compounds, such as saccharides and polysaccharides, with char-  
493 acteristic peaks at around  $3400\text{ cm}^{-1}$  (O-H stretching) and  $1050\text{ cm}^{-1}$  (C-O stretching), is  
494 overlapped by peaks that correspond to membrane materials, as well as absorption bands at  
495 around  $1160\text{ cm}^{-1}$  (stretching of the C–O–bridge) and  $1024\text{ cm}^{-1}$  (skeletal vibration involving  
496 the C–O stretch), which are characteristic of the saccharide structure [51, 48]. Although the  
497 characteristic peak of the  $\beta$ -glycosidic groups was reduced, this band can also be present in  
498 the membranes after processing if  $\beta$ -glucans are deposited on the surface of the membranes  
499 [55].

500 Bands corresponding to RNA were also superposed with molecules containing phosphate  
501 groups, such as proteins and phospholipids, as well as of C-O stretching (bands around  $1240$   
502  $\text{cm}^{-1}$ ) [48]. The band at  $1120\text{ cm}^{-1}$  is also characteristic of RNA levels but is superposed  
503 with saccharides and cellulose bands ( $1000\text{-}1235\text{ cm}^{-1}$ ).

504 In a recent study, the intensification or enlargement of the  $1485\text{ cm}^{-1}$  peak was closely  
505 related to the accumulation of phenolic compounds on a membrane surface [56]. In the PES  
506 membrane, this peak was found to be less intense, suggesting the deposition of compounds  
507 on the membrane surface. Phenolic compounds could be present in the hydrolysate and  
508 could form complexes with peptides, which may have masked the peak.

509 In conclusion, FT-IR analysis has confirmed that several compounds (peptides, polysac-  
510 charides, RNA and phenolics) of the SBY are involved in the fouling of PES and RC mem-  
511 branes. The decrease of the characteristic peaks of the materials after adsorption are in

512 agreement with the results for membranes surfaces (roughness, contact angle) and the role  
513 of sanitisation in the partial regeneration of flux.

#### 514 **4. Conclusions**

515 This study investigated the fouling of spent yeast protein hydrolysate in polymeric mem-  
516 branes. Regenerated cellulose membranes and SBY hydrolysate at pH 8 showed low protein  
517 adsorption in a static condition and higher permeate fluxes, with close retention of solids  
518 and peptides compared to polyethersulfone membranes under the same conditions. Peptides  
519 and protein fractions, which are the main compounds in the SBY hydrolysate, seem to be  
520 primarily responsible for the formation of fouling on the surface of membranes. Our findings  
521 suggest that protein deposition occurs preferentially by physical adsorption rather than by  
522 electrostatic interactions. The findings presented in this advances on the comprehension of  
523 fouling in the treatment of yeast products, contributing to the development of processes for  
524 the production of fractions rich in peptides from spent brewer's yeast and other yeast-based  
525 wastes for the application in food and pharmaceutical industries.

#### 526 **Acknowledgements**

527 This work was supported by São Paulo Research Foundation (FAPESP) [grant numbers  
528 #2018/04067-6, #2018/15737-2, #2017/23670-2, #2016/18465-8, #2011/51707-1, #2011/06083-  
529 0, EMU #2009/54137-1, #2009/50593-2, #2009/50591-0, #2007/54520-4, #2004/08517-3],  
530 FAEPEX (UNICAMP) [#2422/16; 519.292] and the Brazilian National Council for Scien-  
531 tific and Technological Development (CNPq) [#306461-2017-0 and #303063/2018-1]. This

532 study was also financed in part by the Committee for the Development of Higher Education  
533 Personnel (CAPES) - Brazil. The authors are thankful to the Food Engineering Doctoral  
534 Program of UNICAMP (Brazil), GAIA Doctoral School and Institut Européen des Mem-  
535 branes (Université de Montpellier, France) and the Multi-user Laboratory (LAMULT) of the  
536 Institute of Physics Gleb Wataghin (IFGW) of UNICAMP for AFM and FT-IR analyses.  
537 Special thanks to Prozyn and Novozymes for the kind supply of enzymes; Pedro Moura  
538 (Haus Beer Brewery) for donating the spent brewer's yeast used in the experiments and to  
539 Matheus Henrique Monteiro de Oliveira for the artwork of the membrane system.

#### 540 Declaration of interests

541 None.

#### 542 References

- 543 [1] K. M. Lynch, E. J. Steffen, E. K. Arendt, Brewers' spent grain: a review with an emphasis on food and health,  
544 J. Inst. Brew. 122 (4) (2016) 553–568. doi:<https://doi.org/10.1002/jib.363>.
- 545 [2] S. I. Mussatto, Biotechnological potential of brewing industry by-products, in: P. Singh nee' Nigam, A. Pandey  
546 (Eds.), Biotechnology for Agro-Industrial Residues Utilisation: Utilisation of Agro-Residues, Springer Nether-  
547 lands, Dordrecht, 2009, pp. 313–326. doi:[https://doi.org/10.1007/978-1-4020-9942-7\\_16](https://doi.org/10.1007/978-1-4020-9942-7_16).
- 548 [3] M. Mirzaei, S. Mirdamadi, M. R. Ehsani, M. Aminlari, E. Hosseini, Purification and identification of antioxidant  
549 and ACE-inhibitory peptide from *Saccharomyces cerevisiae* protein hydrolysate, J. Funct. Foods 19 (2015) 259  
550 – 268. doi:<https://doi.org/10.1016/j.jff.2015.09.031>.
- 551 [4] G. V. Marson, R. J. S. de Castro, M. T. da Costa Machado, F. da Silva Zandonadi, H. D. de Freitas Queiroz Bar-  
552 ros, M. R. M. Júnior, A. Sussulini, M. D. Hubinger, Proteolytic enzymes positively modulated the physico-  
553 chemical and antioxidant properties of spent yeast protein hydrolysates, Process Biochem. 91 (2020) 34 – 45.  
554 doi:<https://doi.org/10.1016/j.procbio.2019.11.030>.
- 555 [5] A. Nazir, K. Khan, A. Maan, R. Zia, L. Giorno, K. Schroën, Membrane separation technology for the recovery  
556 of nutraceuticals from food industrial streams, Trends Food Sci. & Tech. 86 (2019) 426 – 438. doi:<https://doi.org/10.1016/j.tifs.2019.02.049>.

- 558 [6] M. Amorim, J. O. Pereira, D. Gomes, C. D. Pereira, H. Pinheiro, M. Pintado, Nutritional ingredients from  
559 spent brewer's yeast obtained by hydrolysis and selective membrane filtration integrated in a pilot process, J.  
560 Food Eng. 185 (2016) 42 – 47. doi:<https://doi.org/10.1016/j.jfoodeng.2016.03.032>.
- 561 [7] S. Phongthai, S. D'Amico, R. Schoenlechner, W. Homthawornchoo, S. Rawdkuen, Fractionation and antioxidant  
562 properties of rice bran protein hydrolysates stimulated by *in vitro* gastrointestinal digestion, Food Chem. 240  
563 (2018) 156 – 164. doi:<https://doi.org/10.1016/j.foodchem.2017.07.080>.
- 564 [8] J. Roslan, S. M. M. Kamal, K. F. M. Yunus, N. Abdullah, Assessment on multilayer ultrafiltration membrane for  
565 fractionation of tilapia by-product protein hydrolysate with angiotensin I-converting enzyme (ACE) inhibitory  
566 activity, Sep. Purif. Technol. 173 (2017) 250 – 257. doi:<https://doi.org/10.1016/j.seppur.2016.09.038>.
- 567 [9] Y. Pouliot, M. C. Wijers, S. F. Gauthier, L. Nadeau, Fractionation of whey protein hydrolysates using charged  
568 UF/NF membranes, J. Membr. Sci. 158 (1) (1999) 105 – 114. doi:[https://doi.org/10.1016/S0376-7388\(99\)](https://doi.org/10.1016/S0376-7388(99)00006-X)  
569 00006-X.
- 570 [10] C. Emin, E. Kurnia, I. Katalia, M. Ulbricht, Polyarylsulfone-based blend ultrafiltration membranes with  
571 combined size and charge selectivity for protein separation, Sep. Purif. Technol. 193 (2018) 127 – 138.  
572 doi:<https://doi.org/10.1016/j.seppur.2017.11.008>.
- 573 [11] R. Ghosh, Z. F. Cui, Protein purification by ultrafiltration with pre-treated membrane, J. Membr. Sci. 167 (1)  
574 (2000) 47 – 53. doi:[https://doi.org/10.1016/S0376-7388\(99\)00275-6](https://doi.org/10.1016/S0376-7388(99)00275-6).
- 575 [12] J. Roslan, S. M. M. Kamal, K. F. M. Yunus, N. Abdullah, Evaluation on performance of dead-end ultrafiltration  
576 membrane in fractionating tilapia by-product protein hydrolysate, Sep. Purif. Technol. 195 (2018) 21 – 29.  
577 doi:<https://doi.org/10.1016/j.seppur.2017.11.020>.
- 578 [13] Z. Xu, J. Liao, H. Tang, N. Li, Antifouling polysulfone ultrafiltration membranes with pendent sulfonamide  
579 groups, J. Membr. Sci. 548 (2018) 481 – 489. doi:<https://doi.org/10.1016/j.memsci.2017.11.064>.
- 580 [14] A. Saxena, B. P. Tripathi, M. Kumar, V. K. Shahi, Membrane-based techniques for the separation and  
581 purification of proteins: An overview, Adv. Colloid Interface Sci. 145 (1) (2009) 1 – 22. doi:<https://doi.org/10.1016/j.cis.2008.07.004>.
- 582 //doi.org/10.1016/j.cis.2008.07.004.
- 583 [15] A. Halász, R. Lásztity, Chemical composition and biochemistry of yeast biomass, in: A. Halász, R. Lásztity  
584 (Eds.), Use of yeast biomass in food production, CRC Press, Boca Raton, USA, 1991, pp. 23–41.
- 585 [16] K. Huang, J.-Y. Gao, S. Ma, J.-J. Lu, Optimising separation process of protein and polysaccharide from spent  
586 brewer's yeast by ultrafiltration, Int. J. Food Sci. & Technol. 47 (6) (2012) 1259–1264. doi:<https://doi.org/10.1111/j.1365-2621.2012.02967.x>.
- 587 10.1111/j.1365-2621.2012.02967.x.
- 588 [17] B. P. Tripathi, P. Das, F. Simon, M. Stamm, Ultralow fouling membranes by surface modification with functional  
589 polydopamine, Eur. Polym. J. 99 (2018) 80 – 89. doi:<https://doi.org/10.1016/j.eurpolymj.2017.12.006>.
- 590 [18] Y. Pouliot, S. F. Gauthier, P. E. Groleau, Membrane-based fractionation and purification strategies for bioactive  
591 peptides, in: Y. Mine, F. Shahidi (Eds.), Nutraceutical Proteins and Peptides in Health and Disease, CRC Press,  
592 Boca Raton, USA, 2005, pp. 639–658.

- 593 [19] X. Shi, G. Tal, N. P. Hankins, V. Gitis, Fouling and cleaning of ultrafiltration membranes: A review, *J. Water*  
594 *Process Eng.* 1 (Supplement C) (2014) 121 – 138. doi:<https://doi.org/10.1016/j.jwpe.2014.04.003>.
- 595 [20] A. C. Habert, C. P. Borges, R. Nobrega, Aspectos gerais dos processos com membranas, in: A. C. Habert, C. P.  
596 Borges, R. Nobrega (Eds.), *Processos de Separação por Membranas*, 1st Edition, E-papers, Rio de Janeiro,  
597 Brasil, 2006, pp. 9 – 24.
- 598 [21] R. Das, C. Bhattacharjee, S. Ghosh, Effects of operating parameters and nature of fouling behavior in ultra-  
599 filtration of sesame protein hydrolysate, *Desalin.* 237 (1) (2009) 268 – 276. doi:[https://doi.org/10.1016/j.](https://doi.org/10.1016/j.desal.2008.01.020)  
600 [desal.2008.01.020](https://doi.org/10.1016/j.desal.2008.01.020).
- 601 [22] A. Chabeaud, L. Vandanjon, P. Bourseau, P. Jaouen, F. Guérard, Fractionation by ultrafiltration of a saithe  
602 protein hydrolysate (*Pollachius virens*): Effect of material and molecular weight cut-off on the membrane  
603 performances, *J. Food Eng.* 91 (3) (2009) 408 – 414. doi:[https://doi.org/10.1016/j.](https://doi.org/10.1016/j.jfoodeng.2008.09.018)  
604 [jfoodeng.2008.09.018](https://doi.org/10.1016/j.jfoodeng.2008.09.018).
- 605 [23] E. Matthiasson, The role of macromolecular adsorption in fouling of ultrafiltration membranes, *J. Membr. Sci.*  
606 16 (1983) 23 – 36. doi:[https://doi.org/10.1016/S0376-7388\(00\)81297-1](https://doi.org/10.1016/S0376-7388(00)81297-1).
- 607 [24] L. J. Zeman, Adsorption effects in rejection of macromolecules by ultrafiltration membranes, *J. Membr. Sci.*  
608 15 (3) (1983) 213 – 230. doi:[https://doi.org/10.1016/S0376-7388\(00\)82300-5](https://doi.org/10.1016/S0376-7388(00)82300-5).
- 609 [25] C. Taddei, J. A. Howell, On the effect of membrane conditioning in cell harvesting using microfiltration, *Biotech-*  
610 *nol. Tech.* 3 (1989) 155 – 160. doi:<https://doi.org/10.1007/BF01875612>.
- 611 [26] A. Fane, C. Fell, A. Waters, Ultrafiltration of protein solutions through partially permeable membranes - the  
612 effect of adsorption and solution environment, *J. Membr. Sci.* 16 (1983) 211 – 224. doi:[https://doi.org/10.](https://doi.org/10.1016/S0376-7388(00)81311-3)  
613 [1016/S0376-7388\(00\)81311-3](https://doi.org/10.1016/S0376-7388(00)81311-3).
- 614 [27] E. Soufi-Kechaou, M. Derouiniot-Chaplin, R. B. Amar, P. Jaouen, J.-P. Berge, Recovery of valuable marine  
615 compounds from cuttlefish by-product hydrolysates: Combination of enzyme bioreactor and membrane tech-  
616 nologies: Fractionation of cuttlefish protein hydrolysates by ultrafiltration: Impact on peptidic populations, *C.*  
617 *R. Chim.* 20 (9) (2017) 975 – 985. doi:[https://doi.org/10.1016/j.](https://doi.org/10.1016/j.crci.2016.03.018)  
618 [crci.2016.03.018](https://doi.org/10.1016/j.crci.2016.03.018).
- 619 [28] AOAC, *Official Methods of Analysis of the Association of Official Analytical Chemists*, 18th Edition, Gaithers-  
620 burg, MD, USA, 2006.
- 621 [29] A. Aitken, M. P. Learmonth, Protein determination by UV absorption, in: J. M. Walker (Ed.), *The Protein Pro-*  
622 *cedures Handbook*, Humana Press, Totowa, NJ, 2002, pp. 3–6. doi:[https://doi.org/10.1385/1-59259-169-8:](https://doi.org/10.1385/1-59259-169-8:3)  
623 [3](https://doi.org/10.1385/1-59259-169-8:3).
- 624 [30] J. M. Webb, H. L. Levy, A sensitive method for the determination of deoxyribonucleic acid in tissues and  
625 microorganisms, *J. Biol. Chem.* 213 (1955) 107 – 117.
- 626 [31] J. M. Webb, Studies on the determination of total nucleic acids by ultraviolet absorption methods, *J. Biol.*  
627 *Chem.* 230 (1958) 1023 – 1030.
- 628 [32] P. Sceni, G. G. Palazolo, M. del Carmen Vasallo, M. C. Puppo, M. A. Otero, J. R. Wagner, Thermal and surface  
629 behavior of yeast protein fractions from *Saccharomyces cerevisiae*, *LWT - Food Sci. Technol.* 42 (6) (2009) 1098

- 628 – 1106. doi:<https://doi.org/10.1016/j.lwt.2009.02.010>.
- 629 [33] G. Hurwitz, G. R. Guillen, E. M. Hoek, Probing polyamide membrane surface charge, zeta potential, wettability,  
630 and hydrophilicity with contact angle measurements, *J. Membr. Sci.* 349 (1) (2010) 349 – 357. doi:<https://doi.org/10.1016/j.memsci.2009.11.063>.
- 632 [34] R. N. Wenzel, Surface roughness and contact angle, *J. Phys. Colloid Chem.* 53 (9) (1949) 1466–1467. doi:  
633 <https://doi.org/10.1021/j150474a015>.
- 634 [35] A. Weis, M. R. Bird, M. Nyström, C. Wright, The influence of morphology, hydrophobicity and charge upon the  
635 long-term performance of ultrafiltration membranes fouled with spent sulphite liquor, *Desalin.* 175 (1) (2005)  
636 73 – 85. doi:<https://doi.org/10.1016/j.desal.2004.09.024>.
- 637 [36] A. K. Ghosh, B.-H. Jeong, X. Huang, E. M. Hoek, Impacts of reaction and curing conditions on polyamide  
638 composite reverse osmosis membrane properties, *J. Membr. Sci.* 311 (1) (2008) 34 – 45. doi:<https://doi.org/10.1016/j.memsci.2007.11.038>.
- 640 [37] G. V. Lowry, R. J. Hill, S. Harper, A. F. Rawle, C. O. Hendren, F. Klaessig, U. Nobbmann, P. Sayre, J. Rumble,  
641 Guidance to improve the scientific value of zeta-potential measurements in nanoehs, *Environ. Sci. Nano* 3 (2016)  
642 953–965. doi:<https://doi.org/10.1039/c6en00136j>.
- 643 [38] S. Amrhein, K. C. Bauer, L. Galm, J. Hubbuch, Non-invasive high throughput approach for protein hydropho-  
644 bicity determination based on surface tension, *Biotechnol. Bioeng.* 112 (12) (2015) 2485–2494. doi:<https://doi.org/10.1002/bit.25677>.
- 646 [39] S. Saidi, A. Deratani, R. B. Amar, M.-P. Belleville, Fractionation of a tuna dark muscle hydrolysate by a two-  
647 step membrane process, *Sep. Purif. Technol.* 108 (2013) 28 – 36. doi:<https://doi.org/10.1016/j.seppur.2013.01.048>.
- 649 [40] A. Marshall, P. Munro, G. Trägårdh, The effect of protein fouling in microfiltration and ultrafiltration on  
650 permeate flux, protein retention and selectivity: A literature review, *Desalin.* 91 (1) (1993) 65 – 108. doi:  
651 [https://doi.org/10.1016/0011-9164\(93\)80047-Q](https://doi.org/10.1016/0011-9164(93)80047-Q).
- 652 [41] I. Manzano, A. L. Zydney, Quantitative study of RNA transmission through ultrafiltration membranes, *J.*  
653 *Membr. Sci.* 544 (2017) 272 – 277. doi:<https://doi.org/10.1016/j.memsci.2017.09.042>.
- 654 [42] L. A. Božič, R. Podgornik, pH dependence of charge multipole moments in proteins, *Biophys J.* 113 (2017) 1454  
655 – 1465. doi:<https://doi.org/10.1016/j.bpj.2017.08.017>.
- 656 [43] J. F. Zayas, *Solubility of Proteins*, Springer Berlin Heidelberg, Berlin, Heidelberg, 1997. doi:10.1007/  
657 978-3-642-59116-7\_2.
- 658 [44] G. E. Kassalainen, S. K. R. Williams, Assessing protein-ultrafiltration membrane interactions using flow field-  
659 flow fractionation, in: S. K. R. Williams, K. D. Caldwell (Eds.), *Field-Flow Fractionation in Biopolymer Analysis*,  
660 Springer - Verlag / Wien, Vienna, 2012, pp. 23–36. doi:<https://doi.org/10.1007/978-3-7091-0154-4>.
- 661 [45] S. Jeon, S. Rajabzadeh, R. Okamura, T. Ishigami, S. Hasegawa, N. Kato, H. Matsuyama, The effect of membrane  
662 material and surface pore size on the fouling properties of submerged membranes, *Water* 8 (12). doi:<https://doi.org/10.1016/j.watres.2016.11.010>.

663 //doi.org/10.3390/w8120602.

664 [46] C. Cano-Sarmiento, D. Téllez-Medina, R. Viveros-Contreras, M. Cornejo-Mazón, C. Y. Figueroa-Hernández,  
665 E. García-Armenta, L. Alamilla-Beltrán, H. S. García, G. F. Gutiérrez-López, Zeta potential of food matrices,  
666 Food Eng. Rev. 10 (2018) 113 – 138. doi:<https://doi.org/10.1007/s12393-018-9176-z>.

667 [47] J. Lee, S. Jeong, Y. Ye, V. Chen, S. Vigneswaran, T. Leiknes, Z. Liu, Protein fouling in carbon nanotubes  
668 enhanced ultrafiltration membrane: Fouling mechanism as a function of pH and ionic strength, Sep. Purif.  
669 Technol. 176 (2017) 323 – 334. doi:<https://doi.org/10.1016/j.seppur.2016.10.061>.

670 [48] W. Li, G. Ling, F. Lei, N. Li, W. Peng, K. Li, H. Lu, F. Hang, Y. Zhang, Ceramic membrane fouling and  
671 cleaning during ultrafiltration of limed sugarcane juice, Sep. Purif. Technol. 190 (2018) 9 – 24. doi:<https://doi.org/10.1016/j.seppur.2017.08.046>.

672 [49] N. H. Abd-Razak, Y. J. Chew, M. R. Bird, Membrane fouling during the fractionation of phytosterols isolated  
673 from orange juice, Food Bioprod. Process. 113 (2019) 10 – 21. doi:[https://doi.org/10.1016/j.fbp.2018.09.](https://doi.org/10.1016/j.fbp.2018.09.005)  
674 005.

675 [50] C. R. Dias, M. J. Rosa, M. N. de Pinho, Structure of water in asymmetric cellulose ester membranes - an ATR-  
676 FTIR study, J. Membr. Sci. 138 (2) (1998) 259 – 267. doi:[https://doi.org/10.1016/S0376-7388\(97\)00226-3](https://doi.org/10.1016/S0376-7388(97)00226-3).

677 [51] S. S. Madaeni, F. Heidary, Improving separation capability of regenerated cellulose ultrafiltration membrane by  
678 surface modification, Appl. Surf. Sci. 257 (11) (2011) 4870 – 4876. doi:[https://doi.org/10.1016/j.apsusc.](https://doi.org/10.1016/j.apsusc.2010.12.128)  
679 2010.12.128.

680 [52] R. Ravindran, S. Jaiswal, N. Abu-Ghannam, A. K. Jaiswal, A comparative analysis of pretreatment strategies  
681 on the properties and hydrolysis of brewers' spent grain, Bioresour. Technol. 248 (2018) 272 – 279. doi:<https://doi.org/10.1016/j.biortech.2017.06.039>.

682 [53] M. Luján-Facundo, J. Mendoza-Roca, B. Cuartas-Urbe, S. Álvarez-Blanco, Evaluation of cleaning efficiency of  
683 ultrafiltration membranes fouled by BSA using FTIR-ATR as a tool, J. Food Eng. 163 (2015) 1 – 8. doi:<https://doi.org/10.1016/j.jfoodeng.2015.04.015>.

684 [54] M. Chen, H. Ji, Z. Zhang, X. Zeng, W. Su, S. Liu, A novel calcium-chelating peptide purified from *Auvis*  
685 *thazard* protein hydrolysate and its binding properties with calcium, J. Funct. Foods 60 (2019) 103447. doi:  
686 <https://doi.org/10.1016/j.jff.2019.103447>.

687 [55] V. Zechner-Krpan, V. Petravić-Tominac, I. Gospodarić, L. Sajli, S. Daković, J. Filipović-Grčić, Characterization  
688 of  $\beta$ -glucans isolated from brewer's yeast and dried by different methods, Food Technol. Biotechnol. 48 (2) (2010)  
689 189–197.

690 [56] M. Bdiri, V. Perreault, S. Mikhaylin, C. Larchet, F. Hellal, L. Bazinet, L. Dammak, Identification of phenolic  
691 compounds and their fouling mechanisms in ion-exchange membranes used at an industrial scale for wine tartaric  
692 stabilization by electro dialysis, Sep. Purif. Technol. 233 (2020) 115995. doi:[https://doi.org/10.1016/j.](https://doi.org/10.1016/j.seppur.2019.115995)  
693 seppur.2019.115995.

## Chapter 8

# Article 4: Peptides fractionation in ceramic membranes

**Antioxidant, anti-diabetic and anti-Alzheimer peptides from spent brewer's yeast protein hydrolysate fractionated by ultrafiltration**

Gabriela Vollet Marson<sup>a,b</sup>, Stella Lacour<sup>a</sup>, Miriam Dupas Hubinger<sup>b</sup> Marie-Pierre Belleville<sup>a</sup>

<sup>a</sup>Institut Européen des Membranes (IEM), Université de Montpellier, CNRS, ENSCM, UM, CC 047, 2, Place Eugène Bataillon, 34095, Montpellier, Occitanie, France.

<sup>b</sup>Department of Food Engineering (DEA), School of Food Engineering (FEA), University of Campinas (UNICAMP), R. Monteiro Lobato, 80, 13083-862, Campinas, São Paulo, Brazil.

Results of this chapter were submitted in the Elsevier's Journal "Separation & Purification Technology", 2020.

ISSN: 1383-5866



## Antioxidant, anti-diabetic and anti-Alzheimer peptides from spent brewer's yeast protein hydrolysate fractionated by ultrafiltration

Gabriela Vollet Marson<sup>a,b,1,\*</sup>, Stella Lacour<sup>a</sup>, Miriam Dupas Hubinger<sup>b</sup>, Marie-Pierre Belleville<sup>a</sup>

<sup>a</sup>*Institut Européen des Membranes, IEM – UMR 5635, ENSCM, CNRS, Université de Montpellier, CC 047, Place Bataillon, 34095 Montpellier cedex 5, France.*

<sup>b</sup>*Laboratory of Process Engineering, Department of Food Engineering, School of Food Engineering, UNICAMP, Rua Monteiro Lobato, 80, 13083-862, Campinas, SP, Brazil*

---

### Abstract

Antioxidant, anti-diabetic and anti-Alzheimer potential of spent brewer's yeast peptides fractionated by membrane separation technology was evaluated in this work. An enzymatic protein hydrolysate from spent yeasts (*Saccharomyces cerevisiae*) was fractionated using ultrafiltration in ceramic membranes in the molecular weight cut-off (MWCO) range of 50 to 1 kg mol<sup>-1</sup>. The separation of protein fractions from ribonucleic acids (RNA) and total sugars was evaluated in each fractionation step. For the fractionation sequence 15-8-1 kg mol<sup>-1</sup> MWCO maximum protein purity in relation to total sugars and RNA was obtained in the retentate after 15 and 8 kg mol<sup>-1</sup> MWCO membranes, with about 34 and 17 g of proteins per g of total sugars and RNA, respectively. This fraction also showed the highest scavenging activity against the ABTS radical (5770 μmol TROLOX equivalents (TE) per g of dry weight (d.w.)) and ferric reducing activity (269 μmol<sub>TE</sub> g<sup>-1</sup> d.w.). All fractions obtained from the 15-8-1 kg mol<sup>-1</sup> MWCO fractionation sequence showed inhibitory activity against α-amylase (IC<sub>50</sub> ranging from 0.018-0.058 mg<sub>protein</sub> mL<sup>-1</sup>), with highest inhibitory activity observed for smaller molecular weight peptides. Some fractions also inhibited α-glucosidase (7-14%) at concentrations around 0.4 mg<sub>protein</sub> mL<sup>-1</sup>. SBY peptides were also able to inhibit acetylcholinesterase enzyme, involved in the onset of Alzheimer's disease, up to 36% at concentrations of protein of 4.8 mg mL<sup>-1</sup>. Ultrafiltration (UF) fractionation was able to separate peptides from SBY while separating them from other compounds and enhancing their bio-activities. This was the first report of the potential multi-function peptides from SBY against type-II diabetes, oxidant stress and Alzheimer's disease.

**Keywords:** Bioactive peptides, Peptide fractionation, *Saccharomyces cerevisiae*, Acetylcholinesterase inhibition, Alpha-glucosidase inhibition, Yeast ribonucleic acids separation.

---

## 1. Introduction

Type II diabetes is a chronic disease associated with alterations in pancreatic insulin secretion and insulin action, causing hyperglycemia. One strategy to manage hyperglycemia is the inhibition of enzymes involved in the digestion of carbohydrates [1]. In humans, carbohydrate digestion is commanded by pancreatic  $\alpha$ -amylase and intestinal  $\alpha$ -glucosidase. Molecules capable of inhibiting these enzymes to some extent can slow down the release of monosaccharides from ingested complex carbohydrates [2, 3]. If a hyperglycemic condition persists, accompanied by moderate inflammation, oxidation by reactive species and hypertension - all part of the metabolic syndrome - serious effects may be seen in other important body organs, such as liver, heart and brain. These effects are associated with an increased risk of the development of several diseases including cancer, cardiovascular problems and neurodegenerative disorders, such as Alzheimer [1, 4].

Alzheimer is a neurodegenerative disease characterised by memory dysfunction. One of the main biochemical dysfunctions related to the development of Alzheimer's disease is the reduction of acetylcholine levels in the brain. Acetylcholinesterase (AChE) is a protease involved in the synaptic transmission through the hydrolysis of a neurotransmitter, acetylcholine [5]. Restoration of acetylcholine levels in the brain is one of the strategies to treat Alzheimer's disease, by the use of specific AChE inhibitors [1].

Side effects of currently used anti-diabetic and anti-Alzheimer drugs and their high cost have increased the interest in the research of new natural inhibitors as nutraceuticals for these purposes [6]. Acarbose and metformin are widely employed inhibitors of both  $\alpha$ -amylase and  $\alpha$ -glucosidase, but can cause flatulence and diarrhea [7]. Common inhibitors of AChE (galantamine, donepezil, tacrine and rivastigmine) are also re-

---

*Abbreviations:* SBY: spent brewer's yeast; UF: ultrafiltration; MW: molecular weight; RNA: ribonucleic acids; MWCO: molecular weight cut-off; AChE: acetylcholinesterase; T50, T15, T8 and T1: ceramic membranes of 50, 15, 8 and 1 kg mol<sup>-1</sup> molecular weight cut-off, respectively; SEC: size-exclusion chromatography; FRAP: ferric reducing antioxidant power; ABTS: radical scavenging activity against the organic radical 2,2'-azinobis(3-ethylbenzothiazoline-6-sulphonic acid) diammonium salt; TE: Trolox equivalents; d.w.: dry weight; VCF: volumetric concentration factor; IC<sub>50</sub>: concentration necessary to cause a 50% inhibition.

\*Corresponding author

*Email address:* gabrielavollet@gmail.com (Gabriela Vollet Marson)

<sup>1</sup>Present Address: Institut Européen des Membranes, IEM – UMR 5635, ENSCM, CNRS, Université de Montpellier, CC 047, Place Bataillon, 34095 Montpellier cedex 5, France.

20 ported to have gastrointestinal side effects (such as nausea, vomiting and loss of appetite) and hepatotoxicity  
21 [5, 8].

22 Plant extracts and food protein hydrolysates with  $\alpha$ -amylase,  $\alpha$ -glucosidase, AChE inhibitory and an-  
23 tioxidant activities have emerged as an innovative strategy for the prevention and management of metabolic  
24 syndrome-related diseases [6–9]. The development of peptide inhibitors with multiple bio-activities would  
25 be of great interest as a strategy to fight the metabolic syndrome [10, 11].

26 Spent brewer’s yeast is a widely available, underutilised and protein-rich by-product from the brew-  
27 ing industry with great potential for the production of multi-functional bioactive peptides. Recent reports  
28 have found antioxidant and anti-hypertensive peptides from SBY protein hydrolysates [12–14]. SBY pro-  
29 tein hydrolysate is a complex matrix that contains high amounts of proteins and other components such  
30 as polysaccharides, ribonucleic acids (RNA), vitamins and minerals [12, 15]. The separation of protein  
31 fractions and peptides of interest from other components of a protein hydrolysate is a necessary step to  
32 achieve a minimum purity level that allows its application as a nutraceutical [10]. Membrane separation  
33 technologies have been employed successfully for this purpose, allowing the recovery of enriched bioactive  
34 fractions following fractionation [16]. Recent works report the use of ultrafiltration (UF) to recover bioactive  
35 peptides from several matrices such as milk [17, 18], corn [19], flaxseed [20], soybeans [21], algae [22]. Only  
36 a few reports are available on the fractionation of antioxidant and anti-hypertensive peptides from SBY  
37 protein hydrolysates by UF [12, 13, 15], with limited information on the separation of peptides from other  
38 components such as RNA and polysaccharides in a cascade fractionation [15, 23].

39 In this context, the objective of this work was to establish anti-diabetic and anti-Alzheimer potential  
40 of peptide fractions from spent brewer’s yeast protein hydrolysate obtained by a multi-stage UF process.  
41 Firstly, the fractionation of SBY protein hydrolysate was studied using two different UF sequences involving  
42 ceramic membranes. Purity, molecular weight distribution and antioxidant activity of obtained fractions

43 were evaluated. For the first time, the inhibitory ability of SBY fractions against  $\alpha$ -amylase,  $\alpha$ -glucosidase  
44 and AChE enzymes was evidenced.

## 45 2. Material and Methods

### 46 2.1. Materials

#### 47 2.1.1. Reagents

48 Azocasein (A2765), 2,2'-azinobis(3-ethylbenzothiazoline-6-sulphonic acid) diammonium salt, acetylcholine  
49 iodide, Folin reagent 2 N, p-nitrophenyl- $\alpha$ -D-glucopyranoside, 5-5'-dithiobis(2-nitrobenzoic acid), bovine  
50 serum albumin, insulin, substance P 1-7, leupeptin, triglycine, glycine, RNA from *S. cerevisiae* yeast, soluble  
51 starch, acarbose (certified reference material, PHR1253), galantamine hydrobromide from *Lycoris* sp. and  
52 D-(+)-glucose were purchased from Sigma-Aldrich (Steinheim, Germany). Enzymes  $\alpha$ -amylase from *Bacil-*  
53 *lus licheniformis* (A4551),  $\alpha$ -glucosidase from *Saccharomyces cerevisiae* (G5003) and acetylcholinesterase  
54 (AChE) from *Electrophorus electricus* (electric eel) (C3389) were purchased from Sigma-Aldrich (Steinheim,  
55 Germany). All other reagents were of analytical grade.

#### 56 2.1.2. Spent brewer's yeast (SBY) hydrolysate

57 SBY from Ale beer production (*Saccharomyces cerevisiae*, SafAle™ HA-18, Fermentis, France) was col-  
58 lected after 11 days of beer maturation without repitching at Brasserie La Singulière (Sète, France). The  
59 collected material had about 10% dry weight and a pH value at 20 °C of  $4.8 \pm 0.1$ . The production of  
60 the protein hydrolysate followed the procedure developed by Marson *et al.* (2020) [12], with modifications.  
61 Temperature of the heat treatment prior to hydrolysis was adjusted to  $85 \pm 2$  °C for 30 min, to ensure  
62 the inactivation of remaining glucoamylase used during brewing. A total amount of 2000 U of protease  
63  $g_{\text{protein}}^{-1}$  divided in an equal proportion of enzymes Brauzyn® (Prozyn, Brazil), Protamex™ and Alcalase™  
64 (Novozymes, Denmark) was used. Proteolytic activity of enzymes was determined using azocasein as sub-  
65 strate [24, 25] and were, 11,700; 83,300 and 256,500 U mL<sup>-1</sup>, respectively. SBY protein hydrolysate was

66 produced in a 7 L capacity jacketed glass reactor connected to a recirculating water bath (Haake S30,  
 67 Thermo Fisher Scientific, USA) and an automatic titrator (TitroLine Alpha plus, Schott Instruments, Ger-  
 68 many). Mechanical agitation at 1000 rpm was needed to ensure a well-mixed system. Enzymes inactivation  
 69 was done at  $95 \pm 1$  °C for 20 min. Reaction mixture was centrifuged at  $10,000 \times g$  for 15 min at 4 °C (3-  
 70 16KL Sigma, Germany) separating the protein hydrolysate from yeast cell debris. The degree of hydrolysis  
 71 was determined as previously described [26]. A protein hydrolysate with a degree of hydrolysis of 7.5% was  
 72 obtained.

### 73 2.1.3. Ultrafiltration membranes

74 Commercial flat ceramic membrane disks of 90 mm of diameter (Inside Disram™, Tami Industries, France)  
 75 of 50, 15, 8 and 1 kg mol<sup>-1</sup> molecular weight cut-off (MWCO) were used. Membranes support was made  
 76 of titanium dioxide and membranes were made of both titanium and zirconium dioxide. Membranes were  
 77 autoclavable supporting transmembrane pressures up to 4 bar. Other membrane characteristics are presented  
 78 in Table 1.

Table 1: Characteristics of flat ceramic membranes used for the fractionation of spent brewer's yeast protein hydrolysate.

Membrane	T50	T15	T8	T1
MWCO <sup>a</sup> (kg mol <sup>-1</sup> )	50	15	8	1
pH range <sup>a</sup>	0-14	0-14	0-14	2-14
Initial water permeation <sup>b</sup> (L m <sup>-2</sup> h <sup>-1</sup> bar <sup>-1</sup> )	242 ± 2	69 ± 3	46 ± 8	88 ± 6

MWCO: molecular weight cut-off. <sup>a</sup>Manufacturer data. <sup>b</sup>Initial water permeation determined under the conditions evaluated in this work (0.5-2.0 ± 0.2 bar of transmembrane pressure, 20 °C, using deionised water) in a pseudo-tangential module for ceramic disk membranes.

## 79 2.2. Fractionation of proteins fractions and peptides

### 80 2.2.1. Experimental procedure

81 Two fractionation sequences were carried out using UF membranes, as presented in Figure 1. UF was  
 82 performed in a stainless steel pseudo tangential membrane system (Spiralab®<sup>®</sup>, Tami Industries, France) of  
 83 52.7 cm<sup>2</sup> of effective permeation area at controlled temperature, using a recirculating water bath. Pristine

84 membranes were conditioned following the cleaning procedure proposed by the manufacturer, before initial  
 85 water permeation measurement at 20 °C. Cleaning procedure included cleaning with 1.5% (m/v) NaOH  
 86 solution and 1.5% HNO<sub>3</sub> (v/v) at 60 °C for 15 min in recirculation mode and 5 min under pressure (up  
 87 to 0.5 bar). Deionised water was used between steps to wash out the cleaning solutions, until the pH of  
 88 permeate and retentate was 7.0. Initial water permeation was conducted at 20 ± 1 °C, at transmembrane  
 89 pressure of 0.5, 1.0, 1.5 and 2.0 bar.

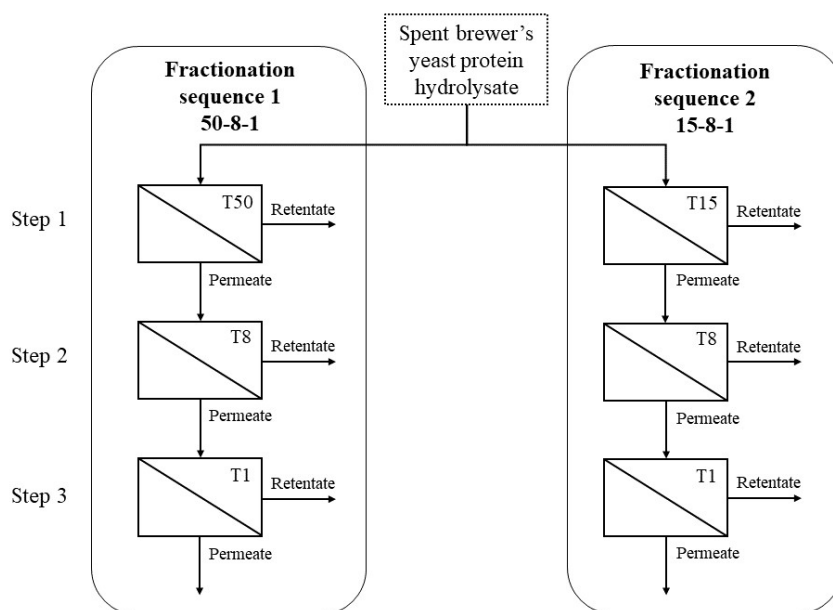

Figure 1: Experimental scheme of UF sequences and steps used in the fractionation of spent brewer's yeast protein hydrolysate using ceramic membranes of 50 (T50), 15 (T15), 8 (T8) and 1 (T1) kg mol<sup>-1</sup> molecular weight cut-off, respectively.

90 UF experiments were performed at 20 ± 1 °C and 2.0 ± 0.2 bar until a volumetric concentration factor  
 91 (VCF = ratio between feed and retentate volume) of 4.0 for the first UF step and 2.5 for the others was  
 92 reached (Figure 1). The feed contained 1% (m/m) of dry weight (d.w.) and 46% (m/m) of protein (d.w.).  
 93 For the first UF step, a new membrane was used, and a mass of 400 g of feed at pH 7.0 was used. For  
 94 the next steps, about 200 g of permeate from the previous UF step was used as feed. The collected mass  
 95 of permeate was registered automatically as a function of time. Permeate volumetric flux was calculated  
 96 at a given instant  $t$ , according to Equation 1, where  $J_p$  is the volumetric flux of permeate (L m<sup>-2</sup> h<sup>-1</sup>);  $m_p$

is the permeate mass (kg);  $\rho$  is the specific mass of the hydrolysate ( $\text{kg L}^{-1}$ );  $t$  is the time (h) and  $A_p$  is the effective permeation area ( $\text{m}^2$ ). The specific mass of hydrolysate and fractions was determined using a pycnometer at  $20 \pm 1$  °C. All fractions were kept frozen at  $-20$  °C until analysis.

$$J_p = \frac{m_p}{\rho t A_p} \quad (1)$$

### 2.2.2. Membrane hydraulic resistances

The flux of water before and after the filtration of the hydrolysate (or the permeate from the previous UF step), as well as after membrane cleaning were measured, following the same procedure for initial water permeation, at transmembrane pressures of 0.5-2 bar. Permeate fluxes of hydrolysate and water were used for the calculation of mass transfer resistances, using the resistance-in-series model. Intrinsic membrane resistance ( $R_M$ ) was calculated using initial water flux ( $J_0$ ), water dynamic viscosity data under the experiment conditions applied ( $\mu_w$ ), as shown in Equation 2. Total resistance ( $R_T$ ) was calculated considering the hydrolysate dynamic viscosity under operation conditions ( $\mu_{hyd} = 0.00123 \text{ kg m s}^{-1}$ ) and the permeate flux of the hydrolysate ( $J_{hyd}$ ) (Equation 3). Finally, resistances related to the fluid layers (concentration polarisation in the boundary layer and fouling) were obtained considering the water flux after the hydrolysate and rinsing ( $J_w'$ ) and their difference to the total resistance, as shown by Equations 4 and 5. In this last expression, parts of total resistance that are and are not eliminated by water rinsing represent, respectively, the reversible  $R_{pl}$  and irreversible fouling  $R_I$  [27, 28]. In Equations 2, 3, 4 and 5, transmembrane pressure ( $\Delta P$ ) is in  $\text{kg m}^{-1} \text{ s}^{-2}$ , dynamic viscosity in  $\text{kg m s}^{-1}$  and flux of permeate in  $\text{m}^3 \text{ m}^{-2} \text{ s}^{-1}$ .

$$R_M = \frac{\Delta P}{\mu_w J_0} \quad (2)$$

$$R_T = \frac{\Delta P}{\mu_{hyd} J_{hyd}} \quad (3)$$

$$R_I = \frac{\Delta P}{\mu_w J_w'} - R_M \quad (4)$$

$$R_{pl} = R_T - R_M - R_I \quad (5)$$

### 115 2.2.3. Physicochemical analyses

116 Proximal composition of SBY protein hydrolysate was determined using a different protocol than that  
 117 of UF fractions. Prior to the determination of total sugars in the hydrolysate, the protein hydrolysate was  
 118 submitted to a polysaccharide precipitation protocol [29] with modifications. Briefly, to 10 mg of yeast  
 119 hydrolysate, 2 mL of ethanol were added (12 h at 4 °C). Samples were centrifuged (5000 × g for 10 min at  
 120 4 °C), washed with 2 mL of ethanol and left to dry in a bath at 70 °C to remove residual solvent. Pellet was  
 121 then redissolved in 2 mL of deionised water at 60 °C and mixed. Total sugars content of this solution was  
 122 estimated by the Phenol-sulfuric acid assay [30]. Results were expressed in g 100 g<sub>d.w.</sub><sup>-1</sup>. Protein fractions  
 123 and peptides concentration in the hydrolysate (g 100 g<sub>d.w.</sub><sup>-1</sup>) was measured by far-UV absorbance at 214  
 124 nm (2800, Unico, United States) [31]. Dry weight and RNA concentration were determined as for fractions.

125 For all UF fractions, dry weight (% m/m) was determined gravimetrically at 105 °C for 12 h using an  
 126 incubator (UE 400, Memmert, Germany), an analytical balance (XT 120A, Precisa, Hong Kong) and a glass  
 127 desiccator [32]. Protein content was determined by the Lowry method (g 100 g<sub>d.w.</sub><sup>-1</sup>) measuring absorbance  
 128 of the reaction mixture at 750 nm using a bovine serum albumin standard curve for reference (UV-2401 PC,  
 129 software UV Probe (version 2.21), Shimadzu, Japan) [33]. Ribonucleic acid content (RNA) was determined  
 130 spectrophotometrically (260-290 nm) following trichloroacetic acid hydrolysis (75 μL of 70% acid per 1 mL  
 131 of sample) at 90 °C for 30 min. A standard curve using RNA from *S. cerevisiae* was used at 260 nm, and



132 results were expressed in  $\text{g (100 g}_{\text{d.w.}})^{-1}$  [34–36]. Total reducing sugars were determined in dried samples  
133 using the Somogyi-Nelson method measuring absorbance at 500 nm [30] after hydrolysis with concentrated  
134 sulphuric acid and centrifugation at  $3800 \times g$  for 5 min at 4 °C [37]. Reducing sugars in samples were  
135 determined by the DNS method [38]. Results were expressed in  $\text{g (100 g}_{\text{d.w.}})^{-1}$  considering D-(+)-glucose  
136 standard curves. Conductivity of fractions was determined using a conductivity meter at  $21 \pm 1$  °C (LF  
137 320, WTW, Xylem Analytics, Germany).

### 138 *2.3. Anions determination in the hydrolysate by ion-exchange chromatography*

139 The content of cations and anions in the spent brewer’s yeast feed before UF was determined by ion-  
140 exchange chromatography in order to correctly establish ionic strength in size-exclusion chromatography  
141 experiments. Anion and cation determination was done in a Dionex ICS1000 and ICS900 systems (Ther-  
142 mofisher Scientific, USA), respectively, composed of an eluent producer, a suppressor system (ADRS-600 for  
143 anions and CERS 500 for cations) to reduce background eluent conductivity and a conductivity detector.  
144 Anion and cation separations were carried out using a Dionex AS19 and Dionex CS12A columns (4x250 mm)  
145 (Thermofisher Scientific, USA), respectively . Elution of anions was done by an aqueous solution containing  
146 KOH at 10 mM (10 min) followed by a gradient for 20 min until 45 mM and then 10 mM (10 min), in a flow  
147 rate of  $1.0 \text{ mL min}^{-1}$ . Cations elution was carried out using a 20 mM methanesulphonic acid solution, in a  
148 flow rate of  $1.0 \text{ mL min}^{-1}$ . The amount of sample injected was 25  $\mu\text{L}$ . All samples were filtered in 0.22  $\mu\text{m}$   
149 polytetrafluoroethylene (PTFE) syringe filters prior to analysis. Data were collected using the Chromeleon™  
150 Chromatography Data System (CDS) Software v. 7.2.9.11323 (Thermo Fisher Scientific, USA). Anions and  
151 cations concentration in yeast samples was calculated using calibration curves relating amount of analyte  
152 ( $\text{Cl}^{-1}$ ,  $\text{NO}_2^{-1}$ ,  $\text{NO}_3^{-1}$ ,  $\text{ClO}^{-3}$ ,  $\text{Br}^{-1}$ ,  $\text{SO}_4^{-2}$ ,  $\text{PO}_4^{-3}$ ,  $\text{Na}^{+1}$ ,  $\text{NH}_4^{+1}$ ,  $\text{K}^{+1}$ ,  $\text{Mg}^{+2}$ ,  $\text{Ca}^{+2}$ ) and peak area.

153 *2.4. Molecular weight distribution of SBY protein fractions and peptides by size-exclusion chromatography*  
154 *(SEC)*

155 Molecular weight distribution of protein fractions and peptides in non-treated and heat-treated SBY as  
156 well as in the protein hydrolysate and UF fractions was determined using the column Superdex Peptide GL  
157 10/300 (GE Healthcare, USA) with a fractionation range of 100-7000 g mol<sup>-1</sup> in a chromatography system  
158 (Thermo Fisher Scientific, USA) including a pump system Dionex (ICS1000), a UV detector (Ultimate  
159 3000) and an auto-sampler (AS40). Size-exclusion chromatography was performed using a 50 mM sodium  
160 phosphate buffer as eluent (ionic strength of 0.5 M, pH 7.0) at 20 °C, at a constant flow rate of 0.5 mL min<sup>-1</sup>  
161 for 70 min, monitored at 214 nm. The ionic strength of the eluent was selected considering a 12 fold more  
162 important ionic strength than in the most concentrated sample (40 mM) (section 2.3). Volume of injected  
163 sample was 25 μL. A calibration curve using peptidic standards (bovine serum albumin, aprotinin, insulin,  
164 cyanocobalamin, substance P 1-7, leupeptin, triglycine and glycine) was used to determine the molecular  
165 weight distribution of fractions (log of molecular weight versus retention volume). All samples were filtered  
166 in 0.22 μm polytetrafluoroethylene (PTFE) syringe filters prior to analysis. Instrument was controlled  
167 and data were generated by the software Chromeleon™ Chromatography Data System (CDS) v. 7.2.9.11323  
168 (Thermo Fisher Scientific, USA). Definite integral values were determined by a numerical integration method  
169 (trapezoid rule) after baseline correction using a developed Python script for this purpose. The retention of  
170 protein fractions ( $R_{pf}$ ) was calculated using the integrated peaks of feed ( $S_f$ ) and permeate ( $S_p$ ) divided in  
171 molecular weight (MW) ranges, as presented in Equation 6.

$$R_{pf} (\%) = \left(1 - \left(\frac{S_p}{S_f}\right)\right) \times 100 \quad (6)$$

172 *2.5. In vitro assessment of SBY protein fractions and peptides antioxidant activity*

173 Antioxidant activity of fractions of SBY protein hydrolysate was determined by the Ferric Reducing  
174 Ability of Plasma (FRAP) and ABTS<sup>•+</sup> organic radical antioxidant assay. Protein concentration and pH

of all samples were standardised ( $0.77 \text{ g L}^{-1}$ , at pH 7.0) before antioxidant measurements to detect different protein fractions and peptides activity and not differences in protein compounds concentration [12]. TROLOX was used as standard and results were expressed as TROLOX equivalents, in  $\mu\text{mol}_{\text{TE}} \text{ g}_{\text{d.w.}}^{-1}$ .

#### 2.5.1. Ferric Reducing Antioxidant Power (FRAP)

Antioxidant activity by the Ferric Reducing Ability of Plasma assay (FRAP) was carried out as described by Benzie and Strain (1996) [39] with modifications [40]. Briefly,  $100 \mu\text{L}$  of previously diluted samples were mixed with  $115 \mu\text{L}$  of water and  $1.6 \text{ mL}$  of FRAP reagent. The reaction mixture was incubated at  $37 \text{ }^\circ\text{C}$  for 30 min and the absorbance of samples was read at  $595 \text{ nm}$  using polystyrene cuvettes.

#### 2.5.2. ABTS radical scavenging activity (ABTS)

The scavenging activity of samples towards the organic cation radical 2,2'-azinobis(3-ethylbenzothiazoline-6-sulphonic acid) diammonium salt ( $\text{ABTS}^{\bullet+}$ ) was performed in pure ethanol [41, 42], with some modifications. Briefly,  $\text{ABTS}^{\bullet+}$  radical solution was produced by reacting a  $7 \text{ mM}$  ABTS stock solution with  $2.45 \text{ mM}$  potassium persulphate (final concentration) for 16 h in the dark.  $\text{ABTS}^{\bullet+}$  solution was diluted with ethanol to an absorbance of  $0.70 \pm 0.05$  (at  $734 \text{ nm}$ ) and equilibrated at  $30 \text{ }^\circ\text{C}$ . Reaction started with the mixture of  $20 \mu\text{L}$  of previously diluted sample in  $2 \text{ mL}$  of the  $\text{ABTS}^{\bullet+}$  solution. Absorbance at  $734 \text{ nm}$  was determined within 3-6 min after incubation at  $30 \text{ }^\circ\text{C}$  in a dark room, using polystyrene cuvettes.

### 2.6. In vitro assessment of SBY protein fractions and peptides anti-diabetic activities

#### 2.6.1. alpha-amylase inhibitory activity

Inhibitory activity of  $\alpha$ -amylase was performed using a photometric method, with minor modifications [43]. Enzyme activity was monitored through the development in the yellow colour of 3,5-dinitrosalicylic acid (DNS), that reacts with the released reducing sugars after the enzyme cleaves starch molecules. Firstly,  $500 \mu\text{L}$  of 1% (m/v) starch solution (in a  $20 \text{ mM}$  sodium phosphate buffer at pH 6.9, for use at  $37.5 \text{ }^\circ\text{C}$ ),  $10 \mu\text{L}$  of a  $1 \text{ U mL}^{-1}$   $\alpha$ -amylase solution and  $30 \mu\text{L}$  of diluted sample (in buffer) were mixed and incubated at

198 37.5 °C ± 0.5 for 10 min. Then, 600 µL of DNS reagent were added and incubated at 100 °C for 15 min.  
199 Absorbance was monitored after the solution cooled down, at 540 nm. Inhibitory activity was calculated as  
200 presented in Equation 7, considering proper blanks:  $A_{cb}$  is the control blank, produced with buffer instead  
201 of the sample;  $A_{bb}$  is the background blank, with neither sample nor enzyme;  $A_s$  is the sample absorbance  
202 and  $A_{sb}$  is the sample blank, performed with sample but not added enzyme. Acarbose, an anti-diabetic drug  
203 used to treat type II diabetes, was used as positive control.

$$Enzyme\ inhibition\ (\%) = \frac{[(A_{cb} - A_{bb}) - (A_s - A_{sb})]}{(A_{cb} - A_{bb})} \times 100 \quad (7)$$

#### 204 2.6.2. *alpha-glucosidase inhibitory activity*

205 The ability of SBY protein fractions to inhibit  $\alpha$ -glucosidase was determined by a photometric method  
206 with minor modifications [44]. The extent of  $\alpha$ -glucosidase activity was measured at 405 nm after a colourful  
207 product was formed as p-nitrophenyl- $\alpha$ -D-glucopyranoside (PNP-G) was hydrolysed. After samples dilution  
208 in a 20 mM sodium phosphate buffer (pH 6.8, for use at 37 °C), 375 µL of diluted sample were added as  
209 well as the same amount of buffer and a 5 mM PNP-G solution (in buffer) and the reaction mixture was  
210 incubated at 37 °C for 5 min. Then, 75 µL of a 0.2 U mL<sup>-1</sup> enzyme solution (prepared in buffer) were added  
211 and the mixture was incubated again, at the same temperature for 30 min. The reaction was stopped by  
212 the addition of 600 µL of a 2 M sodium carbonate solution and the absorbance was measured at 405 nm.  
213 Results were calculated as presented in Equation 7. Acarbose was also used as positive control.

#### 214 2.7. *In vitro assessment of SBY protein fractions and peptides anti-Alzheimer activity*

##### 215 2.7.1. *Inhibition of acetylcholinesterase activity*

216 The inhibition of acetylcholinesterase (AChE) was determined by the Ellman's method [8], with some  
217 modifications. As acetylcholine reacts with 5-5'-dithiobis (2-nitrobenzoic acid) (DTNB, Ellman's reagent),  
218 a yellow coloured product (412 nm) is formed, indicating the AChE activity. Firstly, 111 µL of a 1.5 mM

219 acetylcholine iodide (prepared in a 100 mM sodium phosphate buffer at pH 7.5 for use at 25 °C), 556  $\mu\text{L}$  of  
220 0.3 mM DTNB solution (in buffer) and 222  $\mu\text{L}$  of diluted sample (in buffer) were mixed. Then, 222  $\mu\text{L}$  of  
221 AChE enzyme solution (0.026 U  $\text{mL}^{-1}$ ) were added and the reaction mixture was incubated at 25 °C for 15  
222 min. The absorbance of samples and respective blanks was monitored at 412 nm. Inhibition was calculated  
223 as previously presented (Equation 7). Galantamine hydrobromide, a standard inhibitor of AChE, was used  
224 as positive control.

### 225 2.8. Statistical analysis

226 Experiments were performed in triplicate and all analyses were determined at least in triplicate. Results  
227 were expressed as average values  $\pm$  standard deviation and were submitted to analysis of variance (ANOVA)  
228 one and two way, followed by the comparison of means by Tukey HSD test. ANOVA assumptions were  
229 checked through analysis of the residues, data distribution (Ryan-Joiner's and Shapiro Wilk's tests) and  
230 homogeneity of variances (Bartlett's and Levene's tests). Differences were considered significant at a level  
231 of 5% for all statistical analysis.

## 232 3. Results and Discussion

### 233 3.1. SBY protein hydrolysate composition and molecular weight distribution

234 Proximal composition and protein fractions's molecular weight distribution of the protein hydrolysate  
235 are presented in Figure 2. SBY hydrolysate consisted of 7% dry weight, about 76% (d.w.) protein (Far-UV  
236 detection of peptide bonds at 214 nm), 6% (d.w.) RNA, 6% (d.w.) total sugars (Phenol-sulphuric acid  
237 assay), and 13% of other compounds such as fibre and ashes (d.w.). The molecular weight distribution  
238 included mostly the presence of protein fractions and peptides of 1-7  $\text{kg mol}^{-1}$ . The yield of hydrolysate  
239 obtained from non-treated SBY was  $75 \pm 5\%$  (m/m).

240 The confirmation of protein hydrolysis is shown in the chromatograms generated by size-exclusion chro-  
241 matography (SEC) of non-treated material, the spent yeast after the heat treatment and the protein hy-

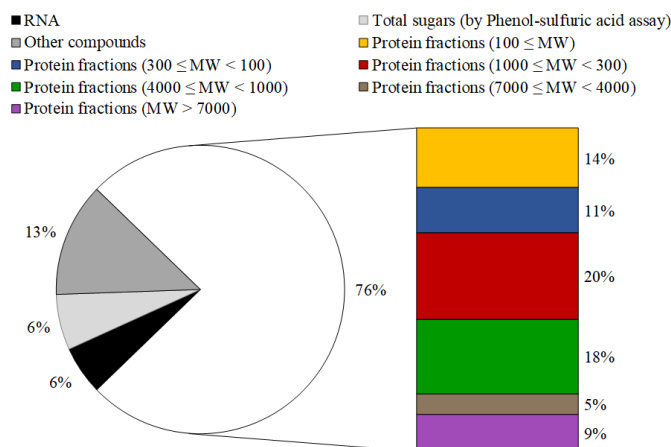

Figure 2: Proximal composition of the spent brewer's yeast protein hydrolysate and the molecular weight (MW) distribution of the protein fractions present, in  $\text{kg mol}^{-1}$

242 drolysate, given in Figure 3. In the chromatograms, peaks in the range of higher molecular weight molecules  
 243 ( $> 7000 \text{ g mol}^{-1}$ ) are abundantly present in the non-treated and heat-treated yeast materials, but are found  
 244 in much less amounts in the hydrolysate. The yeast protein hydrolysate is rich in protein fractions and  
 245 peptides in the whole range of the column (from  $7000$  to  $1000 \text{ g mol}^{-1}$ ), confirming that yeast proteins  
 246 were cleaved into peptides. Smaller peptides and amino acids are also present ( $1000 - 100 \text{ g mol}^{-1}$ ) in the  
 247 hydrolysate. The estimated ionic strength of the diluted hydrolysate used in UF was  $40 \text{ mM}$ .

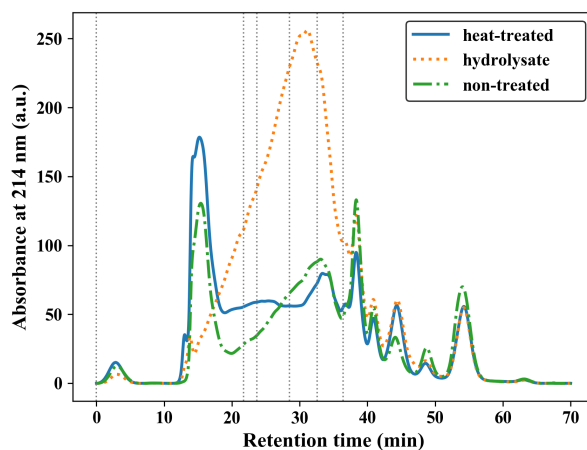

Figure 3: Size-exclusion chromatographs of non-treated, after heat-treatment and hydrolysed spent brewer's yeast. Vertical grey dashed lines represent the molecular weight limits. From the left to the right:  $\text{MW} > 7000 \text{ g mol}^{-1}$ ,  $4000 - 7000 \text{ g mol}^{-1}$ ,  $1000 - 4000 \text{ g mol}^{-1}$ ,  $300 - 1000 \text{ g mol}^{-1}$  and  $100 - 300 \text{ g mol}^{-1}$  ( $t = 36.4 \text{ min}$  corresponds to the total column volume and  $t = 14.2 \text{ min}$  corresponds to the void column volume). Absorbance units in mAU.

248 3.2. *UF fractionation performance in the separation of SBY protein fractions and peptides*

249 3.2.1. *Flux of permeate*

250 Table 1 shows that initial water permeation data varied greatly among the membranes used. Water  
251 permeation was 3.5 fold higher for T50 in comparison to T15 membrane. Water permeation through T8  
252 membrane was 1.5 and 1.9 smaller than T15 and T1 membranes, respectively. This results show that water  
253 permeation values were smaller as the membranes MWCO decreased, with an exception for T1 membrane,  
254 for which the water permeability was higher than that of T15 and T8 membranes. This could be related to  
255 the membrane morphology (i.e. membrane thickness, porosity, etc.) and manufacturer's production method  
256 of T1.

257 Similar trends were observed when the SBY protein hydrolysate was ultrafiltered (Figure 4). The flux of  
258 permeate in T50 membrane was 1.8 fold higher ( $16.0 \pm 1.9 \text{ L m}^{-2} \text{ h}^{-1}$ ) than that observed in T15 membrane  
259 ( $8.9 \pm 1.9 \text{ L m}^{-2} \text{ h}^{-1}$ ) (Figure 4a). The rapid decrease of permeate flux followed by the stabilisation at  
260 higher VCFs for both membranes suggest that a surface deposition of molecules occurs. The accumulated  
261 layer plays the role of a secondary membrane that prevents smaller particles and molecules from blocking  
262 membrane pores. In this fouling mechanism, often reported for the membrane filtration of food and biological  
263 fluids, there is limited risk of internal clogging and total blockage of the membranes in concentration mode,  
264 a great feature for industrial processing [45].

265 For the second step of fractionation using  $8 \text{ kg mol}^{-1}$  MWCO membrane (Figure 4b), very similar per-  
266 meate fluxes were observed (about  $5 \text{ L m}^{-2} \text{ h}^{-1}$  for both sequences 50-8 and 15-8). In this step, the flux  
267 decreased at a slower rate than that observed in the first step, suggesting that an internal pore clogging  
268 fouling mechanism played a role [45].

269 Different permeate fluxes were seen for sequences 1 and 2 in the third fractionation step using  $1 \text{ kg mol}^{-1}$   
270 MWCO membrane (Figure 4c). Whereas for sequence 1 (50-8-1) the permeate flux decreased gradually as  
271 concentration factor increased (until reaching  $9.2 \pm 0.5$  at VCF 2.5), suggesting that, at least at some extent,

272 an internal pore clogging mechanism took place, for sequence 2 (15-8-1) the flux decreased rapidly and then  
 273 stabilised at a 79% higher value ( $16.5 \pm 0.8$ ), as seen for T50 and T15 membranes. Further information on  
 274 fouling mechanisms taking place during the UF of SBY protein hydrolysate could be obtained evaluating  
 275 hydraulic resistances involved in the separation.

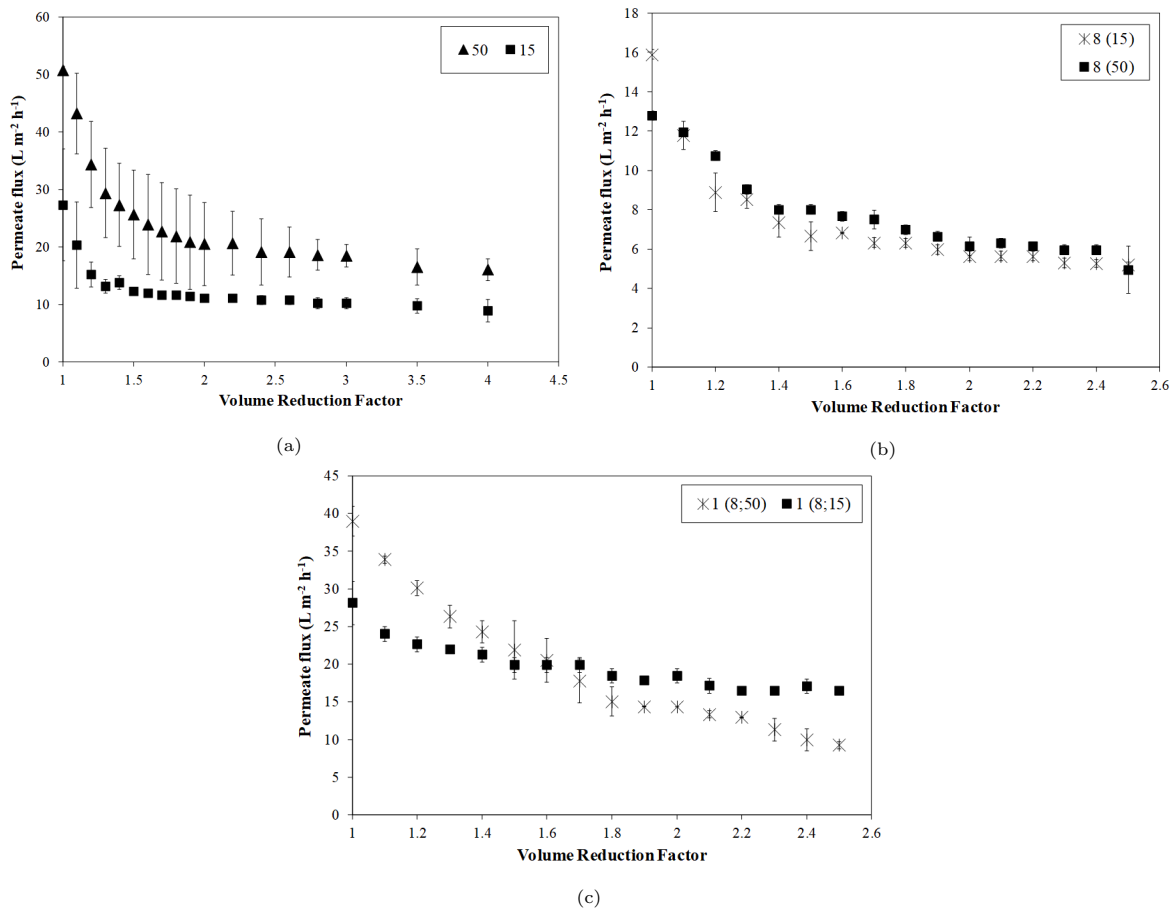

Figure 4: Permeate flux of spent brewer's yeast hydrolysate at fractionation steps 1 (50 or 15  $kg \cdot mol^{-1}$  molecular weight cut-off, MWCO) (a), 2 (8  $kg \cdot mol^{-1}$  MWCO) (b) and 3 (1  $kg \cdot mol^{-1}$  MWCO) (c)

### 276 3.2.2. Hydraulic resistances of the membranes

277 In practice, more than one fouling mechanism act simultaneously during the UF of heterogeneous mix-  
 278 tures [46], such as the SBY protein hydrolysate. In contrast to concentration polarisation, which is an  
 279 inherently reversible phenomena, fouling may cause irreversible losses on membrane permeability. In this



280 work, the part of fouling removed with simple rinsing was defined as "reversible" ( $R_{pl}$ ), whereas the "irre-  
281 versible" part ( $R_I$ ) was the one that was not.

282 All components of hydraulic resistances of the ceramic membranes used in the study are presented in  
283 Figure 5. All membranes showed similar distributions of the components of the total resistance to mass  
284 transport. Intrinsic resistance of membrane T15 was higher than that of T50, in agreement with water and  
285 hydrolysate flux results, that were 3.5 and 1.8 fold smaller for T15.

286 T8 membrane, used in step 2 of both sequences, showed a higher total resistance compared to T50, T15  
287 and T1. For this membrane, a higher intrinsic resistance was also observed. This result is in agreement  
288 with water permeation results, where T8 membrane presented the smallest water flux, and thus, a higher  
289 resistance to permeation. The polarisation layer resistance, referred to as reversible resistance, was also  
290 higher for T8 membrane compared to the others. For this membrane, the lowest flux values were achieved,  
291 regardless of fractionation sequence. A very small part of the total resistance was not recovered after  
292 rinsing. In the third step of fractionation, a smaller total resistance was found for sequence 1, represented by  
293 a higher reversible resistance. This effect could be related to the different membranes used in the previous  
294 fractionation steps. Irreversible resistances accounted for less than 10% of total resistance in all membranes,  
295 indicating that accumulated material onto the surface or in the pores were easily removed by simple water  
296 rinsing.

### 297 3.2.3. Membrane selectivity: fractions characterisation and mass balances

298 Full physicochemical characterisation of fractions of the sequences 50-8-1 and 15-8-1 kg mol<sup>-1</sup> MWCO  
299 membranes as well as the mass of fraction recovered are available in Table 2. Mass balances for all components  
300 presented an error smaller than 20%. The mass balance distribution of dry weight, RNA, total sugars and  
301 protein is given for fractions of sequences 1 (50-8-1) and 2 (15-8-1) in Figures 6a and 6b, respectively.

302 More than 65% mass of dry weight, RNA, total sugars and protein were present in the retentates of

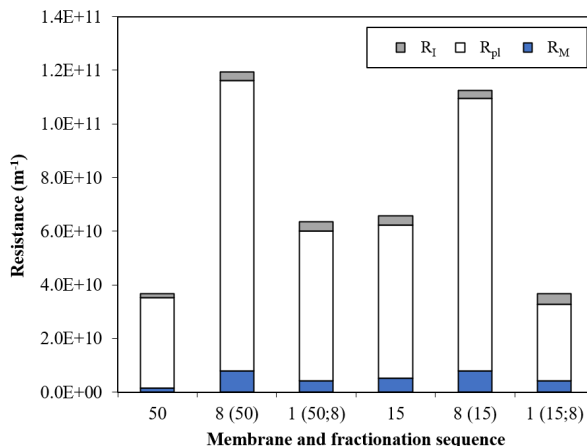

Figure 5: Hydraulic resistances of membranes of 50, 15, 8 and 1 kg mol<sup>-1</sup> MWCO in sequences 1 (50-8-1) and 2 (15-8-1). Total hydraulic resistance divided in the following components:  $R_M$ , the intrinsic hydraulic resistance of the membrane,  $R_{pl}$ , the resistance related to the polarised layer and  $R_I$ , the resistance part not recovered after water rinsing.

303 first and second steps, regardless of the sequence. The transfer of dry weight was very similar for both  
 304 sequences, specially in the last step (retentate and permeate of the third UF), in which about 25% of dry  
 305 weight mass was found. Interestingly, mass distribution of RNA among fractions was very different between  
 306 fractionation sequences. In sequence 1, a equivalent distribution of RNA was observed for retentates 1 and  
 307 2. This indicates that retentates of membranes T8 presented an important mass of RNA, confirming that  
 308 T50 membrane did not retain RNA molecules. On the contrary, a higher proportion of RNA mass was found  
 309 in the retentate of T15 membrane, leaving a smaller mass to go through the second step. The same trend  
 310 was observed in the mass balance of protein. More protein were found in the retentate of T15 membrane  
 311 compared to that of T50. The distribution of total sugars mass in all fractions was very similar for both  
 312 fractionation sequences.

313 Concentrations of protein (Lowry), RNA and total sugars (after hydrolysis, determined by Somogyi-  
 314 Nelson method) in dry weight are given Table 2. Those three components represented 22 to 82% of total  
 315 solids in fractions. The SBY protein hydrolysate contained other compounds that were not quantified, such  
 316 as fibres, ashes, lipids as well as polysaccharides and protein fractions that were not be detected by the  
 317 analytical methods used in this work. Salt content is usually representative in yeast hydrolysates, with

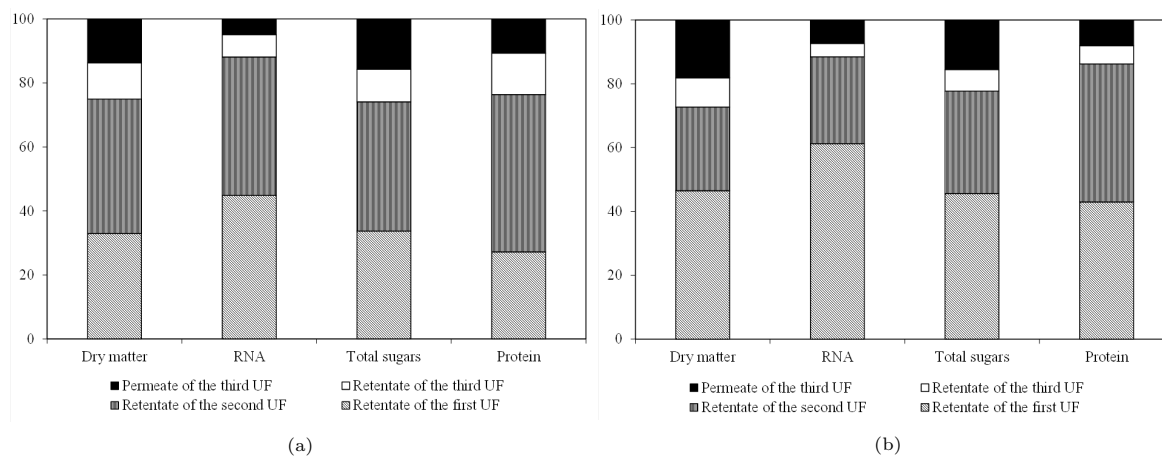

Figure 6: Mass balance of dry weight, protein, RNA and total sugars for UF fractions obtained after the fractionation sequences 1 (50-8-1) (a) and 2 (15-8-1) (b).

318 about 10 g per 100 g [47]. In the SBY protein hydrolysate fractions after UF, salts were probably present,  
 319 as indicated by ions determination and conductivity data, contributing to the unattributed composition  
 320 percentage.

321 Total solids content in fractions were decreased as the fractionation steps were carried out and compounds  
 322 were retained. RNA content also decreased in relation to the dry weight in fractions from step 1 to 3. The  
 323 evolution of concentration of proteins, RNA, total and reducing sugars in the three retentates and the last  
 324 permeate obtained after the two fractionation sequences are given in Figures 7a and 7b (for sequences 50-  
 325 8-1 and 15-8-1, respectively). In both fractionation sequences, fractions of T8 membranes were the ones  
 326 that contained the highest amount of protein compounds (confirmed by the high protein concentration in  
 327 retentates and permeates of the second step). Thus, higher resistance to mass transport of T8 membrane  
 328 could be related to the higher content of protein compounds found in this feed fraction.

329 As observed in Table 2, total sugars content in dry weight did not show any specific trend after each  
 330 fractionation step. We also investigated the evolution of reducing sugars content in fractions and found that it  
 331 decreased as fractionation went on, independently of membranes sequence (Figures 7a and 7b). Protein and  
 332 nucleic acids in yeast protein hydrolysates are often found as complexes, bound to sugars. Polysaccharides

<sup>333</sup> and sugars can also interact with fibres and minerals [48].

Table 2: Concentration of dry weight, protein, RNA, total sugars in fractions and mass of each fraction, obtained in fractionation sequence 1 involving the membranes of 50, 8 and 1 kg mol<sup>-1</sup> molecular weight cut-off and in fractionation sequence 2, with 15, 8 and 1 kg mol<sup>-1</sup> molecular weight cut-off in steps 1, 2 and 3, respectively.

Sequence 50-8-1	1			2			3		
	Feed	Retentate	Permeate	Feed	Retentate	Permeate	Feed	Retentate	Permeate
Step									
Dry weight	0.98 ± 0.10	1.45 ± 0.08	0.91 ± 0.02	0.77 ± 0.01	0.98 ± 0.01	0.53 ± 0.01	0.53 ± 0.08	0.57 ± 0.01	0.49 ± 0.01
Protein	46.1 ± 5.9	33.5 ± 3.5	47.4 ± 1.3	49.6 ± 5.1	47.5 ± 1.5	67.9 ± 0.8	37.7 ± 3.8	46.2 ± 2.2	31.7 ± 2.1
RNA	4.5 ± 0.1	5.3 ± 0.1	3.9 ± 0.1	3.8 ± 0.1	4.0 ± 0.1	3.5 ± 0.1	2.2 ± 0.1	2.4 ± 0.1	1.4 ± 0.2
Total sugars	1.3 ± 0.1	1.6 ± 0.1	1.4 ± 0.1	1.4 ± 0.3	1.5 ± 0.2	2.2 ± 0.2	1.4 ± 0.1	1.4 ± 0.1	1.8 ± 0.1
Conductivity	1937 ± 142	2255 ± 42	1943 ± 12	1657 ± 1	1842 ± 1	1412 ± 1	878 ± 2	984 ± 2	665 ± 2
Mass of fraction (g)	400 ± 15	57 ± 20	343 ± 31	253 ± 20	107 ± 20	146 ± 35	119 ± 25	50 ± 10	70 ± 30

Sequence 15-8-1	1			2			3		
	Feed	Retentate	Permeate	Feed	Retentate	Permeate	Feed	Retentate	Permeate
Step									
Dry weight	0.98 ± 0.10	1.26 ± 0.01	0.67 ± 0.01	0.65 ± 0.01	0.74 ± 0.01	0.50 ± 0.01	0.50 ± 0.01	0.56 ± 0.01	0.41 ± 0.01
Protein	46.1 ± 5.9	38.4 ± 0.9	61.5 ± 3.5	62.1 ± 3.7	68.6 ± 2.9	75.1 ± 12.6	21.3 ± 3.7	25.8 ± 2.8	18.5 ± 2.1
RNA	4.5 ± 0.1	5.2 ± 0.1	4.0 ± 0.1	3.9 ± 0.1	4.1 ± 0.1	3.5 ± 0.2	1.5 ± 0.1	1.8 ± 0.2	1.6 ± 0.1
Total sugars	1.3 ± 0.1	1.6 ± 0.2	1.2 ± 0.2	2.1 ± 0.3	2.0 ± 0.1	2.8 ± 0.1	1.5 ± 0.1	1.2 ± 0.1	1.4 ± 0.2
Conductivity	1937 ± 142	2097 ± 6	1636 ± 1	1282 ± 3	1337 ± 2	934 ± 2	639 ± 1	717 ± 2	508 ± 2
Mass of fraction (g)	414 ± 13	99 ± 25	315 ± 30	310 ± 25	123 ± 25	187 ± 30	162 ± 29	45 ± 5	119 ± 22

Dry weight data in g humid sample<sup>-1</sup>; Protein (Lowry), RNA and total sugars (after hydrolysis by Somogyi-Nelson) results in g 100 g.d.w.<sup>-1</sup>; Conductivity results in  $\mu\text{S cm}^{-1}$ .

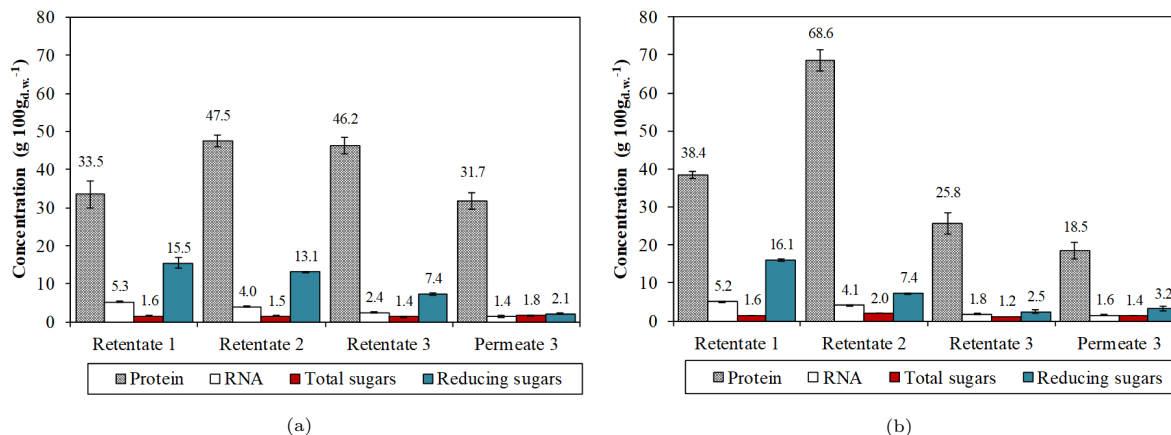

Figure 7: Concentrations of protein (Lowry), RNA, total sugars (after hydrolysis by Somogyi-Nelson) and reducing sugars (DNS) for UF fractions obtained after the fractionation sequences 1 (50-8-1) (a) and 2 (15-8-1) (b).

334 For those reasons, specific trends in the transmission of those components is difficult to interpret because  
 335 while some sugars are retained, smaller ones can permeate the membrane, resulting in no specific trends on  
 336 total sugars following fractionation.

337 On the other hand, reducing sugars are more reactive and are more susceptible to be associated with  
 338 proteins and nucleic acids. Their interaction with peptides and nucleic acids could have contributed to the  
 339 observed decrease in reducing sugars content as fractionation progressed.

340 Protein hydrolysates from agro-industrial by-products commonly consist of a wide range of compounds.  
 341 Peptides-rich fractions should attain a certain separation level from the other components so that their use  
 342 as ingredients or nutraceuticals can be envisaged [10]. Figures 8a and 8b show the evolution of protein purity  
 343 with regard to RNA, total sugars (Somogyi-Nelson) and reducing sugars as fractionation sequences 50-8-1  
 344 and 15-8-1 were carried out. Relative protein purity concerning RNA in the sequence 1 of fractionation  
 345 increased 3.4 fold (comparison between the first retentate and the last permeate). Higher protein purity  
 346 regarding RNA for this sequence was obtained for the permeate obtained after the T1 membrane (22.1  
 347  $g_{\text{protein}}/g_{\text{RNA}}$ ). In the 15-8-1 fractionation sequence, protein purity with regard to RNA was higher for the  
 348 retentate obtained from the T8 membrane (16.6  $g_{\text{protein}}/g_{\text{RNA}}$ ) and decreased 30% in comparison to the last

349 recovered permeate. Protein purity of fractions regarding total sugars (Somogyi-Nelson) showed roughly the  
 350 same tendency for both fractionation sequences. Higher purity for sequences 50-8-1 and 15-8-1 was achieved  
 351 for the retentate of T8 for both membranes, around 31-34  $\text{g}_{\text{protein}}/\text{g}_{\text{total sugars}}$ . For the first fractionation  
 352 sequence, the purity was also high for the retentate of T1 membrane.

353 The decrease in protein purity regarding total sugars, RNA and reducing sugars in the permeate of of  
 354 membrane T1 of sequence 2 is related to its smaller relative protein concentrations. Indeed, an increase in  
 355 protein purity after the first and second membranes is observed for all components (RNA, total sugars and  
 356 reducing sugars) regardless of the fractionation sequence also because protein concentration was increased  
 357 from retentate 1 to retentate 2 (Figures 7a and 7b). These results confirm the differences observed in the  
 358 concentrations and mass balances of fractions, where more important differences were observed for the first  
 359 membranes (of 50 or 15  $\text{kg mol}^{-1}$  MWCO). This affected the following UF fractionation stages in relation to  
 360 purity/composition of fractions.

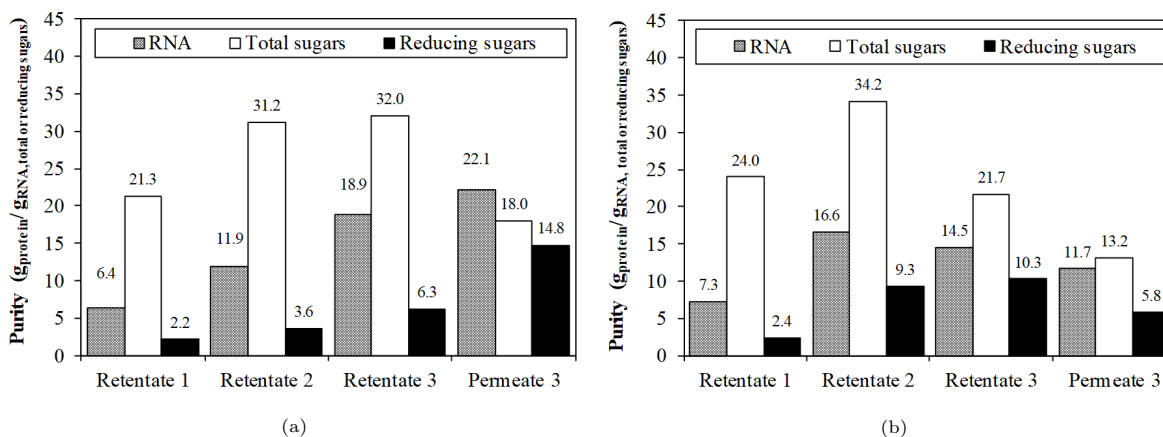

Figure 8: Evolution of fractions purity (ratio of protein in comparison to RNA, total and reducing sugars) in the first, second and third fractionation steps for 50-8-1 (a) and 15-8-1 sequences (b).

### 3.2.4. Molecular weight distribution of protein fractions and peptides

362 Size-exclusion chromatograms of 50-8-1 and 15-8-1 sequences are given in Figures 9a and 9b. It can be  
 363 observed that SBY protein hydrolysate chromatographic profiles were not much changed comparing the two

364 fractionation sequences. The retentate of T8 membrane (retentate 2), for example, have shown very similar  
 365 profiles.

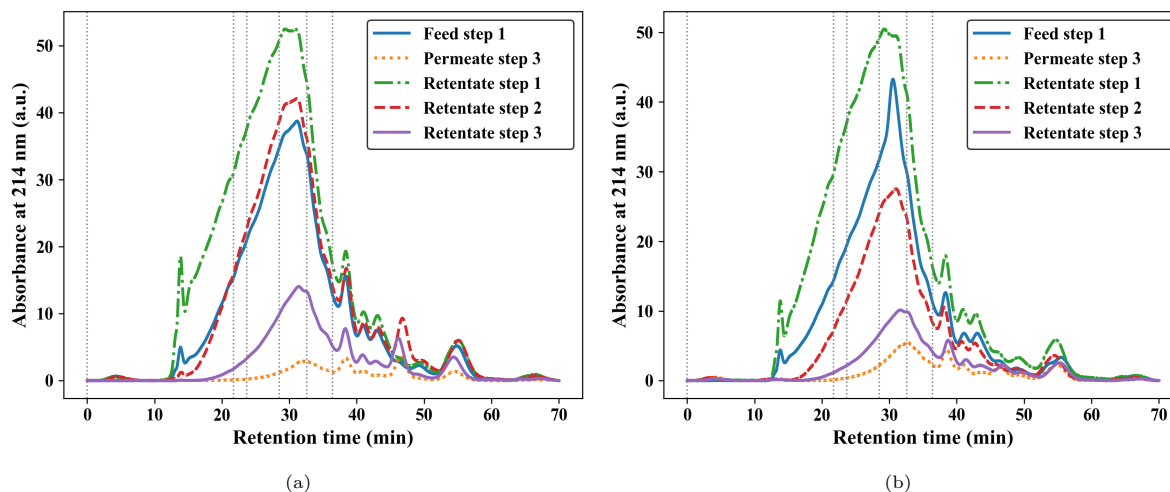

Figure 9: Size-exclusion chromatograms of fractions obtained after the fractionation sequences 1 (50-8-1) (a) and 2 (15-8-1) (b). Vertical grey dashed lines represent the molecular weight limits. From the left to the right:  $MW > 7000 \text{ g mol}^{-1}$ ,  $4000 - 7000 \text{ g mol}^{-1}$ ,  $1000 - 4000 \text{ g mol}^{-1}$ ,  $300 - 1000 \text{ g mol}^{-1}$  and  $100 - 300 \text{ g mol}^{-1}$  ( $t = 36.4 \text{ min}$  corresponding to the total column volume and  $t = 14.2 \text{ min}$  corresponds to the void column volume). Absorbance units (a.u.) in mAU.

366 Molecular weight distribution considering the ranges smaller than  $1 \text{ kg mol}^{-1}$ , between  $1$  and  $7 \text{ kg mol}^{-1}$   
 367 and higher than  $7 \text{ kg mol}^{-1}$  for both fractionation sequences is given in Table 3. As seen in the chromatograms,  
 368 very small changes between sequences were detected in the molecular distribution of fractions, but the  
 369 molecular distribution of the hydrolysate was gradually changed with further fractionation. The initial  
 370 hydrolysate contained 59% of peptides equal or smaller than  $1 \text{ kg mol}^{-1}$ , 30% between  $1$  and  $7 \text{ kg mol}^{-1}$ ,  
 371 and 11% bigger than  $7 \text{ kg mol}^{-1}$ . After the first fractionation step using either T50 or T15 membranes, the  
 372 peptides within the  $MW \leq 1$  range were smaller, peptides of the middle range were kept constant while  
 373  $MW > 7$  peptides were increased 1.5-1.7 fold. In the second and third fractionation steps the concentration  
 374 of smaller peptides ( $1 \leq MW$ ) in the recovered fractions increased until almost doubled concentrations were  
 375 achieved while higher molecular weight peptides concentrations went down.

376 Retention factors achieved in each fractionation step for both tested sequences (50-8-1 and 15-8-1) are  
 377 presented in Figures 10a, 10b and 10c. A higher retention of peptides of all molecular ranges was achieved



Table 3: Molecular weight (MW) distribution (%) of protein fractions and peptide recovered after sequences 50-8-1 and 15-8-1 divided in three regions: smaller than 1 kg mol<sup>-1</sup>, between 1 and 7 kg mol<sup>-1</sup> and higher than 7 kg mol<sup>-1</sup>.

<b>Protein fractions molecular weight distribution (%)</b>			
	MW ≤ 1	1 < MW ≤ 7	7 < MW
<i>Sequence 50-8-1</i>			
Retentate 1	50.0	30.8	19.2
Retentate 2	62.3	29.6	8.1
Retentate 3	79.0	19.0	2.0
Permeate 3	91.7	7.0	1.3
<i>Sequence 15-8-1</i>			
Retentate 1	51.0	32.2	16.8
Retentate 2	66.0	28.7	5.3
Retentate 3	80.3	17.1	2.6
Permeate 3	88.7	7.9	3.4

Molecular weight ranges in kg mol<sup>-1</sup>. Standard deviations smaller than 15%.

378 for the T15 membrane. This result is in agreement with the lower hydrolysate flux and higher reversible  
 379 resistance found for this membrane in comparison to T50. In the second fractionation step, using T8, the  
 380 retention of peptides was very similar for both membranes. Retention of sequence 15-8-1 seems higher  
 381 because the initial feed solids concentration for this sequence was also higher, as shown in Table 2. Even  
 382 though, peptides with a MW higher than 7 kg mol<sup>-1</sup> were 8% and 5% of total distribution in the first and  
 383 second sequences, respectively. This result confirms that the previous membrane T15 was able to retain  
 384 slightly more higher molecular weight peptides. Finally, in the third step, the retention of peptides smaller  
 385 than 7 kg mol<sup>-1</sup> was higher than that of sequence 15-8-1 as well as a 11% higher percentage of peptides within  
 386 1-7 kg mol<sup>-1</sup> range. This result is related to a higher initial solids concentration in this step feed stream  
 387 than in the 50-8-1 sequence (Table 3). The higher retention of T1 membrane in sequence 1 is in agreement  
 388 with mass balance and concentration results, that showed a higher protein amount for T1 retentate.

### 389 3.3. Effect of fractionation on antioxidant properties of SBY

390 Table 4 show antioxidant properties of SBY peptides obtained after 50-8-1 and 15-8-1 fractionation  
 391 sequences measured by FRAP and ABTS methods, which evaluate antioxidant properties by different reac-

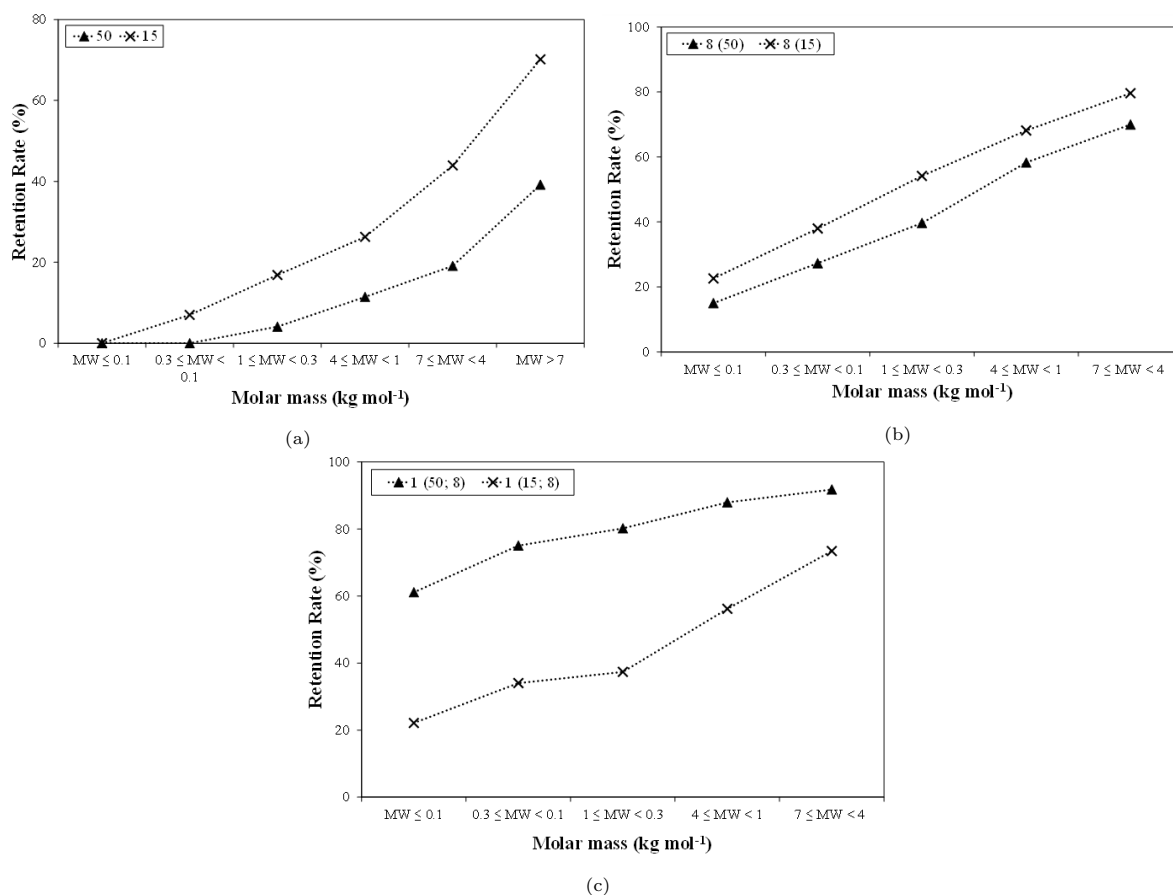

Figure 10: Retention rates versus molar mass of peptide fractions during UF fractionation in steps 1 (a), 2 (b) and 3 (b) using 50, 15, 8 and 1 kg mol<sup>-1</sup> MWCO membranes.

Standard deviations smaller than 15%.

392 tions. The ability of antioxidant compounds to be involved in radical quenching by hydrogen atom transfer  
 393 and electron transfer, by the neutralisation of ABTS<sup>•+</sup> organic radical, was measured by the ABTS radical  
 394 scavenging activity of peptide samples. ABTS antioxidant properties in samples ranged from 1550 to 5770  
 395  $\mu\text{mol}_{\text{TE}} \text{g}^{-1}$  (d.w.). Highest ABTS scavenging activity was found for the retentate 2 of fractionation sequence  
 396 15-8-1. For this fraction, 1.2 fold increased activity was found in comparison to the initial hydrolysate. This  
 397 fraction contained approximately 66% of peptides smaller than 1 kg mol<sup>-1</sup> and 29% of peptides between 1-7  
 398 kg mol<sup>-1</sup> (Table 3), which could be related to the expressed antioxidant activity. Other reports suggest that  
 399 ABTS scavenging activity of peptides decrease with increased molecular weight [49]. In this work, this was

400 not observed, as fractions with more than 80% peptides with a molecular weight smaller than  $1 \text{ kg mol}^{-1}$   
401 exhibited reduced ABTS scavenging properties. These fractions could have concentrated mainly amino acids  
402 instead of peptides, the latter being more effective ABTS<sup>•+</sup> scavengers. ABTS scavenging ability of a yeast  
403 hydrolysate fraction obtained after UF ( $MW < 10 \text{ kg mol}^{-1}$ ) enriched in the Cyclo-His Pro peptide was  
404 reported previously, with 50% of inhibition achieved at a hydrolysate concentration of  $0.9 \text{ mg/mL}$  [23]. A  
405 non-fractionated *S. cerevisiae* protein hydrolysate with a degree of hydrolysis of 18.5% showed the highest  
406 ABTS scavenging activity ( $4653 \pm 50 \mu\text{mol}_{\text{TE}} \text{ mg}_{\text{protein}}^{-1}$ ). These authors detected higher scavenging activ-  
407 ities for peptide fractions smaller than  $3 \text{ kg mol}^{-1}$ , but in autolysed samples of higher degree of hydrolysis  
408 (about 50%), peptide fractions within  $5\text{--}10 \text{ kg mol}^{-1}$  molecular weight range showed higher ABTS radical-  
409 scavenging activity compared to lower molecular weight peptides. The presence of hydrophobic amino acid  
410 residues such as proline, tyrosine and glycine seemed to have played a role in the expression of antioxidant  
411 activity [42]. It is important to note that ABTS assay was determined in pure ethanol, that would better  
412 solubilise hydrophobic peptides than water.

413 Ferric reducing ability of SBY peptide samples by direct reduction via electron transfer was measured  
414 by the FRAP assay. Peptides found in the retentate 2 of sequence 50-8-1 and retentates 1 and 2 of sequence  
415 15-8-1 acted as stronger reducing agents than the initial hydrolysate (20% to 30% higher values). Higher  
416 antioxidant properties of retentates 1 and 2 could be related to the higher percentage of peptides in the  
417 molecular weight range of  $1\text{--}7 \text{ kg mol}^{-1}$ , as discussed in section 3.2.4. In the fractions obtained in the last  
418 step, the concentration of very small peptides or amino acids ( $< 1 \text{ kg mol}^{-1}$ ) could limit their expressed  
419 antioxidant properties.

420 A highly antioxidant initial hydrolysate before fractionation is expected for spent yeast hydrolysates  
421 because the feed usually contains several compounds with antioxidant properties, such as phenols, polysac-  
422 charides, Maillard-reaction products among other molecules [50]. As fractionation is carried out, these high

423 molecular weight compounds are retained in the first retentate or on the membrane surface, and the antioxi-  
 424 dant activity can be reduced. Even though, antioxidant activity of retentate 2 of 15-8-1 sequence was 1.2 and  
 425 1.7 fold higher than the initial feed, for FRAP and ABTS methods. Antioxidant properties of non-purified  
 426 *S. pastorianus* autolysates were reported, with FRAP assay values of 199-383  $\mu\text{mol}_{\text{TE}} \text{mL}^{-1}$  of fraction, but  
 427 the observed antioxidant properties were attributed to bioactive peptides as well as to glutathione, vitamins  
 428 and phenolic compounds in their free or bond forms [51]. In crude yeast extracts produced by mechanical  
 429 disruption from SBY, antioxidant activity can be even higher (mean values of antioxidant activity evaluated  
 430 by FRAP were  $261 \pm 14 \text{ mg}_{\text{TE}} 100 \text{ g}^{-1}$  of fraction) [52]. Antioxidant activities found in this work were  
 431 probably expressed by peptides and not by the other SBY compounds.

Table 4: Antioxidant properties of the main fractions obtained after UF fractionation measured using ABTS and FRAP methods (in  $\mu\text{mol}_{\text{TE}} \text{g}^{-1}$  d.w.).

	FRAP	ABTS
<i>Sequence 50-8-1</i>		
Retentate 1	$159 \pm 14$	$2371 \pm 8$
Retentate 2	$288 \pm 16$	$3860 \pm 11$
Retentate 3	$69 \pm 9$	$3958 \pm 6$
Permeate 3	$3 \pm 1$	$2710 \pm 35$
<i>Sequence 15-8-1</i>		
Retentate 1	$265 \pm 25$	$2976 \pm 22$
Retentate 2	$269 \pm 20$	$5770 \pm 41$
Retentate 3	$72 \pm 9$	$2121 \pm 17$
Permeate 3	$13 \pm 2$	$1551 \pm 27$

432 Overall, for both antioxidant methods, the most antioxidant fraction for the sequence 15-8-1 was the one  
 433 obtained after UF in 8 kg mol<sup>-1</sup> MWCO membranes (retentate 2), followed by the retentate of the first step  
 434 (retentate 1), the retentate and permeate from 1 kg mol<sup>-1</sup> MWCO membranes, in that order (Table 4). These  
 435 data are independent on protein concentration, because samples were tested at a fixed protein concentration  
 436 (section 2.5). Antioxidant properties results suggest that the molecular weight distribution and the presence  
 437 of intermediate size peptides play a role in the expression of antioxidant activities. Considering the very

438 small differences obtained in the antioxidant properties of the fractions of different fractionation sequences,  
439 anti-diabetic and anti-Alzheimer properties of fractions from only one sequence were investigated. Sequence  
440 2 (15-8-1) was selected considering its higher ABTS antioxidant activity and wider peptides molecular weight  
441 distribution.

#### 442 3.4. *Anti-diabetic properties of SBY peptides*

443  $\alpha$ -amylase inhibitory potential of ultrafiltered peptide fractions from SBY is presented in Table 5, as  
444 the concentration of protein in the SBY extract necessary to cause a 50% inhibition in the enzyme activity  
445 ( $IC_{50}$ ). All fractions from UF fractionation presented the ability to inhibit  $\alpha$ -amylase in concentrations  
446 ranging from 0.018-0.058  $mg_{protein} mL^{-1}$ . The smaller the size of peptides (section 3.2.4), the higher the  
447 inhibitory activity regarding  $\alpha$ -amylase, as a smaller concentration of peptides is required to promote the  
448 same inhibition (50%). Acarbose is a well established  $\alpha$ -amylase and  $\alpha$ -glucosidase inhibitor and the  $IC_{50}$   
449 concentration found in this work was within the range reported in previous works (50-80% inhibition caused  
450 by 0.06-0.30  $mg mL^{-1}$  for  $\alpha$ -amylase) [6, 53]. The concentration of the most active fraction (permeate 3,  
451 considering the protein amount in the extract) was 18 fold higher than the required amount of the standard  
452 acarbose to cause a 50% inhibition in  $\alpha$ -amylase. Although permeate 3 is less efficient than a reference  
453 inhibitor, the concentration is still very small for a non-purified material.

454 At higher concentrations, retentates from the first and second steps of the fractionation sequence were  
455 capable of inhibiting  $\alpha$ -glucosidase (Table 5). Although those yeast peptides inhibited  $\alpha$ -glucosidase activity  
456 in a dose-dependent manner, it was up to a maximum inhibition (about 7-14%) for both retentates 3 and  
457 2. For these reasons, the estimation of the  $IC_{50}$  concentration was not possible for these samples in the  
458 tested peptide concentrations. Highest inhibition activity (14%) by retentate 2 was achieved at a protein  
459 concentration of 0.32  $mg mL^{-1}$  whereas for retentate 1, a 7% inhibition was achieved at around 0.4  $mg_{protein}$   
460  $mL^{-1}$ . For  $\alpha$ -glucosidase, fractions from the 1  $kg mol^{-1}$  MWCO membranes (both retentate 3 and permeate

3) did not show inhibition potential at the maximum final protein concentrations tested (0.4 and 0.1 g<sub>protein</sub> L<sup>-1</sup>, respectively). Limited inhibition ability of fenugreek and quinoa extracts (about 20%) was also reported by other authors for natural inhibitors [54]. Inhibitory activity against  $\alpha$ -glucosidase of acarbose was higher than any of the SBY peptide fractions. Acarbose is a purified synthetic inhibitor whereas SBY fractions are crude mixtures of peptides and other non-protein components, with no prior concentration. Similar acarbose IC<sub>50</sub> concentration (0.15-0.30 mg mL<sup>-1</sup>) regarding  $\alpha$ -glucosidase inhibition was found in literature [9].

Table 5: Inhibition ability of peptide fractions from spent brewer's yeast hydrolysate from ultrafiltration sequence 15-8-1 and relevant standards for  $\alpha$ -amylase,  $\alpha$ -glucosidase and acetylcholinesterase (AChE) inhibition.

Sample	$\alpha$ -amylase	$\alpha$ -glucosidase		AChE	
	IC <sub>50</sub>	I <sub>max</sub> (%)	<i>C</i>	I <sub>max</sub> (%)	<i>C</i>
Retentate 1	0.058 <sup>a</sup>	7	0.398	36	4.84
Retentate 2	0.051 <sup>b</sup>	14	0.322	16	3.92
Retentate 3	0.023 <sup>c</sup>	n.d.*		5	1.44
Permeate 3	0.018 <sup>d</sup>	n.d.#		(<1%) <sup>+</sup>	
Acarbose	<0.060	0.264 (IC <sub>50</sub> )		-	
Galantamine	-	-		0.001 (IC <sub>50</sub> )	

Standard deviations for IC<sub>50</sub> of all samples were smaller than 10%; Different letters in the same column indicate significant differences (95% level). IC<sub>50</sub> is the effective concentration of sample at which the enzyme was inhibited by 50%; IC<sub>50</sub> concentrations for SBY peptide samples are expressed in mg<sub>protein</sub> mL<sup>-1</sup> and for standards (acarbose and galantamine) in mg<sub>standard</sub> mL<sup>-1</sup>; I<sub>max</sub> is the maximum detected enzyme inhibition. *C* is the protein concentration of the sample to promote fraction's maximum inhibition, in mg<sub>protein</sub> mL<sup>-1</sup>; n.d.\*: No inhibitory effects observed at the highest concentration used (0.4 mg<sub>protein</sub> mL<sup>-1</sup>); n.d.#: No inhibitory effects observed at the highest concentration used (0.1 mg<sub>protein</sub> mL<sup>-1</sup>); (<1%)<sup>+</sup>: less than 1% inhibitory effects were observed at the highest concentration used (0.8 mg<sub>protein</sub> mL<sup>-1</sup>).

Limited information is available on anti-diabetic properties of yeast protein hydrolysates as this seems to be the first report of inhibitory activities of SBY protein hydrolysate against  $\alpha$ -amylase and  $\alpha$ -glucosidase. Apart from peptides from plants (soy, barley) [11], endophytic fungi [55], silkworm pupae [7], albumin [43] and salamander [56], various constituents are reported to possess inhibition potential of  $\alpha$ -amylase and  $\alpha$ -glucosidase, such as polyphenols (flavones, flavone glycosides, triterpenes, alkaloids, tannins) [2]. SBY peptide fractions produced in this work showed higher inhibition against  $\alpha$ -amylase than several plant protein extracts. Gastroduodenal quinoa protein digests showed maximum  $\alpha$ -amylase inhibition activity (IC<sub>50</sub> = 0.19 ± 0.02 mg mL<sup>-1</sup>) at the end of digestive process [57]. A protein hydrolysate from black beans

475 promoted a 53% inhibition of  $\alpha$ -amylase at a hydrolysate concentration of  $0.33 \text{ mg L}^{-1}$  [58]. Protein extracts  
476 from bitter gourd showed a very high ability to inhibit both  $\alpha$ -amylase *in vitro*, with a  $\text{IC}_{50}$  of  $0.26 \text{ mg mL}^{-1}$   
477 [6]. A  $\text{IC}_{50}$  concentration of  $0.7\text{-}1 \text{ mg mL}^{-1}$  for protein extracts of *Spirulina platensis* was able to promote  
478 inhibition of  $\alpha$ -amylase. In ethanol quinoa extracts containing saponins and phenolics, the highest inhibition  
479 (25%) of  $\alpha$ -amylase was detected at  $0.6 \text{ mg}_{\text{extract}} \text{ mL}^{-1}$  [54].

480 Protein extracts from *Spirulina platensis* showed inhibition activity regarding  $\alpha$ -glucosidase with about  
481 10-15% inhibition detected for some extracts at  $0.25 \text{ mg mL}^{-1}$  [9], in the same range of values found in this  
482 work. Brewers' spent grain protein hydrolysates showed smaller inhibitory activity against  $\alpha$ -glucosidase  
483 ( $\text{IC}_{50}$  of  $5 \text{ mg mL}^{-1}$ ) [11] than those found for SBY. On the other hand, protein extracts from bitter gourd  
484 ( $\text{IC}_{50} = 0.29 \text{ mg mL}^{-1}$ ) [6], from Chinese salamander ( $\text{IC}_{50} = 0.04\text{-}0.21 \text{ mg mL}^{-1}$ ) [56] and peptides from  
485 dark tea ( $\text{IC}_{50} = 0.04\text{-}1.03 \text{ mg mL}^{-1}$ ) [59] showed a superior ability to inhibit  $\alpha$ -glucosidase enzymes *in vitro*  
486 compared to SBY fractions.

487 In this work, the required concentration of the same fraction of SBY hydrolysate to promote limited  
488 inhibition of  $\alpha$ -glucosidase were much higher than that required to inhibit  $\alpha$ -amylase. Digests from quinoa  
489 protein with a  $\text{IC}_{50}$  of  $0.19 \pm 0.02 \text{ mg}_{\text{protein}} \text{ mL}^{-1}$  to inhibit  $\alpha$ -amylase, also showed higher  $\text{IC}_{50}$  regarding  
490  $\alpha$ -glucosidase ( $\text{IC}_{50} = 1.75 \pm 0.13 \text{ mg}_{\text{protein}} \text{ mL}^{-1}$ ). In another work, extracts from the herb *T. terrestris*  
491 and chickpea showed high inhibitory activity against  $\alpha$ -amylase and a moderate inhibitory effects against  
492  $\alpha$ -glucosidase [3]. The role played by  $\alpha$ -amylase and  $\alpha$ -glucosidase in carbohydrates digestion in human is  
493 synergistic. The first hydrolyses starch into oligo and disaccharides that are then turned into monosaccharides  
494 by  $\alpha$ -glucosidase. Release of monosaccharides in the blood is dependent of an equilibrium of both activities. If  
495 the inhibitor contains a very strong activity against  $\alpha$ -amylase, disaccharides become available for microbiota  
496 fermentation in the gut, possibly leading to gastrointestinal problems due to excessive fermentation [3].  
497 Prospective inhibitors should be able to inhibit the enzymes while maintaining this thin balance. That is

498 why mild inhibitory activities against  $\alpha$ -amylase and  $\alpha$ -glucosidase might be also of interest. Further studies  
499 are necessary to analyse the *in vivo* effect of the SBY peptides on the digestion of carbohydrates.

500 The enzymes used to promote protein hydrolysis as well as the amino acids composition, the degree  
501 of hydrolysis and the size of peptides seem to be related to the expression of anti-diabetic activities by  
502 the inhibition of  $\alpha$ -amylase and  $\alpha$ -glucosidase. Enzymes from *Bacillus* sp. such as trypsin or commercial  
503 enzyme preparations from this micro-organism such as Alcalase™ and Protamex™ are reported to release  
504 peptides with high inhibitory activity against  $\alpha$ -amylase and  $\alpha$ -glucosidase [11, 43, 60, 61]. Peptides from  
505 SBY were produced with two of those enzymes: Alcalase™ and Protamex™ that may be related to the  
506 release of peptides with anti-diabetic properties. Indeed, trypsin specificity to cleave bonds next to arginine  
507 and lysine residues was related to the generation of peptides with the ability to inhibit  $\alpha$ -glucosidase [43].  
508 Several active peptides were reported to contain the basic amino acid arginine and proline but mechanistic  
509 explanations are still lacking [7, 43]. The presence of some hydrophobic amino acids, particularly proline  
510 and leucine, in the case of hemp seed protein hydrolysates, contributed to the  $\alpha$ -glucosidase inhibition [60].  
511 The influence of the enzyme used in the protein hydrolysis seems to be more important than the degree of  
512 hydrolysis as correlations between  $\alpha$ -glucosidase inhibition values and degrees of hydrolysis (1.2 to 14.7%) of  
513 brewer's spent grain hydrolysates were not found, but important differences between enzymes were reported  
514 [11]. A recent study on the influence of the degree of hydrolysis on the  $\alpha$ -glucosidase inhibition activities of  
515 Alcalase™-produced hemp seed protein hydrolysates report that excessive hydrolysis (degrees of hydrolysis  
516 higher than 33%) could limit the generation of inhibitor peptides. Hydrolysates with a degree of hydrolysis  
517 smaller than 10% also did not show any inhibition activity against  $\alpha$ -glucosidase [60]. These results suggest  
518 that in protein hydrolysates of small degree of hydrolysis, further progression of protein hydrolysis (like  
519 the one that happens during gastro-intestinal digestion) may result in enhanced  $\alpha$ -glucosidase inhibition  
520 activities. In our work, SBY protein hydrolysate fractions with a degree of hydrolysis of 7.5% were already



521 able to inhibit this enzyme in a small extent. After gastro-intestinal digestion, the inhibition could be even  
522 higher. On the other hand, a slightly decrease in enzymes inhibitions following *in vitro* digestion was also  
523 reported recently, for the herb *Tribulus terrestris* and chickpea [3].

524 The only report of anti-diabetic activity of yeast peptides reported an *in vivo* effect of the peptide  
525 Cyclo-His-Pro, in rats. Although the mechanism was not clearly established, authors hypothesised that this  
526 peptide played a role in the regulation of insulin and leptin sensitivity by the stimulation of zinc metabolism  
527 [23]. To our best knowledge, this is the first report of both  $\alpha$ -amylase and  $\alpha$ -glucosidase inhibition activities  
528 of SBY protein hydrolysate. These fractions may work against diabetes through multiple mechanisms. The  
529 contribution of specific peptides or a synergistic activity among several peptides or other components, their  
530 mechanism of action and the confirmation of these effects *in vivo* remains to be studied.

### 531 3.5. Anti-Alzheimer properties of SBY peptides

532 SBY ultrafiltered fractions presented the ability to inhibit AChE. All samples inhibited AChE in a dose-  
533 dependent manner with the maximum inhibitions achieved showed in Table 5. To achieve the same inhibition  
534 (15%), smaller amounts of retentate 1 ( $1.6 \text{ mg}_{\text{protein}} \text{ mL}^{-1}$ ) were needed in comparison to retentate 2 ( $3.6$   
535  $\text{mg}_{\text{protein}} \text{ mL}^{-1}$ ). On the other hand, retentates 2 and 3 required the same concentration to achieve a 5%  
536 inhibition (about  $1.5 \text{ mg}_{\text{protein}} \text{ mL}^{-1}$ ). These results suggest that the size of peptides are important but  
537 are not solely responsible for the increased AChE inhibitory activity. All active fractions presented AChE  
538 inhibitory activity much smaller than the common inhibitor galantamine [5].

539 As discussed for the inhibitory activities against  $\alpha$ -amylase and  $\alpha$ -glucosidase, the properties of peptides  
540 can greatly influence the activity observed. Malomo and Aluko (2016) [62] reported that higher AChE-  
541 inhibitory activities were probably related to wider size range peptides and were not correlated to the degree  
542 of hydrolysis. The authors hypothesised that synergistic effects between various peptides could be responsible  
543 for the increased activity. Most active hemp seed protein hydrolysates against AChE were rich in positively

544 charged amino acids (40%) as well as in arginine. According to the authors, arginine, a positively-charged  
545 amino acid, may be able to form a stable complex with a unique anionic site present in the surface of AChE  
546 protein, hindering the access of substrate to the active site [4, 62].

547 Antioxidant activities determined by both FRAP and ABTS methods (section 3.3) were superior for  
548 retentates 1 and 2 in comparison to the other fractions of sequence 15-8-1. One accepted mechanism of  
549 inhibition of enzyme catalysed processes such as those involved in  $\alpha$ -amylase,  $\alpha$ -glucosidase and AChE is by  
550 proton transfer. ABTS scavenging activity work at least by some extent through a hydrogen atom transfer  
551 mechanism [4], which is probably related to the enhanced inhibition activity against  $\alpha$ -glucosidase and AChE  
552 for the same fractions. On the other hand, the increased effect against  $\alpha$ -amylase of the permeate from the  
553 1 kg mol<sup>-1</sup> molecular weight cut-off membrane was not correlated to antioxidant results.

554 Herbal methanol extracts (of *Centaurea* L. species) at 2 mg mL<sup>-1</sup> were able to inhibit AChE (14-25%),  
555 but water extracts of the same plants did not exhibit any activity against AChE [8]. SBY fractions showed  
556 higher AChE inhibitory activity than these plant extracts but more powerful peptides against AChE were  
557 reported as well. Hemp seed protein hydrolysates smaller than 1 kg mol<sup>-1</sup> molecular weight were able to  
558 inhibit AChE in the range of 1-50% for a concentration of 0.010 mg mL<sup>-1</sup> [62]. This appears to be the first  
559 report of the inhibitory activity of SBY protein fractions against AChE activity, and further *in vivo* studies  
560 are needed to confirm peptides potential as anti-Alzheimer nutraceuticals.

#### 561 4. Conclusions

562 Peptide fractions from SBY protein hydrolysate were produced from an agroindustrial by-product of the  
563 brewing industry. Membrane fractionation was able to separate proteins from other yeast compounds (RNA  
564 and sugars). Fractions with various molecular weight distribution were successfully obtained and presented  
565 different abilities to inhibit enzymes involved in the digestion of carbohydrates ( $\alpha$ -amylase and  $\alpha$ -glucosidase)  
566 and in the development of the Alzheimer's disease (AChE), both associated with the metabolic syndrome

567 disorder. The retentate obtained after membrane of  $8\text{kg mol}^{-1}$  of molecular weight cut-off, could be used as  
568 an interesting option as a multi-bioactive ingredient for it presented the higher protein compounds purity  
569 regarding RNA and sugars whilst presenting elevated levels of all bio-activities tested. Further research  
570 should provide the identification of peptides involved in bio-activities expression for a deeper comprehension  
571 of underlying mechanisms and peptide properties, the investigation of the effect of these peptides following  
572 gastro-intestinal digestion and the confirmation *in vivo* of their properties.

### 573 Acknowledgements

574 This work was supported by São Paulo Research Foundation (FAPESP) [grant numbers #2018/04067-  
575 6, #2016/18465-8], the Brazilian National Council for Scientific and Technological Development (CNPq)  
576 [#306461-2017-0] and "Coordenação de Aperfeiçoamento de Pessoal de Nível Superior" (CAPES) - Brazil.  
577 The authors are thankful to the Food Engineering Doctoral Program of UNICAMP (Brazil), GAIA Doctoral  
578 School and Institut Européen des Membranes (Université de Montpellier, France). Special thanks to Valérie  
579 Bonniol and Eddy Petit for the help in chromatographic analyses; Prozyn and Novozymes for the kind  
580 supply of enzymes and Jérôme Panine (Brasserie La Singulière, Sète, France) for donating the spent yeast  
581 from brewing.

### 582 Declaration of interests

583 None.

### 584 References

- 585 [1] A. A. Farooqui, T. Farooqui, Chapter 19 - Contribution of diabetes and metabolic syndrome in the pathogenesis of  
586 Alzheimer's disease, in: T. Farooqui, A. A. Farooqui (Eds.), Role of the Mediterranean Diet in the Brain and Neurode-  
587 generative Diseases, Academic Press, 2018, pp. 301 – 316. doi:<https://doi.org/10.1016/B978-0-12-811959-4.00019-5>.  
588 [2] R. L. Gajbhiye, A. Ganapathy, P. Jaisankar, A review of  $\alpha$ -glucosidase and  $\alpha$ -amylase inhibitors for type 2 diabetes  
589 isolated from some important indian medicinal plants, Ann. Clin. Pharmacol. Ther. 1 (1003).  
590 URL <http://www.remedypublications.com/annals-of-clinical-pharmacology-therapeutics-abstract.php?aid=2350>

- 591 [3] P. Ercan, S. N. El, Inhibitory effects of chickpea and tribulus terrestris on lipase,  $\alpha$ -amylase and  $\alpha$ -glucosidase, Food  
592 Chem. 205 (2016) 163 – 169. doi:<https://doi.org/10.1016/j.foodchem.2016.03.012>.
- 593 [4] S. Riaz, I. U. Khan, M. Bajda, M. Ashraf, Q. ul Ain, A. Shaukat, T. U. Rehman, S. Mutahir, S. Hussain, G. Mustafa,  
594 M. Yar, Pyridine sulfonamide as a small key organic molecule for the potential treatment of type-II diabetes mellitus and  
595 Alzheimer’s disease: *In vitro* studies against yeast  $\alpha$ -glucosidase, acetylcholinesterase and butyrylcholinesterase, Bioorgan.  
596 Chem. 63 (2015) 64 – 71. doi:<https://doi.org/10.1016/j.bioorg.2015.09.008>.
- 597 [5] P. Saravanaraman, R. K. Chinnadurai, R. Boopathy, A new role for the nonpathogenic nonsynonymous single-nucleotide  
598 polymorphisms of acetylcholinesterase in the treatment of Alzheimer’s Disease: A computational study, J. Comput. Biol.  
599 21 (8) (2014) 632–647. doi:<https://doi.org/10.1089/cmb.2014.0005>.
- 600 [6] S. Poovitha, M. Parani, *In vitro* and *in vivo*  $\alpha$ -amylase and  $\alpha$ -glucosidase inhibiting activities of the protein extracts  
601 from two varieties of bitter gourd (*Momordica charantia* L.), BMC Complement. Altern. Med. 16 (185). doi:<https://doi.org/10.1186/s12906-016-1085-1>.
- 602  
603 [7] Y. Zhang, N. Wang, W. Wang, J. Wang, Z. Zhu, X. Li, Molecular mechanisms of novel peptides from silkworm pupae  
604 that inhibit  $\alpha$ -glucosidase, Pept. 76 (2016) 45 – 50. doi:<https://doi.org/10.1016/j.peptides.2015.12.004>.
- 605 [8] A. Aktumsek, G. Zengin, G. O. Guler, Y. S. Cakmak, A. Duran, Antioxidant potentials and anticholinesterase activities  
606 of methanolic and aqueous extracts of three endemic *Centaurea* l. species, Food Chem. Toxicol. 55 (2013) 290 – 296.  
607 doi:<https://doi.org/10.1016/j.fct.2013.01.018>.
- 608 [9] S. Hu, X. Fan, P. Qi, X. Zhang, Identification of anti-diabetes peptides from *Spirulina platensis*, J. Funct. Foods 56 (2019)  
609 333 – 341. doi:<https://doi.org/10.1016/j.jff.2019.03.024>.
- 610 [10] C. Lammi, G. Aiello, G. Boschini, A. Arnoldi, Multifunctional peptides for the prevention of cardiovascular disease: A  
611 new concept in the area of bioactive food-derived peptides, J. Funct. Foods 55 (2019) 135 – 145. doi:<https://doi.org/10.1016/j.jff.2019.02.016>.
- 612  
613 [11] A. Connolly, C. O. Piggott, R. J. FitzGerald, *In vitro*  $\alpha$ -glucosidase, angiotensin converting enzyme and dipeptidyl  
614 peptidase-IV inhibitory properties of brewers’ spent grain protein hydrolysates, Food Res. Int. 56 (2014) 100 – 107.  
615 doi:<https://doi.org/10.1016/j.foodres.2013.12.021>.
- 616 [12] G. V. Marson, R. J. S. de Castro, M. T. da Costa Machado, F. da Silva Zandonadi, H. D. de Freitas Queiroz Barros,  
617 M. R. M. Júnior, A. Sussulini, M. D. Hubinger, Proteolytic enzymes positively modulated the physicochemical and  
618 antioxidant properties of spent yeast protein hydrolysates, Process Biochem. 91 (2020) 34 – 45. doi:<https://doi.org/10.1016/j.procbio.2019.11.030>.
- 619  
620 [13] M. Amorim, C. Marques, J. Pereira, L. G. ao, M. Martins, H. Osório, D. Moura, C. Calhau, H. Pinheiro, M. Pintado,  
621 Antihypertensive effect of spent brewer yeast peptide, Process Biochem. 76 (2019) 213 – 218. doi:<https://doi.org/10.1016/j.procbio.2018.10.004>.
- 622  
623 [14] M. Amorim, H. Pinheiro, M. Pintado, Valorization of spent brewer’s yeast: Optimization of hydrolysis process towards  
624 the generation of stable ACE-inhibitory peptides, LWT - Food Sci. Technol. 111 (2019) 77 – 84. doi:<https://doi.org/10.1016/j.lwt.2019.05.011>.
- 625  
626 [15] M. Amorim, J. O. Pereira, D. Gomes, C. D. Pereira, H. Pinheiro, M. Pintado, Nutritional ingredients from spent brewer’s  
627 yeast obtained by hydrolysis and selective membrane filtration integrated in a pilot process, J. Food Eng. 185 (2016) 42  
628 – 47. doi:<https://doi.org/10.1016/j.jfoodeng.2016.03.032>.
- 629 [16] E. Bukusoglu, H. Koku, P. Z. Çulfaz Emecen, Addressing challenges in the ultrafiltration of biomolecules from complex

- aqueous environments, *Curr. Opin. Colloid Interface Sci.* 46 (2020) 52 – 64. doi:<https://doi.org/10.1016/j.cocis.2020.03.003>.
- [17] Y. Xia, J. Yu, W. Xu, Q. Shuang, Purification and characterization of angiotensin-I-converting enzyme inhibitory peptides isolated from whey proteins of milk fermented with *Lactobacillus plantarum* QS670, *J. Dairy Sci.* 103 (6) (2020) 4919 – 4928. doi:<https://doi.org/10.3168/jds.2019-17594>.
- [18] A. Boukil, S. Suwal, J. Chamberland, Y. Pouliot, A. Doyen, Ultrafiltration performance and recovery of bioactive peptides after fractionation of tryptic hydrolysate generated from pressure-treated  $\beta$ -lactoglobulin, *J. Membr. Sci.* 556 (2018) 42 – 53. doi:<https://doi.org/10.1016/j.memsci.2018.03.079>.
- [19] K. Zhou, S. Sun, C. Canning, Production and functional characterisation of antioxidative hydrolysates from corn protein via enzymatic hydrolysis and ultrafiltration, *Food Chem.* 135 (3) (2012) 1192 – 1197. doi:<https://doi.org/10.1016/j.foodchem.2012.05.063>.
- [20] I. D. Nwachukwu, A. T. Girgih, S. A. Malomo, J. O. Onuh, R. E. Aluko, Thermoase-derived flaxseed protein hydrolysates and membrane ultrafiltration peptide fractions have systolic blood pressure-lowering effects in spontaneously hypertensive rats, *Int. J. Mol. Sci.* 15 (10) (2014) 18131–18147. doi:<https://doi.org/10.3390/ijms151018131>.
- [21] L. Wu, A. Jiang, Y. Jing, Y. Zheng, Y. Yan, Antioxidant properties of protein hydrolysate from Douchi by membrane ultrafiltration, *Int. J. Food Prop.* 20 (5) (2017) 997–1006. doi:<https://doi.org/10.1080/10942912.2016.1192644>.
- [22] S. Bondu, C. Bonnet, J. Gaubert, E. Deslandes, S. L. Turgeon, L. Beaulieu, Bioassay-guided fractionation approach for determination of protein precursors of proteolytic bioactive metabolites from macroalgae, *J Appl Phycol* 27 (2015) 2059 – 2074. doi:<https://doi.org/10.1007/s10811-014-0425-0>.
- [23] E. Y. Jung, H.-S. Lee, J. W. Choi, K. S. Ra, M.-R. Kim, H. J. Suh, Glucose tolerance and antioxidant activity of spent brewer's yeast hydrolysate with a high content of Cyclo-His-Pro (CHP), *J. Food Sci.* 76 (2) (2011) C272–C278. doi:<https://doi.org/10.1111/j.1750-3841.2010.01997.x>.
- [24] J. Charney, R. M. A. Tomarelli, A colorimetric method for the determination of the proteolytic activity of duodenal juice, *J. Biol. Chem.* 170 (1947) 501–505.
- [25] R. J. S. de Castro, H. H. Sato, A response surface approach on optimization of hydrolysis parameters for the production of egg white protein hydrolysates with antioxidant activities, *Biocatal. Agric. Biotechnol.* 4 (1) (2015) 55 – 62. doi:<https://doi.org/10.1016/j.bcab.2014.07.001>.
- [26] G. V. Marson, M. T. da Costa Machado, R. J. S. de Castro, M. D. Hubinger, Sequential hydrolysis of spent brewer's yeast improved its physico-chemical characteristics and antioxidant properties: A strategy to transform waste into added-value biomolecules, *Process Biochem.* 84 (2019) 91 – 102. doi:<https://doi.org/10.1016/j.procbio.2019.06.018>.
- [27] C. Taddei, J. A. Howell, On the effect of membrane conditioning in cell harvesting using microfiltration, *Biotechnol. Tech.* 3 (1989) 155 – 160. doi:<https://doi.org/10.1007/BF01875612>.
- [28] A. Fane, C. Fell, A. Waters, Ultrafiltration of protein solutions through partially permeable membranes - the effect of adsorption and solution environment, *J. Membr. Sci.* 16 (1983) 211 – 224. doi:[https://doi.org/10.1016/S0376-7388\(00\)81311-3](https://doi.org/10.1016/S0376-7388(00)81311-3).
- [29] J. Xu, R.-Q. Yue, J. Liu, H.-M. Ho, T. Yi, H.-B. Chen, Q.-B. Han, Structural diversity requires individual optimization of ethanol concentration in polysaccharide precipitation, *Int. J. Biol. Macromol.* 67 (2014) 205 – 209. doi:<https://doi.org/10.1016/j.ijbiomac.2014.03.036>.
- [30] E. Fournier, Colorimetric quantification of carbohydrates, in: R. E. Wrolstad (Ed.), *Current Protocols in Food Analytical*

- 669 Chemistry, John Wiley & Sons, Inc., 2001, pp. E1.1.1–E1.1.8. doi:<https://doi.org/10.1002/0471142913.fae0101s00>.
- 670 [31] A. Aitken, M. P. Learmonth, Protein determination by UV absorption, in: J. M. Walker (Ed.), The Protein Protocols  
671 Handbook, Humana Press, Totowa, NJ, 2002, pp. 3–6. doi:<https://doi.org/10.1385/1-59259-169-8:3>.
- 672 [32] AOAC, Official Methods of Analysis of the Association of Official Analytical Chemists, 18th Edition, Gaithersburg, MD,  
673 USA, 2006.
- 674 [33] J. H. Waterborg, The lowry method for protein quantitation, in: J. M. Walker (Ed.), The Protein Protocols Handbook,  
675 Humana Press, Totowa, NJ, 2002, pp. 7–9. doi:<https://doi.org/10.1385/1-59259-169-8:7>.
- 676 [34] J. M. Webb, H. L. Levy, A sensitive method for the determination of deoxyribonucleic acid in tissues and microorganisms,  
677 J. Biol. Chem. 213 (1955) 107 – 117.
- 678 [35] J. M. Webb, Studies on the determination of total nucleic acids by ultraviolet absorption methods, J. Biol. Chem. 230  
679 (1958) 1023 – 1030.
- 680 [36] P. Sceni, G. G. Palazolo, M. del Carmen Vasallo, M. C. Puppo, M. A. Otero, J. R. Wagner, Thermal and surface  
681 behavior of yeast protein fractions from *Saccharomyces cerevisiae*, LWT - Food Sci. Technol. 42 (6) (2009) 1098 – 1106.  
682 doi:<https://doi.org/10.1016/j.lwt.2009.02.010>.
- 683 [37] N. Dallies, J. François, V. Paquet, A new method for quantitative determination of polysaccharides in the yeast cell wall.  
684 application to the cell wall defective mutants of *Saccharomyces cerevisiae*, Yeast 14 (14) (1998) 1297–1306. doi:[https://doi.org/10.1002/\(SICI\)1097-0061\(1998100\)14:14<1297::AID-YEA310>3.0.CO;2-L](https://doi.org/10.1002/(SICI)1097-0061(1998100)14:14<1297::AID-YEA310>3.0.CO;2-L).
- 685 [38] N. M. Vasconcelos, G. A. S. Pinto, F. A. S. Aragão, Determinação de açúcares redutores pelo ácido 3,5-dinitrosalicílico:  
687 histórico do desenvolvimento do método e estabelecimento de um protocolo para o laboratório de bioprocessos, Tech. rep.,  
688 EMBRAPA, Fortaleza, number 88 (2013).  
689 URL <http://ainfo.cnptia.embrapa.br/digital/bitstream/item/103342/1/BPD13017>
- 690 [39] I. F. Benzie, J. Strain, The ferric reducing ability of plasma (FRAP) as a measure of “Antioxidant Power”: The FRAP  
691 assay, Anal. Biochem. 239 (1) (1996) 70 – 76. doi:<https://doi.org/10.1006/abio.1996.0292>.
- 692 [40] M. S. M. Rufino, R. E. Alves, E. S. Brito, J. Mancini Filho, A. V. B. Moreira, Metodologia científica: determinação  
693 da atividade antioxidante total em frutas no sistema  $\beta$ -caroteno/ácido linoleico, Tech. Rep. 126, EMBRAPA, Fortaleza  
694 (2006).  
695 URL <http://ainfo.cnptia.embrapa.br/digital/bitstream/CNPAT-2010/11963/1/cot-126>
- 696 [41] R. Re, N. Pellegrini, A. Proteggente, A. Pannala, M. Yang, C. Rice-Evans, Antioxidant activity applying an improved  
697 ABTS radical cation decolorization assay, Free Radic. Biol. Med. 26 (9) (1999) 1231 – 1237. doi:[https://doi.org/10.1016/S0891-5849\(98\)00315-3](https://doi.org/10.1016/S0891-5849(98)00315-3).
- 698 [42] M. Mirzaei, S. Mirdamadi, M. R. Ehsani, M. Aminlari, E. Hosseini, Purification and identification of antioxidant and  
700 ACE-inhibitory peptide from *Saccharomyces cerevisiae* protein hydrolysate, J. Funct. Foods 19 (2015) 259 – 268. doi:  
701 <https://doi.org/10.1016/j.jff.2015.09.031>.
- 702 [43] Z. Yu, Y. Yin, W. Zhao, J. Liu, F. Chen, Anti-diabetic activity peptides from albumin against  $\alpha$ -glucosidase and  $\alpha$ -amylase,  
703 Food Chem. 135 (3) (2012) 2078 – 2085. doi:<https://doi.org/10.1016/j.foodchem.2012.06.088>.
- 704 [44] R. Wang, H. Zhao, X. Pan, C. Orfila, W. Lu, Y. Ma, Preparation of bioactive peptides with antidiabetic, antihypertensive,  
705 and antioxidant activities and identification of  $\alpha$ -glucosidase inhibitory peptides from soy protein, Food Sci. Nutr. 7 (5)  
706 (2019) 1848–1856. doi:<https://doi.org/10.1002/fsn3.1038>.
- 707 [45] H. Ma, C. N. Bowman, R. H. Davis, Membrane fouling reduction by backpulsing and surface modification, J. Membr. Sci.

- 708 173 (2) (2000) 191 – 200. doi:[https://doi.org/10.1016/S0376-7388\(00\)00360-4](https://doi.org/10.1016/S0376-7388(00)00360-4).
- 709 [46] X. Shi, G. Tal, N. P. Hankins, V. Gitis, Fouling and cleaning of ultrafiltration membranes: A review, *J. Water Process*  
710 *Eng. 1* (Supplement C) (2014) 121 – 138. doi:<https://doi.org/10.1016/j.jwpe.2014.04.003>.
- 711 [47] F. F. Jacob, L. Striegel, M. Rychlik, M. Hutzler, M. F.-J., Yeast extract production using spent yeast from beer manufacture:  
712 influence of industrially applicable disruption methods on selected substance groups with biotechnological relevance, *Eur.*  
713 *Food Res. Technol.* 245 (2019) 1169–1182. arXiv:<https://doi.org/10.1007/s00217-019-03237-9>.
- 714 [48] A. Halász, R. Lásztity, Chemical composition and biochemistry of yeast biomass, in: A. Halász, R. Lásztity (Eds.), *Use*  
715 *of yeast biomass in food production*, CRC Press, Boca Raton, USA, 1991, pp. 23–41.
- 716 [49] A. I. Olagunju, O. S. Omoba, V. N. Enujiugha, A. M. Alashi, R. E. Aluko, Pigeon pea enzymatic protein hydrolysates and  
717 ultrafiltration peptide fractions as potential sources of antioxidant peptides: An *in vitro* study, *LWT - Food Sci. Technol.*  
718 97 (2018) 269 – 278. doi:<https://doi.org/10.1016/j.lwt.2018.07.003>.  
719 URL <http://www.sciencedirect.com/science/article/pii/S0023643818305735>
- 720 [50] B. Podpora, F. Świdorski, A. Sadowska, R. Rakowska, G. Wasiak-zys, Spent brewer's yeast extracts as a new component  
721 of functional food, *Czech J. Food Sci.* 34 (6) (2016) 554–563. doi:<https://doi.org/10.17221/419/2015-CJFS>.
- 722 [51] E. F. Vieira, A. Melo, I. M. Ferreira, Autolysis of intracellular content of brewer's spent yeast to maximize ACE-inhibitory  
723 and antioxidant activities, *LWT - Food Sci. Technol.* 82 (2017) 255 – 259. doi:[https://doi.org/10.1016/j.lwt.2017.](https://doi.org/10.1016/j.lwt.2017.04.046)  
724 04.046.
- 725 [52] E. F. Vieira, J. Carvalho, E. Pinto, S. Cunha, A. A. Almeida, I. M. Ferreira, Nutritive value, antioxidant activity and  
726 phenolic compounds profile of brewer's spent yeast extract, *J. Food Compos. Anal.* 52 (2016) 44 – 51. doi:<https://doi.org/10.1016/j.jfca.2016.07.006>.
- 727 [53] G. R. M. Chelladurai, C. Chinnachamy, Alpha amylase and alpha glucosidase inhibitory effects of aqueous stem extract  
728 of *Salacia oblonga* and its GC-MS analysis, *Braz. J. Pharm. Sci.* 54 (1) (2018) 1–10. doi:[https://doi.org/10.1590/](https://doi.org/10.1590/s2175-97902018000117151)  
729 [s2175-97902018000117151](https://doi.org/10.1590/s2175-97902018000117151).
- 730 [54] T. Herrera, J. N. del Hierro], T. Fornari, G. Reglero, D. Martin, Inhibitory effect of quinoa and fenugreek extracts on  
731 pancreatic lipase and  $\alpha$ -amylase under *in vitro* traditional conditions or intestinal simulated conditions, *Food Chem.* 270  
732 (2019) 509 – 517. doi:<https://doi.org/10.1016/j.foodchem.2018.07.145>.
- 733 [55] S. Al-Hosni, T. S. Rizvi, A. Khan, L. Ali, N. U. Rehman, U. Rashid, J. Hussian, A. L. Khan, A. Al-Harrasi, Diketopeprazin  
734 and methyl-5-docosenoate from endophytic fungi *Aureobasidium pollulan* BSS6 with  $\alpha$ -glucosidase inhibition and its  
735 validation through molecular docking, *S Afr. J. Bot.* In press. doi:<https://doi.org/10.1016/j.sajb.2020.03.007>.
- 736 [56] A. H. Ramadhan, T. Nawas, X. Zhang, W. M. Pembe, W. Xia, Y. Xu, Purification and identification of a novel antidiabetic  
737 peptide from chinese giant salamander (*Andrias davidianus*) protein hydrolysate against  $\alpha$ -amylase and  $\alpha$ -glucosidase, *Int.*  
738 *J. Food Prop.* 20 (sup3) (2017) S3360–S3372. doi:<https://doi.org/10.1080/10942912.2017.1354885>.
- 739 [57] R. Vilcacundo, C. Martínez-Villaluenga, B. Hernández-Ledesma, Release of dipeptidyl peptidase IV,  $\alpha$ -amylase and  $\alpha$ -  
740 glucosidase inhibitory peptides from quinoa (*Chenopodium quinoa* Willd.) during *in vitro* simulated gastrointestinal di-  
741 gestion, *J. Funct. Foods* 35 (2017) 531 – 539. doi:<https://doi.org/10.1016/j.jff.2017.06.024>.
- 742 [58] L. Mojica, E. G. de Mejía, Optimization of enzymatic production of anti-diabetic peptides from black bean (*Phaseolus*  
743 *vulgaris* l.) proteins, their characterization and biological potential, *Food Funct.* 7 (2016) 713–727. doi:[https://doi.org/](https://doi.org/10.1039/C5F001204J)  
744 [10.1039/C5F001204J](https://doi.org/10.1039/C5F001204J).
- 745 [59] B. Zhao, K. Su, X. Mao, X. Zhang, Separation and identification of enzyme inhibition peptides from dark tea protein,

- 747 Bioorgan. Chem. 99 (2020) 103772. doi:<https://doi.org/10.1016/j.bioorg.2020.103772>.
- 748 [60] Y. Ren, K. Liang, Y. Jin, M. Zhang, Y. Chen, H. Wu, F. Lai, Identification and characterization of two novel  $\alpha$ -glucosidase  
749 inhibitory oligopeptides from hemp (*Cannabis sativa* L.) seed protein, J. Funct. Foods 26 (2016) 439 – 450. doi:<https://doi.org/10.1016/j.jff.2016.07.024>.
- 750
- 751 [61] C. Uraipong, J. Zhao, Rice bran protein hydrolysates exhibit strong *in vitro*  $\alpha$ -amylase,  $\alpha$ -glucosidase and ACE-inhibition  
752 activities, J. Sci. Food Agric. 96 (4) (2016) 1101–1110. doi:<https://doi.org/10.1002/jsfa.7182>.
- 753 [62] S. A. Malomo, R. E. Aluko, *In Vitro* acetylcholinesterase-inhibitory properties of enzymatic hemp seed protein hy-  
754 drolysates, J. Am. Oil Chem. Soc. 93 (3) (2016) 411–420. doi:<https://doi.org/10.1007/s11746-015-2779-0>.



## Chapter 9

# General Discussion

The extraction of compounds from agro-industrial by-products has been an important research subject. The development of processing strategies for the extraction of specific components from complex matrices with the minimum amount of steps and minimum cost is currently being investigated for a wide variety of by-products. The search for alternative sources of protein and peptides fits in this context, being motivated by customer demands and recent market trends.

The recovery of value-added components from agro-industrial by-products is of interest from both economic and environmental points of view. The processing strategy needs to consider process sustainability and carefully define technologies choice. Enzymatic hydrolysis has currently been employed in the treatment of various by-products and waste streams from the food industry, allowing the recovery of several value-added components, such as peptides. Once a hydrolysate is produced, complex composition and the need to separate molecules which generally have similar sizes and physico-chemical properties) require efficient downstream technologies. Membrane separation technology is one of the main separation strategies used in the recovery of value-added fractions from agro-industrial by-products. It is much employed in the recovery of bioactive peptides because a high throughput separation in mild temperature conditions is possible. Energy consumption and general cost involved in this technology are also usually smaller than those of other very performing separation technologies.

The spent brewer's yeast is an under-explored material with more than half of its composition represented by proteins (in dry matter). Several challenges are related to the processing of spent yeasts from brewing: on one side, the complex composition

(characterised by a naturally high ribonucleic acids content) and variability of strains and brewing method, that requires a resilient and versatile process; on the other side, the thick and resistant yeast cell walls, that need to be disrupted in order to release yeast components.

This work aimed at associating the advantages of efficient and “green” technologies such as enzymatic hydrolysis and membrane separation with the need to reuse and add-value to agro-industrial by-products. The search was directed to the production of bioactive peptides from this by-product from brewing.

The first step in processing the residual yeast was to rupture the cell wall and release yeast components. For this, we tested two conventional methods (autolysis and glass bead milling) with a novel enzymatic process using a commercial enzyme Brauzyn<sup>TM</sup> (Chapter 5). Hydrolysis conditions using this enzyme were studied. At pH 5.5, 60 °C, no dilution and a 10% enzyme and substrate ratio, maximum yield and antioxidant activity of the hydrolysate were obtained. The comparison of enzymatically-produced rupture with autolysis and glass bead milling suggested that the first promoted a higher release of protein compounds and a more efficient cell breakdown, while maintaining a higher antioxidant capacity in the final extract. We also evaluated the susceptibility of different brewing yeasts and reported that repitched yeasts presented a higher resistance of yeast cells to disruption. These results confirm that yeast processes should contemplate yeast differences so that a successful implementation of the technology is possible.

As indicated by the results of Chapter 5, one of the most innovative and efficient way of solubilising proteins from yeasts is through enzymatic hydrolysis. With the objective of producing peptides, the use of sequential protein hydrolysis in the ruptured material were evaluated, and a high solids recovery and improvement in antioxidant properties were achieved. In order to decrease the number of processing steps, a simultaneous enzymatic hydrolysis to promote both cell wall disruption and peptide production using Brauzyn<sup>TM</sup>, Protamex<sup>TM</sup> and Alcalase<sup>TM</sup> was proposed (Chapter 6). Enzyme proportions were changed inside of a mixture design and it how the physicochemical characteristics of the yeast protein hydrolysate changed when the enzymes proportions did were evaluated, considering total solids and crude protein content, the release of hydrophobic residues, the degree of hydrolysis, antioxidant properties and colour of the hydrolysates. All yeast fractions and products were characterised, considering their proximal

composition and physico-chemical properties. Antioxidant activity of all yeast hydrolysate was monitored throughout the processing steps, to evaluate how processing affected the expression of antioxidant abilities, sometimes associated with other bioactive effects. Yeast protein hydrolysates presented a varying dry matter (d. m.) content that was dependent on spent brewer's yeast collection conditions. A high content of crude protein (>50%, d. m.) was achieved in most of the produced hydrolysates. Content of polysaccharide is the second most representative (20-35%, d. m.) followed by an important ash content (about 10%) and the presence of ribonucleic acids (3-7%). A recovery of 70% of crude proteins from the raw material was achieved. Protein hydrolysates with limited degree of hydrolysis were produced (average: 15%). This work demonstrated that the enzyme choice modulated the degree of hydrolysis, the release of solids, the darkening and browning of samples, and their antioxidant properties. Depending on the considered product outcome, a different mixture of enzymes should be selected. The combination of Protamex<sup>TM</sup> and Brauzyn<sup>TM</sup>, for instance, seemed to maximise the degree of hydrolysis and antioxidant activity by the FRAP assay. Protamex<sup>TM</sup> alone or in high proportions resulted in the darker, more brown hydrolysates. Finally, equal proportions of the three enzymes resulted in maximum DPPH antioxidant activity. These results suggested that different applications for the spent brewer's yeast protein hydrolysate should envisage different enzyme proportions. A single protein hydrolysate was chosen to the membrane separation study. For this, the hydrolysate using equal proportions of all three enzymes was chosen. This condition resulted in the maximum protein and solids recovery, limited colour development, limited degree of hydrolysis, release of hydrophobic residues and the hydrolysate presented high antioxidant activity by DPPH method. The DPPH method was prioritised over FRAP because the DPPH antioxidant method works from both hydrogen atom transfer and electron transfer mechanisms, while the FRAP assay only evaluates the electron transfer mechanism of the species. Correlations between antioxidant and bioactive properties suggest that antioxidant protein hydrolysates have a higher probability of presenting bioactive peptides. The membrane separation of the peptides from spent yeast ultimately envisaged the concentration of bioactive peptides, thus, this parameter was one of the most important factors on the choice of protein hydrolysis conditions.

The separation of the spent brewer's yeast protein hydrolysate was first studied in polymeric membranes of polyethersulphone and regenerated cellulose, the most common materials used in the food industry. Fouling is one of the main challenges of pressure-driven membrane processes, and the study was focused on understanding which were the main mechanisms behind this phenomenon during the ultrafiltration of spent yeasts hydrolysate (Chapter 7), as no information on this subject, that is essential in process design of unexploited by-products separation such as spent brewer's yeast was available in the literature. The aim of this first work on membranes was to investigate membrane selectivity and fouling after the dead-end ultrafiltration of spent brewer's yeast protein hydrolysate. For this we used regenerated cellulose and polyethersulphone membranes of 30 kDa of molecular weight cut-off from Microdyn Nadir, in two pH (5 and 8). The evaluation was done considering static and dynamic conditions, and a detailed characterisation of the membranes was done considering surface properties (roughness, zeta potential, hydrophilicity), resistance to transport and selectivity. Higher peptide retention was achieved using polyethersulfone membranes and a feed pH of 5. The susceptibility to fouling was decreased when more hydrophilic regenerated cellulose membranes were used. A smaller adsorption of proteins and decreased resistance to mass transfer were achieved at pH 8. Membrane and fractions characterisations confirmed that peptides are the main foulant in polymeric membranes and suggested that foulants aggregate on the surface of membranes by weak physical adsorption.

Our results have shown that hydrophilic membranes seemed more adapted to the ultrafiltration of spent brewer's yeast. However, polymeric membranes have a limited resistance to cleaning, an important factor to food industrial processing. Because of this, we chose to continue the study in hydrophilic ceramic membranes, in a pseudo-tangential module. Membranes from TAMI Industries (France) were used, with molecular weight cut-off from 50 to 1 kDa, made of titanium oxide. These membranes are resistant to high temperatures, concentrated acids and bases, are autoclavable and have long functional life. Thus, in the last part of this work, two fractionation sequences using ceramic membranes were evaluated in the recovery of peptide-rich fractions with bioactive properties (Chapter 8). A thorough characterisation of fractions composition allowed the evaluation of how peptides are separated from the other components of the

spent brewer's yeast protein hydrolysate. Protein purity regarding RNA was increased during fractionation with a maximum purity of protein compounds was 34 g per g of total sugars and 17 g per g of ribonucleic acids. Peptides fractionation was possible using membranes in the range of 50-1 kg mol<sup>-1</sup> of molecular weight cut-off, confirmed through size exclusion chromatography. Yeast fractionated peptides have shown antioxidant activities by determined by two methods: Ferric Reducing Ability of Plasma (FRAP) and ABTS radical scavenging activity. Data suggested that the molecular weight distribution and the presence of intermediate size peptides played a role in the expression of these antioxidant activities. Multi-active fractions against the metabolic syndrome were obtained, presenting antioxidant properties and inhibition activities against  $\alpha$ -amylase,  $\alpha$ -glucosidase and acetylcholinesterase. The contribution of specific peptides or a synergistic activity among several peptides or other components, their mechanism of action and the confirmation of these effects in vivo remains to be studied. Each fraction presented different extents of activity, and each could be used for one purpose. The retentate obtained after the 15 and 8 kg mol<sup>-1</sup> molecular weight cut-off membranes could be used as an interesting option as a multi-bioactive ingredient. It presented the higher protein compounds purity regarding RNA and sugars whilst presenting elevated levels of all bio-activities tested.

The results presented in this work encourage studies and development of strategies to the valorisation of agro-industrial residues, specially yeast-based by-products as source of bioactive peptides. The obtained peptides showed characteristics that are in harmony with the trend of alternative sources of proteins and the movement towards a more sustainable economy with less residues. The spent yeast fractions produced in this work may be used as ingredients for applications in the food, biotechnological and pharmaceutical industries.

## Chapter 10

# General Conclusions and Perspectives

### 10.1 Conclusions

Enzymatic hydrolysis was a technically efficient method to promote yeast disruption and produce peptides from spent brewer's yeast. The process developed with commercial enzymes Brauzyn<sup>®</sup>, Alcalase<sup>™</sup> and Protamex<sup>™</sup> was effective at high solid concentrations, without previous dilution of the substrate, at mild conditions (pH 7 and 50 °C). Proportion of enzymes as well as enzyme choice modulated the degree of hydrolysis, release of solids, browning degree of samples and antioxidant properties, and should be defined according to the ingredient intended application.

The production of protein-rich fractions from spent brewer's yeast protein hydrolysate was possible through ultra and nanofiltration in both polymeric and ceramic membranes. In polymeric membranes, fouling can be minimised if hydrophilic membrane materials are used and at higher pH values. The multi-stage fractionation of spent brewer's yeast bioactive peptides was possible using ceramic membranes of molecular weight cut-off between 50-1 kg mol<sup>-1</sup>. Peptides with multiple activities against the metabolic syndrome were found, being able to act as antioxidants or inhibitors of enzymes involved in the digestion of carbohydrates and in the development of Alzheimer's disease.

Based on the findings and knowledge presented in this work, it is concluded that sequential processes based on enzymatic hydrolysis and membrane separation are capable of producing fractions rich in peptides from spent brewer's yeast and therefore this by-product can be considered as an alternative source of protein for the production

of peptides. The process developed may be applicable for the reuse and transformation of other biomass or yeast-based wastes of complex composition.

## 10.2 Perspectives

This work was able to assess a small portion of the potential of spent yeasts as novel ingredients. Further research in targeted processing technologies with smaller steps and higher efficiency are required to add even more value to spent brewer's yeast-based ingredients. Some points to be explored that could certainly aggregate to this field of research, are:

- Expand the application of residual yeast processing technology: studies on the influence of yeast strain, changes in brewing parameters and the development of more flexible processes that are able to handle these variations; evaluation of the influence of fermentation processes on the recovery of targeted molecules from inactivated spent brewer's yeast, instead of protein hydrolysis; further research in targeted processing technologies with fewer steps and improved efficiency; industrial scale adaptation of the technology;
- Optimise separation: optimisation of process conditions for the ultrafiltration of spent brewer's yeast hydrolysates focused on flux and yield performance, in pilot and industrial scales, for different modules and systems; simultaneous extraction and separation, for instance, using membrane bioreactors; evaluation of the development of multi-stage fractionation bio-processes able to separate more than one component of the hydrolysate at the same time, in different fractions, such as  $\beta$ -glucans, GABA, kynurenic acid, etc;
- Investigate functional and bioactive properties and aspects of product engineering: further exploration of spent brewer's yeast peptides technological functionalities (emulsification capacity, water-holding ability, etc.) and bio-activities, *in vitro* and *in vivo*; investigation of underlying mechanisms of the anti-diabetic, antioxidant and anti-Alzheimer activities found in this work; identification of the different spent brewer's yeast peptides released, by mass spectrometry; toxicity evaluation of final peptide extracts and all fractions/ingredients with commercial potential

generated during the process; digestibility/bio-accessibility investigation of the developed ingredients; sensorial analysis of the obtained fractions and peptides should be carried out to evaluate the acceptability and application of those ingredients in food products.



## References

ABOU-ZEID, A.; JALALUDDIN, A. K.; ABULNAJA, K. O. On methods for reduction of nucleic acids content in a single-cell protein from gas oil. **Bioresour. Technol.**, v. 52, n. 1, p. 21–24, 1995. ISSN 0960-8524. DOI: 10.1016/0960-8524(95)99782-Q.

AMORIM, M.; PEREIRA, J. O.; GOMES, D.; PEREIRA, C. D.; PINHEIRO, H.; PINTADO, M. Nutritional ingredients from spent brewer's yeast obtained by hydrolysis and selective membrane filtration integrated in a pilot process. **J. Food Eng.**, v. 185, p. 42–47, 2016. ISSN 0260-8774. DOI: 10.1016/j.jfoodeng.2016.03.032.

BUKUSOGLU, E.; KOKU, H.; ÇULFAZ-EMECEN, P. Z. Addressing challenges in the ultrafiltration of biomolecules from complex aqueous environments. **Curr. Opin. Colloid Interface Sci.**, v. 46, p. 52–64, 2020. ISSN 1359-0294. DOI: 10.1016/j.cocis.2020.03.003.

EMIN, C.; KURNIA, E.; KATALIA, I.; ULBRICHT, M. Polyarylsulfone-based blend ultrafiltration membranes with combined size and charge selectivity for protein separation. **Sep. Purif. Technol.**, v. 193, p. 127–138, 2018. ISSN 1383-5866. DOI: 10.1016/j.seppur.2017.11.008.

FERREIRA, I. M. P. L. V. O.; PINHO, O.; VIEIRA, E.; TAVARELA, J. G. Brewer's *Saccharomyces* yeast biomass: characteristics and potential applications. **Trends Food Sci. & Technol.**, v. 21, n. 2, p. 77–84, 2010. ISSN 0924-2244. DOI: 10.1016/j.tifs.2009.10.008.

HALÁSZ, A.; LÁSZTITY, R. Chemical composition and biochemistry of yeast biomass. In: HALÁSZ, A.; LÁSZTITY, R. (Eds.). **Use of yeast biomass in food production**. Boca Raton, USA: CRC Press, 1991. p. 23–41. ISBN 9780849358661.

- KUMAR, R. S.; CHANDRASEKARAN, M. Beverages. In: CHANDRASEKARAN, M. (Ed.). **Valorization of Food Processing By-Products**. Boca Raton: CRC Press, 2016. p. 589–614. ISBN 9781439848876.
- LAMMI, C.; AIELLO, G.; BOSCHIN, G.; ARNOLDI, A. Multifunctional peptides for the prevention of cardiovascular disease: A new concept in the area of bioactive food-derived peptides. **J. Funct. Foods**, v. 55, p. 135–145, 2019. ISSN 1756-4646. DOI: 10.1016/j.jff.2019.02.016.
- MATHIAS, T. R. d. S.; ALEXANDRE, V. M. F.; CAMMAROTA, M. C.; MELLO, P. P. M.; SÉRVULO, E. F. C. Characterization and determination of brewer's solid wastes composition. **J. Inst. Brew.**, v. 121, n. 3, p. 400–404, 2015. DOI: 10.1002/jib.229.
- MUSSATTO, S. I. Biotechnological Potential of Brewing Industry By-Products. In: NIGAM, S. n.; POONAM; PANDEY, A. (Eds.). **Biotechnology for Agro-Industrial Residues Utilisation: Utilisation of Agro-Residues**. 1. ed. Dordrecht, Netherlands: Springer Netherlands, 2009. p. 313–326. ISBN 978-1-4020-9942-7. DOI: 10.1007/978-1-4020-9942-7\_16.
- NAYAK, A.; BHUSHAN, B. An overview of the recent trends on the waste valorization techniques for food wastes. **J. Environ. Manag.**, v. 233, p. 352–370, 2019. ISSN 0301-4797. DOI: 10.1016/j.jenvman.2018.12.041.
- NAZIR, A.; KHAN, K.; MAAN, A.; ZIA, R.; GIORNO, L.; SCHROËN, K. Membrane separation technology for the recovery of nutraceuticals from food industrial streams. **Trends Food Sci. & Tech.**, v. 86, p. 426–438, 2019. ISSN 0924-2244. DOI: 10.1016/j.tifs.2019.02.049.
- PHONGTHAI, S.; D'AMICO, S.; SCHOENLECHNER, R.; HOMTHAWORNCHOO, W.; RAWDKUEN, S. Fractionation and antioxidant properties of rice bran protein hydrolysates stimulated by *in vitro* gastrointestinal digestion. **Food Chem.**, v. 240, p. 156–164, 2018. ISSN 0308-8146. DOI: 10.1016/j.foodchem.2017.07.080.
- PINTO, M.; COELHO, E.; NUNES, A.; BRANDÃO, T.; COIMBRA, M. A. Valuation of brewers spent yeast polysaccharides: A structural characterization approach. **Carbohydr.**

- Polym.**, v. 116, Supplement C, p. 215–222, 2015. ISSN 0144-8617. DOI: 10.1016/j.carbpol.2014.03.010.
- POULIOT, Y.; WIJERS, M. C.; GAUTHIER, S. F.; NADEAU, L. Fractionation of whey protein hydrolysates using charged UF/NF membranes. **J. Membr. Sci.**, v. 158, n. 1, p. 105–114, 1999. ISSN 0376-7388. DOI: 10.1016/S0376-7388(99)00006-X.
- ROSLAN, J.; KAMAL, S. M. M.; YUNOS, K. F. M.; ABDULLAH, N. Evaluation on performance of dead-end ultrafiltration membrane in fractionating tilapia by-product protein hydrolysate. **Sep. Purif. Technol.**, v. 195, p. 21–29, 2018. ISSN 1383-5866. DOI: 10.1016/j.seppur.2017.11.020.
- SAXENA, A.; TRIPATHI, B. P.; KUMAR, M.; SHAHI, V. K. Membrane-based techniques for the separation and purification of proteins: An overview. **Adv. Colloid Interface Sci.**, v. 145, n. 1, p. 1–22, 2009. ISSN 0001-8686. DOI: 10.1016/j.cis.2008.07.004.
- VIEIRA, E.; TEIXEIRA, J.; FERREIRA, I. M. P. L. V. O. Valorization of brewers' spent grain and spent yeast through protein hydrolysates with antioxidant properties. **Eur. Food Res. Technol.**, v. 242, n. 11, p. 1975–1984, 2016. ISSN 1438-2385. DOI: 10.1007/s00217-016-2696-y.
- XU, Z.; LIAO, J.; TANG, H.; LI, N. Antifouling polysulfone ultrafiltration membranes with pendent sulfonamide groups. **J. Membr. Sci.**, v. 548, p. 481–489, 2018. ISSN 0376-7388. DOI: 10.1016/j.memsci.2017.11.064.

# Appendix A

## Report of performed activities and project progression

### Performed activities and research schedule

Gabriela Vollet Marson entered in the Honours Doctorate program in Food Engineering at School of Food Engineering of UNICAMP and in Process Engineering at GAIA Doctoral School of Université de Montpellier in a dual-degree agreement in March 2017. The student was awarded with two FAPESP scholarships for the dual-degree honours doctorate in March 2017 (grant numbers: 2016/18465-8 and 2018/04067-6). During the years 2016-2017 the compulsory and elective disciplines were completed at UNICAMP as well as the first stages of the study. In 2017, the student also participated in the Teacher Training Internship program (PED - UNICAMP) for the course "Industrial Projects" in the undergraduate Food Engineering program (60 h). In February 2017, the student was awarded with the second FAPESP scholarship to continue her research in the European Institute of Membranes. In July 2018 the student presented her research progress in qualification required by UNICAMP and was approved. From August 2018 to December 2019, the student performed research activities at Institut Européen des Membranes. Credits required by the Doctoral School of Université de Montpellier were completed, including transversal competences such as improved thesis writing, data analysis and development of communication skills. Two qualifications required by Université de Montpellier were carried out with a group of three independent researchers

to access the progress of the project (one in September 2018 and the other in June 2019). In Table A.1, research activities performed during PhD were presented.

Credits completed at UNICAMP (300 h):

- Transport phenomena 1 (Mass transport) - 60 h;
- Transport phenomena 2 (Mass transport, heat and movement) - 60 h;
- Thermodynamics - 45 h;
- Special Topics in Food Science (Bioactive molecules) - 30 h;
- Special Topics in Food Engineering (Production and characterisation of powders) - 30 h;
- Seminars - 30 h;
- Bioactive compounds evaluation *in vitro* and *ex vivo* - 45 h;

Credits completed at Université de Montpellier (96 h):

- Management tools - 14 h;
- Write to convince - 14 h;
- How to improve your communication - 14 h;
- Thesis writing and structuring - 20 h;
- Research ethics - 20 h;
- Statistics using R - 14 h;

Table A.1: Schedule of research activities during the PhD program

Activities	2016	2017	2018	2019	2020 (1S)
State of the art	X	X	X	X	X
Project preparation	X	X			
Methodology definition	X	X	X		
Yeast cell wall rupture	X		X		
Protein hydrolysis		X	X		
Fractionation using polymeric membranes		X			
Fractionation using ceramic membranes			X		
Purification using electro dialysis				X	
Purification and identification of peptides				X	X
<i>In vitro</i> biological activity tests				X	
Data analysis	X	X	X	X	X
Manuscripts redaction	X	X	X	X	X
Thesis preparation				X	X
Thesis defence					X

\*1S\*: First semester.

#### *Other academic activities*

##### **Published papers in Research Journals**

Ahmad, S.; Marson, G. V.; Zeb, W.; Rehman, W. U.; Younas, M.; Farrukh, S.; Rezakazemi, M. (2020) Mass transfer modelling of hollow fiber membrane contactor for apple juice concentration using osmotic membrane distillation. **Separation and Purification Technology**, v. 250, 117209. <https://doi.org/10.1016/j.seppur.2020.117209>

Pereira, D. T. V.; Marson, G. V.; Barbero, G.; Tarone, A. G.; Cazarin, C.; Hubinger, M. D.; Martínez, J. (2020) Concentration of bioactive compounds from grape marc using pressurized liquid extraction followed by integrated membrane processes. **Separation and Purification Technology**, v. 250, 117206. <https://doi.org/10.1016/j.seppur.2020.117206>

Marson, G. V.; Saturno, R. P.; Comunian, T. A.; Consoli, L.; Machado, M. T. da C.; Hubinger, M. D. (2020) Maillard conjugates from spent brewer's yeast by-product as an innovative encapsulating material. **Food Research International**, v. 136, 109365. <https://doi.org/10.1016/j.foodres.2020.109365>

Marson, G. V.; Castro, R. J. S. de; Belleville, M-P.; Hubinger, M. D. (2020) Spent brewer's yeast as a source of high added value molecules: a systematic review on its characteristics, processing and potential applications. **World Journal of Microbiology and Biotechnology**, v. 36, n. 95, p. 1-22. <https://doi.org/10.1007/s11274-020-02866-7>

Los, P. R.; Marson, G. V.; Dutcosky, S. D.; Nogueira, A.; Marinho, M. T.; Simões, D. R. S. (2020) Optimization of beef patties produced with vegetable oils: a mixture design approach and sensory evaluation. **Food Science and Technology**, v. 40, suppl. 1, p. 12-20. <http://dx.doi.org/10.1590/fst.22518>

Marson, G. V.; Castro, R. J. S. de; Machado, M. T. da C.; Zandonadi, F. da S.; Barros, H. D. de F. Q.; Maróstica Júnior, M. R.; Sussulini, A.; Hubinger, M. D. (2020) Proteolytic enzymes positively modulated the physicochemical and antioxidant properties of spent yeast protein hydrolysates. **Process Biochemistry**, v. 91, p. 34-45. <https://doi.org/10.1016/j.procbio.2019.11.030>

Marson, G. V., Machado, M. T. da C.; Castro, R. J. S. de; Hubinger, M. D. (2019) Sequential hydrolysis of spent brewer's yeast improved its physico-chemical characteristics and antioxidant properties: A strategy to transform waste into added-value biomolecules. **Process Biochemistry**, v. 84, p. 91–102. <https://doi.org/10.1016/j.procbio.2019.06.018>

Battirola, L. C., Andrade, P. F., Marson, G. V., Hubinger, M. D., Gonçalves, M. do C. (2017) Cellulose acetate/cellulose nanofiber membranes for whey and fruit juice microfiltration. **Cellulose**, v. 24, i. 12, p. 5593–5604. <https://doi.org/10.1007/s10570-017-1510-8>

#### **Extended abstracts published in scientific events**

Saturno, R. P.; Hubinger, M. D.; Marson, G. V. Brewer's spent yeast as wall material for microencapsulation of food compounds (2019) In: **Revista dos Trabalhos de Iniciação Científica da UNICAMP**, n. 26, 15 fev. <https://doi.org/10.20396/revpibic2620181175>

Pereira, D. T. V.; Marson, G. V.; Hubinger, M. D.; Martínez, J. Concentration of anthocyanins from grape marc extract using pressurised liquids and nanofiltration (2018) In: **18th Euromembrane** – València, Spain.

Marson, G. V.; Machado, M. T. da C.; Hubinger, M. D. Influence of feed pH and membrane material on protein fractionation of brewer's spent yeast hydrolysate (2018) In: **18th Euromembrane** – Valencià, Spain.

**Simple abstracts published in scientific events**

Marson, G. V.; Saturno, R. P.; Vélez-Eraza, E. M.; Hubinger, M. D. Spent brewer's yeast as a new source of protein: peptides concentrate and yeast cell debris (2020) In: **VII International Conference on Food Proteins and Colloids (CIPCA)** – Campinas, Brazil.

Marson, G. V.; Saturno, R. P.; Vélez-Eraza, E. M.; Hubinger, M. D. Production of concentrated brewer spent yeast protein hydrolysate with a low content of RNA (2019) In: **13th International Congress on Engineering and Food (ICEF13)** – Melbourne, Australia.

Marson, G. V.; Saturno, R. P.; Vélez-Eraza, E. M.; Hubinger, M. D. Brewer spent yeast protein hydrolysate as an emulsifying agent (2019) In: **13th International Congress on Engineering and Food (ICEF13)** – Melbourne, Australia.

Marson, G. V.; Hubinger, M. D.; Belleville, M-P. Valorisation of spent brewer's yeast through enzymatic hydrolysis and membrane fractionation (2019) In: **Journée des Doctorants de l'IEM (Institut Européen des Membranes)** – Montpellier, France.

Marson, G. V.; Castro, R. J. S. de; Machado, M. T. da C.; Belleville, M-P.; Hubinger, M. D. Brewer spent yeast susceptibility to protein hydrolysis: effect of serial repitching and yeast supplier (2019) In: **12th Iberoamerican Congress of Food Engineering (CIBIA)** – Faro, Portugal.

Marson, G. V.; Machado, M. T. da C.; Hubinger, M. D. Effect of protein hydrolysis on the antioxidant capacity of brewer's spent yeast (2017) **12o Simpósio Latino-Americano de Ciência de Alimentos (SLACA)** – Campinas, Brazil.

Marson, G. V.; Machado, M. T. da C.; Hubinger, M. D. Lager Pilsen and English Ale's brewer spent yeast: an enzymatic cell rupture study (2017) **12o Simpósio Latino-Americano de Ciência de Alimentos (SLACA)** – Campinas, Brazil.

Marson, G. V.; Machado, M. T. da C.; Hubinger, M. D. Performance comparison of cell wall rupture methods for brewer spent yeast (2017) **São Paulo School of Advanced Sciences (SPSAS) on Reverse Engineering of Processed Food** – Campinas, Brazil.

**Presentations in scientific events**



Spent brewer's yeast as a new source of protein: peptides concentrate and yeast cell debris (2020) In: **VII International Conference on Food Proteins and Colloids (CIPCA)** – Campinas, Brazil. Type of presentation: oral.

Production of concentrated brewer spent yeast protein hydrolysate with a low content of RNA (2019) In: **13th International Congress on Engineering and Food (ICEF13)** – Melbourne, Australia. Type of presentation: oral.

Brewer spent yeast protein hydrolysate as an emulsifying agent (2019) In: **13th International Congress on Engineering and Food (ICEF13)** – Melbourne, Australia. Type of presentation: oral.

Valorisation of spent brewer's yeast through enzymatic hydrolysis and membrane fractionation (2019) In: **Journée des Doctorants de l'IEM (Institut Européen des Membranes)** – Montpellier, France. Type of presentation: oral. *Best oral presentation*

Brewer spent yeast susceptibility to protein hydrolysis: effect of serial repitching and yeast supplier (2019) In: **12th Iberoamerican Congress of Food Engineering (CIBIA)** – Faro, Portugal. Type of presentation: poster.

Concentration of anthocyanins from grape marc extract using pressurised liquids and nanofiltration (2018) In: **18th Euromembrane** – Valencià, Spain. Type of presentation: poster.

Influence of feed pH and membrane material on protein fractionation of brewer's spent yeast hydrolysate (2018) In: **18th Euromembrane** – Valencià, Spain. Type of presentation: poster.

Effect of protein hydrolysis on the antioxidant capacity of brewer's spent yeast (2017) In: **12o Simpósio Latino-Americano de Ciência de Alimentos (SLACA)** – Campinas, Brazil. Type of presentation: poster.

Lager Pilsen and English Ale's brewer spent yeast: an enzymatic cell rupture study (2017) In: **12o Simpósio Latino-Americano de Ciência de Alimentos (SLACA)** – Campinas, Brazil. Type of presentation: poster.

Performance comparison of cell wall rupture methods for brewer spent yeast (2017) In: **São Paulo School of Advanced Sciences (SPSAS) on Reverse Engineering of Processed Food** – Campinas, Brazil. Type of presentation: poster.

#### **Other participation in scientific events**

Journée Doctorale Filière APAB (Agro-ressources, processes, food and bioproducts) from GAIA Doctoral School, 2019.

Mesa Redonda: Tendências em Gastronomia, Ciência e Indústria, 2017.

*Peer reviewer* at XXV Congresso de Iniciação Científica da UNICAMP, 2017.

First International Workshop Bioactive Compounds: From Food Science to Human Nutrition, 2016.

Food Toxicology: in particular related to the veterinary drug residues in food, 2016.

Workshop: Concentration, Crystallisation, Spray drying & Rehydration: Effect on dairy powder quality, 2016.

**Teacher Training Internship program (PED - UNICAMP)**

Participant with a scholarship (PED C-category), in the course "Industrial Projects" in the undergraduate Food Engineering program (60 h), under the supervision of Prof. Miriam Dupas Hubinger, in the first semester of 2017.

**Co-orientation in the "Initiation on scientific studies program"**

Co-orientation of the project "Protein hydrolysate of spent brewer's yeast as an emulsifier and wall material for microencapsulation" carried out by the undergraduate student Rafaela Polessi Saturno, with a scholarship granted by FAPESP (#2018/11442-8), during the period from August 2018 to July 2019.

Co-orientation of the project "Brewer's spent yeast as wall material for microencapsulation of food compounds" carried out by the undergraduate student Rafaela Polessi Saturno, with a scholarship granted by UNICAMP (PIBIC), during the period from August 2017 to July 2018.

**Peer-reviewer in Research Journals**

Food Research International (Elsevier), since January 2019.

Brazilian Journal of Microbiology (Springer), since May 2020.

Journal of the American Society of Brewing Chemists (Taylor & Francis), since August 2020.

International Journal of Food Science and Technology (John Wiley & Sons), since September 2020.

Process Biochemistry (Elsevier), since October 2020.

# Appendix B

## Article 5: Microencapsulation

**Maillard conjugates from spent brewer's yeast byproduct as an innovative encapsulating material**

Gabriela Vollet Marson<sup>a</sup>, Rafaela Polessi Saturno<sup>a</sup>, Talita Aline Comunian<sup>a</sup>, Larissa Consoli<sup>a</sup>, Mariana Teixeira da Costa Machado<sup>b</sup>, Miriam Dupas Hubinger<sup>a</sup>

<sup>a</sup>Department of Food Engineering (DEA), School of Food Engineering (FEA), University of Campinas (UNICAMP), R. Monteiro Lobato, 80, 13083-862, Campinas, São Paulo, Brazil.

<sup>b</sup>Department of Food Technology, Federal Rural University of Rio de Janeiro, BR 465, km 7, 23890-000, Seropédica, Rio de Janeiro, Brazil.

Results of this section were published in the Elsevier's Journal "Food Research International", Vol. 136, 109365, 2020.

ISSN: 0963-9969

DOI: <https://doi.org/10.1016/j.foodres.2020.109365>



Contents lists available at ScienceDirect

Food Research International

journal homepage: [www.elsevier.com/locate/foodres](http://www.elsevier.com/locate/foodres)

## Maillard conjugates from spent brewer's yeast by-product as an innovative encapsulating material



Gabriela Vollet Marson<sup>a,\*</sup>, Rafaela Polesi Saturno<sup>a</sup>, Talita Aline Comunian<sup>a</sup>, Larissa Consoli<sup>a</sup>, Mariana Teixeira da Costa Machado<sup>b</sup>, Miriam Dupas Hubinger<sup>a</sup>

<sup>a</sup> Department of Food Engineering, School of Food Engineering, UNICAMP, Rua Monteiro Lobato, 80, Campinas, SP, Brazil

<sup>b</sup> Department of Food Technology, Federal Rural University of Rio de Janeiro, Rodovia BR 465, km 7, Seropédica, RJ, Brazil

### ARTICLE INFO

#### Keywords:

Ascorbic acid  
Spray drying  
Yeast-based by-products  
*Saccharomyces pastorianus*  
Hydrolysed yeast protein  
Yeast cell debris  
Food-grade carrier agents

### ABSTRACT

Yeast-based by-products are greatly available, have a rich nutritional composition and functional properties. The spent brewer's yeast (SBY) cells after enzymatic hydrolysis may be a sustainable and low-cost alternative as carrier material for encapsulation processes by spray drying. Our work had as main purpose to characterise the hydrolysed SBY cell debris after the Maillard reaction and to study their potential as a microencapsulation wall material. SBY-based Maillard reaction products (MRPs) were used to encapsulate ascorbic acid (AA) by spray drying. The Maillard Reaction was able to improve the solubility of solids and proteins by 15% and promoted brown color development (230% higher Browning Index). SBY-based MRPs resulted in particles of a high encapsulation yield of AA ( $101.90 \pm 5.5\%$ ), a moisture content of about 3.4%, water activity of 0.15, hygroscopicity values ranging from 13.8 to 19.3 g<sub>H<sub>2</sub>O</sub>/100 g and a glass transition temperature around 71 °C. The shape and microstructure of the produced particles were confirmed by scanning electron microscopy (MEV), indicating very similar structure for control and AA encapsulated particles. Fourier Transform Infrared Spectroscopy (FT-IR) results confirmed the presence of yeast cell debris in the surface of particles. Ascorbic acid was successfully encapsulated in Maillard conjugates of hydrolysed yeast cell debris of *Saccharomyces pastorianus* and maltodextrin as confirmed by optical microscopy, differential scanning calorimetry, MEV and FT-IR.

### 1. Introduction

Great amounts of by-products and residues are produced by the food industry as a result of raw materials processing. In 2010, about 90 million tons of food waste were produced due only to food manufacturing (Ravindran & Jaiswal, 2016). These materials usually have high moisture content, biological instability and organic load, requiring an appropriate handling and waste management system that considers environmental and economical aspects (Nayak & Bhushan, 2019). Some of those food by-products are underutilised even though they present great potential to become added-value innovative ingredients for the food and pharmaceutical industries once adequately processed (Nayak & Bhushan, 2019; Ravindran & Jaiswal, 2016).

Yeast-based by-products may be an attractive option due to their

great availability, nutritional composition, biocompatibility and environmental perspective (Ciamponi, Duckham, & Tirelli, 2012; Paramera, Karathanos, & Konteles, 2014, cha 23; Pérez-Torrado et al., 2015). The spent brewer yeast (SBY) consists of the spent yeast cells collected after beer fermentation and is the second most relevant by-product of the brewing industry (Ferreira, Pinho, Vieira, & Tavela, 2010; Mathias, Alexandre, Cammarota, Mello, & Sérvulo, 2015), which is responsible for the generation and management of about 2.3 g of this waste material per litre of beer produced (Kumar & Chandrasekaran, 2016; Pinto, Coelho, Nunes, ao, & Coimbra, 2015). SBY is rich in carbohydrates (about 40% in dry basis) and proteins (about 50% in dry basis) as well as in vitamins from the B complex and minerals (Mathias et al., 2015; Mussatto, 2009). Despite presenting a notably high nutritional value and a steady availability throughout the year (Mathias

**Abbreviations:** SBY, spent brewer's yeast; YP, non-treated yeast cells; HP, hydrolysed yeast cells; MRPs, Maillard Reaction Products; RNA, ribonucleic acid; EY, encapsulation yield; AA, Ascorbic acid; M20, maltodextrin with a dextrose equivalent of 20; YMC, SBY-based Maillard conjugates produced with only hydrolysed yeast cells; YMC20, SBY-based Maillard conjugates produced with hydrolysed yeast cells and maltodextrin;  $a_w$ , water activity;  $\zeta$ -potential, zeta potential;  $T_g$ , glass transition temperature;  $\Delta E$ , Total Color Difference; BI, Browning Index; BSA, bovine serum albumin; WPI, whey protein isolate

\* Corresponding author at: Institut Européen des Membranes, Université de Montpellier, CNRS, ENSCM, UM, CC 047, 2 Place Eugène Bataillon, 34095 Montpellier, France.

E-mail address: [gabriela.vollet@gmail.com](mailto:gabriela.vollet@gmail.com) (G.V. Marson).

<https://doi.org/10.1016/j.foodres.2020.109365>

Received 3 January 2020; Accepted 25 May 2020

Available online 29 June 2020

0963-9969/ © 2020 Elsevier Ltd. All rights reserved.

et al., 2015; Mussatto, 2009; Podpora, Świdorski, Sadowska, Rakowska, & Wasiak-zys, 2016), it is still underutilised as animal feed, with low commercial value (Shurson, 2018; Vieira, Teixeira, & Ferreira, 2016). Technological and processing strategies as well as value-added applications for yeast by-products are being investigated, but the exploration of SBY is still under development (Amorim, Pinheiro, & Pintado, 2019; Love, Dalvie, & Love, 2018; Marson et al., 2020; Marson, da Costa Machado, de Castro, & Hubinger, 2019; Vieira & Ferreira, 2017).

The first step in processing SBY material is to disrupt yeast cell walls so that cell debris and intracellular compounds may be accessed (Liu, Zeng, Sun, & Han, 2013). Enzymatic hydrolysis can promote the rupture of the yeast cells, enhance the cell wall porosity, enlarge cell wall pore size and extract proteins, producing smaller fractions of peptides (Chae, Joo, & In, 2001; Wei, Thakur, Liu, Zhang, & Wei, 2018; Marson et al., 2020; Marson, da Costa Machado, de Castro, & Hubinger, 2019; Wei et al., 2018). After centrifugation, the *Saccharomyces* sp. cell wall debris are recovered. The cell wall of *Saccharomyces* sp. is approximately 100–200 nm thick and comprises 15–25% of the dry mass of the cell. It is made of a  $\beta$ -1,3-glucan network crosslinked to  $\beta$ -1,6-glucans, a mannoprotein layer, and a small amount of chitin (Nelson, Duckham, & Crothers, 2006; Paramera et al., 2014, chap. 23; Shurson, 2018; Zechner-Krpan et al., 2010). Glucans represents 50–60% of the dry weight of yeast cell walls (Nakhaee Moghadam, Khameneh, & Fazly Bazzaz, 2019; Shurson, 2018; Zechner-Krpan et al., 2010) and along with chitin, are responsible for the mechanical rigidity of the cell wall (Paramera et al., 2014, chap. 23). The porosity and molecular flux passing through yeast cell walls are controlled by the plasma membrane and mannoproteins (Paramera et al., 2014, Pham-hoang, Voilley, & Waché, 23; Pham-hoang et al., 2016).  $\beta$ -glucans are functional ingredients successfully employed for microencapsulation and reported to play a role in the retention capability of yeast as a coating material (Ahmad, Ashraf, Gani, & Gani, 2018; Sobieralska & Kurek, 2019; Sultana, Tanaka, Fushimi, & Yoshii, 2018). The hydrophobicity and composition of the yeast cell walls can be changed by factors such as growth media and strain, influencing the encapsulation properties of yeast cells (Pham-hoang et al., 2016). Because of its composition and unique characteristics, the yeast cell wall is currently being used as a novel coating for the encapsulation of different materials in the food industry (Mokhtari, Jafari, Khomeiri, Maghsoudlou, & Ghorbani, 2017).

Microencapsulation is a technique in which a core compound of interest is surrounded by another material, a carrier, resulting in the formation of small particles. Spray drying is one of the most used techniques in the food industry for this purpose (O'Sullivan, Norwood, O'Mahony, & Kelly, 2019), turning liquids into powders of higher stability and lower transportation costs (Assadpour & Jafari, 2019). The encapsulation impacts the stability of the core compound because the carrier protects them against environmental conditions (light, oxygen, moisture and heating), undesired biological reactions, masks off-flavours and influences their release in products and in complex biological systems (Anandharamakrishnan & Ishwarya, 2015; Pham-hoang et al., 2016; Reineccius, 2001, 2004; Saifullah, Shishir, Ferdowsi, Rahman, & Vuong, 2019; Timilsena, Akanbi, Khalid, Adhikari, & Barrow, 2019). The extent of those effects is highly dependent on processing parameters and carrier composition (Paramera, Konteles, & Karathanos, 2011). A suitable carrier is selected based on process parameters and technique, cost, functionality, nutritional characteristics, stability during storage, and other applicable restraints (Assadpour & Jafari, 2019; Mokhtari, Jafari, et al., 2017; Paramera et al., 2011).

The most commonly employed biopolymers used as carrier agents for encapsulation are proteins and polysaccharides, namely Arabic gum, maltodextrin, gelatin, soy and whey proteins. In spray-drying microencapsulation, maltodextrin is widely used because it is cost-effective, presents high water solubility, low viscosity and moderate sweet taste, allowing to attain high solid ratios, advantageous for core retention (Sultana et al., 2018). Maltodextrin rapidly forms a dense film around the core, providing an excellent protection for the core material,

specially when combined with proteins, which increase their emulsification capacity (Anandharamakrishnan & Ishwarya, 2015).

Great interest surrounds the investigation of new food-grade wall materials. Agro-industrial by-products may be a compelling alternative, proposing water-soluble, protein and polysaccharides-rich materials for biomolecules encapsulation associated with a sustainable approach and waste management solution. Alternative sources of protein are also increasingly in demand as substitutes for animal proteins in human nutrition, and SBY is considered as an option (Love et al., 2018; Mussatto, 2009).

Yeast materials are reported successfully in the encapsulation of several hydrophilic and hydrophobic food compounds (Nelson et al., 2006; Paramera et al., 2011, 2014; Pham-hoang et al., 2016; Shi et al., 2010; Sultana et al., 2017). The main cell components responsible for the yeasts' excellent encapsulating agent properties are cell wall constituents and inner plasma membrane (Paramera et al., 2014, chap. 23). Yeasts can be used as microcapsules (the core material penetrates the cells via passive diffusion) in viable or not, entire or plasmolysed yeast (Paramera et al., 2011; Pham-hoang et al., 2016; Shi et al., 2010). Yeast cell debris are also suitable carriers for food microencapsulation (Mokhtari, Jafari, et al., 2017; Paramera et al., 2014, chap. 23). Broken yeast cell wall material from *S. cerevisiae* was used in the encapsulation of probiotic bacteria which are bigger in size (Mokhtari, Jafari, et al., 2017). The yeast coating impacted positively the resistance of the encapsulated probiotic bacteria in triple layered microcapsules with alginate, retarding gastric fluid permeation (Mokhtari, Jafari, et al., 2017). The yeast cell wall is reported to promote a successful protection against the oxidation of compounds and some authors stated that the yeast cell wall may have a better antioxidative ability than isolated  $\beta$ -glucan (Jaehrig, Rohn, Kroh, Fleischer, & Kurz, 2007; Sultana et al., 2018). Yeast cell mannans from *S. cerevisiae* are also reported to have antioxidant and antimutagenic properties (Křižková, Ďuračková, Šandula, Sasinková, & Krajčovič, 2001; Liu, Huang, & Lv, 2018). Indeed, there seem to be a tendency to produce capsules with dual health-promoting properties, from both the core and coating materials (Drozińska, Kanclerz, & Kurek, 2019).

The Maillard reaction is defined as the reaction between amino acids and reducing sugars, eventually forming melanoidins, brown-coloured polymers (Mirafzali, Thompson, & Tallua, 2014, chap. 13). The Maillard reaction can also result in an increased solubility and decreased allergic effects, caused mainly by the glycation of carbohydrates to proteins (Consoli et al., 2018; Yang et al., 2015). Moreover, the enhancement of antioxidant properties may occur, and have been related to the development of advanced Maillard Reaction Products (MRPs) (Consoli et al., 2018; Li et al., 2013; O'Regan & Mulvihill, 2009). In this context, the Maillard reaction may be seen as an option to obtain ingredients of improved functional and sensorial properties. Protein hydrolysates have been studied as substrate for the Maillard reaction to obtain ingredients of improved functional and sensorial properties (Hou, Li, Zhao, Zhang, & Li, 2011; Liu, Liu, He, Song, & Chen, 2015; Wei et al., 2018). Regarding the SBY material, this reaction was previously reported as a processing step for brewer yeast extract production as a flavour enhancing step (In, Kim, & Chae, 2005), but was not employed with the interest of improving functional properties as the solubility of yeast compounds and development of colour.

In previous works, standard, plasmolysed or milled compressed baker's yeast (*Saccharomyces cerevisiae*) (Mokhtari, Jafari, et al., 2017; Mokhtari, Khomeiri, Jafari, Maghsoudlou, & Ghorbani, 2017; Paramera et al., 2011) or spent yeast by-product from  $\beta$ -glucan production (*Saccharomyces cerevisiae*) (Sultana et al., 2017; Sultana et al., 2018) were used for microencapsulation purposes. In Mokhtari, Jafari, et al. (2017), Mokhtari, Khomeiri, et al. (2017) works, baker's yeast cells were used to encapsulate probiotics through coating of alginate capsules. Paramera et al. (2011), Sultana et al. (2017), Sultana et al. (2018), Shi et al. (2010) encapsulated, respectively, curcumin, flavors and chlorogenic acid in yeast cells as preformed natural capsules, by

passive cell transport, and then dried the obtained material. Spray drying using hydrolysed SBY cell walls was not yet reported. The SBY proposed in this work is still a different material because it is not a yeast pure material - which is usually used in microencapsulation studies - it contains compounds from the beer production process and are exhausted cells after fermentation, which changes their characteristics and cell wall composition (Marson et al., 2019; Mathias et al., 2015). Moreover, in those works the yeast cells were not enzymatically hydrolysed - what causes important changes on the physico-chemical characteristics of the material - and were  $\beta$ -glucan depleted (because of their previous application). Because of all those particularities and because of the recently reported importance of  $\beta$ -glucan in the microencapsulation capacity of yeast cells (Ahmad et al. (2018), Ahmad et al. (2018), Marson, de Castro, et al. (2019)), the evaluation of this material is of great interest. In this work, we propose the use of Maillard-reacted SBY cell wall debris as a coating material for ascorbic acid, a model core material. Ascorbic acid is a widely used ingredient in the food industry added as a vitamin supplement and antioxidant, but its high reactivity and low stability to oxygen and metallic ions limits their direct application as an ingredient. Acids can also promote undesirable changes in foods such as colour degradation, undesirable odours, changes in pH and flavor when incorporated directly (Trindade & Grosso, 2000).

## 2. Material and methods

### 2.1. Material

#### 2.1.1. Microencapsulation materials

The carrier material proposed was the enzymatically hydrolysed yeast cells of SBY (Section 2.2). The raw material (*S. pastorianus*) from Lager Pilsen beer production (Diamond Lager, Lallemand, Canada), collected after 11 days of beer maturation without any repitching at Haus Bier Brewery (São José dos Campos, Brazil), was homogenised and kept at 2 °C until processing. Enzymes used were Alcalase™ 2.4 L and Protamex™, supplied by Novozymes (Denmark), and Brauzyn® 100 L, supplied by Prozyn (Brazil). Maltodextrin with a dextrose equivalent of 20% (MOR-REX® 1920) was supplied by Ingredion (Brazil) and L-ascorbic acid (99%), which was used as the core material, was purchased from Sigma-Aldrich (Steinheim, Germany).

#### 2.1.2. Reagents

Bovine serum albumine (BSA) (electrophoretic grade) was purchased from Sigma-Aldrich (Steinheim, Germany). All other reagents were of analytical grade.

### 2.2. Production of spent brewer's yeast hydrolyzed cells

The schematic representation of all experimental steps taken in this work to study the hydrolysed yeast cells as carrier materials for ascorbic acid microencapsulation are presented in Fig. 1. The hydrolysed yeast cell debris (HP) were produced using the method of Marson, de Castro, et al. (2019). Briefly, the yeast slurry was heat-treated, at  $70.0 \pm 0.2$  °C, under 1000 rpm of agitation for an hour, followed by an ice bath. Then hydrolysis was done at pH 7.0, 50 °C, under agitation, for 2 h. A mixture of enzymes was added (Alcalase™, Protamex™, Brauzyn®) in an enzyme:substrate ratio of  $666.67 \text{ U g}_{\text{protein}}^{-1}$  each. Enzymes were then inactivated by heating (95 °C for 15 min). Non-treated raw material and hydrolysate were centrifuged at 15,300g for 30 min at 4 °C (Allegra 25R, Beckman Coulter, United States), to harvest the yeast cells, which were kept at - 20 °C in polypropylene bottles until further analysis.

### 2.3. Characterisation of spent brewer's yeast material and fractions

Physico-chemical and proximal composition analysis were performed in the non-treated and hydrolysed SBY cell debris. Total solids, pH value, total titratable acidity, crude protein content, total sugars,

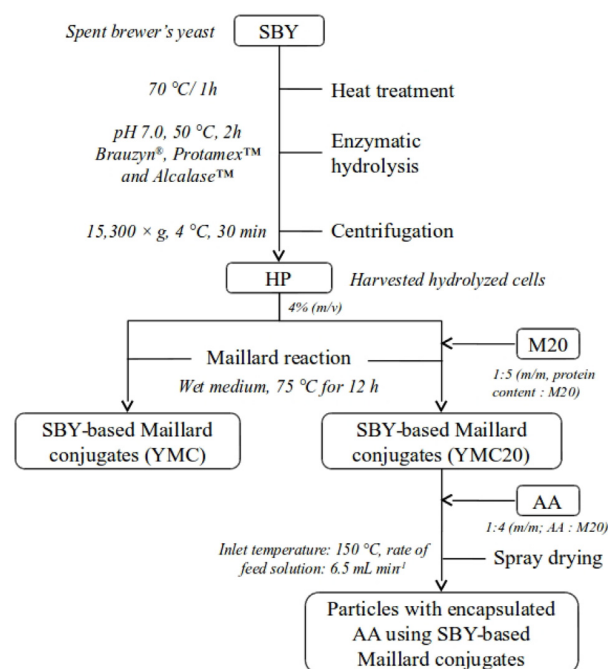

**Fig. 1.** Full schematic representation of experimental plan for the production of hydrolysed yeast cells (HP) from spent brewer's yeast (Y) and encapsulation of ascorbic acid (AA) using SBY-based Maillard conjugates and maltodextrin (YMC20) as a wall material. SBY: spent brewer's yeast; HP: hydrolysed yeast cells; M20: Maltodextrin with a dextrose equivalent of 20%; YMC: SBY-based Maillard conjugates produced with only hydrolysed yeast cells; YMC20: SBY-based Maillard conjugates produced with hydrolysed yeast cells and maltodextrin; AA: ascorbic acid.

fibres, ash and ribonucleic acids (RNA) content were determined as described below in Section 2.3.1. Particle's size distribution (2.3.2), surface tension (2.3.3) and  $\zeta$  potential (2.3.4) of the yeast materials were also determined.

#### 2.3.1. Proximal composition

Sample's total solids content (% , m/m) was determined gravimetrically at 105 °C for 12 h using an incubator (C-HT 515, Fanem, Brazil). Ashes and fibres were determined (AOAC, 2006) as well as total titratable acidity (AOAC, 2006) considering citric acid as the major acid present in the samples. Total sugars content was measured according to the Phenol-Sulphuric Acid Assay (Fournier, 2001) and reducing sugars by the method of Somogyi-Nelson (Fournier, 2001) using glucose as standard. Crude protein content was determined by the Dumas method (Wrolstad et al., 2005) in an element analyser CHNS-O (Flash 2000, ThermoScientific, USA). A nitrogen conversion factor of 5.5 was considered because of the high content of non-proteic nitrogen in yeast, as previously reported by other papers which measured crude protein in yeast products (Caballero-Córdoba & Sgarbieri, 2000; de la Hoz et al., 2014; Reed & Nagodawithana, 1991). RNA was extracted according to the method of Webb (1958), Webb and Levy (1955) and determined based on the calculation presented by Sceni et al. (2009).

#### 2.3.2. Particle size

Estimation of particle size and particle size distribution in the yeast materials was determined by the angular variation in the intensity of scattered light, as a laser beam passes through the sample (Mastersizer 2000, Malvern Instruments Ltd., UK), using water as dispersant. Non-treated yeast cells (YP) and hydrolysed yeast cell debris (HP) were diluted in distilled water to reach a concentration of 3% (m/v, wet basis). Whole yeast (Y) was not diluted. Mean diameter of particles was expressed as the volume-weighted mean diameter,  $D_{[4,3]}$  (Fan & Zhu,

1998), as presented in Eq. 1, where  $d_i$  represents the particles diameter and  $n$  is the amount of particles.

$$D_{[4.3]} = \frac{\sum_{i=1}^n n \cdot d_i^4}{\sum_{i=1}^n n \cdot d_i^3} \quad (1)$$

The particle size distribution was measured as the span, which considers the equivalent volume diameters at 90% ( $D_{(0.9)}$ ), 10% ( $D_{(0.1)}$ ), and 50% ( $D_{(0.5)}$ ) cumulative volume (Jinapong, Suphantharika, & Jamnong, 2008), as presented in Eq. 2.

$$\text{Span} = \frac{D_{(0.9)} - D_{(0.1)}}{D_{(0.5)}} \quad (2)$$

### 2.3.3. Surface tension

Non-treated (YP) and hydrolysed yeast cell debris (HP) were diluted prior to analysis to a concentration of 3% (m/v, wet basis). The solution was left 1 h at 2 °C, the supernatant was collected and the pH adjusted using NaOH or HCl. Multiple measurements via camera were made of a sample's drop of 6  $\mu$ L in contact with air for 2000 s in a tensiometer (Teclis, Tracker, France), on pendant drop mode. For the hydrolysed yeast cell debris (HP) measurements were made for pH values of 5, 6, 7 and 8 and for the other yeast materials, at pH 7. Six replicates were determined for each sample. Results were expressed as mN m<sup>-1</sup>.

### 2.3.4. Zeta potential

The  $\zeta$ -potential of yeast materials was determined using a Zetasizer Nano Series (Malvern Instruments, UK) at 25 °C. HP samples were suspended in water and diluted as described previously (Section 2.3.3) and the non-treated yeast (Y) was diluted to 0.1% (m/v, wet basis). For HP, measurements were made for pH values of 5, 6, 7 and 8 and for the other yeast materials, at pH 7. The average pI of HP proteins was determined as the pH where the surface charge density was equal to zero.

## 2.4. Preparation of SBY-based Maillard conjugates

### 2.4.1. Preparation of the yeast suspensions

The influence of the addition of maltodextrin in the production of hydrolysed yeast Maillard conjugates was evaluated. The control (without maltodextrin) suspension was prepared mixing the hydrolysed yeast cells (HP) directly in distilled water at the concentration of 4% (m/v, wet basis), resulting in yeast cells Maillard conjugates (YMC). The experimental suspension was produced the same way, with the addition of maltodextrin in the proportion of 1:5 (protein content in HP: maltodextrin, m/m), resulting in another yeast cells Maillard conjugates with added maltodextrin (YMC20) (Fig. 1).

### 2.4.2. Maillard reaction

The Maillard reaction in the HP was prepared in wet medium, according to the methodology of Augustin, Sanguansri, and Bode (2006), with the modifications proposed by Consoli et al. (2018). Briefly, the suspensions were kept under agitation (400 rpm) at 75 °C for 12 h and after, cooled down in an ice bath. Non-heated control suspensions were prepared as well.

### 2.4.3. Evaluation of the extent of the Maillard Reaction

The extent of Maillard reaction was evaluated by the pH measurement before and after the reaction, supernatant mass recovery, soluble solids content, peptide content in the supernatant fraction and evolution of colour.

The pH values of the suspensions before and after the Maillard reaction were determined in triplicate using a two-point calibrated pH meter (K39-1014B, Kasvi, Brazil). Then, it was adjusted at the isoelectric pH (pI) (Section 2.3.4) prior to centrifugation at 15,300  $\times$  g for 15 min at 4 °C (Allegra 25R, Beckman Coulter, United States). The mass

of recovered supernatant was recorded. Soluble solid content ( $^{\circ}$ BRIX) was determined at 25 °C in a refractometer (N-1 alpha, ATAGO, Japan). (AOAC, 2006).

The peptide concentration of the supernatants was measured by Far-UV (2800, Unico, United States) following the method of Aitken and Learmonth (2002) with some modifications. Briefly, samples were carefully diluted 55 fold using a 5 mM phosphate buffer (pH 7) with 50 mM of sodium sulfate and the absorbance at 205 nm was registered. A standard curve of BSA diluted under the same conditions was prepared (concentration range of 2–25 mg<sub>BSA</sub> L<sup>-1</sup>).

Colour of suspensions before and after the Maillard reaction was measured in an UV-vis spectrophotometer in reflectance mode using D65 illuminant (model UltraScan, Hunterlab, United States). Results were expressed as the Total Color Difference ( $\Delta E$ ) and Browning Index (BI), which were calculated considering the parameters of the CIE - L\*a\*b\* scale where L\* represents the luminosity (L = 0 corresponds to the darkest black and L = 100 to the brightest white), a\* represents the green (-)/red (+) colours and b\* the blue (-)/yellow (+) colours.

The magnitude of colour changes between control and treated samples were evaluated through the  $\Delta E$ , using the first formula of the Euclidean distance between two points in the CIE - L\*a\*b\* space (Mokrzycki & Tatol, 2011), as presented in Eq. 3.

$$\Delta E = [(L_{control}^* - L_{sample}^*)^2 + (a_{control}^* - a_{sample}^*)^2 + (b_{control}^* - b_{sample}^*)^2]^{\frac{1}{2}} \quad (3)$$

The BI was calculated using Eqs. 4 and 5. It measures the shift towards a more brown colour, used to describe non-enzymatic color development, such as that caused by the MRPs (In et al., 2005; Song, Yang, Wei, & Ruan, 2016; Yu et al., 2018).

$$x = \frac{a^* + (1.75 \cdot L^*)}{(5.65 \cdot L^*) + a^* - (3.01 \cdot b^*)} \quad (4)$$

$$BI = \frac{x - 0.31}{0.17} \times 100 \quad (5)$$

## 2.5. Application of SBY-based Maillard conjugates as a wall material

### 2.5.1. Encapsulation of ascorbic acid

Two suspensions of 4% (m/v) HP and maltodextrin (1:5, protein content in HP:maltodextrin, m/m) were prepared in 500 mL jacketed glass beakers and mixed at 10230 rpm for 8 min in a rotor stator (L5M-A, Silverson, United States). The Maillard reaction took place as previously described (Section 2.4.2). After the reaction, the pH of the solution was adjusted to 6.0 and AA was added to one of the suspensions and submitted to the agitation on the rotor stator using the same conditions. Solid content was 29% with a ratio of wall material to ascorbic acid of 5:1 (m/m). Both formulations were dried in a mini Spray Dryer (B-290, Büchi, Switzerland), with a double-fluid-type atomizer nozzle with a diameter of 0.7 mm operated by compressed air. Constantly stirred feeding solutions were pumped into the drying chamber by a peristaltic pump. Inlet temperature was determined at 150 °C based on previous research of the drying of yeast materials (Luna-Solano, Salgado-Cervantes, Rodríguez-Jimenes, & García-Alvarado, 2005; Sultana et al., 2017; Sultana et al., 2018; Zechner-Krpan et al., 2010) and spray-drying of ascorbic acid using other wall materials (Trindade & Grosso, 2000). Aspiration rate was about 37 m<sup>3</sup> h<sup>-1</sup>, gas flow of 742 L h<sup>-1</sup> and feeding rate of the solutions was approximately 6.5 mL min<sup>-1</sup>.

Particles were characterised regarding their encapsulation yield (Section 2.5.2), moisture content, water activity, hygroscopicity (Section 2.5.3), glass transition temperature (Section 2.5.4), morphology by optical microscopy (Section 2.5.5) as well as particles size distribution (Section 2.3.2, with compressed air as dispersant).

### 2.5.2. Encapsulation yield

Encapsulation yield (EY) was calculated according to Eq. 6, considering the initial and final concentration of ascorbic acid (AA) present in the particles.

$$EY (\%) = \frac{x_{\text{encapsulated}}}{x_{\text{total}}} \times 100 \quad (6)$$

where  $x_{\text{encapsulated}}$  is the concentration of AA quantified in the particles ( $\text{mg g}^{-1}$ );  $x_{\text{total}}$  is the concentration of AA quantified in feed before drying ( $\text{mg g}^{-1}$ ), on dry basis.

The content of AA in the particles was determined using the methodology of Estevinho, Carlan, Blaga, and Rocha (2016) with modifications. Briefly, particles were solubilised in deionised water ( $58.3 \text{ mg}_{\text{particles}} \text{ L}^{-1}$ ) and the absorbance was measured at 260.6 nm in quartz cuvettes after the samples stood for 10 min. A standard curve of AA was prepared (concentration range of 0.5–22  $\text{mg}_{\text{AA}} \text{ L}^{-1}$ ) and results were expressed as  $\text{mg}_{\text{AA}} \text{ g}_{\text{particles}}^{-1}$ . Particles produced without AA were considered as the controls.

### 2.5.3. Physico-chemical properties of the particles

The moisture content of the particles was determined using a moisture-determining balance (model Moc63u, Shimadzu, Japan). The samples were heated until 105.0 °C and remained at that temperature until the moisture content, which was measured every 30 s, had a variation coefficient smaller than 0.01%. Water activity ( $a_w$ ) was measured using Aqualab digital meter (model 3TE series, Decagon, USA), and hygroscopicity was determined according to the method of Cai and Corke (2000), with modifications. One gram of particles was stored in an hermetic container with saturated NaCl solution (relative humidity of 75%) at 25 °C. Samples were weighed on the first and seventh days of conditioning. Hygroscopicity was expressed as g of absorbed  $\text{H}_2\text{O}$  per 100 g of sample.

### 2.5.4. Glass transition temperature

Glass transition temperature ( $T_g$ ) and heat flow of the dried hydrolysed yeast cells (HP) and of the spray-dried particles (control and with AA) were determined by differential scanning calorimetry (DSC) (TA-MDSC-2920, TA Instruments, USA) equipped with a mechanical refrigeration system (RCS-refrigerated cooling accessory). Approximately 3 mg of powder were placed into DSC aluminum pans (20  $\mu\text{L}$ ). Samples were heated at 5 °C  $\text{min}^{-1}$  from 0 to 150 °C and an empty pan was used as reference. Equipment calibration was performed with indium (melting temperature of 156.6 °C). Helium at 25  $\text{mL min}^{-1}$  was used as the purge gas. All data was treated using the software Universal Analysis 2.6 (TA Instruments, USA).

### 2.5.5. Morphology of particles by optical and scanning electron microscopy

The particle morphology was analysed using a Carl Zeiss optical microscope (Axio Scope A1 model, Gottingen, Germany), with an increase of 100  $\times$ , and a scanning electron microscope with X-ray dispersed energy detector, model Leo 440i, EDS 6070 (LEO Electron Microscopy, Cambridge, UK). Metallic coating was applied to the samples using a sputter coater, model k450 (Emitech, Kent, UK), with a gold thickness estimated at 200 Å. Tensions of 5, 10 and 15 kV were used, an electric current of 50 mA and amplifications from 150 to 6000 times.

### 2.5.6. Fourier-Transform Infrared Spectroscopy (FT-IR)

Produced particles as well as vitamin C, maltodextrin and dried yeast cell wall debris were analysed by Fourier Transform Infrared Spectroscopy (FT-IR) using a spectrophotometer model IRPrestige-21 (Shimadzu, Kyoto, Japan). Data was analysed using the software IRSolution, version 1.6. Powder samples were mixed to potassium bromate into a 13 mm pellet in the proportion of 1:100 (sample:KBr). The spectra were obtained in the range from 4000 to 400  $\text{cm}^{-1}$ .

**Table 1**

Proximal composition and physico-chemical data of non-treated spent brewer's yeast (SBY), non-treated yeast cells (YP) and hydrolysed yeast cells (HP)

Analysis	SBY	YP	HP
Total solids (%)	12.3 ± 0.1	26.9 ± 0.2 <sup>a</sup>	26.3 ± 0.3 <sup>b</sup>
Crude protein (%)	40.8 ± 0.1	49.6 ± 0.9 <sup>a</sup>	43.0 ± 0.3 <sup>b</sup>
RNA (%)	1.9 ± 0.1	3.0 ± 0.1 <sup>a</sup>	2.0 ± 0.1 <sup>b</sup>
Total sugars (%)	43.5 ± 2.4	30.9 ± 6.8 <sup>a</sup>	37.2 ± 1.0 <sup>a</sup>
Reducing sugars (%)	nd	nd	9.0 ± 0.2
Ash (%)	7.0 ± 0.1	4.5 ± 0.1 <sup>a</sup>	5.1 ± 0.1 <sup>b</sup>
Fibre (%)	6.6 ± 0.1	11.3 ± 0.3 <sup>a</sup>	18.4 ± 0.6 <sup>b</sup>
Lipids <sup>1</sup> (%)	0.21	0.7	0.0
Total titratable acidity (g 100 $\text{g}_{\text{citric acid}}^{-1}$ )	8.2 ± 0.1	3.8 ± 0.1 <sup>a</sup>	2.0 ± 0.1 <sup>b</sup>
Particle size in suspension - Diameter ( $\mu\text{m}$ )	42.8 ± 2.4	86.1 ± 3.8 <sup>a</sup>	57.0 ± 2.7 <sup>b</sup>
Particle size in suspension - Span (d.u.)	13.2 ± 0.4	10.6 ± 0.9 <sup>a</sup>	20.9 ± 1.1 <sup>b</sup>
Surface tension at pH 7 ( $\text{mN m}^{-1}$ )	nd	40.1 ± 0.3 <sup>a</sup>	40.4 ± 0.1 <sup>a</sup>
Surface charge density at pH 7 (mV)	-8.7 ± 0.3	-19.2 ± 1.3 <sup>a</sup>	-13.3 ± 0.6 <sup>b</sup>

Nd: not determined; d.u.: dimensionless units;

Different letters in the same row indicate significant differences among non-treated yeast cells (YP) and hydrolysed yeast cells obtained after heating pretreatment followed by hydrolysis (HP) with a confidence level of 5%. All proximal composition results were expressed in dry basis.

<sup>1</sup> Determined by difference from total composition (crude proteins, total sugars, ribonucleic acids (RNA), fiber and ash).

### 2.6. Statistical analysis

All experiments were studied in duplicate and all analyses were performed at least in triplicate. Results were expressed as average values ± standard deviation and were submitted to analysis of variance (ANOVA) and comparison of means by Tukey HSD test. ANOVA assumptions were checked through analysis of the residues, tests for data distribution (Ryan Joiner and Shapiro Wilk) and homogeneity of variances (Multiple Comparisons' and Levene). Differences were considered significant at a level of 5%. Correlations between data were determined by Pearson test followed by paired Student test.

## 3. Results and discussion

### 3.1. Characterization of spent brewer's yeast materials

#### 3.1.1. Proximal composition

The proximal analysis of non-centrifuged whole SBY (Y) and its precipitate fraction (YP) are presented in Table 1. SBY yeast slurry contains 12.3% of dry matter, which mainly consists of proteins (41%) and total sugars (44%), with lower amounts of ash (7%), fibers (7%), RNA (2%) and lipids (0.2%). Results were in agreement with centesimal data for *Saccharomyces* sp. whole cells and SBY, which usually present a total sugar content of 21.5%–42.3% (Borchani et al., 2014; Caballero-Córdoba & Sgarbieri, 2000; Sceni et al., 2009) and crude protein content varying from 27.6% to 50.5% (Borchani et al., 2014; Caballero-Córdoba & Sgarbieri, 2000; Mathias et al., 2015). Nucleic acid content was smaller than the previously presented levels (from 6.9% to 10%), but as it is strain-dependent, high variations are expected (Caballero-Córdoba & Sgarbieri, 2000; Castrillo & Ugalde, 2003, chap. 22; Sceni et al., 2009). Ash contents are also within the reported range (5.9% for SBY and 8.5% to *S. cerevisiae* yeast biomass) (Caballero-Córdoba & Sgarbieri, 2000; Mathias et al., 2015). Fibres and lipids usually represent, respectively, less than 12% and 4% (dry basis) of global composition in *S. cerevisiae* yeast biomass (Pacheco, Caballero-Córdoba, & Sgarbieri, 1997).

It is important to emphasise that SBY chemical composition as well as its susceptibility to cell wall breakage is reported to vary greatly



among yeast strains and suppliers, brewing conditions, the number of times it is reused and also depends on the stage of fermentation/maturation at which it is removed (Mathias et al., 2015).

The precipitate fraction of the non-treated yeast presents a 2.2 times higher total solids content than the whole yeast slurry. Indeed, following centrifugation, yeast cell wall components such as glucans and mannans, which are mostly insoluble, are concentrated on the precipitate (Shurson, 2018). Higher amounts of crude protein, RNA and fibres were found, by 22%, 58% and 71%, respectively, whereas the total sugar content and ash content were lower (by 29% and 36%) in comparison to the whole residual yeast.

The effect of the hydrolysis in the chemical composition of yeast cells before and after hydrolysis are also presented in Table 1. A 13% decrease in crude protein content can be observed. The enzymatic hydrolysis promotes the breakdown of the peptide bonds of the proteins, resulting in lower molecular weight peptides (Kunst, 2003, chap. 17). These molecules become more soluble and are more susceptible to migrate to the supernatant fraction (Borchani et al., 2014). This solubilisation, therefore, is traduced into a decrease in the protein content in the precipitate.

The RNA content of hydrolysed precipitate (HP) was 33% lower than the non-treated precipitate (YP). Proteins are the components to which, in acid medium, about 80% of the RNA is complexed (Oliveira & Oliva Neto, 2011). Both the heat treatment and the hydrolysis alter the structure of the proteins, releasing their amino acids and, consequently, the nucleic acids, which become more soluble and migrate to the supernatant fraction. Moreover, Sgarbieri, Alvim, Vilela, Baldini, and Bragagnolo (1999) also reported a decrease in RNA content and protein in the precipitate fractions of yeast after rupture of the cell wall. A RNA content of 5.7% was reported for the precipitate fraction of yeast whole cells but after the autolysis procedure, the content decreased to 1.8% for the yeast cell debris.

Total sugar content increased 20% in the precipitate fraction after hydrolysis. As proteins were cleaved and the yeast cell wall was ruptured, carbohydrates could also be released, but because they were not soluble or were complexed to other molecules, they stayed in the precipitate fraction. The content of reducing sugars in the HP was higher (9.0%) than the one reported value in SBY slurry (1.3%) (Mathias et al., 2015). They appeared to be released during hydrolysis and were present in the precipitate fraction.

The contents of ash and fibres seemed to be slightly higher in the precipitate fraction after the hydrolysis step. Yeast cell wall components such as glucans and chitin may be determined as fibres, further confirming that the precipitate fraction was enriched in cell wall components (Shurson, 2018).

In sum, HP was considered a potential substrate for the Maillard reaction due to the high content of proteins and total sugars (Table 1). The effect of the addition of maltodextrin was investigated in order to supplement the reducing sugars content and ensure a good rate of reaction. The effect of the addition of amino acids to improve the Maillard reaction was previously reported for SBY, but it did not contribute to the extent of the reaction in comparison to the effect of added sugars because yeast hydrolysates usually have already enough amino acids and amino components (In et al., 2005).

### 3.1.2. Physico-chemical properties

The values obtained for total titratable acidity are shown in Table 1. Yeast slurry value was smaller than that previously reported for SBY (32.7%) but this parameter is strongly affected by beer composition and process conditions (Mathias et al., 2015). After the hydrolysis, total titratable acidity was reduced by 47%. A hydrolysis treatment releases fatty acids and amino acids in the medium, and these components are believed to influence this parameter (Mathias et al., 2015). Indeed, after centrifugation, these components probably migrated to the supernatant fraction (Kunst, 2003, chap. 17), resulting in a decrease of total titratable acidity in the HP.

The mean values of particle diameter and span are presented in Table 1. The mean diameter of the particles in the precipitate fraction of non-treated yeast (YP) was 2 times bigger than that of the non-centrifuged yeast (Y). After hydrolysis, the mean particle size was smaller by 1.5-fold. Although native yeast cells are reported to have a diameter of approximately 2–5  $\mu\text{m}$  (Paramera et al., 2014, chap. 23), non-treated *S. cerevisiae* cell wall was reported to contain particles ranging from 1 to 500  $\mu\text{m}$  (Borchani et al., 2016), 10 times higher than the hydrolysed yeast cell debris that produced in this study. Despite of size, compounds larger than yeast cell wall (4–40  $\mu\text{m}$ ) were encapsulated recently (Mokhtari, Khomeiri, et al., 2017). High span values indicate a high polydispersion of the particles' size (from 10.6 to 20.9). In other words, the span suggests a non-uniform size distribution which can be explained due to the high degree of complexity of the composition of the material, as presented in Section 3.1.1. All those chemical components differ in size and structure and are probably interacting with each other, resulting in a wider size distribution.

The surface tension of the non-treated yeast precipitate (YP) was kept constant after the hydrolysis (HP) at pH 7 (Table 1). Surface tension is known to depend on protein conformation as well as on pH value of surface-active species. Recently, a method to obtain the hydrophobicity of proteins via surface tension measurements was proposed, taking into account the long known inverse correlation between surface tension and relative hydrophobicity of proteins (Amrhein, Bauer, Galm, & Hubbuch, 2015). According to this relationship, hydrophobic amino acids reduce the surface tension while hydrophilic ones increase it (Amrhein et al., 2015). Proteins with a hydrophobic character play a key role in the biological and technological properties of proteins (solubility, and aggregation tendency) which are of interest in the pharmaceutical and food industries and needed for application studies (Amrhein et al., 2015; Phongthai, D'Amico, Schoenlechner, Homthawornchoo, & Rawdkuen, 2018; Xia, Bamdad, Gänzle, & Chen, 2012). Because of this, we determined surface tension of yeast hydrolysate suspension at different pHs (Fig. 2). Among pH values evaluated, surface tension was maximum at pH 5. Maximum hydrophobicity of the proteins in solution was achieved around pH 7, when the surface tension was smaller.

In food ingredients microencapsulation, various wall materials with ionic properties are used, such as phospholipids, proteins and polysaccharides. These chemical compounds have electric charges at their surface which play a role in the stability and physico-chemical properties of encapsulated products (Arpagaus, Collenberg, Rütli, Assadpour, & Jafari, 2018). In suspensions, the  $\zeta$  potential evinces the surface charge density of a dispersed phase (Ye, Georges, & Selomulya, 2018; Wen-qiong, Lan-wei, Xue, & Yi, 2017) and is an indicator of the stability or ability of aggregation of the dispersed particles (Arpagaus et al., 2018; Ye et al., 2018). Strongly charged surfaces ( $\zeta > \pm 30$  mV) are usually considered as more stable and may result in minimum

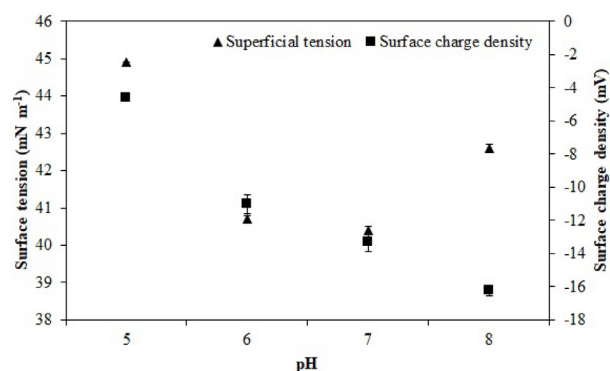

Fig. 2. Surface tension ( $\text{mN m}^{-1}$ ) and surface charge density (mV) of the hydrolysed yeast cell (HP) suspensions at pH 5, 6, 7 and 8.

aggregation due to intense repulsive forces (Arpagaus et al., 2018; Wenqiong et al., 2017). For protein-rich solutions, around the pI, the surface charge is close to zero and aggregation occurs (Ye et al., 2018). The approximate pI of HP was 3.6 (determined as described in Section 2.3.4). Debittered SBY biomass (*Saccharomyces* sp.) pI was previously reported as 4.5 (Pacheco et al., 1997) but it can change with the proteins present in the material and thus with SBY provenance. We evaluated the surface charge density and surface tension in the HP samples in pH values above the pI (Fig. 2).

The zeta potential values (mV) for all yeast samples are presented in Table 1. Comparing the surface charge density of the non-treated yeast (YP) with that of HP at pH 7, a decrease in the surface charge density value was observed. The hydrolysis and heating pre-treatment process contribute to the degradation of the phospholipid membrane and yeast cell wall, potentially modifying the physico-chemical characteristics of the material, such as surface charge density (Pradelles, Vichi, Alexandre, & Chassagne, 2009).

At highly positive or negative  $\zeta$  potentials, the suspension is more likely to be stable (Ye et al., 2018). Yeast hydrolysate (HP) presented negative  $\zeta$  potentials for pH values ranging from 5 to 8 (Fig. 2). In Fig. 2 it can be observed that as the pH increased, there was an increase in the  $\zeta$  potential of the solutions, which occurs due to the elevation of the electrostatic repulsion between the proteins as the pH is farther away from the pI (Arpagaus et al., 2018; Magdassi & Toledano, 1996, chap. 2). In the studied range, highest surface charge density was attained around pH 8, but at this pH, the surface tension went up, which could negatively influence the stability of encapsulated products in which there is a surface-active stabilisation mechanism. Moreover, the chosen active for the microencapsulation application study using HP was AA, which is a compound sensible to pH and stable in the pH range of 4 to 6. Above this range, the ascorbic acid is irreversibly changed to 2,3-diketogulonic acid, which is an inactive form (Eitenmiller, Landen, & Ye, 2007, chap. 5).

### 3.2. Maillard reaction

#### 3.2.1. Solubilisation of proteins and extent of reaction

The Maillard reaction was used to increase the solubilisation of yeast cell debris in water. One indication that the reaction effectively caused an increase in solubility is the mass transfer from the precipitated material to the supernatant after centrifugation. As the reaction proceeds, the basic amino group is consumed and the media becomes more acidic (Mirafzali et al., 2014, chap. 13). The evolution of soluble peptide content, pH and BI in the samples before and after the Maillard reaction are shown in Fig. 3.

It was observed that supernatant mass percentage after centrifugation was not statistically different both for the HP-only dispersions and those containing HP and M20. Supernatant recovery was, in average 96% (m/m) for all experiments. Even before the Maillard reaction took place, the supernatant fraction already represented 95% of the recovered mass after centrifugation and maybe because of the low solid concentration of the suspensions, significant differences in solids migration could not be detected. However, in HP dispersions there was an increase of 20% in soluble solids content, probably due to solubilisation of yeast compounds. After the Maillard reaction, soluble solids content in the dispersions with and without maltodextrin were 0.6 and 2.5 °BRIX, respectively.

According to Fig. 3a, it was observed that the Maillard reaction raised the concentration of peptides in solution in the suspensions with maltodextrin by 14.3%, in comparison with the control. The Maillard reaction is indeed reported to cause the solubilisation of components (Consoli et al., 2018; Oliver, Melton, & Stanley, 2006).

The extent of the Maillard reaction of the yeast hydrolysate solution was also checked by monitoring the pH, Browning Index and  $\Delta E$  against a control sample. The extent of the change in colour was already reported as a measure of the rate of the Maillard reaction. The rate of

brown pigment formation in SBY was found proportional to the square of amino content, reducing sugar concentration and time of reaction (In et al., 2005). The values of pH and Browning Index (BI) of the samples before and after Maillard reaction, containing or not maltodextrin, are shown in Figs. 3a and b. A reduction of the pH values of 4.5 and 5.4% and an increase in BI values of 227.6 and 230.3% in the suspensions without and with added maltodextrin were observed, respectively, corroborating the development of the Maillard reaction. In addition, according to the  $\Delta E$ , the colour variation of the sample containing maltodextrin was slightly higher ( $5.5 \pm 0.1$ ) than the sample that did not contain it ( $5.3 \pm 0.1$ ). It may be explained due to a higher amount of sugars in the suspension containing maltodextrin, allowing the reaction to occur more intensely (Ames, 1992, chap. 4; Oliver et al., 2006).

### 3.3. Microencapsulation by spray drying

Considering the protein and polysaccharide-rich composition of the hydrolysed yeast cell debris, this material was used along with maltodextrin after the Maillard reaction as a carrier material for encapsulation of ascorbic acid (AA). Vitamin C is the most unstable of vitamins, very susceptible to degradation when in contact with light, heating and oxygen (Eitenmiller et al., 2007, chap. 5).

#### 3.3.1. Encapsulation yield

In the microencapsulation of materials by spray drying, a high product yield and a maximum encapsulation efficiency are intended (Assadpour & Jafari, 2019). The EY for the ascorbic acid particles was  $101.90 \pm 5.5\%$ , showing that the use of yeast as a carrier agent ensured very little loss of the active materials during the process. In spray dried particles, the encapsulated compound is dispersed in a porous and hollow matrix, potentially resulting in lower values of retention, which was not observed in AA particles with yeast hydrolysate debris as carrier. Lee, Ahn, Lee, and Kwak (2004) encapsulated ascorbic acid using polyacylglycerol monostearate by spray drying, obtaining EY values in the range of 80.7–94.2%. The microencapsulation of ascorbic acid in gelatin, rice starch and Arabic gum by spray drying resulted in EYs higher than 98% (Trindade & Grosso, 2000). Carvalho, Oriani, Oliveira, and Hubinger (2019) studied the characterisation of ascorbic acid encapsulated by spray chilling using palm oil and fully hydrogenated palm oil as carriers and obtained values of encapsulation efficiency in the range of 82.6%–96.1%. In other research, Hoyos-Leyva, Chavez-Salazar, Castellanos-Galeano, Bello-Perez, and J (2018) studied the physical and chemical stability of L-ascorbic acid microencapsulated into taro starch spherical aggregates by spray drying and obtained total retention of  $99.0 \pm 0.40\%$ . The encapsulation of vitamin C by spray drying using YMC20 as carrier material promoted similar retention of AA when compared to the results obtained by these authors. However, our approach presents advantages since we used a material from an agro-industrial underutilised residue (food-grade material) with high protein content (nutritive). In addition, the reuse of this material presents a sustainable approach and waste management solution. In other words, YMC20 may be considered a better carrier in relation to polyacylglycerol monostearate, palm oil and fully hydrogenated palm oil and taro starch spherical aggregates, as a new sustainable alternative for encapsulation of bioactive compounds by spray drying.

#### 3.3.2. Moisture, water activity and hygroscopicity of particles

The values of moisture,  $a_w$  and hygroscopicity of the particles obtained by spray drying are presented in Table 2. Particles containing AA presented lower values of moisture and water activity. However, higher values of hygroscopicity when compared with the control particles (without AA) were found. All these values obtained for the AA particles using SBY-maltodextrin-based Maillard conjugates as carrier material resulted in low values of moisture,  $a_w$  and hygroscopicity, which is expected for proper handling, storage and application of the powder. In addition,  $a_w$  values lower than 0.6 were obtained, suggesting

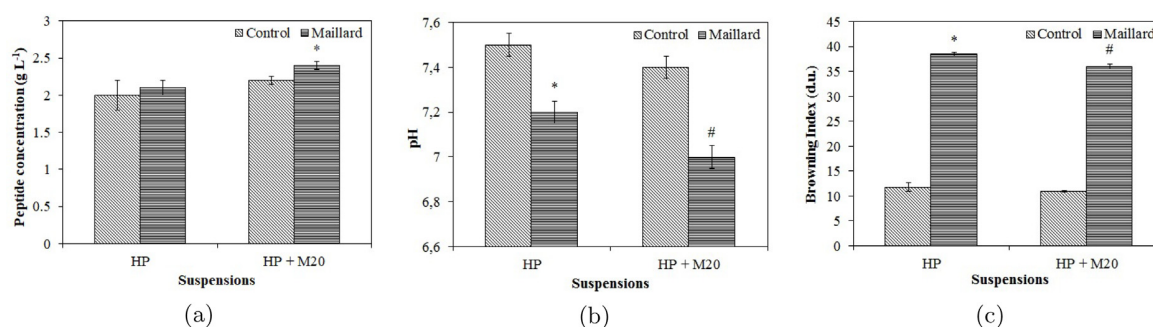

**Fig. 3.** Effect of maltodextrin (M20) addition in the hydrolysed yeast cells (HP) suspension after the Maillard Reaction on peptide concentration (a), pH (b) and Browning Index (c). The presence of symbols (\* or #) in the same group of columns indicates statistical difference ( $p < 0,05$ ) between the control and Maillard reaction experiments. Different symbols indicate statistical difference ( $p < 0,05$ ) between groups (HP and HP + M20).

**Table 2**

Moisture, water activity ( $a_w$ ) and hygroscopicity of control (pure wall material) and ascorbic acid (AA) particles produced by spray drying with SBY-maltodextrin-based Maillard conjugates (YMC20) as a wall material.

Characterisation	YMC20	YMC20 + AA
Moisture (%)	$3.8 \pm 0.1^a$	$3.0 \pm 0.1^b$
$a_w$	$0.2 \pm 0.0^a$	$0.1 \pm 0.0^b$
Hygroscopicity ( $g_{H_2O}/100 g_{particles}$ )	$13.8 \pm 0.4^a$	$19.3 \pm 0.4^b$

Different letters on the same line indicate significant differences between treatments ( $p < 0.05$ ).

microbiological stability of the powder, limiting the microorganisms development below this value. Moreover, particles with  $a_w$  values below 0.2 have lower susceptibility to enzymatic and non-enzymatic reactions during storage (Belitz, Grosch, & Schieberle, 2009; Comunian et al., 2013; Croguennec, 2016; Damodaran, Fennema, & Parkin, 5; Damodaran et al., 2010).

Hygroscopicity of the encapsulated AA powder was slightly higher than the control. As the amount of carrier agent is smaller, the hygroscopicity of the powders tends to get higher (Breternitz, de Vasconcelos Fidelis, Silva, Eberlin, & Hubinger, 2017). This parameter is inversely dependent on the components molecular weight as well as the physico-chemical structure of the material (chains arrangements). The complex composition of YMC20 may form a fairly open structure that provides available interaction with water (Botrel, de Barros Fernandes, Borges, & Yoshida, 2014).

Choi et al. (2019) studied the enhancement of ultrafine *Angelica gigas* powder by spray drying encapsulation using maltodextrin as carrier material and obtained moisture values in the range of 4.0%-5.5%. On the other hand, Otálora, Carriazo, Osorio, and Nazareno (2018) obtained a moisture content of  $1.2 \pm 0.1\%$  for particles obtained by spray drying when cactus (*Opuntia megacantha*) betaxanthins was

encapsulated using a mixture of maltodextrin-cactus cladode mucilage as carrier. In another recent research, Machado et al. (2018) evaluated the encapsulation of anthocyanin-rich extract from blackberry residues by spray drying using polyvinylpyrrolidone as carrier. These authors obtained moisture values of  $5.3 \pm 0.1\%$ . These results indicate that particles obtained with HP result in moisture values lower than particles with maltodextrin or polyvinylpyrrolidone as carriers, but higher than when maltodextrin is used as carrier in combination with another material. However, all these results are appropriate for application since they are considered low for a powdered product.

The microencapsulation of jabuticaba, jussara and blueberry phenolic extracts blends by spray drying using maltodextrin, gum Arabic and whey protein concentrate as wall materials resulted in water activity and hygroscopicity values in the range of 0.34–0.45% and 9.1–15.5%, respectively (Rocha et al., 2019). Otálora et al. (2018) obtained a  $a_w$  value of  $0.39 \pm 0.01$  for cactus betaxanthins particles with maltodextrin-cactus cladode mucilage as carrier. It seems that particles with HD as carrier resulted in samples with lower  $a_w$  and hygroscopicity values similar to particles with different wall materials obtained by spray drying.

Matos, Comunian, Thomazini, and Fávoro-Trindade (2017) evaluated the effect of feed preparation on the properties and stability of ascorbic acid microparticles produced by spray chilling using inter-esterified fat as carrier and obtained values of  $a_w$  in the range of 0.63–0.97. These high values were already expected since inter-esterified fat was used as carrier. Rezende, Nogueira, and Narain (2018) studied the encapsulation of extract obtained from acerola by spray and freeze drying using Arabic gum and maltodextrin as encapsulating agents and obtained hygroscopicity values in the range of 9%–12.5%. It seems that particles with YMC20 as carrier resulted in samples with lower  $a_w$  values and hygroscopicity similar to particles with different wall materials obtained by spray drying.

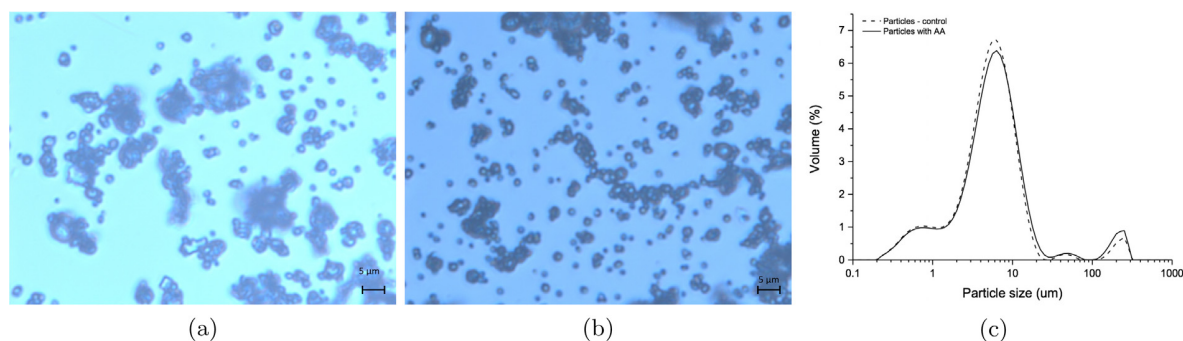

**Fig. 4.** Optical microscopy (increase of 100x) of the particles produced: control (only wall material - YMC20) (a) and ascorbic acid encapsulated in YMC20 (b); and the particle size distribution of those formulations (c).

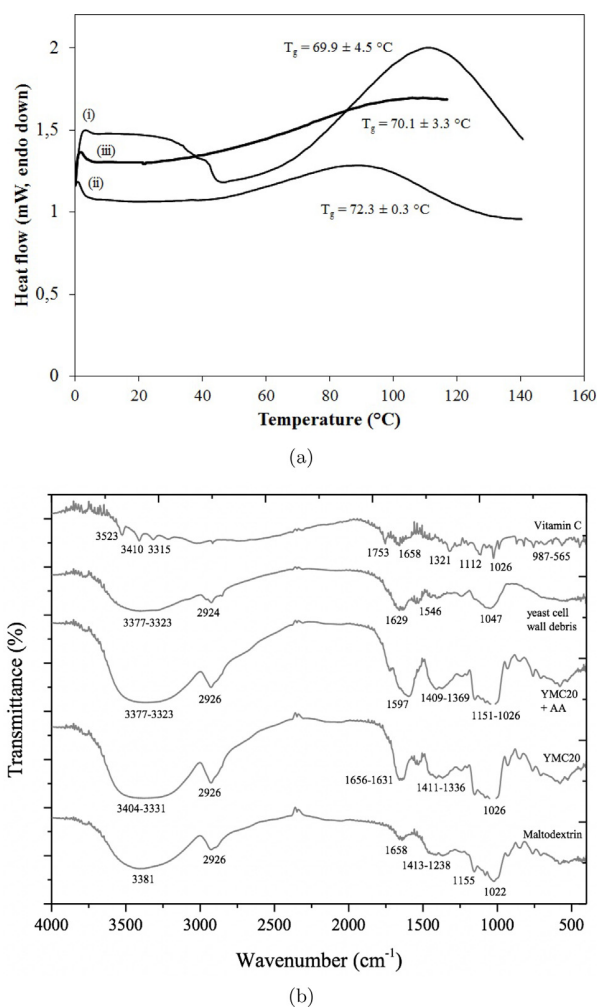

**Fig. 5.** DSC thermograms (a) of (i) control particles (YMC20), (ii) encapsulated ascorbic acid in YMC20 and (iii) hydrolysed yeast cell (HP); and FT-IR spectra (b) of particles and separated materials (vitamin C, hydrolysed yeast cell debris (HP) and maltodextrin). From up to bottom of Figure b: ascorbic acid (vitamin C); yeast cell wall hydrolysed debris (HP); vitamin C encapsulated in SBY-based Maillard conjugates and maltodextrin (YMC20 + AA); control particles (YMC20); maltodextrin (M20).

### 3.3.3. DSC and FT-IR study of particles

Spray-dried samples were studied with Differential Scanning Calorimetry (DSC) and Fourier-Transform Infrared Spectroscopy (FT-IR) in order to evaluate their changes in structure after spray-drying. DSC thermograms indicate system changes in terms of exothermic, endothermic and heat capacity processes as a function of temperature. The glass transition temperature ( $T_g$ ), which is an important parameter for particulate systems such as samples obtained by spray drying, can also be determined. Particles are either in a glassy or a rubbery state. Molecular mobility is reduced in the glassy state, improving the material stability and properly protecting the encapsulated compounds (Kasapis, 2005; Kurozawa, Terng, Hubinger, & Park, 2014). Above the  $T_g$ , the particles' structure are in a physico-chemical state called "gummy state". This condition is characterised by a higher mobility where physico-chemical modifications are more likely to happen, possibly resulting in agglomeration, crystallisation, loss of volatiles, darkening or oxidation reactions and consequently destabilisation of the particulate system. Therefore, a  $T_g$  as far as possible from room temperature is desirable to ensure stability and quality of the particles obtained after drying and during storage (Bhandari & Howes, 1999).

DSC thermograms in Fig. 5a show slightly different profiles for

control particles (YMC20) (i), encapsulated ascorbic acid in YMC20 (ii) and hydrolysed yeast cell debris (HP) (iii) but in all three, an exothermic peak that starts around 60–70 °C can be observed. This peak may be attributed to the aggregation of yeast proteins or rearranging of the structure. Thermally induced-transitions are represented by changes in peaks shape, temperature and area, providing information about the interactions of a system (Kaletunc, 2009). Differences in composition may help to explain the observed changes. Only in YMC20 control particles, an endothermic peak around 45 °C can be seen. Gelatinization of  $\beta$ -D-glucan is an endothermic process and was reported previously with an onset temperature of 52 °C (Khan et al., 2016). In protein-rich materials, endothermic peaks are also usually related to the denaturation of proteins or melting of solids (Kaletunc, 2009). To the authors best knowledge, until now, DSC thermograms of disrupted BSY were not reported. Other authors reported structure changes in whole yeast cells regarding the phase transition temperature of yeasts phospholipid bilayer (endothermic) and destruction of yeast cell (exothermic) at higher temperatures (160 and 265 °C) (Paramera et al., 2011).

The glass transition temperature of the yeast cell debris, control and AA particles ranged from 70 to 72 °C. This result agrees with the values obtained by Schebor, Galvagno, del Pilar Buera, and Chirife (2000), which determined the glass transition temperature of dried samples of *S. cerevisiae*, obtaining values in the range of 64–87 °C, according to the moisture content of the samples. No statistical difference ( $p > 0.05$ ) between values of  $T_g$  for particles with and without AA was found. The  $T_g$  obtained for the microparticles with vitamin C ( $72.3 \pm 0.3$  °C) was high compared to the ambient temperature, which, in combination with the other parameters, assures the stability of the system and of the encapsulated material. Zhong, Tan, and Langrish (2019) studied the redness generation via Maillard reaction of whey protein isolate (WPI) and AA in spray dried powders and observed  $T_g$  values around 80 °C due to the presence of WPI. Particles obtained with YMC20 as carrier showed  $T_g$  values lower than particles with WPI. Both are considered good for samples obtained by spray drying for future food applications.

FT-IR spectra of wall materials, vitamin C and particles are presented in Fig. 5b. Wall materials and particles showed peaks in the range of 3410–3315 and at 2926–2924  $\text{cm}^{-1}$ , which are related to O-H stretching, residual water and C-H stretching (Akbarbaglu et al., 2019). The spectra obtained for maltodextrin is similar to reported spectra when this material was used in the study of spray drying encapsulation on the retention of antioxidant properties and microstructure of flaxseed protein hydrolysates (Akbarbaglu et al., 2019). According to these authors, the peaks at 1658, 1413–1238, 1155 and 1022  $\text{cm}^{-1}$  correspond to O-H,  $\text{CH}_2$ , C-O and C-O-H and  $=\text{CH}/=\text{CH}_2$  bonds, respectively. Regarding to yeast cell wall debris, besides the peaks in the range of 3377–3323  $\text{cm}^{-1}$ , peaks at 2924, 1629, 1546 and 1047  $\text{cm}^{-1}$  were observed. Spectra in the range of 3377–3323  $\text{cm}^{-1}$  correspond, besides O-H stretching and residual water, to NH stretching vibrations of proteins and peptides and to amide II overtone (Paramera et al., 2011). Moreover, the changes in the peaks at 1629 and 1546  $\text{cm}^{-1}$  (present in yeast cell wall debris) to 1597–1409 and to 1656–1411  $\text{cm}^{-1}$  (present in YMC20 + AA and YMC20, respectively), could be related to partial protein degradation associated to yeast cell wall (Paramera et al., 2011). Peaks from 1151 to 1026  $\text{cm}^{-1}$  are related to absorptions of mannans and glucans. The spectra of particles (YMC20 + AA and YMC20) presented characteristics similar to wall materials, with some peaks shifted, which are related to presence of vitamin C and formation of compounds during the Maillard reaction. The FT-IR spectra of AA encapsulated particles is very similar to that of control particles (just the carrier material), which confirms the presence of YMC20 in the surface of the particles.

### 3.3.4. Microstructure and particle size

The micrographs of the particles obtained by optical microscopy are shown in Fig. 4a and b. The micrographs did not indicate relevant morphological differences in the samples with and without AA. In other

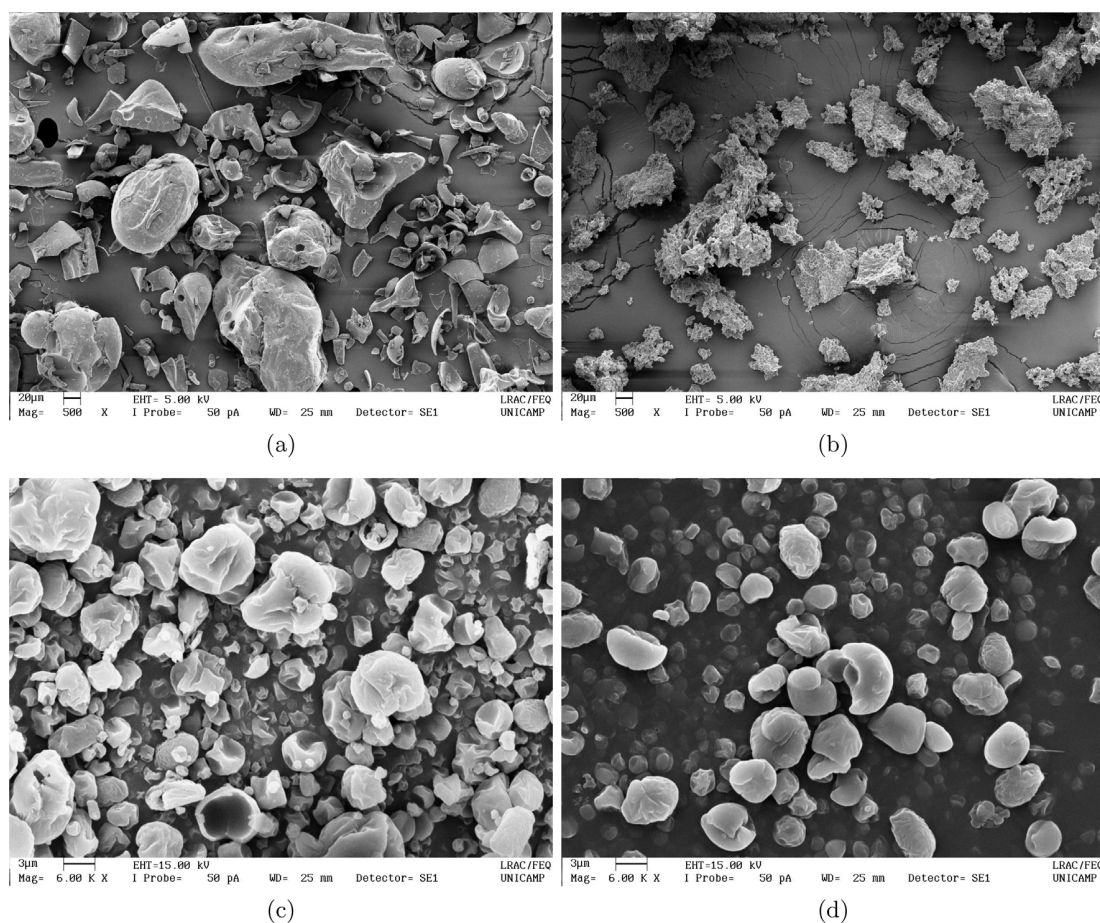

**Fig. 6.** Scanning electron microscopy of (a) maltodextrin and (b) yeast cell wall debris (HP), control particles (only wall material - YMC20) (c) and ascorbic acid encapsulated in YMC20 (d). SEM images of carrier materials (a and b) and particles (c and d) were amplified 500 and 6000 times, respectively.

words, the incorporation of vitamin C into the formulation and the use of HP with maltodextrin as carriers did not seem to influence particle's morphology. As confirmed by SEM images of the control and vitamin C particles (Fig. 6c and d, respectively), the encapsulated vitamin C particles presented a rounded shape, as expected using this method of encapsulation (Bastan, Erdogan, Moskalewicz, & Ustel, 2017). A smooth and shrinkaged surface was observed, with hollows and without pores. The observed shrinking characteristic is explained by the sudden evaporation of water that takes place during the atomisation process. SEM images of the carrier materials show a very random morphology of maltodextrin (Fig. 6a). Yeast cell debris hydrolysed material (HP) (Fig. 6b) shows clearly disrupted yeast cells, very different from rounded-shaped yeast cells non-hydrolysed as previously reported (Sultana et al., 2017).

The particle size distribution for the formulations is shown in Fig. 4c. A bimodal behavior for the particles with AA and control was observed with only a peak with higher intensity. This behavior was already expected for this type of material since it is not possible to control the particle size during atomisation. The particles were not homogeneous, which makes the small particles occupy the space among larger ones, reducing the volume and favouring their food application. A wide range of size distribution (24–280  $\mu\text{m}$ ) was also obtained for alginate-calcium microcapsules containing probiotics and a coating of yeast cell wall material (Mokhtari, Jafari, et al., 2017) although this higher span could be attributed to the addition of more layers and not specifically to the addition of the yeast coating.

Average particle size  $D_{[4.3]}$  obtained for the particles containing ascorbic acid and the control (only wall material without AA) were

$14.7 \pm 0.6$  and  $11.6 \pm 0.7$   $\mu\text{m}$ , respectively. The addition of AA resulted in 21% larger particles. Despite particles' size being different, the particles loaded with vitamin C resulted in appropriate average sizes for application in food products. Although the absolute size detection threshold and acceptability are matrix specific and depends on particles surface morphology, diameters below 100  $\mu\text{m}$  are often reported as acceptable for most applications in foods because at that size there is little influence on perceived texture (Annan, Borza, & Hansen, 2008; Lee, Lee, & Donovan, 2014, cha 28; Yan & Zhang, 2014, chap. 12).

The encapsulation of peppermint oil in whole non-viable *S. cerevisiae* and *S. boulardi* cells, approximately 30  $\mu\text{m}$  diameter particles were obtained (Nelson et al., 2006). Those spray-dried particles formed aggregates, resulting in 6 times bigger particles than non-treated yeast cells (approximately 5  $\mu\text{m}$ ) (Nelson et al., 2006). Particles with mean diameters around 7 and 35  $\mu\text{m}$  were obtained in the encapsulation of flavours using yeast cells by-product from  $\beta$ -glucan production using mini and pilot-scale spray dryers, respectively (Sultana et al., 2017). The particles obtained in this paper using yeast cell debris were much smaller even though some agglomerates bigger than 100  $\mu\text{m}$  were detected (Fig. 4c). The encapsulation of AA using Arabic gum, gelatin and rice starch by spray drying resulted in particles of a mean diameters of 8  $\mu\text{m}$  and 18–21  $\mu\text{m}$ , respectively. Multimodal distributions were observed, with particles ranging from 0.3 to 90  $\mu\text{m}$  for Arabic gum and to 224  $\mu\text{m}$  for gelatin and rice starch (Trindade & Grosso, 2000). Hoyos-Leyva et al. (2018) studied the microencapsulation of L-ascorbic acid into starch spherical aggregates by spray drying and obtained particle size of 16.4  $\mu\text{m}$  and particle size distribution similar to particles with HP, maltodextrin and AA, showing that the use of the precipitate

fraction of spent brewer's yeast hydrolysate as carrier promoted the formation of particles with the similar size and distribution when compared to standard encapsulating agents.

#### 4. Conclusions

Spent yeasts from brewing are an inexpensive raw material and a good source of proteins and carbohydrates that can be used in the development of food ingredients while promoting the valorisation of relevant agricultural by-products. Our work demonstrated the potential of SBY hydrolysed cell debris to generate MRPs and encapsulate compounds of interest. SBY-based Maillard conjugates were able to encapsulate ascorbic acid, resulting in particles of high values of EY, low  $a_w$ , moisture and hygroscopicity. The effects of yeast cell wall material in the particle matrix was clearly depicted through SEM and FT-IR spectroscopy. In average, particles were smaller than 15  $\mu\text{m}$  and the glass transition temperature was relatively high (72  $^{\circ}\text{C}$ ), indicating product stability. Future studies are committed to evaluate the viability of encapsulated compounds using yeast cell debris as wall material, the stability of the particles along storage as well as appraise particles' nutritional and potential health-promoting characteristics.

#### CRedit authorship contribution statement

**Gabriela Vollet Marson:** Conceptualization, Methodology, Validation, Formal analysis, Investigation, Resources, Writing - original draft, Writing - review & editing, Visualization, Funding acquisition. **Rafaela Polessi Saturno:** Validation, Formal analysis, Investigation, Writing - original draft, Visualization. **Talita Aline Comunian:** Visualization, Investigation, Writing - original draft, Writing - review & editing. **Larissa Consoli:** Conceptualization, Validation, Writing - review & editing. **Mariana Teixeira da Costa Machado:** Conceptualization, Writing - review & editing, Supervision. **Miriam Dupas Hubinger:** Conceptualization, Resources, Writing - review & editing, Supervision, Project administration, Funding acquisition.

#### Declaration of Competing Interest

The authors declare that they have no known competing financial interests or personal relationships that could have appeared to influence the work reported in this paper.

#### Acknowledgements

This work was supported by FAPESP (São Paulo Research Foundation) [Grant Nos. #2018/04067-6, #2016/18465-8, #2015/24351-2, #2015/11984-7, #2012/50411-4, #2011/51707-1, #2011/06083-0, #2009/50593-2, #2009/50591-0, #2007/58017-5, #2007/54520-4, #2006/03263-9, and #96/08366-5]; EMU [Grant Nos. #2009/54137-1]; FAEPEX (UNICAMP) [#2422/16; 519.292]; and CNPq [# 306461/2017-0, #148665/2017-9]. The authors thank Prozyn and Novozymes for the kind supply of enzymes; Pedro Moura (Haus Beer Brewery) for donating SBYs. Funding sources had no involvement in any steps of this research.

#### References

Ahmad, M., Ashraf, B., Gani, A., & Gani, A. (2018). Microencapsulation of saffron anthocyanins using  $\beta$ glucan and  $\beta$ cyclodextrin: Microcapsule characterization, release behaviour & antioxidant potential during in-vitro digestion. *International Journal of Biological Macromolecules*, *109*, 435–442. <https://doi.org/10.1016/j.ijbiomac.2017.11.122>.

Aitken, A., & Learmonth, M. P. (2002). Protein determination by UV absorption. In J. M. Walker (Ed.), *The Protein Protocols Handbook* (pp. 3–6). Totowa, NJ: Humana Press. <https://doi.org/10.1385/1-59259-169-8:3>.

Akbarbaglu, Z., Jafari, S. M., Sarabandi, K., Mohammadi, M., Heshmati, M. K., & Pezeshki, A. (2019). Influence of spray drying encapsulation on the retention of antioxidant properties and microstructure of flaxseed protein hydrolysates. *Colloids*

*and Surfaces B: Biointerfaces*, *178*, 421–429. <https://doi.org/10.1016/j.colsurfb.2019.03.038>.

Ames, J. M. (1992). The Maillard Reaction. In B. J. F. Hudson (Ed.), *Biochemistry of food proteins* (pp. 99–153). (1st ed.). Dordrecht: Springer Science + Business Media. <https://doi.org/10.1007/978-1-4684-9895-0>.

Amorim, M., Pinheiro, H., & Pintado, M. (2019). Valorization of spent brewer's yeast: Optimization of hydrolysis process towards the generation of stable ACE-inhibitory peptides. *LWT*, *111*, 77–84. <https://doi.org/10.1016/j.lwt.2019.05.011>.

Amrhein, S., Bauer, K. C., Galm, L., & Hubbuch, J. (2015). Non-invasive high throughput approach for protein hydrophobicity determination based on surface tension. *Biotechnology and Bioengineering*, *112*, 2485–2494. <https://doi.org/10.1002/bit.25677>.

Anandharamkrishnan, C., & Ishwarya, S. P. (2015). Selection of wall material for encapsulation by spray drying. In C. Anandharamkrishnan, & S. P. Ishwarya (Eds.), *Spray Drying Techniques for Food Ingredient Encapsulation 4* (pp. 77–100). John Wiley & Sons, Ltd. <https://doi.org/10.1002/9781118863985.ch4>.

Annan, N., Borza, A., & Hansen, L. T. (2008). Encapsulation in alginate-coated gelatin microspheres improves survival of the probiotic *Bifidobacterium adolescentis* 15703T during exposure to simulated gastro-intestinal conditions. *Food Research International*, *41*, 184–193. <https://doi.org/10.1016/j.foodres.2007.11.001> <http://www.sciencedirect.com/science/article/pii/S0963996907001937>.

AOAC (2006). *Official Methods of Analysis of the Association of Official Analytical Chemists* (18th ed.). MD, USA: Gaithersburg.

Arpagaus, C., Collenberg, A., Rüttli, D., Assadpour, E., & Jafari, S. M. (2018). Nano spray drying for encapsulation of pharmaceuticals. *International Journal of Pharmaceutics*, *546*, 194–214. <https://doi.org/10.1016/j.ijpharm.2018.05.037>.

Assadpour, E., & Jafari, S. M. (2019). Advances in spray-drying encapsulation of food bioactive ingredients: From microcapsules to nanocapsules. *Annual Review of Food Science and Technology*, *10*, 103–131. <https://doi.org/10.1146/annurev-food-032818-121641>.

Augustin, M. A., Sanguansri, L., & Bode, O. (2006). Maillard reaction products as encapsulants for fish oil powders. *Journal of Food Science*, *71*, E25–E32. <https://doi.org/10.1111/j.1365-2621.2006.tb08893.x>.

Bastan, F., Erdogan, G., Moskalewicz, T., & Ustel, F. (2017). Spray drying of hydroxyapatite powders: The effect of spray drying parameters and heat treatment on the particle size and morphology. *Journal of Alloys and Compounds*, *724*, 586–596. <https://doi.org/10.1016/j.jallcom.2017.07.116>.

Belitz, H. D., Grosch, W., & Schieberle, P. (2009). *Food Chemistry* (4th ed.). Berlin, Germany: Springer - Verlag Berlin Heidelberg <https://doi.org/10.1007/978-3-540-69934-7>.

Bhandari, B. R., & Howes, T. (1999). Implication of glass transition for the drying and stability of dried foods. *Journal of Food Engineering*, *40*, 71–79. [https://doi.org/10.1016/S0260-8774\(99\)00039-4](https://doi.org/10.1016/S0260-8774(99)00039-4).

Borchani, C., Fonteyn, F., Jamin, G., Paquot, M., Blecker, C., & Thonart, P. (2014). Enzymatic process for the fractionation of baker's yeast cell wall (*Saccharomyces cerevisiae*). *Food Chemistry*, *163*, 108–113. <https://doi.org/10.1016/j.foodchem.2014.04.086>.

Borchani, C., Fonteyn, F., Jamin, G., Paquot, M., Thonart, P., & Blecker, C. (2016). Physical, functional and structural characterization of the cell wall fractions from baker's yeast *Saccharomyces cerevisiae*. *Food Chemistry*, *194*, 1149–1155. <https://doi.org/10.1016/j.foodchem.2015.08.106>.

Botrel, D. A., de Barros Fernandes, R. V., Borges, S. V., & Yoshida, M. I. (2014). Influence of wall matrix systems on the properties of spray-dried microparticles containing fish oil. *Food Research International* *62*, 344 – 352. URL <http://www.sciencedirect.com/science/article/pii/S0963996914001021>. doi:<https://doi.org/10.1016/j.foodres.2014.02.003>.

Breternitz, N. R., de Vasconcelos Fidelis, C. H., Silva, V. M., Eberlin, M. N., & Hubinger, M. D. (2017). Volatile composition and physicochemical characteristics of mussel (*Perna perna*) protein hydrolysate microencapsulated with maltodextrin and n-OSA modified starch. *Food and Bioprocess Processing*, *105*, 12–25. <https://doi.org/10.1016/j.fbp.2017.05.008>.

Caballero-Córdoba, G. M., & Sgarbieri, V. C. (2000). Nutritional and toxicological evaluation of yeast (*Saccharomyces cerevisiae*) biomass and a yeast protein concentrate. *Journal of the Science of Food and Agriculture*, *80*, 341–351. [https://doi.org/10.1002/1097-0010\(200002\)80:3<341::AID-JSFA533>3.0.CO;2-M](https://doi.org/10.1002/1097-0010(200002)80:3<341::AID-JSFA533>3.0.CO;2-M).

Cai, Y., & Corke, H. (2000). Production and properties of spray-dried amaranthus betacyanin pigments. *Journal of Food Science*, *65*, 1248–1252. <https://doi.org/10.1111/j.1365-2621.2000.tb10273.x>.

Carvalho, J. D. d. S., Oriani, V. B., Oliveira, G. M. d., & Hubinger, M. D. (2019). Characterization of ascorbic acid microencapsulated by the spray chilling technique using palm oil and fully hydrogenated palm oil. *LWT*, *101*, 306–314. <https://doi.org/10.1016/j.lwt.2018.11.043>.

Castrillo, J. I., & Ugalde, U. (2003). *Mycoprotein and related microbial protein products*. In D. Arora, & J. Bennett (Eds.), *Biotechnology in Agricultural, Food, and Environmental Applications* (pp. 245–253). (1st ed.). Boca Raton: CRC Press.

Chae, H. J., Joo, H., & In, M.-J. (2001). Utilization of brewer's yeast cells for the production of food-grade yeast extract. part 1: Effects of different enzymatic treatments on solid and protein recovery and flavor characteristics. *Bioresource Technology*, *76*, 253–258. [https://doi.org/10.1016/S0960-8524\(00\)00102-4](https://doi.org/10.1016/S0960-8524(00)00102-4).

Choi, K.-O., Kim, D., Lim, J. D., Ko, S., Hong, G.-P., & Lee, S. (2019). Functional enhancement of ultrafine Angelica gigas powder by spray-drying microencapsulation. *LWT*, *101*, 161–166. <https://doi.org/10.1016/j.lwt.2018.10.097>.

Ciamponi, F., Duckham, C., & Tirelli, N. (2012). Yeast cells as microcapsules, analytical tools and process variables in the encapsulation of hydrophobes in *S. cerevisiae*. *Applied Microbiology and Biotechnology*, *95*, 1445–1456. <https://doi.org/10.1007/s00253-012-4127-8>.

- Comunian, T. A., Thomazini, M., Alves, A. J. G., de Matos Junior, F. E., de Carvalho Balieiro, J. C., & Favaro-Trindade, C. S. (2013). Microencapsulation of ascorbic acid by complex coacervation: Protection and controlled release. *Food Research International*, 52, 373–379. <https://doi.org/10.1016/j.foodres.2013.03.028>.
- Consoli, L., Dias, R. A., Rabelo, R. S., Furtado, G. F., Sussulini, A., Cunha, R. L., & Hubinger, M. D. (2018). Sodium caseinate-corn starch hydrolysates conjugates obtained through the Maillard reaction as stabilizing agents in resveratrol-loaded emulsions. *Food Hydrocolloids*, 84, 458–472. <https://doi.org/10.1016/j.foodhyd.2018.06.017>.
- Croguenne, T. (2016). Non-enzymatic browning. In R. Jeantet, T. Croguenne, P. Schuck, & G. Brulé (Eds.), *Handbook of Food Science and Technology 1* (pp. 133–157). John Wiley & Sons, Ltd. doi:10.1002/9781119268659.ch5.
- Damodaran, S., Fennema, O. R., & Parkin, K. L. (2010). *Química de Alimentos de Fennema* (4th ed.). Porto Alegre, Brazil: Artmed. Language: portuguese.
- Drozińska, E., Kanclerz, A., & Kurek, M. A. (2019). Microencapsulation of sea buckthorn oil with  $\beta$ -glucan from barley as coating material. *International Journal of Biological Macromolecules*, 131, 1014–1020. <https://doi.org/10.1016/j.ijbiomac.2019.03.150>.
- Eitenmiller, R. R., Landen, W. O., & Ye, L. (2007). Ascorbic acid: vitamin C. In R.R. Eitenmiller, W.O. Landen, & L. Ye (Eds.), *Vitamin Analysis for the Health and Food Sciences* (pp. 231–290). Boca Raton, USA: CRC Press. (2nd ed.). Section II: water soluble vitamins.
- Estevinho, B. N., Carlan, I., Blaga, A., & Rocha, F. (2016). Soluble vitamins (vitamin B12 and vitamin C) microencapsulated with different biopolymers by a spray drying process. *Powder Technology*, 289, 71–78. <https://doi.org/10.1016/j.powtec.2015.11.019>.
- Fan, L.-S., & Zhu, C. (1998). Size and properties of particles. In *Principles of Gas-Solid Flows Cambridge Series in Chemical Engineering* (pp. 3–45). Cambridge, UK: Cambridge University Press. doi:10.1017/CBO9780511530142.002.
- Ferreira, I., Pinho, O., Vieira, E., & Tavela, J. (2010). Brewer's Saccharomyces yeast biomass: Characteristics and potential applications. *Trends in Food Science & Technology*, 21, 77–84. <https://doi.org/10.1016/j.tifs.2009.10.008>.
- Fournier, E. (2001). Colorimetric quantification of carbohydrates. In R. E. Wrolstad (Ed.), *Current Protocols in Food Analytical Chemistry* John Wiley & Sons, Inc. <https://doi.org/10.1002/0471142913.fae0101s00>.
- Hou, H., Li, B., Zhao, X., Zhang, Z., & Li, P. (2011). Optimization of enzymatic hydrolysis of Alaska pollock frame for preparing protein hydrolysates with low-bitterness. *LWT - Food Science and Technology*, 44, 421–428. <https://doi.org/10.1016/j.lwt.2010.09.009>.
- Hoyos-Leyva, J., Chavez-Salazar, A., Castellanos-Galeano, F., Bello-Perez, L. A., & J. A.-R. (2018). Physical and chemical stability of L-ascorbic acid microencapsulated into taro starch spherical aggregates by spray drying. *Food Hydrocolloids*, 83, 143–152. <https://doi.org/10.1016/j.foodhyd.2018.05.002>.
- de la Hoz, L., Ponezi, A. N., Milani, R. F., da Silva, V. S. N., de Souza, A. S., & Bertoldo-Pacheco, M. T. (2014). Iron-binding properties of sugar cane yeast peptides. *Food Chemistry*, 142, 166–169. <https://doi.org/10.1016/j.foodchem.2013.06.133>.
- In, M.-J., Kim, D. C., & Chae, H. J. (2005). Downstream process for the production of yeast extract using brewer's yeast cells. *Biotechnology and Bioengineering*, 10, 85. <https://doi.org/10.1002/BF02931188>.
- Jaehrig, S. C., Rohn, S., Kroh, L. W., Fleischer, L.-G., & Kurz, T. (2007). In vitro potential antioxidant activity of (1 $\rightarrow$ 3), (1 $\rightarrow$ 6)- $\beta$ -D-glucan and protein fractions from Saccharomyces cerevisiae cell walls. *Journal of Agricultural and Food Chemistry*, 55, 4710–4716. <https://doi.org/10.1021/jf063209q>.
- Jinapong, N., Suphantharika, M., & Jammong, P. (2008). Production of instant soymilk powders by ultrafiltration, spray drying and fluidized bed agglomeration. *Journal of Food Engineering*, 84, 194–205. <https://doi.org/10.1016/j.jfoodeng.2007.04.032>.
- Kaletunç, G. (2009). Calorimetric methods as applied to food: An overview. In G. Kaletunç (Ed.), *Calorimetry in Food Processing: Analysis and Design of Food Systems* (pp. 5–14). Iowa, USA: Wiley-Blackwell and Institute of Food Technologists.
- Kasapis, S. (2005). Glass transition phenomena in dehydrated model systems and foods: A review. *Drying Technology*, 23, 731–757. <https://doi.org/10.1081/DRT-200054182>.
- Khan, A. A., Gani, A., Masoodi, F., Amin, F., Wani, I. A., Khanday, F. A., & Gani, A. (2016). Structural, thermal, functional, antioxidant & antimicrobial properties of  $\beta$ -D-glucan extracted from bakers yeast (*Saccharomyces cerevisiae*) - Effect of  $\gamma$ -irradiation. *Carbohydrate Polymers*, 140, 442–450. <https://doi.org/10.1016/j.carbpol.2016.01.003>.
- Križková, L., Ďuračková, Z., Šandula, J., Sasinková, V., & Krajčovič, J. (2001). Antioxidative and antimutagenic activity of yeast cell wall mannans in vitro. *Mutation Research/Genetic Toxicology and Environmental Mutagenesis*, 497, 213–222. [https://doi.org/10.1016/S1383-5718\(01\)00257-1](https://doi.org/10.1016/S1383-5718(01)00257-1).
- Kumar, R. S., & Chandrasekaran, M. (2016). Beverages. In M. Chandrasekaran (Ed.), *Valorization of Food Processing By-Products* (pp. 589–614). Boca Raton: CRC Press.
- Kunst, T. (2003). Protein Modification to Optimize Functionality: Protein Hydrolysates. In J. R. Whitaker, A. G. J. Voragen, & D. W. S. Wong (Eds.), *Handbook of Food Enzymology* (pp. 221–236). (1st ed.). New York: Marcel Dekker.
- Kurozawa, L. E., Terng, I., Hubinger, M. D., & Park, K. J. (2014). Ascorbic acid degradation of papaya during drying: Effect of process conditions and glass transition phenomenon. *Journal of Food Engineering*, 123, 157–164. <https://doi.org/10.1016/j.jfoodeng.2013.08.039>.
- Lee, J.-B., Ahn, J., Lee, J., & Kwak, H.-S. (2004). L-ascorbic acid microencapsulated with polyacylglycerol monostearate for milk fortification. *Bioscience, Biotechnology, and Biochemistry*, 68, 495–500. <https://doi.org/10.1271/bbb.68.495>.
- Lee, Y., Lee, S.-Y., & Donovan, J. D. (2014). Stability characterization and sensory testing in food products containing microencapsulants. In A. G. Gaonkar, N. Vasisht, A. R. Khare, & R. Sobel (Eds.), *Microencapsulation in the Food Industry* (pp. 367–381). San Diego: Academic Press. <https://doi.org/10.1016/B978-0-12-404568-2.00028-5>.
- Li, Y., Zhong, F., Ji, W., Yokoyama, W., Shoemaker, C. F., Zhu, S., & Xia, W. (2013). Functional properties of Maillard reaction products of rice protein hydrolysates with mono-, oligo- and polysaccharides. *Food Hydrocolloids*, 30, 53–60. <https://doi.org/10.1016/j.foodhyd.2012.04.013>.
- Liu, D., Zeng, X.-A., Sun, D.-W., & Han, Z. (2013). Disruption and protein release by ultrasonication of yeast cells. *Innovative Food Science & Emerging Technologies*, 18, 132–137. <https://doi.org/10.1016/j.ifset.2013.02.006>.
- Liu, J., Liu, M., He, C., Song, H., & Chen, F. (2015). Effect of thermal treatment on the flavor generation from Maillard reaction of xylose and chicken peptide. *LWT - Food Science and Technology*, 64, 316–325. <https://doi.org/10.1016/j.lwt.2015.05.061>.
- Liu, Y., Huang, G., & Lv, M. (2018). Extraction, characterization and antioxidant activities of mannan from yeast cell wall. *International Journal of Biological Macromolecules*, 118, 952–956. <https://doi.org/10.1016/j.ijbiomac.2018.06.145>.
- Love, K. R., Dalvie, N. C., & Love, J. C. (2018). The yeast stands alone: the future of protein biologic production. *Current Opinion in Biotechnology*, 53, 50–58. <https://doi.org/10.1016/j.copbio.2017.12.010> Chemical Biotechnology - Pharmaceutical Biotechnology.
- Luna-Solano, G., Salgado-Cervantes, M., Rodríguez-Jimenes, G., & García-Alvarado, M. (2005). Optimization of brewer's yeast spray drying process. *Journal of Food Engineering*, 68, 9–18. <https://doi.org/10.1016/j.jfoodeng.2004.05.019>.
- Machado, A. P. d. F., Rezende, C. A., Rodrigues, R. A., Barbero, G. F., Vieira e Rosa, P. d. T., & Martínez, J. (2018). Encapsulation of anthocyanin-rich extract from blackberry residues by spray-drying, freeze-drying and supercritical antisolvent. *Powder Technology*, 340, 553–562. <https://doi.org/10.1016/j.powtec.2018.09.063>.
- Magdassi, S., & Toledano, O. (1996). Enhanced Hydrophobicity: Formation and Properties of Surface-Active Proteins. In S. Magdassi (Ed.), *Surface Activity of Proteins: Chemical and Physicochemical Modifications* (pp. 39–60). New York: Marcel Dekker.
- Marson, G. V., de Castro, R. J. S., da Costa Machado, M. T., da Silva Zandonadi, F., de Freitas Queiroz Barros, H. D., Júnior, M. R. M., Sussulini, A., & Hubinger, M. D. (2020). Proteolytic enzymes positively modulated the physicochemical and antioxidant properties of spent yeast protein hydrolysates. *Process Biochemistry*, 91, April 2020, 34–45. <https://doi.org/10.1016/j.procbio.2019.11.030>.
- Marson, G. V., da Costa Machado, M. T., de Castro, R. J. S., & Hubinger, M. D. (2019). Sequential hydrolysis of spent brewer's yeast improved its physico-chemical characteristics and antioxidant properties: A strategy to transform waste into added-value biomolecules. *Process Biochemistry*, 84, 91–102. <https://doi.org/10.1016/j.procbio.2019.06.018>.
- Mathias, T. R. d. S., Alexandre, V. M. F., Cammarota, M. C., Mello, P. P. M., & Sérvulo, E. F. C. (2015). Characterization and determination of brewer's solid wastes composition. *Journal of the Institute of Brewing*, 121, 400–404. <https://doi.org/10.1002/jib.229>.
- Matos, F. E. d., Jr., Comunian, T. A., Thomazini, M., & Favaro-Trindade, C. S. (2017). Effect of feed preparation on the properties and stability of ascorbic acid micro-particles produced by spray chilling. *LWT*, 75, 251–260. <https://doi.org/10.1016/j.lwt.2016.09.006>.
- Mirafzal, Z., Thompson, C. S., & Tallua, K. (2014). Application of liposomes in the food industry. In A. G. Gaonkar, N. Vasisht, A. R. Khare, & R. Sobel (Eds.), *Microencapsulation in the Food Industry* (pp. 139–150). San Diego: Academic Press. <https://doi.org/10.1016/B978-0-12-404568-2.00013-3>.
- Mokhtari, S., Jafari, S. M., Khomeiri, M., Maghsoudlou, Y., & Ghorbani, M. (2017). The cell wall compound of Saccharomyces cerevisiae as a novel wall material for encapsulation of probiotics. *Food Research International*, 96, 19–26. <https://doi.org/10.1016/j.foodres.2017.03.014>.
- Mokhtari, S., Khomeiri, M., Jafari, S. M., Maghsoudlou, Y., & Ghorbani, M. (2017). Descriptive analysis of bacterial profile, physicochemical and sensory characteristics of grape juice containing Saccharomyces cerevisiae cell wall-coated probiotic microcapsules during storage. *International Journal of Food Science & Technology*, 52, 1042–1048. <https://doi.org/10.1111/ijfs.13370>.
- Mokrzycki, W. S., & Tatol, M. (2011). Colour difference Delta E - A survey. *Machine Graphics and Vision*, 20, 383–412. <https://www.tib.eu/en/search/id/BLS%3ARN341838136/Colour-difference-Delta-E-A-survey/>.
- Mussatto, S. I. (2009). Biotechnological potential of brewing industry by-products. In P. Singh nee' Nigam, & A. Pandey (Eds.), *Biotechnology for Agro-Industrial Residues Utilisation: Utilisation of Agro-Residues* (pp. 313–326). Dordrecht: Springer, Netherlands. doi:10.1007/978-1-4020-9942-7\_16.
- Nakhaee Moghadam, M., Khameneh, B., & Fazly Bazzaz, B. S. (2019). Saccharomyces cerevisiae as an efficient carrier for delivery of bioactives: A Review. *Food Biophysics*, 14, 346–353. <https://doi.org/10.1007/s11483-019-09584-0>.
- Nayak, A., & Bhushan, B. (2019). An overview of the recent trends on the waste valorization techniques for food wastes. *Journal of Environmental Management*, 233, 352–370. <https://doi.org/10.1016/j.jenvman.2018.12.041>.
- Nelson, G., Duckham, S. C., & Crothers, M. E. D. (2006). Microencapsulation in yeast cells and applications in drug delivery. In S. Sönke (Vol. Ed.), *Polymeric Drug Delivery I chapter: 19*, (pp. 268–281). Washington, DC: American Chemical Society. <https://doi.org/10.1021/bk-2006-0923.ch019>.
- Oliveira, A. M., & Oliva Neto, P. d. (2011). Improvement in RNA extraction from S. cerevisiae by optimization in the autolysis and NH3 hydrolysis. *Brazilian Archives of Biology and Technology*, 54, 1007–1018. <https://doi.org/10.1590/S1516-89132011000500019>.
- Oliver, C. M., Melton, L. D., & Stanley, R. A. (2006). Creating proteins with novel functionality via the Maillard Reaction: A Review. *Critical Reviews in Food Science and Nutrition*, 46, 337–350. <https://doi.org/10.1080/104086905090957250>.
- O'Regan, J., & Mulvihill, D. M. (2009). Preparation, characterisation and selected functional properties of sodium caseinate-maltodextrin conjugates. *Food Chemistry*, 115, 1257–1267. <https://doi.org/10.1016/j.foodchem.2009.01.045>.
- O'Sullivan, J. J., Norwood, E.-A., O'Mahony, J. A., & Kelly, A. L. (2019). Journal of Food technologies used in spray drying in the dairy industry: A review. *Journal of Food*

- Engineering*, 243, 57–69. <https://doi.org/10.1016/j.jfoodeng.2018.08.027>.
- Otálora, M. C., Carriazo, J. G., Osorio, C., & Nazareno, M. A. (2018). Encapsulation of cactus (*Opuntia megacantha*) betaxanthins by ionic gelation and spray drying: A comparative study. *Food Research International*, 111, 423–430. <https://doi.org/10.1016/j.foodres.2018.05.058>.
- Pacheco, M. T., Caballero-Córdoba, G. M., & Sgarbieri, V. C. (1997). Composition and nutritive value of yeast biomass and yeast protein concentrates. *Journal of Nutritional Science and Vitaminology* 43, 601–612.
- Paramera, E. I., Karathanos, V. T., & Konteles, S. J. (2014). Yeast cells and yeast-based materials for microencapsulation. In A. G. Gaonkar, N. Vasisht, A. R. Khare, & R. Sobel (Eds.). *Microencapsulation in the Food Industry* (pp. 267–281). San Diego: Academic Press. <https://doi.org/10.1016/B978-0-12-404568-2.00023-6>.
- Paramera, E. I., Konteles, S. J., & Karathanos, V. T. (2011). Microencapsulation of curcumin in cells of *Saccharomyces cerevisiae*. *Food Chemistry*, 125, 892–902. <https://doi.org/10.1016/j.foodchem.2010.09.063>.
- Pérez-Torradó, R., Gamero, E., Gómez-Pastor, R., Garre, E., Aranda, A., & Matallana, E. (2015). Yeast biomass, an optimised product with myriad applications in the food industry. *Trends in Food Science & Technology*, 46, 167–175. <https://doi.org/10.1016/j.tifs.2015.10.008>.
- Pham-hoang, B. N., Voilley, A., & Waché, Y. (2016). Molecule structural factors influencing the loading of flavoring compounds in a natural-preformed capsule: Yeast cells. *Colloids and Surfaces B: Biointerfaces*, 148, 220–228. <https://doi.org/10.1016/j.colsurfb.2016.08.045>.
- Phongthai, S., D'Amico, S., Schoenlechner, R., Homthawornchoo, W., & Rawdkuen, S. (2018). Fractionation and antioxidant properties of rice bran protein hydrolysates stimulated by in vitro gastrointestinal digestion. *Food Chemistry*, 240, 156–164. <https://doi.org/10.1016/j.foodchem.2017.07.080>.
- Pinto, M., Coelho, E., Nunes, A., ao, T. B., & Coimbra, M. A. (2015). Valuation of brewers spent yeast polysaccharides: A structural characterization approach. *Carbohydrate Polymers*, 116, 215–222. <https://doi.org/10.1016/j.carbpol.2014.03.010>.
- Podpora, B., Świdorski, F., Sadowska, A., Rakowska, R., & Wasiaik-zys, G. (2016). Spent brewer's yeast extracts as a new component of functional food. *Czech Journal of Food Science*, 34, 554–563. <https://doi.org/10.17221/419/2015-CJFS>.
- Pradelles, R., Vichi, S., Alexandre, H., & Chassignac, D. (2009). Influence of the drying processes of yeasts on their volatile phenol sorption capacity in model wine. *International Journal of Food Microbiology*, 135, 152–157. <https://doi.org/10.1016/j.ijfoodmicro.2009.07.019>.
- Ravindran, R., & Jaiswal, A. K. (2016). Exploitation of food industry waste for high-value products. *Trends in Biotechnology*, 34, 58–69. <https://doi.org/10.1016/j.tibtech.2015.10.008>.
- Reed, G., & Nagodawithana, T. W. (1991). *Food and feed yeast*. In *Yeast Technology*. Dordrecht: Springer 413–440. <https://doi.org/10.1007/978-94-011-9771-7>.
- Reineccius, G. A. (2001). Multiple-core encapsulation: The spray drying of food ingredients. In P. Vilstrup (Ed.). *Microencapsulation of Food Ingredients* (pp. 151–185). Surrey, UK: Leatherhead Publishing.
- Reineccius, G. A. (2004). The spray drying of food flavors. *Drying Technology*, 22, 1289–1324. <https://doi.org/10.1081/DRT-120038731>.
- Rezende, Y. R. S., Nogueira, J. P., & Narain, N. (2018). Microencapsulation of extracts of bioactive compounds obtained from acerola (*Malpighia emarginata* dc) pulp and residue by spray and freeze drying: Chemical, morphological and chemometric characterization. *Food Chemistry*, 254, 281–291. <https://doi.org/10.1016/j.foodchem.2018.02.026>.
- Rocha, J. d. C. G., de Barros, F. A. R., Perrone, I. T., Viana, K. W. C., Tavares, G. M., Stephani, R., & Stringheta, P. C. (2019). Microencapsulation by atomization of the mixture of phenolic extracts. *Powder Technology*, 343, 317–325. <https://doi.org/10.1016/j.powtec.2018.11.040>.
- Saifullah, M., Shishir, M. R. I., Ferdowsi, R., Rahman, M. R. T., & Vuong, Q. V. (2019). Micro and nano encapsulation, retention and controlled release of flavor and aroma compounds: A critical review. *Trends in Food Science & Technology*, 86, 230–251. <https://doi.org/10.1016/j.tifs.2019.02.030>.
- Sceni, P., Palazol, G. G., del Carmen Vasallo, M., Puppo, M. C., Otero, M. A., & Wagner, J. R. (2009). Thermal and surface behavior of yeast protein fractions from *Saccharomyces cerevisiae*. *LWT - Food Science and Technology*, 42, 1098–1106. <https://doi.org/10.1016/j.lwt.2009.02.010>.
- Schebor, C., Galvagno, M., del Pilar Buera, M., & Chirife, J. (2000). Glass transition temperatures and fermentative activity of heat-treated commercial active dry yeasts. *Biotechnology Progress*, 16, 163–168. <https://doi.org/10.1021/bp990147y>.
- Sgarbieri, V. C., Alvim, I. D., Vilela, E. S. D., Baldini, V. L. S., & Bragagnolo, N. (1999). Produção piloto de derivados de levedura (*Saccharomyces* sp.) para uso como ingrediente na formulação de alimentos. *Brazilian Journal of Food Technology*, 2, 119–125.
- Shi, G., Rao, L., Xie, Q., Li, J., Li, B., & Xiong, X. (2010). Characterization of yeast cells as a microencapsulation wall material by fourier-transform infrared spectroscopy. *Vibrational Spectroscopy*, 53, 289–295. <https://doi.org/10.1016/j.vibspec.2010.04.007>.
- Shurson, G. (2018). Yeast and yeast derivatives in feed additives and ingredients: Sources, characteristics, animal responses, and quantification methods. *Animal Feed Science and Technology*, 235, 60–76. <https://doi.org/10.1016/j.anifeedsci.2017.11.010>.
- Sobieralska, M., & Kurek, M. A. (2019). Beta-glucan as wall material in encapsulation of elderberry (*Sambucus nigra*) extract. *Plant Foods for Human Nutrition*. <https://doi.org/10.1007/s11130-019-00741-x>.
- Song, R., Yang, P., Wei, R., & Ruan, G. (2016). Antioxidative, antibacterial, and food functional properties of the half-fin anchovy hydrolysates-glucose conjugates formed via maillard reaction. *Molecules*, 21. <https://doi.org/10.3390/molecules21060795>.
- Sultana, A., Miyamoto, A., Hy, Q. L., Tanaka, Y., Fushimi, Y., & Yoshii, H. (2017). Microencapsulation of flavors by spray drying using *Saccharomyces cerevisiae*. *Journal of Food Engineering*, 199, 36–41. <https://doi.org/10.1016/j.jfoodeng.2016.12.002>.
- Sultana, A., Tanaka, Y., Fushimi, Y., & Yoshii, H. (2018). Stability and release behavior of encapsulated flavor from spray-dried *Saccharomyces cerevisiae* and maltodextrin powder. *Food Research International*, 106, 809–816. <https://doi.org/10.1016/j.foodres.2018.01.059>.
- Timilsena, Y., Akanbi, T. O., Khalid, N., Adhikari, B., & Barrow, C. J. (2019). Complex coacervation: Principles, mechanisms and applications in microencapsulation. *International Journal of Biological Macromolecules*, 121, 1276–1286. <https://doi.org/10.1016/j.ijbiomac.2018.10.144>.
- Trindade, M. A., & Grosso, C. R. F. (2000). The stability of ascorbic acid micro-encapsulated in granules of rice starch and in gum arabic. *Journal of Microencapsulation*, 17, 169–176. <https://doi.org/10.1080/026520400288409>.
- Vieira, E., Teixeira, J., & Ferreira, I. M. P. L. V. O. (2016). Valorization of brewers' spent grain and spent yeast through protein hydrolysates with antioxidant properties. *European Food Research and Technology*, 242, 1975–1984. <https://doi.org/10.1007/s00217-016-2696-y>.
- Vieira, E. F., & Ferreira, I. M. (2017). Antioxidant and antihypertensive hydrolysates obtained from by-products of cannery sardine and brewing industries. *International Journal of Food Properties*, 20, 662–673. <https://doi.org/10.1080/10942912.2016.1176036>.
- Webb, J. M. (1958). Studies on the determination of total nucleic acids by ultraviolet absorption methods. *Journal of Biological Chemistry*, 230, 1023–1030.
- Webb, J. M., & Levy, H. L. (1955). A sensitive method for the determination of deoxyribonucleic acid in tissues and microorganisms. *Journal of Biological Chemistry*, 213, 107–117.
- Wei, C.-K., Thakur, K., Liu, D.-H., Zhang, J.-G., & Wei, Z.-J. (2018). Enzymatic hydrolysis of flaxseed (*Linum usitatissimum* L.) protein and sensory characterization of Maillard reaction products. *Food Chemistry*, 263, 186–193. <https://doi.org/10.1016/j.foodchem.2018.04.120>.
- Wen-qiong, W., Lan-wei, Z., Xue, H., & Yi, L. (2017). Cheese whey protein recovery by ultrafiltration through transglutaminase (TG) catalysis when protein cross-linking. *Food Chemistry*, 215, 31–40. <https://doi.org/10.1016/j.foodchem.2016.07.057>.
- Wrolstad, R. E., Acree, T. E., Decker, E. A., Penner, M. H., Reid, D. S., Schwartz, S. J., Shoemaker, C. F., Smith, D., & Sporns, P. (2005). *Measurements of protein content*. In *Handbook of Food Analytical Chemistry*. John Wiley & Sons, Inc. 73–121. <https://doi.org/10.1002/0471709085.ch3>.
- Xia, Y., Bamdad, F., Gänzle, M., & Chen, L. (2012). Fractionation and characterization of antioxidant peptides derived from barley glutelin by enzymatic hydrolysis. *Food Chemistry*, 134. <https://doi.org/10.1016/j.foodchem.2012.03.063>.
- Yan, C., & Zhang, W. (2014). Coacervation processes. In A. G. Gaonkar, N. Vasisht, A. R. Khare, & R. Sobel (Eds.). *Microencapsulation in the Food Industry* (pp. 125–137). San Diego: Academic Press. <https://doi.org/10.1016/B978-0-12-404568-2.00012-1>.
- Yang, S.-Y., Kim, S.-W., Kim, Y., Lee, S.-H., Jeon, H., & Lee, K.-W. (2015). Optimization of maillard reaction with ribose for enhancing anti-allergy effect of fish protein hydrolysates using response surface methodology. *Food Chemistry*, 176, 420–425. <https://doi.org/10.1016/j.foodchem.2014.12.090>.
- Ye, Q., Georges, N., & Selomulya, C. (2018). Microencapsulation of active ingredients in functional foods: From research stage to commercial food products. *Trends in Food Science & Technology*, 78, 167–179. <https://doi.org/10.1016/j.tifs.2018.05.025>.
- Yu, M., He, S., Tang, M., Zhang, Z., Zhu, Y., & Sun, H. (2018). Antioxidant activity and sensory characteristics of Maillard reaction products derived from different peptide fractions of soybean meal hydrolysate. *Food Chemistry*, 243, 249–257. <https://doi.org/10.1016/j.foodchem.2017.09.139>.
- Zechner-Krpan, V., Petrávič-Tominac, V., Gospodarić, I., Sajli, L., Daković, S., & Filipović-Grčić, J. (2010). Characterization of  $\beta$ -glucans isolated from brewer's yeast and dried by different methods. *Food Technology and Biotechnology*, 48, 189–197.
- Zhong, C., Tan, S., & Langrish, T. (2019). Redness generation via maillard reactions of whey protein isolate (WPI) and ascorbic acid (vitamin c) in spray-dried powders. *Journal of Food Engineering*, 244, 11–20. <https://doi.org/10.1016/j.jfoodeng.2018.09.020>.



# Reprinting permission for published articles

## Reprinting permissions

Reprinting permission for published article corresponding to Chapter 3

Reprinted (adapted) with permission from “Marson et al. Spent brewer’s yeast as a source of high added value molecules: a systematic review on its characteristics, processing and potential applications. *World Journal of Microbiology and Biotechnology*, v. 36, n. 95, p. 1-22 (2020)”. Copyright 2020 Springer Nature.



Gabriela Vollet &lt;gabriela.vollet@gmail.com&gt;

---

**Copyright Transfer Statement (CTS) for your article in World Journal of Microbiology and Biotechnology (2866)**

---

**Springer** <springerauthorquery@springeronline.com>  
Reply-To: customerservice@springer.com  
To: gabriela.vollet@gmail.com

Tue, Jun 9, 2020 at 9:53 AM

*Copyright Transfer*

09.06.2020

[visit us at springer.com](http://springer.com)

---

## Confirmation of your Copyright Transfer

---

Dear Author,

Please note: This e-mail is a confirmation of your copyright transfer and was sent to you only for your own records.

**1. Publication**

The copyright to this article, (including any supplementary information and graphic elements therein (e.g. illustrations, charts, moving images) (the 'Article'), is hereby assigned for good and valuable consideration to Springer Nature B.V. (the 'Assignee'). Headings are for convenience only.

**2. Grant of Rights**

In consideration of the Assignee evaluating the Article for publication, the Author(s) grant the Assignee without limitation the exclusive (except as set out in clauses 3, 4 and 5 a) iv), assignable and sub-licensable right, unlimited in time and territory, to copy-edit, reproduce, publish, distribute, transmit, make available and store the Article, including abstracts thereof, in all forms of media of expression now known or developed in the future, including pre- and reprints, translations, photographic reproductions and extensions. Furthermore, to enable additional publishing services, such as promotion of the Article, the Author(s) grant the Assignee the right to use the Article (including the use of any graphic elements on a stand-alone basis) in whole or in part in electronic form, such as for display in databases or data networks (e.g. the Internet), or for print or download to stationary or portable devices. This includes interactive and multimedia use as well as posting the Article in full or in part or its abstract on social media, and the right to alter the Article to the extent necessary for such use. The Assignee may also let third parties share the Article in full or in part or its abstract on social media and may in this context sub-license the Article and its abstract to social media users. Author(s) grant to Assignee the right to re-license Article metadata without restriction (including but not limited to author name, title, abstract, citation, references, keywords and any additional information as determined by Assignee).

**3. Self-Archiving**

Author(s) are permitted to self-archive a pre-print and an Author's accepted manuscript version of their Article.

- a. A pre-print is the Author's version of the Article before peer-review has taken place ("Pre-Print"). Prior to acceptance for publication, Author(s) retain the right to make a Pre-Print of their Article available on any of the following: their own personal, self-maintained website; a legally compliant pre-print server such as but not limited to arXiv and bioRxiv. Once the Article has been published, the Author(s) should update the acknowledgement and provide a link to the definitive version on the publisher's website: "This is a pre-print of an article published in [insert journal title]. The final authenticated version is available online at: [https://doi.org/\[insert DOI\]](https://doi.org/[insert DOI])".
- b. An Author's Accepted Manuscript (AAM) is the version accepted for publication in a journal following peer review but prior to copyediting and typesetting that can be made available under the following conditions:
  - a. Author(s) retain the right to make an AAM of their Article available on their own personal, self-maintained website immediately on acceptance,
  - b. Author(s) retain the right to make an AAM of their Article available for public release on any of the following 12 months after first publication ("Embargo Period"): their employer's internal website; their institutional and/or funder repositories. AAMs may also be deposited in such repositories immediately on acceptance, provided that they are not made publicly available until after the Embargo Period.

An acknowledgement in the following form should be included, together with a link to the published version on the publisher's website: "This is a post-peer-review, pre-copyedit version of an article published in [insert journal title]. The final authenticated version is available online at: [http://dx.doi.org/\[insert DOI\]](http://dx.doi.org/[insert DOI])".

#### 4. Authors' Retained Rights

Author(s) retain the following non-exclusive rights for the published version provided that, when reproducing the Article or extracts from it, the Author(s) acknowledge and reference first publication in the Journal:

- a. to reuse graphic elements created by the Author(s) and contained in the Article, in presentations and other works created by them;
- b. they and any academic institution where they work at the time may reproduce the Article for the purpose of course teaching (but not for inclusion in course pack material for onward sale by libraries and institutions); and
- c. to reproduce, or to allow a third party Licensee to reproduce the Article in whole or in part in any printed volume (book or thesis) written by the Author(s).
- d. To reproduce, or to allow a third party Licensee to reproduce the Article, in whole or in part, in any other type of work (other than thesis) written by the Author(s) for distribution by a publisher after an embargo period of 12 months.

#### 5. Warranties

The Author(s) warrant and represent that:

- a. (i) the Author(s) are the sole copyright owners or have been authorised by any additional copyright owner(s) to grant the rights defined in clause 2, (ii) the Article does not infringe any intellectual property rights (including without limitation copyright, database rights or trade mark rights) or other third party rights and no licence from or payments to a third party are required to publish the Article, (iii) the Article has not been previously published or licensed, (iv) if the Article contains materials from other sources (e.g. illustrations, tables, text quotations), Author(s) have obtained written permissions to the extent necessary from the copyright holder(s), to license to the Assignee the same rights as set out in clause 2 but on a non-exclusive basis and without the right to use any graphic elements on a stand-alone basis and have cited any such materials correctly;
- b. all of the facts contained in the Article are according to the current body of science true and accurate;
- c. nothing in the Article is obscene, defamatory, violates any right of privacy or publicity, infringes any other human, personal or other rights of any person or entity or is otherwise unlawful and that informed consent to publish has been obtained for all research participants;
- d. nothing in the Article infringes any duty of confidentiality which any of the Author(s) might owe to anyone else or violates any contract, express or implied, of any of the Author(s). All of the institutions in which work recorded in the Article was created or carried out have authorised and approved such research and publication; and

09/06/2020

Gmail - Copyright Transfer Statement (CTS) for your article in World Journal of Microbiology and Biotechnology (2866)

- e. the signatory (the Author or the employer) who has signed this agreement has full right, power and authority to enter into this agreement on behalf of all of the Author(s).

#### 6. Cooperation

The Author(s) shall cooperate fully with the Assignee in relation to any legal action that might arise from the publication of the Article, and the Author(s) shall give the Assignee access at reasonable times to any relevant accounts, documents and records within the power or control of the Author(s). The Author(s) agree that the distributing entity is intended to have the benefit of and shall have the right to enforce the terms of this agreement.

#### 7. Author List

After signing, changes of authorship or the order of the authors listed will not be accepted unless formally approved in writing by the Assignee.

#### 8. Edits & Corrections

The Author(s) agree(s) that the Assignee may retract the Article or publish a correction or other notice in relation to the Article if the Assignee considers in its reasonable opinion that such actions are appropriate from a legal, editorial or research integrity perspective.

This is an automated e-mail; please do not reply to this account. If you have any questions, please go to our help pages.

Thank you very much.

Kind regards,

Springer Author Services

---

### Article Details

---

#### Journal title

World Journal of Microbiology and Biotechnology

#### Article title

Spent brewer's yeast as a source of high added value molecules: a systematic review on its characteristics, processing and potential applications

#### DOI

10.1007/s11274-020-02866-7

#### Corresponding Author

Gabriela Vollet Marson

#### Copyright transferred to

Springer Nature B.V.

#### Transferred on

Tue Jun 09 14:51:12 CEST 2020

---

### Service Contacts

---

**Springer Nature Customer Service Center**

**Springer New York, LCC**

233 Spring Street

09/06/2020

Gmail - Copyright Transfer Statement (CTS) for your article in World Journal of Microbiology and Biotechnology (2866)

Tiergartenstr. 15-17

69121 Heidelberg

Germany

phone: +49 6221 345 0

fax: +49 6221 345 4229

customerservice@springernature.com

New York, NY 10013

USA

phone: +1 212 460 1500 or 800-SPRINGER

(Weekdays 8:30am - 5:30pm ET)

fax: +1 212-460-1700

customerservice@springernature.com

---

© Springer Nature 2020, [springer.com](https://www.springer.com)

Reprinting permission for published article corresponding to Chapter 5

Reprinted (adapted) with permission from “Marson et al. Sequential hydrolysis of spent brewer’s yeast improved its physico-chemical characteristics and antioxidant properties: A strategy to transform waste into added-value biomolecules. *Process Biochemistry* 84, 91-102 (2019)”. Copyright 2019 Elsevier.



Home



Help



Email Support



Sign in



Create Account

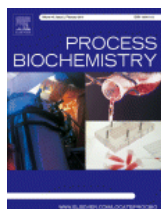

### Sequential hydrolysis of spent brewer's yeast improved its physico-chemical characteristics and antioxidant properties: A strategy to transform waste into added-value biomolecules

**Author:**

Gabriela Vollet Marson, Mariana Teixeira da Costa Machado, Ruann Janser Soares de Castro, Miriam Dupas Hubinger

**Publication:** Process Biochemistry**Publisher:** Elsevier**Date:** September 2019

*© 2019 Elsevier Ltd. All rights reserved.*

Please note that, as the author of this Elsevier article, you retain the right to include it in a thesis or dissertation, provided it is not published commercially. Permission is not required, but please ensure that you reference the journal as the original source. For more information on this and on your other retained rights, please visit: <https://www.elsevier.com/about/our-business/policies/copyright#Author-rights>

[BACK](#)[CLOSE WINDOW](#)

Reprinting permission for published article corresponding to Chapter 6

Reprinted (adapted) with permission from “Marson et al. Proteolytic enzymes positively modulated the physicochemical and antioxidant properties of spent yeast protein hydrolysates. *Process Biochemistry* 91, 34-45 (2020)”. Copyright 2019 Elsevier.





Home



Help



Email Support



Sign in



Create Account

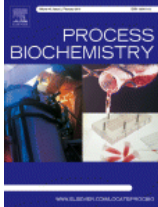

### Proteolytic enzymes positively modulated the physicochemical and antioxidant properties of spent yeast protein hydrolysates

**Author:**

Gabriela Vollet Marson, Ruann Janser Soares de Castro, Mariana Teixeira da Costa Machado, Flávia da Silva Zandonadi, Helena Dias de Freitas Queiroz Barros, Mário Roberto Maróstica Júnior, Alessandra Sussulini, Miriam Dupas Hubinger

**Publication:** Process Biochemistry**Publisher:** Elsevier**Date:** April 2020

© 2019 Elsevier Ltd. All rights reserved.

Please note that, as the author of this Elsevier article, you retain the right to include it in a thesis or dissertation, provided it is not published commercially. Permission is not required, but please ensure that you reference the journal as the original source. For more information on this and on your other retained rights, please visit: <https://www.elsevier.com/about/our-business/policies/copyright#Author-rights>

[BACK](#)[CLOSE WINDOW](#)

Reprinting permission for published article corresponding to Appendix B

Reprinted (adapted) with permission from “Marson et al. Maillard conjugates from spent brewer’s yeast by-product as an innovative encapsulating material. Food Research International 136, 109365 (2020)”. Copyright 2019 Elsevier.



RightsLink®



Home



Help



Email Support



Sign in



Create Account



### Maillard conjugates from spent brewer's yeast by-product as an innovative encapsulating material

**Author:**

Gabriela Vollet Marson,Rafaela Polessi Saturno,Talita Aline Comunian,Larissa Consoli,Mariana Teixeira da Costa Machado,Miriam Dupas Hubinger

**Publication:** Food Research International**Publisher:** Elsevier**Date:** October 2020*© 2020 Elsevier Ltd. All rights reserved.*

Please note that, as the author of this Elsevier article, you retain the right to include it in a thesis or dissertation, provided it is not published commercially. Permission is not required, but please ensure that you reference the journal as the original source. For more information on this and on your other retained rights, please visit: <https://www.elsevier.com/about/our-business/policies/copyright#Author-rights>

BACK

CLOSE WINDOW