



HAL
open science

Bord de Poisson de marches aléatoires sur les groupes et profils isopérimétriques

Bogdan Stankov

► **To cite this version:**

Bogdan Stankov. Bord de Poisson de marches aléatoires sur les groupes et profils isopérimétriques. Mathématiques générales [math.GM]. Université Paris sciences et lettres, 2021. Français. NNT : 2021UPSLE029 . tel-03854377

HAL Id: tel-03854377

<https://theses.hal.science/tel-03854377>

Submitted on 15 Nov 2022

HAL is a multi-disciplinary open access archive for the deposit and dissemination of scientific research documents, whether they are published or not. The documents may come from teaching and research institutions in France or abroad, or from public or private research centers.

L'archive ouverte pluridisciplinaire **HAL**, est destinée au dépôt et à la diffusion de documents scientifiques de niveau recherche, publiés ou non, émanant des établissements d'enseignement et de recherche français ou étrangers, des laboratoires publics ou privés.

THÈSE DE DOCTORAT
DE L'UNIVERSITÉ PSL

Préparée à École Normale Supérieure

**Bord de Poisson de marches aléatoires sur les groupes et
profils isopérimétriques**

Soutenue par

Bogdan STANKOV

Le 27 Mai 2021

École doctorale n°574

Mathématique Hadamard

Spécialité

Mathématiques fondamentales

Composition du jury :

Pierre PANSU Pr, Université Paris-Saclay	Président
Anna ERSCHLER DR, École Normale Supérieure	Directeur de thèse
Anders KARLSSON Pr, Uppsala universitet	Rapporteur
Christophe PITTET Pr, Aix-Marseille Université	Rapporteur
Peter HAISSINSKY Pr, Aix-Marseille Université	Examinateur

Remerciements

Je tiens surtout à remercier de tout cœur ma directrice de thèse, Anna Erschler. Des le début de cette expérience extraordinaire elle m'a guidé vers des questions inspirantes, garantissant une entrée exceptionnelle dans le monde de la recherche. Mais ce n'est pas juste les discussions mathématiques - elle a aussi veillé à ce que j'interagisse avec d'autres mathématiciennes et mathématiciens, et que je participe aux événements variés dont elle me faisait découvrir l'existence.

Je voudrai aussi adresser des remerciements spéciaux à Vadim Kaimanovich, qui a joué un rôle important dans mes premiers pas en tant que chercheur. Il a notamment su saisir l'intérêt d'un résultat de mon premier article, et me suggérer de le développer. Sa suggestion s'est prouvée extrêmement bien venue puisqu'elle a aboutit à mon deuxième article.

Mes sincères remerciements vont à Anders Karlsson et Christophe Pittet pour avoir accepté d'être rapporteurs ainsi que pour les suggestions de corrections détaillées, et à Peter Haïssinsky et Pierre Pansu pour m'avoir fait l'honneur de faire parti du jury.

Merci bien aussi à l'équipe administrative du DMA. Les efforts de Fabienne Renia, Zaïna Elmir, Amélie Castelian, Françoise Dessalle, Laurence Gareaux, Anna Arato, Albane Trémeau, Bénédicte Auffray ont été essentiels pour le bon déroulement de tout ce qu'on a fait pendant ces années.

Mes camarades de bureau ont joué un rôle très important. Un grand merci à Yanis Amirou, Markus Steenbock, Arman Darbinyan et Nima Hoda pour leurs discussions et leurs amitiés.

Beaucoup d'individus m'ont enseigné les mathématiques durant mon parcours, mais je tiens en particulier à exprimer ma gratitude envers Lionel Nguyen Van Thé, qui m'a encadré pour un stage passionnant, mes professeurs de mathématiques de prépa : Roger Mansuy et Nicolas Tosel, et ma professeur de mathématiques pour tout mon enseignement secondaire : Iliana Tzvetkova. Je voudrais aussi remercier ma famille. Ma mère Nadezhda Ribarska, qui est professeur de mathématiques à l'Université de Sofia, et la personne qui a éveillé ma passion envers les mathématiques.

Finalement, je voudrais remercier le professeur Minko Balkanski et tout le monde de la Fondation Balkanski, sans qui je n'aurais jamais eu l'idée de venir en France et découvrir toutes ces possibilités.

Table des matières

1	Présentation des résultats	5
2	Contexte historique	7
2.1	Moyennabilité	7
2.1.1	Définitions	7
2.1.2	Groupes élémentairement moyennables	10
2.1.3	Sous-groupes libres	10
2.1.4	Groupes de torsion bornée	13
2.1.5	La classe de groupes $H(A)$ d'un article de Monod	13
2.1.6	Produits en couronnes	14
2.2	Graphes de Cayley et Schreier	15
2.2.1	Définitions et résultats généraux	15
2.2.2	Bouts des graphes	16
2.2.3	Exemples	16
2.3	Profils géométriques	19
2.3.1	Croissance des groupes	19
2.3.2	Groupe de Grigorchuk	20
2.3.3	Définition de la fonction de Følner	21
2.3.4	Quasi-isométries et équivalence asymptotique	21
2.3.5	Fonctions de Følner	22
2.4	Marches aléatoires gouvernées par des mesures sur les groupes	27
2.4.1	Définitions	27
2.4.2	Liens avec la moyennabilité	29
2.4.3	Graphes de Schreier	31
2.4.4	Caractérisation complète des bords de Poisson	33
3	Non-triviality of the Poisson boundary of random walks on the group $H(\mathbb{Z})$ of Monod	35
4	Convergence Towards the End Space for Random Walks on Schreier Graphs	65
5	Følner functions and sets on wreath products and Baumslag-Solitar groups	77
	Bibliographie	91

Chapitre 1

Présentation des résultats

Mes deux premiers résultats portent sur les marches aléatoires induites par des mesures sur des groupes (voir Section 2.4.1). On étudie leur comportements asymptotiques, surtout en terme de leurs bords de Poisson (voir Définition 28, Section 2.4.2). Dans [1] (voir Chapitre 3), on considère les sous-groupes du groupe des homéomorphismes projectifs par morceaux sur les entiers $H(\mathbb{Z})$, présenté dans un article de Monod [Mon13]. On va expliquer les résultats de Monod et définir ce groupe dans la Section 2.1.5. On aborde la question si des mesures sur les sous-groupes de $H(\mathbb{Z})$ sont Liouvilles, c'est-à-dire si la marche induite sur le sous-groupe a un bord de Poisson trivial.

Théorème A. *Pour tout sous-groupe H de $H(\mathbb{Z})$ qui n'est pas localement résoluble et toute mesure μ sur H avec une espérance fini du nombre de fins de morceaux (voir la définition de $H(\mathbb{Z})$ dans Section 2.1.5) et dont le support engendre H comme semi-groupe, (H, μ) n'est pas Liouville.*

Comme $H(\mathbb{Z})$ contient le groupe F de Thompson comme sous-groupe, cela répond en particulier à une question de Kaimanovich [Kai17, 7.A].

Dans [2] (voir Chapitre 4), on s'intéresse aux questions qui sont, comme dans [1], relatifs aux marches aléatoires induites par des mesures sur des groupes, mais cette fois on considère les marches induites par une action du groupe. Le bord de Poisson de cette marche est toujours un quotient du bord de Poisson de la marche sur le groupe (voir Section 2.4.3). On obtient des résultats sur les comportements asymptotiques des marches provenant d'une classe de mesures de premier moment fini :

Théorème B. *Considérons une action transitive d'un groupe G . Soit S un ensemble générateur et Γ le graphe de Schreier associé. Soit μ une mesure sur G avec premier moment fini tel que la marche aléatoire induite sur Γ est transiente. Alors elle converge presque sûrement vers un bout (aléatoire) du graphe.*

On y trouve un corollaire qui s'applique en particulier au groupe F de Thompson.

Corollaire C. *Considérons une action transitive d'un groupe G . Soit S un ensemble générateur et Γ le graphe de Schreier associé. Supposons que Γ est transient. Alors pour tout mesure μ sur G dont le support engendre G en tant que semi groupe et qui a un premier moment fini, la marche aléatoire induite converge presque sûrement vers un bout du graphe.*

On peut appliquer ce corollaire à l'action de F sur les nombres dyadiques. Il n'est pas difficile d'obtenir que la convergence vers les bouts implique que les bords de Poisson des marches induites par ces mesures ne sont pas triviaux.

Dans [3] (voir Chapitre 5) on s'intéresse aux profils isopérimétriques des groupes, encodés par la fonction de Følner (voir Sections 2.3.3 et 2.3.5). Cette fonction a été auparavant étudiée à équivalence asymptotique près (autrement dit, de façon indépendante du choix de l'ensemble générateur fini (voir Section 2.3.4)). On obtient ses valeurs exactes pour deux exemples classiques :

Théorème D. *La fonction de Følner sur le groupe $\mathbb{Z} \wr \mathbb{Z} / 2\mathbb{Z}$ est, pour $n \geq 2$, $F\text{øl}(n) = 2n2^{2(n-1)}$ pour l'ensemble générateur standard et $F\text{øl}_{sws}(n) = 2n2^{2n}$ pour l'ensemble générateur «switch-walk-switch».*

On donne aussi une description des ensembles de Følner pour lesquels on obtient une égalité.

On obtient de plus un résultat isopérimétrique sur le groupe de Baumslag-Solitar $BS(1, 2) = \langle a, b | bab^{-1} = a^2 \rangle$ en terme du bord par rapport aux arêtes.

Théorème E. *Considérons le groupe de Baumslag-Solitar $BS(1, 2)$ avec l'ensemble générateur $\{a, b\}$. Alors pour tout $n \in \mathbb{N}$ et tout $F \subset BS(1, 2)$ fini tel que $|F| \leq |F_n|$, on a $\frac{|\partial F|}{|F|} \geq \frac{|\partial F_n|}{|F_n|}$, où F_n sont les ensembles de Følner standards (voir Équation 2.4), et si $|F| < |F_n|$, l'inégalité est stricte.*

Chapitre 2

Contexte historique

2.1 Moyennabilité

2.1.1 Définitions

L'origine de la notion de moyennabilité vient du paradoxe de Banach-Tarski (ou Hausdorff-Banach-Tarski). En 1924, Banach et Tarski [BT24] découpent la boule de \mathbb{R}^3 en un nombre fini de parties, puis, en y appliquant des isométries, ils reconstruisent deux boules chacune identique à la première. Leur preuve est inspiré par un résultat similaire de Hausdorff sur la sphère. Cela est contraire à l'idée intuitive de volume, et, clairement, les morceaux ne sont pas Lebesgue-mesurables. Pour comprendre la structure qui permet cela, étant donnée une action (à droite) d'un groupe sur un espace, on définit :

Définition 1. Soit un groupe G qui agit sur un ensemble X . On dit que l'action est **paradoxale** s'ils existent deux entiers positifs m et n et des sous-ensembles $A_1, A_2, \dots, A_m, B_1, \dots, B_n$ de X deux-à-deux disjoints, ainsi que $g_1, g_2, \dots, g_m, h_1, \dots, h_n \in G$ tels que $X = \bigcup (A_i)g_i = \bigcup (B_i)h_i$.

Avec cette notation, le paradoxe de Banach-Tarski dit que l'action des isométries de \mathbb{R}^3 sur une boule est paradoxale. Cette propriété est reliée à la structure du groupe des isométries de \mathbb{R}^3 . En effet, définissons qu'un groupe est paradoxal si l'action sur lui-même par multiplication à droite l'est. Alors pour une action paradoxale de G sur X , pour un point $x \in X$, en prenant des ensembles obtenus comme images inverses d'une décomposition paradoxale sur X par $g \rightarrow x.g$ on obtient une décomposition paradoxale sur G . Le groupe est donc paradoxal, et on peut aussi obtenir un résultat inverse partiel (voir [Wag93]) :

Proposition 2. *Si G est paradoxal et agit librement sur X , alors cette action est paradoxale.*

On peut donc, comme remarqué par John von Neumann, chercher une explication du paradoxe dans les propriétés du groupe des isométries de \mathbb{R}^3 . Cela donne une première définition de moyennabilité :

Définition 3. Un groupe est **moyennable** si et seulement s'il n'est pas paradoxal.

Remarquons qu'on parle ici de moyennabilité des groupes dénombrables. Des notions plus générales existent pour les groupes topologiques.

Plus généralement, une action est moyennable si et seulement si elle n'est pas paradoxale. Aujourd'hui il existe des nombreuses caractérisations de la moyennabilité (voir [Bar18],[CSGdlH99],[Gre69],[Wag93]). Commençons par la définition canonique de moyennabilité, donnée (sur les groupes) par John von Neumann. Les notations qu'on utilisera sont inspirées par le livre de Juschenko en préparation [Jus15] et le survol de Bartholdi [Bar18]. Soit G un groupe agissant à droite sur X . Une **moyenne** (ou moyenne l^∞ ; «mean» en anglais) sur X est une fonctionnelle linéaire μ sur $l^\infty(X)$ qui vérifie $\mu(\chi_X) = 1$, $\mu(0) = 0$ et $\mu(f) \geq 0$ pour chaque $f \geq 0$. Pour une fonction f sur X et $g \in G$, on dénote par $T_g(f)$ la fonction $x \mapsto f(x.g^{-1})$ pour tout $g \in G$. Une moyenne sur X est invariante (à droite) si pour chaque $f \in l^\infty(X)$, $g \in G$,

$$\mu(T_g f) = \mu(f).$$

Définition 4. Un groupe G (respectivement une action $G \curvearrowright X$) est moyennable s'il (respectivement elle) admet une moyenne invariante sur G (respectivement sur X).

Remarquons qu'en considérant l'action à gauche par g^{-1} , une moyenne invariante à droite devient invariante à gauche. Le choix de coté est donc une convention que chaque auteur choisit. En passant par la dualité entre fonctionnelles et mesures, on a de manière équivalente :

Définition 5. Un action $G \curvearrowright X$ est moyennable si et seulement s'il existe $\mu : \mathcal{P}(X) \rightarrow [0, 1]$ qui vérifie $\mu(X) = 1$, $\mu(\emptyset) = 0$,

$$\mu(A \cup B) = \mu(A) + \mu(B)$$

pour $A \cap B = \emptyset$ et

$$\mu(E.g) = \mu(E)$$

pour tout $g \in G$, $E \in \mathcal{P}(X)$.

Une telle «mesure» est dite moyenne sur les sous-ensembles de X . Il est assez claire que l'existence d'une décomposition paradoxale implique la non-moyennabilité. Le sens inverse a été montré pour une action de groupe sur lui-même par multiplication par Tarski [Tar38]. Cela montre l'équivalence entre Définition 4 et Définition 3 pour les groupes. On présente maintenant plusieurs définitions équivalentes :

Théorème 6. *Considérons une action $G \curvearrowright X$. Alors on a une équivalence entre :*

1. $G \curvearrowright X$ est moyennable.

2. (**Condition de Reiter** [Rei68, Chapitre 8]) Pour chaque $E \subset G$ fini et $\varepsilon > 0$, et pour $p \geq 1$ ($p = 1$), il existe $\phi \in l^p(X)$ tel que $\|T_s\phi - \phi\|_p \leq \varepsilon\|\phi\|_p$ pour tout $s \in E$.
3. (**Condition de Følner** [Føl55]) Pour chaque $E \subset G$ fini et $\varepsilon > 0$, il existe un ensemble fini $F \subset X$ (appelé ensemble de Følner) qui vérifie :

$$|F.s \triangle F| \leq \varepsilon|F| \text{ pour tout } s \in E.$$

Remarquons que pour un groupe de type fini, il suffit de fixer un ensemble générateur fini pour E . Remarquons aussi que pour ces deux définitions on n'a pas besoin de l'axiome du choix. Par contre, la Définition 4 avec les moyennes ne serait pas équivalente sans cet axiome. Même sur le groupe infini le plus simple, \mathbb{Z} , on ne peut pas construire une moyenne invariante sans utiliser des ultrafiltres. Remarquons les exemples de groupes moyennables qu'on voit ici : les groupes finis et les groupes cycliques (c'est immédiat par exemple en utilisant la condition de Følner).

Proposition 7 (Critère de Kesten [Kes59]). *Une action $G \curvearrowright X$ est moyennable si et seulement si pour une (toute) mesure symétrique non-dégénérée μ sur G , le **rayon spectral***

$$\rho(p, x) = \limsup_{n \rightarrow \infty} \sqrt[n]{p_n(x, x)}$$

de la marche induite sur X est 1.

Ici $p_n(x, x)$ est la probabilité d'être au point x après n pas en commençant de x . On va préciser les termes relatifs aux marches aléatoires dans la Section 2.4.1.

A partir d'ici on va se concentrer sur les groupes moyennables plutôt que les actions moyennables. On y retrouve une critère très utilisé. Considérons un groupe G de type fini. Soit S un ensemble générateur qui ne contient ni l'élément neutre, ni deux éléments qui sont mutuellement inverses. On s'intéresse aux mots sur l'alphabet $S \cup S^{-1}$. Comme on s'intéresse aux propriétés de groupe, on se permet de supprimer des combinaisons xx^{-1} ou $x^{-1}x$, ce qui est notre action de réduction. On dit qu'un mot qui ne contient pas de tels combinaisons est un mot réduit. On dénote γ_n le nombre de mots réduits de longueur au plus n sur $S \cup S^{-1}$ qui sont égaux à l'élément neutre comme éléments de G .

Une autre façon équivalente de définir cela est de considérer le groupe libre $F_{|S|}$ sur S (voir Section 2.1.3). Il y a un morphisme de groupes naturel de F vers G - il suffit d'associer à chaque élément de S dans F le même élément de S dans G . Si N est son noyau, γ_n est la taille de la boule de rayon n dans N .

Proposition 8 (Critère de co-croissance de Grigorchuk [Gri77]). *G est moyennable si et seulement si*

$$\lim_{n \rightarrow \infty} \sqrt[n]{\gamma_n} = 2|S| - 1.$$

Ce critère n'est pas difficile à prouver en utilisant le critère de Kesten, mais sa formulation algébrique le rend très utilisable. On va approfondir sur ses applications dans la Section 2.1.3.

2.1.2 Groupes élémentairement moyennables

Il suit directement des définitions que la moyennabilité est préservée par plusieurs opérations :

Proposition 9. *Tout sous-groupe H d'un groupe moyennable G est moyennable.*

Proposition 10. *Soit G_i une suite de groupes moyennables telle que $G_i \subset G_{i+1}$ pour chaque i . Alors $G = \bigcup_{i=0}^{\infty} G_i$ est moyennable.*

Corollaire 11. *Un groupe est moyennable si et seulement si chaque sous-groupe de type fini l'est.*

Proposition 12. *Si G est moyennable et N est un sous-groupe normal, alors G/N est moyennable.*

Proposition 13. *Si N est un sous-groupe normal de G , et N et G/N sont moyennables, alors G est moyennable.*

Avec le fait que les groupes cycliques sont moyennables, on obtient déjà que les groupes résolubles sont moyennables. De façon générale, les groupes qu'on peut obtenir à partir des groupes cycliques en appliquant ces propositions forment la classe des groupes **élémentairement moyennables**. Comme on verra dans la Section 2.3.1, les groupes de croissance sous-exponentielle sont moyennables. On obtient une classe plus grande de groupes moyennables : c'est les groupes **sous-exponentiellement moyennables**, qui sont les groupes obtenus à partir des groupes de croissance sous-exponentielle en appliquant ces opérations. Ce ne sont encore tous les groupes moyennables comme montré par Bartholdi et Virág [BV05]. On discutera sur leur résultat dans la Section 2.4.2 (le groupe qu'ils utilisent comme exemple est défini dans la Section 2.2.3).

2.1.3 Sous-groupes libres

Considérons le groupe engendré par deux éléments a et b tel que chaque mot réduit non-trivial sur ces deux éléments ne donne pas l'identité. De façon équivalente, on peut le considérer comme l'ensemble de mots réduits muni de la concaténation (puis réduction). On appelle cela le groupe **libre non-abélien** à deux générateurs, et on le dénote F_2 .

Lemme 14. *Le groupe F_2 est paradoxal.*

On va exhiber une décomposition associée. Prenons les quatre ensembles A_1, \dots, A_4 des mots réduits qui commencent par a, a^{-1}, b et b^{-1} respectivement. Autrement dit, $A_1 = \{ax_0x_1 \dots x_n \text{ sous forme réduite, } n \in \mathbb{N}, x_i \in \{a, a^{-1}, b, b^{-1}\}\}$, etc. Alors $A_1 \cup a.A_2 = F_2$. Voir sur Figure 2.1 son

graphe de Cayley (voir Définition 20) avec A_1 représenté par des lignes en tirets (et en rouge si vous avez imprimé en couleur) et A_2 par des lignes pointillées (bleus).

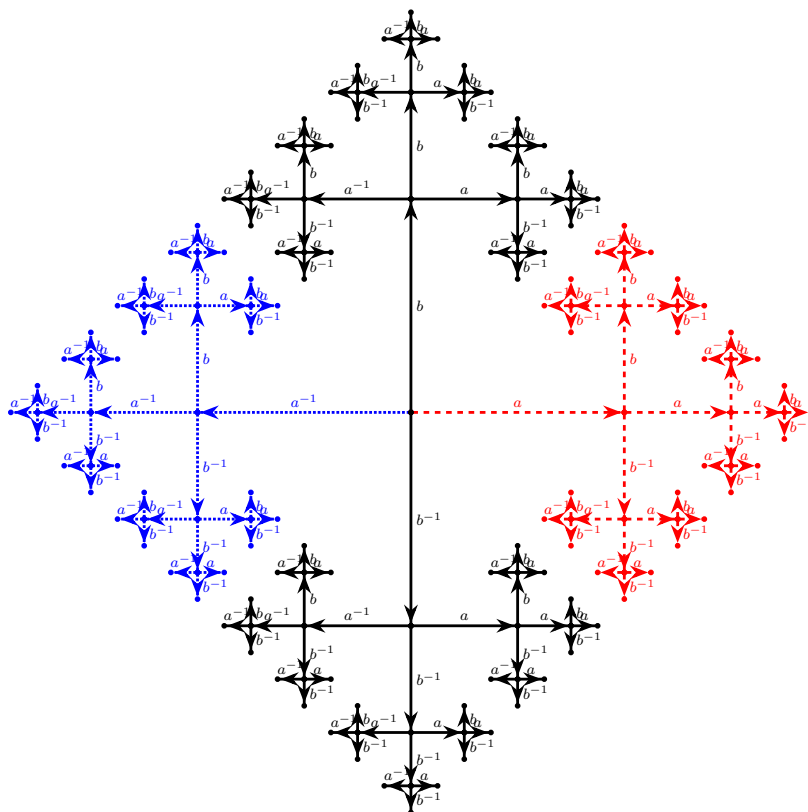

FIGURE 2.1 – Graphe de Cayley de F_2

De manière similaire, $A_3 \cup b.A_4$ donne aussi le groupe tout entier. En ajoutant l'élément neutre dans un de ces ensembles, on obtient une décomposition paradoxale. D'après Proposition 9, cela implique que chaque groupe qui contient un sous-groupe libre est non-moyennable. Cela donne la classe la plus évidente d'exemples de groupes non-moyennables (on peut en penser comme des groupes élémentairement non-moyennables). Le groupe des isomorphismes de \mathbb{R}^3 appartient à celle-ci, c'est-à-dire qu'il contient un sous-groupe libre. Par contre, trouver un exemple de groupe non-moyennable en-dehors de cette classe n'est pas facile - la question de leur existence est restée ouverte pendant 30 ans. Elle a été formulée par Day dans les années 1950, ce qui était appelé le «problème de von Neumann-Day». Le premier exemple a été donné en 1980 et on en parlera en détail dans la prochaine Section 2.1.4. Malgré le quantité énorme de définitions équivalentes, à notre connaissance, jusqu'à récemment, toutes les (premières) preuves de non-moyennabilité de groupes sans sous-groupe libre sont faites avec le critère de co-croissance (voir Proposition 8). Dans la Section 2.1.5 on va présenter des résultats autour d'un article qui

change cela.

Plus généralement, on ne sait même pas si avoir un sous-groupe libre est une condition géométrique (on expliquera ce que cela veut dire dans la Section 2.3.4). Cela conduit à une des grandes questions ouvertes dans le domaine - donner une condition de moyennabilité algébrique.

Les deux approches les plus connues pour chercher des sous-groupes libres sont le lemme du ping-pong et l'alternative de Tits [Tit72] :

Théorème 15 (Alternative de Tits). *Soit G un sous-groupe de $GL_n(\mathbf{K})$ pour $n \geq 1$ et K un corps de caractéristique zéro. Alors soit G a un sous-groupe libre non-abélien, soit G a un sous-groupe résoluble d'indice fini.*

Plus généralement, il y a une fonction $n \mapsto \lambda(n)$ telle que, indépendamment de \mathbf{K} , si G n'a pas de sous-groupe libre, il a un sous-groupe résoluble d'indice $\lambda(n)$. Le résultat est aussi correct si K est de caractéristique fini, mais seulement pour les sous-groupes de type fini. Des théorèmes similaires ont été démontrés pour d'autres groupes, et on dit qu'une classe de groupes \mathcal{C} satisfait l'alternative de Tits si tout groupe de la classe possède soit un sous-groupe libre, soit un sous-groupe résoluble d'indice fini. Par exemple, Karrass et Solitar [KS71, Théorème 3] ont montré que pour un groupe G défini par une seule relation, soit il contient un sous-groupe libre, soit il est résoluble. Explicitons ce que signifie être défini par une seule relation. Pour cela, on a besoin d'un lemme. Considérons un groupe G engendré par un ensemble S . Il y a un morphisme naturel du groupe libre non-abélien $F_{|S|}$ sur S vers G . On peut donc écrire G comme un quotient de ce groupe (par le noyau du morphisme). On a donc :

Lemme 16. *Tout groupe G est un quotient d'un groupe libre. De plus, si G est de type fini, il est quotient d'un groupe libre sur un nombre fini de générateurs.*

On considère alors un groupe comme le quotient F_k/N d'un groupe libre F_k par un sous-groupe normal N . Si dans une telle représentation, N est engendré par un nombre fini d'éléments comme sous-groupe normal, alors on dit que F_k/N est **de présentation finie**. Si de plus il est engendré comme sous-groupe normal par un seul générateur A , on dit que F_k/N est défini par une relation. On écrit $F_k/N = \langle x_1, \dots, x_k | A \rangle$ (où $S = \{x_1, \dots, x_k\}$). Plus généralement, si A_1, \dots, A_n sont des éléments de F_k (dites aussi relations sur F_k), on dénote par $\langle x_1, \dots, x_k | A_1, \dots, A_n \rangle$ le groupe F_k/N' où N' est le sous-groupe normal engendré par A_1, \dots, A_n . On les écrit parfois comme des égalités : par exemple pour le Théorème E on a défini $BS(1, 2) = \langle a, b | bab^{-1} = a^2 \rangle$. Cela veut dire que c'est le groupe $\langle a, b | bab^{-1}a^{-2} \rangle$.

Un autre exemple d'alternative de Tits est donné par les sous-groupes des groupes modulaires des surfaces de Riemann [Iva84, McC85] (c'est-à-dire les classes d'isotopie des difféomorphismes). C'est aussi vrai [Par92] pour les groupes fondamentaux des variétés M fermées, orientables et irréductibles de dimension 3 telles que $H_1(M, \mathbb{Z}/p\mathbb{Z}) \geq 3$ pour un p premier, ainsi que pour [Gro87, 8.2.F] les sous-groupes de groupes Gromov

hyperboliques. Pour une liste plus complète, voir le livre de Pierre de la Harpe [dlH00, II.42].

2.1.4 Groupes de torsion bornée

En 1902 William Burnside demande si chaque groupe de type fini de torsion est fini, c'est-à-dire s'il existe un groupe G infini de type fini tel que pour chaque $g \in G$ il existe $p > 0$ tel que $g^p = Id$. En 1964 la conjecture est réfutée. Ici on s'intéressera au problème de Burnside **borné** : existe-t-il un nombre entier p et un groupe infini de type fini G tel que $g^p = Id$ pour chaque $g \in G$? Cette question se ramène aux groupes de Burnside libres, qui sont des objets universels (dans un certain sens). On définit $B(m, n)$ comme le quotient de F_m par le sous-groupe normal engendré par les g^n pour $g \in F_m$. C'est un groupe de torsion n qui est universel pour tous les groupes de torsion n engendrés par au plus m éléments. Le problème de Burnside borné demande alors s'il y a des groupes de Burnside libres infinis, et lesquels. En 1968, Adyan et Novikov [NA68] démontrent que $B(m, n)$ est infini pour $m \geq 2$ et $n \geq 4381$ impaire.

Ol'shanskii développe leur méthode et en 1980 [Ol'80b] donne le premier exemple de groupe **non-moyennable sans sous-groupe libre**. Plus tard dans la même année, il présente aussi des groupes de torsion non-moyennables [Ol'80a]. On obtient même une propriété plus forte : tous leurs sous-groupes sont cycliques. C'est ce qu'on appelle les monstres de Tarski. Puisqu'un groupe non-moyennable est toujours infini, cela implique qu'un nombre infini de groupes de Burnside sont infinis.

En 1983 Adyan [Ady83] montre que $B(m, n)$ pour $m \geq 2$ et $n \geq 655$ impaire est non-moyennable (et donc aussi infini). Dans [Gri80] Grigorchuk décrit un groupe de torsion infini moyennable (voir Section 2.3.2). Mais c'est une question ouverte [Sha06] de savoir si un groupe de Burnside peut être infini et moyennable. Plus généralement, on ne sait pas si un groupe peut être infini, moyennable et de torsion bornée.

Un autre exemple connu de groupe non-moyennable sans sous-groupe libre est donné par Ol'shanskii et Sapir [OS03] quand ils décrivent pour la première fois un groupe non-moyennable sans sous-groupe libre de présentation finie.

2.1.5 La classe de groupes $H(A)$ d'un article de Monod

Monod [Mon13] construit une classe de groupes non-moyennables sans sous-groupe libre d'homéomorphismes projectifs par morceaux $H(A)$, où A est un sous-anneau de \mathbb{R} . Considérons l'action de $PSL_2(\mathbb{R})$ sur la ligne projective réelle $\mathbb{P}^1 = \mathbb{P}^1(\mathbb{R})$. Cette dernière peut être muni d'une topologie canonique qui fait d'elle un cercle : par exemple, en la décrivant comme le quotient de \mathbb{S}^1 par la relation d'équivalence $x \sim -x$. On dénote G le groupe des homéomorphismes de \mathbb{P}^1 qui sont dans $PSL_2(\mathbb{R})$ par morceaux, avec un nombre fini de morceaux et H la sous-groupe de G des éléments qui fixent $\begin{pmatrix} 1 \\ 0 \end{pmatrix} \in \mathbb{R}^2$. Ce point devient le point ∞ si on considère

la description de \mathbb{P}^1 comme $\mathbb{R} \cup \{\infty\}$, et l'action comme $\begin{pmatrix} a & b \\ c & d \end{pmatrix} .x = \frac{ax+b}{cx+d}$ (avec les conventions naturelles pour l'infini).

Soit A un sous-anneau de \mathbb{R} . En particulier, on s'intéresse au cas où A est dénombrable et dense. Soit $P_A \subset \mathbb{P}^1$ l'ensemble des points fixes d'éléments hyperboliques de $PSL_2(A)$. On définit $G(A)$ comme le sous-ensemble de G des éléments qui sont dans $PSL_2(A)$ par morceaux, avec les extrémités des morceaux dans P_A . On obtient le groupe $H(A) = G(A) \cap H$, c'est-à-dire les éléments de $G(A)$ qui fixent le point infini. Ils fixent donc la ligne réelle, et on peut y penser comme des homéomorphismes de \mathbb{R} projectifs par morceaux. Monod obtient :

Théorème 17. *Le groupe $H(A)$ n'est pas moyennable si $A \neq \mathbb{Z}$.*

Théorème 18. *Le groupe H ne contient pas des sous-groupes libres non-abéliens. Alors $H(A)$, comme sous-groupe, n'en contient pas non plus pour chaque A .*

Il vaut de noter que le Théorème 17 est obtenu en comparant l'action de $H(A)$ avec celle de $PSL_2(A)$. Pour $H(\mathbb{Z})$, il est une question ouverte s'il est moyennable, et il contient le groupe de Thompson F (voir Définition 31) comme sous-groupe (voir [KKL19]).

On retrouve des autres groupes intéressants dans cette classe. Lodha [Lod20] montre qu'un certain sous-groupe de $H(\mathbb{Z}[\frac{\sqrt{2}}{2}])$ est de type F_∞ (c'est-à-dire, il existe un CW-complexe X connexe sphérique dans chaque dimension avec un nombre fini de cellules dans chaque dimension tel que $\pi_1(X)$ est isomorphe au sous-groupe). Ce sous-groupe était construit avant par Moore et Lodha [LM16] comme un exemple de groupe de présentation finie non-moyennable sans sous-groupe libre. Il n'a que trois générateurs et 9 relations, bien moins que l'exemple de Ol'shanskii-Sapir [OS03]. Il est le premier exemple de groupe de type F_∞ non-moyennable sans sous-groupe libre. Plus tard, Lodha [Lod16] montre aussi que les nombres de Tarski (le nombre minimal de pièces dans une décomposition paradoxale) des groupes $H(A)$ sont bornées par 25.

2.1.6 Produits en couronnes

On présente ici une construction commune de groupes. On s'en intéresse en particulier dans [3] (voir Chapitre 5). Pour deux groupes A et B , notons $B^{(A)}$ les fonctions de A sur B tels que tout sauf un nombre fini de points valent Id_B .

Définition 19. Le **produit en couronne** $A \wr B$ est le produit semi-directe de A sur $B^{(A)}$ où A agit sur $B^{(A)}$ par translations.

Si on écrit les éléments comme (a, f) où $a \in A$ et $f \in B^{(A)}$, le produit est donc $(a, f)(a', f') = (aa', x \mapsto f(x)f'(xa^{-1}))$.

Pour un ensemble générateur S de A et S' de B , on a un ensemble générateur standard de $A \wr B$. Il est formé des $(s, \mathbb{1}_B)$ pour $s \in S$ (où $\mathbb{1}_B(x) = Id_B$ pour tout $x \in A$), ainsi que les $(Id_A, \delta_{Id_A}^{s'})$ pour $s' \in S'$

où $\delta_{Id_A}^{s'}(Id_A) = s'$ et $\delta_{Id_A}^{s'}(x) = Id_B$ sinon. On peut vérifier que quand on multiplie (a, f) à droite avec le première type d'élément, on obtient (as, f) , et avec le deuxième type, on change le valeur de f au point a par s' .

Similairement, étant donne des ensembles de Følner F_A et F_B sur A et B , cela donne des ensembles de Følner standards pour $A \wr B$. Soit

$$F = \{(a, f) | a \in F_A, \text{supp}(f) \subset F_A, \forall x : f(x) \in F_B\}.$$

Alors (voir Section 2.3.3 pour la définition de ∂F) :

$$\begin{aligned} \partial F = & \{(a, f) | a \in \partial F_A, \text{supp}(f) \subset F_A, \forall x : f(x) \in F_B\} \\ & \cup \{(a, f) | a \in F_A, \text{supp}(f) \subset F_A, f(a) \in \partial F_B\}. \end{aligned}$$

On a $|F| = |F_A||F_B|^{|F_A|}$ et $|\partial F| = |\partial F_A||F_B|^{|F_A|} + |F_A||F_B|^{|F_A|-1}|\partial F_B|$.
Donc

$$\frac{|\partial F|}{|F|} = \frac{|\partial F_A|}{|F_A|} + \frac{|\partial F_B|}{|F_B|}.$$

2.2 Graphes de Cayley et Schreier

2.2.1 Définitions et résultats généraux

Définition 20. Soit G un groupe de type fini et S un ensemble générateur. Son **graphe de Cayley** est $\Gamma = (V, E)$ avec $V = G$ et $E = \{(g, gs) : g \in G, s \in S\}$.

Définition 21. Soit G un groupe de type fini et S un ensemble générateur.

1. Un graphe de «coset» de Schreier est défini par rapport à un sous-groupe H . Ces sommets sont les classes Hg , $g \in G$, et ces arrêtes sont les couples de la forme (Hg, Hgs) pour $g \in G$, $s \in S$.
2. Un graphe d'action de Schreier est défini par rapport à une action transitive à droite de G , soit sur X . L'ensemble de sommets est X , et les arrêtes sont les couples de la forme (x, xs) pour $x \in X$, $s \in S$.
3. L'ensemble de graphes de coset de Schreier et les graphes d'action de Schreier sont les mêmes. On appelle un tel graphe un graphe de Schreier.

Il y a une application évidente des graphes de coset de Schreier avec un sommet marqué vers les graphes d'action de Schreier avec un sommet marqué. Il suffit de considérer l'action de G sur les classes de H par multiplication (à droite). Son inverse n'est pas compliqué non plus : il suffit de considérer le sous-groupe des éléments qui fixent le sommet marqué \mathfrak{o} , dit stabilisateur et noté $St(\mathfrak{o})$.

Les graphes de Schreier généralisent les graphes de Cayley. Effectivement, le graphe de Cayley d'un groupe G est juste le graphe de Schreier

par rapport au sous-groupe trivial $\{e\}$, où par rapport à l'action du groupe sur lui-même par multiplication.

Il est connu que chaque graphe régulier de degré paire est un graphe de Schreier [Gro77]. Pour une preuve détaillée du cas infini, voir [Lee16, Theorem 3.2.5]. Ce n'est pas le cas pour les graphes de Cayley. Comme on verra dans la Section 2.3.1, les graphes de croissance n^d où d n'est pas entier ne sont pas des graphes de Cayley.

2.2.2 Bouts des graphes

Définition 22. Considérons un espace topologique X . Pour un ensemble compact $K \subset X$ on dénote $\pi_0(X \setminus K)$ l'ensemble des composantes connexes de $X \setminus K$. Il y a un ordre naturel défini par $K_1 \leq K_2$ si et seulement si $K_1 \subseteq K_2$. On en obtient un morphisme $\pi_{1,2} : \pi_0(X \setminus K_2) \mapsto \pi_0(X \setminus K_1)$ qui envoie chaque composante connexe dans une composante connexe qui la contient. Cela forme un système inverse indexé par $K \subset X$ (voir [RS09, Section 3.1.2]). **L'espace des bouts** est la limite inverse :

$$\varprojlim_{\substack{K \subset X \\ \text{compact}}} \pi_0(X \setminus K) = \{(x_K) \in \prod_{\substack{K \subset X \\ \text{compact}}} \pi_0(X \setminus K) \mid \pi_{\alpha,\beta} x_\beta = x_\alpha, K_\alpha \subset K_\beta\}.$$

Dans le cas d'un graphe, de façon équivalente, si on prends une suite exhaustive croissante pour l'inclusion d'ensembles finis $K_1 \subset K_2 \subset \dots$, un **bout** est représenté par une suite décroissante $U_1 \supseteq U_2 \supseteq \dots$ de composantes connexes de $X \setminus K_i$.

Par exemple, dans un arbre l'ensemble des bouts est représentable par les branches infinies. Les graphes de Cayley de \mathbb{Z} et F_2 sont des arbres, et ils ont donc deux bouts et un nombre infini de bouts respectivement. Par contre, considérons le graphe de Cayley \mathbb{Z}^d pour $d \geq 2$. Pour chaque K fini, $\mathbb{Z}^d \setminus K$ a exactement une composante connexe infini. Ce graphe a donc un seul bout.

Dans le cas des graphes de Cayley, le nombre de bouts est bien classifié par Stallings [Sta68, Sta72] (voir [Geo08, Sections 13.5 et 13.6]). Il était connu avant lui que le nombre des bouts est 0, 1, 2 ou ∞ , et que les groupes avec 0 bouts sont les groupes finis, et les groupes avec 2 bouts sont les groupes virtuellement \mathbb{Z} . Il démontre qu'un groupe a un nombre infini de bouts si et seulement s'il peut être écrit comme produit libre amalgamé ou comme une extension HNN sur un groupe fini.

2.2.3 Exemples

Le groupe de la Basilique

Notons \mathcal{T} l'arbre infini binaire. Ses sommets sont les suites finies de $\{0, 1\}$, la suite vide étant la racine. On considère des automorphismes sur lui. Comme ils préservent la racine (car il est le seul sommet de degré 2), ils préservent - et donc permutent - chaque niveau. Un automorphisme est

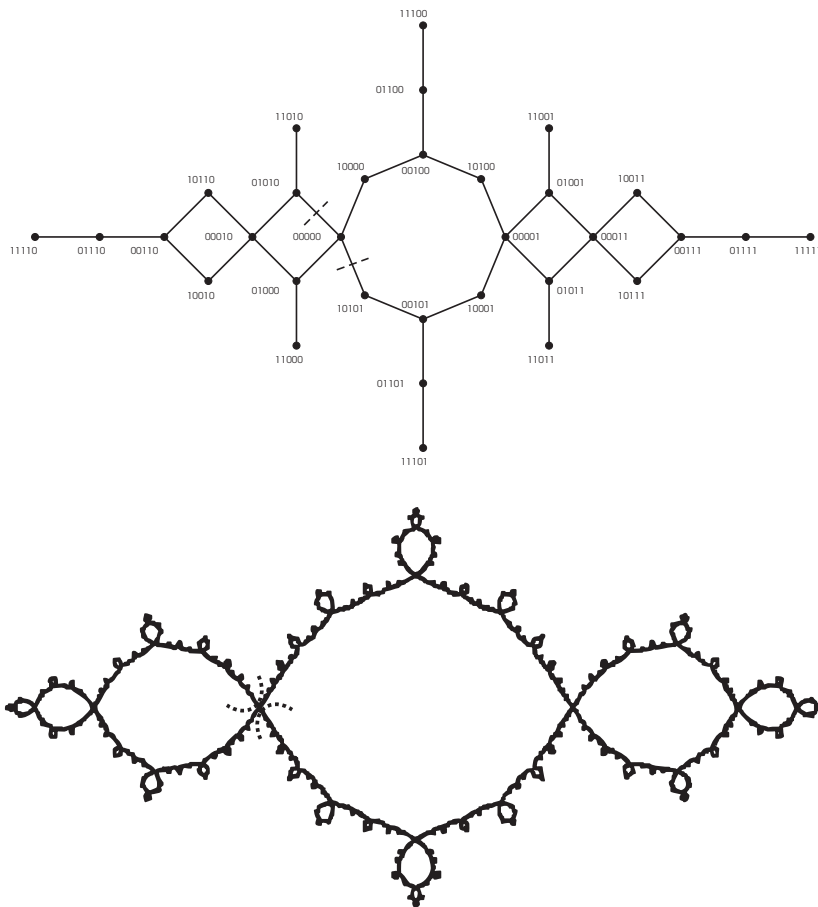

FIGURE 2.2 – Le graphe de Schreier à niveau 5 du groupe de la Basilique et son espace limite par Bondarenko, D’Angeli et Nagnibeda

donc défini de façon unique par le choix, sur chaque sommet, de permuter ou non les deux fils. Un sous-groupe de $Aut(\mathcal{T})$ est appelé un groupe agissant sur un arbre enraciné binaire. On s’intéressera à un tel groupe, le groupe de la Basilique. Il est défini comme le groupe engendré par deux éléments a et b définis par récurrence sur le longueur k de la suite :

$$\begin{cases} a(0, j_2, \dots, j_k) = (0, j_2, \dots, j_k) \\ a(1, j_2, \dots, j_k) = (1, b(j_2, \dots, j_k)) \end{cases} \begin{cases} b(0, j_2, \dots, j_k) = (1, a(j_2, \dots, j_k)) \\ b(1, j_2, \dots, j_k) = (0, j_2, \dots, j_k) \end{cases}$$

Il est aussi le groupe des monodromies itérées du polynôme $z^2 - 1$ (voir le survol par Bartholdi, Grigorchuk et Nekrashevych [BGN03] ; livre de Nekrashevych [Nek05, Chapitres 3 et 5]) ; les graphes de Schreier induits au niveau n convergent, quitte à normaliser la distance, vers l’ensemble de Julia du polynôme. Le groupe doit son nom à cet ensemble : il ressemble

la Basilique de San Marco à Venise. Une visualisation de Bondarenko, D'Angeli et Nagnibeda [BDN17] est présenté dans Figure 2.2.

Le groupe $D_\infty \wr_a \mathbb{Z}_2$

On présente ici un exemple auquel on s'intéresse dans [3] (voir Chapitre 5). On commence par définir une généralisation du produit en couronne (voir Section 2.1.6) :

Définition 23. Considérons un groupe A qui agit sur un ensemble X . Notons cette action a . Le **produit en couronne permutational** (restreint) $A \wr_a B$ est le produit semi-direct de A sur $B^{(X)}$ où A agit sur $B^{(X)}$ par translation.

Remarquons qu'un produit en couronne est un produit en couronne permutational pour l'action du groupe sur lui-même par multiplication.

Considérons le groupe diédral infini D_∞ , défini par

$$D_\infty = \langle a, x \mid x^2 = e, xax = a^{-1} \rangle.$$

De façon équivalent, il est le produit semi-direct de $\mathbb{Z}_2 = \mathbb{Z}/2\mathbb{Z}$ sur \mathbb{Z} , avec l'élément non-neutre de \mathbb{Z}_2 agissant en tant que l'inversion sur \mathbb{Z} . Tout élément s'écrit soit a^n , soit xa^n . On considère un autre ensemble générateur : $\{x, y\}$ avec

$$y = xa.$$

Alors $xax = a^{-1}$ devient $(xa)^2 = e$ et donc D_∞ est aussi le produit libre de \mathbb{Z}_2 avec lui-même.

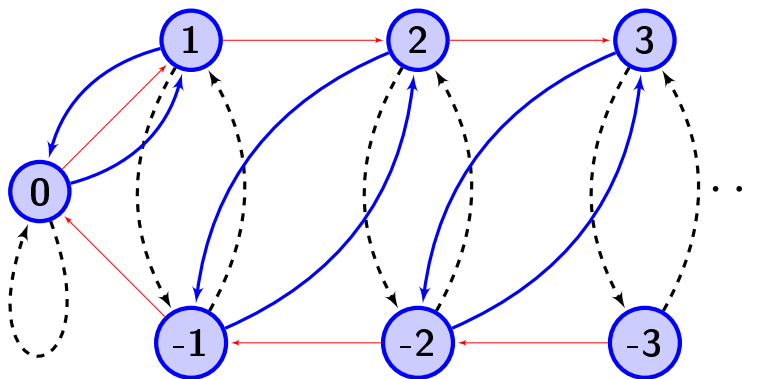

FIGURE 2.3 – (Une partie du) Graphe de Schreier de D_∞ pour le sous-groupe $\{e, x\}$ avec x (pointillée, noire), y (bleue) et a (fine, rouge). On va considérer l'ensemble générateur $\{x, y\}$ (sans les lignes rouges)

Considérons le sous-groupe $\{e, x\}$ et le graphe de Schreier de coset qu'il définit (avec ensemble générateur $\{x, y\}$). Chaque sommet est de la forme $\{g, xg\}$, et il peut donc s'écrire comme $\{xa^n, a^n\}$ pour un $n \in \mathbb{Z}$. Si on représente les sommets avec ces entiers, le graphe est dessiné

dans la Figure 2.3. Avec l'ensemble générateur $\{x, y\}$, il est un rayon : $0, 1, -1, 2, -2, 3, -3, \dots$.

On s'intéressera à l'action a de D_∞ que cela définit (voir Définition 21), et le produit en couronne permutatif $D_\infty \wr \mathbb{Z}_2$ qu'on y obtient. On expliquera dans la Section 2.3.5 que cela donne un exemple où la fonction de Følner est similaire à la fonction de croissance.

2.3 Profils géométriques

2.3.1 Croissance des groupes

Pour un groupe G de type fini, et un ensemble S fini générateur, on dénote $V(k) = V(G, S, k)$ la taille de la boule autour de l'identité dans le graphe de Cayley associé. On dénote $\omega(G, S) = \limsup_k \sqrt[k]{V(G, S, k)}$. Si $\omega(G, S) > 1$, on dit que G est de **croissance exponentielle** (remarquons que cela ne dépend pas du choix de S fini ; par contre le valeur exact de $\omega(G, S)$ si). Si $V(G, S, k)$ est majorée par un polynôme, on dit que G est de **croissance polynomiale**. Sinon, si V croît plus vite que chaque polynôme mais plus lentement que chaque exponentielle, on dit que le groupe est de **croissance intermédiaire**. Il n'est pas évident de construire un tel groupe. On exprimera un exemple dans la prochaine Section 2.3.2.

Les groupes de croissance polynomiale sont bien classifiés par un résultat célèbre de Gromov [Gro81]. Il obtient qu'ils sont exactement les groupes virtuellement nilpotents. En particulier, leur croissance vérifie que $V(n)n^{-d}$ converge pour l'entier $d = \sum_{i \geq 1} i \operatorname{rang}(G_i/G_{i+1})$ où (G_i) est la suite centrale descendante. Voir Bass [Bas72], Guivarc'h [Gui73] pour $V(n)$ entre $C_1 n^d$ et $C_2 n^d$ et Pansu [Pan83a] pour la convergence.

Si un groupe n'est pas de croissance exponentielle, on peut montrer qu'une sous-suite de boules autour de l'identité forme des ensembles de Følner. En effet, si $\omega(G, S) < 1 + \epsilon$, alors à partir d'un certain k , $V(G, S, k) < (1 + \epsilon)^k$. Cela implique que l'on peut en extraire une sous-suite de boules telle que le bord est toujours plus petit que ϵ fois l'intérieur. En procédant par extraction diagonale, on obtient le résultat. Il est donc moyennable. Par contre, l'inverse n'est pas vrai. Considérons par exemple le produit en couronne $\mathbb{Z} \wr \mathbb{Z}_2$ (où $\mathbb{Z}_2 = \mathbb{Z}/2\mathbb{Z}$). Il n'est pas difficile de voir que les éléments $(1, \mathbf{0})$ et $(1, \delta_0^1)$ (avec les notations de Section 2.1.6) forment un sous-semi-groupe libre. La croissance de $\mathbb{Z} \wr \mathbb{Z}_2$ est donc au moins 2^n pour un ensemble générateur qui les contient. On a donc une croissance exponentielle. Par contre il est moyennable, et même résoluble. Comme on a vu dans la Section 2.1.6, un exemple d'ensembles de Følner pour ce groupe est l'ensemble F_n des (k, f) tels que $\operatorname{supp}(f) \subset \llbracket 1 \dots n \rrbracket$ et $k \in \llbracket 1 \dots n \rrbracket$. Ils vérifient $\frac{|\partial F_n|}{|F_n|} = \frac{2}{n}$. La question suivante reste ouverte. Peut-on choisir pour chaque groupe moyennable certaines boules comme ensembles de Følner ? Si l'on sait que la croissance est intermédiaire ou polynomiale, c'est vrai, mais dans ce cas la question se pose de savoir si on peut choisir toutes les boules comme des ensembles de Følner.

2.3.2 Groupe de Grigorchuk

Pour plus de références sur cette section, voir le livre de Pierre de la Harpe [dlH00, Ch. VIII]. On rappelle quelques définitions de la Section 2.2.3. Notons \mathcal{T} l'arbre infini binaire. Ses sommets sont les suites finies de $\{0, 1\}$, la suite vide étant la racine. On considère des automorphismes sur lui. Comme ils préservent la racine (car il est le seul sommet de degré 2), ils préservent - et donc permutent - chaque niveau. Un automorphisme est donc défini de façon unique par le choix, sur chaque sommet, de permuter ou non ses deux fils. Notons a l'automorphisme qui permute les deux branches principales et rien d'autre. Autrement dit,

$$a(j_1, j_2, \dots, j_k) = (\bar{j}_1, j_2, j_3, \dots, j_k)$$

où $\bar{j} = 1 - j$. On définit aussi b, c et d par récurrence. L'automorphisme b va agir comme a sur le sous-arbre à gauche (celui dont les sommets sont de la forme $(0, j_2, j_3, \dots, j_k)$) et comme c à droite. De même, $c = (a, d)$, mais $d = (1, b)$. Formellement :

$$\begin{cases} b(0, j_2, j_3, \dots, j_k) = (0, \bar{j}_2, j_3, \dots, j_k) \\ b(1, j_2, j_3, \dots, j_k) = (1, c(j_2, j_3, \dots, j_k)) \end{cases}$$

$$\begin{cases} c(0, j_2, j_3, \dots, j_k) = (0, \bar{j}_2, j_3, \dots, j_k) \\ c(1, j_2, j_3, \dots, j_k) = (1, d(j_2, j_3, \dots, j_k)) \end{cases}$$

$$\begin{cases} d(0, j_2, j_3, \dots, j_k) = (0, j_2, j_3, \dots, j_k) \\ d(1, j_2, j_3, \dots, j_k) = (1, b(j_2, j_3, \dots, j_k)). \end{cases}$$

Le **groupe de Grigorchuk** (ou première groupe de Grigorchuk) est alors $\Gamma = \langle a, b, c, d \rangle$ (le sous-groupe de $Aut(\mathcal{T})$ engendré par ces quatre éléments). Notons qu'on a $a^2 = b^2 = c^2 = d^2 = 1$ et aussi $bc = cb = d$. Cela veut dire que pour chaque mot sur a, b, c, d qui est de longueur minimale pour l'élément du groupe qu'elle représente, elle est de la forme $ax_1ax_2\dots x_k a$, $ax_1\dots x_k$, $x_1a\dots x_k a$ ou $x_1a\dots x_k$ pour x_1, \dots, x_k parmi b, c, d . Notons $St_\Gamma(k)$ le sous-groupe qui fixe les k premiers niveaux. Il agit séparément sur chaque sous-arbre défini en prenant un sommet de profondeur k comme racine. On peut vérifier que la restriction donne aussi un élément de Γ . On a donc des morphismes naturels $St_\Gamma(k) \mapsto \Gamma^{2^k}$. Considérons en particulier $St_\Gamma(3)$. D'après les définitions on peut voir que pour chaque élément parmi b, c, d , on peut trouver une branche sur laquelle cet élément agit trivialement jusqu'à cette profondeur. On peut utiliser cela et l'écriture ci-dessus pour démontrer :

Lemme 24. *Considérons $\gamma \in St_\Gamma(3)$ et soient $\gamma_1, \dots, \gamma_8$ les restrictions de γ sur les sous-arbres. On a donc :*

$$\sum_{i=1}^8 |\gamma_i| \leq \frac{3}{4}|\gamma| + 8.$$

On sait que, pour tout $\varepsilon > 0$, $V(k) = V(\Gamma, \{a, b, c, d\}, k) \leq (\omega(\Gamma, \{a, b, c, d\}) + \varepsilon)^k$ à partir d'un certain rang (par définition de limite supérieure). Si on applique à cela ce Lemme 24 et le fait que $St_\Gamma(3)$ est d'indice 2^7 (voir [dlH00, VIII.22]), on obtient

$$V(k) \leq DP(k)(\omega + \varepsilon)^{\frac{3}{4}(k+2^7-1)+8}$$

pour une constante D et un polynôme P . Cela implique que $\omega \leq (\omega + \varepsilon)^{\frac{3}{4}}$. On a donc $\omega(\Gamma, \{a, b, c, d\}) = 1$ et le groupe de Grigorchuk n'est pas de croissance exponentielle (il est donc moyennable). On peut montrer aussi qu'il n'est pas de croissance polynomiale [dlH00, VIII.63]. Il est le premier tel exemple. Cela ne résout pas encore la question sur la classification des croissances : il reste ouvert le Growth Gap Conjecture [Gri14, Conjecture 2], qui conjecture que la croissance en volume doit être soit polynomiale, soit plus grande que $\exp(\sqrt{n})$. Plus généralement, la version faible de cette conjecture est qu'il existe un $0 < \beta < 1$ tel que la croissance en volume doit être soit polynomiale, soit plus grande que $\exp(n^\beta)$.

On peut aussi montrer que ce groupe est de torsion, mais pas de torsion fini : plus précisément, pour chaque $\gamma \in \Gamma$ il existe N tel que $\gamma^{2^N} = 1$, mais pour chaque n il existe γ tel que $\gamma^{2^n} \neq 1$.

2.3.3 Définition de la fonction de Følner

Fixons un groupe G moyennable de type fini et un ensemble générateur S et soit Γ son graphe de Cayley. Rappelons la condition de Følner : Théorème 6(3). On rappelle que pour un groupe de type fini, on peut considérer E comme n'importe quel ensemble générateur fixé. On s'intéressera en particulier à $E = S \cup S^{-1} \cup \{Id\}$. Alors pour un ensemble F , $F.E \Delta F$ est l'ensemble des éléments g qui ne sont pas dans F mais pour lesquels il existe un $s = s(g) \in S$ tel que $s.g$ où $s^{-1}.g$ est dans F . Autrement dit, ce sont les éléments dans le complémentaire de F qui sont à distance 1 de F dans Γ . On appellera cet ensemble $\partial_{out}F$ (définition valable de façon générale pour tout graphe). Similairement, $\partial_{in}F$ sera l'ensemble des éléments de F à distance 1 de l'extérieur. Finalement, ∂F est l'ensemble d'arrêtes entre F et son complémentaire. La fonction de Følner est alors :

$$Føl(n) = \min \left\{ |F| : F \subset G, \frac{|\partial_{in}F|}{|F|} \leq \frac{1}{n} \right\}. \quad (2.1)$$

Remarquons que $Føl(1) = 1$ pour tout groupe et tout ensemble générateur.

2.3.4 Quasi-isométries et équivalence asymptotique

Soient X et X' deux espaces métriques. Une fonction $\phi : X \mapsto X'$ est appelée un **plongement quasi-isométrique** s'il existe des constantes $\lambda \geq 1$ et $C \geq 0$ telles que pour tout x, y :

$$\frac{1}{\lambda}d(x, y) - C \leq d'(\phi(x), \phi(y)) \leq \lambda d(x, y) + C.$$

C'est une **quasi-isométrie** si de plus il existe $D \geq 0$ tel que chaque point de X' est à distance plus petite que D d'un point de $\phi(X)$. On le considère dans le cas des groupes de type fini avec la métrique de longueur de mots.

Proposition 25. *Soit G un groupe de type fini et S et S' deux ensembles générateurs. Alors G avec la métrique de longueur de mots sur S est quasi-isométrique à G avec la métrique de longueur de mots sur S' .*

On a donc une notion de quasi-isométrie de groupes bien définie pour les groupes de type fini. Les propriétés préservées par quasi-isométrie sont considérées comme des propriétés géométriques. La moyennabilité en est une. Une façon simple de voir cela est d'utiliser la condition de Følner.

Il existe plusieurs propriétés pour lesquelles on ne sait pas si elles sont géométriques. Par exemple, on ne sait pas si deux groupes, l'un avec un sous-groupe libre et l'autre sans, peuvent être quasi-isométriques. Être de torsion aussi, on ne sait pas si cette propriété est préservé par quasi-isométrie.

Le type de croissance (comme défini dans la Section 2.3.1) est préservé par quasi-isométries. Par rapport aux fonctions de Følner, les quasi-isométries les préservent à **équivalence asymptotique** près. Deux fonctions sont asymptotiquement équivalentes s'il existe des constantes A et B tels que $f(xA)/B < g(X) < f(xA)B$. L'approche standard pour décrire la fonction de Følner d'un groupe est ainsi de donner sa classe d'équivalence asymptotique. Il vaut de noter aussi que la classe d'équivalence asymptotique de la probabilité de retour après $2n$ pas est préservé par quasi-isométrie pour les graphes de Cayley (voir Pittet et Saloff-Coste [PSC00]).

2.3.5 Fonctions de Følner

Comme on l'a mentionné dans la Section 2.3.4, généralement, on cherche à classifier les fonctions de Følner à équivalence asymptotique près. Le Théorème isopérimétrique classique dit que le compact dans \mathbb{R}^n qui minimise le bord pour un volume fixé est la boule (voir le survol d'Osserman [Oss78, Section 2]). Car \mathbb{Z}^n est quasi-isométrique à \mathbb{R}^n , cela est aussi un première résultat pour les groupes discrets. Le fait que si un minimum existe, il est réalisé uniquement sur la boule est obtenu (dans \mathbb{R}^2) par Steiner au XIX^e siècle, en utilisant ce qui est maintenant appelé symétrisation de Steiner (voir Hehl [Heh13], Hopf [Hop40], Froehlich [Fro09]). L'existence du minimum est prouvé, dans \mathbb{R}^3 , par Schwarz [Sch84]. Varopoulos [Var85b] démontre plus généralement une inégalité isopérimétrique pour les produits directs. Pansu [Pan83b] (voir aussi [Pan82]) en obtient dans le groupe de Heisenberg H_3 . Un résultat central est l'inégalité de Coulhon et Saloff-Coste [CSC93], qui relie la croissance en volume et la fonction de Følner :

Théorème 26 (Inégalité de Coulhon et Saloff-Coste). *Soit G un groupe infini engendré par un ensemble S fini et soit $\phi(\lambda) = \min(n|V(n) > \lambda)$, où $V(n)$ est la taille de la balle de rayon n dans le graphe de Cayley. Alors pour tout ensemble F fini on a*

$$\frac{|\partial_{in}F|}{|F|} \geq \frac{1}{8|S|\phi(2|F|)}.$$

Les constantes multiplicatives peuvent être améliorées (voir G. Pete [Pet20, Theorem 5.11], B. L. Santos Correia [SC20]) :

$$\frac{|\partial_{in}F|}{|F|} \geq \frac{1}{2\phi(2|F|)}. \quad (2.2)$$

Le résultat de Santos Correia est annoncé également pour les groupes finis pour $|F| \leq \frac{1}{2}|G|$. L'inégalité de Coulhon et Saloff-Coste (Théorème 26) implique en particulier que pour un groupe de croissance exponentielle, sa fonction de Følner est au moins exponentielle. Similairement, il est connu que les fonctions de Følner des groupes de croissances polynomiales sont au plus polynomiales (voir par exemple [Woe00, Section I.4.C]). Une autre inégalité sur l'isopérimétrie des groupes est donné par Żuk [Żuk00]. Vershik [Ver73] demande si la fonction de Følner peut être super-exponentielle, ce qui marque le début de l'étude des fonctions de Følner. Il suggère le produit en couronne $\mathbb{Z} \wr \mathbb{Z}$ comme un exemple à considérer. Pittet [Pit95] montre que les fonctions de Følner des groupes polycycliques sont au plus exponentielles (elles sont donc exponentielles pour les groupes polycycliques de croissance exponentielle). Cela est plus généralement vrai pour les groupes résolubles avec rang de Prüfer fini, voir [PSC03] et [KL20]. Le premier exemple de groupe avec fonction de Følner super-exponentielle est obtenu par Pittet et Saloff-Coste [PSC99] pour $\mathbb{Z}^d \wr \mathbb{Z}/2\mathbb{Z}$. Plus tard les fonctions de Følner des produits en couronnes avec certaines conditions de régularité sur les groupes de base sont décrites par Erschler [Ers03] à équivalence asymptotique près. Spécifiquement, on dénote qu'une fonction f vérifie la propriété (*) si pour tout $C > 0$ il existe $k > 0$ tel que $f(kn) > Cf(n)$. Son résultat dit alors que pour deux groupes dont les fonctions de Følner vérifient cette propriété, la fonction de Følner de leur produit en couronne $A \wr B$ est $\text{Føl}_{A \wr B}(n) = \text{Føl}_B(n)^{\text{Føl}_A(n)}$.

Une direction d'études des fonctions de Følner cherche à décrire la classe de fonctions f pour lesquelles il existe un groupe dont la fonction de Følner est asymptotiquement équivalente à f . Plusieurs auteurs ont trouvé des conditions de plus en plus faibles. Gromov [Gro08, Section 8.2, Remark (b)] construit des groupes avec des fonctions de Følner prescrits pour toutes les fonctions dont des dérivées croissent assez vite. Saloff-Coste et Zheng [SCZ18] décrivent les fonctions de Følner, entre autres, d'une classe des «bubble» groupes et d'une classe de groupes cycliques de Neumann-Segal. Plus récemment, Brioussell et Zheng [BZ21] démontrent que pour toute f croissante avec $f(1) = 1$ et $n/f(n)$ croissante, il existe un groupe dont la fonction de Følner est asymptotiquement équivalente à l'exponentielle de la fonction inverse de $n/f(n)$. Erschler et Zheng [EZ21] obtient des exemples pour une classe de fonctions super-exponentielles en dessous de $\exp(n^2)$ avec des conditions de régularité plus faibles. Spécifiquement, pour tout $d \in \mathbb{N}$ et $\tau(n) \leq n^d$ largement

croissante elles obtiennent qu'il existe un groupe G et une constante C avec

$$Cn \exp(n + \tau(n)) \geq \text{Føl}_G(n) \geq \exp\left(\frac{1}{C}(n + \tau(n/C))\right). \quad (2.3)$$

La coté gauche est toujours asymptotiquement équivalente à $\exp(n + \tau(n))$, et il suffit donc que la coté droite le soit aussi pour décrire la fonction de Følner de G . En particulier, il suffirait que τ vérifie (*). Remarquons que les conditions décrites ici ne considèrent que les fonctions plus grandes que $\exp(n)$; c'est une question ouverte de savoir si une fonction de Følner peut avoir croissance intermédiaire (voir Grigorchuk [Gri14, Conjecture 5(ii)]). Par Erschler [Ers06, Lemme 3.1], une réponse négative impliquerait le Growth Gap Conjecture. On peut définir une version faible de la conjecture pour les fonctions de Følner de façon similaire à la forme faible du Growth Gap Conjecture. Les versions faibles sont équivalentes (voir la discussion après Conjecture 6 dans [Gri14]).

On connaît encore moins les descriptions exactes des fonctions de Følner. Dans un travail en cours [3] (voir Chapitre 5) on obtient des valeurs exactes pour les fonctions de Følner du produit en couronne (voir Section 2.1.6) $\mathbb{Z} \wr \mathbb{Z}_2$ pour deux ensembles générateurs (on dénote $\mathbb{Z}_2 = \mathbb{Z}/2\mathbb{Z}$), et des résultats isopérimétriques sur le groupe de Baumslag-Solitar $BS(1, 2)$. Des connaissances de l'auteur, ce sont les premières exemples où les valeurs exactes d'une fonction de Følner non-polynomiale sont connues. On rappelle que les ensembles de Følner standards F_n sur $\mathbb{Z} \wr \mathbb{Z}_2$ sont $F_n = \{(k, f) | k \in \llbracket 1, n \rrbracket, \text{supp}(f) \subset \llbracket 1, n \rrbracket\}$. On dénote $t = (1, \mathbf{0})$ et $\delta = (0, \delta_0^1)$. Les deux ensembles générateurs qu'on considère ici sont l'ensemble standard $S = \{t, \delta\}$ et l'ensemble «switch-walk-switch» $S' = \{t, \delta, t\delta, \delta t, \delta t\delta\}$.

Définition 27. On dira qu'un sous-ensemble F fini d'un groupe G est **optimal** par rapport au bord intérieur (respectivement extérieur, par rapport aux arrêtes) si pour tout F' avec $|F'| \leq |F|$, on a

$$\frac{|\partial_{in} F'|}{|F'|} \geq \frac{|\partial_{in} F|}{|F|}$$

(respectivement $\frac{|\partial_{out} F'|}{|F'|} \geq \frac{|\partial_{out} F|}{|F|}$, $\frac{|\partial F'|}{|F'|} \geq \frac{|\partial F|}{|F|}$), et si $|F'| < |F|$, les inégalités sont strictes.

On obtient alors :

Théorème F. *Considérons le produit en couronne $\mathbb{Z} \wr \mathbb{Z}_2$.*

1. *Pour tout $n \in \mathbb{N}$, l'ensemble de Følner standard F_n est optimal par rapport au bord extérieur et le bord par rapport aux arrêtes pour l'ensemble générateur standard S . Autrement dit, pour tout $F \subset \mathbb{Z} \wr \mathbb{Z}_2$ tel que $|F| \leq |F_n|$, on a*

$$\frac{|\partial F|}{|F|} \geq \frac{|\partial_{out} F|}{|F|} \geq \frac{|\partial_{out} F_n|}{|F_n|} = \frac{|\partial F_n|}{|F_n|},$$

et si $|F| < |F_n|$, les inégalités sont strictes,

2. Pour tout $n \in \mathbb{N}$ on a
- (a) Pour S , $F_n \cup \partial_{out} F_n$ est optimal par rapport au bord intérieur,
 - (b) Pour S' , $F_n \cup \partial'_{out} F_n$ est optimal par rapport au bord intérieur,
3. Les résultats de (2) impliquent que, pour $n \geq 2$, la fonction de Følner sur $\mathbb{Z} \setminus \mathbb{Z}_2$ pour l'ensemble générateur standard est

$$F\phi(n) = 2n2^{2(n-1)}$$

et pour l'ensemble «switch-walk-switch» elle est

$$F\phi_{sws}(n) = 2n2^{2n}.$$

De plus les ensembles qui donnent l'égalité sont uniques à translation prêt. Remarquons que le point (3) est le Théorème D.

On substitue ces valeurs dans l'inégalité de Coulhon et Saloff-Coste pour étudier les constantes multiplicatives. L'inégalité 2.2 implique (pour toute groupe infini et toute ensemble générateur fini) :

$$2F\phi(n) > V\left(\frac{n}{2} - 1\right).$$

Pour les groupes de croissance exponentielle, il n'est pas difficile de voir que la constante multiplicative devant n est plus importante que les autres constantes. Effectivement, si on obtient $AF\phi(n) \geq V(n(\frac{1}{2} + \varepsilon) - B)$ pour certains $\varepsilon, A, B > 0$, ce résultat est strictement plus fort pour n assez grand. On peut donc demander :

Question. Pour un groupe G et un ensemble générateur S , on dénote $C_{G,S}$ le supremum de l'ensemble des constantes C tels qu'ils existent A et B avec $AF\phi(n) \geq V(Cn - B)$. Quel est l'infimum C_0 de l'ensemble de tout $C_{G,S}$ sur tout groupe et tout ensemble générateur fini ?

L'inégalité originale donne une réponse positive pour $C = \frac{1}{8|S|}$ (et donc $C_0 \geq \frac{1}{8|S|}$), et les résultats de [Pet20, Theorem 5.11] et [SC20] qu'on a cité en tant qu'Équation 2.2 montrent que $C_0 \geq \frac{1}{2}$.

Il n'est pas difficile de voir que si les limites $\lim \frac{\ln F\phi(n)}{n}$ et $\lim \frac{\ln V(n)}{n}$ existent pour un groupe et un ensemble générateur, le supremum $C_{G,S}$ sera leur quotient. La deuxième limite existe toujours. Chaque élément de longueur au plus mn s'écrit comme le produit de deux éléments de longueur respectivement au plus m et au plus n . On a donc

$$V(m+n) \leq V(m)V(n),$$

et $\ln V(n)$ est sous-additive. La limite existe alors par le lemme sous-additif de Fekete. Par contre, l'autre limite $\lim \frac{\ln F\phi(n)}{n}$ peut ne pas exister. Un exemple trivial vient des groupes avec fonctions de Følner super-exponentielles, où la suite diverge vers $+\infty$. Mais même si on décide de considérer cela comme une suite convergente (vers $+\infty$), la limite n'est encore pas toujours existant. On peut considérer des exemples de

Erschler et Zheng où la fonction de Følner oscille entre $\exp n$ et $\exp n^c$. Alors $\frac{\ln \text{Føl}(n)}{n}$ oscille entre une constante finie et $+\infty$. Spécifiquement, considérons [EZ21, Exemple 3.8(2)] avec $\alpha = 1$ et $\beta = 2$. Prenons une suite (η_i) et une fonction $\tau(n) = n^\alpha$ pour $n \in [\eta_{2j-1}, \eta_{2j}]$ et $\tau(n) = n^\beta$ pour $n \in [\eta_{2j}, \eta_{2j+1}]$. L'exemple nous donne un groupe dont la fonction de Følner vérifie Inégalité 2.3. Pour $n \in [\eta_{2j-1}, \eta_{2j}]$ on a $\frac{\ln \text{Føl}(n)}{n} \leq \frac{\ln(Cn)}{n} + 1 + \frac{\tau(n)}{n}$, qui est plus petit que 3 pour n grand. En autre, si $n \in [\eta_{2j}, \eta_{2j+1}]$, $\frac{\ln \text{Føl}(n)}{n} \geq \frac{1}{Cn}(n + \tau(n/C)) = \frac{1}{C} + \frac{n}{C^3}$. En particulier, il est plus grand que 4 pour n grand. On a donc que $\frac{\ln \text{Føl}(n)}{n}$ ne converge pas vers une constante finie, et ne diverge pas vers $+\infty$. On peut quand même considérer \liminf .

Proposition G. $C_{G,S} = \frac{\liminf \frac{\ln \text{Føl}(n)}{n}}{\lim \frac{\ln V(n)}{n}}$.

D'après le Théorème D, sur $\mathbb{Z} \wr \mathbb{Z}_2$ on a (voir [3, Section 5]; Chapitre 5 pour les estimations sur le volume) :

Proposition H. *Le produit en couronne $\mathbb{Z} \wr \mathbb{Z}_2$ vérifie*

$$C_{\mathbb{Z} \wr \mathbb{Z}_2, S} = \frac{\lim \frac{\ln \text{Føl}(n)}{n}}{\lim \frac{\ln V(n)}{n}} = \frac{\ln 4}{\ln(\frac{1}{2}(1 + \sqrt{5}))} \approx 2,88$$

pour l'ensemble générateur standard, et

$$C_{\mathbb{Z} \wr \mathbb{Z}_2, S'} = \frac{\lim \frac{\ln \text{Føl}_{sws}(n)}{n}}{\lim \frac{\ln V_{sws}(n)}{n}} = 2.$$

On obtient une borne supérieure $C_0 \leq 2$. Cette borne était déjà connu avant de montrer que les ensembles standards sont optimaux; Théorème D démontre que ces exemples ne peuvent pas donner mieux. Par contre, on démontre dans [3] (voir Chapitre 5) que $C_0 \leq 1$.

Proposition I. *Le produit en couronne permutatif $D_\infty \wr_a \mathbb{Z}_2$ (qu'on a décrit dans Section 2.2.3) avec l'ensemble générateur $\{t_x, t_y, \delta, t_x \delta, \delta t_x, \delta t_x \delta, t_y \delta, \delta t_y, \delta t_y \delta\}$ vérifie $\frac{\liminf \frac{\ln \text{Føl}(n)}{n}}{\lim \frac{\ln V(n)}{n}} = 1$.*

Spécifiquement, on obtient $\text{Føl}(2n+1) = 2(2n+1)2^{2n+1}$ et $\lim \frac{\ln \text{Føl}(n)}{n} = \ln 2$. Cela vient du fait que dans les ensembles standards, le support des fonctions est contenu dans un intervalle d'un rayon (le rayon qu'on voit sur la Figure 2.3 sur page 18), et (s'il est bien choisi) le bord du support est donc de cardinal 1.

Une voie de recherche connue est l'étude de la série de croissance $\sum_n V(n)x^n$, spécifiquement si elle est une fonction rationnelle. Une réponse positive est obtenu pour les groupes hyperboliques pour tout ensemble générateur par Gromov [Gro87] (voir aussi [Can84],[GdlH90, Chapitre 9]), et par Benson [Ben83] pour les groupes virtuellement abéliens. Une condition suffisante qu'on remarque est d'avoir un "nombre fini de types co-

niques". Passant des groupes virtuellement abéliens vers les groupes nilpotents, Benson [Ben87] et Shapiro [Sha89] montrent que la série de croissance du groupe de Heisenberg sur les entiers H_3 est rationnelle pour l'ensemble générateur standard. Stoll [Sto96] étudie le groupe de Heisenberg H_5 de dimension plus grande et obtient que la série n'est pas rationnelle pour l'ensemble standard, mais elle l'est pour un autre ensemble générateur. Duchin et Shapiro [DS19] obtiennent plus tard la rationalité sur H_3 pour tout ensemble générateur. Voir Grigorchuk-de la Harpe [GdlH97, Section 4] pour un survol. Avoir des valeurs exactes pour les fonctions de Følner nous permet d'étudier la série $\sum_n \text{Føl}(n)x^n$. Comme une corollaire de Théorème D, on obtient que les séries dans ces deux exemples sont des fonctions rationnelles : respectivement $\frac{2x}{(4x-1)^2}$ et $\frac{8x}{(4x-1)^2}$. Il serait intéressant de trouver une condition géométrique suffisante qui explique cela.

On obtient de plus un résultat isopérimétrique sur le groupe de Baumslag-Solitar $BS(1, 2)$ en terme du bord par rapport aux arêtes. Les groupes de Baumslag-Solitar sont définis par la présentation $BS(m, n) = \langle a, b | ba^m b^{-1} = a^n \rangle$. Il est moyennable si et seulement s'il est résoluble, si et seulement si $|m| = 1$ où $|n| = 1$. Le groupe $BS(1, p)$ est isomorphe au groupe engendré par $x \mapsto x + 1$ et $x \mapsto px$ (qui seront respectivement l'image de a et de b^{-1}). On peut écrire ces éléments de la forme $x \mapsto p^n x + f$ avec $n \in \mathbb{Z}$ et $f \in \mathbb{Z}[\frac{1}{p}]$. Les générateurs agissent (à droite) respectivement en rajoutant p^n dans f ou en changeant n , ce qui présente une structure similaire aux produits en couronnes. Si on écrit cet élément de la forme (n, f) , les ensembles standards s'expriment de la même façon que pour les produits en couronnes. Autrement dit,

$$F_n = \{p^k x + f | k \in \llbracket 1, n \rrbracket, f \in \mathbb{Z}, 0 \leq f < p^{n+1}\}. \quad (2.4)$$

Théorème (Théorème E). *Considérons le groupe de Baumslag-Solitar $BS(1, 2)$ avec l'ensemble générateur $\{a, b\}$. Alors pour tout $n \in \mathbb{N}$ et tout $F \subset BS(1, 2)$ fini tel que $|F| \leq |F_n|$, on a $\frac{|\partial F|}{|F|} \geq \frac{|\partial F_n|}{|F_n|}$, et si $|F| < |F_n|$, l'inégalité est stricte.*

Dans le cas général de $BS(1, p)$, on montre que dans $BS(1, 8)$, l'ensemble standard avec 8 éléments n'est pas optimal. Par contre, ce résultat est relié au fait que p n'est pas négligeable par rapport au longueur de l'intervalle qui définit l'ensemble standard, et il est possible que pour $BS(1, p)$ aussi, les ensembles standards sont optimaux pour grands n .

2.4 Marches aléatoires gouvernées par des mesures sur les groupes

2.4.1 Définitions

Soit une mesure μ sur un groupe G . La marche aléatoire associée sur G est la chaîne de Markov gouvernée par la probabilité de transition

$p(f_1, f_2) = \mu(f_1^{-1}f_2)$. Autrement dit, $p(f, fg) = \mu(g)$. Intuitivement, à chaque pas on choisit un élément g par μ et on multiplie (à droite) la position où on se trouve par g . Si on part de l'élément neutre, cela donne une trajectoire $T_n = g_1g_2 \dots g_n$ où g_i sont indépendantes et identiquement distribuées par μ . Remarquons que la trajectoire reste dans le semi-groupe engendré par le support de μ . On dira qu'une mesure est **non-dégénérée** si son support engendre G . Il vaut de noter qu'on aurait pu également multiplier à gauche - c'est un choix de convention.

On définit la marche aléatoire induite par une action de façon similaire. Encore une fois, à chaque pas on choisit un élément $g \in G$ par μ et on multiplie par lui. On obtient $p(x, y) = \sum_{x.g=y} \mu(g)$, et la trajectoire est $T_n = \mathbf{o}.g_1g_2 \dots g_n$. Noter qu'on a pris l'action à droite.

On cherche à comprendre le comportement limite de ces marches, spécifiquement en terme de leurs bords de Poisson. Le bord de Poisson (aussi dit de Poisson-Furstenberg) est défini de façon générale pour une marche quelconque, et il y a plusieurs définitions équivalentes (voir [KV83]).

Définition 28. Considérons une marche aléatoire et la mesure P induite sur l'espace des trajectoires $G^{\mathbb{Z}^+}$. Considérons la relation d'équivalence suivante : $(x_0, x_1, \dots) \sim (y_0, y_1, \dots)$ si et seulement s'il existe $i_0 \in \mathbb{N}$ et $k \in \mathbb{Z}$ tels que pour tout $i > i_0$, $x_i = y_{i+k}$. Autrement dit, deux trajectoires sont équivalentes quand elles sont les mêmes quitte à supprimer un nombre fini (possiblement différent) de points au début. Le **Bord de Poisson** de la marche est le quotient de $(G^{\mathbb{Z}^+}, P)$ par l'enveloppe mesurable de cette relation d'équivalence.

De façon équivalente, le bord de Poisson B peut être défini comme le μ -bord maximal, un μ -bord étant un quotient de P par une partition mesurable et invariante par rapport aux translations et par rapport aux multiplication par les éléments de G .

Pour une marche sur un groupe, une formule dite **formule de Poisson** donne un isomorphisme entre $L^\infty(B)$ et l'espace des fonctions μ -harmoniques bornées sur le groupe. Une fonction est μ -harmonique si pour tout x , $f(x) = \sum_g \mu(g)f(xg)$. Cela permet de définir le bord de Poisson aussi comme le spectre de l'algèbre de Banach que cet espace forme avec le produit approprié. Une autre réalisation abstraite du bord est en tant que l'espace des composantes ergodiques pour la translation. Voir aussi les survols par Erschler [Ers10], Furman [Fur02].

Si le bord de Poisson n'admet que des ensembles de mesure 0 ou 1, on dit qu'il est trivial. Quand le bord de la marche aléatoire induite sur un groupe G par une mesure μ sur G est trivial, on dit que (G, μ) est **Liouville**. Remarquons que la formule de Poisson dit qu'une mesure est Liouville si et seulement si les seules fonctions μ -harmoniques bornées sur G sont les fonctions constantes.

On a une définition similaire sur les graphes où on dit qu'un graphe Γ vérifie la propriété de Liouville si les seules fonctions harmoniques bornées sur Γ sont les fonctions constantes (pour un graphe de Cayley cela est équivalente au fait que la mesure de comptage normalisé sur $S \cup S^{-1}$ est Liouville). Cette propriété n'est pas stable par quasi-isométrie d'après un

résultat de Lyons [Lyo87] : il décrit deux graphes quasi-isomorphes où l'un admet la propriété de Liouville et l'autre non. Benjamini [Ben91] obtient de plus un exemple qui vérifie ces conditions et pour lequel les graphes sont de croissance polynomiale.

Pour une classe de mesures, on peut savoir si elles sont Liouville en utilisant l'entropie de la marche. L'entropie d'une mesure est défini par

$$H(\mu) = \sum_{g \in G} -\mu(g) \log \mu(g),$$

et celle de la marche associée (dite **entropie asymptotique**, voir Avez [Ave72]) par

$$h(\mu) = \lim_{n \rightarrow \infty} \frac{H(\mu^{*n})}{n}.$$

On a $H(\mu * \lambda) \leq H(\mu) + H(\lambda)$ et donc si $H(\mu)$ est fini, cette limite existe et $h(\mu)$ est fini. Avez [Ave76] obtient que si $h(\mu) = 0$, alors la mesure est Liouville. Pour les mesures avec entropie fini, l'inverse est aussi vrai :

Théorème 29 (Critère d'entropie (Kaimanovich-Vershik [KV79, KV83], Derriennic [Der80])). *Soit G un groupe dénombrable et μ une mesure sur G avec entropie finie. Alors (G, μ) est Liouville si et seulement si $h(\mu) = 0$.*

Pour les mesures de premier moment fini, on peut relier l'entropie à la vitesse de fuite. Le premier moment d'une mesure est l'espérance de la longueur de mot $\sum_{g \in G} |g| \mu(g)$. Il dépende du choix d'ensemble générateur, mais sa finitude n'en dépend pas. La vitesse de fuite est $l_S(\mu) = \lim_{n \rightarrow \infty} \frac{L(n)}{n}$ où $L(n) = \sum_{g \in G} |g| \mu^{*n}(g)$ (et S est un ensemble générateur). Il n'est pas difficile de voir que $h \leq \omega l$ (voir [Gui80, Section C]), et donc si $l = 0$, on a $h = 0$. Pour les mesures symétriques, l'inverse est aussi vrai. Ceci est obtenu par Varopoulos [Var85a] pour les mesures de support fini, et par Karlsson et Ledrappier [KL07] pour les mesures de premier moment fini.

2.4.2 Liens avec la moyennabilité

Le bord de Poisson donne une autre critère de moyennabilité :

Théorème 30. *Un groupe G est moyennable si et seulement s'il existe un mesure Liouville μ non-dégénérée sur G .*

Le sens inverse est donné par Azencott [Aze70], voir aussi Furstenberg [Fur73] qui conjecture de plus le sens direct. Celui-ci est montré par Rosenblatt [Ros81] et Kaimanovich-Vershik [KV79, KV83].

Il vaut de noter qu'un groupe peut avoir certaines mesures qui sont Liouville et d'autres qui ne le sont pas. Kaimanovich et Vershik [KV83] montrent que les mesures non-dégénérés de support fini sur $\mathbb{Z}^d \wr \mathbb{Z}_2$ pour $d \geq 3$ ne sont pas Liouville (et une mesure Liouville existe car le groupe est moyennable). Pour les mêmes groupes, Kaimanovich [Kai85] montre

qu'il existe une mesure non-Liouville dont l'inverse est Liouville. Erschler [Ers04] obtient que l'entropie asymptotique des mesures non-dégénérées sur une classe de groupes qui contient les groupes $\mathbb{Z}^d \wr \mathbb{Z}_2$ pour $d \geq 3$ n'est jamais nulle. En particulier, toute mesure avec entropie finie n'est pas Liouville, et l'entropie de la mesure Liouville qui existe d'après le Théorème 30 est infinie.

La théorème décrit la classe de groupes où il existe une mesure Liouville - les groupes moyennables. Parmi eux ils existent de plus des groupes où *toute* mesure est Liouville. Ceci est obtenu pour les groupes abéliens par Blackwell [Bla55] (voir aussi [DSW60],[CD60]), puis pour les groupes nilpotents [DM61],[Mar66], et ensuite les groupes hyper-FC-centraux [LZ98],[Jaw04]. Il vaut de noter qu'un groupe de type fini est hyper-FC-central si et seulement s'il est virtuellement nilpotent. Dans un résultat récent, Frisch, Hartman, Tamuz et Vahidi Ferdowsi [FHTV19] montrent que toutes les mesures sur un groupe sont Liouville si et seulement si le groupe est hyper-FC-central. En particulier, sur tout groupe de croissance sur-polynomiale il existe une mesure non-Liouville. Cela était conjecturé pour les groupes de croissance exponentielle par Kaimanovich et Vershik [KV83]. Une description complète du bord de Poisson est donné dans [EK19] pour une classe de mesures contenant les mesures non-Liouvilles présentées dans [FHTV19] (sur les groupes qui ne sont pas hyper-FC-centraux).

Dans [1] (voir Chapitre 3) on s'intéresse aux sous-groupes de $H(\mathbb{Z})$ (voir Section 2.1.5). Il n'est pas connu si ce groupe est moyennable ou non, donc on ne sait pas s'il existe une mesure Liouville. On démontre que certaines classes de mesures sur des sous-groupes de $H(\mathbb{Z})$ ne sont pas Liouville. Ces résultats sont inspirés par les travaux de Vadim Kaimanovich sur le groupe de Thompson F (comme on a mentionné, $H(\mathbb{Z})$ contient F comme sous-groupe).

Définition 31. Le **groupe de Thompson F** est le groupe des homéomorphismes affines par morceaux de $[0, 1]$ qui préservent l'orientation, avec un nombre fini de morceaux, dont les extrémités des morceaux sont dyadiques, et les pentes sont des puissances de 2.

Il est de type fini, avec deux générateurs :

$$A(t) = \begin{cases} \frac{t}{2} & 0 \leq t \leq \frac{1}{2} \\ t - \frac{1}{4} & \frac{1}{2} \leq t \leq \frac{3}{4} \\ 2t - 1 & \frac{3}{4} \leq t \leq 1 \end{cases} \quad B(t) = \begin{cases} t & 0 \leq t \leq \frac{1}{2} \\ \frac{t}{2} + \frac{1}{4} & \frac{1}{2} \leq t \leq \frac{3}{4} \\ t - \frac{1}{8} & \frac{3}{4} \leq t \leq \frac{7}{8} \\ 2t - 1 & \frac{7}{8} \leq t \leq 1 \end{cases}$$

C'est une question ouverte célèbre de savoir s'il est moyennable ou non. Vadim Kaimanovich [Kai17] démontre que les mesures de support fini sur F dont le support engendre F comme semi-groupe sont non-Liouvilles. Dans [1] (voir Chapitre 3), on montre :

Théorème. *Pour tout sous-groupe de type fini H de $H(\mathbb{Z})$ qui n'est pas*

résoluble et toute mesure μ sur H avec premier moment fini et dont le support engendre H comme semi-groupe, (H, μ) n'est pas Liouville.

En considérant une généralisation de la notion de premier moment fini sur des sous-groupes de $H(\mathbb{Z})$ qui ne sont pas de type fini, on obtient :

Théorème (Théorème A). *Pour tout sous-groupe de H de $H(\mathbb{Z})$ qui n'est pas localement résoluble et toute mesure μ sur H avec espérance finie du nombre de fins de morceaux et dont le support engendre H comme semi-groupe, (H, μ) n'est pas Liouville.*

Il s'en suit que les mesures avec premier moment fini sur F , dont le support engendre F comme semi-groupe, sont non-Liouville. Cela était soulevé comme question dans l'article de Kaimanovich [Kai17, 7.A]. Pour les mesures de support fini qu'il considère, les configurations associées stabilisent (point par point) dès que la marche transiente induite sur les nombres dyadiques sort d'un ensemble fini fixé. Pour les mesures de premier moment fini, la valeur peut changer tout au long de la trajectoire, et on a dû montrer (voir [1, Lemma 7.2]; Chapitre 3) que l'espérance du nombre de changements est fini.

La condition de moyennabilité avec le bord de Poisson est nécessaire et suffisante, mais à mes connaissances, elle n'a pas été utilisée pour démontrer la non-moyennabilité d'un groupe. Dans l'autre direction par contre, elle a été utilisée pour montrer la moyennabilité d'un groupe. Bartholdi et Virág [BV05] démontrent que le groupe de la Basilique (voir Section 2.2.3) est moyennable en montrant que l'espérance de la distance à l'origine augmente de façon sous-linéaire; et puis en appliquant le critère de Kesten. Dans un article inspiré par leur méthode, Kaimanovich [Kai05] démontre plus généralement que pour une classe de groupes auto-similaires (qui contient le groupe de la Basilique), pour certaines mesures l'entropie asymptotique est zéro. Ils sont donc Liouilles (voir Théorème 29), et les groupes de cette classe sont moyennables.

2.4.3 Graphes de Schreier

On a aussi des résultats plus généraux sur les marches sur le graphe de Schreier de F (voir Définition 21). On rappelle que la marche aléatoire est définie par le noyau $p(x, y) = \sum_{x.g=y} \mu(g)$. Il n'est pas difficile de voir que le bord de Poisson de cette marche est un quotient du bord de Poisson de la marche sur le groupe. En particulier, si le bord sur le graphe de Schreier est non-trivial, la mesure n'est pas Liouville.

Mishchenko [Mis15] développe une autre approche pour étudier la non-trivialité des bords de Poisson sur F . Il démontre que la marche aléatoire simple sur le graphe de Schreier que F induit sur les nombres dyadiques a un bord de Poisson non-trivial. Kaimanovich [Kai17, Section 6] obtient ce résultat pour les mesures de support fini. Dans [2] (voir Chapitre 4) on prouve que le bord de Poisson de la marche induite sur le graphe de Schreier est non-trivial pour les mesures avec premier moment fini dont le support engendre F comme semi-groupe. C'est une conséquence (d'un corollaire) du résultat suivant :

Théorème (Théorème B). *Considérons une action transitive d'un groupe G . Soit S un ensemble générateur et Γ le graphe de Schreier associé. Soit μ une mesure sur G avec premier moment fini tel que la marche aléatoire induite sur Γ est transiente. Alors elle converge presque sûrement vers un bout (aléatoire) du graphe.*

Ce résultat était déjà connu dans le cas où l'action de G sur X est non-moyennable (voir Woess [Woe00, Théorème 21.16] - c'est un cas particulière de ce théorème), encore avec la condition de premier moment fini. La théorème cité est plus généralement vrai pour une marche aléatoire qui n'est pas nécessairement induite par une mesure sur un groupe. Elle suppose plutôt une marche uniformément irréductible, de premier moment uniforme, et avec $\rho < 1$ (on rappelle le Critère de Kesten dans la Proposition 7). Dans [2] (voir Chapitre 4), on montre aussi que le résultat n'est plus vrai si on ne suppose ni que la marche est induite par une mesure sur un groupe, ni $\rho < 1$.

Il faut aussi mentionner que la transience est dans certains cas impliquée par les propriétés du graphe de Schreier. On utilise un lemme de comparaison de Baldi-Lohoué-Peyrière [BLP77].

Lemme 32 (Lemme de comparaison). *Soit $P_1(x, y)$ et $P_2(x, y)$ des noyaux doublement stochastiques sur un ensemble dénombrable X et supposons que P_2 est symétrique. Supposons qu'il existe $\varepsilon \geq 0$ tel que*

$$P_1(x, y) \geq \varepsilon P_2(x, y)$$

pour tout x, y . Alors si P_2 est transient, P_1 l'est aussi.

Ici, doublement stochastique veut dire que les opérateurs sont inversibles et les inverses sont aussi Markov. De façon équivalente, ils préservent la mesure de comptage ; le résultat est encore vrai dans un cas général où les opérateurs ont une autre mesure stationnaire commune, voir Kaimanovich [Kai17, Section 3.C] ; voir aussi Woess [Woe00, Sections 2.C et 3.A]. Pour les marches qu'on considère, il est direct de vérifier qu'ils sont doublement stochastiques.

Si on applique le lemme au Théorème B on obtient :

Corollaire (Corollaire C). *Considérons une action transitive d'un groupe G . Soit S un ensemble générateur et Γ le graphe de Schreier associé. Supposer que Γ est transient. Alors pour tout mesure μ sur G dont le support engendre G en tant que semi groupe et qui a un premier moment fini, la marche aléatoire induite converge presque sûrement vers un bout du graphe.*

On peut l'appliquer en particulier à l'action de F sur les nombres dyadiques. La marche induite converge donc vers les bouts du graphe, et en utilisant l'auto-similarité du graphe il n'est pas difficile de voir qu'il ne peut pas converger avec probabilité 1 vers un bout spécifique. Ce comportement non-trivial implique que son bord de Poisson n'est pas trivial. Sans la condition de premier moment fini par contre, il existe des mesures

sur F telles que la marche induite sur les nombre dyadiques a un bord trivial comme montré par Juschenko et Zheng [JZ18]. Juschenko [Jus18] a aussi étudié les marches induites sur les ensembles de cardinal n de nombres dyadiques, donnant une condition combinatoire pour le trivialité du bord de Poisson, et montrant qu'il existe une mesure avec un bord trivial pour $n = 2$. Schneider et Thom [ST20, Corollary 6.2(3)] démontrent que pour une action fortement transitive $G \curvearrowright X$ (comme celle de F), pour tout n il y a une mesure avec un bord trivial si et seulement si F est moyennable en tant que sous-groupe topologique de $Sym(X)$. Avec cette topologie, F est un sous-groupe de $Aut(\mathbb{Z}[\frac{1}{2}], \leq)$, qui est connu comme (extrêmement) moyennable d'après Pestov [Pes98]. On peut trouver une présentation plus détaillée de la moyennabilité extrême dans Kechris-Pestov-Todorcevic [KPT05], où ils développent la théorie qui permet d'obtenir des groupes extrêmement moyennables d'après la théorie de Ramsey structurelle. En particulier, la moyennabilité extrême de $Aut(\mathbb{Z}[\frac{1}{2}], \leq)$ est équivalente [KPT05, 6(A)(iv)] à (une version généralisé du) théorème classique de Ramsey.

2.4.4 Caractérisation complète des bords de Poisson

Dans [1] (voir Chapitre 3) on démontre la non-trivialité du bord en décrivant un μ -bord de configurations associées (comme Kaimanovich a fait dans [Kai17]). Une question plus difficile serait d'obtenir une description complète du bord de Poisson. Kaimanovich [Kai00] a développé des critères géométriques pour montrer qu'un μ -bord est le bord de Poisson pour des groupes avec des propriétés hyperboliques. Il décrit le bord des groupes hyperboliques, et aussi des sous-groupes discrets des groupes de Lie semi-simples et les groupes avec un nombre infini de bouts. Le «strip» critère de cet article a depuis été utilisé pour nombreuses descriptions complètes de bords de Poisson, comme les groupes de difféotopie (Kaimanovich et Masur [KM96]), $Out(F_N)$ (Horbez [Hor16]), produits en couronnes de groupes libres avec des groupes finis (Karlsson et Woess [KW07]), produits en couronnes $\mathbb{Z}^d \wr B$ où B est fini (Erschler [Ers11] pour $d \geq 5$, Lyons et Peres [LP20] pour $d \geq 3$), groupes agissant sur des \mathbb{R} -arbres (Gautero et Mathéus [GM12]), groupes d'automorphismes de complexes cubiques $CAT(0)$ (Nevo et Sageev [NS13]), groupes fondamentaux de 3-variétés fermées (Malyutin et Svetlov [MS14]).

Chapitre 3

Non-triviality of the Poisson boundary of random walks on the group $H(\mathbb{Z})$ of Monod

Non-triviality of the Poisson boundary of random walks on the group $H(\mathbb{Z})$ of Monod

Bogdan Stankov*

Département de mathématiques et applications, École normale supérieure, CNRS,
PSL Research University, 75005 Paris, France
bogdan.zl.stankov@gmail.com

23 September, 2019

Abstract

We give sufficient conditions for the non-triviality of the Poisson boundary of random walks on $H(\mathbb{Z})$ and its subgroups. The group $H(\mathbb{Z})$ is the group of piecewise projective homeomorphisms over the integers defined by Monod. For a finitely generated subgroup H of $H(\mathbb{Z})$, we prove that either H is solvable, or every measure on H with finite first moment that generates it as a semigroup has non-trivial Poisson boundary. In particular, we prove the non-triviality of the Poisson boundary of measures on Thompson's group F that generate it as a semigroup and have finite first moment, which answers a question by Kaimanovich.

Keywords— Random walks on groups, Poisson boundary, Schreier graph, Thompson's group F , groups of piecewise projective homeomorphisms, solvable group, locally solvable group

1 Introduction

In 1924 Banach and Tarski [4] decompose a solid ball into five pieces, and reassemble them into two balls using rotations. That is now called the Banach-Tarski paradox. Von Neumann [38] observes that the reason for this phenomenon is that the group of rotations of \mathbb{R}^3 admits a free subgroup. He introduces the concept of amenable groups. Tarski [48] later proves amenability to be the only obstruction to the existence of "paradoxical" decompositions (like the one in Banach-Tarski's article [4]) of the action of the group on itself by multiplication, as well as any free actions of the group. One way to prove the result of Banach-Tarski is to see it as an almost everywhere free action of $SO_3(\mathbb{R})$ and correct for the countable set where it is not (see e.g. Wagon [50, Cor. 3.10]).

The original definition of amenability of a group G is the existence of an invariant mean. A mean is a normalised positive linear functional on $l^\infty(G)$. It is called invariant if it is preserved by translation on the argument. Groups that contain free subgroups are non-amenable. It is proven by Ol'shanskii in 1980 [40] that it is also possible for a non-amenable group to not have a free subgroup. Adyan [1] shows in 1982 that all Burnside groups of a large enough odd exponent (which are known to be infinite by result of Novikov and Adyan from 1968 [39]) are non-amenable. Clearly they do not contain free subgroups. For more information and properties of amenability, see [5],[9],[17],[50].

*The author's work is supported by the ERC grant GroIsRan.

It is worth noting that despite the existence of a large amount of equivalent definitions of amenability, to our knowledge until recently all examples of non-amenable groups without free subgroups are proven (Ol'shanskii [40], Adyan [1], Ol'shanskii [41], Ol'shanskii-Sapir [42]) to be such using the co-growth criterion. See Grigorchuk [18] for the announcement of the criterion, or [19] for a full proof. For other proofs, see Cohen [11], Szwarz [47]. The criterion is closely related to Kesten's criterion in terms of probability of return to the origin [29].

Monod constructs in [36] a class of groups of piecewise projective homeomorphisms $H(A)$ (where A is a subring of \mathbb{R}). By comparing the action of $H(A)$ on the projective line $\mathbb{P}^1(\mathbb{R})$ with that of $PSL_2(A)$, he proves that it is non-amenable for $A \neq \mathbb{Z}$ and without free subgroups for all A . This can be used to obtain non-amenable subgroups with additional properties. In particular, Lodha [31] proves that a certain subgroup of $H(\mathbb{Z}[\frac{\sqrt{2}}{2}])$ is of type F_∞ (in other words, such that there is a connected CW complex X which is aspherical and has finitely many cells in each dimension such that $\pi_1(X)$ is isomorphic to the group). That subgroup was constructed earlier by Moore and Lodha [33] as an example of a group that is non-amenable, without free subgroup and finitely presented. It has three generators and only 9 defining relations (compare to the previous example by Ol'shanskii-Sapir [42] with 10^{200} relations). This subgroup is the first example of a group of type F_∞ that is non-amenable and without a free subgroup. Later, Lodha [32] also proves that the Tarski numbers (the minimal number of pieces needed for a paradoxical decomposition) of all the groups of piecewise projective homeomorphisms are bounded by 25.

It is not known whether the group $H(\mathbb{Z})$ of piecewise projective homeomorphisms in the case $A = \mathbb{Z}$ defined by Monod is amenable. One of the equivalent conditions for amenability is the existence of a non-degenerate measure with trivial Poisson boundary (see Kaimanovich-Vershik [27], Rosenblatt [44]). This measure can be chosen to be symmetric. It is also known that amenable groups can have measures with non-trivial boundary. In a recent result Frisch-Hartman-Tamuz-Vahidi-Ferdowski [16] describe an algebraic necessary and sufficient condition for a group to admit a measure with non-trivial boundary. In the present paper we give sufficient conditions for non-triviality of the Poisson boundary on $H(\mathbb{Z})$. There are several equivalent ways to define the Poisson boundary (see Kaimanovich-Vershik [27]). Consider a measure μ on a group G and the random walk it induces by multiplication on the left. It determines an associated Markov measure P on the trajectory space $G^{\mathbb{N}}$.

Definition 1.1. Consider the following equivalence relation on $G^{\mathbb{N}}$: two trajectories (x_0, x_1, \dots) and (y_0, y_1, \dots) are equivalent if and only if there exist $i_0 \in \mathbb{N}$ and $k \in \mathbb{Z}$ such that for every $i > i_0$ $x_i = y_{i+k}$. In other words, if the trajectories coincide after a certain time instant up to a time shift. The *Poisson boundary* (also called *Poisson-Furstenberg boundary*) of μ on G is the quotient of $(G^{\mathbb{N}}, P)$ by the measurable hull of this equivalence relation.

Note that if the support of the measure does not generate G , in which case we say that the measure is *degenerate*, this defines the boundary on the subgroup generated by the support of the measure rather than on G . For a more recent survey on results concerning the Poisson boundary, see [14].

Thompson's group F is a subgroup of $H(\mathbb{Z})$, as follows from Kim, Koberda and Lodha [30]. This group is the group of orientation-preserving piecewise linear self-isomorphisms of the closed unit interval with dyadic slopes, with a finite number of break points, all break points being dyadic numbers (see Cannon-Floyd-Perry [8] or Meier's book [34, Ch. 10] for details and properties). It is not known whether it is amenable, which is a celebrated open question. Kaimanovich [26] and Mishchenko [35] prove that the Poisson boundary on F is not trivial for finitely supported non-degenerate measures. They study the induced walk on the dyadic numbers in their proofs. However, there exist non-degenerate symmetric measures on F for which the induced walk has

trivial boundary as proven by Juschenko and Zheng [21]. An equivalent statement is true for finitely generated subgroups of $H(\mathbb{Z})$, see Remark 6.4. The results of the current article are inspired by the paper of Kaimanovich. It is not hard to prove that $H(\mathbb{Z})$ is not finitely generated (see Remark 3.1.2), so we will consider measures the support of which is not necessarily finite.

Our main result is as follows. Consider the group $H(\mathbb{Z})$ of piecewise projective homeomorphisms, as defined by Monod [36], in the case $A = \mathbb{Z}$. For $g \in H(\mathbb{Z})$ denote by $Br(g)$ the number of *break points* of g , which is the ends of pieces in its piecewise definition. We will say that a measure μ on a subgroup of $H(\mathbb{Z})$ has *finite first break moment* if the expected number of break points $\mathbb{E}[Br]$ is finite. A group H is called *locally solvable* if all finitely generated subgroups are solvable. Then

Theorem 1.2. *For any subgroup H of $H(\mathbb{Z})$ which is not locally solvable and any measure μ on H with finite first break moment $\mathbb{E}[Br]$ and such that the support of μ generates H as a semigroup, the Poisson boundary of (H, μ) is non-trivial.*

For a measure μ on a finitely generated group, we say that μ has *finite first moment* if the word length over any finite generating set has finite first moment with respect to μ . This is well defined as word lengths over different finite generating sets are bilipschitz, and in particular the finiteness of the first moment does not depend on the choice of generating set. We remark (see Remark 7.4) that any measure μ on a finitely generated subgroup H of $H(\mathbb{Z})$ that has finite first moment also has finite expected number of break points. Therefore by Theorem 1.2 if μ is a measure on a non-solvable finitely generated subgroup H such that the support of μ generates H as a semigroup and μ has finite first moment, the Poisson boundary of (H, μ) is non-trivial. Furthermore, in the other case we will show (Lemma 9.1) that so long as H is not abelian, we can construct a symmetric non-degenerate measure with finite $1 - \varepsilon$ moment and non-trivial Poisson boundary.

The structure of the paper is as follows. In Section 3, given a fixed $s \in \mathbb{R}$, to every element $g \in H(\mathbb{Z})$ we associate (see Definition 3.2.1) a configuration C_g . Each configuration is a function from the orbit of s into \mathbb{Z} . The value of a configuration C_g at a given point of the orbit of s represents the slope change at that point of the element g to which it is associated. There is a natural quotient map of the boundary on the group into the boundary on the configuration space. The central idea of the paper is to show that under certain conditions, the value of the configuration at a given point of the orbit of s almost always stabilises. If that value is not fixed, this then implies non-triviality of the boundary on the configuration space, and thus non-triviality of the Poisson boundary on the group. These arguments bear resemblance to Kaimanovich's article on Thompson's group [26], but we would like to point out that the action on \mathbb{R} considered in the present article is different.

In Section 4 we obtain the first result for non-triviality of the Poisson boundary (see Lemma 4.2). Measures satisfying the assumptions of that lemma do not necessarily have finite first break moment. In Section 5 we study copies of Thompson's group F in $H(\mathbb{Z})$. Building on the results from it, in Section 6 we obtain transience results (see Lemma 6.1) which we will need to prove Theorem 1.2. In Section 7 we prove Lemma 7.2 which is the main tool for proving non-triviality of the Poisson boundary. In the particular case of Thompson's group, the lemma already allows us to answer a question by Kaimanovich [26, 7.A]:

Corollary 1.3. *Any measure on Thompson's group F that has finite first moment and the support of which generates F as a semi-group has non-trivial Poisson boundary.*

We mention that the arguments of Lemma 7.2 could also be applied for the action and configurations considered in Kaimanovich's article, giving an alternative proof of the corollary. Combining the lemma with the transience results from Section 6 we obtain non-triviality of the Poisson boundary under certain conditions (see Lemma 7.3), which we will use to prove the main result. As the negation of those conditions passes to subgroups, it suffices to show that if H is

finitely generated and does not satisfy them, it is then solvable, which we do in Section 8. Remark that the theorem generalises the result of Corollary 1.3. In Section 9 we give an additional remark on the case of finite $1 - \varepsilon$ moment.

Acknowledgements

I would like to offer my special thanks to my thesis director, Anna Erschler. Discussions with Laurent Bartholdi have been extremely helpful, and they inspired me to consider the case of finite first moment. I would also like to thank Vadim Kaimanovich for his remarks on the preliminary version of the paper. I am also grateful to Dmytro Savchuk for the question that lead to Remark 6.3.

2 Preliminaries

2.1 $PSL_2(\mathbb{Z})$ and $H(\mathbb{Z})$

The projective linear group $PSL_2(\mathbb{R})$ is defined as $SL_2(\mathbb{R})/\{Id, -Id\}$, which is the natural quotient that describes the linear actions on the projective space $\mathbb{P}^1(\mathbb{R})$. As the latter can be defined as $\mathbb{S}/(x \sim -x)$, we can think of it as a circle for understanding the dynamics of the action of the projective group. Remark that it is commonly understood as the boundary of the hyperbolic plane. In this paper we will not be interested in the interior of the hyperbolic plane as we do a piecewise definition of $H(A)$ on $\mathbb{P}^1(\mathbb{R})$. An element $h \in PSL_2(\mathbb{R})$ is called:

1. **Hyperbolic** if $|tr(h)| > 2$ (or equivalently, $tr(h)^2 - 4 > 0$). In this case a calculation shows that h has two fixed points in $\mathbb{P}^1(\mathbb{R})$. One of the points is attractive and the other repulsive for the dynamic of h , meaning that starting from any point and multiplying by h (respectively h^{-1}) we get closer to the attractive (resp. the repulsive) fixed point.
2. **Parabolic** if $|tr(h)| = 2$. In this case h has exactly one "double" fixed point. We can identify $\mathbb{P}^1(\mathbb{R})$ with $\mathbb{R} \cup \{\infty\}$ in such a way that the fixed point is ∞ , in which case h becomes a translation on \mathbb{R} . We will go into detail about the identification below.
3. **Elliptic** if $|tr(h)| < 2$. Then h has no fixed points in $\mathbb{P}^1(\mathbb{R})$ and is conjugate to a rotation. If we consider it as an element of $PSL_2(\mathbb{C})$, we can see that it has two fixed points in $\mathbb{P}^1(\mathbb{C})$ that are outside $\mathbb{P}^1(\mathbb{R})$.

Consider an element $\begin{pmatrix} x \\ y \end{pmatrix} \in \mathbb{R}^2 \setminus \{0\}$. If $y \neq 0$, identify it with $\frac{x}{y}$, otherwise with ∞ . This clearly passes on $\mathbb{P}^1(\mathbb{R})$, and the action of $PSL_2(\mathbb{R})$ becomes $\begin{pmatrix} a & b \\ c & d \end{pmatrix} .x = \frac{ax+b}{cx+d}$. The conventions for infinity are $\begin{pmatrix} a & b \\ c & d \end{pmatrix} (\infty) = \frac{a}{c}$ if $c \neq 0$ and ∞ otherwise, and if $c \neq 0$, $\begin{pmatrix} a & b \\ c & d \end{pmatrix} .(-\frac{d}{c}) = \infty$. Note that by conjugation we can choose any point to be the infinity.

Let us now look into the groups defined by Monod [36]. We define Γ as the group of all homeomorphisms of $\mathbb{R} \cup \{\infty\}$ that are piecewise in $PSL_2(\mathbb{R})$ with a finite number of pieces. Take a subring A of \mathbb{R} . We define $\Gamma(A)$ to be the subgroup of Γ the elements of which are piecewise in $PSL_2(A)$ and the extremities of the intervals are in P_A , the set of fixed points of hyperbolic elements of $PSL_2(A)$.

Definition 2.1.1. The group of piecewise projective homeomorphisms $H(A)$ is the subgroup of $\Gamma(A)$ formed by the elements that fix infinity.

It can be thought of as a group of homeomorphisms of the real line, and we will use the same notation in both cases. We will note $G = H(\mathbb{Z})$ to simplify. Note in particular that $\infty \notin P_{\mathbb{Z}}$. This means that the germs around $+\infty$ and $-\infty$ are the same for every element of G . The only elements in $PSL_2(\mathbb{Z})$ that fix infinity are

$$\left\{ \left(\alpha_n = \begin{pmatrix} 1 & n \\ 0 & 1 \end{pmatrix} \right)_{n \in \mathbb{Z}} \right\} = G \cap PSL_2(\mathbb{Z}). \quad (1)$$

Fix $g \in G$ and let its germ at infinity (on either side) be α_n . Then $g\alpha_{-n}$ has finite support. The set of elements $\tilde{G} \subset G$ that have finite support is clearly a subgroup, and therefore if we denote $\mathcal{A} = \{\alpha_n, n \in \mathbb{Z}\}$, we have

$$G = \tilde{G} + \mathcal{A}$$

For the purposes of this article, we also need to define:

Definition 2.1.2. Consider the elements of Γ that fix infinity and are piecewise in $PSL_2(\mathbb{Z})$. We call the group formed by those elements the *piecewise $PSL_2(\mathbb{Z})$ group*, and denote it as \tilde{G} .

Remark that in an extremity γ of the piecewise definition of an element $g \in \tilde{G}$, the left and right germs $g(\gamma - 0)$ and $g(\gamma + 0)$ have a common fixed point. Then $g(\gamma + 0)^{-1}g(\gamma - 0) \in PSL_2(\mathbb{Z})$ fixes γ . Therefore the extremities are in $P_{\mathbb{Z}} \cup \mathbb{Q} \cup \{\infty\}$, that is in the set of fixed points of any (not necessarily hyperbolic) elements of $PSL_2(\mathbb{Z})$. In other words, the only difference between \tilde{G} and $G = H(\mathbb{Z})$ is that \tilde{G} is allowed to have break points in $\mathbb{Q} \cup \{\infty\}$, that is in the set of fixed points of parabolic elements. Clearly, $G \leq \tilde{G}$. This allows us to restrain elements, which we will need in Section 8:

Definition 2.1.3. Let $f \in \tilde{G}$, and $a, b \in \mathbb{R}$ such that $f(a) = a$ and $f(b) = b$. The function $f \upharpoonright_{(a,b)}$ defined by $f \upharpoonright_{(a,b)}(x) = f(x)$ for $x \in (a, b)$ and $f(x) = x$ otherwise is called a restriction.

Remark that $f \upharpoonright_{(a,b)} \in \tilde{G}$. The idea of this definition is that we extend the restrained function with the identity function to obtain an element of \tilde{G} .

The subject of this paper is G , however in order to be able to apply results from previous sections in Section 8, we will prove several lemma for \tilde{G} . The equivalent result will easily follow for G just from the fact that it is a subgroup.

2.2 Random walks

Throughout this article, for a measure μ on a group H we will consider the random walk by multiplication on the left. That is the walk $(x_n)_{n \in \mathbb{N}}$ where $x_{n+1} = y_n x_n$ and the increments y_n are sampled by μ . In other words, it is the random walk defined by the kernel $p(x, y) = yx^{-1}$. Remark that for walks on groups it is standard to consider the walk by multiplications on the right. In this article the group elements are homeomorphisms on \mathbb{R} and as such they have a natural action on the left on elements of \mathbb{R} , which is $(f, x) \mapsto f(x)$.

We will use Definition 1.1 as the definition of Poisson boundary. For completeness' sake we also mention its description in terms of harmonic functions. For a group H and a probability measure μ on H we say that a function f on H is *harmonic* if for every $g \in H$, $f(g) = \sum_{h \in H} f(hg)\mu(h)$. For a non-degenerate measure, the L^∞ space on the Poisson boundary is isomorphic to the space of bounded harmonic functions on H , and the exact form of that isomorphism is given by a classical result called the *Poisson formula*. In particular, non-triviality of the Poisson boundary is equivalent to the existence of non-trivial bounded harmonic functions.

We recall the entropy criterion for triviality of the Poisson boundary.

Definition 2.2.1. Consider two measures μ and λ on a discrete group H . We denote $\mu * \lambda$ their *convolution*, defined as the image of their product by the multiplication function. Specifically:

$$\mu * \lambda(A) = \int \mu(Ah^{-1})d\lambda(h).$$

Remark that μ^{*n} gives the probability distribution for n steps of the walk, starting at the neutral element. For a probability measure μ on a countable group H we denote $H(\mu)$ its *entropy*, defined by

$$H(\mu) = \sum_{g \in H} -\mu(g) \log \mu(g).$$

One of the main properties of entropy is that the entropy of a product of measures is not greater than the sum of their entropies. Combining that with the fact that taking image of a measure by a function does not increase its entropy, we obtain $H(\mu * \lambda) \leq H(\mu) + H(\lambda)$. Avez [2] introduces the following definition:

Definition 2.2.2. The *entropy of random walk* (also called *asymptomatic entropy*) of a measure μ on a group H is defined as $\lim_{n \rightarrow \infty} \frac{H(\mu^{*n})}{n}$.

Theorem 2.2.3 (Entropy Criterion (Kaimanovich-Vershik [27], Derriennic [12])). *Let H be a countable group and μ a non-degenerate probability measure on H with finite entropy. Then the Poisson boundary of (H, μ) is trivial if and only if the asymptotic entropy of μ is equal to zero.*

3 Some properties of groups of piecewise projective homeomorphisms

In Subsection 3.1 we study $P_{\mathbb{Z}}$ and the group action locally around points of it. In Subsection 3.2, using the results from the first subsection, to each element $g \in \tilde{G}$ we associate a configuration C_g . We then also describe how to construct an element with a specific associated configuration.

3.1 Slope change points in $G = H(\mathbb{Z})$

Let g be a hyperbolic element of $PSL_2(\mathbb{Z})$. Let it be represented by $\begin{pmatrix} a & b \\ c & d \end{pmatrix}$ and denote $tr(g) = a+d$ its trace. Then its fixed points are $\frac{d-a \pm \sqrt{tr(g)^2 - 4}}{c}$. As the trace is integer and greater than 2 in absolute value, this number is never rational. Furthermore, it is worth noting that $\mathbb{Q}(\sqrt{tr(g)^2 - 4})$ is stable by $PSL_2(\mathbb{Z})$ and therefore by \tilde{G} (and G). If we enumerate all prime numbers as $(p_i)_{i \in \mathbb{N}}$, we have, for $I \neq J \subset \mathbb{N}$ finite, $\mathbb{Q}(\sqrt{\prod_{i \in I} p_i}) \cap \mathbb{Q}(\sqrt{\prod_{i \in J} p_i}) = \mathbb{Q}$. We just mentioned that $P_{\mathbb{Z}} \cap \mathbb{Q} = \emptyset$ so we have

$$P_{\mathbb{Z}} = \bigsqcup_{I \subset \mathbb{N} \text{ finite}} \left(P_{\mathbb{Z}} \cap \mathbb{Q} \left(\sqrt{\prod_{i \in I} p_i} \right) \right)$$

where each set in the decomposition is stable by \tilde{G} . Note also that the fixed points of parabolic elements of $PSL_2(\mathbb{Z})$ are rational. This actually completely characterizes the set $P_{\mathbb{Z}}$, as we will now show that $P_{\mathbb{Z}} \cap \mathbb{Q}(\sqrt{\prod_{i \in I} p_i}) = \mathbb{Q}(\sqrt{\prod_{i \in I} p_i}) \setminus \mathbb{Q}$:

Lemma 3.1.1. *Take any $s \in \mathbb{Q}(\sqrt{k}) \setminus \mathbb{Q}$ for some $k \in \mathbb{N}$. Then $s \in P_{\mathbb{Z}}$.*

Remark that k is not an exact square, as $\mathbb{Q}(\sqrt{k}) \setminus \mathbb{Q}$ has to be non-empty.

Proof. Note first that to have $\sqrt{tr^2 - 4} \in \mathbb{Q}(\sqrt{k})$ for some matrix it suffices to find integers $x \geq 2$ and y such that $x^2 - ky^2 = 1$. Indeed, any matrix with trace $2x$ will then satisfy this, for example $\begin{pmatrix} x & x^2 - 1 \\ 1 & x \end{pmatrix}$. This is known as Pell's equality, and has infinitely many solutions for any k that is not a square (see Mordell's book [37, Ch. 8]).

Write $s = \frac{p}{q} + \frac{p'}{q'}\sqrt{k}$ for some integers p, q, p', q' . Applying Pell's equality for $(p'q'q^2)^2k$, we obtain integers x and a such that $x^2 - a^2(p'q'q^2)^2k = 1$. In other words, $x^2 - y^2k = 1$ for $y = p'q'q^2a$. We construct $\begin{pmatrix} x + q'^2pqa & b \\ q'^2q^2a & x - q'^2pqa \end{pmatrix}$ where $b = \frac{x^2 - q'^4p^2q^2a^2 - 1}{q'^2q^2a} = p'^2q^2ak - q'^2p^2a \in a\mathbb{Z}$. The matrix has s for a fixed point, and s is not rational, therefore the matrix is a hyperbolic element of $PSL_2(\mathbb{Z})$. \square

Remark 3.1.2. The break points a finite number of elements of $H(\mathbb{Z})$ are all contained in the sets $\mathbb{Q}(\sqrt{k})$ for a finite number of k , so Lemma 3.1.1 implies that $H(\mathbb{Z})$ is not finitely generated.

In order to define configurations, we wish to study the slope changes at elements of $P_{\mathbb{Z}}$. Consider $g \in \tilde{G}$ and $s \in P_{\mathbb{Z}}$ such that $g(s+0) \neq g(s-0)$. Then it is easy to see that $f = g(\gamma-0)^{-1}g(\gamma+0) \in PSL_2(\mathbb{Z})$ fixes s . Therefore, in order to study the slope changes we need to understand the stabiliser of s in $PSL_2(\mathbb{Z})$. We prove:

Lemma 3.1.3. *Fix $s \in \mathbb{P}^1(\mathbb{R})$. The stabiliser St_s of s in $PSL_2(\mathbb{Z})$ is either isomorphic to \mathbb{Z} or trivial.*

Proof. Assume that St_s is not trivial, and let $f \in St_s$ be different from the identity. Clearly, f is not elliptic. If f is hyperbolic, $s \in P_{\mathbb{Z}}$, and if f is parabolic, $s \in \mathbb{Q} \cup \{\infty\}$. We distinguish three cases, that is $s \in P_{\mathbb{Z}}$, $s = \infty$ and $s \in \mathbb{Q}$.

We first assume $s \in P_{\mathbb{Z}}$. Let $s = r + r'\sqrt{k}$ with $r, r' \in \mathbb{Q}$ and $k \in \mathbb{Z}$. Note that the calculations in the beginning of the section yield that for every element f in St_s that is not the identity, f is hyperbolic and the other fixed point of f is $\bar{s} = r - r'\sqrt{k}$. Let $i = \begin{pmatrix} \frac{1}{2} & -\frac{r+r'\sqrt{k}}{2} \\ \frac{1}{r'\sqrt{k}} & 1 - \frac{r}{r'\sqrt{k}} \end{pmatrix} \in PSL_2(\mathbb{R})$ and consider the conjugation of St_s by i . By choice of i we have that $i(s) = 0$ and $i(\bar{s}) = \infty$. Therefore the image of St_s is a subgroup of the elements of $PSL_2(\mathbb{R})$ that have zeros on the secondary diagonal. Furthermore, calculating the image of an example matrix $\begin{pmatrix} a & b \\ c & d \end{pmatrix}$, for $tr = a + d$ the trace of the matrix, we get

$$i \begin{pmatrix} a & b \\ c & d \end{pmatrix} i^{-1} = \begin{pmatrix} \frac{\sqrt{tr^2-4}+tr}{2} & 0 \\ 0 & \frac{\sqrt{tr^2-4}-tr}{2} \end{pmatrix} \quad (2)$$

Thus to understand the image of St_s we just need to study the elements of the form $\frac{x+y\sqrt{k}}{2}$ with $x^2 - ky^2 = 4$. This appears in a generalized form of Pell's equation, and those elements are known [37, Ch. 8] to be powers of a fundamental solution (which is also true for the classic Pell equation if you identify a solution $x^2 - y^2k = 1$ with a unit element $x + y\sqrt{k}$ in $\mathbb{Z}[\sqrt{k}]$). This proves that the image of St_s by this conjugation, which is isomorphic to St_s , is a subgroup of a group isomorphic to \mathbb{Z} . St_s is then also isomorphic to \mathbb{Z} . The matrix with the fundamental solution in the upper left corner defines a canonical generator for the group of elements of the form seen in (2), and its smallest positive power in the image of St_s defines a canonical generator for St_s .

Assume now $s = \infty$. As we described in (1), the stabiliser of ∞ is $(\alpha_n)_{n \in \mathbb{N}}$, which is trivially isomorphic to \mathbb{Z} .

Lastly, assume that $s = \frac{p}{q} \in \mathbb{Q}$ with p and q co-prime. There exist m and n such that $pm + qn = 1$. Then $i = \begin{pmatrix} m & n \\ -q & p \end{pmatrix} \in PSL_2(\mathbb{Z})$ verifies $i(s) = \infty$. Thus the conjugation by i defines an injection from the subgroup that fixes s into $St_\infty = \mathcal{A}$. We observe that non-trivial subgroups of \mathbb{Z} are isomorphic to \mathbb{Z} , which concludes the proof. \square

Having an isomorphism between St_s (for $s \in P_{\mathbb{Z}}$) and \mathbb{Z} will be useful to us, so we wish to know its exact form. We prove:

Lemma 3.1.4. *Let $s \in P_{\mathbb{Z}}$. There exists $\phi_s \in \mathbb{R}^+$ that remains constant on the orbit Gs of s such that $f \mapsto \log_{\phi_s}(f'(s))$ defines an isomorphism between St_s and \mathbb{Z} .*

Proof. The derivative on the fixed point is multiplicative. Therefore for a fixed s , this follows from Lemma 3.1.3 and the fact that subgroups of \mathbb{Z} are isomorphic to \mathbb{Z} (or trivial, which is impossible here). What we need to prove is that ϕ remains constant on Gs . Fix s and consider $s' \in Gs$. Let $j \in PSL_2(\mathbb{Z})$ be such that $j(s) = s'$. Then the conjugation by j defines a bijection between St_s and $St_{s'}$. Calculating the derivative on an element $f \in St_s$ we get $(j f j^{-1})'(s') = j'(s)(j^{-1})'(j(s))f'(s) = f'(s)$, which proves the result. \square

We further denote $\psi : \mathcal{A} \mapsto \mathbb{Z}$ (see 1) the map that associates n to α_n , and ψ_r the conjugate map for any $r \in \mathbb{Q}$. Remark that this is well defined by Lemma 3.1.3 and conjugations in \mathbb{Z} being trivial.

3.2 Configurations

Fix $s \in P_{\mathbb{Z}}$ and let $\phi = \phi_s$ be given by Lemma 3.1.4. By the isomorphism it defines, there exists an element g_s that fixes s , such that $g'_s(s) = \phi_s$. As $s \notin \mathbb{Q}$, g_s is hyperbolic. We associate to each element of the piecewise $PSL_2(\mathbb{Z})$ group \tilde{G} (see Definition 2.1.2) a configuration representing the changes of slope at each point of the orbit $\tilde{G}s = Gs$ of s , precisely:

Definition 3.2.1. To $g \in \tilde{G}$ we assign $C_g : Gs \rightarrow \mathbb{Z}$ by

$$C_g(\gamma) = \log_{\phi}(g'(\gamma + 0)g'(\gamma - 0)^{-1}).$$

Note that by choice of ϕ this value is well defined: indeed, $g(\gamma + 0)g(\gamma - 0)^{-1} \in PSL_2(\mathbb{Z})$, fixes γ , and is therefore in St_γ .

Remark that by definition of \tilde{G} each configuration in the image of the association has a finite support. Remark also that the configuration ignores information about the changes in slope outside the orbit of s . For $s \in \mathbb{Q}$ we further denote $C_g(\gamma) = \psi_\gamma(g'(\gamma + 0)g'(\gamma - 0)^{-1})$, which will have similar properties. In the rest of the paper we will consider $s \in P_{\mathbb{Z}}$ unless otherwise specified. For completeness' sake, remark also that $G = H(\mathbb{Z}) \leq \tilde{G}$ and the orbits of G and \tilde{G} on s are the same (as they are both the same as the orbit of $PSL_2(\mathbb{Z})$) and therefore Definition 3.2.1 could be done directly for G , and what we would obtain is the same as restraining from the current definition.

Lemma 3.2.2. *For every $s \in P_{\mathbb{Z}}$, there exists an element $h_s \in G$ such that $h_s(s-0)^{-1}h_s(s+0) = g_s$ and all other slope changes of h_s are outside Gs . In particular, $C_{h_s} = \delta_s$.*

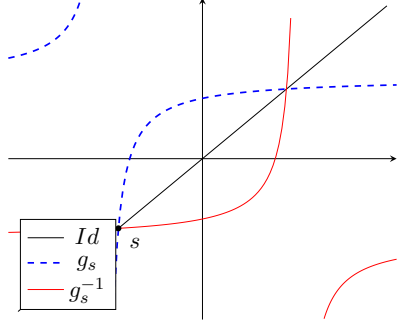
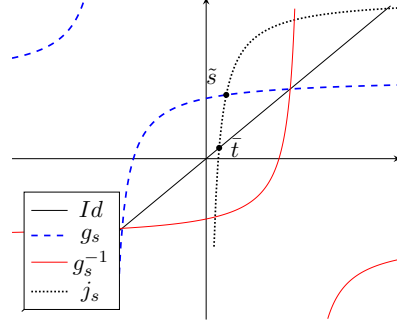
Figure 1: Graphs of g_s and the identityFigure 2: Graphs of g_s and j_s 

Proof. Fix $s \in P_{\mathbb{Z}}$ and let $k = k_s$ be the unique square-free integer such that $s \in \mathbb{Q}(\sqrt{k})$. We will construct h_s such that $h_s(s) = s$. Note that in that case we have $C_{h_s^{-1}} = -\delta_s$. This implies that if we construct an element \tilde{h}_s that verifies $\tilde{h}_s(s-0)^{-1}\tilde{h}_s(s+0) = g_s^{\pm 1}$ and all other slope changes are outside G_s , choosing $h_s = \tilde{h}_s^{\pm 1}$ gives the result. In other words, we can replace g_s with g_s^{-1} . Seen as a function on \mathbb{R} , g_s is defined in all points but $-\frac{d}{c}$. It is then continuous in an interval around s . Moreover, if the interval is small enough, s is the only fixed point in it. Therefore for some ε , either $g_s(x) > x$ for every $x \in (s, s + \varepsilon)$, or $g_s(x) < x$ in that interval. As we have the right to replace it with its inverse, without loss of generality we assume that g_s is greater than the identity in a right neighbourhood of s .

Write $s = r + r'\sqrt{k}$ with $r, r' \in \mathbb{Q}$. Then the other fixed point of g_s is its conjugate $\bar{s} = r - r'\sqrt{k}$. Remark that it is impossible for $-\frac{d}{c}$ to be between s and \bar{s} as the function g_s is increasing where it is continuous and has the same limits at $+\infty$ and $-\infty$ (see Figure 1). If $r' < 0$, g_s is greater than the identity in (s, \bar{s}) as it is continuous there. In that case, it is smaller than the identity to the left of the fixed points, but as it is increasing and has a finite limit at $-\infty$, this implies (see Figure 1) that $-\frac{d}{c} < s$. Similarly, if $s > \bar{s}$, g_s is increasing and greater than the identity to the right of s , but has a finite limit at $+\infty$, so $-\frac{d}{c} > s$.

We will find a hyperbolic element j_s verifying: the larger fixed point t of j_s is not in G_s and $t > -\frac{d}{c}$, while the smaller fixed point \bar{t} is between s and \bar{s} , and j_s is greater than the identity between \bar{t} and t . If $r' < 0$ consider the interval (\bar{t}, \bar{s}) . At its infimum, j_s has a fixed point while g_s is greater than the identity, and at its supremum the inverse is true. By the mean values theorem, there exists \bar{s} in that interval such that $j_s(\bar{s}) = g_s(\bar{s})$ (see Figure 2). If $r' > 0$, consider the interval $(s, -\frac{d}{c})$. At its infimum, g_s is fixed and therefore smaller than j_s , and at its supremum g_s diverges towards $+\infty$ while j_s has a finite limit. Again by the mean values theorem, there exists \bar{s} in that interval where g_s and j_s agree. As $-\frac{d}{c} < t$ by hypothesis, in both cases we have $s < \bar{s} < t$. We then define

$$h_s(x) = \begin{cases} x & x \leq s \\ g_s(x) & s \leq x \leq \bar{s} \\ j_s(x) & \bar{s} \leq x \leq t \\ x & t \leq x \end{cases}$$

Thus it would suffice to prove that we can construct j_s that verifies those properties and such that $\bar{s} \notin G_s$. Note that \bar{s} is a fixed point of $g_s^{-1}j_s$, so to prove that it is not in G_s it will suffice to study the trace of the latter. Remark that in this definition h_s is strictly greater than the identity

in an open interval, and equal to it outside (this is with the assumption on g_s , in the general case h_s has its support in an open interval, and is either strictly greater than the identity on the whole interval, or strictly smaller).

Write $r = \frac{p}{q}$. By Bezout's identity, there are integers \tilde{m} and \tilde{n} such that $q\tilde{n} - p\tilde{m} = 1$.

Then the matrix $i = \begin{pmatrix} \tilde{n} & p \\ \tilde{m} & q \end{pmatrix} \in PSL_2(\mathbb{Z})$ verifies $i.0 = \frac{p}{q}$. Taking $\tilde{j}_s = i^{-1}j_s i$ it suffices to find \tilde{j}_s with fixed points outside G_s , the smaller one being close enough to 0, and the greater one large enough. Remark that the only information we have on g_s is its trace, so this does not complicate the computations for \tilde{s} .

We will define \tilde{j}_s in the form $\begin{pmatrix} x' + ma' & n^2 l_s a' - m^2 a' \\ a' & x' - ma' \end{pmatrix}$ where $x'^2 - n^2 a'^2 l_s = 1$. Its fixed points are $m \pm n\sqrt{l_s}$. By choosing m arbitrarily large, the second condition will be satisfied. Note $i g_s^{-1} i^{-1} = \begin{pmatrix} \tilde{a} & \tilde{b} \\ \tilde{c} & \tilde{d} \end{pmatrix}$ and $tr(g_s)^2 - 4 = o^2 k$. Calculating the trace of $g_s^{-1} j_s$ we get $tr(g_s)x' + a'\tilde{b} + m z_1 + n z_2$ with $z_1, z_2 \in \mathbb{Z}$. Then, admitting that n divides $x' - 1$ (which will be seen in the construction of x') we obtain for some $z_i \in \mathbb{Z}$, $i \in \mathbb{N}$:

$$\begin{aligned} tr(g_s^{-1} j_s)^2 - 4 &= m z_3 + n z_4 + a'^2 \tilde{b}^2 + 2a'\tilde{b}x'tr(g_s) + x'^2 tr(g_s)^2 - tr(g_s)^2 + tr(g_s)^2 - 4 \\ &= m z_3 + n z_5 + a'^2 \tilde{b}^2 + 2a'\tilde{b}tr(g_s) + n^2 a'^2 l_s tr(g_s)^2 + o^2 k \\ &= m z_3 + n z_6 + a'^2 \tilde{b}^2 + 2a'\tilde{b}tr(g_s) + o^2 k. \end{aligned} \quad (3)$$

Take a prime p_s that is larger than k and $b(tr(g_s) + 2)$. There is an integer $a'' < p_s$ such that $b(tr(g_s) + 2)a'' \equiv -1 \pmod{p_s}$. Take $a = o^2 k a''$. Then

$$a'^2 \tilde{b}^2 + 2a'\tilde{b}tr(g_s) + o^2 k = o^2 k (b(tr(g_s) + 2)a'' + 1)(b(tr(g_s) - 1)).$$

As $\mathbb{Z}[p_s]$ is a field, clearly $b(tr(g_s) - 2)a'' \not\equiv -1 \pmod{p_s}$. As $b(tr(g_s) + 2)a'' < p_s^2$, the product is divisible by p_s but not p_s^2 . We will choose m and n divisible by p_s^2 , which will then ensure that the value in (3) is divisible by p_s but not p_s^2 , proving that $\tilde{s} \notin G_s$.

All that is left is choosing n and m . As we just noted, we need them to be multiples of p_s^2 . Aside from that n needs to satisfy $x'^2 - n^2 a'^2 l_s = 1$, l_s must not be a square times k and we need to be able to make $m - n\sqrt{l_s}$ arbitrarily small. Write $m = p_s^2 m'$ and $n = p_s^2 n'$. Then m' can be anything so long as $m - n\sqrt{l_s}$ becomes arbitrarily small. In other words, we are only interested in the fractional part of $n'\sqrt{l_s}$. We choose $x' = n'^2 a'^2 p_s^5 - 1$ and will prove that the conditions are satisfied for n' large enough. Then $x'^2 - n^2 a'^2 l_s = 1$ is satisfied for $l_s = p_s(n'^2 a'^2 p_s^5 - 2)$. In particular, p_s divides l_s but its square does not, so l_s is not equal to a square times k . Moreover, $\sqrt{l_s} = \sqrt{(n' a' p_s^3)^2 - 2p_s}$ and as the derivative of the square root is strictly decreasing, $\sqrt{(n' a' p_s^3)^2 - 2p_s} - n' a' p_s^3 \rightarrow 0$ for $n' \rightarrow \infty$. Its factorial part then clearly converges towards 1, which concludes the proof. \square

For a product inside the group \tilde{G} , by the chain rule we have

$$(g_2 g_1)'(\gamma) = g_2'(g_1(\gamma))g_1'(\gamma)$$

and thus

$$C_{g_2 g_1}(\gamma) = C_{g_1}(\gamma) + C_{g_2}(g_1(\gamma)) \quad (4)$$

That gives us a natural action of \tilde{G} on \mathbb{Z}^{G_s} by the formula $(g, C) \rightarrow C_g + S^g C$ where $S^g C(\gamma) = C(g(\gamma))$. It is easy to check that it also remains true for $s \in \mathbb{Q}$.

Lemma 3.2.3. *There is no configuration $C : Gs \rightarrow \mathbb{Z}$ such that $C = C_{h_s} + S^{h_s}C$.*

Indeed, applying (4) and taking the value at s we get a contradiction.

Consider g and h such $C_g = C_h$. We have $C_{Id} = C_{g^{-1}} + S^{g^{-1}}C_g$ and thus $C_{hg^{-1}} = C_{g^{-1}} + S^{g^{-1}}C_h = C_{Id} = 0$. We denote

$$H_s = \{g \in G : C_g = 0\}.$$

Then:

Lemma 3.2.4. *The element h_s and the subgroup H_s generate G for every $s \in P_{\mathbb{Z}}$.*

Proof. We show for $g \in G$ by induction on $\|C_g\|_1 = \sum_{x \in Gs} |C_g(x)|$ that it is in the group generated by $\{h_s\} \cup H_s$. The base is for $\|C_g\|_1 = 0$, in which case we have $C_g \equiv 0$ and the result is part of the statement hypothesis. We take $g \in G$ and assume that every element with smaller l^1 measure of its configuration is in the group generated by $\{h_s\} \cup H_s$. We take any $\alpha \in \text{supp}(C_g)$. Without loss of generality, we can assume that $C_g(\alpha) > 0$. As $g(\alpha) \in Gs$, by Lemma 3.2.5 there exists $h \in H_s$ such that $h(s) = g(\alpha)$ and $C_h = 0$. Let $\tilde{g} = hh_s h^{-1}$. As $h_s \in \{h_s\} \cup H_s$, we have $\tilde{g} \in \langle \{h_s\} \cup H_s \rangle$. Applying the composition formula (4) we obtain $C_{\tilde{g}}(x) = 0$ for $x \neq g(\alpha)$ and $C_{\tilde{g}}(g(\alpha)) = 1$. We consider $\bar{g} = \tilde{g}^{-1}g$. If $x \neq g(\alpha)$, by the composition formula (4) we get $C_{\bar{g}}(x) = C_g(x)$, and at α we have $C_{\bar{g}}(\alpha) = C_g(\alpha) - 1$. By hypothesis we then have $\bar{g} \in \langle \{h_s\} \cup H_s \rangle$, and as \tilde{g} is also included in this set, so is g . \square

Lemma 3.2.5. *For any $g \in PSL_2(\mathbb{Z})$ and $\gamma \in \mathbb{R}$ there exists $h \in H_s$ such that $g(\gamma) = h(\gamma)$.*

Proof. By Monod's construction in [36, Proposition 9], we know that we can find $h \in G$ that agrees with g on γ of the form $q^{-1}g$ where $q = \begin{pmatrix} a & b+ra \\ c & d+rc \end{pmatrix}$ in the interval between its fixed points that contains infinity and the identity otherwise. To have this result, what is required is that either r or $-r$ (depending on the situation) be large enough. Clearly, $C_h \equiv 0$ would follow from slope change points of q being outside Gs (as neither of them is infinity). In particular, it is enough to prove that for some infinitely large r , the fixed points of $\begin{pmatrix} a & b+ra \\ c & d+rc \end{pmatrix}$ are outside $\mathbb{Q}(\sqrt{k})$. The trace of that matrix is $(a+d)+rc$. Let p be a large prime number that does not divide 2, k or c . As c and p are co-prime, there exists r_0 such that $a+d+r_0c = p+2 \pmod{p}$. Then for every $i \in \mathbb{Z}$, we have $(a+d+(r_0+p^2i)c)^2 - 4 = 4p \pmod{p^2}$. As p and 4 are co-prime, this implies that for each $r = r_0 + p^2i$ the fixed points of that matrix are not in $\mathbb{Q}(\sqrt{k})$ as p does not divide k . \square

4 Convergence condition

Fix $s \in P_{\mathbb{Z}}$ and let us use the notations from Subsection 3.2. For a measure μ on \tilde{G} we denote $C_\mu = \bigcup_{g \in \text{supp}(\mu)} \text{supp}(C_g)$ its "support" on Gs . That is, $C_\mu \subset Gs$ is the set of points in which at least one element that is inside the support of μ in the classical sense changes slope. We thus obtain the first result

Lemma 4.1. *Consider the piecewise $PSL_2(\mathbb{Z})$ group \tilde{G} (see Definition 2.1.2). Let μ be a measure on a subgroup of \tilde{G} such that C_μ is transient with respect to μ for the natural action of \tilde{G} on \mathbb{R} and h_s is in the semigroup generated by $\text{supp}(\mu)$. Then the Poisson boundary of μ on the subgroup is not trivial.*

Proof. Consider a random walk g_n with $g_{n+1} = h_n g_n$. For a fixed $\gamma \in Gs$ we have

$$C_{g_{n+1}}(\gamma) = C_{g_n}(\gamma) + C_{h_n}(g_n(\gamma))$$

By the hypothesis of transiency this implies that $C_{g_n}(\gamma)$ stabilises. In other words, C_{g_n} converges pointwise towards a limit C_∞ . This defines a hitting measure on \mathbb{Z}^{Gs} that is a quotient of μ 's Poisson boundary. Moreover, it is μ -invariant by the natural action on \mathbb{Z}^{Gs} . It remains to see that it is not trivial. Assume the opposite, which is that there exists a configuration C such that for almost all walks, the associated configuration C_{g_n} converges pointwise to C . By hypothesis there are elements h_1, \dots, h_m with positive probability such that $h_m h_{m-1} \dots h_1 = h_s$. There is a strictly positive probability for a random walk to start with $h_m h_{m-1} \dots h_1$. Applying (4) we get $C = C_{h_s} + S^{h_s}C$, which is contradictory to Lemma 3.2.3. \square

This lemma, along with Lemma 3.2.4 implies:

Lemma 4.2. *Fix $s \in P_{\mathbb{Z}}$. Let μ be a measure on $G = H(\mathbb{Z})$ that satisfies the following conditions:*

- (i) *The element h_s belongs to the support of μ ,*
- (ii) *The intersection of the support of μ with the complement of H_s is finite,*
- (iii) *The action of μ on the orbit of s is transient.*

Then the Poisson boundary of μ is non-trivial.

We will now show how measures satisfying whose assumptions can be constructed. Remark that the question of existence of a measure with non-trivial boundary has already been solved by Frisch-Hartman-Tamuz-Vahidi-Ferdowski [16]. In our case, notice that $\mathcal{A} \subset H_s$ (see (1)), and it is isomorphic to \mathbb{Z} . We can then use a measure on \mathcal{A} to ensure transience of the induced walk on the orbit. To prove that, we use a lemma from Baldi-Lohoué-Peyrière [3] (see also Woess [51, Section 2.C,3.A]). Here we formulate a stronger version of the lemma, as proven by Varopoulos [49]:

Lemma 4.3 (Comparison lemma). *Let $P_1(x, y)$ and $P_2(x, y)$ be doubly stochastic kernels on a countable set X and assume that P_2 is symmetric. Assume that there exists $\varepsilon \geq 0$ such that*

$$P_1(x, y) \geq \varepsilon P_2(x, y)$$

for any x, y . Then

1. For any $0 \leq f \in l^2(X)$

$$\sum_{n \in \mathbb{N}} \langle P_1^n f, f \rangle \leq \frac{1}{\varepsilon} \sum_{n \in \mathbb{N}} \langle P_2^n f, f \rangle.$$

2. If P_2 is transient then so is P_1 (for any point $x \in X$, it follows from (1) applied to $f = \delta_x$).

Here, doubly stochastic kernels means that the operators are reversible and the inverse is also Markov. It is in particular the case for $P(x, y) = \mu(yx^{-1})$ for some measure on a group (as the inverse is $(x, y) \mapsto \mu(xy^{-1})$).

Remark 4.4. If λ is a transient measure on \mathcal{A} and μ satisfies conditions (i) and (ii) of Lemma 4.2, then the comparison lemma by Baldi-Lohoué-Peyrière (Lemma 4.3) implies that $\varepsilon\lambda + (1 - \varepsilon)\mu$ satisfies all the conditions of the lemma for any $0 < \varepsilon < 1$. In other words, this is a way to construct non-degenerate symmetric measures on G with non-trivial Poisson boundary.

For completeness' sake, we show that there exist measures positive on all of G that have non-trivial boundary.

Lemma 4.5. *Let μ be a measure on a group H with finite entropy and non-zero asymptotic entropy and which generates H as a semigroup. Then there exists a measure $\tilde{\mu}$ with support equal to H that also has finite entropy and non-zero asymptotic entropy. Furthermore, if μ is symmetric, so is $\tilde{\mu}$.*

Proof. Define $\tilde{\mu} = \frac{1}{e} \sum_{i \in \mathbb{N}} \frac{\mu^{*i}}{i!}$. By a result of Kaimanovich [23, Corollary to Theorem 4] we get

$$h(H, \tilde{\mu}) = h(H, \mu) \sum_{i \in \mathbb{N}} \frac{i}{e i!} = h(H, \mu).$$

Moreover, as the entropy of $\tilde{\mu}^{*n}$ is not smaller than the entropy of $\tilde{\mu}$, finite asymptotic entropy implies finite entropy. \square

From this lemma and the entropy criterion Theorem 2.2.3 it follows that to have a measure positive on all of G with non-trivial boundary it suffices to construct a measure verifying the conditions of Lemma 4.2 with finite asymptotic entropy, which we can achieve with the construction presented in Remark 4.4.

5 Thompson's group as a subgroup of $G = H(\mathbb{Z})$

In [30] Kim, Koberda and Lodha show that any two increasing homeomorphisms of \mathbb{R} the supports of which form a 2-chain (as they call it) generate, up to taking a power of each, a group isomorphic to Thompson's group F . Let us give the exact definition of this term. For a homeomorphism f of \mathbb{R} we call its support $\text{supp}(f)$ the set of points x where $f(x) \neq x$. Remark that we do not define the closure of that set as support, as it is sometimes done. Consider four real numbers a, b, c, d with $a < b < c < d$. Take two homeomorphisms f and g such that $\text{supp}(f) = (a, c)$ and $\text{supp}(g) = (b, d)$. In that case we say that their supports form a 2-chain, and the homeomorphisms generate a 2-prechain group. In other words, two homeomorphisms generate a 2-prechain if their supports are open intervals that intersect each other but neither is contained in the other.

Clearly, there exist many such pairs in G . We will give a simple example. Fix s and find positive rational numbers \tilde{r} and \tilde{r}' such that $\tilde{r} < s < \tilde{r} + \tilde{r}'\sqrt{p_s} < t$. Recall that p_s is a prime larger than k . Then choose a hyperbolic element \tilde{g} that fixes $\tilde{r} + \tilde{r}'\sqrt{p_s}$ and define

$$\tilde{h}_s(x) = \begin{cases} \tilde{g}_s(x) & \tilde{r} - \tilde{r}'\sqrt{p_s} \leq x \leq \tilde{r} + \tilde{r}'\sqrt{p_s} \\ x & \text{otherwise.} \end{cases}$$

By definition of \tilde{r} and \tilde{r}' , \tilde{h}_s and h_s clearly form a 2-prechain, and thus up to a power they generate a copy of Thompson's group (see [30, Theorem 3.1]). We will denote \mathfrak{a}_s the action $F \curvearrowright \mathbb{R}$ this defines. To obtain the convergence results, we need to prove that the induced random walks on the Schreier graphs of certain points are transient. By the comparison lemma by Baldi-Lohoué-Peyrière (Lemma 4.3) it would suffice to prove it for the simple random walk on the graph, which is why we will study its geometry. In the dyadic representation of Thompson's group, the geometry of the Schreier graph on dyadic numbers has been described by Savchuk [45, Proposition 1]. It is a tree quasi-isometric to a binary tree with rays attached at each point (see Figure 4), which implies transience of the simple random walk. For a different proof of transience see Kaimanovich [26, Theorem 14]. We will see that the Schreier graph has similar geometry in the case of \mathfrak{a}_s (see Figure 3).

Lemma 5.1. *Consider two homeomorphisms f and g of \mathbb{R} the supports of which are $\text{supp}(f) = (a, c)$ and $\text{supp}(g) = (b, d)$ with $a < b < c < d$. Denote H the group generated by f and g . Then the simple random walk on the Schreier graph of H on the orbit of b is transient.*

Proof. Up to replacing f or g with its inverse, we can assume without loss of generality that $f(x) > x$ for $x \in \text{supp}(f)$ and $g(x) > x$ for $x \in \text{supp}(g)$. Denote by Γ the Schreier graph of H on the orbit of b . The vertices of this graph are the points of the orbit Hb of b by H , and two points are connected by an edge if and only if f, g, f^{-1} or g^{-1} sends one point into the other. Denote by $\tilde{\Gamma}$ the subgraph defined by the vertices that belong to the closed interval $[b, c]$. At every point x of Γ such that $x \notin [b, c]$, in a neighbourhood $(x - \varepsilon, x + \varepsilon)$ of x , one of the two elements f and g acts trivially, and the other one is strictly greater than the identity map. Without loss of generality, let f act trivially. Let i_0 be the largest integer such that $g^{i_0}(x) \in [b, c]$. Then the set of points $(g^i(x))_{i \geq i_0}$ is a ray that starts at an element of $\tilde{\Gamma}$. As the simple random walk on \mathbb{Z} is recurrent (see [13, Chapter 3, Theorem 2.3]), the walk always returns to $\tilde{\Gamma}$ in finite time, and that part of the graph ($\tilde{\Gamma}$) is what we need to study.

Replacing, if necessary, f or g by its power, we can assume that $g^{-1}(c) < f(b)$. Denote $A = [b, g^{-1}(c)] = g^{-1}([b, c])$, $B = [f(b), c] = f([b, c])$ and $C = (g^{-1}(c), f(b)) = [b, c] \setminus (A \cup B)$. Consider $x \in \tilde{\Gamma}$ with $x \neq b$ and $x \notin C$. Consider a reduced word $c_n c_{n-1} \dots c_1$ with $c_i \in \{f^{\pm 1}, g^{\pm 1}\}$ that describes a path in $\tilde{\Gamma}$ from b to x . In other words $c_n c_{n-1} \dots c_1(b) = x$ and the suffixes of that word satisfy $c_i c_{i-1} \dots c_1(b) \in \tilde{\Gamma}$ for every $i \leq n$. The fact that the word is reduced means that $c_i \neq c_{i+1}^{-1}$ for every i . We claim that if $x \in A$, this word ends with $g^{-1} = c_n$, and if $x \in B$, $c_n = f$.

We prove the latter statement by induction on the length of the word n . If a word of length one, it is g since f fixes b and since $g^{-1}(b) \notin [b, c]$. As $g(b) \in B$ this gives the base for the induction.

Assume that the result is true for any reduced word of length strictly less than n whose suffixes, when applied to b , stay in $[b, c]$. We will now prove it for $x = c_n c_{n-1} \dots c_1(b)$. We denote $y = c_{n-1} c_{n-2} \dots c_1(b)$ the point just before x in that path. We first consider the case $x \in B$ (as we will see from the proof, the other case is equivalent). We distinguish three cases: $y \in A$, $y \in B$ and $y \in C$.

If $y \in A$, by induction hypothesis we have $c_{n-1} = g^{-1}$. As the word is reduced we thus have $c_n \neq g$. However, from $y \in A$ and $x \in B$ we have $y < x$. Therefore, $c_n \notin \{f^{-1}, g^{-1}\}$, and the only possibility left is $c_n = f$.

If $y \in B$, by induction hypothesis we have $c_{n-1} = f$. Therefore, as the word is reduced, $c_n \neq f^{-1}$. From $g^{-1}(c) < f(b)$ it follows that $g(B) \cap [b, c] = \emptyset$. As $x \in B$, this implies that $c_n \neq g$. Similarly, $g^{-1}(B) \subset A$, therefore $c_n \neq g^{-1}$. The only possibility left is $c_n = f$.

If $y \in C$, consider the point $y' = c_{n-2} \dots c_1(b)$. If $y' \in A$, by induction hypothesis $c_{n-2} = g^{-1}$. Then $c_{n-1} \neq g$. As $y > y'$, this implies that $c_{n-1} = f$. However, $g(A) \subset B$, which is a contradiction. In a similar way, we obtain a contradiction for $y' \in B$. However, both $f^{-1}(C)$ and $g(C)$ are outside $[b, c]$, while $f(C) \subset B$ and $g^{-1}(C) \subset A$. Therefore the case $y \in C$ is impossible by induction hypotheses on $c_{n-2} \dots c_1$.

This completes the induction. Remark that we also obtained $\tilde{\Gamma} \cap C = \emptyset$, so the result holds for all points of $\tilde{\Gamma}$. In particular, if two paths in $\tilde{\Gamma}$ described by reduced words arrive at the same point, the last letter in those words is the same, which implies that $\tilde{\Gamma}$ is a tree. Remark also that the result implies that $c \notin \tilde{\Gamma}$ as $c \in B$ and $f^{-1}(c) = c$.

Moreover, for a vertex $x \in A$, we have that $f(x), g(x)$ and $g^{-1}(x)$ also belong to $\tilde{\Gamma}$. Similarly, for $x \in B$, $g^{-1}(x), f(x)$ and $f^{-1}(x)$ are in $\tilde{\Gamma}$. Therefore every vertex aside from b has three different neighbours. The simple walk on $\tilde{\Gamma}$ is thus transient. \square

By the comparison lemma by Baldi-Lohoué-Peyrière (Lemma 4.3), this implies transience on the Schreier graph of s for any measure on G such that h_s and \bar{h}_s are in the semigroup generated by the support of the measure. If the support of a given measure generates G as a semigroup, conditions (i) and (iii) in Lemma 4.1 are then automatically satisfied. In particular, any measure μ on G that generates it as a semigroup and such that there exists s for which $\text{supp}(\mu) \cap (G \setminus H_s)$

is finite has a non-trivial Poisson boundary.

In the proof of Lemma 5.1 we obtained a description of the graph of \mathbf{a}_s , which is similar to the one by Savchuk [45] in the case of the dyadic action:

Remark 5.2. Consider two homeomorphisms f and g of \mathbb{R} the supports of which are $\text{supp}(f) = (a, c)$ and $\text{supp}(g) = (b, d)$ with $a < b < c < d$. Denote H the group generated by f and g . Then the Schreier graph of H on the orbit of b is described in Figure 3 (solid lines are labelled by f and dashed lines by g).

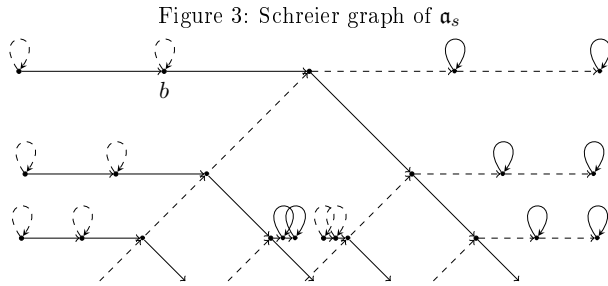

Proof. In the proof of Lemma 5.1 we have shown that for every vertex $x \in \tilde{\Gamma}$ that is not b , x has exactly three different neighbours in $\tilde{\Gamma}$. We also proved that $\tilde{\Gamma}$ is a tree. It is therefore a binary tree. Furthermore, if $x \in A$, it is equal to $g^{-1}(y)$ where y is closer to b than x (in the graph), and if $x \in B$, $x = f(y)$ where y is again closer to b . We think of y as the parent of x . Then every vertex x has two children: left child $g^{-1}(x)$ and right child $f(x)$. Furthermore, if x is a left child, $x \in A$ and $f^{-1}(x) \notin \tilde{\Gamma}$. Equivalently, if x is a right child, $g(x) \notin \tilde{\Gamma}$. \square

Compare to the Schreier graph of the dyadic action as described by Savchuk [45, Proposition 1](see Figure 4).

Figure 4: Schreier graph of the dyadic action of F for the standard generators

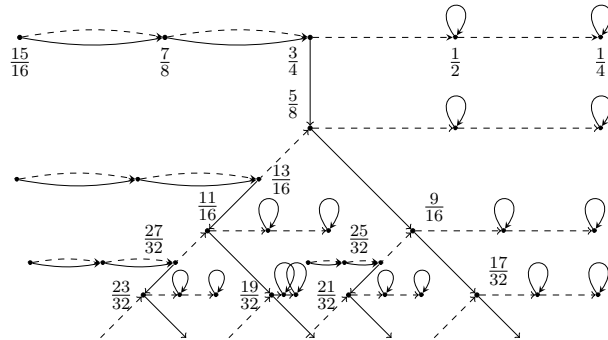

6 Schreier graphs of finitely generated subgroups of $H(\mathbb{Z})$ and \tilde{G}

We will build on the result from Remark 5.2. In a more general case, the comparison lemma by Baldi-Lohoué-Peyrière (Lemma 4.3) implies that the existence of a regular subtree (like $\tilde{\Gamma}$) is enough

to ensure transience on the Schreier graph. To obtain such a tree, we only need the assumptions of the remark inside the closed interval $[b, c]$. We will now prove a lemma that ensures transience while allowing the graph to be more complicated outside $[b, c]$. This will help us understand subgroups of G for which the supports of their generators are not necessarily single intervals.

Lemma 6.1. *Let f, g be homeomorphisms on \mathbb{R} and assume that there exist $b < c$ such that $g(b) = b$, $f(c) = c$, $(b, c) \subset \text{supp}(g)$ and $[b, c) \subset \text{supp}(f)$. Assume also that there exists $s \in \mathbb{R}$ with $s \leq b$ such that for some $n \in \mathbb{Z}$, $f^n(s) \in [b, c]$. Let H be the subgroup of the group of homeomorphisms on \mathbb{R} generated by f and g . Then the simple walk of H on the Schreier graph Γ of H on the orbit s is transient.*

Proof. Without loss of generality, $f(x) > x$ and $g(x) > x$ for $x \in (b, c)$ (and the end point that they do not fix). In that case clearly $n \geq 0$. We will apply the comparison lemma by Baldi-Lohoué-Peyrière (Lemma 4.3) with P_1 defined on Γ as the kernel of the simple random walk of H on Γ . In other words, $P_1(x, f(x)) = P_1(x, f^{-1}(x)) = P_1(x, g(x)) = P_1(x, g^{-1}(x)) = \frac{1}{4}$ for every $x \in \Gamma$. Let us now define P_2 . Let a be the largest fixed point of f that is smaller than b , and d the smallest fixed point of g that is larger than c . For $x \in (a, b)$ we define $n(x) = \min\{n \mid f^n(x) \in [b, c]\}$. Similarly, we define for $x \in (c, d)$, $m(x) = \min\{m \mid g^{-m}(x) \in [b, c]\}$. We define

$$P_2(x, f(x)) = \begin{cases} \frac{1}{4} & x \in [b, c] \\ \frac{1}{4} & x \in (a, b) \text{ and } n(x) \text{ is odd} \\ \frac{3}{4} & x \in (a, b) \text{ and } n(x) \text{ is even} \\ 0 & \text{otherwise.} \end{cases} \quad P_2(x, f^{-1}(x)) = \begin{cases} \frac{1}{4} & x \in [b, c] \\ \frac{3}{4} & x \in (a, b) \text{ and } n(x) \text{ is odd} \\ \frac{1}{4} & x \in (a, b) \text{ and } n(x) \text{ is even} \\ 0 & \text{otherwise.} \end{cases}$$

$$P_2(x, g(x)) = \begin{cases} \frac{1}{4} & x \in [b, c] \\ \frac{3}{4} & x \in (c, d) \text{ and } m(x) \text{ is odd} \\ \frac{1}{4} & x \in (c, d) \text{ and } m(x) \text{ is even} \\ 0 & \text{otherwise.} \end{cases} \quad P_2(x, g^{-1}(x)) = \begin{cases} \frac{1}{4} & x \in [b, c] \\ \frac{1}{4} & x \in (c, d) \text{ and } m(x) \text{ is odd} \\ \frac{3}{4} & x \in (c, d) \text{ and } m(x) \text{ is even} \\ 0 & \text{otherwise.} \end{cases}$$

Of course, we have $P_2(x, y) = 0$ otherwise. This clearly defines a stochastic kernel (as the sum of probabilities at each x is 1), and it follows directly from the definition that it is symmetric. It is therefore doubly stochastic and symmetric.

We now check that it is transient similarly to Lemma 5.1. Indeed, take a point $x \in [f(b), c]$ (respectively $x \in [b, g^{-1}(c)]$). Consider the subgraph $\tilde{\Gamma}(x)$ of the vertices of the form $c_n c_{n-1} \dots c_1(x)$ with $c_i c_{i-1} \dots c_1(x) \in [b, c]$ for every i and $c_1 \in \{f^{-1}, g^{-1}\}$ (respectively $c_1 \in \{g, f\}$). Equivalently to Lemma 5.1, $\tilde{\Gamma}(x)$ is a binary tree. Moreover, the graph $\tilde{\Gamma}(x)$ defined by the vertices of the form $\tilde{c}^n(y) \in \Gamma$ with $\tilde{c} \in \{g, f^{-1}\}$, $n \in \mathbb{N}$ and $y \in \tilde{\Gamma}(x)$ is equivalent to the one in Lemma 5.1. In particular, the simple random walk on it is transient. Take any $y \in \Gamma \cap (a, d)$. Then either $f^n(y) \in [f(b), c]$ for some n , or $g^{-n}(y) \in [b, g^{-1}(c)]$. In either case, there is x such that y belongs to $\tilde{\Gamma}(x)$. By the comparison lemma by Baldi-Lohoué-Peyrière (Lemma 4.3), we have $\sum_{n \in \mathbb{N}} \langle P_2^n \delta_y, \delta_y \rangle < \infty$. Therefore P_2 is transient. We apply Lemma 4.3 again for $P_1 \geq \frac{1}{3} P_2$, which concludes the proof. \square

Remark that with this result we can apply the comparison lemma by Baldi-Lohoué-Peyrière (Lemma 4.3) to obtain transience for a random walk induced by a measure on a subgroup of the piecewise $PSL_2(\mathbb{Z})$ group \tilde{G} (see Definition 2.1.2), the support of which contains two such elements and generates that subgroup as a semi-group.

For the sake of completeness, we will also consider amenability of Schreier graphs of subgroups of \tilde{G} . A locally finite graph is called amenable if for every ε there exists a finite set of vertices S

such that $|\partial S|/|S| < \varepsilon$ where ∂S is the set of vertices adjacent to S . This closely mirrors Følner's criterion for amenability of groups. In particular, a finitely generated group is amenable if and only if its Cayley graph is. In his article, Savchuk [45] shows that the Schreier graph of the dyadic action of Thompson's group F is amenable. He also mentions that it was already noted in private communication between Monod and Glasner. The amenability of the graph comes from the fact that sets with small boundary can be found in the rays (see Figure 4). We will prove that for finitely generated subgroups of \tilde{G} we can find sets quasi-isometric to rays.

Remark 6.2. Consider a point $s \in \mathbb{R}$ and a finitely generated subgroup H of the piecewise $PSL_2(\mathbb{Z})$ group \tilde{G} (see Definition 2.1.2). Let $a = \sup(Hs)$. Let S be a finite generating set and consider the Schreier graph Γ defined by the action of H on Hs . Then there is $b < a$ such that the restriction of Γ to (b, a) is a union of subgraphs quasi-isometric to rays.

Proof. As all elements of H are continuous (when seen as functions on \mathbb{R}), they all fix a . Therefore they admit left germs at a . By definition, the germs belong to the stabiliser St_a of a in $PSL_2(\mathbb{Z})$.

By Lemma 3.1.3, St_a is cyclic. Let $h \in PSL_2(\mathbb{Z})$ be a generator of St_a . Then the left germ at a of any element $s_i \in S$ is equal to h^{n_i} for some $n_i \in \mathbb{Z}$. Up to replacing h with $h^{GCD(\{n_i: s_i \in S\})}$, we can assume that there exists $g \in H$ such that the left germ at a of g is h . Let (b, a) be a small enough left neighbourhood such that the restrictions of all elements of $S \cup \{g\}$ to (b, a) are equal to their left germs at a . For example, one can choose b to be the largest break point of an element of $S \cup \{g\}$ that is smaller than a .

Consider the following equivalence relation on $Hs \cap (b, a)$: $x \sim y$ if and only if there exists $n \in \mathbb{Z}$ such that $h^n(x) = y$. As the restriction of h to (b, a) is an increasing function, an equivalence class is of the form $(h^n(x))_{n \in \mathbb{N}}$ for some $x \in (b, a)$. We will prove that this set is quasi-isometric to a ray (when seen as a subgraph of Γ). It is by definition b preserved by elements of S . Furthermore, the graph distance d is bilipschitz to the standard distance d' on \mathbb{N} . Indeed, on one hand, we have $d > \frac{1}{\max(|n_i|: s_i \in S)} d'$. On the other hand, $d < |g| d'$ where $|g|$ is the word length of g . This proves the result. \square

This implies:

Remark 6.3. Consider a point $s \in \mathbb{R}$ and a finitely generated subgroup $H < \tilde{G}$. The Schreier graph defined by the action of H on Hs is amenable.

As mentioned in the introduction, the result of Juschenko and Zheng holds true not only for the Schreier graph of Thompson's group F , but also for the Schreier graphs of finitely generated subgroups of \tilde{G} :

Remark 6.4. Consider a point $s \in \mathbb{R}$ and a finitely generated subgroup $H < \tilde{G}$. There is a non-degenerate measure such that the induced random walk on Hs has trivial Poisson boundary.

This follows from the results of a recent paper by Schneider and Thom [46, Section 6]. We will adapt their result on Thompson's group F . In that section, they consider a topological subgroup of $Sym(X)$ for a countable set X . If the action is strongly transitive, Corollary 6.2(3) states that the subgroup is amenable (as a topological group, with the induced topology from $Sym(X)$) if and only if for any n , there is a non-degenerate probability measure such that the induced walk on n -element subsets of X has trivial Poisson boundary. The considered action of F is strongly transitive. It also makes F a subgroup of the group of order-preserving automorphisms of the dyadic numbers, which we will denote $Aut(\mathbb{Z}[\frac{1}{2}], \leq)$. The latter has been proven to be (extremely) amenable as a topological group by Pestov [43]. A more detailed presentation of extreme amenability can be found in Kechris-Pestov-Todorćević [28], where they provide the theory allowing to obtain

extremely amenable groups from structural Ramsey theory. In particular, the extreme amenability of $Aut(\mathbb{Z}[\frac{1}{2}], \leq)$ is shown [28, 6(A)(iv)] to follow from the classical theorem of Ramsey.

Schneider and Thom thus obtain that for any n , there is a non-degenerate probability measure on F such that the induced random walk on n -element sets of dyadic numbers has trivial boundary. It is worth noting that this result extends previous work by Juschenko [20], who proved it for $n = 2$. Schneider and Thom also point out that since there is a free non-abelian group that is a subgroup of $Aut(\mathbb{Z}[\frac{1}{2}], \leq)$, and that the latter acts strongly transitively, $Aut(\mathbb{Z}[\frac{1}{2}], \leq)$ provides an example of an action of a non-amenable group (in the discrete sense of amenability) such that for every n there is a measure with trivial boundary of the walk on n -element subsets, which confirms Juschenko's expectations.

For $H < \tilde{G}$, its action on Hs presents an embedding into $Aut(Hs, \leq)$. Applying [46, Corollary 6.2(1)], Remark 6.4 follows. Notice that the remark only treats the case $n = 1$. To obtain the result for n -element subsets we would need to prove strong transitivity.

7 Convergence conditions based on expected number of break points

The aim of this section is to describe sufficient conditions for convergence similar to Theorem 4.1 that do not assume leaving C_μ (which is potentially infinite). The ideas presented are similar to the arguments used in studies of measures with finite first moment on wreath products (see Kaimanovich [24, Theorem 3.3], Erschler [15, Lemma 1.1]). Consider the piecewise $PSL_2(\mathbb{Z})$ group \tilde{G} (see Definition 2.1.2) and a measure μ on it. We think of the measure as something that could be positive on all points of \tilde{G} . Fix $s \in P_{\mathbb{Z}} \cup \mathbb{Q}$ and denote, for $g \in \tilde{G}$, $A_g = \text{supp}(C_g)$ (for $s \in \mathbb{Q}$, see discussion after Definition 3.2.1 and after the proof of Lemma 3.1.4). Take $x \in Gs$ and consider a random walk $(g_n)_{n \in \mathbb{N}}$ with increments h_n , that is $g_{n+1} = h_n g_n$. Then by (4),

$$C_{g_n}(x) \neq C_{g_{n+1}}(x) \iff g_n(x) \in A_{h_n}.$$

In other words, $C_{g_n}(x)$ converges if and only if $g_n(x) \in A_{h_n}$ only for a finite number of values of n . For a fixed n , the probability that $g_n(x)$ belongs to A_{h_n} is

$$\langle p^{*n} \delta_x, \sum_{h \in \tilde{G}} \mu(h) \chi_{A_h} \rangle$$

where p is the induced kernel on Gs . Taking the sum over n we get:

Lemma 7.1. *Fix $\mathfrak{o} \in Gs$. For a random walk g_n on \tilde{G} with law μ , the value $C_{g_n}(\mathfrak{o})$ converges with probability 1 if and only if*

$$\sum_{n \in \mathbb{N}} \langle p^{*n} \delta_{\mathfrak{o}}, \sum_{h \in \tilde{G}} \mu(h) \chi_{A_h} \rangle < \infty$$

where p is the induced kernel on Gs .

We define f_μ as

$$f_\mu = \sum_{h \in \tilde{G}} \mu(h) \chi_{\text{supp}(C_h)} \quad (5)$$

and show that it suffices for f_μ to be l^1 and μ transient :

Lemma 7.2. *Let $s \in P_{\mathbb{Z}} \cup \mathbb{Q}$ be fixed. Take a measure μ on \tilde{G} such that the induced random walk on the Schreier graph on Gs is transient and $f_{\mu} \in l^1(Gs)$ (as defined in (5)). Then for a random walk g_n on \tilde{G} with law μ , the associated configuration C_{g_n} converges pointwise with probability 1.*

Remark in particular that $\mathbb{E}[Br] < \infty$ implies $f_{\mu} \in l^1(\tilde{G})$, where $Br(g)$ is the number of break points of g . Indeed, for any fixed s , $\|f_{\mu}\|_1$ is the expected number of break points inside the orbit Gs , which is smaller than the total expected number of break points. This is, of course, also true for measures on $H(\mathbb{Z})$ as $H(\mathbb{Z}) \leq \tilde{G}$.

Proof. Fix a point \mathfrak{o} in the Schreier graph on Gs . We denote by p the induced kernel on Gs and write $f = f_{\mu}$. We have

$$\sum_{n \in \mathbb{N}} \langle p^{*n} \delta_{\mathfrak{o}}, f \rangle = \sum_{n \in \mathbb{N}} \sum_{x \in Gs} p^{*n}(\mathfrak{o}, x) f(x) = \sum_{x \in Gs} f(x) \sum_{n \in \mathbb{N}} p^{*n}(\mathfrak{o}, x) \quad (6)$$

where we will have the right to interchange the order of summation if we prove that the right-hand side is finite. We write $p^{*n}(\mathfrak{o}, x) = \check{p}^{*n}(x, \mathfrak{o})$ where \check{p} is the inverse kernel of p . Let $\check{P}(x, y)$ be the probability that a random walk (with law \check{p}) starting at x visits y at least once. Then $\sum_{n \in \mathbb{N}} \check{p}^{*n}(x, y) = \check{P}(x, y) \sum_{n \in \mathbb{N}} \check{p}^{*n}(y, y)$. Indeed, $\sum_{n \in \mathbb{N}} \check{p}^{*n}(x, y)$ is the expected number of visits of y of a walk starting at x and random walk that starts from x and visits y exactly k times is the same as the concatenation of a walk that goes from x to y and a walk that starts from y and visits it k times. Thus

$$\sum_{n \in \mathbb{N}} p^{*n}(\mathfrak{o}, x) = \sum_{n \in \mathbb{N}} \check{p}^{*n}(x, \mathfrak{o}) = \check{P}(x, \mathfrak{o}) \sum_{n \in \mathbb{N}} \check{p}^{*n}(\mathfrak{o}, \mathfrak{o}) \leq \sum_{n \in \mathbb{N}} \check{p}^{*n}(\mathfrak{o}, \mathfrak{o}). \quad (7)$$

Then if we denote $c(p, \mathfrak{o}) = \sum_{n \in \mathbb{N}} p^{*n}(\mathfrak{o}, \mathfrak{o})$,

$$\sum_{x \in Gs} f(x) \sum_{n \in \mathbb{N}} p^{*n}(\mathfrak{o}, x) \leq c(p, \mathfrak{o}) \|f\|_1 < \infty. \quad (8)$$

Applying Lemma 7.1 we obtain the result. \square

Combining this result with the result of Lemma 6.1 which gives transience of the induced random walk on Gs under certain conditions, we obtain:

Lemma 7.3. *Consider the piecewise $PSL_2(\mathbb{Z})$ group \tilde{G} (see Definition 2.1.2). Let H be a subgroup of \tilde{G} . Assume that there exist $b < c$ such that $g(b) = b$, $f(c) = c$, $(b, c] \subset \text{supp}(g)$ and $[b, c) \subset \text{supp}(f)$ for some $f, g \in H$ (see Figure 5 on page 21). Assume also that there exists $s \in P_{\mathbb{Z}} \cup \mathbb{Q}$ and $\varepsilon_s > 0$ with $s \leq b$ such that for some $n \in \mathbb{Z}$, $f^n(s) \in [b, c]$, and also $g(s - \varepsilon) = s - \varepsilon$ and $g(s + \varepsilon) \neq s + \varepsilon$ for every $0 < \varepsilon \leq \varepsilon_s$. Then for any μ on H with finite first break moment ($\mathbb{E}[Br] < \infty$) such that $\text{supp}(\mu)$ generates H as a semigroup, the Poisson boundary of μ on H is non-trivial.*

Proof. By Lemma 6.1, the simple random walk on the Schirer graph of s by $\langle f, g \rangle$ is transient. By the comparison lemma by Baldi-Lohoué-Peyrière (Lemma 4.3), as the support of μ generates H as a semigroup, the random walk by μ on the Schreier graph of s is then transient. Applying Lemma 7.2, the associated configurations converge as μ has finite first break moment. However, by hypothesis on s , $g(s) = s$ and $C_g(s) \neq 0$. Therefore, as $g \in H$, the limit configuration cannot be singular. Thus the Poisson boundary of μ on H is non-trivial. \square

For finitely generated subgroups of \tilde{G} , from Lemma 7.2 we have:

Remark 7.4. The amount of break points is subadditive in relation to multiplication. In particular, if a measure μ has finite first moment, then it has finite first break moment.

Corollary 7.5. *Consider a measure μ on \tilde{G} , the support of which generates a finitely generated subgroup, and such that μ has a finite first moment on that subgroup. Assume that there exists $s \in P_{\mathbb{Z}}$ such that the random walk on the Schreier graph on Gs of this subgroup is transient. Then, for almost all random walks on \tilde{G} with law μ , the associated configuration converges pointwise.*

Proof. Follows from Remark 7.4 and Lemma 7.2. \square

In such cases it is enough to prove that the associated limit configuration is not always the same, which can require case-specific arguments. We already have it in the case of Thompson's group:

Proof of Corollary 1.3. Fix $s \in P_{\mathbb{Z}}$ and consider the action \mathbf{a}_s of Thompson's group F on \mathbb{R} as defined in Section 5. Take a measure μ on F that generates it as a semigroup. From Lemma 5.1 and the comparison lemma by Baldi-Lohoué-Peyrière (Lemma 4.3) the walk μ induces on the orbit of s is transient. Applying Corollary 7.5 this implies that the associated configuration stabilises, and by Lemma 3.2.3, it cannot always converge towards the same point. Therefore the Poisson boundary of μ is not trivial. \square

We remark that arguments similar to the ones in this section can also be made for the action of Thompson's group considered in Kaimanovich's article [26].

In a more general case, we can use the stronger result by Varopoulos of the comparison Lemma 4.3 in order to prove that if the transient walk diverges quickly enough, we can also have the result for $f_{\mu} \in l^2(Gs)$ (and not necessarily in l^1):

Lemma 7.6. *Fix $s \in P_{\mathbb{Z}}$. Consider a measure μ_0 such that $\tilde{f} = f_{\mu_0} \in l^2(Gs)$. Consider λ on H_s such that $\sum_{n \in \mathbb{N}} \langle \lambda^{*n} \tilde{f}, \tilde{f} \rangle < \infty$. Let $\mu = \varepsilon \lambda + (1 - \varepsilon) \mu_0$ with $0 < \varepsilon < 1$. Then for almost all random walks on G with law μ , the associated configuration converges pointwise.*

Proof. Clearly, $f_{\mu} = (1 - \varepsilon) \tilde{f}$. Then by the comparison Lemma 4.3 we get:

$$\sum_{n \in \mathbb{N}} \langle \mu^{*n} f_{\mu}, f_{\mu} \rangle < \frac{1}{\varepsilon(1 - \varepsilon)^2} \sum_{n \in \mathbb{N}} \langle \lambda^{*n} \tilde{f}, \tilde{f} \rangle < \infty.$$

Denote $f = f_{\mu}$. Consider $x \in P_{\mathbb{Z}}$ such that it is possible for the value of the associated configuration at x to change. In other words, there is $n_0 \in \mathbb{N}$ and $y \in P_{\mathbb{Z}}$ such that $x \in \text{supp}(\mu^{*n_0})y$ and $f(y) > 0$. Denote by p the probability to reach x from y . Then $\sum_{n \in \mathbb{N}} \langle \mu^{*n} \delta_y, f \rangle > p \sum_{n \in \mathbb{N}} \langle \mu^{*n+n_0} \delta_x, f \rangle$. In particular, if the first is finite, so is the second. However, we clearly have $\sum_{n \in \mathbb{N}} \langle \mu^{*n} \delta_y, f \rangle < \frac{1}{f(y)} \sum_{n \in \mathbb{N}} \langle \mu^{*n} f, f \rangle$ which concludes the proof. \square

In particular, if for any s all associated configurations cannot be stable by all the elements of $\langle \text{supp}(\mu) \rangle$, we obtain a non-trivial boundary.

Corollary 7.7. *Fix $s \in P_{\mathbb{Z}}$. Consider a measure μ_0 such that $h_s \in \text{supp}(\mu_0)^{*n_0}$ for some n_0 and $\tilde{f} = f_{\mu_0} \in l^2(Gs)$. Consider λ on H_s such that $\sum_{n \in \mathbb{N}} \langle \lambda^{*n} \tilde{f}, \tilde{f} \rangle < \infty$. Let $\mu = \varepsilon \lambda + (1 - \varepsilon) \mu_0$ with $0 < \varepsilon < 1$. Then the Poisson boundary of μ on the subgroup generated by its support is non-trivial.*

Proof. Follows from Lemma 7.6 and Lemma 3.2.3. \square

Remark that there always exists a symmetric measure λ satisfying those assumptions as $A \subset H_s$ (A was defined in (1)).

Figure 5: Graphs of f and g and positions of b and c

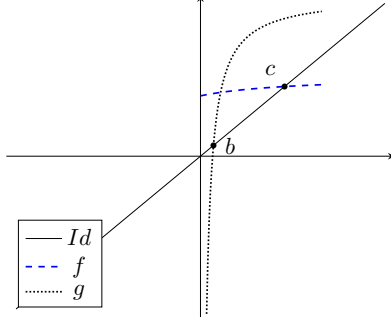
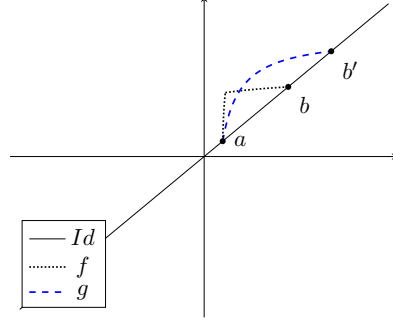

Figure 6: Graphs of f and g in (a, b')



8 An algebraic lemma and proof of the main result

Consider the piecewise $PSL_2(\mathbb{Z})$ group \tilde{G} (see Definition 2.1.2). Take a subgroup H of \tilde{G} . In Lemma 7.3 we proved that if there are $f, g \in H$ and $b, c, s \in \mathbb{R}$ that satisfy certain assumptions, for every measure μ on H the support of which generates H as a semigroup and that has finite first break moment $\mathbb{E}[Br]$, (H, μ) has non-trivial Poisson boundary. To prove the main result (Theorem 1.2) we will study subgroups that do not contain elements satisfying those assumptions.

Lemma 8.1. *Let $H = \langle h_1, \dots, h_k \rangle$ be a finitely generated subgroup of \tilde{G} . Then either H is solvable, or the assumptions of Lemma 7.3 are satisfied for some $f, g \in H$, $b, c, s \in \mathbb{R}$.*

We recall that for $f \in \tilde{G}$, and $a, b \in \mathbb{R}$ such that $f(a) = a$ and $f(b) = b$, we defined (see Definition 2.1.3) $f \upharpoonright_{(a,b)} \in \tilde{G}$ by $f \upharpoonright_{(a,b)}(x) = f(x)$ for $x \in (a, b)$ and x otherwise.

Proof. We first check that with the appropriate assumptions on (f, g, b, c) , s always exists:

Lemma 8.2. *Let H be a subgroup of \tilde{G} . Assume that there exist $b < c$ such that $g(b) = b$, $f(c) = c$, $(b, c) \subset \text{supp}(g)$ and $[b, c) \subset \text{supp}(f)$ for some $f, g \in H$. Then there exist f', g', b', c' and s that satisfy the assumptions of Lemma 7.3.*

The assumptions of the lemma are illustrated in Figure 5. Recall that we defined $\text{supp}(f) = \{x \in \mathbb{R} : f(x) \neq x\}$.

Proof. Without loss of generality assume that b is minimal among all b for which there exists c such that either (f, g, b, c) or (g, f, b, c) satisfy the assumptions of this lemma. We can assume without loss of generality that $f(x) > x$ and $g(x) > x$ for $x \in (b, c)$ (otherwise, we can replace either or both with their inverse). Let a be the largest fixed point of f that is smaller than b .

By minimality of b we clearly have that $g(a) = a$. The stabiliser St_a of a in $PSL_2(\mathbb{Z})$ is cyclic by Lemma 3.1.3. Therefore there exist k and l such that $f^k(x) = g^l(x)$ for $x \in (a, a + \varepsilon)$ for some $\varepsilon > 0$. Take $(f', g') = (f, f^{-k}g^l)$. By our assumption, f^k and g^l are strictly greater than the identity function in (b, c) . As they are continuous and each fixes an end of the interval, by the mean values theorem there exists $b' \in (b, c)$ such that $f^k(b') = g^l(b')$. Then (f', g') and (b', c) satisfy the assumptions of this lemma. Furthermore, $f^{-k}g^l$ is the identity in a small enough right neighbourhood of a , which implies that there exists an element s that satisfies the assumptions of Lemma 7.3. \square

We now assume that the assumptions of Lemma 7.3, and therefore also the assumptions of Lemma 8.2, are not satisfied by any couple of elements in H . We will prove that H is solvable. For any element in $g \in \tilde{G}$, its support $\text{supp}(g)$ is a finite union of (not necessarily finite) open intervals. The intervals in the support of h_i we denote $I_j^i = (a_i^j, b_i^j)$ for $j < r_i$ where r_i is the number of intervals in the support of h_i . In terms of those intervals, the negation of Lemma 8.2 means that for every (i, j) and (i', j') , either $I_j^i \cap I_{j'}^{i'} = \emptyset$, or $I_j^i \subset I_{j'}^{i'}$, or $I_{j'}^{i'} \subset I_j^i$. We further check that if the inclusion is strict, it must be strict at both extremities. Specifically:

Lemma 8.3. *Let H be a subgroup of \tilde{G} . Assume that there exist $a < b < b' \in \mathbb{R} \cup \{-\infty\}$ such that $f(a) = g(a) = a$, $f(b) = b$, $g(b') = b'$, $(a, b) \subset \text{supp}(f)$ and $(a, b') \subset \text{supp}(g)$ for some $f, g \in H$ (see Figure 6). Then the assumptions of Lemma 8.2 are satisfied by some elements of the group.*

Proof. In a small enough right neighbourhood of a there are no break points of f and g . Let c be a point in that neighbourhood. Clearly, $a < c < b$. Without loss of generality, we can assume that $f(x) > x$ for $x \in (a, b)$, and idem for g (otherwise, we can replace them with their inverse). For some $k \in \mathbb{N}$, $f^{-k}(b) < c$. Denote $g' = f^{-k}g f^k$. Consider the elements g' and $g^{-1}g'$. As the stabiliser of a in $PSL_2(\mathbb{Z})$ is cyclic (by Lemma 3.1.3), $g^{-1}g'(x) = x$ for $x \in (a, f^{-k}(c))$. However, $g^{-1}g'(x) = g^{-1}(x)$ for $x \in (f^{-k}(b), b)$, and in particular $g^{-1}g'(x) \neq x$ in that interval. Let c' be the largest fixed point of $g^{-1}g'$ that is smaller than $f^{-k}(b)$. Consider now g' . It is the conjugate of g , therefore it is different from the identity in $(a, f^{-k}(b))$ and fixes $f^{-k}(b) < c$. Clearly, $c' < f^{-k}(b)$. Then $g', g^{-1}g'$ and $c', f^{-k}(b)$ satisfy the assumptions of Lemma 8.2. Observe that the same arguments can be used for two elements with supports (a, b) and (a', b) with $a \neq a'$. \square

Consider the natural extension of the action of \tilde{G} on $\mathbb{R} \cup \{+\infty, -\infty\}$, which is that every element of \tilde{G} fixes both $-\infty$ and $+\infty$. We make the convention that $+\infty$ is considered to be a break point of $f \in \tilde{G}$ if and only if for every $M \in \mathbb{R}$ there is $x > M$ such that $f(x) \neq x$ (and idem for $-\infty$). In other words, if the support of an element is equal to an interval (a, b) , a and b are break points even if one or both are infinite. We now prove that H is solvable by induction on the number of different orbits of H on $\mathbb{R} \cup \{\pm\infty\}$ that contain non-trivial break points of elements of H . Remark that the number of orbits of H that contain non-trivial break points of elements of H is the same as the number of orbits that contain non-trivial break points of h_1, \dots, h_k . In particular, it is finite.

Consider all maximal (for inclusion) intervals I_j^i over all couples (i, j) . We denote them I_1, I_2, \dots, I_n . By our hypothesis we have that they do not intersect each other. We denote $h_i^j = h_i \upharpoonright_{I_j}$ and $H_j = \langle h_1^j, h_2^j, \dots, h_k^j \rangle$ for every $j < n$. As the intervals I_j do not intersect each other, H is a subgroup of the Cartesian product of H_j :

$$H \leq \prod_{j=1}^n H_j. \quad (9)$$

Moreover, for every j , the amount of orbits with non-trivial break points of H_j is not greater than that of H . Indeed, the orbits with break points of H_j inside I_j coincide with those of H , and it has only two other orbits containing break points, which are the singletons containing the end points of I_j . We just need to prove that H has at least two other orbits containing non-trivial break points. If $I_j = I_{i'}^{j'}$, then the supremum and infimum of the support of $h_{i'}$ are break points, and by definition of I_j their orbits by H do not intersect the interior of I_j . The convention we chose assures that our arguments are also correct if one or both of the end points is infinite. It is thus sufficient to prove the induction step for H_j for every j . Therefore without loss of generality we can assume $n = 1$. Remark that in this case the end points of I_1 are both non-trivial break points, and both clearly have trivial orbits.

We denote $(a, b) = I = I_1$. Consider the germs $g_i \in St_a$ of h_i at a right neighbourhood of a . As St_a is cyclic, there exist $m_i \in \mathbb{Z}$ such that $\prod_i g_i^{m_i}$ generates a subgroup of St_a that contains g_i for all i . Specifically, the image in \mathbb{Z} of this product is the greatest common divisor of the images in \mathbb{Z} of g_i . We denote $h = \prod_i h_i^{m_i}$ and let, for every i , n_i satisfy $(\prod_i g_i^{m_i})^{n_i} = g_i$. For every $i \leq k$, we consider $h'_i = h_i h^{-n_i}$.

Clearly, $H = \langle h, h'_1, h'_2, \dots, h'_k \rangle$, and there exists ε such that for every i , $\text{supp}(h'_i) \subset (a + \varepsilon, b - \varepsilon)$ (as the assumptions of Lemma 8.3 are not satisfied by h, h'_i). Consider the set of $h^{-l} h'_i h^l$ for $i < k, l \in \mathbb{Z}$ and their supports. They are all elements of H . Furthermore, there is a power n such that $h^n(a + \varepsilon) > b - \varepsilon$. Therefore, for every point $x \in (a, b)$, the number of elements of that set that contain x in their support is finite. Considering the intervals that define those supports, we can therefore choose a maximal one (for the inclusion). Let x_0 be the lower bound of a maximal interval. By our assumption, x_0 is then not contained in the support of any of those elements, and neither is $x_l = h^l(x_0)$ for $l \in \mathbb{Z}$. We denote $h'^j_i = h^j h'_i h^{-j} \upharpoonright (x_0, x_1)$. For $i < k$, let J_i be the set of $j \in \mathbb{Z}$ such that $h'^j_i \neq Id$. Then H is a subgroup of

$$\left\langle h, \bigcup_{i < k} \bigcup_{j \in J_i} h'^j_i \right\rangle \cong \langle h \rangle \wr \left\langle \bigcup_{i < k} \bigcup_{j \in J_i} h'^j_i \right\rangle. \quad (10)$$

For a group F , $\mathbb{Z} \wr F$ denotes the wreath product of \mathbb{Z} on F . It is a group, the elements of which are pairs (n, f) with $n \in \mathbb{Z}$ and $f \in \prod_{k \in \mathbb{Z}} F$ with finite support. The group multiplication is defined as $(n, f)(n', f') = (n + n', T^{n'} f + f')$, where $T^{n'} f(k) = f(k - n')$. It is a well known property of wreath products that if F is solvable, so is $\mathbb{Z} \wr F$.

Denote $H' = \langle \bigcup_{i < k} \bigcup_{j \in J_i} h'^j_i \rangle$. The non-trivial break points and supports of h'^j_i are contained in (x_0, x_1) , and they fix that interval. Therefore the orbits that contain those break points are the same in relation to $\langle h, H' \rangle$ and to H' . On the other hand, $\langle h, H' \rangle$ and H act the same way locally, which means that they have the same orbits. Those two facts imply that H' has at least two less orbits containing non-trivial break points than H (as it does not have non-trivial break points in the orbits of the end points of I). That group also does not contain elements that satisfy the assumptions of Lemma 8.2. Indeed, assume that there are two words on $\bigcup_{i < k} \bigcup_{j \in J_i} h'^j_i$ and $a, b \in \mathbb{R}$ that satisfy those assumptions. Their supports are also contained in (x_0, x_1) , therefore so are a and b . Then the same words in $\bigcup_{i < k} \bigcup_{j \in J_i} h'_i$ are equal inside (a, b) , and they satisfy the conditions of Lemma 8.2. However, h'_i are elements of H and this is contradictory to our assumptions.

This provides the induction step. The induction basis is the trivial group, which is solvable. Therefore H is solvable. \square

We can now prove the main result, that is that for any subgroup H of $H(\mathbb{Z})$ which is not locally solvable and any measure μ on H such that the support of μ generates H as a semigroup and has finite first break moment $\mathbb{E}[Br]$, the Poisson boundary of (H, μ) is non-trivial.

Proof of Theorem 1.2. Fix H and take μ on H with finite first break moment and the support of which generates H as a semigroup. We distinguish two cases.

Assume first that there exist $f, g \in H$ and $b, c, s \in \mathbb{R}$ that satisfy the assumptions of Lemma 7.3. By the result of the lemma, the Poisson boundary of (H, μ) is non-trivial.

We now assume that no such f, g, b, c, s exist and will prove that H is locally solvable. Any finitely generated subgroup \tilde{H} of H clearly also does not contain such f and g for any $b, c, s \in \mathbb{R}$. Furthermore, $H(\mathbb{Z})$ is a subgroup of the piecewise $PSL_2(\mathbb{Z})$ group \tilde{G} (see Definition 2.1.2), and thus \tilde{H} is a subgroup of \tilde{G} . Therefore by Lemma 8.1 we obtain that \tilde{H} is solvable, which proves that H is locally solvable. \square

9 A remark on the case of finite $1 - \varepsilon$ moment

Remark that in the proof of Lemma 8.1, for a finitely generated subgroup that does not satisfy the assumptions of Lemma 7.3 we obtained more than it being solvable. If the subgroup is also non-abelian, we have proven that it contains a wreath product of \mathbb{Z} with another subgroup (see (10)). In particular, it is not virtually nilpotent, which implies (as it is finitely generated) that there exists a measure on it with non-trivial boundary by a recent result of Frisch-Hartman-Tamuz-Vahidi-Ferdowski [16]. Furthermore, it is known that on the wreath products $\mathbb{Z} \wr \mathbb{Z}$ it is possible to obtain a measure with finite $1 - \varepsilon$ moment and non-trivial Poisson boundary for every $\varepsilon > 0$ (see Lemma 9.2 and discussion before and after it). The same arguments can be used in \tilde{G} :

Lemma 9.1. *For every finitely generated subgroup $H = \langle h_1, \dots, h_k \rangle$ of \tilde{G} that is not abelian and every $\varepsilon > 0$ there exists a symmetric non-degenerate measure μ on H with non-trivial Poisson boundary such that $\int_H |g|^{1-\varepsilon} d\mu(g) < \infty$, where $|g|$ is the word length of g .*

We recall that every measure on an abelian group has trivial Poisson boundary (see Blackwell [7], Choquet-Deny [10]).

Proof. As there is always a non-degenerate symmetric measure with finite first moment, we can assume that the assumptions of Lemma 7.3 are not satisfied in H . We will use the results on the structure of H seen in the proof of Lemma 8.1. It is shown (see (9)) that H is a subgroup of a Cartesian product $\prod_{j=1}^n H_j$. Specifically, there exist disjoint intervals I_1, I_2, \dots, I_n such that the supports of elements of H are included in the union of those intervals. Taking $h_i^j = h_i \upharpoonright_{I_j}$ to be the restriction on one of those intervals (as defined in Definition 2.1.3), the group H_j is then equal to $\langle h_1^j, h_2^j, \dots, h_k^j \rangle$. For any j , consider the composition of the projection of $\prod_{j=1}^n H_j$ onto H_j and the inclusion of H in $\prod_{j=1}^n H_j$. Then H_j is the quotient of $\prod_{j=1}^n H_j$ by the kernel of this composition, which is equal to $\{h \in \prod_{j=1}^n H_j, h \upharpoonright_{I_j} \equiv 0\}$.

We can therefore separately define measures on H_j and on the kernel, and the Poisson boundary of their sum would have the Poisson boundary of the measure on H_j as a quotient. In particular, it suffices to show that for some j we can construct a measure on H_j with non-trivial boundary satisfying the conditions of the lemma. As H is non-abelian, so is at least one H_j . Without loss of generality, let that be H_1 . In the proof of Lemma 8.1 we have shown (see (10)) that in H_1 there are elements h^1 and $h^{1'_j}$ for $j = 1, 2, \dots, k$ such that $H_1 = \langle h^1, h^{1'_1}, h^{1'_2}, \dots, h^{1'_k} \rangle$ and is isomorphic to a subgroup of the wreath product of h^1 on a group H' defined by the rest of the elements. Remark that H_1 not being abelian implies that H' is not trivial. Furthermore, by taking the group morphism of H_1 into $\mathbb{Z} \wr H'$, we see that the image of h^1 is the generator $(1, 0)$ of the active group, while for every j , the image of $h^{1'_j}$ is of the form $(0, f_j)$ where f_j has finite support. The following result is essentially due to Kaimanovich and Vershik [27, Proposition 6.1], [22, Theorem 1.3], and has been studied in a more general context by Bartholdi and Erschler [6]:

Lemma 9.2. *Consider the wreath product $\mathbb{Z} \wr H'$ where H' is not trivial, and let μ be a measure on it such that the projection of μ on \mathbb{Z} gives a transient walk and the projection of μ on $H'^{\mathbb{Z}}$ is finitary and non-trivial. Then the Poisson boundary of μ is not trivial.*

In the article of Kaimanovich and Vershik, it is assumed that the measure is finitary, and the acting group is \mathbb{Z}^k for $k \geq 3$, which assures transience. The proof remains unchanged with our assumptions. Remark that those results have also been generalised in the case of a measure with finite first moment that is transient on the active group, see Kaimanovich [24, Theorem 3.3], [25, Theorem 3.6.6], Erschler [15, Lemma 1.1].

Proof. Take a random walk $(g_n)_{n \in \mathbb{N}}$ on $\mathbb{Z} \wr H'$ with law μ . Let p be the projection of the wreath product onto the factor isomorphic to H' that has index 0 in $H'^{\mathbb{Z}}$. By the assumptions of the lemma, $p(h_n)$ stabilises, and is not almost always the same. This provides a non-trivial quotient of the Poisson boundary of μ . \square

All that is left is constructing a measure that verifies the assumptions of Lemma 9.2. Consider a symmetric measure μ_1 on $\langle h^1 \rangle$ that has finite $1 - \varepsilon$ moment and is transient. Let μ_2 be defined by being symmetric and by $\mu_2(h^j) = \frac{1}{2k}$ for every j . Then $\mu = \frac{1}{2}(\mu_1 + \mu_2)$ is a measure on H_1 with non-trivial Poisson boundary. \square

References

- [1] S I Adyan. Random walks on free periodic groups. *Izv. Akad. Nauk SSSR Ser. Mat.*, 46(6):1139–1149,1343, 1982.
- [2] Andre Avez. Entropie des groupes de type fini. *C.R.Acad.Sci.Paris, Sér. A*, 275:1363–1366, 1972.
- [3] Paolo Baldi, Noël Lohoué, and Jacques Peyrière. Sur la classification des groupes récurrents. *C. R. Acad. Sci. Paris Sér. A-B*, 285(16):A1103–A1104, 1977.
- [4] St Banach and A Tarski. Sur la décomposition des ensembles de points en parties respectivement congruentes. *Fundamenta Mathematicae*, 6:244–277, 1924.
- [5] Laurent Bartholdi. Amenability of Groups and G-Sets. In Valérie Berthé and Michel Rigo, editors, *Sequences, Groups, and Number Theory*, pages 433–544. Springer International Publishing, Cham, 2018.
- [6] Laurent Bartholdi and Anna Erschler. Poisson–Furstenberg boundary and growth of groups. *Probability Theory and Related Fields*, 168(1-2):347–372, jun 2017.
- [7] David Blackwell. On transient Markov processes with a countable number of states and stationary transition probabilities. *The Annals of Mathematical Statistics*, 26(4):654–658, dec 1955.
- [8] J W Cannon, W J Floyd, and W R Parry. Introductory notes on Richard Thompson’s groups. *Enseign. Math. (2)*, 42(3-4):215–256, 1996.
- [9] Tullio Ceccherini-Silberstein, Rostislav I. Grigorchuk, and Pierre de la Harpe. Amenability and paradoxical decompositions for pseudogroups and for discrete metric spaces. *Tr. Mat. Inst. Steklova*, 224, apr 1998.
- [10] Gustave Choquet and Jacques Deny. Sur l’équation de convolution $\mu = \mu * \sigma$. *Comptes Rendus de l’Académie des Sciences de Paris*, 250:799–801, 1960.
- [11] Joel M. Cohen. Cogrowth and amenability of discrete groups. *Journal of Functional Analysis*, 48(3):301–309, oct 1982.
- [12] Yves Derriennic. Quelques applications du théorème ergodique sous-additif. *Astérisque*, 74:183–201, 1980.
- [13] Rick Durrett. *Probability: Theory and Examples*. Duxbury advanced series. Brooks/Cole, Belmont, USA, third edition, 2005.

- [14] Anna Erschler. Poisson-Furstenberg boundaries, large-scale geometry and growth of groups. In *Proceedings of the International Congress of Mathematicians. Volume II*, pages 681–704. Hindustan Book Agency, New Delhi, 2010.
- [15] Anna Erschler. Poisson–Furstenberg boundary of random walks on wreath products and free metabelian groups. *Commentarii Mathematici Helvetici*, 86(1):113–143, 2011.
- [16] Joshua Frisch, Yair Hartman, Omer Tamuz, and Pooya Vahidi Ferdowsi. Choquet-Deny groups and the infinite conjugacy class property. *Annals of Mathematics*, 190(1):307–320, 2019.
- [17] F P Greenleaf. *Invariant means on topological groups and their applications*. Van Nostrand mathematical studies. Van Nostrand Reinhold Co., 1969.
- [18] Rostislav I. Grigorchuk. Symmetric random walks on discrete groups. *Uspekhi Mat. Nauk*, 32(6(198)):217–218, 1977.
- [19] Rostislav I. Grigorchuk. Symmetric random walks on discrete groups. *Advances in Probability and Related Topics*, 6:285–325, 1980.
- [20] Kate Juschenko. A remark on Liouville property of strongly transitive actions. preprint, arXiv:1806.02753, jun 2018.
- [21] Kate Juschenko and Tianyi Zheng. Infinitely supported Liouville measures of Schreier graphs. *Groups, Geometry, and Dynamics*, 12:911–918, 2018.
- [22] Vadim A Kaimanovich. Examples of nonabelian discrete groups with nontrivial exit boundary. *Zap. Nauchn. Sem. Leningrad. Otdel. Mat. Inst. Steklov. (LOMI)*, 123:167–184, 1983.
- [23] Vadim A Kaimanovich. The differential entropy of the boundary of a random walk on a group. *Russian Mathematical Surveys*, 38(5):142–143, 1983.
- [24] Vadim A Kaimanovich. Poisson boundaries of random walks on discrete solvable groups. In Herbert Heyer, editor, *Probability Measures on Groups X*, pages 205–238. Springer US, Boston, MA, 1991.
- [25] Vadim A Kaimanovich. Poisson boundary of discrete groups. 2007.
- [26] Vadim A Kaimanovich. Thompson’s group F is not Liouville. In Tullio Ceccherini-Silberstein, Maura Salvatori, and Ecaterina Sava-Huss, editors, *Groups, Graphs and Random Walks*, London Mathematical Society Lecture Note Series, pages 300–342. Cambridge University Press, Cambridge, 2017.
- [27] Vadim A Kaimanovich and A M Vershik. Random walks on discrete groups: boundary and entropy. *The Annals of Probability*, 11(3):457–490, 1983.
- [28] A. S. Kechris, V. G. Pestov, and S. Todorćević. Fraïssé Limits, Ramsey Theory, and Topological Dynamics of Automorphism Groups. *GFA Geometric And Functional Analysis*, 15(1):106–189, may 2003.
- [29] Harry Kesten. Full Banach mean values on countable groups. *Mathematica Scandinavica*, 7:146–156, 1959.
- [30] Sang-Hyun Kim, Thomas Koberda, and Yash Lodha. Chain groups of homeomorphisms of the interval and the circle. preprint, arXiv:1610.04099, oct 2016.

- [31] Yash Lodha. A nonamenable type F_∞ group of piecewise projective homeomorphisms. preprint, arXiv:1408.3127, aug 2014.
- [32] Yash Lodha. An upper bound for the Tarski numbers of non amenable groups of piecewise projective homeomorphisms. *International Journal of Algebra and Computation*, 27:315–322, 2016.
- [33] Yash Lodha and Justin Tatch Moore. A nonamenable finitely presented group of piecewise projective homeomorphisms. *Groups, Geometry, and Dynamics*, 10(1):177–200, 2016.
- [34] John Meier. *Groups, Graphs and Trees*. Cambridge University Press, Cambridge, 2008.
- [35] Pavlo Mishchenko. Boundary of the action of Thompson group F on dyadic numbers. preprint, arXiv:1512.03083, 2015.
- [36] Nicolas Monod. Groups of piecewise projective homeomorphisms. *Proceedings of the National Academy of Sciences of the United States of America*, 110(12):4524–4527, mar 2013.
- [37] L J Mordell. *Diophantine Equations*. Pure and Applied Mathematics. Academic press, London; New York, 1969.
- [38] J Neumann. Zur allgemeinen Theorie des Masses. *Fundamenta Mathematicae*, 13(1):73–116, 1929.
- [39] P S Novikov and S I Adyan. On infinite periodic groups. I, II, III. *Izv. Akad. Nauk SSSR Ser. Mat.*, 32:212–244, 251–524, 709–731, 1968.
- [40] A Yu Ol’shanskii. An infinite group with subgroups of prime orders. *Izv. Akad. Nauk SSSR Ser. Mat.*, 44(2):309–321, 1980.
- [41] A Yu Ol’shanskii. On the question of the existence of an invariant mean on a group. *Russian Mathematical Surveys*, 35(4):180, 1980.
- [42] A Yu Ol’shanskii and M V Sapir. Non-amenable finitely presented torsion-by-cyclic groups. *Publ. Math. Inst. Hautes Études Sci.*, 96(1):43–169, 2003.
- [43] Vladimir G Pestov. On Free Actions, Minimal Flows, and a Problem by Ellis. *Transactions of the American Mathematical Society*, 350(10):4149–4165, 1998.
- [44] Joseph Rosenblatt. Ergodic and mixing random walks on locally compact groups. *Mathematische Annalen*, 257(1):31–42, 1981.
- [45] Dmytro Savchuk. Some graphs related to Thompson’s group F . In Oleg Bogopolski, Inna Bumagin, Olga Kharlampovich, and Enric Ventura, editors, *Combinatorial and geometric group theory*, pages 279–296, Basel, 2010. Birkhäuser Basel.
- [46] Friedrich Martin Schneider and Andreas Thom. The Liouville property and random walks on topological groups. preprint, arXiv:1902.10243, mar 2019.
- [47] Ryszard Szwarc. A short proof of the Grigorchuk-Cohen cogrowth theorem. *Proc. Amer. Math. Soc.*, 106(3):663–665, 1989.
- [48] A Tarski. Algebraische Fassung des Massproblems. *Fundamenta Mathematicae*, 31:47 – 66, 1938.

- [49] Nicolas Th. Varopoulos. Brownian motion and transient groups. *Annales de l'institut Fourier*, 33(2):241–261, 1983.
- [50] S Wagon. *The Banach-Tarski Paradox*. Encyclopedia of Mathematics and its Applications. Cambridge University Press, 1993.
- [51] Wolfgang Woess. *Random Walks on Infinite Graphs and Groups*. Cambridge Tracts in Mathematics. Cambridge University Press, 2000.

Chapitre 4

Convergence Towards the End Space for Random Walks on Schreier Graphs

First published in *Journal of Theoretical Probability* (2021) by Springer Nature. Reproduced with permission from Springer Nature.

Convergence Towards the End Space for Random Walks on Schreier Graphs

Bogdan Stankov¹

Received: 30 September 2019 / Revised: 25 November 2020 / Accepted: 29 April 2021
© The Author(s), under exclusive licence to Springer Science+Business Media, LLC, part of Springer Nature 2021

Abstract

We consider a transitive action of a finitely generated group G and the Schreier graph Γ defined by this action for some fixed generating set. For a probability measure μ on G with a finite first moment, we show that if the induced random walk is transient, it converges towards the space of ends of Γ . As a corollary, we obtain that for a probability measure with a finite first moment on Thompson's group F , the support of which generates F as a semigroup, the induced random walk on the dyadic numbers has a non-trivial Poisson boundary. Some assumption on the moment of the measure is necessary as follows from an example by Juschenko and Zheng.

Keywords Random walks on groups · Poisson boundary · Schreier graph · Thompson's group F

Mathematics Subject Classification Primary classes: 05C81 · 60B15 · 60J50, Secondary classes: 05C25 · 20F65 · 60J10

1 Introduction

Consider a finitely generated group G acting on a space X (on the right). For a point $x \in X$ and a generating set S , the Schreier graph $\Gamma = (xG, E)$ is the graph the vertex set of which is the orbit xG of x , and the edges E are the couples of the form $(y, y.s)$ for $y \in xG$ and $s \in S$. Throughout this article, we will assume the action to be transitive, that is for every $x, xG = X$. We take a measure μ on G and will study for which (G, Γ, μ) the induced random walk on Γ converges towards an end of the graph.

The author's work is supported by the European Research Council grant GroIsRan.

Bogdan Stankov
bogdan.stankov@ens.fr

¹ Département de mathématiques et applications, École normale supérieure, CNRS, PSL Research University, 75005 Paris, France

Published online: 17 May 2021

 Springer

We recall the definition of the end space. Consider an exhaustive increasing sequence $K_1 \subset K_2 \subset \dots$ of finite subsets of X . An *end* of Γ is a sequence $U_1 \supseteq U_2 \supseteq \dots$ where U_n is an infinite connected component of the subgraph obtained by deleting the vertices in K_n and adjacent edges. For more details, see Definition 2.1. Our main result states:

Theorem 1.1 *Consider a finitely generated group G acting transitively on a space X . Fix a generating set S and let $\Gamma = (X, E)$ be the associated Schreier graph. Let μ be a measure on G with a finite first moment such that the induced random walk on Γ is transient. Then, the random walk almost surely converges towards a (random) end of the graph.*

Notice that for measures with finite support, the result is straightforward. The result is also already known in the case where the action of G on X is non-amenable (this is a particular case of [20, Theorem 21.16], which we recall as Theorem 2.5), under the condition of a finite first moment. An action is non-amenable when there is no G -invariant mean on X . Kesten's criterion [11] states that for any symmetric non-degenerate measure on the group, the action is non-amenable if and only if the induced random walk on X has probability of return to the origin that decreases exponentially (see Bartholdi [2] for a survey on the amenability of group actions). The general case of the cited [20, Theorem 21.16] does not assume that the random walk is induced by a measure on a group. The result is no longer true if we assume neither that the walk is induced by a measure on a group nor that the probability of return to the origin decreases exponentially. We prove that in Proposition 2.6, where we construct a Markov chain (X, P) that is transient, uniformly irreducible and has a uniform first moment, but does not converge towards an end of Γ .

If the action is non-amenable, the random walk induced by any non-degenerate measure is transient (see [20, Lemma 1.9]). In the general case, transience can sometimes be obtained from the graph geometry using a comparison Lemma 2.2 due to Baldi–Lohoué–Peyrière [1]. Combining this lemma and the theorem, we obtain:

Corollary 1.2 *Consider a finitely generated group G acting transitively on a space X . Fix a generating set S and let $\Gamma = (X, E)$ be the associated Schreier graph. Assume that Γ is a transient graph. Then, for all measures μ on G with finite first moments such that $\text{supp}(\mu)$ generates G as a semigroup, the induced random walk almost surely converges towards an end of the graph.*

We will also explain how this result can be applied to Thompson's group F . Let us recall the definition of this group. The set of dyadic rationals $\mathbb{Z}[\frac{1}{2}]$ is the set of numbers of the form $a2^b$ with $a, b \in \mathbb{Z}$. Thompson's group F is the group of orientation-preserving piecewise linear self-isomorphisms of the closed unit interval with dyadic slopes, with a finite number of break points, all break points being in $\mathbb{Z}[\frac{1}{2}]$. It is a finitely generated group with a canonical generating set (with two elements). See Cannon–Floyd–Parry [3] or Meier's book [13, Ch. 10] for details and properties. Its amenability is a celebrated open question. It is well known that amenability is equivalent to the existence of a non-degenerate measure with trivial Poisson boundary (see Kaimanovich–Vershik [10], Rosenblatt [16]). The boundary of a random walk induced by an action is a quotient of the boundary of the walk on the group.

The Schreier graph on $\mathbb{Z}[\frac{1}{2}]$ (of a conjugate action of F) has been described by Savchuk [17, Proposition 1]. It is a tree that can be understood as a combination of a skeleton quasi-isometric to a binary tree, and rays attached at each point of the skeleton (see Fig. 2). Understanding the geometry of the graph directly shows that it is transient. Kaimanovich [9, Theorem 14] also proves this result without using the geometry of the graph. Hence, by Corollary 1.2 and Lemma 4.2 we obtain

Corollary 1.3 *Consider a measure on Thompson's group F with a finite first moment, the support of which generates F as a semigroup. Then, the induced random walk on $\mathbb{Z}[\frac{1}{2}]$ has non-trivial Poisson boundary.*

This extends the following previous results. Kaimanovich [9] and Mishchenko [14] prove that the simple random walk on the Schreier graph given by that action has non-trivial boundary. Kaimanovich [9, Section 6.A] further shows that it is non-trivial for walks induced by measures with supports that are finite and generate F as a semigroup. We have also shown [19] that for any measure with a finite first moment on F , the support of which generates F as a semigroup, the walk on the group has non-trivial Poisson boundary.

The result of the corollary is false without assuming a finite first moment. Juschenko and Zheng [7] have proven that there exists a symmetric non-degenerate measure on F such that the induced random walk has trivial Poisson boundary. If the trajectories almost surely converge towards points on the end space, the end space endowed the exit measure on it is a quotient of the Poisson boundary. However, the self-similarity of the graph implies that the exit measure cannot be trivial, as we prove in Lemma 4.2. Combining the result of Juschenko–Zheng with this lemma, we obtain:

Corollary 1.4 *There exists a finitely generated group G , a space X and a symmetric non-degenerate measure on G such that*

- G acts amenably and transitively on X ,
- the induced random walk on the Schreier graph is transient,
- the induced random walk on the Schreier graph does not converge towards an end of the graph.

In particular, the measure described by Juschenko and Zheng [7, Theorem 3] provides an example for the action of Thompson's group F on $\mathbb{Z}[\frac{1}{2}]$.

Concerning Thompson's group F , studying the Poisson boundary of random walks on it has been highlighted as a possible approach to proving non-amenability in the work of Kaimanovich. The results by him and Mischenko further suggested that one could consider the boundary of induced random walks $\mathbb{Z}[\frac{1}{2}]$, but that was shown impossible by the result of Juschenko–Zheng. In more recent results, Juschenko [6] studied walks on the space of n -element subsets of $\mathbb{Z}[\frac{1}{2}]$ and gave a combinatorial necessary and sufficient condition for the Poisson boundary of induced walks on that space to be non-trivial for all non-degenerate measures. In that situation, the existence of a measure with trivial boundary is due to Juschenko for $n = 2$ and to Schneider and Thom [18] for a general n .

2 Preliminaries

Consider a finitely generated group G acting transitively on a space X and a measure μ on G . The random walk on G is defined by multiplication on the right. That is, the walk with trajectories (g_n) for $n \in \mathbb{N}$ where $g_{n+1} = g_n h_n$ and the increments h_n are sampled by μ . In other words, the random walk is defined by the kernel $(g, h) \mapsto \mu(g^{-1}h)$. The trajectory of the induced random walk on X starting at a point o is the image of the trajectory of the walk on the group by the map:

$$(g_n) \mapsto (o, g_n).$$

Its kernel is $P(x, y) = \sum_{x, g=y} \mu(g)$. We now fix a generating set S of G and consider the undirected graph $\Gamma = (X, E)$ with vertices X and edges $E = \{(x, x.s) \text{ for } s \in S, x \in X\}$. We recall that this is called the *Schreier graph*, and that it is connected as we assumed the action to be transitive. It is worth noting that the directed version of the same definition is also referred to as the Schreier graph, and that in the figures in this article, the edges will have an assigned direction for easier visualisation. It is known that every connected regular graph of even degree is isomorphic to a Schreier graph. It was first proven by Gross [5] for finite graphs. For a detailed proof of the infinite case, see [12, Theorem 3.2.5].

Definition 2.1 For a compact $K \subset X$ denote by $\pi_0(X \setminus K)$ the set of connected components of $X \setminus K$. There is a natural partial order defined by $K_1 \leq K_2$ if and only if $K_1 \subseteq K_2$. That order gives rise to a natural morphism $\pi_{1,2} : \pi_0(X \setminus K_2) \mapsto \pi_0(X \setminus K_1)$ which sends a connected component into the connected component of which it is a subset. This forms an inverse system indexed by $K \subset X$ (see [15, Section 3.1.2]). The end space is then the inverse limit

$$\varprojlim_{\substack{K \subset X \\ \text{compact}}} \pi_0(X \setminus K) = \{(x_K) \in \prod_{\substack{K \subset X \\ \text{compact}}} \pi_0(X \setminus K) \mid \pi_{1,2} x_2 = x_1, K_1 \subset K_2\}.$$

In our case, the end space can be described using an increasing exhaustive sequence of finite sets K_n , as such sequences are cofinal in the set of all compact subsets. That is, any compact set is included in K_n for n large enough.

We use the following comparison lemma by Baldi–Lohoué–Peyrière [1].

Lemma 2.2 (Comparison lemma) *Let $P_1(x, y)$ and $P_2(x, y)$ be doubly stochastic kernels on a countable set X and assume that P_2 is symmetric. Assume that there exists $\varepsilon \geq 0$ such that*

$$P_1(x, y) \geq \varepsilon P_2(x, y)$$

for any x, y . Then, if P_2 is transient, then so is P_1 .

Here, doubly stochastic kernels means that the operators are reversible and the inverse of each is also Markov. Equivalently, they preserve the counting measure;

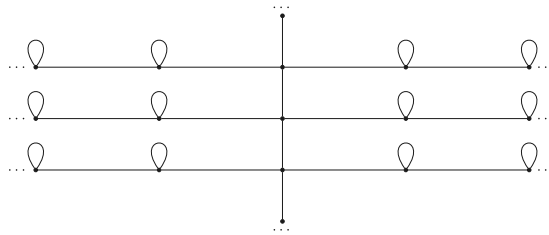

Fig. 1 A recurrent graph with infinitely many ends

it is worth noting that the result holds true more generally for operators with any common stationary measure, see Kaimanovich [9, Section 3.C]; see also Woess [20, Section 2.C.3.A]. For the walks considered in this article, it is direct to verify that for all probability measures, $p(x, y) = \mu(x^{-1}y)$ is doubly stochastic (as the inverse operator is defined by $(x, y) \mapsto \mu(y^{-1}x)$).

We recall that a random walk is called *transient* if, for any point, almost every trajectory leaves that point after finite time. Otherwise, the walk is called *recurrent* and there is a point that the walk almost surely visits an infinite amount of times. A graph is called transient (recurrent) if the simple random walk on it is transient (recurrent). The *Green function* G is defined by $G_z(x, y) = \sum_{n \in \mathbb{N}} p^{(n)}(x, y)z^n$ where $p^{(n)}$ is the n -time transition probability of p . In other words, $p^{(n)}(x, y)$ is the probability that a random walk starting in x is at y after n steps. We will write $G(x, y) = G_1(x, y)$. A walk is transient if and only if $G(x, x) < \infty$ for all $x \in X$.

Remark that recurrent walks do not converge to the end space. However, it is possible for a measure on a group to induce a transient walk even if the uniform measure is recurrent, in which case we can apply Theorem 1.1. Here, we give an example of that situation in which the graph has infinitely many ends.

Example 2.3 Consider the graph Ψ in Fig. 1. Consider the action of the free group on two generators F_2 on it where the first generator a sends each vertex to the right, and the second generator b sends a vertex to the vertex above if possible, and to itself otherwise. The graph is recurrent. Consider the measure $\mu(a) = \frac{3}{8}$, $\mu(a^{-1}) = \frac{1}{8}$, $\mu(b) = \mu(b^{-1}) = \frac{1}{4}$. It is transient and converges towards the ends defined by the right-hand side rays.

If we do not require the measure on F_2 to have a finite first moment, it can be chosen symmetric, while the induced walk remains transient. This can be done on any graph containing an infinite array, see [4, Lemma 7.1]. Furthermore, we can construct recurrent graphs for which it is possible to have symmetric measures (on the acting group) with finite first moments that induce transient walks:

Example 2.4 Consider the graph Ψ' obtained by Ψ by replacing the horizontal lines with \mathbb{Z}^2 planes. It is a recurrent graph. Consider the free product $\mathbb{Z} * \mathbb{Z}^2$ with generators $a \in \mathbb{Z}$ and $b, c \in \mathbb{Z}^2$. Consider its action on Ψ' where a moves a vertex to the vertex above if possible, and to itself otherwise, and b and c act horizontally. There is a

symmetric transient measure μ on \mathbb{Z}^2 with a finite first moment. Consider $\mu' = \frac{1}{4}(\delta_a + \delta_{a-1}) + \frac{1}{2}\mu$. It induces a transient walk on Ψ' , which by Theorem 1.1 almost surely converges to an element of end space.

Let us recall the exact statement of Theorem 21.16 from the book of Woess [20]. For a graph $\Gamma = (X, E)$ and a Markov operator P on X , the theorem states:

Theorem 2.5 ([20, Theorem 21.16]) *If (X, P) is uniformly irreducible and has a uniform first moment, and $\rho(P) < 1$, then the random walk defined by (X, P) converges almost surely to a random end of Γ .*

Let us define the concepts in the statement. The walk is uniformly irreducible if there exists $c > 0$ and finite $K \in \mathbb{N}$ such that for all neighbouring vertices x and y , there exists $k \leq K$ such that $p^{(k)}(x, y) \geq c$. The step distribution on a point $x \in X$ is defined as $\sigma_x(n) = \sum_{y:d(x,y)=n} p(x, y)$. The step distributions are *tight* if there is a distribution σ on \mathbb{N}_0 , such that for all x and all n , the tails $\sigma_x([n, +\infty))$ are bounded by the tails of σ . The walk has uniform first moment if the step distributions are tight with some σ that has finite first moment. The spectral radius is $\rho(P) = \limsup_{n \rightarrow \infty} p^{(n)}(x, y)^{1/n}$. (This quantity does not depend on x and y .) It is straightforward to check that if $\rho(P) < 1$, then the random walk is transient. Moreover, applying the definition for $x = y$ we see that $\rho(P) < 1$ if and only if the probability of return to the origin decreases exponentially. We will show that the result of Theorem 2.5 is not true without the assumption $\rho(P) < 1$. By sgn we denote the sign function on \mathbb{Z} : $\text{sgn}(z) = 1$ if $x \geq 0$ and $\text{sgn}(x) = -1$ if $x < 0$.

Proposition 2.6 1. *There is a graph $\Gamma = (X, E)$ and a Markov operator P on X such that (X, P) is transient, uniformly irreducible and has a uniform first moment, but the random walk defined by (X, P) does not converge almost surely to a random end of Γ .*

2. *Consider the Markov chain $(\mathbb{Z}, P_{p_n, \varepsilon_n})$ which, given $p_n \geq 0$ and $\varepsilon_n \geq 0$, is defined as*

$$P(x, y) = \begin{cases} (1 - p_n)^{\frac{1+\varepsilon_n}{2}} & \text{for } y = \text{sgn}(x)(|x| + 1) \\ (1 - p_n)^{\frac{1-\varepsilon_n}{2}} & \text{for } y = \text{sgn}(x)(|x| - 1) \\ p_n & \text{for } y = -x \\ 0 & \text{otherwise.} \end{cases}$$

There is a choice of $p_n \geq 0$ and $\varepsilon_n \geq 0$ such that $(\mathbb{Z}, P_{p_n, \varepsilon_n})$ is transient, uniformly irreducible, has uniform first moment and has an infinite expected number of steps where the sign changes. In particular, it verifies the conditions of (1).

The exact values that appear in the proof are $p_n = \frac{1}{n^2(\ln n)^2}$ and $\varepsilon_n = \frac{(n+1)(\ln(n+1))^2 - n(\ln n)^2}{(n+1)(\ln(n+1))^2 + n(\ln n)^2}$.

Proof We will find sufficient conditions on $p_n \geq 0$ and $\varepsilon_n \geq 0$ under which $(\mathbb{Z}, P_{p_n, \varepsilon_n})$ verifies the conditions we seek, and then provide a choice that satisfies those conditions. Specifically, the sufficient conditions are (1), (2), (3) and (4).

The tails $\sigma_x([n, +\infty))$ are bounded by the tail of the distribution σ on \mathbb{N}_0 defined by $\sigma(0) = \sigma(1) = 1$, $\sigma(2n) = p_n$ for $n \geq 1$ and $\sigma(x) = 0$ otherwise. The Markov

chain $(\mathbb{Z}, P_{p_n, \varepsilon_n})$ has uniform first moment if and only if σ has finite first moment, or equivalently

$$\sum_{n \in \mathbb{N}} np_n < \infty. \tag{1}$$

For $(\mathbb{Z}, P_{p_n, \varepsilon_n})$ to be uniformly irreducible, it would suffice that there should exist $c > 0$ such that $(1 - p_n)^{\frac{1-\varepsilon_n}{2}} \geq c$ for all n . If we have

$$p_n \xrightarrow{n \rightarrow \infty} 0 \text{ and } \varepsilon_n \xrightarrow{n \rightarrow \infty} 0 \tag{2}$$

then $(1 - p_n)^{\frac{1-\varepsilon_n}{2}} \xrightarrow{n \rightarrow \infty} \frac{1}{2}$. In that case, replacing if necessary the values a finite number of p_n and/or ε_n with 0, we can have $(1 - p_n)^{\frac{1-\varepsilon_n}{2}} \geq c$.

To study the transience of $(\mathbb{Z}, P_{p_n, \varepsilon_n})$, we consider \tilde{P} on \mathbb{N}_0 defined by $\tilde{P}(k, k + 1) = (1 - p_n)^{\frac{1+\varepsilon_n}{2}}$, $\tilde{P}(k, k - 1) = (1 - p_n)^{\frac{1-\varepsilon_n}{2}}$ and $\tilde{P}(k, k) = p_n$. It is a nearest neighbour random walk on \mathbb{N}_0 , and its transience is equivalent to the transience of $(\mathbb{Z}, P_{p_n, \varepsilon_n})$. Nearest neighbour random walks on \mathbb{N}_0 are well understood. As seen in [20, Section 2.16], $(\mathbb{N}_0, \tilde{P})$ is transient if and only if

$$\sum_{k=1}^{\infty} r(e_k) < \infty \tag{3}$$

where $r(e_k) = \frac{\tilde{P}(k-1, k-2) \dots \tilde{P}(1, 0)}{\tilde{P}(0, 1) \dots \tilde{P}(k-1, k)}$. We have $\frac{r(e_{k+1})}{r(e_k)} = \frac{1-\varepsilon_k}{1+\varepsilon_k}$ and therefore defining ε_k is equivalent to defining $r(e_k)$.

Finally, if the Green function of \tilde{P} is $G(\tilde{P})$, then the expected number of ‘‘jumps’’ between n and $-n$ is $G(\tilde{P})(n, n)p_n$. We wish to obtain $\sum_n G(\tilde{P})(n, n)p_n = \infty$. From the results of [20, Example 2.13, Section 2.16], it follows that $G(\tilde{P})(n, n) = \frac{1}{r(e_n)\tilde{P}(n, n-1)} \sum_{k=n+1}^{\infty} r(e_k)$. If $\tilde{P}(n, n - 1) \geq c$, it would suffice to have

$$\sum_{n \in \mathbb{N}} p_n \frac{1}{r(e_n)} \sum_{k=n+1}^{\infty} r(e_k) = \infty. \tag{4}$$

We now define $r(e_k)$ and p_k and claim that those choices verify conditions (1), (2), (3) and (4). Let

$$r(e_k) = \frac{1}{k(\ln k)^2} \text{ and } p_k = \frac{1}{k^2(\ln k)^2}.$$

We first prove condition (1). It suffices to observe that

$$\sum_{n \geq 2} np_n \leq \int_1^{\infty} \frac{x}{x^2(\ln x)^2} dx = -\frac{1}{\ln x} \Big|_1^{\infty},$$

which is finite. As $r(e_k) = kp_k$, this also proves condition (3). Condition (2) is straightforward.

We now only need to prove condition (4). Similarly, we have

$$\sum_{k=n+1}^{\infty} r(e_k) \geq \int_{n+1}^{\infty} \frac{1}{x(\ln x)^2} dx = -\frac{1}{\ln x} \Big|_{n+1}^{\infty}$$

and thus

$$\frac{1}{r(e_n)} \sum_{k=n+1}^{\infty} r(e_k) \geq \frac{n(\ln n)^2}{\ln(n+1)} \approx n \ln n.$$

Then,

$$\sum_{n \in \mathbb{N}} p_n \frac{1}{r(e_n)} \sum_{k=n+1}^{\infty} r(e_k) \geq \sum_{n \in \mathbb{N}} \frac{1}{n \ln(n+1)} \geq \int_2^{\infty} \frac{1}{x \ln x} dx = \ln(\ln(x)) \Big|_2^{\infty}$$

which is not finite. □

3 Proof of Main Theorem 1.1

Consider a finite set $K \subset X$ and denote $\Gamma_1, \dots, \Gamma_k$ the connected components of its complement. We will study the probability to change the component at step n and prove that the sum over n is finite.

Consider $x \in X \setminus K$ and $g \in G$. We will study the probability that $x.g$ is not in the same component. Let $g = s_1 s_2 \dots s_n$ where $|g| = n$ and $s_i \in S$. If x and $x.g$ are in different components, by definition the path $x, x.s_1, \dots, x.g$ passes through K . Therefore, there is i such that $x.s_1 s_2 \dots s_i \in K$. Equivalently, $\langle \sum_{i \leq n} \tau_{s_1 s_2 \dots s_i} \delta_x, \sum_{k \in K} \delta_k \rangle \geq 1$ where δ_y is the characteristic function at a given point y and τ_f is the translation defined by $\tau_f \delta_y = \delta_{y.f}$. We observe

$$\langle \sum_{i \leq n} \tau_{s_1 s_2 \dots s_i} \delta_x, \sum_{k \in K} \delta_k \rangle = \langle \delta_x, \sum_{i \leq n} \sum_{k \in K} \tau_{s_i^{-1} \dots s_2^{-1} s_1^{-1}} \delta_k \rangle.$$

We denote

$$f = \sum_{s_1 s_2 \dots s_n \in G} \mu(s_1 s_2 \dots s_n) \sum_{i \leq n} \sum_{k \in K} \tau_{s_i^{-1} \dots s_2^{-1} s_1^{-1}} \delta_k.$$

Then, the probability that x and $x.g$ are in different components is not greater than $\langle \delta_x, f \rangle$. Furthermore, the l^1 norm of f satisfies $\|f\|_1 \leq |K| \|\mu\|_1$ where $\|\mu\|_1$ is the first moment of μ . In particular, it is finite.

Take a random walk starting at a fixed point \mathfrak{o} and consider n large enough so that the transient walk has left K . The probability of changing component at step $n + 1$ is then not greater than

$$\langle p^{(n)}\delta_{\mathfrak{o}}, f \rangle.$$

We have

$$\sum_{n \in \mathbb{N}} \langle p^{(n)}\delta_{\mathfrak{o}}, f \rangle = \sum_{n \in \mathbb{N}} \sum_{x \in X} p^{(n)}(\mathfrak{o}, x) f(x) = \sum_{x \in X} f(x) G(\mathfrak{o}, x)$$

where we will have the right to interchange the order of summation if we prove that the right-hand side is finite. Let \check{p} be the kernel induced by the inverse measure $\check{\mu} : g \mapsto \mu(g^{-1})$, and $G^{(\check{p})}$ the Green function corresponding to that kernel. Then, $G(\mathfrak{o}, x) = G^{(\check{p})}(x, \mathfrak{o})$. It is a known property of the Green function that for all $x, y \in X$, we have $G^{(\check{p})}(x, y) \leq G^{(\check{p})}(y, y)$. This follows from the fact that the left-hand side is the expected number of visits of y of a walk starting at x , while the right-hand side is the expected number of visits starting at y . Thus,

$$\sum_{x \in X} f(x) G(\mathfrak{o}, x) \leq G^{(\check{p})}(\mathfrak{o}, \mathfrak{o}) \|f\|_1 < \infty.$$

This proves that after finite time, the walk almost surely stays in the same connected component of the complement of K . Applying this for an increasing exhaustive sequence of K , we obtain the result of Theorem 1.1.

It is worth mentioning that this approach is similar to the one used by Kaimanovich [8, Theorem 3.3] to prove pointwise convergence of the configuration of walks on lamplighter groups with a finite first moment.

4 Thompson’s Group F

We now apply Theorem 1.1 to Thompson’s group F . The Schreier graph on the dyadic numbers has been described by Savchuk [17, Proposition 1](see Fig. 2). We have the following self-similarity result:

Lemma 4.1 *Consider the Schreier graphs of F for its action on $\mathbb{Z}[\frac{1}{2}]$ (see Fig. 2). We denote left (respectively right) branch the subgraph of the vertices v for which any geodesic between v and $\frac{5}{8}$ passes through $\frac{13}{16}$ (respectively, $\frac{9}{16}$). On the figure, those are the left and right branches of the tree, along with the rays starting at them. Then, each branch can be embedded as a labelled graph into the other.*

Remark that stronger results of self-similarity of this graph have already been observed, see, for example, [9, Section 5.F].

Proof Each branch is a labelled tree, and thus, an equivariant embedding is uniquely defined by the image of the root. We choose the image of $\frac{13}{16}$ to be $\frac{25}{32}$. This defines an

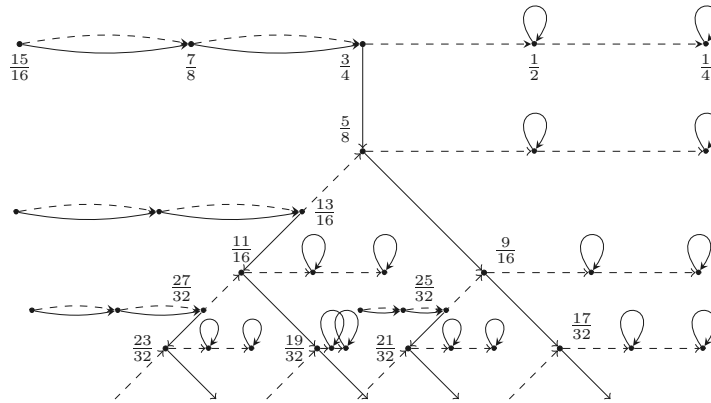

Fig. 2 Schreier graph of the dyadic action of F for the standard generators

embedding of the left branch into the right one. Similarly, choosing $\frac{11}{16}$ as the image of $\frac{9}{16}$ defines an embedding of the right branch into the left one. \square

This implies:

Lemma 4.2 Fix a measure on F , the support of which generates F as a semi-group such that the induced random walk on the dyadic numbers almost surely converges towards an end of the graph. Then, the exit measure on the end space is not trivial.

Proof We decompose the end space into five sets: two sets containing, respectively, the ends of the left or the right branch, and three sets that are the singletons corresponding to the rays at $\frac{5}{8}$ and $\frac{3}{4}$. The rays have equivariant embeddings into the branches. Combining with Lemma 4.1, this means that any of those five sets can be equivariantly embedded into another one. In particular, if the restriction of the exist measure on one of them has nonzero mass, then by transitivity the restriction on the embedding also has nonzero mass. \square

Acknowledgements I would like to thank Professor Wolfgang Woess for a discussion on the early variants of this paper which helped to improve the original version. I am very grateful to Professor Vadim Kaimanovich for his detailed comments and useful suggestions.

References

1. Baldi, P., Lohoué, N., Peyrière, J.: Sur la classification des groupes récurrents. C. R. Acad. Sci. Paris Sér. A-B **285**(16), A1103–A1104 (1977)
2. Bartholdi, L.: Amenability of groups and G-sets. In: Berthé, V., Rigo, M. (eds.) Sequences, Groups, and Number Theory, pp. 433–544. Springer, Cham (2018)
3. Cannon, J.W., Floyd, W.J., Parry, W.R.: Introductory notes on Richard Thompson’s groups. Enseign. Math. **42**, 215–256 (1996)

4. Erschler, A.: Boundary behavior for groups of subexponential growth. *Ann. Math.* **160**(3), 1183–1210 (2004)
5. Gross, J.L.: Every connected regular graph of even degree is a Schreier coset graph. *J. Combin. Theory Ser. B* **22**(3), 227–232 (1977)
6. Juschenko, K.: Liouville property of strongly transitive actions. preprint, arXiv: 1806.02753 (June 2018)
7. Juschenko, K., Zheng, T.: Infinitely supported Liouville measures of Schreier graphs. *Groups Geom. Dyn.* **12**, 911–918 (2018)
8. Kaimanovich, V.A.: Poisson boundaries of random walks on discrete solvable groups. In: Heyer, H. (ed.) *Probability Measures on Groups X*, pp. 205–238. Springer, Boston (1991)
9. Kaimanovich, V.A.: Thompson’s group F is not Liouville. In: Ceccherini-Silberstein, T., Salvatori, M., Sava-Huss, E. (eds.) *Groups, Graphs and Random Walks*, London Mathematical Society Lecture Note Series, pp. 300–342. Cambridge University Press, Cambridge (2017)
10. Kaimanovich, V.A., Vershik, A.M.: Random walks on discrete groups: boundary and entropy. *Ann. Probab.* **11**(3), 457–490 (1983)
11. Kesten, H.: Symmetric random walks on groups. *Trans. Am. Math. Soc.* **92**(2), 336–336 (1959)
12. Leemann, P.-H.: On subgroups and Schreier graphs of finitely generated groups. PhD thesis, Univ. Genève (Aug 2016)
13. Meier, J.: *Groups, Graphs and Trees*. Cambridge University Press, Cambridge (2008)
14. Mishchenko, P.: Boundary of the action of Thompson group F on dyadic numbers. Preprint, arXiv: 1512.03083 (2015)
15. Rhodes, J., Steinberg, B.: *The q -Theory of Finite Semigroups*. Springer Monographs in Mathematics. Springer, Boston (2009)
16. Rosenblatt, J.: Ergodic and mixing random walks on locally compact groups. *Math. Ann.* **257**(1), 31–42 (1981)
17. Savchuk, D.: Some graphs related to Thompson’s group F . In: Bogopolski, O., Bumagin, I., Kharlampovich, O., Ventura, E. (eds.) *Combinatorial and Geometric Group Theory*, pp. 279–296. Birkhäuser, Basel (2010)
18. Schneider, F.M., Thom, A.: The Liouville property and random walks on topological groups. *Comment. Math. Helv.* **95**(3), 483–513 (2020)
19. Stankov, B.: Non-triviality of the Poisson boundary of random walks on the group $H(\mathbb{Z})$ of Monod. In: *Ergodic Theory and Dynamical Systems*, 41(4):1160–1189 (2021). <https://doi.org/10.1017/etds.2019.76>
20. Woess, W.: *Random Walks on Infinite Graphs and Groups* Cambridge Tracts in Mathematics. Cambridge University Press, Cambridge (2000)

Publisher’s Note Springer Nature remains neutral with regard to jurisdictional claims in published maps and institutional affiliations.

Chapitre 5

Følner functions and sets on wreath products and Baumslag-Solitar groups

FØLNER FUNCTIONS AND SETS ON WREATH PRODUCTS AND BAUMSLAG-SOLITAR GROUPS

BOGDAN STANKOV

ABSTRACT. We calculate the exact values of the Følner function of the lamplighter group for the standard and the switch-walk-switch generating sets. Følner functions encode the isoperimetric properties of amenable groups and have previously been studied up to asymptotic equivalence (that is to say, independently of the choice of finite generating set). We also obtain a lower bound for the Følner function for a class of permutational wreath products (with certain generating sets). We use that bound to construct an example of a group, the Følner function of which has the same exponent as its growth function. What is more, we prove an isoperimetric result concerning the edge boundary on the Baumslag-Solitar group $BS(1, 2)$ with the standard generating set.

Følner function, Følner sets, lamplighter group, wreath products, permutational wreath products, Baumslag-Solitar groups, Coulhon and Saloff-Coste inequality, growth function

1. INTRODUCTION

One equivalent characterisation of the amenability of an infinite group G , called the *Følner condition*, is that the isoperimetric constant (also known as Cheeger constant) of its Cayley graph should be 0. That constant is defined as the infimum of $\frac{|\partial F|}{|F|}$ over all finite sets $F \subset G$ with $|F| \leq \frac{1}{2}|G|$. As the quotient cannot reach 0, amenability is therefore characterised by the existence of a sequence of sets F_n such that $\frac{|\partial F_n|}{|F_n|}$ converges towards 0, also known as a *Følner sequence*. One natural direction for studying the possible Følner sequences on a given group is to ask how small the sets can be. We consider the Følner function (see (3) for the definition of ∂_{in}):

Definition 1.1. The *Følner function* $F\phi$ (or $F\phi_S$; or $F\phi_{G,S}$) of a group G with a given finite generating set S is defined on \mathbb{N} by

$$F\phi(n) = \min \left\{ |F| : F \subset G, \frac{|\partial_{in} F|}{|F|} \leq \frac{1}{n} \right\}.$$

Remark that $F\phi(1) = 1$. Most research seeks to classify it up to asymptotic equivalence. Two functions are asymptotically equivalent if there are constants A and B such that $f(x/A)/B < g(X) < f(xA)B$. The Følner function of a group clearly depends on the choice of a generating set, but the functions arising from different generating sets (and more generally, functions arising from quasi-isometric spaces) are asymptotically equivalent.

The classical isoperimetric theorem states that among domains of given volume in \mathbb{R}^n , the minimal surface area is obtained on a ball (see survey by Osserman [18, Section 2]). As \mathbb{Z}^n is quasi-isometric to \mathbb{R}^n , this is also a first isoperimetric result for discrete groups. The fact that if a minimum exists, it is realised only on the ball is obtained (in \mathbb{R}^2) by Steiner in the XIXth century, using what is now called Steiner symmetrization (see Hehl [14], Hopf [15], Froehlich [8]). The existence of a minimum is obtained, in \mathbb{R}^3 , by Schwarz [28]. Varopoulos [31] shows more generally an isoperimetric inequality for direct products. Pansu [20] (see also [19]) obtains one for the Heisenberg group H_3 . One central result is the Coulhon and Saloff-Coste inequality [5]:

Theorem 1.2 (Coulhon and Saloff-Coste inequality). *Consider an infinite group G generated by a finite set S and let $\phi(\lambda) = \min(n|V(n) > \lambda)$. Then for all finite sets F*

$$\frac{|\partial_{in} F|}{|F|} \geq \frac{1}{8|S|\phi(2|F|)}.$$

Date: 20 June, 2021.

The multiplicative constants can be improved (see Gábor Pete [22, Theorem 5.11], Bruno Luiz Santos Correia [27]):

$$(1) \quad \frac{|\partial_{in} F|}{|F|} \geq \frac{1}{2\phi(2|F|)}.$$

The result of Santos Correia is also announced for finite groups for $|F| \leq \frac{1}{2}|G|$. The Coulhon and Saloff-Coste inequality (Theorem 1.2) implies in particular that for a group with exponential growth, the Følner function must also grow at least exponentially. Similarly, it is known that the Følner functions of groups with polynomial growth are polynomial (see for example [34, Section I.4.C]). Another inequality on group isoperimetry is given by Żuk [35]. Vershik [32] asks if Følner function can be super-exponential, initiating the study of Følner functions. He suggests studying the wreath product $\mathbb{Z} \wr \mathbb{Z}$ as a possible example. Pittet [23] shows that the Følner functions of polycyclic groups are at most exponential (and are therefore exponential for polycyclic groups with exponential growth). This is true more generally for solvable groups of finite Prüfer rank, see [25] and [16]. The first example of a group with super-exponential Følner function is obtained by Pittet and Saloff-Coste [24] for $\mathbb{Z}^d \wr \mathbb{Z}/2\mathbb{Z}$. Later the Følner functions of wreath products with certain regularity conditions are described by Erschler [6] up to asymptotic equivalence. Specifically, say that a function f verifies property (*) if for all $C > 0$ there is $k > 0$ such that $f(kn) > Cf(n)$. The result of [6] then states that if the Følner functions of two groups A and B both verify property (*), then the Følner function of $A \wr B$ is $\text{Føl}_{A \wr B}(n) = \text{Føl}_B(n)^{\text{Føl}_A(n)}$.

Other examples with known Følner functions have been presented by Gromov [12, Section 8.2, Remark (b)] for all functions with sufficiently fast growing derivatives. Saloff-Coste and Zheng [26] provide upper and lower bounds for it on, among others, "bubble" groups and cyclic Neumann-Segal groups, and those two bounds are asymptotically equivalent under certain conditions. Recently, Briussel and Zheng [3] show that for any non-decreasing f with $f(1) = 1$ and $x/f(x)$ non-decreasing, there is a group whose Følner function is asymptotically equivalent to the exponent of the inverse function of $x/f(x)$. Erschler and Zheng [7] obtain examples for a class of super-exponential functions under $\exp(n^2)$ with weaker regularity conditions. Specifically, for any d and any non-decreasing τ such that $\tau(n) \leq n^d$, there is a group G and a constant C such that

$$(2) \quad Cn \exp(n + \tau(n)) \geq \text{Føl}_G(n) \geq \exp\left(\frac{1}{C}(n + \tau(n/C))\right).$$

The left-hand side of this inequality is always asymptotically equivalent to $\exp(n + \tau(n))$, and it suffices therefore that the right-hand side be asymptotically equivalent to that function to have a description of the Følner function of G . Notice in particular that if τ verifies condition (*), this is verified. Remark that the conditions we mentioned only consider functions at least as large as $\exp(n)$; it is an open question whether a Følner function can have intermediate growth (see Grigorchuk [10, Conjecture 5(ii)]). By a result of Erschler, a negative answer would imply the Growth Gap Conjecture [10, Conjecture 2], which conjectures that the volume growth function must be either polynomial or at least as fast as $\exp(\sqrt{n})$. Those conjectures also have weak versions, which are equivalent to each other (see discussion after Conjecture 6 in [10]).

1.1. Formulation of results. In this paper, we obtain the exact values of the Følner function for two classical generating sets on the lamplighter group $\mathbb{Z} \wr \mathbb{Z}_2$ (see Definition 2.2) where by \mathbb{Z}_2 we denote $\mathbb{Z}/2\mathbb{Z}$. The standard Følner sets F_n on that group are defined as $F_n = \{(k, f) | k \in \llbracket 1, n \rrbracket, \text{supp}(f) \subset \llbracket 1, n \rrbracket\}$. The two generating sets we consider are the standard set $S = \{t, \delta\}$ (see (4)) and the switch-walk-switch set $S' = \{t, \delta, t\delta, \delta t, \delta t\delta\}$.

We will provide a lower bound for the outer boundary of a class of permutational wreath products in Theorem 4.1. It applies in particular to $\mathbb{Z} \wr \mathbb{Z}_2$, and we will obtain that the standard sets are optimal (see Definition 3.1) for the outer and edge boundaries for the standard generating set. We then show that by Lemma 3.2, $F_n \cup \partial_{out} F_n$ is optimal for the inner boundary, and obtain the Følner functions :

Theorem 1.3. *Consider the lamplighter group $\mathbb{Z} \wr \mathbb{Z}_2$.*

(1) *For any $n \in \mathbb{N}$ and any $F \subset \mathbb{Z} \wr \mathbb{Z}_2$ such that $|F| \leq |F_n|$, we have*

$$\frac{|\partial F|}{|F|} \geq \frac{|\partial_{out} F|}{|F|} \geq \frac{|\partial_{out} F_n|}{|F_n|} = \frac{|\partial F_n|}{|F_n|},$$

2

- and if $|F| < |F_n|$, the inequalities are strict,
- (2) From point (1) it follows that for any $n \in \mathbb{N}$ and any $F \subset \mathbb{Z} \wr \mathbb{Z}_2$ such that
- (a) (For the standard generating set) $|F| \leq |F_n \cup \partial_{out} F_n|$, we have $\frac{|\partial_{in} F|}{|F|} \geq \frac{|\partial_{in}(F_n \cup \partial_{out} F_n)|}{|F_n \cup \partial_{out} F_n|}$, and if $|F| < |F_n \cup \partial_{out} F_n|$, the inequality is strict,
 - (b) (For S') $|F| \leq |F_n \cup \partial'_{out} F_n|$, we have $\frac{|\partial'_{in} F|}{|F|} \geq \frac{|\partial'_{in}(F_n \cup \partial'_{out} F_n)|}{|F_n \cup \partial'_{out} F_n|}$ (notice that $F_n \cup \partial'_{out} F_n = t^{-1}F_{n+2}$), and if $|F| < |F_n \cup \partial'_{out} F_n|$, the inequality is strict,
- (3) From point (2) it follows that, for $n \geq 2$, the Følner functions of the lamplighter group for the standard generating set is

$$\text{Føl}(n) = 2n2^{2(n-1)}$$

and for the switch-walk-switch set it is

$$\text{Føl}_{sws}(n) = 2n2^{2n}.$$

We also obtain that for the standard generators, the sets giving equality are unique up to translation.

We then substitute those values in the Coulhon and Saloff-Coste inequality in order to study the multiplicative constants. The inequality 1 implies (for all groups and all generating sets) that

$$2\text{Føl}(n) > V\left(\frac{n}{2} - 1\right).$$

For groups with exponential growth, it is easy to see that the multiplicative constant in front of n holds more importance than the other constants. Indeed, if we were to prove that $A\text{Føl}(n) \geq V(n(\frac{1}{2} + \varepsilon) - B)$ for any $\varepsilon, A, B > 0$, that would be a strictly stronger result for large n . One may then ask:

Question 1.4. For a group G and a generating set S , denote by $C_{G,S}$ the supremum of the set of constants C such that there exist A, B such that $A\text{Føl}(n) \geq V(Cn - B)$. What is the infimum C_0 of the set of $C_{G,S}$ over all finitely generated groups and all finite generating sets?

The original inequality obtains a positive result for $C = \frac{1}{8|S|}$ (and thus $C_0 \geq \frac{1}{8|S|}$), while the results of [22, Theorem 5.11] and [27] that we cited as Equation 1 show that $C_0 \geq \frac{1}{2}$. We will go in detail on this constant in the preliminary Section 2, where we will show in Proposition 2.4 that $C_{G,S} = \frac{\liminf \frac{\ln \text{Føl}(n)}{n}}{\lim \frac{\ln V(n)}{n}}$.

Proposition 1.5. *The lamplighter group verifies*

$$C_{\mathbb{Z} \wr \mathbb{Z}_2, S} = \frac{\lim \frac{\ln \text{Føl}(n)}{n}}{\lim \frac{\ln V(n)}{n}} = \frac{\ln 4}{\ln(\frac{1}{2}(1 + \sqrt{5}))} \approx 2,88$$

for the standard generating set, and

$$C_{\mathbb{Z} \wr \mathbb{Z}_2, S'} = \frac{\lim \frac{\ln \text{Føl}_{sws}(n)}{n}}{\lim \frac{\ln V_{sws}(n)}{n}} = 2.$$

This provides an upper bound of 2 for C_0 . Remark that the bound was already known before proving that the standard sets are optimal; what Theorem 1.3 gives is that this example cannot improve it. In Example 2.6 we will see that the upper bound can be lowered to $C_0 \leq 1$.

Another direction that can be considered once one has exact evaluations of Følner functions is studying the power series $\sum_n \text{Føl}(n)x^n$. The equivalent series have been studied for volume growth (see Grigorchuk-de la Harpe [11, Section (4)]). One central question that a lot of authors have considered is the rationality of those series as a function. For the two examples shown here, the power series of the Følner function are rational functions: they are respectively $\frac{2x}{(4x-1)^2}$ et $\frac{8x}{(4x-1)^2}$.

We also obtain results for the Baumslag-Solitar group $BS(1,2)$ (see Definition 2.3), however only in respect to the edge boundary. Taking the notation from the definition, its standard sets are defined the same way as in the lamplighter group.

Theorem 1.6. *Consider the Baumslag-Solitar group $BS(1,2)$ with the standard generating set. Then for any $n \in \mathbb{N}$ and any $F \subset \mathbb{Z} \wr \mathbb{Z}_2$ such that $|F| \leq |F_n|$, we have $|\partial F| \geq |\partial F_n|$ (where F_n are the standard sets), and if $|F| < |F_n|$, the inequality is strict.*

This result is not always true for $B(1, p)$ for larger p , and we will provide a counter example for $p = 8$ and the standard set with 8 elements. However this counter example comes from p being significant when compared to the length of the interval defining the standard set, and it is possible that for $B(1, p)$ as well, standard sets are optimal above a certain size.

We present more detailed definitions and construct Example 2.6 in the next section. In Section 3, we present associated graphs, which are the main tool of the proof, and prove some general results. In particular, we show Lemma 3.2, which will be used to obtain that part (2)a of Theorem 1.3 follows from part (1). In Section 4, we announce and prove Theorem 4.1 and show that the main Theorem 1.3 follows from it. In Section 5, we prove Proposition 1.5. Finally, in Section 6, we study Baumslag-Solitar groups.

2. PRELIMINARIES AND EXAMPLES

The concept of amenability finds its origins in a 1924 result by Banach and Tarski [1], where they decompose a solid ball in \mathbb{R}^3 into five pieces, and reassemble them into two balls using rotations. That is now called the Banach-Tarski paradox. The proof makes use of the fact that the group of rotations of \mathbb{R}^3 admits a free subgroup. Von Neumann [17] considers it as a group property and introduces the concept of amenable groups. Tarski [29] later proves amenability to be the only obstruction to the existence of "paradoxical" decompositions (like the one in Banach-Tarski's article) of the action of the group on itself by multiplication, as well as any free actions of the group. One way to prove the result of Banach-Tarski is to see it as an almost everywhere free action of $SO_3(\mathbb{R})$ and correct for the countable set where it is not (see Wagon [33, Cor. 3.10]). For more information and properties of amenability, see books by Greenleaf [9] and Wagon [33], or an article by Ceccherini-Silberstein-Grigorchuk-la Harpe [4], or a recent survey by Bartholdi [2].

Definition 2.1 (Følner criterion). A group G is amenable if and only if for every finite set $S \subset G$ and every $\varepsilon > 0$ there exists a set F such that

$$|F\Delta S.F| \leq \varepsilon|F|.$$

If G is finitely generated, it suffices to consider a single generating set S instead of all finite sets. We can also apply Definition 2.1 for $S \cup S^{-1} \cup \{Id\}$. Then $|F\Delta(S \cup S^{-1} \cup \{Id\}).F|$ is the set of vertices in the Cayley graph of G that are at a distance exactly 1 from F . We denote that the outer boundary $\partial_{out}F$. Then the condition can be written as $\frac{|\partial_{out}F_n|}{|F_n|} \leq \varepsilon$, or in other words that the infimum of those quotients should be 0. Similarly, let

$$(3) \quad \partial_{in}F = \left\{ g \in F : \exists s \in S \cup S^{-1} : gs \notin F \right\}.$$

Finally, we consider ∂F to be the set of edges between F and its complement. Remark that while those values can differ, whether the infimum of $\frac{|\partial F|}{|F|}$ is 0 or not does not depend on which boundary we consider.

For groups of subexponential growth, for every ε , there is some n such that the ball around the identity of radius n is a corresponding Følner set. Note that to obtain a Følner sequence from this, one needs to consider a subsequence of the sequence of balls of radius n . It is an open question whether in every group of subexponential growth, all balls form a Følner sequence. For groups of exponential growth, it is generally not sufficient to consider balls, and it is an open question whether there exists any group of exponential growth where some subsequence of balls forms a Følner sequence (one place where the question is mentioned is by Tessera [30, Question 15]).

For two groups A and B , denote $B^{(A)}$ the set of functions from A onto B such that all but a finite number of values are Id_B .

Definition 2.2. The (restricted) wreath product $A \wr B$ is the semi-direct product of A and $B^{(A)}$ where A acts on $B^{(A)}$ by translation.

We can write the elements as (a, f) with $a \in A$ and $f \in B^{(A)}$. The group law is then $(a, f)(a', f') = (aa', x \mapsto f(x)f'(xa^{-1}))$.

Given generating sets S and S' on A and B respectively, we can define a standard generating set of $A \wr B$. It consists of the elements of the form (s, \mathbb{I}_B) for $s \in S$ (where $\mathbb{I}_B = Id_B$ for all $x \in A$), as well as $(Id_A, \delta_{Id_A}^{s'})$ for $s' \in S'$ where $\delta_{Id_A}^{s'}(Id_A) = s'$ and $\delta_{Id_A}^{s'}(x) = Id_B$ for all other x . One can verify that multiplying an element (a, f) on the right with the first type of generating element, one obtains (as, f) , and with the second type, the value of f at the point a is changed by s' .

4

Similarly, given Følner sets F_A and F_B on A and B respectively, one obtains standard Følner sets on $A \wr B$:

$$F = \{(a, f) \mid a \in F_A, \text{supp}(f) \subset F_B, \forall x : f(x) \in F_B\}.$$

Their outer boundary is

$$\partial_{\text{out}} F = \{(a, f) \mid a \in \partial_{\text{out}} F_A, \text{supp}(f) \subset F_B, \forall x : f(x) \in F_B\} \cup \{a \in F_A, \text{supp}(f) \subset F_A, f(a) \in \partial_{\text{out}} F_B\}.$$

As $|F| = |F_A||F_B|^{|F_A|}$ and $|\partial_{\text{out}} F| = |\partial_{\text{out}} F_A||F_B|^{|F_A|} + |F_A||F_B|^{|F_A|-1}|\partial_{\text{out}} F_B|$, we have

$$\frac{|\partial_{\text{out}} F|}{|F|} = \frac{|\partial_{\text{out}} F_A|}{|F_A|} + \frac{|\partial_{\text{out}} F_B|}{|F_B|}.$$

We will focus on the lamplighter group $\mathbb{Z} \wr \mathbb{Z}_2$. As both of those groups have standard generating sets, this gives us a standard generating set on the lamplighter group:

$$(4) \quad S = \{t, \delta\} \text{ where } t = (1, \mathbf{0}) \text{ and } \delta = (0, \delta_0^1).$$

The Baumslag-Solitar groups are defined as follows:

Definition 2.3. The Baumslag-Solitar group $BS(m, n)$ is the two-generator group given by the presentation $\langle a, b : ba^m b^{-1} = a^n \rangle$.

The standard generating set is $\{a, b\}$.

We will focus on the groups $BS(1, p)$. That group is isomorphic to the group generated by $x \mapsto px$ and $x \mapsto x + 1$ (by mapping b^{-1} and a to them respectively). In that group, any element can be written as $p^n x + f$ with $n \in \mathbb{Z}$ and $f \in \mathbb{Z}[\frac{1}{p}]$. Its generators act respectively by changing n or by adding p^n to f . Similarly to the lamplighter group, we will write the elements as (n, f) . The standard Følner sets are then expressed in the same way as for wreath products. In other words:

$$F_n = \{p^k x + f \mid k \in \llbracket 1, n \rrbracket, f \in \mathbb{Z}, 0 \leq f < p^{n+1}\}.$$

With regards to the constant mentioned in Question 1.4, it is not hard to see that if the limits $\lim \frac{\ln \text{Føl}(n)}{n}$ and $\lim \frac{\ln V(n)}{n}$ exist for a given group and generating set, the supremum $C_{G,S}$ in that case would be their quotient (a proof will be given in Proposition 2.4). The second limit always exists. Indeed, as any element of length at most mn can be written as a product of two elements of length at most m and n respectively, we have

$$V(m+n) \leq V(m)V(n),$$

and thus $\ln V(n)$ is sub-additive. The limit then exists by Fekete's Subadditive Lemma. However, the other limit $\lim \frac{\ln \text{Føl}(n)}{n}$ doesn't always exist. The trivial example would be groups with super-exponential Følner functions, where it diverges towards $+\infty$. However, even choosing the convention that we will consider that as a converging sequence, the limit still doesn't always exist. We can see that in examples by Erschler and Zheng where the Følner function oscillates between $\exp n$ and $\exp n^c$. In that case $\frac{\ln \text{Føl}(n)}{n}$ oscillates between a finite constant and plus infinity. Specifically, consider [7, Example 3.8(2)] for $\alpha = 1$ and $\beta = 2$. Take a sequence (η_i) and a function $\tau(n) = n^\alpha$ for $n \in [\eta_{2j-1}, \eta_{2j}]$ and $\tau(n) = n^\beta$ for $n \in [\eta_{2j}, \eta_{2j+1}]$. The example then gives us a group, the Følner function of which verifies Inequality 2. For $n \in [\eta_{2j-1}, \eta_{2j}]$ we have $\frac{\ln \text{Føl}(n)}{n} \leq \frac{\ln(Cn)}{n} + 1 + \frac{\tau(n)}{n}$, which is smaller than 3 for large n . On the other hand, if $n \in [\eta_{2j}, \eta_{2j+1}]$, $\frac{\ln \text{Føl}(n)}{n} \geq \frac{1}{Cn}(n + \tau(n/C)) = \frac{1}{C} + \frac{n}{C^2}$. In particular, it is strictly larger than 4 for large n . Thus, $\frac{\ln \text{Føl}(n)}{n}$ neither converges towards a finite number, nor diverges towards $+\infty$. However, we can still consider \liminf .

Proposition 2.4. For any given group and generating set, the supremum of the constants C such that $A \text{Føl}(n) \geq V(Cn - B)$ for some A, B is $C_{G,S} = \frac{\liminf \frac{\ln \text{Føl}(n)}{n}}{\lim \frac{\ln V(n)}{n}}$.

Proof. Assume that $A \text{Føl}(n) \geq |B(Cn - B)|$ for some A, B, C . For any n , we have

$$\frac{\ln \text{Føl}(n)}{n} \geq \frac{\ln(|B(Cn - B)|) - \ln A}{n} = C \frac{\ln(|B(Cn - B)|)}{Cn} - \frac{A'}{n}$$

where A' is a constant. This is in particular true on any subsequence and thus

$$\liminf \frac{\ln \text{Fol}(n)}{n} \geq C.$$

Inversely, if $C < \frac{\liminf \frac{\ln \text{Fol}(n)}{n}}{\lim \frac{\ln b_n}{n}}$, by definition of \lim and \liminf , there is N_0 such that for any $n \geq N_0$, $\frac{\ln \text{Fol}(n)}{\frac{\ln |B(Cn)|}{Cn}} > C$. Equivalently, $\frac{\ln \text{Fol}(n)}{n} \geq C \frac{\ln(|B(Cn)|)}{Cn}$, or

$$\text{Fol}(n) \geq |B(Cn)|.$$

By choosing appropriate A and B we obtain the result for $n < N_0$ as well. \square

In order to provide an example where $C_{G,S} \leq 1$, we will need to consider a generalisation of wreath products.

Definition 2.5. Consider a group A acting on a set X and denote the action by a . The (restricted) permutational wreath product $A \wr_a B$ is the semi-direct product of A and $B^{(X)}$ where A acts on $B^{(X)}$ by translation.

Remark that a wreath product $A \wr B$ is the permutational wreath product with regards to the action of A on itself by multiplication.

Consider the infinite dihedral group D_∞ , defined as

$$D_\infty = \langle a, x | x^2 = e, xax = a^{-1} \rangle.$$

Alternatively, it is the semi-direct product of $\mathbb{Z}/2\mathbb{Z}$ on \mathbb{Z} , with the non-identity acting as the inverse map on \mathbb{Z} . All elements can thus be written either as xa^n or as a^n for some $n \in \mathbb{Z}$. We will consider it with a different generating set : the set $\{x, y\}$ where

$$y = xa.$$

Note that $xax = a^{-1}$ becomes $(xa)^2 = e$ and thus the infinite dihedral group is the free product of two copies of $\mathbb{Z}/2\mathbb{Z}$.

FIGURE 1. (A portion of the) Schreier graph of D_∞ for the subgroup $\{e, x\}$ with x (dashed, black), y (blue) and a (thin, red). We will consider it with the generating set $\{x, y\}$ (without the red lines)

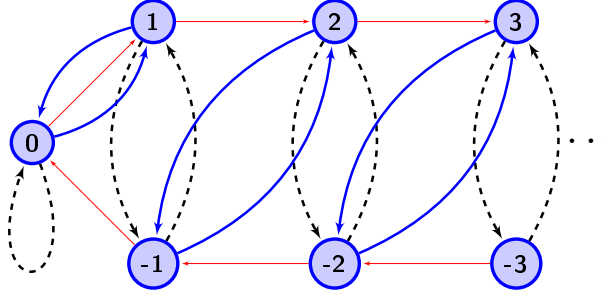

Consider the subgroup $\{e, x\} < D_\infty$ and the (left) Schreier coset graph it defines (with generating set $\{x, y\}$). We are interested in the associated action a of D_∞ on the cosets (defined by multiplication). By definition, each vertex of the graph is of the form $\{g, xg\}$. Since $x^2 = e$, we have

$$\{g, xg\} = \{xa^n, a^n\}$$

for some $n \in \mathbb{Z}$. Representing the set $\{xa^n, a^n\}$ with the integer n , the graph is pictured in Figure 1. Considering it with the generating set $\{x, y\}$, it becomes a ray: $0, 1, -1, 2, -2, 3, -3, \dots$

Example 2.6. The wreath product $D_\infty \wr_a \mathbb{Z}_2$ with the generating set $S_{dih} = \{t_x, t_y, \delta, t_x \delta, \delta t_x, \delta t_x \delta, t_y \delta, \delta t_y, \delta t_y \delta\}$ verifies $C_{D_\infty \wr_a \mathbb{Z}_2, S_{dih}} = \frac{\liminf \frac{\ln \text{Fol}(n)}{n}}{\lim \frac{\ln V(n)}{n}} \leq 1$.

Proof. Fix some integer n . We have standard Følner sets on D_∞ defined as

$$A_n = \{a^k, xa^k; |k| \leq n\}.$$

This gives us standard Følner sets on the wreath product $D_\infty \wr_a \mathbb{Z}/2\mathbb{Z}$:

$$F_{2n+1} = \{(k, f); |k| \leq n, \text{supp}(f) \subseteq A_n\}.$$

Remark that since the Schreier graph of the action a is a ray, the boundary of the image of A_n is only 1. We claim that we thus have $\frac{|\partial_{in} F_{2n+1}|}{|F_{2n+1}|} = \frac{1}{2n+1}$. Let us verify that. We have

$$|F_{2n+1}| = 2(2n+1)2^{2n+1}.$$

Consider a point $(\varepsilon a^k, f) \in \partial_{in} F_{2n+1}$ where $\varepsilon = x$ or the neutral element e . By definition, there exists $s \in S_{dih}$ such that $(\varepsilon a^k, f)s = (\varepsilon' a^{k'}, f') \notin F_{2n+1}$. We have either $\text{supp}(f') \not\subseteq A_n$, or $\varepsilon' a^{k'} \notin A_n$. If $\text{supp}(f') \not\subseteq A_n$ then either εa^k or $\varepsilon' a^{k'}$ is not in A_n . As $\varepsilon a^k \in A_n$ by definition, we have $\varepsilon' a^{k'} \notin A_n$. In both cases we obtain that $\varepsilon' a^{k'} \notin A_n$. Therefore $\varepsilon a^k \in \partial_{in} A_n$; or in other words $k = -n$. Thus

$$|\partial_{in} F_{2n+1}| = 2 \times 2^{2n+1}.$$

This proves that their quotient is $\frac{1}{2n+1}$. Then $\text{Føl}(2n+1) \leq 2(2n+1)2^{2n+1}$ and

$$\liminf \frac{\ln \text{Føl}(n)}{n} \leq \ln 2.$$

We now estimate $V(n)$. Consider products of type $s_1 s_2 \dots s_n$ where $s_{2i} \in \{t_x, \delta t_x\}$ and $s_{2i+1} \in \{t_y, \delta t_y\}$. We have

$$\begin{aligned} s_1 s_2 \dots s_{2i} &= (a^{-i}, f_{2i}) \\ s_1 s_2 \dots s_{2i+1} &= (xa^{i+1}, f_{2i+1}) \end{aligned}$$

for some functions f_i . Then the two choices of s_i we consider determine the value of $f_n(i)$. In particular, any two different choices result in $s_1 s_2 \dots s_n$ being a different element of $D_\infty \wr_a \mathbb{Z}/2\mathbb{Z}$. Moreover, we have that the length of $s_1 s_2 \dots s_n$ is n . Therefore $V(n) \geq 2^n$ and

$$\lim \frac{\ln V(n)}{n} \geq \ln 2.$$

□

Applying Proposition 2.4 we obtain:

Corollary 2.7. *The answer to Question 1.4 is at most 1.*

We will also show that those Følner sets are optimal in Section 4.

Proposition 2.8. *In the wreath product $D_\infty \wr_a \mathbb{Z}_2$ with the generating set $S_{dih} = \{t_x, t_y, \delta, t_x \delta, \delta t_x, \delta t_x \delta, t_y \delta, \delta t_y, \delta t_y \delta\}$, the standard Følner sets $F_{2n+1} = \{(k, f); |k| \leq n, \text{supp}(f) \subseteq A_n\}$ are optimal with respect to the inner and outer boundaries.*

3. MAIN CONCEPTS OF THE PROOF

Definition 3.1. We will call a set F in a group G *optimal* with respect to the inner (respectively outer, edge) boundary if for any F' with $|F'| \leq |F|$, it is true that $\frac{|\partial_{in} F'|}{|F'|} \geq \frac{|\partial_{in} F|}{|F|}$ (respectively $\frac{|\partial_{out} F'|}{|F'|} \geq \frac{|\partial_{out} F|}{|F|}$, $\frac{|\partial_{edge} F'|}{|F'|} \geq \frac{|\partial_{edge} F|}{|F|}$), and if $|F'| < |F|$, the inequalities are strict.

Lemma 3.2. *If F is optimal for the outer boundary, up to replacing F with another optimal set of the same size, $F \cup \partial_{out} F$ is optimal for the inner boundary,*

Proof. We will prove the large inequality. The case for the strict inequality is equivalent.

Let F be optimal for the outer boundary and consider F' such that $|F'| \leq |F \cup \partial_{out} F|$ and the quotient of the inner boundary is smaller. Without loss of generality, we can assume that F' is optimal for the inner boundary.

Let $F'' = F' \setminus \partial_{in} F'$. Observe that $\partial_{out} F'' \subseteq \partial_{in} F'$. We first claim that F' being optimal implies that $\partial_{out} F'' = \partial_{in} F'$. Indeed, $|F'' \cup \partial_{out} F''| \leq |F'|$, and

7

$$\frac{|\partial_{in}(F'' \cup \partial_{out} F'')|}{|F'' \cup \partial_{out} F''|} \leq \frac{|\partial_{out} F''|}{|F'' \cup \partial_{out} F''|} = \frac{\frac{|\partial_{out} F''|}{|F''|}}{1 + \frac{|\partial_{out} F''|}{|F''|}},$$

while

$$\frac{|\partial_{in} F'|}{|F'|} = \frac{\frac{|\partial_{in} F'|}{|F''|}}{1 + \frac{|\partial_{in} F'|}{|F''|}}.$$

As $\partial_{out} F'' \subset \partial_{in} F'$ and $\frac{x}{x+1}$ is an increasing function in \mathbb{R}_+ , the first quantity is smaller than the second, and by F' being optimal, we have an equality.

We now consider cases for the size of F'' . If $|F''| \leq |F|$, then we can apply the assumption that F is optimal and we get

$$\frac{|\partial_{out} F|}{|F|} \leq \frac{|\partial_{out} F''|}{|F''|} = \frac{|\partial_{in} F'|}{|F'' \setminus \partial_{in} F'|} = \frac{\frac{|\partial_{in} F'|}{|F''|}}{1 - \frac{|\partial_{in} F'|}{|F''|}}.$$

However, applying the initial assumption by which we chose F' gives us the inverse inequality, and strict.

We are left with the case where $|F''| > |F|$. Let $k = |F''| - |F|$ and remove any k points from F'' to obtain F''' . We obtain a set that is the same size as F and has an outer boundary no larger than that of F . It is therefore another optimal set of the same size, and by the optimality of F' for the inner boundary, $F''' \setminus \partial_{out} F''' = F'$, which concludes the proof. \square

The central idea of this paper is to work on an associated graph structure which we can define for a group, the elements of which we have written in the form (n, f) .

Definition 3.3. Consider a group G and an encoding of its elements as pairs $(n, f) \in A \times B$. Consider a generating set S of G . We define the *associated graph* as the directed labelled graph $\Gamma = \Gamma_S$ with vertex set $V(\Gamma) = B$ and edge set

$$\vec{E} = \{(f_1, f_2) : \exists s \in S, n_1, n_2 \in A \text{ such that } (n_1, f_1)s = (n_2, f_2)\}.$$

With those notations, the edge (f_1, f_2) is labelled s .

As mentioned, the two examples we will consider here are the lamplighter group $\mathbb{Z} \wr \mathbb{Z}_2$ and the Baumslag-Solitar group $BS(1, p)$. In both examples we have $A = \mathbb{Z}$. In the case of the lamplighter group we have $B = \mathbb{Z}_2^{(\mathbb{Z})}$, and for $BS(1, p)$, B is the set of p -adic numbers.

We define an associating function $\phi : G \rightarrow \mathcal{P}(\Gamma)$ by

$$\phi(n, f) = \{(f, f_j) | (n, f)s = (n', f_j) \text{ for some } n' \in A, s \in S\}.$$

Definition 3.4. Consider a group G and an encoding of its elements as pairs $(n, f) \in A \times B$. Let F be a finite subset of G . The *associated subgraph* of F is the subgraph of the associated graph Γ made of the edges

$$\bigcup_{x \in F} \phi(x)$$

and all adjacent vertices.

We will provide a bound for the boundary of a set based on a formula on the associated subgraph, and maximise the value of that formula over all subgraphs of Γ no larger (in terms of number of edges) than the associated subgraph.

4. THE LAMPLIGHTER GROUP

In this section we provide the proof of Theorem 1.3, the larger part being a proof of Theorem 1.3(1). In other words, we show that the standard sets are optimal with respect to the outer boundary, and uniquely so up to translation. We will present it in a more general context, so that Proposition 2.8 also follows. Specifically, they will be shown to follow from the following lower bound:

8

Theorem 4.1. Consider a permutational wreath product $A \wr \mathbb{Z}_2$, where A is infinite, equipped with generating set that includes a set of elements of the form $(t, \mathbb{1}_{\mathbb{B}})$ where the set of these t generates A . Denote by β the cardinal of any (every) stabiliser of the action. Then for every finite subset F of $A \wr \mathbb{Z}_2$ with $|F| \leq \beta n 2^n$, we have $\frac{|\partial_{out} F|}{|F|} \geq \frac{2}{\beta n}$. Furthermore, equality can only be achieved by sets, the associated subgraph of which is formed of all configurations with support in some set I in the space acted on, such that the boundary of I is exactly $2/\beta$.

Remark in particular that for those groups we will have $\liminf \frac{\ln \text{Fol}(n)}{n} \geq \ln 2^{2/\beta}$.

We first prove an inequality relying the isoperimetry of a subset with values of the associated subgraph.

Lemma 4.2. Let F be a finite set in $A \wr \mathbb{Z}_2$. Let Γ be the associated graph (see Definition 3.3). Then

$$\frac{|\partial_{out} F|}{|F|} \geq \min \left(\frac{2|V(G)|}{|E(G)|} \text{ for } G \text{ subgraph of } \Gamma \text{ with at most } |F| \text{ edges} \right).$$

We will obtain that by estimating the number of points in the boundary that are reachable from the set by multiplication by a generating element of A . Remark that every (labelled) edge corresponds to exactly β elements in the group.

Proof. Consider a finite set F of elements of $A \wr \mathbb{Z}_2$. Let \tilde{F} be the associated subgraph (see Definition 3.4). A leaf we call a vertex which is included in exactly one edge of the subgraph and is at the head of that edge. The set of leaves we denote by $L(\tilde{F})$. We claim:

$$(5) \quad |\partial_{out} F| \geq 2|V(\tilde{F})| - |L(\tilde{F})| = 2(|V(\tilde{F})| - |L(\tilde{F})|) + |L(\tilde{F})|.$$

More specifically, we claim that for each configuration f that is a vertex of this subgraph, either f is a leaf and there is at least one element of $\partial_{out} F$ that has f as its configuration, or f is not a leaf and there are at least two such elements. The first case follows directly from the definition of a leaf.

Assume that f is not a leaf. Then either there are two edges ending in f , or there is at least one edge starting at f . Once again, the first case follows directly from the definition. In the second case, A being infinite implies that its Cayley graph has \mathbb{Z} as a subgraph, and thus any subset of A has at least two points in its boundary. If they are a and b , then (a, f) and (b, f) are in the outer boundary of F .

Now we only need to prove that

$$\frac{2|V(\tilde{F})| - |L(\tilde{F})|}{|E(F)|} \geq \min \left(\frac{2|V(G)|}{|E(G)|} \text{ for } G \text{ subgraph of } \Gamma \text{ with at most } |F| \text{ edges} \right).$$

We will prove it by induction on the number of edges. The base is trivial, and so is the case where \tilde{F} has no leaves. Assume now that it contains a leaf and remove that leaf and the edge leading to it. Denote by F' the set we obtained. We have $|V(\tilde{F}')| = |V(\tilde{F})| - 1$, $|E(F')| = |E(F)| - 1$ and $|L(\tilde{F}')| \geq |L(\tilde{F})| - 1$. Therefore

$$\frac{2|V(\tilde{F}')| - |L(\tilde{F}')|}{|E(F')|} \leq \frac{2|V(\tilde{F})| - |L(\tilde{F})| - 1}{|E(F)| - 1} \leq \frac{2|V(\tilde{F})| - |L(\tilde{F})|}{|E(F)|}.$$

Furthermore, F' has less edges, which concludes the induction step. \square

Having proven Lemma 4.2, we now need to show that the standard sets minimise $\frac{2|V(G)|}{|E(G)|}$ over subgraphs of Γ with a fixed amount of edges. It would suffice to show that any subgraph with strictly less vertices has strictly less edges. In other words, we have to understand the sets of fixed size that maximise the amount of edges between them. Remark that if a graph contains the directed edge (x, y) , adding the edge (y, x) increases the number of edges without changing the number of vertices. We can therefore assume that any directed edge is present simultaneously with its inverse and replace them both with one undirected edge.

The graph we obtain is the infinite hypercube. As the subgraphs G we consider are finite, by hypothesis, they are contained in a finite hypercube. In that case, the question of maximising the number of edges on a fixed number of vertices has already been answered in literature. One proof is presented in Harper's book [13, Section 1.2.3]. Taking notations from the book, for any subset $C \subset \mathbb{N}$ of cardinal c , and any configuration f supported outside of C , we consider the set of vertices that are equal to f outside of C and can be anything inside C and call that a c -subcube. A vertex set S of cardinal $k = \sum_{i=1}^K 2^{c_i}$ with

$c_i < c_j$ for $i < j$ is *cubal* if it is a disjoint union of c_i -subcubes with the c_i -subcube being contained in the neighbourhood of the c_j -subcube for $i < j$. Here, neighbourhood means the set of points at distance 1 in graph distance. Remark that two cubal sets of the same cardinality are isomorphic. Then Theorem 1.1 from the cited section states

Theorem 4.3 ([13, Section 1.2.3 - Theorem 1.1]). *S maximises $|E(S)|$ for its cardinality if and only if S is cubal.*

As the associated graphs of the standard sets are cubal, and all cubal sets of a size that is a power of 2 are also subcubes, Theorem 4.1 follows. We have now obtained Theorem 1.3(1) and the outer boundary case of Proposition 2.8.

We now turn to the general case. By Lemma 3.2, Theorem 1.3(2)a follows from Theorem 1.3(1) (and the unicity of the optimal sets). To show that Theorem 1.3(2)b follows from Theorem 1.3(2)a, observe that we always have $\partial_{in}F \subset \partial'_{in}F$, and their sizes are the same for the standard sets. The inner boundary case of Proposition 2.8 also follows as in that group we have $F_n \cup \partial_{out}F_n = F_{n+1}$ (similarly to the switch-walk-switch generating set). Theorem 1.3(3) follows directly from Theorem 1.3(2).

5. BOUNDS FOR THE COULHON AND SALOFF-COSTE INEQUALITY FOR THE LAMPLIGHTER GROUP

We recall that in terms of exponential growth, the Coulhon and Saloff-Coste inequality implies

Corollary 5.1. *Given a group G and a generating set S, the Følner function $F\phi l(n)$ and the volume growth $V(n)$ verify*

$$\liminf \frac{\ln F\phi l(n)}{n} \geq \frac{1}{2} \lim \frac{\ln V(n)}{n}.$$

We will now prove Proposition 1.5. Recall its statement:

Proposition. *The lamplighter group verifies*

$$\frac{\lim \frac{\ln F\phi l(n)}{n}}{\lim \frac{\ln V(n)}{n}} = \frac{\ln 4}{\ln(\frac{1}{2}(1 + \sqrt{5}))} \approx 2,88$$

for the standard generating set, and

$$\frac{\lim \frac{\ln F\phi l_{sws}(n)}{n}}{\lim \frac{\ln V_{sws}(n)}{n}} = 2.$$

Proof. We have $\lim \sqrt[n]{F\phi l(n)} = \lim \sqrt[n]{F\phi l_{sws}(n)} = 4$. What is left is to calculate the exponent of their volume growth.

For the standard generating set, we write an element in a standard form. To obtain it, we consider the support of the element's configuration. If that support is $[m, p]$ we can then write it as $t^m A t^i$ where A is a non-reducible word of length at most $p - m$ on t and δ (without their inverses). In particular, m , i and $p - m$ are all less than n . Therefore if we denote by $V'(n)$ the amount of non-reducible words on t and δ of length at most n , we obtain that $V'(n)4n^2 \geq V(n) \geq V'(n)$. We then need only to understand $V(n)$. Notice that the only condition on those words in the lamplighter group is to not have two consecutive δ -s. Therefore $V'(n)$ is same as the amount of subsets of $[1, n]$ without two consecutive elements. A simple induction shows that those are (up to translation) the Fibonacci numbers: such a subset either has n in it, in which case the rest of the subset is contained in $[1, n - 2]$, or it does not have n . Therefore $\lim \sqrt[n]{V(n)} = \frac{1 + \sqrt{5}}{2}$.

The switch-walk-switch volume is similarly controlled by the size of the set of possible configurations given a certain interval. However, in its case all configurations with support in that interval are found on an element in the ball. Thus $4n^3 2^n \geq V_{sws}(n) \geq 2^n$ and $\lim \sqrt[n]{V_{sws}(n)} = 2$. \square

It is worth noting that the exact value of the volume growth power series $\sum_n V(n)x^n$ for the standard generating set has been described by Parry [21].

6. THE BAUMSLAG-SOLITAR GROUP $B(1,2)$

Similarly to the case of the lamplighter group, it is important to understand subgraphs of the associated graph with n vertices and a maximal number of edges. In the case of the Baumslag-Solitar group, configurations are represented by sums of powers of 2, with the value of a configuration at a given point representing the presence or absence of a given power. As a conjugation by the active generator in the group amounts to multiplying by a power of 2, without loss of generality we can assume that the vertices of Γ are the natural numbers, and that edges are of the form $(n, n + 2^i)$ for $n, i \in \mathbb{N}$. Furthermore, as this structure is preserved by translation by an integer, we can assume that the smallest vertex label in our subgraph is 1. We will prove:

Lemma 6.1. *A subgraph with a maximal number of edges and n vertices is $\llbracket 1, n \rrbracket$.*

Proof. We will prove the result by induction on n . Fix a subgraph F with n vertices. We will prove that it has less edges than $\llbracket 1, n \rrbracket$, the equation being strict unless they are equal (or a translation thereof).

Assume first that all elements of F are odd. In that case we consider the set $F' = \{f - 1 : f \in F\}$. Let 2^i be the largest power dividing all elements of F' . Define $\psi(f) = \frac{f-1}{2^i} + 1$. Then the set $\psi(F)$ is a set of integers with the smallest element being 1. Furthermore, $f - f'$ is a power of 2 if and only if $\psi(f') - \psi(f)$ is. Without loss of generality we can replace F by $\psi(F)$.

We now have that F has both even and odd elements. Let F_1 be the set of odd elements of F , and F_2 the set of even elements. By F'_1 we will denote $(F_1 - 1)/2$, and by F'_2 we will denote $F_2/2$. As the difference between elements of F_1 and F_2 is always odd, there can be an edge if and only if the difference is 1. Then the number of edges in F is not greater than

$$e(|F_1|) + e(|F_2|) + 2 \min(|F_1|, |F_2|) - \varepsilon$$

where $e(n)$ is the number of edges in $\llbracket 1, n \rrbracket$ and $\varepsilon = 1$ if $|F_1|$ and $|F_2|$ are equal, and 0 otherwise.

For $a \in \mathbb{N}$ with $2^{k-1} < a \leq 2^k$ we have that $e(a)$ is the sum over i of the amount of edges between elements with difference 2^i . In other words,

$$e(a) = \sum_{i=0}^{k-1} a - 2^i = ka - 2^k + 1.$$

Let us denote $2^{k-1} < a = |F_1| \leq 2^k$, $2^{l-1} < b = |F_2| \leq 2^l$ and $2^{t-1} < a + b = n \leq 2^t$. Without loss of generality, assume $a \leq b$. Then $t - 1 \leq l \leq t$. Let $\delta = t - l$. We calculate

$$\begin{aligned} e(|F_1|) + e(|F_2|) + 2 \min(|F_1|, |F_2|) - \varepsilon - e(n) &= e(a) + e(b) + 2a - \varepsilon - e(n) \\ &= ka - 2^k + 1 + lb - 2^l + 1 + 2a - \varepsilon - n(a + b) + 2^t - 1 \\ &= (k - l + 2)a - \delta(a + b) + 1 - 2^k + 2^t - 2^l - \varepsilon = A. \end{aligned}$$

We consider several cases. First, assume $\delta = 0$. Then $2^t = 2^l$ and

$$A = (k + 2 - t)a + 1 - 2^k - \varepsilon.$$

As $k \leq t - 1$, we have $A \leq a + 1 - 2^k - \varepsilon \leq 0$.

Assume now $\delta = 1$. Then

$$A = (k + 3 - t)a - n + 1 - 2^k + 2^{t-1} - \varepsilon.$$

Assume first that $k \leq t - 2$. Then $A \leq a - 2^k + 1 - (n - 2^{t-1}) - \varepsilon \leq 0$. □

Considering the edge boundary, the Baumslag-Solitar group has two types of edges on the boundary corresponding to the two generators. In the last section, we described the boundary corresponding to $(1, 0)$. We will now also describe the boundary corresponding to $(0, 1)$. As before, for an element (n, f) in a set F in the group, we can consider its orbit by $(0, 1)$, which is isomorphic to \mathbb{Z} and therefore has at least two elements in the boundary. Therefore the boundary corresponding to $(0, 1)$ is at least $2o(\Gamma_F)$ where $o(\Gamma_F)$ is the amount of orbits corresponding to adding 2^n for some n for some subgraph $\Gamma - F$ of Γ . For the subgraph $\llbracket 1, n \rrbracket$, that number is $n - 1$. We will prove that that is optimal by induction on $|V(\Gamma_F)| + o(\Gamma_F)$.

Lemma 6.2. *Consider a subgraph Γ_F such that $|V(\Gamma_F)| + o(\Gamma_F) = 2n - 1$ or $2n$. Then it has at most $e(n)$ edges.*

Proof. We will prove it by induction on n . Without loss of generality, we can assume that Γ_F has both even and odd vertices, the sets of which we denote F_1 and F_2 . Once again, without loss of generality we can assume that there is at least one edge between F_1 and F_2 (otherwise we can move F_2 to a set of even elements disjoint from F_1 and divide everything with a power of 2). Therefore $o(\Gamma_F) \geq o(F_1) + o(F_2) + 1$ and $|V(\Gamma_F)| = |V(F_1)| + |V(F_2)|$. Then $2n - 1 \geq |V(\Gamma_F)| + o(\Gamma_F) - 1 \geq |V(F_1)| + o(F_1) + |V(F_2)| + o(F_2)$. If $k_1 = \lceil \frac{|V(F_1)| + o(F_1)}{2} \rceil$ and $k_2 = \lceil \frac{|V(F_2)| + o(F_2)}{2} \rceil$, this implies $k_1 + k_2 \leq n$. The rest follows from the proof of Lemma 6.1. \square

Consider a set F in the Baumslag-Solitar group $B(2, 1)$. Its boundary is then at least

$$|\delta F| \geq 2(|V(\Gamma_F)| + o(\Gamma_F)).$$

Therefore Γ_F has at most $e(|\delta F|)$ edges. To each element in F correspond two edges. They are either in the graph (where each edge is counted twice) or sticking out of it along an orbit. We obtain

$$2|F| = 2|E(\Gamma_F)| + 2o(\Gamma_F).$$

This concludes the proof of Theorem 1.6.

Finally, we consider $BS(1, 8)$ with the standard generating set. The standard Følner set F_1 is $\{x + f : f \in \mathbb{N}, 0 \leq f \leq 7\}$. It has 8 elements, and $|\partial F| = 2.8 + 2 = 4.8$. Consider the set $F = \{(k, f) : k = 1 \text{ or } 2, f \in \mathbb{Z}, 0 \leq f \leq 3\}$. Similarly, we have $|F| = 8$. However, $|\partial F| = 2.4 + 2.2 = 4.6 < 4.8$. Therefore the result of Theorem 1.6 is not true for $BS(1, 8)$ for small enough sets.

REFERENCES

- [1] Stefan Banach and Alfred Tarski. Sur la décomposition des ensembles de points en parties respectivement congruentes. *Fundamenta Mathematicae*, 6:244–277, 1924. doi:10.1007/978-1-4939-1474-6.
- [2] Laurent Bartholdi. *Amenability of Groups and G-Sets*, pages 433–544. Springer International Publishing, Cham, 2018. doi:10.1007/978-3-319-69152-7_11.
- [3] Jérémie Brieussel and Tianyi Zheng. Speed of random walks, isoperimetry and compression of finitely generated groups. *Annals of Mathematics*, 193(1):1, 2021. doi:10.4007/annals.2021.193.1.1.
- [4] Tullio Ceccherini-Silberstein, Rostislav I. Grigorchuk, and Pierre de la Harpe. Amenability and paradoxical decompositions for pseudogroups and for discrete metric spaces. *Proceedings of the Steklov Institute of Mathematics*, 224:57–97, apr 1999.
- [5] Thierry Coulhon and Laurent Saloff-Coste. Isopérimétrie pour les groupes et les variétés. *Revista Matemática Iberoamericana*, 9(2):293–314, 1993. doi:10.4171/RMI/138.
- [6] Anna Erschler. On Isoperimetric Profiles of Finitely Generated Groups. *Geometriae Dedicata*, 100(1):157–171, 2003. doi:10.1023/A:1025849602376.
- [7] Anna Erschler and Tianyi Zheng. Isoperimetric inequalities, shapes of Følner sets and groups with Shalom’s property H_{FD} . *Annales de l’Institut Fourier*, 70(4):1363–1402, apr 2021. doi:10.5802/aif.3360.
- [8] Steffen Froehlich. *Konvexe Kurven und das isoperimetrische Problem*, 2009. FU Berlin.
- [9] Frederick P. Greenleaf. *Invariant means on topological groups and their applications*. Van Nostrand mathematical studies. Van Nostrand Reinhold Co., 1969.
- [10] Rostislav I. Grigorchuk. Milnor’s problem on the growth of groups and its consequences. In *Frontiers in Complex Dynamics*, pages 705–774. Princeton University Press, dec 2014. doi:10.1515/9781400851317-027.
- [11] Rostislav I. Grigorchuk and Pierre de la Harpe. On problems related to growth, entropy, and spectrum in group theory. *Journal of Dynamical and Control Systems*, 3(1):51–89, 1997. doi:10.1007/BF02471762.
- [12] Misha Gromov. Entropy and isoperimetry for linear and non-linear group actions. *Groups, Geometry, and Dynamics*, pages 499–593, 2008. doi:10.4171/GGD/48.
- [13] Larry H. Harper. *Global Methods for Combinatorial Isoperimetric Problems*. Cambridge University Press, Cambridge, UNITED KINGDOM, 2004.
- [14] Andreas Hehl. The Isoperimetric Inequality, Feb 2013. [handout. URL: https://www.math.uni-tuebingen.de/ab/GeometrieWerkstatt/IsoperimetricInequality.pdf](https://www.math.uni-tuebingen.de/ab/GeometrieWerkstatt/IsoperimetricInequality.pdf).
- [15] Heinz Hopf. *Selected Chapters of Geometry*, 1940. ETH Zuerich.
- [16] Peter H. Kropholler and Karl Lorensen. Virtually torsion-free covers of minimax groups. *Annales scientifiques de l’École normale supérieure*, 53(1):125–171, 2020. doi:10.24033/asens.2419.
- [17] John Von Neumann. Zur allgemeinen Theorie des Masses. *Fundamenta Mathematicae*, 13(1):73–116, 1929.
- [18] Robert Osserman. The isoperimetric inequality. *Bulletin of the American Mathematical Society*, 84(6):1182–1239, nov 1978. doi:10.1090/S0002-9904-1978-14553-4.
- [19] Pierre Pansu. Une inégalité isopérimétrique sur le groupe de Heisenberg. *Comptes Rendus des Séances de l’Académie des Sciences. Série I. Mathématique*, 295(2):127–130, 1982.

- [20] Pierre Pansu. An isoperimetric inequality on the Heisenberg group. In *Rendiconti del Seminario Matematico (già "Conferenze di Fisica e di Matematica")*. Università e Politecnico di Torino, number Special Issue, pages 159–174 (1984). 1983. Conference on differential geometry on homogeneous spaces (Turin, 1983).
- [21] Walter Parry. Growth of Some Wreath Products. *Transactions of the American Mathematical Society*, 331(2):751, jun 1992. doi:10.2307/2154138.
- [22] Gábor Pete. Probability and Geometry on Groups. Current version available at <http://math.bme.hu/~gabor/PGG.pdf>., sep 2020.
- [23] Christophe Pittet. Følner Sequences in Polycyclic Groups. *Revista Matemática Iberoamericana*, 11(3):675–685, 1995. doi:10.4171/RMI/189.
- [24] Christophe Pittet and Laurent Saloff-Coste. Amenable groups, isoperimetric profiles and random walks. In *Geometric Group Theory Down Under*, pages 293–316. DE GRUYTER, Berlin, New York, 1999. doi:10.1515/9783110806861.293.
- [25] Christophe Pittet and Laurent Saloff-Coste. Random walks on finite rank solvable groups. *Journal of the European Mathematical Society*, 5(4):313–342, nov 2003. doi:10.1007/s10097-003-0054-4.
- [26] Laurent Saloff-Coste and Tianyi Zheng. Isoperimetric profiles and random walks on some permutation wreath products. *Revista Matemática Iberoamericana*, 34(2):481–540, may 2018. doi:10.4171/RMI/994.
- [27] Bruno Luiz Santos Correia. On the isoperimetric inequality of Coulhon and Saloff-Coste. preprint, feb 2020. arXiv:2002.06996.
- [28] Hermann A. Schwarz. Beweis des Satzes, dass die Kugel kleinere Oberfläche besitzt, als jeder andere Körper gleichen Volumens. *Nachrichten von der Königl. Gesellschaft der Wissenschaften und der Georg-Augusts-Universität zu Göttingen*, 1884:1–13, 1884.
- [29] Alfred Tarski. Algebraische Fassung des Massproblems. *Fundamenta Mathematicae*, 31:47–66, 1938.
- [30] Romain Tessera. Volume of spheres in doubling metric measured spaces and in groups of polynomial growth. *Bulletin de la Société Mathématique de France*, 135(1):47–64, 2007. doi:10.24033/bsmf.2525.
- [31] Nicolas Th. Varopoulos. Random walks on groups. Applications to Fuchsian groups. *Arkiv för Matematik*, 23(1-2):171–176, dec 1985. doi:10.1007/BF02384423.
- [32] Anatoly M. Vershik. Countable groups that are close to finite ones, Appendix in: FP Greenleaf “Invariant Means on Topological Groups and Their Applications”, 1973. (in Russian), a revised English translation Amenability and approximation of infinite groups, *Selecta Math. Sov.* 2 (4), 311–330 (1982).
- [33] Stan Wagon. *The Banach-Tarski Paradox*. Encyclopedia of Mathematics and its Applications. Cambridge University Press, 1993.
- [34] Wolfgang Woess. *Random Walks on Infinite Graphs and Groups*. Cambridge Tracts in Mathematics. Cambridge University Press, 2000.
- [35] Andrzej Żuk. On an isoperimetric inequality for infinite finitely generated groups. *Topology*, 39(5):947–956, sep 2000. doi:10.1016/S0040-9383(99)00043-9.

DEPARTEMENT DE MATHÉMATIQUES ET APPLICATIONS, ÉCOLE NORMALE SUPÉRIEURE, CNRS, PSL RESEARCH UNIVERSITY, 75005 PARIS, FRANCE
 Email address: bogdan.zl.stankov@gmail.com

Articles

- [1] Bogdan Stankov. Non-triviality of the Poisson boundary of random walks on the group of Monod. *Ergodic Theory and Dynamical Systems*, 41(4) :1160–1189, apr 2021. doi:10.1017/etds.2019.76.
- [2] Bogdan Stankov. Convergence Towards the End Space for Random Walks on Schreier Graphs. *Journal of Theoretical Probability*, may 2021. doi:10.1007/s10959-021-01104-6.
- [3] Bogdan Stankov. Følner functions and sets on wreath products and Baumslag-Solitar groups. work in progress.

Bibliographie

- [Ady83] Sergei I. Adyan. Random walks in free periodic groups. *Mathematics of the USSR-Izvestiya*, 21(3) :425–434, jun 1983. doi:10.1070/IM1983v021n03ABEH001799.
- [Ave72] Andre Avez. Entropie des groupes de type fini. *Comptes-rendus de l'Académie des Sciences de Paris, Série A*, 275 :1363–1366, 1972.
- [Ave76] Andre Avez. Harmonic Functions on Groups. In M Cahen and M Flato, editors, *Differential Geometry and Relativity : A Volume in Honour of André Lichnerowicz on His 60th Birthday*, pages 27–32. Springer Netherlands, Dordrecht, 1976. doi:10.1007/978-94-010-1508-0_4.
- [Aze70] Robert Azencott. *Espaces de Poisson des Groupes Localement Compacts*, volume 148 of *Lecture Notes in Mathematics*. Springer Berlin Heidelberg, Berlin, Heidelberg, 1970. doi:10.1007/BFb0059352.
- [Bar18] Laurent Bartholdi. *Amenability of Groups and G-Sets*, pages 433–544. Springer International Publishing, Cham, 2018. doi:10.1007/978-3-319-69152-7_11.
- [Bas72] Hyman Bass. The Degree of Polynomial Growth of Finitely Generated Nilpotent Groups. *Proceedings of the London Mathematical Society*, s3-25(4) :603–614, nov 1972. doi:10.1112/plms/s3-25.4.603.
- [BDN17] Ievgen Bondarenko, Daniele D'Angeli, and Tatiana Nagnibeda. Ends of Schreier graphs and cut-points of limit spaces of self-similar groups. *Journal of Fractal Geometry*, 4(4) :369–424, dec 2017. doi:10.4171/JFG/55.
- [Ben83] Michael Benson. Growth series of finite extensions of \mathbb{Z}^n are rational. *Inventiones Mathematicae*, 73(2) :251–269, jun 1983. doi:10.1007/BF01394026.
- [Ben87] Max Benson. *On the rational growth of virtually nilpotent groups*, volume 111 of *Annals of Mathematics Studies*, pages 185–196. Princeton University Press, Princeton, dec 1987. doi:10.1515/9781400882083-012.
- [Ben91] Itai Benjamini. Instability of the Liouville property for quasi-isometric graphs and manifolds of polynomial volume

- growth. *Journal of Theoretical Probability*, 4(3) :631–637, jul 1991. doi:10.1007/BF01210328.
- [BGN03] Laurent Bartholdi, Rostislav Grigorchuk, and Volodymyr Nekrashevych. From Fractal Groups to Fractal Sets. In Peter Grabner and Wolfgang Woess, editors, *Fractals in Graz 2001*, pages 25–118, Basel, 2003. Birkhäuser Basel.
- [Bla55] David Blackwell. On transient Markov processes with a countable number of states and stationary transition probabilities. *The Annals of Mathematical Statistics*, 26(4) :654–658, dec 1955. doi:10.1214/aoms/1177728425.
- [BLP77] Paolo Baldi, Noël Lohoué, and Jacques Peyrière. Sur la classification des groupes récurrents. *Comptes rendus de l'Académie des Sciences de Paris, Série A-B*, 285(16) :A1103–A1104, 1977.
- [BT24] Stefan Banach and Alfred Tarski. Sur la décomposition des ensembles de points en parties respectivement congruentes. *Fundamenta Mathematicae*, 6 :244–277, 1924. doi:10.1007/978-1-4939-1474-6.
- [BV05] Laurent Bartholdi and Bálint Virág. Amenability via random walks. *Duke Mathematical Journal*, 130(1) :39–56, 2005. doi:10.1215/S0012-7094-05-13012-5.
- [BZ21] Jérémie Briussel and Tianyi Zheng. Speed of random walks, isoperimetry and compression of finitely generated groups. *Annals of Mathematics*, 193(1) :1, 2021. doi:10.4007/annals.2021.193.1.1.
- [Can84] James W. Cannon. The combinatorial structure of co-compact discrete hyperbolic groups. *Geometriae Dedicata*, 16(2) :123–148, 1984. doi:10.1007/BF00146825.
- [CD60] Gustave Choquet and Jacques Deny. Sur l'équation de convolution $\mu = \mu * \sigma$. *Comptes Rendus de l'Académie des Sciences de Paris*, 250 :799–801, 1960.
- [CSC93] Thierry Coulhon and Laurent Saloff-Coste. Isopérimétrie pour les groupes et les variétés. *Revista Matemática Iberoamericana*, 9(2) :293–314, 1993. doi:10.4171/RMI/138.
- [CSGdlH99] Tullio Ceccherini-Silberstein, Rostislav I. Grigorchuk, and Pierre de la Harpe. Amenability and paradoxical decompositions for pseudogroups and for discrete metric spaces. *Proceedings of the Steklov Institute of Mathematics*, 224 :57–97, apr 1999.
- [Der80] Yves Derriennic. Quelques applications du théorème ergodique sous-additif. In *Journées sur les marches aléatoires*, number 74 in Astérisque, pages 183–201. Société mathématique de France, 1980.
- [dlH00] Pierre de la Harpe. *Topics in Geometric Group Theory*. Chicago Lectures in Mathematics. University of Chicago Press, 2000.

- [DM61] Evgenii B. Dynkin and Mikhail B. Maljutov. Random walk on groups with a finite number of generators. *Doklady Akademii Nauk SSSR*, 137(5) :1042–1045, 1961.
- [DS19] Moon Duchin and Michael Shapiro. The Heisenberg group is pan-rational. *Advances in Mathematics*, 346 :219–263, apr 2019. doi:10.1016/j.aim.2019.01.046.
- [DSW60] Joseph L. Doob, J. Laurie Snell, and Ralph E. Williamson. Application of boundary theory to sums of independent random variables. In *Contributions to probability and statistics*, pages 182–197. Stanford Univ. Press, Stanford, Calif., 1960.
- [EK19] Anna Erschler and Vadim Kaimanovich. Arboreal structures on groups and the associated boundaries. preprint, Mar 2019. arXiv:1903.02095.
- [Ers03] Anna Erschler. On Isoperimetric Profiles of Finitely Generated Groups. *Geometriae Dedicata*, 100(1) :157–171, 2003. doi:10.1023/A:1025849602376.
- [Ers04] Anna Erschler. Liouville property for groups and manifolds. *Inventiones mathematicae*, 155(1) :55–80, jan 2004. doi:10.1007/s00222-003-0314-7.
- [Ers06] Anna Erschler. Piecewise automatic groups. *Duke Mathematical Journal*, 134(3) :591–613, 2006. doi:10.1215/S0012-7094-06-13435-X.
- [Ers10] Anna Erschler. Poisson-Furstenberg boundaries, large-scale geometry and growth of groups. In *Proceedings of the International Congress of Mathematicians*, volume II, pages 681–704. Hindustan Book Agency, New Delhi, 2010.
- [Ers11] Anna Erschler. Poisson–Furstenberg boundary of random walks on wreath products and free metabelian groups. *Commentarii Mathematici Helvetici*, 86(1) :113–143, 2011. doi:10.4171/CMH/220.
- [EZ21] Anna Erschler and Tianyi Zheng. Isoperimetric inequalities, shapes of Følner sets and groups with Shalom’s property H_{FD} . *Annales de l’Institut Fourier*, 70(4) :1363–1402, apr 2021. doi:10.5802/aif.3360.
- [FHTV19] Joshua Frisch, Yair Hartman, Omer Tamuz, and Pooya Vahidi Ferdowsi. Choquet-Deny groups and the infinite conjugacy class property. *Annals of Mathematics*, 190(1) :307–320, 2019.
- [Føl55] Erling Følner. On groups with full Banach mean value. *Mathematica Scandinavica*, 3 :243–254, dec 1955. doi:10.7146/math.scand.a-10442.
- [Fro09] Steffen Froehlich. Konvexe Kurven und das isoperimetrische Problem, 2009. FU Berlin.

- [Fur73] Harry Furstenberg. Boundary theory and stochastic processes on homogeneous spaces. In *Harmonic analysis on homogeneous spaces (Proc. Sympos. Pure Math., Vol. XXVI, Williams Coll., Williamstown, Mass., 1972)*, pages 193–229, 1973.
- [Fur02] Alex Furman. Random walks on groups and random transformations. In B Hasselblatt and A Katok, editors, *Handbook of Dynamical Systems*, volume 1 of *Handbook of Dynamical Systems*, chapter 12, pages 931–1014. Elsevier Science, 2002. doi:10.1016/S1874-575X(02)80014-5.
- [GdlH90] Étienne Ghys and Pierre de la Harpe. *Sur les Groupes Hyperboliques d’après Mikhael Gromov*, volume 83 of *Progress in Mathematics*. Birkhäuser Boston, Boston, MA, 1990. doi:10.1007/978-1-4684-9167-8.
- [GdlH97] Rostislav I. Grigorchuk and Pierre de la Harpe. On problems related to growth, entropy, and spectrum in group theory. *Journal of Dynamical and Control Systems*, 3(1) :51–89, 1997. doi:10.1007/BF02471762.
- [Geo08] Ross Geoghegan. *Topological Methods in Group Theory*, volume 243 of *Graduate Texts in Mathematics*. Springer New York, New York, NY, 2008. doi:10.1007/978-0-387-74614-2.
- [GM12] François Gautero and Frédéric Mathéus. Poisson boundary of groups acting on \mathbb{R} -trees. *Israel Journal of Mathematics*, 191(2) :585–646, 2012. doi:10.1007/s11856-011-0215-1.
- [Gre69] Frederick P. Greenleaf. *Invariant means on topological groups and their applications*. Van Nostrand mathematical studies. Van Nostrand Reinhold Co., 1969.
- [Gri77] Rostislav I. Grigorchuk. Symmetric random walks on discrete groups. *Uspekhi Matematicheskikh Nauk*, 32(6(198)) :217–218, 1977.
- [Gri80] Rostislav I. Grigorchuk. Bernside’s problem on periodic groups. *Functional Analysis and Its Applications*, 14(1) :41–43, jan 1980. doi:10.1007/BF01078416.
- [Gri14] Rostislav I. Grigorchuk. Milnor’s problem on the growth of groups and its consequences. In *Frontiers in Complex Dynamics*, pages 705–774. Princeton University Press, dec 2014. doi:10.1515/9781400851317-027.
- [Gro77] Jonathan L. Gross. Every connected regular graph of even degree is a Schreier coset graph. *Journal of Combinatorial Theory, Series B*, 22(3) :227–232, jun 1977. doi:10.1016/0095-8956(77)90068-5.
- [Gro81] Misha Gromov. Groups of polynomial growth and expanding maps. *Publications mathématiques de l’IHÉS*, 53(1) :53–78, dec 1981. doi:10.1007/BF02698687.

- [Gro87] Misha Gromov. Hyperbolic Groups. In S. M. Gersten, editor, *Essays in Group Theory*, volume 8 of *Mathematical Sciences Research Institute Publications*, pages 75–263. Springer, New York, 1987. doi:10.1007/978-1-4613-9586-7_3.
- [Gro08] Misha Gromov. Entropy and isoperimetry for linear and non-linear group actions. *Groups, Geometry, and Dynamics*, pages 499–593, 2008. doi:10.4171/GGD/48.
- [Gui73] Yves Guivarc’h. Croissance polynomiale et périodes des fonctions harmoniques. *Bulletin de la Société Mathématique de France*, 79 :333–379, 1973. doi:10.24033/bsmf.1764.
- [Gui80] Yves Guivarc’h. Sur la loi des grands nombres et le rayon spectral d’une marche aléatoire. In *Journées sur les marches aléatoires*, number 74 in Astérisque. Société mathématique de France, 1980.
- [Heh13] Andreas Hehl. The Isoperimetric Inequality, Feb 2013. handout. URL : <https://www.math.uni-tuebingen.de/ab/GeometrieWerkstatt/IsoperimetricInequality.pdf>.
- [Hop40] Heinz Hopf. Selected Chapters of Geometry, 1940. ETH Zuerich.
- [Hor16] Camille Horbez. The Poisson boundary of $\text{Out}(F_N)$. *Duke Mathematical Journal*, 165(2) :341–369, 2016. doi:10.1215/00127094-3166308.
- [Iva84] Nikolai V. Ivanov. Algebraic properties of the Teichmüller modular group. *Soviet Mathematics. Doklady*, 29 :288–291, 1984.
- [Jaw04] Wojciech Jaworski. Countable Amenable Identity Excluding Groups. *Canadian Mathematical Bulletin*, 47(2) :215–228, jun 2004. doi:10.4153/CMB-2004-021-1.
- [Jus15] Kate Juschenko. Amenability of discrete groups by examples. Current version available at <http://www.math.northwestern.edu/~juschenk/book.html>., 2015.
- [Jus18] Kate Juschenko. Liouville property of strongly transitive actions. preprint, jun 2018. arXiv:1806.02753.
- [JZ18] Kate Juschenko and Tianyi Zheng. Infinitely supported Liouville measures of Schreier graphs. *Groups, Geometry, and Dynamics*, 12 :911–918, 2018. doi:10.4171/GGD/464.
- [Kai85] Vadim A. Kaimanovich. Examples of noncommutative groups with nontrivial exit-boundary. *Journal of Soviet Mathematics*, 28(4) :579–591, feb 1985. doi:10.1007/BF02104988.
- [Kai00] Vadim A. Kaimanovich. The Poisson formula for groups with hyperbolic properties. *The Annals of Mathematics*, 152(3) :659, nov 2000. doi:10.2307/2661351.

- [Kai05] Vadim A. Kaimanovich. "Münchhausen trick" and amenability of self-similar groups. *International Journal of Algebra and Computation*, 15(5-6) :907–937, 2005. doi: 10.1142/S0218196705002694.
- [Kai17] Vadim A. Kaimanovich. Thompson's group F is not Liouville. In Tullio Ceccherini-Silberstein, Maura Salvatori, and Ecaterina Sava-Huss, editors, *Groups, Graphs and Random Walks*, London Mathematical Society Lecture Note Series, pages 300–342. Cambridge University Press, Cambridge, 2017. doi:10.1017/9781316576571.013.
- [Kes59] Harry Kesten. Full Banach mean values on countable groups. *Mathematica Scandinavica*, 7 :146–156, 1959.
- [KKL19] Sang-Hyun Kim, Thomas Koberda, and Yash Lodha. Chain groups of homeomorphisms of the interval. *Annales scientifiques de l'École normale supérieure*, 52(4) :797–820, 2019. doi:10.24033/asens.2397.
- [KL07] Anders Karlsson and Francois Ledrappier. Linear Drift and Poisson Boundary for Random Walks. *Pure and Applied Mathematics Quarterly*, 3(4) :1027–1036, 2007. doi: 10.4310/PAMQ.2007.v3.n4.a8.
- [KL20] Peter H. Kropholler and Karl Lorensen. Virtually torsion-free covers of minimax groups. *Annales scientifiques de l'École normale supérieure*, 53(1) :125–171, 2020. doi: 10.24033/asens.2419.
- [KM96] Vadim A. Kaimanovich and Howard Masur. The Poisson boundary of the mapping class group. *Inventiones Mathematicae*, 125(2) :221–264, 1996. doi:10.1007/s002220050074.
- [KPT05] Alexander S. Kechris, Vladimir G. Pestov, and Stevo Todorcevic. Fraïssé Limits, Ramsey Theory, and topological dynamics of automorphism groups. *GFAA Geometric And Functional Analysis*, 15(1) :106–189, feb 2005. doi: 10.1007/s00039-005-0503-1.
- [KS71] Abraham Karrass and Donald Solitar. Subgroups of HNN groups and groups with one defining relation. *Journal canadien de mathématiques*, 23(4) :627–643, 1971. doi: 10.4153/CJM-1971-070-x.
- [KV79] Vadim A. Kaimanovich and Anatoly M. Vershik. Random walks on groups : boundary, entropy, uniform distribution. *Soviet Mathematics : Doklady*, 249(1) :15–18, 1979.
- [KV83] Vadim A. Kaimanovich and Anatoly M. Vershik. Random walks on discrete groups : boundary and entropy. *The Annals of Probability*, 11(3) :457–490, 1983.
- [KW07] Anders Karlsson and Wolfgang Woess. The Poisson boundary of lamplighter random walks on trees. *Geometriae Dedicata*, 124(1) :95–107, 2007. doi:10.1007/s10711-006-9104-x.

- [Lee16] Paul-Henry Leemann. *On subgroups and Schreier graphs of finitely generated groups*. PhD thesis, Univ. Genève, aug 2016.
- [LM16] Yash Lodha and Justin T. Moore. A nonamenable finitely presented group of piecewise projective homeomorphisms. *Groups, Geometry, and Dynamics*, 10(1) :177–200, 2016. doi:10.4171/GGD/347.
- [Lod16] Yash Lodha. An upper bound for the Tarski numbers of non amenable groups of piecewise projective homeomorphisms. *International Journal of Algebra and Computation*, 27 :315–322, 2016. doi:10.1142/S0218196717500151.
- [Lod20] Yash Lodha. A nonamenable type F_∞ group of piecewise projective homeomorphisms. *Journal of Topology*, 13(4) :1767–1838, dec 2020. doi:10.1112/topo.12172.
- [LP20] Russell Lyons and Yuval Peres. Poisson boundaries of lamplighter groups : proof of the Kaimanovich–Vershik conjecture. *Journal of the European Mathematical Society*, 2020. doi:10.4171/jems/1030.
- [Lyo87] Terry Lyons. Instability of the Liouville property for quasi-isometric Riemannian manifolds and reversible Markov chains. *Journal of Differential Geometry*, 26(1) :33–66, 1987. doi:10.4310/jdg/1214441175.
- [LZ98] Vladimir Ya. Lin and Mikhail Zaidenberg. Liouville and Carathéodory coverings in Riemannian and complex geometry. In *Voronezh Winter Mathematical Schools*, volume 184 of *American Mathematical Society Translations : Series 2*, pages 111–130. American Mathematical Society, Providence, RI, apr 1998. doi:10.1090/trans2/184/08.
- [Mar66] Grigorii A. Margulis. Positive harmonic functions on nilpotent groups. *Soviet Mathematics : Doklady*, 7 :241–244, 1966.
- [McC85] John McCarthy. A "tits-alternative" for subgroups of surface mapping class groups. *Transactions of the American Mathematical Society*, 291(2) :583–612, 1985.
- [Mis15] Pavlo Mishchenko. Boundary of the action of Thompson group F on dyadic numbers. preprint, 2015. arXiv:1512.03083.
- [Mon13] Nicolas Monod. Groups of piecewise projective homeomorphisms. *Proceedings of the National Academy of Sciences of the United States of America*, 110(12) :4524–4527, mar 2013. doi:10.1073/pnas.1218426110.
- [MS14] Andrei V. Malyutin and Pavel V. Svetlov. Poisson–Furstenberg boundaries of fundamental groups of closed 3-manifolds. preprint, mar 2014. arXiv:1403.2135.

- [NA68] Petr S. Novikov and Sergei I. Adyan. On infinite periodic groups. I, II, III. *Izvestiya Akademii Nauk SSSR. Seriya Matematicheskaya*, 32 :212–244, 251–524, 709–731, 1968.
- [Nek05] Volodymyr Nekrashevych. *Self-Similar Groups*, volume 117 of *Mathematical Surveys and Monographs*. American Mathematical Society, Providence, Rhode Island, aug 2005. doi : 10.1090/surv/117.
- [NS13] Amos Nevo and Michah Sageev. The Poisson boundary of CAT(0) cube complex groups. *Groups, Geometry, and Dynamics*, 7(3) :653–695, 2013. doi : 10.4171/GGD/202.
- [Ol’80a] Alexander Yu. Ol’shanskii. An infinite group with subgroups of prime orders. *Izvestiya Akademii Nauk SSSR. Seriya Matematicheskaya*, 44(2) :309–321, 1980.
- [Ol’80b] Aleksandr Yu. Ol’shanskii. On the question of the existence of an invariant mean on a group. *Russian Mathematical Surveys*, 35(4) :180–181, 1980.
- [OS03] Alexander Yu. Ol’shanskii and Mark V. Sapir. Non-amenable finitely presented torsion-by-cyclic groups. *Publications mathématiques de l’IHÉS*, 96(1) :43–169, may 2003. doi : 10.1007/s10240-002-0006-7.
- [Oss78] Robert Osserman. The isoperimetric inequality. *Bulletin of the American Mathematical Society*, 84(6) :1182–1239, nov 1978. doi : 10.1090/S0002-9904-1978-14553-4.
- [Pan82] Pierre Pansu. Une inégalité isopérimétrique sur le groupe de Heisenberg. *Comptes Rendus des Séances de l’Académie des Sciences. Série I. Mathématique*, 295(2) :127–130, 1982.
- [Pan83a] Pierre Pansu. Croissance des boules et des géodésiques fermées dans les nilvariétés. *Ergodic Theory and Dynamical Systems*, 3(3) :415–445, sep 1983. doi : 10.1017/S0143385700002054.
- [Pan83b] Pierre Pansu. An isoperimetric inequality on the Heisenberg group. In *Rendiconti del Seminario Matematico (già “Conferenze di Fisica e di Matematica”)*. Università e Politecnico di Torino, number Special Issue, pages 159–174 (1984). 1983. Conference on differential geometry on homogeneous spaces (Turin, 1983).
- [Par92] Walter Parry. A sharper tits alternative for 3-manifold groups. *Israel Journal of Mathematics*, 77(3) :265–271, 1992. doi : 10.1007/BF02773691.
- [Pes98] Vladimir G. Pestov. On Free Actions, Minimal Flows, and a Problem by Ellis. *Transactions of the American Mathematical Society*, 350(10) :4149–4165, 1998.
- [Pet20] Gábor Pete. Probability and Geometry on Groups. Current version available at <http://math.bme.hu/~gabor/PGG.pdf>., sep 2020.

- [Pit95] Christophe Pittet. Følner Sequences in Polycyclic Groups. *Revista Matemática Iberoamericana*, 11(3) :675–685, 1995. doi:10.4171/RMI/189.
- [PSC99] Christophe Pittet and Laurent Saloff-Coste. Amenable groups, isoperimetric profiles and random walks. In *Geometric Group Theory Down Under*, pages 293–316. DE GRUYTER, Berlin, New York, 1999. doi:10.1515/9783110806861.293.
- [PSC00] Christophe Pittet and Laurent Saloff-Coste. On the stability of the behavior of random walks on groups. *Journal of Geometric Analysis*, 10(4) :713–737, dec 2000. doi:10.1007/BF02921994.
- [PSC03] Christophe Pittet and Laurent Saloff-Coste. Random walks on finite rank solvable groups. *Journal of the European Mathematical Society*, 5(4) :313–342, nov 2003. doi:10.1007/s10097-003-0054-4.
- [Rei68] Hans Reiter. *Classical harmonic analysis and locally compact groups*. Clarendon Press, Oxford, 1968.
- [Ros81] Joseph Rosenblatt. Ergodic and mixing random walks on locally compact groups. *Mathematische Annalen*, 257(1) :31–42, 1981. doi:10.1007/BF01450653.
- [RS09] John Rhodes and Benjamin Steinberg. *The q -theory of Finite Semigroups*. Springer Monographs in Mathematics. Springer US, Boston, MA, 2009. doi:10.1007/b104443.
- [SC20] Bruno Luiz Santos Correia. On the isoperimetric inequality of Coulhon and Saloff-Coste. preprint, feb 2020. arXiv:2002.06996.
- [Sch84] Hermann A. Schwarz. Beweis des Satzes, dass die Kugel kleinere Oberfläche besitzt, als jeder andere Körper gleichen Volumens. *Nachrichten von der Königl. Gesellschaft der Wissenschaften und der Georg-Augusts-Universität zu Göttingen*, 1884 :1–13, 1884.
- [SCZ18] Laurent Saloff-Coste and Tianyi Zheng. Isoperimetric profiles and random walks on some permutation wreath products. *Revista Matemática Iberoamericana*, 34(2) :481–540, may 2018. doi:10.4171/RMI/994.
- [Sha89] Michael Shapiro. A geometric approach to the almost convexity and growth of some nilpotent groups. *Mathematische Annalen*, 285(4) :601–624, dec 1989. doi:10.1007/BF01452050.
- [Sha06] Yehuda Shalom. The algebraization of Kazhdan’s property (T). In *Proceedings of the International Congress of Mathematicians*, volume II, pages 1283–1310, Zuerich, Switzerland, 2006. European Mathematical Society Publishing House. doi:10.4171/022-2/60.

- [ST20] Friedrich Martin Schneider and Andreas Thom. The Liouville property and random walks on topological groups. *Commentarii Mathematici Helvetici*, 95(3) :483–513, 2020. doi :10.4171/CMH/494.
- [Sta68] John R. Stallings. On Torsion-Free Groups with Infinitely Many Ends. *The Annals of Mathematics*, 88(2) :312, sep 1968. doi :10.2307/1970577.
- [Sta72] John R. Stallings. *Group theory and three-dimensional manifolds*. Yale University Press, 1972.
- [Sto96] Michael Stoll. Rational and transcendental growth series for the higher Heisenberg groups. *Inventiones Mathematicae*, 126(1) :85–109, sep 1996. doi :10.1007/s002220050090.
- [Tar38] Alfred Tarski. Algebraische Fassung des Massproblems. *Fundamenta Mathematicae*, 31 :47–66, 1938.
- [Tit72] Jacques Tits. Free subgroups in linear groups. *Journal of Algebra*, 20(2) :250–270, 1972. doi :10.1016/0021-8693(72)90058-0.
- [Var85a] Nicolas Th. Varopoulos. Long range estimates for markov chains. *Bulletin Des Sciences Mathematiques*, 109 :225–252, 1985.
- [Var85b] Nicolas Th. Varopoulos. Random walks on groups. Applications to Fuchsian groups. *Arkiv för Matematik*, 23(1-2) :171–176, dec 1985. doi :10.1007/BF02384423.
- [Ver73] Anatoly M. Vershik. Countable groups that are close to finite ones, Appendix in : FP Greenleaf “Invariant Means on Topological Groups and Their Applications”, 1973. (in Russian), a revised English translation Amenability and approximation of infinite groups, *Selecta Math. Sov.* 2 (4), 311–330 (1982).
- [Wag93] Stan Wagon. *The Banach-Tarski Paradox*. Encyclopedia of Mathematics and its Applications. Cambridge University Press, 1993.
- [Woe00] Wolfgang Woess. *Random Walks on Infinite Graphs and Groups*. Cambridge Tracts in Mathematics. Cambridge University Press, 2000.
- [Żuk00] Andrzej Żuk. On an isoperimetric inequality for infinite finitely generated groups. *Topology*, 39(5) :947–956, sep 2000. doi :10.1016/S0040-9383(99)00043-9.

On étudie les marches aléatoires sur les groupes, et plus généralement les marches induites par des mesures sur des groupes. On cherche à comprendre leur comportement à l'infini, surtout en terme du non-trivialité de leur bords de Poisson. On s'intéresse en particulier aux sous-groupes de $H(\mathbb{Z})$, y compris le groupe de Thompson F . Le groupe $H(\mathbb{Z})$ est le groupe des homéomorphismes projectifs par morceaux sur les entiers défini par Monod. Pour un sous-groupe H de $H(\mathbb{Z})$ de type fini, on montre que soit H est résoluble, soit pour tout mesure sur H dont le premier moment est fini et le support engendre H en tant que semi-groupe, le bord de Poisson de la marche aléatoire sur H est non-trivial. En particulier, on démontre la non-trivialité du bord de Poisson des marches aléatoires sur le groupe de Thompson F pour les mesures sur F dont le support l'engendre en tant que semi-groupe et qui sont de premier moment fini. Cela répond à une question de Kaimanovich.

Considérons une action transitive d'un groupe G de type fini, et le graphe de Schreier Γ que cette action définit pour un ensemble générateur fixé. Pour une mesure de probabilité μ sur G de premier moment fini, on prouve que si la marche aléatoire induite sur Γ est transiente, alors elle converge vers un bout de Γ . On obtient comme corollaire que pour une mesure de probabilité de premier moment fini sur le groupe de Thompson F , dont le support engendre F en tant que semi-groupe, la marche aléatoire induite sur les nombres dyadiques a un bord de Poisson non-trivial. Il est nécessaire d'avoir une hypothèse sur le moment de la mesure d'après un résultat de Juscheno et Zheng.

En outre, on calcule les valeurs exactes des fonctions de Følner sur le groupe d'allumeur de réverbères $\mathbb{Z} \wr \mathbb{Z}/2\mathbb{Z}$ pour l'ensemble générateur standard et l'ensemble générateur «switch-walk-switch». Les fonctions de Følner encodent les propriétés isopérimétriques des groupes moyennables et ont été auparavant étudiées à équivalence asymptotique prêt (autrement dit, de façon indépendante du choix d'ensemble générateur fini). On obtient aussi une borne inférieure pour les fonctions de Følner d'une classe de produits en couronnes permutationnels (avec certains ensembles générateurs). On l'utilise pour construire un exemple de groupe dont la fonction de Følner a la même exponente que sa fonction de croissance. De plus, on démontre un résultat isopérimétrique par rapport au bord sur les arrêtes sur le groupe de Baumslag-Solitar $BS(1, 2)$ avec l'ensemble générateur standard.

MOTS CLÉS

Marches aléatoires sur les groupes, bord de Poisson, graphe de Schreier, espace des bouts, groupe F de Thompson, groupes d'homéomorphismes projectifs par morceaux, groupes résolubles, groupes localement résolubles, auto-similarité, fonction de Følner, groupe d'allumeur de réverbères, produits en couronnes, produits en couronnes permutationnels, groupe de Baumslag-Solitar, inégalité de Coulhon et Saloff-Coste, fonction de croissance

ABSTRACT

We study random walks on groups, and more generally walks induced by measures on groups. We seek to understand their limit behaviour, in particular in terms of whether their Poisson boundary is trivial or not. We are specifically interested in measures on subgroups of $H(\mathbb{Z})$, including Thompson's group F . The group $H(\mathbb{Z})$ is the group of piecewise projective homeomorphisms over the integers defined by Monod. For a finitely generated subgroup H of $H(\mathbb{Z})$, we prove that either H is solvable, or for every measure on H with finite first moment and support that generates H as a semigroup, the random walk on H has non-trivial Poisson boundary. In particular, we prove the non-triviality of the Poisson boundary of walks on Thompson's group F induced by measures, the support of which generates F as a semigroup and which have finite first moments. This answers a question by Kaimanovich.

Consider a transitive action of a finitely generated group G and the Schreier graph Γ defined by this action for some fixed generating set. For a probability measure μ on a group with a finite first moment we show that if the induced random walk on Γ is transient, it converges towards the space of ends of Γ . As a corollary we obtain that for a probability measure with a finite first moment on Thompson's group F , the support of which generates F as a semigroup, the induced random walk on the dyadic numbers has a non-trivial Poisson boundary. Some assumption on the moment of the measure is necessary as follows from an example by Juschenko and Zheng.

Additionally, we calculate the exact values of the Følner function of the lamplighter group $\mathbb{Z} \wr \mathbb{Z}/2\mathbb{Z}$ for the standard and the switch-walk-switch generating sets. Følner functions encode the isoperimetric properties of amenable groups and have previously been studied up to asymptotic equivalence (that is to say, independently of the choice of finite generating set). We also obtain a lower bound for the Følner function for a class of permutational wreath products (with certain generating sets). We use that bound to construct an example of a group, the Følner function of which has the same exponent as its growth function. What is more, we prove an isoperimetric result concerning the edge boundary on the Baumslag-Solitar group $BS(1, 2)$ with the standard generating set.

KEYWORDS

Random walks on groups, Poisson boundary, Schreier graph, end space, Thompson's group F , groups of piecewise projective homeomorphisms, solvable group, locally solvable group, self-similarity, Følner function, lamplighter group, wreath products, permutational wreath products, Baumslag-Solitar groups, Coulhon and Saloff-Coste inequality, growth function