



HAL
open science

Analysis on fractals and applications

Nizare Riane

► **To cite this version:**

Nizare Riane. Analysis on fractals and applications. Analysis of PDEs [math.AP]. Sorbonne Université, 2022. English. NNT : 2022SORUS277 . tel-03865256

HAL Id: tel-03865256

<https://theses.hal.science/tel-03865256v1>

Submitted on 22 Nov 2022

HAL is a multi-disciplinary open access archive for the deposit and dissemination of scientific research documents, whether they are published or not. The documents may come from teaching and research institutions in France or abroad, or from public or private research centers.

L'archive ouverte pluridisciplinaire **HAL**, est destinée au dépôt et à la diffusion de documents scientifiques de niveau recherche, publiés ou non, émanant des établissements d'enseignement et de recherche français ou étrangers, des laboratoires publics ou privés.

SORBONNE UNIVERSITÉ

ÉCOLE DOCTORALE DE SCIENCES MATHÉMATIQUES DE PARIS
CENTRE

LABORATOIRE JACQUES-LOUIS LIONS

Analyse sur les fractales et applications

Analysis on fractals and applications

Par

Nizare RIANE

Thèse de doctorat en Mathématiques

dirigée par Claire DAVID

Présentée et soutenue le 17/10/22 devant le jury composé de :

CLAIRE DAVID	Sorbonne Université	Directrice de thèse
FATIHA ALABAU	Sorbonne Université	Présidente de jury
BEN HAMBLY	University of Oxford	Rapporteur
FRANÇOIS VIGNERON	Université de Reims Champagne-Ardenne	Rapporteur
ERIC AKKERMANS	Technion	Examineur
ATHANASIOS BATAKIS	Institut Denis Poisson	Examineur
DIDIER LEBERT	ENSTA Paris	Examineur
KASSO OKOUDJOU	Tufts University	Examineur

À mes parents
À ma femme

Remerciements

Les mots sont impuissants pour exprimer ma gratitude envers Claire David, mon travail de thèse n'aurait pas pu aboutir sans son soutien. Merci d'avoir cru en moi et de m'avoir soutenu jusqu'au bout malgré tous les obstacles.

J'adresse mes remerciements aux rapporteurs Ben Hambly et François Vigneron pour la lecture minutieuse de mon travail, pour les commentaires et les remarques. Un grand merci aux professeurs qui ont accepté de participer à mon jury de thèse et de l'intérêt qu'ils ont porté à mon travail : Eric Akkermans, Fatiha Alabau, Athanasios Batakis, Didier Lebert et Kasso Okoudjou.

Je souhaite exprimer ma gratitude aux professeurs qui ont soutenu la reconnaissance de ce travail : Emmanuel Trélat, Jean-Yves Chemin, Hajer Bahouri, Laurent Boudin, Marie Doumic, Hervé Le Dret. J'étends avec plaisir ces remerciements à Alex Upellini pour son assistance sur Mathematica, et à Grégoire Allaire et Christophe Rabut pour les discussions mathématiques autour des méthodes numériques.

Je remercie très chaleureusement ma famille qui n'a jamais cessé de me soutenir, et particulièrement mes parents Fatima et El Mofadel, ma sœur Sanaa et son mari Hamza, mon frère Wassim et mes sœurs Siham et Aya. J'exprime tout mon amour à ma femme Kawtar, pour sa confiance et son soutien. Merci !

Contents

Contents	iv
Introduction	1
Notations	6
1 ANALYSIS ON FRACTALS	8
1.1 General considerations	9
1.2 A few recalls	10
1.3 Post-critically Finite Fractals	11
1.4 Self-Similar Measure	18
1.5 Dirichlet forms on P.C.F. sets	20
1.6 Laplacian on P.C.F. sets	24
1.7 Generalized combinatorial Laplacian	28
1.8 Spectral decimation function	30
1.9 Einstein relation and Weyl's formula for P.C.F. Sets	32
1.10 Partial differential equations on fractals	34
1.10.1 Solvability of partial differential equations	35
1.10.2 The heat equation	36
2 NUMERICAL ANALYSIS ON FRACTALS AND APPLICATIONS	40
2.1 The Finite Difference Method	41
2.1.1 The Finite Difference Method, for the Heat Equation on Sierpiński Simplices	41
2.2 The Finite Volume Method	66
2.2.1 The Finite Volume Method on Sierpiński Simplices	66
3 OPTIMAL CONTROL AND OPTIMIZATION ON FRACTALS	89
3.1 Optimization on Fractal Sets	90
3.1.1 Existence of Extrema	90
3.1.2 Numerical Algorithm and Dynamic Programming	91
3.2 Optimal Control of Partial differential Equation on Fractal Sets	98
3.2.1 Distributed Control of the Heat Equation	98
3.3 The Specific Case of the Sierpiński Gasket	105
4 DOMAINS WITH FRACTAL BOUNDARIES	111
4.1 The Membrane Problem on Open Subsets with Fractal Boundaries	112
4.1.1 The Koch Snowflake	113
4.1.2 Integration and Function Spaces	116
4.1.3 Sobolev Spaces, Trace and Weak Formulation	122
4.1.4 Solution of the Membrane Problem on a Domain with Fractal Boundary	128
4.2 The Finite Element Method for the Koch Snowflake	128
4.2.1 \mathbb{P}_1 Finite Element on a Uniform Mesh	130
4.2.2 Convergence and Error Estimates	136
4.2.3 Numerical Results	142
4.3 Parametric Optimization	143
4.3.1 An Alternative Definition	143
4.3.2 Optimization Thickness of an Elastic Membrane on Fractals	144
4.3.3 Resolution by the Discrete Projected Gradient Algorithm (D.P.G.A.)	146
4.3.4 Numerical Results	151
5 APPLICATION TO FINANCE	153
5.1 The Self-Similar Black-Scholes Model	154
5.1.1 The Black-Scholes Operator	154
5.2 Non-Symmetric Dirichlet forms and the Self-Similar Black-Scholes Operator	157
5.3 Pointwise Formula	163

5.4	Proof of the Assumption	167
5.4.1	First Assumption	167
5.4.2	Commentary on the Second Assumption	168
5.5	Numerical Simulation of Self-Similar European Options	168
5.5.1	The Finite Difference Method	169
5.5.2	Numerical Analysis	171
5.5.3	Self-Similar Pricing	174
5.5.4	The Greeks	175
5.5.5	Discussion	178
	Appendix	179
.1	The finite element method	180
.1.1	Multiharmonic splines	180
.1.2	The finite element method	184
	Bibliography	188
	Index	195

Introduction

Not so long ago, irregular objects were considered to be erratic and pathological, thus, unworthy to be studied from a mathematical point of view. This changed drastically in the the 1970's.

It was, first, Benoît B. Mandelbrot, who introduced, in 1975, the new word **fractal**, derived from the Latin *fractus*, to qualify a class of irregular sets: according to him, an object is considered to be fractal if its topological dimension is strictly lower than its **fractal dimension** [Man77a], a first definition of a *fractal dimension*, by means of its **Hausdorff-Besicovitch dimension**. We will see below that this definition does not always hold.

New improvements then came with the introduction, in 1981, of *iterated function systems* (I.F.S.), by John E. Hutchinson in [Hut81]. As explained in [Dav19], an I.F.S. is a finite set of contractive maps, each defined on a compact metric set K of the euclidean space \mathbb{R}^d , $d \in \mathbb{N}^*$:

$$\mathcal{S} = \{T_1, \dots, T_N\} \quad , \quad N \in \mathbb{N}^*$$

where \mathbb{N}^* denotes the set of strictly positive integers, such that

$$K = \bigcup_{i=1}^N T_i(K)$$

The compact set K is then said to be “invariant” with respect to the set \mathcal{S} (one often refer to this result as the “Gluing Lemma”).

A prequel occurrence of such maps, under the form of similarities, can already be found in the Mandelbrot books of 1977 [Man77b], [Man77c].

The novelty of the work of John E. Hutchinson is to consider not the compact K itself, but the set $\mathcal{S} = \{T_1, \dots, T_N\}$: not only the invariant compact K is fully determined by this set, but it is, also, the limit of a sequence of prefactal graphs that can be built, in an iterative way, thanks to the maps that constitute the set \mathcal{S} .

Iterated function systems were taken up and even more developed by Michael F. Barnsley et al. (see, for instance, [BD85a]), as “a unified way of generating and classifying a broad class of fractals”. As explained by the authors, fractals were “traditionally viewed as being produced by a process of successive microscopic refinement taken to the limit”, which, of course, makes sense with the geometric representation one may have of fractal sets, since, when looking at smaller and smaller scales, one finds, again and again, the same form. Of course, at stake are specific and classical types of fractals, as Sierpiński gaskets, dragon curves, Cantor sets, Julia curves, ... Michael F. Barnsley, along with Stephen Demko, layed the emphasis upon the fact that those fractals are to be seen as the attractors of iterated function systems.

The first fractal object to be formally studied was the Sierpiński Gasket, originally, by physicists – one may refer to the work of Rammal Rammal and Gérard Toulouse [RT83], or to the paper by Rammal Rammal [Ram84], where the author investigates the density of states and the nature of the eigenmodes of the vibrating d -dimensional Sierpiński Gasket; very interestingly, and as is often the case, both papers present results that would be later proved by mathematicians. Among them, and non-exhaustively, Sheldon Goldstein [Gol87], Shigeo Kusuoka [Kus87], Martin T. Barlow and Edwin A. Perkins [BP88], who developped a probabilistic approach, based on random walks across prefractions (a sequence of finite graphs that converge towards the fractal). In this approach, the Laplacian stands as the infinitesimal generator of the semigroup associated to the diffusion process.

Those substantial advances were followed by a second kind of approach, an analytical one, initiated by Jun Kigami [Kig89], [Kig93]. It has been, then, taken up, developed and popularized by Robert S. Strichartz (see, among numerous references, the book [Stro6]). New developments came with the theory of **Complex Dimensions**, as laid by Michel L. Lapidus and his collaborators in [Lap91], [Lap92], [Lap93], [LP93], [LM95], [LFoo], [LPo6], [Lap08], [LPW11], [ELMR15] [LF13], [LRŽ17a], [LRŽ18], [Lap19], [HL21] and [Lap22], in particular. The theory provides a very natural and intuitive way to characterize *fractal strings* or *drums*, in relation with their intrinsic vibrational properties.

Thus far, the definition of *fractality* by Benoît B. Mandelbrot is not widely accepted by mathematicians. For instance, according to this definition, the Devil's Staircase – or graph of the Cantor-Lebesgue function (see Figure 1), would not be fractal.

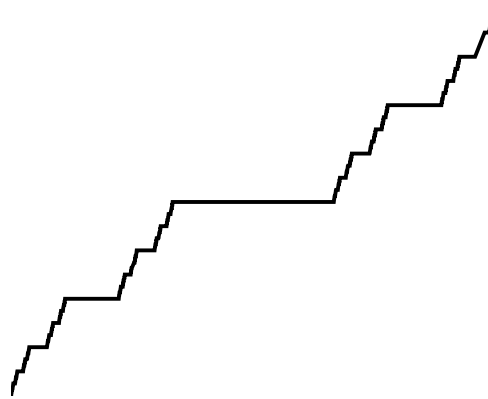

Figure 1: The Devil's Staircase.

To this point, an interesting point of view is the one of Kenneth Falconer [Fal14]:

“My personal feeling is that the definition of a ‘fractal’ should be regarded in the same way as a biologist regards the definition of ‘life’. There is no hard and fast definition, but just a list of properties characteristic of a living thing, such as the ability to reproduce or to move or to exist to some extent independently of the environment. Most living things have most of the characteristics on the list, though there are living objects that are exceptions to each of them. In the same way, it seems best to regard a fractal as a set that has properties such as those listed below, rather than to look for a precise definition which will almost certainly exclude some interesting cases. From the mathematician’s point of view, this approach is no bad thing. ”

Kenneth Falconer claims that the name *fractal* should be used to qualify a more general class of sets $\mathcal{F} \subset \mathbb{R}^d$, which possess all or at most one of the following properties [Fal97]:

- \mathcal{F} has a fine structure, that is irregular detail at arbitrarily small scales.
- \mathcal{F} is too irregular to be described by calculus or traditional geometrical language, either locally or globally.

- Often \mathcal{F} has some sort of self-similarity or self-affinity, perhaps in a statistical or approximate sense.
- Usually the **fractal dimension** of \mathcal{F} is strictly greater than its topological dimension.
- In many cases of interest \mathcal{F} has a very simple, perhaps recursive, definition.
- Often \mathcal{F} has a **natural** appearance.

Recent work, by Michel L. Lapidus [LF13] and [LRŽ17b], gave a more accurate definition of fractality: a geometric object is then said to be *fractal* if it admits at least one *nonreal Complex Dimension*.

Note that motivations to study fractals from a mathematical point of view appeared in the 1980's-1990's, when physicists put the light on the strange diffusion and vibrational properties of disordered media (one may refer to the works of the physicists Samuel H. Liu [Liu86], or Shlomo Havlin and Daniel Ben-Avraham [HBA87]). Recall that the Koch Curve was used as a model for chains of polymers, and the Menger Sponge as a model for porous media.

The vibrational modes of those disordered media of \mathbb{R}^d , $d \geq 2$, seemed to satisfy an asymptotic law of the form

$$\lambda_k \approx k^{\frac{2}{D_S}}, \quad k \gg 1$$

where, contrary to the Weyl law [Wey12], the spectral dimension D_S was not equal to the Euclidean Dimension,

$$D_S \neq d.$$

The hint was that this unusual diffusion would come from “a ramification at all scales”, as explained, this time, by the mathematician Umberto Mosco [Mos02].

As is explained by Robert S. Strichartz in [Stro1], “A theory of analysis on fractals is now emerging and is perhaps poised for the kind of explosive and multilayered expansion that has characterized analysis on manifolds”. The natural question that one may ask then is: how can one define differential operators on fractals? Again, as also explained by Robert S. Strichartz in [Stro1], “The central character in the theory of analysis on manifolds is the Laplacian. Thus the starting point for analysis on fractals will be the construction of an analogous operator on a class of fractals”.

This is the starting point of this thesis, based upon the seminal work of Jun Kigami. Our work is organized as follows:

- i. Chapter one is a general introduction to J. Kigami's theory, as presented by R. S. Strichartz in his book [Stro6]. The notions of Dirichlet form, Laplacian, normal derivative ... are introduced for the class of post critical finite sets. Spectral analysis of the Laplacian and an equivalent Weyl formula are given. We present a result about general partial differential equations on fractals, in particular, the solution of heat problem is described in terms of heat semigroup.
- ii. In chapter two, we present numerical methods on fractals. The finite difference method, introduced in [DSV99], and rigorously analysed in [RD19] is exposed, as well as the finite volume

method, which we developed in [RD21a]. We conclude the chapter by a breve presentation of the finite element method.

- iii. Chapter three summarizes our articles [RD21d] and [RD21c]. In the first one, we give necessary condition and a numerical algorithm to find extrema of functions on self-similar domains. The second one establishes a controllability result for the heat equation on self-similar domains.
- iv. In chapter four we analyze a different type of problems, where the set is an open domain with fractal boundary. By implementing the finite element method, we solve an optimal shape problem on this domain.
- v. Chapter five is an application of the general theory of Krein-Feller-Stieljes to finance, leading, in particular, the Black-Scholes formula. Using the fractal Laplacian we construct a self-similar Black-Scholes equation, and we establish the existence and uniqueness of the solution with numerical simulations.

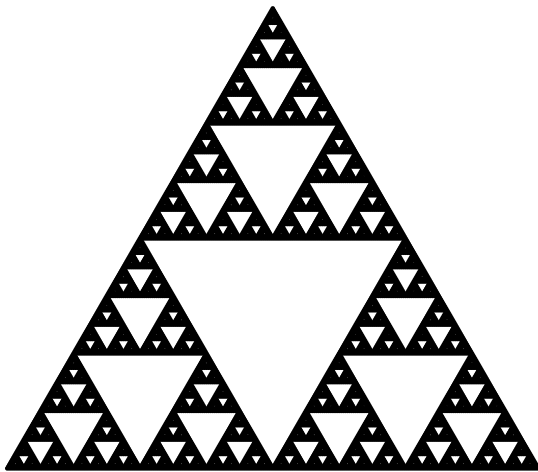

The Sierpiński Gasket.

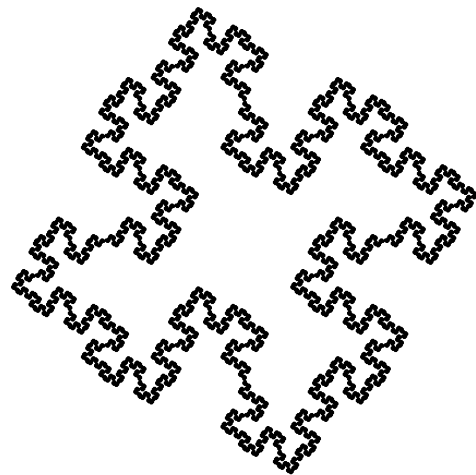

The Minkowski Island.

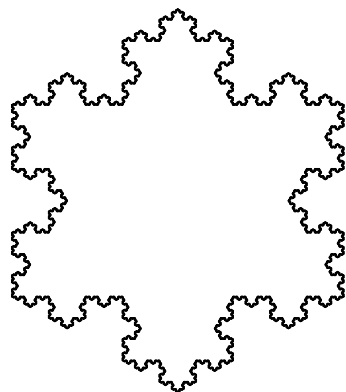

The Koch Snowflake.

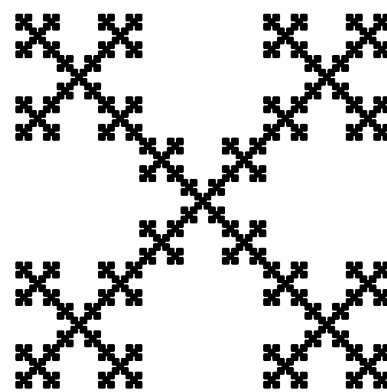

The Vicsek Set.

Figure 2: Examples of fractal sets.

Notations

\mathcal{F}	Fractal object
$\mathcal{S}\mathcal{G}$	Sierpiński gasket
$\mathcal{S}\mathcal{T}$	Sierpiński tetrahedron
$\mathcal{S}\mathcal{S}$	Sierpiński simplex
$\mathcal{S}\mathcal{C}$	Sierpiński carpet
$\mathcal{M}\mathcal{C}$	Minkowski curve
$\mathcal{K}\mathcal{C}$	Koch curve
$\mathcal{K}\mathcal{S}$	Koch Snowflake
D_H	Hausdorff-Besicovitch dimension - similarity dimension
D_S	Spectral dimension
D_W	Walk dimension
μ	Self-similar measure
\mathcal{E}	Dirichlet form
r	Energy normalization constant
Δ_μ	Self-similar Laplacian
∂_n	Normal derivative
FDM	Finite difference method
FVM	Finite volume method
FEM	Finite element method
PGA	Projected gradient algorithm
$\mathcal{B}\mathcal{S}$	Black-Scholes operator
$\mathcal{B}\mathcal{S}_\mu$	Self-similar Black-Scholes operator
$\psi_{X_m}^{(m)}$	Harmonic spline function of order m

Chapter 1

Analysis on Fractals

1.1 GENERAL CONSIDERATIONS

The Laplacian plays a major role in the mathematical analysis of partial differential equations. Recently, the work of Jun Kigami [Kig89], [Kig93], taken up by Robert S. Strichartz [DSV99], [Str99], allowed the construction of an operator of the same nature, defined locally, on graphs having a fractal character: the Sierpiński Gasket, the Sierpiński Carpet, the Diamond Fractal, the Julia sets, the Barnsley Fern.

Jun Kigami starts from the definition of the Laplacian on the unit segment of the real line. For a double-differentiable function u on $[0, 1]$, the Laplacian Δu is obtained as a second derivative of u on $[0, 1]$. For any pair (u, v) belonging to the space of functions that are differentiable on $[0, 1]$, such that

$$v(0) = v(1) = 0$$

he puts the light on the fact that, taking into account that

$$\int_0^1 (\Delta u)(x) v(x) dx = - \int_0^1 u'(x) v'(x) dx = - \lim_{n \rightarrow +\infty} \sum_{k=1}^n \int_{\frac{k-1}{n}}^{\frac{k}{n}} u'(x) v'(x) dx.$$

If $\varepsilon > 0$, the continuity of u' and v' shows the existence of a natural rank n_0 such that, for any integer $n \geq n_0$, and any real number x of $\left[\frac{k-1}{n}, \frac{k}{n}\right]$, $1 \leq k \leq n$:

$$\left| u'(x) - \frac{u\left(\frac{k}{n}\right) - u\left(\frac{k-1}{n}\right)}{\frac{1}{n}} \right| \leq \varepsilon, \quad \left| v'(x) - \frac{v\left(\frac{k}{n}\right) - v\left(\frac{k-1}{n}\right)}{\frac{1}{n}} \right| \leq \varepsilon$$

The relation

$$\int_0^1 (\Delta u)(x) v(x) dx = - \lim_{n \rightarrow +\infty} n \sum_{k=1}^n \left(u\left(\frac{k}{n}\right) - u\left(\frac{k-1}{n}\right) \right) \left(v\left(\frac{k}{n}\right) - v\left(\frac{k-1}{n}\right) \right) \quad (1)$$

enables one to define, under a weak form, the Laplacian of u , while avoiding first derivatives. It thus opens the door to Laplacians on fractal domains.

Concretely, the weak formulation is obtained by means of Dirichlet forms, built by induction on a sequence of graphs that converges towards the considered domain. For a continuous function on this domain, its Laplacian is obtained as the renormalized limit of the sequence of graph Laplacians.

In this chapter, we present the foundation of the theory of Laplacian on fractals and related fields, with examples from self-similar sets, starting from the spectral analysis of the induced Laplacian to the general theory of partial differential equations on fractals.

1.2 A FEW RECALLS

For the benefit of the reader who may not be familiar with mathematical notions devoted to fractals, we shall first recall several definitions.

Definition 1.2.1. Hausdorff Measure [Fal14]

Let $E \subset \mathbb{R}^n$ and $s \geq 0$. The s -**dimensional Hausdorff measure** $\mathcal{H}^s(E)$ of E is defined as

$$\begin{aligned} \mathcal{H}^s(E) &= \lim_{\delta \rightarrow 0} \mathcal{H}_\delta^s(E) \\ &= \lim_{\delta \rightarrow 0} \inf \left\{ \sum_{i=1}^{\infty} |U_i|^s \quad : \quad \{U_i\} \text{ is a } \delta\text{-cover of } E \right\}. \end{aligned}$$

A δ -cover of a set E is a countable collection of sets $\{U_i\}$ with diameter $0 \leq |U_i| \leq \delta$ that cover E .

Definition 1.2.2. Hausdorff-Besicovitch Dimension [Fal14]

Given $E \subset \mathbb{R}^n$ and $s \geq 0$, the **Hausdorff-Besicovitch dimension** $D_H(E)$ of E is defined as

$$\begin{aligned} D_H(E) &= \inf \{s \geq 0 \quad : \quad \mathcal{H}^s(E) = 0\} \\ &= \sup \{s \geq 0 \quad : \quad \mathcal{H}^s(E) = \infty\}. \end{aligned}$$

Next, we present methods associated to a subclass of fractal sets, the so-called **self-similar sets**. John E. Hutchinson [Hut81] was the first to give a rigorous study of those objects.

Theorem 1.2.1. Gluing Lemma [BD85a]

Given a complete metric space (E, δ) , a strictly positive integer N , and a set $\{f_i\}_{1 \leq i \leq N}$ of contractions on E with respect to the metric δ , there exists a unique non-empty compact subset $K \subset E$ such that

$$K = \bigcup_{i=1}^N f_i(K).$$

*The set K is said **self-similar** with respect to the family $\{f_1, \dots, f_N\}$, and called attractor of the iterated function system (IFS) $\{f_1, \dots, f_N\}$.*

1.3 POST-CRITICALLY FINITE FRACTALS

Notation.

In the sequel, \mathcal{F} denotes a fractal domain of Hausdorff dimension $D_H(\mathcal{F})$ such that

$$\mathcal{F} = \bigcup_{i=1}^N f_i(\mathcal{F}), \quad (2)$$

where N denotes a strictly positive integer, and $\{f_1, \dots, f_N\}$ is a set of contractive maps, where, for any integer i of $\{1, \dots, N\}$, $R_i \in]0, 1[$ is the contraction ratio of f_i , and $P_i \in \mathbb{R}^d$ is the fixed point of f_i .

Jun Kigami's analytic approach [Kigo1] consists in the construction of an increasing sequence of finite graphs which approximate the self-similar set \mathcal{F} ; this enables the definition of Dirichlet form as the limit of Dirichlet forms on the sequence of finite graphs that approximate the fractal, as presented below.

Definition 1.3.1. Boundary (or initial) Graph

We denote by V_0 the ordered set of the fixed points $\{P_1, \dots, P_{N_0}\}$.

The set of points V_0 – where, for any integer i in $\{1, \dots, N_0 - 1\}$, the point P_i is linked to the point P_{i+1} – constitutes a finite graph, which we will denote by \mathcal{F}_0 . Then, V_0 is called *the set of vertices* of the graph \mathcal{F}_0 .

The set V_0 is called the **boundary** of \mathcal{F} .

Remark 1.3.1.

- i.* As pointed by Strichartz in [Stro6], the choice of the boundary is not necessarily unique. Moreover, in some cases, \mathcal{F}_0 is not complete, but this choice is made to rule out finding a non-degenerate solution to the renormalization equation as it will be detailed next.
- ii.* The topological notion of boundary is irrelevant in our case since Post-critically Finite fractals have no interior in general.
- iii.* We will give below a systematic definition of the boundary.

Definition 1.3.2. Word

Given a strictly positive integer m , we will call **number-letter** any integer \mathcal{W}_i of $\{1, \dots, N\}$, and **word of length** $|\mathcal{W}| = m$, any set of number-letters of the form

$$\mathcal{W} = (\mathcal{W}_1, \dots, \mathcal{W}_m) \cdot$$

We will write

$$f_{\mathcal{W}} = f_{\mathcal{W}_1} \circ \dots \circ f_{\mathcal{W}_m} \cdot$$

Definition 1.3.3. Edge Relation

For any $m \in \mathbb{N}$, the prefractal graph $\Gamma_{\mathcal{W}_m}$ is equipped with an edge relation \sim_m , as follows: two vertices X and Y of \mathcal{F}_m (i.e. two points belonging to V_m) will be said to be *adjacent* (i.e., *neighboring* or *junction points*) if and only if the line segment $[X, Y]$ is an edge of $\Gamma_{\mathcal{W}_m}$; we then write $X \sim_m Y$. Note that this edge relation depends on m , which means that points adjacent in V_m might not remain adjacent in V_{m+1} .

Note that, equivalently, two points X and Y are *adjacent* if and only if there exist a word $\mathcal{W} = (\mathcal{W}_1, \dots, \mathcal{W}_m)$ of length m , such that X and Y both belong to the iterate

$$f_{\mathcal{W}} V_0 = (f_{\mathcal{W}_1} \circ \dots \circ f_{\mathcal{W}_m}) V_0 \cdot$$

Definition 1.3.4. Addresses

Given a natural integer m , a word \mathcal{W} of length m , a point $P_i \in V_0$, we will call **address** of the vertex X an expression of the form

$$X = f_{\mathcal{W}}(P_i)$$

Definition 1.3.5. Prefractal Graph of Order m , $m \in \mathbb{N}^*$

For any strictly positive integer m , we set

$$V_m = \bigcup_{i=1}^N f_i(V_{m-1}) \cdot \quad (3)$$

The set of points V_m , where the points of an m^{th} -order cell are connected using the edge relation \sim_m , is called **the prefractal graph of order m** and will be denoted by \mathcal{F}_m .

By extension, we will write

$$\mathcal{F}_m = \bigcup_{i=1}^N f_i(\mathcal{F}_{m-1}) \cdot \quad (4)$$

We can prove that the sequence $\{V_m\}_{m \in \mathbb{N}}$ is increasing and that its limit is dense in \mathcal{F} , as it can be found in Jun Kigami's book [Kigo1]:

Property 1.3.1.

For any natural integer m ,

$$V_m \subset V_{m+1}.$$

Property 1.3.2. Density [Hut81]

The set $V_\star = \bigcup_{m \in \mathbb{N}} V_m$ is dense in \mathcal{F} .

Note that the graph \mathcal{F}_m is the union of N copies $f_i(\mathcal{F}_{m-1})$ for some $i \in \{1, \dots, N\}$. This gives an alternative way to view this construction, as explained below.

Property 1.3.3. Subcell - Junction Points

Given a natural integer m , the graph \mathcal{F}_m can be written as the finite union of N^m subgraphs,

$$\mathcal{F}_m = \bigcup_{|\mathcal{W}|=m} f_{\mathcal{W}}(\mathcal{F}_0).$$

For any word \mathcal{W} of length m , $f_{\mathcal{W}}(\mathcal{F}_0)$ will be called m^{th} -order cell, or subcell.

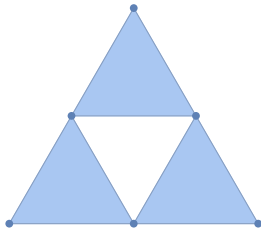

Figure 3: $\mathcal{S}\mathcal{G}_1$ of the Sierpiński Gasket

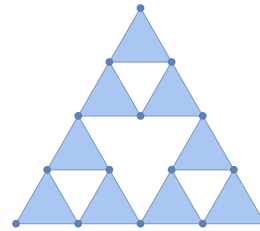

Figure 4: $\mathcal{S}\mathcal{G}_2$ of the Sierpiński Gasket

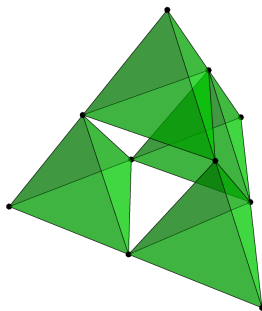

Figure 5: $\mathcal{S}\mathcal{T}_1$ of the Sierpiński Tetrahedron

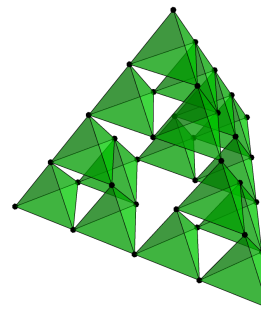

Figure 6: $\mathcal{S}\mathcal{T}_2$ of the Sierpiński Tetrahedron

In the following, we give a rigorous definition of the central object of this thesis: Post-critically finite sets. We refer the reader to the book of J. Kigami [Kigo1] for more details.

Notation.

i. Given a strictly positive integer m , we will denote by Σ_m to be the set of words $\mathcal{W} \in \{1, \dots, N\}^m$ of length m .

ii. We then set

$$\Sigma_* = \bigcup_{m \in \mathbb{N}^*} \Sigma_m.$$

and we define Σ to be the collection of one-sided infinite words.

Notation.

For the sake of clarity, we will, from now on, refer to a self-similar set either by \mathcal{F} or by the **self-similar structure**

$$\mathcal{L} = (\mathcal{F}, S, (f_i)_{i \in S}).$$

Remark 1.3.2.

The index set S contributes to the **identification** of the structure \mathcal{L} by building sets of words and addresses.

Notation.

We will denote by:

i. σ , the **shift map** from Σ to Σ which, for any word \mathcal{W} , deletes the first "**letter**", i.e.,

$$\sigma(12233\dots) = 2233\dots$$

ii. π , the unique continuous surjective map from Σ to \mathcal{F} defined for every infinite "word" $\mathcal{W} = \mathcal{W}_1\mathcal{W}_2\dots \in \Sigma$, by:

$$\pi(\mathcal{W}) = \bigcap_{m \in \mathbb{N}^*} f_{\mathcal{W}_1\dots\mathcal{W}_m}(\mathcal{F})$$

where $f_{\mathcal{W}_1\dots\mathcal{W}_m} = f_{\mathcal{W}_1} \circ \dots \circ f_{\mathcal{W}_m}$.

iii.

$$C_{\mathcal{L},\mathcal{F}} = \bigcup_{(i,j) \in \Sigma^2, i \neq j} (\mathcal{F}_i \cap \mathcal{F}_j)$$

Remark 1.3.3.

i. We can think of a word $\mathcal{W} \in \Sigma$ as a limit of some increasing sequence of finite words $(\mathcal{W}_m)_{m \in \mathbb{N}^*} \in \Sigma_{\star}$, this induce a decreasing sequence of compacts in the sense of inclusion $f_{\mathcal{W}_{m+1}}(\mathcal{F}) \subset f_{\mathcal{W}_m}(\mathcal{F})$ converging to a singleton. The definition of π follows

$$\pi(\mathcal{W}) = f_{\mathcal{W}}(\mathcal{F}) = \lim_{m \rightarrow +\infty} f_{\mathcal{W}_m}(\mathcal{F}) = \bigcap_{m \in \mathbb{N}^*} f_{\mathcal{W}_1 \dots \mathcal{W}_m}(\mathcal{F})$$

ii. To visualize how the map π works, we use in the following figure the notation $f_{\mathcal{W}}(\mathcal{F}) = \mathcal{F}_{\mathcal{W}}$

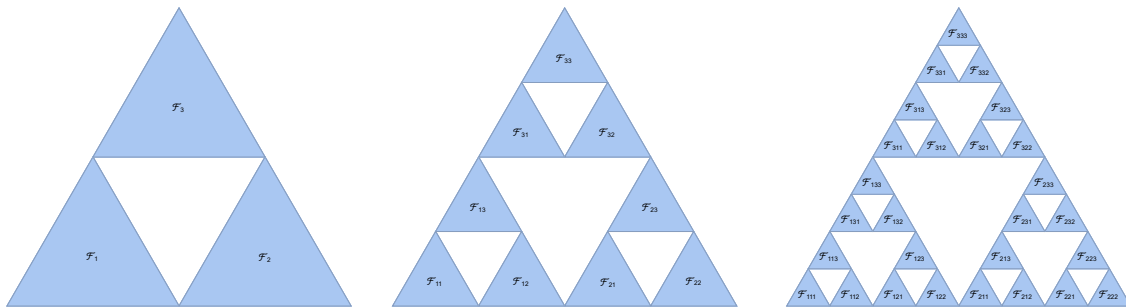

Figure 7: Topological structure of the Sierpiński gasket.

iii. The set $C_{\mathcal{L},\mathcal{F}}$ contains ramification points.

Definition 1.3.6. Critical Set, Post-Critical Set (See [Kigo1], Chapter 1, Section 1.3., Definition 1.3.13, page 23.)

We define:

i. The **critical set**,

$$C_{\mathcal{L}} = \pi^{-1}(C_{\mathcal{L},\mathcal{F}}) \cdot$$

ii. The **post-critical set**,

$$P = \bigcup_{m \in \mathbb{N}^*} \sigma^m(C_{\mathcal{L}}) \cdot$$

The critical set $C_{\mathcal{L}}$ and the post-critical set P play an important role in the topology of $(\mathcal{F}, \Sigma, (f_i)_{i=1}^M)$, in so far as:

- i.* If the post-critical set P is finite, then the set $(\mathcal{F}, S, (f_i)_{i \in S})$ is called **post-critically finite** or sometimes **finitely ramified**. We have to notice that finitely ramified sets are post-critically finite but the inverse is not true [Kigo1].
- ii.* **finitely ramified fractal** means that the fractal may become a disconnected set by removing a finite number of points.
- iii.* The **post-critically finite sets (P.C.F. sets)** plays an important role in the theory of partial differential on fractals and constitute the principal domain of applications.
- iv.* If $C_{\mathcal{L}}$ is empty, then \mathcal{L} is homeomorphic to the Cantor set.

Property 1.3.4.

$$V_0 = \pi \left(\bigcup_{m \in \mathbb{N}^*} \sigma^m(C_{\mathcal{L}}) \right)$$

In the sequel, we give an equivalent definition of neighborhood in the case of self-similar set:

Definition 1.3.7. System of Neighborhood [Kigo1]

Let us denote by $(\mathcal{F}, S, (f_i)_{i \in S})$ a self-similar structure. For any $X \in \mathcal{F}$, and any natural integer m , we set:

$$\mathcal{F}_{m,X} = \bigcup_{W \in \Sigma_m, X \in f_W(\mathcal{F})} f_W(\mathcal{F})$$

which will be called **system of neighborhood** of X .

Example 1.3.1. Sierpiński Gasket

Let us denote by $\mathfrak{S}\mathfrak{G}$ the Sierpiński Gasket (see figure 8). It is defined as the self-similar set with respect to the contractions family

$$f_1(X) = \frac{X + P_1}{2}, \quad f_2(X) = \frac{X + P_2}{2}, \quad f_3(X) = \frac{X + P_3}{2}$$

where $P_1 = (0,0)$, $P_2 = (1,0)$, $P_3 = (\frac{1}{2}, \frac{\sqrt{3}}{2})$ and $S = \{1,2,3\}$. $\mathfrak{S}\mathfrak{G}$ is a post-critical finite set with $C_{L,\mathcal{F}} = \{f_2(P_1), f_3(P_2), f_1(P_3)\}$, $C_{\mathcal{L}} = \{1222\dots, 2111\dots, 2333\dots, 3222\dots, 1333\dots, 3111\dots\}$, $P = \{111\dots, 222\dots, 333\dots\}$ and $V_0 = \{P_1, P_2, P_3\}$.

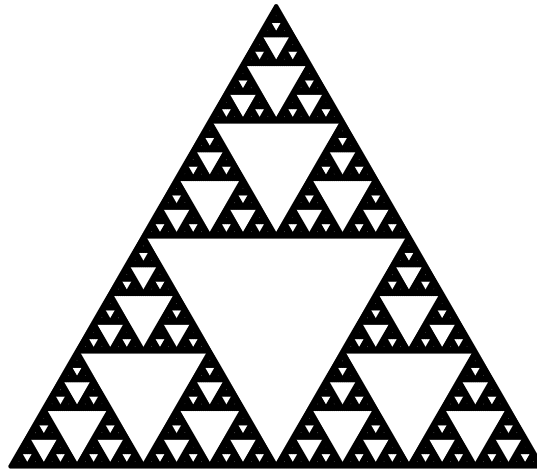

Figure 8: The Sierpiński Gasket.

Example 1.3.2. The Sierpiński Carpet

Let us denote by $\mathfrak{S}\mathfrak{C}$ the Sierpiński Carpet (see figure 9). It is defined as the self-similar set with respect to the contractions family

$$\begin{aligned} f_1(X) &= \frac{X + 2P_1}{3} & f_2(X) &= \frac{X + 2P_2}{3} & f_3(X) &= \frac{X + 2P_3}{3} & f_4(X) &= \frac{X + 2P_4}{3} \\ f_5(X) &= \frac{X + 2P_5}{3} & f_6(X) &= \frac{X + 2P_6}{3} & f_7(X) &= \frac{X + 2P_7}{3} & f_8(X) &= \frac{X + 2P_8}{3} \end{aligned}$$

where $P_1 = (0,0)$, $P_2 = (0, \frac{1}{2})$, $P_3 = (0,1)$, $P_4 = (\frac{1}{2}, 1)$, $P_5 = (1,1)$, $P_6 = (1, \frac{1}{2})$, $P_7 = (1,0)$, $P_8 = (\frac{1}{2}, 0)$ and $S = \{1, \dots, 8\}$. $\mathfrak{S}\mathfrak{C}$ is a post-critical infinite set with V_0 the boundary of the unit square $[0, 1] \times [0, 1]$.

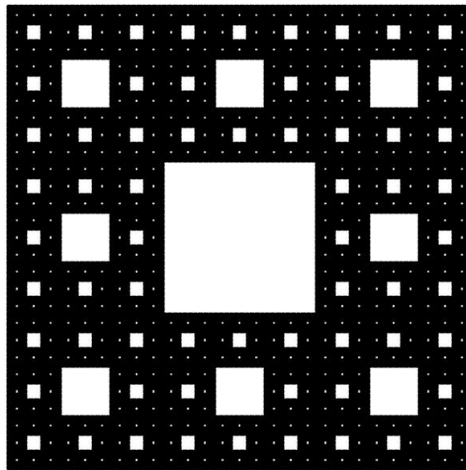

Figure 9: The Sierpiński Carpet.

In the sequel, we recall the notions of connectivity and arcwise connectivity.

Definition 1.3.8 (Connected Set ([Kigo1], Chapter 1, Section 1.6., Definition 1.6.1, page 33)).

A metric space (E, d) is said to be *connected* if and only if any closed and open subset of E is E or the empty set \emptyset .

Definition 1.3.9 (Arcwise Connected Set ([Kigo1], Chapter 1, Section 1.6., Definition 1.6.1, page 33)).

A subset A of a metric space (E, d) is said to be *arcwise connected* if and only if, for all $(x, y) \in A^2$, there exists a path between x and y ; i.e., there exists a continuous map $\gamma : [0, 1] \rightarrow A$ such that $\gamma(0) = x$ and $\gamma(1) = y$.

Theorem 1.3.5 ([Kigo1] (Chapter 1, Section 1.6., Theorem 1.6.2, page 33)).

Arcwise connectivity and connectivity are equivalent in the case of self-similar sets.

Throughout this work, we exclusively deal with **connected P.C.F. sets**.

1.4 SELF-SIMILAR MEASURE

Differential operators on fractals are deduced from the integration by part formula, which calls for the definition of an appropriate integration on fractals. To this purpose, we need to introduce an appropriate measure theory on self-similar sets; see [Hut81].

Definition 1.4.1. Self-Similar Measure on \mathcal{F} [Hut81]

Given a family of strictly positive weights $(\mu_i)_{1 \leq i \leq N}$ such that

$$\sum_{i=1}^N \mu_i = 1,$$

there exist a unique measure μ with full support on \mathbb{R}^d which is called **self-similar measure** on $\mathcal{F} = \bigcup_{i=1}^N f_i(\mathcal{F})$ if,

$$\mu = \sum_{i=1}^N \mu_i \mu \circ f_i^{-1}. \quad (5)$$

Definition 1.4.2. The Open Set Condition – Similarity Dimension

The set of maps $\{f_1, \dots, f_N\}$ satisfies the **open set condition** if there exists a non-empty bounded open set \mathcal{O} such that

$$\cup_{i=1}^N f_i(\mathcal{O}) \subset \mathcal{O} \quad \text{and} \quad f_i(\mathcal{O}) \cap f_j(\mathcal{O}) = \emptyset \quad \text{for } i \neq j$$

Therefore, there exists a real number $D_H(\mathcal{F})$ satisfying

$$\sum_{i=1}^N R_i^{D_H(\mathcal{F})} = 1 \tag{6}$$

which is called the **similarity dimension** of \mathcal{F} (see [Fal14]); it is also the Hausdorff dimension of \mathcal{F} .

Property 1.4.1. Building of a Self-similar Measure on \mathcal{F}

We set, for any integer i belonging to $\{1, \dots, N\}$, where $R_i \in]0, 1[$ is the contraction ratio of f_i ,

$$\mu_i = R_i^{D_H(\mathcal{F})}.$$

Under the O.S.C. 1.4.2, one has, then,

$$\sum_{i=1}^N R_i^{D_H(\mathcal{F})} = 1.$$

which enables us to define a self-similar measure μ on \mathcal{F} through

$$\mu = \sum_{i=1}^N \mu_i \mu \circ f_i^{-1}.$$

Note that the measure μ corresponds to the normalized $D_H(\mathcal{F})$ -dimensional Hausdorff measure ($\mathcal{H}^{D_H(\mathcal{F})}$) (we refer to [Fal85]):

$$\mu(E) = \frac{\mathcal{H}^{D_H(\mathcal{F})}(E \cap \mathcal{F})}{\mathcal{H}^{D_H(\mathcal{F})}(\mathcal{F})}$$

for any subset $E \subset \mathbb{R}^d$.

Remark 1.4.1.

It is clear that $\mu(\mathcal{F}) = 1$.

Definition 1.4.3. Integration on \mathcal{F} [Stro6]

Given a self-similar measure μ and a continuous function u on \mathcal{F} , we define the integral:

$$\int_{\mathcal{F}} u d\mu = \lim_{m \rightarrow +\infty} \sum_{\mathcal{W} \in \Sigma_m} u(X_{\mathcal{W}}) \mu(f_{\mathcal{W}}(\mathcal{F}))$$

for $X_{\mathcal{W}} \in f_{\mathcal{W}}(\mathcal{F})$. Moreover, using self-similarity of the measure we have that

$$\int_{\mathcal{F}} u d\mu = \sum_{i=1}^N \mu_i \int_{\mathcal{F}} u \circ f_i^{-1} d\mu. \tag{7}$$

Proof.

The function f is bounded on the compact \mathcal{F} and by definition of μ

$$0 < \mu(f_{\mathcal{W}}(\mathcal{F})) = \prod_{i \in \mathcal{W}} \mu_i < 1$$

for all $\mathcal{W} \in \Sigma_m$, thus

$$\left| \sum_{\mathcal{W} \in \Sigma_m} u(X_{\mathcal{W}}) \mu(f_{\mathcal{W}}(\mathcal{F})) \right| \leq \|u\|_{C(\mathcal{F})} \sum_{i=1}^m (\max_j \mu_j)^i$$

The convergence of the integral is guaranteed by the geometric criterion. □

1.5 DIRICHLET FORMS ON P.C.F. SETS

Following the construction of the first section, given a natural integer m , and two real valued functions u and v , defined on the set V_m of the vertices of \mathcal{F}_m , we introduce **the energy, on the graph \mathcal{F}_m , of the pair of functions (u, v)** , as

$$E_{\mathcal{F}_m}(u, v) = \sum_{(X, Y) \in V_m^2, X \sim Y} (u(X) - u(Y)) (v(X) - v(Y)) \cdot$$

For the sake of simplicity, we will write it under the form

$$E_{\mathcal{F}_m}(u, v) = \sum_{X \sim_m Y} (u(X) - u(Y)) (v(X) - v(Y)) \cdot$$

Moving from the order m to $m + 1$, there exists a unique **harmonic extension** \tilde{u} of u to the graph \mathcal{F}_{m+1} which minimize the energy $E_{\mathcal{F}_{m+1}}(u) = E_{\mathcal{F}_{m+1}}(\tilde{u}, u)$ [Kigo1]. It may happen that

$$E_{\mathcal{F}_{m+1}}(\tilde{u}) = r E_{\mathcal{F}_m}(u) \cdot \tag{8}$$

for some normalization constant $0 < r < 1$ independent of m , which leads to the definition of **normalized energy $\mathcal{E}_{\mathcal{F}_m}$** ,

$$\mathcal{E}_{\mathcal{F}_m}(u) = r^{-m} E_{\mathcal{F}_m}(u) \cdot$$

This definition guarantees that the sequence $\{\mathcal{E}_{\mathcal{F}_m}\}_{m \in \mathbb{N}}$ is an non-decreasing sequence for any function u on \mathcal{F}_m , and it can be shown that it is a sequence of **Dirichlet forms**:

Definition 1.5.1. Dirichlet Form, on a Finite Set (see [Kigo3])

Let us denote by V a finite set V , equipped with the usual inner product which, to any pair (u, v) of functions defined on V , associates

$$(u, v) = \sum_{p \in V} u(p) v(p) \cdot$$

A **Dirichlet form** on V is a symmetric bilinear form \mathcal{E} , such that:

1. For any real valued function u defined on V : $\mathcal{E}(u, u) \geq 0$.
2. $\mathcal{E}(u, u) = 0$ if and only if u is constant on V .
3. For any real-valued function u defined on V , if: $u_* = \min(\max(u, 0), 1)$, i.e.,

$$\forall p \in V : u_*(p) = \begin{cases} 1 & \text{if } u(p) \geq 1 \\ u(p) & \text{si } 0 < u(p) < 1 \\ 0 & \text{if } u(p) \leq 0 \end{cases}$$

then: $\mathcal{E}(u_*, u_*) \leq \mathcal{E}(u, u)$ (Markov property).

Property 1.5.1.

Given a natural integer m , and a real-valued function u , defined on the set V_m of vertices of \mathcal{F}_m , the map, which, to any pair of real-valued, continuous functions (u, v) defined on V_m , associates

$$\mathcal{E}_{\mathcal{F}_m}(u, v) = r^{-m} \sum_{X \sim_m Y} (u(X) - u(Y)) (v(X) - v(Y))$$

is a Dirichlet form on \mathcal{F}_m .

Moreover,

$$\mathcal{E}_{\mathcal{F}_m}(u, u) = 0 \Leftrightarrow u \text{ is constant}$$

It makes sense to define

$$\mathcal{E}(u) = \lim_{m \rightarrow +\infty} \mathcal{E}_{\mathcal{F}_m}(u) \cdot \tag{9}$$

We can check that [Stro6]:

Theorem 1.5.2.

If $u \in \text{dom } \mathcal{E}$ then $u \circ f_i \in \text{dom } \mathcal{E}$ for all i and

$$\mathcal{E}(u) = \sum_{i=1}^N r^{-1} \mathcal{E}(u \circ f_i) \cdot$$

Notation.

We will denote by:

- i. $\text{dom } \mathcal{E}$ the subspace of continuous functions defined on \mathcal{F} , such that

$$\mathcal{E}(u) < \infty \cdot$$

- ii. $\text{dom}_0 \mathcal{E}$ the subspace of continuous functions defined on \mathcal{F} , which take the value zero on V_0 , and such that:

$$\mathcal{E}(u) < \infty.$$

Let us now introduce the notion of **Dirichlet form on a measured space**.

Definition 1.5.2. Dirichlet Form on a Measured Space ([BD85b],[FOT94])

Given a measured space (E, μ) , a *Dirichlet form* on E is a bilinear symmetric form, that we will denote by \mathcal{E} , defined on a vectorial subspace D dense in $L^2_\mu(E)$, such that:

1. For any real-valued function u defined on D : $\mathcal{E}(u, u) \geq 0$.
2. D , equipped with the inner product which, to any pair (u, v) of $D \times D$, associates:

$$(u, v)_\mathcal{E} = (u, v)_{L^2_\mu(E)} + \mathcal{E}(u, v)$$

is a Hilbert space.

3. For any real-valued function u defined on D , if

$$u_* = \min(\max(u, 0), 1) \in D$$

then, $\mathcal{E}(u_*, u_*) \leq \mathcal{E}(u, u)$ (Markov property, or lack of memory property).

We refer to the book of Robert S. Strichartz [Stro6] for a proof of the following results:

Lemma 1.5.3.

We have that: $\text{dom } \mathcal{E} \subset C(\mathcal{F})$. Moreover, it can be shown that $\text{dom } \mathcal{E}$ are the space of Hölder continuous functions on \mathcal{F} .

Lemma 1.5.4.

The map:

$$\begin{array}{ccc} \text{dom } \mathcal{E} / \text{Constants} \times \text{dom } \mathcal{E} / \text{Constants} & \rightarrow & \mathbb{R} \\ (u, v) & \mapsto & \mathcal{E}(u, v) \end{array}$$

defines an inner product on $\text{dom } \mathcal{E} / \text{Constants}$.

Theorem 1.5.5.

The space $(\text{dom } \mathcal{E} / \text{Constants}, \mathcal{E}(\cdot, \cdot))$ is a complete Hilbert space.

Definition 1.5.3.

The space $S(\mathcal{H}_0, V_m)$ of **piecewise harmonic splines of level m** is defined to be the space of continuous functions u such that $u \circ f_{\mathcal{W}}$ is harmonic for all $|\mathcal{W}| = m$.

Definition 1.5.4.

We say that the sequence $\{u_n\}_{n \in \mathbb{N}}$ converges to u **in energy** if these following two conditions hold:

1. $\lim_{n \rightarrow +\infty} \mathcal{E}(u - u_n) = 0$.
2. $\lim_{n \rightarrow +\infty} \|u - u_n\|_{C(\mathcal{F})} = 0$.

Proposition 1.5.6.

Any function $u \in C(\mathcal{F})$ may be approximated uniformly by a sequence $\{u_n\}_{n \in \mathbb{N}} \subset S(\mathcal{H}_0, V_m)$, with $u_n|_{V_m} = u|_{V_m}$. Moreover, if $u \in \text{dom } \mathcal{E}$ then u_m converges to u in energy.

In more general cases, the normalized equality

$$E_{\mathcal{F}_{m+1}}(\tilde{u}) = r E_{\mathcal{F}_m}(u)$$

fails to be satisfied. This implies a general definition of the Dirichlet form if such a form exist.

Definition 1.5.5. Dirichlet Form on P.C.F. sets

Given the sequence of graphs $(\mathcal{F}_m)_{m \in \mathbb{N}'}$ and a pair (u, v) of continuous function defined on \mathcal{F} , we define the following Dirichlet form

$$\mathcal{E}_{\mathcal{F}}(u, v) = \lim_{m \rightarrow +\infty} \mathcal{E}_{\mathcal{F}_m}(u, v) \tag{10}$$

$$= \lim_{m \rightarrow +\infty} \sum_{\substack{X \sim Y \\ m}} c_m(X, Y) (u(X) - u(Y)) (v(X) - v(Y)) \tag{11}$$

for some sequence $\{c_m(X, Y)\}_{m \in \mathbb{N}'}$ satisfying

1. $\mathcal{E}_{\mathcal{F}_{m+1}}(\tilde{u}) = \mathcal{E}_{\mathcal{F}_m}(u)$, if \tilde{u} is the harmonic extension of u .

2. $\mathcal{E}_{\mathcal{F}_{m+1}}(u) = \sum_{i=1}^N r_i^{-1} \mathcal{E}_{\mathcal{F}_m}(u \circ f_i)$, for suitable resistance renormalization factors r_i satisfying $0 < r_i < 1$.

A P.C.F. fractal satisfying these conditions is said to have a **regular harmonic structure**.

1.6 LAPLACIAN ON P.C.F. SETS

The Dirichlet form \mathcal{E} on P.C.F. sets can be seen as an analogous of the following Dirichlet form, in the case of an open subset $\Omega \subset \mathbb{R}^n$, and two smooth functions u and v on Ω ,

$$\mathcal{E}(u, v) = \int_{\Omega} \nabla u \nabla v \, dx.$$

It is known via the integration by parts formula that

$$\int_{\Omega} \nabla u \nabla v \, dx = - \int_{\Omega} \Delta u v \, dx + \int_{\partial\Omega} \partial_n u v \, dx.$$

Now, if we consider the case $u \in C^2(\Omega)$ and $v \in C_c^1(\Omega)$ we get

$$\int_{\Omega} \nabla u \nabla v \, dx = - \int_{\Omega} \Delta u v \, dx$$

We can use this correspondence to define the Laplacian using a suitable choice of v .

Theorem 1.6.1. Correspondence between Dirichlet Forms and Laplacians [FOT94]

Let us denote by H a Hilbert space, equipped with a scalar product $\langle \cdot, \cdot \rangle_H$, and by \mathcal{E} a Dirichlet form on H . There exists a natural correspondence between the Dirichlet form \mathcal{E} and the Laplacian Δ in the following way,

$$\mathcal{E}(u, v) = - \langle \Delta u, v \rangle_H.$$

The above correspondence enables us to build a Laplacian (with respect to μ) via the following definition.

Definition 1.6.1. Laplacian on P.C.F. Sets

Let us consider $u \in \text{dom}\mathcal{E}$. Then, u belongs to $\text{dom}\Delta_{\mu}$, with $\Delta_{\mu}u = f$, if

$$\mathcal{E}(u, v) = - \int_{\mathcal{F}} f v \, d\mu, \quad \forall v \in \text{dom}_0\mathcal{E}$$

In the case where $f \in L_{\mu}^2(\mathcal{F})$, the same definition holds, this time with $u \in \text{dom}_{L_{\mu}^2}\Delta_{\mu}$.

We have the following theorem:

Theorem 1.6.2.

$$(u \in \text{dom } \Delta \quad \text{and} \quad \Delta u = 0) \quad \underline{\text{if and only if } u \text{ is harmonic}}$$

For an appropriate choice of the function v , we can deduce the Laplacian formula, by exploiting the nature of the Dirichlet form \mathcal{E} :

Theorem 1.6.3. Pointwise Formula

Let us denote by m be a strictly positive integer, $X \in V_\star \setminus V_0$, and $\psi_X^m \in \mathcal{S}(\mathcal{H}_0, V_m)$ a spline function such that

$$\psi_X^m(Y) = \begin{cases} \delta_{XY} & \forall Y \in V_m \\ 0 & \forall Y \notin V_m \end{cases}, \quad \text{where} \quad \delta_{XY} = \begin{cases} 1 & \text{if } X = Y \\ 0 & \text{else} \end{cases}$$

i. For any function u of $\text{dom } \Delta$, such that its Laplacian exists, the sequence

$$\left(r^{-m} \left\{ \int_{\mathcal{F}} \psi_X^m d\mu \right\}^{-1} \Delta_m u(X) \right)_{m \in \mathbb{N}}$$

converges uniformly towards

$$\Delta_\mu u(X),$$

where

$$\Delta_m u(X) = \sum_{Y \underset{m}{\sim} X} (u(Y) - u(X)),$$

ii. Conversely, given a continuous function u on \mathcal{F} such that the sequence

$$\left(r^{-m} \left\{ \int_{\mathcal{F}} \psi_X^m d\mu \right\}^{-1} \Delta_m u(X) \right)_{m \in \mathbb{N}}$$

converges uniformly towards a continuous function on $V_\star \setminus V_0$, we have that

$$u \in \text{dom } \Delta_\mu \quad \text{and} \quad \Delta_\mu u(X) = \lim_{m \rightarrow +\infty} r^{-m} \left\{ \int_{\mathcal{F}} \psi_X^m d\mu \right\}^{-1} \Delta_m u(X).$$

Corollary 1.6.4. [Stro6]

For an arbitrary point $X \in \mathcal{F}$ and a sequence $(X_m)_{m \in \mathbb{N}}$ in V_m converging to X , the pointwise formula of theorem 1.6.3 holds by density (theorem 1.3.2) and uniform continuity extension, and it becomes:

$$\Delta_\mu u(X) = \lim_{m \rightarrow +\infty} r^{-m} \left\{ \int_{\mathcal{F}} \psi_{X_m}^m d\mu \right\}^{-1} \Delta_m u(X_m). \quad (12)$$

Remark 1.6.1.

The extension described in the corollary is more complicated than it may seem, the process goes through three stages:

- i. Construct a (resistance) metric on V_* (denoted by $\mathcal{R}\mathcal{M}_{\mathcal{F}}$) and establish Hölder continuity: for $X, Y \in V_*$ and $u \in \text{dom}(\mathcal{E})$

$$|u(X) - u(Y)| \leq \sqrt{\mathcal{E}(u)} \sqrt{\mathcal{R}\mathcal{M}_{\mathcal{F}}(X, Y)}$$

- ii. Define $(\Omega, \mathcal{R}\mathcal{M}_{\mathcal{F}})$ the completion of the metric space $(V_*, \mathcal{R}\mathcal{M}_{\mathcal{F}})$, extend u by uniform continuity on $(\Omega, \mathcal{R}\mathcal{M}_{\mathcal{F}})$, then think of $(\text{dom}\mathcal{E}, \mathcal{E})$ as a subset of $C(\Omega, \mathcal{R}\mathcal{M}_{\mathcal{F}})$.
- iii. Identify Ω with \mathcal{F} in the case of regular harmonic structures (definition 1.5.5).

We refer the reader to [Kigo1] for a detailed proof.

Remark 1.6.2. Hölder Continuity and $\text{dom}\mathcal{E}$

The result of lemma 1.5.3 can be improved in light of remark 1.6.1: the Hölder continuity exponent with respect to the resistance metric $\mathcal{R}\mathcal{M}_{\mathcal{F}}$ is $\frac{1}{2}$, and according to [Stro6], it is equivalent to Hölder continuity constant $\alpha = \frac{\ln(r)}{2 \ln(R)}$ with respect to the euclidean metric, where $R = \max_i R_i$ is the maximum contraction ratio.

Integration by part induces a definition on the normal derivative on fractals, this definition is valid either on boundary V_0 or in the **interior** of the self-similar set \mathcal{F} . In addition, we can deduce an equivalent to the **Gauss-Green formula**:

Definition 1.6.2. Normal Derivative

Given a boundary point $X = f_{\mathcal{W}}(P_i)$ of a cell $f_{\mathcal{W}}(\mathcal{F})$, $1 \leq i \leq N_0$, $\mathcal{W} \in \{1, \dots, d\}^\ell$, and a continuous function u on \mathcal{F} , we will say that the normal derivative $\partial_n u$ exists if the limit

$$\partial_n u(P_i) = \lim_{m \rightarrow +\infty} r^{-m} \sum_{\substack{Y \sim_m P_i \\ Y \in f_{\mathcal{W}}(\mathcal{F})}} (u(P_i) - u(Y)) \quad (13)$$

exists. The local normal derivative satisfies

$$\partial_n u(X) = r^{-\ell} \partial_n (u \circ f_{\mathcal{W}})(P_i).$$

Theorem 1.6.5. Green-Gauss Formula

Given $u \in \text{dom}\Delta_\mu$ for a measure μ , $\partial_n u$ exists for all $X \in V_0$, and

$$\mathcal{E}(u, v) = - \int_{\mathcal{F}} \Delta_\mu u v d\mu + \sum_{X \in V_0} \partial_n u(X) v \quad (14)$$

holds for all $v \in \text{dom } \mathcal{E}$.

Corollary 1.6.6.

Given $u \in \text{dom}\Delta_\mu$ for a measure μ :

$$\int_{\mathcal{F}} \Delta_\mu u v d\mu - \int_{\mathcal{F}} u \Delta_\mu v d\mu = \sum_{V_0} (\partial_n u(X) v - u \partial_n v(X)) \quad (15)$$

holds for all $v \in \text{dom } \mathcal{E}$.

Theorem 1.6.7. Matching Condition

Given $u \in \text{dom}\Delta_\mu$, at each junction point

$$X = f_{\mathcal{W}}(P_i) = f_{\mathcal{W}'}(P_j) \quad , \quad (i, j) \in \{1, \dots, N_0\}^2 \quad , \quad (\mathcal{W}, \mathcal{W}') \in \{1, \dots, N\}^m \times \{1, \dots, N\}^m$$

the local normal derivative exists, and

$$\partial_n u(f_{\mathcal{W}}(P_i)) + \partial_n u(f_{\mathcal{W}'}(P_j)) = 0 \quad (16)$$

holds for all $v \in \text{dom } \mathcal{E}$.

Example 1.6.1. Sierpiński Gasket

In the case of Sierpiński gasket $\mathfrak{S}\mathfrak{G}$, we can check that the normalization constant $r = \frac{3}{5}$, the Dirichlet form, the Laplacian and the normal derivative are given respectively by

$$\begin{aligned} \mathcal{E}(u, v) &= \lim_{m \rightarrow +\infty} \left(\frac{5}{3}\right)^m \sum_{X \sim_m Y} (u(X) - u(Y)) (v(X) - v(Y)) \\ \Delta_\mu u(X) &= \lim_{m \rightarrow +\infty} \left(\frac{3}{2}\right) \times 5^m \sum_{Y \sim_m X} (u(Y) - u(X)) \quad , \\ \partial_n u(P_i) &= \lim_{m \rightarrow +\infty} \left(\frac{5}{3}\right)^m \sum_{\substack{Y \sim_m P_i \\ Y \in f_{\mathcal{W}}^m(\mathfrak{S}\mathfrak{G})}} (u(P_i) - u(Y)) \quad . \end{aligned}$$

Example 1.6.2. Sierpiński Tetrahedron

In the case of the Sierpiński Tetrahedron \mathfrak{ST} , the normalization constant equals to $r = \frac{2}{3}$, the Dirichlet form, the Laplacian and the normal derivative are given respectively by

$$\begin{aligned}\mathcal{E}(u, v) &= \lim_{m \rightarrow +\infty} \left(\frac{3}{2}\right)^m \sum_{X \sim_m Y} (u(X) - u(Y)) (v(X) - v(Y)) \\ \Delta_\mu u(X) &= \lim_{m \rightarrow +\infty} 2 \times 6^m \sum_{Y \sim_m X} (u(Y) - u(X)) , \\ \partial_n u(P_i) &= \lim_{m \rightarrow +\infty} \left(\frac{3}{2}\right)^m \sum_{\substack{Y \sim_m P_i \\ Y \in f_{\mathcal{W}}(\mathfrak{ST})}} (u(P_i) - u(Y)) .\end{aligned}$$

Example 1.6.3. Minkowski Curve

In the case of Minkowski Curve \mathfrak{MC} , the normalization constant equals to $r = \frac{1}{3}$, the Dirichlet form, the Laplacian and the normal derivative are given respectively by

$$\begin{aligned}\mathcal{E}(u, v) &= \lim_{m \rightarrow +\infty} 3^m \sum_{X \sim_m Y} (u(X) - u(Y)) (v(X) - v(Y)) \\ \Delta_\mu u(X) &= \lim_{m \rightarrow +\infty} 3^{2m} \sum_{Y \sim_m X} (u(Y) - u(X)) \\ \partial_n u(P_i) &= \lim_{m \rightarrow +\infty} 3^m \sum_{\substack{Y \sim_m P_i \\ Y \in f_{\mathcal{W}}(\mathfrak{MC})}} (u(P_i) - u(Y))\end{aligned}$$

1.7 GENERALIZED COMBINATORIAL LAPLACIAN

The Laplacian can be represented in a different way, through **discrete Laplacian matrix**. For more details we refer to [Shi96]. This combinatorial construction allows one to define Dirichlet form and Laplacian on the general class of P.C.F. sets and to sketch out spectral results:

Definition 1.7.1. Real valued function on a graph

Let U and V denote two finite sets. The set of real valued functions on U is denoted by $l(U)$ and

$$\begin{aligned}l_0(V) &= \{f \in l(U) : f(P_i) = 0 \text{ for } P_i \in V_0\} \\ L(U, V) &= \{A : l(U) \rightarrow l(V) \text{ and } A \text{ is linear}\} .\end{aligned}$$

We shall write $L(U) = L(U, U)$.

Let us denote by Δ_0 be the Laplacian matrix on \mathcal{F}_0 . We consider the bijection

$$f_{\mathcal{W}} : V_0 \rightarrow f_{\mathcal{W}}(V_0)$$

for any word $\mathcal{W} \in \{1, \dots, N\}^m$. This allows one to identify V_0 with $f_{\mathcal{W}}(V_0)$ and hence regard $\Delta_0 \in L(f_{\mathcal{W}}(V_0))$. Let again define the restriction map to $f_{\mathcal{W}}(V_0)$:

$$\begin{aligned} \mathbb{R}_{\mathcal{W}} &\in L(V_m, f_{\mathcal{W}}(V_0)) \\ \mathbb{R}_{\mathcal{W}}(u) &= u|_{f_{\mathcal{W}}(V_0)} \end{aligned}$$

Then the graph Laplacian matrix $\Delta_m \in L(V_m)$ is given by

$$\Delta_m = \sum_{\mathcal{W} \in \Sigma_m} \mathbb{R}_{\mathcal{W}}^T \Delta_0 \mathbb{R}_{\mathcal{W}}.$$

In the general case, one chooses $\rho = (\rho_1^{-1}, \dots, \rho_N^{-1}) \in l(S)$ with $S = \{1, \dots, N\}$. The number $\rho_0^{-1} = \sum_{i=1}^N \rho_i^{-1}$ is called **measure factor**.

We can then define $(\tilde{\Delta}_m, \rho)$, the **generalized Laplacian with weight ρ** on the graph \mathcal{F}_m , through

$$\tilde{\Delta}_m = \sum_{\mathcal{W} \in \Sigma_m} \rho_{\mathcal{W}}^{-1} \mathbb{R}_{\mathcal{W}}^T \Delta_0 \mathbb{R}_{\mathcal{W}}. \quad (17)$$

It can be decomposed into

$$\tilde{\Delta}_m = \begin{pmatrix} T_m & J_m^T \\ J_m & X_m \end{pmatrix}$$

where $T_m \in L(V_0)$, $J_m \in L(V_0, V_m \setminus V_0)$ and $X_m \in L(V_m \setminus V_0)$.

We define next the **discrete generalized measure on V_m** ,

$$\hat{\mu}_m = \sum_{X \in V_m} \left(\sum_{\mathcal{W} \in \Sigma_m} \rho_{\mathcal{W}}^{-1} \mathbb{R}_{\mathcal{W}}^T (-T_1) \mathbb{R}_{\mathcal{W}} \right)_{X,X} \delta_X$$

where δ is the Dirac measure, and the **normalized Laplacian on \mathcal{F}_m** ,

$$\hat{\Delta}_m = \frac{\tilde{\Delta}_m}{\hat{\mu}_m(X)}.$$

Note that if we define $\mu_m = \frac{\rho_0^m}{-\text{trace}(T_1)} \hat{\mu}_m$, then the sequence $\{\mu_m\}_{m \in \mathbb{N}}$ converges weakly to the self-similar measure μ with weights $\frac{\rho_i}{\rho_0}$ [Shi96].

1.8 SPECTRAL DECIMATION FUNCTION

In this section, we consider connected P.C.F sets \mathcal{F} with

1. $\#f_i(V_0) \cap V_0 \leq 1$ (V_0 vertices are not neighbors in V_m , for $m \geq 1$).
2. \mathcal{F} is connected.

We set

$$T = T_1, \quad X = X_1, \quad J = J_1 \quad M = -\text{diag}(X), \quad D = \Delta_0$$

where $M = -\text{diag}(X)$ means that M is a diagonal matrix with $M_{i,i} = -X_{i,i}$.

We are hereafter interested in the solution of the following spectral problems:

$$\text{The Dirichlet problem } \begin{cases} \Delta_\mu u = \lambda u \\ u|_{V_0} = 0 \end{cases} \quad \text{and} \quad \text{the Neumann problem } \begin{cases} \Delta_\mu u = \lambda u \\ \partial_n u|_{V_0} = 0. \end{cases}$$

The solution λ of the first (resp. the second) problem is called the **Dirichlet eigenvalue** (resp. **Neumann eigenvalue**) corresponding to the **Dirichlet eigenfunction** (resp. **Neumann eigenfunction**) u .

Set $\mathcal{N}(x) = \#\{i : \lambda_i \leq x\}$.

Definition 1.8.1. Strong harmonic structure [Shi96]

The generalized Laplacian $(\tilde{\Delta}_m, \rho)$ is said to have a **strong harmonic structure** if there exist rational functions $K_D(\lambda)$ and $K_T(\lambda)$ such that $X + \lambda M$ is invertible; then,

$$T - J^T(X + \lambda M)^{-1}J = K_D(\lambda)D + K_T(\lambda)T$$

where $K_D(0)$ is the energy renormalization constant. We denote by

$$\mathfrak{F} = \{\lambda \in \mathbb{R} : K_D(\lambda) = 0 \quad \text{or} \quad \det(X + \lambda M) = 0\}$$

the set of **forbidden eigenvalues**. Moreover, we introduce

$$\mathfrak{F}_k = \{\lambda \in \mathfrak{F} : \lambda \text{ is an eigenvalue of } -\tilde{\Delta}_k\}$$

as the set of **forbidden eigenvalues at step k** .

We define the **spectral decimation** through

$$\mathcal{R}(\lambda) = \frac{\lambda - K_T(\lambda)}{K_D(\lambda)}. \tag{18}$$

Remark 1.8.1.

i. In the general case, the Dirichlet form is given by

$$\mathcal{E}(u) = \lim_{m \rightarrow +\infty} - \left(\frac{1}{K_D(0)} \right)^m \langle u, \Delta_m u \rangle \quad (19)$$

By analogy to the previous section, it can be shown that ([Kum93])

$$\begin{aligned} \mathcal{E}_{\mathcal{F}}(u) &= \sum_{i=1}^N (K_D(0)\rho_i)^{-1} \mathcal{E}_{\mathcal{F}}(u \circ f_i) \\ &= \sum_{i=1}^N r_i^{-1} \mathcal{E}_{\mathcal{F}}(u \circ f_i) \end{aligned}$$

ii. In the case of the Sierpiński Gasket $\mathfrak{S}\mathfrak{G}$:

$$\rho_1 = \rho_2 = \rho_3 = 1, \quad \rho_0 = 3, \quad K_D(0) = r = \frac{3}{5}$$

and

$$\begin{aligned} \mathcal{E}(u) &= \lim_{m \rightarrow +\infty} - \left(\frac{1}{K_D(0)} \right)^m \langle u, \Delta_m u \rangle \\ &= \lim_{m \rightarrow +\infty} - \left(\frac{5}{3} \right)^m \sum_X u(X) \sum_{Y \sim_m X} (u(Y) - u(X)) \\ &= \lim_{m \rightarrow +\infty} \left(\frac{5}{3} \right)^m \sum_{X \sim_m Y} (u(X) - u(Y))^2. \end{aligned}$$

iii. Observe that the Laplacian Δ_μ in the case of the Sierpiński Gasket $\mathfrak{S}\mathfrak{G}$ is just the limit

$$\begin{aligned} \Delta_\mu u(X) &= \lim_{m \rightarrow +\infty} \left(\frac{1}{K_D(0)\rho_0} \right)^m \tilde{\Delta}_m u(X) \\ &= \lim_{m \rightarrow +\infty} r^{-m} \mu_m(X)^{-1} \Delta_m u(X). \end{aligned}$$

Theorem 1.8.1. Spectral Decimation Property [Shi96]

Suppose the generalized Laplacian has a strong harmonic structure. We have the following results:

- i. If f is an eigenfunction of $-\tilde{\Delta}_{m+1}$ with eigenvalue λ , i.e., $-\tilde{\Delta}_{m+1}f = \lambda f$, and $\lambda \notin \mathfrak{F}$, then $-\tilde{\Delta}_m f|_{V_m} = \mathcal{R}(\lambda)f$.

- ii. Conversely, If $-\tilde{\Delta}_m f|_{V_m} = \mathcal{R}(\lambda)f$ and $\lambda \notin \mathfrak{S}$, then there exists a unique extension \tilde{f} of f such that $-\tilde{\Delta}_{m+1}\tilde{f} = \lambda\tilde{f}$.

Proposition 1.8.2. [Shig6]

The spectral decimation function \mathcal{R} satisfies

$$\mathcal{R}(0) = 0 \quad \text{and} \quad \mathcal{R}'(0) = \frac{1}{K_D(0)\rho_0}.$$

Thus, 0 is a repelling fixed point of \mathcal{R} .

Proposition 1.8.3. [Zhoo7]

If a Laplacian has the strong harmonic structure and all $\rho_i = 1$, then it admits spectral decimation.

1.9 EINSTEIN RELATION AND WEYL'S FORMULA FOR P.C.F. SETS

In order to establish an analogous result to the Weyl asymptotic law in smooth analysis, we need to introduce some notions relatives to fractal analysis:

Definition 1.9.1. Spectral Dimension [Kig98]

Let \mathcal{F} be a self-similar set. We call **spectral dimension** the unique real number $D_S(\mathcal{F})$ which satisfies

$$\sum_{i=1}^N \left(\frac{\rho_i \mu_i}{K_D(0)} \right)^{\frac{D_S(\mathcal{F})}{2}} = 1. \quad (20)$$

Definition 1.9.2. Walk Dimension [HKKo2]

Let us denote by $\tau(B(X, R))$ the time taken for the diffusion, whose infinitesimal generator is the Laplace operator Δ_μ on self-similar set \mathcal{F} , to exit a ball centered at X with radius R . We call **walk dimension** the limit $D_W(\mathcal{F})$ of

$$D_W(\mathcal{F}) = \lim_{R \rightarrow +\infty} \sup \frac{\log(E_X(\tau(B(X, R))))}{\log(R)} \quad (21)$$

when it exists independently of X , where E_X stands for expectation conditioned on starting at $X \in \mathcal{F}$.

Next, we present the **Einstein relation** which connects three fundamental numbers associated to fractal objects.

Theorem 1.9.1. Einstein Relation on Fractals [Bar98]

The similarity dimension $D_H(\mathcal{F})$, the spectral dimension $D_S(\mathcal{F})$ and the walk dimension $D_W(\mathcal{F})$, of a self-similar object \mathcal{F} are related by the so called **Einstein relation**

$$2 D_H(\mathcal{F}) = D_S(\mathcal{F}) \times D_W(\mathcal{F}). \quad (22)$$

We recall next the Weyl formula for ordinary Laplacians on bounded domains Ω in \mathbb{R}^n .

Theorem 1.9.2. Weyl's Formula [Kigo1]

Let Ω be a bounded domain in \mathbb{R}^n . Let λ_i be the i -th eigenvalue of the Dirichlet eigenvalue problem of $-\Delta$ on Ω , that is

$$\begin{cases} \Delta u = \lambda u \\ u|_{\partial\Omega} = 0 \end{cases}$$

Then, as $x \rightarrow +\infty$,

$$\mathcal{N}(x) = \frac{1}{(2\pi)^n} \mathcal{B}_n |\Omega|_n x^{\frac{n}{2}} + o(x^{\frac{n}{2}})$$

where $|\cdot|$ is n -dimensional Lebesgue measure and \mathcal{B}_n is the Lebesgue measure n -dimensional ball.

In the case of fractal objects, the physicist Michael V. Berry made the following conjecture in [Ber80]:

$$\mathcal{N}(x) = C \mathcal{H}^{D_H(\mathcal{F})}(\Omega) x^{\frac{D_H(\mathcal{F})}{2}} + o(x^{\frac{D_H(\mathcal{F})}{2}}).$$

By replacing n by the Hausdorff dimension $D_H(\mathcal{F})$. Unfortunately, this is wrong. The right formula is given by the theorem below:

Theorem 1.9.3. Weyl's Formula [Kigo1]

In the case of self-similar set \mathcal{F} , set $\gamma_i = \sqrt{r_i \mu_i}$, the eigenvalues counting function satisfies

$$0 < \liminf_{x \rightarrow +\infty} \frac{\mathcal{N}(x)}{x^{\frac{D_S(\mathcal{F})}{2}}} \leq \limsup_{x \rightarrow +\infty} \frac{\mathcal{N}(x)}{x^{\frac{D_S(\mathcal{F})}{2}}} < +\infty$$

for Dirichlet and Neumann Eigenvalues. Moreover,

- i. **Non-lattice case** : If $\sum_{i=1}^N \mathbb{Z} \log(\gamma_i)$ is a dense subgroup of \mathbb{R} . Then, the limit $\lim_{x \rightarrow +\infty} \frac{\mathcal{N}(x)}{x^{\frac{D_S(\mathcal{F})}{2}}}$ exists and is independent of the boundary conditions.

ii. **Lattice case** : If $\sum_{i=1}^N \mathbb{Z} \log(\gamma_i)$ is a discrete group of \mathbb{R} , let us denote by T its generator. Then, when $x \rightarrow +\infty$, we have that

$$\mathcal{N}(x) = \left(G \log \left(\frac{x}{2} \right) + o(1) \right) x^{\frac{D_S(\mathcal{F})}{2}}$$

where G denotes a right-continuous, T -periodic function satisfying $0 < \inf G(x) < \sup G(x) < \infty$, and $o(1)$ a term which vanishes as $x \rightarrow +\infty$. Moreover, the periodic function G is independent of the boundary conditions.

Example 1.9.1. Sierpiński Tetrahedron

According to [RD17a], the Sierpiński Tetrahedron is characterized by $D_H(\mathfrak{S}\mathfrak{T}) = 2$, $D_S(\mathfrak{S}\mathfrak{T}) = 2 \frac{\ln(4)}{\ln(6)}$ and $D_W(\mathfrak{S}\mathfrak{T}) = 2 \frac{\ln(6)}{\ln(4)}$ according to Einstein's relation. The spectral decimation function is given by $\mathcal{R}(\lambda) = \lambda(6 - \lambda)$ and the eigenvalues are given by the limit $\lambda = 2 \lim_{m \rightarrow +\infty} 6^m \lambda_m$. Moreover, the eigenvalue counting function follow the modified Weyl law:

$$\mathcal{N}^{\mathfrak{S}\mathfrak{T}}(x) = \left(G \left(\frac{\ln x}{2} \right) + o(1) \right) x^{\frac{\ln(4)}{\ln(6)}}.$$

Example 1.9.2. Minkowski Curve [RD17b]

For the Minkowski Curve, we respectively have that $D_H(\mathfrak{M}\mathfrak{C}) = \frac{3}{2}$, $D_S(\mathfrak{M}\mathfrak{C}) = 1$ and $D_W(\mathfrak{M}\mathfrak{C}) = 3$, according to Einstein's relation. The spectral decimation function is given by $\mathcal{R}(\lambda) = -\lambda(\lambda - 4)(\lambda - 2)^2(\lambda(\lambda - 4) + 1)$ and the eigenvalues are given by the limit $\lambda = 2 \lim_{m \rightarrow +\infty} 8^{2m} \lambda_m$. According to the result of Jun Kigami in [Kig98], one has the modified Weyl formula:

$$\mathcal{N}^{\mathfrak{M}\mathfrak{C}}(x) = \left(G \left(\frac{\ln x}{2} \right) + o(1) \right) x^{\frac{1}{2}}.$$

1.10 PARTIAL DIFFERENTIAL EQUATIONS ON FRACTALS

In this section, we deal with the construction of PDE's on P.C.F. fractals. Since the Laplacian has been formerly introduced, we are now able to ask the following questions:

1. Can we define PDE's on fractals?
2. Can we establish existence and uniqueness of the solution?
3. The solution is it local or global?

We shall try next to answer these questions in the case of static and dynamical PDE's.

1.10.1 Solvability of partial differential equations

Let us denote by \mathcal{F} a P.C.F. fractal with regular harmonic structure, and Δ_μ the Laplacian with respect to the self similar measure μ . We consider the general partial differential equation on \mathcal{F}

$$-\Delta_\mu u(X) = F(X, u(X))$$

where F is a continuous function on $\mathcal{F} \times \mathbb{R}$ and u a real valued function. We state next local existence and uniqueness of the solution.

Theorem 1.10.1. Local Solvability [Stro5]

Let us assume that $-\Delta_\mu u(X) = F(X, u(X))$ holds on the m -cell $f_{\mathcal{W}}(\mathcal{F})$, for $|\mathcal{W}| = m$, with boundary $f_{\mathcal{W}}(V_0)$, and that

i. F satisfies a local Lipschitz condition in the u -variable,

$$\begin{aligned} \forall T > 0, \quad \exists M_T < \infty \quad \text{such that :} \\ |F(X, u) - F(X, v)| \leq M_T |u - v| \quad \text{provided } |u|, |v| \leq T. \end{aligned}$$

ii. u satisfies the boundary condition

$$u(f_{\mathcal{W}}(P_i)) = a_i \quad \text{for } i = 1, \dots, N.$$

Then, for every $A > 0$, there exists m such that for all choices of $\{a_i\}$ with $|a_i| \leq A$, the equation has a unique solution.

Theorem 1.10.2. Peano Existence Theorem [Stro5]

Let us assume that $-\Delta_\mu u(X) = F(X, u(X))$ holds on the m -cell $f_{\mathcal{W}}(\mathcal{F})$, for $|\mathcal{W}| = m$, with boundary $f_{\mathcal{W}}(V_0)$, and that:

i. F is continuous.

ii. u satisfies the boundary condition

$$u(f_{\mathcal{W}}(P_i)) = a_i \quad \text{for } i = 1, \dots, N.$$

Then, for every A there exists m such that for all choices of $\{a_i\}$ with $|a_i| \leq A$, the equation has a solution.

Note that the global solvability can fail in some situation, even for linear constant coefficient like

$$-\Delta_\mu u(X) = \lambda u(X) + F(X)$$

where F is continuous, and λ is an eigenvalue. We have the following counter-example in the case of the Sierpiński Gasket $\mathfrak{S}\mathfrak{G}$:

Theorem 1.10.3. [Stro5]

The equation

$$-\Delta_\mu u(X) = \lambda u(X) + F(X)$$

is not solvable if and only if λ is a joint Dirichlet-Neumann eigenvalue.

We have the following result on open sets of \mathcal{F} :

Theorem 1.10.4. Existence on Open Sets [Stro5]

Let Ω be an open set of \mathcal{F} not containing any points of V_0 . The equation

$$-\Delta_\mu u(X) = F(X)$$

is solvable for any continuous function F .

1.10.2 The heat equation

As previously, given a P.C.F. set \mathcal{F} with regular harmonic structure, and $T > 0$. We are interested in the solution of

$$\begin{aligned} \partial_t u - \Delta_\mu u &= g & \text{in }]0, T[\times \mathcal{F} \\ u(0, X) &= u_0(X) & \text{in } \mathcal{F} \end{aligned}$$

with Dirichlet (resp. Neumann) boundary conditions,

$$u = 0 \text{ on } V_0 \quad (\text{resp. } \partial_n u = 0 \text{ on } V_0).$$

Definition 1.10.1. Heat Kernel [Kigo1]

For the Dirichlet (resp. Neumann) case, let us define the heat kernel H on $]0, +\infty[\times \mathcal{F} \times \mathcal{F}$ as

$$\mathcal{K}(t, X, Y) = \sum_{i=1}^{\infty} e^{-\lambda_i t} \phi_i(X) \phi_i(Y)$$

where ϕ_i and λ_i are respectively Dirichlet (resp. Neumann) eigenfunctions and eigenvalues of the Laplacian.

Definition 1.10.2. Heat Operator [Kigo1]

For $g \in L^1_\mu(\mathcal{F})$, let us define

$$S_t g(X) = \int_{\mathcal{F}} \mathcal{K}(t, X, Y) g(Y) d\mu(Y)$$

for $t > 0$ and $X \in \mathcal{F}$.

We recall that $L_{\mu}^p(\mathcal{F}) \subseteq L_{\mu}^1(\mathcal{F})$ for $p \in [1, +\infty]$.

Theorem 1.10.5. Heat Semigroup [Kigo1]

1. S_t is a bounded operator from $L_{\mu}^p(\mathcal{F}) \longrightarrow C(\mathcal{F}) \subset L_{\mu}^2(\mathcal{F})$, for any $t > 0$ and $p \in [1, +\infty]$.
2. $S_t \circ S_s = S_{t+s}$ for any $s, t > 0$.
3. $S_t(L_{\mu}^1(\mathcal{F})) \subset \text{dom}\Delta_{\mu}$ for any $t > 0$.
4. Let $u_0 \in L^1(\mathcal{F}, \mu)$ and $u(t, X) = S_t u_0(X)$ for $]0, \infty[\times \mathcal{F}$, then $u(\cdot, X) \in C^{\infty}(]0, +\infty[)$ for any $X \in \mathcal{F}$. Moreover,

$$\partial_t u(t, X) = \Delta_{\mu} u(t, X) \quad \text{for any } (t, X) \in]0, \infty[\times \mathcal{F}$$

5. The semigroup $(S_t)_{t>0}$ is strongly continuous on $L_{\mu}^2(\mathcal{F})$, its generator is $-\Delta_{\mu}$, and

$$\lim_{t \rightarrow 0} \| S_t u_0 - u_0 \|_{L^2(K, \mu)} = 0$$

6. The C_0 semigroup $(S_t)_{t \geq 0}$ is a semigroup of contractions.

Proof.

1)2)3)4)5) See [Kigo1].

6) Note first that we can extend by continuity the semigroup $(S_t)_{t>0}$ to zero. Let us then set

$u_0(x) = \sum_{i=1}^{\infty} a_i \phi_i(x)$ in the eigenfunctions base, we have, thus,

$$\begin{aligned} \| S_t u_0 \| &= \sup_{u_0 \in L_{\mu}^2(\mathcal{F}), u_0 \neq 0} \frac{\| S_t u_0 \|_{L_{\mu}^2(\mathcal{F})}}{\| u_0 \|_{L_{\mu}^2(\mathcal{F})}} \\ &= \frac{\| \sum_{i=1}^{\infty} e^{-\lambda_i t} a_i \phi_i(x) \|_{L_{\mu}^2(\mathcal{F})}}{\| u_0 \|_{L_{\mu}^2(\mathcal{F})}} \\ &\leq 1. \end{aligned}$$

□

Theorem 1.10.6. Weak Solution of the Heat Problem

Let us consider $u_0 \in L^2_\mu(\mathcal{F})$.

1. For the homogeneous problem:

- There is a unique solution of the homogeneous heat problem ($g = 0$) given by

$$\begin{cases} u(t, X) &= S_t u_0 \\ &= \int_{\mathcal{F}} \mathcal{K}(t, X, Y) u_0(Y) d\mu(Y) \\ u(0, X) &= u_0 \end{cases}$$

where

$$\begin{aligned} \lim_{t \rightarrow 0} \| u_t - u_0 \|_{L^2_\mu(\mathcal{F})} &= 0 \\ u(t, P_i) &= 0 \quad (\text{resp. } \partial_n u(t, P_i) = 0) \quad \text{for } P_i \in V_0 \end{aligned}$$

- The regularity of the solution is $u \in C^1(]0, T[; L^2_\mu(\mathcal{F})) \cap C(]0, T[; \text{dom}_{L^2_\mu(\mathcal{F})} \Delta_\mu)$.

2. For the Nonhomogeneous problem:

- There is a unique solution of the non-homogeneous heat problem given by the Duhamel formula,

$$\begin{cases} u(t, X) &= S_t u_0 + \int_0^t S_{t-s} g(s) ds \\ &= \int_{\mathcal{F}} \mathcal{K}(t, X, Y) u_0(Y) d\mu(Y) + \int_0^t \int_{\mathcal{F}} \mathcal{K}(t-s, X, Y) g(s, Y) d\mu(y) ds \\ u(0, x) &= u_0(x) \end{cases}$$

where

$$\begin{aligned} \lim_{t \rightarrow 0} \| u_t - u_0 \|_{L^2_\mu(\mathcal{F})} &= 0 \\ u(t, P_i) &= 0 \quad (\text{resp. } \partial_n u(t, P_i) = 0) \quad \text{for } P_i \in V_0 \end{aligned}$$

- The regularity of the solution is $u \in C^1(]0, T[; L^2_\mu(\mathcal{F})) \cap C(]0, T[; \text{dom}_{L^2_\mu(\mathcal{F})} \Delta_\mu)$.

Proof.

1. We refer to [Kigo1].
2. It is clear that the Duhamel formula solves the non-homogeneous problem, the uniqueness can also be deduced by considering two solutions u_1 and u_2 , the difference $Z = u_1 - u_2$ leads to an homogeneous problem

$$\begin{aligned} \partial_t Z &= \Delta_\mu Z && \text{in }]0, T[\times \mathcal{F} \\ Z &= 0 \quad (\text{resp. } \partial_n u(t, P_i) = 0) && \text{on }]0, T[\times V_0 \\ Z(0, X) &= 0 && \text{in } \mathcal{F} \end{aligned}$$

with null solution $Z = 0$, which implies the uniqueness.

The regularity of the solution is a consequence of the homogeneous case.

□

Theorem 1.10.7. Parabolic Maximum Principle [Kigo1]

Let us denote by $u : [0, \infty[\times \mathcal{F} \longrightarrow \mathbb{R}$ the solution of homogeneous heat problem. Then, for any $T > 0$,

$$\begin{aligned} \max_{U_T} u(t, X) &= \max_{\partial U_T} u(t, X) \\ \min_{U_T} u(t, X) &= \min_{\partial U_T} u(t, X) \end{aligned}$$

where $U_T = [0, T] \times \mathcal{F}$ and $\partial U_T = \{0\} \times \mathcal{F} \cup [0, T] \times V_0$.

Chapter 2

Numerical Analysis on Fractals and Applications

Following the seminal work of Jun Kigami [Kig89], [Kig93], [Kigo1], [Kigo3] in the field of analysis on fractals, the natural step was to explore the numerical related areas.

It has been initiated, in the case of the Sierpiński gasket, by Kyallee Dalrymple, Robert S. Strichartz, and Jade Vinson [DSV99], who gave an equivalent method for the finite difference approximation. More precisely, the authors use the spectral shape of the solution (heat kernel), which involves eigenvalues and eigenvectors, and therefore calls for an approximation of the eigenvalues. This work has been followed by the one of Nizare Riane and Claire David in [RD17b], [RD19], [RD20b], where they establish numerical analysis of the finite difference method in the case of Sierpiński simplices.

On the other hand, Michael Gibbons, Arjun Raj and Robert S. Strichartz [GRS01] described how one can build approximate solutions, by means of piecewise harmonic, or biharmonic, splines, again in the case of $\mathfrak{S}\mathfrak{G}$. They go so far as giving theoretical error estimates, through a comparison with experimental numerical data.

Finally, The finite volume method was introduced by Nizare Riane and Claire David [RD21a] by exploiting the average method defined by Robert S. Strichartz in [Stro1].

2.1 THE FINITE DIFFERENCE METHOD

As in the smooth case, numerical methods can be used to approximate solutions of partial differential equations. The first method discussed in the fractal case is the **finite difference method**.

The principle of the method is simple: given the self-similar Laplacian with respect to the measure μ , on a self similar set \mathcal{F} , we exploit the pointwise formula

$$\Delta_\mu u(X) = \lim_{m \rightarrow +\infty} \delta_m \Delta_m u(X)$$

for some normalization constant δ_m . The idea is to use the sequence of graph approximations $(\mathcal{F}_m)_{m \in \mathbb{N}}$, and the sequence of associated graph Laplacians, as an approximation of Δ_μ which can lead to:

$$\Delta_\mu u(X) \approx \delta_m \Delta_m u(X).$$

The goal is to prove that the induced scheme is **consistent, stable and then convergent**.

2.1.1 The Finite Difference Method, for the Heat Equation on Sierpiński Simplices

In the sequel, we place ourselves in the Euclidean space of dimension $d - 1$ for a strictly positive integer d , referred to a direct orthonormal frame. The usual Cartesian coordinates will be denoted by $(x_1, x_2, \dots, x_{d-1})$.

Let us introduce the family of contractions f_i , $1 \leq i \leq d$, of fixed point P_i such that, for any $X \in \mathbb{R}^{d-1}$, and any integer i belonging to $\{1, \dots, d\}$,

$$f_i(X) = \frac{1}{2} (X + P_i).$$

According to [Hut81], there exists a unique subset $\mathfrak{S}\mathfrak{S} \subset \mathbb{R}^{d-1}$ such that

$$\mathfrak{S}\mathfrak{S} = \bigcup_{i=1}^d f_i(\mathfrak{S}\mathfrak{S})$$

which will be called the Sierpiński Simplex.

Following the construction of chapter 1, we denote by V_0 the boundary set of points

$$\{P_1, \dots, P_d\} \cdot$$

and the prefractal graph of order 0 to be the complete graph on V_0 , that we will denote by $\mathfrak{S}\mathfrak{S}_0$.

For any strictly positive integer m , we set

$$V_m = \bigcup_{i=1}^d f_i(V_{m-1}) \cdot$$

The sequence of prefractal graphs $(\mathfrak{S}\mathfrak{S}_m)_{m \in \mathbb{N}^*}$ is constituted according to definition 1.3.5. We will denote, in the following, by \mathcal{N}_m the number of vertices of the graph $\mathfrak{S}\mathfrak{S}_m$.

Proposition 2.1.1.

Given a natural integer m , we will denote by \mathcal{N}_m the number of vertices of the graph $\mathfrak{S}\mathfrak{S}_m$. One has

$$\mathcal{N}_0 = d$$

and, for any strictly positive integer m ,

$$\mathcal{N}_m = d \mathcal{N}_{m-1} - \frac{d(d-1)}{2}.$$

Proof.

For any strictly positive integer m , the graph $\mathfrak{S}\mathfrak{S}_m$ is the union of d copies of the graph $\mathfrak{S}\mathfrak{S}_{m-1}$. Each copy shares a vertex with the other ones. So, one may consider the copies as the vertices of a complete graph K_d , the number of edges is equal to $\frac{d(d-1)}{2}$, which leads to $\frac{d(d-1)}{2}$ vertices to take into account. \square

Remark 2.1.1.

One may check that $\mathcal{N}_m = \frac{d^{m+1} + d}{2}$.

Formulation of the Problem

Let us denote by T a strictly positive real number, by \mathcal{N}_0 the cardinal of V_0 , and by \mathcal{N}_m the cardinal of V_m . We may now consider a solution u of the problem:

$$\begin{cases} \frac{\partial u}{\partial t}(t, X) - \Delta_\mu u(t, X) & = 0 & \forall (t, X) \in]0, T[\times \mathfrak{S}\mathfrak{S} \\ u(t, X) & = 0 & \forall (t, X) \in [0, T[\times \partial\mathfrak{S}\mathfrak{S} \\ u(0, X) & = g(x) & \forall X \in \mathfrak{S}\mathfrak{S} \end{cases}$$

In order to define a numerical scheme, one may use a first order forward difference scheme to approximate the time derivative $\frac{\partial u}{\partial t}$. The Laplacian is approximated by means of the sequence of graph Laplacians $(\Delta_m u)_{m \in \mathbb{N}^*}$, defined on the sequence of graphs $(\mathfrak{S}\mathfrak{S}_m)_{m \in \mathbb{N}^*}$.

To this purpose, we fix a strictly positive integer N , and set

$$h = \frac{T}{N}.$$

One has, for any integer k belonging to $\{0, \dots, N-1\}$:

$$\forall X \in \mathfrak{S}\mathfrak{S} : \quad \frac{\partial u}{\partial t}(kh, X) = \frac{1}{h} (u((k+1)h, X) - u(kh, X)) + \mathcal{O}(h)$$

According to [Stro6], the Laplacian on Sierpiński simplices $\mathfrak{S}\mathfrak{S}$ is given by

$$\forall X \in \mathfrak{S}\mathfrak{S} : \quad \Delta_\mu u(t, X) = \lim_{m \rightarrow +\infty} r^{-m} \left(\int_{\mathfrak{S}\mathfrak{S}} \psi_{X_m}^{(m)} d\mu \right)^{-1} \left(\sum_{X_m \sim Y} u(t, Y) - u(t, X_m) \right)$$

where, for any natural integer m , $X_m \in V_m \setminus V_0$, $\psi_{X_m}^{(m)}$ a piecewise harmonic function as in theorem 1.6.3, $0 < r < 1$ the normalization constant in equation 8, and where

$$\lim_{m \rightarrow \infty} X_m = X.$$

This enables one to approximate the Laplacian, at a m^{th} order, $m \in \mathbb{N}^*$, using the graph normalized Laplacian as follows:

$$\forall k \in \{0, \dots, N-1\}, \forall X \in \mathfrak{S}\mathfrak{S} : \quad \Delta u(t, X) \approx r^{-m} \left(\int_{\mathfrak{S}\mathfrak{S}} \psi_{X_m}^{(m)} d\mu \right)^{-1} \left(\sum_{X_m \sim Y} u(kh, Y) - u(kh, X_m) \right).$$

By combining those two relations, one gets the following scheme, for any integer k belonging to $\{0, \dots, N-1\}$, any point P_j of V_0 , $1 \leq j \leq \mathcal{N}_0$, and any X in the set $V_m \setminus V_0$,

$$(\mathcal{S}_H) \quad \begin{cases} \frac{u_h^m((k+1)h, X) - u_h^m(kh, X)}{h} & = & r^{-m} \left(\int_{\mathfrak{S}\mathfrak{S}} \psi_{X_m}^{(m)} d\mu \right)^{-1} \left(\sum_{X_m \sim Y} u_h^m(kh, Y) - u_h^m(kh, X) \right) \\ u_h^m(kh, P_j) & = & 0 \\ u_h^m(0, X) & = & g(X) \end{cases}$$

Let us define the approximate equation as

$$u_h^m((k+1)h, X) = u_h^m(kh, X) + hr^{-m} \left(\int_{\mathfrak{S}\mathfrak{S}} \psi_{X_m}^{(m)} d\mu \right)^{-1} \left(\sum_{X \sim_m^Y} u_h^m(kh, Y) - u_h^m(kh, X) \right). \quad (23)$$

$\forall k \in \{0, \dots, N-1\}$, $\forall X \in V_m \setminus V_0$. We now fix $m \in \mathbb{N}$, and consider any $X \in V_m \setminus V_0$ in the addresses form $X = f_{\mathcal{W}}(P_i) = \{\mathcal{W}, P_i\}$, where $\mathcal{W} \in \Sigma_m = \{1, \dots, d\}^m$ is a word of length m , and where P_i , $1 \leq i \leq \mathcal{N}_0$ belongs to V_0 .

This induce a natural ordering of the vertices in V_m , and enables one to introduce, for any integer k belonging to $\{0, \dots, N-1\}$, the solution vector $U(k)$ as

$$U_h^m(k) = \begin{pmatrix} u_h^m(kh, X_1) \\ \vdots \\ u_h^m(kh, X_{\mathcal{N}_m-d}) \end{pmatrix}$$

which satisfies the recurrence relation:

$$U_h^m(k+1) = A U_h^m(k) \quad (24)$$

where

$$A = I_{\mathcal{N}_m-d} - h \tilde{\Delta}_m \quad (25)$$

and where $I_{\mathcal{N}_m-d}$ denotes the $(\mathcal{N}_m - d) \times (\mathcal{N}_m - d)$ identity matrix, and $\tilde{\Delta}_m$ the $(\mathcal{N}_m - d) \times (\mathcal{N}_m - d)$ normalized Laplacian matrix.

Remark 2.1.2. Natural order

The natural order induced by the couple $\{\mathcal{W}, P_i\}$ is perturbed by the fact that a point may have multiple addresses, we solve the problem by assigning to a vertex an address of the lowest lexicographic order.

Theoretical Study of the Error, for Hölder Continuous Functions

In the spirit of the work of Robert S. Strichartz [Str99], [Str12], it is interesting to consider the case of Hölder continuous functions. Why? First, Hölder continuity implies continuity, which is a required condition for functions in the domain of the Laplacian (we refer to our work [RD17b] for further details).

Second, a Hölder condition for such a function will result in fruitful estimates for its Laplacian, which is a limit of difference quotients.

Let us thus consider a function u in the domain of the Laplacian, and the nonnegative real constant $\alpha = \frac{\ln(r)}{2\ln(R)}$ given in remark 1.6.2, such that

$$\forall (X, Y) \in \mathfrak{S}\mathfrak{S}^2, \forall t > 0 : |u(t, X) - u(t, Y)| \leq C(t) |X - Y|^\alpha$$

where C denotes a positive function of the time variable t .

Given a strictly positive integer m , due to

$$\Delta_m u(t, X) = \sum_{Y \in V_m, Y \sim_m X} (u(t, Y) - u(t, X)) \quad \forall t > 0, \forall X \in V_m \setminus V_0$$

thus, given a strictly positive integer m , its Laplacian is defined as the limit

$$\Delta_\mu u(t, X) = \lim_{m \rightarrow +\infty} r^{-m} \left(\int_{\mathfrak{S}\mathfrak{S}} \psi_{X_m}^{(m)} d\mu \right)^{-1} \Delta_m u(t, X_m) \quad \forall t > 0, \forall X \in \mathfrak{S}\mathfrak{S}$$

where $(X_m \in V_m \setminus V_0)_{m \in \mathbb{N}}$ is a sequence a points such that:

$$\lim_{m \rightarrow +\infty} X_m = X$$

and where r denotes the normalization constant, $\psi_{X_m}^{(m)}$ a harmonic spline function, and where

$$\Delta_m u(t, X) = \sum_{Y \in V_m, Y \sim_m X} (u(t, Y) - u(t, X)) \quad \forall t > 0, \forall X \in V_m \setminus V_0.$$

Let us now introduce a strictly positive number $\delta_{ij} = |P_i - P_j|$, for any P_i belonging to the set V_0 , and any P_j such that $P_j \sim P_i$. On the one hand, we set: $\delta = \max_{i,j} \delta_{ij}$.

On the other hand, we define R as the maximum contraction ratio of the similarities f_i (note that, in the case of Sierpiński simplices, $R = \frac{1}{2}$).

One has then, for any X belonging to the set $V_m \setminus V_0$, any integer k belonging to $\{0, \dots, N-1\}$, and any strictly positive number h ,

$$\begin{aligned} \left| r^{-m} \left(\int_{\mathfrak{S}\mathfrak{S}} \psi_{X_m}^{(m)} d\mu \right)^{-1} \right| h |\Delta_m u(kh, X)| &\leq \left| r^{-m} \left(\int_{\mathfrak{S}\mathfrak{S}} \psi_{X_m}^{(m)} d\mu \right)^{-1} \right| h \sum_{Y \in V_m, Y \sim_m X} |u(kh, Y) - u(kh, X)| \\ &\leq \left| r^{-m} \left(\int_{\mathfrak{S}\mathfrak{S}} \psi_{X_m}^{(m)} d\mu \right)^{-1} \right| h C(kh) \sum_{Y \in V_m, Y \sim_m X} |X - Y|^\alpha \\ &\leq \left| r^{-m} \left(\int_{\mathfrak{S}\mathfrak{S}} \psi_{X_m}^{(m)} d\mu \right)^{-1} \right| h C(kh) \sum_{m | Y \in V_m, Y \sim_m X} \delta^\alpha R^{m\alpha} \\ &\leq \left| r^{-m} \left(\int_{\mathfrak{S}\mathfrak{S}} \psi_{X_m}^{(m)} d\mu \right)^{-1} \right| h C(kh) \sum_{p=0}^{+\infty} \delta^\alpha R^{p\alpha} \\ &= \delta^\alpha \frac{\left| r^{-m} \left(\int_{\mathfrak{S}\mathfrak{S}} \psi_{X_m}^{(m)} d\mu \right)^{-1} \right| h C(kh)}{(1 - R^\alpha)}. \end{aligned}$$

We have used the fact that, for $X \sim_m Y$, X and Y have addresses such that:

$$X = f_{\mathcal{W}}(P_i) \quad , \quad Y = f_{\mathcal{W}}(P_j)$$

for some P_i and P_j in V_0 and $\mathcal{W} \in \Sigma_m$. May one set

$$R(\mathcal{W}) = R_{\mathcal{W}_1} R_{\mathcal{W}_2} \dots R_{\mathcal{W}_m} = R^m$$

we then obtain that

$$|X - Y| = |f_{\mathcal{W}}(P_i) - f_{\mathcal{W}}(P_j)| = R(\mathcal{W}) |P_i - P_j| \leq R^m \delta.$$

The scheme (\mathcal{S}_h) enables us to write

$$|u((k+1)h, X) - u(kh, X)| \leq \delta^\alpha \frac{\left| r^{-m} \left(\int_{\mathfrak{S}\mathfrak{S}} \psi_{X_m}^{(m)} d\mu \right)^{-1} \right| h C(kh)}{\left(1 - \frac{1}{2}^\alpha\right)}.$$

One may note that a required condition for the convergence of the scheme is

$$\lim_{m \rightarrow +\infty, h \rightarrow 0^+} \left| r^{-m} \left(\int_{\mathfrak{S}\mathfrak{S}} \psi_{X_m}^{(m)} d\mu \right)^{-1} \right| h C(kh) = 0.$$

We take $C = \sup_k C(kh)$, it reduces to the necessary condition

$$\lim_{m \rightarrow +\infty, h \rightarrow 0^+} \left| r^{-m} \left(\int_{\mathfrak{S}\mathfrak{S}} \psi_{X_m}^{(m)} d\mu \right)^{-1} \right| h = 0. \quad (26)$$

According to [FS92], in the case of Sierpiński simplices, $r^m = \left(\frac{d}{d+2}\right)^m$, $\alpha = -\frac{\ln\left(\frac{d}{d+2}\right)}{2 \ln(2)}$, a simple calculus as in [Stro6] shows that $\int_{\mathfrak{S}\mathfrak{S}} \left(\psi_{X_m}^{(m)} d\mu\right) = \frac{2}{d^{m+1}}$, the relation reduces to

$$\lim_{m \rightarrow +\infty, h \rightarrow 0^+} \frac{d(d+2)^m}{2} h = 0. \quad (27)$$

Consistency, Stability and Convergence

THE SCHEME ERROR

Let us consider a continuous function u defined on $\mathfrak{S}\mathfrak{S}$. On the one hand, for all k in $\{0, \dots, N-1\}$, we have that

$$\forall X \in \mathfrak{S}\mathfrak{S} : \quad \frac{\partial u}{\partial t}(kh, X) = \frac{1}{h} (u((k+1)h, X) - u(kh, X)) + \mathcal{O}(h).$$

On the other hand, given a strictly positive integer m , $X \in V_m \setminus V_0$, and a harmonic function $\psi_X^{(m)}$ on the m^{th} -order cell, taking the value 1 on X and 0 on the others vertices (see [Str99]):

$$\int_{\mathfrak{S}\mathfrak{S}} \psi_X^{(m)}(y) (\Delta u(X) - \Delta u(Y)) d\mu(Y) = \frac{2}{d} d^{-m} \Delta u(X) - \left(\frac{d+2}{d}\right)^m \Delta_m u(X)$$

Then,

$$\Delta u(X) - \frac{d}{2}(d+2)^m \Delta_m u(X) = \frac{d}{2} d^m \int_{\mathfrak{S}\mathfrak{S}} \psi_X^{(m)}(Y) (\Delta u(X) - \Delta u(Y)) d\mu(Y).$$

Let us now consider the case of Hölder continuous functions, as in the above,

$$\forall (X, Y) \in \mathfrak{S}\mathfrak{S}^2: |u(X) - u(Y)| \leq C |X - Y|^\alpha$$

where C and α are nonnegative real constants.

Given a strictly positive integer m , since

$$\Delta_m u(X) = \sum_{Y \in V_m, Y \sim_m X} (u(Y) - u(X)) \quad \forall t > 0, \forall X \in V_m \setminus V_0$$

we obtain that

$$|\Delta_m u(X)| \lesssim |Y - X|^\alpha \quad \forall X \in V_m \setminus V_0,$$

and, thus,

$$|\Delta u(X)| \lesssim |Y - X|^\alpha \quad \forall X \in \mathfrak{S}\mathfrak{S} \setminus V_0.$$

One may note that

$$\frac{d}{2} d^m \int_{\mathfrak{S}\mathfrak{S}} \psi_X^{(m)}(Y) (\Delta u(X) - \Delta u(Y)) d\mu(Y)$$

is the mean value of $\Delta u(X) - \Delta u(Y)$ over the m^{th} -order cell containing X , and Δu is a Hölder-continuous function, so we can apply the mean value formula for integrals; there exists c_m in the m^{th} -order cell containing X such that :

$$\begin{aligned} \left| \Delta u(X) - \frac{d}{2}(d+2)^m \Delta_m u(X) \right| &= \Delta u(X) - \Delta u(c_m) \\ &\lesssim |X - c_m|^\alpha \\ &\lesssim \left(\frac{1}{2}\right)^{m\alpha}. \end{aligned}$$

In the end,

$$\Delta u(x) = \frac{d}{2}(d+2)^m \Delta_m u(x) + \mathcal{O}(2^{-m\alpha})$$

CONSISTENCY

Definition 2.1.1 (Consistency Error - Consistent Scheme).

The consistency error of our scheme is given by

$$\varepsilon_{k,i}^m = \mathcal{O}(h) + \mathcal{O}(2^{-m\alpha}) \quad 0 \leq k \leq N-1, 1 \leq i \leq \mathcal{N}_m - d.$$

The scheme is said to be **consistent** if the consistency error go to zero when $h \rightarrow 0$ and $m \rightarrow +\infty$, for some norm.

One may check that

$$\lim_{h \rightarrow 0, m \rightarrow +\infty} \varepsilon_{k,i}^m = 0.$$

The scheme is then consistent.

STABILITY

Definition 2.1.2.

Let us recall that the **spectral norm** ρ is defined as the induced norm of the norm $\|\cdot\|_2$. It is given, for a square matrix A , by:

$$\rho(A) = \sqrt{\lambda_{\max}(A^T A)}$$

where λ_{\max} stands for the spectral radius.

Proposition 2.1.2.

Let us denote by \mathcal{R} the spectral decimation function in definition 1.8.1 such that:

$$\forall x \neq 0: \quad \mathcal{R}(x) = x(d+2-x).$$

According to [FS92], the eigenvalues λ_m , $m \in \mathbb{N}$, of the discrete Laplacian Δ_m are related recursively

$$\forall m \geq 1: \quad \lambda_{m-1} = \mathcal{R}(\lambda_m).$$

Remark 2.1.3.

The eigenvalues λ of the self-similar Laplacian Δ_μ are obtained as limits of the eigenvalues λ_m of the discrete Laplacian Δ_m :

$$\lambda = \lim_{m \rightarrow +\infty} r^{-m} \left(\int_{\mathfrak{S}\mathfrak{S}} \psi_{X_m}^{(m)} d\mu \right)^{-1} \lambda_m.$$

We deduce that, for any strictly positive integer m ,

$$\lambda_m^\pm = \frac{(d+2) \pm \sqrt{(d+2)^2 - 4\lambda_{m-1}}}{2}$$

We introduce the functions ϕ^- and ϕ^+ such that, for any x in $\left] -\infty, \frac{(d+2)^2}{4} \right]$,

$$\phi^-(x) = \frac{(d+2) - \sqrt{(d+2)^2 - 4x}}{2}, \quad \phi^+(x) = \frac{(d+2) + \sqrt{(d+2)^2 - 4x}}{2}.$$

We have that:

$$\phi^+(0) = d+2, \quad \phi^-\left(\frac{(d+2)^2}{4}\right) = \frac{d+2}{2}, \quad \phi^-(0) = 0 \quad \text{and} \quad \phi^+\left(\frac{(d+2)^2}{4}\right) = \frac{d+2}{2}.$$

The function ϕ^- is increasing. Its fixed point is $x^{-,*} = 0$.

The function ϕ^+ is non increasing. Its fixed point is $x^{+,*} = (d+2) - 1$.

One may also check that the following two maps are contractions, since:

$$\left| \frac{d}{dx} \phi^-(0) \right| = \frac{1}{\sqrt{(d+2)^2}} = \frac{1}{d+2} < 1$$

and:

$$\left| \frac{d}{dx} \phi^+((d+2) - 1) \right| = \frac{1}{\sqrt{(d+2)^2 - 4(d+2) + 4}} = \frac{1}{d} < 1.$$

In [Shi91], Tadashi Shima shows that the discrete Laplacian Δ_1 on V_1 has Dirichlet eigenvalues $d+2$ with multiplicity $d-1$, and 2 with multiplicity 1, and gives the complete spectrum for $m \geq 1$.

The complete Dirichlet spectrum, for $m \geq 2$, is generated by the recurrent stable maps (convergent towards the fixed points) ϕ^+ and ϕ^- with initial values $2, d+2$ and $2d$.

One may finally conclude that, for any natural integer m ,

$$0 \leq \lambda_m \leq 2d. \tag{28}$$

Definition 2.1.3.

The scheme is said to be:

- unconditionally stable if there exist a constant $C < 1$ independent of h and m such that:

$$\rho(A^k) \leq C \quad \forall k \in \{1, \dots, N\}$$

- conditionally stable if there exist three constants $\alpha > 0, C_1 > 0$ and $C_2 < 1$ such that:

$$h \leq C_1 ((d+2)^{-m})^\alpha \implies \rho(A^k) \leq C_2 \quad \forall k \in \{1, \dots, N\}$$

Proposition 2.1.3.

Let us denote by γ_i , $i = 1, \dots, \mathcal{N}_m - d$, the eigenvalues of the matrix A of equation 37. Then,

$$\forall i = 1, \dots, \mathcal{N}_m - d : \quad h(d+2)^m \leq \frac{2}{d^2} \implies |\gamma_i| \leq 1. \quad (29)$$

We designate this result by **Courant–Friedrichs–Lewy (CFL) stability condition**.

Proof.

Let us recall our scheme can be written, for any integer k belonging to $\{1, \dots, N\}$:

$$(\mathcal{S}_H) \quad \left\{ \begin{array}{l} \frac{u_h^m((k+1)h, X_i) - u_h^m(kh, X_i)}{h} = \frac{d}{2}(d+2)^m \sum_{X_i \sim Y} (u_h^m(kh, Y) - u_h^m(kh, X_i)) \quad \forall 1 \leq i \leq \mathcal{N}_m - d \\ u_h^m(kh, P_j) = 0 \quad P_j \in V_0 \\ u_h^m(0, X_i) = g(X_i) \quad 1 \leq i \leq \mathcal{N}_m - d \end{array} \right.$$

i.e., under matrix form,

$$U_h^m(k) = \begin{pmatrix} u_h^m(kh, X_1) \\ \vdots \\ u_h^m(kh, X_{\mathcal{N}_m-d}) \end{pmatrix} \quad \forall k \in \{1, \dots, N\}.$$

It satisfies the recurrence relation:

$$U_h^m(k+1) = A U_h^m(k) \quad \forall k \in \{1, \dots, N\}$$

where

$$A = I_{\mathcal{N}_m-d} - h \tilde{\Delta}_m.$$

One may use the recurrence to obtain

$$U_h^m(k) = A^k U_h^m(0) \quad \forall k \in \{1, \dots, N\}.$$

The eigenvalues γ_i of A are related to the discrete Laplacian eigenvalues λ_i , $i = 1, \dots, \mathcal{N}_m - d$, by the formula

$$\gamma_i = 1 - h \left(\frac{d}{2} (d+2)^m \right) \lambda_i.$$

Using the spectral bound in equation 28, one has, for any integer i belonging to $\{1, \dots, \mathcal{N}_m - d\}$:

$$1 - h \frac{d}{2} (d+2)^m (2d) \leq \gamma_i \leq 1$$

which leads to

$$h(d+2)^m \leq \frac{2}{d^2} \implies |\gamma_i| \leq 1.$$

□

Remark 2.1.4.

We can compare the CFL condition 29 on Sierpiński simplices with the classical CFL condition on a smooth domains of \mathbb{R}^d . To this purpose, we set $\delta t = h$, $\delta x = 2^{-m}$, we then have that

$$\delta t \lesssim (d+2)^{-m} = 2^{-\frac{\ln(d+2)}{\ln(2)}m} = (\delta x)^{D_W(\mathfrak{S}\mathfrak{S})}$$

where $D_W(\mathfrak{S}\mathfrak{S})$ designate the Walk dimension.

CONVERGENCE

Definition 2.1.4.

- The scheme is said to be convergent for the matrix norm $\|\cdot\|$ if:

$$\lim_{h \rightarrow 0, m \rightarrow +\infty} \left\| (u(kh, X_i) - u_h^m(kh, X_i))_{0 \leq k \leq N, 1 \leq i \leq \mathcal{N}_m} \right\| = 0.$$

- The scheme is said to be conditionally convergent for the matrix norm $\|\cdot\|$ if there exist two real constants α and C such that :

$$\lim_{h \leq C((d+2)^{-m})^\alpha, m \rightarrow +\infty} \left\| (u(kh, X_i) - u_h^m(kh, X_i))_{0 \leq k \leq N, 1 \leq i \leq \mathcal{N}_m} \right\| = 0.$$

Theorem 2.1.4. Lax-Richtmyer for linear scheme

If the scheme is stable and consistent, then it is also convergent for the norm $\|\cdot\|_{2,\infty}$, such that:

$$\left\| (u_h^m(kh, X_i))_{0 \leq k \leq N, 1 \leq i \leq \mathcal{N}_m} \right\|_{2,\infty} = \max_{0 \leq k \leq N} \left(d^{-m} \sum_{1 \leq i \leq \mathcal{N}_m} |u_h^m(kh, X_i)|^2 \right)^{\frac{1}{2}}.$$

Proof.

Let us set:

$$w_i^k = u(kh, X_i) - u_h^m(kh, X_i), \quad 0 \leq k \leq N, 1 \leq i \leq \mathcal{N}_m.$$

One may check that,

$$\begin{aligned} w_{\mathcal{N}_m-d+1}^k &= \dots = w_{\mathcal{N}_m}^k = 0 & 0 \leq k \leq N \\ w_i^0 &= 0 & 1 \leq i \leq \mathcal{N}_m - d. \end{aligned}$$

Let us now introduce, for any integer k belonging to $\{0, \dots, N\}$,

$$W^k = \begin{pmatrix} w_1^k \\ \vdots \\ w_{\mathcal{N}_m-d}^k \end{pmatrix}, \quad E^k = \begin{pmatrix} \varepsilon_{k,1}^m \\ \vdots \\ \varepsilon_{k,\mathcal{N}_m-d}^m \end{pmatrix}$$

One has then $W^0 = 0$, and, for any integer k belonging to $\{1, \dots, N-1\}$:

$$W^{k+1} = A W^k + h E^k.$$

One finds recursively, for any integer k belonging to $\{0, \dots, N-1\}$,

$$W^{k+1} = A^k W^0 + h \sum_{j=0}^{k-1} A^j E^{k-j-1} = h \sum_{j=0}^{k-1} A^j E^{k-j-1}$$

Since the matrix A is a symmetric one, the CFL stability condition $h(d+2)^m \leq \frac{2}{d^2}$ yields, for any integer k belonging to $\{0, \dots, N\}$,

$$\begin{aligned} |W^k| &\leq h \left(\sum_{j=0}^{k-1} \|A\|^j \right) \left(\max_{0 \leq k \leq j-1} |E^k| \right) \\ &\leq h k \left(\max_{0 \leq k \leq j-1} |E^k| \right) \\ &\leq h N \left(\max_{0 \leq k \leq j-1} |E^k| \right) \\ &\leq T \left(\max_{0 \leq k \leq j-1} \left(\sum_{i=1}^{\mathcal{N}_m-d} |\varepsilon_{k,i}^m|^2 \right)^{\frac{1}{2}} \right). \end{aligned}$$

One deduces, then,

$$\begin{aligned} \max_{0 \leq k \leq N} \left(d^{-m} \sum_{i=1}^{\mathcal{N}_m-d} |w_i^k|^2 \right)^{\frac{1}{2}} &= d^{-\frac{m}{2}} \max_{1 \leq k \leq N} |W^k| \\ &\leq \left(d^{-\frac{m}{2}} \right) T \left(\max_{0 \leq k \leq N-1} \left(\sum_{i=1}^{\mathcal{N}_m-d} |\varepsilon_{k,i}^m|^2 \right)^{\frac{1}{2}} \right) \\ &\leq \left(d^{-\frac{m}{2}} \right) T \left((\mathcal{N}_m - d)^{\frac{1}{2}} \max_{0 \leq k \leq N-1, 1 \leq i \leq \mathcal{N}_m-d} |\varepsilon_{k,i}^m| \right) \\ &= \sqrt{\left(d^{-m} \frac{d^{m+1} - d}{2} \right)} T \left(\max_{0 \leq k \leq N-1, 1 \leq i \leq \mathcal{N}_m-d} |\varepsilon_{k,i}^m| \right) \\ &= \mathcal{O}(h) + \mathcal{O}(2^{-m\alpha}) \\ &= \mathcal{O}((d+2)^{-m}) + \mathcal{O}(2^{-m\alpha}) \\ &= \mathcal{O}(2^{-m\alpha}). \end{aligned}$$

The scheme is thus convergent. □

Remark 2.1.5.

One has to bear in mind that, for piecewise constant functions u on the m^{th} -order cells:

$$\|(u_h^m(kh, X_i))\|_2 = \left(d^{-m} \sum_{1 \leq i \leq \mathcal{N}_m} |u_h^m(kh, X_i)|^2 \right)^{\frac{1}{2}} = \|(u_h^m(kh, X_i))\|_{L^2(\mathfrak{S}\mathfrak{S})}.$$

The Specific Case of the Implicit Euler Method

Let consider the implicit Euler scheme, for any integer k belonging to $\{0, \dots, N - 1\}$, any point P_j of V_0 , $1 \leq j \leq \mathcal{N}_0$, and any X in the set $V_m \setminus V_0$:

$$(\mathcal{S}_H) \quad \begin{cases} \frac{u_h^m(kh, X) - u_h^m((k-1)h, X)}{h} & = r^{-m} \left(\int_{\mathfrak{S}\mathfrak{S}} \psi_{X_m}^{(m)} d\mu \right)^{-1} \left(\sum_{X \overset{m}{\sim} Y} u_h^m(kh, Y) - u_h^m(kh, X) \right) \\ u_h^m(kh, P_j) & = 0 \\ u_h^m(0, X) & = g(X) \end{cases}$$

Let us define the approximate equation as:

$$u_h^m(kh, X) - h \times r^{-m} \left(\int_{\mathfrak{S}\mathfrak{S}} \psi_{X_m}^{(m)} d\mu \right)^{-1} \left(\sum_{X \overset{m}{\sim} Y} u_h^m(kh, Y) - u_h^m(kh, X) \right) = u_h^m((k-1)h, X). \quad (30)$$

$\forall k \in \{0, \dots, N - 1\}, \forall X \in V_m \setminus V_0$. As previously done, we fix $m \in \mathbb{N}$, and we use the natural order (remark 2.1.2) to obtain, for any integer k belonging to $\{0, \dots, N - 1\}$, the solution vector $U(k)$ as before,

$$U_h^m(k) = \begin{pmatrix} u_h^m(kh, X_1) \\ \vdots \\ u_h^m(kh, X_{\mathcal{N}_m-d}) \end{pmatrix}$$

It satisfies the recurrence relation:

$$\tilde{A} U_h^m(k) = U_h^m(k-1) \quad (31)$$

where

$$\tilde{A} = I_{\mathcal{N}_m-d} + h \times \tilde{\Delta}_m \quad (32)$$

and where $I_{\mathcal{N}_m-d}$ denotes the $(\mathcal{N}_m - d) \times (\mathcal{N}_m - d)$ identity matrix, and $\tilde{\Delta}_m$ the $(\mathcal{N}_m - d) \times (\mathcal{N}_m - d)$ normalized Laplacian matrix.

Notice that the scheme is well defined: using the spectral bound 28, and designate the eigenvalues of the matrix \tilde{A} by $\tilde{\gamma}_i, i = 1, \dots, \mathcal{N}_m - d$, we get:

$$1 \leq \tilde{\gamma}_i \leq 1 + \frac{d(d+2)^m}{2}(2d)$$

Thus

$$1 \leq |\tilde{\gamma}_i| \tag{33}$$

and the matrix \tilde{A} is invertible and

$$|\tilde{\gamma}_i^{-1}| \leq 1. \tag{34}$$

CONSISTENCY, STABILITY AND CONVERGENCE

i. The Scheme Error Let us denote by u a function defined on $\mathfrak{S}\mathfrak{S}$. On the one hand, for all k in $\{0, \dots, N-1\}$,

$$\forall X \in \mathfrak{S}\mathfrak{S} : \quad \frac{\partial u}{\partial t}(kh, X) = \frac{1}{h} (u(kh, X) - u((k-1)h, X)) + \mathcal{O}(h).$$

On the other hand, for $X \in V_m \setminus V_0$, we have that

$$\Delta u(x) = \frac{d}{2}(d+2)^m \Delta_m u(x) + \mathcal{O}(2^{-m\alpha}).$$

ii. Consistency The consistency error of the implicit Euler scheme is given by :

$$\varepsilon_{k,i}^m = \mathcal{O}(h) + \mathcal{O}(2^{-m\alpha}) \quad 0 \leq k \leq N-1, 1 \leq i \leq \mathcal{N}_m - d$$

We can check that

$$\lim_{h \rightarrow 0, m \rightarrow \infty} \varepsilon_{k,i}^m = 0$$

The scheme is then consistent.

iii. Stability Under the definition 2.1.3, the implicit scheme is unconditionally stable thanks to the spectral bound 34.

iv. Convergence

Theorem 2.1.5.

The implicit euler scheme is convergent for the norm $\| \cdot \|_{2,\infty}$ of theorem 2.1.4.

Proof.

Let us set

$$w_i^k = u(kh, X_i) - u_m^h(kh, X_i), \quad 0 \leq k \leq N, 1 \leq i \leq \mathcal{N}_m.$$

One can check that

$$\begin{aligned} w_{\mathcal{N}_m-d+1}^k &= \cdots = w_{\mathcal{N}_m}^k = 0 & 0 \leq k \leq N \\ w_i^0 &= 0 & 1 \leq i \leq \mathcal{N}_m - d. \end{aligned}$$

We set

$$W^k = \begin{pmatrix} w_1^k \\ \vdots \\ w_{\mathcal{N}_m-d}^k \end{pmatrix}, \quad E^k = \begin{pmatrix} \varepsilon_{k,1}^m \\ \vdots \\ \varepsilon_{k,\mathcal{N}_m-d}^m \end{pmatrix}.$$

Thus, $W^0 = 0$, and, for $0 \leq k \leq N-1$,

$$W^{k+1} = \tilde{A}^{-1}W^k + hE^k \quad 0 \leq k \leq N-1.$$

We find, by induction, for $0 \leq k \leq N-1$, that

$$\begin{aligned} W^{k+1} &= \tilde{A}^{-k}W^0 + h \sum_{j=0}^{k-1} \tilde{A}^{-j}E^{k-j-1} \\ &= h \sum_{j=0}^{k-1} \tilde{A}^{-j}E^{k-j-1}. \end{aligned}$$

Due to the stability of the scheme, for $k = 0, \dots, N$, we have that

$$\begin{aligned} |W^k| &\leq h \left(\sum_{j=0}^{k-1} \|\tilde{A}^{-j}\| \right) \left(\max_{0 \leq k \leq j-1} |E^k| \right) \\ &\leq hk \left(\max_{0 \leq k \leq j-1} |E^k| \right) \\ &\leq hN \left(\max_{0 \leq k \leq j-1} |E^k| \right) \\ &\leq T \left(\max_{0 \leq k \leq j-1} \left(\sum_{i=1}^{\mathcal{N}_m-d} |\varepsilon_{k,i}^m|^2 \right)^{\frac{1}{2}} \right). \end{aligned}$$

One deduces, then, that

$$\begin{aligned}
\max_{0 \leq k \leq N} \left(d^{-m} \sum_{i=1}^{\mathcal{N}_m-d} |w_i^k|^2 \right)^{\frac{1}{2}} &= (d)^{-\frac{m}{2}} \max_{1 \leq k \leq N} |W^k| \\
&\leq (d^{-\frac{m}{2}}) T \left(\max_{0 \leq k \leq N-1} \left(\sum_{i=1}^{\mathcal{N}_m-d} |\varepsilon_{k,i}^m|^2 \right)^{1/2} \right) \\
&\leq (d^{-\frac{m}{2}}) T \left((\mathcal{N}_m - d)^{\frac{1}{2}} \max_{0 \leq k \leq N-1, 1 \leq i \leq \mathcal{N}_m-d} |\varepsilon_{k,i}^m| \right) \\
&= \sqrt{\left(d^{-m} \frac{d^{m+1} - d}{2} \right)} T \left(\max_{0 \leq k \leq N-1, 1 \leq i \leq \mathcal{N}_m-d} |\varepsilon_{k,i}^m| \right) \\
&= (\mathcal{O}(h) + \mathcal{O}(2^{-m\alpha})) .
\end{aligned}$$

The scheme is thus convergent thanks again to equation 27. \square

Numerical Results - Gasket and Tetrahedron

RECURSIVE CONSTRUCTION OF THE MATRIX ASSOCIATED TO THE SEQUENCE OF GRAPH LAPLACIANS

We describe next our recursive algorithm used to construct matrix, related to the sequence of graph Laplacians, in the case of Sierpiński Gasket and Tetrahedron.

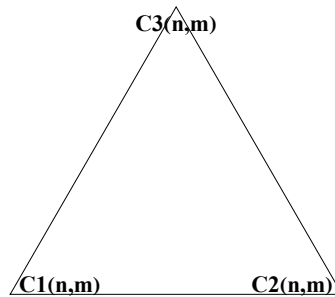

Figure 10: m^{th} -order cell of the Sierpiński Gasket.

i. The Sierpiński Gasket. One may note, first, that, given a strictly positive integer m , a m^{th} -order triangle has three corners, that we will denote by $C1$, $C2$ and $C3$; the $(m+1)^{\text{th}}$ -order triangle is then constructed by connecting three m copies $T(n)$ with $n = 1, 2, 3$.

The initial triangle is labeled such that $C1 \sim 1$, $C2 \sim 2$ and $C3 \sim 3$ (see figure 10).

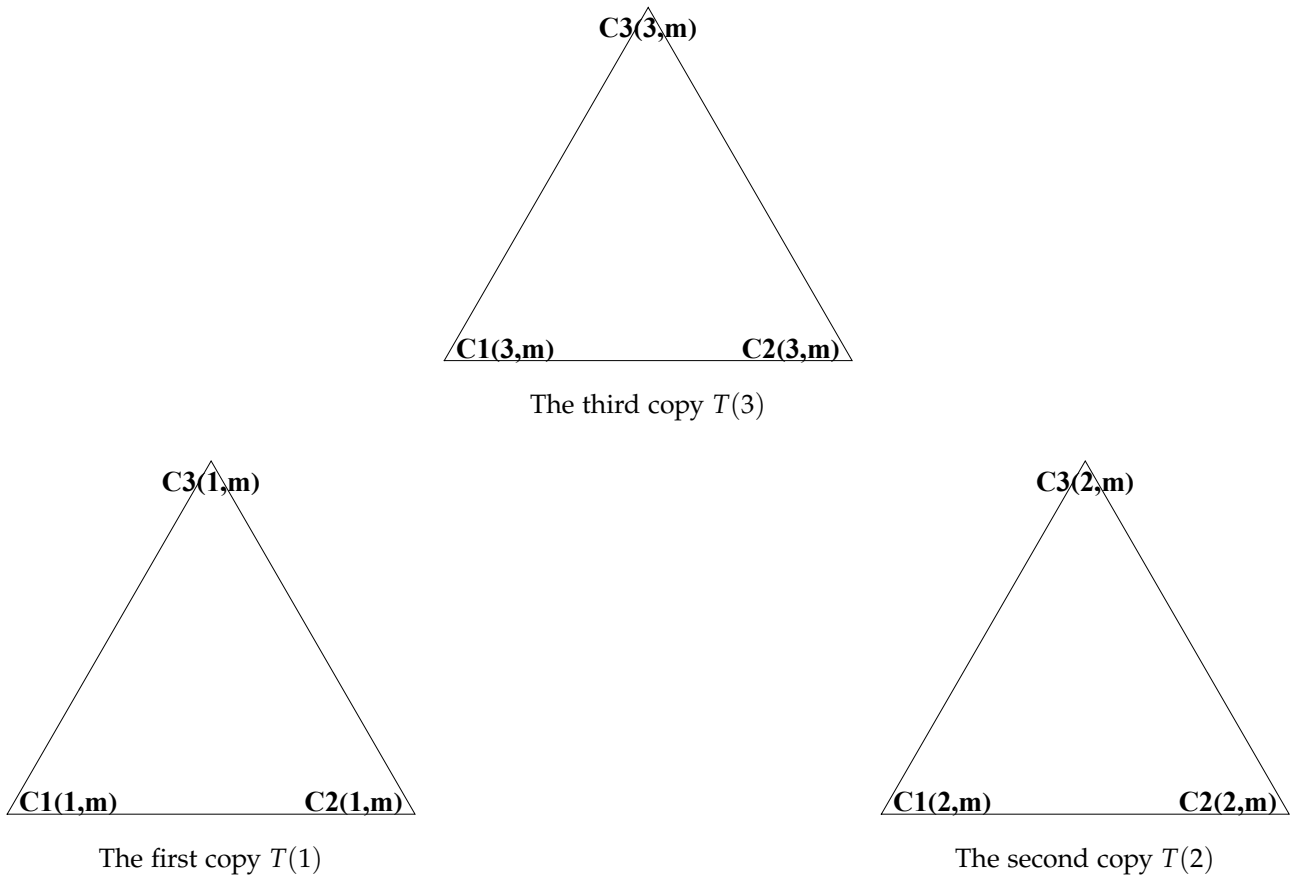

Figure 11: The three copies.

The fusion is done by connecting $C2(1, m) \sim C1(2, m)$, $C3(1, m) \sim C1(3, m)$, and $C3(2, m) \sim C2(3, m)$ (see figure 11).

The label of the corner vertex can be obtained by means of the following recursive sequence, for any strictly positive integer m ,

$$\begin{aligned} C1(n, m) &= 1 + (n - 1) \mathcal{N}_{m-1} \\ C2(n, m) &= I2(m) + (n - 1) \mathcal{N}_{m-1} \\ C3(n, m) &= n \mathcal{N}_{m-1} \end{aligned}$$

where

$$\begin{aligned} \mathcal{N}_{-1} &= 3 \quad , \quad I2(0) = 0 \\ I2(m) &= I2(m - 1) + \mathcal{N}_{m-2} - 1. \end{aligned}$$

1. One may start with the initial triangle with the set of vertices V_0 . The corresponding matrix is given by:

$$A_0 = \begin{pmatrix} 2 & -1 & -1 \\ -1 & 2 & -1 \\ -1 & -1 & 2 \end{pmatrix}$$

2. If $m = 0$, the Laplacian matrix is A_0 , else, A_m is constructed recursively from three copies of the Laplacian matrices A_{m-1} of the graph V_{m-1} . First, we build, for any strictly positive integer m , the block diagonal matrix:

$$B_m = \begin{pmatrix} A_{m-1} & 0 & 0 \\ 0 & A_{m-1} & 0 \\ 0 & 0 & A_{m-1} \end{pmatrix}$$

3. One may then introduce, for any strictly positive integer m , the connection matrix as in [FL04]:

$$C_m = \begin{pmatrix} C2(1, m) & C3(1, m) & C3(2, m) \\ C1(2, m) & C1(3, m) & C2(3, m) \end{pmatrix}$$

4. One has then to sum the rows (resp. the columns) $C_m(2, j)$ and $C_m(1, j)$, and delete the row and the column $C_m(2, j)$.

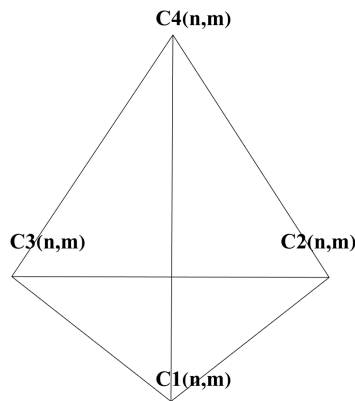

Figure 12: m^{th} -order cell of the Sierpiński Tetrahedron.

ii. The Sierpiński Tetrahedron. One may note, first, that, given a strictly positive integer m , a m^{th} -order tetrahedron has four corners $C1$, $C2$, $C3$ and $C4$ (see figure 5), and that the $(m + 1)^{\text{th}}$ -order triangle is constructed by connecting four m copies $T(n)$, with $n = 1, 2, 3, 4$ (see figure 6, 7, 8, 9).

As in the case of the triangle, the initial tetrahedron is labeled such that $C1 \sim 1$, $C2 \sim 2$, $C3 \sim 3$ and $C4 \sim 4$.

The fusion is done by connecting $C2(1, m) \sim C1(2, m)$, $C3(1, m) \sim C1(3, m)$, $C4(1, m) \sim C1(4, m)$, $C3(2, m) \sim C2(3, m)$, $C4(2, m) \sim C2(4, m)$, $C4(3, m) \sim C3(4, m)$.

The fourth copy $T(4)$.The first copy $T(1)$.The second copy $T(2)$.The third copy $T(3)$.

Figure 13: The four copies.

The number of corners can be obtained by means of the following recursive sequence, for any strictly positive integer m ,

$$\begin{aligned} C1(n, m) &= 1 + (n - 1) \mathcal{N}_{m-1} \\ C2(n, m) &= I2(m) + (n - 1) \mathcal{N}_{m-1} \\ C3(n, m) &= I3(m) + (n - 1) \mathcal{N}_{m-1} \\ C4(n, m) &= n \mathcal{N}_{m-1} \end{aligned}$$

where:

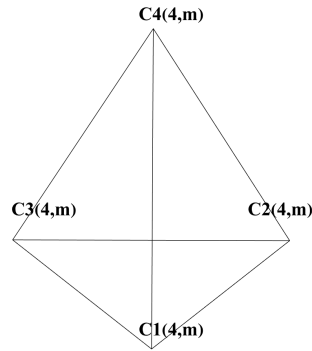
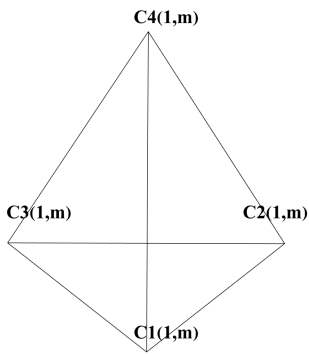
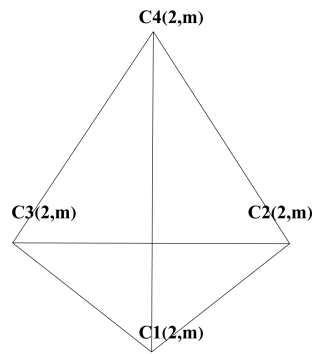
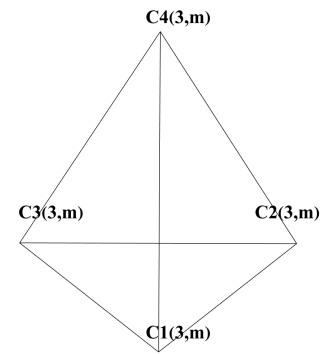
$$\begin{aligned} \mathcal{N}_{-1} &= 3 \\ I2(0) &= 0 \\ I2(m) &= I2(m - 1) + \mathcal{N}_{m-2} - 1 \\ I3(1) &= 3 \\ I3(m) &= I3(m - 1) + 2 \times \mathcal{N}_{m-2} - 3 \end{aligned}$$

1. One starts with initial tetrahedron with the set of vertices V_0 . The corresponding matrix is given by:

$$A_0 = \begin{pmatrix} 3 & -1 & -1 & -1 \\ -1 & 3 & -1 & -1 \\ -1 & -1 & 3 & -1 \\ -1 & -1 & -1 & 3 \end{pmatrix}.$$

2. If $m = 0$ the Laplacian matrix is A_0 , else, for any strictly positive integer m , A_m is constructed recursively from three copies of the Laplacian matrices A_{m-1} of the graph V_{m-1} . Thus, we build the block diagonal matrix

$$B_m = \begin{pmatrix} A_{m-1} & 0 & 0 & 0 \\ 0 & A_{m-1} & 0 & 0 \\ 0 & 0 & A_{m-1} & 0 \\ 0 & 0 & 0 & A_{m-1} \end{pmatrix}.$$

3. We then write the connection matrix:

$$C_m = \begin{pmatrix} C2(1, m) & C3(1, m) & C3(2, m) & C4(1, m) & C4(2, m) & C4(3, m) \\ C1(2, m) & C1(3, m) & C2(3, m) & C1(4, m) & C2(4, m) & C3(4, m) \end{pmatrix}.$$

4. One then has to sum the rows (resp. the columns) $C_m(2, j)$ to $C_m(1, j)$, and delete the row and the column $C_m(2, j)$.

NUMERICAL RESULTS

i. The Sierpiński Gasket

In the sequel, we present the numerical results for $m = 6$, $T = 1$ and $N = 2 \times 10^5$.

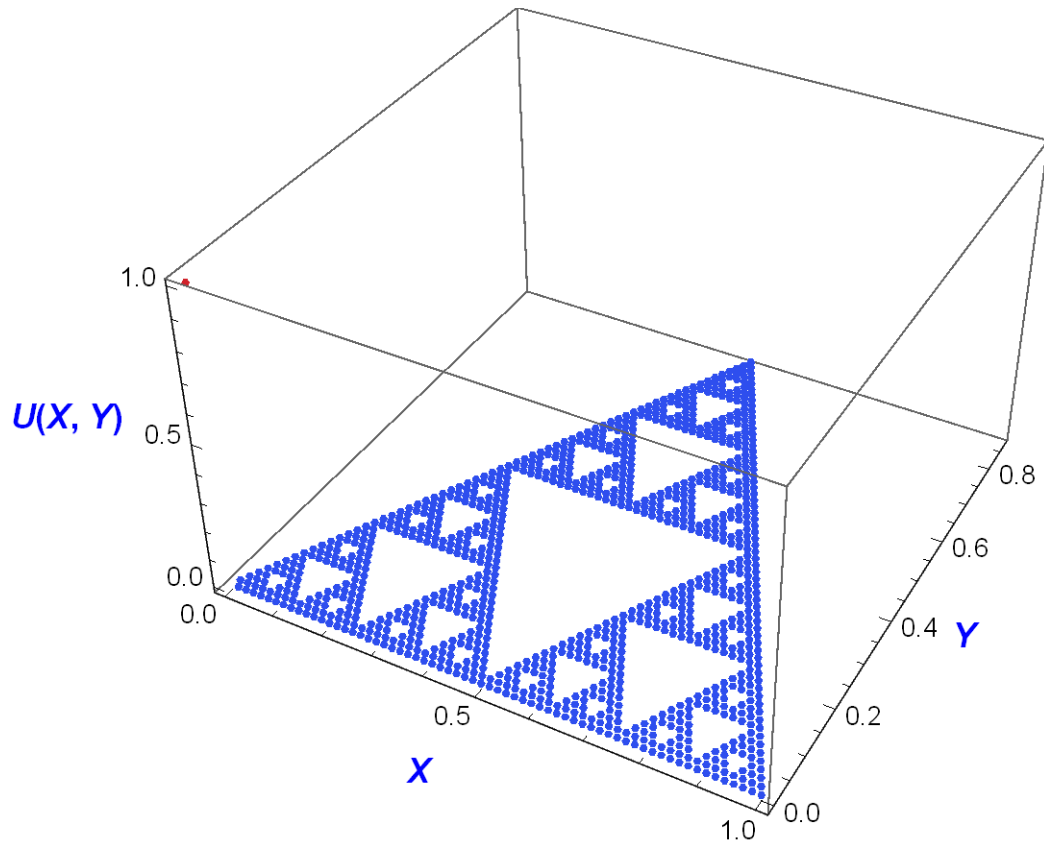

The graph of the approached solution of the heat equation for $k=0$.

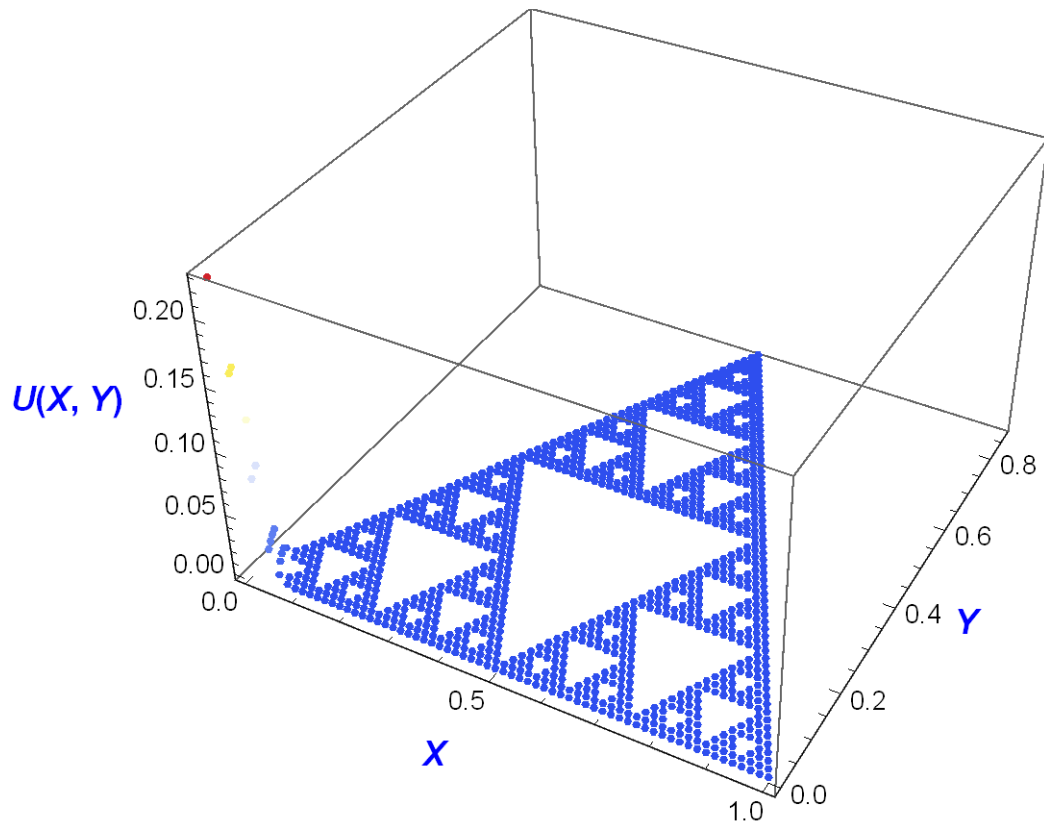

The graph of the approached solution of the heat equation for $k=10$.

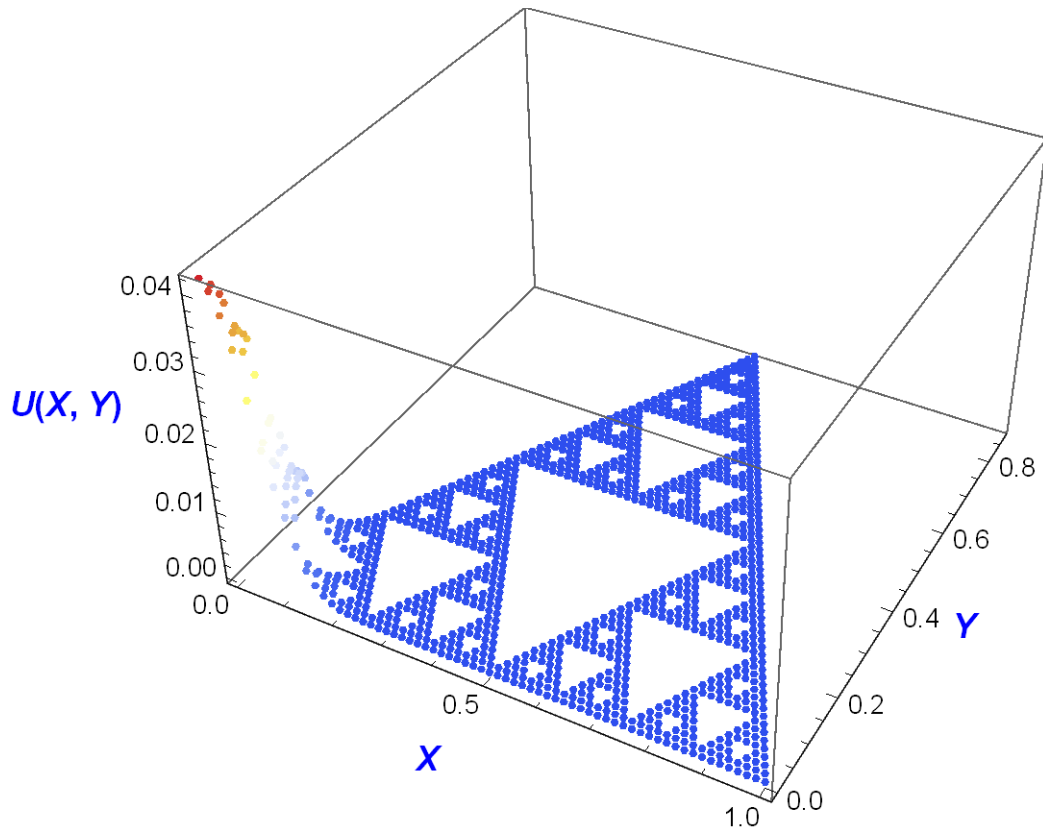

The graph of the approached solution of the heat equation for $k = 100$.

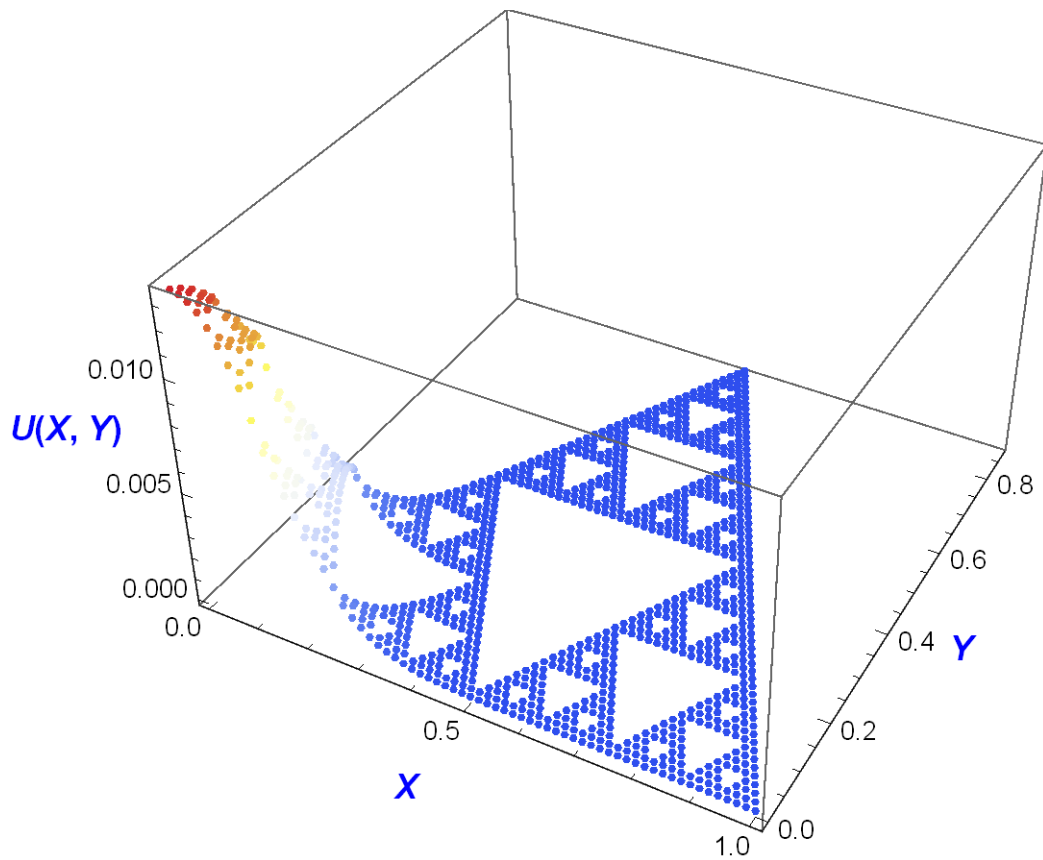

The graph of the approached solution of the heat equation for $k = 500$.

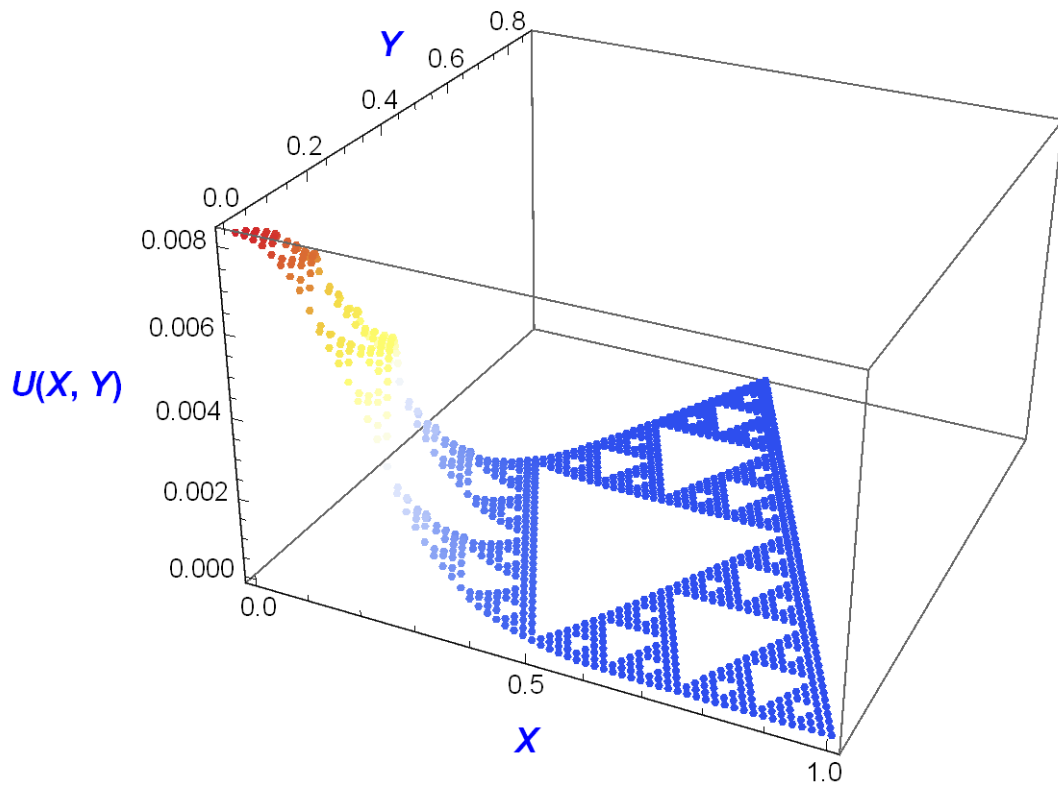

The graph of the approached solution of the heat equation for $k = 1000$.

ii. The Sierpiński Tetrahedron

In the sequel, we present the numerical results for $m = 5$, $T = 1$ and $N = 10^5$.

Our heat transfer simulation consists in a propagation scenario, where the initial condition is a harmonic spline g , the support of which being a m -cell, such that it takes the value 1 on a vertex x , and 0 otherwise.

The color function is related to the gradient of temperature, high values ranging from red to blue.

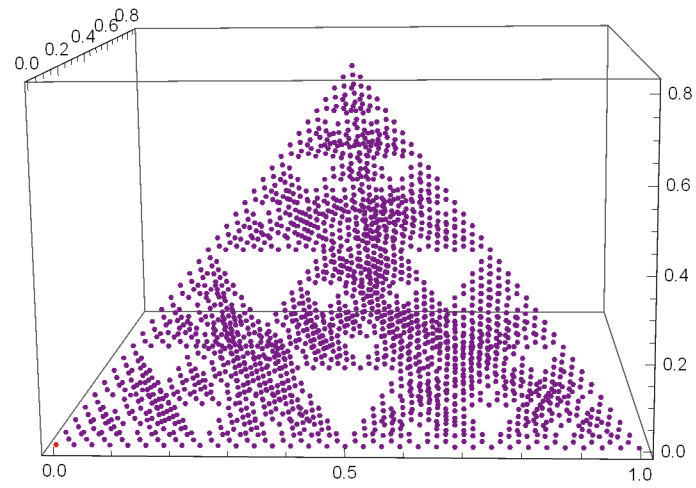

The graph of the approached solution of the heat equation for $k=0$.

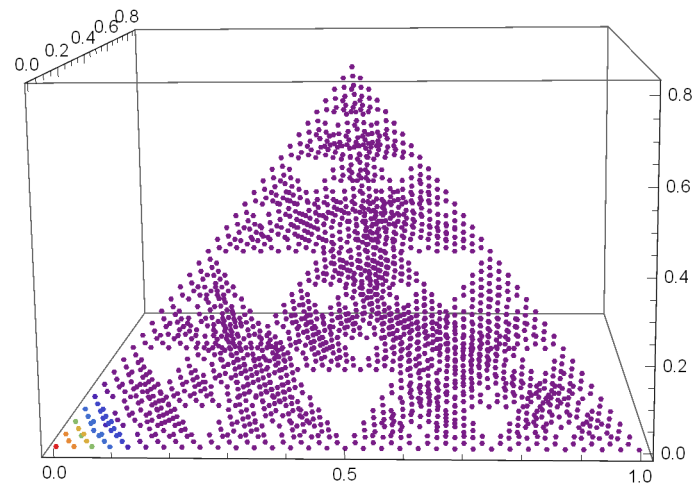

The graph of the approached solution of the heat equation for $k=10$.

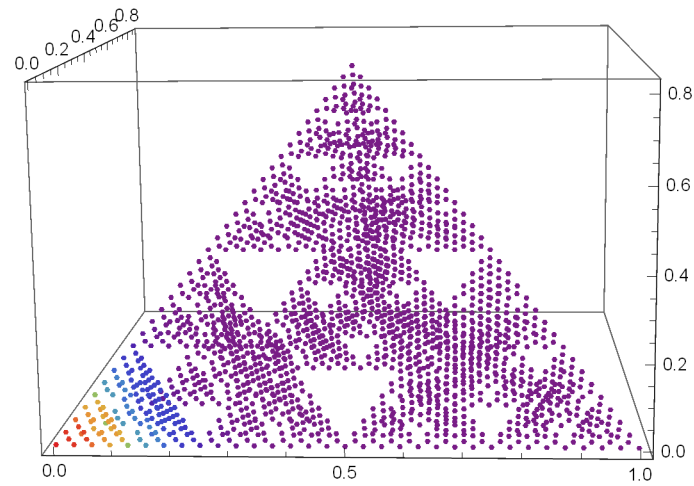

The graph of the approached solution of the heat equation for $k = 50$.

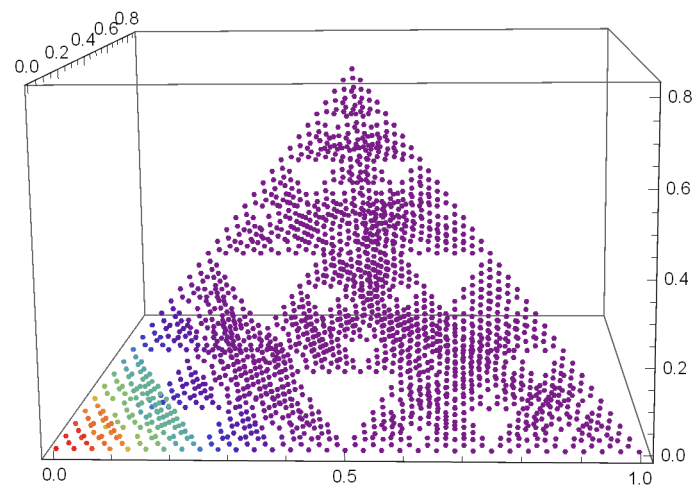

The graph of the approached solution of the heat equation for $k = 100$.

An interesting feature in our work is that, contrary to existing ones, we do not rely on heat kernel estimates. Using a direct method has thus enabled us to discuss the choices of parameters as the integer m , the step h , and the convergence.

As expected, the numerical scheme is unstable and diverges until one respects the stability condition between h and m . Also, the propagation process evolves with time, directed from hot regions, towards cold ones.

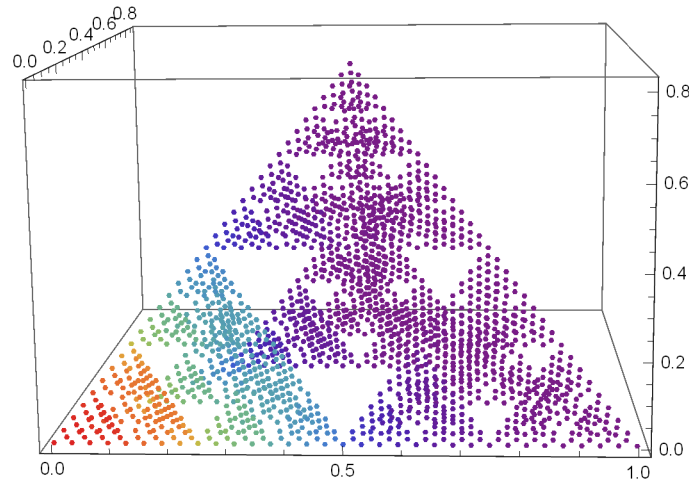

The graph of the approached solution of the heat equation for $k = 500$.

2.2 THE FINITE VOLUME METHOD

The finite volume method on fractals consists on local integration of the partial differential equation over a region $f_{\mathcal{W}}(\mathcal{F})$, and use matching conditions to glue the solution. The solution is then given as a mean value over the region $f_{\mathcal{W}}(\mathcal{F})$.

2.2.1 The Finite Volume Method on Sierpiński Simplices

In order to define the finite volume method on Sierpiński simplices, we need to introduce a new sequence of graphs.

Definition 2.2.1.

For any natural integer m , we introduce the graph \mathcal{SS}_m , built from \mathcal{GS}_m in the following way:

- i.* a cell in \mathcal{GS}_m becomes a vertex in \mathcal{SS}_m ;
- ii.* two vertices are linked in \mathcal{SS}_m if the corresponding cells in \mathcal{GS}_m have a vertex in common.
- iii.* The vertices set of \mathcal{SS}_m is \mathcal{V}_m and their number is d^m .

Example 2.2.1. In the case of the Sierpiński Gasket:

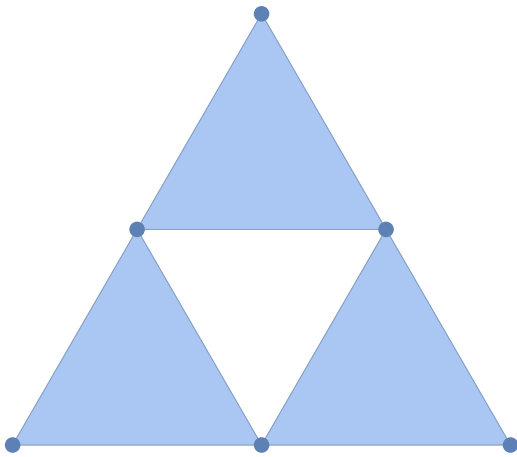

Figure 14: $\mathcal{S}\mathcal{S}_1$

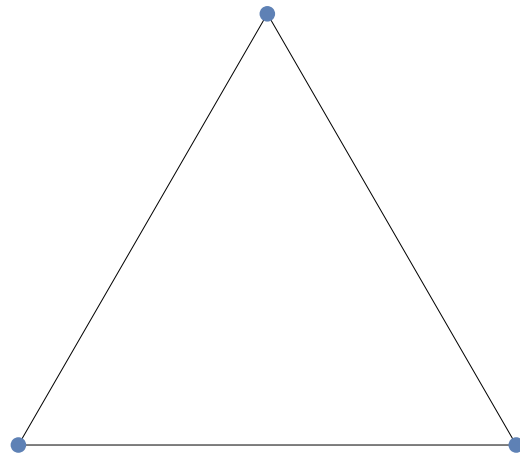

Figure 15: $\mathcal{S}\mathcal{S}_1$

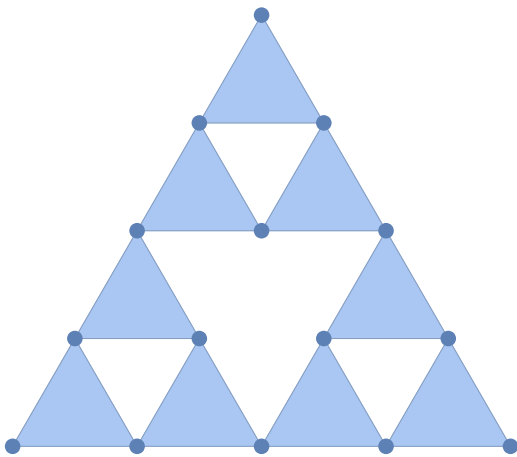

Figure 16: $\mathcal{S}\mathcal{S}_2$

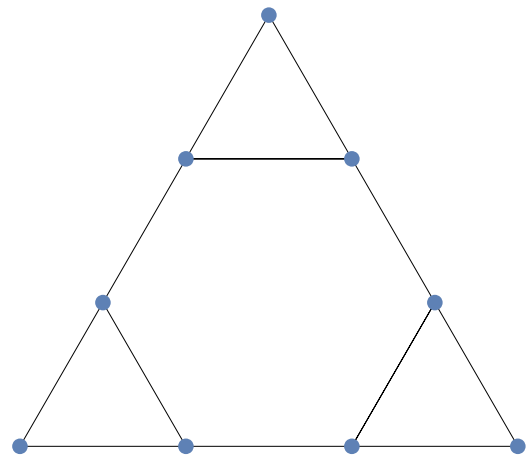

Figure 17: $\mathcal{S}\mathcal{S}_2$

Formulation of the Problem

Notation. Let us again denote by T a strictly positive real number, and by N a strictly positive integer. We set:

$$h = \frac{T}{N} \quad , \quad t_n = n \times h \quad , \quad n = 0, 1, \dots, N - 1$$

We consider again the solution u of the problem:

$$\begin{cases} \frac{\partial u}{\partial t}(t, X) - \Delta u(t, X) = 0 & \forall (t, X) \in]0, T[\times \mathcal{S}\mathcal{S} \\ u(t, X) = 0 & \forall (t, X) \in [0, T[\times \partial\mathcal{S}\mathcal{S} \\ u(0, X) = g(X) & \forall X \in \mathcal{S}\mathcal{S} \end{cases}$$

Definition 2.2.2.

Given a natural integer m , we define the m^{th} -**control volume** as the m^{th} -order cell

$$C_m^j = f_{\mathcal{W}^j}(\mathfrak{S}\mathfrak{S}) \quad , \quad \mathcal{W}^j \in \Sigma_m = \{1, \dots, d\}^m$$

where \mathcal{W}^j is some word of length m , and whose m^{th} -order cells neighbors are

$$C_m^{\ell(j)} = f_{\mathcal{W}^{\ell(j)}}(\mathfrak{S}\mathfrak{S}) \quad , \quad \mathcal{W}^{\ell(j)} \in \{1, \dots, d\}^m \quad , \quad \ell(j) = 1, \dots, d-1.$$

Remark 2.2.1.

One may check that

$$\bigcup_{j=1}^{d^m} C_m^j = \mathfrak{S}\mathfrak{S}.$$

We define, then,

$$u_j^0 = \frac{1}{\mu(C_m^j)} \int_{C_m^j} g(x) d\mu(x).$$

The local version of Gauss-Green formula 15 enables one to write

$$\int_{C_m^j} \Delta_\mu u \, d\mu = \sum_{x \in \partial C_m^j} \partial_n u(x)$$

where ∂C_m^j stands for the boundary points $F_{\mathcal{W}^j}(V_0)$, and, given a natural integer n , to integrate the heat equation over $C_m^j \times]t_n, t_{n+1}[$:

$$\int_{C_m^j} u(t_{n+1}, x) - u(t_n, x) \, d\mu = \int_{t_n}^{t_{n+1}} \sum_{x \in \partial C_m^j} \partial_n u(t, x) \, dt \quad (35)$$

The boundary points admit a double writing

$$f_{\mathcal{W}^j}(P_i) = f_{\mathcal{W}^{\ell(j)}}(P_k)$$

for some $(i, k) \in \{1, \dots, d\}^2$, and $\ell(j) \in \{1, \dots, d-1\}$. One may use the approximation

$$\begin{aligned}
\partial_n u(t, X) &\approx r^{-m} \sum_{\substack{Y \sim_m X \\ Y \in C_m^j}} (u(t, X) - u(t, Y)) \\
&= r^{-m} \left((d-1)u(t, X) - \sum_{\substack{Y \sim_m X \\ Y \in C_m^j}} u(t, Y) \right) \\
&= r^{-m} \left(d u(t, X) - u(t, X) - \sum_{\substack{Y \sim_m X \\ Y \in C_m^j}} u(t, Y) \right) \\
&\approx r^{-m} d \left(u(t, X) - u_j^t \right)
\end{aligned}$$

in conjunction with

$$\frac{1}{d} \sum_{Y \in \partial C_m^j} u(t, Y) \approx \frac{1}{\mu(C_m^j)} \int_{C_m^j} u(t, x) d\mu(x) = u_j^t.$$

We then introduce the matching condition 1.6.7

$$\partial_n u(t, f_{\mathcal{W}^j}(P_i)) = -\partial_n u(t, f_{\mathcal{W}^{\ell(j)}}(P_k)),$$

i.e.,

$$r^{-m} d \left(u(t, X) - u_j^t \right) = -r^{-m} d \left(u(t, X) - u_{\ell(j)}^t \right).$$

This implies that

$$u(t_n, X) = \frac{(u_j^n + u_{\ell(j)}^n)}{2}.$$

The normal derivative writes then

$$\begin{aligned}
\partial_n u(t, X) &= r^{-m} d \left(\frac{(u_j^t + u_{\ell(j)}^t)}{2} - u_j^t \right) \\
&= r^{-m} \frac{d}{2} \left(u_{\ell(j)}^t - u_j^t \right).
\end{aligned}$$

Thus, back to the equation 35, we have that

$$u_j^{n+1} = u_j^n + \frac{h}{\mu(C_m^j)} \sum_{X \in \partial C_m^j} \partial_n u(t_n, X).$$

One may now build the finite volume scheme:

$$u_j^{n+1} = u_j^n + \frac{h}{\mu(C_m^j)} r^{-m} \frac{d}{2} \sum_{j \sim_m \ell(j)} \left(u_{\ell(j)}^t - u_j^t \right) \quad (36)$$

where $j \sim_m \ell(j)$ means that the cell $f_{\mathcal{W}^j}(\mathcal{G}\mathcal{G})$ and $f_{\mathcal{W}^{\ell(j)}}(\mathcal{G}\mathcal{G})$ are neighbors.

Remark 2.2.2.

- i. One may note that we have found miraculously the finite difference scheme.
- ii. We can also define the backward scheme:

$$u_j^n = u_j^{n-1} + \frac{h}{\mu(C_m^j)} r^{-m} \frac{d}{2} \sum_{j \sim \ell(j)} (u_{\ell(j)}^t - u_j^t)$$

Let us now fix $m \in \mathbb{N}$, and denote again any m^{th} control volume C_m^j as $C_m^j = f_{\mathcal{W}^j}(\mathfrak{S}\mathfrak{S})$, $\mathcal{W}^j \in \Sigma_m = \{1, \dots, d\}^m$.

This enables us to introduce, for any integer n belonging to $\{0, \dots, N-1\}$, the solution vector $U(n)$ as

$$U(n) = \begin{pmatrix} u_1^n \\ \vdots \\ u_{d_m}^n \end{pmatrix}$$

by using the fact that the number of m^{th} -order cells is d^m . It satisfies the recurrence relation:

$$U(n+1) = A U(n) \tag{37}$$

where

$$A = I_{d^m} - h \frac{d}{2} \tilde{\Delta}_m$$

and where I_{d^m} denotes the $d^m \times d^m$ identity matrix, and $\tilde{\Delta}_m$ the $d^m \times d^m$ Laplacian normalized matrix.

Consistency, Stability and Convergence

THEORETICAL STUDY OF THE ERROR

Let us consider a continuous function u defined on $\mathfrak{S}\mathfrak{S}$. On the one hand, for all n in $\{0, \dots, N-1\}$,

$$\forall X \in \mathfrak{S}\mathfrak{S} : \int_{t_n}^{t_{n+1}} u(t, X) dt = h u(t_n, X) + \mathcal{O}(h^2).$$

On the other hand, given a strictly positive integer m , $X \in V_m \setminus V_0$, and a harmonic function $\psi_X^{(m)}$ on the m^{th} -order cell, taking the value 1 on $X = F_{\mathcal{W}^j}(P_i) = F_{\mathcal{W}^j}(P_k)$ and 0 on the others vertices (see [Str99]), and using the corollary of the Gauss-Green formula 15:

$$\int_{f_{\mathcal{W}^j}(\mathfrak{S}\mathfrak{S})} \Delta_\mu u \psi_X^{(m)} d\mu = \partial_n u(X) - r^{-m} \sum_{\substack{Y \sim X \\ m \\ Y \in f_{\mathcal{W}^j}(\mathfrak{S}\mathfrak{S})}} (u(t, X) - u(t, Y))$$

We add the same relation on the neighbor cell $f_{\mathcal{W}^i}(\mathfrak{E}\mathfrak{E})$ and we use the matching condition 1.6.7 to obtain

$$\begin{aligned} \int_{\mathfrak{E}\mathfrak{E}} \Delta_\mu u \psi_X^{(m)} d\mu &= r^{-m} \Delta_m u(X) \\ &= \mathcal{O} \left(\int_{\mathfrak{E}\mathfrak{E}} \psi_X^{(m)} d\mu \right) \end{aligned}$$

We just proved that

$$\partial_n u(X) - r^{-m} \sum_{\substack{Y \sim X \\ Y \in f_{\mathcal{W}^i}(\mathfrak{E}\mathfrak{E})}} (u(t, X) - u(t, Y)) = \mathcal{O} \left(\int_{\mathfrak{E}\mathfrak{E}} \psi_X^{(m)} d\mu \right).$$

In the end, for the discrete average, on a m^{th} -order cell $f_{\mathcal{W}^i}(\mathfrak{E}\mathfrak{E})$:

$$\begin{aligned} \frac{1}{\mu(f_{\mathcal{W}^i}(\mathfrak{E}\mathfrak{E}))} \int_{f_{\mathcal{W}^i}(\mathfrak{E}\mathfrak{E})} u(t, X) d\mu(X) - \frac{1}{d} \sum_{Y \in \partial f_{\mathcal{W}^i}(\mathfrak{E}\mathfrak{E})} u(t, Y) &= \frac{1}{\mu(f_{\mathcal{W}^i}(\mathfrak{E}\mathfrak{E}))} \int_{f_{\mathcal{W}^i}(\mathfrak{E}\mathfrak{E})} u(t, X) - \frac{1}{d} \sum_{Y \in \partial f_{\mathcal{W}^i}(\mathfrak{E}\mathfrak{E})} u(t, Y) d\mu(X) \\ &= \frac{1}{\mu(f_{\mathcal{W}^i}(\mathfrak{E}\mathfrak{E}))} \int_{f_{\mathcal{W}^i}(\mathfrak{E}\mathfrak{E})} \left(\frac{1}{d} \sum_{Y \in \partial f_{\mathcal{W}^i}(\mathfrak{E}\mathfrak{E})} u(t, X) - u(t, Y) \right) d\mu(X) \\ &\leq \max_{Y \in \partial f_{\mathcal{W}^i}(\mathfrak{E}\mathfrak{E})} \| u(t, X) - u(t, Y) \|_\infty \\ &= \delta_u(2^{-m}) \end{aligned}$$

where $\delta_u(\cdot)$ is the continuity modulus of u (which is $\mathcal{O}(2^{-\alpha m})$ if u is α -Hölderian, $\alpha > 0$).

CONSISTENCY

Proposition 2.2.1.

The scheme is **consistent**, because the consistency error tends towards zero when $h \rightarrow 0$ and $m \rightarrow +\infty$, for a given norm.

Proof.

For $0 \leq n \leq N - 1$, $1 \leq i \leq d^m$, the consistency error of our scheme is given by:

$$\begin{aligned} \varepsilon_{n,i}^m &= \mathcal{O}(h^2) + \mathcal{O} \left(\int_{\mathfrak{E}\mathfrak{E}} \psi_X^{(m)} d\mu \right) + \delta(2^{-m}) \\ &= \mathcal{O}(h^2) + \mathcal{O}(d^{-m}) + \mathcal{O}(2^{-\alpha m}) \\ &= \mathcal{O}(h^2) + \mathcal{O}(2^{-\alpha m}) \quad \text{if } u \in C^{0,\alpha}(\mathfrak{E}\mathfrak{E}) \end{aligned}$$

One may check that

$$\lim_{h \rightarrow 0, m \rightarrow +\infty} \varepsilon_{k,i}^m = 0.$$

The scheme is then consistent. □

STABILITY

Proposition 2.2.2.

Let us denote by \mathcal{R} the real valued function, defined on \mathbb{R} , through:

$$\forall x \neq 0 : \quad \mathcal{R}(x) = x(d+2-x).$$

The eigenvalues λ_m , $m \in \mathbb{N}$ of the discrete Laplace operator on the sequence of graphs $(\mathcal{S}\mathcal{S}_m)_{m \geq 1}$ satisfy the recurrence relation:

$$\forall m \geq 1 : \quad \lambda_{m-1} = \mathcal{R}(\lambda_m).$$

Remark 2.2.3.

The eigenvalues in Proposition 2.2.2 just above are not to be confused with the eigenvalues of the Laplace operator on the considered fractal. See, for instance, [Stro6], Chapter 3, for further details.

Proof. of Proposition 2.2.2

Let us consider the sequence of graphs $(\mathcal{S}\mathcal{S}_m)_{m \geq 1}$ related to the sequence of vertices $(\mathcal{V}_m)_{m \geq 1}$. The initial graph $\mathcal{S}\mathcal{S}_1$ is just a d -simplex, and one may construct the next graph as the union of d copies which are linked in the same manner as $\mathcal{S}\mathcal{S}_1$; and so on.

We now fix $m \in \mathbb{N}$, and choose a vertex X_1 of $\mathcal{S}\mathcal{S}_m$, of neighbors X_2, \dots, X_d, Y , such that Y belongs to another m -simplex (we can remark that the graph $\mathcal{S}\mathcal{S}_m$ is composed by d m -simplices).

We denote by u the eigenfunction related to the eigenvalue λ_m . On the one hand, we have that

$$(d - \lambda_m)u(X) = \sum_{i=1}^{d-1} u(X_i) + u(Y). \quad (38)$$

On the other hand, with the same idea for the graph $\mathcal{S}\mathcal{S}_{m+1}$: by considering the vertex a_1^k and its neighbors $a_2^k, \dots, a_d^k, a_h^l$ in the graph $\mathcal{S}\mathcal{S}_{m+1}$, where a_h^l belongs to another m -simplex, we have for every interior (non-boundary) vertex:

$$(d - \lambda_{m+1})u(a_i^k) = \sum_{j \neq i} u(a_j^k) + u(a_h^l).$$

Using the mean property

$$u(X_k) = \frac{1}{d} \sum_{i=1}^d u(a_i^k)$$

one obtains, by adding a_i^k to both sides of the eigenfunction relation

$$(d+1 - \lambda_{m+1})u(a_i^k) = d u(X_k) + u(a_h^l) \quad , \quad (d+1 - \lambda_{m+1})u(a_h^l) = d u(X_h) + u(a_i^k)$$

which leads to

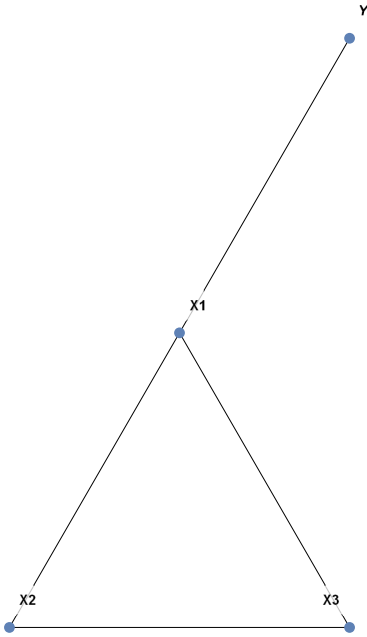

Figure 18: $\mathfrak{S}\mathfrak{S}_m$ for the Sierpiński triangle.

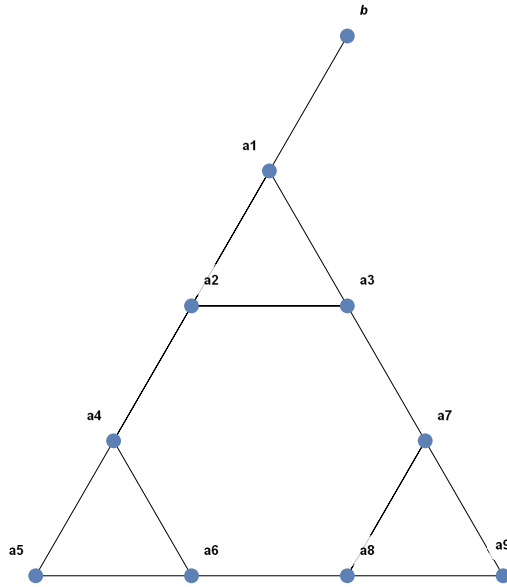

Figure 19: $\mathfrak{S}\mathfrak{S}_{m+1}$ for the Sierpiński triangle.

$$u(a_i^k) = d \frac{((d+1) - \lambda_{m+1})u(X_k) + u(X_h)}{(d+2 - \lambda_{m+1})(d - \lambda_{m+1})}.$$

Now, given a boundary vertex c_i , we have that

$$((d-1) - \lambda_{m+1})u(c_i) = \sum_{j \neq i} u(c_j)$$

$$(d - \lambda_{m+1})u(c_i) = d u(X_l),$$

$$u(c_i) = \frac{d u(X_l)}{(d - \lambda_{m+1})}.$$

Finally, by summation over all the $u(a_i^k)$ and using the equation 38, we obtain that

$$\lambda_m = \lambda_{m+1} (d + 2 - \lambda_{m+1}).$$

□

We deduce that, for any strictly positive integer m ,

$$\lambda_m^\pm = \frac{(d+2) \pm \sqrt{(d+2)^2 - 4\lambda_{m-1}}}{2}$$

With a similar argument to paragraph 2.1.1, we get for any natural integer m , the spectral bound:

$$0 \leq \lambda_m \leq 2d$$

and the following CFL stability condition:

Proposition 2.2.3.

Let us denote by $\gamma_i, i = 1, \dots, d^m$, the eigenvalues of the matrix A of the equation 37. Then:

$$\forall i = 1, \dots, d^m : \quad h(d+2)^m \leq \frac{2}{d^2} \implies |\gamma_i| \leq 1.$$

CONVERGENCE

Definition 2.2.3.

i. The scheme is said to be *convergent* for the matrix $\| \cdot \|$ if:

$$\lim_{h \rightarrow 0, m \rightarrow +\infty} \left\| \left(u_j^k - \frac{1}{\mu(C_m^j)} \int_{C_m^j} g(x) d\mu(x) \right)_{0 \leq k \leq N, 1 \leq j \leq d^m} \right\| = 0$$

ii. The scheme is said to be *conditionally convergent* for the matrix norm $\| \cdot \|$ if there exist two real constants α and C such that :

$$\lim_{h \leq C((d+2)^{-m})^\alpha, m \rightarrow +\infty} \left\| \left(u_j^k - \frac{1}{\mu(C_m^j)} \int_{C_m^j} g(x) d\mu(x) \right)_{0 \leq k \leq N, 1 \leq j \leq d^m} \right\| = 0$$

Theorem 2.2.4.

If the scheme is stable and consistent, then it is also convergent for the norm $\| \cdot \|_{2,\infty}$, such that

$$\left\| \left(u_j^k \right)_{0 \leq k \leq N, 1 \leq j \leq d^m} \right\|_{2,\infty} = \max_{0 \leq k \leq N} \left(d^{-m} \sum_{1 \leq i \leq d^m} |u_i^k|^2 \right)^{\frac{1}{2}}.$$

Proof.

Let us set

$$w_i^k = u_j^k - \frac{1}{\mu(C_m^j)} \int_{C_m^j} g(x) d\mu(x), \quad 0 \leq k \leq N, 1 \leq j \leq d^m.$$

We now introduce, for any integer k belonging to $\{0, \dots, N\}$:

$$W^k = \begin{pmatrix} w_1^k \\ \vdots \\ w_{d^m}^k \end{pmatrix}, \quad E^k = \begin{pmatrix} \varepsilon_{k,1}^m \\ \vdots \\ \varepsilon_{k,d^m}^m \end{pmatrix}.$$

One has then $W^0 = 0$, and, for any integer k belonging to $\{1, \dots, N-1\}$,

$$W^{k+1} = A W^k + h E^k.$$

One finds recursively, for any integer k belonging to $\{0, \dots, N-1\}$:

$$W^{k+1} = A^k W^0 + h \sum_{j=0}^{k-1} A^j E^{k-j-1} = h \sum_{j=0}^{k-1} A^j E^{k-j-1}.$$

Since the matrix A is a symmetric one, the CFL stability condition $h(d+2)^m \leq \frac{2}{d^2}$ yields, for any integer k belonging to $\{0, \dots, N-1\}$,

$$\begin{aligned} |W^k| &\leq h \left(\sum_{j=0}^{k-1} \|A\|^j \right) \left(\max_{0 \leq k \leq j-1} |E^k| \right) \\ &\leq h k \left(\max_{0 \leq k \leq j-1} |E^k| \right) \\ &\leq h N \left(\max_{0 \leq k \leq j-1} |E^k| \right) \\ &\leq T \left(\max_{0 \leq k \leq j-1} \left(\sum_{i=1}^{d^m} |\varepsilon_{k,i}^m|^2 \right)^{\frac{1}{2}} \right). \end{aligned}$$

One deduces, then,

$$\begin{aligned} \max_{0 \leq k \leq N-1} \left(d^{-m} \sum_{i=1}^{d^m} |w_i^k|^2 \right)^{\frac{1}{2}} &= d^{-\frac{m}{2}} \max_{1 \leq k \leq N-1} |W^k| \\ &\leq \left(d^{-\frac{m}{2}} \right) T \left(\max_{0 \leq k \leq N-1} \left(\sum_{i=1}^{d^m} |\varepsilon_{k,i}^m|^2 \right)^{\frac{1}{2}} \right) \\ &\leq \left(d^{-\frac{m}{2}} \right) T \left((d^m)^{\frac{1}{2}} \max_{0 \leq k \leq N-1, 1 \leq i \leq d^m} |\varepsilon_{k,i}^m| \right) \\ &= \sqrt{\left(d^{-m} \frac{d^{m+1} - d}{2} \right)} T \left(\max_{0 \leq k \leq N-1, 1 \leq i \leq d^m} |\varepsilon_{k,i}^m| \right) \\ &= \mathcal{O}(h^2) + \mathcal{O}(d^{-m}) + \mathcal{O}(2^{-\alpha m}) \\ &= \mathcal{O}((d+2)^{-2m}) + \mathcal{O}(d^{-m}) + \mathcal{O}(2^{-\alpha m}) \\ &= \mathcal{O}(2^{-\alpha m}). \end{aligned}$$

The last equality holds if we assume that the function u is Hölder-continuous. The scheme is thus convergent. \square

The Specific Case of the Implicit Euler Method

Let consider the implicit Euler scheme, for any integer k belonging to $\{0, \dots, N-1\}$:

$$u_j^n = u_j^{n-1} + \frac{h}{\mu(C_m^j)} r^{-m} \frac{d^{d-1}}{2} \sum_{l=1}^{d-1} (u_l^t - u_j^t)$$

It satisfies the recurrence relation

$$\tilde{A} U(n) = U(n-1),$$

where

$$\tilde{A} = I_{d^m} + h \times \tilde{\Delta}_m$$

and where I_{d^m} denotes the $(d^m) \times (d^m)$ identity matrix, and $\tilde{\Delta}_m$ the $(d^m) \times (d^m)$ normalized Laplacian matrix.

CONSISTENCY, STABILITY AND CONVERGENCE

i. Consistency

For $0 \leq n \leq N-1$, $1 \leq i \leq d^m$, the consistency error of our implicit Euler scheme is given by:

$$\begin{aligned} \varepsilon_{n,i}^m &= \mathcal{O}(h^2) + \mathcal{O}(d^{-m}) + \mathcal{O}(2^{-\alpha m}) \\ &= \mathcal{O}(h^2) + \mathcal{O}(2^{-\alpha m}) \quad \text{if } u \in C^{0,\alpha}(\mathfrak{S}\mathfrak{S}). \end{aligned}$$

We can check that

$$\lim_{h \rightarrow 0, m \rightarrow \infty} \varepsilon_{k,i}^m = 0.$$

The scheme is then consistent.

ii. Stability The arguments of the implicit finite difference method 2.1.1 are still valid: the matrix \tilde{A} is invertible, its eigenvalues $\tilde{\gamma}_i$ satisfies the spectral bound

$$|\tilde{\gamma}_i^{-1}| \leq 1.$$

and the scheme is unconditionally stable.

iii. Convergence

Theorem 2.2.5.

The implicit Euler scheme is convergent for the norm $\|\cdot\|_{2,\infty}$.

Proof.

Let us set

$$w_i^k = u_j^k - \frac{1}{\mu(C_m^j)} \int_{C_m^j} g(x) d\mu(x), \quad 0 \leq k \leq N, 1 \leq j \leq d^m$$

and

$$W^k = \begin{pmatrix} w_1^k \\ \vdots \\ w_{d^m}^k \end{pmatrix}, \quad E^k = \begin{pmatrix} \varepsilon_{k,1}^m \\ \vdots \\ \varepsilon_{k,d^m}^m \end{pmatrix}.$$

Thus, $W^0 = 0$, and, for $0 \leq k \leq N-1$, we have that

$$W^{k+1} = \tilde{A}^{-1} W^k + h E^k \quad 0 \leq k \leq N-1.$$

We find, by induction, for $0 \leq k \leq N-1$,

$$\begin{aligned} W^{k+1} &= \tilde{A}^{-k} W^0 + h \sum_{j=0}^{k-1} \tilde{A}^{-j} E^{k-j-1} \\ &= h \sum_{j=0}^{k-1} \tilde{A}^{-j} E^{k-j-1}. \end{aligned}$$

Due to the stability of the scheme, for $k = 0, \dots, N$, we have that

$$\begin{aligned} |W^k| &\leq h \left(\sum_{j=0}^{k-1} \|\tilde{A}^{-1}\|^j \right) \left(\max_{0 \leq k \leq j-1} |E^k| \right) \\ &\leq h k \left(\max_{0 \leq k \leq j-1} |E^k| \right) \\ &\leq h N \left(\max_{0 \leq k \leq j-1} |E^k| \right) \\ &\leq T \left(\max_{0 \leq k \leq j-1} \left(\sum_{i=1}^{d^m} |\varepsilon_{k,i}^m|^2 \right)^{\frac{1}{2}} \right). \end{aligned}$$

One deduces, then, that

$$\begin{aligned}
\max_{0 \leq k \leq N} \left(d^{-m} \sum_{i=1}^{d^m} |w_i^k|^2 \right)^{\frac{1}{2}} &= (d)^{-\frac{m}{2}} \max_{1 \leq k \leq N} |W^k| \\
&\leq (d^{-\frac{m}{2}}) T \left(\max_{0 \leq k \leq N-1} \left(\sum_{i=1}^{d^m} |\varepsilon_{k,i}^m|^2 \right)^{1/2} \right) \\
&\leq (d^{-\frac{m}{2}}) T \left((d^m)^{\frac{1}{2}} \max_{0 \leq k \leq N-1, 1 \leq i \leq d^m} |\varepsilon_{k,i}^m| \right) \\
&= \sqrt{\left(d^{-m} \frac{d^{m+1} - d}{2} \right)} T \left(\max_{0 \leq k \leq N-1, 1 \leq i \leq d^m} |\varepsilon_{k,i}^m| \right) \\
&= \mathcal{O}(h^2) + \mathcal{O}(d^{-m}) + \mathcal{O}(2^{-\alpha m}) \\
&= \mathcal{O}((d+2)^{-2m}) + \mathcal{O}(d^{-m}) + \mathcal{O}(2^{-\alpha m}) \\
&= \mathcal{O}(2^{-\alpha m}).
\end{aligned}$$

The last equality holds if one assumes that u is Hölder-continuous. The scheme is thus convergent. \square

Numerical Results - Gasket and Tetrahedron

RECURSIVE CONSTRUCTION OF THE MATRIX ASSOCIATED TO THE SEQUENCE OF GRAPH LAPLACIANS

In the sequel, we describe our recursive algorithm used to construct the matrices related to the sequence of graph Laplacians, in the case of Sierpiński Gasket and Tetrahedron.

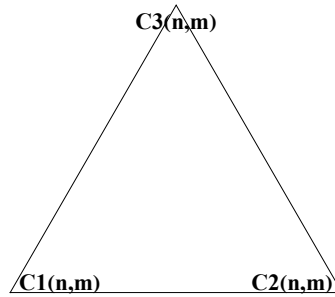

Figure 20: m^{th} -order cell of the Sierpiński Gasket.

i. The Sierpiński Gasket. One may note, first, that, given a strictly positive integer m , a m^{th} -order triangle has three corners, that we will denote by $C1$, $C2$ and $C3$; the $(m+1)^{\text{th}}$ -order triangle is then constructed by connecting three m copies $T(n)$ with $n = 1, 2, 3$.

The initial triangle is labelled such that $C1 \sim 1$, $C2 \sim 2$ and $C3 \sim 3$ (see figure 1).

The fusion is done by connecting $C2(1, m) \sim C1(2, m)$, $C3(1, m) \sim C1(3, m)$, and $C3(2, m) \sim C2(3, m)$ (see figures 2, 3, 4).

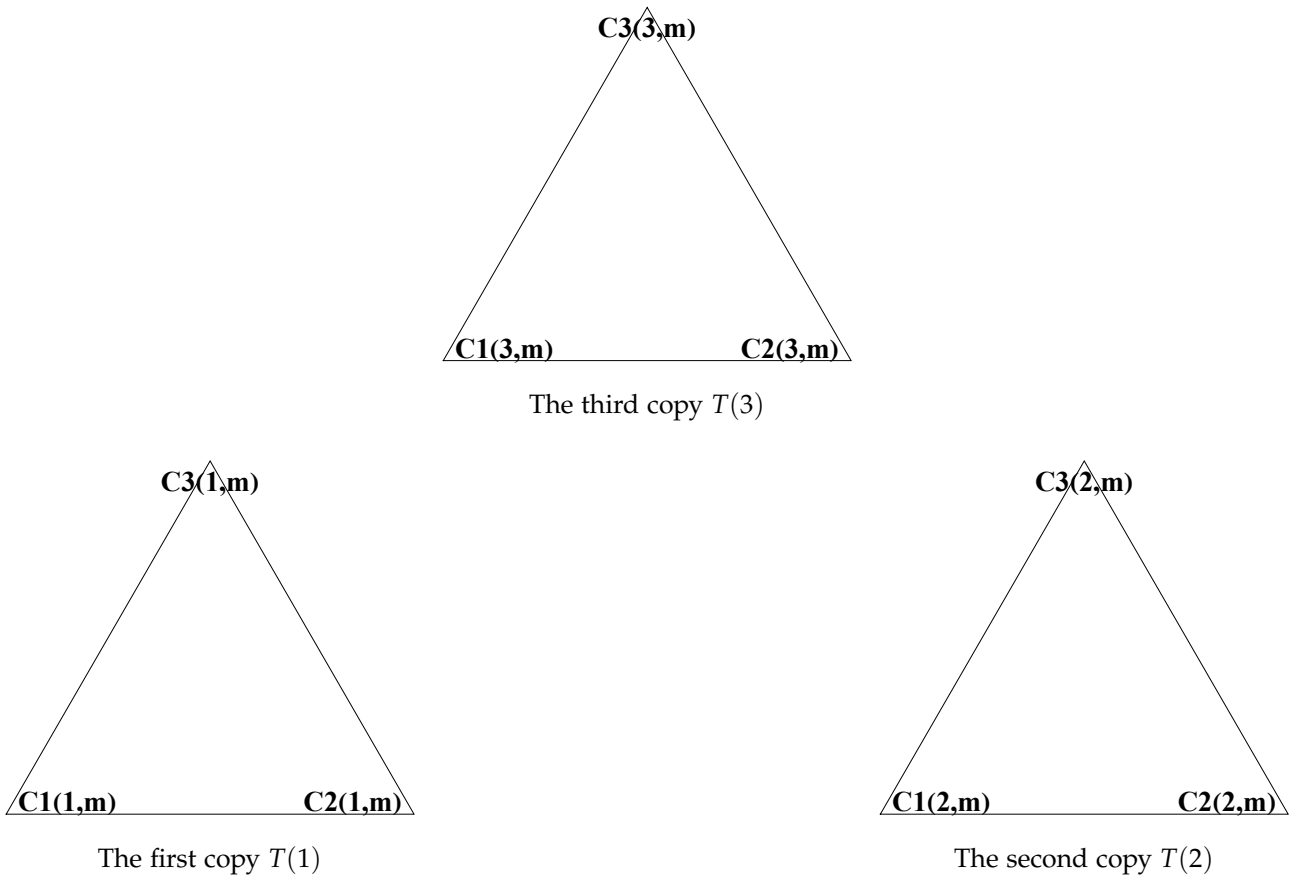

Figure 21: The three copies.

The label of the corner vertex can be obtained by means of the following recursive sequence, for any strictly positive integer m ,

$$\begin{aligned} C1(n, m) &= 1 + (n - 1) 3^{m-1} \\ C2(n, m) &= I2(m) + (n - 1) 3^{m-1} \\ C3(n, m) &= n 3^{m-1} \end{aligned}$$

where

$$\begin{aligned} I2(1) &= 2 \\ I2(m) &= I2(m - 1) + 3^{m-2}. \end{aligned}$$

1. One may start with the initial triangle with the set of vertices V_0 . The corresponding matrix is given by:

$$A_0 = \begin{pmatrix} 2 & -1 & -1 \\ -1 & 2 & -1 \\ -1 & -1 & 2 \end{pmatrix}$$

2. If $m = 0$, the Laplacian matrix is A_0 , else, A_m is constructed recursively from three copies of the Laplacian matrices A_{m-1} of the graph V_{m-1} . First, we build, for any strictly positive integer m , the block diagonal matrix:

$$B_m = \begin{pmatrix} A_{m-1} & 0 & 0 \\ 0 & A_{m-1} & 0 \\ 0 & 0 & A_{m-1} \end{pmatrix}$$

3. One may then introduce, for any strictly positive integer m , the connection matrix as in [FL04]:

$$C_m = \begin{pmatrix} C2(1, m) & C3(1, m) & C3(2, m) \\ C1(2, m) & C1(3, m) & C2(3, m) \end{pmatrix}$$

4. One has then to set $A_{C_m(2,j), C_m(1,j)} = A_{C_m(1,j), C_m(2,j)} = -1$, and $A_{C_m(2,j), C_m(2,j)} = A_{C_m(1,j), C_m(1,j)} = 3$.

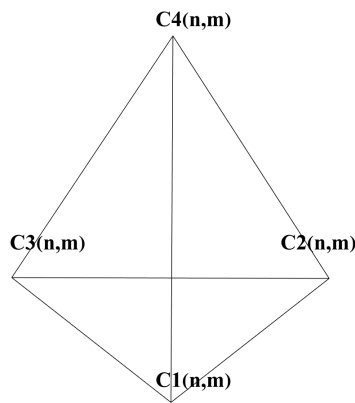

Figure 22: m^{th} -order cell of the Sierpiński Tetrahedron.

ii. The Sierpiński Tetrahedron. One may note, first, that, given a strictly positive integer m , a m^{th} -order tetrahedron has four corners $C1$, $C2$, $C3$ and $C4$ (see figure 5), and that the $(m + 1)^{\text{th}}$ -order triangle is constructed by connecting four m copies $T(n)$, with $n = 1, 2, 3, 4$ (see figure 6, 7, 8, 9).

As in the case of the triangle, the initial tetrahedron is labeled such that $C1 \sim 1$, $C2 \sim 2$, $C3 \sim 3$ and $C4 \sim 4$.

The fusion is done by connecting $C2(1, m) \sim C1(2, m)$, $C3(1, m) \sim C1(3, m)$, $C4(1, m) \sim C1(4, m)$, $C3(2, m) \sim C2(3, m)$, $C4(2, m) \sim C2(4, m)$, $C4(3, m) \sim C3(4, m)$.

The number of corners can be obtained by means of the following recursive sequence, for any strictly positive integer m ,

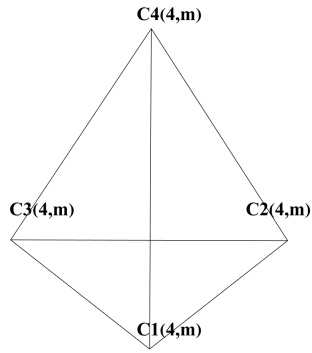

The fourth copy $T(4)$.

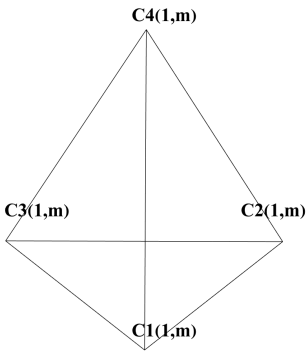

The first copy $T(1)$.

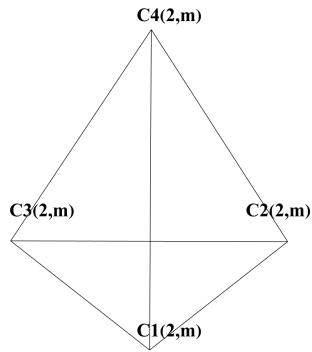

The second copy $T(2)$.

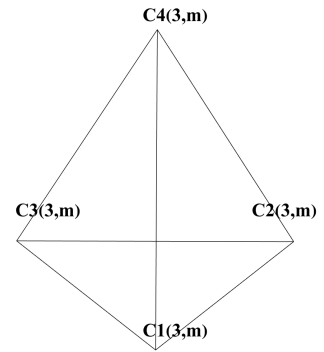

The third copy $T(3)$.

Figure 23: The four copies.

$$\begin{aligned}
 C1(n, m) &= 1 + (n - 1) 4^{m-1} \\
 C2(n, m) &= I2(m) + (n - 1) 4^{m-1} \\
 C3(n, m) &= I3(m) + (n - 1) 4^{m-1} \\
 C4(n, m) &= n 4^{m-1}
 \end{aligned}$$

where

$$\begin{aligned}
 I2(1) &= 2 \\
 I2(m) &= I2(m - 1) + 4^{m-2} \\
 I3(1) &= 3 \\
 I3(m) &= I3(m - 1) + 2 \times 4^{m-2}.
 \end{aligned}$$

1. One starts with initial tetrahedron with the set of vertices V_0 . The corresponding matrix is given by:

$$A_0 = \begin{pmatrix} 3 & -1 & -1 & -1 \\ -1 & 3 & -1 & -1 \\ -1 & -1 & 3 & -1 \\ -1 & -1 & -1 & 3 \end{pmatrix}.$$

2. If $m = 0$ the Laplacian matrix is A_0 , else, for any strictly positive integer m , A_m is constructed recursively from three copies of the Laplacian matrices A_{m-1} of the graph V_{m-1} . Thus, we build the block diagonal matrix:

$$B_m = \begin{pmatrix} A_{m-1} & 0 & 0 & 0 \\ 0 & A_{m-1} & 0 & 0 \\ 0 & 0 & A_{m-1} & 0 \\ 0 & 0 & 0 & A_{m-1} \end{pmatrix}.$$

3. We then write the connection matrix

$$C_m = \begin{pmatrix} C2(1, m) & C3(1, m) & C3(2, m) & C4(1, m) & C4(2, m) & C4(3, m) \\ C1(2, m) & C1(3, m) & C2(3, m) & C1(4, m) & C2(4, m) & C3(4, m) \end{pmatrix}.$$

4. One then has to set

$$A_{C_m(2,j), C_m(1,j)} = A_{C_m(1,j), C_m(2,j)} = -1$$

and

$$A_{C_m(1,j), C_m(1,j)} = A_{C_m(2,j), C_m(2,j)} = 4.$$

NUMERICAL RESULTS

i. The Sierpiński Gasket

In the sequel, we present the numerical results for

$$m = 6 \quad , \quad T = 1 \quad , \quad N = 70.5 \times 10^3.$$

Each point represents a m -cell of the Sierpiński Gasket.

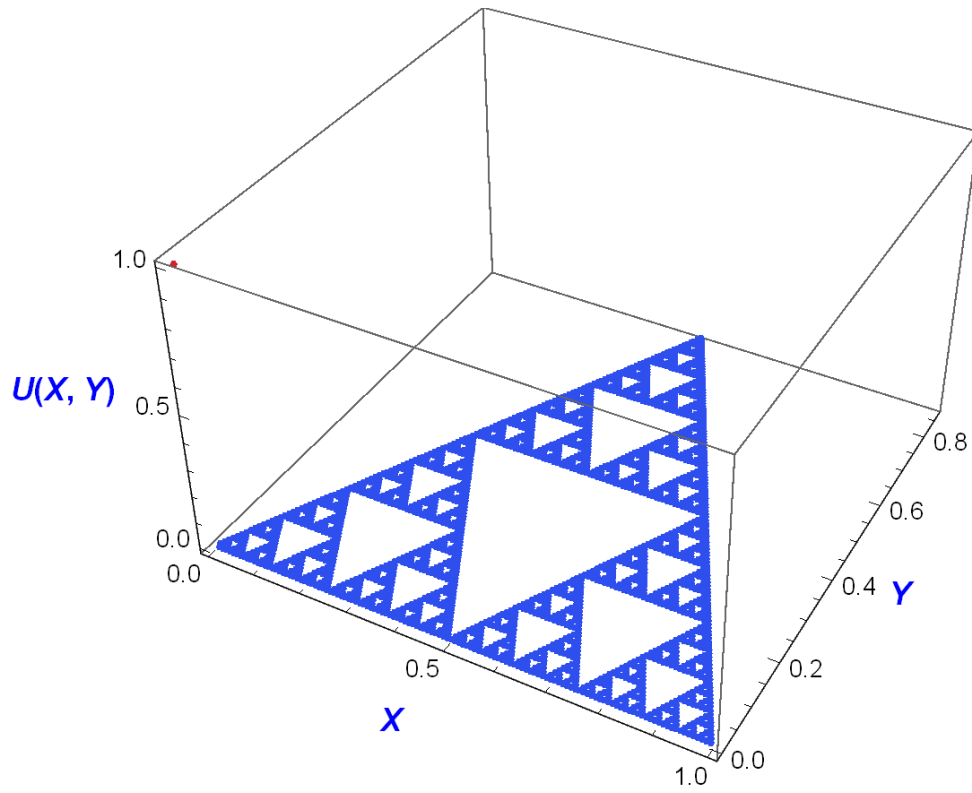

The numerical solution for the initial condition $n = 0$.

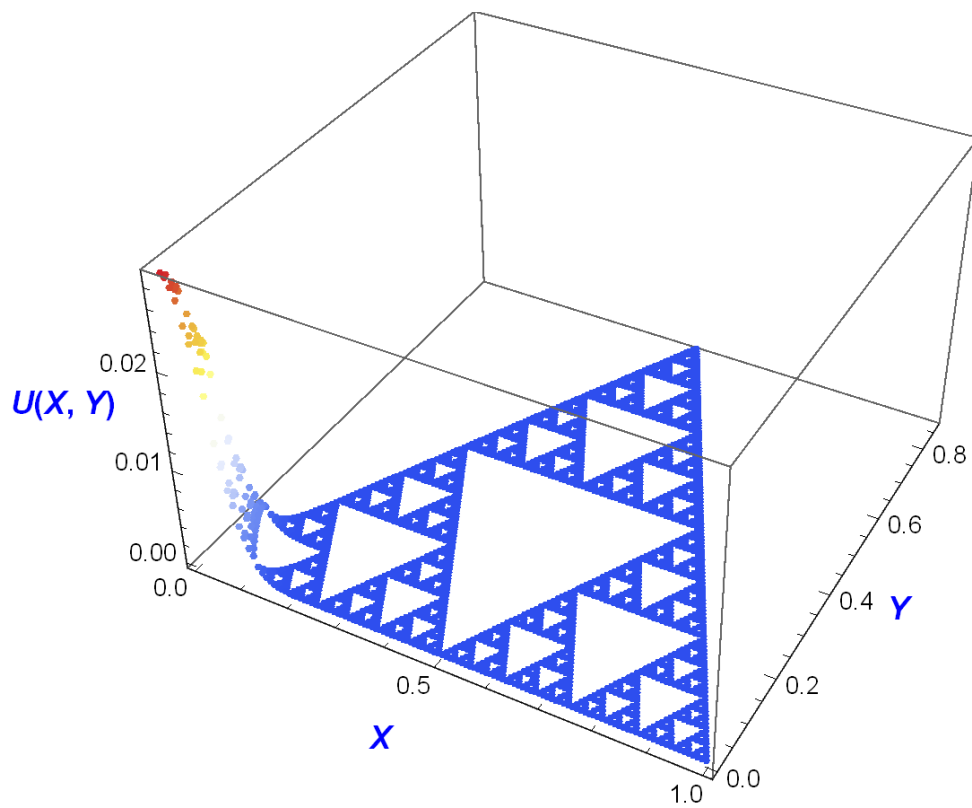

The numerical solution, in the case $n = 100$.

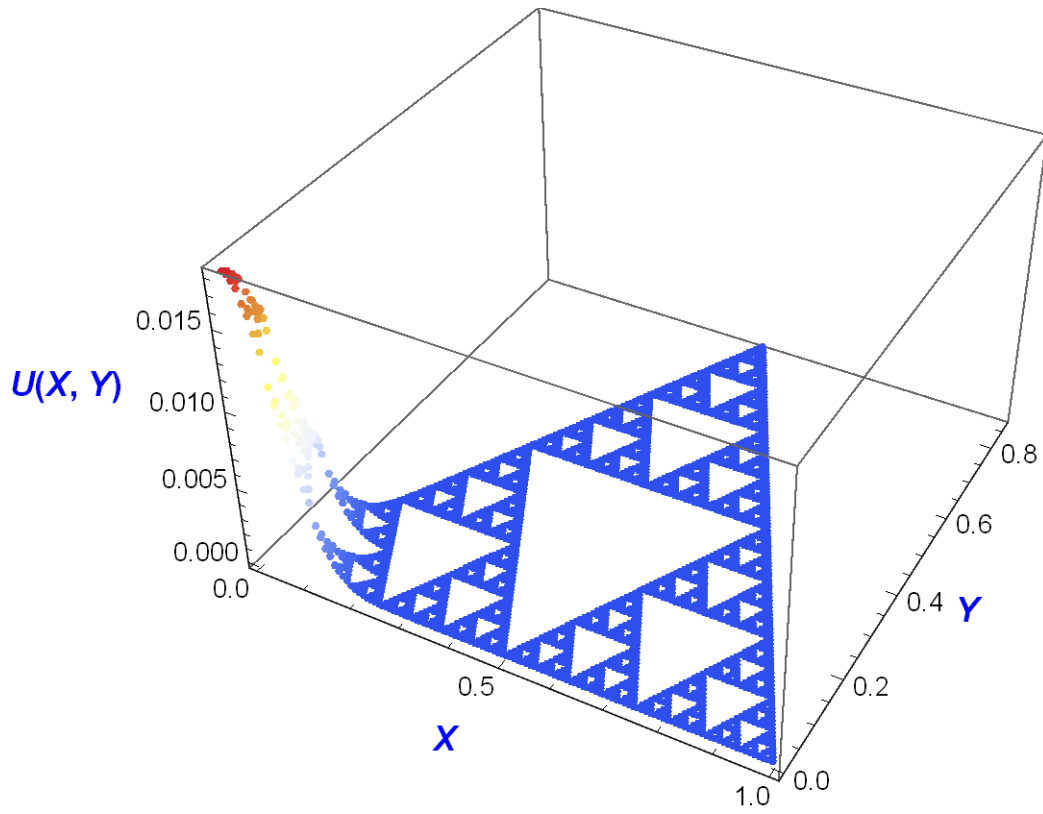

The numerical solution, in the case $n = 200$.

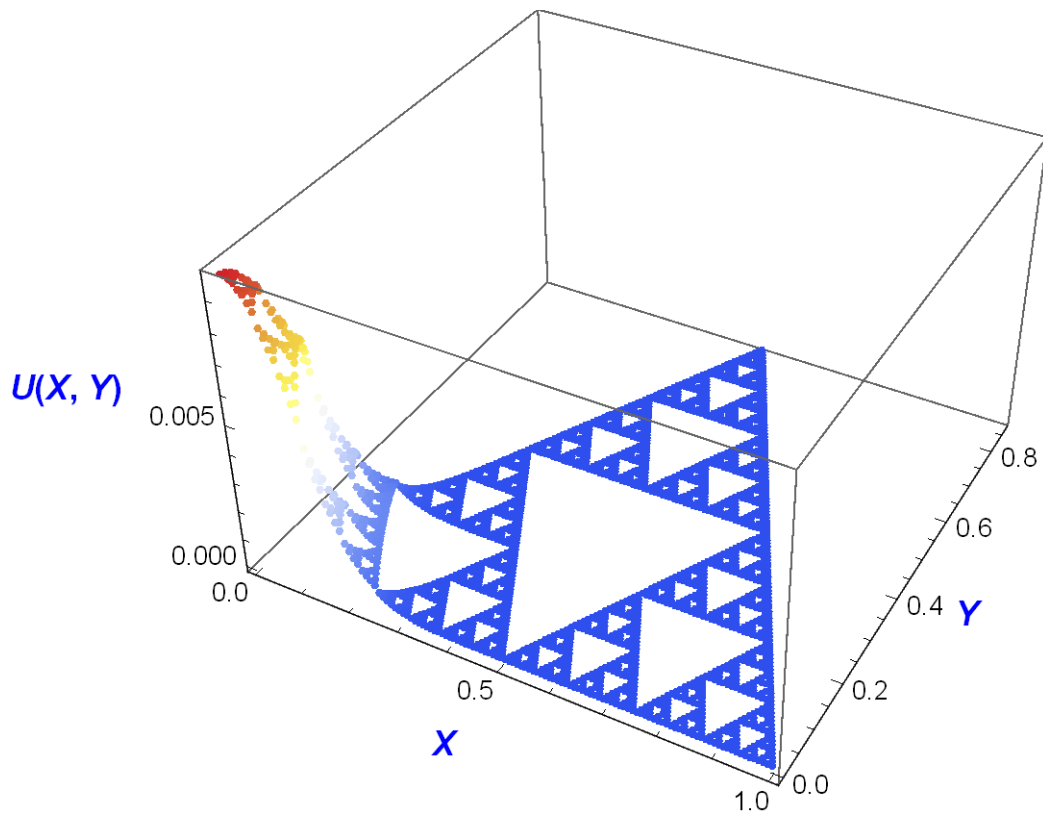

The numerical solution, in the case $n = 500$.

ii. The Sierpiński Tetrahedron

In the sequel , we present the numerical results for

$$m = 5 \quad , \quad T = 1 \quad , \quad N = 60 \times 10^3 .$$

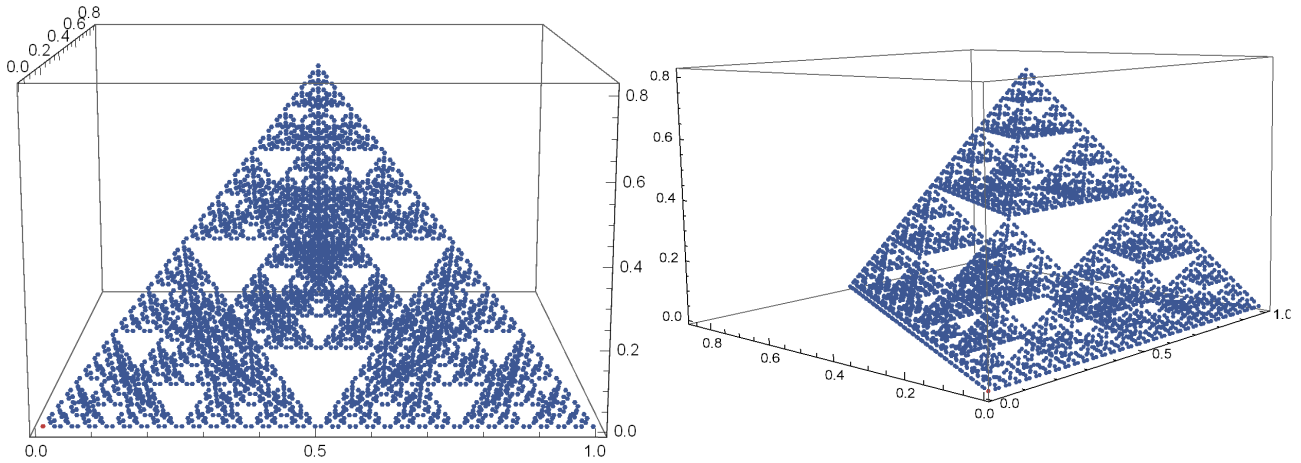

The numerical solution for the initial condition.

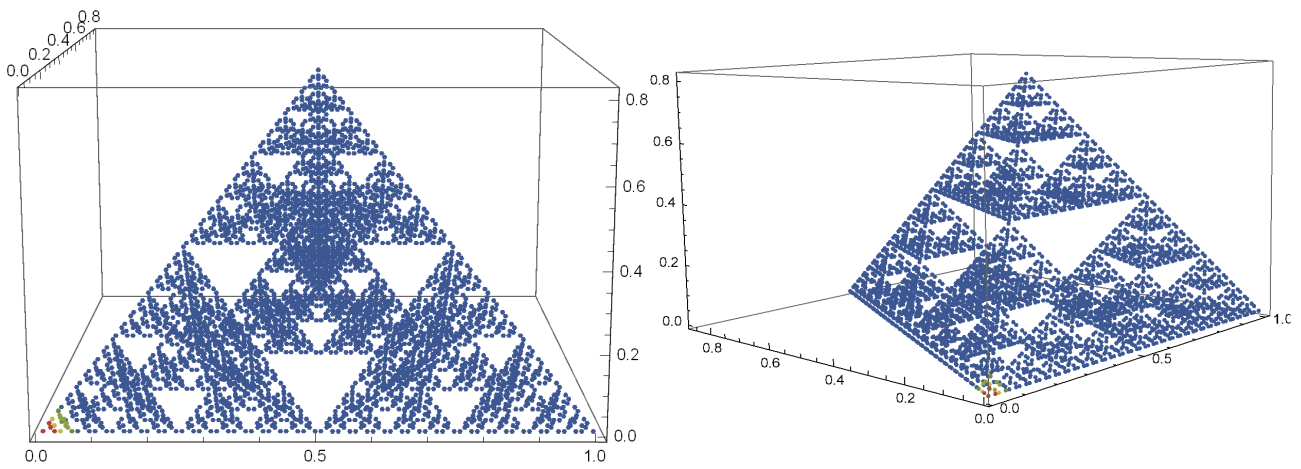

The numerical solution, in the case $n = 10$.

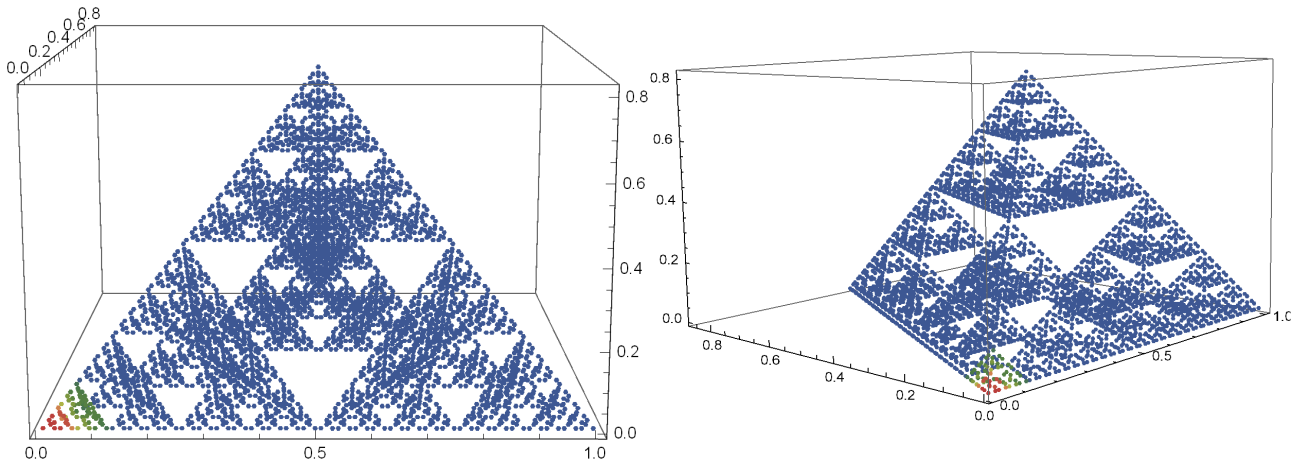

The numerical solution, in the case $n = 50$.

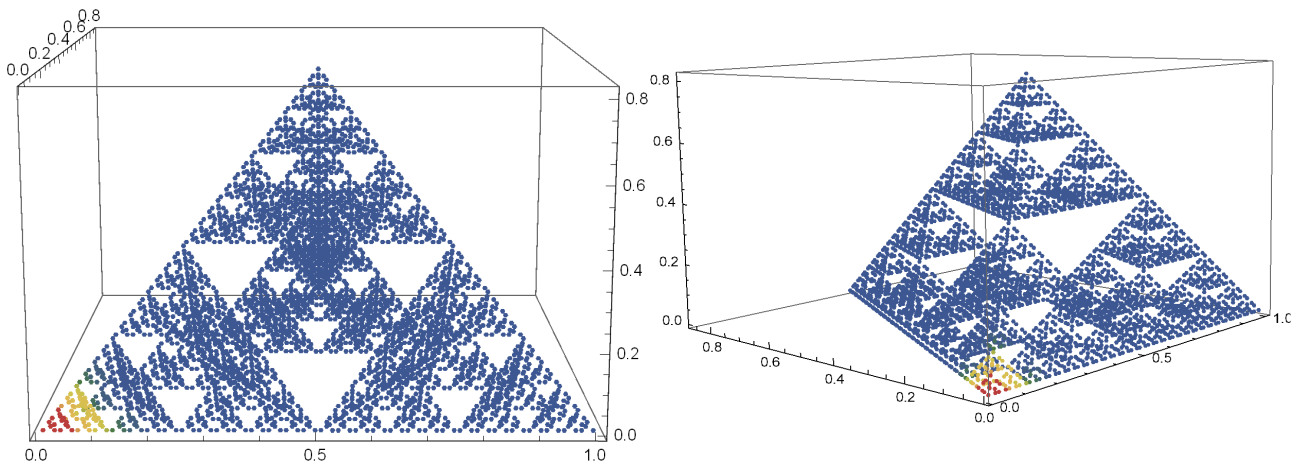

The numerical solution, in the case $n = 100$.

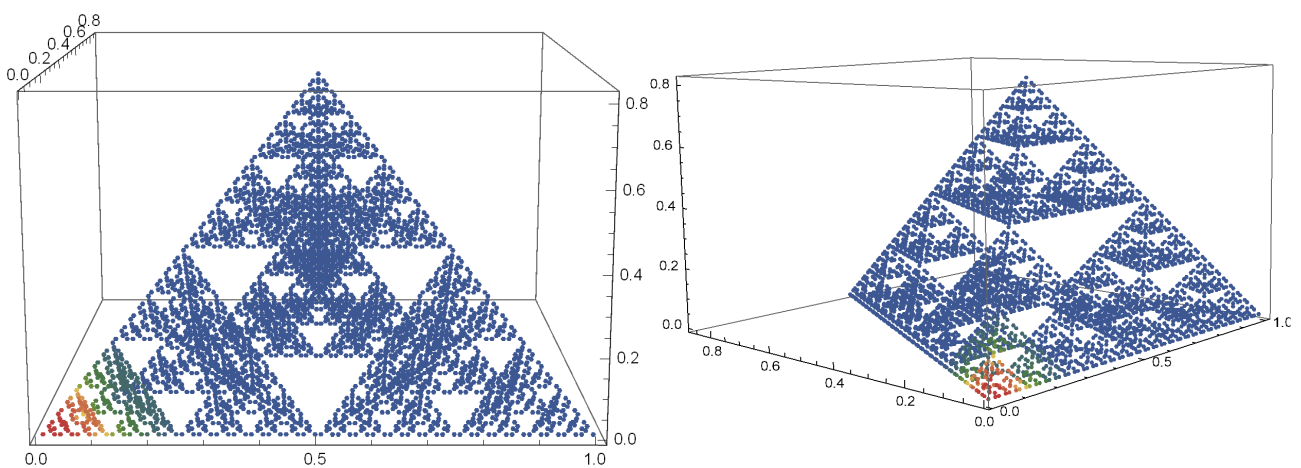

The numerical solution, in the case $n = 200$.

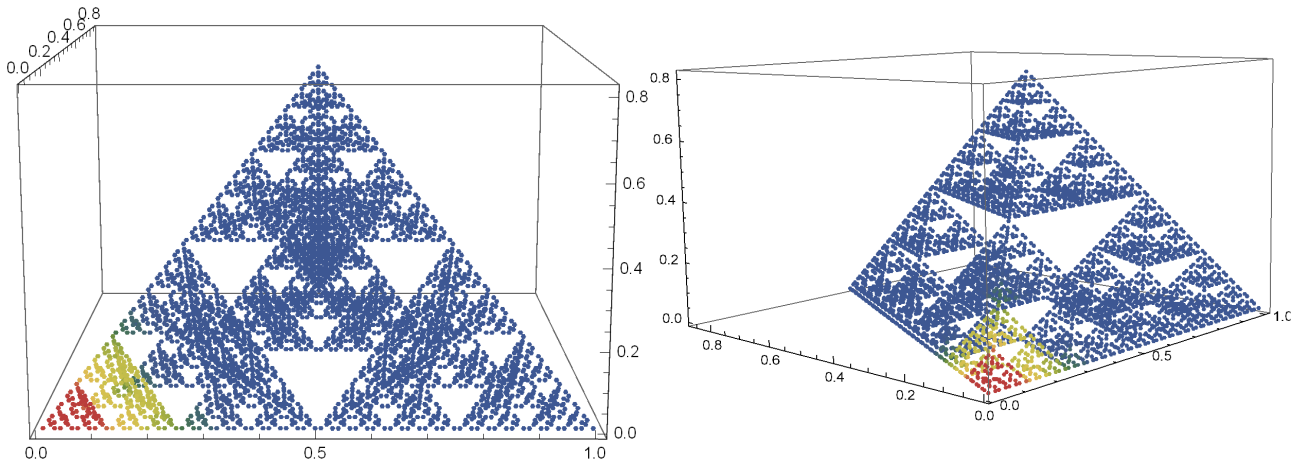

The numerical solution, in the case $n = 500$.

DISCUSSION

Our heat transfer simulation consists in a propagation scenario, where the initial condition is a harmonic spline g , the support of which being an m -cell of $\mathfrak{S}\mathfrak{S}$, such that it takes the value 1 on a vertex X , and 0 otherwise. This implies that g is everywhere null except the cell containing X , which a vertex of the graph $\mathcal{S}\mathcal{S}_m$.

Each point represents a m -cell as before. The color function is related to the gradient of temperature, high values ranging from red to blue.

By comparing the explicit finite difference method (FDM) and the finite volume method (FVM), one may deduce from the theoretical results that there are some similarities:

- i. The FDM is based on the sequence of graphs $(\mathfrak{S}\mathfrak{S}_m)_{m \in \mathbb{N}'}$, and the FVM is based on the sequence of graphs $(\mathcal{S}\mathcal{S}_m)_{m \in \mathbb{N}'}$, but both generate the same spectral decimation function.
- ii. The theoretical errors of both methods are the same for Hölder continuous functions.
- iii. The time theoretical error is of order h in the case of the FDM, and of order h^2 in the case of the FVM (the convergence is faster).
- iv. The stability conditions are the same.
- v. Finally, the numerical simulation shows the same behavior in both approaches.

An interesting question is to compare the diffusion on the Sierpiński Tetrahedron, and on a plain three-dimensional one. In fact, following the results of Robert S. Strichartz in [Str99] concerning *localization phenomena*, a challenging and original experiment was conducted in summer 2009 in Miraikan (Japan), where a rooftop, the so-called *Sierpiński Forest*, was installed just outside the National Museum of Emerging Science and Innovation. It appeared that this fractal shaped rooftop was much more effective in heat dissipation than a flat one; i.e., the diffusion was slower than in a non-fractal case. See [SNF⁺12]. This is in perfect agreement with the feeling that the presence of many holes implies a slower diffusion. Hence, one could envision improving the insulation properties of a given material by making it fractal.



Sierpiński Forest, National Museum of Emerging Science and Innovation, Miraikan, Japan, Summer 2009. Source: [SNF⁺12].

Chapter 3

Optimal Control and Optimization on Fractals

In 1636, in a correspondence with Martin Mersenne, Pierre de Fermat established a necessary condition for the existence of the minimum and the maximum of a function [dF36]:

“When a quantity, for example the ordinate of a curve, reached its maximum or its minimum, in a situation infinitely close, his increase or decrease is null.”

Since then, many results have been obtained, ranging from free and constraint conditions, giving birth to numerical algorithms that enable one to find the extrema of a function.

But, until now, optimization has mainly concerned regular domains, without there being really specific results for fractal sets. The following citation of Godfrey H. Hardy [Har16], on a close subject, and even if some may here call it a truism, perfectly reflects the fact that it was “in consequence of the methods employed”.

As is evoked in the end of Chapter 2, fractal shaped roofs are very effective when it comes to reduce surface temperature and provide a cool environment without strong heat radiation; see [SNF⁺12], where Sierpiński tetrahedrons are involved. In these lines, it appears of great interest to go further, in terms of optimization or control.

In the spirit of the Fermat paper, we have generalized the results of smooth analysis on extrema to the case of fractals in [RD21d]. We present, next this analysis. Local extremas are obtained by using the **discrete gradient method**.

Our results concerning optimization on fractals are followed by an extension of optimal control theory of partial differential equations to fractal sets; it is similar to the classical one that can be found in [Zua06] or [Tré15].

The mathematical framework is that of chapter 1, i.e. post-critically finite fractals with regular harmonic structure (definition 1.5.5).

3.1 OPTIMIZATION ON FRACTAL SETS

3.1.1 Existence of Extrema

In the sequel, we present an equivalent theory to the smooth case, which enable one to study the existence of extrema on fractal sets.

Definition 3.1.1. Extrema

Given a continuous function u defined on the fractal set \mathcal{F} , and $X \in \mathcal{F}$, we will say that u :

i. has a global minimum (resp. a global maximum) at X if:

$$\forall Y \in \mathcal{F} : u(X) \leq u(Y) \quad (\text{resp. } u(X) \geq u(Y)) :$$

ii. a local minimum (resp. a local maximum) at X if there exist a neighborhood V of X such that

$$\forall Y \in V : u(X) \leq u(Y) \quad (\text{resp. } u(X) \geq u(Y)).$$

Theorem 3.1.1.

Given a continuous function u defined on the compact fractal set

$$\mathcal{F} = \bigcup_{i=1}^N f_i(\mathcal{F})$$

the Weierstrass extreme value theorem ensures the existence of

$$\min_{X \in \mathcal{F}} u \quad \text{and} \quad \max_{X \in \mathcal{F}} u.$$

Theorem 3.1.2. Laplacian test for fractals [Kigo1]

Given a continuous, real-valued function u defined on \mathcal{F} , and belonging to dom_{Δ_μ} (definition 1.6.1):

i. If u admits a local maximum at $X_0 \in \mathcal{F}$, then,

$$\Delta_\mu u(X_0) \leq 0. \quad (39)$$

ii. If u admits a local minimum at $X_0 \in \mathcal{F}$, then,

$$\Delta_\mu u(X_0) \geq 0. \quad (40)$$

3.1.2 Numerical Algorithm and Dynamic Programming

In the sequel, we present a numerical algorithm, based on discrete gradient, to find a local maximizer (resp. local minimizer) of a function continuous u on \mathcal{F} .

The Algorithm

We recall that, given a natural integer m , $\mathcal{F}_m = (V_m, A_m)$ is the prefractal graph approximation of \mathcal{F} of order m (definition 1.3.5), where V_m is the vertices set and A_m is the oriented edge set. We can check that the distance between two connected vertices is of order at most R^m , where $R = \max_i R_i$ the maximum contraction ratio.

In order to find the local maximizer, we will provide every oriented edge $\{XY\}$ with the weight $D_{XY} = u(Y) - u(X)$. In order to find an appropriate approximation of the maximizer X^* , we fix a degree of tolerance $\varepsilon = \delta_0 R^m$, for some $m \in \mathbb{N}$, where $\delta_0 = \max_{(P_i, P_j) \in V_0 \times V_0} d(P_i, P_j)$.

Starting at an arbitrary point X_0 in V_m , we follow the direction of the maximal positive gradient at X_0 , i.e.,

$$\max_{X_0 \sim_m Y} \{D_{X_0 Y} \mid D_{X_0 Y} > 0\}.$$

We replace the initial point by $\arg \max_{X_0 \sim_m Y} \{D_{X_0 Y} \mid D_{X_0 Y} > 0\}$, with the smallest address $\mathcal{W}(P_j)$ (definition 2.1.1) in the lexicographic order, and repeat the same operation until

$$\max_{X_0 \sim_m Y} \{D_{X_0 Y} \mid D_{X_0 Y} \geq 0\} = 0$$

In this case, the algorithm stops and we have the approximation of X^* . We can summarize the algorithm in the following steps :

Discrete gradient algorithm

1. Fix $m \in \mathbb{N}$, define the tolerance degree $\varepsilon = \delta_0 R^m$ and choose $X = X_0 \in V_m$ for some address $X_0 = f_{\mathcal{W}}(P_i)$.
2. While $\max_{X \sim_m Y} \{D_{XY} \mid D_{XY} \geq 0\} > 0$:

Update $X = \arg \min_{\mathcal{W}(P_j) \mid Y=f_{\mathcal{W}}(P_j)} \arg \max_{X \sim_m Y} \{D_{XY} \mid D_{XY} > 0\}$.
3. Return X .

Numerical Analysis and Dynamic Programming

The algorithm presented above can be viewed as a dynamical programming algorithm on the directed graph \mathcal{F}_m , $m \in \mathbb{N}^*$ (we refer to [BG15]). Values of the function can be calculated recursively, as follows:

$$v_X^0 = 0 \quad , \quad \forall X \in V_m \quad v_X^m = \mathcal{B} \left(v^{m-1} \right)_X = \sup_{Y \in V_m} \left(D_{XY} + v_X^{m-1} \right)$$

where \mathcal{B} denotes the Bellman operator:

$$\begin{aligned} \mathcal{B} : \mathbb{R}^{V_m} &\rightarrow \mathbb{R}^{V_m} \\ \mathcal{B}(v)_X &= \sup_{Y \in V_m} (D_{XY} + v_Y) \end{aligned}$$

where D_{XY} is the weight associated to the oriented edge $XY \in A_m$ and $D_{XY} = -\infty$ if $XY \notin A_m$.

As shown in [RD21d], $\#A_m = \mathcal{O}(\mathcal{N}_m)$ and $\#V_m = \mathcal{O}(\mathcal{N}_m)$, where \mathcal{N}_m is the vertices number, the number of possible transitions is at most of order $\#A_m = \mathcal{O}(\mathcal{N}_m)$. Since

$$\#V_m = \mathcal{O}(\mathcal{N}_m),$$

we can deduce that the calculation time of the maximum is at most of order $\mathcal{O}(\mathcal{N}_m^2)$.

Sierpiński Simplices

Sierpiński Simplices are sparse graph. Thus, the calculation time required for the gradient algorithm can be optimized: each vertex has a finite number of neighbors, which ensures a calculation time at any step $m \in \mathbb{N}^*$ which is of order $\mathcal{O}(\mathcal{N}_m)$.

Moreover, computations can be simplified using the fact that every vertex X has two addresses:

$$X = f_{\mathcal{W}_1}(P_i) = f_{\mathcal{W}_2}(P_j)$$

where $(\mathcal{W}_1, \mathcal{W}_2) \in \Sigma^2$ and $(P_i, P_j) \in V_0^2$, with $i \neq j$. Thus, the neighbors of X are given by

$$\left\{ \bigcup_{k \neq i} f_{\mathcal{W}_2}(P_k) \right\} \cup \left\{ \bigcup_{\ell \neq j} f_{\mathcal{W}_1}(P_\ell) \right\} .$$

THE SIERPIŃSKI GASKET

In the case of Sierpiński Gasket, we can optimize the calculation time of the gradient algorithm. Indeed, for any natural integer m ,

$$\#V_m = \frac{3^{m+1} + 3}{2} \quad \text{and} \quad \#A_m = 2 \times 3^{m+1}$$

and since every vertex $X \in V_m \setminus V_0$ has four neighbors, it follows that the calculation time of the maximum at step $m \in \mathbb{N}^*$ is thus of order $\mathcal{O}(3^m)$.

In the sequel, we present results of our algorithm in the case of Sierpiński Gasket with vertices:

$$P_0 = (0,0) \quad , \quad P_1 = (1,0) \quad , \quad P_2 = \left(\frac{1}{2}, \frac{\sqrt{3}}{2} \right)$$

for the value $m = 6$.

The color is related to the gradient of the function involved, high values ranging from red to blue.

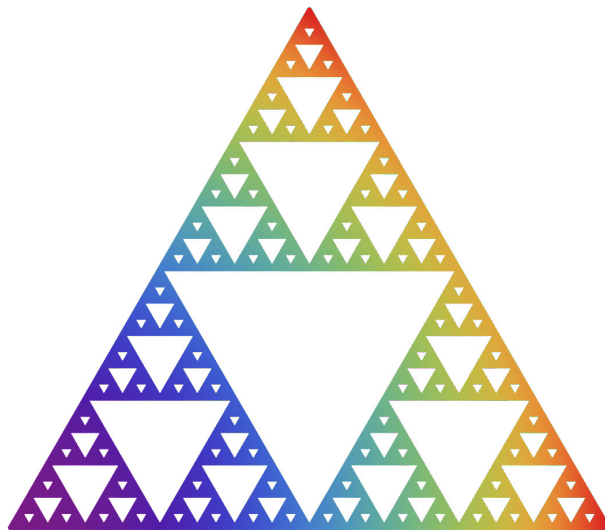
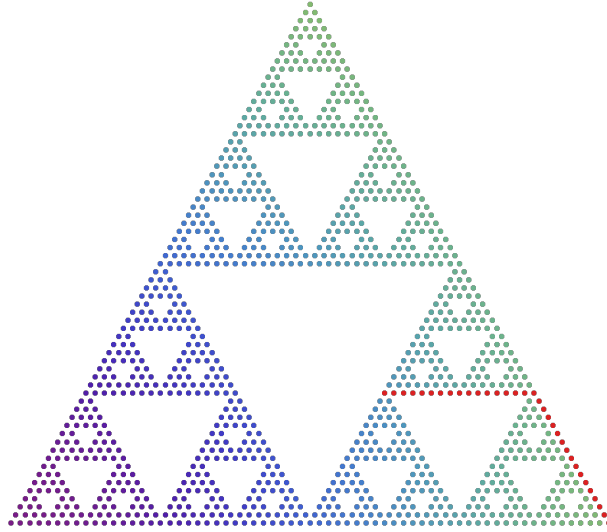
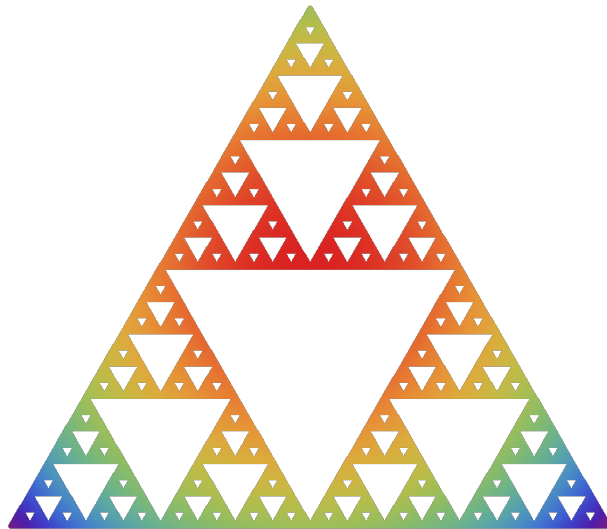

Figure 24: The graph of the function $X \mapsto f(X) = \|X\|^2$.Figure 25: The algorithm path from $X_0 = \left(\frac{5}{8}, \frac{\sqrt{3}}{8}\right)$ to X^* .

For this first example, the algorithm starts with $X_0 = \left(\frac{5}{8}, \frac{\sqrt{3}}{8}\right)$, following the largest gradient (red points), the algorithm converges to the local maximum 1 at $(1, 0)$.

Figure 26: The graph of the function $X \mapsto g(X) = -\left\|X - \left(\frac{1}{2}, \frac{\sqrt{3}}{4}\right)\right\|^2$.

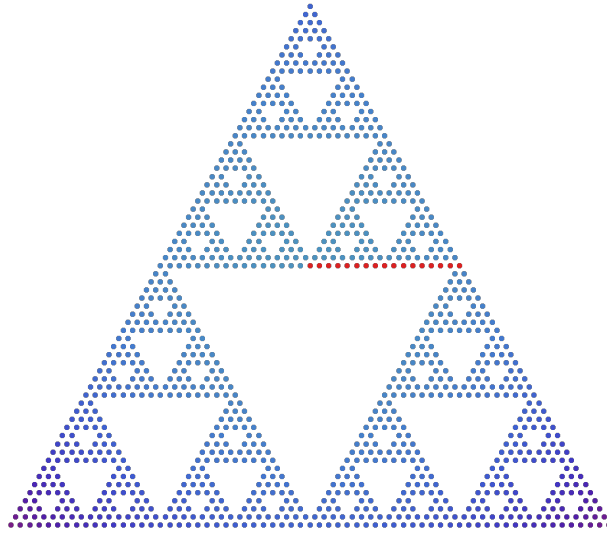

Figure 27: The algorithm path from $X_0 = \left(\frac{3}{4}, \frac{\sqrt{3}}{4}\right)$ to X^* .

In the second example, the algorithm starts with $X_0 = \left(\frac{3}{4}, \frac{\sqrt{3}}{4}\right)$, and converges to the global maximum 0 at $\left(\frac{1}{2}, \frac{\sqrt{3}}{4}\right)$.

THE SIERPIŃSKI TETRAHEDRON

The Sierpiński Tetrahedron requires a calculation time for the maximum at step $m \in \mathbb{N}^*$ which is of order $\mathcal{O}(4^m)$.

In the sequel, we present results of our algorithm in the case of Sierpiński Tetrahedron, with vertices:

$$P_0 = (0,0,0) \quad , \quad P_1 = (1,0,0) \quad , \quad P_2 = \left(\frac{1}{2}, \frac{\sqrt{3}}{2}, 0\right) \quad , \quad P_3 = \left(\frac{1}{2}, \frac{1}{2\sqrt{3}}, \sqrt{\frac{2}{3}}\right)$$

for the value $m = 6$.

The color function is related to the gradient of the one at stake, high values ranging from red to blue.

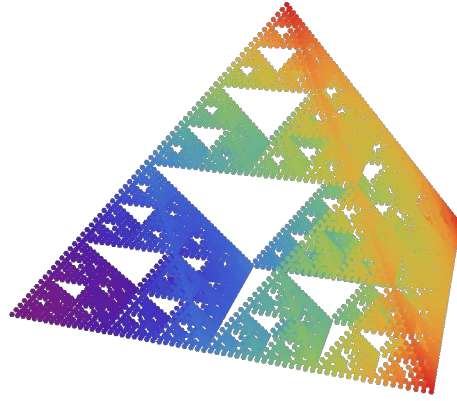

Figure 28: The graph of the function $X \mapsto f(X) = \| X \|^2$.

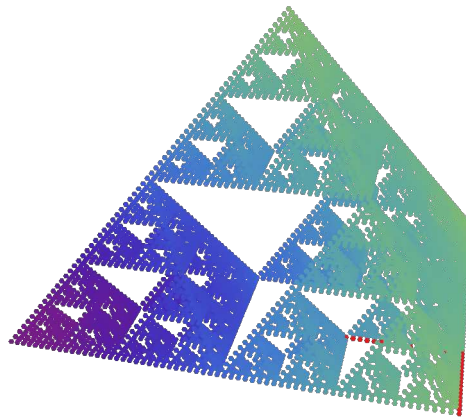

Figure 29: The algorithm path from $X_0 = \left(\frac{41}{64}, \frac{1}{64} + \frac{\sqrt{3}}{8}, \frac{1}{64} \right)$ to X^* .

For this first example, the algorithm start with $X_0 = \left(\frac{41}{64}, \frac{1}{64} + \frac{\sqrt{3}}{8}, \frac{1}{64} \right)$, following the largest gradient (red points), the algorithm converges to the local maximum 1 at $(1, 0, 0)$.

Self-similar Curves

Self-similar curves require a calculation time which is, at a given step $m \in \mathbb{N}^*$, of order $\mathcal{O}(\mathcal{N}_m)$, due to the fact that every vertex has only two neighbors. In such cases: $V_0 = \{P_0, P_1\}$. Thus, every vertex X has exactly two addresses:

$$X = f_{\mathcal{W}_i}(P_0) = f_{\mathcal{W}_{i+1}}(P_1)$$

where $(\mathcal{W}_i, \mathcal{W}_j) \in \Sigma^2$. The neighbors of X are thus given by:

$$f_{\mathcal{W}_{i-1}}(P_0) \quad \text{and} \quad f_{\mathcal{W}_{j+1}}(P_1)$$

where \mathcal{W}_{i-1} (resp. \mathcal{W}_{j+1}) is the next (resp. the past) address of \mathcal{W}_i (resp. \mathcal{W}_j) in the lexicographical order.

In the sequel (see figures 7 and 8), we present results of our algorithm in the case of the Minkowski Curve, with $V_0 = \{(0,0);(1,0)\}$, for the value $m = 3$.

The color function is related to the gradient of the one at stake, high values ranging from red to blue.

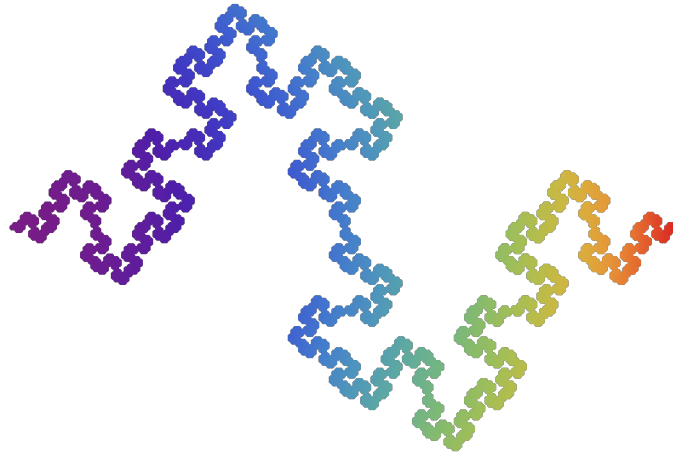

Figure 30: The graph of the function $X \mapsto f(X) = \|X\|^2$.



Figure 31: The algorithm path from $X_0 = (0,0)$ to X^* .

For this example, the algorithm starts with $X_0 = (0,0)$; following the largest gradient (red points), the algorithm converges to the local maximum $\left(\frac{5}{4096}\right)$ at $\left(\frac{1}{32}, \frac{1}{64}\right)$.

3.2 OPTIMAL CONTROL OF PARTIAL DIFFERENTIAL EQUATION ON FRACTAL SETS

3.2.1 Distributed Control of the Heat Equation

Admissible control

Let us set $\Omega \subset \mathcal{F}$. We consider the general problem

$$(\mathcal{H}_C) \quad \begin{cases} \partial_t Y - \Delta_\mu Y = \mathbf{1}_\Omega u & \text{in }]0, T[\times \mathcal{F} \\ Y = 0 & \text{on }]0, T[\times \partial\mathcal{F} \\ Y(0, x) = Y^0(x) & \text{in } \mathcal{F} \end{cases}$$

where $\partial\mathcal{F} = V_0$ and $u \in L^2_\mu(\Omega)$. Using Duhamel formula, we know that the solution of this problem is given by

$$\begin{aligned} Y(t, x) &= S_t Y_0 + \int_0^t S_{t-s} \mathbf{1}_\Omega u(s) ds \\ &= S_t Y_0 + L_t u. \end{aligned}$$

For the sake of simplicity, we will write $Y(T)$ for $Y(T, x)$, where $x \in \mathcal{F}$.

In order to have a solution $Y \in L^2_\mu(\mathcal{F})$, we now need to introduce the following definition:

Definition 3.2.1. Admissible Control

A control B is said to be admissible for the semigroup $(S_t)_{t>0}$ if there exists a time T such that

$$\text{Range} L_T \subset L^2_\mu(\mathcal{F}).$$

In our case, $B = \mathbf{1}_\Omega$, and following the solution existence theorem, the control is admissible.

Controllability

We introduce the following definitions (see [Zua06]):

Definition 3.2.2. Reachable States

For any initial data $Y^0 \in L^2_\mu(\mathcal{F})$, define the set of reachable states to be

$$R(T; Y^0) = \{Y(T) : Y \text{ is a solution of the control problem with } u \in L^2((0, T) \times (\Omega, \mu))\}$$

Definition 3.2.3. System Exactly Controllable in Time T

The control system is said to be **exactly controllable in time T** if for every initial data $Y^0 \in L^2_\mu(\mathcal{F})$, the set of reachable states verify $R(T; Y^0) = L^2_\mu(\mathcal{F})$.

Definition 3.2.4. System Approximately Controllable in Time T

The control system is said to be **approximately controllable in time T** if for every initial data $Y^0 \in L^2_\mu(\mathcal{F})$, the set of reachable states is dense in $L^2_\mu(\mathcal{F})$.

Definition 3.2.5. System Null Controllable in Time T

The control system is said to be **null controllable in time T** if for every initial data $Y^0 \in L^2_\mu(\mathcal{F})$, the set of reachable states contains the element 0.

Remark 3.2.1. [Zua06]

1. Null controllability in time implies approximate controllability.
2. The problem of approximate controllability may be reduced to the case $Y^0 = 0$.

Definition 3.2.6. Cost Function

Given a final target $Y^1 \in L^2_\mu(\mathcal{F})$, and a strictly positive number ε , we are presently looking for a control u of our heat problem (\mathcal{H}_C) such that:

$$\|Y(T) - Y^1\|_{L^2_\mu(\mathcal{F})} \leq \varepsilon.$$

To this purpose, for $u_T \in L^2_\mu(\mathcal{F})$, we introduce the adjoint problem:

$$\begin{cases} \partial_t u + \Delta u = 0 & \text{in }]0, T[\times \mathcal{F} \\ u = 0 & \text{in } \partial\mathcal{F} \\ u(T) = u_T & \text{in } \mathcal{F} \end{cases} \quad (\mathcal{A}_\mathcal{H})$$

and introduce the **cost function** J_ε such that:

$$\begin{aligned} J_\varepsilon : L^2_\mu(\mathcal{F}) &\longrightarrow \mathbb{R} \\ u_T &\longmapsto \frac{1}{2} \int_0^T \int_\Omega u^2 d\mu dt + \frac{\varepsilon}{2} \|u_T\|_{L^2_\mu(\mathcal{F})}^2 - \int_\mathcal{F} Y^1 u_T d\mu \end{aligned}$$

Theorem 3.2.1. Variational Approach to the Approximate Controllability

Given a strictly positive number ε , if \tilde{u}_T is a minimum of the cost function J_ε on the closed unit ball $\mathcal{B}_{L^2_\mu(\mathcal{F})} = \{v \in L^2_\mu(\mathcal{F}), \|v\|_{L^2_\mu(\mathcal{F})} \leq 1\}$, and \tilde{u} a solution of the adjoint equation $(\mathcal{A}_\mathcal{H})$ with initial data \tilde{u}_T , then the solution Y satisfies the following inequality

$$\|Y(T) - Y^1\|_{L^2_\mu(\mathcal{F})} \leq \varepsilon.$$

Proof.

Thanks to Remark 3.2.1, we can take $Y^0 = 0$.

Let us suppose then that J_ε hits the minimal value at \tilde{u}_T in \mathcal{S} . Then, for any $\psi_0 \in L^2_\mu(\mathcal{F})$, and any real number h such that $\tilde{u}_T + h\psi_0 \in \mathcal{B}_{L^2_\mu(\mathcal{F})}$:

$$J_\varepsilon(\tilde{u}_T) \leq J_\varepsilon(\tilde{u}_T + h\psi_0).$$

Moreover,

$$\begin{aligned} J_\varepsilon(\tilde{u}_T + h\psi_0) &= \frac{1}{2} \int_0^T \int_\Omega |\tilde{u} + h\psi|^2 d\mu dt + \frac{\varepsilon}{2} \|\tilde{u}_T + h\psi_0\|_{L^2_\mu(\mathcal{F})}^2 - \int_{\mathcal{F}} Y^1(\tilde{u}_T + h\psi_0) d\mu \\ &= \frac{1}{2} \int_0^T \int_\Omega |\tilde{u}|^2 d\mu dt + \frac{1}{2} \int_0^T \int_\Omega |h\psi|^2 d\mu dt + h \int_0^T \int_\Omega \tilde{u}\psi d\mu dt \\ &\quad + \frac{\varepsilon}{2} \|\tilde{u}_T + h\psi_0\|_{L^2_\mu(\mathcal{F})}^2 - \int_{\mathcal{F}} Y^1(\tilde{u}_T + h\psi_0) d\mu. \end{aligned}$$

This implies

$$\begin{aligned} J_\varepsilon(\tilde{u}_T + h\psi_0) - J_\varepsilon(\tilde{u}_T) &= \frac{\varepsilon}{2} \left(\|\tilde{u}_T + h\psi_0\|_{L^2_\mu(\mathcal{F})}^2 - \|\tilde{u}_T\|_{L^2_\mu(\mathcal{F})}^2 \right) \\ &\quad + \frac{h^2}{2} \int_0^T \int_\Omega |\psi|^2 d\mu dt + h \left(\int_0^T \int_\Omega \tilde{u}\psi d\mu dt - \int_{\mathcal{F}} Y^1 \psi_0 d\mu dt \right) \\ &\geq 0. \end{aligned}$$

Now, since

$$\left(\|\tilde{u}_T + h\psi_0\|_{L^2_\mu(\mathcal{F})}^2 - \|\tilde{u}_T\|_{L^2_\mu(\mathcal{F})}^2 \right) = 2h \int_{\mathcal{F}} \tilde{u}_T \psi_0 d\mu + h^2 \|\psi_0\|_{L^2_\mu(\mathcal{F})}^2$$

we obtain, for h , and ψ_0 ,

$$\varepsilon h \int_{\mathcal{F}} \tilde{u}_T \psi_0 d\mu + \varepsilon \frac{h^2}{2} \|\psi_0\|_{L^2_\mu(\mathcal{F})}^2 + \frac{h^2}{2} \int_0^T \int_\Omega |\psi|^2 d\mu dt + h \left(\int_0^T \int_\Omega \tilde{u}\psi d\mu dt - \int_{\mathcal{F}} Y^1 \psi_0 d\mu dt \right) \geq 0.$$

In the case where $h > 0$, going through the limit when h tends towards 0 yields

$$\varepsilon \int_{\mathcal{F}} \tilde{u}_T \psi_0 d\mu + \left(\int_0^T \int_\Omega \tilde{u}\psi d\mu dt - \int_{\mathcal{F}} Y^1 \psi_0 d\mu dt \right) \geq 0.$$

In the case where $h < 0$, one obtains

$$\varepsilon \int_{\mathcal{F}} \tilde{u}_T \psi_0 d\mu + \left(\int_0^T \int_{\Omega} \tilde{u} \psi d\mu dt - \int_{\mathcal{F}} Y^1 \psi_0 d\mu dt \right) \leq 0.$$

Thus,

$$\varepsilon \int_{\mathcal{F}} \tilde{u}_T \psi_0 d\mu = \int_{\mathcal{F}} Y^1 \psi_0 d\mu dt - \int_0^T \int_{\Omega} \tilde{u} \psi d\mu dt. \quad (41)$$

Given a solution ψ of the adjoint problem $(\mathcal{A}_{\mathcal{H}})$, i.e., such that,

$$\begin{cases} \partial_t \psi + \Delta \psi = 0 & \text{in }]0, T[\times \mathcal{F} \\ \psi = 0 & \text{in } \partial \mathcal{F} \\ \psi(T) = \psi_0 & \text{in } \mathcal{F} \end{cases}$$

multiplication term by term with ψ of the initial heat equation

$$\partial_t Y - \Delta Y = \mathbf{1}_{\Omega} \tilde{u}$$

Integration, and the specially designed Gauss-Green formula for fractals 1.6.5 yield:

$$\begin{aligned} \int_0^T \int_{\Omega} \tilde{u} \psi d\mu dt &= \int_0^T \int_{\mathcal{F}} (\partial_t Y - \Delta Y) \psi d\mu dt \\ &= - \int_0^T \int_{\mathcal{F}} (\partial_t \psi + \Delta \psi) Y d\mu dt + \left[\int_{\mathcal{F}} Y \psi d\mu \right]_0^T + \int_0^T \int_{\partial \mathcal{F}} (\partial_n Y \psi - \partial_n \psi Y) d\mu dt \\ &= \int_{\mathcal{F}} Y(T) \psi_0 d\mu. \end{aligned}$$

After substitution in 41, one deduces, then, that

$$\begin{aligned} \int_{\mathcal{F}} (Y^1 - Y(T)) \psi_0 d\mu &= \varepsilon \int_{\mathcal{F}} \tilde{u}_T \psi_0 d\mu \quad \forall \psi_0 \in L_{\mu}^2(\mathcal{F}) \\ &\leq \varepsilon \|\tilde{u}_T\|_{L_{\mu}^2(\mathcal{F})} \|\psi_0\|_{L_{\mu}^2(\mathcal{F})}. \end{aligned}$$

Finally,

$$\|Y(T) - Y^1\|_{L_{\mu}^2(\mathcal{F})} \leq \varepsilon.$$

Since $\|\tilde{u}_T\|_{L_{\mu}^2(\mathcal{F})} \leq 1$.

□

Theorem 3.2.2. Existence of a Minimum for the Cost Function

Given a strictly positive number ε , the cost function J_{ε} reaches a unique minimum at some $\tilde{u}_T \in \mathcal{B}_{L_{\mu}^2(\mathcal{F})}$.

Proof.

The proof requires the following preliminary results:

Theorem 3.2.3. [Breg9]

Given a Banach space E , a non-empty closed convex subset A of E , and a proper, convex, lower semi-continuous function $J : A \rightarrow]-\infty, +\infty[$, such that

$$\lim_{\substack{x \in A \\ \|x\| \rightarrow \infty}} J(x) = +\infty$$

then, J reaches its minimum on A .

Lemma 3.2.4. [BC11]

Given a strictly positive real number β , a Hilbert space E , and a proper function $f : E \rightarrow]-\infty, +\infty]$, such that $f - \frac{\beta}{2} \|\cdot\|_E^2$ is convex.

Then, the function f is **strongly convex**.

Proposition 3.2.5. [BC11]

A strongly convex, lower semi-continuous, proper function J on E is also supercoercive, i.e.,

$$\lim_{\|u\|_E \rightarrow \infty} \frac{J(u)}{\|u\|_E} = +\infty.$$

and it has exactly one minimizer over E .

Back to our cost function

$$\begin{aligned} J_\varepsilon : L_\mu^2(\mathcal{F}) &\longrightarrow \mathbb{R} \\ u_T &\longmapsto \frac{1}{2} \int_0^T \int_\Omega u^2 d\mu dt + \frac{\varepsilon}{2} \|u_T\|_{L_\mu^2(\mathcal{F})}^2 - \int_{\mathcal{F}} Y^1 u_T d\mu \end{aligned}$$

The continuity is a consequence of the continuity of the solution operator of the adjoint equation $u_T \longrightarrow u$ (see for example [LM68]):

$$\begin{aligned} |J_\varepsilon(u_T)| &= \left| \frac{1}{2} \int_0^T \int_\Omega u^2 d\mu dt + \frac{\varepsilon}{2} \|u_T\|_{L_\mu^2(\mathcal{F})}^2 - \int_{\mathcal{F}} Y^1 u_T d\mu \right| \\ &\leq C \|u_T\|_{L_\mu^2(\mathcal{F})}^2 + \frac{\varepsilon}{2} \|u_T\|_{L_\mu^2(\mathcal{F})}^2 + \|Y_1\|_{L_\mu^2(\mathcal{F})} \|u_T\|_{L_\mu^2(\mathcal{F})} \\ &\leq \tilde{C} \|u_T\|_{L_\mu^2(\mathcal{F})} \end{aligned}$$

The strongly convexity follows from lemma 3.2.4 for $\beta = \varepsilon$. Proposition 3.2.5 applied on the closed, bounded, convex set $\mathcal{B}_{L_\mu^2(\mathcal{F})}$ yields the supercoercivity and the existence of a unique minimum.

□

Definition 3.2.7. Bang-bang Control

Given a final target $Y^1 \in L^2_\mu(\mathcal{F}, \mu)$, and a strictly positive number ε , we are still looking for a control u of our heat problem (\mathcal{H}_C) such that the solution Y satisfies the following inequality:

$$\|Y(T) - Y^1\|_{L^2_\mu(\mathcal{F})} \leq \varepsilon.$$

The adjoint problem (\mathcal{A}_H) is the same as previously introduced in Definition 3.2.6. We now change the **cost function** J_ε into a new **bang-bang** cost one J_{bb} such that:

$$J_{bb} : L^2_\mu(\mathcal{F}) \longrightarrow \mathbb{R}$$

$$J_{bb}(u_T) = \frac{1}{2} \left(\int_0^T \int_\Omega |u| \, d\mu \, dt \right)^2 + \frac{\varepsilon}{2} \|u_T\|_{L^2_\mu(\mathcal{F})}^2 - \int_\mathcal{F} Y^1 u_T \, d\mu.$$

The change from the previous one J_ε comes from the term $\frac{1}{2} \left(\int_0^T \int_\Omega |u| \, d\mu \, dt \right)^2$ instead of $\frac{1}{2} \int_0^T \int_\Omega u^2 \, d\mu \, dt$.

Such a control is called *bang-bang* in so far that not only the control function is restricted between a lower and an upper bound, but, also, that it only switches between those two extremes.

Remark 3.2.2.

The heat equation is a very well suited candidate for bang-bang controls. In every day's life, boiling milk when cooking and some bit in a hurry, one applies full heat and turn off just before the milk spills all over the hob which was spotless before !

Theorem 3.2.6. Existence of a minimum for the bang-bang cost function

Given a strictly positive number ε , the bang-bang cost function J_{bb} reaches a unique minimum at some $\tilde{u}_T \in \mathcal{B}_{L^2_\mu(\mathcal{F})}$, where $\mathcal{B}_{L^2_\mu(\mathcal{F})} = \{v \in L^2_\mu(\mathcal{F}), \|v\|_{L^2_\mu(\mathcal{F})} \leq 1\}$.

Proof.

The proof is obtained in a similar manner as in the L^2_μ case, using proposition 3.2.5.

□

Theorem 3.2.7.

Given a strictly positive number ε , if \tilde{u}_T is a minimum of the bang-bang cost function J_{bb} on $\mathcal{B}_{L^2_\mu(\mathcal{F})}$, and \tilde{u} a solution of the adjoint equation (\mathcal{A}_H) with initial data \tilde{u}_T , then

$$u = \operatorname{sgn}(\tilde{u}) \int_{\Omega} \int_0^T |\tilde{u}| d\mu dt$$

and the solution Y of the heat problem satisfies the following inequality

$$\left\| Y(T) - Y^1 \right\|_{L^2_\mu(\mathcal{F})} \leq \varepsilon.$$

Proof.

As previously, we can take $Y^0 = 0$.

Let us suppose then that the bang-bang cost function J_{bb} hits its minimal value at $\tilde{u}_T \in L^2_\mu(\mathcal{F})$. Then, for any $\psi_0 \in L^2_\mu(\mathcal{F})$, and any real number h such that $\tilde{u}_T + h\psi_0 \in \mathcal{B}_{L^2_\mu(\mathcal{F})}$:

$$J_{bb}(\tilde{u}_T) \leq J_{bb}(\tilde{u}_T + h\psi_0).$$

Moreover,

$$\begin{aligned} J_{bb}(\tilde{u}_T + h\psi_0) - J_{bb}(\tilde{u}_T) &= \frac{\varepsilon}{2} \left(\|\tilde{u}_T + h\psi_0\|_{L^2_\mu(\mathcal{F})}^2 - \|\tilde{u}_T\|_{L^2_\mu(\mathcal{F})}^2 \right) \\ &\quad + \frac{1}{2} \left(\left(\int_0^T \int_{\Omega} |\tilde{u} + h\psi| d\mu dt \right)^2 - \left(\int_0^T \int_{\Omega} |\tilde{u}| d\mu dt \right)^2 \right) - h \int_{\mathcal{F}} Y^1 \psi_0 d\mu dt \\ &\geq 0 \end{aligned}$$

Since

$$\left(\|\tilde{u}_T + h\psi_0\|_{L^2_\mu(\mathcal{F})}^2 - \|\tilde{u}_T\|_{L^2_\mu(\mathcal{F})}^2 \right) = 2h \int_{\mathcal{F}} \tilde{u}_T \psi_0 d\mu + h^2 \|\psi_0\|_{L^2_\mu(\mathcal{F})}^2$$

we obtain that

$$\varepsilon h \int_{\mathcal{F}} \tilde{u}_T \psi_0 d\mu + \varepsilon \frac{h^2}{2} \|\psi_0\|_{L^2_\mu(\mathcal{F})}^2 + \frac{1}{2} \left(\left(\int_0^T \int_{\Omega} |\tilde{u} + h\psi| d\mu dt \right)^2 - \left(\int_0^T \int_{\Omega} |\tilde{u}| d\mu dt \right)^2 \right) - h \int_{\mathcal{F}} Y^1 \psi_0 d\mu dt \geq 0.$$

In the case where $h > 0$, going through the limit when h tends towards 0 yields:

$$\varepsilon \int_{\mathcal{F}} \tilde{u}_T \psi_0 d\mu + \left(\int_0^T \int_{\Omega} |\tilde{u}| d\mu dt \right) \operatorname{sgn}(\tilde{u}) \left(\int_0^T \int_{\Omega} \psi d\mu dt \right) - \int_{\mathcal{F}} Y^1 \psi_0 d\mu dt \geq 0.$$

In the case where $h < 0$, we obtain that

$$\varepsilon \int_{\mathcal{F}} \tilde{u}_T \psi_0 d\mu + \left(\int_0^T \int_{\Omega} |\tilde{u}| d\mu dt \right) \operatorname{sgn}(\tilde{u}) \left(\int_0^T \int_{\Omega} \psi d\mu dt \right) - \int_{\mathcal{F}} Y^1 \psi_0 d\mu dt \leq 0.$$

We then deduce that

$$\varepsilon \int_{\mathcal{F}} \tilde{u}_T \psi_0 d\mu = \int_{\mathcal{F}} Y^1 \psi_0 d\mu dt - \left(\int_0^T \int_{\Omega} |\tilde{u}| d\mu dt \right) \operatorname{sgn}(\tilde{u}) \left(\int_0^T \int_{\Omega} \psi d\mu dt \right).$$

Given a solution ψ of the adjoint problem $(\mathcal{A}_{\mathcal{H}})$, i.e., such that

$$\begin{cases} \partial_t \psi + \Delta \psi = 0 & \text{in }]0, T[\times \mathcal{F} \\ \psi = 0 & \text{in } \partial \mathcal{F} \\ \psi(T) = \psi_0 & \text{in } \mathcal{F} \end{cases}$$

multiplication term by term with ψ of the initial heat equation

$$\partial_t Y - \Delta Y = \mathbf{1}_{\Omega} \tilde{u}$$

Integration using the Gauss-Green formula for fractals 1.6.5 yield:

$$\begin{aligned} \left(\int_0^T \int_{\Omega} |\tilde{u}| d\mu dt \right) \operatorname{sgn}(\tilde{u}) \left(\int_0^T \int_{\Omega} \psi d\mu dt \right) &= \int_0^T \int_{\mathcal{F}} (\partial_t Y - \Delta Y) \psi d\mu dt \\ &= - \int_0^T \int_{\mathcal{F}} Y (\partial_t \psi + \Delta \psi) d\mu dt + \left[\int_{\mathcal{F}} Y \psi d\mu \right]_0^T \\ &\quad + \int_0^T \int_{\partial \mathcal{F}} (\partial_n Y \psi - \partial_n \psi Y) d\mu dt \\ &= \int_{\mathcal{F}} Y(T) \psi_0 d\mu. \end{aligned}$$

We then deduce that

$$\begin{aligned} \int_{\mathcal{F}} (Y^1 - Y(T)) \psi_0 d\mu &= \varepsilon \int_{\mathcal{F}} \tilde{u}_T \psi_0 d\mu \quad \forall \psi_0 \in L_{\mu}^2(\mathcal{F}) \\ &\leq \varepsilon \|\tilde{u}_T\|_{L_{\mu}^2(\mathcal{F})} \|\psi_0\|_{L_{\mu}^2(\mathcal{F})}. \end{aligned}$$

Finally,

$$\|Y(T) - Y^1\|_{L_{\mu}^2(\mathcal{F})} \leq \varepsilon.$$

□

3.3 THE SPECIFIC CASE OF THE SIERPIŃSKI GASKET

Optimal control problems can be discretized according the following paradigms:

i. Discretization of the continuous control problem, and resolution in a finite dimensional space:

$$MODEL \rightarrow DISCRETIZATION \rightarrow CONTROL$$

ii. Solving of the continuous control problem, and discretization of the solution:

$$MODEL \rightarrow CONTROL \rightarrow DISCRETIZATION$$

We hereafter choose the second one, which appeared as best fitted to our study.

Formulation of the Problem

We hereafter consider the specific case when **our fractal set \mathcal{F} is the Sierpiński Gasket $\mathfrak{S}\mathfrak{G}$** . Further details on the gasket, and the related Laplacian can be found in [RD21a]. One simply requires here to know that the boundary set V_0 is:

$$V_0 = \{P_1, P_2, P_3\}$$

where:

$$P_1 = (0, 0) \quad , \quad P_2 = (1, 0) \quad , \quad P_3 = \left(\frac{1}{2}, \frac{\sqrt{3}}{2}\right) .$$

As for the contractive maps, they are defined, for any x of \mathbb{R}^2 , through

$$f_i(x) = \frac{1}{2} (x + P_i) \quad , \quad 1 \leq i \leq 3 .$$

The coefficients of the self-similar measure are

$$\mu_1 = \mu_2 = \mu_3 = \frac{1}{3} .$$

One also requires the normalization factor. It is presently given by

$$r = \frac{3}{5} .$$

As for the Laplacian, it is approximated by means of the sequence of graph Laplacians $(\Delta_m)_{m \in \mathbb{N}^*}$. Since, for any strictly positive integer m ,

$$\int_{\mathfrak{S}\mathfrak{G}} \psi_{x_m}^{(m)} d\mu = \frac{2}{3^{m+1}}$$

this yields, for any sequence of points $(x_m)_{m \in \mathbb{N}}$ such that, for any natural integer m , $x_m \in V_m$:

$$\begin{aligned} \Delta Y(t, \lim_{m \rightarrow +\infty} x_m) &= \lim_{m \rightarrow +\infty} r^{-m} \left(\int_{\mathfrak{S}\mathfrak{G}} \psi_{x_m}^{(m)} d\mu \right)^{-1} \sum_{x_m \sim_m y} (Y(t, y) - Y(t, x_m)) \\ &= \lim_{m \rightarrow +\infty} \frac{3}{2} 5^m \sum_{x_m \sim_m y} (Y(t, y) - Y(t, x_m)) \end{aligned}$$

The adjoint problem introduced in Definition 3.2.6 can be solved by means of the transformation defined through:

$$\forall (t, x) \in [0, T] \times \mathfrak{S}\mathfrak{G} : \quad \kappa(t, x) = u(T - t, x) .$$

Notations.

i. In the following, T is the strictly positive real number. N_T is a non-zero natural integer. We introduce:

$$h = \frac{T}{N_T} \quad , \quad t_n = k \times h \quad , \quad k = 0, 1, \dots, N_T - 1 .$$

ii. For the sake of simplicity, we set:

$$\forall x \in \mathfrak{GG} : u(T, x) = u_T(x).$$

At a given step $m \in \mathbb{N}^*$ of the prefractal graph approximation, and a given one $k \in \{0, 1, \dots, N_T - 1\}$ of the discretization, our scheme can be written, for any point P_j , $1 \leq j \leq 3$ of the boundary set V_0 , and any vertex $x = f_{\mathcal{W}}(P_i)$ of $V_m \setminus V_0$:

$$\begin{cases} \frac{Y_m^{k+1}(x) - Y_m^k(x)}{h} &= 5^m \left(\sum_{x \sim y} Y_m^k(y) - Y_m^k(x) \right) + u_m^k(x) \\ Y_m^k(P_j) &= 0 \\ Y_m^0(x) &= 0 \end{cases}$$

and:

$$\begin{cases} \frac{\kappa_m^{k+1}(x) - \kappa_m^k(x)}{h} &= 5^m \left(\sum_{X \sim y} \kappa_m^k(y) - \kappa_m^k(x) \right) \\ \kappa_m^k(P_j) &= 0 \\ \kappa_m^0(x) &= u_T(x) \end{cases}$$

Let us set:

$$\mathbf{Y}^0 = \begin{pmatrix} 0 \\ \vdots \\ 0 \end{pmatrix}, \quad \mathbf{K}^0 = \begin{pmatrix} u(T, x_1) \\ \vdots \\ u(T, x_{\mathcal{N}_m-3}) \end{pmatrix}$$

This enables one to introduce, for $k \in \{0, 1, \dots, N_T - 1\}$, the solution vectors \mathbf{Y}^k and \mathbf{K}^k :

$$\mathbf{Y}^k = \begin{pmatrix} Y(kh, x_1) \\ \vdots \\ Y(kh, x_{\mathcal{N}_m-3}) \end{pmatrix}, \quad \mathbf{K}^k = \begin{pmatrix} \kappa(kh, x_1) \\ \vdots \\ \kappa(kh, x_{\mathcal{N}_m-3}) \end{pmatrix}$$

They satisfy the linear system

$$(\mathcal{S}_{\mathcal{H}}) \quad \begin{cases} \mathbf{Y}^{k+1} &= \mathbf{A} \mathbf{Y}^k + \mathbf{B}^k \\ \mathbf{K}^{k+1} &= \mathbf{A} \mathbf{K}^k \end{cases}$$

where

$$\mathbf{A} = I_{\mathcal{N}_m-3} - h \tilde{\Delta}_m$$

and where $I_{\mathcal{N}_m-3}$ denotes the $(\mathcal{N}_m - 3) \times (\mathcal{N}_m - 3)$ identity matrix, $\tilde{\Delta}_m$ the $(\mathcal{N}_m - 3) \times (\mathcal{N}_m - 3)$ normalized Laplacian matrix, and \mathbf{B}^k is the matrix of the form

$$\mathbf{B}^k = h \begin{pmatrix} u_m(kh, x_1) \\ \vdots \\ u_m(kh, x_{N_m-3}) \end{pmatrix}$$

We hereafter describe a discrete iterative projected gradient algorithm (D.P.G.A.) with optimal stepsize, starting with an initial control value:

$$u_{m,T}^{(0)} = 0$$

and, for any strictly positive integers j :

$$\begin{cases} \nabla J(u_{m,T}^{(j)}) & = \varepsilon u_{m,T}^{(j)} + Y_m^{(j)}(T) - Y^1 \\ \tilde{u}_{m,T}^{(j+1)} & = u_{m,T}^{(j)} - \rho_j \nabla J(u_{m,T}^{(j)}) \\ u_{m,T}^{(j+1)} & = \frac{\tilde{u}_{m,T}^{(j+1)}}{\|\tilde{u}_{m,T}^{(j+1)}\|} \\ \rho_j & = \arg \inf_{\rho} J(u_{m,T}^{(j+1)}) \end{cases}$$

Numerical Analysis

In the spirit of [EG67], we give a convergence proof of the D.P.G.A., let introduce the following controls and the corresponding trajectories:

$$\begin{array}{ccc} u_{m,T}^* & \xrightarrow{\text{FDM}} & Y_m^*(t) \\ \tilde{u}_T^* & \xrightarrow{\text{Continuous}} & \tilde{Y}^*(t) \\ \bar{u}_{m,T}^* & \xrightarrow{\text{FDM}} & \bar{Y}_m^*(t) \\ u_T^* & \xrightarrow{\text{Continuous}} & Y^*(t) \end{array}$$

where $u_{m,T}^*$ and u_T^* stand respectively for the optimal control of the discrete and continuous heat problem, \tilde{u}_T^* is the piecewise constant control obtained from $u_{m,T}^*$, and $\bar{u}_{m,T}^*$ is the discretized version of u_T^* . One has, $\forall \varepsilon > 0$

$$-\varepsilon < J(u_{m,T}^*) - J(\tilde{u}_T^*) \leq J(u_{m,T}^*) - J(u_T^*) \leq J(\bar{u}_{m,T}^*) - J(u_T^*) < \varepsilon$$

Since \tilde{u}_T^* is not better than u_T^* and $\bar{u}_{m,T}^*$ is better than $u_{m,T}^*$. The convergence of the both sides is ensured by theorem 2.1.4.

The discrete projected gradient algorithm (DPGA) is based on the approximation scheme

$$u_T^* \xrightarrow{\text{FDM}} u_{m,T}^* \xrightarrow{\text{PGA}} u_{m,T}^{(j^*)}$$

where j^* is the optimal stopping iteration. Remark that

$$\begin{aligned}\|\nabla J(\phi_1) - \nabla J(\phi_2)\| &= \|\varepsilon(\phi_1 - \phi_2) + (Y_1(T) - Y_2(T))\| \\ &\leq C \|\phi_1 - \phi_2\|\end{aligned}$$

from the continuity of the solution operator in 1.10.5.

Theorem 3.3.1. [Allo7]

Suppose that J is differentiable and strongly convex for some constant β , and J' is Lipschitz continuous for some constant C . Then the projected gradient algorithm converge if $0 < \rho < \frac{2\alpha}{C^2}$.

The convergence of the DPGA follows since:

$$\|J(u_T^*) - J(u_{m,T}^{(j^*)})\| \leq \|J(u_T^*) - J(u_{m,T}^*)\| + \|J(u_{m,T}^*) - J(u_{m,T}^{(j^*)})\|$$

Numerical Results

We hereafter expose the results obtained by applying a heat control to reach a target state Y^1 on the Sierpiński gasket. This is done with an approximation error ε . The control is a L^2 -one.

Numerical results are given in the case where $m = 4$, $T = 1$, and $N_T = 2850$. Figures 32, 33 and 34 respectively display the target Y^1 , the controlled solutions and the control u_T , obtained after $iMax = 2000$ iterations.

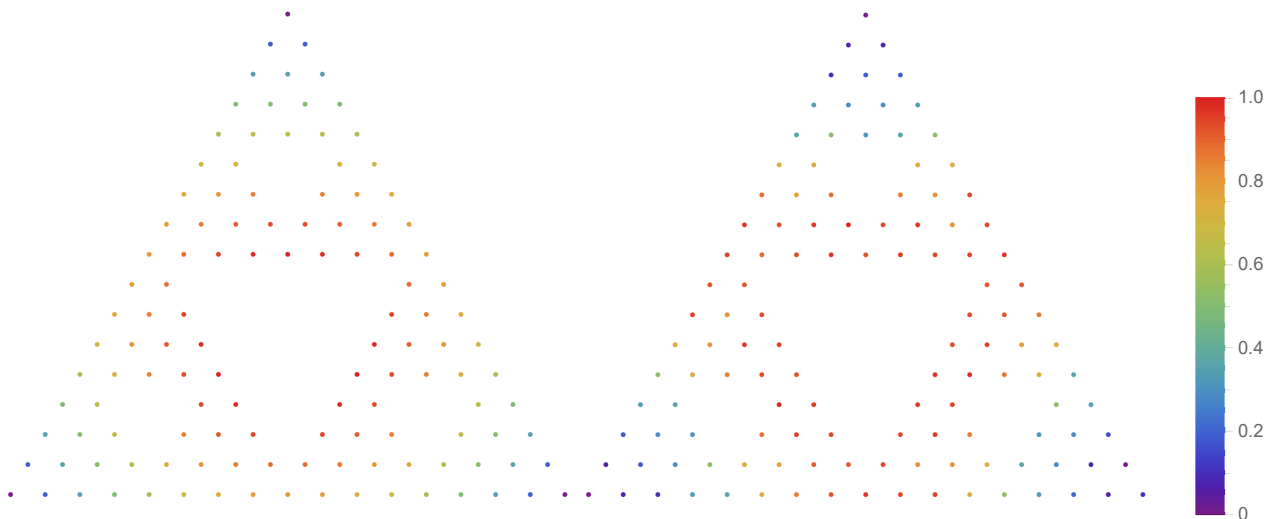

Figure 32: The target Y^1 .

Figure 33: The controlled solution.

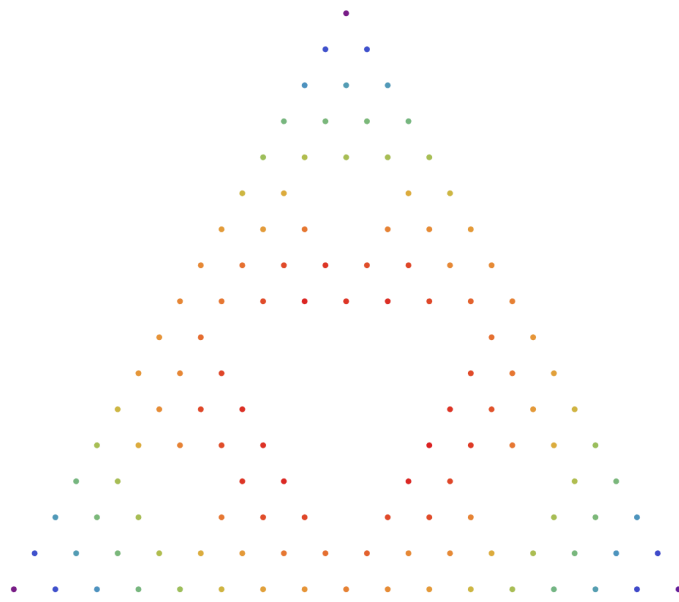

Figure 34: The control u_T .

Chapter 4

Domains with Fractal Boundaries

Analysis on domains with fractal boundaries constitute a different branch of analysis on fractals. The set of interest is an open subset of \mathbb{R}^n , but the frontier is supposed to be a fractal set. The existence of the Laplacian is not problematic, but the smooth calculus results of trace theorem, integration by parts and Poincaré inequality needs to be adapted.

This theory is older than the Kigami one, and has interested many authors, with a variety of contributions, from related functional analysis [HN92], [JW84], [Joh61], [CRW13], [Jon81] passing by numerical analysis [LNRG96] to the applications in the domains of wave propagation and heat diffusion [LN10],[LV10] ... etcetera

In this chapter, we expose our non published results about the vibration of the Koch drum. We present in the first section the theory of existence and uniqueness of the solution, and we present in the next section a shape optimization problem, related to the choice of the membrane thickness that minimizes an objective criterion.

4.1 THE MEMBRANE PROBLEM ON OPEN SUBSETS WITH FRACTAL BOUNDARIES

In the following, we deal with the elastic membrane problem, solution of the non-autonomous Poisson equation :

$$(\mathcal{P}_h) \quad \begin{cases} -\operatorname{div}(h\nabla u) & = f & \text{in } \Omega \\ u & = 0 & \text{in } \partial\Omega \end{cases}$$

where Ω is an open subset of \mathbb{R}^2 with fractal boundary $\partial\Omega$ which is taken as a fractal curve.

In the classical case where Ω is a smooth domain, if we take $h \in L^\infty(\Omega)$ such that $h_{\min} \leq h \leq h_{\max}$, this equation admits a weak solution in $W_2^1(\Omega) = H^1(\Omega)$: we multiply the equation by $v \in \mathcal{D}(\Omega)$ and use integration by parts formula

$$\int_{\Omega} h\nabla u \nabla v \, dx = \int_{\Omega} f v \, dx$$

The existence and uniqueness of the problem can be established using Lax-Milgram theorem (see [All12] for example), and the existence of weak solution can be used to prove the existence of the strong one.

Next, we will be concerned with the existence and uniqueness of the solution of the variational problem in the case of the Koch Snowflake. This require some results of the theory of analysis on fractal sets, which will be introduced in the next section. We refer the reader to K. Falconer books [Fal14], [Fal97] and [Fal85].

Let us consider a family of similarities f_i for $i \in \{1, \dots, N\}$, with contraction ratio R_i , $\{P_0, P_1\}$ two (boundary) points of the two-dimensional Euclidean plane, and $X \in \mathbb{R}^2$.

We define the self-similar curve \mathcal{F} to be the unique curve of \mathbb{R}^2 such that (see [Hut81])

$$\mathcal{F} = \bigcup_{i=1}^N f_i(\mathcal{F}).$$

Let $V_0 = \{P_0, P_1\}$. Connect P_0 to P_1 to constitute a segment, that we will denote by \mathcal{F}_0 , as before, V_0 is the boundary set.

We then set, for any strictly positive integer m , $V_m = \bigcup_{i=1}^N f_i(V_{m-1})$, and link the points of an m -cell in the same way as \mathcal{F}_0 , to form the oriented graph \mathcal{F}_m . Again, V_m is the set of vertices of the graph \mathcal{F}_m .

We set $V^* = \bigcup_{m \geq 0} V_m$, and recall that

$$\mathcal{F} = \overline{V^*}.$$

4.1.1 The Koch Snowflake

The Koch Snowflake as a Self-Similar Set

The Koch Snowflake $\mathfrak{K}\mathfrak{S}$ is the domain delimited by the union of three copies of Koch curves $\mathfrak{K}\mathfrak{C}$, each curve is a self similar set of the similarities family $\{f_1, f_2, f_3, f_4\}$, where

$$f_1(X) = \frac{1}{3} \mathcal{R}_{O,0} X + \begin{pmatrix} -\frac{1}{\sqrt{3}} \\ \frac{1}{3} \end{pmatrix}, \quad f_2(X) = \frac{1}{3} \mathcal{R}_{O,\frac{\pi}{3}} X + \begin{pmatrix} 0 \\ \frac{2}{3} \end{pmatrix}, \quad f_3(X) = \frac{1}{3} \mathcal{R}_{O,-\frac{\pi}{3}} X + \begin{pmatrix} 0 \\ \frac{2}{3} \end{pmatrix}$$

$$f_4(X) = \frac{1}{3} \mathcal{R}_{O,0} X + \begin{pmatrix} \frac{1}{\sqrt{3}} \\ \frac{1}{3} \end{pmatrix}$$

and where $\mathcal{R}_{O,\theta}$ is the following rotation matrix,

$$\mathcal{R}_{O,\theta} = \begin{pmatrix} \cos \theta & -\sin \theta \\ \sin \theta & \cos \theta \end{pmatrix}.$$

The two other copies are obtained by rotating the Koch curve, i.e.,

$$\partial \mathfrak{K}\mathfrak{S} = \mathfrak{K}\mathfrak{C} \cup \mathfrak{h}_1(\mathfrak{K}\mathfrak{C}) \cup \mathfrak{h}_2(\mathfrak{K}\mathfrak{C})$$

where \mathfrak{h}_1 and \mathfrak{h}_2 are given by

$$\mathfrak{h}_1(X) = \mathcal{R}_{O,-\frac{2\pi}{3}} X$$

$$\mathfrak{h}_2(X) = \mathcal{R}_{O,\frac{2\pi}{3}} X.$$

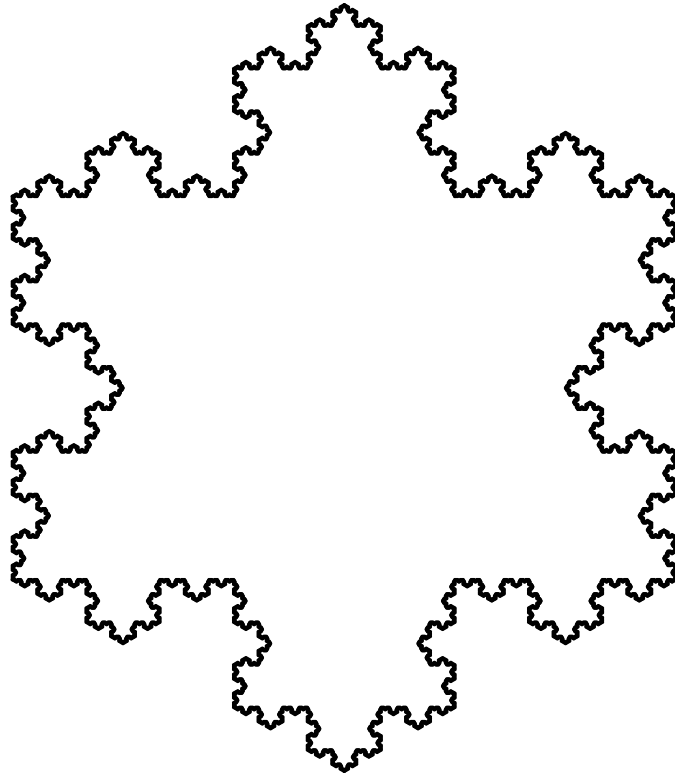

Figure 35: Koch Snowflake.

The Koch Snowflake has a very interesting property: it is itself self-similar for the family of contractions $\{g_1, \dots, g_7\}$, such that

$$g_1(X) = \frac{1}{3} \mathcal{R}_{O,0} X + \begin{pmatrix} -\frac{1}{\sqrt{3}} \\ -\frac{1}{3} \end{pmatrix}, \quad g_2(X) = \frac{1}{3} \mathcal{R}_{O,0} X + \begin{pmatrix} 0 \\ -\frac{2}{3} \end{pmatrix}, \quad g_3(X) = \frac{1}{3} \mathcal{R}_{O,0} X + \begin{pmatrix} \frac{1}{\sqrt{3}} \\ -\frac{1}{3} \end{pmatrix}$$

$$g_4(X) = \frac{1}{\sqrt{3}} \mathcal{R}_{O, \frac{\pi}{6}} X$$

$$g_5(X) = \frac{1}{3} \mathcal{R}_{O,0} X + \begin{pmatrix} -\frac{1}{\sqrt{3}} \\ \frac{1}{3} \end{pmatrix}, \quad g_6(X) = \frac{1}{3} \mathcal{R}_{O,0} X + \begin{pmatrix} 0 \\ \frac{2}{3} \end{pmatrix}, \quad g_7(X) = \frac{1}{3} \mathcal{R}_{O,0} X + \begin{pmatrix} \frac{1}{\sqrt{3}} \\ \frac{1}{3} \end{pmatrix}.$$

Proposition 4.1.1.

We have that

$$D_H(\mathfrak{K}\mathfrak{C}) = \frac{\ln(4)}{\ln(3)}, \quad D_H(\mathfrak{K}\mathfrak{S}) = 2.$$

Proof.

This directly follows from the definition of the similarity dimension [1.4.2](#), since:

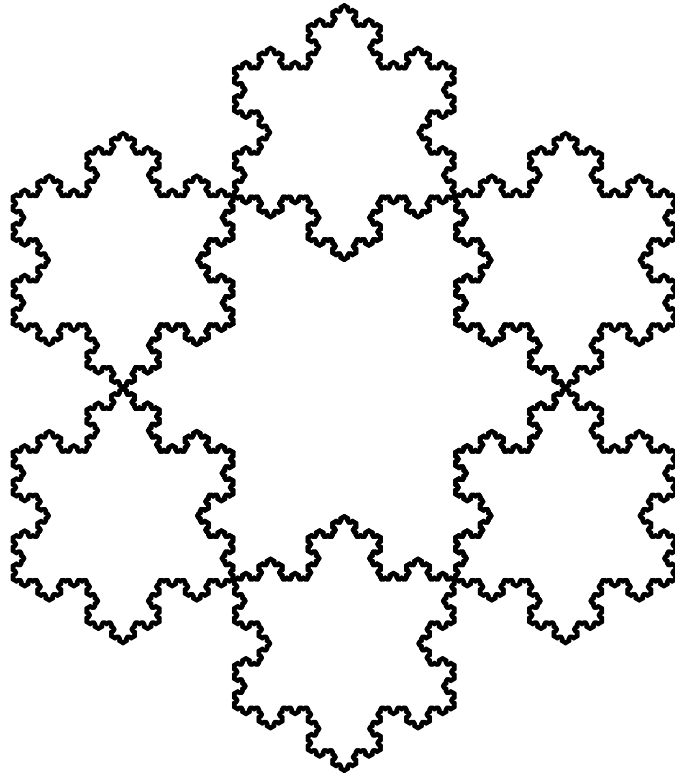

Figure 36: Koch Snowflake as the union of seven copies.

i.

$$\sum_{i=1}^4 \left(\frac{1}{3}\right)^{D_H(\mathfrak{K}\mathcal{C})} = 1.$$

ii.

$$\sum_{i=1}^6 \left(\frac{1}{3}\right)^{D_H(\mathfrak{K}\mathcal{S})} + \left(\frac{1}{\sqrt{3}}\right)^{D_H(\mathfrak{K}\mathcal{S})} = 1.$$

□

The Koch Snowflake as a Limit Set

On the one hand, the Koch Curve $\mathfrak{K}\mathcal{C}$ can be considered as the limit of the sequence $(\mathfrak{K}\mathcal{C}_m)_{m \in \mathbb{N}}$ such that

$$\begin{aligned} \mathfrak{K}\mathcal{C}_0 &= [P_0P_1] \\ \mathfrak{K}\mathcal{C}_m &= \bigcup_{\mathcal{W} \in \Sigma_m} f_{\mathcal{W}}(\mathfrak{K}\mathcal{C}_0) \quad , \quad \mathcal{W} \in \Sigma_m = \{1, 2, 3, 4\}^m \end{aligned}$$

where $[P_0P_1]$ is the initial segment.

On the other hand, the Koch Snowflake is the limit of the sequence $(\mathfrak{K}\mathcal{S}_m)_{m \in \mathbb{N}}$ where $\mathfrak{K}\mathcal{S}_m$ is the so-called **prefractal set** delimited by the three copies $\{\mathfrak{K}\mathcal{C}_m; h_1(\mathfrak{K}\mathcal{C}_m); h_2(\mathfrak{K}\mathcal{C}_m)\}$.

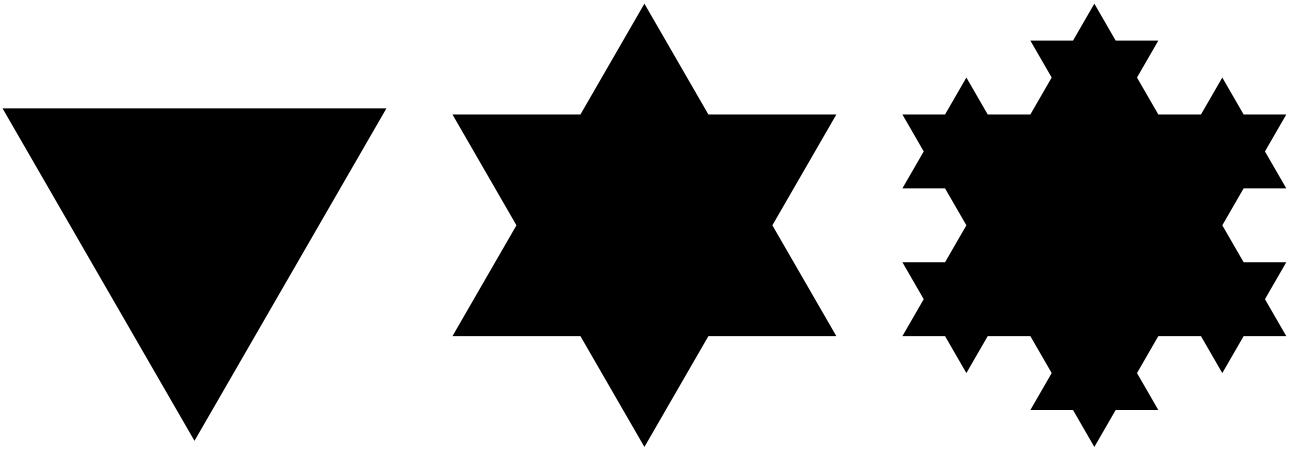
Figure 37: $\mathfrak{K}\mathfrak{S}_0$, $\mathfrak{K}\mathfrak{S}_1$ and $\mathfrak{K}\mathfrak{S}_2$.

4.1.2 Integration and Function Spaces

Next, we will establish some analysis results on the Koch Snowflake. For the sake of clarity, we set

$$\overline{\Omega} = \mathfrak{K}\mathfrak{S}, \quad \overline{\Omega}_m = \mathfrak{K}\mathfrak{S}_m \quad (42)$$

$$\Omega = \overset{\circ}{\mathfrak{K}\mathfrak{S}}, \quad \Omega_m = \overset{\circ}{\mathfrak{K}\mathfrak{S}_m} \quad (43)$$

$$\partial\Omega = \partial\mathfrak{K}\mathfrak{S}, \quad \partial\Omega_m = \partial\mathfrak{K}\mathfrak{S}_m. \quad (44)$$

Integration on the Koch Snowflake

In order to define integration on $\mathfrak{K}\mathfrak{S}$, we will use properties of Jordan integrable sets. First, let us note that, for any natural integer m ,

$$\text{area}(\mathfrak{K}\mathfrak{C}_m) = 0.$$

Moreover,

$$\mathfrak{K}\mathfrak{C} \subset \bigcup_{m=0}^{\infty} \mathfrak{K}\mathfrak{C}_m.$$

Then,

$$\text{area}(\mathfrak{K}\mathfrak{C}) \leq \text{area}\left(\bigcup_{m \in \mathbb{N}} \mathfrak{K}\mathfrak{C}_m\right) \leq \sum_{m=0}^{\infty} \text{area}(\mathfrak{K}\mathfrak{C}_m) = 0.$$

Since the boundary $\partial\Omega = \mathfrak{K}\mathfrak{C} \cup \mathfrak{h}_1(\mathfrak{K}\mathfrak{C}) \cup \mathfrak{h}_2(\mathfrak{K}\mathfrak{C})$ is Lebesgue negligible, the set $\Omega = \mathfrak{K}\mathfrak{S}$ is Jordan measurable, and then Lebesgue measurable.

Accordingly, every characteristic function is integrable on $\mathfrak{K}\mathfrak{S}$:

$$\int_{\mathfrak{K}\mathfrak{S}} 1_A dX = \lambda(A \cap \mathfrak{K}\mathfrak{S})$$

for any subset $A \subset \mathbb{R}^2$ and Lebesgue measure λ . Moreover, by the fundamental theorem of approximation, we can define Lebesgue integrable functions over $\mathfrak{K}\mathfrak{S}$ if

$$\int_{\mathfrak{R}\mathfrak{S}} |f| dX < \infty$$

The definition of $L^p(\mathfrak{R}\mathfrak{S})$ spaces, $p \in [1, +\infty]$, follows.

INTEGRATION BY PARTS FORMULA

Let us recall the following identity for smooth functions over a smooth domain Ω

$$\int_{\Omega} \operatorname{div}(u) dX = \int_{\partial\Omega} u \cdot \vec{n} d\sigma$$

and its corollary

$$\int_{\Omega} \nabla u \nabla v dX = \int_{\partial\Omega} (\nabla u \cdot \vec{n}) v d\sigma - \int_{\Omega} \Delta u v dX.$$

Let us also recall that the set $\bar{\Omega} := \mathfrak{R}\mathfrak{S}$ is a compact set. As a consequence, every continuous function is bounded on it.

Let f be a continuous function on $\mathfrak{R}\mathfrak{S}$. We introduce the sequence of functions

$$(f_m)_{m \in \mathbb{N}} = (1_{\Omega_m} f)_{m \in \mathbb{N}}$$

where Ω_m is the set introduced in 42. We can check that

$$\begin{aligned} \lim_{m \rightarrow +\infty} f_m &= 1_{\Omega} f \\ |f_m| &\leq \|f\|_{C(\bar{\Omega})}. \end{aligned}$$

From the dominated convergence theorem, we have that

$$\lim_{m \rightarrow +\infty} \int f_m dX = \lim_{n \rightarrow +\infty} \int_{\Omega_m} f dX = \int 1_{\Omega} f dX = \int_{\Omega} f dX.$$

Let us consider two $C^2(\Omega)$ functions u and v . The integration by parts formula on the prefractal set enables us to obtain

$$\int_{\Omega_m} \nabla u \nabla v dX = \int_{\partial\Omega_m} (\nabla u \cdot \vec{n}) v d\sigma - \int_{\Omega_m} \Delta u v dX.$$

We then apply the dominated convergence argument to obtain

$$\int_{\Omega} \nabla u \nabla v dX = \int_{\partial\Omega} (\nabla u \cdot \vec{n}) v d\sigma - \int_{\Omega} \Delta u v dX \quad (45)$$

Consequently, the classical formula holds, provided that we give a suitable definition of normal derivative over $\mathfrak{R}\mathfrak{S}$.

NORMAL DERIVATIVE

In order to derive the explicit normal derivative $\partial_n u = \nabla u \cdot \vec{n}$ we use and recursive definition of the Dirichlet form $\mathcal{E}(u, v) = \int_{\Omega} \nabla u \nabla v \, dX$, to this end, we need the sequence of points $(V'_m)_{m \in \mathbb{N}}$ from a uniform discretization of the boundary $(\partial \mathfrak{K} \mathfrak{S}_m)_{m \in \mathbb{N}}$ such that $V'_m = V_m \cup \mathfrak{h}_1(V_m) \cup \mathfrak{h}_2(V_m)$:

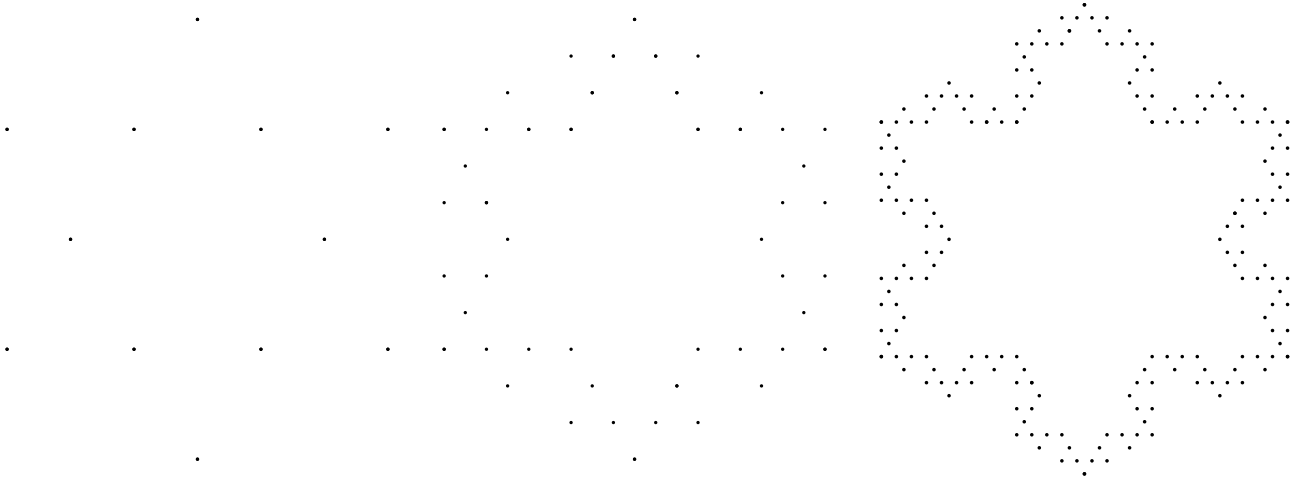
Figure 38: V'_1 , V'_2 and V'_3 .

and a sequence of points $(V''_m)_{m \in \mathbb{N}}$ from a uniform discretization mesh of the sets $(\mathfrak{K} \mathfrak{S}_m)_{m \in \mathbb{N}}$ (see the FEM section):

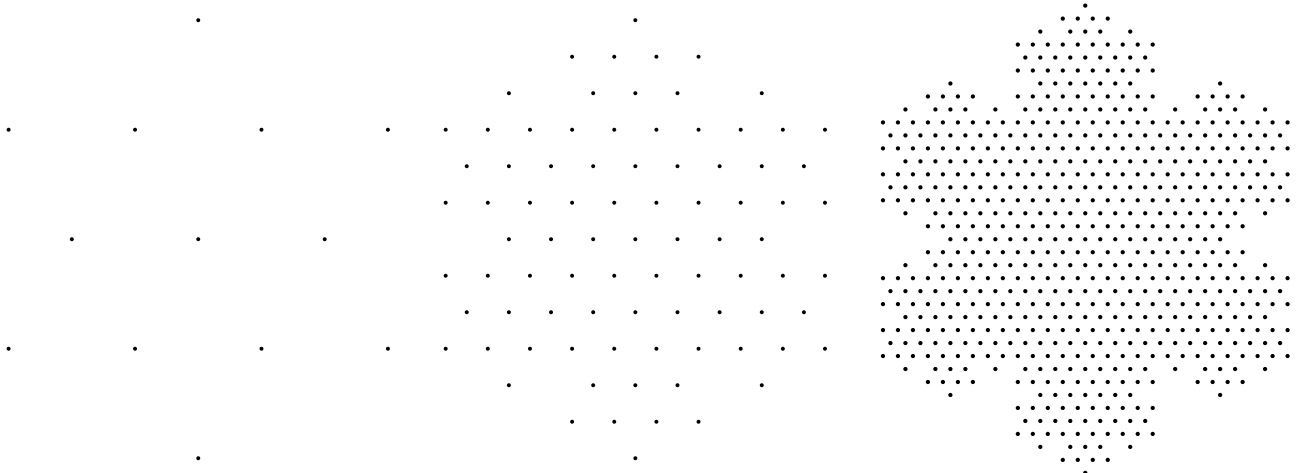
Figure 39: V''_1 , V''_2 and V''_3 .

Every interior point has six neighbors forming a hexagon, where every point has a distance $\delta_m = \mathcal{O}(3^{-m})$ with his neighbors:

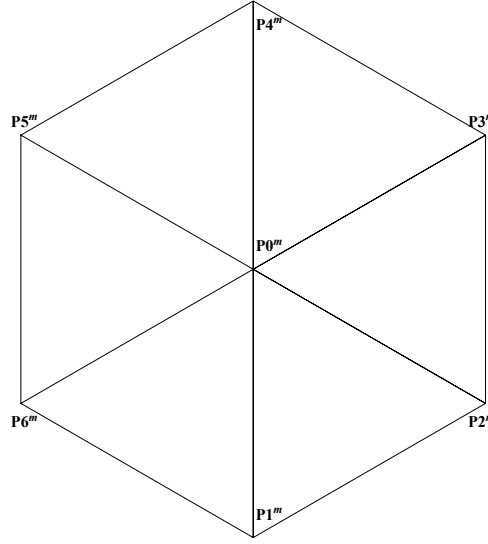
Figure 40: Hexagonal neighbor of interior point P_0 .

We define the operator **carré du champs** as the limit:

$$\gamma[u, v](X) = \lim_{m \rightarrow +\infty} \frac{1}{3} \sum_{Y \sim X}^m \frac{(u(X) - u(Y))(v(X) - v(Y))}{\delta_m^2}$$

where $\sum_{Y \sim X}^m$ means the sum over the neighbors of X . If we take the example of the figure 40, and two differentiable functions u and v , we can show that

$$\begin{aligned} \lim_{m \rightarrow +\infty} \frac{(u(P_0) - u(P_1^m))(v(P_0) - v(P_1^m))}{\delta_m^2} &= \lim_{m \rightarrow +\infty} \frac{(u(P_0) - u(P_4^m))(v(P_0) - v(P_4^m))}{\delta_m^2} \\ &= \langle \nabla u, \vec{e}_y \rangle \langle \nabla v, \vec{e}_y \rangle \end{aligned}$$

$$\begin{aligned} \lim_{m \rightarrow +\infty} \frac{(u(P_0) - u(P_3^m))(v(P_0) - v(P_3^m))}{\delta_m^2} &= \lim_{m \rightarrow +\infty} \frac{(u(P_0) - u(P_6^m))(v(P_0) - v(P_6^m))}{\delta_m^2} \\ &= \langle \nabla u, \cos(\alpha)\vec{e}_x + \sin(\alpha)\vec{e}_y \rangle \langle \nabla v, \cos(\alpha)\vec{e}_x + \sin(\alpha)\vec{e}_y \rangle \end{aligned}$$

$$\begin{aligned} \lim_{m \rightarrow +\infty} \frac{(u(P_0) - u(P_2^m))(v(P_0) - v(P_2^m))}{\delta_m^2} &= \lim_{m \rightarrow +\infty} \frac{(u(P_0) - u(P_5^m))(v(P_0) - v(P_5^m))}{\delta_m^2} \\ &= \langle \nabla u, \cos(\alpha)\vec{e}_x - \sin(\alpha)\vec{e}_y \rangle \langle \nabla v, \cos(\alpha)\vec{e}_x - \sin(\alpha)\vec{e}_y \rangle \end{aligned}$$

Since $\alpha = \frac{\pi}{6}$, we obtain, after simplification,

$$\begin{aligned} \gamma[u, v](X) &= \lim_{m \rightarrow +\infty} \frac{1}{3} \sum_{Y \sim X}^m \frac{(u(X) - u(Y))(v(X) - v(Y))}{\delta_m^2} \\ &= \frac{1}{3} (3 \langle \nabla u(X), \nabla v(X) \rangle) \\ &= \langle \nabla u(X), \nabla v(X) \rangle . \end{aligned}$$

Let us now introduce the Dirichlet form

$$\begin{aligned}\mathcal{E}(u, v) &= \int_{\Omega} \gamma[u, v] dX \\ &= \int_{\Omega} \nabla u \cdot \nabla v dX.\end{aligned}$$

For a continuous function f , it is known that

$$\int_{\Omega} f dX = \lim_{m \rightarrow +\infty} \sum_i f(X^i) \lambda(T_m^i).$$

for $X^i \in T_m^i$, where T_m^i is a triangle of the mesh and λ the Lebesgue measure. To derive the limit expression of \mathcal{E} , we use the mean value over the vertices on the boundary of every triangle T_m^i ,

$$\begin{aligned}\int_{\Omega} f dX &= \lim_{m \rightarrow +\infty} \sum_i \frac{1}{3} \sum_{k=1}^3 f(X_k^i) \lambda(T_m^i) \\ &= \lim_{m \rightarrow +\infty} \sum_i \frac{1}{3} \sum_{k=1}^3 f(X_k^i) \frac{\delta_m^2}{2} \\ &= \lim_{m \rightarrow +\infty} \sum_{X \in V''_m} f(X) \delta_m^2\end{aligned}$$

by using the fact that the measure of every triangle T_m is $\frac{\delta_m^2}{2}$, and that every vertex X appears in six triangles. Back to the Dirichlet form, we obtain that

$$\begin{aligned}\mathcal{E}(u, v) &= \int_{\Omega} \gamma[u, v] dX \\ &= \lim_{m \rightarrow +\infty} \sum_{X \in V_m} \gamma[u, v](X) \delta_m^2 \\ &= \lim_{m \rightarrow +\infty} \sum_{X \in V_m} \left(\frac{1}{3} \sum_{Y \sim_m X} \frac{(u(X) - u(Y))(v(X) - v(Y))}{\delta_m^2} \right) \delta_m^2 \\ &= \lim_{m \rightarrow +\infty} \sum_{X \in V_m} \frac{1}{3} \sum_{Y \sim_m X} (u(X) - u(Y))(v(X) - v(Y)) \\ &= \lim_{m \rightarrow +\infty} \frac{2}{3} \sum_{\substack{X \sim Y \\ m}} (u(X) - u(Y))(v(X) - v(Y))\end{aligned}$$

where $\sum_{Y \sim_m X}$ means the sum over the neighbours of X , and $\sum_{X \sim_m Y}$ the sum over all the couple (X, Y) . In particular, we have that

$$\mathcal{E}(u) = \lim_{m \rightarrow +\infty} \frac{2}{3} \sum_{\substack{X \sim Y \\ m}} (u(X) - u(Y))^2.$$

Let us now define the m^{th} Dirichlet form on Ω_m , as

$$\mathcal{E}_m(u) = \frac{2}{3} \sum_{X \sim_m Y} (u(X) - u(Y))^2 .$$

By splitting the terms, we can show that

$$\begin{aligned} \mathcal{E}_m(u, v) &= \frac{2}{3} \sum_{X \sim_m Y} (u(X) - u(Y)) (v(X) - v(Y)) \\ &= -\frac{2}{3} \sum_{X \in V''_m, X \notin V'_m} v(X) \sum_{Y \sim_m X} (u(Y) - u(X)) \\ &\quad + \frac{2}{3} \sum_{X \in V'_m} v(X) \sum_{Y \sim_m X} (u(X) - u(Y)) \\ &= - \sum_{X \in V''_m, X \notin V'_m} v(X) \left(\sum_{Y \sim_m X} \frac{2}{3\delta_m^2} (u(Y) - u(X)) \right) \delta_m^2 \\ &\quad + \frac{1}{3} \sum_{X \in V'_m} v(X) \left(\sum_{Y \sim_m X} \frac{(u(X) - u(Y))}{\delta_m} \right) \delta_m . \end{aligned}$$

By passing through the limit, we then obtain that

$$\begin{aligned} \mathcal{E}(u, v) &= - \lim_{m \rightarrow +\infty} \sum_{X \in V''_m, X \notin V'_m} v(X) \left(\sum_{Y \sim_m X} \frac{2}{3\delta_m^2} (u(Y) - u(X)) \right) \delta_m^2 \\ &\quad + \lim_{m \rightarrow +\infty} \frac{1}{3} \sum_{X \in V'_m} v(X) \left(\sum_{Y \sim_m X} \frac{(u(X) - u(Y))}{\delta_m} \right) \delta_m \\ &= - \int_{\Omega} \Delta u v dX + \int_{\partial\Omega} \partial_n u v dX . \end{aligned}$$

We have the following theorem:

Theorem 4.1.2. Normal Derivatives on a Fractal Boundary

If $u \in C^2(\overline{\Omega})$, then the normal derivative of u on the boundary exists as a linear continuous functional on $C^1(\overline{\Omega})$ defined by

$$\int_{\partial\Omega} \partial_n u v dX = \int_{\Omega} \Delta u v dX + \int_{\partial\Omega} \nabla u \nabla v dX, \quad \forall v \in C^1(\overline{\Omega}).$$

Proof.

The continuity follows from

$$\begin{aligned} \left| \int_{\partial\Omega} \partial_n u v \, dX \right| &\leq \|\Delta u\|_{L^2(\Omega)} \|v\|_{L^2(\Omega)} + \|\nabla u\|_{L^2(\Omega)} \|\nabla v\|_{L^2(\Omega)} \\ &\leq C \left(\|\Delta u\|_{L^2(\Omega)} + \|\nabla u\|_{L^2(\Omega)} \right) \|v\|_{C^1(\bar{\Omega})} \end{aligned}$$

□

4.1.3 Sobolev Spaces, Trace and Weak Formulation

(ϵ, δ) -Domains, John Domains and d -sets

To solve the weak formula, we need results from integration, Sobolev spaces, and traces of functions on domains with fractal boundary. Since the boundary is not Lipschitz, we cannot apply the traditional calculus, and especially the Gauss-Green formula.

Alf Jonsson and Hans Wallin give in [JW84] a panoply of theorems on so-called d -sets, including self-similar curves:

Definition 4.1.1. (ϵ, δ) -Domains [Jon81]

An open connected subset $\Omega \subset \mathbb{R}^n$ is an (ϵ, δ) -domain, $0 < \epsilon, 0 < \delta \leq \infty$, if whenever $X, Y \in \Omega$ and $|X - Y| < \delta$, there is a rectifiable arc $\gamma \in \Omega$ with length $l(\gamma)$ joining X to Y and satisfying

1. $l(\gamma) \leq \frac{|X - Y|}{\epsilon}$.
2. $d(Z, \partial\Omega) \geq \frac{\epsilon |X - Z| |Y - Z|}{|X - Y|}$ for all $Z \in \gamma$.

Definition 4.1.2. John Domains [Joh61]

An open connected subset $\Omega \subset \mathbb{R}^n$ is a **John domain**, if there exists $\alpha, \beta > 0$, and a point $X \in \Omega$ called the **center of** Ω such that for every $Y \in \Omega$ we can find a rectifiable arc $\gamma \in \Omega$ with length $l(\gamma) \leq \beta$ joining X to Y and satisfying

$$d(Z, \partial\Omega) \geq \alpha l(\gamma(Z, Y)) \quad \text{for all } Z \in \gamma.$$

Remark 4.1.1. [JW84]

(ϵ, δ) -domains are John domains.

The Koch Snowflake $\mathfrak{K}\mathfrak{S}$ is an (ϵ, δ) -domain, and a John domain.

See figure 41 for an illustration.

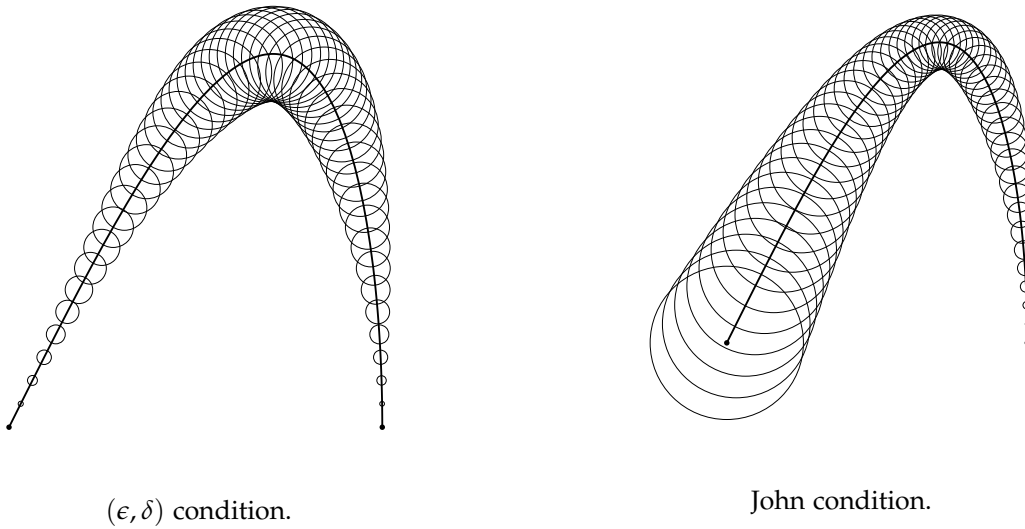
Figure 41: (ϵ, δ) domain and John domain.**Definition 4.1.3. d -Measure [JW84]**

Let us denote by F be a closed non-empty subset of \mathbb{R}^n and d a real number such that $0 < d \leq n$. The closed ball with center X and radius r is denoted by $B(x, r)$. A positive Borel measure μ with support F , is called a **d -measure on F** if, for some constants $c_1, c_2 > 0$,

$$c_1 r^d \leq \mu(B(X, r)) \leq c_2 r^d \quad \text{for } X \in F, \quad 0 < r \leq 1.$$

Definition 4.1.4. d -Set [JW84]

A closed, non-empty subset F of \mathbb{R}^n is a **d -set** ($0 < d \leq n$) if there exists a d -measure on F .

Theorem 4.1.3. [JW84]

The self-similar sets of \mathbb{R}^n with Hausdorff dimension D_H are d -sets for the invariant measure μ , where $d = D_H$.

Function Spaces and Trace Theorem

In the following, we recall the definition of some functional spaces:

Definition 4.1.5. Sobolev spaces [Eva10]

Let us denote by Ω an open subset of \mathbb{R}^n , by α an integer. Let us consider $1 \leq p \leq \infty$. The Sobolev space $W_p^\alpha(\Omega)$ is the space of locally summable functions f such that for each multi-index k with $|k| \leq \alpha$, $D^k f$ exists in the weak sense and belongs to $L^p(\Omega)$.

Definition 4.1.6. Hölder Spaces [Eva10]

Let us denote by Ω an open subset of \mathbb{R}^n , $\alpha > 0$ and k an integer such that $k < \alpha \leq k + 1$. The Hölder space $C^{k,\alpha-k}(\overline{\Omega})$ is the space of $C^k(\overline{\Omega})$ functions f for which the norm

$$\|f\|_{C^{k,\alpha-k}} = \sum_{|j| \leq k} \|D^j f\|_{C(\overline{\Omega})} + \sum_{|j|=k} \sup_{h \in \Omega} \frac{|D^j f(X+h) - D^j f(X)|}{|h|^{\alpha-k}}$$

is finite.

Definition 4.1.7. Besov Spaces [JW84]

Given an open subset Ω of \mathbb{R}^n , $\alpha > 0$, $1 \leq p, q \leq \infty$, along with an integer k such that $0 \leq k < \alpha \leq k + 1$, the Besov space, or (Hölder spaces in L^p -norm) $B_\alpha^{p,q}(\Omega)$ is the set of $L^p(\Omega)$ functions f for which the norm

$$\|f\|_{B_\alpha^{p,q}} = \sum_{|j| \leq k} \|D^j f\|_{L^p} + \sum_{|j|=k} \left(\int_{\mathbb{R}^n} \frac{\|D^j f(X+h) - D^j f(X)\|_{L^p}^q}{|h|^{n+(\alpha-k)q}} dh \right)^{\frac{1}{q}}$$

is finite.

Proposition 4.1.4. [JW84]

The space $B_\alpha^{p,q}(\Omega)$ is a Banach space for the norm $\|\cdot\|_{B_\alpha^{p,q}}$ and if $1 \leq p, q < \infty$, then $\mathcal{D}(\Omega)$, the space of infinitely differentiable functions with compact support on Ω , is dense in $B_\alpha^{p,q}(\Omega)$.

Definition 4.1.8. Besov Spaces on d -Sets [JW84]

Let $0 < \alpha < 1$, $1 \leq p \leq \infty$ and F a d -set with respect to the d -measure μ . A function f belongs to the Besov space $B_\alpha^{p,p}(F)$ if and only if it has finite norm

$$\|f\|_{B_\alpha^{p,p}} = \|f\|_{L_\mu^p} + \left(\int \int_{|X-Y| < 1} \frac{|f(X) - f(Y)|^p}{|h|^{d+\alpha p}} d\mu(X) d\mu(Y) \right)^{\frac{1}{p}}.$$

Theorem 4.1.5. Rellich Embedding Theorem for John Domains [CRW13]

If $1 \leq p < \infty$ and Ω a John domain of \mathbb{R}^n , then the injection

$$W_p^1(\Omega) \rightarrow L^p(\Omega)$$

is compact.

As a consequence, we have the following Poincaré inequality (for a more general result, we refer to [CDMP19]):

Theorem 4.1.6. Poincaré Inequality for John Domains

Let us denote by Ω a John domain of \mathbb{R}^n . Then, there exists a constant $C > 0$ such that

$$\|f\|_{L^2(\Omega)} \leq C \|\nabla f\|_{L^2(\Omega)}$$

for every $f \in H_0^1(\Omega)$.

Proof.

Let us assume that the Poincaré inequality is not verified, then we can find $(u_n)_{n \in \mathbb{N}}$ in $H_0^1(\Omega)$ such that, for every $n \in \mathbb{N}$

$$\begin{aligned} \|u_n\|_{L^2(\Omega)} &= 1 \\ \|u_n\|_{L^2(\Omega)} &\geq n \|\nabla u_n\|_{L^2(\Omega)} \end{aligned}$$

On the one hand, $\|\nabla u_n\|_{L^2(\Omega)} \leq \frac{1}{n}$ and $\nabla u_n \rightarrow 0$ in $L^2(\Omega)$.

In particular, the sequence $(u_n)_{n \in \mathbb{N}}$ is bounded in $H^1(\Omega)$. By using the Rellich theorem, we can extract a sub-sequence $(u_{n_k})_{k \in \mathbb{N}}$ converging in $L^2(\Omega)$ to a function $u \in L^2(\Omega)$.

In the other hand, by continuity of derivation in the distribution sense, this means that

$$\begin{aligned} u_k &\rightarrow u && \text{in } \mathcal{D}'(\Omega) \\ \nabla u_k &\rightarrow \nabla u && \text{in } \mathcal{D}'(\Omega). \end{aligned}$$

By uniqueness of the weak limit $\nabla u = 0$, since Ω is connected and $u \in H_0^1(\Omega)$, we deduce that $u = 0$.

□

Now, we introduce a trace theorem theorem for d -sets. Let us recall that the trace operator of a function f on a set F is the operator

$$\mathbf{R} : f \rightarrow f|_F$$

and that the extension operator of a function g , defined on F , to \mathbb{R}^n , yields

$$\mathbf{E} : g \rightarrow \mathbf{E}g \quad \text{such that} \quad (\mathbf{E}g)|_F = g.$$

Theorem 4.1.7. Trace of Sobolev Spaces on d -Sets [JW84]

Let us denote by F a d -set with respect to the d -measure μ , α an integer, $0 < d < n$, $0 < \beta = \alpha - \frac{n-d}{p}$ and $1 < p < \infty$. Then, the restriction operator

$$W_p^\alpha(\mathbb{R}^n)|_F = B_\beta^{p,p}(F)$$

where $W_p^\alpha(\mathbb{R}^n)$ is the Sobolev space on \mathbb{R}^n , is a linear bounded operator.

Theorem 4.1.8. Jones Extension Theorem of Sobolev Spaces [Jon81]

If $\Omega \subset \mathbb{R}^n$ is an (ϵ, δ) -domain, then there exists a linear bounded extension operator

$$W_p^\alpha(\Omega) \rightarrow W_p^\alpha(\mathbb{R}^n)$$

for $1 \leq p \leq \infty$ and $\alpha \geq 0$.

Corollary 4.1.9. Trace operator [Wal91]

Let $\Omega \subset \mathbb{R}^n$ be an (ϵ, δ) -domain, $\partial\Omega$ a d -set with respect to a d -measure μ , α an integer, $0 < d < n$, $0 < \beta = \alpha - \frac{n-d}{p}$ and $1 < p < \infty$. If $\partial\Omega$ preserves Markov's inequality, that is $d > n - 1$, Then

$$W_p^\alpha(\Omega)|_{\partial\Omega} = B_\beta^{p,p}(\partial\Omega)$$

and the trace operator is a linear bounded surjection; (see [Wal91], Proposition 4, page 120).

Integration by Parts Formula

Now, we have all the ingredients necessary to obtain the integration by parts. Recall from remark 4.1.1 that Koch snowflake $\Omega = \mathfrak{K}\mathfrak{C}$ is an (ϵ, δ) -domain with a d -set boundary $\partial\Omega$, with $d = \frac{\ln(4)}{\ln(3)}$ since

$$\begin{aligned} D_H(\partial\Omega) &= D_H(\mathfrak{K}\mathfrak{C} \cup \mathfrak{h}_1(\mathfrak{K}\mathfrak{C}) \cup \mathfrak{h}_2(\mathfrak{K}\mathfrak{C})) \\ &= \max(D_H(\mathfrak{K}\mathfrak{C}), D_H(\mathfrak{h}_1(\mathfrak{K}\mathfrak{C})), D_H(\mathfrak{h}_2(\mathfrak{K}\mathfrak{C}))) \\ &= D_H(\mathfrak{K}\mathfrak{C}) \\ &= \frac{\ln(4)}{\ln(3)} \end{aligned}$$

where we used countable stability of Hausdorff dimension [Fal14].

Theorem 4.1.10. Density

Let us denote by $\overline{\Omega}$ the Koch Snowflake set introduced before. For every $u \in H^1(\Omega)$, there exists a sequence of functions $(u_k)_{k \in \mathbb{N}} \subset C^\infty(\overline{\Omega})$ such that

$$\lim_{k \rightarrow +\infty} \|u - u_k\|_{H^1(\Omega)} = 0.$$

Proof.

From the Jones extension theorem, there exist an extension $\bar{u} \in H^1(\mathbb{R}^2)$ such that $\bar{u}|_{\Omega} = u$ and $\|\bar{u}\|_{H^1(\mathbb{R}^2)} \leq \|u\|_{H^1(\Omega)}$. So we can choose a function $\rho \in C^\infty(\mathbb{R}^2)$ such that

$$\begin{aligned} \rho(x) &\geq 0 && \text{for } x \in \mathbb{R}^2 \\ \rho(x) &= 0 && \text{for } \|x\| \geq 1 \\ \int_{\mathbb{R}^2} \rho \, dx &= 1. \end{aligned}$$

and define the mollifier $\rho_k = k^2 \rho(kx)$, then the sequence of terms $u_k = (\bar{u} \star \rho_k)$ verify the theorem. \square

Now, we obtain the main theorem of this section.

Theorem 4.1.11. Integration by Parts

Let us denote by u and v two functions in $H^1(\Omega)$ with fractal boundary $\partial\Omega$, and $\Delta u \in L^2(\Omega)$. Then the following integration by parts holds:

$$\int_{\Omega} \Delta u \, v \, dx = - \int_{\Omega} \nabla u \, \nabla v \, dx + \int_{\partial\Omega} \partial_n u|_{\partial\Omega} \, v|_{\partial\Omega} \, dx$$

Proof.

It follows immediately from the density theorem 4.1.10 that there exists two sequences $(u_k)_{k \in \mathbb{N}}$ and $(v_k)_{k \in \mathbb{N}}$ of $C^\infty(\bar{\Omega})$ such that

$$\lim_{k \rightarrow +\infty} \|u - u_k\|_{H^1(\Omega)} = 0, \quad \lim_{k \rightarrow +\infty} \|v - v_k\|_{H^1(\Omega)} = 0.$$

The integration by parts result 45 gives

$$\int_{\Omega} \Delta u_k \, v_k \, dx = - \int_{\Omega} \nabla u_k \, \nabla v_k \, dx + \int_{\partial\Omega} \partial_n u_k \, v_k \, dx.$$

By using the trace theorem 4.1.9, for $p = 2$, $\alpha = 1$ and $\beta = \frac{D_H}{2}$, passing through the limit using dominated convergence, we obtain that

$$\int_{\Omega} \Delta u \, v \, dx = - \int_{\Omega} \nabla u \, \nabla v \, dx + \int_{\partial\Omega} \partial_n u|_{\partial\Omega} \, v|_{\partial\Omega} \, dx.$$

\square

Theorem 4.1.12. Normal Derivatives on a Fractal Boundary [Lano2]

If $u \in H^1(\Omega)$ and $\Delta u \in L^2(\Omega)$, then the normal derivative of u on the boundary exists as a linear continuous functional on $B_{\frac{D_H(\partial\Omega)}{2}}^{2,2}(\partial\Omega)$, where $B_\alpha^{p,p}$ is the Besov space introduced in definition 4.1.8 with

$$D_H(\partial\Omega) = \frac{\ln(4)}{\ln(3)}, \text{ and defined by}$$

$$\langle \partial_n u, v|_{\partial\Omega} \rangle = \int_{\Omega} \Delta u v dX + \int_{\Omega} \nabla u \nabla v dX, \quad \forall v \in H^1(\Omega).$$

4.1.4 Solution of the Membrane Problem on a Domain with Fractal Boundary

We can now consider the variational Dirichlet problem, by taking $v \in \mathcal{D}(\Omega)$

$$\int_{\Omega} h \nabla u \nabla v dX = \int_{\Omega} f v dX \quad (46)$$

for $h \in L^\infty(\Omega)$ such that $h_{\min} \leq h \leq h_{\max}$, and Ω a (ϵ, δ) -domain delimited by a d-set, in particular, the Koch Snowflake. We can now show that this equation admits a weak solution in $H^1(\Omega)$.

The bilinear form $a(u, v) = \int_{\Omega} h \nabla u \nabla v dX$ is symmetric and continuous:

$$\begin{aligned} a(u, v) &= \int_{\Omega} h \nabla u \nabla v dX \\ &\leq h_{\max} \|\nabla u\|_{L^2(\Omega)} \|\nabla v\|_{L^2(\Omega)} \\ &\leq C_1 \|u\|_{H^1(\Omega)} \|v\|_{H^1(\Omega)} \end{aligned}$$

where $C_1 = h_{\max}$, and coercive

$$\begin{aligned} a(u, u) &= \int_{\Omega} h |\nabla u|^2 dX \\ &\geq h_{\min} \|\nabla u\|_{L^2(\Omega)}^2 \\ &\geq C_2 \|u\|_{H^1(\Omega)}^2 \end{aligned}$$

where $C_2 = \frac{h_{\min}}{(C+1)}$ and C is Poincaré constant.

It is clear that the form $\int_{\Omega} f v dX$ is linear and continuous. So we can deduce by Lax-Milgram theorem that the problem admits a unique solution in the Hilbert space $H_0^1(\Omega)$.

4.2 THE FINITE ELEMENT METHOD FOR THE KOCH SNOWFLAKE

Let us again consider the Dirichlet membrane problem in the variational form:

$$\int_{\Omega} h \nabla u \nabla v dX = \int_{\Omega} f v dX \quad (47)$$

For the benefit of the reader who may not be familiar with mathematical notions devoted to Lagrange finite elements, we shall first recall several definitions (see [All12] for further details).

Definition 4.2.1. Lagrange finite element

A **Lagrange finite element** is a triplet (K, Σ, P) such that

- K is a compact, convex, and non empty interior.
- $\Sigma = \{a_1, \dots, a_N\}$, $N \in \mathbb{N}^*$, is a finite set of (distinct) points of K .
- P is a function vector space of finite dimension defined on K , such that Σ is unisolvent in the sens of definition 4.2.2.

Definition 4.2.2. Local Basic Function

Let us denote by (K, Σ, P) a Lagrange finite element. We call **local basic functions** the N functions e_i ($i = 1, \dots, N$) of P such that

$$e_i(a_j) = \delta_{ij} \quad 1 \leq i, j \leq N$$

The N -uplet (e_1, \dots, e_N) is a base of P .

We call the **P -interpolation operator** on Σ the operator π_K which, for every function g on K , gives $\pi_K g$ defined as

$$\pi_K g = \sum_{i=1}^N g(a_i) e_i$$

This function $(\pi_K g)$ is the unique element of P taking the same values as g on Σ .

Definition 4.2.3. Triangular Mesh

Given a polyhedral, connected, open $\Omega \subset \mathbb{R}^n$, a **triangular mesh** of $\overline{\Omega}$ is a set \mathcal{T}_δ of N -simplices $(\mathcal{T}_i)_{1 \leq i \leq N}$ such that

- $\mathcal{T}_i \subset \overline{\Omega}$ and $\bigcup_{1 \leq i \leq N} \mathcal{T}_i = \overline{\Omega}$.
- $\mathcal{T}_i \cap \mathcal{T}_j$ is an m -simplex, $0 \leq m \leq n - 1$, whose vertices are vertices of \mathcal{T}_i and \mathcal{T}_j .
- $\delta = \max_{i=1, \dots, N} |\mathcal{T}_i|$ is the maximum diameter.

Definition 4.2.4. Triangular Lagrange Finite Element

Given a triangular mesh \mathcal{T}_δ of a polyhedral, connected, open $\Omega \subset \mathbb{R}^n$. **The Triangular Lagrange finite element of k -order**, associated to this mesh, is defined by the discrete spaces

$$\begin{aligned} V_\delta &= \{v \in C(\overline{\Omega}) \mid v|_{\mathcal{T}_i} \in \mathbb{P}_k \quad \forall \mathcal{T}_i \in \mathcal{T}_\delta\} \\ \tilde{V}_\delta &= \{v \in V_\delta \mid v|_{\partial\Omega} = 0\} . \end{aligned}$$

where \mathbb{P}_k is the space of polynomials of order $\leq k$.

The problem of applying the triangular Lagrange finite element is that the boundary $\partial\Omega$ is a self-similar set, which implies that the triangulation mesh is not an easy task. A solution of this problem is to approximate $\partial\Omega$ by an increasing sequence of regular curves which converges towards it.

4.2.1 \mathbb{P}_1 Finite Element on a Uniform Mesh

Let us start with a finite set of points:

$$\begin{aligned}
 P_1 &= (0, -1), & P_2 &= \left(-\frac{\sqrt{3}}{2}, -\frac{1}{2}\right), & P_3 &= \left(-\frac{1}{2\sqrt{3}}, -\frac{1}{2}\right), & P_4 &= \left(\frac{1}{2\sqrt{3}}, -\frac{1}{2}\right) \\
 P_5 &= \left(\frac{\sqrt{3}}{2}, -\frac{1}{2}\right), & P_6 &= \left(-\frac{1}{\sqrt{3}}, 0\right), & P_7 &= (0, 0), & P_8 &= \left(\frac{1}{\sqrt{3}}, 0\right) \\
 P_9 &= \left(-\frac{\sqrt{3}}{2}, \frac{1}{2}\right), & P_{10} &= \left(-\frac{1}{2\sqrt{3}}, \frac{1}{2}\right), & P_{11} &= \left(\frac{1}{2\sqrt{3}}, \frac{1}{2}\right), & P_{12} &= \left(\frac{\sqrt{3}}{2}, \frac{1}{2}\right) \\
 P_{13} &= (0, 1)
 \end{aligned}$$

We then obtain the initial triangular mesh $\mathfrak{R}\mathfrak{S}_1$; see Figure 42.

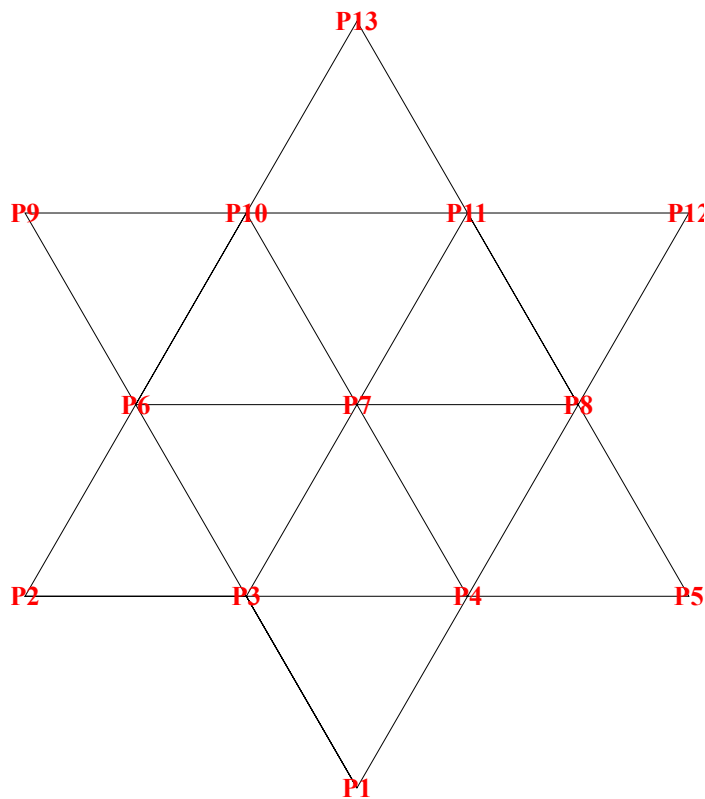

Figure 42: $\mathfrak{R}\mathfrak{S}_1$.

This provides us with the first set of vertices V''_1 .

Next, we use the successive discretization of the Koch Curve to fix the discretization diameter, so we can construct a uniform triangulation mesh of the whole Koch Snowflake (we plot in the next figure the vertices sequence V_m of this triangulation).

The Koch Curve discretization sequence $(\mathfrak{K}\mathcal{C}_m)_{m \in \mathbb{N}^*}$ is generated by starting with five points

$$P_9 = \left(-\frac{\sqrt{3}}{2}, \frac{1}{2}\right), \quad P_{10} = \left(-\frac{1}{2\sqrt{3}}, \frac{1}{2}\right), \quad P_{11} = \left(\frac{1}{2\sqrt{3}}, \frac{1}{2}\right), \quad P_{12} = \left(\frac{\sqrt{3}}{2}, \frac{1}{2}\right), \quad P_{13} = (0, 1)$$

and by using the similarities in section 4.1.1 to construct the recursion

$$\mathfrak{K}\mathcal{C}_m = \bigcup_{1 \leq i \leq 4} f_i(\mathfrak{K}\mathcal{C}_{m-1}).$$

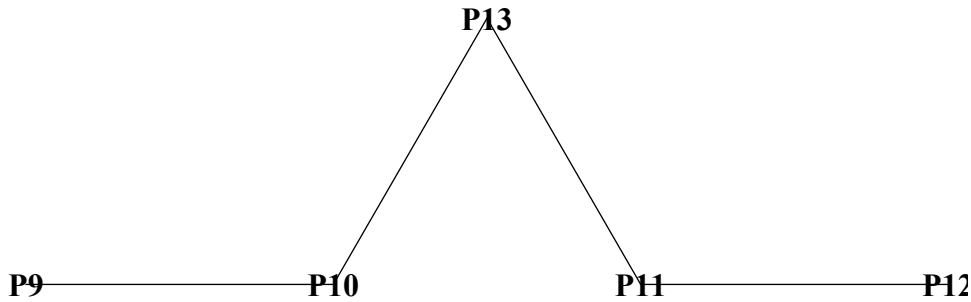

Figure 43: $\mathfrak{K}\mathcal{C}_1$.

By using the two rotations \mathfrak{h}_1 and \mathfrak{h}_2 , we obtain the sequence of boundary points $(V'_m)_{m \in \mathbb{N}}$.

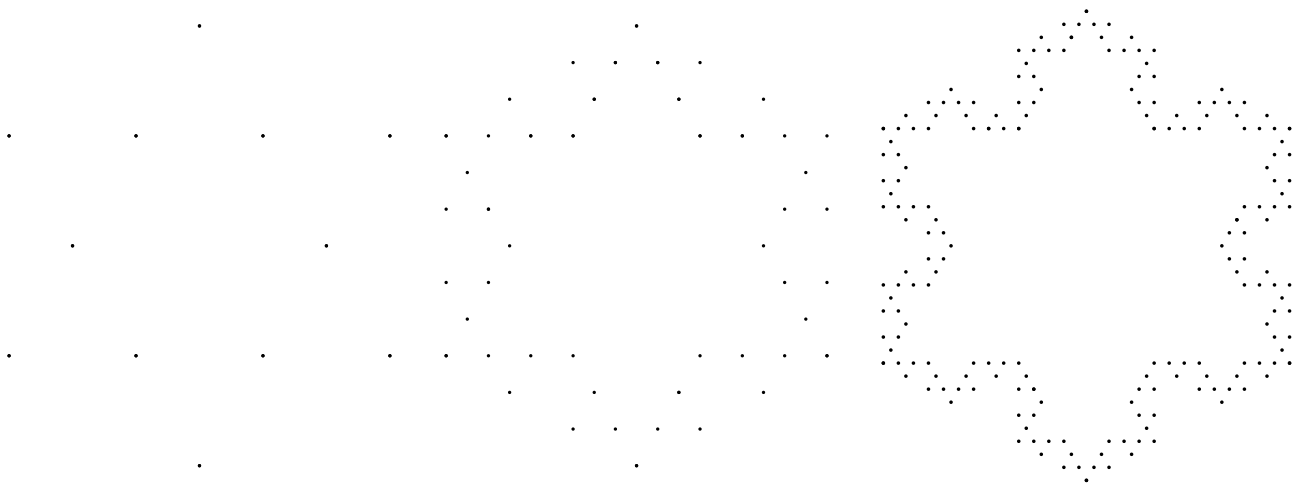

Figure 44: V'_1, V'_2 and V'_3 .

Using a uniform diameter $\delta = \delta_m = \frac{1}{3^m}$, we obtain the points of the discretization of the Snowflake $(V''_m)_{m \in \mathbb{N}}$.

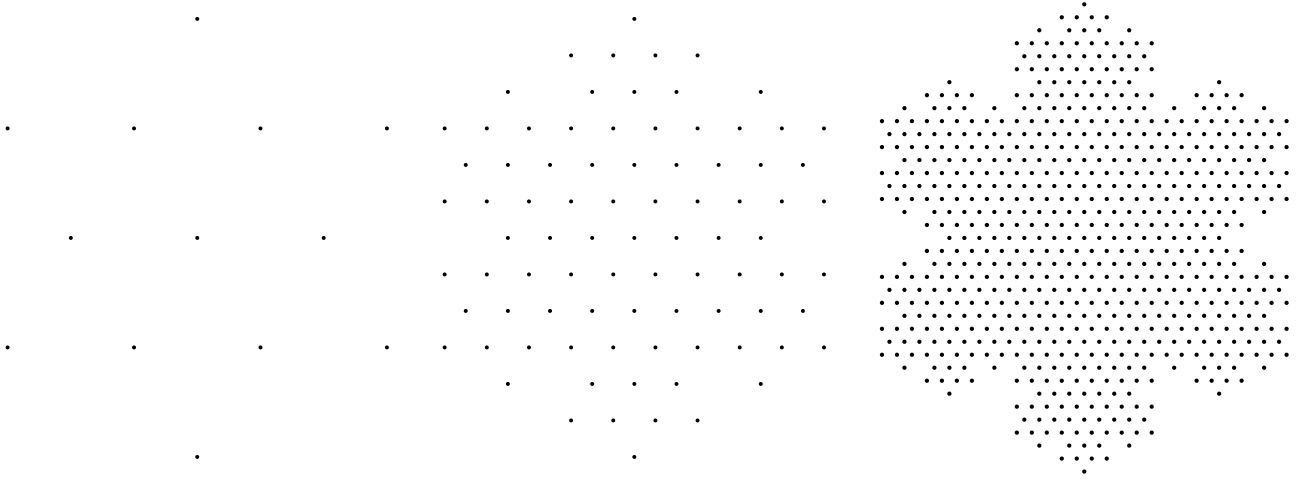

Figure 45: V''_1 , V''_2 and V''_3 .

Proposition 4.2.1. [LNRG96]

Given a natural integer m , let us denote respectively by \mathcal{N}'_m , the number of vertices of the triangulation of the boundary, and by $\mathcal{N}(\mathfrak{KS})_m$ and \mathcal{N}_m , the numbers of triangles and vertices of the Snowflake triangulation. We have that

$$\mathcal{N}'_1 = 12 \quad , \quad \mathcal{N}(\mathfrak{KS})_1 = 12, \quad \mathcal{N}_1 = 13,$$

and, for any strictly positive integer m :

$$\begin{aligned} \mathcal{N}'_m &= 3 \times 4^m \\ \mathcal{N}(\mathfrak{KS})_m &= \left(9^m + \frac{3}{5} (9^m - 4^m) \right) \\ \mathcal{N}_m &= \frac{\mathcal{N}'_m + \mathcal{N}(\mathfrak{KS})_m}{2} + 1. \end{aligned}$$

First, we calculate the respective areas $(|\mathcal{T}_i^m|)_{1 \leq i \leq \mathcal{N}(\mathfrak{KS})_m}$ of the m -order triangles $(\mathcal{T}_i^m)_{1 \leq i \leq \mathcal{N}(\mathfrak{KS})_m}$ (see Definition 4.2.3)

$$\begin{aligned} |\mathcal{T}^0| &= |P_2 P_5 P_{13}| = \frac{1}{2} \left(\frac{\sqrt{3}}{2} + \frac{\sqrt{3}}{2} \right) \times \left(1 + \frac{1}{2} \right) = \frac{3\sqrt{3}}{4} \\ |\mathcal{T}_i^1| &= \frac{|\mathcal{T}^0|}{9} = \frac{\sqrt{3}}{12} \\ |\mathcal{T}_i^m| &= \frac{|\mathcal{T}^0|}{9^m}. \end{aligned}$$

Given the discretization points V''_m , $m \in \mathbb{N}$, let $\mathcal{T}_l^m = P_a P_b P_c$, $1 \leq l \leq \mathcal{N}(\mathfrak{K}\mathfrak{S})_m$, be a triangle of the mesh, we define the **barycentric coordinates** λ_i^m ([Luc04]), $i = \{a, b, c\}$, such that, for all $X \in \mathbb{R}^2$

$$\sum_{i \in \{a, b, c\}} \lambda_i^m(X) = 1 \quad , \quad \sum_{i \in \{a, b, c\}} P_i \lambda_i^m(X) = X$$

For the initial triangle $\mathcal{T}^0 = P_2 P_5 P_{13}$, we compute

$$\begin{aligned} \nabla \lambda_2^0(X, Y) &= \frac{2}{3\sqrt{3}} \begin{pmatrix} -\frac{1}{2} - 1 \\ 0 - \frac{\sqrt{3}}{2} \end{pmatrix} = \begin{pmatrix} -\frac{1}{\sqrt{3}} \\ -\frac{1}{3} \end{pmatrix} \\ \nabla \lambda_5^0(X, Y) &= \frac{2}{3\sqrt{3}} \begin{pmatrix} 1 + \frac{1}{2} \\ -\frac{\sqrt{3}}{2} - 0 \end{pmatrix} = \begin{pmatrix} \frac{1}{\sqrt{3}} \\ -\frac{1}{3} \end{pmatrix} \\ \nabla \lambda_{13}^0(X, Y) &= \frac{2}{3\sqrt{3}} \begin{pmatrix} -\frac{1}{2} + \frac{1}{2} \\ \frac{\sqrt{3}}{2} + \frac{\sqrt{3}}{2} \end{pmatrix} = \begin{pmatrix} 0 \\ \frac{2}{3} \end{pmatrix} . \end{aligned}$$

$$\begin{aligned} \int_{\mathcal{T}_0} |\nabla \lambda_2^0|^2 dX dY &= \frac{1}{\sqrt{3}} \\ \int_{\mathcal{T}_0} |\nabla \lambda_5^0|^2 dX dY &= \frac{1}{\sqrt{3}} \\ \int_{\mathcal{T}_0} |\nabla \lambda_{13}^0|^2 dX dY &= \frac{1}{\sqrt{3}} \\ \int_{\mathcal{T}_0} \nabla \lambda_2^0 \nabla \lambda_5^0 dX dY &= -\frac{\sqrt{3}}{6} \\ \int_{\mathcal{T}_0} \nabla \lambda_2^0 \nabla \lambda_{13}^0 dX dY &= -\frac{\sqrt{3}}{6} \\ \int_{\mathcal{T}_0} \nabla \lambda_5^0 \nabla \lambda_{13}^0 dX dY &= -\frac{\sqrt{3}}{6} . \end{aligned}$$

Next, we can compute the integrals on the triangle $\mathcal{T}_2^1 = P_2 P_3 P_6$, for $P_2 = \left(-\frac{\sqrt{3}}{2}, -\frac{1}{2}\right)$, $P_3 = \left(-\frac{1}{2\sqrt{3}}, -\frac{1}{2}\right)$ and $P_6 = \left(-\frac{1}{\sqrt{3}}, 0\right)$:

$$\begin{aligned} \nabla \lambda_2^1(X, Y) &= 2\sqrt{3} \begin{pmatrix} -\frac{1}{2} - 0 \\ -\frac{1}{\sqrt{3}} + \frac{1}{2\sqrt{3}} \end{pmatrix} = \begin{pmatrix} -\sqrt{3} \\ -1 \end{pmatrix} = 3\nabla \lambda_2^0(X, Y) \\ \nabla \lambda_3^1(X, Y) &= 2\sqrt{3} \begin{pmatrix} 0 + \frac{1}{2} \\ -\frac{\sqrt{3}}{2} + \frac{1}{\sqrt{3}} \end{pmatrix} = \begin{pmatrix} \sqrt{3} \\ -1 \end{pmatrix} = 3\nabla \lambda_3^0(X, Y) \\ \nabla \lambda_6^1(X, Y) &= 2\sqrt{3} \begin{pmatrix} -\frac{1}{2} + \frac{1}{2} \\ -\frac{1}{2\sqrt{3}} + \frac{\sqrt{3}}{2} \end{pmatrix} = \begin{pmatrix} 0 \\ 2 \end{pmatrix} = 3\nabla \lambda_6^0(X, Y) . \end{aligned}$$

Thus,

$$\begin{aligned}
\int_{\mathcal{T}_2^1} |\nabla \lambda_2^1|^2 dX dY &= \frac{1}{\sqrt{3}} = \int_{\mathcal{T}^0} |\nabla \lambda_2^0|^2 dX dY \\
\int_{\mathcal{T}_2^1} |\nabla \lambda_3^1|^2 dX dY &= \frac{1}{\sqrt{3}} = \int_{\mathcal{T}^0} |\nabla \lambda_5^0|^2 dX dY \\
\int_{\mathcal{T}_2^1} |\nabla \lambda_6^1|^2 dX dY &= \frac{1}{\sqrt{3}} = \int_{\mathcal{T}^0} |\nabla \lambda_{13}^0|^2 dX dY \\
\int_{\mathcal{T}_2^1} \nabla \lambda_2^1 \nabla \lambda_3^1 dX dY &= -\frac{\sqrt{3}}{6} = \int_{\mathcal{T}^0} \nabla \lambda_2^0 \nabla \lambda_5^0 dX dY \\
\int_{\mathcal{T}_2^1} \nabla \lambda_2^1 \nabla \lambda_6^1 dX dY &= -\frac{\sqrt{3}}{6} = \int_{\mathcal{T}^0} \nabla \lambda_2^0 \nabla \lambda_{13}^0 dX dY \\
\int_{\mathcal{T}_2^1} \nabla \lambda_3^1 \nabla \lambda_6^1 dX dY &= -\frac{\sqrt{3}}{6} = \int_{\mathcal{T}^0} \nabla \lambda_5^0 \nabla \lambda_{13}^0 dX dY
\end{aligned}$$

In general, given the set $\mathfrak{K}\mathfrak{S}_m$, consider a triangle $\mathcal{T}_l^m = P_i P_j P_k$, $1 \leq l \leq \mathcal{N}(\mathfrak{K}\mathfrak{S})_m$, for some vertices $P_i = (X_i, Y_i)$, $P_j = (X_j, Y_j)$, $P_k = (X_k, Y_k)$. The barycentric coordinates are given by:

$$\begin{aligned}
\lambda_i^m(X, Y) &= \frac{1}{2|\mathcal{T}_l^m|} (X(Y_j - Y_k) + Y(X_k - X_j) + X_j Y_k - Y_j X_k) \\
\lambda_j^m(X, Y) &= \frac{1}{2|\mathcal{T}_l^m|} (X(Y_k - Y_i) + Y(X_i - X_k) + X_k Y_i - Y_k X_i) \\
\lambda_k^m(X, Y) &= \frac{1}{2|\mathcal{T}_l^m|} (X(Y_i - Y_j) + Y(X_j - X_i) + X_i Y_j - Y_i X_j)
\end{aligned}$$

and the corresponding gradients by

$$\begin{aligned}
\nabla \lambda_i^m(X, Y) &= \frac{1}{2|\mathcal{T}_l^m|} \begin{pmatrix} Y_j - Y_k \\ X_k - X_j \end{pmatrix} = \frac{2 \times 9^m}{3\sqrt{3}} \begin{pmatrix} Y_j - Y_k \\ X_k - X_j \end{pmatrix} = \frac{2 \times 9^m}{3\sqrt{3}} 3^{-m} \begin{pmatrix} Y_5 - Y_{13} \\ X_{13} - X_5 \end{pmatrix} \\
&= 3^m \nabla \lambda_2^0(X, Y) \\
\nabla \lambda_j^m(X, Y) &= \frac{1}{2|\mathcal{T}_l^m|} \begin{pmatrix} Y_k - Y_i \\ X_i - X_k \end{pmatrix} = \frac{2 \times 9^m}{3\sqrt{3}} \begin{pmatrix} Y_k - Y_i \\ X_i - X_k \end{pmatrix} = \frac{2 \times 9^m}{3\sqrt{3}} 3^{-m} \begin{pmatrix} Y_{13} - Y_1 \\ X_1 - X_{13} \end{pmatrix} \\
&= 3^m \nabla \lambda_5^0(X, Y) \\
\nabla \lambda_k^m(X, Y) &= \frac{1}{2|\mathcal{T}_l^m|} \begin{pmatrix} Y_i - Y_j \\ X_j - X_i \end{pmatrix} = \frac{2 \times 9^m}{3\sqrt{3}} \begin{pmatrix} Y_i - Y_j \\ X_j - X_i \end{pmatrix} = \frac{2 \times 9^m}{3\sqrt{3}} 3^{-m} \begin{pmatrix} Y_1 - Y_5 \\ X_5 - X_1 \end{pmatrix} \\
&= 3^m \nabla \lambda_{13}^0(X, Y)
\end{aligned}$$

We can deduce that

$$\begin{aligned}
\int_{\mathcal{T}_l^m} |\nabla \lambda_i^m|^2 dX dY &= 9^{-m} \int_{\mathcal{T}^0} 9^m |\nabla \lambda_2^0|^2 dX dY = \frac{1}{\sqrt{3}} \\
\int_{\mathcal{T}_l^m} |\nabla \lambda_j^m|^2 dX dY &= 9^{-m} \int_{\mathcal{T}^0} 9^m |\nabla \lambda_5^0|^2 dX dY = \frac{1}{\sqrt{3}} \\
\int_{\mathcal{T}_l^m} |\nabla \lambda_k^m|^2 dX dY &= 9^{-m} \int_{\mathcal{T}^0} 9^m |\nabla \lambda_{13}^0|^2 dX dY = \frac{1}{\sqrt{3}} \\
\int_{\mathcal{T}_l^m} \nabla \lambda_i^m \nabla \lambda_j^m dX dY &= 9^{-m} \int_{\mathcal{T}^0} 9^m \nabla \lambda_2^0 \nabla \lambda_5^0 dX dY = -\frac{\sqrt{3}}{6} \\
\int_{\mathcal{T}_l^m} \nabla \lambda_i^m \nabla \lambda_k^m dX dY &= 9^{-m} \int_{\mathcal{T}^0} 9^m \nabla \lambda_2^0 \nabla \lambda_{13}^0 dX dY = -\frac{\sqrt{3}}{6} \\
\int_{\mathcal{T}_l^m} \nabla \lambda_j^m \nabla \lambda_k^m dX dY &= 9^{-m} \int_{\mathcal{T}^0} 9^m \nabla \lambda_5^0 \nabla \lambda_{13}^0 dX dY = -\frac{\sqrt{3}}{6}.
\end{aligned}$$

Now, we can compute the cross product involving the local basic functions. The function h is taken as constant on every triangle \mathcal{T}_l^m , and given a local basic function e_i (definition 4.2.2) associated to a point P_i , we designate by $l(S)$ the triangle number l containing vertex P_i , $i \in S$. The following two configurations may occur:

1. The point P_i is an interior point, in which case

$$\begin{aligned}
\int_{\mathbb{R}^{\mathbb{S}}} h |\nabla e_i|^2 dX dY &= \sum_{l=1}^6 h_{l(i)} \int_{\mathcal{T}_l^m} |\nabla \lambda_i|^2 dX dY = \left(\sum_{l=1}^6 h_{l(i)} \right) \frac{1}{\sqrt{3}} \\
\int_{\mathbb{R}^{\mathbb{S}}} h \nabla e_i \nabla e_j dX dY &= \begin{cases} (h_{1(i,j)} + h_{2(i,j)}) \int_{\mathcal{T}_l^m} \nabla \lambda_i \nabla \lambda_j dX dY = (h_{1(i,j)} + h_{2(i,j)}) \frac{-\sqrt{3}}{6} \\ 0 & \text{If } \text{Supp}(e_i) \cap \text{Supp}(e_j) = \emptyset \end{cases}
\end{aligned}$$

2. The point P_i is a boundary point, two situations have then to be considered:

- (a) The point P_i has two adjacent vertices, in which case

$$\begin{aligned}
\int_{\mathbb{R}^{\mathbb{S}}} h |\nabla e_i|^2 dX dY &= h_l \int_{\mathcal{T}_l^m} |\nabla \lambda_i|^2 dX dY = h_l \frac{1}{\sqrt{3}} \\
\int_{\mathbb{R}^{\mathbb{S}}} h \nabla e_i \nabla e_j dX dY &= \begin{cases} h_l \int_{\mathcal{T}_l^m} \nabla \lambda_i \nabla \lambda_j dX dY = h_l \frac{-\sqrt{3}}{6} \\ 0 & \text{If } \text{Supp}(e_i) \cap \text{Supp}(e_j) = \emptyset \end{cases}
\end{aligned}$$

- (b) The point P_i has five adjacent vertices, in which case

$$\begin{aligned}
\int_{\mathbb{R}^{\mathbb{S}}} h |\nabla e_i|^2 dX dY &= \sum_{l=1}^5 h_{l(i)} \int_{\mathcal{T}_l^m} |\nabla \lambda_i|^2 dX dY = \left(\sum_{k=1}^5 h_k \right) \frac{1}{\sqrt{3}} \\
\int_{\mathbb{R}^{\mathbb{S}}} h \nabla e_i \nabla e_j dX dY &= \begin{cases} (h_1(i,j) + h_2(i,j)) \int_{\mathcal{T}_l^m} \nabla \lambda_i \nabla \lambda_j dX dY = (h_k + h_l) \frac{-\sqrt{3}}{6} & \text{If } P_j \text{ is an interior point} \\ h_l \int_{\mathcal{T}_l^m} \nabla \lambda_i \nabla \lambda_j dX dY = h_l \frac{\sqrt{-3}}{6} & \text{If } P_j \text{ is a boundary point} \\ 0 & \text{If } \text{Supp}(e_i) \cap \text{Supp}(e_j) = \emptyset \end{cases}
\end{aligned}$$

4.2.2 Convergence and Error Estimates

Recall the notations $\Omega = \overset{\circ}{\mathfrak{K}\mathfrak{S}}$ and $\bar{\Omega} = \mathfrak{K}\mathfrak{S}$. Given an integer m , we consider $\bar{\Omega}_m = \mathfrak{K}\mathfrak{S}_m$ as the uniform triangulation of the Koch snowflake at the order m . The main object of this section is to estimate the convergence of the finite element method at the order m . We adopt the methodology of [RT04].

First, let us observe that

$$\bar{\Omega}_m = \cup_i \mathcal{T}_i^m \subset \bar{\Omega}.$$

The triangulation is regular, since

$$\begin{aligned} \delta_m &= \frac{\sqrt{3}}{3^m}, \\ \rho_m &= \frac{1}{3^m}, \\ \frac{\delta_m}{\rho_m} &= \sqrt{3}, \quad \lim_{m \rightarrow \infty} \delta_m = 0, \end{aligned}$$

$$\forall X \in \partial \bar{\Omega}_m \cap \mathcal{T}_i^m, \quad d(X, \partial \Omega) \leq C_0 \delta_m. \quad (48)$$

where δ_m and ρ_m are respectively the triangle diameter and roundness (incircle diameter). Let us consider the discrete spaces

$$V_{\delta_m} = \left\{ v \in C(\bar{\Omega}_m); \quad v|_{\mathcal{T}_i^m} \in \mathbb{P}_k \quad \forall \mathcal{T}_i^m \in \mathcal{T}_{\delta_m}, \quad v|_{\partial \Omega_m} = 0 \right\}$$

and the natural extension by zero on the unresolved features

$$\tilde{V}_{\delta_m} = \left\{ \tilde{v} \in C(\bar{\Omega}); \quad \tilde{v}|_{\Omega_m} \in V_{\delta_m}, \quad \tilde{v}|_{\Omega \setminus \Omega_m} = 0 \right\}.$$

Now, let us consider the solution \tilde{u}_m of the variational Dirichlet problem defined in 4.1.4

$$\forall \tilde{v}_m \in \tilde{V}_{\delta_m}, \quad a(\tilde{u}_m, \tilde{v}_m) = L(\tilde{v}_m).$$

It follows by symmetry of the bilinear form that

$$\| u - \tilde{u}_m \|_{H_0^1(\Omega_m)} \leq \sqrt{\frac{C_1}{C_2}} \inf_{\tilde{v}_m \in \tilde{V}_{\delta_m}} \| u - \tilde{v}_m \|_{H_0^1(\Omega_m)}.$$

Indeed, by using the fact that

$$\begin{aligned} \forall \tilde{v}_m \in \tilde{V}_{\delta_m}, \quad a(u, \tilde{v}_m - \tilde{u}_m) &= L(\tilde{v}_m - \tilde{u}_m) \\ \forall \tilde{v}_m \in \tilde{V}_{\delta_m}, \quad a(\tilde{u}_m, \tilde{v}_m - \tilde{u}_m) &= L(\tilde{v}_m - \tilde{u}_m) \end{aligned}$$

we show that

$$\forall \tilde{v}_m \in \tilde{V}_{\delta_m}, \quad a(u - \tilde{u}_m, \tilde{v}_m - \tilde{u}_m) = 0, \quad (49)$$

i.e.,

$$\forall \tilde{v}_m \in \tilde{V}_{\delta_m}, \quad a(u - \tilde{u}_m, u - \tilde{u}_m) = a(u - \tilde{u}_m, u - \tilde{v}_m). \quad (50)$$

Using the regularity of the bilinear form $a(\cdot, \cdot)$ we can write

$$\|u - \tilde{u}_m\|_{H_0^1(\Omega_m)} \leq \frac{C_1}{C_2} \|u - \tilde{v}_m\|_{H_0^1(\Omega_m)}.$$

With this result and equation 49 we deduce that \tilde{u}_m is the orthogonal projection of u with respect to the norm $\|\cdot\|_a$ the scalar product defined by the bilinear form on $H_0^1(\Omega_m)$, i.e. $\forall \tilde{v}_m \in \tilde{V}_{\delta_m}$

$$\|u - \tilde{u}_m\|_a^2 \leq \|u - \tilde{v}_m\|_a^2.$$

We use the regularity of $a(\cdot, \cdot)$ on this expression

$$C_1 \|u - \tilde{u}_m\|_{H_0^1(\Omega_m)}^2 \leq C_2 \|u - \tilde{v}_m\|_{H_0^1(\Omega_m)}^2. \quad (51)$$

to finally obtain that

$$\|u - \tilde{u}_m\|_{H_0^1(\Omega_m)} \leq \sqrt{\frac{C_1}{C_2}} \inf_{\tilde{v}_m \in \tilde{V}_{\delta_m}} \|u - \tilde{v}_m\|_{H_0^1(\Omega_m)}. \quad (52)$$

We take into account the fact that

$$\|u - \tilde{u}_m\|_{H_0^1(\Omega)} = \left(\|u - \tilde{u}_m\|_{H_0^1(\Omega_m)}^2 + \|u\|_{H_0^1(\Omega \setminus \Omega_m)}^2 \right)^{\frac{1}{2}}. \quad (53)$$

We will get rid of the remainder term later, but let us prove first the following result:

Theorem 4.2.2.

If $\Omega \subset \mathbb{R}^n$ is an (ϵ, δ) -domain and if $k > \frac{n}{p}$, then $W_p^k(\Omega)$ is a subset of $C^0(\overline{\Omega})$.

Proof.

According to theorem 4.1.8, there exists a linear bounded extension operator $\mathbf{E} : W_p^k(\Omega) \rightarrow W_p^k(\mathbb{R}^n)$ such that

$$\begin{aligned} (\mathbf{E}g)|_{\Omega} &= g \\ \|\mathbf{E}g\|_{W_p^k(\mathbb{R}^n)} &\lesssim \|g\|_{W_p^k(\Omega)} \end{aligned}$$

One can then use the following classical result to conclude:

Lemma 4.2.3. [Bre99]

The injection $\iota : W_p^k(\mathbb{R}^n) \rightarrow C^0(\mathbb{R}^n)$ is compact, for $k > \frac{n}{p}$.

□

Now, let us consider the interpolation operator π_m on Ω_m , which for every continuous function on $\overline{\Omega}$, associate the function $\pi_m u$ continuous on $\overline{\Omega}_m$, for which the restriction $(\pi_m u)|_{\mathcal{T}_l^m}$ for $\mathcal{T}_l^m \in \mathcal{T}_{\delta_m}$ is the Lagrange interpolation on \mathcal{T}_l^m , and null on $\partial\Omega_m$ vertices.

Lemma 4.2.4. [RT04]

Let \mathcal{T}_l^m be a triangle and an interpolation order $k \geq 1$. There exists a constant C independent of k , for every function $u \in H^2(\Omega) \cap H_0^1(\Omega)$, such that, for all $0 \leq n \leq k+1$, $\forall v \in H^{k+1}(\mathcal{T}_l^m)$,

$$\|v - \pi_m v\|_{H^n(\mathcal{T}_l^m)} \leq C \frac{\delta_m^{k+1}}{\rho_m^n} \|v\|_{H_0^{k+1}(\mathcal{T}_l^m)} .$$

- **The case $k = 1$:**

In that case, the function $\pi_m u$ belongs to V_{δ_m} . We have the following lemma:

Lemma 4.2.5. [RT04]

Let us assume that $k = 1$. There exists a constant C_2 independent of δ_m , for every function $u \in H^2(\Omega) \cap H_0^1(\Omega)$, such that

$$\inf_{v_m \in V_{\delta_m}} \|u - v_m\|_{H_0^1(\Omega_m)} \leq C_2 \delta_m \|u\|_{H_0^2(\Omega)} .$$

- The case $k \geq 2$:

In that case, the function $\pi_m u \notin V_{\delta_m}$. We need to prove the following lemma:

Lemma 4.2.6. [RT04]

Let us assume that $k \geq 2$. There exists a constant C_3 independent of δ_m , for every function $u \in H^3(\Omega) \cap H_0^1(\Omega)$, such that

$$\inf_{v_m \in V_{\delta_m}} \|u - v_m\|_{H_0^1(\Omega_m)} \leq C_3 \sqrt{\delta_m} \|u\|_{H_0^3(\Omega)} .$$

Proof.

We give here an adaptation of the proof in [RT04]. Let π_m^0 be the interpolation function such that $\pi_m^0 u \in V_{\delta_m}$. The support of $\pi_m u - \pi_m^0 u$ is the set of boundary triangles $\mathcal{T}_l^m \cap \partial\mathcal{T}_{\delta_m} \neq \emptyset$. We can use the decomposition

$$\begin{aligned} \inf_{v_m \in V_{\delta_m}} \|u - v_m\|_{H_0^1(\Omega_m)} &\leq \|u - \pi_m^0 u\|_{H_0^1(\Omega_m)} \\ &\leq \|u - \pi_m u\|_{H_0^1(\Omega_m)} + \|\pi_m u - \pi_m^0 u\|_{H_0^1(\Omega_m)} . \end{aligned}$$

In one hand, lemma 4.2.4 allows us to write

$$\|u - \pi_m u\|_{H_0^1(\mathcal{T}_l^m)} \lesssim \frac{\delta_m^3}{\rho_m} \|u\|_{H_0^3(\mathcal{T}_l^m)} .$$

Then

$$\|u - \pi_m u\|_{H_0^1(\Omega_m)} \lesssim \delta_m^2 \|u\|_{H_0^3(\Omega)} .$$

In the other hand, let $\mathcal{T}_l^m = P_i P_j P_k$ be a triangle from the boundary such that $\{P_i, P_j\} \in \partial\Omega$, let $P_{ij} = \frac{P_i + P_j}{2}$ and P_{ij^*} to be the intersection of the bisector of $[P_i, P_j]$ with $\partial\Omega$:

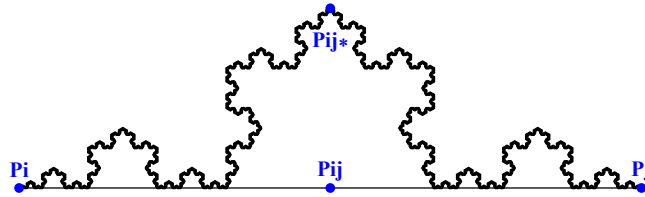

The edge $\{P_i, P_j\} \in \partial\Omega$ of the boundary triangle \mathcal{T}_l^m .

We get, given the basic function e_l associated to \mathcal{T}_l^m ,

$$(\pi_m u - \pi_m^0 u)|_{\mathcal{T}_l^m} = u(P_{ij})e_l$$

Using the mean value formula, theorem 4.2.2 and regularity 48

$$\begin{aligned} |u(P_{ij})| &= |u(P_{ij}) - u(P_{ij^*})| \\ &\leq |P_{ij} - P_{ij^*}| \left| \frac{\partial u}{\partial \eta} \right| \\ &\lesssim \delta_m \|u\|_{H_0^3(\Omega)} \end{aligned}$$

Consequently, $\forall \mathcal{T}_l^m \in \partial\Omega_m$,

$$\|\pi_m u - \pi_m^0 u\|_{H_0^1(\mathcal{T}_l^m)} \lesssim \delta_m \|u\|_{H_0^3(\Omega)}$$

Finally

$$\begin{aligned} \|\pi_m u - \pi_m^0 u\|_{H_0^1(\Omega_m)} &= \left(\sum_{\mathcal{T}_l^m \in \partial\Omega_m} \|\pi_m u - \pi_m^0 u\|_{H_0^1(\mathcal{T}_l^m)}^2 \right)^{\frac{1}{2}} \\ &\lesssim \sqrt{\delta_m} \|u\|_{H_0^3(\Omega)} \end{aligned}$$

The result follows. □

Now, we need to give an upper bound of $\|u\|_{H_0^1(\Omega \setminus \Omega_m)}^2$. Given a triangle $\mathcal{T}_l^m = P_i P_j P_k$ from the boundary $\partial\Omega_m$, where $\{P_i, P_j\} \in \partial\Omega$, we can represent the open $\Omega \setminus \Omega_m$ in the neighborhood of the segment $[P_i, P_j]$:

This boundary part is just a copy of the Koch self-similar curve, for a function $v \in H^1(\Omega)$, we can exploit the density theorem 4.1.10 and choose $v \in \mathcal{D}(\Omega)$, then we write for some $z(x) \in \partial\Omega$

$$v(x, y) = v(x, z(x)) + \int_{z(x)}^y \partial_y v(x, s) ds$$

then,

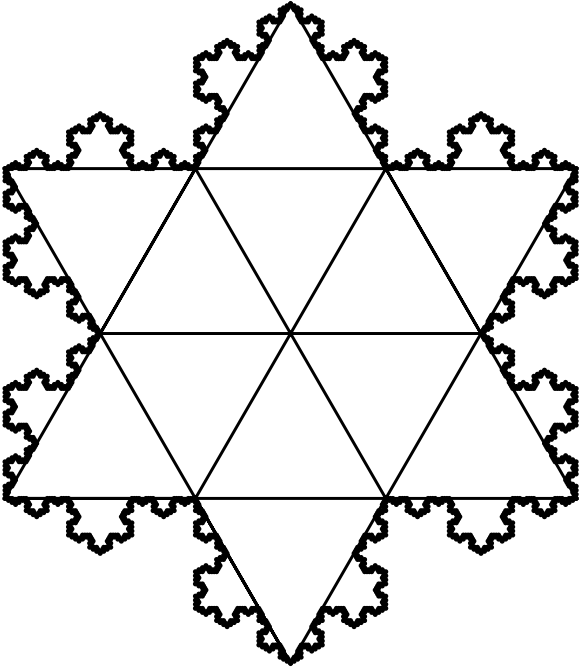

The open set $\Omega \setminus \Omega_m$ for $m = 1$.

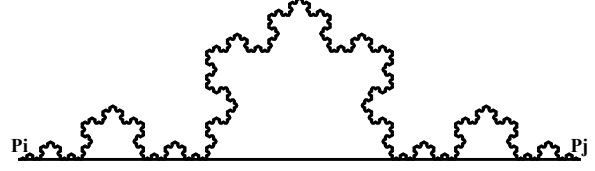

The open set O_i of $\Omega \setminus \Omega_m$ delimited by $[P_i, P_j]$.

$$\begin{aligned}
 v^2(x, y) &\leq 2v^2(x, z(x)) + 2\left|\int_{z(x)}^y \partial_y v(x, s) ds\right|^2 \\
 &\leq 2v^2(x, z(x)) + 2|y - z(x)| \int_{z(x)}^y |\partial_y v(x, s)|^2 ds \\
 &\leq 2v^2(x, z(x)) + C_0 \delta_m \int_{z(x)}^y |\partial_y v(x, s)|^2 ds
 \end{aligned}$$

by using the boundary regularity 48, and, by integration over O_i , the subset of $\Omega \setminus \Omega_m$ delimited by $[P_i, P_j]$,

$$\|v\|_{L^2(O_i)}^2 \lesssim \left(\delta_m \|v\|_{L^2(O_i \cap \partial\Omega)}^2 + \delta_m^2 \|\partial_y v\|_{L^2(O_i)}^2 \right).$$

By summation, this yields

$$\|v\|_{L^2(\Omega \setminus \Omega_m)}^2 \lesssim \left(\delta_m \|v\|_{L^2(\partial\Omega)}^2 + \delta_m^2 \|v\|_{H_0^1(\Omega \setminus \Omega_m)}^2 \right).$$

We conclude that

$$\|v\|_{L^2(\Omega \setminus \Omega_m)} \lesssim \left(\sqrt{\delta_m} \|v\|_{L^2(\partial\Omega)} + \delta_m \|v\|_{H_0^1(\Omega \setminus \Omega_m)} \right)$$

by using the trace theorem 4.1.9

$$\|v\|_{L^2(\Omega \setminus \Omega_m)} \lesssim \sqrt{\delta_m} \|v\|_{H^1(\Omega)}.$$

By applying this inequality to $\partial_x u$ and $\partial_y u$, we obtain the following lemma:

Lemma 4.2.7.

There exists a constant C_5 independent of δ_m , for every function $u \in H^2(\Omega)$, such that

$$\|u\|_{H_0^1(\Omega \setminus \Omega_m)} \leq C_5 \sqrt{\delta_m} \|u\|_{H^2(\Omega)}$$

This lemma enables one to compute the solution on Ω_m and ignore $\Omega \setminus \Omega_m$, for m sufficiently high. Now, by combining those results with equation 53 and 52, we obtain the following theorem about the convergence of the finite element method:

Theorem 4.2.8.

There exist constants \tilde{C} independent of δ_m , such that

$$\begin{aligned} \|u - \tilde{u}_m\|_{H_0^1(\Omega)} &\leq \tilde{C} \sqrt{\delta_m} \|u\|_{H^2(\Omega)} && \text{if } k = 1 \text{ and } u \in H_0^1(\Omega) \cap H^2(\Omega) \\ \|u - \tilde{u}_m\|_{H_0^1(\Omega)} &\leq \tilde{C} \sqrt{\delta_m} \|u\|_{H^3(\Omega)} && \text{if } k \geq 2 \text{ and } u \in H_0^1(\Omega) \cap H^3(\Omega). \end{aligned}$$

4.2.3 Numerical Results

In the following, we report the finite element solution of the Dirichlet membrane problem

$$\begin{aligned} -\operatorname{div}(h\nabla u) &= f && \text{in } \Omega \\ u &= 0 && \text{in } \partial\Omega \end{aligned}$$

for $h = 1$ and $f = e^{-(x^2+y^2)}$. The solution are generated by using the package NDSolve'FEM' of Mathematica:

Next, we report a \mathbb{P}_2 solution for $m = 4$ with a uniform mesh.

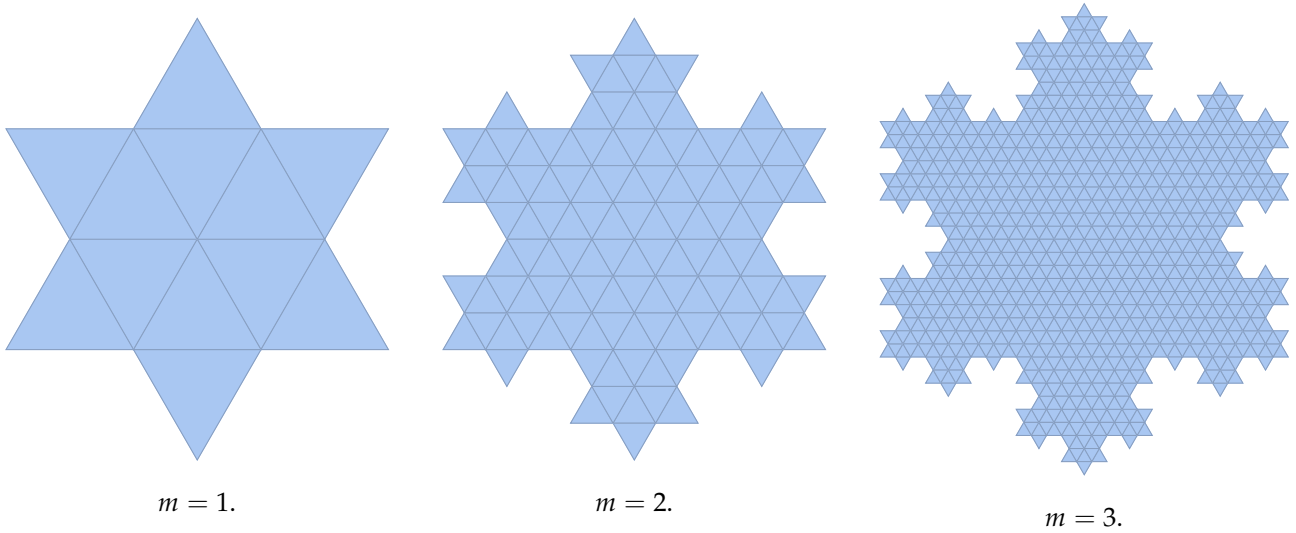

Figure 46: The meshes.

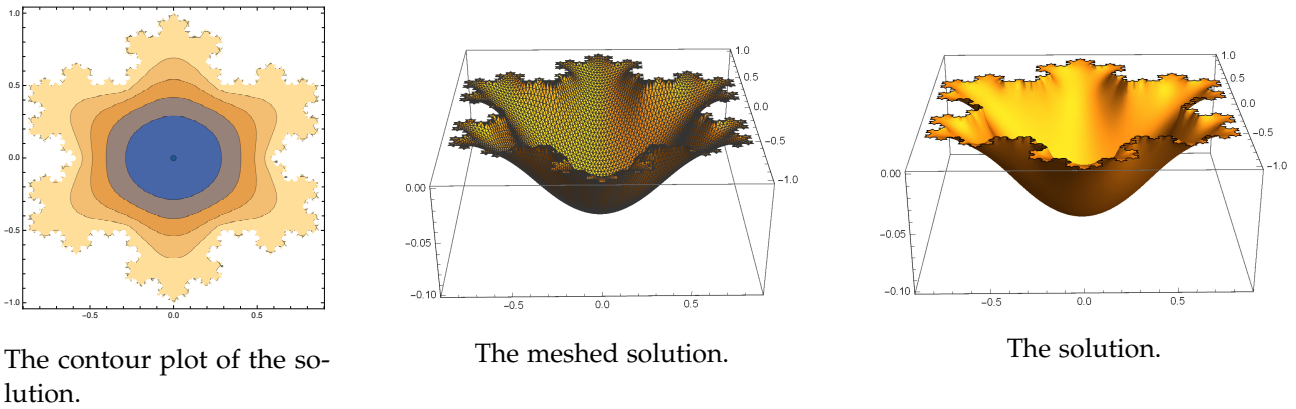

Figure 47: The solution.

4.3 PARAMETRIC OPTIMIZATION

4.3.1 An Alternative Definition

Let us recall the Poisson equation with Dirichlet condition

$$(\mathcal{P}_H) \quad \begin{cases} -\operatorname{div}(h\nabla u) & = f & \text{in } \Omega \\ u & = 0 & \text{in } \partial\Omega \end{cases}$$

for $f \in L^2(\Omega)$, $h \in L^\infty(\Omega)$ such that $h_{\min} \leq h \leq h_{\max}$, and Ω a (ϵ, δ) -domain delimited by a d-set (The Koch Snowflake for example). As proved before, this equation admits a weak solution in $W_2^1(\Omega) = H^1(\Omega)$.

Moreover, the bilinear form $a(\cdot, \cdot)$ is symmetric, which enables us to deduce that [Bregg]:

$$u = \min_{v \in H_0^1(\Omega)} \left\{ \Phi(v) = \frac{1}{2} \int_{\Omega} h \nabla v \nabla v \, dX - \int_{\Omega} f v \, dX \right\}.$$

By taking $e = \nabla v$, this is equivalent to

$$\min_{\substack{v \in H_0^1(\Omega), e \in L^2(\Omega)^2 \\ e = \nabla v}} \left\{ \Phi(v, e) = \frac{1}{2} \int_{\Omega} h e \cdot e \, dX - \int_{\Omega} f v \, dX \right\}.$$

The intermediary Lagrangian of the problem is

$$\tilde{\mathcal{L}}(e, v, \lambda) = \Phi(v, e) + \int_{\Omega} \lambda \cdot (\nabla v - e) \, dX.$$

The Lagrangian of the problem is then

$$\mathcal{L}(v, \lambda) = \min_{e \in L^2(\Omega)^2} \tilde{\mathcal{L}}(e, v, \lambda).$$

The function $e \rightarrow \tilde{\mathcal{L}}(e, v, \lambda)$ is strongly convex, and then admits a unique minimum given by the Euler equation $e^* = h^{-1}\lambda$, which implies that

$$\begin{aligned} \mathcal{L}(v, \lambda) &= -\frac{1}{2} \int_{\Omega} h^{-1} \lambda \cdot \lambda \, dX - \int_{\Omega} f v \, dX + \int_{\Omega} \lambda \cdot \nabla v \, dX \\ &= -\frac{1}{2} \int_{\Omega} h^{-1} \lambda \cdot \lambda \, dX - \int_{\Omega} v (\operatorname{div}(\lambda) + f) \, dX. \end{aligned}$$

The dual problem is then

$$\max_{\substack{\lambda \in L^2(\Omega)^2 \\ -\operatorname{div}(\lambda) = f}} \left\{ \Psi(\lambda) = \frac{1}{2} \int_{\Omega} h^{-1} \lambda \cdot \lambda \, dX \right\}.$$

Thus, we can establish the following theorem:

Theorem 4.3.1. [All12]

There exists a unique saddle point (u, σ) of the Lagrangian $\mathcal{L}(v, \lambda)$ on $H_0^1(\Omega) \times L^2(\Omega)^2$

$$\mathcal{L}(u, \sigma) = \max_{\lambda \in L^2(\Omega)^2} \min_{v \in H_0^1(\Omega)} \mathcal{L}(v, \lambda) = \min_{v \in H_0^1(\Omega)} \max_{\lambda \in L^2(\Omega)^2} \mathcal{L}(v, \lambda)$$

with $\sigma = h \nabla u$.

4.3.2 Optimization Thickness of an Elastic Membrane on Fractals

In the following, we consider the problem of the optimal thickness $h(X)$ of a membrane deformed by a force f . We will proceed as in [Allo7] to prove the existence of a solution of this problem. The thickness satisfy $0 < h_{\min} \leq h(X) \leq h_{\max}$ and the behavior of the membrane is described by the Dirichlet problem:

$$(\mathcal{P}_{\mathcal{H}}) \quad \begin{cases} -\operatorname{div}(h\nabla u) & = f & \text{in } \Omega \\ u & = 0 & \text{in } \partial\Omega \end{cases}$$

where Ω is a domain with a fractal boundary $\partial\Omega$. The problem is to find $h \in \mathcal{H}$ which minimizes the compliance

$$J(h) = \int_{\Omega} j(u_h) dX \quad (54)$$

$$= \int_{\Omega} f u_h dX \quad (55)$$

where

$$\mathcal{H} = \left\{ h \in L^{\infty}(\Omega) \text{ such that } 0 < h_{\min} \leq h(X) \leq h_{\max} \text{ and } \int_{\Omega} h(X) dX = h_0 |\Omega| \right\}$$

and where u_h is the solution of the weak problem

$$\int_{\Omega} h \nabla u \nabla v dX = \int_{\Omega} f v dX.$$

The operator $T : h \rightarrow u_h$ is linear and continuous, indeed, let $(h_n)_{n \in \mathbb{N}}$ an $L^{\infty}(\Omega)$ -sequence converging to some h in $L^{\infty}(\Omega)$, by the reciprocal Lebesgue theorem, there exist a subsequence $(h_{n_k})_{k \in \mathbb{N}}$ such that $h_{n_k} \rightarrow h$ a.e. on Ω and $\forall k \in \mathbb{N}$, $|h_{n_k}(X)| \leq C$ a.e. on Ω , for some constant C . Passing to the limit in the weak formula

$$\lim_{k \rightarrow \infty} \int_{\Omega} h_{n_k} \nabla u \nabla v dX - \int_{\Omega} f v dX = \int_{\Omega} h \nabla u \nabla v dX - \int_{\Omega} f v dX$$

We conclude that $\lim_{n \rightarrow \infty} T(h_n) = T(h)$, since

$$\begin{aligned} & \left| \left(\lim_{k \rightarrow \infty} \int_{\Omega} h_{n_k} \nabla u \nabla v dX - \int_{\Omega} f v dX \right) - \left(\lim_{n \rightarrow \infty} \int_{\Omega} h_n \nabla u \nabla v dX - \int_{\Omega} f v dX \right) \right| \\ & \leq \left| \int_{\Omega} \nabla u \nabla v dX \right| \left\| \lim_{k \rightarrow \infty} h_{n_k} - \lim_{n \rightarrow \infty} h_n \right\|_{L^{\infty}(\Omega)} \\ & \leq 0. \end{aligned}$$

We can now conclude that the form J is continuous and linear: if $f \in L^2(\Omega)$, the function $u \rightarrow \int_{\Omega} f u dX$ is continuous linear form from $L^2(\Omega)$ to \mathbb{R} , the continuity and linearity of J is a consequence of composition of linear continuous applications.

In addition, the theorem of the last section allows us to write

$$\int_{\Omega} f u_h dX = \min_{\substack{\lambda \in L^2(\Omega)^2 \\ -\operatorname{div}(\lambda) = f}} \frac{1}{2} \int_{\Omega} h^{-1} |\lambda|^2 dX.$$

The optimization problem is then

$$\inf_{h \in \mathcal{H}} \min_{\substack{\lambda \in L^2(\Omega)^2 \\ -\operatorname{div}(\lambda) = f}} \frac{1}{2} \int_{\Omega} h^{-1} |\lambda|^2 dX = \inf_{(h, \lambda) \in \mathcal{H} \times \mathcal{J}} \frac{1}{2} \int_{\Omega} h^{-1} |\lambda|^2 dX \quad (56)$$

where $\mathcal{J} = \{\lambda \in L^2(\Omega)^2, -\operatorname{div}(\lambda) = f \text{ in } \Omega\}$. The set $\mathcal{H} \times \mathcal{J}$ is closed and convex as a product of two closed convex sets, and the function $\Psi(h, \lambda) = \frac{1}{2} \int_{\Omega} h^{-1} |\lambda|^2$ is convex, since the associated Hessian matrix is positive, and coercive,

$$\lim_{\|(h, \lambda)\|_{\mathcal{H} \times \mathcal{J}} \rightarrow \infty} \Psi(h, \lambda) = \infty$$

and since \mathcal{H} is bounded. The existence of the solution is ensured by the following theorem:

Theorem 4.3.2. [Breg99]

Let us denote by E a reflexive Banach space, and by $A \subset E$ a convex closed non-empty subset of E , and by $J : A \rightarrow]-\infty, +\infty]$ a convex function, lower semi-continuous with $J \not\equiv +\infty$ such that

$$\lim_{\substack{x \in A \\ \|x\| \rightarrow \infty}} J(x) = +\infty.$$

Then, J reaches its minimum on A , i.e., $\exists x_0 \in A$ such that $J(x_0) = \min_{x \in A} J(x)$.

We have the following result:

Theorem 4.3.3. [All12]

Given $\lambda \in L^2(\Omega)^2$, the problem

$$\min_{h \in \mathcal{H}} \frac{1}{2} \int_{\Omega} h^{-1} |\lambda|^2 dX$$

has a minimum $h(\lambda)$ in \mathcal{H} given by

$$h(\lambda)(x) = \begin{cases} h^*(x) = \frac{|\lambda(x)|}{\sqrt{l}} & \text{if } h_{\min} < h^* < h_{\max} \\ h_{\min} & \text{if } h^* \leq h_{\min} \\ h_{\max} & \text{if } h_{\max} \leq h^* \end{cases}$$

where $l \in \mathbb{R}_+$ is the unique value such that $\int_{\Omega} h dX = h_0 |\Omega|$. This value is unique as $l \neq 0$.

4.3.3 Resolution by the Discrete Projected Gradient Algorithm (D.P.G.A.)

This section is based on the algorithm introduced by A. M. Toader in [Toa97] and described G. Allaire in his book [All07]. Since the convergence of the finite element approximation has been proved,

we can build a projected gradient algorithm on this approximation. We give next a convergence result for \mathbb{P}_1 approximation. Set

$$V_{\delta_m} = \left\{ v \in C(\overline{\Omega}_m); \quad v|_{\mathcal{T}_l^m} \in \mathbb{P}_1 \quad \forall \mathcal{T}_l^m \in \mathcal{T}_{\delta_m}, \quad v|_{\partial\Omega_m} = 0 \right\}$$

$$\tilde{V}_{\delta_m} = \left\{ \tilde{v} \in C(\overline{\Omega}); \quad \tilde{v}|_{\Omega_m} \in V_{\delta_m}, \quad \tilde{v}|_{\Omega \setminus \Omega_m} = 0 \right\}.$$

$$\Psi(h, \lambda) = \frac{1}{2} \int_{\Omega} h^{-1} |\lambda|^2 dX$$

$$\mathcal{H}_m = \left\{ h \in L^\infty(\Omega) : 0 < h_{\min} \leq h(X) \leq h_{\max} \text{ on } \Omega_m, \quad h(X) = 0 \text{ on } \Omega \setminus \Omega_m, \quad \int_{\Omega_m} h(X) dX = h_0 |\Omega_m| \right\}$$

$$\mathcal{J}_m = \left\{ \lambda = h \nabla u, \quad (h, u) \in \mathcal{H}_m \times \tilde{V}_{\delta_m}, \quad -\operatorname{div}(h \nabla u) = f \text{ in } \Omega_m, \quad u = 0 \text{ in } \partial\Omega_m \right\}$$

Define the restriction operator

$$\begin{aligned} \mathbf{R} : \mathcal{H} &\rightarrow \{h \in L^\infty(\Omega) : 0 < h_{\min} \leq h(X) \leq h_{\max} \text{ on } \Omega_m, \quad h(X) = 0 \text{ on } \Omega \setminus \Omega_m\} \\ &h \rightarrow \mathbf{1}_{\Omega_m} h|_{\Omega_m} \end{aligned}$$

and the extension operator

$$\begin{aligned} \mathbf{E} : \mathcal{H}_m &\rightarrow \mathcal{H} \\ h &\rightarrow \tilde{h} \quad \text{s.t.} \quad (\tilde{h})|_{\Omega_m} = h \quad \text{and} \quad (\tilde{h})|_{\Omega \setminus \Omega_m} = \mathbf{P}_{\mathcal{H}}(h) \end{aligned}$$

where

$$\mathbf{P}_{\mathcal{H}}(h) = \max(h_{\min}, \min(h_{\max}, h - l)).$$

and l is the solution of:

$$\int_{\Omega} \mathbf{P}_{\mathcal{H}}(h) dX = h_0 |\Omega|$$

Let use the finite element discretization to define

$$\min_{(h, \lambda) \in \mathcal{H}_m \times \mathcal{J}_m} \Psi(h, \lambda) \tag{57}$$

Given $m \in \mathbb{N}^*$, the D.P.G.A. is as follows:

Numerical algorithm:

1. Fix $h_0^m \in \mathcal{H}_m$.

2. For $n \geq 0$:

(a) Compute $\lambda_n^m = h_n^m \nabla u_n^m$, where $u_n^m \in \tilde{V}_{\delta_m}$ is the unique solution of:

$$(\mathcal{P}_{\mathcal{H}_m}) \quad \begin{cases} -\operatorname{div}(h_n^m \nabla u_n^m) = f & \text{in } \Omega_m \\ u_n^m = 0 & \text{in } \partial\Omega_m \end{cases}$$

(b) Update h :

$$h_{n+1}^m = \mathbf{P}_{\mathcal{H}_m}(h_n^m - \mu \partial_h \Psi(h_n^m, \lambda_n^m))$$

where

$$\mathbf{P}_{\mathcal{H}_m}(h) = \max(h_{\min}, \min(h_{\max}, h - l)).$$

l is the solution of:

$$\int_{\Omega_m} \mathbf{P}_{\mathcal{H}_m}(h) dX = h_0 |\Omega_m|$$

$\mu > 0$ and

$$\partial_h \Psi(h, \lambda_n^m) = -\frac{|\lambda_n^m|^2}{h^2}.$$

3. Stop when

$$|h_n^m - \mathbf{P}_{\mathcal{H}_m}(h_n^m - \mu \Psi'(h_n^m, \lambda_n^m))| < \varepsilon \mu h_{\max}.$$

The update can be written more explicitly

$$h_{n+1}^m = \mathbf{P}_{\mathcal{H}_m} \left(h_n^m + \mu \frac{|\lambda_n^m|^2}{(h_n^m)^2} \right). \quad (58)$$

The discrete projected gradient approximation is done in two steps:

$$h^* \xrightarrow{\text{FEM}} h^{*,m} \xrightarrow{\text{PGA}} h_{n^*}^m$$

where we denote respectively by h^* , $h^{*,m}$ and $h_{n^*}^m$, the solutions of 56, 57 and 58. Let's introduce

$$\begin{array}{ccc} h^{*,m} & \xrightarrow{\text{FEM}} & \lambda^{*,m} \\ \tilde{h}^* & \xrightarrow{\text{Continuous}} & \tilde{\lambda}^* \\ \bar{h}^{*,m} & \xrightarrow{\text{FEM}} & \bar{\lambda}^{*,m} \\ h^* & \xrightarrow{\text{Continuous}} & \lambda^* \end{array}$$

where $h^{*,m}$ and h^* stand respectively for the optimal thickness of discrete and continuous problems, $\tilde{h}^* = \mathbf{E}(h^{*,m})$ is the extension of $h^{*,m}$ to Ω , and $\bar{h}^{*,m} = \mathbf{P}_{\mathcal{H}_m}(\mathbf{R}(h^*))$ is the projected restriction of h^* on \mathcal{H}_m , we can check that

$$\begin{aligned} |\bar{h}^{*,m} - h^*| &\leq |\bar{h}^{*,m} - \mathbf{P}_{\mathcal{H}_m}(h^*)| + |\mathbf{P}_{\mathcal{H}_m}(h^*) - h^*| \\ &\leq |\mathbf{R}(h^*) - h^*| + |\mathbf{P}_{\mathcal{H}_m}(h^*) - h^*| \\ &\rightarrow 0 \end{aligned}$$

since $h^* = \mathbf{P}_{\mathcal{H}}(h^*)$, and

$$\begin{aligned} \|h^{*,m} - \tilde{h}^*\|_{L^\infty(\Omega)} &= \|\tilde{h}^*\|_{L^\infty(\Omega \setminus \Omega_m)} \\ &\rightarrow 0 \end{aligned}$$

and we got $L^\infty(\Omega)$ convergences. One has, $\forall \varepsilon > 0$

$$-\varepsilon < \Psi(h^{*,m}, \lambda^{*,m}) - \Psi(\tilde{h}^*, \tilde{\lambda}^*) \leq \Psi(h^{*,m}, \lambda^{*,m}) - \Psi(h^*, \lambda^*) \leq \Psi(\bar{h}^{*,m}, \bar{\lambda}^{*,m}) - \Psi(h^*, \lambda^*) < \varepsilon$$

Since $\Psi(h^*, \lambda^*) \leq \Psi(\tilde{h}^*, \tilde{\lambda}^*)$ and $\Psi(h^{*,m}, \lambda^{*,m}) \leq \Psi(\bar{h}^{*,m}, \bar{\lambda}^{*,m})$. To get convergence of the bounds, consider the general case $h^m \in \mathcal{H}_m$ and $h \in \mathcal{H}$ such that $h^m \rightarrow h$ in $L^\infty(\Omega)$, $u^m \in \tilde{V}_{\delta_m}$ the corresponding solution of $(\mathcal{P}_{\mathcal{H}_m})$, through the variational equality by choosing $v^m = u^m$, one can write

$$h_{min} \|\nabla u^m\|_{L^2(\Omega)}^2 \leq \int_{\Omega} h^m |\nabla u^m|^2 dX = \int_{\Omega} f u^m dX \leq \|f\|_{L^2(\Omega)} \|u^m\|_{L^2(\Omega)}$$

Using Poincaré inequality 4.1.6,

$$\|\nabla u^m\|_{L^2(\Omega)} \leq \frac{C}{h_{min}} \|f\|_{L^2(\Omega)} \quad (59)$$

u^m is bounded in $H_0^1(\Omega)$, we can extract a subsequence $u^m \rightharpoonup u$ weakly in $H_0^1(\Omega)$. Now let $v \in H_0^1(\Omega)$, there exists a sequence $v^m \in \tilde{V}_{\delta_m}$ converging to v in $H_0^1(\Omega)$, by the inequality 59 we found

$$\begin{aligned} \left| \int_{\Omega} h \nabla u \nabla v dX - \int_{\Omega} h^m \nabla u^m \nabla v^m dX \right| &\leq \left| \int_{\Omega} h (\nabla u - \nabla u^m) \nabla v dX \right| + \left| \int_{\Omega} h \nabla u^m (\nabla v - \nabla v^m) dX \right| \\ &\quad + \left| \int_{\Omega} (h - h^m) \nabla u^m \nabla v^m dX \right| \\ &\leq h_{max} \left| \int_{\Omega} (\nabla u - \nabla u^m) \nabla v dX \right| + h_{max} \|\nabla u^m\|_{L^2(\Omega)} \|\nabla(v - v^m)\|_{L^2(\Omega)} \\ &\quad + \|h - h^m\|_{L^\infty(\Omega)} \|\nabla u^m\|_{L^2(\Omega)} \|\nabla v^m\|_{L^2(\Omega)} \\ &\rightarrow 0 \end{aligned}$$

and

$$\int_{\Omega} f v^m dX \longrightarrow \int_{\Omega} f v dX$$

Thus, $u^m \rightharpoonup u$ in $H_0^1(\Omega)$, the unique solution of (\mathcal{P}_h) . To prove strong convergence, let $\|\cdot\|_a$ be the norm on $H_0^1(\Omega)$ introduced in section 4.2.2, and defined for all $v \in H_0^1(\Omega)$ by

$$\|v\|_a = \sqrt{\int_{\Omega} h |\nabla v|^2 dX}$$

Then

$$\begin{aligned} \|u^m\|_a^2 &= \int_{\Omega} h |\nabla u^m|^2 dX \\ &= \int_{\Omega} (h - h^m) |\nabla u^m|^2 dX + \int_{\Omega} h^m |\nabla u^m|^2 dX \\ &= \int_{\Omega} (h - h^m) |\nabla u^m|^2 dX + \int_{\Omega} f u^m dX \\ &\leq \|h - h^m\|_{L^\infty(\Omega)} \|\nabla u^m\|_{L^2(\Omega)}^2 + \int_{\Omega} f u^m dX \\ &\longrightarrow \int_{\Omega} f u dX \\ &= \int_{\Omega} h |\nabla u|^2 dX \\ &= \|u\|_a^2 \end{aligned}$$

Proposition 4.3.4. [Toa97]

For fixed domain Ω_m , $m \in \mathbb{N}$, the projected gradient algorithm converges to the optimal solution $h^{*,m}$.

We have proved that

Corollary 4.3.5.

The discrete projected gradient algorithm 4.3.3 converges to the optimal solution h^* .

Proof.

It follows from the decomposition

$$\|\Psi(h^*, \lambda^*) - \Psi(h_{n^*}^m, \lambda_{n^*}^m)\| \leq \|\Psi(h^*, \lambda^*) - \Psi(h^{*,m}, \lambda^{*,m})\| + \|\Psi(h^{*,m}, \lambda^{*,m}) - \Psi(h_{n^*}^m, \lambda_{n^*}^m)\|$$

where n^* is the optimal stopping iteration. □

4.3.4 Numerical Results

In the sequel, we represent the optimal solution of the compliance problem for the Koch Snowflake domain Ω :

$$\min_{h \in \mathcal{H}} J(h) = \int_{\Omega} f u_h dX$$

where

$$\mathcal{H} = \left\{ h \in L^{\infty}(\Omega) \text{ such that } 0.1 \leq h(X) \leq 1 \text{ and } \int_{\Omega} h(X) dX = \frac{1}{2} |\Omega| \right\}$$

and u is the solution of

$$\begin{aligned} -\operatorname{div}(h \nabla u) &= e^{-(x^2+y^2)} && \text{in } \Omega \\ u &= 0 && \text{in } \partial\Omega. \end{aligned}$$

The approximation parameters are $m = 4$, $\varepsilon = 0.05$ and $\mu = 0.05$:

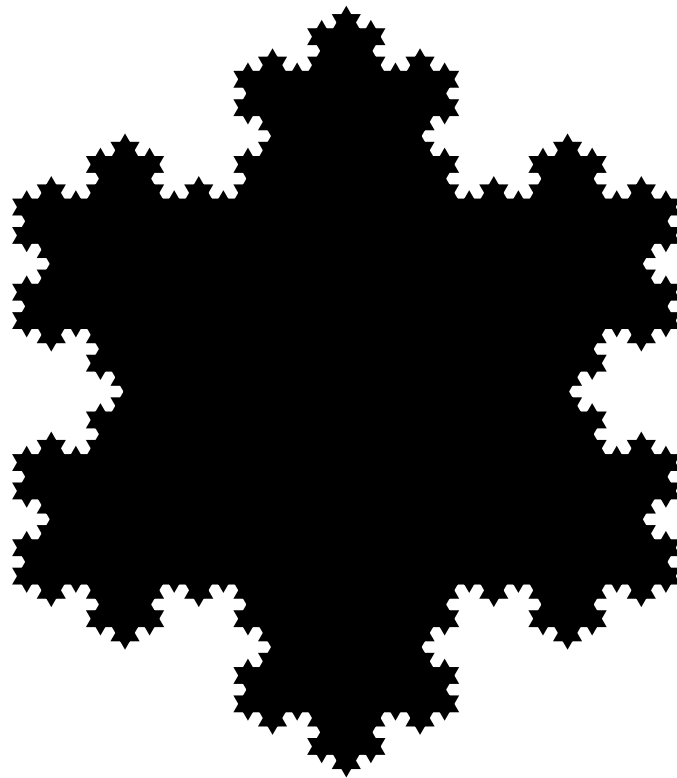

Figure 48: The approximated domain $\mathfrak{K}\mathfrak{S}_4$.

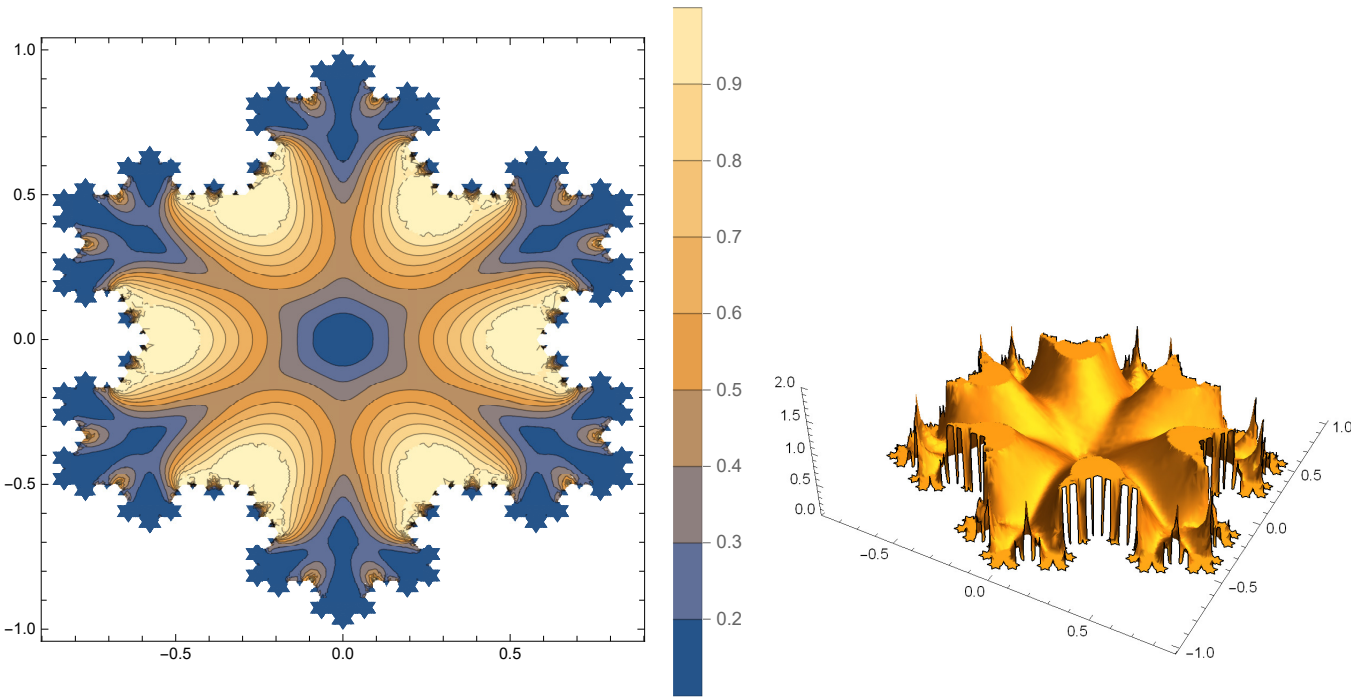

Figure 49: Contour plot and 3D representation of the optimal thickness.

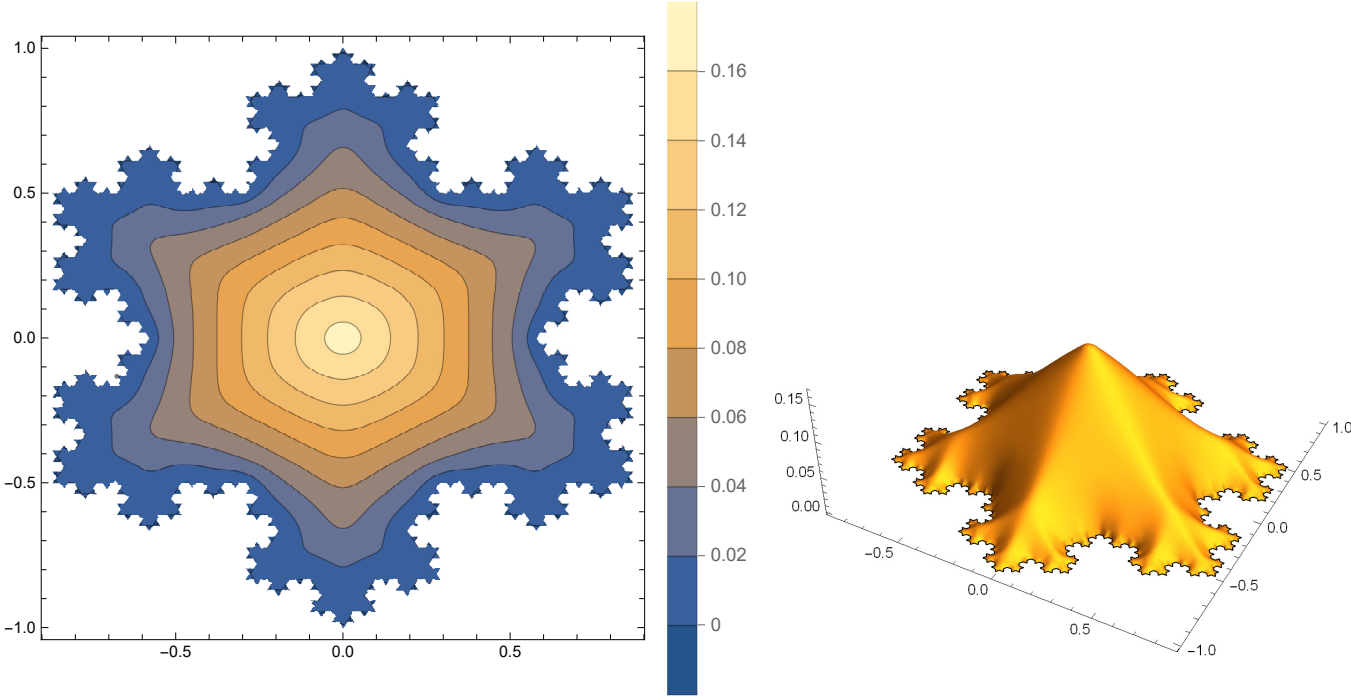

Figure 50: Contour plot and 3D representation of the optimal solution.

Chapter 5

Application to Finance

The Black-Scholes model arises as one of the most important application of mathematics to economics and finance of the 20th century, allowing the emergence of the theory of financial partial differential equations and the related numerical analysis.

Yet, despite its phenomenal success in the financial market, the model suffers from deficiencies, for instance, when it comes to the modeling of real market options, with erratic behaviors.

Interestingly, the Black-Scholes equation can be transformed into a linear heat one (see, for instance [Dav17]), which makes it a good candidate for techniques involving scale invariance. Knowing that stochastic behaviors, of erratic appearance, are involved, it was natural to consider an alternative model, based on the theory of partial differential equations on fractals, as introduced by J. Kigami (see [Kigo1], [Stro6]). So far, this had not been done. In [RD20a], we thus introduced the so called **self-similar Black-Scholes equation**, emerging from a transformation of the **self-similar heat equation**. Our results showed that this model can handle a multitude of behaviors, and that the associated solution can be non-standard, depending on the self-similar measure.

In this chapter, we give a direct derivation of the self-similar Black-Scholes model, based on the theory of non-symmetric Dirichlet forms, and prove the existence of a self-similar Black-Scholes operator and we give an explicit formula to calculate this operator for some function in his domain.

After establishing the CFL convergence condition for the finite difference scheme, we simulate the solution as a function of the weights. The results confirm our previous ones exposed in [RD20a], and we can detect some specific behaviors characteristic of risk aversion and risk loving.

5.1 THE SELF-SIMILAR BLACK-SCHOLES MODEL

5.1.1 The Black-Scholes Operator

Notation (Space of test functions).

Given a continuous subset E of \mathbb{R} , we will denote by $\mathcal{D}(E)$ the space of test functions on E , i.e. the space of smooth functions with compact support in E .

Definition 5.1.1 (Self-Similar Black-Scholes Equation).

We introduce the self-similar Black-Scholes equation [RD20a], for European options, in the sense of distributions:

$$\begin{cases} \frac{\partial u}{\partial t}(t, x) d\mu &= \left(-r(t) x \frac{\partial u}{\partial x}(t, x) - \frac{\sigma^2(t)}{2} x^2 \Delta u(t, x) + r(t) u(t, x) \right) dx & \forall (t, x) \in [0, T] \times]L, M[\\ u(T, x) &= h(x) & \forall x \in [L, M] \end{cases}$$

where the variable $0 < L < x < M$ is the price of the underlying financial instrument, σ denotes the volatility, r the risk-free interest rate, T the maturity of the option, μ a self-similar measure and u

represents the option price. The real valued function h takes the values $h(x) = (x - K)^+$ for a call¹, and $h(x) = (K - x)^+$ for a put², given a constant K : "the strike".

In order to prove that the problem has a solution, technical results related to the classical Black-Scholes model are required. We refer to [AP05] for the proof of the following assertions:

Notation (Black-Scholes Bilinear Form).

For any pair $(u, v) \in (\mathcal{D}(\mathbb{R}_+))^2$, we set:

$$B(u, v) = \int_{\mathbb{R}_+} \frac{\sigma^2 x^2}{2} \frac{\partial u}{\partial x} \frac{\partial v}{\partial x} dx + \int_{\mathbb{R}_+} (\sigma^2 - r) x \frac{\partial u}{\partial x} v dx + \int_{\mathbb{R}_+} r u v dx.$$

Property 5.1.1.

The bilinear form $B(\cdot, \cdot)$ is non-symmetric.

We define its symmetric part, for any pair $(u, v) \in (\mathcal{D}(\mathbb{R}_+))^2$, through:

$$\begin{aligned} \tilde{B}(u, v) &= \frac{1}{2} (B(u, v) + B(v, u)) \\ &= \int_{\mathbb{R}_+} \frac{\sigma^2 x^2}{2} \frac{\partial u}{\partial x} \frac{\partial v}{\partial x} dx + \frac{1}{2} \int_{\mathbb{R}_+} (\sigma^2 - r) x \left(\frac{\partial u}{\partial x} v + u \frac{\partial v}{\partial x} \right) dx + \int_{\mathbb{R}_+} r u v dx \\ &= \frac{\sigma^2}{2} \int_{\mathbb{R}_+} x^2 \frac{\partial u}{\partial x} \frac{\partial v}{\partial x} dx + \frac{3r - \sigma^2}{2} \int_{\mathbb{R}_+} u v dx \end{aligned}$$

Notations.

We set

$$V = \left\{ v \in L^2(\mathbb{R}_+) \quad , \quad x \frac{\partial v}{\partial x} \in L^2(\mathbb{R}_+) \right\} \quad , \quad W = \left\{ v \in L^2(\mathbb{R}_+) \quad , \quad x^2 \frac{\partial^2 v}{\partial x^2} \in L^2(\mathbb{R}_+) \right\}.$$

¹ The *call* is an option on a financial instrument, which consists in a right to buy. Concretely, it consists in a contract which allows the subscriber to get the targeted financial product, at a price fixed in advance - the *strike* price - at a given date - the expiry one, or *maturity* of the call.

² As for the *put*, it is this time a right to sell - or not - at the maturity date.

Property 5.1.2.

The space

$$V = \left\{ v \in L^2(\mathbb{R}_+) \quad , \quad x \frac{\partial v}{\partial x} \in L^2(\mathbb{R}_+) \right\}$$

endowed with the inner product

$$(u, v) \mapsto \langle u, v \rangle_V = \langle u, v \rangle_{L^2(\mathbb{R}_+)} + \left\langle x \frac{du}{dx}, x \frac{dv}{dx} \right\rangle_{L^2(\mathbb{R}_+)} .$$

is a Hilbert space.

Definition 5.1.2 (Black-Scholes Weak Formula).

The Black-Scholes variational formula reads: find $u \in C([0, T]; L^2(\mathbb{R}_+)) \cap L^2((0, T); V)$ such that $\partial_t u \in L^2((0, T); V^*)$, satisfying:

$$\begin{cases} B(u, v) &= \frac{d}{dt} \int_{\mathbb{R}_+} u(t, x) v(x) dx \quad , \quad \forall v \in \mathcal{D}(\mathbb{R}_+) \\ u(T, x) &= h(x) \end{cases}$$

where V^* is the dual space of V .

Proposition 5.1.3 (Black-Scholes Operator).

There exists a unique linear bounded operator $\mathcal{BS} : V \rightarrow V'$, which will be called Black-Scholes operator, such that:

$$\forall (u, v) \in V^2 : \quad B(u, v) = \langle \mathcal{BS}(u), v \rangle_{L^2(\mathbb{R}_+)} .$$

Definition 5.1.3.

The Black-Scholes operator is given, for any v in W , by

$$\mathcal{BS}(v) = -\frac{x^2 \sigma^2}{2} \frac{\partial^2 v}{\partial x^2} - r x \frac{\partial v}{\partial x} + r v .$$

Proposition 5.1.4.

The set

$$W = \left\{ v \in V \quad , \quad x^2 \frac{\partial^2 v}{\partial x^2} \in L^2(\mathbb{R}_+) \right\}$$

is dense in V .

Theorem 5.1.5 (Black-Scholes Weak Solution).

For h in $L^2(\mathbb{R}_+)$, the Black-Scholes problem has a unique weak solution.

Remark 5.1.1.

Given two strictly positive numbers $L < M$, replacing \mathbb{R}_+ by $[L, M]$ does not have a dramatic effect on the mathematical nor the economical foundations of the model from two points of view:

1. **Financial stability:** One can suppose, in short run, boundedness of the underlying financial instrument price.
2. **Numerical analysis:** It is well known that infinite boundaries are replaced with finite ones for numerical simulations (See [KN01] for error estimates).

5.2 NON-SYMMETRIC DIRICHLET FORMS AND THE SELF-SIMILAR BLACK-SCHOLES OPERATOR

Definition 5.2.1 (Self-Similar Measure on a Real Interval, Associated to a Set of Contractions [Stro6]).

We hereafter consider an arbitrary real interval $\mathcal{M} =]L, M[\subset \mathbb{R}_+$, and denote by f_1 and f_2 the contractions defined, for any real number x , by:

$$f_1(x) = \frac{1}{2}(x + L) \quad , \quad f_2(x) = \frac{1}{2}(x + M) \quad .$$

A measure μ with full support on $\overline{\mathcal{M}}$ will be called **self-similar measure** on $\overline{\mathcal{M}}$, relatively to the set of contractions (f_1, f_2) if, given a family of strictly positive pounds (μ_1, μ_2) such that

$$\mu_1 + \mu_2 = 1 \quad ,$$

one has, then,

$$\mu = \mu_1 \mu \circ f_1^{-1} + \mu_2 \mu \circ f_2^{-1} \quad .$$

Notations.

In the sequel, we keep the notations introduced in Definition 5.2.1.

Remark 5.2.1.

- i. μ can be replaced by any positive finite Borel measure on \mathcal{M} with full support included in $\overline{\mathcal{M}}$.
- ii. This thus enable one to build more exotic self-similar behaviours.

Notations.

We introduce the spaces:

$$V_{\mathcal{M}} = \left\{ v \in L^2(\mathcal{M}) \quad , \quad x \frac{\partial v}{\partial x} \in L^2(\mathcal{M}) \right\} \quad ,$$

$$L_{\mu}^2(\mathcal{M}) = \left\{ v \quad , \quad \int_L^M v^2 d\mu < \infty \right\} \quad .$$

The dual space of $V_{\mathcal{M}}$ will be denoted by $V_{\mathcal{M}}^*$ and the closure of $D(\mathcal{M})$ in $V_{\mathcal{M}}$ by $V_{0,\mathcal{M}}$.

Proposition 5.2.1.

The space $\mathcal{D}(\mathcal{M})$ is dense in $L_{\mu}^2(\mathcal{M})$.

As in [HLN06], the fundamental conditions under which the solution exist are obtained thanks to the following assumptions:

Assumptions 5.2.2.

For any u in $\mathcal{D}(\mathcal{M})$, there exists a positive constant C_0 :

$$\|u\|_{L_{\mu}^2(\mathcal{M})} \leq C_0 \left\| x \frac{\partial u}{\partial x} \right\|_{L^2(\mathcal{M})} \quad , \quad (60)$$

$$\sigma^2 < 4r \quad . \quad (61)$$

Proposition 5.2.3.

Under the first condition in conjecture 5.2.2, there exists a unique $L_{\mu}^2(\mathcal{M})$ -representative \tilde{u} of each equivalence class of functions u in $V_{\mathcal{M}}$ such that the above condition holds. There also exists a $\mathcal{D}(\mathcal{M})$ sequence $(u_n)_{n \in \mathbb{N}}$ which converges towards \tilde{u} both in $V_{\mathcal{M}}$ and in $L_{\mu}^2(\mathcal{M})$, since $\mathcal{D}(\mathcal{M})$ is dense in $V_{\mathcal{M}}$ and $L_{\mu}^2(\mathcal{M})$ [Kil94].

Let us consider the bilinear form $B(\cdot, \cdot)$ with domain $\text{dom}(B)$ on the Hilbert space $V_{\mathcal{M}}$. We introduce the bilinear form:

$$B^*(\cdot, \cdot) = B(\cdot, \cdot) + \langle \cdot, \cdot \rangle_{L_{\mu}^2(\mathcal{M})}$$

and the symmetric one:

$$\tilde{B}^*(\cdot, \cdot) = \tilde{B}(\cdot, \cdot) + \langle \cdot, \cdot \rangle_{L_{\mu}^2(\mathcal{M})} \quad .$$

We refer to [MR92] for more details on the theory of non-symmetric Dirichlet forms.

Definition 5.2.2 (Symmetric Closed Form).

A pair $(B, \text{dom}(B))$ is **symmetric closed form** (on H) if $\text{dom}(B)$ is a dense linear subspace of H and $B : \text{dom}(B) \times \text{dom}(B) \rightarrow \mathbb{R}$ is a positive definite bilinear which is symmetric and closed on H (i.e., $\text{dom}(B)$ is complete with respect to the norm $B^*(\cdot, \cdot)^{\frac{1}{2}}$).

Definition 5.2.3 (Sector Condition).

Let us denote by B a bilinear form on the Hilbert space H , and by $\text{dom}(B)$ its domain. The pair $(B, \text{dom}(B))$ is said to satisfy:

i. The weak sector condition if there exists $K > 0$ such that:

$$\forall (u, v) \in \text{dom}(B) \times \text{dom}(B) : |B^*(u, v)| \leq K \sqrt{B^*(u, u) B^*(v, v)}. \quad (62)$$

ii. The strong sector condition if there exists $K > 0$ such that

$$\forall (u, v) \in \text{dom}(B) \times \text{dom}(B) : |B(u, v)| \leq K \sqrt{B(u, u) B(v, v)}.$$

Remark 5.2.2.

A coercive continuous bilinear form satisfies both conditions.

Definition 5.2.4 (Coercive Closed Form).

A pair $(B, \text{dom}(B))$ will be called a **coercive closed form** (on H) if $\text{dom}(B)$ is a dense linear subspace of H and $B : \text{dom}(B) \times \text{dom}(B) \rightarrow \mathbb{R}$ is a bilinear form such that the following two conditions hold:

- i.* Its symmetric part $(\tilde{B}, \text{dom}(B))$ is a symmetric closed form on H .
- ii.* $(B, \text{dom}(B))$ satisfies the weak sector condition inequality 62.

Definition 5.2.5 (Symmetric Vs Non-Symmetric Dirichlet Form).

A coercive closed form $(B, \text{dom}(B))$ on $L^2_\mu(\mathcal{M})$, for a given measure μ , will be called a **Dirichlet form** if, for any u in $\text{dom}(B)$, one has:

$$\tilde{u} \in \text{dom}(B) \quad \text{and} \quad \begin{cases} B(u + \tilde{u}, u - \tilde{u}) \geq 0 \\ B(u - \tilde{u}, u + \tilde{u}) \geq 0 \end{cases}$$

where $\tilde{u} = \max(0, \min(u, 1))$. If $(B, \text{dom}(B))$ is in addition symmetric, this is equivalent to:

$$B(\tilde{u}, \tilde{u}) \leq B(u, u).$$

B will be called a **symmetric Dirichlet form**.

Theorem 5.2.4. [MR92]

Let us denote by $(B, \text{dom}(B))$ a coercive closed form on H , and J a continuous linear functional on $\text{dom}(B)$. Then, there exists a unique $u \in \text{dom}(B)$ such that

$$\forall v \in \text{dom}(B) : \quad B^*(u, v) = J(v).$$

Definition 5.2.6 (Non-Symmetric Dirichlet Forms).

Let us consider a coercive closed form on H , $(B, \text{dom}(B))$. There exists a one-to-one correspondence with a pair of linear bounded operators (L, \tilde{L}) :

$$\forall (u, v) \in \text{dom}(L) \times \text{dom}(L) : \quad B(u, v) = (-Lu, v) = (u, -\tilde{L}v)$$

where $\text{dom}(L)$ is the domain of L . Also, $\text{dom}(L)$ is a dense subset of $\text{dom}(B)$.

The operator L (respectively \tilde{L}) is the generator of a strongly continuous contraction semi-group $(T_t)_{t>0}$ (respectively $(\tilde{T})_{t>0}$).

The following result follows from [AP05].

Proposition 5.2.5 (Poincaré Inequality).

The space $\mathcal{D}(\mathcal{M})$ is dense in $V_{\mathcal{M}}$, and, for any $v \in \mathcal{D}(\mathcal{M})$, the following inequality is satisfied:

$$\|v\|_{L^2(\mathcal{M})} \leq 2 \left\| x \frac{dv}{dx} \right\|_{L^2(\mathcal{M})}$$

This inequality induces a second norm on $V_{\mathcal{M}}$, given, for any v in $V_{\mathcal{M}}$, by:

$$|v|_{V_{\mathcal{M}}} = \left\| x \frac{dv}{dx} \right\|_{L^2(\mathcal{M})}.$$

Proposition 5.2.6. (Continuity and Gårding Inequality)

The bilinear form $B(\cdot, \cdot)$ is continuous on $V_{\mathcal{M}}$, and satisfies the Gårding inequality:

$$\forall u \in V_{\mathcal{M}} : \quad B(u) \geq \frac{\sigma^2}{2} |u|_{V_{\mathcal{M}}}^2 - \lambda \|u\|_{L^2(\mathcal{M})}^2$$

where $\lambda = \frac{(\sigma^2 - 3r)}{2}$. Moreover, $B(\cdot, \cdot)$ is coercive under the second assumption 5.2.2.

Proof.

For any pair $(u, v) \in (\mathcal{D}(\mathcal{M}))^2$, using Poincaré inequality we get:

$$\begin{aligned}
|B(u, v)| &= \left| \int_L^M \frac{\sigma^2 x^2}{2} \frac{\partial u}{\partial x} \frac{\partial v}{\partial x} dx + \int_L^M (\sigma^2 - r) x \frac{\partial u}{\partial x} v dx + \int_L^M r u v dx \right| \\
&\leq \frac{\sigma^2}{2} |u|_{V_{\mathcal{M}}} |v|_{V_{\mathcal{M}}} + (\sigma^2 - r) \|u\|_{V_{\mathcal{M}}} \|v\|_{L^2(\mathcal{M})} + r \|u\|_{L^2(\mathcal{M})} \|v\|_{L^2(\mathcal{M})} \\
&\leq C_1 |u|_{V_{\mathcal{M}}} |v|_{V_{\mathcal{M}}}
\end{aligned}$$

where $C_1 = 2r + \frac{5\sigma^2}{2}$. For the coercivity, we use again Poincaré inequality:

$$\begin{aligned}
B(u) &= \frac{\sigma^2}{2} |u|_{V_{\mathcal{M}}}^2 + \int_L^M (\sigma^2 - r) x \frac{\partial u}{\partial x} u dx + r \|u\|_{L^2(\mathcal{M})}^2 \\
&= \frac{\sigma^2}{2} |u|_{V_{\mathcal{M}}}^2 - \frac{(\sigma^2 - 3r)}{2} \|u\|_{L^2(\mathcal{M})}^2 \\
&\geq C_2 |u|_{V_{\mathcal{M}}}^2
\end{aligned}$$

where $C_2 = 6r - \frac{3\sigma^2}{2}$.

□

Definition 5.2.7.

We define the mapping $\iota : V_{\mathcal{M}} \rightarrow L_{\mu}^2(\mathcal{M})$ by

$$\iota(u) = \bar{u}$$

where \bar{u} is the unique $L_{\mu}^2(\mathcal{M})$ -representative of u , and the closed set:

$$\mathcal{N} = \left\{ v \in V_{\mathcal{M}} : \|v\|_{L_{\mu}^2(\mathcal{M})} = 0 \right\}.$$

Theorem 5.2.7. The Black-Scholes Non-Symmetric Dirichlet Form

Under the conditions 5.2.2:

- i. $\text{dom}(B) = V_{\mathcal{M}}$ is dense in $L_{\mu}^2(\mathcal{M})$.
- ii. $(\tilde{B}^*, V_{\mathcal{M}})$ is a Hilbert space.
- iii. $(B, \text{dom}(B))$ is a (non-symmetric) Dirichlet form.

Proof.

- Let us consider a sequence $(u_n)_{n \in \mathbb{N}}$ of $\mathcal{D}(\mathcal{M})$, which converges towards u in $L^2_\mu(\mathcal{M})$.

We then consider two sequences, $(a_n)_{n \in \mathbb{N}} \in \mathcal{N}^{\mathbb{N}}$, and $(b_n)_{n \in \mathbb{N}} \in V_{\mathcal{M}}^{\mathbb{N}}$ such that, for any natural integer n :

$$u_n = a_n + b_n.$$

Then, the sequence $(b_n)_{n \in \mathbb{N}}$ converges towards u in $L^2_\mu(\mathcal{M})$.

- Under the first condition 5.2.2, the induced norm $\tilde{B}^*(\cdot, \cdot)^{\frac{1}{2}}$ is equivalent to the norm $|\cdot|_{V_{\mathcal{M}}}$. Hence, $(B^*, \text{dom}(B))$ is complete.
- It follows from the coercivity of B that:

$$0 \leq C_2 |u^2 - \tilde{u}^2|_{V_{\mathcal{M}}}^2 \leq B(u \pm \tilde{u}, u \mp \tilde{u}).$$

□

Theorem 5.2.8 (Self-Similar Black-Scholes Operator).

*Under the conjecture 5.2.2, there exists a linear bounded operator \mathcal{BS}_μ , that we will call **self-similar Black-Scholes operator**, such that, for any pair $(u, v) \in \text{dom}(\mathcal{BS}_\mu) \times \text{dom}(B)$:*

$$B(u, v) = \langle \mathcal{BS}_\mu(u), v \rangle_{L^2_\mu(\mathcal{M})}$$

Moreover, we will say that $u \in \text{dom}(\mathcal{BS}_\mu)$ and $\mathcal{BS}_\mu(u) = f$ if and only if

$$B(u, v) = \int_{\mathcal{M}} f v d\mu \quad , \quad \forall v \in V_{0, \mathcal{M}}$$

Remark 5.2.3.

The self-similar Black-Scholes operator is bounded from $V_{\mathcal{M}}$ to $V_{\mathcal{M}}^*$ since, $\forall v \in V_{0, \mathcal{M}}$

$$\begin{aligned} \left| \langle \mathcal{BS}_\mu(u), v \rangle_{L^2_\mu(\mathcal{M})} \right| &= |B(u, v)| \\ &\leq C_1 |u|_{V_{\mathcal{M}}} |v|_{V_{\mathcal{M}}} \end{aligned}$$

by continuity of $B(\cdot, \cdot)$.

Notations (Sobolev Spaces). Given a strictly positive integer d , an open bounded subset E of \mathbb{R}^d , $k \in \mathbb{N}$, and $p \geq 1$, we recall that the classical Sobolev spaces on E are

$$W_p^k(E) = \left\{ f \in L^p(E), \forall j \leq k : D^j f \in L^p(E) \right\}$$

and

$$H^k(E) = W_2^k(E) = \left\{ f \in L^2(E), \forall j \leq k : D^j f \in L^2(E) \right\}.$$

The subspace H_0^k of functions which vanish on ∂E is

$$H_0^k(E) = \left\{ f \in L^2(E), f|_{\partial E} = 0 \text{ and } \forall j \leq k : D^j f \in L^2(E) \right\}.$$

It directly comes from the abstract theory of partial differential equations [Zeig0], [Wlo87], [LM68] that:

Theorem 5.2.9 (Self-Similar Black-Scholes Weak Solution).

Let us define the Gelfand triple (or equipped Hilbert space) $V_{\mathcal{M}} \subset L_{\mu}^2(\mathcal{M}) \subset V_{\mathcal{M}}^*$. For h in $L_{\mu}^2(\mathcal{M})$, the self-similar Black-Scholes problem admits, under the assumption 5.2.2, a unique weak solution. Moreover, for $k \geq 1$, the solution map:

$$\begin{aligned} L_{\mu}^2(\mathcal{M}) &\rightarrow W_2^k([0, T]; V_{\mathcal{M}}) \\ h &\mapsto u \end{aligned}$$

is continuous.

5.3 POINTWISE FORMULA

Let us consider $u \in \text{dom}(\mathcal{BS}_{\mu})$. We set: $\mathcal{BS}_{\mu}(u) = f$.

In order to compute the explicit formula of \mathcal{BS}_{μ} , we set $\mathbb{M} = M - L$ and we recall the self similar construction of \mathcal{M} (chapter 1):

$$\overline{\mathcal{M}} = \sum_{i=1}^2 f_i(\overline{\mathcal{M}}).$$

Definition 5.3.1 (Prefractal Graph Approximation).

We denote by V_0 the ordered set of the (boundary) points:

$$\{L, M\}$$

We build the graph \mathcal{M}_0 by connecting the two extremities of V_0 .

For any strictly positive integer m , we set:

$$V_m = \bigcup_{i=1}^2 f_i(V_{m-1}) .$$

The set of points V_m , where consecutive points are connected, will be denoted by \mathcal{M}_m .

The set V_m is called the set of vertices of the graph \mathcal{M}_m . By extension, we will write that

$$\mathcal{M}_m = \bigcup_{i=1}^2 f_i(\mathcal{M}_{m-1}) .$$

One can prove that the sequence $\{V_m\}_{m \in \mathbb{N}}$ is increasing and its limit dense in \mathcal{M} (property 1.3.2).

Proposition 5.3.1.

Given a natural integer m , we will denote by \mathcal{N}_m the number of vertices of the graph \mathcal{M}_m . One has:

$$\mathcal{N}_0 = 2$$

and, for any strictly positive integer m :

$$\mathcal{N}_m = 2^m + 1 .$$

We recall the following definitions:

Definition 5.3.2 (Word).

Given a strictly positive integer m , we will call **number-letter** any integer \mathcal{W}_i of $\{1, 2\}$, and **word of length** $|\mathcal{W}| = m$, on the graph \mathcal{M}_m , any set of number-letters of the form:

$$\mathcal{W} = (\mathcal{W}_1, \dots, \mathcal{W}_m) .$$

We will write:

$$f_{\mathcal{W}} = f_{\mathcal{W}_1} \circ \dots \circ f_{\mathcal{W}_m} .$$

Definition 5.3.3 (Addresses).

Given a natural integer m , and a vertex X of \mathcal{M}_m , we will call address of the vertex X an expression of the form

$$X = f_{\mathcal{W}}(L) \quad \text{or} \quad X = f_{\mathcal{W}'}(M)$$

where \mathcal{W} and \mathcal{W}' denote words of length m . The vertex X has thus a double address.

Property 5.3.2 (Space of Harmonic Splines [RD20a]).

Given a strictly positive integer m , we introduce the space of harmonic splines of order m , denoted by $\mathcal{H}^m([L, M])$, as the space of functions ψ_X^m , $X \in [L, M]$, such that:

$$\forall Y \in \mathcal{M}_m \quad \psi_X^m(Y) = \delta_{XY}.$$

For $k \in \{1, \dots, 2^m - 1\}$, and $Y \in [L, M]$:

$$\psi_{L+\frac{k\mathbb{M}}{2^m}}^m(Y) = \begin{cases} \frac{2^m}{\mathbb{M}}(Y-L) - (k-1) & L + \frac{(k-1)\mathbb{M}}{2^m} \leq Y \leq L + \frac{k\mathbb{M}}{2^m} \\ -\frac{2^m}{\mathbb{M}}(Y-L) + (k+1) & L + \frac{k\mathbb{M}}{2^m} \leq Y \leq L + \frac{(k+1)\mathbb{M}}{2^m} \\ 0 & \text{otherwise} \end{cases}$$

and

$$\psi_L^m(Y) = \begin{cases} -\frac{2^m}{\mathbb{M}}(Y-L) + 1 & L \leq Y \leq L + \frac{\mathbb{M}}{2^m} \\ 0 & \text{otherwise} \end{cases},$$

$$\psi_M^m(Y) = \begin{cases} \frac{2^m}{\mathbb{M}}(Y-M) + 1 & M - \frac{\mathbb{M}}{2^m} \leq Y \leq M \\ 0 & \text{otherwise} \end{cases}$$

Proposition 5.3.3 (Integration of Harmonic Splines [RD20a]).

Let us consider a strictly positive integer m . For $k \in \{1, \dots, 2^m - 1\}$, we denote by $\mathcal{V}_{\mathcal{M}k}$ and \mathcal{W}_k the unique indices such that

$$f_{\mathcal{V}_{\mathcal{M}k}}([L, M]) = \left[L + \frac{(k-1)\mathbb{M}}{2^m}, L + \frac{k\mathbb{M}}{2^m} \right] \quad \text{and} \quad f_{\mathcal{W}_k}([L, M]) = \left[L + \frac{k\mathbb{M}}{2^m}, L + \frac{(k+1)\mathbb{M}}{2^m} \right].$$

Then,

$$\int_L^M \psi_{L+\frac{k\mathbb{M}}{2^m}}^m d\mu = \mu_1^{s_{\mathcal{V}_{\mathcal{M}k}}} \mu_2^{m+1-s_{\mathcal{V}_{\mathcal{M}k}}} + \mu_1^{s_{\mathcal{W}_k}+1} \mu_2^{m-s_{\mathcal{W}_k}}$$

and

$$\int_L^M \psi_L^m d\mu = \mu_1^{m+1} \quad \int_L^M \psi_M^m d\mu = \mu_2^{m+1}.$$

In addition, if $\mu_1 < \frac{1}{2}$:

$$\int_L^M \psi_L^m d\mu < \int_L^M \psi_{L+\frac{k\mathbb{M}}{2^m}}^m d\mu < \int_L^M \psi_M^m d\mu.$$

Property 5.3.4. Given a strictly positive integer m , we set, for any integer $k \in \{0, \dots, 2^m\}$:

$$x_k = L + \left(k \frac{\mathbb{M}}{2^m}\right)$$

and, for any $u \in \text{dom}(\mathcal{BS}_\mu)$:

$$\begin{aligned} B(u, \psi_{x_k}^m) &= \int_L^M \left(-\frac{\sigma^2 x^2}{2} \frac{\partial^2 u}{\partial x^2} - r x \frac{\partial u}{\partial x} + r u \right) \psi_{x_k}^m dx \\ &= \lim_{m \rightarrow +\infty} \sum_{j=0}^{2^m} \mathcal{BS}_m(u(t, x_j)) \psi_{x_k}^m \left(\frac{\mathbb{M}}{2^m} \right) \\ &= \lim_{m \rightarrow +\infty} \mathcal{BS}_m(u(t, x_k)) \left(\frac{\mathbb{M}}{2^m} \right) \end{aligned}$$

where \mathcal{BS}_m is the Black-Scholes discrete operator defined, for any t in $[0, T]$, by:

$$\begin{aligned} \mathcal{BS}_m u(t, x_k) &= -\frac{\sigma^2}{2} x_k^2 \left(\frac{u(t, x_{k+1}) - 2u(t, x_k) + u(t, x_{k-1}))}{\left(\frac{\mathbb{M}}{2^m}\right)^2} \right) \\ &\quad - r x_k \left(\frac{u(t, x_{k+1}) - u(t, x_{k-1}))}{2 \left(\frac{\mathbb{M}}{2^m}\right)} \right) + r C(t, x_k) \\ &= -\frac{\sigma^2}{2} k^2 (u(t, x_{k+1}) - 2u(t, x_k) + u(t, x_{k-1})) \\ &\quad - r k \left(\frac{u(t, x_{k+1}) - u(t, x_{k-1}))}{2} \right) + r C(t, x_k) \end{aligned}$$

The mean value formula yields asymptotically

$$\int_L^M \mathcal{BS}_\mu u(x) \psi_{x_k}^m d\mu \approx \mathcal{BS}_\mu u(x_k) \int_L^M \psi_{x_k}^m d\mu.$$

Theorem 5.3.5 (Self-Similar Black-Scholes Operator Pointwise Formula).

Let us consider $u \in \text{dom}(\mathcal{BS}_\mu)$. Then, for any $x \in \overline{\mathcal{M}}$, and any sequence $(x_m)_{m \in \mathbb{N}}$ of $V_m \setminus V_0$ which uniformly converges towards x :

$$\mathcal{BS}_\mu(u)(x) = \lim_{m \rightarrow +\infty} 2^{-m} \left(\int_L^M \psi_{x_m}^m d\mu \right)^{-1} \mathcal{BS}_m(u)(x_m).$$

Proof.

The uniform convergence directly comes from the fact that

$$\left(\frac{\mathbb{M}}{2^m}\right) \left(\int_L^M \psi_{x_m}^m d\mu\right)^{-1} \mathcal{BS}_m(u)(x_m) = C \frac{\int_L^M \mathcal{BS}_\mu \psi_{x_m}^m d\mu}{\int_L^M \psi_{x_m}^m d\mu} = C \mathcal{BS}_\mu(u)(x).$$

The extension to $\overline{\mathcal{M}}$ is done according to remark 1.6.1.

For $\mu_1 = \mu_2 = \frac{1}{2}$, one recovers the classical Black-Scholes operator, which implies that: $C = \mathbb{M}$. \square

5.4 PROOF OF THE ASSUMPTION

5.4.1 First Assumption 5.2.2

Notation (Space of Weighted Continuous Functions).

We will denote by $C(\overline{\mathcal{M}})$ the space of weighted continuous functions on $\overline{\mathcal{M}}$ endowed with the norm

$$\|u\|_{\eta,\infty} = \max_{x \in \overline{\mathcal{M}}} |x u(x)|.$$

Proof. of the first assumption

Let us consider $u \in V_{0,\mathcal{M}}$. In one hand:

$$\begin{aligned} |x u(x)| &= \left| \int_L^x (su(s))' ds \right| \\ &= \left| \int_L^x u(s) ds + \int_L^x su'(s) ds \right| \\ &\leq \sqrt{\mathbb{M}} (\|u\|_{L^2} + \|u\|_{V_{\mathcal{M}}}) \\ &\leq \sqrt{\mathbb{M}} \|u\|_{V_{\mathcal{M}}} \end{aligned}$$

We deduce the continuity of the injection $\iota : (V_{\mathcal{M}}, \|\cdot\|_{V_{\mathcal{M}}}) \rightarrow (C_\eta(\overline{\mathcal{M}}), \|\cdot\|_{\eta,\infty})$. In the other hand, for $u \in C_\eta(\overline{\mathcal{M}})$:

$$\|u\|_{L_\mu^2(\mathcal{M})} = \left(\int_L^M \frac{1}{x^2} (x u)^2 d\mu \right)^{\frac{1}{2}} \leq \|u\|_{\eta,\infty} \left(\int_L^M \frac{1}{x^2} d\mu \right)^{\frac{1}{2}} \leq \|u\|_{\eta,\infty} \frac{\mu(\overline{\mathcal{M}})^{\frac{1}{2}}}{L}$$

the injection $\iota : (C_\eta(\overline{\mathcal{M}}), \|\cdot\|_{\eta,\infty}) \rightarrow (L_\mu^2(\mathcal{M}), \|\cdot\|_{L_\mu^2(\mathcal{M})})$ is continuous, so we got finally

$$\|u\|_{L_\mu^2(\mathcal{M})} \leq C_0 \|u\|_{V_{\mathcal{M}}}$$

for $C_0 = \frac{\sqrt{\mathbb{M} \mu(\overline{\mathcal{M}})}}{L}$.

\square

5.4.2 Commentary on the Second Assumption 5.2.2

The assumption $4r > \sigma^2$ is not that restrictive as it may seem in the first sight, for example, if we give a look to sample from Vance L. Martin data [LMM05]. The sample consist of $N = 269$ observations on the European call options written on the S&P500 stock index on the 4th of April, 1995. We can calculate (see [RD21b])

- The interest rate $r = 0.0591$.
- The volatility $\sigma = 0.076675$.

which means that

$$4r = 0.2364 \gg 0.00587906 = \sigma^2.$$

5.5 NUMERICAL SIMULATION OF SELF-SIMILAR EUROPEAN OPTIONS

Let us consider as in the above, the self-similar Black-Scholes equation, for a call European options, defined by the system:

$$\begin{aligned} \frac{\partial C}{\partial t}(t, S) &= \mathcal{BS}_\mu(C)(t, S) & \forall t \in [0, T], \forall S \in \mathcal{M} \\ C(T, S) &= h(S) & \forall S \in \mathcal{M} \\ C(t, L) &= 0 & \forall t \in [0, T] \\ C(t, M) &= g(t) & \forall t \in [0, T] \end{aligned}$$

for a self-similar measure μ on $\overline{\mathcal{M}}$, under the condition

$$4r > \sigma^2.$$

where $h(S) = (S - K)^+$ and $g(t) = M - K \exp(-r(T - t))$, and where the constant σ is the volatility, r the risk-free interest rate, T the maturity of the option and C represents the call price.

We will use the following change of variables: $\tau = T - t$, which leads to the following equation (with the same notations):

$$\begin{aligned} -\frac{\partial C}{\partial t}(t, S) &= \mathcal{BS}_\mu(C)(t, S) & \forall t \in [0, T], \forall S \in \mathcal{M} \\ C(0, S) &= h(S) & \forall S \in \mathcal{M} \\ C(t, L) &= 0 & \forall t \in [0, T] \\ C(t, M) &= g(t) & \forall t \in [0, T] \end{aligned}$$

for $g(t) = M - K \exp(-rt)$.

Remark 5.5.1.

The results of section 5.2 still hold, if we write $\tilde{C} = C - \tilde{g}$, where $\tilde{g}(t, x) = (x - L) \left(\frac{M - K \exp(-rt)}{M - L} \right)$, and replace the space $V_{\mathcal{M}}$ by $V_{0, \mathcal{M}}$, then we solve the non homogeneous problem

$$\int_L^M \frac{\partial \tilde{C}}{\partial t} v d\mu + B(\tilde{C}, v) = \int_L^M \frac{d\tilde{g}}{dt} v d\mu$$

applying abstract theory of partial differential equations [Wlo87].

5.5.1 The Finite Difference Method

In the spirit of our previous work [RD19], we fix a strictly positive integer N , and set:

$$h = \frac{T}{N}$$

We will write, for a function f , $n \in \{0, \dots, N\}$ and $k \in \{0, \dots, 2^m\}$:

$$f(h, k) = f(nh, L + k \frac{\mathbb{M}}{2^m}).$$

We use the Euler implicit scheme, for any integer n belonging to $\{0, \dots, N - 1\}$:

$$\forall k \in \{0, \dots, 2^m\} : \quad \frac{\partial C}{\partial t}(n, k) \approx \frac{1}{h} (C(n+1, k) - C(n, k))$$

The self-similar Black-Scholes operator for $k = \{0, \dots, 2^m\}$ is approximated through

$$\begin{aligned} \mathcal{BS}_\mu C(n, k) &\approx \left(\frac{2^{-m}}{\mu_1^{s_{\nu\mathcal{M}}} \mu_2^{m-s_{\nu\mathcal{M}}+1} + \mu_1^{s_{\nu\mathcal{W}}+1} \mu_2^{m-s_{\nu\mathcal{W}}}} \right) \mathcal{BS}_m C(n, k) \\ &\approx \delta_m \mathcal{BS}_m C(n, k) \end{aligned}$$

where \mathcal{BS}_m is the Black-Scholes discretized operator given by

$$\begin{aligned} \mathcal{BS}_m C(n, k) &= -\frac{\sigma^2}{2} \left(\frac{k\mathbb{M}}{2^m} \right)^2 \left(\frac{C(n, k+1) - 2C(n, k) + C(n, k-1)}{\left(\frac{\mathbb{M}}{2^m}\right)^2} \right) \\ &\quad - r \left(\frac{k\mathbb{M}}{2^m} \right) \left(\frac{C(n, k+1) - C(n, k-1)}{2 \left(\frac{\mathbb{M}}{2^m}\right)} \right) + r C(n, k). \end{aligned}$$

For $0 \leq n \leq N - 1$, and $1 \leq k \leq 2^m - 1$, we define the following scheme:

$$(\mathcal{S}_{BS}) \quad \begin{cases} -\frac{C_{h,m}(n+1, k) - C_{h,m}(n, k)}{h} &= \delta_m \mathcal{BS}_m C_{h,m}(n, k) \\ C_{h,m}(n, 0) &= 0 \\ C_{h,m}(n, 2^m) &= g(n) \\ C_{h,m}(0, k) &= h(k). \end{cases}$$

For $n \in \{0, \dots, N - 1\}$, we set:

$$\mathcal{C}(n) = \begin{pmatrix} \mathcal{C}_{h,m}(n, 1) \\ \vdots \\ \mathcal{C}_{h,m}(n, 2^m - 1) \end{pmatrix} = \begin{pmatrix} \mathcal{C}_{h,m}(n, f_{\mathcal{W}^1}(M)) \\ \vdots \\ \mathcal{C}_{h,m}(n, f_{\mathcal{W}^{2^m-1}}(M)) \end{pmatrix}, \quad \{\mathcal{W}^1, \dots, \mathcal{W}^{2^m-1}\} \in \{1, 2\}^m.$$

We have the following recurrence relation:

$$\mathcal{C}(n+1) = A \mathcal{C}(n) + B(n)$$

where the $(2^m - 1) \times (2^m - 1)$ matrix A is given by:

$$A = I_{2^m-1} - h 2^{-m} \Psi_m^{-1} BS_m$$

and where I_{2^m-1} denotes the $(2^m - 1) \times (2^m - 1)$ identity matrix, Ψ_m and BS_m the $(2^m - 1) \times (2^m - 1)$ matrices:

$$\Psi_m = \begin{pmatrix} \ddots & & & & & & 0 \\ & \mu_1^{s_{\mathcal{V}_M}} \mu_2^{m+1-s_{\mathcal{V}_M}} + \mu_1^{s_{\mathcal{W}^1}} \mu_2^{m-s_{\mathcal{W}^1}} & & & & & \\ & & \ddots & & & & \\ 0 & & & & & & \ddots \end{pmatrix}$$

$$BS_m = \begin{pmatrix} -\sigma^2 - r & \frac{\sigma^2}{2} + \frac{r}{2} & 0 & \dots & 0 & 0 \\ 2\sigma^2 - r & -4\sigma^2 - r & 2\sigma^2 + r & \dots & 0 & 0 \\ \vdots & \vdots & \vdots & \ddots & \vdots & \vdots \\ 0 & 0 & 0 & \dots & -(2^m - 2)^2 \sigma^2 - r & (2^m - 2)^2 \frac{\sigma^2}{2} + (2^m - 2) \frac{r}{2} \\ 0 & 0 & 0 & \dots & (2^m - 1)^2 \frac{\sigma^2}{2} - (2^m - 1) \frac{r}{2} & -(2^m - 1)^2 \sigma^2 - r \end{pmatrix}$$

and

$$B(n) = h 2^{-m} \mu_2^{-(m+1)} \left((2^m - 1)^2 \frac{\sigma^2}{2} + (2^m - 1) \frac{r}{2} \right) \begin{pmatrix} 0 \\ \vdots \\ 0 \\ g(n) \end{pmatrix}.$$

5.5.2 Numerical Analysis

THE SCHEME ERROR AND CONSISTENCY

Let us consider a function $V_{\mathcal{M}}$ defined on \mathcal{M} . For any integer n in $\{0, \dots, N-1\}$, and any X in \mathcal{M} :

$$\frac{\partial v}{\partial t}(nh, X) = \frac{1}{h} (v((n+1)h, X) - v(nh, X)) + \mathcal{O}(h)$$

As in [RD19], for any strictly positive integer m , and any X in $V_m \setminus V_0$, one can prove that:

$$2^{-m} \left(\int_L^M \psi_X^m d\mu \right)^{-1} \mathcal{BS}_m v(X) = \frac{\int_L^M \mathcal{BS}_\mu \psi_X^m d\mu}{\int_L^M \psi_X^m d\mu}$$

and that there exists a vertex Z in the m -cell $f_{\mathcal{W}}([L, M])$ containing X such that

$$\begin{aligned} \left| \mathcal{BS}_\mu v(X) - 2^{-m} \left(\int_L^M \psi_X^m d\mu \right)^{-1} \mathcal{BS}_m v(X) \right| &= \left| \mathcal{BS}_\mu v(X) - \mathcal{BS}_\mu v(Z) \right| \\ &\lesssim |v(X) - v(Z)| \\ &\lesssim |X - Z| \\ &\lesssim \left(\frac{1}{2} \right)^m. \end{aligned}$$

using remark 5.2.3 and the uniform continuity of $v \in V_{\mathcal{M}}$. Thus,

$$\mathcal{BS}_\mu v(X) = 2^{-m} \left(\int_L^M \psi_X^m d\mu \right)^{-1} \mathcal{BS}_m v(X) + \mathcal{O}(2^{-m}).$$

The consistency error of our scheme is given by :

$$\varepsilon_{n,k}^{h,m} = \mathcal{O}(h) + \mathcal{O}(2^{-m}) \quad 0 \leq n \leq N, 0 \leq k \leq 2^m.$$

We can check that the scheme is consistent:

$$\lim_{h \rightarrow 0, m \rightarrow \infty} \varepsilon_{n,k}^{h,m} = 0.$$

STABILITY

We hereafter prove that the scheme is conditionally stable for the $\|\cdot\|_\infty$ norm.

Let us recall that, for $0 \leq n \leq N$, and $0 \leq k \leq 2^m$:

$$\begin{aligned}
\mathcal{C}_{h,m}(n+1, k) &= \mathcal{C}_{h,m}(n, k) (1 - h \delta_m \sigma^2 k^2) \\
&\quad + \mathcal{C}_{h,m}(n, k+1) \left(h \delta_m \frac{\sigma^2}{2} k^2 + h \delta_m \frac{r}{2} k \right) \\
&\quad + \mathcal{C}_{h,m}(n, k-1) \left(h \delta_m \frac{\sigma^2}{2} k^2 - h \delta_m \frac{r}{2} k \right) \\
&\quad - \mathcal{C}_{h,m}(n, k) h \delta_m r \\
&= \mathcal{C}_{h,m}(n, k) (1 - \alpha_k) + \mathcal{C}_{h,m}(n, k+1) \left(\frac{\alpha_k}{2} + \beta_k \right) + \mathcal{C}_{h,m}(n, k-1) \left(\frac{\alpha_k}{2} - \beta_k \right) \\
&\quad - \mathcal{C}_{h,m}(n, k) \gamma
\end{aligned}$$

If we consider $\gamma = 0$, this is just an affine combination. Moreover, we have:

$$1 - \alpha_k \geq 1 - \sigma^2 \frac{h 2^{2m}}{2^m \left(\int_L^M \psi_X^m d\mu \right)} \geq 0, \quad \frac{\alpha_k}{2} - \beta_k \geq 0, \quad 1 - \gamma \geq 0.$$

May we suppose that $\sigma^2 \geq r$ and that the following CFL condition

$$\frac{h 2^m}{\left(\int_L^M \psi_X^m d\mu \right)} \leq \frac{1}{\sigma^2}$$

is satisfied, the combination is then convex, and the scheme is stable for the norm $\| \cdot \|_\infty$.

For $\gamma \neq 0$, one has:

$$\begin{aligned}
(1 - \gamma) \min_{0 \leq j \leq 2^m} \mathcal{C}_{h,m}(n, j) &\leq \mathcal{C}_{h,m}(n+1, k) \leq \max_{0 \leq j \leq 2^m} \mathcal{C}_{h,m}(n, j) - \gamma \min_{0 \leq j \leq 2^m} \mathcal{C}_{h,m}(n, j) \\
&\leq \max_{0 \leq j \leq 2^m} \mathcal{C}_{h,m}(n, j) - \gamma (1 - \gamma)^n \min_{0 \leq j \leq 2^m} \mathcal{C}_{h,m}(0, j) \\
&\leq \max_{0 \leq j \leq 2^m} \mathcal{C}_{h,m}(n, j)
\end{aligned}$$

and the scheme is $\| \cdot \|_\infty$ -stable under the same conditions.

CONVERGENCE

Theorem 5.5.1.

If the above CFL condition holds, the scheme is convergent for the norm $\| \cdot \|_{2,\infty}$ given by:

$$\| (\mathcal{C}_{h,m}(n, k))_{0 \leq n \leq N, 0 \leq k \leq 2^m} \|_{2,\infty} = \max_{0 \leq n \leq N} \left(\sum_{0 \leq k \leq 2^m} \mu(f_{\mathcal{W}^k}(\mathcal{M})) (\mathcal{C}_{h,m}(n, k))^2 \right)^{\frac{1}{2}}$$

where $\mu(f_{\mathcal{W}^k}(\mathcal{M}))$ is the measure of the $f_{\mathcal{W}^k}(\mathcal{M})$.

Proof.

For $0 \leq n \leq N$ and $0 \leq k \leq 2^m$, we set:

$$w_k^n = C(n, k) - \mathcal{C}_{h,m}(n, k)$$

and:

$$\begin{aligned} \mathcal{BS}_m C(n, k) &= -\frac{\sigma^2}{2} \left(\frac{k\mathbb{M}}{2^m} \right)^2 \left(\frac{C(n, k+1) - 2C(n, k) + C(n, k-1)}{\left(\frac{\mathbb{M}}{2^m}\right)^2} \right) \\ &\quad - r \left(\frac{k\mathbb{M}}{2^m} \right) \left(\frac{C(n, k+1) - C(n, k)}{\left(\frac{\mathbb{M}}{2^m}\right)} \right) + r C(n, k). \end{aligned}$$

One may check that:

$$\begin{aligned} \frac{w_k^{n+1} - w_k^n}{h} - \frac{\sigma^2}{2} k^2 \delta_m (w_{k+1}^n - 2w_k^n + w_{k-1}^n) - r k \delta_m (w_{k+1}^n - w_k^n) + r \delta_m w_k^n &= \varepsilon_{n,k}^{h,m} & 0 \leq n \leq N-1, 1 \leq k \leq 2^m-1 \\ w_0^n = w_{2^m}^n &= 0 & 0 \leq n \leq N \\ w_k^0 &= 0 & 1 \leq k \leq 2^m-1. \end{aligned}$$

Let us set, for any integer n in $\{0, \dots, N\}$:

$$W^n = \begin{pmatrix} w_1^n \\ \vdots \\ w_{2^m-1}^n \end{pmatrix}, \quad E^n = \begin{pmatrix} \varepsilon_{n,1}^{h,m} \\ \vdots \\ \varepsilon_{n,2^m-1}^{h,m} \end{pmatrix}.$$

One has:

$$W^0 = 0 \quad \text{and} \quad \forall n \in \{0, \dots, N-1\}: \quad W^{n+1} = A W^n + h E^n.$$

By induction, this yields, for any integer n in $\{0, \dots, N-1\}$:

$$W^{n+1} = A^n W^0 + h \sum_{j=0}^n A^j E^{n-j} = h \sum_{j=0}^n A^j E^{n-j}$$

Since A is a symmetric matrix, the CFL stability condition yields, for any integer n in $\{0, \dots, N\}$:

$$\begin{aligned} |W^n| &\leq h \left(\sum_{j=0}^{n-1} \|A\|^j \right) \left(\max_{0 \leq j \leq n-1} |E^j| \right) \\ &\leq h n \left(\max_{0 \leq j \leq n-1} |E^j| \right) \\ &\leq h N \left(\max_{0 \leq j \leq n-1} |E^j| \right) \\ &\leq T \left(\max_{0 \leq j \leq n-1} \left(\sum_{k=1}^{2^m-1} |\varepsilon_{j,k}^{h,m}|^2 \right)^{\frac{1}{2}} \right). \end{aligned}$$

By assuming $\mu_1 \geq \frac{1}{2}$ (the same result holds for $\mu_1 \leq \frac{1}{2}$ by changing μ_1 into μ_2), we deduce then that:

$$\begin{aligned}
\max_{0 \leq n \leq N} \left(\sum_{k=1}^{2^m-1} \mu(f_{\mathcal{W}^k}(\mathcal{M})) |w_k^n|^2 \right)^{\frac{1}{2}} &\leq \max_{1 \leq k \leq 2^m-1} (\mu(f_{\mathcal{W}^k}(\mathcal{M})))^{\frac{1}{2}} \max_{1 \leq n \leq N} |W^n| \\
&\leq \max_{1 \leq k \leq 2^m-1} (\mu(f_{\mathcal{W}^k}(\mathcal{M})))^{\frac{1}{2}} T \left(\max_{0 \leq n \leq N-1} \left(\sum_{k=1}^{2^m-1} |\varepsilon_{n,k}^{h,m}|^2 \right)^{1/2} \right) \\
&\leq \max_{1 \leq k \leq 2^m-1} (\mu(f_{\mathcal{W}^k}(\mathcal{M})))^{\frac{1}{2}} T \left((2^m-1)^{\frac{1}{2}} \max_{0 \leq n \leq N-1, 1 \leq k \leq 2^m-1} |\varepsilon_{n,k}^{h,m}| \right) \\
&\leq \sqrt{(\mu_1 \times 2)^m} T \left(\max_{0 \leq n \leq N-1, 1 \leq k \leq 2^m-1} |\varepsilon_{n,k}^{h,m}| \right) \\
&= \sqrt{(\mu_1 \times 2)^m} (\mathcal{O}(h) + \mathcal{O}(2^{-m})) \\
&= \mathcal{O} \left(\left(\sqrt{\frac{\mu_1}{2}} \right)^m \right)
\end{aligned}$$

The scheme is then convergent. □

5.5.3 Self-Similar Pricing

In the sequel, we give a numerical simulation of the self-similar pricing, in the case of a call:

$$\begin{aligned}
\frac{\partial C}{\partial t}(t, S) &= \mathcal{BS}_\mu(C)(t, S) && \forall t \in [0, T], \forall S \in [L, M[\\
C(T, S) &= (S - K)^+ && \forall x \in [L, M[\\
C(t, L) &= 0 && \forall t \in v[0, T] \\
C(t, M) &= M - K \exp(-r(T - t)) && \forall t \in [0, T]
\end{aligned}$$

for a self-similar measure μ on $[L, M]$. The solutions are generated using the finite difference method, for

$$T = 1 \quad , \quad K = 150 \quad , \quad \sigma = 0.3 \quad , \quad r = 0.1 \cdot$$

1. The region $x \geq 230$: the option price records its lowest level for $\mu_1 < \frac{1}{2}$, with slight difference with the classical model.
2. The region $100 \leq x \leq 230$: the alternative models overprice the option, $\mu_1 < \frac{1}{2}$ records the highest level.

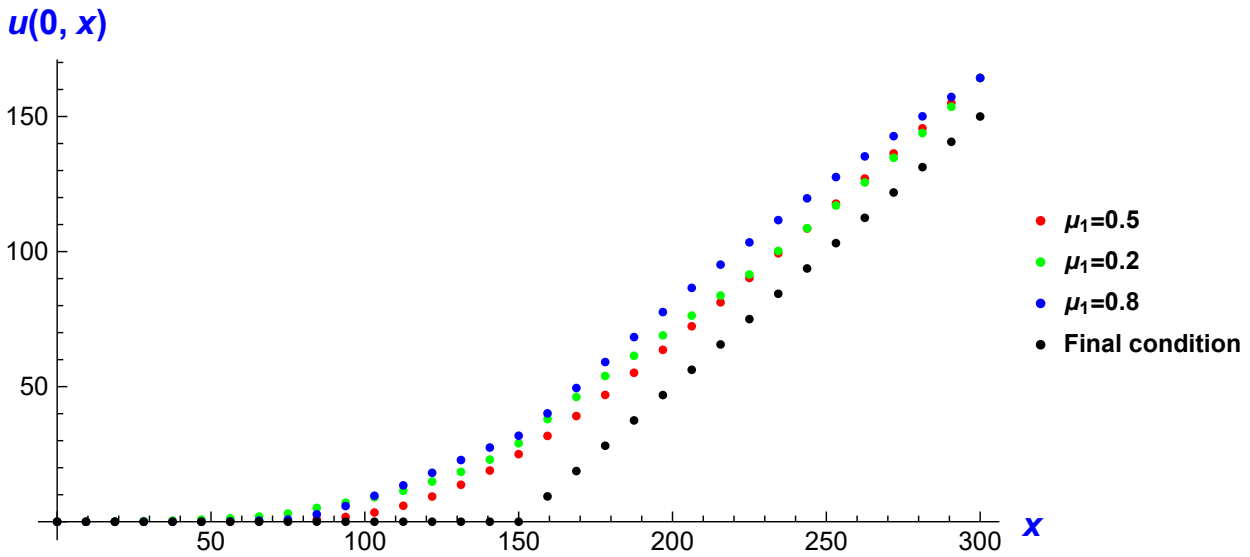

Figure 51: Black-Scholes solution $u(0, x)$ for different values of the weights.

3. The region $x \leq 100$: $\mu_1 < \frac{1}{2}$ is the highest price, followed by $\mu_1 > \frac{1}{2}$, then the classical model.

There are differences with the curves given in [RD20a]: this is due to the exponential transformation of the solution in our previous study.

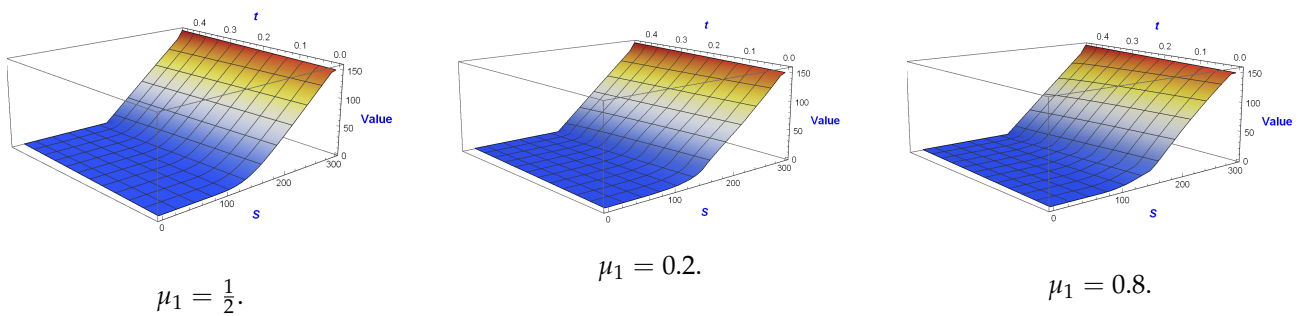

Figure 52: The call value for different values of the weights.

5.5.4 The Greeks

As in [Dav17], we recall that, in finance, the sensitivity of a portfolio to changes in parameters values can be measured through what commonly call "the Greeks", i.e.:

- i. The Delta, $\Delta = \frac{\partial C}{\partial S} \in [0, 1]$, which enables one to quantify the risk, and is thus the most important Greek. It can also be interpreted as a probability that the option will expire in the money.
- ii. The Gamma, $\Gamma = \frac{\partial^2 C}{\partial S^2} \geq 0$, which measures the rate of the acceleration of the option price, with respect to changes in the underlying price.

- iii. The Vega (the name of which comes from the form of the Greek letter ν), $\nu = \frac{\partial C}{\partial \sigma}$, which measures the sensitivity to volatility.
- iv. The Theta $\Theta = \frac{\partial C}{\partial t}$, which is the time cost of holding an option.
- v. The rho, $\rho = \frac{\partial C}{\partial r}$, which measures the sensitivity to the risk-free interest rate.

The good strategy, for traders, is to have delta-neutral positions at least once a day, and, whenever the opportunity arises, to improve the Gamma and the Vega.

The Delta

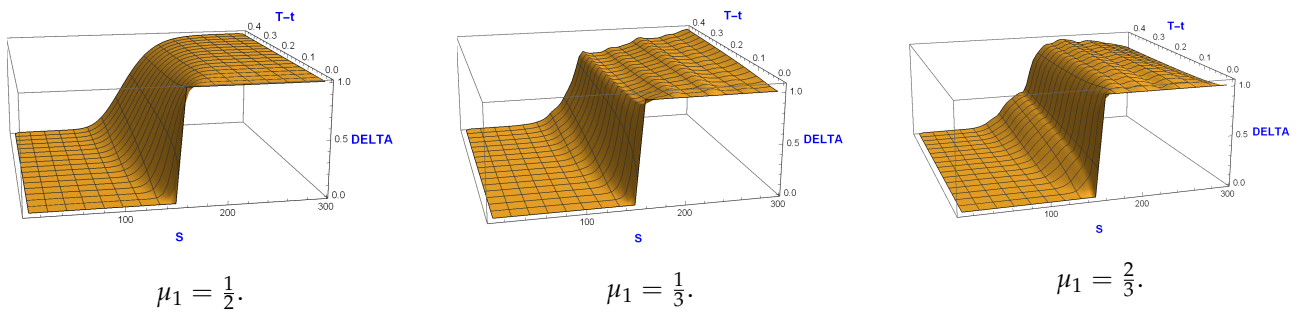

Figure 53: The Δ , for different values of the weights.

The Gamma

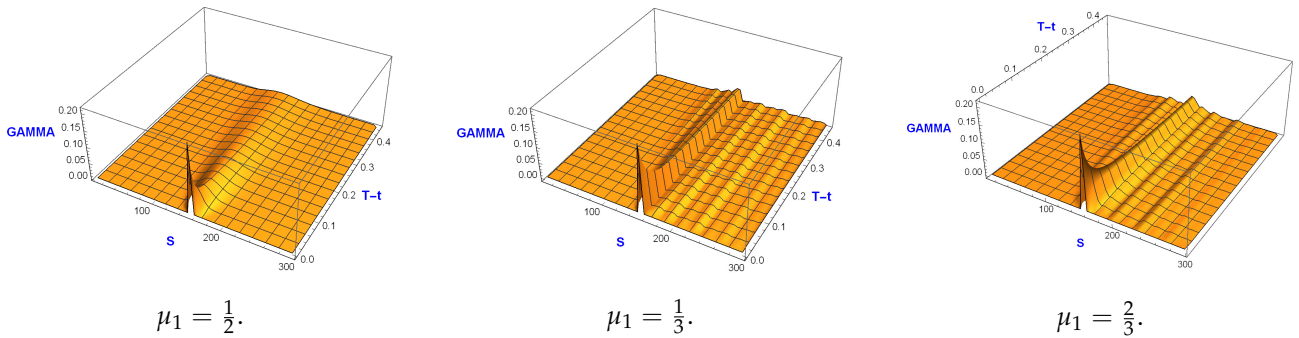
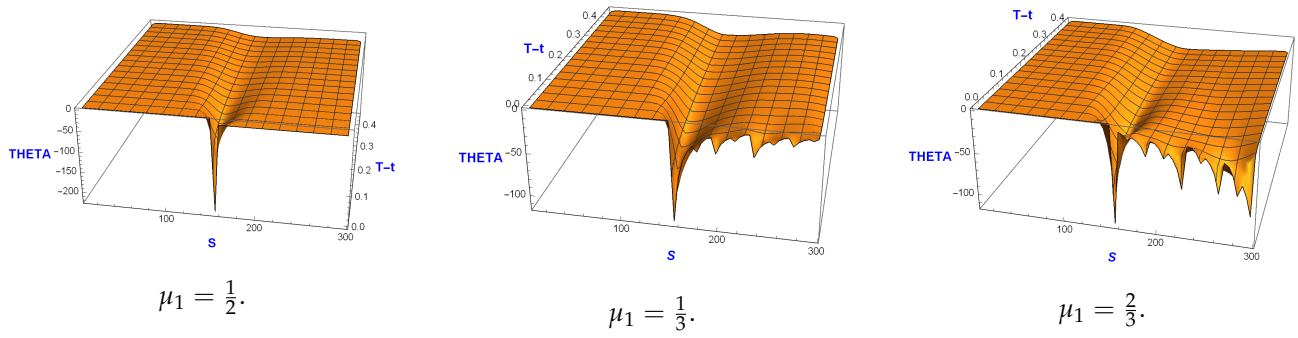
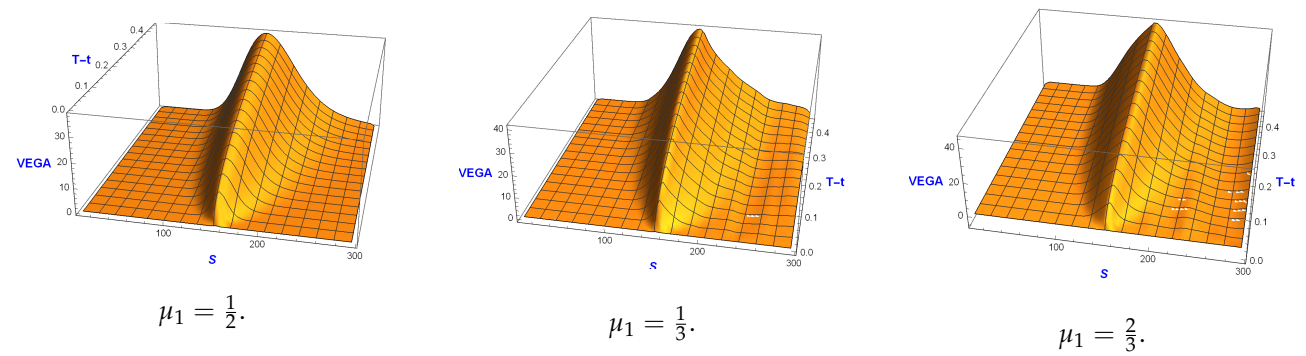
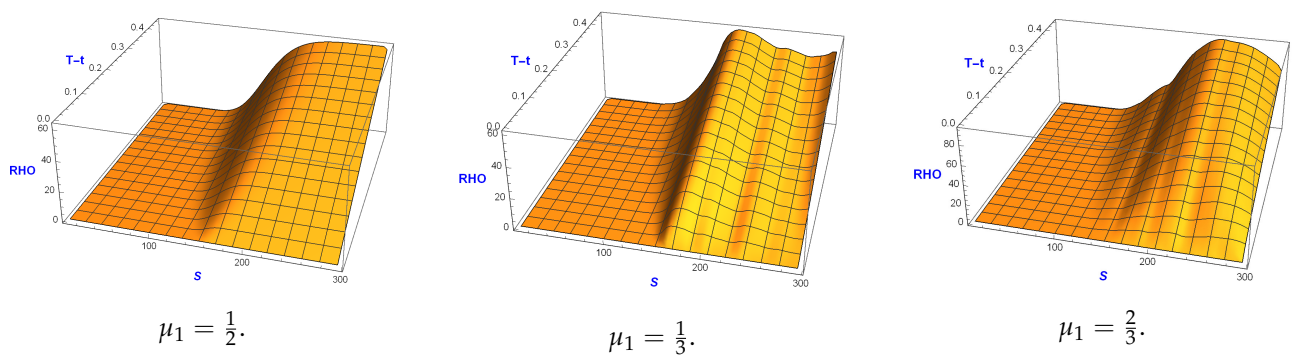

Figure 54: The Γ , for different values of the weights.

The ThetaFigure 55: The Θ , for different values of the weights.*The Vega*Figure 56: The ν , for different values of the weights.*The rho*Figure 57: The ρ , for different values of the weights.

5.5.5 Discussion

Let us make a few remarks about the behavior of the solution with respect to the weight μ at $t = 0$:

- i. For $\mu_1 = \frac{1}{3}$: the premium is greater than that of the classical model under the strike and smaller above. The Greeks value shows a drastic increase in the strike neighbor, and self-similarity clearly affects *in the money* region. The Theta shows a slower premium expected decrease.
- ii. For $\mu_1 = \frac{2}{3}$: the premium is everywhere greater than that of the classical model. The Greeks value increases progressively in the strike neighbor, and self-similarity affects *in the money* region. The Theta indicates a slower premium expected decrease *in the money* and a greater decrease *deep in the money*.

The dynamic generated by the self-similar Black-Scholes model is exotic and enables the emergence of non-standard behaviors, the parameter μ_1 can capture the behavior of non confident investors under **uncertainty** and other factors influencing their perception of future.

The self-similar Black-Scholes equation can be understood as a diffusion equation with a time change through a self-similar probability μ , where the cumulative distribution function satisfies for $x \in]0, 1[$, $[0, x] = f_{\mathcal{W}}([0, 1])$ for some word \mathcal{W} ,

$$\mu [0, x] = \prod_{i \in \mathcal{W}} \mu_i$$

depending on the address (path) of x .

According to this remark, one can create more exotic behavior using a self-similar measure μ with many weights or enable the weights to change over time.

One last question remains: how to choose M and L ? to answer this question, one can use the law of S_t , the underlying asset price, then choose $M(\alpha)$ (respectively $L(\alpha)$) using the rule:

$$1 - \mathbb{P}(L(\alpha) \leq S_t \leq M(\alpha)) \leq \alpha \quad , \quad 0 \leq t \leq T$$

for some tolerance level α .

Appendix

.1 THE FINITE ELEMENT METHOD

In the following, we present the works of Strichartz [SU00] [GRSo1] for the construction of splines and finite element method on fractals.

.1.1 Multiharmonic splines

Multiharmonic function spaces

In order to approximate solutions on fractals as in [GRSo1], we need to introduce the space of multiharmonic spline. To do this we follow the construction of [SU00].

On the unit interval, the space of polynomials is the solution space of $\Delta^k u = 0$ for some k . In the case of a self-similar set \mathcal{F} , the solution of this equation is an harmonic function.

Let $\mathcal{H}_k = \{u : \Delta^{k+1}u = 0\}$ be the space of multiharmonic functions of level $k + 1$. Setting $N_0 = \#(V_0)$, the number of vertices in the initial graph V_0 , we can verify that the dimension of \mathcal{H}_k is $(k + 1)N_0$.

According to Strichartz and Usher [SU00] there exist two basis for this space, the first type of basis is the so called the **easy basis**.

Definition .1.1.

For $0 \leq j$ and $1 \leq k \leq N_0$, we define the **easy basis** of \mathcal{H}_j to be the family $\{f_{jk}\}_{0 \leq m \leq j, 1 \leq k \leq N_0}$ solution of $\Delta^{j+1}f_{jk} = 0$ satisfying the boundary conditions :

$$\Delta^m f_{jk}(P_n) = \delta_{mj} \delta_{kn} \quad \text{for } 1 \leq n \leq N_0, \quad m \geq 0 \quad \text{and} \quad P_n \in V_0$$

Every $f \in \mathcal{H}_j$ has the explicit representation :

$$f = \sum_{m=0}^j \sum_{k=1}^{N_0} (\Delta^m f(P_k)) f_{mk}$$

Proposition .1.1.

The solution f_{jk} satisfies $\Delta f_{jk} = f_{(j-1)k}$ and is given by :

$$f_{jk} = - \int G(x, y) f_{(j-1)k}(y) d\mu y \quad \text{for } j \geq 1$$

where $G(x, y)$ is the Green function.

We define a inner product for this basis :

Proposition .1.2.

For all j, k, j', k' , we have :

$$\begin{aligned}
 I(jk, j'k') &:= \int f_{jk} f_{j'k'} d\mu \\
 &= \sum_{i=1}^N \sum_{l=0}^j \sum_{n=1}^{N_0} \sum_{l'=0}^{j'} \sum_{n'=1}^{N_0} \mu_i (r_i \mu_i)^{l+l'} f_{(j-l)k}(F_i(P_n)) f_{(j'-l')k'}(F_i(P_{n'})) I(ln, l'n')
 \end{aligned}$$

And for $j = j' = 0$:

$$I(0k, 0k') = \sum_{n=1}^{N_0} \sum_{n'=1}^{N_0} A(kk', nn') I(0n, 0n')$$

with $A(kk', nn') = \sum_{i=1}^N \mu_i f_{0k}(F_i(P_n))(F_i(P_{n'}))$. And we can verify that

$$I(jk, j'k') = I((j + j')k, 0k')$$

Theorem .1.3.

Assume that the matrix $A(kk', nn')$ is irreducible. If the values of $f_{ml}(F_i(P_n))$ are known for $m \leq \max(j, j')$, then we can uniquely determine $I(jk, j'k')$ by imposing :

$$\sum_{k=0}^{N_0} \sum_{k'=0}^{N_0} I(0k, 0k') = 1$$

Proposition .1.4.

We can write the Green function explicitly as :

$$G(F_i(P_n), F_i(P_{n'})) = \sum_{n'=1}^{N_0} \gamma(i, i', n, n') f_{0n'}(y)$$

where $\gamma(i, i', n, n') = G_{pq}$ for $p = F_i(P_n)$ $q = F_i(P_{n'})$, and the matrix G_{pq} is given by $G = -X^{-1}$, where X denotes the restriction to $(V_1 \setminus V_0) \times (V_1 \setminus V_0)$ of the Dirichlet form \mathcal{E}_1 on $V_1 \times V_1$.

Proposition .1.5.

For all j, k, i, n , we have :

$$f_{jk}(F_i(P_n)) = - \sum_{i'=1}^N \sum_{l=0}^{j-1} \sum_{n'=1}^{N_0} \sum_{k'=l}^{N_0} \mu_{i'} (r_{i'} \mu_{i'})^l \gamma(i, i', n, n') I(lk', 0n') f_{(j-1-l)k}(F_{i'}(P_{k'}))$$

Proposition .1.6.

For every j, k, l, m , with $l < j$ we have :

$$\partial_n(\Delta^l f_{jk}(P_m)) = I((j - 1 - l)k, 0m)$$

The **easy basis** for \mathcal{H}_j don't give an information about the normal derivatives, Strichartz and Usher [SU00] suggest a **better basis** involving it :

Theorem .1.7.

Consider the space \mathcal{H}_j of multiharmonic functions.

1. Case 1 : j is odd.

For $n \leq (j-1)/2$ and $l \leq (j-1)/2$, we construct a basis of \mathcal{H}_j consisting of functions $f_{nk}^{(j)}$ and $g_{nk}^{(j)}$ satisfying :

$$\Delta^l f_{nk}^{(j)}(P_m) = \delta_{ln} \delta_{km} \quad \partial_n \Delta^l f_{nk}^{(j)}(P_m) = 0 \quad (63)$$

$$\Delta^l g_{nk}^{(j)}(P_m) = 0 \quad \partial_n \Delta^l g_{nk}^{(j)}(P_m) = \delta_{ln} \delta_{km} \quad (64)$$

2. Case 2 : j is even.

We construct a basis consisting of functions $f_{nk}^{(j)}$ for $n \leq j/2$ and $g_{nk}^{(j)}$ for $n < j/2$ satisfying :

$$\Delta^l f_{nk}^{(j)}(P_m) = \delta_{ln} \delta_{km} \quad \Delta^l g_{nk}^{(j)}(P_m) = 0$$

for $n \leq j/2$ and

$$\partial_n \Delta^l f_{nk}^{(j)}(P_m) = 0 \quad \partial_n \Delta^l g_{nk}^{(j)}(P_m) = \delta_{ln} \delta_{km}$$

for $n < j/2$.

Splines

A multiharmonic harmonic spline is a continuous function that are multiharmonic on each m -cell. Let denote by $J_m(x)$ the set of all pairs (w, k) such that $x = F_w(v_k)$. We reintroduce now the space of multiharmonic splines $S(\mathcal{H}_j, V_m)$ of functions belonging to \mathcal{H}_j when restricted to $F_w K$ for all words of length m , and satisfying matching conditions at junction points :

Definition .1.2.

We say $f \in S(\mathcal{H}_j, V_m)$ if $f \circ F_w \in \mathcal{H}_j$ for all words with $|w| = m$, and for all junction points x in V_m the following matching conditions hold :

$$(r_w \mu_w)^{-l} \Delta^l (f \circ F_w)(P_k)$$

is the same for all $(w, k) \in J_m(x)$, for each $l \leq j/2$, and

$$\sum_{(w,k) \in J_m(x)} r_w^{-1} (r_w \mu_w)^{-l} \partial_n \Delta^l (f \circ F_w)(P_k) = 0$$

for each $l < j/2$.

Remark .1.1.

For each vertex $y \in V_m$ we will have functions $\phi_{ly}^{(j)}$ for $j \leq \frac{j}{2}$, and $\psi_{ly}^{(j)}$ for $j < \frac{j}{2}$.

A function $u \in S(\mathcal{H}_j, V_m)$ can be written as :

$$u = \sum_{y \in V_m} \left(\sum_{l \leq \frac{j}{2}} \Delta^l u(y) \phi_{ly}^{(j)} + \sum_{l < \frac{j}{2}} \partial_n \Delta^l u(y) \psi_{ly}^{(j)} \right)$$

Definition .1.3.

We define $S_0(\mathcal{H}_j, V_m)$ the subspace of $S(\mathcal{H}_j, V_m)$ consisting of function vanishing on V_0 .

Theorem .1.8.

*If the inner product for the **easy basis** is uniquely determined, the space $S(\mathcal{H}_j, V_m)$ for j odd has dimension :*

$$(1 + [j/2])(\#V_m) + [(j+1)/2] (N^m N_0 - \#J_m)$$

where J_m denotes the set of junction points in V_m , and each element of $S(\mathcal{H}_j, V_m)$ is uniquely determined by specifying

$$\Delta^l f(x) \quad \text{for } x \in V_m \quad \text{and } l \leq j/2$$

and

$$\partial_n \Delta^l (f \circ F_w)(P_k) \quad \text{for } |w| = m, P_k \in V_0 \quad \text{and } l < j/2$$

subject to the matching condition for all $x \in J_m$ and $l < j/2$.

The same result holds for j even when the construction of the better basis is possible.

In order to construct a finite element approximation to the solution of a partial differential equation on fractal, we need some numerical properties about the approximation of a solution using the splines space $S(\mathcal{H}_j, V_m)$.

Proposition .1.9.

If $u \in \text{dom}_{L^2}(\Delta)$ and $u|_{\partial K} = 0$, then

$$\mathcal{E}(u, u)^{\frac{1}{2}} \leq c \|\Delta u\|_2$$

for some constant c .

Proposition .1.10.

Suppose $u \in \text{dom}_{L^2}(\Delta^{2n})$, $\Delta^l u|_{\partial K} = 0$ and $\partial_n \Delta^l u|_{\partial K} = 0$ for all $l \leq 2^{n-1} - 1$. Then

$$\mathcal{E}(u, u)^{\frac{1}{2}} \leq c_n \|\Delta^{2n} u\|_2$$

Proposition .1.11.

For $j = 2^n - 1$ there exists a constant C_j such that for any $u \in \text{dom}_{L^2}(\Delta^{j+1})$ and any m there exists $u_m \in S(\mathcal{H}_j, V_m)$ with :

$$\mathcal{E}(u - u_m, u - u_m)^{\frac{1}{2}} \leq C_j \|\Delta^{j+1} u\|_2 \rho^{(j+\frac{1}{2})m}$$

where $\rho = \max\{r_i \mu_i : 1 \leq i \leq N\}$.

Theorem .1.12.

According to the last proposition, and for $u \in \text{dom}_{L^2}(\Delta^{j+1})$ we have:

$$\|u - u_m\|_{\infty} \leq C_j \|\Delta^{j+1} u\|_{\infty} \rho^{(j+1)m}$$

.1.2 The finite element method

Now that we are done with the multiharmonic spline space, we can transform the resolution of a PDE to a problem of finite dimensional algebraic system, this is what we call Galerkin method.

In the sequel, we use the approach of [GRSo1]. Let recall a fundamental theorem :

Theorem .1.13. [All12]

Let $(X, \langle \cdot, \cdot \rangle)$ a Hilbert space. Let $a : X \times X \rightarrow \mathbb{R}$ a bilinear, continue and coercive form, and let $l : X \rightarrow \mathbb{R}$ a continuous linear function satisfying, for $u \in X$:

$$a(u, v) = l(v) \quad \text{for all } v \in X$$

this problem has a unique solution via the Lax-Milgram theorem.

1. Let X_h a finite dimensional subspace of X . Then the variational problem :

$$u_h \in X_h$$

$$a(u_h, v_h) = l(v_h) \quad \text{for all } v_h \in X_h$$

satisfies the Lax-Milgram theorem and has in consequence a unique solution u_h .

2. u and u_h satisfies :

$$\text{dist}(u, X_h) \leq \| u - u_h \|_X \leq \frac{C}{\alpha} \text{dist}(u, X_h)$$

with C the constant of ellipticity and α the constant of continuity corresponding to a .

3. Let $\{e_1, \dots, e_d\}$ a base of X_h . Then:

$$U_h = \begin{pmatrix} u_{h,1} \\ \cdot \\ \cdot \\ \cdot \\ u_{h,d} \end{pmatrix}$$

satisfies the system $A_h U_h = F_h$, with :

$$A_h = \begin{pmatrix} a(e_1, e_1) & a(e_2, e_1) & \dots & a(e_d, e_1) \\ a(e_1, e_2) & a(e_2, e_2) & \dots & a(e_d, e_2) \\ \cdot & \cdot & \cdot & \cdot \\ \cdot & \cdot & \cdot & \cdot \\ a(e_1, e_d) & a(e_2, e_d) & \dots & a(e_d, e_d) \end{pmatrix}$$

and

$$F_h = \begin{pmatrix} l(e_1) \\ \cdot \\ \cdot \\ \cdot \\ l(e_d) \end{pmatrix}$$

This theorem the foundation of the finite element method. In the sequel we present the method for two classes of PDE : a static PDE and a dynamical one.

The Dirichlet problem

The first class of equation we consider is the Dirichlet problem :

$$\begin{aligned} -\Delta u + qu &= f \\ u|_{V_0} &= 0 \end{aligned}$$

where q and f are given continuous function. We multiply the first equation by a specific function v such that $v|_{V_0} = 0$ and integrate, we obtain the weak formulation :

$$\mathcal{E}(u, v) + \int_K quvd\mu = \int_K fvd\mu \quad \forall v \in \text{dom}\mathcal{E}_0$$

By choosing the spline space $S_0(\mathcal{H}_j, V_m)$ instead of $\text{dom}\mathcal{E}_0$, we obtain the finite element approximation.

Recall that every function u of $S_0(\mathcal{H}_j, V_m)$ has a unique representation : $u = \sum_i c_i \phi_i$ for ϕ_i the elements of the better basis. We replace u by his expression in the weak formulation and we take v to be an element ϕ_k of the basis, we obtain :

$$-\sum_i c_i \int_K (\Delta \phi_i) \phi_k d\mu + \sum_i c_i \int_K q \phi_i \phi_k d\mu = \int_K f \phi_k d\mu$$

which leads to the system of equations :

$$-EC + QC = F$$

where

$$\begin{aligned} E_{ki} &= \mathcal{E}(\phi_i, \phi_k) \\ Q_{ki} &= \int_{\mathcal{F}} q \phi_i \phi_k d\mu \\ F_k &= \int_{\mathcal{F}} f \phi_k d\mu \\ C_i &= c_i \end{aligned}$$

The heat equation

In a second time we consider the heat problem :

$$\begin{aligned} \partial_t u(t, x) &= \Delta u(t, x) & \forall (t, x) \in]0, T[\times \mathcal{F} \\ u(t, x) &= 0 & \text{for } x \in \partial\mathcal{F} \text{ and } \forall t \in [0, T[\\ u(0, x) &= g(x) & \forall x \in \mathcal{F} \end{aligned}$$

Again, we multiply the first equation by a specific function $v(x)$ such that $v|_{V_0} = 0$ and integrate, we obtain :

$$\int_{\mathcal{F}} \partial_t uvd\mu = \int_{\mathcal{F}} \Delta uvd\mu$$

using the fact that nor K or v depends on t we can write :

$$\frac{d}{dt} \int_{\mathcal{F}} uv d\mu = -\mathcal{E}(u, v) \quad \forall v \in \text{dom}\mathcal{E}_0$$

We choose again the spline space $S_0(\mathcal{H}_j, V_m)$ instead of $\text{dom}\mathcal{E}_0$ to obtain the finite element approximation.

We look for a function $u(t, x)$ in $S_0(\mathcal{H}_j, V_m)$ of the form : $u = \sum_i c_i(t)\phi_i$ for ϕ_i the elements of the better basis. We replace u by his expression in the weak formulation and we take v to be a element ϕ_k of the basis, we obtain :

$$\sum_i \frac{d}{dt} c_i(t) \int_K \phi_i \phi_k d\mu = - \sum_i c_i(t) \mathcal{E}(\phi_i, \phi_k)$$

which leads to the system of equations :

$$Q \frac{d}{dt} C(t) = -EC(t)$$

where

$$\begin{aligned} E_{ki} &= \mathcal{E}(\phi_i, \phi_k) \\ Q_{ki} &= \int_{\mathcal{F}} \phi_i \phi_k d\mu \\ C_i(t) &= c_i(t) \end{aligned}$$

We can use a first finite difference in time to obtain a discrete version of the equation. So let fix $N \in \mathbb{N}$ and define h to be $h := \frac{T}{N}$, we know that :

$$\frac{\partial u}{\partial t}(kh, x) = \frac{1}{h} (u((k+1)h, x) - u(kh, x)) + O(h)$$

We find the following scheme :

$$C(t+h) = (I - h * Q^{-1}E)C(t)$$

Assuming Q is invertible.

Bibliography

- [Allo7] G. Allaire. *Conception optimale de structures*. Springer, 2007.
- [All12] G. Allaire. *Analyse numérique et optimisation*. Éditions de l'École Polytechnique, 2012.
- [AP05] Y. Achdou and O. Pironneau. *Computational Methods for Option Pricing*. Society for Industrial and Applied Mathematics, 2005.
- [Bar98] M. T. Barlow. Diffusions on fractals. *Lecture Notes in Mathematics*, 1690, 1998.
- [BC11] H. H. Bauschke and P. L. Combettes. *Convex Analysis and Monotone Operator Theory in Hilbert Spaces*. Springer Publishing Company, 2011.
- [BD85a] M. F. Barnsley and S. G. Demko. Iterated function systems and the global construction of fractals. *The Proceedings of the Royal Society of London*, A(399):243–275, 1985.
- [BD85b] A. Beurling and J. Deny. Espaces de Dirichlet. i. le cas élémentaire. *Annales scientifiques de l'É.N.S. 4 e série*, 99(1):203–224, 1985.
- [Ber80] M. V. Berry. Some geometric aspects of wave motion: wavefront dislocations, diffraction catastrophes, diffractals. *Proceedings of Symposia in Pure Mathematics*, 36:13–38, 1980.
- [BG15] F. Bonnans and S. Gaubert. *Recherche opérationnelle : aspects mathématiques et applications*. Éditions de l'École Polytechnique, 2015.
- [BP88] M. T. Barlow and E. A. Perkins. Brownian motion on the Sierpiński gasket. *Probab. Theory. Related Fields*, 79:543–623, 1988.
- [Bre99] H. Brezis. *Analyse fonctionnelle : théorie et applications*. Éditions Dunod, 1999.
- [CDMP19] M. E. Cejas, I. Drelichman, and J. C. Martínez-Perales. Improved fractional poincaré type inequalities on john domains. *Arkiv för Matematik*, 57(2):285 – 315, 2019.
- [CRW13] S.-K. Chua, S. Rodney, and R. L. Wheeden. A compact embedding theorem for generalized Sobolev spaces. *Pacific journal of mathematics*, 265, 2013.
- [Dav17] C. David. Control of the Black-Scholes equation. *Comput. Math. Appl.*, 73(7):1566–1575, 2017.
- [Dav19] C. David. On fractal properties of Weierstrass-type functions. *Proceedings of the International Geometry Center*, 12(2):43–61, 2019.
- [dF36] P. de Fermat. Œuvres de Fermat - Méthode pour la Recherche du Minimum et du Maximum. *Gauthier-Villars*, 1896, pages 121–123, 1936.
- [DSV99] K. Dalrymple, R. S. Strichartz, and J. P. Vinson. Fractal differential equations on the Sierpiński Gasket. *The Journal of Fourier Analysis and Applications*, 5(2/3):203–284, 1999.
- [EG67] Y. M. Ermol'ev and V. P. Gulenko. The finite-difference method in optimal control problems. *Cybernetics*, 3(3):1–16, 1967.
- [ELMR15] K. E. Ellis, M. L. Lapidus, M. C. Mackenzie, and J. A. Rock. Partition zeta functions, multifractal spectra, and tapestries of complex dimensions. In M. Frame and N. Cohen, editors, *Benoît Mandelbrot: A Life in Many Dimensions*. The Mandelbrot Memorial, pages 267–322. World Scientific Publishers, Singapore and London, 2015.
- [Eva10] L. C. Evans. *Partial differential equations*. American Mathematical Society, 2010.
- [Fal85] K. Falconer. *The Geometry of Fractal Sets*. Cambridge University Press, 1985.

- [Fal97] K. Falconer. *Techniques in Fractal Geometry*. John Wiley and Sons Ltd, 1997.
- [Fal14] K. Falconer. *Fractal Geometry : Mathematical Foundations and Applications*. John Wiley and Sons Ltd, 2014.
- [FL04] U. R. Freiberg and M. R. Lancia. Energy form on a closed fractal curve. *Journal for Analysis and its Applications*, 23(1):115–137, 2004.
- [FOT94] M. Fukushima, Y. Oshima, and M. Takeda. *Dirichlet forms and symmetric Markov processes*. Walter de Gruyter & Co, 1994.
- [FS92] M. Fukushima and T. Shima. On a spectral analysis for the Sierpiński gasket. *Potential Anal*, 1:1–3, 1992.
- [Gol87] S. Goldstein. Random walks and diffusions on fractals. in percolation theory and ergodic theory of infinite particle systems. *The IMA Volumes in Mathematics and Its Applications*, 8:121–129, 1987.
- [GRS01] M. Gibbons, A. Raj, and R. S. Strichartz. The Finite Element Method on the Sierpiński gasket. *Constructive Approximation*, 17(4):561–588, 2001.
- [Har16] G. H. Hardy. Weierstrass’s Non-Differentiable Function. *Transactions of the American Mathematical Society*, 17(3):301–325, 1916.
- [HBA87] S. Havlin and D. Ben-Avraham. Diffusion in disordered media. *Adv. Phys.*, 36:695–798, 1987.
- [HKK02] B. M. Hambly, J. Kigami, and T. Kumagai. Multifractal formalisms for the local spectral and walk dimensions. *Mathematical Proceedings of the Cambridge Philosophical Society*, 132(3):555–571, 2002.
- [HL21] H. Herichi and M. L. Lapidus. *Quantized Number Theory, Fractal Strings and the Riemann Hypothesis: From Spectral Operators to Phase Transitions and Universality*. World Scientific Publishing, Singapore and London, 2021.
- [HLN06] J. Hu, K.-S. Lau, and S.-M. Ngai. Laplace operators related to self-similar measures on \mathbb{R}^d . *Journal of Functional Analysis*, 239:542–565, 2006.
- [HN92] J. Harrison and A. Norton. The Gauss-Green theorem for fractal boundaries. *Duke Math. Journal*, pages 575–588, 1992.
- [Hut81] J. E. Hutchinson. Fractals and self similarity. *Indiana University Mathematics Journal*, 30:713–747, 1981.
- [Joh61] F. John. Rotation and strain. *Communications on pure and applied mathematics*, 14:391–413, 1961.
- [Jon81] P. W. Jones. Quasiconformal mappings and extendability of functions in Sobolev spaces. *Acta Mathematica*, 147:71–88, 1981.
- [JW84] A. Jonsson and H. Wallin. *Function spaces on subsets of \mathbb{R}^n* . Mathematical reports (Chur, Switzerland). Harwood Academic Publishers, 1984.
- [Kig89] J. Kigami. A harmonic calculus on the Sierpiński spaces. *Japan J. Appl. Math.*, 8:259–290, 1989.

- [Kig93] J. Kigami. Harmonic calculus on p.c.f. self-similar sets. *Trans. Amer. Math. Soc.*, 335:721–755, 1993.
- [Kig98] J. Kigami. Distributions of localized eigenvalues of laplacians on post critically finite self-similar sets. *Journal of Functional Analysis*, 156(1):170–198, 1998.
- [Kig01] J. Kigami. *Analysis on Fractals*. Cambridge University Press, 2001.
- [Kig03] J. Kigami. Harmonic Analysis for Resistance Forms. *Japan J. Appl. Math.*, 204:399–444, 2003.
- [Kil94] T. Kilpeläinen. Weighted sobolev spaces and capacity. *Annales Academiæ Scientiarum Fennicæ. Series A I. Mathematica*, 19(1):95–113, 1994.
- [KN01] R. Kangro and R. Nicolaides. Far field boundary conditions for black-scholes equations. *SIAM Journal on Numerical Analysis*, 38(4):1357–1368, 2001.
- [Kum93] T. Kumagai. Regularity, closedness and spectral dimensions of the dirichlet forms on P.C.F. self-similar sets. *Journal of Mathematics of Kyoto University*, 33:765–786, 1993.
- [Kus87] S. Kusuoka. A diffusion process on a fractal. *Probabilistic methods in mathematical physics*, pages 251–274, 1987.
- [Lan02] M. R. Lancia. A transmission problem with a fractal interface. *Zeitschrift Fur Analysis Und Ihre Anwendungen*, 21:113–133, 2002.
- [Lap91] M. L. Lapidus. Fractal drum, inverse spectral problems for elliptic operators and a partial resolution of the Weyl-Berry conjecture. *Transactions of the American Mathematical Society*, 325:465–529, 1991.
- [Lap92] M. L. Lapidus. Spectral and fractal geometry: From the Weyl-Berry conjecture for the vibrations of fractal drums to the Riemann zeta-function. In *Differential Equations and Mathematical Physics (Birmingham, AL, 1990)*, volume 186 of *Math. Sci. Engrg.*, pages 151–181. Academic Press, Boston, MA, 1992.
- [Lap93] M. L. Lapidus. Vibrations of fractal drums, the Riemann hypothesis, waves in fractal media and the Weyl-Berry conjecture. In *Ordinary and Partial Differential Equations, Vol. IV (Dundee, 1992)*, volume 289 of *Pitman Research Notes Mathematical Series*, pages 126–209. Longman Sci. Tech., Harlow, 1993.
- [Lap08] M. L. Lapidus. *In Search of the Riemann Zeros: Strings, Fractal Membranes and Noncommutative Spacetimes*. American Mathematical Society, Providence, RI, 2008.
- [Lap19] M. L. Lapidus. An overview of complex fractal dimensions: From fractal strings to fractal drums, and back. In *Horizons of Fractal Geometry and Complex Dimensions*, volume 731 of *Contemporary Mathematics*, pages 143–265. Amer. Math. Soc., Providence, RI, 2019.
- [Lap22] M. L. Lapidus. *From Complex Fractal Dimensions and Quantized Number Theory To Fractal Cohomology: A Tale of Oscillations, Unreality and Fractality*, book in preparation. World Scientific Publishing, Singapore and London, 2022.
- [LFoo] M. L. Lapidus and M. Van Frankenhuijsen. *Fractal Geometry and Number Theory: Complex Dimensions of Fractal Strings and Zeros of Zeta Functions*. Birkhäuser Boston, Inc., Boston, MA, 2000.
- [LF13] M. L. Lapidus and M. Van Frankenhuijsen. *Fractal Geometry, Complex Dimensions and Zeta Functions: Geometry and Spectra of Fractal Strings*. Springer Monographs in Mathematics. Springer, New York, second revised and enlarged edition (of the 2006 edition), 2013.

- [Liu86] S. H. Liu. Fractals and their applications in condensed matter physics. *Solid State Physics*, 39(2):207–273, 1986.
- [LM68] J.-L. Lions and E. Magenes. *Problèmes aux limites non homogènes et applications*. Dunod, 1968.
- [LM95] M. L. Lapidus and H. Maier. The Riemann hypothesis and inverse spectral problems for fractal strings. *Journal of the London Mathematical Society. Second Series*, 52(1):15–34, 1995.
- [LMM05] G. C. Lim, G. M. Martin, and V. L. Martin. Parametric pricing of higher order moments in s&p500 options. *Journal of Applied Econometrics*, 20(3):377–404, 2005.
- [LN10] M. L. Lapidus and R. G. Niemeyer. Towards the Koch Snowflake fractal billiard: Computer experiments and mathematical conjectures. 2010.
- [LNRG96] M. L. Lapidus, J. W. Neuberger, R. J. Renka, and C. A. Griffith. Snowflake harmonics and computer graphics: Numerical computation of spectra on fractal drums. *International Journal of Bifurcation and Chaos*, pages 1185–1210, 1996.
- [LP93] M. L. Lapidus and C. Pomerance. The Riemann zeta-function and the one-dimensional Weyl-Berry conjecture for fractal drums. *Proceedings of the London Mathematical Society. Third Series*, 66(1):41–69, 1993.
- [LP06] M. L. Lapidus and Erin P. J. Pearse. A tube formula for the Koch snowflake curve, with applications to complex dimensions. *Journal of the London Mathematical Society. Second Series*, 74(2):397–414, 2006.
- [LPW11] M. L. Lapidus, E. P. J. Pearse, and S. Winter. Pointwise tube formulas for fractal sprays and self-similar tilings with arbitrary generators. *Advances in Mathematics*, 227(4):1349–1398, 2011.
- [LRŽ17a] M. L. Lapidus, G. Radunović, and D. Žubrinić. Distance and tube zeta functions of fractals and arbitrary compact sets. *Advances in Mathematics*, 307:1215–1267, 2017.
- [LRŽ17b] M. L. Lapidus, G. Radunović, and D. Žubrinić. *Fractal Zeta Functions and Fractal Drums: Higher-Dimensional Theory of Complex Dimensions*. Springer Monographs in Mathematics. Springer, New York, 2017.
- [LRŽ18] M. L. Lapidus, G. Radunović, and D. Žubrinić. Fractal tube formulas for compact sets and relative fractal drums: Oscillations, complex dimensions and fractality. *Journal of Fractal Geometry. Mathematics of Fractals and Related Topics*, 5(1):1–119, 2018.
- [Luco4] B. Lucquin. *Equations aux dérivées partielles et leurs approximations*. Ellipses, 2004.
- [LV10] M. R. Lancia and P. Vernole. Irregular heat flow problems. *SIAM Journal on Mathematical Analysis*, 42(4):1539–1567, 2010.
- [Man77a] B. B. Mandelbrot. *The Fractal Geometry of Nature*. San Francisco: W.H.Freeman & Co Ltd, 1977.
- [Man77b] B. B. Mandelbrot. *Fractals: Form, Chance, and Dimension*. W. H. Freeman & Co, San Francisco, Calif., revised edition, 1977. Translated from the French.
- [Man77c] B. B. Mandelbrot. *Fractals: Form, Chance, and Dimension*. W. H. Freeman & Co, San Francisco, Calif., revised edition, 1977. Translated from the French.
- [Mos02] U. Mosco. Energy functionals on certain fractal structures. *Journal of Convex Analysis*, 9(2):581–600, 2002.

- [MR92] Z.-M. Ma and M. Röckner. *Introduction to the Theory of (Non-Symmetric) Dirichlet Forms*. Springer-Verlag, 1992.
- [Ram84] R. Rammal. Spectrum of harmonic excitations on fractals. *J. Phys. France*, 45(2):13–22, 1984.
- [RD17a] N. Riane and C. David. Laplacian, on the sierpinski tetrahedron, arxiv:1703.05793, 2017.
- [RD17b] N. Riane and C. David. A spectral study of the Minkowski Curve, hal-01527996, 2017.
- [RD19] N. Riane and C. David. The finite difference method for the heat equation on sierpiński simplices. *International Journal of Computer Mathematics*, 96(7):1477–1501, 2019.
- [RD20a] N. Riane and C. David. From the self-similar heat equation to the self-similar Black-Scholes formula, 2020.
- [RD20b] N. Riane and C. David. Sierpiński Gasket versus Arrowhead curve. *Communications in Nonlinear Science and Numerical Simulation*, 89:105311, 2020.
- [RD21a] N. Riane and C. David. The finite volume method on sierpiński simplices. *Communications in Nonlinear Science and Numerical Simulation*, 92:105468, 2021.
- [RD21b] N. Riane and C. David. An inverse black–scholes problem. *Optimization and Engineering*, 22:2183–2204, 2021.
- [RD21c] N. Riane and C. David. Optimal control of the heat equation on a fractal set. *Optimization and Engineering*, 22:2263–2289, 2021.
- [RD21d] N. Riane and C. David. Optimization on fractal sets. *Optimization Letters*, 15:2681–2700, 2021.
- [RT83] R. Rammal and G. Toulouse. Random walks on fractal structures and percolation clusters. *J. Phys. Lett.*, 44:13–22, 1983.
- [RT04] P.-A. Raviart and J.-M. Thomas. *Introduction à l'analyse numérique des équations aux dérivées partielles*. Dunod, 2004.
- [Shi91] T. Shima. On eigenvalue problems for the random walks on the Sierpiński pre-gasket. *Japan J. Indus. Appl. Math.*, 8:127–141, 1991.
- [Shi96] T. Shima. On eigenvalue problems for Laplacians on P.C.F. self-similar sets. *Japan J. Indus. Appl. Math.*, 13:1–23, 1996.
- [SNF⁺12] S. Sakai, M. Nakamura, K. Furuya, N. Amemura, M. Onishi, I. Iizawa, J. Nakata, K. Yamaji, R. Asano, and K. Tamotsu. Sierpinski's forest: New technology of cool roof with fractal shapes. *Energy & Buildings*, 55(Complete):28–34, 2012.
- [Str99] R. S. Strichartz. Analysis on fractals. *Notices of the AMS*, 46(8):1199–1208, 1999.
- [Stro1] R. S. Strichartz. The Laplacian on the Sierpiński gasket via the method of averages. *Pacific Journal of Mathematics*, 201(1):241–256, 2001.
- [Stro5] R. S. Strichartz. Solvability of partial differential equations. *Journal d'analyse mathématique*, 96:247–267, 2005.
- [Stro6] R. S. Strichartz. *Differential Equations on Fractals. A Tutorial*. Princeton University Press, 2006.

- [Str12] R. S. Strichartz. Taylor Approximations on Sierpiński Gasket Type Fractals. *Journal of Functional Analysis*, 174:76–127, 2012.
- [SU00] R. S. Strichartz and M. Usher. Splines on fractals. *Mathematical Proceedings of the Cambridge Philosophical Society*, 129:331–360, 2000.
- [Toa97] A. M. Toader. Convergence of an algorithm in optimal design. *Structural Optimization*, 13:195–198, 1997.
- [Tré15] E. Trélat. Lecture notes: Control in finite and infinite dimension, 2015.
- [Wal91] H. Wallin. The trace to the boundary of sobolev spaces on a snowflake. *Manuscripta Math*, 73:117 – 125, 1991.
- [Wey12] H. Weyl. Über die Abhängigkeit der Eigenschwingungen einer Membran von deren Begrenzung (reprinted in [Wey75], vol. I, pp. 431–441). *J. Reine Angew. Math.*, 141:1–11, 1912.
- [Wlo87] J. Wloka. *Partial differential equations*. Cambridge University Press, 1987.
- [Ze90] E. Zeidler. *Nonlinear Functional Analysis and its Applications. II/A.: Linear Monotone Operators*. Springer, 1990.
- [Zho07] D. Zhou. *Spectral Analysis of Laplacians on Certain Fractals*. PhD thesis, University of Waterloo, 2007.
- [Zua06] E. Zuazua. Controllability of partial differential equations. Hal-00392196, 2006.

Index

- (ϵ, δ) -Domain, 122
- d -Set, 123
- Algorithm
 - Discrete gradient, 92
 - Finite difference matrix, 56
 - Finite volume matrix, 78
- Control
 - Admissible, 98
 - Approximate, 99
 - Exact, 99
 - Null, 99
- Courant-Friedrich-Levy
 - Explicit finite volume, 75
- Courant-Friedrich-Levy condition
 - Explicit finite difference, 52
- Dimension
 - Hausdorff dimension, 2
 - Spectral dimension, 32
 - Walk dimension, 32
- Dirichlet form, 20–24, 27, 31
- Einstein relation, 32
- Energy, 20, 23
- Finite difference method, 41
- Finite element method, 180
- Finite volume method, 66
 - Control volume, 68
- Finitely ramified fractal, 16
- Fractal, 2
 - Boundary, 112
 - Set, 2
- Green-Gauss Formula, 27
- Hausdorff dimension, 11
- Heat
 - Finite Difference Method, 41
 - Heat equation, 36
 - Heat kernel, 36
 - Heat Semigroup, 37
 - Operator, 36
 - Weak solution, 38
- John Domain, 122
- Koch Snowflake, 113
- Laplacian, 24, 27
 - Generalized Laplacian, 29
 - Laplacian on P.C.F. sets, 24
 - Laplacian optimization test, 91
 - Pointwise formula, 25
- Membrane problem, 112
 - Finite element, 128
 - Parametric optimization, 144
- Minkowski Curve, 28, 34, 97
- Normal Derivative, 26
- Normal derivative, 26, 27, 121, 128
- Open set condition, 18
- Peano Existence Theorem, 35
- Piecewise harmonic splines, 23
- Post-critically finite sets, 16
- Self-similar measure, 18, 19, 154
- Self-similar set, 10
- Sierpiński Carpet, 17
- Sierpiński Gasket, 16, 27, 93
- Sierpiński gasket, 56, 78
- Sierpiński tetrahedron, 56
- Sierpiński Tetrahedron, 28, 34, 95
- Sierpiński tetrahedron, 78
- Spectral decimation, 31
- Weyl's Formula, 33

Analyse sur les fractales et applications

Résumé :

Cette thèse explore la théorie et les applications de l'analyse sur les fractales. Dans le premier chapitre, on présente la théorie générale, en particulier, les opérateurs différentiels spécifiques sur une classe particulière de ces objets singuliers (ensembles p.c.f., i.e., post-critiques finis : laplacien, dérivée normale. Dans le second chapitre, on introduit des méthodes numériques pour la résolution des équations aux dérivées partielles sur ces objets. Deux méthodes sont exposées : la méthode des différences finies et la méthode des volumes finis. Le troisième chapitre traite dans un premier temps du problème de la recherche des extremas d'une fonction, définie sur un objet singulier/ fractal, et l'obtention d'un résultat analogue à la règle de Fermat; dans un second temps, nous résolvons, sur le plan théorique, et numérique, un problème de contrôle optimal de l'équation de la chaleur. Le chapitre quatre est une brève introduction à la théorie des EDP sur des domaines à frontière fractale. Dans le cas particulier de l'équation de Poisson, nous démontrons l'existence et l'unicité des solutions. Nous présentons également la solution numérique. Le dernier chapitre présente de nouvelles pistes de recherche, pour appliquer la théorie de Krein-Feller-Stieljes au modèle de Black-Scholes, dans le cas de mesures auto-similaires. Nos résultats montrent, en particulier, que le nouveau modèle auto-similaire ainsi obtenu ne surestime pas le prix des options *at the money* (i.e., lorsque les options commencent à avoir une certaine valeur intrinsèque).

Mots-clefs: Fractales – Laplacien – Analyse Numérique – Optimisation – Contrôle Optimal – Évaluation des Options Financières.

Analysis on Fractals and Applications

Abstract:

This thesis explores the theory and applications of analysis on fractals. In the first chapter, we present the general theory, in particular, the specific differential operators on a particular class of these singular objects (p.c.f. sets, i.e., finite post-critical: Laplacian, normal derivative. In the second chapter, numerical methods are introduced for solving partial differential equations on these objects. Two methods are exposed: the finite difference method and the finite volume method. The third chapter deals initially with the problem of finding the extrema of a function, defined on a singular/fractal object, and obtaining a result analogous to Fermat's rule; secondly, we solve, theoretically and numerically, a problem of optimal control of the heat equation. Chapter four is a brief introduction to the theory of PDEs on domains with a fractal boundary. In the particular case of the Poisson equation, we prove the existence and uniqueness of solutions. We also present the associated numerical solution. The last chapter presents new perspectives of research, where we plan to apply the Krein-Feller-Stieljes theory to the financial Black-Scholes model, in the case of self-similar measures. Our results show, in particular, that the new self-similar model thus obtained does not overestimate the price of options *at the money* (i.e., when the options begin to have a certain intrinsic value).

Keywords: Fractals – Laplacian – Numerical Analysis – Optimization – Optimal Control – Option Pricing.