



HAL
open science

Behavioral and Neural Dynamics of Fear Extinction

Marco Pompili

► **To cite this version:**

Marco Pompili. Behavioral and Neural Dynamics of Fear Extinction. Neurons and Cognition [q-bio.NC]. Université Paris sciences et lettres, 2019. English. NNT : 2019PSLET045 . tel-03887721

HAL Id: tel-03887721

<https://theses.hal.science/tel-03887721v1>

Submitted on 7 Dec 2022

HAL is a multi-disciplinary open access archive for the deposit and dissemination of scientific research documents, whether they are published or not. The documents may come from teaching and research institutions in France or abroad, or from public or private research centers.

L'archive ouverte pluridisciplinaire **HAL**, est destinée au dépôt et à la diffusion de documents scientifiques de niveau recherche, publiés ou non, émanant des établissements d'enseignement et de recherche français ou étrangers, des laboratoires publics ou privés.



THÈSE DE DOCTORAT
DE L'UNIVERSITÉ PSL

Préparée au Collège de France

Dynamiques Comportementales et Neurales de l'Extinction de la Peur

Soutenue par

Marco POMPILI

le 6 décembre 2019

École doctorale N° 158
**Cerveau, Cognition,
Comportement**

Spécialité
Neurosciences

Composition du jury :

Dr Valérie DOYÈRE *Presidente*
Institut des Neurosciences Paris-Saclay,
Université Paris-Sud, CNRS

Dr Cyril HERRY *Rapporteur*
Institut François Magendie,
Université de Bordeaux, INSERM

Dr Daniela POPA *Examinatrice*
Institut de Biologie de l'École Normale Supérieure,
École Normale Supérieure, INSERM

Dr Sidney WIENER *Directeur de thèse*
Centre Interdisciplinaire de Recherche en Biologie,
Collège de France, CNRS



Behavioral and Neural Dynamics of Fear Extinction

PhD Thesis

Marco N. Pompili

A thesis submitted in partial fulfilment of the requirements for the
degree of
Doctor of Philosophy in *Neuroscience*

Université Paris Sciences et Lettres - Collège de France
Sorbonne Université - École doctorale “Cerveau, Cognition, Comportement”
Paris, France

January the 30th, 2020

*A Mamma e Papà,
senza il cui affetto, sostegno ed esempio
non avrei mai fatto nulla*

Contents

Avant-propos	v
Prologue	ix
Acknowledgments	xiii
I Introduction	1
1 Fear, Aversive Memory, and Defensive Behavior	3
1.1 Fear as an Emotional and Motivational System	4
1.2 What is Memory?	5
1.2.1 Different Types of Memory	6
1.3 Pavlovian Associative Memory	7
1.3.1 Aversive Pavlovian Conditioning	8
1.4 Defensive Behavior	9
1.4.1 Levels of Defense in Rodents	10
1.4.2 Role of Learning in Defensive Behavior	11
1.4.3 Measuring Fear Learning	11
Method Box 1: Quantifying Freezing in Rodents	14
1.5 The Learning versus Performance Ambiguity in Animal Behavior Research	16
1.6 Extinction Learning	17
1.6.1 Fear Renewal	19
1.7 What is Context?	20
1.7.1 Contextual Modulation of Memory Retrieval	21
1.7.2 Contextual Conditioning	21
1.7.3 The Contextual Dependency of Extinction	22
1.7.4 Taking Context into Account to Model Extinction Learning	22
1.8 Associative Learning Contamination by Episodic Memory	23
1.9 Choosing What to Do When Facing Threat	24
1.9.1 Danger Imminence	25
1.9.2 Interindividual Differences in Fear and Recovery	27
1.9.3 Increasing the Power of Rodents Models of Pathological Fear with Eco-/Etho-logically Relevant Paradigms	28

2	Neuroanatomical Substrates of Fear Memory	31
2.1	The Amygdala	34
2.1.1	Amygdala Anatomy	34
2.1.2	Fear Learning and Expression Control by the Amygdala	38
2.2	The Hippocampus	39
2.2.1	Hippocampal and Para-Hippocampal Region Anatomy .	40
2.2.2	Hippocampus and Fear Memory	46
2.3	The Medial Prefrontal Cortex	51
2.3.1	What is the (medial) Prefrontal Cortex?	52
2.3.2	Anatomy and Connectivity of the Medial prefrontal cortex (PFC)	53
2.3.3	medial prefrontal cortex (mPFC) in Fear Learning and Behavior	60
2.4	An Overview of Neural Circuits Underpinning Fear Learning .	67
2.4.1	Other Limbic Structures Implicated in Fear Learning Beyond the Hippocampo-Amygdalo-Prefrontal Network	67
3	Memory Neurophysiology	73
3.1	Memory and plasticity	74
3.1.1	Synaptic Plasticity	74
3.1.2	Physical Substrates of the Memory Trace	77
3.2	Memory Consolidation	83
3.2.1	Synaptic Consolidation	83
3.2.2	System consolidation	84
	Method Box 2: Recording electrical signals in the brain	87
3.3	Brain Rhythms	87
3.3.1	Sleep	89
3.3.2	Brain Rhythm Taxonomy	92
3.3.3	Prefrontal-Hippocampal Interplay during Memory Encoding	98
3.4	Role of Sleep in Memory Consolidation	98
3.4.1	Sleep oscillations and memory consolidation	99
3.4.2	Prefrontal-Hippocampal Interplay In Memory Consolidation	103
4	Neural Coding of Fear Learning and Defensive Behavior	107
4.1	Amygdala	108
4.1.1	Fear Acquisition in basolateral complex of the amygdala (bICA) Circuits	108
4.1.2	central amygdalar nucleus (CeA) Regulates Defensive Behavior	109
4.1.3	Control of Extinction Learning by basal amygdala (BA) Circuits	111
4.2	Hippocampus	113
4.2.1	Hippocampal Coding for Space and Context	115
4.2.2	Modulation of Contextual Coding by Fear and Anxiety	117
4.2.3	Off-line Reactivation of Place Cell Sequences	119

4.3	Medial Prefrontal Cortex	123
4.3.1	mPFC Circuit Strategies to Support Emotional Learning and Fear Behavior Control	124
4.4	Dynamics of the Synchrony between the amygdala (AMG), hippocampus (HPC), and mPFC	132
4.4.1	HPC and BA Inputs to the mPFC Modulate mPFC Coding	132
4.4.2	4 Hz vs. Theta Synchrony during Fear Behavior	134
4.4.3	Theta and Gamma Synchrony, Stimulus Discrimination and Fear Inhibition	135
4.4.4	Interstructure Communication during Sleep Supports Fear Memory Consolidation	137
II	Results	139
5	Ventral Hippocampus Terminals in Prelimbic Cortex Control Contextual Fear Expression after Extinction Learning	141
5.1	Introduction	142
5.2	Results	144
5.3	Discussion	149
5.4	Methods	149
5.5	Supplementary Figures	154
6	Wireless Inertial Measurement of Head Kinematics in Freely-Moving Rats	159
6.1	Introduction	160
6.2	Results	162
6.3	Discussion	172
6.4	Methods	176
6.5	Supplementary Figures	181
6.6	Supplementary Methods	194
7	Extinction Training In a Large Open Field Reveals Inter-Individual Differences In Conditioned Fear Recovery and Relapse	203
7.1	Introduction	204
7.2	Results	206
7.3	Discussion	213
7.4	Methods	216
7.5	Supplementary Figures	220
8	A Scalable Iterative Algorithm to Accurately and Precisely Detect Cell Assemblies	225
8.1	Introduction	226
8.2	Results	228
8.3	Discussion	234
8.4	Methods	236

- 8.5 Supplementary Figures 240
- 9 Consolidation of Fear Extinction Memory Traces in the Hippocampal-Amygdalo-Prefrontal Network during Sleep 243**
 - 9.1 Introduction 244
 - 9.2 Results 245
 - 9.3 Discussion 250
 - 9.4 Methods 251
 - 9.5 Supplementary Figures 258

- III General Discussion 263**
- 10 Overcoming the Limits of Current Rodent Models of Fear Learning 265**
 - 10.1 The Limits of Fear Behavioral Measurements 265
 - 10.1.1 Developing more "Naturalistic" Tasks for the Study of Fear Behavior 265
 - 10.1.2 Shortcomings of Measuring Fear with Freezing Behavior 267
 - 10.2 Sleep as a Measure to Disambiguate between Fear Behavior and Fear Learning Neural Correlates 269
 - 10.2.1 Who Reads mPFC Cell Assemblies Reactivation During Sleep? 269
- 11 Coding Differences between Ventral and Dorsal Hippocampus 271**
 - 11.1 Dorsal vs. Ventral HPC Neural Code for Fear Learning 271
 - 11.1.1 Population Coding Analysis to Study Contextual Representations 272
 - 11.2 Dorsal vs. Ventral HPC Neural Code for Spatial Learning . . . 274
 - 11.3 Dorsal vs. Ventral HPC Communication with the mPFC 274
 - 11.3.1 The Nucleus Reuniens as a Communication Buffer between the HPC and mPFC during Fear Memory Consolidation 275

- 12 Conclusions 277**

- Bibliography 279**

- List of Figures 341**

- List of Abbreviations 345**

Avant-propos

Le souvenir d'événements traumatiques permet d'appréhender les dangers et anticiper de futures menaces. Cependant, une peur excessive peut entraîner des pathologies psychiatriques débilatantes tels que le trouble de l'anxiété généralisé et le trouble post-traumatique. Ces pathologies sont modélisées chez des rongeurs avec des paradigmes expérimentaux de conditionnement de la peur. Depuis près d'un siècle, ces paradigmes sont par ailleurs parmi les plus réussis pour l'étude des bases comportementales et neurobiologiques de l'apprentissage.

Au niveau expérimental, dans le conditionnement de peur Pavlovien, le sujet apprend l'association entre la présentation d'un signal et un événement aversif. Plus tard, en présence du stimulus, il affiche une peur conditionnée sous la forme d'un comportement défensif. Cependant, une exposition répétée au signal conduit à l'extinction de l'expression conditionnée de la peur. La mémoire traumatique d'origine n'est toutefois pas oubliée et si le signal est retrouvé dans un contexte différent de celui dans lequel s'est produit l'apprentissage par extinction, la peur revient.

Au niveau clinique, l'apprentissage par extinction est la pierre angulaire des thérapies basées sur l'exposition pour traiter les troubles de l'anxiété, les troubles liés au stress et aux traumatismes, ainsi que d'autres troubles de l'affection. Malheureusement, à l'instar de l'extinction expérimentale, l'extinction clinique est dépendante du contexte. Ainsi, même si les approches thérapeutiques cognitivo-comportementales sont efficaces pour réduire les symptômes du sujet dans un contexte clinique, la réduction de la peur ne parvient souvent pas à se généraliser hors de l'environnement dans lequel la thérapie a eu lieu. Le patient rechute donc en dehors de ce contexte.

Pour cette raison, la communauté de neuropsychiatrie translationnelle a identifié comme un objectif clé l'amélioration de notre compréhension des mécanismes comportementaux et neurobiologiques à la base de l'apprentissage de l'extinction. Le travail présenté dans ce manuscrit cherche à contribuer à cette entreprise scientifique.

Des décennies de recherche impliquant des paradigmes d'apprentissage de la peur avec des rongeurs ont démontré qu'un circuit neuronal composé principalement de l'amygdale, de l'hippocampe et du cortex préfrontal médian est particulièrement impliqué dans les processus de mémoire émotionnelle.

De plus, des recherches cliniques ont montré que des problèmes à la fois anatomiques et fonctionnels de ce réseau cérébral pouvaient contribuer à l'étiologie des troubles liés aux traumatismes. Pour ces raisons, nous nous sommes concentrés sur l'étude des dynamiques fonctionnelles dans ce circuit pendant l'extinction. En particulier nous nous intéressons au cortex préfrontal médian impliqué dans l'apprentissage d'extinction, et à l'hippocampe concernée par le traitement des informations contextuelles.

Le travail de thèse décrit ici s'est déroulé dans le cadre d'un projet collaboratif entre deux laboratoires. La première partie du projet a été réalisée dans l'équipe dirigée par Thérèse Jay (désormais dirigée par Marie-Odile Krebs), qui se dédie principalement à la psychiatrie translationnelle. La deuxième partie du travail s'est déroulée dans l'équipe fondée par Sidney Wiener (à présent dirigée par Michaël Zugaro), qui étudie les mécanismes neurophysiologiques fondamentaux de l'apprentissage et de la mémoire et possède une expertise reconnue dans l'étude de la dynamique des circuits soutenant les processus d'apprentissage chez les animaux se déplaçant librement.

—

L'introduction de cette thèse est structurée en quatre parties et traite les connaissances de base sur lesquelles repose notre projet de recherche.

Le **Chapitre 1** illustre les mécanismes comportementaux de l'apprentissage et du comportement de peur. Après avoir introduit les concepts de base sur la mémoire et le conditionnement classique, la discussion se concentre sur le conditionnement de peur et les comportements défensifs, et en particulier sur leur étude chez les rongeurs. Les sections suivantes expliquent les mécanismes comportementaux sous-jacents à l'apprentissage de l'extinction, le rôle du contexte dans la détermination de l'extinction, ainsi que des modèles expérimentaux et théoriques pertinents. Enfin, le chapitre aborde la variété des réponses défensives et des différences entre individus, ainsi que leurs implications dans l'étude de l'apprentissage de peur chez les rongeurs en tant que modèle pour la pathologie humaine.

Le **Chapitre 2** présente la neuroanatomie fonctionnelle du réseau cérébral qui régit l'apprentissage émotionnel et le contrôle du comportement défensif. Il est divisé en trois sections principales consacrées respectivement à l'amygdale, à l'hippocampe et au cortex préfrontal médian. L'anatomie générale et la connectivité sont présentées pour chacune de ces régions avant de passer en revue la littérature qui a étudié leur rôle dans le conditionnement de la peur et l'extinction. Enfin, une brève section présente les autres structures cérébrales impliquées dans la régulation émotionnelle et l'apprentissage.

Le **Chapitre 3** expose les mécanismes neurophysiologiques qui sous-tendent le traitement de la mémoire dans le cerveau. Dans un premier temps, les mécanismes de plasticité cellulaire prenant en charge le stockage de traces mnésiques sont brièvement présentés, suivis d'un aperçu des principales notions et théories de la consolidation de la mémoire. Dans la mesure du possible, les cas spécifiques de conditionnement de la peur et d'extinction sont

également abordés. Suit une introduction aux notions sur les signaux électrophysiologiques que l'on enregistre dans le cerveau, les rythmes cérébraux et le sommeil. Ensuite, les contributions des mécanismes de sommeil et oscillatoires pour le codage, la consolidation et la récupération de traces de mémoire dans des réseaux de neurones sont présentées.

Enfin, le **Chapitre 4** est consacré à la révision de l'état de l'art en ce qui concerne la dynamique au sein du circuit amygdale-hippocampe-cortex préfrontal médian sous-jacente aux processus de mémoire de peur et au contrôle du comportement défensif. Le chapitre est divisé en quatre sections, une pour chacune des trois structures clés et une autre traitant les mécanismes permettant la synchronisation et le transfert d'informations entre elles.

La section *Résultats* de ce manuscrit présente les projets expérimentaux faisant partie de mon travail de doctorat sous la supervision de Sidney Wiener au Collège de France, et de Bill Godsil et Thérèse Jay à l'Hôpital Sainte-Anne.

Le **Chapitre 5** présente les résultats d'un projet visant à sonder le rôle de la voie anatomique reliant l'hippocampe ventral et le cortex préfrontal médian dans la modulation contextuelle de l'apprentissage par extinction avec l'utilisation de l'optogénétique. Ces résultats indiquent que l'activité de cette voie contrôle la peur contextuelle après que l'apprentissage par extinction a lieu, mais pas avant.

Le **Chapitre 6** est composé d'un article que nous avons publié en 2016 et qui présentait un nouveau système permettant de mesurer sans fil la cinématique de la tête de rats se déplaçant librement. Ma contribution a été de montrer que le dispositif convient à la détection fiable du comportement d'immobilisation chez les rats avec une précision temporelle élevée et une grande transportabilité entre environnements différents.

Le **Chapitre 7** consiste en la version actuelle d'un manuscrit que nous préparons pour la soumission à un journal. Il décrit une expérience dans laquelle nous avons utilisé le système présenté au chapitre 6 dans un nouveau paradigme comportemental pour l'apprentissage d'extinction dans un environnement spacieux pendant que les rats cherchent de la nourriture. Dans cet article, nous montrons que les données de la cinématique de la tête et du suivi de la position peuvent être traitées automatiquement pour marquer plusieurs comportements des animaux. Des analyses plus poussées ont regroupé les individus en deux groupes affichant des profils comportementaux différents au cours de l'apprentissage d'extinction, qui prédisent leur vulnérabilité à la rechute de peur liée au contexte.

Le **Chapitre 8** présente un manuscrit en préparation à la soumission, dans lequel nous présentons un nouveau cadre mathématique pour la détection précise et complète de groupes de neurones co-actifs ("assemblées cellulaires") à partir d'enregistrements extra-cellulaires à haute densité de l'activité d'unités isolées. Notre méthode permet de séparer les schémas de co-activation qui sont combinés à tort par des techniques standards et surperforme ces dernières à la fois en sensibilité et en taux de faux positifs. Ce travail sera déterminant pour les analyses futures du travail décrit au chapitre 9.

Enfin, le **Chapitre 9** présente l'état d'avancement d'un projet de recherche

en cours dans lequel nous avons enregistré plus de 500 neurones simultanément dans le cortex préfrontal médian, l'hippocampe et l'amygdale de rats se déplaçant librement au cours d'un protocole expérimental sur plusieurs jours impliquant le conditionnement, l'extinction et le renouvellement de la peur dépendante du contexte. L'objectif de ce projet est d'étudier la dynamique du réseau qui sous-tend la consolidation de la mémoire d'extinction pendant le sommeil. Il devrait être achevé dans les prochains mois.

La *Discussion Générale* présente des perspectives possibles pour des travaux futurs.

Dans le **Chapitre 10** j'examine certaines des principales limites des paradigmes de recherche actuels en matière d'apprentissage de peur chez les rongeurs et suggère des stratégies possibles d'amélioration.

Le **Chapitre 11** est consacré aux perspectives en matière d'analyses de données visant à caractériser les rôles mutuels et distincts des parties ventrale et dorsale de l'hippocampe dans l'apprentissage et le comportement émotionnels. Ce projet utiliserait certaines des données recueillies lors des expériences décrites au chapitre 9.

Le **Chapitre 12** contient les remarques finales.

Prologue

Memories of traumatic events are essential to help animals learn what is dangerous and avoid future threats. However, excessive and uncontrollable fear can lead to debilitating psychiatric conditions such as generalized and post-traumatic stress disorders. Trauma and fear-related pathologies are modeled in rodents with fear conditioning paradigms, which, for almost a century, have also been among the most successful models for the investigation of the behavioral and neurobiological basis of learning.

In classical fear conditioning the animal learns the association between the presentation of a cue and an aversive event. Later, in the presence of the cue, the animal displays conditioned fear in the form of defensive behavior. Repeated exposure to the cue alone leads to the extinction of the conditioned expression of fear. However, the original traumatic memory is not forgotten, and if the cue is encountered again in a context different from the one where extinction learning took place, fear returns.

Notably, extinction learning is the basis of exposure-based therapies, a primary treatment for anxiety, stress- and trauma-related, as well as affective disorders. The context-dependency of extinction learning in rodents parallels what happens in these clinical behavioral approaches, which are effective in reducing the subject's symptoms in the context of the clinic. However, this reduction of fear often fails to generalize outside of the context where the therapy took place, and the patient relapses.

For this reason, the translational neuropsychiatry community has identified as a key challenge improving our understanding of the behavioral and neurobiological mechanisms underpinning extinction learning. The work presented in this manuscript seeks to contribute to this scientific endeavor. Decades of research involving fear learning paradigms with rodents has demonstrated that a neural circuit composed principally by the amygdala, hippocampus, and medial prefrontal cortex is particularly implicated in emotional memory processes. Moreover, clinical research has shown that both anatomical and functional problems in this brain network may contribute to the aetiology of trauma-related disorders.

The *Introduction* of this thesis, which is structured in four parts, discusses the

background knowledge upon which our research project is built.

Chapter 1 illustrates the behavioral mechanisms of fear learning and behavior. After introducing basic concepts about memory and classical conditioning, the discussion focuses on fear conditioning and defensive behaviors, and in particular their study in rodents. The next sections explain the behavioral mechanisms underlying extinction learning, the role of context in shaping extinction, as well as relevant experimental and theoretical models. Finally, the chapter discusses the variety of defensive responses and inter-individual differences, as well as their implications in the study of fear learning in rodents as a model for human pathology.

Chapter 2 presents the functional neuroanatomy of the brain network which regulates emotional learning and the control of defensive behavior. It is divided into three main sections dedicated, respectively, to the amygdala, the hippocampus, the medial prefrontal cortex. For each of these regions, the general anatomy and connectivity is presented before reviewing the literature that has probed their role in fear conditioning and extinction. Finally, a brief section presents other brain structures implicated in emotional regulation and learning.

Chapter 3 exposes the neurophysiological mechanisms underpinning memory processing in the brain. First, cellular plasticity mechanisms supporting memory trace storage are briefly presented, followed by an overview of the principal notions and theories of memory consolidation. When possible, the specific cases of fear conditioning and extinction are also discussed. This is followed by an introduction to the notions of electrophysiological signals, brain rhythms, and sleep. Afterwards, the contributions of sleep and oscillatory mechanisms for the encoding, consolidation, and retrieval of memory traces in neural networks are presented.

Finally, **Chapter 4** is dedicated to reviewing the state of the art concerning the circuit dynamics underpinning fear memory processes and defensive behavior control. The chapter is divided in four sections, one for each of the key structures (amygdala, hippocampus, and medial prefrontal cortex) and one discussing the mechanisms allowing synchronization amongst them and information transfer between them.

The PhD work described here took place in the framework of a collaborative project between two laboratories. The initial part of the project was performed in the team directed by Thérèse Jay (now directed by Marie-Odile Krebs) with a primary focus on translational psychiatry. The second part of the work took place in the team founded by Sidney Wiener (now directed by Michaël Zugaro), which studies the fundamental neurophysiological mechanisms underpinning learning and memory and has a renowned expertise in the study of the circuit dynamics supporting learning processes in freely behaving animals.

The *Results* section of this manuscript presents the experimental projects that were part of my PhD work under the supervision of Sidney Wiener at the Collège de France, and Bill Godsil and Thérèse Jay at the Hôpital Sainte-Anne.

Chapter 5 presents the results obtained in a project aimed at probing the

role of the anatomical pathway connecting the ventral hippocampus and medial prefrontal cortex in the contextual modulation of extinction learning with the use of optogenetics. These results indicate that the activity of this pathway controls contextual fear after, but not before, extinction learning takes place.

Chapter 6 is comprised of a paper that we published in 2016 presenting a novel system to wirelessly measure the kinematics of the head of rats. My contribution to this was to show that the device is suitable to reliably detect freezing behavior in rats with high temporal precision and versatility across environments.

Chapter 7 consists of the current draft of a manuscript we are preparing for submission. It describes an experiment where we used the system presented in Chapter 6 in a new behavioral paradigm for extinction training in a semi-naturalistic open field. In this paper we show that the data from the head kinematics and position tracking can be processed automatically to score multiple behaviors of the animals. Further analyses clustered individuals into two groups displaying different behavioral profiles during extinction training which, critically, predicted their susceptibility to context-dependent fear relapse.

Chapter 8 presents a manuscript in preparation for submission where we present a novel mathematical framework for precise and comprehensive detection of groups of co-active neurons ('cell assemblies') from high density recordings of single cell activity. Our method permits separation of co-activation patterns that are erroneously combined by standard techniques and outperforms the latter both in sensitivity and false-positive rate. This work will be instrumental for future analyses of the work described in Chapter 9.

Finally, **Chapter 9** presents the current status of an ongoing research project where we recorded more than 500 neurons simultaneously in the medial prefrontal cortex, hippocampus, and amygdala of freely behaving rats while they underwent a multi-day training and testing sequence comprising fear conditioning, extinction learning, and context-dependent fear renewal. The goal of this project is to study the network dynamics underpinning the consolidation of extinction memory during sleep, and it is set to be completed in the next months.

The *General Discussion* presents some general considerations and possible perspectives for future work.

In **Chapter 10** I examine some of the main limitations of current research paradigms for fear learning with rodents, and suggest possible strategies for improvement.

Chapter 11 is dedicated to perspectives regarding data analyses aimed at characterizing the mutual and distinct roles of the ventral and dorsal portions of the hippocampus in emotional learning and behavior. This project would employ some of the data collected in the experiments described in Chapter 9.

Chapter 12 contains the concluding remarks.

Acknowledgments

A PhD is a rather demanding scientific and personal journey that cannot be accomplished without the direct or indirect help of many people.

First of all I would like to thank the member of the PhD evaluation committee who made me the honor to evaluate my work. Many thanks to *Valérie Doyère* and *Cyril Herry* for having accepted to write a report about this thesis with only few weeks to read it. Thanks again to Cyril and to *Daniela Popa* for monitoring the evolution of my PhD work through the years. Thanks also to *Karim Benchenane* and *Gabrielle Girardeau* for their availability and advices.

I owe my gratitude to the senior scientists who willed to coach and advise me, and took the risk to invest time and grants in my experiments.

I need to deeply thank *Sidney Wiener* for having supervised my PhD work and above all for not giving up despite my stubbornness. Sid gave me the scientific freedom allowing me to develop my own interests, become autonomous, and learn from my mistakes, but he also provided me with the needed guidance to not be overwhelmed by all the things I wanted to do. If I had to choose one thing, I would like to thank Sid for teaching me how to be rigorous. If one day I will manage to be a decent scientist, it will be thank to him.

My essential acknowledgment goes also to *Thérèse Jay* whose support and guidance never lacked these last years. I would like to thank her for her trust and warm management of the lab, but also for trying to teach me how to do decent histology (as one can see here, there is a long road ahead still).

I'm also grateful to *Bill Godsil* for knowing everything about fear conditioning, and for his continuous support and advice throughout the years despite the difficulties.

A special thank goes to *Michaël Zugaro* for being such a human team leader, for his continuous support, advice, and help and for never forgetting the importance of having lunch.

Thanks also to *Marie-Odile Krebs* who keeps supporting my work, and to *Susan Sara* for her advices and for constantly recalling me the interest of skiing.

Acknowledgments

The work presented here would have never been accomplished without the collaboration and help of other talented and motivated fellow PhD, master, and undergraduate students.

First of all, I am extremely grateful to *Ralitsa Todorova*, whose contribution, voluntarily or not, was key in almost all the experimental work presented here. She is the balkanic Neo of neuroscience who sees and manipulates the matrix of our datasets. Thanks to Raly for being my coding superhero, being interested in the data I produce, and also to be such a good friend. I still cannot imagine how I will ever be able to do any science without her.

I need also to thank *Adam Eckmier* with whom I worked shoulder to shoulder for more than two years. Thanks for teaching me how to do injections and, above all, for being such a nice guy. Adam is the main contributor of the work presented in the chapter 5 of this manuscript and clearly none of it would be there without him.

I had the chance to count on the work of many motivated master and undergraduate interns in the past four years and a half. Without the talent and hard work of these students (here rigorously cited in chronological order), I would barely have produced half of what is presented here. Moreover, they were very cool people to work with and to them goes my eternal gratitude.

Pierre-Antoine Vigneron, *Cédric Colas*, and, one year later, *Benjamin Billot* joined the lab at the Hôpital Sainte-Anne hoping to do some neuroscience and then ended up being involved in the setting up and debugging of the overly complicated electronics and software controlling my experiments. Their work was crucial and that set up was used to collect the data of almost all my experiments (chapters 7, 8, and 9 here).

Margot Tirole brilliantly helped me figuring out how to build decent optotrodes and record the responses of prefrontal neurons to the the optogenetic stimulation of the hippocampal axons (chapter 5).

Fanny Demars is the main contributor of the work presented in chapter 7. She was, on the one hand, crazy enough to follow me when I proposed her to train (and chase) rats in a gigantic maze whose configuration changes required circus acrobatics and, on the other hand, motivated enough to keep working on the data analysis of this project for years. I need to thank her for always trusting me (or at least always displaying her trust) and for her patience and dedication.

Gabriel Makdah is the bright mind behind the work presented in chapter 8 and he is probably the most hardworking person I have ever met. A part from developing a brand new method to detect cell assemblies, Gabriel also played a major role in integrating the use of Kilosort in our cluster cutting pipeline. Gabriel as well did not escape from electronics clumsiness and helped me to develop a functional mean to integrate the use of commutators in our recordings.

Eulalie Leroux, and Gabriel before her as well, provided an essential contribution to the development, assembly, and surgical implant of the prostheses with

which we obtained such dense recordings from so many brain structures. Eulalie never stopped with any difficulty and also took care of the data collection for two rats and of the histological analysis for four rats. Without Gabriel and Eulalie the beautiful dataset that will probably keep me busy for the incoming years would not be there yet.

—

Most of the experimental work during my PhD relied also to the use of inertial measurement units on the rats head. This would have been much harder (or I would eventually have given up) without the help of our collaborators at the ENS.

Many thanks to *Guillaume Dugué* for proposing me to use their device after reading about my struggles in one of my students' report. Thanks also for his continuous help and guidance over the years with inertial measurements but also with optogenetics.

Thanks also to *Matthieu Pasquet* for his patience and willingness to help facing my emergency calls and to *Aurélien Gourgeon* for her collaborative spirit facing the struggles. Thanks also to all the members of the Léna-Popa team at the ENS for the nice welcoming all the times I passed by.

—

Merci aussi à tous ceux qui m'ont fourni une précieuse aide technique et administrative ces dernières années.

Un énorme merci à *Yves Dupraz* pour sa patience qui lui a permis de supporter mes urgences bricolage et besoin de matériel à toute heure. Sa grande compétence, de la micro- à la macro-mécanique, a été fondamentale pour la réussite de mes expérimentations. Merci aussi à *France Maloumian* pour sa contribution à mes figures.

Pour faire du développement à budget réduit, il faut parfois avoir des exigences informatiques un peu particulières, et passer des commandes de produits étranges chez des fournisseurs à l'autre bout de la planète. Un grand merci aux services de gestion administrative et du réseau informatique des deux labos qui m'ont accueilli. Merci donc à *Martine Barret, Claude Chabret, Catherine Rogers, Christophe Delbassez et Lovely Perelus* de l'ancien Centre de Psychiatrie et Neurosciences et *Nicole Braure, Sandrine Grosclaude, Sophie Maussion et Christophe Trehen* au Collège de France pour avoir toujours gardé le sang-froid face à mes requêtes.

Malgré mes expériences particulières, j'ai dû parfois me comporter comme un biologiste normal et utiliser des microscopes, objets mystiques et mystérieux. En ces occasions j'ai bien profité de l'aide précieuse de *David Geny* au CPN et *Philippe Mailly et Estelle Anceaume* au CIRB, que je remercie.

Acknowledgments

Un grand merci aux gestionnaires et techniciens des animaleries, *Lucie Collet* et *Jean-Charles Graziano* au CIRB et *François Mailliet*, *Julie Cognet* et *Dominique Dumoulin* au CPN pour leur disponibilité et leur flexibilité face à mes besoins.

—

Beyond direct scientific and logistic help and collaboration, also indirect help comes from a nice human environment, and both the lab at the Collège de France and the one at the Hôpital Sainte-Anne were source of very good work company and support in the last years.

Merci à *Céline Drieu*, *Nicolas Maingret*, *Virginie Oberto* et *Raly* pour m'avoir accueilli dans un environnement de travail aussi chaleureux et collaboratif en 2014. J'espère continuer à vous retrouver au Village ou ailleurs dès que l'on pourra. Je dois aussi remercier Céline et Nico pour m'avoir montré comment faire les chirurgies, les implants et les enregistrements (en plus qu'à ne pas désespérer quand rien ne marche).

Through the years the lab has been populated with many different beautiful people that I would like to thank first of all for bearing my invasive presence and for the nice exchanges. Therefore thanks to *Anne Cei*, *HongYing Gao*, *Liyang Xiang*, *Jumpei Matsumoto*, *Anna Segù*, *Antoine Harel*, *Romain Fayat*, *Laura Sylvander*, *Diane Vilmer*...

Pour les mêmes raisons je voudrais remercier les membres actuels du labo. Courage à *Nadia Benabdallah* et *Ariane Bocheureau* pour la dernière ligne droite et à *Ombeline Hoa* pour obtenir les plus belles séquences ! Merci à *Raphaël Brito* et à *Céline Boucly* pour faire confiance en mes conseils et en mes données. Je vous dis à tous les deux "on va y arriver et ça va être magique" !

Au delà de l'équipe, merci aussi à *Willy*, *Sébastien*, *Jonathan*, *Glenn*, *Jérôme*, *Marie* et *Pascal* pour l'esprit collaboratif entre neuroscientifiques au CIRB (mais aussi dans les bars à côté).

En dehors des échanges de bureau, le travail au CIRB m'a aussi donné l'occasion de rencontrer directement ou indirectement du beau monde : je voudrais mentionner *Rémi*, *Jeanne*, *Richard*, *Anabelle* et *Tanguy*, avec lesquels on a désormais dépassé le 5ème arrondissement.

I need also to thank the nice past and present members of the Jay-Krebs team that also welcomed and endured my presence in the lab. Also there I've seen many cycles of researchers, post-doc, doctoral and undergraduate students passing by and they never judged me for doing "weird" experiments compared to them. I would therefore like to thank *Gwenaëlle Le Pen*, *Emilie Lacombe*, *Anushree Tripathi*, *Zbigniew Zielinski*, *Boris Chaumette*, *Oussama Kebir*, *Fabrice Rivollier*, *Aude Marzo*, *Olivier Gay*, *Clementine Vincent*, *Cléo Desormeaux*, *Audrey Vautheny* for the nice ambiance in the lab.

Pendant ma thèse j'ai aussi eu la chance de travailler dans l'enseignement et l'organisation pédagogique en me permettant d'avoir une partie de mon travail avec des résultats un peu plus immédiats. Cela à été possible tout d'abord grâce à la disponibilité d'*Andréa Dumoulin* et *Ann Lohof* qui sont des super cheffes et dont j'ai pu profiter du soutien depuis le début de mon master.

J'ai aussi pu intégrer l'équipe enseignante en physiologie animale de l'Université Paris Diderot et il été un véritable bonheur d'y travailler. Merci à *Céline Cruciani* de m'avoir choisi mais aussi à *Stéphanie Gil*, *Muriel Amar*, *Stéphanie Migrenne-Li*, *David L'Hôte*, *Giuseppe Gangarossa* et les autres enseignants pour la bonne ambiance de travail.

—

A special thank goes to *Mirella Cinacchi*, without whom inspired teaching I would have never discovered the beauty of the nervous system; and to all the great teachers who taught me to be curious and showed me how to enjoy learning.

I would also like to thank *Kate Jeffery* and the members of the IBN back in 2010-2012, in particular *Aleksandar Jovalekic* and *Robin Hayman*. Without such a great experience there I would have probably moved to another neuroscience research field.

—

Outside the lab universe I have the chance of being supported by marvelous people that would deserve an entire book to be acknowledged and here I will not be able to do it as worthily as I should.

A special thank goes to *Giulio Casali*, *Riccardo Avisati*, and *Irene Cogliati Dezza* with whom I decided to pursue a career in neuroscience and with whom we have supported each other remotely for more than a decade now. Thanks also to *Silvia Sposini*, at this point culturally assimilated to neuroscience.

When I arrived in Paris I would have never imagined to live here so long. If it happened, it's because of the true friendships I could establish here, which made me decide to stay for my PhD.

Grazie a *Nico*, con cui intrecciamo i cammini da una vita e che, forse inconsapevolmente, mi ha convinto a diventare uno scienziato 15 anni fa.

Gracias a *Marcia* por haber traído la iberidad a mi casa y a *Joseba* por haber continuado. Gracias tambien a *Rita* que nunca vivió en el Vellefaux pero por lo menos es la unica espanola al 100%, y a *Martino* espanol adoptado. El jamon iberico es fenomenal pero vosotros no teneis la bresaola!

Ma non ho vissuto solo con spagnoli. Grazie a *Guido* per avermi sopportato, pure in sud america. Ed oltre a lui grazie alla famiglia del Mamiani a Parigi,

Acknowledgments

Alessandro e *Cecco*, che mi ha accolto nel 2009 e che mi ha convinto a ritornare. E tra tutte le splendide persone a cui il Mamiani in Paris mi ha fatto avvicinare, menzione speciale per *Carlotta* e *Nino*.

Grazie alla grande famiglia italiana dell'ENS e derivati. Grazie a *Fede* e *Mattia*, per smallworld e per lo sci senza neve. Merci à *Fréd* et *Louise* car sinon on était que des ritals et espagnols. Grazie a *Inès* e *Vito* per essere hippies senza esserlo. Grazie a *Giulia* e *Camilla*, che relativizzano la romanità dei ritals. Grazie a *Jared*, guida hippie del gruppo, ed a *Dudo*, suo seguace (?). Grazie a *Valerio* e *Giulio* per ricordarmi che si può essere scienziati e vivere al sole. Grazie a *Francesco* ed *Ale* per non lasciarmi da solo a soffrire per la AS Roma.

Merci à *Martin* et *Clément* avec lesquels on se suit depuis Londres et à *Gabi* por confiar en mi en la nieve. Merci aussi à *Cédric* pour le BDA et ses super potes et à *Tom* pour être revenu.

—

Vorrei anche ringraziare chi ho lasciato in Italia o altrove. Gli anni lontani oramai si accumulano ma la voglia di tornare appena posso per abbracciarvi rimane.

Grazie al branco, *piezz' 'e core*: *Busca*, *Gaia*, *Gianco*, *Giorgio*, *Lilla*, *Sacco* e *Simò*. Grazie a *Caro*, grazie a *Giuliano* e grazie a *Giacomo* perché mica si torna solo per vedere gruppi di gente.

Un ringraziamento speciale va alla famiglia più affettuosa del mondo: una sfilza di *zie*, *zii*, *cugine* e *cugini* da fare invidia a chiunque. Mi piange il cuore a sapervi così lontani. Non vi elenco sennò le zie si ingelosiscono su chi viene prima. Grazie anche a *Marty* e *Nives*, niente sangue in comune, ma è come se.

Grazie a *Dario*, il fratello grande, la persona che ha sempre saputo di più come farmi ritornare con i piedi per terra. E grazie a *Francesca* per esserselo accattato.

—

Enfin et surtout, merci à mon chéri *Nico*. Merci pour me soutenir au quotidien, pour avoir supporté ma monomanie de thèse, mes soirées et mes weekends au labo. Cette thèse est un peu aussi la tienne.

Part I

Introduction

1 Fear, Aversive Memory, and Defensive Behavior

1.1	Fear as an Emotional and Motivational System	4
1.2	What is Memory?	5
1.2.1	Different Types of Memory	6
1.3	Pavlovian Associative Memory	7
1.3.1	Aversive Pavlovian Conditioning	8
1.4	Defensive Behavior	9
1.4.1	Levels of Defense in Rodents	10
1.4.2	Role of Learning in Defensive Behavior	11
1.4.3	Measuring Fear Learning	11
	The Startle Reflex and its Potentiation by Fear	12
	Freezing	14
	Method Box 1: Quantifying Freezing in Rodents	14
1.5	The Learning versus Performance Ambiguity in Animal Behavior Research	16
1.6	Extinction Learning	17
1.6.1	Fear Renewal	19
1.7	What is Context?	20
1.7.1	Contextual Modulation of Memory Retrieval	21
1.7.2	Contextual Conditioning	21
1.7.3	The Contextual Dependency of Extinction	22
1.7.4	Taking Context into Account to Model Extinction Learning	22
1.8	Associative Learning Contamination by Episodic Memory	23
1.9	Choosing What to Do When Facing Threat	24
1.9.1	Danger Imminence	25
	Role of Learning in Shaping Danger Imminence	26
1.9.2	Interindividual Differences in Fear and Recovery	27
	Relevance of the Study of Inter-Individual Variability for Translational Research	28
1.9.3	Increasing the Power of Rodents Models of Pathological Fear with Eco-/Etho-logically Relevant Paradigms	28

In 1872, Charles Darwin illustrated the affinity between human and animal expression of emotions and argued that positive and negative feelings are critical components of the behavioral repertoire maximizing species' evolutionary fitness. While positive emotions stimulate social behaviors beneficial for reproduction, negative ones promote defensive actions necessary for survival. Danger puts animals in an emotional state that prepares not only the brain

but also the whole body to strive for life. This emotional state is well described by the famous concept of ‘fight or flight’ first developed by Cannon (1915).

Evolution shaped the cognitive, motor, autonomic, and sensory changes supporting our defensive responses, which are readily and ‘automatically’ triggered in case of danger. These changes also arise in a broad range of psychiatric conditions, such as trauma-related and anxiety disorders. Indeed, fear and anxiety disorders are often described as the dysregulation of the fear and anxiety systems leading the defensive response to exceed its adaptive functions.

Memory of traumatic or dangerous events is adaptive as well, since it allows the anticipation and avoidance of impending threats. Moreover, when danger cannot be avoided, it helps making rapid and appropriate reactions based on past experiences. However, traumatic memories are also involved in the etiology of fear and anxiety disorders (Beckers et al. 2013; Lissek and Grillon 2015; Mineka and Zinbarg 2006; Jacobs et al. 2017; Garfinkel et al. 2014). Understanding the neurophysiological underpinnings of emotional learning is a key challenge to improve current therapeutical strategies for fear and anxiety disorders (anxiety, panic, phobia, and post-traumatic stress disorders) but also for other affective disorders such as depression (Cuthbert 2015; Cuthbert and Insel 2013; Faliagkas et al. 2018; Vervliet et al. 2013; Young and Craske 2018).

1.1 Fear as an Emotional and Motivational System

Recently, the conventional ‘Darwinian’ view about emotions has been challenged by a series of papers where Joseph LeDoux and colleagues argue that the essence of emotion is the subjective experience and, in the case of fear, the conscious feelings of ‘terror’ and ‘horror’. In their view, these higher-order cognitive processes evolved relatively recently in the phylogeny of survival-defensive mechanisms and therefore would be separated from the defensive survival processes regulated by innate and mostly unconsciously driven responses (LeDoux 2012; LeDoux 2014; LeDoux 2017; LeDoux and Brown 2017; LeDoux and Hofmann 2018; LeDoux and Pine 2016). A corollary of this theory is that the subjective and verbally reported experience of fear, a crucial component of fear and anxiety disorders, is distinct from the behavioral and autonomic responses typically measured in the laboratory. This view calls into question the interpretations provided by translational research programs using laboratory model animals to study the underpinnings of psychiatric disorders. Because of its implications, this view has opened a wide debate (Fanselow 2018b; Fanselow and Pennington 2018; Fanselow 2018a; Kim and Jung 2018; Mobbs 2018; Mobbs et al. 2015; Scarantino 2018; Pine and LeDoux 2017).

It is clear that we cannot verbally communicate with animals, and that it is therefore impossible to know their actual feelings. Hence, claiming that they

are ‘scared’ in the sense of our anthropocentric definition of fear can only be an approximation. However, the conscious feeling of ‘being scared’ is powerful and resource-demanding, and if it was just an epiphenomenon imposing high energetic cost without benefits evolutionary biology suggests that it would be selected against. It is therefore parsimonious to assume that the conscious experience of fear is a constitutive part of the defensive-survival mechanisms increasing evolutionary fitness (Fanselow 2018b).

The term ‘fear’ should be taken as a multifaceted term (Kim and Jung 2018). For instance, Darwin used it to describe the nesting behavior of birds (Darwin 1859) and Tinbergen the territorial behavior of different animals (Tinbergen 1968). Fear has been used to both define an *emotional system* and a *motivational state* (Fanselow 2018a; Scarantino 2018). The fear emotional system includes a whole complex of bodily changes, subconscious neurophysiological mechanisms, subjective conscious experience, and set of behaviors that can be adaptive for defense, survival, and, ultimately, to increase the evolutionary fitness of the species. The fear motivational state is only one part of this emotional system, which selects and provides the drive for the defensive behaviors that we measure in the laboratory (Fanselow 2018a). Making this distinction avoids misunderstandings without the necessity to exclusively reserve the term fear for the conscious feelings contributing to the emotion (Scarantino 2018).

1.2 What is Memory?

Memory is the ability to encode, maintain and recall information. This definition is general, and different types of memory exist, supported by separate but overlapping brain circuits. The first evidence promoting this view came with the study of H.M., a patient suffering from severe pharmaco-resistant epilepsy (Scoville and Milner 1957). For this reason he underwent a bilateral resection of the epileptogenic area of his brain: the medial temporal lobes¹. While this surgery cured his epilepsy, the removal of the medial temporal lobes left him with a severe anterograde amnesia, such that he was unable to form new memories lasting more than a few minutes (Scoville and Milner 1957). Nonetheless, H.M. presented intact perceptual, cognitive, and motor abilities and, strikingly, was able to form new perceptual and motor skills. For instance, he was able to learn how to draw looking at his hand in a mirror over daily training sessions. While he was completely unaware of having performed the task before, he learned it with the same rate of normal subjects (Milner 1962). The case of H.M. was the first experimental proof of the existence of different memory systems processed by separate brain areas (Corkin 2002; McDonald et al. 2017).

H.M was also affected by temporally graded retrograde amnesia, meaning that

¹The medial temporal lobe includes the hippocampus, the subiculum, the entorhinal, and the rhinal cortices (see section 2.2.1)

he could remember events up to few days before the surgery, but that memories from events closer in time with the damage of its medial temporal lobes were lost (Milner et al. 1968; Sagar et al. 1985). This result suggested that remote memories ultimately become independent from the temporal lobe, thanks to mechanisms relocating the storage of the memory traces to other parts of the brain. Moreover, the fact that memory was differentially impaired depending on its recency was consistent with the theory called ‘Ribot’s Law’ stating that “the dissolution of memory is inversely related to the recency of the event” (Ribot 1891). The concept of *memory consolidation* refers to both the gradual strengthening and increased resistance to interference of memory with time and to its transfer outside the temporal lobe (cf. 3.2).

1.2.1 Different Types of Memory

Memory can be divided into long-term and short-term. Short-term memory is also called ‘working-memory’ and lasts from seconds to a few minutes. Long-term memory, on the other hand, can persist for an entire lifetime. Beyond duration, a now-classical categorization of memory types was provided by Squire and Zola-Morgan (Figure 1.1; Zola-Morgan and Squire 1991, see also Squire and Wixted 2011 for a recent review). The main subdivision of memory systems relies on whether memories can be consciously recalled or not². Memory that can be verbally reported is called *explicit* or *declarative memory*, while the other is referred to as *implicit* or *non-declarative*.

- Declarative memory is further subdivided in episodic and semantic memory (Tulving 1972). *Episodic memory* is the memory for autobiographic events in their original, detailed context: for example, remembering an embarrassing thing that happened 8 years ago. *Semantic memory* is the memory of facts, meanings, and concept-based knowledge, independently of the context in which they were learned: for example, fish live in water.
- Non-declarative memory results from experience and is expressed by action. One non-declarative memory subtype is *procedural memory*, which refers to sensorimotor habits or automatic skills, like the memory for motor and perceptual abilities, such as riding a bike or reading. Other subtypes of non-declarative memory include *priming* (perceptual identification of words and objects), *non-associative learning* (habituation and sensitization, respectively the diminishing and amplification of an innate response to frequently repeated stimuli), and *classical conditioning*.

²However, it must be noted that this is problematic to identify rigorously in animals

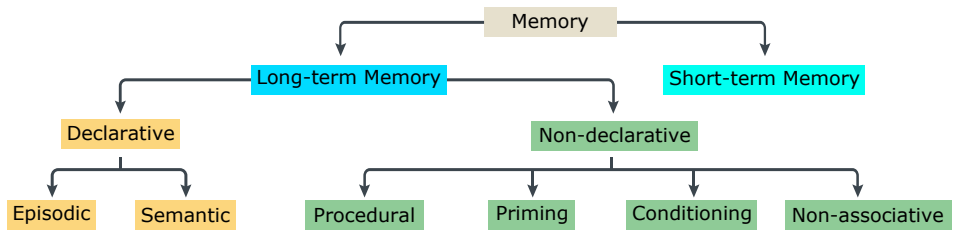

Figure 1.1: Memory systems. The classic organization of memory systems proposed by Squire and Zola-Morgan (1991). Although conceptually useful, its validity had been questioned since experimental data suggest that these categories may have some overlap.

1.3 Pavlovian Associative Memory

Classical or *Pavlovian conditioning* is a simple form of associative learning that was first described by Ivan Pavlov at the turn of the 20th century (Pavlov 1897). Pavlov's initial aim was to study the role of salivation as a preparatory mechanism for digestion. However, he realized that dogs would not only salivate in response to food but also in the presence of any object or event that the animals learned to associate with the food, such as the sound of the footsteps of Pavlov's assistant bringing the meal. Those observations set the grounds to develop a new learning theory that has been highly influential ever since. The theory starts with the assumption that there are things that animals do not need to learn, such as the salivation reflex to the sight of food, which is genetically 'hard-wired' in the nervous system. In the framework proposed by Pavlov and developed in the first 30 years of the last century notably by Watson (Pavlov 1927; Watson 1913), salivation is therefore what is called the unconditioned (or unconditional) response (UR) and food is an unconditioned (or unconditional) stimulus (US). A neutral stimulus such as the sound of the metronome used by Pavlov in his experiments would not usually elicit any specific response. However, if this sound is conditioned to the successive presentation of food it becomes a conditioned (or conditional) stimulus (CS) and, after a certain number of repetitions (also named *trials*) of the conditional presentation of the conditioned stimulus (CS) with the US, the presentation of the CS alone can trigger the salivation, now called the conditioned (or conditional) response (CR). The discovery of Pavlovian conditioning was the first description of a learning mechanism through passive association. Together with Thorndike's introduction of the concepts of reinforcement and active associative learning (operant conditioning; Thorndike 1905), Pavlov's discoveries gave birth to *behaviorism*. One of the fundamental axioms of this influential school of thought is that all behaviors are responses to specific stimuli modulated by the current motivational state. Furthermore, behaviors are mostly controlled

either by hard-wired reflexes or by neural mechanisms resulting from an individual's learning history. In the first half of the last century, the explosion of discoveries about primary learning mechanisms such as Pavlovian conditioning led to the theoretical formulation of behaviorism in its most radical form which claimed that all learning could be explained by conditioning (Hull 1943; Skinner 1938; Skinner 1950; Watson 1913; Watson 1930)³. Pavlov and others, more cautiously, argued that conditioning mechanisms, rather than a unified learning system, were a lens through which we might uncover the brain underpinnings of behavior (Konorski 1948; Konorski 1967; Pavlov 1932). A large variety of species and response systems have proven to display Pavlovian conditioning (Turkkan 1989). The choice of non completely neutral/arbitrary CSs (that ecologically would have chances to be associated with an aversive US) strengthens conditioning, suggesting that classical conditioning may be a learning mechanisms also occurring under natural circumstances, and not only in laboratory settings (see Domjan 2005 for a review).

1.3.1 Aversive Pavlovian Conditioning

The first demonstration that classical conditioning also applies to humans is the famous (though ethically questionable by contemporary standards) Little Albert experiment (Watson and Rayner 1920). Watson presented a live rat (the CS here) to an infant named Albert in conjunction with a loud noise (hammering on an iron rod). The sound alone (the US) could send Little Albert into tears. After numerous trials, the infant started to fear the rat even in the absence of the loud noise. He was also scared of objects sharing features with the rat such as a fur coat or a Santa Claus mask. Thus, Watson and Rayner showed that fear could be induced by conditioned stimuli in humans. Since then, various forms of fear conditioning have been used to study learning in human subjects (e.g. Hartley and Phelps 2010; Lonsdorf et al. 2017).

Fear conditioning in animals, and mostly in rodents, has also been a powerful tool for investigating the biological mechanisms underpinning learning, memory, and emotion. In rodent research, the US is typically a mild electrical shock delivered to the paws of the animal through a metal grid floor of the conditioning apparatus (Heron and Skinner 1939, Figure 1.2). Once a CS such as a visual or auditory stimulus is associated with the US, a variety of conditional responses (CRs) that are typical rodent responses to threats (or their direct consequence) are elicited by the CS. It has been suggested that non-associative processes like sensitization (i.e., US presentation that increases the general responsiveness of the animal even to neutral stimuli independently from any coupling between the two) may also take place in parallel

³In contrast, ethology and behavioral ecology focus on heredity and evolution as crucial factors in determining innate behaviors that are hard-wired in the central nervous system. While these school of thoughts were originally seen as alternative, contemporary theories are aimed at reconciling these different levels of description of behavior.

to conditioning (Harris 1943; Kamprath and Wotjak 2004; Mackintosh 1974; Richardson 2000). Nonetheless, CR elicitation by the CS is estimated to be a useful index of learning, though potentially the result of associative and non-associative learning components.

1.4 Defensive Behavior

Animal behavior is shaped by evolution to assure survival in the face of environmental menaces. One deadly threat is predation, which exerts a strong selective pressure. Animals can react to menaces in multiple ways, and similar behaviors may originate from different psychological processes and different computational processes to deal with the problem of action control (Bach and Dayan 2017). While a categorization based on computationally inspired analysis of behavior has historically been a prerogative of appetitive learning research (Dickinson and Balleine 2002), this has also been emerging in the aversive learning field. Indeed, LeDoux and Daw (2018) recently proposed a subdivision of defensive behaviors into Pavlovian/innate and instrumental categories. The latter are subdivided into goal-directed actions (which depend on the association between action and outcome) and habits (instrumental responses persisting despite no relation with the outcome). A typical example of instrumental action in aversive learning is active avoidance, a learned behavior that allows an animal to escape (e.g., by shuttling in a runway) or prevent (e.g., by pressing a lever) aversive stimuli (for recent reviews see Cain 2019; Kryptos et al. 2015). A detailed description of aversive instrumental behaviors goes beyond the scope of the present discussion, hence the following focuses on innate behaviors.

From a computational perspective, innate behaviors constitute preprogrammed responses to different types of events (Bach and Dayan 2017), which have evolved in order to adapt to the ethological and ecological niche of the organism (Mobbs et al. 2015; Mobbs and Kim 2015). Innate defensive responses can be further subdivided into defensive reflexes, such as eye-blinking in response to air puffs or startle to loud sounds, and more complex species-specific defense reactions (SSDRs; Bolles 1970). SSDRs are homologous to what Tinbergen (1951) and Lorenz (1956) defined *fixed action patterns*, a category that applies also to non-defensive behaviors. In a famous experiment, they presented to naïve chicks with a wooden silhouette which could depict either a goose or a hawk depending on the direction it was moved. The young chicks would try to escape only the hawk-mimicking silhouette (Lorenz and Tinbergen 1938). The escape response of the chicks is a typical SSDR: an instinctive behavioral sequence fairly invariant within the species. It has been selected through evolution since it increases survival, particularly against predation (Bolles 1970). SSDRs are species-specific and determined by the ecological niche. For instance the deer mouse of arid regions tends to jump when scared, which is effective against its natural predators, snakes. In contrast, the closely

related wetland deer mouse has the tendency to freeze, which is an effective strategy against weasels (Hirsch and Bolles 1980). These innate responses highlights the importance of hereditary innate SSDRs and, therefore, of the ethological approach to the study of defensive behaviors, however, it is essential to note that here innate behaviors mean behavioral patterns that do not need to be learned, but it does not mean independent from experience and learning. The chicks' innate reaction to escape from the wooden hawk would be expected to eventually disappear with enough exposure, similarly to the rats learning to fear innocuous sound with aversive conditioning.

SSDRs are widespread in the animal kingdom (Anderson and Adolphs 2014; Hawkins and Byrne 2015). Three main categories have been described in a variety of species (Eilam 2005): freezing, fleeing, and defensive fighting. Freezing allows the prey to prevent being detected by the predator; fleeing is a way to escape and avoid being captured; while fighting may dissuade the predator. These behaviors have also been successfully studied in laboratory settings (Blanchard and Blanchard 1969a; Blanchard et al. 2003; Bolles and Fanselow 1980; Bouton and Bolles 1979; Fadok et al. 2017).

1.4.1 Levels of Defense in Rodents

In rodents, as initially proposed by Caroline and Robert Blanchard in 1988, there is a broad consensus today on the view that innate antipredatory behaviors are organized hierarchically according to different levels of defense. This model is based on a series of observations using wild rats caught in sugar cane farms (Blanchard et al. 1986). According to this paradigm, the levels of defense are, from the lowest to the highest: risk assessment, fleeing, freezing, defensive threatening, and finally fighting. Compared to the three more popular categories (fleeing, freezing, and fighting), risk assessment and defensive treats are more ill-defined and elusive and therefore have been less successfully used as a CR in fear conditioning experiments.

Risk assessment (Blanchard et al. 2011) refers to a set of behaviors aimed at sampling the environment for danger. These behaviors are typically seen as an index of anxiety and expose the animal to detection from a predator more than freezing while still allowing it to be less detectable than during 'non-anxious' behavior like foraging. A typical risk assessment behavior is the stretch-attend posture, where the rodent lowers its back, elongates its body and either moves forward very slowly or stands still (Mackintosh and Grant 1963). In this way it samples the environment while not exposing itself much for detection by predators. Defensive threatening consists of behaviors like jumping and vocalization and can scare the predator off. If none of these strategies works the final defensive strategy is to attack the predator with bites. While these categories have mostly been systematically studied in rodents, they are likely part of the defensive repertoire of other mammals too. In particular, vocal-

izations have been investigated in many species (e.g., Blanchard et al. 2001; Hofer 1996; Owings et al. 2002; Ploog 1981), while primate research (including human) widely uses facial expression (e.g., Ekman 1999).

1.4.2 Role of Learning in Defensive Behavior

Associative trial-and-error learning alone can be time-consuming and hazardous, killing an animal before it learns what is dangerous and what is not (Bolles 1970). Therefore, innate fear instrumental in avoiding physical interaction with predators in the first place (Mobbs and Kim 2015). However, learning mechanisms such as conditioning are crucial to optimally shape behavior allowing animals to ultimately minimize their cost-benefit ratio and adapt to various ecological challenges (Fanselow 2018b; Mobbs et al. 2015; Pellman and Kim 2016). Historically, ethology emphasized the value of innate behaviors while behaviorism highlighted the importance of learning. In real life, both genetically pre-programmed (hardly shaped by learning) and learning-modulated fear are vital in controlling behaviors helping animal survival (Mobbs et al. 2015; Pellman and Kim 2016).

1.4.3 Measuring Fear Learning

The first metric to be consistently used to index fear learning was the CR of suppression of appetitive responding in the presence of a fearful CS (Estes and Skinner 1941). In this case, animals that are preliminarily trained to press a lever to obtain food undergo a fear conditioning procedure. Later, lever-pressing drops considerably during the presentation of the CS compared to intervals before or after CS presentation (Annau and Kamin 1961). Conditioned suppression in rats, as well as eyeblink conditioning in rabbits (Gormezano and Moore 1964; Thompson et al. 1983) dominated Pavlovian conditioning research for twenty years (Fanselow and Wassum 2016). Starting from the pioneering work of the Blanchard and Bolles laboratories, freezing became the dominant metric for assessing fear learning (Blanchard and Blanchard 1969a; Blanchard and Blanchard 1969b; Blanchard and Blanchard 1971; Blanchard et al. 1968; Bouton and Bolles 1980; Sigmundi et al. 1980; LeDoux et al. 1983; Fanselow and Bolles 1979).

Other common CR used for indexing conditioned fear are the potentiation of the startle reflex to loud sounds (Brown et al. 1951), cardiovascular responses (Schneiderman et al. 1966), and hypoalgesia (Fanselow and Bolles 1979). In the following dissertation, I focus the dissertation on the startle reflex and freezing behavior, as they proved to be useful measures in my experimental work.

The Startle Reflex and its Potentiation by Fear

Reflexes, such as retracting from fire, are stimulus-response reactions that are hardwired in the nervous system and are part of a given species genetic heritage. The *startle reflex* has been broadly investigated in mammals (Yeomans et al. 2002). It consists of a rapid tightening of the neck and back muscles accompanied by flinching (Landis and Hunt 1939) which, stiffens the flesh and therefore makes tooth penetration more difficult for the predator, and is thought to protect parts of the body outside of the visual field from sudden attacks (Koch and Schnitzler 1997; LeDoux and Daw 2018).

In rodents, both sudden loud noise and air puffs trigger a startle reflex. The former is more specifically called the *acoustic startle reflex* and is stereotyped but not invariant, as learning can modulate it. It has been widely used in rats to study the neural basis of learned fear especially in the work of Michael Davis

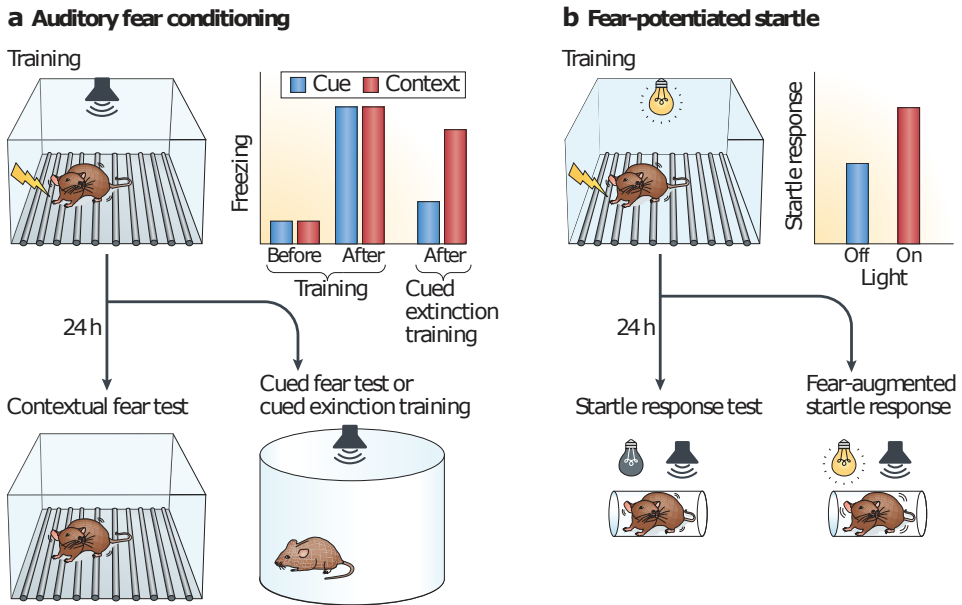

Figure 1.2: Measuring conditioned fear in rodents. (a) After auditory fear conditioning, the level of fear of a mouse or a rat (assessed by the time it spends freezing) is high both in response to the auditory cue and when introduced in the conditioning context. (b) The potentiation of the acoustic startle response is typically assessed in a small tube where the animal is restricted and its movements can be measured. After conditioning a light stimulus to the delivery of a shock, the amplitude of the acoustic startle is higher in the presence of the conditioned light (figure from Tovote et al. 2015).

and collaborators (Davis 1986; Davis 1992; Davis 1998; Davis and Whalen 2001; Davis et al. 1993) and has been described for mice as well (Daldrup et al. 2015). In these experiments, the magnitude of the startle reflex to a loud sound is typically estimated by measuring the amount of movement of a small chamber where the animal is restrained and is assessed before and after that the presence of a visual CS (like a light) is conditioned to an aversive US (Figure 1.2). After conditioning, the magnitude of the startle is potentiated in the presence of the CS compared to pre-conditioning tests, and fear can then be indexed by the increase in the amplitude of the startle (Brown et al. 1951; Davis and Astrachan 1978; Leaton and Cranney 1990). It is important to note that in Pavlovian terms the startle response is not a CR but, instead, the CR elicited by the CS here is the state of fear that potentiates the startle (McAllister and McAllister 1971). Fear-potentiated startle occurs very reliably for at least one month after initial training (Campeau et al. 1990) and can be induced with visual, acoustic, and olfactory CSs (Davis 2001). Startle potentiation is a valid measure of associative conditioning for various reasons. First, unpaired or random presentations of the CS and US fail to potentiate the startle reflex, which occurs only after the CS-US pairing (Davis and Astrachan 1978). Second, the CS-US pairing does not lead to the generalization of fear-potentiated startle to stimuli different from the CS itself (Davis 1988), or to CS, with different duration (Davis et al. 1989; Siegel 1967). Potentiation also occurs in the environment where fear conditioning took place, even in the absence of an explicit CS (this effect is sometimes referred to as ‘context potentiated startle’, Campeau et al. 1991; McNish et al. 1997; Richardson 2000, see also 1.7). Differently from other measures of fear, timing is crucial for the potentiation of the acoustic startle, which is effective only within a brief time window after the CS presentation, when the animal supposedly expects the US (Burman and Gewirtz 2004; Davis et al. 1989).

In rodents and in humans, fear-inducing stimuli, as well as the administration of anxiogenic agents, increase the potentiation of the startle reflex (Grillon 2008). Its magnitude is reduced in subjects with some psychopathic disorders (Patrick et al. 1993) while it is higher in anxiety disorder patients (Butler et al. 1990; Grillon et al. 1994; Grillon et al. 1998). Unconditioned fearful stimuli can potentiate the startle response too. Indeed rats, who are nocturnal animals and find bright light aversive, exhibit a potentiated startle when tested under bright illumination (Davis et al. 1997; Walker and Davis 1997), and analogously, diurnal humans display greater startle in the dark (Grillon et al. 1997). The startle reflex is a key model in translational research as it is a more independent fear measure than verbal reports (Grillon 2008) and similar experiments can be conducted in human subjects and in preclinical rodent models (Grillon and Baas 2003).

Freezing

Experiments exposing rats to innate unconditioned threat stimuli such as the presence of a cat were the first to describe freezing in the laboratory setting (Curti 1935; Curti 1942; Griffith 1919; Griffith 1920). Later, initially referred to as crouching, it was also shown that it develops as a CR after fear conditioning (Blanchard et al. 1968; Blanchard and Blanchard 1969a). Freezing is a tense body posture inducing increased muscle tonus and a complete absence of any movement except for those implicated in respiration. It increases evolutionary fitness not only by avoiding the detection of the predator (Whishaw and Dringenberg 1991), but also by optimizing perceptual and attentional processes (Kapp et al. 1992; Lang et al. 2000), and preparing for fleeing or fighting (Butler et al. 2007; Griebel et al. 1996; Kalin 1993). In addition to rodents, also non-human primates (Kalin and Shelton 1989; Kalin et al. 1998), humans (Azevedo et al. 2005; Hagensaaers et al. 2014; Roelofs 2017; Roelofs et al. 2010), birds (Gabrielsen et al. 1985), and invertebrates (King and Adamo 2006) display freezing in the lab after aversive conditioning.

Method Box 1: Quantifying Freezing in Rodents

For almost 50 years, several forms of body immobility have been employed by researchers to estimate freezing behavior in rodents. Human observation of video recordings or live animal behavior was the most common method for a couple of decades and is still used today (Anagnostaras et al. 1999; Bolles and Fanselow 1980; Bouton and Bolles 1979; Godsil et al. 2015). With this method, freezing is manually scored by experimented observers with two possible systems. One possibility is an instantaneous time-sampling procedure (e.g., Godsil et al. 2015), consisting of a binary assessment of the state of the animal ('freezing' or 'not freezing') based on an instantaneous observation at a fixed frequency (e.g., every 2 s). But, instantaneous time sampling only quantifies freezing in a fraction of the period of interest. Alternatively, freezing can be scored continuously with stopwatches (e.g., Phillips and LeDoux 1992). These methods allow the strict application of the original definition of freezing (Blanchard and Blanchard 1969a), but are time-consuming (often limiting sampling to only a fraction of the entire behavioral procedure). They are also subject to human error, since human reaction times lead to scoring inaccuracy in the proximity of the transitions between freezing and non-freezing epochs. A variety of automated methods to score freezing have also been developed based on the detection of animals' movements, with low thresholds. Some methods detect movement using the difference between successive frames of video recordings (either video-noise for analog videos or pixel difference comparisons for digital ones; Amorim et al. 2019; Anagnostaras 2010; Kopec et al. 2007; Marchand et al. 2003; Pennington et al. 2019; Pham et al. 2009; Richmond et al. 1998; Shoji et al. 2014; Vargas-Irwin and Robles 2009). Others rely onto infrared beam crossings to detect movements (e.g., Courtin et al. 2014; Milanovic et al. 1998;

Misane et al. 2005; Stiedl et al. 1999; Valentinuzzi et al. 1998), or on the detection of the infrared radiation of animals' bodies (Takahashi 2004), or on the signal produced by pressure sensors under the testing chambers (Fitch et al. 2002; Fitzgerald et al. 2015; Maren 1998; Maren 2001a; Nielsen and Cronic 2002). While automated scoring systems are increasingly used in the community (59% of studies used an automated system to quantify freezing until 2018; Carneiro et al. 2018), doubts about their validity persist. A common concern is that systems based on photo-beam crossing would not be enough sensitive to movements smaller than the spacing between IR sensors or happening above or below the beams (notably head and tail movements). The increasing resolution available for digital recordings has boosted the reliability of video-based systems; however, for a given camera and video format their sensitivity decreases with the increasing size of the testing environment. Moreover, parameters are very specific for a given environment depending on lighting, shape, and contrast. For these reasons, they need to be optimized and tested for each configuration separately (Luyten et al. 2014). Indeed, for all automated methods, parameters must be carefully optimized to increase the detection of non-freezing movements such as tail or face movements, while ignoring freezing-compatible movements such as respiration and hearthbeat (Luyten et al. 2014). A benchmark for automated freezing detection methods is that they should have a very high correlation with the results of an experienced human observer, yet many reports describing automated freezing quantification methods lack this comparison (Luyten et al. 2014; Anagnostaras 2010).

Freezing activates the autonomic nervous system (Iwata et al. 1987), which, in turn, controls other physiological changes associated with freezing such as: increased muscle tonus (Azevedo et al. 2005) and arterial pressure (Carrive 2000), pain suppression (Finn et al. 2006), and reduced heart rate (Schenberg et al. 1993; Vianna and Carrive 2005). Although reports of tachycardia instead of bradycardia during freezing exist, human research uses the latter as an indicator of freezing (Lang et al. 2000; Marx et al. 2008) (Stiedl and Spiess 1997). A direct consequence of immobility is also the suppression of other behaviors during freezing (e.g., vocalizations (Jelen et al. 2003), and appetitive responding).

Freezing is by far the most widespread CR metric to evaluate fear learning in rodents. After a CS is conditioned to an aversive US, the amount of time spent freezing during and after the CS presentation is larger than the freezing time during and post-CS before conditioning (Figure 1.2). Similarly, the time spent freezing during a CS is higher for a group of fear-conditioned animals than for a control group that did not undergo any conditioning procedure. As immobility does not always correspond to freezing, the quantification of the time spent freezing is problematic (cf. *Chapter 9*).

Recently, the significance of freezing in humans has been acknowledged (Ha-

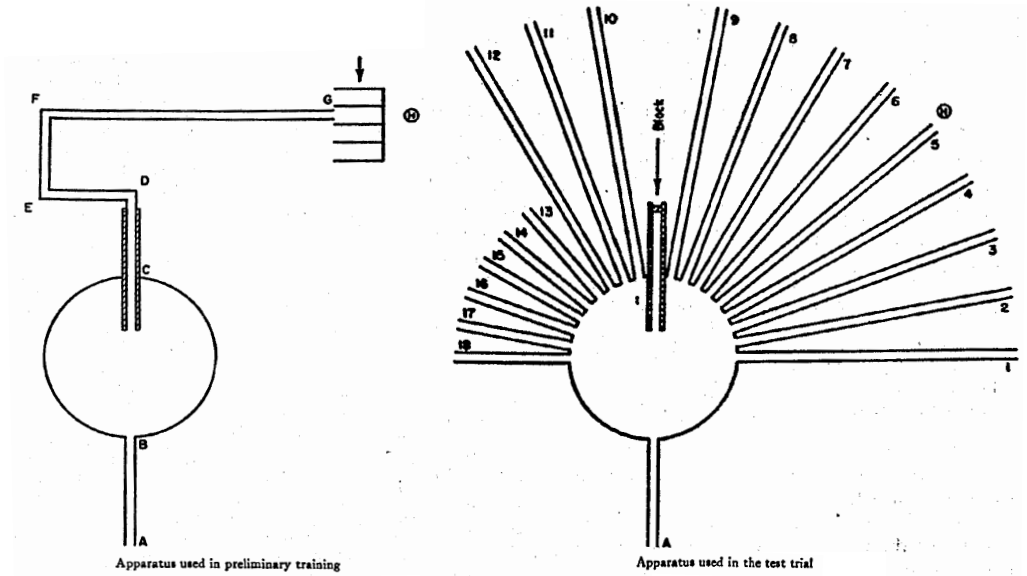

Figure 1.3: Rodents form cognitive representations of the environment. The maze that Tolman (1946) used to show that rodents use allocentric cues for goal directed navigation. Left, training apparatus where the rats learned to retrieve a food reward at the end of a tortuous alley (indicated by an arrow). Right, apparatus used during the test phase where the entrance of the original alley to the reward is closed but many more straight corridors are available. The animals correctly choose the corridor directed at the reward location using cues outside of the maze to orient navigation.

genaars et al. 2012; Hermans et al. 2013; Lang et al. 2000; Marx et al. 2008; Mobbs et al. 2009). Moreover, freezing is thought to participate in the etiology of threat-related disorders such as social phobia (Buss et al. 2004) and post-traumatic stress disorder (PTSD; e.g., Hagenaaars et al. 2008; Rizvi et al. 2008).

1.5 The Learning versus Performance Ambiguity in Animal Behavior Research

Freezing, potentiation of startle responses and other typical CRs acquired with conditioning are widely used as an index of learning. However, it is crucial to highlight that what an animal does is not necessarily the same as what it knows. Psychological and underlying neural changes underpin learning but these induce a behavioral expression measured by performance on a specific

task. Critically the performance of the animal does not provide complete information about underlying learning processes. Tolman (1930) was one of the first to provide a resounding example of this in rodent behavior. In his experiment, rats were allowed to explore a maze where at one end a group of animals received a reward while another group did not. The group receiving the reward explored the maze more efficiently on consecutive trials, making fewer entrances in dead-end corridors compared to the unrewarded group. However, once the unrewarded group started receiving rewards, it reached immediately the same level of performance as the rewarded one. This result suggested that the unrewarded rats had been learning about the layout of the maze the whole time but that the same level of knowledge between groups was not explicit by only looking at animals' behavior (Tolman and Honzik 1930). The reward motivates the animal to perform⁴. In other words, motivation is necessary to translate learning to performance (Bouton and Moody 2004).

Another seminal idea of Tolman that has been crucial to shape our modern view of animal learning is that animals do not learn by merely associating stimuli to responses (S-R learning; as proposed by the behaviorists), but instead they internally represent their experiences cognitively. In a seminal experiment, Tolman trained rats to look for food at the end of a tortuous alley starting from a circular table (Figure 1.3). The maze was then changed to a radial shaped one, with many possible straight corridors starting from the same table, with only one of those leading to the same already learned reward location. Crucially, the entrance of original corridor was blocked, but the animals selected correctly the corridor leading to the reward location by using cues outside of the maze (Tolman et al. 1946). In other words, rats were able to form cognitive maps of the environment and use allocentric cues like distal visual stimuli of the experimental room to navigate to the correct location (Tolman 1948). It is important to recall that animals are not preprogrammed robots: they have a cognitive representation of their environment and their own goals, and they may well learn much more than what we can probe just by looking at their behavior.

1.6 Extinction Learning

Pavlov observed that a recurring lack of reinforcement after conditioning, such as repeated exposures to the CS alone without the US, resulted in a reduction or loss of the CR (Pavlov 1927). This phenomenon is called *extinction learning* and is a crucial mechanism allowing animals to update their behavior in an ever-changing environment. Extinction has been receiving increasing attention in the past decade because of its clinical significance in the treatment of various psychiatric disorders (Milad and Quirk 2012; Vervliet et al. 2013). Notably,

⁴This is called the 'motivational function' of the reward, (Hull 1952; Mowrer 1960; Rescorla and Solomon 1967; Spence 1956; Tolman 1932).

extinction is the basis of *exposure-based therapies* that are a primary behavioral treatment for stress- and trauma-related disorders as well as for addiction, and anxiety disorders (Powers et al. 2010). These involve repeatedly exposing the patient to anxiogenic cues. PTSD is often conceptualized as the inability to extinguish high levels of anxiety and fear after a traumatic experience (Yehuda and LeDoux 2007; Milad et al. 2006; Bryant 2003; Norrholm et al. 2011; Jovanovic and Norrholm 2011). For these reasons, the National Institute of Mental Health's Research Domain Criteria framework pinpointed experimental extinction as a scientific paradigm that has the potential to provide objective neurobehavioral measures of mental illness (Cuthbert and Insel 2010; Cuthbert and Insel 2013; Dunsmoor et al. 2015; Nees et al. 2015).

Fear conditioning memories are powerful and can last years (Gale et al. 2004). Indeed, the simple passage of time is not sufficient for extinction to take place, which therefore does not mean forgetting. The presentation of the CS without the aversive reinforcer (the US) must occur to make the CR disappear (or be reduced). It must be noted, however, that other protocols, beyond the simple absence of reinforcement, can induce a reduction of the CR after conditioning. These include: 1) reducing the percentage of trials where the CS is reinforced compared to conditioning (e.g., DeVito and Fowler 1986), 2) decreasing the intensity of the US compared to conditioning (e.g., Kehoe 2002), and 3) exposure to the CS and US unpaired or in random order (e.g., Ayres and DeCosta 1971). Based on these observations, a prominent theory put forward by Rescorla and Wagner, holds that extinction occurs when there is a violation of the previously learned expected contingency between the CS and US (Rescorla and Wagner 1972; Wagner and Rescorla 1972).

While the Rescorla-Wagner model effectively describes the cause of extinction, it also views extinction as a simple decrease of the associative value of the CS, therefore modeling extinction as a form of unlearning. However, contrary to intuition, extinction learning does not correspond to the erasure of the original conditioning memory trace. Indeed, Pavlov observed that after successful extinction training the CR could reappear just because of the mere passage of time (Pavlov 1927). This phenomenon is called *spontaneous recovery* (Figure 1.4) and is extensively described in the fear conditioning literature (e.g. Brooks and Bouton 1993). Hence, some influential models (e.g., Pearce and Hall 1980) proposed that extinction involves learning of a new association predicting the absence of the US, which inhibits the conditioning association but does not erase it.

Another two common examples of recovery of responding after extinction training that show that extinction does not involve unlearning, and that the original conditioning memory trace remains intact, are *reinstatement* and *renewal* (Figure 1.4). Taken together, these phenomena suggest that the performance in response to a CS underestimates what an animal actually 'knows' about the CS (Bouton 2004). In reinstatement, the US is presented alone a few times after the extinction training is complete and when the animal is re-exposed to

the CS, CR returns (Rescorla and Heth 1975). Since it is central to the experimental work presented here, fear renewal will be presented in more details.

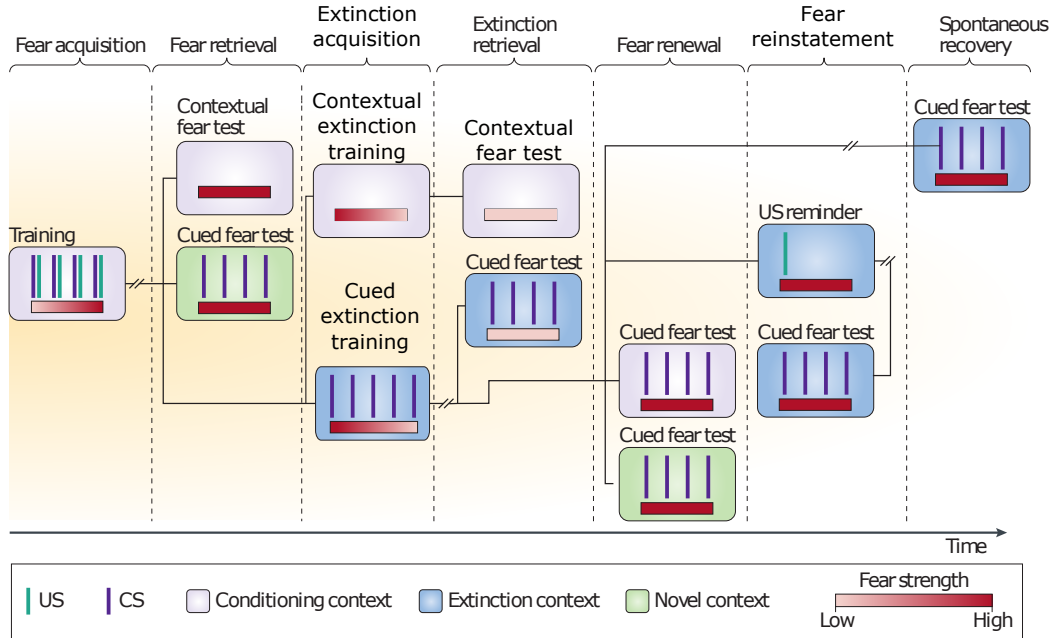

Figure 1.4: Pavlovian fear paradigms. Schematic representation of the most commonly used behavioral paradigms and known effects in conditioning research. Interruptions of the lines represent the passage of time (adapted from Tovote et al. 2015).

1.6.1 Fear Renewal

In a typical fear renewal experiment, the animals are fear conditioned in a context ('context A') and then receive extensive extinction training in a different one ('context B'). These contexts are typically different chambers with different colors, shapes, odors and/or textures. However, by dramatically changing the features of the same chamber elicit discrimination between the contexts. After successful extinction in context B, if the animal is exposed to the CS in context A again the CR recovers, it is 'renewed' (Bouton and Bolles 1979). The majority of studies in renewal used this ABA design, but other designs are also useful. In a second version, ABC, the renewal test is executed in a third neutral context C (Harris et al. 2000). A third renewal protocol uses an AAB

scheme, where conditioning and extinction take place in the same context and then after extinction the CR returns in a second context B (Bouton and Ricker 1994).

It is important to note that this context-dependent renewal effect is not specific for fear learning but also occurs in flavor aversion learning (where a gustatory CS is associated with illness, Rosas and Bouton 1998), appetitive Pavlovian (Bouton and Peck 1989) and instrumental conditioning (Bouton et al. 2012). Thus, renewal is not specific to aversive conditioning and likely involves general mechanisms governing extinction learning. Context-dependent fear renewal is very robust, as the magnitude of extinction training does not affect the extent of the renewal effect (Gunther et al. 1998; Rauhut et al. 2001; Tamai and Nakajima 2000).

Fear renewal after extinction also takes place in humans (Bouton 2002; Rosas et al. 2013). One form of this occurs after exposure-based therapies and is particularly relevant for anxiety disorder research. These therapies, which use extinction protocols to reduce patients' anxiety towards certain stimuli, are effective in the clinical setting. However, there is a 'return of fear' outside of the context where the treatment takes place (Craske and Mystkowski 2006; Lissek et al. 2005; Mineka et al. 1999; Mystkowski et al. 2002; Olatunji et al. 2010; Rachman 1989). This relapse of symptoms is currently the object of intense investigation, and a fundamental challenge for clinical research is to increase the efficacy of exposure-based therapies (Vervliet et al. 2013).

1.7 What is Context?

Context has been defined as the internal (hormonal and cognitive) and external (social and environmental) background where psychological processes operate (Spear 1973). Contexts are continuously encoded without awareness (Barrett and Kensinger 2010), and assist in the essential psychological function that abstracts specific combinations of circumstances into meaning. By matching salient cues and memory traces to given contingencies and circumstances, they help to define sensorial perception, memories of past episodes, and the meaning of ambiguous words, among other things.

Animals form cerebral representations of environmental context as configurations of sensorial cues. These configural representations are also called 'contextual representations' and are acquired latently (with mere exposure to the context as in the case of Tolman's unrewarded rats), as a whole (often called a 'gestalt'), and are learned very quickly (Maren et al. 2013)⁵.

⁵Here configural means that the behavioral response to the contextual representation as a compound cue differs from the response to each individual cue.

1.7.1 Contextual Modulation of Memory Retrieval

Failure to retrieve a memory is colloquially referred to as forgetting. Experimentally, this is evaluated when performance depending upon the memory measured at a time t is lower than that assessed earlier. An intuitive explanation for this behavioral phenomenon is the destruction or deterioration of the original memory trace. However, we know that a forgotten memory can be recovered with the help of retrieval cues (Spear 1978); and therefore forgetting is likely the effect of the failure to retrieve a given memory trace (Sara 2000), rather than the result of its destruction. Tulving's 'Encoding Specificity Principle' states that retrieval depends on the similarity between background contextual cues present during retrieval testing and those present during the initial learning (Tulving and Thomson 1973). Extensive research on humans proved that indeed memory retrieval depends on many contextual stimuli (e.g., Godden and Baddeley 1975) and this general idea is also accepted in animal learning research (Bouton and Moody 2004)⁶.

1.7.2 Contextual Conditioning

Contexts can themselves become associated with other events, such as the presentation of an US. Indeed, after conditioning, the location where conditioning took place gains aversive power and therefore induces CR, even if not paired with the US explicitly in a temporally specific manner (Odling-Smee 1975). In a fear conditioning experiment, CR following exposure to the conditioning context is considered a measure of *contextual fear*, i.e. the fear of the context, which is conditioned to static background cues of the environment. However, de facto, the context here means all the stimuli continuously present in the animal's environment other than the temporally precise ones like a phasic CS. As these stimuli are static, they are less salient and therefore less predictive than the phasic CS, which tends to overshadow them (Odling-Smee 1978).

In some experiments, no phasic CS is presented and these protocols are called *contextual fear conditioning* (Figure 1.3) as opposed to *cued fear conditioning*. As contextual stimuli can either be in the conditioning background (when a phasic CS is present) or in the foreground (when CS is absent), concerning context fear conditioning procedures are also referred to as *background* and *foreground contextual fear conditioning*, respectively (Phillips and LeDoux 1992). Contextual conditioning is becoming more and more popular in neuroscience as a simple model of associative learning in experiments that do not require the study of fear reactions in a precisely timed manner (cf. 3.1.2). Like cued fear

⁶Context-dependent fear renewal can also be explained as contextual modulation of memory retrieval.

conditioning, contextual fear can also undergo extinction following repeated exposure to the conditioned fearful context without any aversive reinforcer⁷.

1.7.3 The Contextual Dependency of Extinction

As discussed, extinction is a new learning process where the original cued fear conditioning trace remains intact. Therefore, after extinction takes place, the CS has two possible associations with the US, or ‘meanings’, and, as it is the case for ambiguous words during a conversation, the context plays a crucial role in disambiguating them (Bouton 2004). While there is no measurable difference in CS responding between the original conditioning context and a different one (Bouton and King 1983), ABC and AAB renewal show that extinction is tightly linked to the context where it takes place, and that performance after extinction learning is context-specific. According to the definition of context above, extinction is also bound to the internal state of the animal during training. Animals that undergo extinction training under the effect of a drug or alcohol will renew fear when tested in a drug- or alcohol-free state (Cunningham 1979)⁸. Furthermore, the spontaneous recovery effect demonstrates that extinction is more sensitive to the passage of time than conditioning, and for this reason, Bouton (1993) argues that the passage of time modulates extinction precisely because ‘time’ is a variable that participates to the contextual representation.

Extinction is, therefore, more context-specific than conditioning. A possible interpretation is that the fear reduction associated with extinction may depend upon learning that the CS is not dangerous only in the specific context where extinction takes place (Bouton 2002). Another possibility, given that context also plays a crucial role in enabling the retrieval of the extinction memory trace, is that animals fail to retrieve the extinction memory in a different context. The ambiguity here lies at the core of the learning vs. performance problem. There is evidence that retrieval cues associated with the extinction training can help maintain extinction and eliminate both spontaneous recovery (Brooks 2000) and fear renewal (Brooks and Bouton 1994).

1.7.4 Taking Context into Account to Model Extinction Learning

Several models propose that the context can be associated with the US just as the CS is, therefore competing with the phasic CS for associative strength in background contextual conditioning (Mackintosh 1974; Pearce and Hall 1980; Rescorla and Wagner 1972). While these models efficiently describe contextual

⁷While fear renewal and reinstatement do not apply to contextual fear extinction, spontaneous recovery can be observed.

⁸This is sometimes called the state-dependency of extinction learning.

conditioning phenomena, a simple summation of such context-US associations with the CS-US one does not explain ABC renewal, where a context that has never been associated with the US has an excitatory effect on performance. Moreover, renewal also takes place in the absence of measurable contextual fear (Bouton and King 1983). The leading model taking into account post-extinction recovery effects is the one proposed by Bouton (1993; 2004). In his view, contexts control the associative properties of cues without themselves acquiring associative strength. Since they are able to interfere with performance without being merely associated with the US or its absence, they are called *occasion setters*. In this framework, the context ‘sets the occasion’ by selecting and activating the current association between the CS and the US (accordingly to all contextual information). However, occasion-setting seems to be effective only in cases of ambiguity (e.g., when the relationship between the CS and the outcome is ambiguous after extinction). Without ambiguity, cue-specific associations transfer well across contexts (e.g., when CS responding is high in a context C in ABC protocols).

It is important to note that, beyond its role as a an occasion setter, the context is still able to act as a discrete cue, eliciting CR and competing with transient events for the control of behavior. These two functions of context can be dissociated but are not mutually exclusive (Urcelay and Miller 2010; Urcelay et al. 2012; Urcelay and Miller 2014).

1.8 Associative Learning Contamination by Episodic Memory

Taken together, this literature further suggests that the CR at the time of the test can be a poor indicator of animals’ long term memory or of memory content. A variety of explanations can be made for the absence of CR: the CS-US association never formed, the CR is inhibited, the internal state is not the same, or the animal is retrieving competing excitatory and inhibitory memory traces. Animals form many associations with the CS (contextual, temporal...) and possibly engage various memory and behavioral systems beyond what the apparent CR can measure (Delamater 2012). The CR likely provides a compound metric over the entire learning history and risks to be an unreliable index of individual learning events (Dunsmoor and Kroes 2019).

The definition of episodic memory states that it “makes it possible for a person to be consciously aware of earlier experience in a certain situation at a certain time” (Tulving 1993). In humans, contradictory results report both that conditioning is dependent (Bekinschtein et al. 2009; Lovibond and Shanks 2002) and independent (Hamm et al. 2003; Knight et al. 2009; Morris et al. 2001) of conscious awareness. Hence, the reports of dependency of conscious awareness during conditioning recall suggest some overlap between the episodic and

conditioning memory systems. Tolman's evidence for latent learning indicates that the acquisition may not be explicitly linked to deliberate behavior, and, because of a lack of verbal reports, the animals' conscious experience is not accessible to us. However, it is possible to test whether animals form an abstract time-place memory that can be modulated by future events (which is accepted as a form of episodic memory in rodent spatial learning research). O'Brien and Sutherland (2007) tested this with an elegant experiment. Rats were first routinely habituated to two different physical contexts: one in the mornings and one in the evenings. Then, either in the morning or in the evening, they were shocked in a third context with equal resemblance to the first two. Finally, their contextual freezing was tested in the middle of the day in one of the two habituation contexts. Strikingly, contextual fear was significantly higher in the context where habituation took place at the time of the day where they received the foot-shock. As discussed above, temporal context is a variable potentially participating in the compound contextual representation; therefore, it is still possible to explain this result with purely associative processes. However, this kind of result should fuel the debate on whether the classical sharp division between simple (implicit) associative learning and complex (explicit) episodic learning may need to be revised.

Episodic memory may be an underestimated player in Pavlovian conditioning and extinction; real-world emotional learning likely engages both Pavlovian and episodic memory systems (Dunsmoor and Kroes 2019). In human research, the possibility to access subjects' verbal reports allowed development of paradigms attempting to disambiguate the two systems (e.g., Dunsmoor et al. 2015). While this is a formidable challenge in animal research, moving beyond a unitary CR as a measure of learning may become useful to capture the multiple aspects of emotional learning.

1.9 Choosing What to Do When Facing Threat

Although experimental designs often focus on single behavioral parameters, in real-world scenarios, what animals do when facing threats is not a binary choice like freeze or don't freeze. Even rodents select what to do by continuously evaluating the circumstances, and even display substantial trial-to-trial variability in defensive strategies and implementing them. For instance, animals choose where to freeze: rats usually freeze next to a wall or object (Godsil and Fanselow 2012). When a feared CS is presented, they occasionally also exhibit a rapid, directed flight to a familiar shelter before freezing (Choi and Kim 2010; De Oca et al. 2007). Alternatively, if they are allowed to perform instrumental behaviors to avoid the US such as moving to a different part of the testing environment, or by stepping onto a platform, they sometimes first freeze and then flight, or escape without freezing, always at different latencies from the CS onset (Kyriazi et al. 2018; Bravo-Rivera et al. 2014). Another example of behavioral flexibility when faced with a threat comes from an ex-

periment on mother rats and their pups. If rat dams are conditioned to fear a specific odor, later they freeze in its presence if they are alone, but attempt to fight the odor if they are together with their pups (Rickenbacher et al. 2017).

Beyond freezing, a wide range of behaviors can be used to confront danger. Animals display different defensive behaviors when the size of the environment changes (Bolles and Collier 1976), as well as when the distance to a safe area changes (Choi and Kim 2010; Ydenberg and Dill 1986). The choice among defensive behaviors is controlled by the situation where the threat is met and the danger's characteristics. Three groups of hypotheses have been advanced to explain how animals decide what to do (Eilam 2005): i) accessibility of a shelter; ii) physical and psychological distance from the danger; and iii) differences among individuals.

R. and C. Blanchard designed an experimental model that allowed to test the first hypothesis: the Mouse-Defense-Test-Battery. The animals are tested in a maze with multiple doors allowing it to be blocked in a dead-end corridor while an experimenter approaches. Observations on rats (Blanchard et al. 1989; Blanchard and Blanchard 1989) and mice (Griebel et al. 1995b; Griebel et al. 1995a) showed that if an escape route or a shelter is available, freezing is brief and is followed by fleeing to a safer area in 97% of cases while if these options are not available, the animals will freeze 100% of the time.

1.9.1 Danger Imminence

The second hypothesis is that exists a "distance-dependent defense hierarchy". Therefore, a distant predator triggers freezing, a closer one prompts escape, and one at a very close distance triggers the final and probably unavoidable act of defense, which is to fight back (Gallup 1974; Ratner 1975; Ratner 1977). Therefore the levels of defense map onto different levels of danger (Blanchard et al. 1986). This theory is consistent with behavioral ecology models suggesting that encounter avoidance maximization is always the first choice of animals (e.g., Lima and Dill 1990).

This framework was expanded in a prominent paper by Fanselow and Lester (1988) who claimed that factors other than the absolute physical distance may contribute to the assessment of risk of the prey. For instance, an approaching predator induces a different behavior than one moving around, at a fixed distance. Similarly, the type of danger also influences the assessment of its imminence. Indeed, gazelles allow hyenas to approach more than cheetahs before fleeing (Walther 1969). Thus, Fanselow and Lester (1988) argued that the behavior of the prey changes as a function of its perception of where the danger is on a physical and psychological continuum called 'predatory imminence'. The *predatory imminence theory* further postulates that the choice between antipredator behaviors and their functional relationship with predation cor-

1 Fear, Aversive Memory, and Defensive Behavior

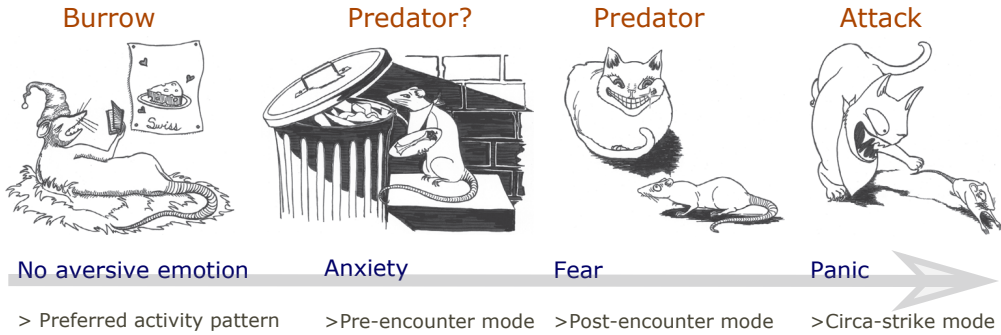

Figure 1.5: Predatory Imminence Theory. Schematic representation of the basic principles of the predatory imminence theory. The arrow depicts the continuum of the levels of danger (red text), the emotional levels (blue) and the levels of defense (green, adapted from Godsil and Fanselow 2012).

responds to switching between different behavioral propensities according to modes: *pre-encounter*, *post-encounter*, and *circa strike behaviors* (Fanselow 1994). These modes are homologous to and encompass the levels of defense proposed by Blanchard and Blanchard (1988; see 1.4.1). Pre-encounter behaviors correspond to risk assessment, post-encounter incorporates fleeing and freezing responses, and circa-strike behaviors correspond to defensive threatening and fighting. Grouping defensive behaviors in three conceptual classes is particularly useful for distinguishing between fear and anxiety. Indeed, in addition to behavioral choices, emotional states are also associated with different levels in the predatory imminence continuum. Therefore, specific emotional states such as anxiety, fear, and panic are valid descriptions of animals' behaviors in pre-encounter, post-encounter, and circa strike modes, respectively (Perusini and Fanselow 2015).

Role of Learning in Shaping Danger Imminence

It would be an incredible load for the genome to encode for all potential threats, and animals would not be capable of adapting to an ever-changing environment if all threats were innately encoded. Therefore, in Fanselow's model, entering in a particular mode is triggered by innate species-specific stimuli but also by past experiences. All stimuli map onto a predatory imminence construct, and learning is key in constantly shaping this continuum across individuals' life spans (Fanselow 2018a; Fanselow and Lester 1988). Indeed, very rarely the traumatic experience inducing PTSD is the encounter with a predator. Similarly, rodents used as experimental models have never encountered electrical foot-shock in their evolutionary history. Rats respond to electrical shocks the same way that they do to the encounter with cats. They also respond defen-

sively to a plastic robot that has never preyed any of their ancestors (Kim et al. 2010; Kim et al. 2015b). Associative learning, and pavlovian conditioning, thanks to its quickness and strength, may play a key role in continuously shaping animals' predatory imminence continua across their lifespan (Fanselow 2018b). Within this framework, fear extinction can be seen as an update of the perceived level of danger, and freezing reduction corresponds to the transition between post- to pre-encounter modes in response to determined stimuli.

1.9.2 Interindividual Differences in Fear and Recovery

A third important factor influencing what animals do when facing threats are interindividual differences. Already in 1928, Pavlov argued that it was necessary to study animal behavior with particular regard to the diversity of their "responses, temperament, and type of nervous system" (Pavlov 1928). Indeed, individuals' temperament also influences their responses to threats. Meadow mice with high basal locomotory activity tend to flee when hearing an owl call (their typical predator), while in response to the same stimulus their generally less active conspecific tend to freeze (Eilam et al. 1999). The shyness or boldness of individuals, as well as their gender and age, also shape interindividual differences of fear responses (Blanchard et al. 1991; Borowski 2002; Perrot-Sinal et al. 1999; Shepherd et al. 1992; Doyère et al. 2000).

Beyond this ethologically relevant issue, the variability in fear expression between subjects has also been described in lab settings (Holmes and Singewald 2013). With large cohorts of animals, it is possible to show that during acquisition of both conditioning (Bush et al. 2007) and extinction (Bush et al. 2007; Reznikov et al. 2015; Galatzer-Levy et al. 2013) there are striking differences among animals. Animals with a fast conditioning phenotype also show higher fear responses to the CS during later tests compared to those with slow acquisition of conditioning (Bush et al. 2007). During extinction, animals can extinguish rapidly, slowly, or not at all (Galatzer-Levy et al. 2013) and the slower ones have poorer extinction retention than more rapid ones (King et al. 2017; Reznikov et al. 2015; Bush et al. 2007). Inter-individual differences were also reported for stimulus and context generalization after conditioning (Duvarci et al. 2009), for long term impact of acute stress on defensive behaviors (Goswami et al. 2010; Krishnan et al. 2008; Siegmund et al. 2009), and in tests of anxiety behaviors (Cohen et al. 2006; O'Leary et al. 2013).

Rodent research with fear conditioning and extinction paradigms was mostly developed analyzing central tendencies, ignoring heterogeneity, and assuming that the overall group averages represent individual behavior (Sotres-Bayon et al. 2008). However, it is important to keep in mind that correlations between behavior and neural or biological variables may only appear when analyzing

data according to the high or low response phenotype of the animals (Cohen and Zohar 2004)⁹.

Relevance of the Study of Inter-Individual Variability for Translational Research

Selecting rodents for breeding based on high and low anxiety traits results in significant behavioral phenotype differences within few generations (Landgraf and Wigger 2002). Also in humans, comparing homo- and heterozygotic twins, heritability accounts for 30-40% of panic, phobic, and anxiety disorders (Hettema et al. 2001). Both genetics and epigenetics play big roles in the etiology of anxiety disorders (Sharma et al. 2016) and this is likely to be associated with widespread differences in the neural networks underlying the different behavioral phenotypes.

Humans display a large variability in how anxious they are and ‘trait anxiety’ defines the long term propensity of certain individuals to experience low or high levels of anxiety (Spielberger and Gorsuch 1983). Only 30-40% of those who experienced multiple traumas develop pathological conditions, even though the majority display acute responses to threat (Steel et al. 2009; Berger et al. 2012). Furthermore, the response to treatments is highly variable in both short and long terms effects: resilient people show only transitory symptoms, and others have a slow remission, while some fail to recover (DeRoos-Cassini et al. 2010; GalatzerLevy et al. 2011; Bonanno et al. 2012). The failure in the recovery process and variations in brain processing would predispose some individuals to pathological vulnerability (Yehuda and LeDoux 2007). Behavioral phenotyping different groups of lab animals suggests that biomarkers for the resilient and vulnerable traits exist (Holmes and Singewald 2013).

Fear generalization is considered a hallmark of anxiety disorders (Dunsmoor et al. 2015), and, as rodents also have a high propensity to generalize (Asok et al. 2019), studying generalization mechanisms may be a promising line of research in the translational efforts between animal fear conditioning and psychiatric research (Headley et al. 2019).

1.9.3 Increasing the Power of Rodents Models of Pathological Fear with Eco-/Etho-logically Relevant Paradigms

It is likely that, in real life, the combination of the type of environment (accessibility of a shelter or escape routes), danger imminence, and individual temperament influences how an individual faces danger. The neural circuits

⁹However these kinds of approach may require high numbers of subjects.

supporting defensive behavior and fear may well overlap with those underpinning decision-making (Mobbs and Kim 2015). An early experimental attempt to simulate a more naturalistic situation of fear is the ‘closed economy paradigm’, where rats live in chambers composed of a safe nest and a foraging arena that they can enter to press levers to obtain food (Collier 1983). The foraging arena floor is made of metal grids that render the environment dangerous by delivering footshocks. Pseudo-random shocks reduce the feeding frequency of animals but increase their duration such that the caloric intake can be maintained while reducing the risk of encountering the aversive stimulus (Helmstetter and Fanselow 1993). Moreover, rats prefer using levers closer to the safe nest in order to be able to escape quickly if necessary (Kim et al. 2014a).

Furthermore, when foraging for food, more than danger imminence, individual temperament, or type of environment, other variables such as current metabolic needs also enter in the equation to select appropriate defensive behavior (Mobbs 2018). Consequently, to disentangle the neural basis of fear learning, it may be crucial to compare the results from tasks that span the spectrum of fear behavior in animals with different fear response profiles in different behavioral states. This effort may help disambiguate between the neurophysiological mechanisms underpinning the production of specific behaviors from those that sustain the processing of threatening stimuli (Headley et al. 2019). In addition, an increased range of behaviors may help characterize individuals into different behavioral phenotype categories.

In a relatively recently developed task, hungry rats can leave a safe nesting area to forage for food pellets in an arena containing a predatory US: a robotic predator that starts to open and close its mechanical jaw when rats approach it (Choi and Kim 2010; Amir et al. 2015; Amir et al. 2018). This protocol revealed that the activity of certain neural populations of the amygdala (a key brain structure in fear processing, cf. 2.1) does not correlate with the presence of threat or the availability of food reward, but rather with behavioral responses such as movements. This discovery would not have been possible studying freezing in a small conditioning box (Paré and Quirk 2017).

Eco-ethological relevant fear paradigms mostly study innate fear towards unconditionally aversive stimuli. Indeed, it is essential to study innate fear in order to help distinguish learned from unlearned components within the biological variables correlating with fear in conditioning paradigms (Pellman and Kim 2016). These fear models may also allow to draw better parallels between human and animal fear, and therefore provide a better model of human pathological conditions (Kim et al. 2018).

2 Neuroanatomical Substrates of Fear Memory

2.1	The Amygdala	34
2.1.1	Amygdala Anatomy	34
	Neuronal Types and Intrinsic Connectivity	36
	Extrinsic Connectivity	36
	The Specific Case of the bed nucleus of the stria terminalis (BNST)	37
	The Amygdala as an Integrator of Different Inputs	37
2.1.2	Fear Learning and Expression Control by the Amygdala	38
2.2	The Hippocampus	39
2.2.1	Hippocampal and Para-Hippocampal Region Anatomy	40
	Hippocampal and Parahippocampal Connectivity	44
2.2.2	Hippocampus and Fear Memory	46
	Dorsal Hippocampus Role in Contextual Fear Acquisition	46
	Ventral Hippocampus Participates in Fear Learning and Behavior Beyond Context Encoding	48
	hippocampus (HPC) Role in Fear Memory Retrieval	49
	HPC and the Context Dependency of Extinction Learning	50
	The role of Parahippocampal Cortical Areas	51
2.3	The Medial Prefrontal Cortex	51
2.3.1	What is the (medial) Prefrontal Cortex?	52
2.3.2	Anatomy and Connectivity of the Medial prefrontal cortex (PFC)	53
	medial prefrontal cortex (mPFC) Cytoarchitecture	56
	mPFC Afferent and Efferent Connections	57
2.3.3	mPFC in Fear Learning and Behavior	60
	mPFC Role in Fear Acquisition	61
	Fear Memory Consolidation and Remote Fear Memory are anterior cingulate cortex (ACC) Dependent	62
	mPFC Role in Fear Expression	62
	mPFC and Extinction Learning	63
	mPFC role in Fear Generalization	64
	Distinct Roles of mPFC Subdivisions in Fear Learning and Behavior	65
2.4	An Overview of Neural Circuits Underpinning Fear Learning	67
2.4.1	Other Limbic Structures Implicated in Fear Learning Beyond the Hippocampo-Amygdalo-Prefrontal Network	67
	The Periaqueductal Gray: Defensive Behavior Control and Prediction Error Learning	67
	A Septohypothalamic Axis Controls Stress and Anxiety guided by the HPC and the amygdala (AMG)	68
	Neuromodulatory Regulation of Fear Learning	69
	The Medial Thalamus: Fear Expression, Retrieval, and Contextual Generalization	69

The first report, although somewhat unreliable, relying emotions and brain activity, is the famous case of Phineas Gage (Bigelow 1850; Harlow 1848). Gage was a railroad worker who amazingly survived after an iron rod passed through his skull resulting in unilateral damage to the anterior half of his prefrontal cortex. As Gage never received any actual cognitive/neurological examination (which hardly existed then), most of the records can be considered as anecdotal (Macmillan 2002). However, Harlow reported that after the injury Gage's personality changed profoundly, while his cognitive faculties remained intact (Harlow 1868). This inspired much speculation about the relation between neural and cognitive impairment. Thus, this case, together with the one of H.M., is probably one of the most described in psychology textbooks. More thorough experimental investigations of emotional changes after brain damages were pioneered by the work of Goltz in 'decorticated' dogs. He surgically removed portions of the dogs' cerebral cortex and, after recovery, observed profound changes in animals' emotional reactivity (Goltz 1884; Goltz 1892). The dogs exhibited acute rage in response to small disturbances, displaying behaviors evoked in healthy animals only by highly aversive stimuli. In parallel to Goltz work, temporal lobe lesions in monkeys were reported to induce profound alterations in emotional regulation (Brown and Sharpey-Schafer 1888; Klüver and Bucy 1937). These more anatomically and behaviorally detailed reports described how temporal lobe resections, spanning both cortical and subcortical structures, induced behavioral changes, including a loss of fear. For instance, after surgery, monkeys who would normally be afraid of human presence would readily be very friendly with their caretakers.

For almost a century, an enduring neuroscience model posited the existence of a *limbic system* that supports emotional processing (Thomas et al. 1968). The concept of the limbic system developed from earlier anatomical descriptions of Paul Broca (1861; 1978) who categorized all the archi- and paleo-cortical structures lying between the neocortex and the diencephalon as the "limbic lobe". Even though this category has been proved to be embryologically and anatomically polyphyletic, the association between the limbic system and emotion is one of the most influential and enduring models of neuroscience (Pessoa and Hof 2015; LeDoux 1996; Kötter and Meyer 1992; Catani et al. 2013). Papez, and later MacLean, investigated the connectivity between the structures of the limbic lobe and developed a circuit-level theory of emotions involving the cingulate gyrus of the cortex, the parahippocampal gyrus, the hippocampal formation, the hypothalamus, and the anterior thalamus (Papez 1937; MacLean 1949). Since then, the list of the participants to the limbic system has steadily expanded well beyond Broca's limbic lobe to include the amygdala, the bed nucleus of the stria terminalis, the septum, part of the brainstem, and the nucleus accumbens and adjacent regions of the basal forebrain. Major fiber bundles heavily interconnect many of these regions, but the significant features which unite them the most into a 'system' are their shared functional implication in emotional cognition (Catani et al. 2013; Vertes et al. 2015).

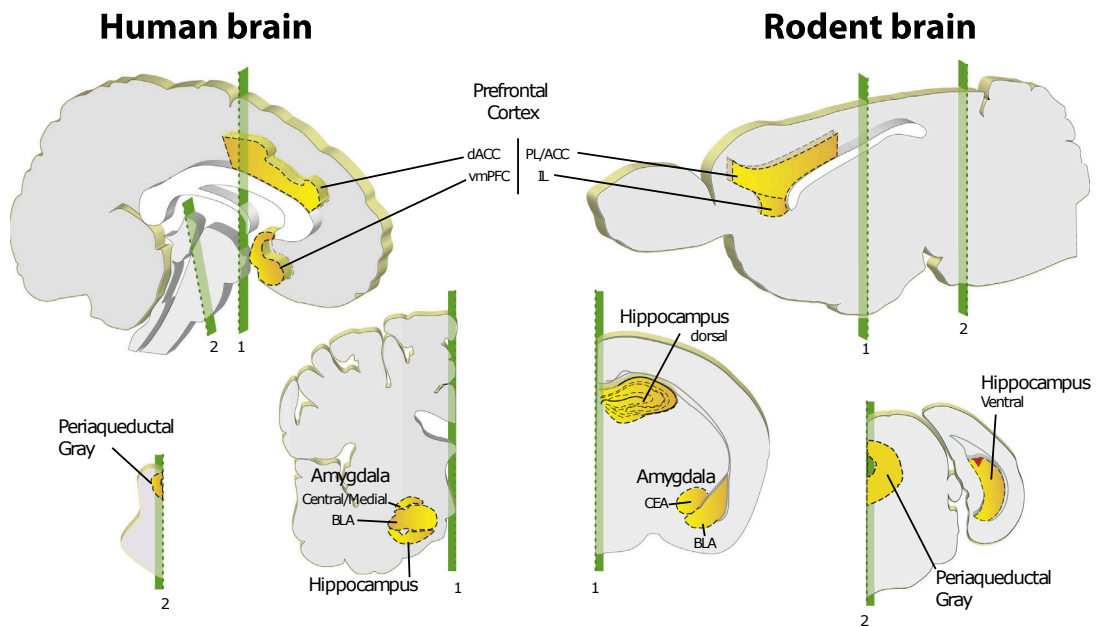

Figure 2.1: The fear learning brain network. Locations in the human and rodent brain of the brain structures majorly implicated in fear learning and fear behavior control (adapted from Dejean et al. 2015).

Of these brain regions, research about fear learning mechanisms in the last three decades concentrated on three telencephalic structures, the AMG, HPC, and the medial prefrontal cortex (mPFC, Broca's and Papez's cingulate cortex), and the mesencephalic periaqueductal gray (Figure 2.1; Fendt and Fanselow 1999; Maren 2001b; Fanselow and Poulos 2005; Tovote et al. 2015; Dejean et al. 2015; Herry and Johansen 2014). While the latter is particularly implicated in the expression of fear behavior, the amygdala, the hippocampus, and the medial prefrontal cortex have been widely involved in fear learning processes and are the focus of this chapter. For each, I briefly present the anatomy and in particular, its connectivity, in order to show how it integrates into a brain circuit supporting emotional learning. I also review the literature that probed these structures with physical, pharmacological, and optogenetical interventions in order to break up their contribution to fear learning. Finally, I briefly present the contributions to fear learning of the other structures of the limbic system and present the current model of the brain-wide circuit underpinning emotional memory.

2.1 The Amygdala

A couple of decades after the description of the fearless behavior of monkeys with temporal lobe lesions, it became clear that this emotional deficit was caused by damage to the amygdala (Weiskrantz 1956). Further studies confirmed the reduction of fear responses after amygdaloidal lesions in rabbits, cats, rats, dogs, and humans (Goddard 1964). Many studies employing diverse experimental fear learning models and techniques consistently confirmed that the amygdala is a critical neural structures for fear and extinction memory acquisition and storage (Maren and Fanselow 1996; Davis 1992; Davis 2000; Ledoux 2000; Ehrlich et al. 2009; Krabbe et al. 2018; Duvarci and Pare 2014; Pape and Pare 2010; Maren and Quirk 2004; Herry et al. 2010; Myers and Davis 2007; Quirk and Mueller 2008). It is important to note, however, that the amygdala is not only implicated in aversion and it is rather view as emotional and motivational processor at the service of decision-making and action control (Pignatelli and Beyeler 2019; Doyère and El Massioui 2016; Janak and Tye 2015). The amygdala also modulates fear learning in other brain regions, like the hippocampus and cortical areas (McGaugh 2018; McGaugh 2004).

One famous clinical case of living without the amygdala is the one of patient S.M., a woman with bilateral amygdala damage (Adolphs and Tranel 2000). Although S.M. presents normal and stable cognitive abilities, she displays an impoverished experience of fear compared to controls (Feinstein et al. 2011) as well as deficits in fear conditioning (Bechara et al. 1995), recognizing fear in facial expression (Adolphs et al. 1994; Adolphs et al. 1995), social judgement (Adolphs et al. 1998; Kennedy et al. 2009), and monetary loss aversion (De Martino et al. 2010).

2.1.1 Amygdala Anatomy

The name amygdala derives from its almond-like shape. It is also called the ‘amygdalar complex’ because it is a heterogeneous group of ~13 nuclei which goes beyond the almond-shape structure identified by the early anatomists. In the mammalian brain it is located near the temporal lobe (Sah et al. 2003). Because of its anatomical but also functional heterogeneity, the AMG has been proposed to be an arbitrary grouping of nuclei belonging to functionally distinct systems (Swanson and Petrovich 1998). These nuclei can be subdivided into four groups depending on their developmental origins, histological organization, and extrinsic connectivity (Figure 2.2):

1. the *basolateral complex* of the amygdala (blCA);
2. the centromedial group including the *central amygdalar nucleus* (CeA) and the *medial amygdalar nucleus* (MeA);
3. the *cortical amygdala* (CoA);

4. all other nuclei that cannot easily fall into any of these groups, including the *intercalated cell masses* (ICMs).

The amygdalar complex together with the *bed nucleus of the stria terminalis* (BNST) form the so-called *extended amygdala*.

A subset of these structures, the basolateral amygdala (BLA), the CeA, the BNST, and, more recently, the ICMs have received particular attention regarding their contribution to fear learning and fear expression (Duvarci and Pare 2014; Krabbe et al. 2018). For this reason, details about the other nuclei are omitted (but see Sah et al. 2003; Swanson and Petrovich 1998 for extensive reviews of their anatomy).

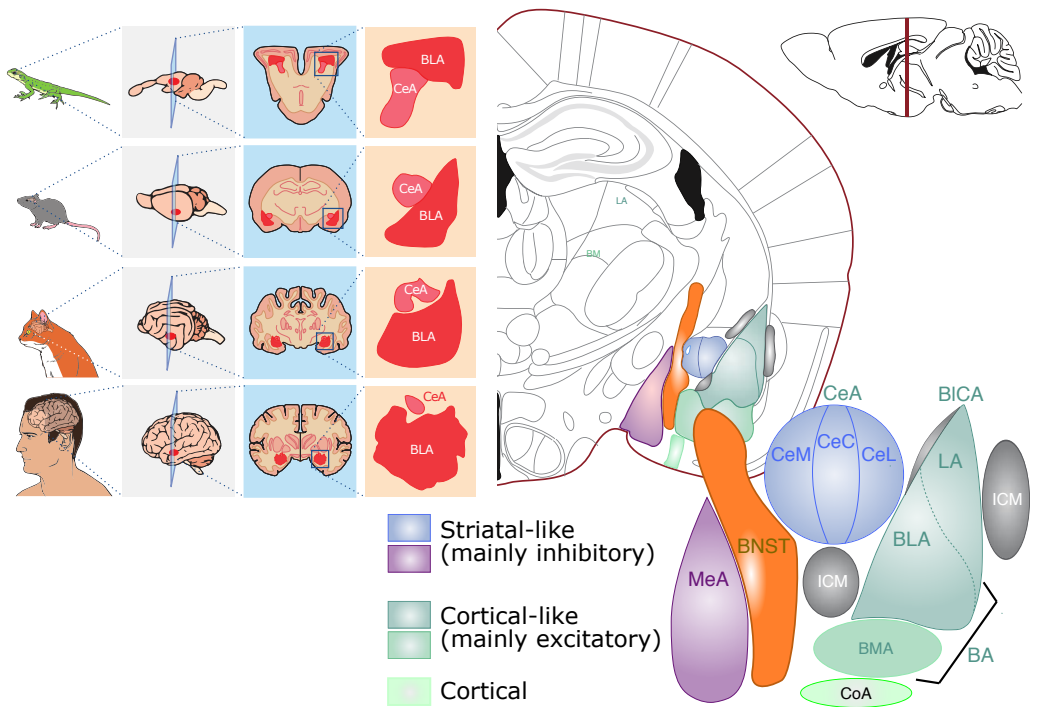

Figure 2.2: Amygdala anatomy. Gross anatomy of the amygdala is preserved across vertebrate species (left). Location of the principal nuclei of the amygdala in the rodent brain (right). BICa: basolateral complex of the amygdala; lateral amygdala (LA): lateral amygdala; basal amygdala (BA): basal amygdala; BLA: basolateral amygdala; basomedial amygdala (BMA): basomedial amygdala; CeA: central amygdala; CeM: centro-medial amygdala; CeL: centro-lateral amygdala; CeC: capsular-central amygdala; ICMs: intercalated cell masses; BNST: bed nucleus of the stria terminalis; MeA: medial amygdala; CoA: cortical amygdala (adapted from Janak and Tye 2015 and Pignatelli and Beyeler 2019).

Neuronal Types and Intrinsic Connectivity

The bICA is composed of the lateral amygdala (LA), and the basal amygdala (BA), itself subdivided in a basolateral component (BLA)¹ and a basomedial one (BMA, also called the accessory basal nucleus). These nuclei are called ‘cortical-like’, because, like the cortex, are mainly composed of excitatory projection neurons (~85%) with a small percentage of local inhibitory interneurons (~15%), and contain cortical-like neurons with pyramidal and stellate morphologies.

The centromedial nuclei, on the other hand, are considered striatal-like, because, like the striatum, they are composed almost exclusively of inhibitory neurons, and the projecting cells resemble the medium spiny neurons of the striatum and release the inhibitory transmitter γ -Aminobutyric acid (GABA). The CeA is further subdivided into its lateral CeA (lCeA), medial CeA (mCeA), and capsular CeA.

The intrinsic and extrinsic connectivity of the AMG correspond to its essential role in fear learning and behavior (LeDoux 2007). The internuclear connections within the AMG are dominantly uni-directional: with strong glutamatergic connections from the LA to the BA and principal cells of the BA projecting to the CeA, while connections in the other direction are sparse (Pare and Smith 1998; Pitkänen et al. 1997).

The intercalated neurons, a large majority of which are GABAergic, do not form compact nuclei but are rather low-density clusters of cells positioned either lateral to the bICA (lateral ICMs) or between the bICA and CeA (medial ICMs). Both LA and BLA project to the ICMs, which then connect with the CeA. One possibility is that the activation of these cells inhibits CeA inhibitory outputs resulting in a disinhibition of the latter’s targets involved in the regulation of many autonomic and behavioral responses.

Extrinsic Connectivity

The AMG forms connections with a wide array of brain regions including the cortex, striatum, hippocampus, some thalamic and hypothalamic nuclei, as well as different basal forebrain and brain stem nuclei such as the periaqueductal gray (PAG) (Pitkänen 2000; Pitkänen et al. 2000). The AMG receives inputs from all sensory modalities, generally not directly from primary cortical sensory areas but after a cascade of cortico-cortical and cortico-thalamic

¹There is no agreement in the literature about the naming of AMG nuclei nor about their acronyms. The acronym BLA is often used in the literature to indicate the whole basolateral complex (sometimes encompassing its basomedial part, sometimes not), but also to indicate only its basal component without LA. With a growing literature indicating complementary roles of the basal amygdalar nuclei BMA and BLA, here I choose to use a non-ambiguous terminology for the whole complex: bICA.

projections whose axons mostly terminate in the LA (McDonald 1998). The BA receives fewer direct sensory projections and, rather, reciprocally connects with other brain areas such as the medial prefrontal cortex, the ventral hippocampal formation, and the entorhinal cortex (Hoover and Vertes 2007; Pape and Pare 2010; Petrovich et al. 2001; Pitkänen et al. 2000). The latter structures also target the CeA and other amygdalar nuclei, but with sparser connections compared to those targeting the BA. The BLA is the main target of mPFC projections, though mPFC axon terminals are also present in the BMA, LA, and CeA (McDonald et al. 1996). In contrast, the BLA receives minor projections from the hypothalamus, which sends substantial inputs to CeA and LA. The CeA is also the privileged target of a variety of midbrain, pons, and medulla nuclei devoted to the control of autonomic and neuromodulatory functions. The CeA strongly projects back to these brain stem and basal forebrain areas, notably the PAG. ICM cells do not project outside of the AMG but receive mPFC projections.

The Specific Case of the BNST

The concept of ‘extended amygdala’ was developed to include both the AMG and the more distant BNST in the same functional brain structure (Goode and Maren 2017; Gungor and Pare 2016; Lebow and Chen 2016; Shackman and Fox 2016). The BNST is actually a collection of nuclei rather than a single nucleus. Its posterior nuclei are not generally considered as part of the extended amygdala while anterior ones are because they are the main termination zone of CeA axons and receive massive projections from the BLA and BMA.

The BNST also receives projections from brain stem and midbrain nuclei implicated in the neuromodulation and autonomic control, the ventral hippocampus, and the mPFC (Pinard et al. 2012). BNST nuclei are highly interconnected, and their efferents (mostly GABAergic) target the CeA, but also, more sparsely, the PFC, BLA, and HPC.

The Amygdala as an Integrator of Different Inputs

Overall, AMG inputs may converge there to produce an integrated representation of all environmental sensory stimuli carrying information about both their saliency and emotional valence (Davis and Whalen 2001; Phelps and LeDoux 2005). This representation is, in turn, processed and transmitted to downstream areas to be used to influence behavior (Yizhar and Klavir 2018).

The unidirectional anatomical connectivity within the AMG inspires the dominant model of AMG physiology supporting fear learning. In this simplified

serial view of AMG function, the LA receives multimodal sensory inputs from the cortex and the thalamus, acting as the principal sensory interface. This information is relayed and integrated by the BA which projects to the CeA (receiving also direct projections from the LA). BA is bidirectionally connected with many cortical and subcortical regions cooperating for the modulation of behavior (such as the HPC and mPFC). Principal neurons of the CeA, the main AMG output, project to the brainstem and the hypothalamus to control the conditioned autonomic and motor responses orchestrated there. The information flowing in this system is processed by the intra-AMG circuitry and integrated with the inputs coming from interacting structures to process sensory inputs and generate fear responses that are relevant for specific conditions, for instance during fear extinction.

2.1.2 Fear Learning and Expression Control by the Amygdala

R. and C. Blanchard not only pioneered the use of freezing as a metric for conditioned fear (cf. 1.4.3) but also the systematic examination of neural systems implicated in the acquisition and retention of conditioned freezing. With a contextual fear conditioning paradigm, they showed that large bilateral amygdala lesions completely eliminate context-conditioned freezing as well as unconditional freezing in the presence of a cat (Blanchard and Blanchard 1972a).

Numerous studies in many laboratories confirmed the critical role of the AMG for fear learning and expression. BLA lesions or pharmacological inactivations induce severe deficits in both the acquisition and expression of conditioned freezing to discrete conditioned stimuli (CSs) (auditory, visual, and olfactory) and contexts (e.g. Ambrogio Lorenzini et al. 1991; Helmstetter 1992; Helmstetter and Bellgowan 1994; Kim et al. 1993; Ledoux et al. 1990; Muller et al. 1997; Otto and Cousens 1998; Wilensky et al. 1999) as well as in the acquisition and expression of the acoustic startle's potentiation (Hitchcock and Davis 1986; Kim and Davis 1992; Sananes and Davis 1992). Amygdala lesions and inactivation have also been shown to affect many other behavioral and autonomic conditioned responses (for a review, see Maren 2017).

Post-conditioning lesions of the BLA induce a complete loss of conditioned freezing, even if lesions are made more than one year after conditioning (Gale et al. 2004; Maren et al. 1996). This suggests that BLA is crucial for the retrieval of even well-consolidated fear conditioning memories. However, if lesions are performed before training, their effects can be mitigated by extensive training during conditioning (Maren 1999a; Poulos et al. 2009; Maren 1998). These results suggest that after BLA damage, other structures may compensate for its absence and support learning, but that once learning takes place with an intact BLA, its absence prevents correct recall. BLA is also necessary for extinction and context-dependent fear renewal (Herry et al. 2008). Crucially,

extinction retrieval and expression are not affected by BLA damage, suggesting that BLA is only necessary for extinction acquisition (Herry et al. 2008).

A widely accepted hypothesis is that the CeA may compensate for BLA damage in some situations. Indeed, damage to CeA impairs acquisition and expression of conditioned fear (Goosens and Maren 2001; Hitchcock and Davis 1986; Kim and Davis 1992; Nader et al. 2001) and transient inactivation of CeA prevents both the acquisition and expression of fear after overtraining (Zimmerman et al. 2007). Intact ICMs and BNST are essential for fear learning too. Indeed, selective lesions of ICMs and the pharmacological inhibition of BLA inputs to ICMs promote freezing and impair extinction (Jüngling et al. 2008; Likhtik et al. 2008). BNST has been traditionally implicated in the acquisition and expression of conditioned fear to contexts but not to discrete CSs. However, more recent reports extend this view proposing that BNST may be crucial to modulate conditioned fear towards threatening stimuli (discrete CSs included) that imprecisely predict (temporally-wise) when the aversive outcome will occur (Goode and Maren 2017; Goode et al. 2019b; Goode et al. 2019a; Gungor and Pare 2016; Lebow and Chen 2016; Shackman and Fox 2016).

In conclusion, lesion and inactivation of AMG experiments have produced a mixed and sometimes conflicting literature. An exhaustive review would be beyond the scope of the present dissertation (for more details see Duvarci and Pare 2014; Pape and Pare 2010). However, converging evidence accumulated over the past three decades shows that:

1. damage to LA, BA, CeA, and BMA affect the acquisition and expression of both auditory and contextual fear conditioning (Amano et al. 2011; Anglada-Figueroa and Quirk 2005; Goosens and Maren 2001; Nader et al. 2001; Wilensky et al. 2006);
2. inactivation of BA and BMA also impairs extinction (Amano et al. 2011; Herry et al. 2008; Livneh and Paz 2012b; Sierra-Mercado et al. 2011)
3. ICMs and BNST play major roles at least in modulating the fear response (Goode and Maren 2017; Likhtik et al. 2008).

Different approaches aimed at studying the neurophysiology of these circuits helped better define the respective and mutual contributions of the various AMG subdivisions during fear learning and expression (see 4.1).

2.2 The Hippocampus

Another brain structure that early on was shown to be necessary for conditioned and unconditioned fear is the hippocampus. Similarly to AMG lesions, the Blanchard lab observed that HPC damage induces a reduction of freezing

towards the fear conditioning context and also to the presence of a cat (Blanchard and Blanchard 1972b; Blanchard et al. 1977; Blanchard et al. 1970).

The HPC plays a critical role in contextual processing (Maren et al. 2013; Anagnostaras et al. 2001; Rudy 2009) and many studies found that damage or temporary pharmacological inactivation of the HPC cause deficits in acquisition of contextual fear but not cued fear (e.g., Esclassan et al. 2009; Kim and Fanselow 1992; Maren and Holt 2004; Phillips and LeDoux 1992; Selden et al. 1991; Sutherland and McDonald 1990; Zhang et al. 2014). These results suggested that the HPC might be particularly implicated in the encoding of context but not of the CS-US association, which may rely solely on AMG circuitry (Fanselow 2000). This view is consistent with decades of research that have detailed how the HPC is particularly implicated in the encoding of spatial context and spatial memory (Jeffery 2017). Spatial tasks (like Tolman's experiments described in 1.5) are widely used to test learning in rodents, and a vast literature shows that the hippocampus (but not the amygdala or other subcortical structures) is necessary for good performance in a number of memory tasks including spatial navigation (e.g., the radial maze, Morris watermaze, etc.; Jarrard 1995; Morris et al. 1982). Therefore, the evidence that HPC lesions impair contextual fear memories is consistent with the fact that the HPC controls spatial cognition (see also 4.2.1).

2.2.1 Hippocampal and Para-Hippocampal Region Anatomy

The HPC is part of a more extensive network of brain regions that together form what is called the hippocampal formation (HF). The HF of rodents is a C-shaped structure bilaterally located right under the cortical lobes of the hemispheres in the caudal part of the brain (Figure 2.3, Van Strien et al. 2009; Witter et al. 1989). The HF has a long curved form in all mammals in a septo-temporal axis (dorso-ventral in rodents corresponding to posterior-anterior in primates). The HF basic circuitry is preserved along the septo-temporal axis and across species. While most of the literature makes a binary distinction between dorsal and ventral HPC (dHPC and vHPC), there is no abrupt transition between HPC portions but rather a continuum across different dorsoventral positions of the HPC circuitry (Strange et al. 2014).

The HF is composed of three distinct regions, the hippocampus proper, the *dentate gyrus* (DG), and the *subiculum* (Sub), all characterized by a laminar organization of three/four layers which is named *archicortex* as opposed to *neocortex* that is formed by five or six layers. The HPC proper and the DG are typically together referred to as the hippocampus; moreover, some authors also include the Sub in the definition of HPC. The HPC proper has three subdivisions in rodents and four in primates: CA1, CA2, CA3, and CA4² (CA stands for *cornu ammonis*; Lorente de N6 1934). In the cornu Ammonis

²Also called *hilus* or hilar region if considered as a part of the dentate gyrus.

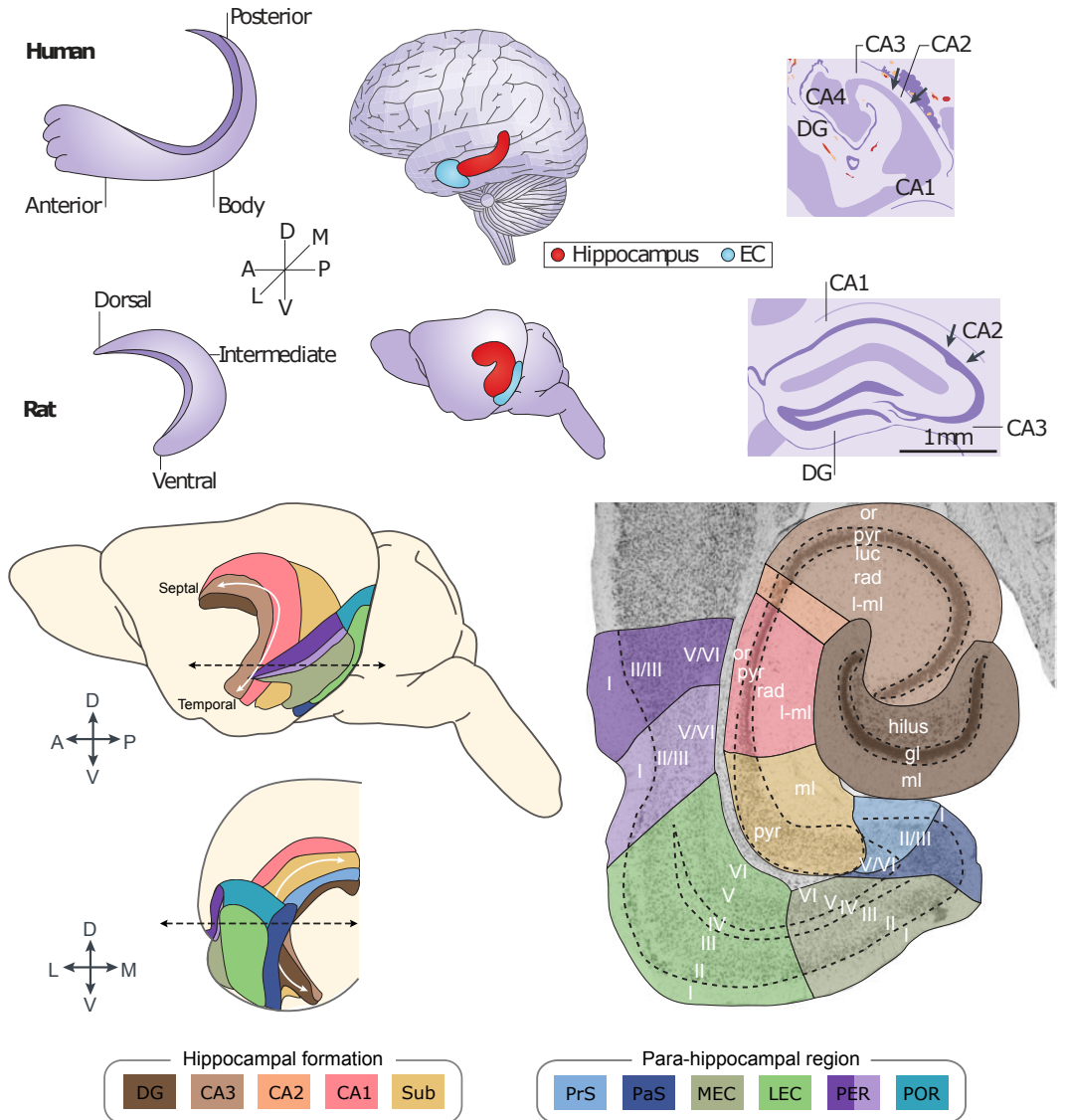

Figure 2.3: The hippocampal formation and the parahippocampal region in the rat brain. Top, comparison between human and rat hippocampal anatomy. The longitudinal axis is described as ventrodorsal in rodents and anteroposterior in primates. [continued on the following page]

Figure 2.3: [continued from previous page] Bottom-left, lateral (top) and caudal (right) views of the hippocampal formation (HF) and para-hippocampal region (PRH). The HF, composed of dentate gyrus (DG), the cornu Ammonis fields (CA1-3) and the subiculum (Sub), is embedded in a broader network of structures: the PRH. The PRH includes the presubiculum (PrS), the parasubiculum (PaS), the medial and lateral parts of the entorhinal cortex (MEC, LEC), the perirhinal cortex (PER) and the postrhinal cortex (POR). A, anterior; P, posterior; D, dorsal; V, ventral; L, lateral; M, medial. Bottom-right, horizontal section of the brain indicated by the dashed lines of the left panels. The HF has a trilaminar profil ('archicortex'), whereas the PRH is generally described as a six-layered structure. Abbreviations: or, stratum oriens; pyr, stratum pyramidale; luc, stratum lucidum; rad, stratum radiatum; l-ml, stratum lacunosum-moleculare; gl, granular layer; ml, stratum moleculare. The Roman numerals indicate cortical layers. Axes: A, anterior; D, dorsal; L, lateral; M, medial; P, posterior; V, ventral (adapted from Strange et al. 2014, Van Strien et al. 2009, and Amaral et al. 2007).

(CA) fields, the principal projecting neurons are pyramidal cells with their somæ gathered together in the *stratum pyramidale*. The basal dendrites and axons of pyramidal cells project towards the *stratum oriens* which contains a mixture of afferent and efferent fibers. Apical dendrites extend through the *stratum radiatum*, and the tufts of the apical dendrites are located in the most superficial layer, the *stratum lacunosum-moleculare*.

The principal cells of the DG are granule cells aligned in the granule layer and whose dendrites extend through the stratum moleculare. The third layer of the DG is called the hilus. This polymorphic layer contains both sparse excitatory cells, the mossy cells, and various interneurons (Amaral et al. 1990). The subiculum is the direct continuation of the CA1 field (Matsumoto et al. 2019). The border between the Sub and CA1 is marked by 1) an abrupt increase of both the thickness and density of cells of the pyramidal layer (which becomes gradually less abrupt along the dorso-ventral axis of HPC), 2) the absence of the stratum oriens, and 3) the replacement of the stratum radiatum and lacunosum-moleculare with the molecular layer.

Some neocortical regions are in direct continuity with the HF and form the parahippocampal region (Van Strien et al. 2009):

- The *pre-* and *parasubiculum* (PrS and PaS) unfold from the subiculum and have no clear laminar profiles. Their layers can be roughly divided into deep (V/VI) and superficial (I and II/III) layers, both of which contain principal cells and interneurons.
- The *entorhinal cortex* displays a clear six-layered organization (neocortex). It is further subdivided into its medial and lateral parts, medial entorhinal cortex (MEC) and LEC, respectively, that have different input and output patterns (described below).
- The *perirhinal* and *postrhinal* cortices (PeR and PoR) are characterized by the lack of a distinct layer IV.

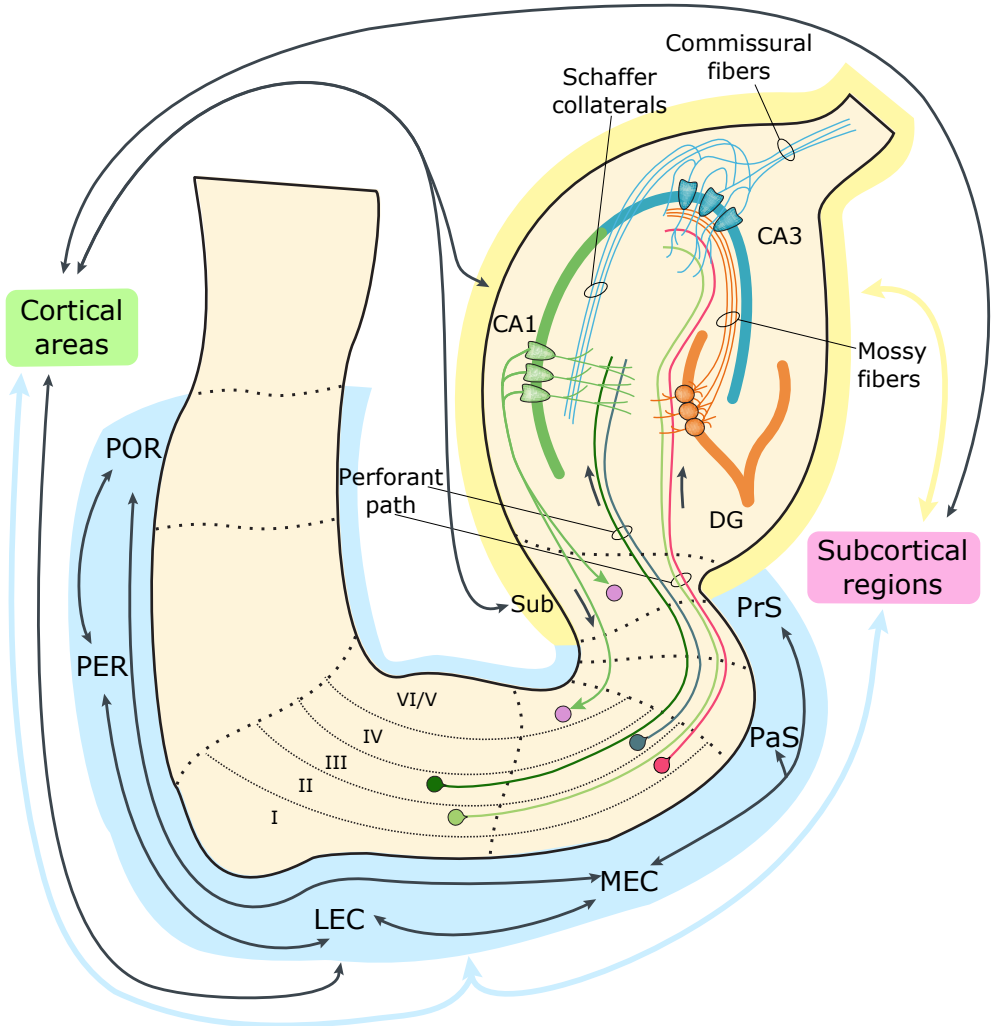

Figure 2.4: Simplified schema of the hippocampal formation and parahippocampal region connectivity. Please note that CA2 is not represented in this horizontal section. Cells from layer II of the medial and lateral entorhinal cortex (light green and red) send axons to the dentate gyrus and CA3, while the perforant path to CA1 originates from layer III entorhinal projections (dark green and dark blue). The dentate gyrus connects to CA3 through the mossy fibers. CA3 sends projections to the ipsilateral CA1 pyramidal cells as well as contralateral CA3 and CA1 via the hippocampal commissure. Note the recurrent collaterals in the CA3 region. [continued on the following page]

Figure 2.4: [continued from previous page] The primary output projections of the hippocampus originate from CA1 and target both the subicular pyramidal cells and cells localized in the deep layers of the entorhinal cortex (pink circles). The hippocampal formation (dentate gyrus, cornu Ammonis fields, subiculum; yellow area) is highly connected to structures of the parahippocampal region (presubiculum, parasubiculum, entorhinal cortex medial and lateral, perirhinal cortex and postrhinal cortex; blue area). Dense reciprocal connections also exist between the parahippocampal structures. The hippocampal formation is linked to both cortical and subcortical areas (yellow arrow), both monosynaptically and through synaptic relays such as the entorhinal cortex or subcortical regions. CA1-3, cornu ammonis 1-3; DG, dentate gyrus; Sub, subiculum; PrS, pre-subiculum; PaS, para-subiculum; MEC, medial entorhinal cortex; lateral entorhinal cortex (LEC), lateral entorhinal cortex; PER, perirhinal cortex; POR, postrhinal cortex. The Roman numerals indicate cortical layers. Arrows indicate the direction of projections. Adapted from Maingret (2016) and Drieu (2017).

Hippocampal and Parahippocampal Connectivity

A simplified schema of the HF intrinsic circuitry is the tri-synaptic loop (described in Figure 2.4, Andersen et al. 2006; Van Strien et al. 2009; Witter et al. 1989). The connection of the HPC with the rest of the brain is then mainly mediated by the structures of the parahippocampal region, although direct projections originating from the HF also exist. The entorhinal cortex (EC) is the principal ‘input gate’ of the HPC, for subcortical and cortical inputs, while both the EC and the Sub are the two main output hubs of the HF (Figure 2.4). The various structures of the hippocampal and parahippocampal region are connected in a topographically conserved manner. Along its temporal-septal axis each slice of the region represents an anatomical module with cross-sectional connectivity as depicted in Figure 2.4. Through this polarized connectivity, the HF and the parahippocampal region are bidirectionally linked with almost any structure of the brain (Furtak et al. 2007; Kerr et al. 2007; Witter et al. 1989).

The lateral and medial subdivisions of the EC receive different sets of inputs. LEC afferents equally originate from cortical, subcortical, and hippocampal regions whereas the MEC receives a substantially greater amount of inputs from hippocampal and parahippocampal structures than from cortical or subcortical regions. Moreover, piriform and insular cortices target the LEC heavily, whereas the visual, posterior parietal, and retrosplenial cortices preferentially connect to the MEC. Regarding subcortical connections, inputs from the amygdala and olfactory structures preferentially target the LEC, whereas the MEC is targeted by the dorsal thalamus (which relays mostly visual information as opposed to amygdala and olfactory cortex relaying ‘non-spatial’ inputs). These substantial differences in the cortical, subcortical, and hippocampal connections of the EC support a primary functional role of the MEC and the LEC in processing spatial and non-spatial information respectively. In parallel, strong reciprocal connections between these two areas can combine spatial and non-

spatial information before sending them to the HF, which thus receives highly processed, multimodal sensory information (Knierim et al. 2014).

HPC Monosynaptic Connections While the bulk of information from extra-hippocampal regions arrives to the HPC via the EC, the HPC also receives various direct projections. Indeed, long-range GABAergic and cholinergic afferents from the medial septum directly project to the DG and all CA fields. Together with heavy projections from the supramammillary nuclei mostly to CA2 as well as weak projections to the DG and CA3 areas, these connections play an essential role in the generation of the theta rhythm (see 3.3.2). Neuromodulatory inputs, primarily originating from the locus coeruleus (noradrenergic and dopaminergic), the raphe nucleus (serotonergic), and the ventral tegmental area (dopaminergic) target all of the hippocampal subfields (Kempadoo et al. 2016; Takeuchi et al. 2016). Besides neuromodulatory connections, bidirectional direct projections from the nucleus reuniens of the thalamus are sent to CA1, and axons from the paraventricular nucleus of the hypothalamus reach all the hippocampal fields, with a higher density in CA2 (Zhang et al. 2013). However, the ventral hippocampus (vHPC) has a more dense connectivity with the endocrine and autonomic nuclei of the hypothalamus than does the dorsal hippocampus (dHPC), and plays a selective role in the endocrine stress response (Henke 1990; Risold and Swanson 1996). Moreover, a unidirectional monosynaptic pathway travels from the subiculum and CA1 to the nucleus accumbens, and the subiculum also projects to the dorsal part of the striatum.

Regarding the monosynaptic efferent projections of the HPC, an interesting study reveals an extensive network of cortical areas targeted by the hippocampal CA1 field (Cenquizca and Swanson 2007). Three bundles of projections arise from CA1: 1) from the dorsal CA1 to the retrosplenial cortex, 2) from the ventral CA1 to primary sensorial, visceral, agranular insular and orbital areas, and 3) from the longitudinal extent of field CA1 through the fornix to the prefrontal, orbital, and olfactory areas.

HPC-AMG Connectivity Substantial reciprocal connections also exist between the amygdalar complex and temporal (ventral) CA1, CA3, and Sub (McDonald and Mott 2017; Felix-Ortiz and Tye 2014; Felix-Ortiz et al. 2013; Pitkänen et al. 2000; Xu et al. 2016; Yang et al. 2016; Yang and Wang 2017; Canteras and Swanson 1992; Van Groen and Wyss 1990). The principal projections from the AMG towards the HF and PRH originate in the LA, BLA, BMA, and CoA, and target ventral CA1, CA3, Sub, PaSub and their topographically equivalent parts of PeR and PoR. In particular: 1) only BLA targets CA3, 2) CA1 and Sub receive the majority of inputs from the BMA and BLA, and 3) LA targets mostly the EC, PeR, PoR, and PaSub. The BLA innervates the strata radiata and oriens of the CA1 and CA3 while BMA projects to the stratum lacunosum moleculare of CA1 (Pikkarainen et al. 1999). There are

no reports of AMG terminals in the dHPC and associated parahippocampal cortices. Accordingly, the biggest hippocampal inputs to the AMG originate in the ventral CA1 and Sub and the topographically equivalent parts of EC and PeR. These axons target mostly the LA, BLA, BMA, CeA, MeA, ICMs, BNST, and a nucleus of the cortical amygdala called amygdalohippocampal area (Hübner et al. 2014). Crucially, these projections are not uniform, and there is a dorsoventral gradient of the density of AMG projecting neurons in CA1 and Sub such that the most ventral part of the HPC projects heavily to the AMG, the intermediate HPC less, while the dHPC sends none at all (Kishi et al. 2006). Moreover, the septo-temporal position of projecting neurons determines a mediolateral gradient of their terminals in the AMG nuclei: most temporal regions of the HPC target preferentially to the medial regions of the AMG such as MeA, ICMs, and BMA while progressively more intermediate portions of the HPC project to more lateral regions such as BLA and LA.

The HPC connectivity with the nucleus accumbens (Groenewegen et al. 1987), the lateral septum (Risold and Swanson 1996), and the neocortex (Jones and Witter 2007) also follows a topographical pattern from the hippocampal region dorsoventral axis, suggesting a functional role of the graduality of these projections. As the differences in connectivity along HPC dorsoventral axis follow a gradient and are not abrupt (Amaral and Witter 1989), also functional variations seem to be gradual (e.g., Kheirbek et al. 2013; Kjelstrup et al. 2008, cf. 4.2).

2.2.2 Hippocampus and Fear Memory

HPC lesions have specific effects on fear memory depending on when they occur compared to training. This suggests that, differently from the AMG, the HPC is not necessary to drive the behavior per se. Moreover, damage to the dHPC does not affect cued fear suggesting that the HPC may be critically involved in the processing necessary for contextual fear but that unimodal auditory cued fear can develop in its absence.

Dorsal Hippocampus Role in Contextual Fear Acquisition

When dHPC is lesioned or inactivated prior to training, the level of deficits in contextual fear learning acquisition can be variable (Broadbent and Clark 2013; Cho et al. 1998; Gisquet-Verrier et al. 1999; Kim et al. 1993; Maren and Holt 2004; Matus-Amat et al. 2004; Phillips and LeDoux 1992; Phillips and LeDoux 1994; Biedenkapp and Rudy 2009; Maren et al. 1997; Frankland et al. 1998). Lesions of CA1 and DG, but not CA3, seem to be responsible for these deficits (Hunsaker and Kesner 2008; Lee and Kesner 2004). The training parameters seem to be relevant for whether dHPC damage may cause

an acquisition deficit or not, as animals with extensive training do not show the deficits displayed by those that received a fewer number of conditioning trials (Wiltgen et al. 2006). The dHPC is therefore crucial for efficient contextual fear learning and if it is damaged shortly after learning the memory is lost, however other structures (such as the mPFC) may be able to compensate for its absence when it is damaged prior to learning (Fanselow 2010; Rozeske et al. 2015), although less efficiently.

As discussed in 1.7.2, a minimal period of exposure to a given context is necessary for the animals to acquire contextual fear (Fanselow 1986; Kiernan and Cranney 1992; Westbrook et al. 1994; Wiltgen et al. 2006) presumably because animals need to form a representation of the context before being able to associate an aversive event to it. The dHPC may be critically involved in this initial contextual encoding rather than in the associative process linking the context to the US. Indeed, pre-exposure to the context before conditioning prevents dHPC lesion-induced anterograde or retrograde amnesia (Young et al. 1994b), suggesting that the pre-exposure allows to form a representation of the context. Accordingly, dHPC inactivation or damage during the pre-exposure disrupts this effect (Matus-Amat et al. 2004; Rudy et al. 2002). Furthermore, fear reinstatement after extinction (which is thought to rely on contextual information, see 1.6), is disrupted by dHPC damage (Frohardt et al. 2000; Wilson et al. 1995). Finally, while pre-training dHPC damage does not reliably affect contextual conditioning acquisition, it abolishes context discrimination and the animals are not able to distinguish between shock and no-shock contexts (Frankland et al. 1998). Taken together, these results support the view that the HPC is crucial to encode the contextual information necessary to support context-dependent fear behavior (Maren et al. 2013).

Temporally Graded Role of the Dorsal Hippocampus in Contextual Fear Memory

The reduction of fear expression after post-conditioning HPC damage is highly dependent on the timing of the lesion. Kim and Fanselow (1992) provided a famous example of memory transfer during consolidation (i.e. system consolidation, cf. 3.2.2). They performed HPC lesions either 1, 7, 14 or 28 days after contextual fear conditioning. Contextual fear recall was drastically impaired in rats that received lesions 1 day after training (Figure 2.5). Interestingly, increasing the number of days between conditioning and surgery led to higher recall performance, with lesioned animals exhibiting the same amount of freezing as the control group when the HPC was lesioned 28 days after learning (Figure 2.5). These observations were replicated with lesions up to 100 days after conditioning (Anagnostaras et al. 1999; Maren et al. 1997). The observation that recent memories are more sensitive to HPC damage than remote ones (i.e., temporally graded amnesia) suggests that HPC is crucial for the consolidation of these memories and that during consolidation the memory traces may be transferred to other brain structures.

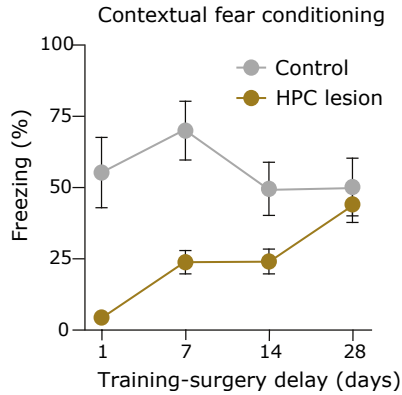

Figure 2.5: Temporally graded amnesia for contextual fear. Hippocampal lesions were made either 1, 7, 14, or 28 days after training. Remote, but not recent memories are spared by the lesions (Panel adapted from Kim and Davis 1992).

Dorsal Hippocampus and Contextual Fear Memory Consolidation Critically, contextual fear memories acquired without the dHPC fail to consolidate, and get degraded beyond one month after training (Zelikowsky et al. 2012). Moreover, chemogenetic chronic suppression of neuronal activity in dorsal CA1 after contextual fear conditioning impairs memory consolidation (Vetere et al. 2017). Therefore, the dHPC is necessary for the long term consolidation of those memories (Zelikowsky et al. 2012).

Ventral Hippocampus Participates in Fear Learning and Behavior Beyond Context Encoding

While damage to the dHPC tends to spare cued fear conditioning, lesions of the vHPC or vSub induce deficits in the acquisition of both contextual and cued fear conditioning (Bannerman et al. 1999; Esclassan et al. 2009; Hunsaker and Kesner 2008; Maren 1999b; Maren and Holt 2004; Maren et al. 1997; Richmond et al. 1999; Rogers et al. 2006; Rudy and Matus-Amat 2005; Yoon and Otto 2007; Wang et al. 2013). However, in some cases temporary inactivation of the vHPC disrupts only contextual but not cued fear conditioning (Bast et al. 2001; Zhang et al. 2014) or does not disrupt any fear memory acquisition (Biedenkapp and Rudy 2009). Similar to the case of dHPC, it has been argued that the intensity of training may affect whether compensating structures may help form the association in the absence of the vHPC (Zhang et al. 2014). As the HPC is composed of different fields, with different connectivity and physiology, it is likely that they contribute differentially to fear learning. Indeed, one study showed that ventral CA3, but not CA1,

lesions impair cued fear acquisition, while both ventral CA1 and CA3 may be implicated in context fear acquisition (Hunsaker and Kesner 2008).

Beyond learned fear, lesions of the vHPC, but not dHPC, impair unconditioned fear to innately aversive stimuli (freezing to cat odor, presence of a cat, and after a footshock, Pentkowski et al. 2006) and avoidance from an aversive probe (McEown and Treit 2010). Moreover, in contrast with dHPC, vHPC damage and inactivation induce anxiolytic effects in tests of innate fear such as the elevated plus maze test (Bannerman et al. 2002; Bannerman et al. 2004; Bertoglio et al. 2006; Kjelstrup et al. 2002; Moser et al. 1995). Therefore, it seems that the vHPC but not dHPC may be implicated in fear behavior regulation. Overall, both learned and innate fear results corroborate the hypothesis that vHPC and dHPC play different roles in fear learning and fear expression.

Ventral vs Dorsal Hippocampus: Mutual and Distinct Roles in Cognition

The different effects of damage to dHPC vs. vHPC is not limited to emotional learning. Early lesion studies showed that dorsal and ventral hippocampal lesions affected behavior differentially (Hughes 1965; Nadel 1968; Sinnamon et al. 1978; Stevens and Cowey 1973). Later studies (Moser et al. 1993; Moser et al. 1995) revealed that only lesions of dHPC and not vHPC compromised spatial learning. This evidence an earlier theory based on anatomical data (described above) positing that vHPC, and not the dHPC, specifically mediates emotional responses (Gray and McNaughton 1982). The observations about the differential functional spatial coding properties of dorsal and ventral HPC (Jung et al. 1994; Poucet et al. 1994, cf. 4.2) then strengthened the still dominating view that dHPC mediates more "cognitive" functions (and particularly spatial cognition) while vHPC is more involved in "emotional" responses (Bannerman et al. 2004; Fanselow and Dong 2010; Moser and Moser 1998; Strange et al. 2014; Tannenholz et al. 2014).

The dichotomy of the roles of dorsal and ventral HPC and para-HPC formation is also supported by differences in the distribution of neuromodulator receptors (Amaral and Kurz 1985; Gasbarri et al. 1994), physiological properties (Giocomo and Hasselmo 2009; Giocomo and Hasselmo 2008), behavioral correlates of neurons (see 4.2, Ciochi et al. 2015), and multiple dorsoventral gradients in the expression of many genes in the HPC (Thompson et al. 2008).

HPC Role in Fear Memory Retrieval

The HPC is not only involved in contextual fear memory encoding but also in its retrieval. The dHPC is not necessary for the retrieval of the contextual fear memory itself if it is given enough time to the memory trace to consolidate with a functional HPC (Kim and Fanselow 1992). In an elegant study, Goshen

et al. (2011) optogenetically inactivated dCA1 during contextual fear recall and showed impairments, even 30 days after conditioning. This contrast with lesion studies concluding that the hippocampus is not required for remote fear memory recall. Critically, this occurred only when hippocampal CA1 was inhibited during (or even halfway through) recall. This approach likely avoids the recruitment of compensating mechanisms that may arise following lesions. The dHPC is therefore continually required for contextual fear memory retrieval. The HPC may send essential contextual information to downstream structures implicated in fear expression and indeed optogenetically silencing vHPC projections to the BA (but not CeA) impairs the retrieval of contextual fear memory (Xu et al. 2016). This may be because of its role in identifying the environment, rather than in storing the memory trace. Consistent with this view, DG inhibition during retrieval induces contextual fear generalization (Kitamura et al. 2015).

HPC and the Context Dependency of Extinction Learning

HPC is also involved in encoding context-dependent fear extinction learning. Indeed, if the HPC is inactivated during extinction learning, rodents exhibit fear renewal regardless of testing context (Corcoran et al. 2005; Sierra-Mercado et al. 2011). However, the pharmacological inactivation of either the dHPC or vHPC during a fear renewal test abolishes the renewal of fear behavior outside the extinction context, suggesting that the HPC is necessary to express the context-dependency of extinction learning (Corcoran and Maren 2001; Hobin et al. 2006). Critically, while post-extinction dHPC lesion impairs fear renewal, pre-extinction lesioned animals exhibit context-dependent retrieval of extinction during fear renewal (Zelikowsky et al. 2012). This result suggests that, as for conditioning acquisition, during extinction learning other structures can compensate for contextual encoding in the absence of HPC. Indeed, if dHPC is lesioned together with the mPFC, both contextual fear recall and fear renewal are impaired (Zelikowsky et al. 2013). With a non-functional HPC animals are still able to discriminate contexts between each other (Holt and Maren 1999; Wang et al. 2009) and to recognize fear signals per se (Corcoran and Maren 2001). Therefore HPC may support fear renewal with a specific CS-context association (Maren et al. 2013). This information may be relayed from the HPC to downstream structures, and, indeed, the disconnection between the vHPC and BA or between the vHPC and the mPFC disrupts fear renewal (Orsini et al. 2011). More specifically, recent work using optogenetics showed that the vHPC→CeA pathway, but not vHPC→BA, is necessary for context-dependent fear renewal (Xu et al. 2016).

The role of Parahippocampal Cortical Areas

A popular theory about the mechanism of hippocampal encoding and recall proposes that entorhinal inputs relay information about the real-time state of the external world and drive encoding in CA1, while CA3 inputs convey information stored within CA3 recurrent network (Hasselmo et al. 2002). Therefore, inputs from the EC would be critical for context encoding and contextual fear acquisition. Indeed, damage to the entorhinal cortex yields contextual fear acquisition deficits mirroring those of the HPC itself (Ji and Maren 2008; Majchrzak et al. 2006; Maren and Fanselow 1997). Moreover, EC inhibition impairs contextual fear acquisition while its excitation facilitates memory retrieval (Kitamura et al. 2015).

Also lesions and inactivations of other parahippocampal cortices such as the perirhinal, postrhinal, postsubiculum and retrosplenial produce deficits in contextual fear memory retention (Burwell et al. 2004; Corcoran et al. 2011; Robinson and Bucci 2012). These cortical areas which the HPC is reciprocally connected with may be involved in maintaining a contextual representation in the absence of HPC (Maren et al. 2013).

2.3 The Medial Prefrontal Cortex

The prefrontal cortex (PFC) is the part of the neocortex that was partially damaged in Phineas Gage, the only part of the frontal lobes where lesions do not produce any sensory or motor deficit (Teuber 1964). Consistent with the standard theory of memory consolidation that posits that memory traces are gradually transferred to the cortex becoming independent from the HPC (see section 3.2.2), extensive literature suggests that the PFC plays a crucial role in remote memory recall. Indeed, early studies showed that post-conditioning lesions of the frontal lobes induced retrograde amnesia (Waterhouse 1957; Streb and Smith 1955; Maher and McIntire 1960). In an often cited experiment, Frankland et al. (2004) showed that the inactivation of the mPFC impairs contextual fear memory 15 and 30 days after training, but not 1 or 3 days after. While these results have been replicated for hippocampal-dependent memory such as spatial learning (Maviel et al. 2004; Teixeira et al. 2006), eyeblink trace conditioning (Takehara et al. 2003), contextual (Zelinski et al. 2010), and trace fear conditioning³ (Quinn et al. 2008), less consistent results have been obtained in cued fear conditioning (see 2.3.3).

³Trace fear conditioning is a specific type of cued fear conditioning where a time interval is introduced between the CS and US presentations.

2 Neuroanatomical Substrates of Fear Memory

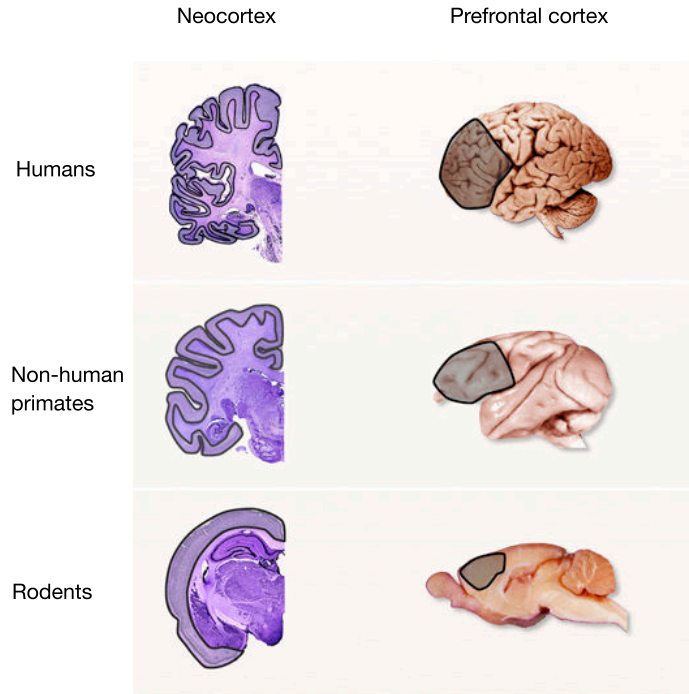

Figure 2.6: Prefrontal cortex comparison across mammals. Comparison of the relative dimension of the neocortex (left, regions enclosed by black trace) and prefrontal cortex (right, shaded areas) between humans, non-human primates, and rodents (adapted from Allen and Fortin 2013).

2.3.1 What is the (medial) Prefrontal Cortex?

While the AMG and HPC are highly conserved structures across mammals, the cerebral cortex is a more phylogenetically divergent one and the cortical volume, especially PFC volume, increased radically in the phylogenetic history of primates (figure 2.6). In humans, the prefrontal cortex is defined as the part of neocortex that lies rostral to (pre)motor areas and has a granular layer IV. The lack of this cytoarchitectural marker in rodents raised a debate about whether primates' prefrontal cortex has a homologous region in rodents' brain (Preuss 1995). However, it is now widely accepted that cytoarchitecture alone is not a good criterion to draw homologies among distant species and that the pattern of the specific connections between brain structures should be primarily taken into account. Across species, the PFC and its subdivisions are distinguished based on the existence and extent of topographical connections

with the mediodorsal thalamus (Heilbronner et al. 2016; Krettek and Price 1977; Leonard 1969; Uylings et al. 2003). Decades of research also confirmed many behavioral and cognitive homologies between rodents and primate PFC functions (Carlén 2017; Dalley et al. 2004; Eichenbaum 2017; Euston et al. 2012).

In rodents, the PFC can be divided into lateral, orbital (also called ventral), and medial PFC (Ongür and Price 2000, Figure 2.7). There is no consensus in the community about these divisions and the naming of the subdivisions of the PFC (Laubach et al. 2018). Here I mostly use the nomenclature proposed in the 2007 edition of the Paxinos and Watson rat brain atlas (Paxinos and Watson 2007)⁴. The main PFC region of interest for the current discussion is the medial prefrontal cortex (mPFC) and its anatomy and contributions to fear learning and behavior are detailed below. Beside that, note that the lateral PFC is mostly formed by the anterior subdivisions of the insular cortex (Gogolla 2017) while the orbitofrontal cortex (OFC) comprises, from more lateral to more medial subdivisions: the lateral orbital, ventral orbital, and medial orbital cortices (Figure 2.7). Some authors add two other regions to the list of those composing the PFC, indicated by Paxinos and Watson as frontal association cortex (FrA, also called frontal polar cortex) and the secondary motor cortex (M2), also called premotor cortex (preM). There is no consensus whether these premotor regions should be called dorsolateral PFC or be included in either the mPFC of lateral PFC. As there is no data available about the latter regions in the affective neuroscience rodent research we can consider them as not part of the limbic system and therefore exclude them from the mPFC (for clarity they are still indicated in Figure 2.7).

2.3.2 Anatomy and Connectivity of the Medial PFC

The mPFC differs from the lateral prefrontal cortex and the orbital prefrontal cortex because of its robust connectivity with the mediodorsal thalamus. Moreover, all mPFC regions, differently from lateral and orbital regions, are agranular cortices, meaning that they lack a clear granular layer IV. mPFC subdivisions present distinct laminar organizations and have been defined according to their specific cytoarchitecture. A widely accepted definition of medial PFC in rodents (Figure 2.7) includes the anterior cingulate cortex (ACC, Cingulate Cortex area 1, Cg1, for Paxinos and Watson) s

⁴Here I use the nomenclature from the 6th edition of the Paxinos and Watson atlas. However, starting from the 7th edition, the authors largely changed their nomenclature using terms based on Brodmann's numbers to better link rodent and primate research (Paxinos and Watson 2013; Vogt and Paxinos 2014). Here, consistently with the current naming found in the literature cited in this dissertation, we kept the classic rodent nomenclature. Moreover, it is worth noting that two different families of rodent atlases exist originating from either the Paxinos or Swanson's first rat atlases. The actual Allen mouse brain reference atlas (Dong 2008) is largely based on the Swanson (2004) rat atlas. Therefore, variations in rodent PFC nomenclature are frequently due to using either the Swanson or Paxinos atlases.

2 Neuroanatomical Substrates of Fear Memory

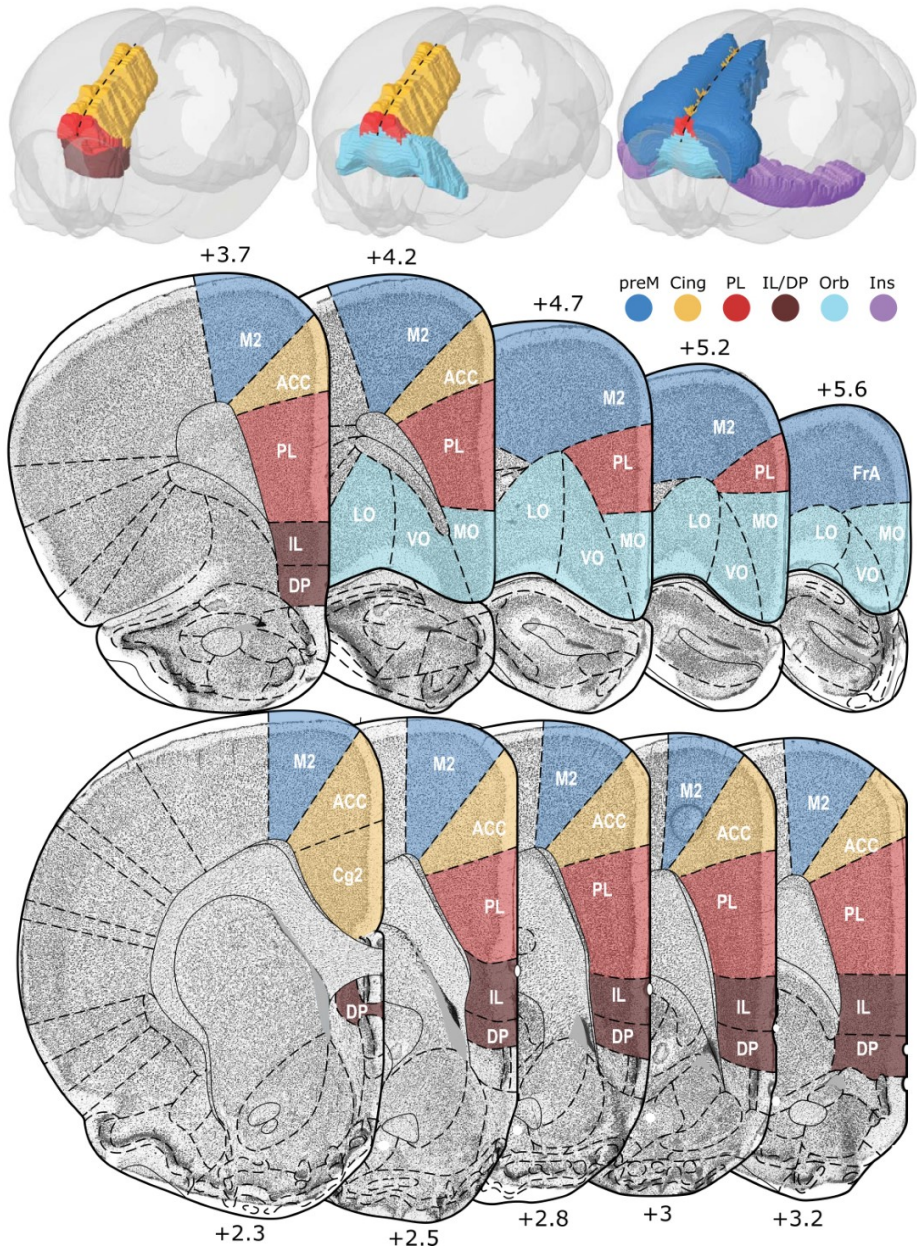

Figure 2.7: Anatomy of the rodent medial prefrontal cortex. Top, 3D reconstruction of the regions of the prefrontal cortex (right), same without premotor and insular areas (middle), and without premotor and orbital areas (left). Color codes: preM, premotor; Cing, cingulate; PL, prelimbic; IL/DP, infralimbic dorsal peduncular; Orb, orbital; Ins, insular (Adapted from Carlén 2017). [continued on the following page]

Figure 2.7: [continued from previous page] Bottom, stereotaxic diagrams of the regions of the medial PFC of the rat. Diagrams and histological pictures are from Paxinos and Watson (2007). Same color code as above. Numbers indicate the relative position of the slice from bregma in mm. Note that, in the strict sense of the term, the mPFC continues caudally until the end of the cingulate cortex. However, the posterior cingulate has a different extrinsic connectivity than its anterior part and is believed to be less implicated in emotional learning and regulation.

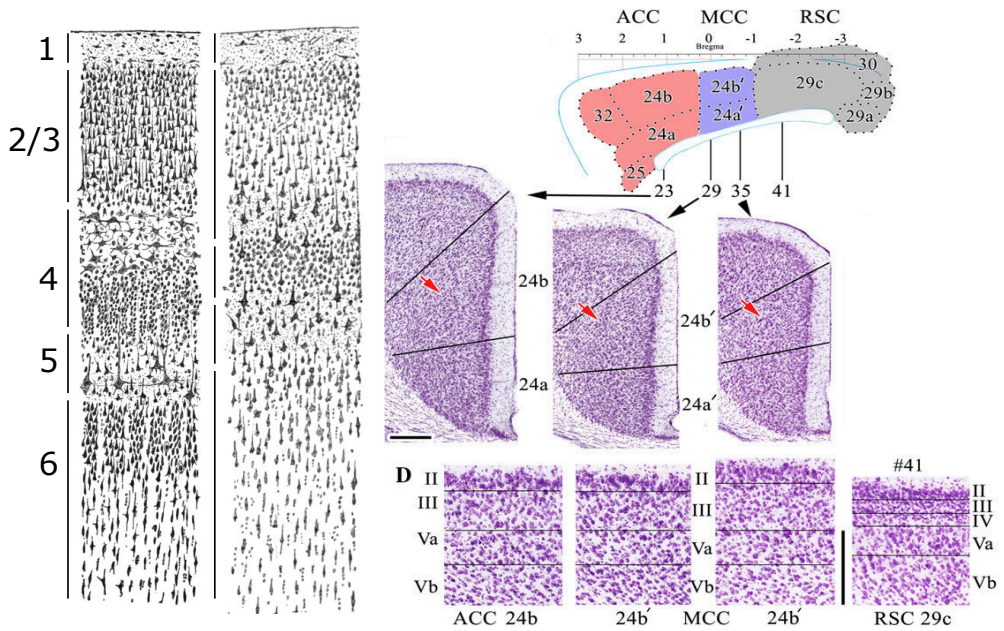

Figure 2.8: Medial prefrontal cortex cytoarchitecture. Left, Nissl staining of the visual (left) and motor (right) cortex in adult human (drawing from Ramón y Cajal 1899). Note the division between layers. Right, cytoarchitectonic organization of the cingulate cortex in the mouse. Note how in more anterior portions the differentiation between layer is less evident (panel from Vogt and Paxinos 2014)

, PLthe Prelimbic Cortex (PL, also called Cg3), and the infralimbic cortex (IL). Dorsal to the ACC there is the secondary motor cortex, also known as medial precentral cortex or second frontal area among other names, which, because of its many direct motor connections (Barthas and Kwan 2017), is sometimes excluded from the definition of mPFC (Laubach et al. 2018). Ventral to the IL lies the dorsal peduncular cortex (DP), which shares connectivity and functional features with the IL and therefore, when not ignored, is included in the mPFC (Akhter et al. 2014; Hajós et al. 1998; Heidbreder and Groenewegen 2003; Owens and Verberne 2001; Peyron et al. 1997; Riga et al. 2014). Finally, the medial part of the OFC, the medial orbital cortex (MO) is located ventrally to the most anterior part of PL and is sometimes incorporated in the definition of mPFC because of its similar connectivity with mPFC areas compared to the rest of the OFC (Hoover and Vertes, 2011). PL and IL are by far the most studied subdivisions of the rodent mPFC and are considered to be homologous to the primate anterior cingulate and ventromedial PFC, respectively (Kesner and Churchwell, 2011; Uylings and Eden, 1991).

Beyond the mPFC subdivision mainly based on cytoarchitectural differences, the mPFC is often divided according to functional and connectivity criteria into a dorsal part (dmPFC), including the ACC and the dorsal portion of PL, and a ventral part (vmPFC), including the ventral portion of PL, IL, DP, and sometimes medial orbital cortex (MO) (Heidbreder and Groenewegen 2003). Because of the connectivity differences between its dorsal and ventral portions PL does not seem to be an anatomically and functionally uniform region, complicating the interpretation of some report not differentiating between its dorsal and ventral part (see below).

mPFC Cytoarchitecture

As the other neocortical areas, the mPFC mostly contains two types of neurons: glutamatergic pyramidal projection neurons (PN) and GABAergic interneurons (IN) which represent respectively 80% and 20% of the cortical neural population (Defelipe et al. 1992; DeFelipe et al. 2013). Besides some exceptions, IN projections are local and do not leave cortical areas (Gonchar et al. 1995; Letinic et al. 2002; Rockland 2019). These neurons are arranged in a laminar organization in six layers parallel to the cortical surface that, although presenting variability across species, is roughly preserved across mammals (Douglas and Martin 2004; Kaas 2013; Silberberg et al. 2002). Based on cytoarchitectonic and extrinsic connectivity criterions from the most superficial to the deepest we find (Figure 2.8):

- **Layer I**, the ‘molecular layer’. As in other neocortical areas, it is thin with few neurons, but a large number of axons which extend parallel to the surface. It receives dendritic input from deeper layers.

- **Layer II**, the ‘external granular layer’. It is characterized by densely concentrated small-sized cell bodies.
- **Layer III**, the ‘external pyramidal layer’. Layers II and III support cortico-cortical connections and are often designated as layer II/III because of their unclear anatomical separation. They are characterized by a low density of PN that are oriented orthogonally relative to the brain surface.
- **Layer IV**, the ‘internal granular layer’. It receives, with layer I, thalamic inputs and presents a high density of small cell bodies.
- **Layer V**, the ‘internal pyramidal layer’. It is mostly composed of sparse and large projection PN radially oriented that are the main source of thalamic projections.
- **Layer VI**, the ‘polymorph layer’, contains a diverse neural population with various morphologies and orientations that project to subthalamic structures.

The mPFC of both mouse and rats is characterized by a more uniform distribution of neurons in all layers and therefore has a less clear laminar organization than other neocortical areas (Van De Werd et al. 2010; Vogt and Paxinos 2014).

mPFC Afferent and Efferent Connections

In addition to the thalamic connections defining its subdivisions, the mPFC is reciprocally connected with other subcortical structures including the AMG, the HPC, and the basal ganglia (Groenewegen et al. 1997). Bidirectional connections with neuromodulatory systems are an exclusivity of the prefrontal cortex relative to other neocortical areas: the mPFC is reciprocally connected with the locus coeruleus (noradrenaline, Jodo and Aston-Jones 1997), the raphe nuclei (serotonine, Hajós et al. 1998), the basal forebrain (acetylcholine, Chandler et al. 2013), and the ventral tegmental area (dopamine, Thierry et al. 1973; Carr and Sesack 2000). The mPFC also monosynaptically contacts the PAG (Vianna and Brandao 2003), the hypothalamus (Floyd et al. 2001), and the septum (Gaykema et al. 1991), and receives projections from other cortical areas including the EC and PeR, somatosensory and motor cortices (the latter projecting specifically to the dorsomedial prefrontal cortex (dmPFC); Courtin et al. 2013).

Heidbreder and Groenewegen (2003) showed that there are marked differences in the connectivity of the dmPFC (which, in their definition, includes the medial premotor areas, ACC, and the dorsal portion of PL) and ventromedial prefrontal cortex (vmPFC) (i.e. ventral part of PL, IL, and DP). The dmPFC is highly connected with sensorimotor and association neocortical areas, while the vmPFC virtually lacks such links but has extensive contacts with the amygdala and temporal, limbic association cortices. The vmPFC also projects to

2 Neuroanatomical Substrates of Fear Memory

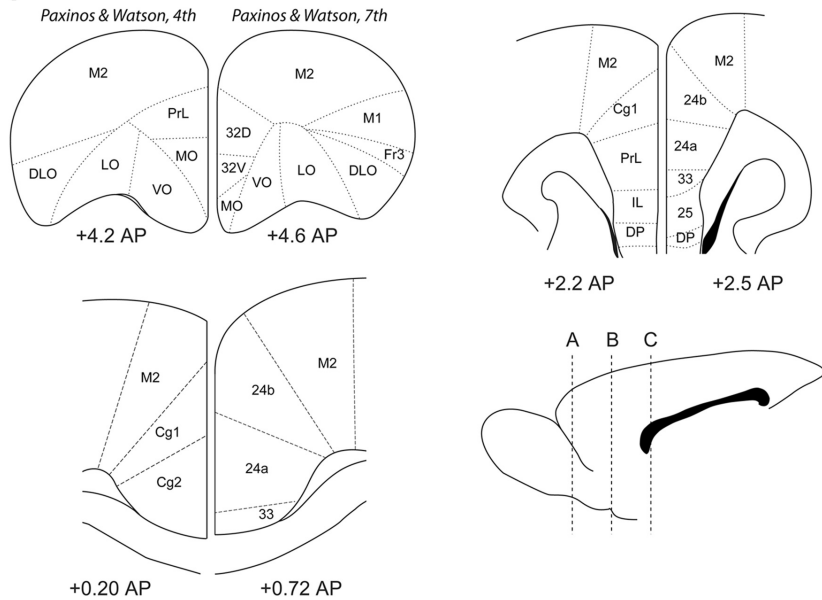

Figure 2.9: Anatomical terminology for rodent PFC areas. Comparison between the anatomical diagrams and nomenclature of the 4th (1998) and 7th (2014) editions of the Paxinos and Watson atlas. Note how the prelimbic cortex is divided into areas 24a and 33 (+2.5 AP), distinguishing its dorsal and ventral parts in the newer edition. These areas extend caudally including the previously called Cg2 (which was the non-anterior part of the cingulate cortex). Rostrally, what was defined PL is now called area 32D (D for dorsal) and the dorsal part of MO is is 32V (V for ventral, figure from Laubach et al. 2018).

the septum, and hypothalamic areas, while dmPFC axon terminals in these regions are sparse. Finally, projections to brainstem monoaminergic nuclei are more numerous from the vmPFC compared to dmPFC. Other studies compared the connectivity of PL and IL confirming that their projection patterns are very different except for their projections to the thalamus, olfactory areas, and entorhinal cortex (Vertes 2004; Vertes 2006). IL mostly targets areas implicated in visceromotor functions such as the hypothalamus (like its homolog orbitomedial PFC in primates) while PL projects to the striatum (homologously to dlPFC in primates). They also have different connectivity with the AMG (see below). The ambiguity about whether PL should be further subdivided into dorsal and ventral portions subsists (Laubach et al. 2018) and the new nomenclature implemented in the latest edition of the Paxinos and Watson atlas (2013) indeed indicates the dorsal and ventral PL as the Brodmann areas 24a and 33, respectively (Figure 2.9). Moreover, with the recent nomenclature, IL becomes Brodmann area 25 and ACC area 24b further sup-

porting the idea that the dorsal part of PL and ACC are functionally tightly associated.

Finally, the mPFC is also equipped with dense intrinsic connectivity, and its subdivisions make extensive contact amongst each other ipsilaterally (Vertes 2004). Indeed, bilateral excitatory projections between PL and IL exist, even though the neurons projecting from IL to PL are much sparser than in the other direction (Ji and Neugebauer 2012; Marek et al. 2018b).

mPFC-AMG Connectivity Both BLA and BMA send heavy projections mostly to PL and IL and, more sparsely, to ACC and MO (Hoover and Vertes 2007; Petrovich et al. 1996; Reppucci and Petrovich 2016; Mátyás et al. 2014). BLA neurons target mostly ACC, PL, and MO, while BMA cells send the majority of their mPFC-targeting axons to IL. Interestingly, like HPC-BA connections, mPFC-BA connectivity is also topographically organized. There is a rostrocaudal to dorsoventral topography in BA to mPFC connections such that posterior regions of the BA tend to target ventral mPFC subdivisions (ventral PL, IL, and possibly DP) while anterior regions target the dmPFC (Reppucci and Petrovich 2016). In contrast with BA, CeA does not project to mPFC (Hoover and Vertes 2007; Reppucci and Petrovich 2016).

Both dmPFC and vmPFC send projections to the BA, however dmPFC mostly projects to BLA rather than BMA while vmPFC essentially targets the BMA (Adhikari et al. 2015; Cassell and Wright 1986; Hurley et al. 1991; Takagishi and Chiba 1991; Vertes 2004). PL and IL also project to CeA (Vertes 2004) and MO sends axons to BMA, BLA and CeA (Hoover and Vertes 2011). Taken together, these reports point to the possible existence of a loop between the mPFC and BA. Indeed, among mPFC innervated PNs in BA, some project back to the mPFC (Hübner et al. 2014). Critically, these mPFC projecting cells also receive inputs from the vHPC, showing that there is a two-synapse pathway from the vHPC to mPFC via the BA.

mPFC-HPC Connectivity Beyond the one passing through BA, the mPFC and HPC are connected through multiple polysynaptic pathways. These include relays in the striatum, the ventral tegmental area, the entorhinal cortex, and the midline thalamus. The mid-dorsal thalamic nucleus reuniens (NR) is of notable interest as its cells have dense, bidirectional projections to the mPFC as well as to both dHPC and vHPC (Vertes 2006; Varela et al. 2014). Indeed, recent works indicate that the NR might play a critical role in relaying information between these structures (Salay et al. 2018; Ferraris et al. 2018; Griffin 2015; Xu and Südhof 2013; Hembrook et al. 2012; Ito et al. 2015a).

The HPC also has monosynaptic projections to mPFC. In the rat, these projections originate mostly from the ventral and intermediate portions of CA1 and Sub and reach IL, PL, and ACC (Padilla-Coreano et al. 2016; Spellman

et al. 2015; Ferino et al. 1987; Jay et al. 1989; Jay and Witter 1991; Cenquizca and Swanson 2007; Swanson 1981; Parent et al. 2009; Swanson and Cowan 1977; Gabbott et al. 2002; Verwer et al. 1997; Condé et al. 1995). While until recently it was thought that the dHPC did not project directly to the mPFC, more recently, it was shown that a small population of dHPC CA1 cells sends axons to the mPFC, although with smaller density than vHPC (DeNardo et al. 2015; Hoover and Vertes 2007; Xu and Südhof 2013; Ye et al. 2016). HPC-mPFC projections follow a dorso-ventral gradient with the ventral portions of HPC sending more projections to the mPFC than intermediate ones (Takita et al. 2013b). A gradient exists also within the mPFC as the vmPFC receives more HPC axon terminals than the dmPFC and while neurons targeting the vmPFC extend from the intermediate to the ventral portions of the vHPC, those projecting to the dmPFC tend to be concentrated in the most ventro-caudal portions of the HPC (Hoover and Vertes 2007; Marek et al. 2018a; Vasquez et al. 2019).

The pathway from the mPFC to HPC is also graded dorsoventrally and passes through the LEC, which is bidirectionally connected with the mPFC (Swanson and Kohler 1986; Chao et al. 2016). The cortical input to the EC is topographically organized with a continuous dorsolateral to ventromedial arrangement, and this topography is reflected in a smooth dorso-ventral gradient of EC projections to the HPC (Strange et al. 2014; Witter et al. 2000). The multisynaptic mPFC projections to the HPC also follow this scheme. For instance, axons originating from the ventral part of the rat cingulate cortex such as the ventral part of PL and IL target primarily ventral parts of the HPC via the ventromedial part of EC. On the other hand, neurons of the dorsal part of PL contact cells in the intermediate parts of the EC, which in turn projects to intermediate portions of the HPC. Finally, the most dorsal subdivisions of the cingulate cortex, such as the ACC and the retrosplenial, send the majority of their outputs to the dorsolateral part of the EC which targets the most dorsal part of the HPC (Jones and Witter 2007). Therefore, the HPC receives a continuum of inputs from cingulate areas. Cortical regions mostly involved in cognitive processes (such as spatial cognition for the retrosplenial cortex or contextual conditioning for the ACC, see below) are mostly connected with HPC dorsal part while areas involved in emotional regulation (e.g., IL) are mostly connected with the vHPC (Boccarda et al. 2010; Strange et al. 2014). Two recent studies also characterized very sparse monosynaptic connection from the dorsal ACC to the dHPC (Rajasetupathy et al. 2015) and vHPC (Bian et al. 2019).

2.3.3 mPFC in Fear Learning and Behavior

In addition to participating in storing long term memories, the mPFC has been implicated in a wide range of higher-order cognitive processes like attention, working memory, and, more broadly, executive functions (Euston et al. 2012;

Miller and Cohen 2001). Executive functions concerns cognitive abilities that allow animals to organize non-stereotyped, goal-directed behavior (Shallice 1982). Inhibitory control is an important component of executive functions (Dias et al. 1996): it inhibits responding when inappropriate and regulates fear via inhibition of fearful responses (Maren and Holt 2004). Because of the multiple roles played by the mPFC, studies probing its role in fear learning with lesions and inactivations have gathered somewhat conflicting results (see Courtin et al. 2013 and Rozeske et al. 2015 for extensive reviews). However, further examining these circuits with electrical and optogenetic stimulation has provided convincing convergent evidence that different subdivisions play separate roles in modulating fear learning and behavior.

mPFC Role in Fear Acquisition

Irreversible pharmacological blockade of mPFC activity during contextual fear memory acquisition does not affect conditioned freezing in a subsequent test (Xu et al. 2012). Accordingly, animals receiving lesions of the vmPFC (spanning ventral PL, MO, IL, and DP) before fear conditioning acquire conditioning to both context and auditory cues normally, but require more extensive training than controls to acquire cued fear extinction (Morgan et al. 1993). While these results may suggest that mPFC circuits may not be implicated in fear acquisition, transient optogenetic inhibition of principal excitatory neurons, but not of inhibitory interneurons, immediately before conditioning blocks all expression of conditioned responses to both cues and context 24h later (Yizhar et al. 2011). Therefore, permanent damages may induce compensatory mechanisms leading other structures to support learning. Conversely, the temporary inactivation results show that mPFC is normally required for fear learning.

Crucially, selective inactivations of the different mPFC subdivisions induce different effects. Pre-training inactivations of PL (Corcoran and Quirk 2007) or of ventral PL and IL (Lee and Choi 2012) alter fear expression on the following day, suggesting that either they are not required for fear acquisition or that partial inactivation of mPFC is not sufficient to impair fear learning. On the other hand, pre-training pharmacological inactivation or activation of ACC respectively reduce and increase cued conditioning acquisition (Bissière et al. 2008; Tang et al. 2005). Interestingly, both electrical and pharmacological stimulation of ACC (but not of non-prefrontal neocortical regions) can be effectively used as an US to induce fear memory with conditioned response (CR) to both an auditory cue and a context (Tang et al. 2005). While these results support the idea that ACC is important for aversive memory formation (Courtin et al. 2013), there are no reports of PL or IL stimulation as an US, and thus it remains unknown whether this effect is exclusive to ACC.

Fear Memory Consolidation and Remote Fear Memory are ACC Dependent

The ACC is also involved in contextual fear consolidation. The disruption of learning-induced dendritic spine growth during contextual fear memory consolidation impairs context-induced freezing on the following day (Vetere et al. 2011). Moreover, post-training inactivation of ACC, but not PL, impairs long-term but not recent contextual fear memory (Frankland et al. 2004; Sacchetti et al. 2003; Einarsson et al. 2015), suggesting that the ACC specifically supports remote contextual fear memory recall. Goshen and colleagues (2011) used halorhodopsin to inhibit glutamatergic cells in mouse ACC for 5 minutes during a contextual fear recall test, and showed that freezing was significantly reduced. Critically, ACC inhibition impaired contextual fear recall only for remote memories (28 days after conditioning) but not for recent ones (24 h old). While these results converge in a critical role of ACC in remote contextual fear memory recall, it is unknown whether ACC (and potentially PL and IL) activity influences the recall of remote cued fear memory as well.

dmPFC Role in Fear Expression

While inactivation of ACC during recent fear memory recall does not have any impact on behavior, inactivation of PL, but not IL, reduces conditioned fear expression to both cues and context (Frankland et al. 2004; Corcoran and Quirk 2007; Sierra-Mercado et al. 2011; Stevenson 2011; Laurent and Westbrook 2009). Furthermore PL electrical stimulation increases fear expression (Vidal-Gonzalez et al. 2006) and inhibiting PL pyramidal cells during the presentation of a previously fear-conditioned CS induces reduced freezing behavior (Do-Monte et al. 2015b). Moreover, as PL inactivation does not impair freezing to the presence of a cat (Corcoran and Quirk 2007), PL may be responsible for learned fear expression. This theory is further corroborated by the observation that PL inactivation during a context dependent fear renewal test (but not during extinction) abolishes fear renewal (Sharpe and Killcross 2015).

However, after extinction training has taken place, silencing all PL neurons during CS presentation does not reduce residual freezing (Kim et al. 2016). This result suggests that after extinction takes place, PL circuitry has less control over behavior than before, maybe because the residual fear is no longer the learned component or because IL activity has taken the lead over the executive control of defensive behavior.

While overall these results point to a role of PL activity in learned fear expression (cf. 4.3.1), pre- or post-conditioning electrolytical lesions of the dmPFC (dorsal PL and ACC) induce an increase of cued and contextual freezing behavior (Vouimba et al. 2000; Morgan and LeDoux 1995). One possible explanation

is that permanent damage to the dmPFC may induce other fear expression guiding structures typically controlled by dmPFC (e.g., CeA) to be overactive because of a lack of inhibitory control, and therefore lead to a global increase of fear behavior; transient inactivation would not be sufficient for this activity change in dmPFC controlled brain structures. Another explanation would be that lesion encompassing both PL and ACC induce mixed behavioral results (Courtin et al. 2013).

mPFC and Extinction Learning

During extinction training (for both cued and contextual fear), while PL inactivation only reduces online fear expression without having any impact of subsequent days' performance (Corcoran and Quirk 2007; Sierra-Mercado et al. 2011; Stevenson 2011; Laurent and Westbrook 2009), IL inactivation impairs extinction recall on the following day (Laurent and Westbrook 2009; Sierra-Mercado et al. 2011)⁵. Conversely, pharmacological activation of IL/DP with a GABA receptor antagonist during extinction learning accelerates extinction acquisition (Thompson et al. 2010; Chang and Maren 2011). These results suggest that the vmPFC supports extinction learning. Consistent with this, post-conditioning lesions and pharmacological inactivations of the vmPFC increase the duration of cued-evoked freezing episodes (Fryszak and Neafsey 1991) and enhance resistance to across-days extinction consolidation without affecting the within-training reduction of fear expression (Morrow et al. 1999; Morgan and LeDoux 1995; Morgan et al. 1993; Quirk et al. 2000; Tian et al. 2011; Lebrón et al. 2004)⁶.

To understand whether vmPFC activity is particularly critical for cued extinction during the processing of learned fear evoking stimuli, IL was electrically stimulated during CS presentation. These stimulations enhanced fear inhibition throughout extinction training and also yield better extinction retrieval the following day (Kim et al. 2010; Maroun et al. 2012; Milad and Quirk 2002; Milad et al. 2004; Vidal-Gonzalez et al. 2006). Critically, the behavioral effects were induced only when the stimulations were paired with the CS onsets, while stimulations delivered 1 s before or after the tone onset did not produce any behavioral change (Milad and Quirk 2002; Milad et al. 2004).

Electrical stimulation studies support the view that IL activity may underpin both fear inhibition and extinction learning, with the two processes likely overlapping and/or influencing each other. Optogenetic manipulations tested whether specific vmPFC neural populations are implicated in fear inhibition and extinction learning during CS presentations. Consistent with electrical

⁵Nonetheless, one study reports an enhancement of extinction recall Akirav et al. 2006).

⁶However, some reports did not find any effect of the lesion (Morgan et al. 2003; Gewirtz et al. 1997) and others showed that the within-session expression of conditioned fear is reduced when the inactivation even minimally entails PL (Sierra-Mercado et al. 2006; Resstel et al. 2006)

stimulation results, optogenetically stimulating IL pyramidal cells during CS presentations induced less freezing and better extinction recall the following day (Do-Monte et al. 2015a; Kim et al. 2016). However, while optogenetically silencing these cells after CS onset during extinction training reduces extinction retrieval the following day, no within-session changes in freezing levels are observed (Do-Monte et al. 2015a). Therefore the activity of IL principal cells is necessary for normal fear extinction learning. Moreover, activating these cells is sufficient to increase fear inhibition, but their activity is not necessary for the fear inhibition levels normally expressed during extinction training.

One possible explanation for the inconsistent effects on fear expression of the excitation vs. inhibition of IL principal cells is that IL projection cells support extinction memory, and are strongly connected to downstream neural populations mediating fear inhibition. Therefore, transitory excitation of IL projecting neurons would be sufficient to trigger downstream mechanisms controlling fear expression while their transient inhibition would not affect connected circuitry. Consistent with this hypothesis, longer inhibition periods (for 7 min) silencing all IL cells at CS presentation during extinction recall induced increased freezing (Kim et al. 2016). However, even this temporally and anatomically broad inhibition does not affect behavior when applied outside CS presentation or before extinction learning takes place (Kim et al., 2016). This further supports the notion that IL circuitry underpins cued extinction memory. Accordingly, photo-activation of IL does not affect the expression of contextual fear even after cued fear has undergone extinction (Kim et al. 2016).

Overall, these results point toward a role of IL, or more generally vmPFC, in extinction learning. Indeed, IL inhibition in rats that already underwent extinction learning does not induce fear expression differences compared to controls but still affects extinction recall on the following day (Laurent and Westbrook 2009), showing that IL is not necessary for extinction recall but rather for extinction memory consolidation.

mPFC role in Fear Generalization

Extensive pre-conditioning lesions of the mPFC induce conditioned freezing that is similar in the conditioning context and another one (Antoniadis and McDonald 2006). This suggests that mPFC activity supports discrimination between contexts or that it inhibits fear generalization. Accordingly, mice that received transient mPFC-wide inhibition froze normally to the conditioning context but generalized their freezing also to a different unconditioned one (Xu et al. 2012). This impairment was later shown to be specifically dependent upon the pathway connecting the mPFC and the nucleus reuniens of the thalamus (Xu and Südhof 2013). Furthermore, mice did not display altered freezing towards a phasic CS different from the one used during conditioning

(Xu and Südhof 2013), showing that the mPFC-reuniens network is specifically involved in context, but not cue, discrimination. Critically, this impairment disappeared if the inhibition was performed after conditioning, showing that mPFC-reuniens communication is necessary for the encoding of contextual fear (cf. 2.4.1). Even though these results show that mPFC is not necessary for correct discrimination of phasic cues, neural correlates of auditory CS discrimination has been described in the mPFC (cf. 4.3.1).

Contextual fear memory become less specific over time and fear generalization to unconditioned contexts increases (Wiltgen and Tanaka 2013; Jasnow et al. 2012). Time-dependent context generalization seems to be particularly dependent upon the ACC and the vHPC as their inactivation (but not dHPC inactivation) prevents generalization (Cullen et al. 2015; Bian et al. 2019) and their activation promotes it (Bian et al. 2019). Crucially, silencing the activity of ACC fibers projecting to the vHPC inhibits contextual fear generalization of remote fear memory (Bian et al. 2019), suggesting that during remote fear recall the ACC may be involved in the reactivation of representations in the HPC supporting contextual generalization. Contextual fear generalization to a novel context also appears to be regulated by the ACC and vHPC neurons projecting to the bICA. Critically, silencing these pathway reduce fear generalization but has no effect on fear to the conditioning context (Ortiz et al. 2019). However, dmPFC neurons activated during contextual fear discrimination (see 4.3.1) preferentially project to the PAG rather than projecting to the AMG. Furthermore, these PAG-projecting mPFC cells are critically involved in fear regulation as their stimulation controls fear expression (Rozeske et al. 2018).

Distinct Roles of mPFC Subdivisions in Fear Learning and Behavior

Taken together, these results suggest that different mPFC subdivisions play distinct roles in fear learning, with ACC, PL, and IL being important respectively for conditioning acquisition (both cued and contextual), fear expression, and extinction learning consolidation. The ACC was moreover shown to be important for remote fear memory retrieval. However, the current state of the literature does not rule out the hypothesis that also other mPFC subdivisions are involved in remote fear memory recall. It is important to note that several works did not find any effect of mPFC lesion on fear behavior (Holson 1986; Rosen et al. 1992; Gewirtz et al. 1997; Farinelli et al. 2006; Garcia et al. 2006). The inconsistency of these results has been explained by different factors such as the strain of the animals (Chang and Maren 2010), sex differences (Baran et al. 2010), and the precise location, timing and nature of the lesion compared to learning (Courtin et al. 2013). Overall, however, the results obtained with local and reversible pharmacological and optogenetic stimulations or inactivations have yielded more consistent results (Courtin et al. 2013).

While the current prominent model of mPFC operation in fear behavior (Quirk

and Mueller 2008; Sotres-Bayon and Quirk 2010) proposes that dorsal and ventral mPFC subdivisions play distinct roles, it is important to note that mPFC subdivisions also mutually contribute to fear learning and fear behavior regulation. Indeed, while PL and IL can compensate for dHPC lesions and support contextual fear and context-dependent fear renewal, if they are disconnected by ipsilateral lesion of both PL and IL contextual fear and fear renewal are impaired (Zelikowsky et al. 2013). This result suggests that while playing separate function dorsal and ventral mPFC need to work in concert to sustain fear learning and behavior. Two-way communication between dorsal and ventral portions of the mPFC is potentially an important factor in regulating their balance of activity and therefore in modulating fear behavior and possibly fear learning. Similar to what was shown probing directly IL, optogenetic stimulation of PL axon terminals in IL enhances extinction learning, while inhibiting them reduces it (Marek et al. 2018b). These results suggest that the model of PL and IL as a mutually inhibitory pair is possibly an oversimplification since stimulation of PL outputs to IL enhances IL function.

Parallel Pathways from the the dm- and vmPFC to the AMG Respectively Control Fear Expression and Extinction

One hypothesis is that competing circuits between PL vs. IL and the AMG may be at the basis of the balance between the retrieval of conditioned fear memory leading to fear expression on the one hand, and extinction memory leading to fear inhibition on the other. Recent studies showed that both dmPFC and vmPFC send axons to the bICA (Adhikari et al. 2015; Bukalo et al. 2015; Do-Monte et al. 2015a; Marek et al. 2018b; Bloodgood et al. 2018). More specifically, it seems that vmPFC subdivisions send most of their axons to the BMA while dmPFC ones project to the BLA (Adhikari et al. 2015). Optogenetic stimulation of either dm- or vmPFC projections to BA during CS presentation throughout cued fear conditioning does not alter freezing. However, throughout extinction, activating vmPFC terminals in the BA during CS presentation reduces fear behavior, also affecting extinction recall the following day (Adhikari et al. 2015; Bukalo et al. 2015). Conversely, stimulating dmPFC terminals does not change freezing behavior during both cued and contextual extinction, but leads to more freezing than controls during the cued extinction recall test on the following day (Do-Monte et al. 2015a). Critically, silencing these terminals at CS presentation during extinction reduces freezing 6 hours after conditioning but not seven days later, suggesting that the long term consolidation of the conditioning memory may disengage mPFC to AMG communication from conditioning memory retrieval and/or fear inhibition processes (Bloodgood et al. 2018; Do-Monte et al. 2015a).

2.4 An Overview of Neural Circuits Underpinning Fear Learning

Fear learning, even in simplified laboratory models, is a complex cognitive process that requires multiple brain areas. Because lesions of AMG, HPC, and mPFC have been shown to have profound impacts on fear learning, these structures traditionally received particular attention when studying fear learning, and the vast literature produced is partially reviewed above. However, functional interrogations of brain circuits in both animals and humans show that fear learning recruits a wide range of brain structures (Headley et al. 2019; Voogd et al. 2018; DeNardo et al. 2019b; Vetere et al. 2017). The neurophysiological mechanisms of the AMG-HPC-mPFC network supporting fear learning are reviewed in chapters 3 and 4. Below I briefly review the participation of other brain areas to fear learning.

2.4.1 Other Limbic Structures Implicated in Fear Learning Beyond the Hippocampo-Amygdalo-Prefrontal Network

Recent research showed how other brain regions also have critical roles in fear memory formation maintenance and recall (Mccullough et al. 2016; Lüthi and Lüscher 2014; Herry and Johansen 2014; Do Monte et al. 2016; Dejean et al. 2015). In some cases, the implication of other brain areas in this circuit has been made based on work investigating the neural basis of anxiety and avoidance behavior. Indeed, these behaviors are likely mediated by a partially overlapping neural circuit with fear learning (Canteras and Gross 2012; Davis et al. 2010; Calhoun and Tye 2015; Tovote et al. 2015; Cain 2019).

The Periaqueductal Gray: Defensive Behavior Control and Prediction Error Learning

The PAG is the gray matter located around the cerebral aqueduct in the mid-brain. It is one of the main targets of CeA projections and is a primary control center for top-down pain modulation (Oka et al. 2008; Silva and McNaughton 2019; Canteras and Gross 2012). Damaging the PAG reduces defensive behavior and freezing (Blanchard et al. 1981; Borszcz et al. 1989; LeDoux et al. 1988; Liebman et al. 1970; Kim et al. 1993; Walker and Carrive 2003) while electrical or pharmacological stimulation have the opposite effect (Bandler and Depaulis 1988; Depaulis et al. 1989). The PAG is not just implicated in the control of defensive behaviors. Indeed, PAG temporary inactivation impairs conditioning acquisition (Johansen et al. 2010b). Moreover, pairing the stimulation of the PAG to a CS in the absence of any innately aversive stimulus is

2 Neuroanatomical Substrates of Fear Memory

sufficient to induce learning of a CR (Di Scala et al. 1987), but BA needs to be functional (Kim et al. 2013).

In light of its CeA afferents, the PAG is seen as a potential coordinator of defensive behavior (Fanselow 1991). However, its ability to instruct learning itself and to modulate LA plasticity instrumental for conditioning (Johansen et al. 2010b) suggested that it may also play a role in generating an instruction signal for AMG plasticity during fear learning involving nociception (McNally et al. 2011; Ozawa and Johansen 2018; Seymour 2019; Yau and McNally 2019; George et al. 2019). Consistently, *prediction error* learning⁷ in LA circuits is modulated by CeA inputs to the PAG (Ozawa et al. 2017).

Finally, the PAG is also linked to the cerebellum, which is implicated in the control of fear-evoked freezing (Watson et al. 2013; Koutsikou et al. 2014; Strata et al. 2011; Supple and Kapp 1993).

A Septohypothalamic Axis Controls Stress and Anxiety guided by the HPC and the AMG

A system including the HPC (in particular the vHPC), the extended amygdala, the septum, and the hypothalamus has long been implicated in the regulation of stress and anxiety (Gray and McNaughton 2000; Sheehan et al. 2004; Bannerman et al. 2014; Calhoun and Tye 2015). The vHPC sends dense projections to the septum and the lateral hypothalamic area (Risold and Swanson 1996), and the septum itself is in turn connected with the anterior hypothalamus (Risold and Swanson 1997). Disconnecting the fibers between the vHPC and the septum has the same anxiolytic effects as the inactivation of either structure (Trent and Menard 2010), and a specific subset of septal neurons targeting the anterior hypothalamus have been shown to promote anxiety (Anthony et al. 2014). Interactions between the HPC and the hypothalamus are crucial to buffer the stress response with an indirect inhibition of the hypothalamic-pituitary-adrenal axis (Ulrich-Lai and Herman 2009; Jacobson and Sapolsky 1991). Recent work with optogenetics showed that the lateral hypothalamus, and its afferents from the vHPC and the BNST, control anxiety (Jennings et al. 2013; Jimenez et al. 2018; Kim et al. 2013). The amygdala proper controls anxiety too and stimulation of BLA to CeA projection is anxiolytic (Tye et al. 2011).

This stress and anxiety controlling circuit runs in parallel and partial overlap with the one guiding fear responses (Canteras and Gross 2012), also given the fact that the ultimately controlled behaviors are largely shared between these two systems (Tovote et al. 2015). Therefore, integrating the knowledge

⁷Prediction error represents the discrepancy between the value (negative or positive) of actual and predicted events. It is a central concept in learning models, and reinforcement signals coupled with prediction errors support a *reinforcement learning* which may be instrumental in linking associative plasticity to specific salient events

coming from these fields of research will be necessary to resolve the neural underpinnings of fear learning.

Neuromodulatory Regulation of Fear Learning

The BNST also controls anxiety via its projections to the ventral tegmental area (VTA) in the midbrain. The BNST to VTA glutamatergic projection activation is anxiogenic while stimulating BNST to VTA GABAergic projections is anxiolytic (Jennings et al. 2013). Recent research suggests that VTA dopaminergic neurons (but also PAG and raphe DA cells, Groessl et al. 2018) play a key role in signaling negative valence. This is crucial for aversive learning (Lammel et al. 2011; Lammel et al. 2012; Joshua et al. 2008; Fadok et al. 2009; Matsumoto and Hikosaka 2009; Zweifel et al. 2011; Oleson et al. 2012; Badrinarayan et al. 2012; Navratilova et al. 2012; Vander Weele et al. 2018; Menegas et al. 2018). Indeed, stimulation of VTA axon terminals in the mPFC is anxiogenic (Gunaydin et al. 2014) and the omission of an expected aversive outcome increases dopamine in the nucleus accumbens (Matsumoto and Hikosaka 2009; Brischoux et al. 2009; Oleson et al. 2012; Badrinarayan et al. 2012; Navratilova et al. 2012). A recent paper showed that VTA dopamine neuronal activity is necessary for extinction learning, in particular of those projecting to the nucleus accumbens (Luo et al. 2018). Striatal-dopaminergic systems may play a crucial role in learning about safety, which is crucial in fear extinction and avoidance (for a review see Weele et al. 2019; Cain 2019; Zweifel 2019). VTA's role in avoidance behavior has been in turn shown to be critically modulated by the habenula (Lammel et al. 2012; Matsumoto and Hikosaka 2007; Stamatakis and Stuber 2012; Vetere et al. 2019; Lazaridis et al. 2019), a basic link structure between the limbic system and basal ganglia (Hikosaka et al. 2008).

The balance between fear and safety learning critical for extinction is also crucially controlled by the noradrenergic inputs from the locus coeruleus to the LA (Uematsu et al. 2017). Fear conditioning activates the neurons of the locus coeruleus projecting to the LA, and optogenetically inhibiting them reduces fear learning. Moreover, the activation of these noradrenergic projections promotes anxiety (McCall et al. 2017). As acetylcholine inputs to the BA enhance the persistence of fear memories (Jiang et al. 2016), the cholinergic neuromodulatory system may work in concert with the dopaminergic and noradrenergic ones during fear learning.

The Medial Thalamus: Fear Expression, Retrieval, and Contextual Generalization

The thalamus is traditionally seen as a sensory-specific gateway while the midline nuclei provide less specific modulatory relay to the cortex (Vertes

et al. 2015). However, more recently, this view is being modified, and some midline nuclei of the so-called limbic thalamus have been implicated in aversive learning and behavior, in particular, its paraventricular and reuniens nuclei. One study also implicated the lateral dorsal thalamus in contextual fear (Vetere et al. 2017).

The *paraventricular nucleus* of the thalamus (Kirouac 2015) is connected with the CeA, mPFC, and PAG, and is involved in fear expression (Penzo et al. 2014; Li et al. 2014) and the retrieval of fear memory (Do-Monte et al. 2015b; Padilla-Coreano et al. 2012). The retrieval of remote fear memories activates PL neurons projecting to the paraventricular nucleus of the thalamus (paraventricular nucleus of the thalamus (PVT)) and silencing this projection prevents it (Do-Monte et al. 2015b). As the PVT is recruited only for remote but not for recent fear memories (relying on mPFC-AMG connections) it is possible that the PVT is a critical node recruited to maintain remote memories (Do-Monte et al. 2015a). Moreover, activation of inhibitory interneurons in the CeA by the PVT (Penzo et al. 2015) drives fear learning through an overall increase in inhibition in the CeL. Selective inactivation of CeA-projecting PVT neurons prevents fear conditioning. This mechanism by which the PVT gates fear learning in CeA is similar to the one used by the blCA for the same purpose (Li et al. 2013, 4.1.2), suggesting that the PVT and blCA inputs may converge in the CeA to modulate fear learning.

The *nucleus reuniens* (NR) is located in the ventral mid-thalamus and is functionally and anatomically tightly linked between the mPFC and the HPC (Griffin 2015; Ito et al. 2015b; Dolleman-van der Weel et al. 2019). Inactivating it impairs the consolidation of aversive memory (Davoodi et al. 2009; Vetere et al. 2017) and the acquisition of contextual, but not auditory cued, fear conditioning (Xu and Südhof 2013; Ramanathan et al. 2018). Moreover, consistent with the finding that mPFC-NR communication underpins correct contextual discrimination (cf. 2.3.3), the NR also controls fear generalization: inactivating it after contextual fear conditioning induce fear to unconditioned contexts (Troyner et al. 2018; Xu and Südhof 2013; Vetere et al. 2017; Ramanathan et al. 2018). While the NR contribution seems specific for contextual generalization, the auditory thalamus may be implicated in auditory discrimination (Ferrara et al. 2017; Han et al. 2008).

The zona incerta and fear generalization A subthalamic structure, the zona incerta (ZI), has recently been shown to be implicated in fear generalization (Venkataraman et al. 2019). Chemogenetically inhibiting (or exciting) it results in increased (or suppressed) cued fear generalization, respectively. ZI principal cells directly innervate the PAG and their optogenetic stimulation reduce both innate flight and conditioned freezing responses (Chou et al. 2018). Moreover, the activity of the pathway from the CeA to the zona incerta is required for the acquisition and remote recall of conditioned fear memory (Zhou et al. 2018). A recent study found that ZI GABAergic neurons receive direct

2.4 An Overview of Neural Circuits Underpinning Fear Learning

inputs from the mPFC and the habenula and target the HPC interneurons of the stratum oriens (Szytiak et al. 2019). Moreover, optogenetic stimulation of either the soma or the terminals in HPC of ZI GABAergic cells during the delivery of an aversive stimulus prevent the formation of fear memory traces. Conversely inhibiting these neurons during conditioning result in enhanced contextual fear memory.

3 Memory Neurophysiology

3.1	Memory and plasticity	74
3.1.1	Synaptic Plasticity	74
	Synaptic Plasticity in Fear Learning	76
3.1.2	Physical Substrates of the Memory Trace	77
	Identification of Engram Cells	80
	Cell assemblies	82
3.2	Memory Consolidation	83
3.2.1	Synaptic Consolidation	83
3.2.2	System consolidation	84
	Theories of Memory Consolidation	84
	Fear Memory Consolidation	86
	Method Box 2: Recording electrical signals in the brain	87
3.3	Brain Rhythms	87
3.3.1	Sleep	89
3.3.2	Brain Rhythm Taxonomy	92
	Sleep Rhythms	92
	Awake Rhythms of the Rodent Brain	95
3.3.3	Prefrontal-Hippocampal Interplay during Memory Encoding	98
3.4	Role of Sleep in Memory Consolidation	98
3.4.1	Sleep oscillations and memory consolidation	99
3.4.2	Prefrontal-Hippocampal Interplay In Memory Consolidation	103

As discussed in chapter 2, fear memory depends upon particular circuits whose physiological mechanisms at the cellular and network scales allow to encode, update, and retrieve memory. All memory types share the bulk of these neurophysiological processes. Therefore, here memory neurophysiology is mostly reviewed in broad terms, without an exclusive focus on fear learning. First, I briefly expose the plasticity mechanisms thought to provide the cellular basis for memory storage, also citing some examples concerning specifically fear memory. Then, because of their relevant roles in memory processes, I introduce the physiology of brain rhythms and sleep. Finally, the role of sleep and the oscillatory interplay between brain structures in learning is discussed. Behavioral neurophysiology investigating spatial learning in rodents has been providing major advancements in the last decades, which are reviewed in the last section. The specific behavioral neurophysiological mechanisms underpinning fear learning are discussed in chapter 4.

3.1 Memory and plasticity

Since the 19th century, it is well known that the overall number of neurons of the brain of adult mammals does not change much (Ramón y Cajal 1899). Even though for many decades it was thought that adult brains do not generate new neurons, today we know that adult neurogenesis takes place in the olfactory bulb and the dentate gyrus in the hippocampus (HPC) (Song et al. 2016). Even though this mechanism is implicated in learning, the ability of the brain to form new memory cannot solely rely on this minimal insertion of new cells in the network. Consequently, the nervous system stores new memory traces by enduring physical modifications of the existing network. The ensemble of physical modifications supporting the storage of new memory is called an *engram* (Semon 1911; Lashley 1950; Thompson 1976).

Santiago Ramón Y Cajal (1899) first suggested that the nervous system stores new information by strengthening the connections between cells. The resulting theory posited that engrams are composed of networks of interconnected neurons, which activation sustains memory recall. The formation of such traces requires the possibility to change pre-existing connections between neurons following new experiences (Konorski 1948). First labile when elaborated, the memory trace is reinforced by the gradual strengthening of connections between the selected neurons, enhancing the reliability of recall. A famous conceptualization of this theory is the one proposed by the Canadian physiologist Donald Hebb (Hebb 1949), who wrote: “When an axon of cell A is near enough to excite a cell B and repeatedly or persistently takes part in firing it, some growth process or metabolic change takes place in one or both cells such that A’s efficiency, as one of the cells firing B, is increased”. Generalizing this idea to large groups of neurons, Hebb (1949) also introduced the concept of *cell assemblies* as the neurophysiological substrate of complex information encoding by the collective firing of cells.

3.1.1 Synaptic Plasticity

The first physiological evidence supporting Hebb’s theory was the discovery of long-term potentiation (LTP) by Bliss and Lømo (1973; 1970). They applied repetitive, high-frequency stimulation trains to the primary input fibers of the HPC (the perforant path, see section 2.2.3) and observed an increase of excitatory postsynaptic potential (EPSP) amplitude in the afferent dentate gyrus, lasting from tens of minutes to many days (Figure 3.1a; Bliss and Gardner-Medwin 1973). This result was the first demonstration of activity-dependent, long-term increase of the efficacy of a synaptic connection, confirming that learning may depend upon changes of synaptic strength between neurons which stabilizes during memory consolidation (Malenka and Nicoll 1999; see 3.2). The opposite effect, that is, long-term depression (LTD), was

further discovered following the application of low-frequency trains of stimulation, typically <1 Hz (Figure 3.1a; Ito and Kano 1982; Ito et al. 1982; Dudek and Bear 1992).

However, the powerful tetanic stimulations used in early experiments to trigger LTP are much stronger than physiological conditions *in vivo*. Moreover, under these circumstances, the timing of post-synaptic firing is not controlled, meaning that the Hebbian rule is not respected in classical LTP protocols. However, it was later discovered that LTP can also be induced under Hebbian conditions. Simultaneous intracellular recordings showed that stimulation of the presynaptic cell followed a few ms later of the post-synaptic cell ('pre-post pairing') leads to long-term enhancement of synaptic efficacy (Markram et al. 1997), even with only a few paired stimulations. When the timing between pre- and post- spike timing is inverted ('post-pre pairing'), the synaptic efficacy is durably depressed. This is known as Hebbian spike timing dependent plasticity (STDP; Sjostrom et al. 2008; Figure 3.1b). In cultured hippocampal neurons, LTP is robustly induced if the delay is <20 ms. Conversely, the synaptic efficacy is reduced (LTD) if the post-synaptic spike precedes the pre-synaptic spike within a <20 ms time-window (Bi and Poo 1998).

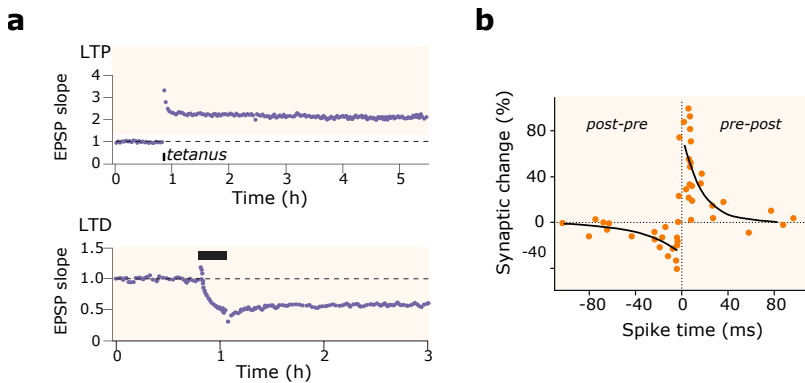

Figure 3.1: Classical LTP, LTD, and STDP results. (a) Alterations in field EPSP (rising slope normalized to baseline) over time, during LTP (100 Hz stimulation, 1 s, baseline intensity) or after the induction of LTD (long-term depression; 1 Hz stimulation, 15 min, baseline intensity). The black bar represents the time of the stimulus (panel from Collingridge et al. 2004). (b) In STDP protocols, the synapse is either potentiated or depotentiated according to the delay between the pre- and post-synaptic spikes (panel from Bi and Poo 2001).

Several *in vivo* experiments showed that the cellular and molecular mechanisms associated with LTP are necessary for memory acquisition (LTP induction; Morris et al. 1986; Laroche et al. 1989; Davis et al. 1992; Tsien et al. 1996; Whitlock et al. 2006) and retention (LTP maintenance; Doyère and

Laroche 1992; Jones et al. 2001; Pastalkova et al. 2006), confirming their value as experimental models of synaptic plasticity.

Synaptic Plasticity in Fear Learning

Recently, Nabavi et al. (2014) induced an artificial fear memory in mice only with optogenetic stimulation of the auditory inputs to the lateral amygdala (LA). Crucially, subsequent optogenetic stimulations of these inputs with LTD- or LTP-like frequencies could respectively inactivate or reactivate the fear memory. Converging evidence over the last four decades corroborated the hypothesis that the increase of fear responses to the conditioned stimulus (CS) after fear conditioning depends upon synaptic plasticity that LTP paradigms can mimic in the lab. This literature is extensively reviewed elsewhere (Blair et al. 2001; Dityatev and Bolshakov 2005; Fanselow and Ledoux 1999; Goossens and Maren 2002; Maren 2005; Sigurdsson et al. 2007; Pape and Pare 2010). However, in brief, three lines of evidence support this hypothesis (Pape and Pare 2010): 1) Fear conditioning facilitates the amygdala (AMG) neural responses to the inputs transmitting CS information. This was shown both by in vivo extra-cellular recordings of CS-evoked firing (cf. 4.1.1) and by in vitro recordings of synaptic responses to afferent stimulation in AMG slices of fear-conditioned animals (McKernan and Shinnick-Gallagher 1997; Tsvetkov et al. 2002). These works showed the associative nature of this plasticity taking place in LA and depicted a causal relationship between the plasticity and fear memory (Maren and Holt 2004). 2) LTP can be induced at the synaptic inputs of the AMG in vitro (e.g., Chapman and Bellavance 1992; Huang and Kandel 1998; Humeau et al. 2005), as well as in vivo in anesthetized (e.g., Clugnet and LeDoux 1990) and freely moving animals (Doyère et al. 2003). 3) The molecular and cellular processes underlying LTP are also necessary for fear conditioning: blockade of NMDA receptors in the AMG blocks both the acquisition, but not the expression, of conditioned fear in vivo and LTP in vitro (e.g. Bauer et al. 2002; Huang and Kandel 1998; Kim et al. 1991; Miserendino et al. 1990)¹

Fear Extinction Synaptic plasticity is also essential for extinction learning (Pape and Pare 2010; Maren 2015). Like fear conditioning, extinction training depends upon a consolidation phase (cf. 3.2) recruiting the same molecular machinery implicated in fear conditioning (Walker et al. 2002; Chhatwal et al. 2006; Tronson et al. 2012; Herry et al. 2006; Merino and Maren 2006). Synaptic plasticity mechanisms play two different roles during extinction learning. The first is reinforcing inhibitory processes that compete with the conditioning memory for the control of defensive behavior. Indeed, extinction learning involves plasticity at the amygdalar γ -Aminobutyric acid (GABA)ergic synapses

¹Beyond thalamic inputs, NMDA-dependent LA neurons also express LTP at the synapses receiving cortical inputs (e.g., Huang and Kandel 1998; Tsvetkov et al. 2004).

that are crucial for fear inhibition (Chhatwal et al. 2005; Trouche et al. 2013). The second mechanism can reverse the changes in synaptic efficacy giving rise to the memory trace induced during fear conditioning (Kim et al. 2007b; Lin et al. 2003; Yu et al. 2008). Within the AMG, fear extinction training depotentiates thalamic inputs that had previously been potentiated during the conditioning and extinction learning leads to the development of CS-responsiveness in a new population of neurons in the AMG. Furthermore, an intact HPC is necessary for neural and behavioral responses only after extinction (cf. 4.1.3). This supports the view that separate pathways relay information about the CS to the AMG before and after extinction. Therefore, extinction learning may induce a re-organization of the fear memory trace and a switch in the circuit relaying CS information to the AMG (Pape and Pare 2010).

Neocortical Synaptic Plasticity It is important to note that auditory fear conditioning leads to extensive synaptic plasticity not only in the amygdala but in many other brain regions including the auditory thalamus and cortex (Letzkus et al. 2011; Weinberger 2011). Interfering with plasticity at these sites prevents the acquisition of conditioned fear, confirming that also plasticity upstream the AMG adds to fear conditioning.

Consistent with the crucial role of medial prefrontal cortex (mPFC) in fear learning, synaptic plasticity in mPFC circuits supports fear memory. Whereas cued fear acquisition is associated with a depression of mPFC synaptic transmission, extinction potentiates it (Herry et al. 1999). Moreover, mPFC LTP, or LTD, during extinction training lead to low, or high, recovery of fear, respectively (Herry and Garcia 2002; Herry and Garcia 2003; Herry and Mons 2004; Hugues and Garcia 2007; Hugues et al. 2006). Furthermore, while during extinction there is a depression of synaptic plasticity in mPFC synapses receiving basolateral amygdala (BLA) inputs and potentiation in BLA neurons receiving mPFC afferents, the reverse happens during fear reinstatement (Vouimba and Maroun 2011). Finally, HPC-mPFC synaptic plasticity is potentiated during extinction training (Farinelli et al. 2006).

3.1.2 Physical Substrates of the Memory Trace

According to Semon's (1923) original memory engram theory "all simultaneous excitations (derived from experience) ... form a connected simultaneous complex of excitations which, as such acts engraphically, that is to say leaves behind it a connected and to that extent, separate unified engram-complex" and "The partial return of an energetic situation which has fixed itself engraphically acts in an ephoric sense upon a simultaneous engram complex"².

²In Semon's terminology *engraphic* means pertaining to an engram, the *ecphoria* is the stage in memory retrieval in which a latent engram is reactivated, and the "energetic situation" refers to the brain/neural network state.

3 Memory Neurophysiology

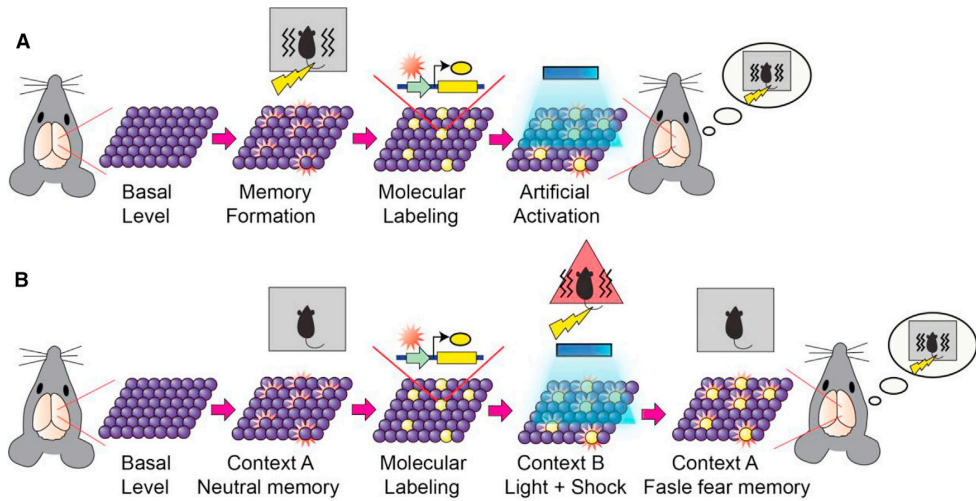

Figure 3.2: Manipulation of memory engrams with optogenetics. (A) Neurons active during memory encoding (e.g., during contextual fear conditioning) can be labeled with an optogenetic actuator such as ChR2 which allows to later selectively activate them with photic stimulations and induce memory recall. (B) An artificial contextual fear memory can be generated by labelling neurons active when an animal is exposed to a context. Later, if these neurons are optogenetically stimulated during the delivery of an unconditioned stimulus (US) (in a different context) the animals acquire contextual fear towards the initial context. Panels from Tonegawa et al. (2015).

Therefore, in Semon's theory, memory engrams correspond to all the physical changes occurring within the nervous system when new experience enables learning of some sort. These modifications allow the animal to memorize the experience and guide future behavior. Moreover, partial re-exposure to the stimuli present at the time of memory encoding induce memory retrieval, meaning that the recall of memory is reintegrative, similarly to the concept of pattern completion (Marr 1970; see below). Experimental evidence collected in the past two decades suggests that these physical changes entail cellular, synaptic, and intracellular molecular processes that, on the one hand, can be labeled and manipulated in sparse cell populations called engram cells (Neves et al. 2008; Silva et al. 2009; Mayford and Reijmers 2016; Tonegawa et al. 2015; Josselyn et al. 2015; Asok et al. 2019; Poo et al. 2016), and, on the other hand, induce the emergence of synchronous firing of groups of neurons called cell assemblies. Engram cells and cell assemblies are somehow different ways to describe the same neural substrate allowing the long term storage of information. One difference between these concepts being that, differently from engrams, although not all cell assemblies reactivations necessarily induce memory retrieval.

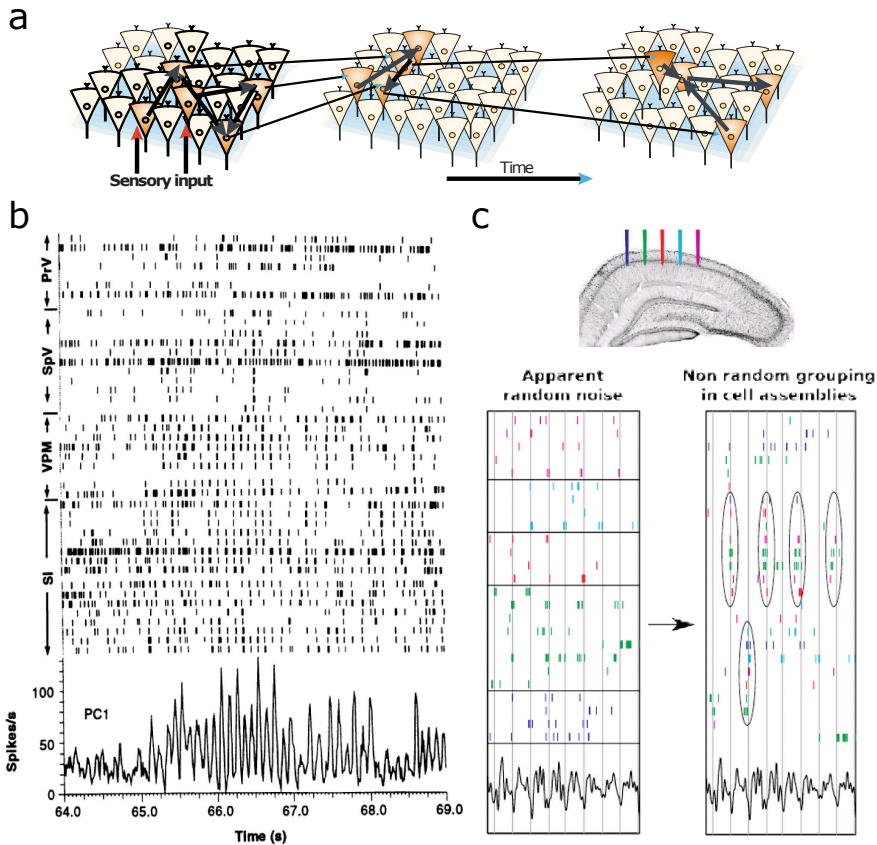

Figure 3.3: Cell assemblies. (a) Schematic representation of the cell assembly hypothesis. Sensory inputs drives a population of neurons to fire. Then, local dynamics strengthen their mutual connections and stabilize the assembly over time. (b) Ensemble recording of cortical (SI), thalamic (VPM) and brainstem (SpV, PrV) neurons reveals spontaneous synchronization of a large population of cells in different brain regions (displayed in raster plots: each row is data from one cell and each raster represents a single action potential). A principal component analysis (PCA) extracted a subset of correlated units. PC1 refers to the first principal component which explains the highest variance of the multidimensional recording. Peaks of PC1 expression correspond to moments of high synchronization (panel adapted from Nicolelis et al. 1995). (c) High-density recording in the HPC shows that assemblies occur at a precise phase of the local theta oscillation (panel adapted from Harris et al. 2003).

Identification of Engram Cells

New experiences induce intense firing activity in neural populations particularly implicated in memory encoding. This activity triggers a cascade of cellular changes within these neurons that activate new gene transcription (Flavell and Greenberg 2008). These genes, such as *c-Fos* and *Zif268*, are called immediate early genes (IEGs). Their expression increases rapidly and transiently in an activity-dependent manner in response to extracellular stimuli and has been shown to play a crucial role in experience-dependent neural plasticity. By inspecting the expression of these genes, numerous studies showed that specific and sparse cell populations in the AMG (Reijmers et al. 2007), HPC (Deng et al. 2013; Tayler et al. 2013), sensory (Xie et al. 2014) and prefrontal cortex (Zelikowsky et al. 2014) active during fear memory encoding were preferentially reactivated during the retrieval of that memory³.

Over the past few years, the development of optogenetics and chemogenetics tools on the one hand (Fenno et al. 2011; Sternson and Roth 2014), and gene expression control techniques on the other, have led to breakthroughs in engram research. The integration of IEG expression signals, inducible gene expression methods, and activity-control tools enabled the expression of optogenetic or chemogenetic receptors specifically in groups of neurons that are active during memory acquisition and to manipulate these memory traces experimentally (Figure 3.2). In recent work, Ghandour et al. (2019) used calcium imaging in freely moving mice to characterize the activity of engram cells in CA1. Engram cells show higher repetitive patterns than non-engram neurons while a new context is experienced. Moreover, these activity patterns of sub-ensembles of engram cells reinstate during post-learning sleep and are more likely to be re-activated during memory retrieval. This activity during sleep is likely implicated in memory consolidation (cf. 3.2 and 3.4).

Fear Memory Engrams By controlling with optogenetics neurons that were particularly active during fear conditioning, it was possible to show that the specific activation of engram cells in LA or BLA is sufficient to induce the recall of cued (Han et al. 2009; Rashid et al. 2016; Zhou et al. 2009; Yiu et al. 2014; Kim et al. 2014b) or contextual (Redondo et al. 2014; Gore et al. 2015) fear memory, respectively. Optogenetic inactivation of activity-labeled HPC cells that are particularly active during contextual fear acquisition impairs fear memory retrieval. This works with either dentate gyrus (DG), CA3 (Denny et al. 2014), or CA1 engram cells inactivation (Tanaka et al. 2014). Conversely, artificial contextual fear can be induced by the excitation of labeled DG cells in a context different from the one where conditioning took place (Liu et al. 2012). Given that IEGs expression is sparse, these results, together with

³IEGs expression notably reveals that the renewal of fear after extinction recruits ventral hippocampus (vHPC) neurons projecting to the AMG (Orsini et al. 2011; Jin and Maren 2015).

those showing that non-specific inhibition of all DG neurons does not impact contextual fear recall (Kheirbek et al. 2013), demonstrate that memory traces are encoded in sparse and specific neural populations. Consistent with this, a recent study showed that distinct DG engrams represent conditioning and extinction memory (Lacagnina et al. 2019). During extinction training, the reactivation of the contextual fear engram is inhibited and a second engram becomes active. If later this ensemble is inhibited or stimulated, contextual fear increases or decreases, respectively.

In summary, manipulating engrams confirmed and further detailed results from lesion and classic optogenetic manipulations about the distinct roles of the HPC and AMG in fear learning. Interestingly, in both the AMG (Rashid et al. 2016) and HPC (Cai et al. 2016) two fear engrams activated a few hours apart share more common cells than two engrams activated 24h apart. The allocation of two engrams to partially overlapping cell populations could facilitate the recall of the temporal proximity of the two events. Furthermore, simultaneous activation of BLA cells representing an aversive US and HPC neurons coding for a specific context induced the formation of an artificial contextual fear memory (Ohkawa et al. 2015), indicating that BLA and HPC may cooperate to encode contextual fear.

Beyond the HPC and BLA, neocortex engrams have also been successfully manipulated to control fear memory. Optogenetic stimulation of *c-fos* tagged neurons in the retrosplenial cortex after contextual fear conditioning is sufficient to induce context-specific fear which is resistant to the inactivation of the HPC (Cowansage et al. 2014). This result confirms an earlier hypothesis that neocortical regions may maintain a contextual representation in the absence of HPC (Maren et al. 2013).

Brain-wide tagging of highly active neurons during contextual fear memory acquisition also shows intense activity of the neocortex (Garner et al. 2012), and experimental activation of this brain-wide network also induces memory retrieval. Similarly, labeling during cued fear conditioning recruits several brain regions including cortex, thalamus, hypothalamus, and brainstem (DeNardo et al. 2019a). Analyzing *c-Fos* expression across 84 brain regions, Wheeler et al. (2013) identified those that were co-active during contextual fear memory recall. Interestingly, long-term fear memory recall engages a network where the thalamus and the prefrontal cortex (PFC) act as hubs and this may be particularly implicated in memory expression (Wheeler et al. 2013). If network nodes active during encoding (CA1, nucleus reuniens (NR), lateral septum, and laterodorsal thalamus) are subsequently inhibited chemogenetically during the three days following conditioning, memory retrieval is impaired (Vetere et al. 2017).

Cell assemblies

While in animals with very few neurons, small circuits with stereotyped connectivity patterns constitute the computational building blocks of the nervous system, populations of neurons, or cell assemblies, are likely the computational unit of bigger brains (Braitenberg 1977; Braitenberg and Schüz 2013). Hebbian cell assemblies are groups of neurons with stronger functional connections between each other than with other cells (Varela et al. 2001; Harris 2005; Buzsáki 2010; Roudi et al. 2015; Sakurai et al. 2018; Eichenbaum 2018a). This stronger within-assembly connectivity drives *attractor* dynamics, which are regarded as the elemental processes of many neural computations (Rolls et al. 1998). Learning shapes these attractors, following Hebb's rule, therefore reinforcing the connections between cells that fire together (Figure 3.3). After the experience, and after plasticity mechanisms take place, if the network receives only a subset of inputs which drove initial learning, the network dynamics converge to a state representing the entire memory trace through a process called *pattern completion* (Marr 1970).

In this view, therefore, memory is not stored in hermetic anatomical blocks; instead, overlapping networks and dynamics provide the brain with a countless number of possible combinations that have the potential to represent a virtually infinite amount of information. As we saw above, memory is continuously reorganized to relate stored experiences with new information, and this can take place with the continuous rearrangement of the attractors. Therefore, "Memory is determined by information processing" (Squire 1987, p. 124). Such dynamic coding and processing of information in memory, rather than just encoding and storing the information in an immutable physical substrate, can be explained by the concept of cell assembly. A radical view of such a system can also conceive that "there may, then, be a memory trace that is wholly a function of a pattern of neural activity, independent of any structural change" (Hebb 1949, p.61). However, as we reviewed above, today we know that the brain continuously changes the expression of genes and the structure of its synapses.

As discussed above, modern genetic and optic techniques allow us to tag, manipulate, and observe the neurons composing cell assemblies. However, calcium imaging still do not allow to reliably record single action potentials over long recording sessions. Therefore, these techniques do not provide yet the fine temporal resolution allowing us to observe the neural population code of action potentials underpinning the activation of the assemblies. This can be achieved with high-density electrophysiological recordings (see 3.3 for the technical details). Because of the necessity to record simultaneously a high number of neurons to observe significant patterns of synchrony, reports of sets of coactive neurons used to be rare in the literature (Nicoletis et al. 1995; Skaggs et al. 1996; Nicoletis et al. 1997b; Figure 3.3). However, the last two decades witnessed noteworthy advances in the technologies allowing high-

density recordings of electrophysiological data (Nicolelis et al. 1997a; Berényi et al. 2013; Jun et al. 2017; Buzsáki 2004b; Steinmetz et al. 2018). These advances have led to an increased number of studies recording cell assemblies (e.g., Harris et al. 2003; Peyrache et al. 2009; Benchenane et al. 2010b; Drieu et al. 2018; Ven et al. 2016; Russo and Durstewitz 2017; Li et al. 2018). Notably, as we discuss in section 4.3.1, cell assemblies in the mPFC have been implicated in the control of fear behavior (Dejean et al. 2016).

3.2 Memory Consolidation

Memory consolidation is a time-dependent process underpinning the stabilization of recently acquired, labile memory traces. This term commonly refers to two temporally distinct mechanisms. First a fast consolidation process (within the first minutes to hours after learning) occurring at local, synaptic nodes in the neural circuit which encodes the memory ('synaptic consolidation'). This is followed by a slower 'system consolidation' stage (from days to even years), during which memory is reinforced and reorganized over distributed brain circuits (Dudai et al. 2015).

3.2.1 Synaptic Consolidation

Synaptic consolidation refers to the molecular and cellular processes⁴ occurring in the minutes and hours following training that are responsible for the formation of long-term memory. This process includes structural and functional changes of existing synapses as well as changes in the number of synapses (Dudai 2004; Asok et al. 2019). Many investigations have dissected the intracellular transduction and signaling pathways implicated in the molecular changes underpinning synaptic plasticity processes like LTP (Malenka 2003; Nicoll 2017). Supporting the idea that the consolidation of synaptic plasticity alterations underpins memory consolidation, LTP-associated transient molecular changes must be stabilized to make the new memory persist (McGaugh 2015). Indeed, the transition from short-term to long-term memory requires gene expression and *de novo* protein synthesis (Kandel 2001) which also induce structural changes of the synapses (*structural plasticity*; Lamprecht and LeDoux 2004). These structural changes include modifications of receptors expression and morphological modifications of the synapses at the levels of spines, terminals, and astrocytic partners. Because protein synthesis inhibitors were shown to impair memory for recently acquired information while sparing older memories, synaptic consolidation requires *de novo* protein synthesis. The same disruptive effect was shown with inhibitors of messenger ribonucleic acid (mRNA) synthesis, suggesting that transcription is also involved. Indeed, learning triggers the rapid expression of IEGs, some of which

⁴Synaptic consolidation is thus also referred as 'cellular' or 'local' consolidation.

3 Memory Neurophysiology

(e.g. c-Fos, zif-268) are transcription factors inducing the expression of other genes (Guzowski et al. 1999).

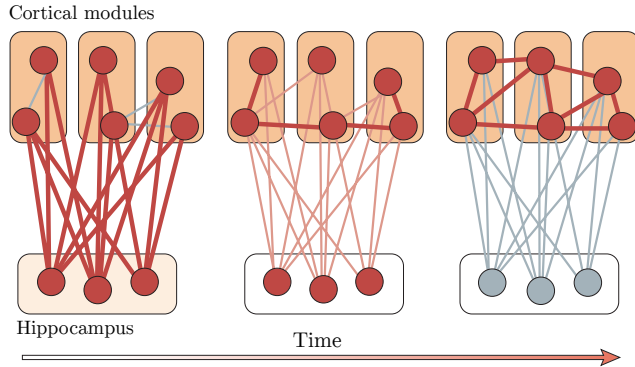

Figure 3.4: Standard consolidation theory. The hippocampus integrates the information initially encoded in various cortical modules. Repeated on-line and off-line reactivations of this hippocampo-cortical network gradually strengthens the cortico-cortical connections which can ultimately sustain the recall of the information independently. A key feature of this model is that changes in the strength of the connections between the hippocampus and the different cortical areas are rapid and transient, whereas changes in the connections between cortical modules are slow and long-lasting (panel reproduced from Frankland and Bontempi 2005).

3.2.2 System consolidation

Systems consolidation refers to the slow processes (days to years) underpinning the gradual strengthening and reorganization of memories with time. This concept mainly arose from the study of amnesic patients who exhibited temporally graded retrograde amnesia obeying Ribot's law (cf. 1.2). An extensive literature of lesions on animals reviewed in chapter 2 confirmed that the HPC damage causes temporally graded amnesia and that therefore the HPC has only a time-limited role in memory storage and retrieval, as demonstrated in the patient H.M. Moreover, accumulating evidence shows that the passage of time and memory consolidation implicate extra-hippocampal and in particular neocortical areas in memory retrieval.

Theories of Memory Consolidation

The **standard consolidation theory** (Squire and Alvarez 1995; Figure 3.4) holds that labile synaptically consolidated memory traces are gradually trans-

ferred to extra-hippocampal areas and finally the HPC is no longer necessary to support them. A potential mechanism supporting this system consolidation process was first proposed by Marr (1970) in his two-stage theory of memory consolidation (Figure 3.4). In his view, information initially and rapidly stored in the hippocampus would spontaneously reactivate. This hippocampal reinstatement of patterns of neural activity would lead to neocortical reactivation through specific HPC-cortical connections formed during the encoding stage, enhancing these connections. The repeated reactivation of activity in the two networks would lead to the progressive decrease of hippocampal involvement until the memory becomes independent of the hippocampus-based representation (McClelland et al. 1995; Buzsaki 1996; Frankland and Bontempi 2005; McClelland 2013; Preston and Eichenbaum 2013; Wiltgen et al. 2004).

Nadel and Moscovitch (1997) proposed an alternative possibility: the **Multiple-Trace Theory**. According to their model, the HPC is necessary for retrieval of memories, regardless of their remoteness in time. Periodic memory recall would lead to the creation of multiple memory traces, spanning both the hippocampus and the neocortex. As a consequence, while recall of detailed memory would always rely on the HPC, the ‘gist’ of the experience would be stored at the neocortical level (Moscovitch et al. 2005). The hippocampal disengagement with system consolidation would thus reflect the existence of extra-hippocampal schematic representations of the experience. Assuming that all context coding requires the HPC, Winocur et al. (2007) provided corroboration to this theory by showing that when tested one day after contextual fear conditioning, animals express memory (freezing) only if exposed to the same context of training but not in a slightly different one. This

fine sensitivity to context was HPC-dependent and disappeared with time. When the animals were tested 28 days after learning, conditioned freezing appeared in new environments that shared general features with the original context. This result suggests that memories undergo a progressive ‘transformation’ with time, ultimately becoming more abstract.

These classical theories, however, do not reconcile with some experimental evidence. For instance, hippocampal-dependent learning, such as contextual fear conditioning, can take place without the HPC if extensive training takes place (Wiltgen et al. 2006; cf. 2.2.2). The **multiple reinstatement theory** (Sutherland and Lehmann 2011) binds together several aspects of the standard and multiple trace theories, in order to reconcile them with these results. It postulates that repetitive encoding (mediated by extensive training) may promote encoding in the cortex (usually regarded as a ‘slow learner’) complementing the hippocampus. This theory is supported by the evidence that system consolidation occurs exceptionally quickly if an associative ‘schema’ into which incorporate new information was established previously (Tse et al. 2011; Van Kesteren et al. 2012).

The **reconsolidation hypothesis** was inspired by a large body of literature

showing that the retrieval of a memory opens a time window of susceptibility to interference (Sara 2010; Alberini and LeDoux 2013; McKenzie and Eichenbaum 2011). According to this theory, memory stabilization is a dynamic and open-ended process rather than a discrete event, and memory reactivations support the update of memories as many times as situations require novel, more adapted behavior, returning previously consolidated memories to a labile state. Therefore, during recall, cortical memory traces could briefly become HPC-dependent again, and be altered or strengthened depending on the current experience.

Fear Memory Consolidation

Consistent with system consolidation theories, neuronal ensembles in mPFC are dynamic. prelimbic cortex (PL) neurons labelled during retrieval of a remote fear memory are more likely to be reactivated and make more substantial behavioral contributions to remote fear memory retrieval compared to those labelled during the initial conditioning (DeNardo et al. 2019a). While results about mPFC dynamics are consistent with the notion of system consolidation, some studies found no temporally graded effect of AMG damage on both cued and contextual fear recall (Gale et al. 2004; Maren et al. 1996), suggesting that the AMG has a permanent role in fear memory storage. Therefore, fear conditioning consolidation may not be supported by classical system consolidation processes. However, recently it was reported that optogenetically silencing PL inputs to the BLA impairs retrieval at early, but not late, time points after conditioning training (Do-Monte et al. 2015b). This suggests a time-dependent reorganization of the neural circuits supporting conditioning memory retrieval. Indeed, silencing the projections from the paraventricular thalamus to the central amygdalar nucleus (CeA) at late, but not early, time points attenuates fear.

A recent study showed that entorhinal cortex (EC) inputs activate BLA engram cells during the first week after fear conditioning, while at later consolidation stages the mPFC drives BLA engram neurons (Kitamura et al. 2017). Therefore, while the AMG remains necessary for successful fear memory retrieval, system consolidation modifies some components of the engram, which extends beyond the engram cells tagged during training, and reorganizes AMG functional connectivity. This same study also provided strong evidence supporting the core of classic memory consolidation theory. They showed that the formation of a neocortical contextual fear engram (in mPFC, posterior cingulate cortex, and retrosplenial cortex) during conditioning could be blocked by inhibiting their EC afferents. Moreover, the formation of the neocortical engram is necessary for fear memory retrieval at late, but not early, time points after acquisition. This engram becomes responsive to the fear context over time, and its “maturation” is supported by HPC engram cells, which if inhibited also prevent the progressive activation of the neocortical engram. There-

fore, fear memory engrams are dynamics, and functional relationships between engrams in different brain sites are necessary for correct memory storage and recall over time.

Method Box 2: Recording electrical signals in the brain

The current fluxes in the dendritic tree of each cell generate an electrical potential and the electrical field recorded with an electrode in the vicinity of a group of neurons is called local field potential (LFP; also known as intracranial electroencephalogram (EEG)). Therefore, the LFP is the average of the potentials generated by each cell acting as a dipole (an antenna). However, despite its name, the LFP also reflects the electrical field reaching the recording electrode after travelling from further away neural sources through the brain tissue. This phenomenon is called volume conduction and, as brain oscillations can travel relatively large distances in the nervous tissue (especially slow waves), it contribute significantly to the recorded LFP. Extracellular recordings, as used in the experimental work described in this manuscript, record a signal composed by the LFP and the action potentials of the neurons in the vicinity of the microelectrode^a. See also Figure 3.5.

^aDepending upon the impedance of the microelectrode, within a spheric volume with a radius of $\sim 60\text{-}100\mu\text{m}$ (Buzsáki 2004b)

3.3 Brain Rhythms

Like many other complex, dynamical systems, neural networks oscillate (Izhikevich 2007). Single neurons are natural oscillators, and the constant flux of ions through their membranes contributes to intrinsic resonance and oscillation of their membrane potential and therefore of their spiking activity (Buzsáki et al. 2012). Synchronization leads networks of densely interconnected neurons to oscillate, generating those that are commonly called brain rhythms. The first to report brain-produced oscillatory activity was Berger (1929) who described cortical alpha waves by recording the EEG with scalp electrodes. The electric field that can be measured with EEG electrodes on the scalp, but also with intracranial electrodes closer to nerve cells in the extracellular medium, is mostly the resultant of the averaged sums of excitatory and inhibitory post-synaptic potentials at the synaptic level⁵ (Figure 3.5 and *Method Box 2*).

Brain oscillations can span five orders of magnitude in frequency from approximately 0.05 Hz to 500 Hz and play critical roles in network synchronization,

⁵However, other sources like Na^+ and Ca^{2+} spikes, ionic fluxes through voltage- and ligand-gated channels, and intrinsic membrane oscillation also participate

3 Memory Neurophysiology

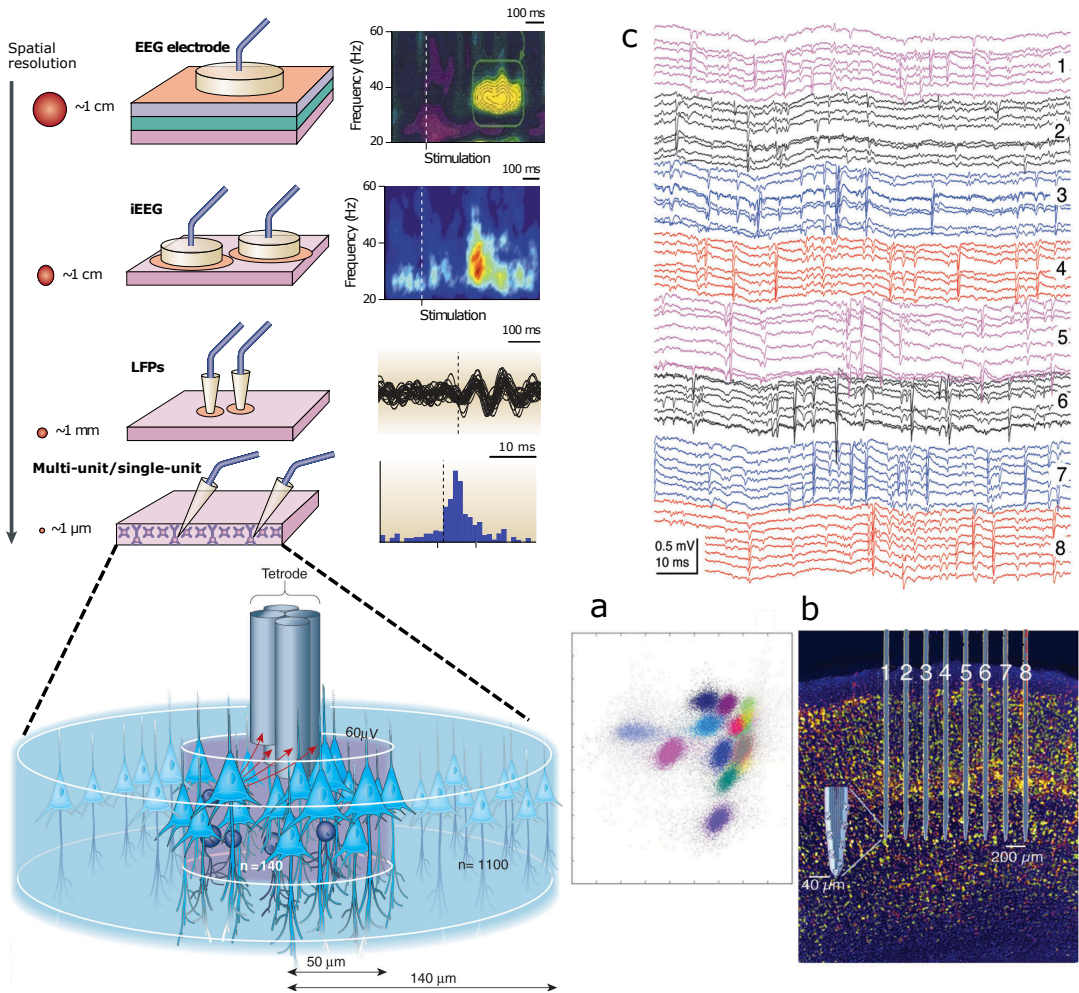

Figure 3.5: Recording brain rhythms and neurons. Left, different spatial scales of recording of neural activity. From top to bottom: scalp electrodes and intracranial electrodes on the brain surface record EEG signals (see Method Box 2). Intracerebral electrodes record LFP signals, which are a spatially more precise version of the EEG and the spiking activity of neurons nearby the electrode. Single electrodes cannot always distinguish the spikes coming a nearby cell or another and record a signal called multiunit activity (MUA). Electrodes with multiple recording sites (like the tetrode depicted in the zoom) record the same signal in parallel on different recording sites but from slightly different distances. This affects the amplitude and the waveform characteristics of the signal recorded by each channel, which form clusters corresponding to the recorded cells (a). (b) Array of another type of multi-electrode, the silicon probe. Each of these eight shanks has eight recording sites which recorded the signal depicted in c (channels from the same probe have the same color). Note how channels from the same shank record the same spikes but with different amplitudes and shapes (adapted from Varela et al. 2001 and Buzsáki 2004a). See also *Method Box 2*.

neural communication, and hence plasticity processes and learning (Engel et al. 2001; Buzsáki 2004a; Varela et al. 2001). LFP oscillations are naturally segregated in different frequency bands that have been associated to specific brain and behavioral states.

Oscillatory Synchrony and Neural Communication One of the hypotheses that motivated Berger to perform the first EEG recordings (1929) was to show that brain oscillations were involved in telepathy, the communication between brains. Even though this was not shown, brain rhythms mediate neural communication within and between brain structures by synchronizing firing activity within suitable temporal windows for Hebbian plasticity mechanisms (Fries 2015; Fell and Axmacher 2011). Indeed, Hebbian learning and the strengthening of the synaptic connection between two neurons (via STDP for instance) can only take place if the two cells fire within a brief time interval. Since LFP oscillations reflect the synchronicity of a particular network (where therefore neurons oscillate synchronously between excitation-inhibition cycles), if two anatomically connected regions oscillate with random phase relationships, Hebbian plasticity cannot take place (Figure 3.6; Fries et al. 2001; Womelsdorf et al. 2007; Lisman and Jensen 2013; Cassenaer and Laurent 2007; Bi and Poo 1998). This consistency of phase relation is measured as *coherence*. During high coherence periods inputs that consistently arrive at moments of high excitability of the afferent structure are more likely to lead to plasticity. On the other hand, when coherence is low, inputs occur at random phases of the cycle and have a lower chance to induce a response. In a phase of network inhibition, principal cells are not able to respond, making the communication inefficient. Therefore, coherent oscillations shape the temporal structure of the neural activity. Within individual brain areas, rhythmicity can synchronize neurons, creating synchronously active cell assemblies (Harris et al. 2003).

3.3.1 Sleep

When thinking about the cellular mechanisms underpinning memory formation, a potential issue arising is the fact that continuous rapid information encoding may ultimately lead to the risk of the same synapses being used in multiple traces, leading to conflicting memory traces. Marr (1971) proposed a possible circumvention of this problem wherein fast encoding would be followed by a progressive redistribution of the information which, in turn, would stabilize the memory and free up storage capacity in fast encoding circuits for the formation of new memories. Sleep is ubiquitous in the animal kingdom (Shein-Idelson et al. 2016; Brown et al. 2012; Hendricks et al. 2000; Raizen et al. 2008; Low et al. 2008) and, by definition, it is a moment of absence of experience, therefore providing a suitable behavioral and neural state where memory trace reorganization may occur (Hasselmo 1999; Buzsáki

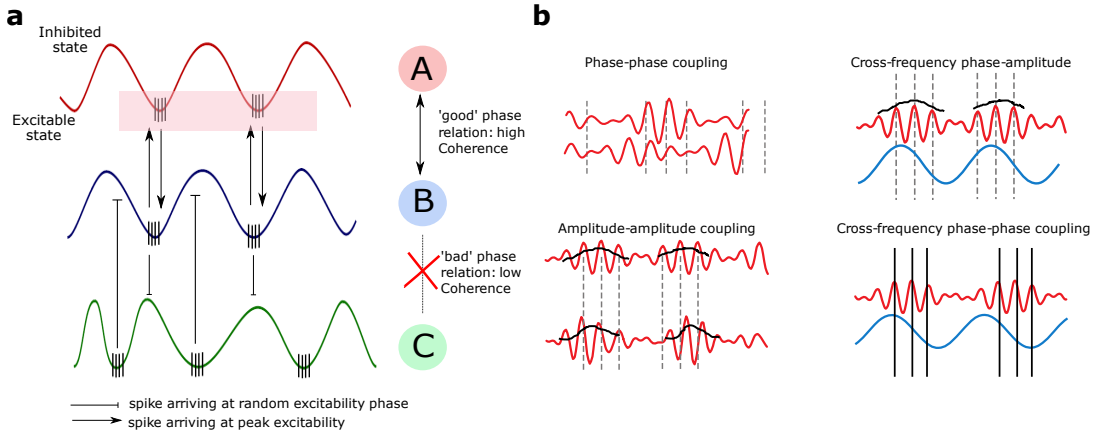

Figure 3.6: Communication through coherence. (a) Schematic representation of three connected brain regions (A,B, and C), each rhythmically active (colored traces are local network states and vertical black bars are spikes). A and B are in 'good phase relation', meaning that the neurons of each region fire during excitable states of the other region. In contrast, the phase relation between B and C is not suitable for communication. Indeed the neural populations have a bad phase relationship and the action potential coming, for instance, from C arrive in B when neurons are inhibited there with low probability to fire themselves. (panel adapted from Womelsdorf et al. 2007). (b) Different types of oscillatory coupling. Oscillations of the same (left) or different (right) frequency range (slow oscillations in blue; fast oscillations in red) can influence each other within and between brain structures. This takes place with modulation of the phase, of the amplitude, or both. Phase-phase coupling (top left): there is a correlation between the phases of the two oscillations (indicated by dashed vertical bars). Amplitude-amplitude coupling (bottom left): the amplitudes of the high frequency waves (black curves) are correlated, probably due to a third slow oscillator entraining them. Cross-frequency phase-amplitude coupling (top right): although phase coupling is absent, the envelope of the high frequency waves is modulated by the phase of the slow rhythm. Cross-frequency phase-phase coupling (bottom right): phases of slow and fast oscillations are correlated (panel adapted from Buzsáki and Wang 2012).

1989; Sutherland and McNaughton 2000). Evidence for this will be presented below.

Sleep Architecture Different patterns of EEG activity emerge during sleep. These correspond to different stages with characteristic muscular and ocular activity (Loomis et al. 1935). In mammals, sleep is classified as rapid eye movement sleep (REM) or non-REM sleep (NREM), whose relative proportions vary across species (Siegel 2005). REM sleep is characterized by low muscle tone, rapid ocular saccades and EEG with low amplitude, high fre-

quency oscillations⁶. REM sleep is also known as paradoxical sleep because the EEG signal is similar to that of the awake state. Indeed, NREM is characterized by slow, high amplitude fluctuations in the EEG signal that cannot be recorded while the animal is awake.

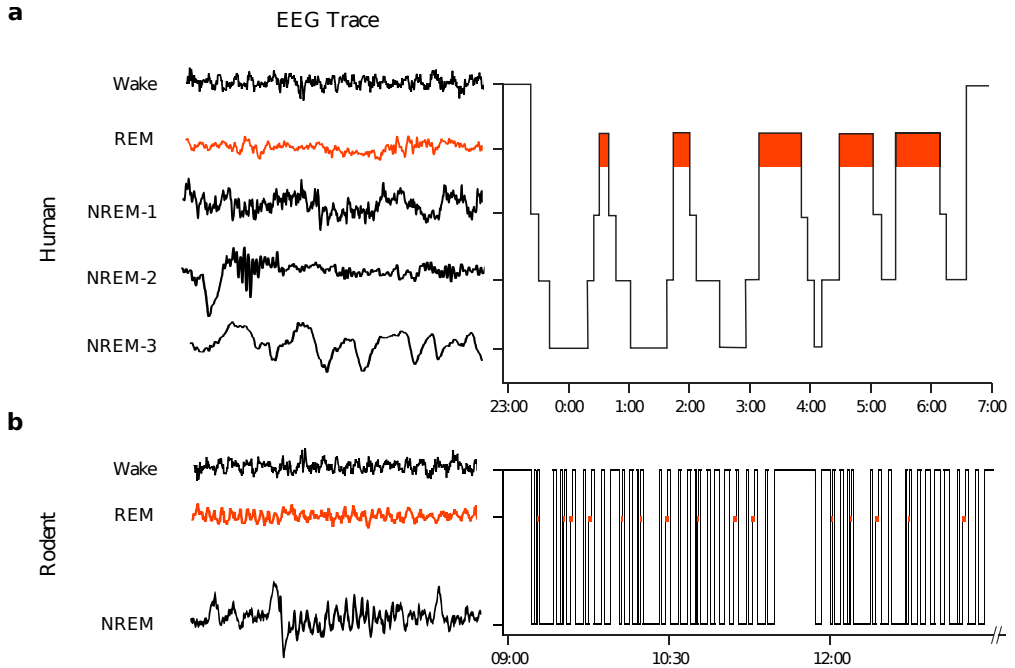

Figure 3.7: Sleep stages in humans and rodents. Example of human (a) and rodent (b) hypnograms. Human sleep is composed of alternating periods of NREM and REM sleep, with NREM subdivided into a further 3 stages. In rodents, sleep is more fragmented and composed of alternating bouts of NREM, REM, and short awakenings.

REM epochs are typically preceded by NREM epochs (Figure 3.7) and cycles of NREM and REM follow one another across the sleeping period. In rodents, NREM-REM cycles are ~ 12 minutes long (McCarley 2007), with $\sim 11\%$ of all sleep spent in the REM stage (Brankack et al. 2010). However, as rodents do not sleep during a single period like humans, these measures are highly variable. In primates and carnivores, it was also possible to further subdivide NREM into three stages corresponding to gradually lower frequencies and higher amplitude EEG signal. The deepest stage of primates' NREM sleep is characterized by the slowest and largest oscillations and is called slow wave

⁶While REM sleep has historically been considered as the dream stage of sleep, several lines of evidence point to dreaming taking place during both REM and NREM sleep (Oudiette et al. 2012; Suzuki et al. 2004)

sleep (SWS). Since the only NREM sleep stage of rodents⁷ strongly resembles primates' stage 3 it is often called SWS.

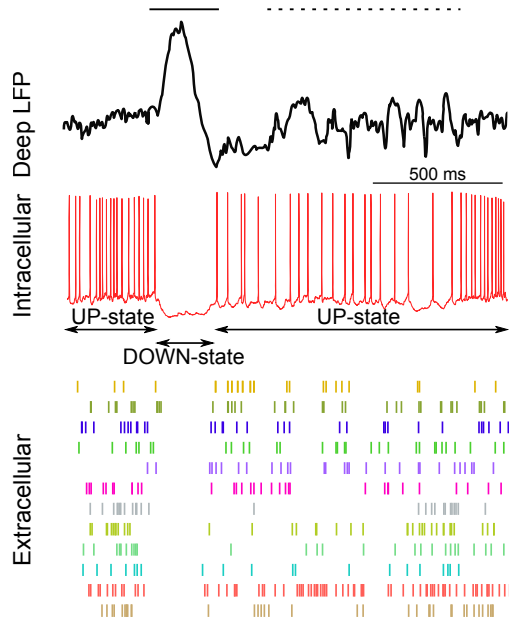

Figure 3.8: Cortical NREM rhythms. Example of simultaneous LFP (top) and extracellular recordings (bottom) in deep layers of prefrontal cortex in the rat. Intracellular recording of a layer V neocortical neuron has been added for schematic representation (middle). Cell membrane potential drops during the DOWN-states, associated with a positive wave at the LFP level (delta wave, solid line) and a silent epoch in neuronal activity. Unit activity resumes at the end of the delta wave (UP-state). Note the spindle (dashed line) following the delta wave in the LFP signal.

3.3.2 Brain Rhythm Taxonomy

Sleep Rhythms

Neocortex The most studied sleep rhythms are those generated by the neocortex, since most can be recorded with scalp EEG electrodes. In contrast to REM sleep, during NREM sleep the neocortex generates several characteristic rhythms during NREM sleep (infraslow, beta, gamma; Buzsaki et al. 2013;

⁷However, a recent report proposes an improved sleep scoring method for rodents that reveals human-like stages (Lacroix et al. 2018).

Figure 3.8). However, the hallmark patterns of the sleeping neocortex are the slow oscillations, delta waves, and spindles:

- **Slow oscillations.** The intracellular membrane potential of neocortical cells has a characteristic slow oscillation ($< 1\text{Hz}$), that is, repeated alternation between a depolarized state, allowing the generation of action potentials (UP state), and a hyperpolarized silent state (DOWN state; Figure 3.8; Steriade et al. 1993b). These states are well-synchronized over broad areas of the cortex generating rhythmic, ‘slow waves’ in the EEG.
- **Delta waves.** A transient cessation of extracellularly recorded firing activity, and a positive deflection known as the delta wave, of the LFP characterize the DOWN state of slow oscillations recorded in deep cortical layers (Sirota and Buzsáki 2005).
- **Sleep spindles.** While delta waves occur at a rather constant 1Hz rate during SWS, every 5 to 15 seconds they are immediately followed by 1-3 second long ‘waxing-and-waning’ oscillations of 7-14 Hz called spindles (Steriade et al. 1993a). While $\sim 40\%$ of spindle follow delta waves (Maingret et al. 2016), they can also occur in an isolated manner (Sirota and Buzsáki 2005; Peyrache et al. 2011).

Hippocampus Like the cortex, during SWS, the HPC LFP is defined by large-amplitude irregular activity (LIA). LIA is also present during drowsiness, quiet wakefulness, consummatory behaviors such as drinking and eating, and immobility in general. This large irregular LFP activity is characterized by the irregular occurrence (0.01 - 2 Hz) of transient events called **sharp waves** (SPW; Figure 3.9; O’Keefe 1976; Buzsáki and Vanderwolf 1983; Buzsáki 1986). Sharp waves last 50 to 150 ms and have a maximum amplitude in stratum radiatum and reverse in the pyramidal layer. Around 10-20% of HPC cells are activated during one sharp wave event and the HPC firing activity increases several-fold during SPW compared to theta oscillations (Csicsvari et al. 2000; Csicsvari et al. 1999). SPW are accompanied by a brief (50-150 ms), high-frequency LFP event (120-250 Hz) mostly detectable in the pyramidal layer: the **ripple**. This oscillation results from the simultaneous massive excitation of pyramidal cells and interneurons in the pyramidal layer. SPWs and ripples form the *sharp-wave-ripple complex* (SPW-R). Ripples can be either local or propagate along the septo-temporal HPC axis, although activity in the septal and temporal poles appear to be independent (Patel et al. 2013; Csicsvari et al. 2000).

Ripple events were long thought to originate in the CA3 region where transient bursts of collective firing would lead to the massive excitation of CA1 dendrites at the level of stratum radiatum through Schaffer collaterals (Buzsaki et al. 1992; Hunt et al. 2018). However, recently, it was shown that a subpopulation

of CA2 cells plays an important role in triggering ripples (Oliva et al. 2016)⁸ CA1 activity may originate from local circuit dynamics (Stark et al. 2015).

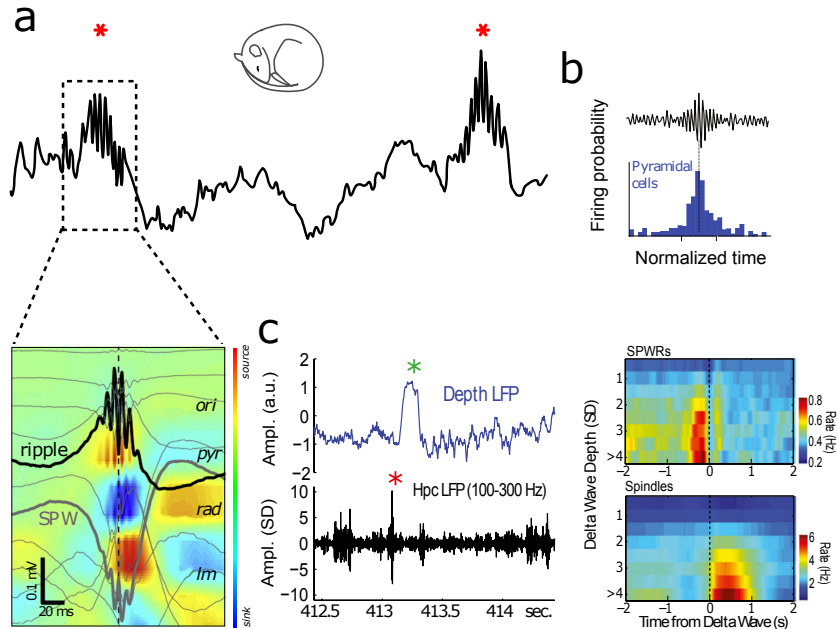

Figure 3.9: Hippocampal sharp wave-ripples. (a), (Top) Hippocampal LFP recorded in CA1 stratum pyramidale during sleep. Stars indicate ripple peaks. (Bottom left) Depth profile of sharp-wave ripples (solid lines) superimposed on current source density (CSD) map of the same events. Note the large sink in the *stratum radiatum* (sharp wave, SPW) and the fast alternation between sinks and sources in the pyramidal layer (ripple). (b), Spiking activity of pyramidal cells during SPW-Rs. (c) Interrelationship between sharp wave-ripples, spindles, and the neocortical slow oscillation. Left, example of simultaneous unfiltered mPFC LFP (upper trace, green asterisk indicates a delta wave) and hippocampal LFP in the pyramidal layer filtered in the ripple band (lower trace, red asterisk indicates a detected SPW-R). Right-top, Cross-correlograms of delta waves (reference) and SPW-Rs occurrence time in function of delta wave onset time (expressed in z-score of the filtered LFP in the 0.1–4 Hz band). Right-bottom, same but for spindle peaks. Panel a is adapted from (Sullivan et al. 2014) (Girardeau and Zugaro 2011), panel b from (Klausberger and Somogyi 2008), and panel c from (Peyrache et al. 2011).

⁸Extra-hippocampal inputs, including neuromodulation (Miyawaki et al. 2014; Vandecasteele et al. 2014; Wang et al. 2015a; Novitskaya et al. 2016) may also affect ripple timing.

Awake Rhythms of the Rodent Brain

The Theta Rhythm During active exploration and REM sleep, the HPC LFP displays a regular sinewave-like oscillation at 7-12 Hz (in rodents) called the theta rhythm (Figure 3.10; Vanderwolf 1969). Theta originates in the CA fields from the rhythmic alternation of excitation and inhibition from two dipoles: one in the pyramidal layer and another in the stratum lacunosum-moleculare. The theta oscillations can be recorded in LFPs throughout the hippocampal formation, as well as in the septum, the amygdala and the prefrontal cortex (Buzsáki 2002). While it has been principally characterized in studies in rodents, theta was also shown in the human hippocampus during virtual navigation (Ekstrom et al. 2005).

The theta synchronous afferent activity (that is detected as theta LFP) actively modulate HPC neuronal firing and pyramidal cells tend to fire at the trough of the oscillation, whereas the various interneurons have different preferred firing phases (Klausberger and Somogyi 2008). Theta propagates along the septo-temporal axis of the HPC (Lubenov and Siapas 2009) with a 180° shift in phase between the septal and temporal poles (Patel et al. 2012). This suggests that the output of HPC projection neurons is temporally segregated between its dorsal and ventral portions which would influence their targeted brain areas differentially. Theta has several rhythm generators. The medial septum and the entorhinal cortex are historically considered as its major pace-makers, however there is also evidence of intrahippocampal generators at the level of CA3 and CA1 (Buzsáki 2002; Goutagny et al. 2009; Montgomery et al. 2009).

Gamma oscillations Many different oscillatory phenomena between 25 and 140 Hz are called gamma oscillations, and they have been described in many brain areas including the olfactory bulb, several areas of the neocortex, the EC, the amygdala, the hippocampus, the striatum, and the thalamus (Buzsáki and Wang 2012). Despite this wide frequency range, they all originate as relatively local phenomena and share similar generation mechanisms. Gamma oscillations are likely generated by the interaction of fast excitatory-inhibitory feedback loops between glutamatergic pyramidal cells and GABAergic interneurons. The characteristic frequencies of gamma oscillations have been shown to vary across brain regions, species, network states, and even cycle-by-cycle excitation-inhibition balance.

The expression ‘fast gamma’ (or ‘high gamma’) is frequently employed to define a frequency band between 90 and 140 Hz (e.g., Stujenske et al. 2014 see 4.4.3). However, some studies revealed that a large fraction of the power in this high-frequency band derives from spikes and spike afterpotentials (Belluscio et al.

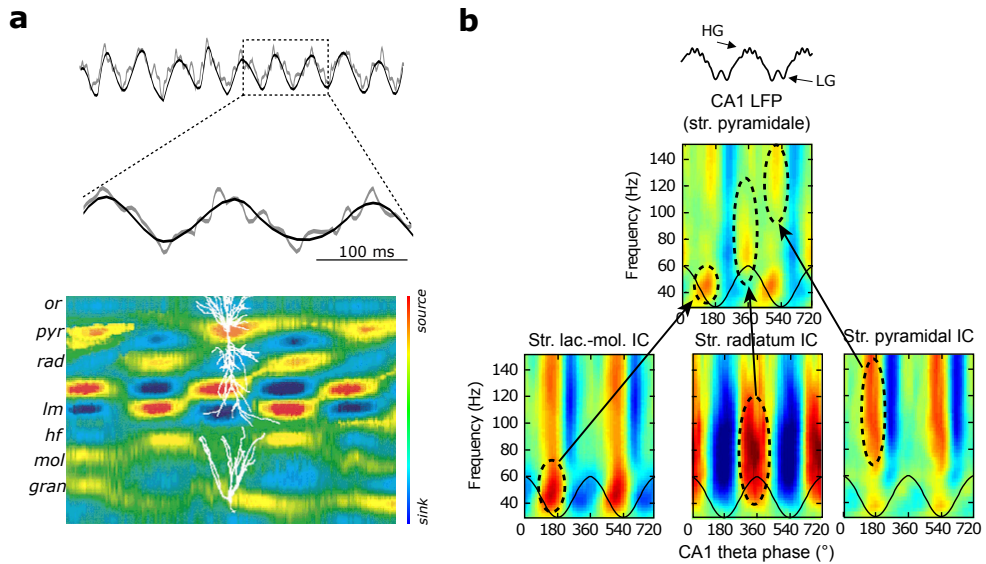

Figure 3.10: Theta and gamma oscillations and associated hippocampal firing. (a) Extracellular current flow during theta oscillation. (Top) Example LFP displaying the theta oscillation. (Bottom) Associated CSD analysis. A pyramidal cell and a granule cell are represented. Note the alternation of sources and sinks associated with theta phase (panel adapted from Kamondi et al. 1998). (b) Theta nested gamma oscillations. The origins of gamma LFP patterns can be revealed with simultaneous multisite recordings of LFP and spiking activity. Multiple gamma patterns in the rat CA1 stratum (str.) pyramidale LFP (top) are discernible at different frequencies and theta phases during locomotion. On the top, a schematic diagram shows that low-gamma and high-gamma in CA1 occurred closest to the trough and peaks, respectively, of CA1 theta. High-density silicon electrode arrays spanning multiple layers provide sufficient coverage and spatial resolution to employ independent component analysis to decompose CA1 LFPs into different physiological components. Arrows indicate independent components (ICs) corresponding to currents in str. lacunosum-moleculare (lac.-mol., bottom left), str. radiatum (bottom middle) and str. pyramidale (bottom right), that were at matching frequencies and theta phases to the three gamma sub-bands visible in the str. pyramidale LFP (panel adapted from Schomburg et al. 2014).

2012b)⁹. Converging evidence argues for a separation between the lower and higher ends of the gamma frequency range in bands respectively called ‘slow gamma’ (or ‘low gamma’, 30-50 Hz) and mid- or mid-range gamma (50-90 Hz; Buzsáki and Schomburg 2015). These three ranges of gamma all occur in short bursts, often embedded and modulated by a slower rhythm such as theta in the hippocampus (Figure 3.10). Different gamma oscillation bands

⁹Hence it was suggested to call the 30-90 Hz band ‘gamma’ and to call the 90-140 Hz band ‘epsilon’ (Buzsáki et al. 2012).

can co-occur at different phases of the same theta cycle (Belluscio et al. 2012a) or be restricted to different theta cycles (Colgin et al. 2009).

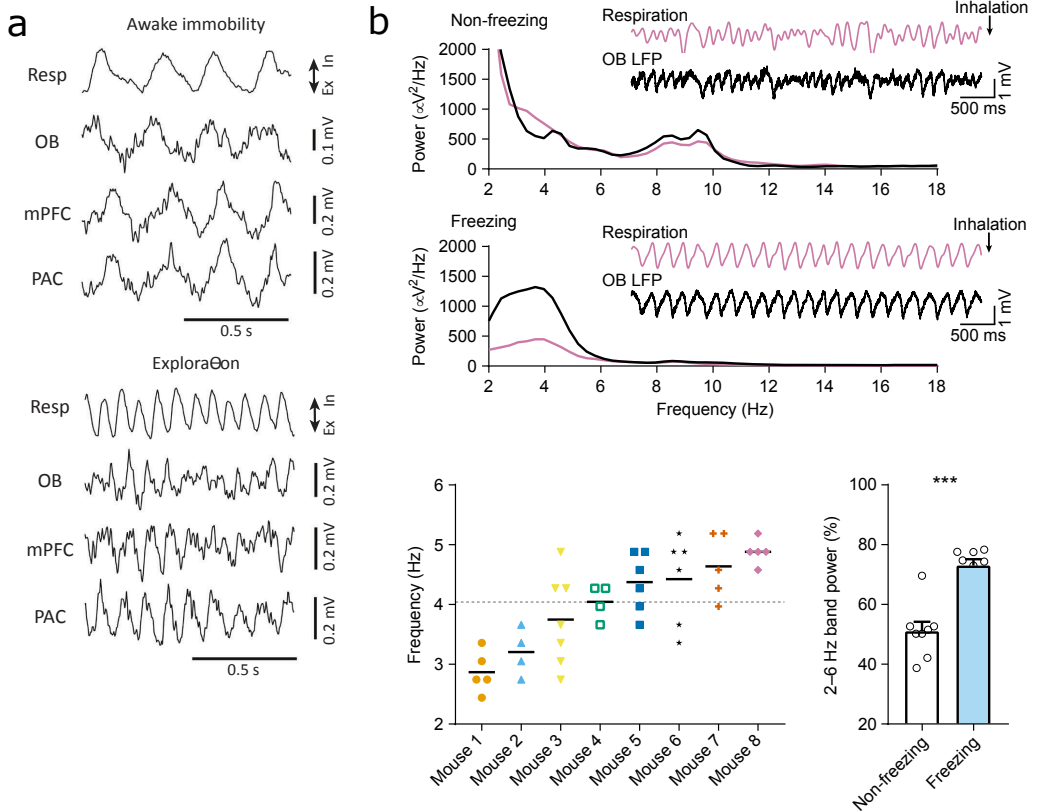

Figure 3.11: Respiration-Entrained LFP Oscillations. (a) Example traces of Respiratory oscillations and simultaneously recorded LFP signals during immobility (top) and exploration (bottom). During immobility, in all brain regions (mPFC, olfactory bulb OB, and parietal cortex PAC) respiration-entrained oscillations are prominent. During exploration they are also visible but less discernible due to concomitant presence of theta (panel from Tort et al. 2018). (b) Top, power spectral density of the respiration oscillations and OB LFP recordings during non-freezing and freezing (bottom) periods. Insets show simultaneously recorded, unfiltered respiration and OB signals. Bottom, respiratory frequency variability across 8 mice during continuous freezing episodes longer than 5 s (left). Power in the 2–6 Hz band during non-freezing baseline is compared to freezing periods (right, panels from Moberly et al. 2018).

Respiration-Entrained Oscillations It is long known that in the olfactory bulb can be recorded brain rhythms phase-locked to respiratory cycles (Adrian 1942; Tort et al. 2018; Kay et al. 2009; Heck et al. 2019). These oscillations are transmitted to the olfactory cortex (Fontanini et al. 2003; Fontanini and Bower 2005) but also to more distant brain regions such as the barrel cortex (Ito et al. 2014), the HPC (Lockmann et al. 2016; Chi et al. 2016; Yanovsky et al. 2014), the mPFC (Zhong et al. 2017; Biskamp et al. 2017b). Bulbectomy abolishes respiratory oscillations, showing that they are not artifacts and originate in the olfactory bulb (Liu et al. 2017; Bagur et al. 2018; Ito et al. 2014; Biskamp et al. 2017b). They coordinate firing activity and strongly organize gamma frequencies (Zhong et al. 2017) and hippocampal ripples (Liu et al. 2017). Their frequency depends on the animal's breathing rate, which in rodents, depending on the behavioral state, ranges between 2 to 14 Hz. Hence, the overlap of respiration coupled LFP frequency with delta and theta rhythms has probably been a source of confounds in the literature (Tort et al. 2018; Heck et al. 2019). During freezing, mice breathe at ~ 4 Hz, generating prominent 4 Hz oscillations in many brain areas that have been critically involved in fear behavior (Moberly et al. 2018; Dejean et al. 2016; Karalis et al. 2016; Bagur et al. 2018; Karalis and Sirota 2018; see 4.4.2).

3.3.3 Prefrontal-Hippocampal Interplay during Memory Encoding

About 35% of mPFC neurons and neocortical gamma bursts are modulated by HPC theta (Siapas et al. 2005; Sirota et al. 2008). The LFP of HPC and mPFC have coherent theta oscillations during active behavior (Sirota et al. 2008; Jones and Wilson 2005) that is stronger when animals are engaged in a memory task and is absent during incorrect recall (Jones and Wilson 2005), suggesting that it is critical for behavioral performance. Similarly, learning new rules in an appetitive behavioural choice task is accompanied by increased coherence of theta oscillations of the LFP between the HPC and the mPFC. During these high coherence states, upon new learning, task-related cell assemblies emerge in the mPFC (Benchenane et al. 2010a). Furthermore, HPC-PFC theta coherence, as well as the proportion of phase-locked neurons in both areas, increase after successful learning of an object-place association (Kim et al. 2011). Beyond theta coupling, HPC-mPFC synchrony in the gamma band may underpin the encoding of task-related spatial information in the mPFC (Spellman et al. 2015). Therefore, the communication between the HPC and mPFC may rely on oscillatory synchrony over multiple time-scales.

3.4 Role of Sleep in Memory Consolidation

Hartley (1801) was the first to postulate that sleeping had mentally restorative effects, with positive effects on memory consolidation. Since the origin

of experimental psychology, it was demonstrated that memory benefits from sleep (Jenkins and Dallenbach 1924). Today a wide literature supports the notion that both NREM and REM sleep play a key role in promoting memory consolidation (e.g., Inostroza et al. 2013; Binder et al. 2012; Smith et al. 1974; Tagney 1973; for reviews see Rasch and Born 2013; Rolls et al. 2011; Smith 1995). However, the nature of the distinct and mutual contributions of REM and NREM sleep is still under debate. The total number of NREM-REM transitions correlates positively with memory performance on an active avoidance task in rats (Ambrosini et al. 1992; Ambrosini et al. 1993). During sleep, cellular and molecular mechanisms that are crucial for memory consolidation take place. For instance, REM sleep was shown to be important for the plasticity mechanisms taking place in the amygdala and HPC in rats after learning of an avoidance task (Datta et al. 2008). Current data support the hypothesis that REM and NREM sleep interact and reinforce each other (Grosmark et al. 2012; Miyawaki and Diba 2016) and it seems that sleep continuity, rather than relative proportions between REM and NREM sleep, is essential for memory consolidation (Rolls et al. 2011). The most influential theory about the role of sleep in cellular plasticity processes is the synaptic homeostasis hypothesis. This model posits that while the synaptic potentiation that takes place during learning overall increases the firing rate of the concerned neural populations, subsequent sleep plays a homeostatic role and globally downscale all synapses, thus decreasing the firing rates to baseline (Tononi and Cirelli 2014). Indeed, recordings in the cortex (Vyazovskiy et al. 2009) and the HPC (Grosmark et al. 2012; Miyawaki and Diba 2016) showed a decrease in firing during sleep compared to waking cycles¹⁰. However neurons with high and low firing change their activity differently during sleep cycles (Watson et al. 2016; Levenstein et al. 2017; Ven et al. 2016; Grosmark and Buzsáki 2016). Even though the changes in firing rate may not be consistent for all neurons during sleep, recent studies provided strong confirmation for synaptic downscaling in the neocortex with both decrease of synaptic spines' size and removal of glutamate receptors (De Vivo et al. 2017; Diering et al. 2017).

3.4.1 Sleep oscillations and memory consolidation

Specific oscillatory events are essential for memory consolidation. Both cortical and hippocampal NREM rhythms have been shown to favorize synaptic potentiation (Sejnowski and Destexhe 2000; Astori et al. 2013; Rosanova and Ulrich 2005). Sleep spindles facilitate synaptic plasticity (Rosanova and Ulrich 2005), and several studies reported that spindle incidence correlates with memory formation and consolidation. For instance, spindle density increases selectively in the first hour of sleep after learning and recall of an odor-reward association task (Eschenko et al. 2006). Similarly, the incidence of SPW-Rs increases after learning and recall (Figure 3.12a,b; Ramadan et al. 2009; Eschenko et al. 2008). As the increased incidence of SPW-Rs following training

¹⁰AMG neurons, however, increase their firing rate during REM sleep

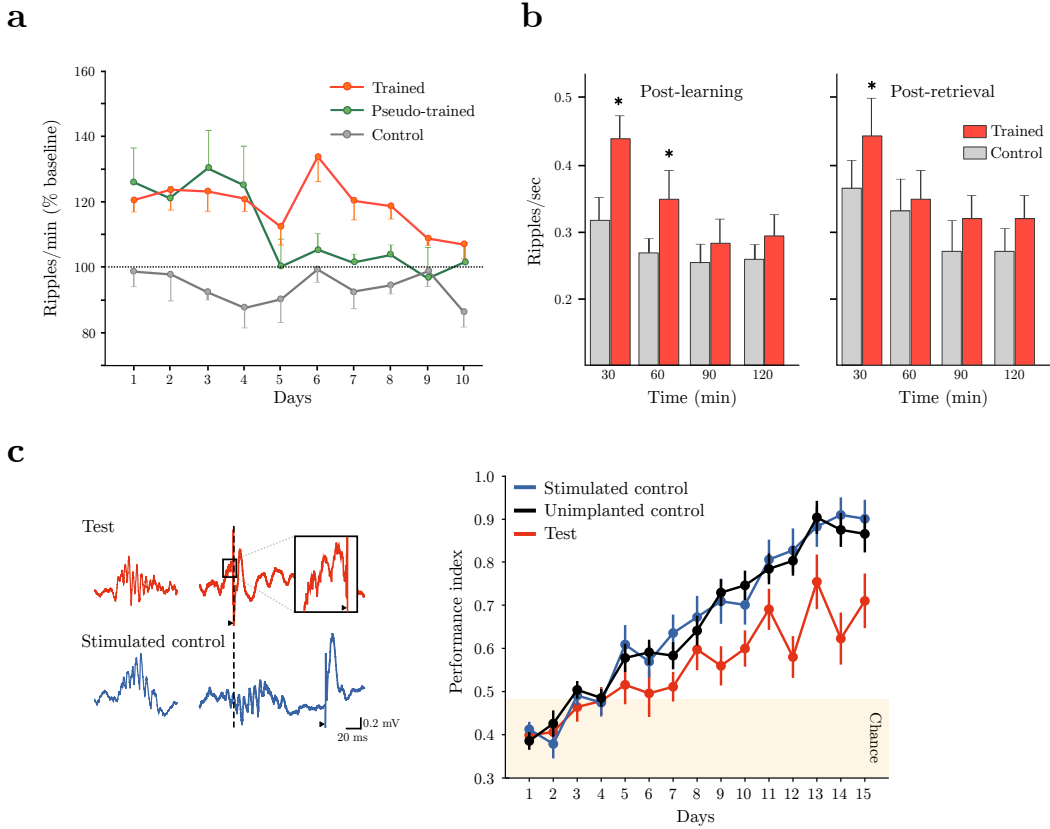

Figure 3.12: Sleep SPW-Rs and memory in rats. (a) Increased SPW-R incidence during sleep following training on a spatial memory task. Rats were either trained on an 8-arm radial maze where the same three arms were baited everyday, or pseudo-trained on the same maze with all arms baited. Both pseudo-trained and trained rats showed a marked increase in SPW-R density after the first sessions of training, compared to a homecage control group. A supplementary increase was observed in the trained group concomitant with a significant improvement in performance after the 6th day of training (panel adapted from Ramadan et al. 2009). (b) (Left) SPW-R incidence is enhanced in the first hour of sleep following training on an odour-reward association task. (Right) An increase in SPWR density is also present during sleep immediately after recall (panel adapted from Eschenko et al. 2008). (c) Suppression of SPW-Rs interferes with memory consolidation. Commissural stimulations were delivered during sleep following training on the radial maze task. In test animals, SPW-Rs were disrupted upon detection; in a control condition, stimulations were delivered outside of SPW-Rs. Compared to unimplanted (black, naive) or stimulated control rats, test rats are impaired in the radial maze task (panel adapted from Girardeau et al. 2009).

closely matches the increase in spindle density following training these results reinforce the idea of a hippocampo-cortical dialogue during memory consolidation after acquisition, and reconsolidation after memory retrieval. One possible

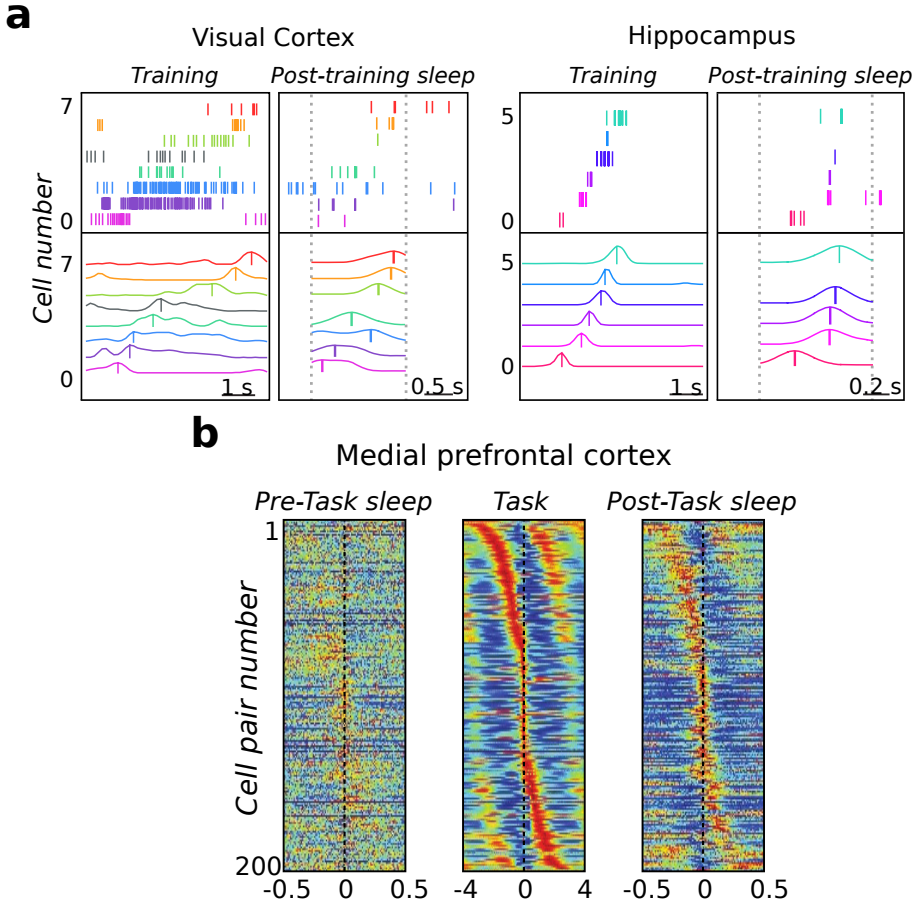

Figure 3.13: Reactivations of experience-induced patterns in cortical areas. (a) Sequential cell activity emerges both in the visual cortex and in the hippocampus during behaviour (Top, example raster plots for a single trial; bottom, average firing rate for each cell over all trials, ordered according to their firing peak). During subsequent sleep, sequences reactivations occur in both regions, sometimes in an inter-area temporally coincident manner. Furthermore, in a few cases, joint reactivations represented the same experience (panel from Ji and Wilson 2007). (b) Cross correlation between mPFC cell pairs formed during training are preserved during following sleep, in a temporally compressed manner (each row is a cross-correlogram between two mPFC cells shown as a heat map; adapted from Euston et al. 2007).

explanation is that the high frequency of hippocampal SPW-R and associated

neural firing facilitate long term plasticity changes (Buzsáki 1984; King et al. 1999; Behrens et al. 2005; Sadowski et al. 2016). Going beyond correlative evidence between ripple occurrence and memory performance, Girardeau et al. (2009; also reported by EgoStengel and Wilson 2010) provided causal evidence for the role of HPC ripples in spatial memory consolidation. During SWS sleep following training, online detection of ripple onsets triggered electrical stimulation to the hippocampal commissure which blocked further development of the oscillation. Ripples suppression induced learning rate deficits while electrical stimulation at a staggered interval from ripple occurrence in control animals did not (Figure 3.12).

Neural Reactivations During Sleep According to the two-stage model of memory consolidation, during awake the HPC rapidly encodes information received from the neocortex via the EC (Chrobak and Buzsáki 1996) while during sleep the information flows in the opposite direction: this allows the memory stored in the HPC to be relayed to the neocortex, particularly during ripples. Consistently with Buzsáki's prediction (1989), during sleep the HPC replays experience-related activity, specifically during ripple events (cf. 4.2.3; Figure 3.13). Recent studies have also shown sleep reactivations of neural activity in the parietal (Qin et al. 1997), visual (Ji and Wilson 2007), entorhinal (Ólafsdóttir et al. 2016), and mPFC (Euston et al. 2007; Johnson et al. 2010) cortices, as well as in the striatum (Lansink et al. 2008; Pennartz et al. 2004; Lansink et al. 2009), thalamus (Peyrache et al. 2015), and amygdala (Girardeau et al. 2017). Crucially, in the HPC and mPFC, sleep reactivations take place in a time-compressed manner that is compatible with Hebbian plasticity mechanisms like STDP (Sadowski et al. 2016; Carr et al. 2011; O'Neill et al. 2010; Euston et al. 2007).

In the past decade, many reports drew a link between HPC reactivations during sleep and memory consolidation. Dupret et al. (2010) recorded the sleep reactivations of CA1 cell assemblies that represented newly learned reward locations in a spatial task. The authors showed that the number of times a given reward location was reactivated predicted how well the animals would remember it in subsequent tests. In order to test the causality of such reactivations, De Lavilleon et al. (2015) created artificial place-reward associations during HPC reactivations (Figure 3.14). They stimulated the medial forebrain bundle (containing reinforcement-related dopaminergic fibers) in mice during exploration of a specific site in an environment induces a place preference in mice. During sleep, when HPC activity associated to a particular location was reactivated, the same stimulation induced a strong preference for that location in subsequent explorations.

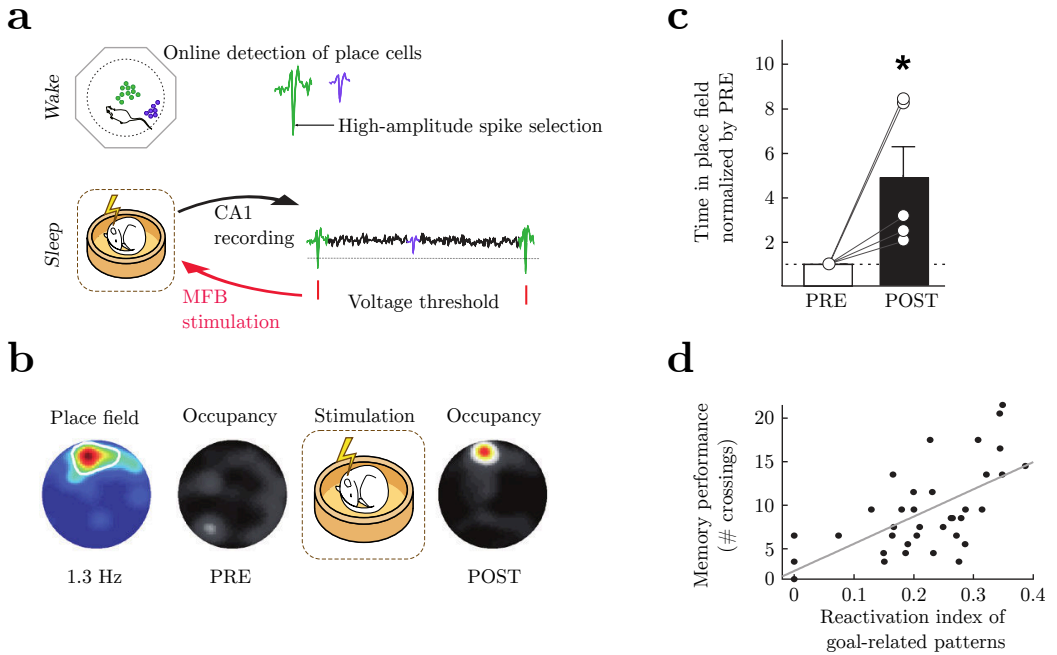

Figure 3.14: Hippocampal reactivations and memory. (a) Place cell-triggered medial forebrain bundle (MFB) stimulation to create an artificial place-reward association. Place cells and associated place fields were detected online, during awake exploration. During subsequent sleep, a voltage threshold was set to be selectively crossed by high amplitude spikes from one identified place cell. Threshold-crossing triggered MFB stimulations. (b) Example session and associated results. (Left), identified place field corresponding to selected high-spike amplitude cell. (Centre left), colour-coded occupancy map during PRE session. (Right), following MFB stimulation during sleep, the animal preferentially occupied the corresponding place field area (hot colours). (c) Time spent in place field following associated place cell-triggered MFB stimulations. Note the strong place preference following stimulation epochs (POST). (d) Correlation between the number of times a given goal location was reactivated during NREM sleep SPW-Rs and subsequent animal’s memory performance on a spatial memory task, indicating a crucial role for SPW-R-associated reactivations for the stabilization of recently acquired memories. Panel a-c adapted from (De Lavilléon et al. 2015), panel d from (Dupret et al. 2010).

3.4.2 Prefrontal-Hippocampal Interplay In Memory Consolidation

Peyrache et al. (2009) provided the first evidence of a functional relationship between HPC ripples and prefrontal reactivations of task-related cell assemblies. They showed that mPFC assembly reactivations significantly increased

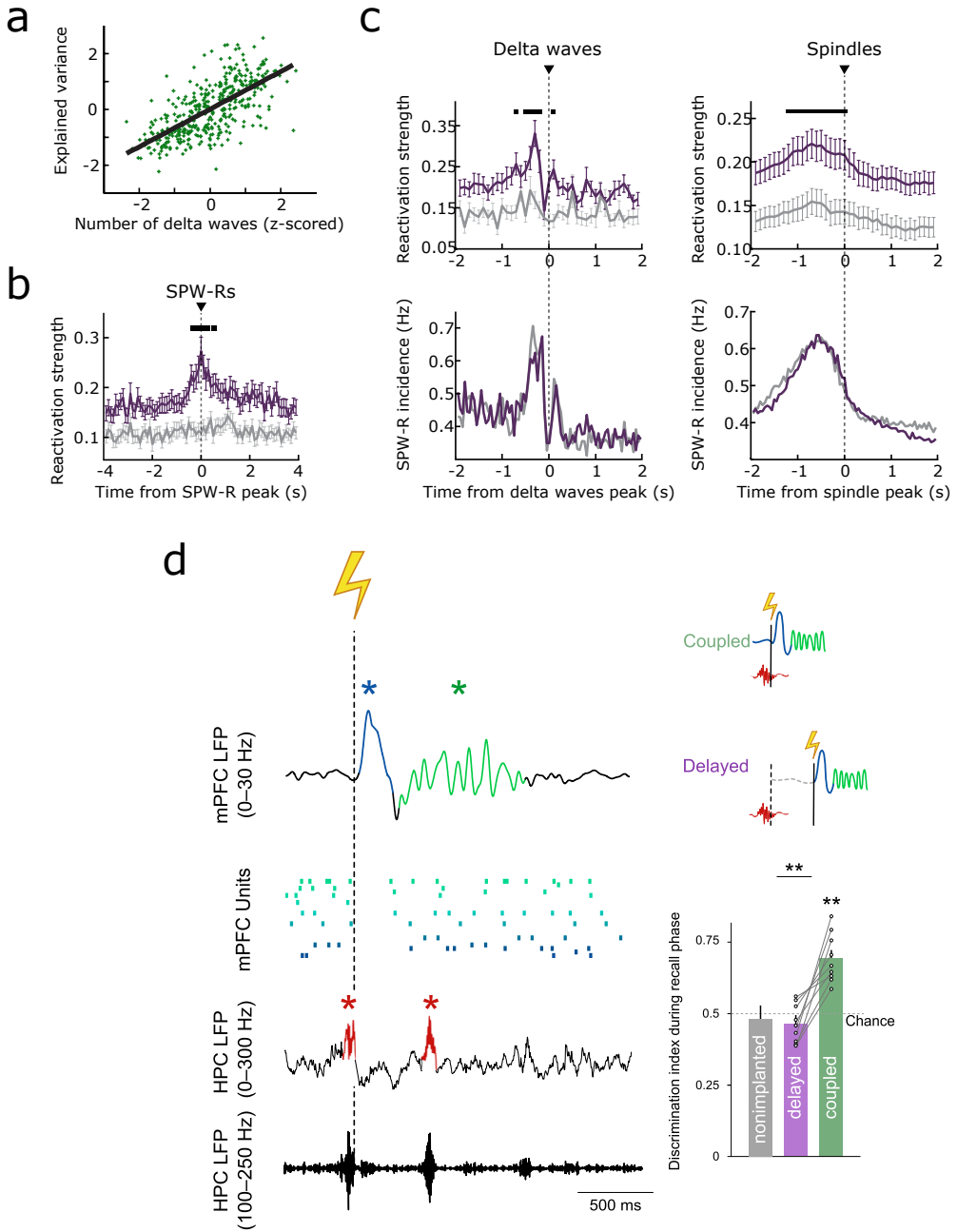

Figure 3.15: Cortical reactivations, delta waves, HPC ripples and memory consolidation. [caption on the following page]

Figure 3.15: [continued from previous page] (a) Linear regression plot between a measure of prefrontal reactivation and delta waves density during NREM sleep. The z-score of the explained variance, a measure of reactivation, is on the y-axis; the z-score of the number of delta waves is on the x-axis. Note the strong correlation between prefrontal reactivation and the density of delta waves. (b) Reactivation strength in mPFC is increased during SPW-R events in sleep following training (purple) compared to sleep preceding training (grey) on a set-shifting task. The peak correlation occurs 40 ms after the peak of the ripples, indicating that SPW-Rs lead mPFC reactivations. (c) Reactivation strength and SPW-R rate are both temporally correlated to cortical SWS rhythms including delta waves and spindles. The black bars indicate significance. (d) Ripple-delta coupling reinforces memory consolidation. Left, example of a ripple-triggered (red) delta wave (blue) induction followed by a spindle (green). Right, artificial delta induction boosted memory recall the following day only when triggered upon ripple detection. Panel a is adapted from (Johnson et al. 2010), panel b-c from (Peyrache et al. 2009), panel d from (Todorova and Zugaro 2018)

in the SWS after learning compared to sleep before. Moreover, this replay took place at short intervals (~ 40 ms) following HPC ripples and peaked ~ 300 ms before delta waves while preceding spindles at a greater interval (Figure 3.15). These results suggest that HPC ripples could inform mPFC replay and promote the consolidation of behavior-related cell assemblies. The subsequent neocortical oscillatory sequence (delta wave and spindle) would then isolate cortical networks from competing inputs during the associated DOWN-state to promote intracortical processing for consolidation during spindles. Indeed, rather than the individual incidence or strength of HPC ripples and neocortical deltas, memory consolidation critically depends on the temporal coordination between these oscillations (Maingret et al. 2016).

The HPC-mPFC dialogue during sleep could support plasticity at hippocampo-cortical and cortico-cortical synapses. Supporting this hypothesis, Maingret et al. (2016) provided causal evidence that memory consolidation depends upon the temporal coordination between HPC ripples and neocortical delta waves and spindles. Using electrical stimulations of the contralateral motor cortex, they were able to artificially induce delta waves in the mPFC. When delta waves were induced upon HPC ripple detection, memory consolidation was enhanced (Figure 3.15). However, since cortical ripple-triggered reactivations take place before the delta wave but synaptic plasticity in the neocortex is thought to occur during the UP state after the delta wave and during spindles until recently it was unknown how the information transmitted from the HPC may persist in the network during the DOWN state. Todorova et al. (2019) showed that occasionally neocortical cells fire isolated spikes during the delta waves ($\sim 10\%$ of them) and that HPC activity preceding the delta wave could predict the delta spikes. Neurons spiking during the same delta wave formed cell assemblies, suggesting that the ‘silence’ during DOWN states may be a mechanisms to isolate crucial reactivations for memory consolidation.

4 Neural Coding of Fear Learning and Defensive Behavior

4.1	Amygdala	108
4.1.1	Fear Acquisition in basolateral complex of the amygdala (blCA) Circuits	108
4.1.2	central amygdalar nucleus (CeA) Regulates Defensive Behavior	109
4.1.3	Control of Extinction Learning by basal amygdala (BA) Circuits	111
4.2	Hippocampus	113
4.2.1	Hippocampal Coding for Space and Context	115
	Ventral vs. dorsal hippocampus (HPC) spatial codes	117
4.2.2	Modulation of Contextual Coding by Fear and Anxiety	117
4.2.3	Off-line Reactivation of Place Cell Sequences	119
	Hippocampal awake replay and fear memory retrieval	121
4.3	Medial Prefrontal Cortex	123
4.3.1	medial prefrontal cortex (mPFC) Circuit Strategies to Support Emotional Learning and Fear Behavior Control	124
	mPFC Coding for Threatening Stimuli May Support the Conditioning Memory Trace	124
	Neurophysiological Underpinnings of Fear Behavior Modulation by the dorsomedial prefrontal cortex (dmPFC)	127
4.4	Dynamics of the Synchrony between the amygdala (AMG), HPC, and mPFC	132
4.4.1	HPC and BA Inputs to the mPFC Modulate mPFC Coding	132
4.4.2	4 Hz vs. Theta Synchrony during Fear Behavior	134
4.4.3	Theta and Gamma Synchrony, Stimulus Discrimination and Fear Inhibition	135
4.4.4	Interstructure Communication during Sleep Supports Fear Memory Consolidation	137

As discussed in chapter 3, the brain has multiple mechanisms to store memory. Research has made advances in understanding the anatomical, pharmacological, and cellular underpinnings of fear learning. This literature (partly reviewed in chapters 2 and 3) indicates that fear learning requires a continuous exchange of information within a network of different brain areas. Little is known about how the activity of the neurons of this limbic network encode, store, and retrieve fear memory. A key approach to address this issue involves recording neurophysiological activity in behaving animals. This chapter reviews the current picture that we have about the coding mechanisms of fear learning and defensive behavior as revealed by recordings of neural activity in the AMG, HPC, and mPFC during fear learning tasks.

4.1 Amygdala

Although the majority of work investigating the neural coding mechanisms of fear learning has involved recordings in the AMG, reviewing this literature in detail is beyond the scope of the present manuscript. In this section, I briefly describe the current model of information processing by the AMG circuitry, which can be later related to that of the HPC and mPFC. For completeness, recent and seminal reviews are cited.

4.1.1 Fear Acquisition in bICA Circuits

As discussed in 2.1.1, inputs carrying information about the conditioned stimulus (CS) and unconditioned stimulus (US) converge in the lateral amygdala (LA), which is a region of synaptic plasticity processes that are crucial for fear learning (cf. 3.1.1). This convergence of information was first described by Romanski and colleagues (1993) who recorded LA neurons in anesthetized rats and showed that LA single units increased their spiking activity in response to both auditory (clicks) and somatosensory (footshock) stimulations. Therefore, the ability of LA neurons to encode both sounds and shocks suggested that the plasticity processes underpinning the associative learning linking auditory CS to somatosensory footshocks may take place in the LA.

An early suggestion that LA neurons may encode fearful stimuli came from the evidence that LTP induction in the pathway transmitting auditory CS information to LA from the auditory thalamus increased CS-evoked field potentials (Rogan and LeDoux 1995) and that, in the same way, fear conditioning increases CS-evoked field potentials in the LA (Rogan et al. 1997) and the amount of freezing depends on the amount of plasticity in LA (Schafe et al. 2005). Indeed, it has been previously shown that in both the basolateral amygdala (BLA) and CeA multi-unit responses to the CS undergo plastic changes after conditioning (Applegate et al. 1982; Maren et al. 1991). These results supported the hypothesis that fear conditioning induces plastic changes in the amygdala transmission. In two seminal studies, Quirk and colleagues (1995; 1997) recorded LA neurons before, during, and after fear conditioning. They showed that fear conditioning enhances LA neuronal responses to the CS (Quirk et al. 1995) and that this learning-dependent plasticity in LA precedes the response changes in auditory cortex cells (Quirk et al. 1997). Further reinforcing the idea that this plasticity is functional for learning, it takes place before behavioral changes are evident (Repa et al. 2001), and is proportional to the subsequent expression of fear behavior towards the CS (Collins and Paré 2000; Maren 2000; Hobin et al. 2003). Crucially, responses to the CS are not higher in the conditioning context, where animals express high levels of conditioned fear, compared to different contexts where fear behavior outside CS presentation is low (Goosens et al. 2003). Therefore, this increase of spiking

activity is uniquely driven by the associative history of the CS. Even though cells in many different brain regions exhibit changes in their firing behavior after fear conditioning (Thompson et al. 1983), LA is believed to be the site where plastic changes, and therefore learning, takes place first (Schafe et al. 2005).

One possibility is that the US acts as a teaching signal to instruct associative plasticity at CS-activated synapses (Johansen et al. 2010b). This view was reinforced in an optogenetic study that showed that during conditioning, excitation of LA projection neurons can partially substitute for the US (Johansen et al. 2010a) while fear memory can be transiently inactivated by inhibiting the sensory afferents to the LA (Nabavi et al. 2014). Neuromodulation may also be crucially implicated in regulating this process (Uematsu et al. 2015; Johansen et al. 2014; Tully et al. 2007; Fadok et al. 2009; Rosenkranz and Grace 2002).

A small proportion of principal neurons in the BA (both BLA and basomedial amygdala (BMA)), which receive inputs from the LA, also show an increase of the CS-evoked response after fear conditioning (Amano et al. 2011; Herry et al. 2008; Grewe et al. 2017; Figure 4.1). This associative plasticity is gated by two distinct disinhibitory mechanisms within the bICA microcircuitry (Wolff et al. 2014). These neurons likely receive inputs from the LA, integrate this information with inputs coming from BA-projecting structures (such as the mPFC and the HPC) and indeed the activity of these BA-projecting pathways is critical for fear acquisition (cf. 2.2.2 and 2.3.3).

4.1.2 CeA Regulates Defensive Behavior

In turn, BA projects to the CeA, where neurons also increase CS-evoked responses after learning (Ciocchi et al. 2010; Duvarci et al. 2011; Fadok et al. 2017; Sanford et al. 2017). Recall that the CeA provides the major output of the AMG towards fear behavior-controlling structures. Moreover, optogenetic activation of CeA neurons induces conditioned freezing while inhibiting them impairs it (Ciocchi et al. 2010). The dynamic interactions between multiple populations of inhibitory cells in CeA supports fear expression (Ciocchi et al. 2010; Duvarci et al. 2011; Li et al. 2011, see Duvarci and Pare 2014 for a review). Moreover, the recent development of specific optogenetic actuators for specific cell types facilitated an extensive study of these multiple recurrent inhibitory circuits (Fadok et al. 2018). These microcircuits can select and control specific defensive behaviors (Tovote et al. 2016; Fadok et al. 2017; Yu et al. 2016; Isosaka et al. 2015; Sanford et al. 2017; Haubensak et al. 2010). However, the activity of these circuits was shown to also affect appetitive (Kim et al. 2017), predatory (Han et al. 2017), consummatory (Douglass et al. 2017), and anxiety-related (Tye et al. 2011; Botta et al. 2015) behaviors. Their activity is at least partially modulated by the inputs they receive from the bICA (Nam-

4 Neural Coding of Fear Learning and Defensive Behavior

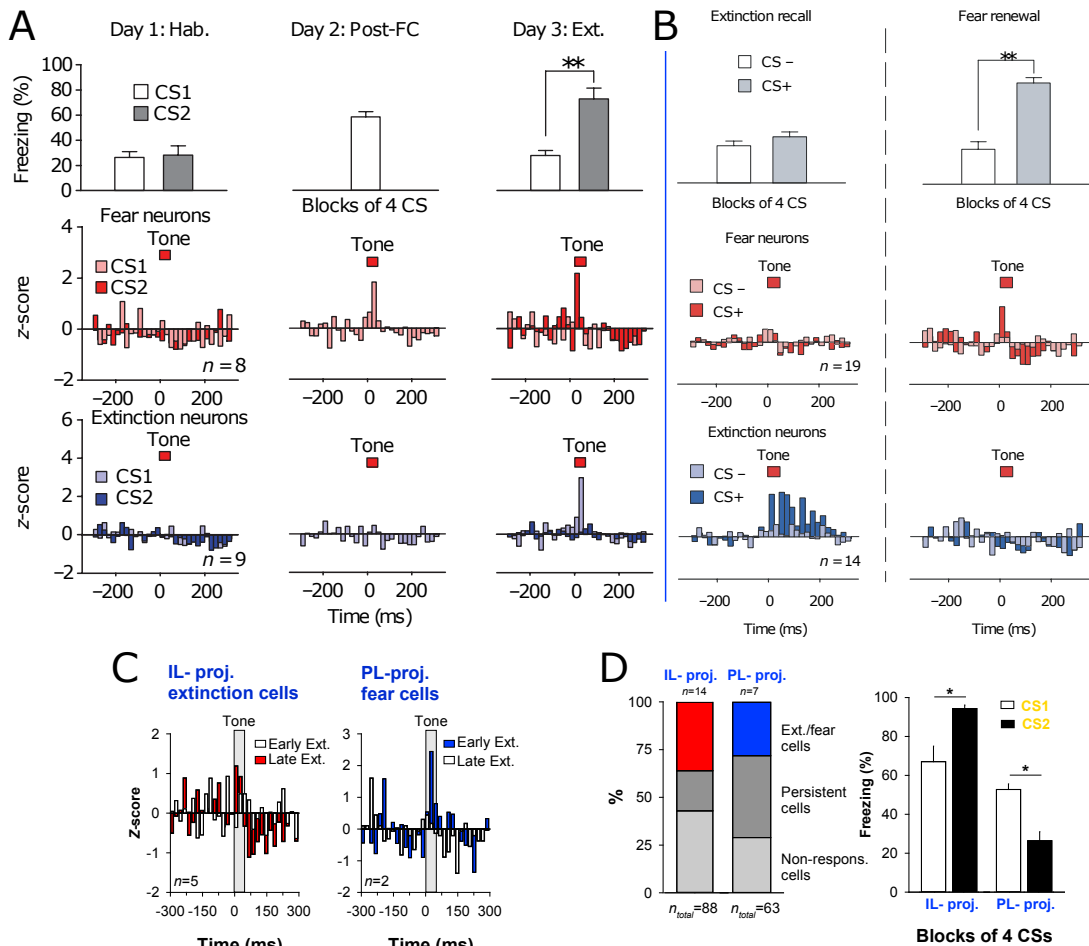

Figure 4.1: Fear and extinction neurons in the BA. (A,B) Representative perit-event time histograms of fear and extinction units in BA across fear learning. (A) In this experiment two different CSs, CS1 and CS2, were paired with a US during conditioning, but only one CS was extinguished. Top: freezing in response to the CSs during before conditioning, after it, and after extinction. CS-evoked firing of fear (middle) and extinction (bottom) neurons at the three stages of learning. Note how fear and extinction neurons did not fire in response to the CSs before conditioning (left), fear neurons did to the presentation of CS1 after conditioning (only CS1 were presented, middle) and to CS2 but not CS1 after extinction (right). Extinction neurons responded only after extinction and to the extinguished CS1. (B) Fear renewal induces a reversal of fear and extinction neurons activity patterns. In this experiment a CS (CS+) was paired to an US during conditioning and another was not (CS-). During extinction recall (left), only extinction neurons display CS-evoked responses and only to CS+. In contrast, during context-dependent fear renewal these neurons stop responding and fear neurons respond to CS+. (C,D) The balance of the activity between infralimbic cortex (IL)- and prelimbic cortex (PL)-projecting BLA neurons controls fear extinction. Excitatory or inhibitory opsins were expressed specifically in BLA neurons projecting to either IL or PL with an intersectional approach. [continued on the following page]

Figure 4.1: [continued from previous page] (C) Histograms illustrating the CS-evoked responses of optogenetically identified IL-projecting extinction neurons (left) and PL-projecting fear neurons (right) in BLA. (D) Left, relative proportions of extinction and fear cells compared to cells persistently responding and not responding in optogenetically identified IL-projecting and PL-projecting neural populations. Right: in this experiment two distinct auditory CSs were both paired with foot shocks. During extinction training, the BLA was illuminated via chronically implanted optic fibers. CS1 was paired with blue and CS2 with yellow light. During retrieval on the next day, CSs were presented without light. Animals exhibited weaker extinction memory (higher freezing) for the CS that was extinguished in conjunction with inhibition of IL-projecting BA neurons (yellow light stimulation). In contrast, when selectively targeting PL-projecting BLA neurons, inhibition of the BLA→PL pathway resulted in increased extinction memory. Panels A and B are reproduced from Herry et al. 2008, panels C-F from Senn et al. 2014.

huri et al. 2015; Li et al. 2013) but also from the paraventricular thalamus (Penzo et al. 2015), the brainstem (carrying nociceptive information necessary for conditioning acquisition; Han et al. 2015), and the ventral hippocampus (vHPC, Xu et al. 2016, cf. 4.1.3).

Furthermore, the CeA is essential for the acquisition and consolidation of conditioned fear behaviors (Fadok et al. 2017; Li et al. 2013; Wilensky et al. 2006; Ciochi et al. 2010) and is potentially implicated in the computation of an aversive predictor error signal in concert with the periaqueductal gray (PAG) (Yu et al. 2017; Ozawa et al. 2017). While the PAG receives sensory inputs about the aversive US, the CeA may send information about the expected aversive outcome to the PAG. This communication between the PAG and CeA is believed to be shared with various amygdalar nuclei, including LA, regulating neural responses to the CS (Ozawa et al. 2017).

4.1.3 Control of Extinction Learning by BA Circuits

The firing of CeA neurons and fear expression are highly correlated, and during extinction learning CS-elicited spiking in CeA decreases in parallel with freezing behavior (Ciochi et al. 2010; Duvarci et al. 2011). BA neurons which densely project to CeA likely control this decrease of fear control activity during extinction. Herry et al. (2008) showed that distinct BA populations fire selectively for conditioning and extinction (Figure 4.1A–B). While some neurons of the LA and BLA persistently respond to the CS across extinction, responses of a second population of cells decline (Repa et al. 2001; Herry et al. 2008; Amano et al. 2011; Grewe et al. 2017). However, in the BA some principal cells become CS-responsive during extinction acquisition (Herry et al. 2008; Amano et al. 2011; Figure 4.1B) and were thus called ‘extinction neurons’. In contrast, BA cells that acquire their CS-responsiveness during conditioning were called ‘fear cells’ if their responses disappear during extinc-

tion or ‘extinction-resistant cells’ otherwise. Activation of BLA paravalbumin interneurons (PV) can inhibit previously encoded fear memory and, at the same time, reduce the activity of extinction-resistant cells after extinction learning (Davis et al. 2017). Therefore, extinction-resistant cells may be involved in the maintenance of the CS-US association after extinction, while fear cells’ activity resembles that of CeA cells and may influence them (Duvarci and Pare 2014). The persistence of responses is consistent with the existence of distinct fear and extinction memory traces. Interestingly, fear neurons receive monosynaptic inputs from the vHPC and target the mPFC, but not the reverse, while extinction cells are bidirectionally connected with the mPFC, but not with the vHPC (Herry et al. 2008).

The reciprocal pathway between the BA and the mPFC is believed to play a significant role in fear regulation, although the respective projections targeting either PL or IL operate differently (Figure 4.1C–D). PL receives direct inputs from BLA neurons expressing immediate early gene (IEG) after fear conditioning while IL inputs come from BLA cells having increased their IEGs expression after extinction (Senn et al. 2014). Critically, the neurons selectively targeting the PL are fear neurons, whereas those projecting to IL are extinction neurons. The activity balance between these two BLA-mPFC pathways regulates the competition between fear and extinction memories. During extinction learning, stimulating BLA terminals in PL promotes fear expression (Burgos-Robles et al. 2017), suggesting that PL’s role in mediating fear expression may depend upon BLA inputs. Inhibiting these terminals reduces freezing and ameliorates extinction recall performance the following day. Conversely, inhibiting IL terminals impairs extinction retrieval the following day (Senn et al. 2014). Moreover, BLA-IL stimulation before conditioning impairs conditioning retention (Klavir et al. 2017). These results suggest that feedback loops from the BLA to the mPFC may be crucial for the offline modulation of long-term emotional memory traces thought to be stored in the mPFC via a mechanism distinct from the one directly controlling behavior online.

Fear Renewal During context-dependent fear renewal, some LA units display a reinstatement of CS-evoked firing (Hobin et al. 2003). Interestingly, dHPC inactivation, in addition to increasing cue-evoked freezing behavior outside of the extinction context (cf. 2.2.2), disrupts this resurgence of CS-elicited activity (Maren and Hobin 2007). Fear neurons of the BLA also reinstate CS-evoked firing during fear renewal (Herry et al. 2008). These results suggest that the HPC sends contextual information to the bICA leading to the resurgence of CS-firing responses there, in turn leading to fear renewal. However, HPC inputs to the CeA, but not bICA, are necessary for fear renewal (Xu et al. 2016; cf. 2.2.2). It is possible that the behavioral deficits observed after the inactivations of the BLA or vHPC are related to an impaired information flow from the bICA to the vHPC rather than the reverse. Consistently, among vHPC-targeting BLA neurons, some project to the CeA-projecting neurons of the vHPC (Xu et al. 2016). Therefore, the vHPC may integrate informa-

tion from the bICA, and possibly the dHPC, and control downstream targets such as the CeA and the mPFC. This is consistent with the observation that the dominant input to BLA fear-engaged cells during renewal comes from the vHPC. (Herry et al. 2008; Knapska et al. 2012).

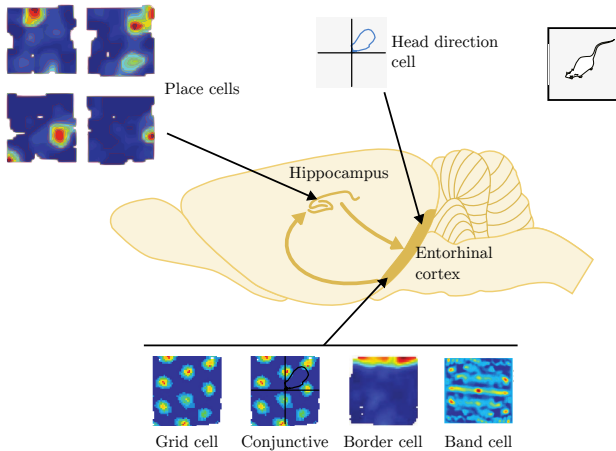

Figure 4.2: Spatial correlates in the hippocampal and para-hippocampal region. Color-coded rate maps for four example place cells recorded in the same environment and for several kinds of spatial cells in the entorhinal cortex. Other areas containing spatially-modulated cells are not shown here. Panel from Mainret 2016.

4.2 Hippocampus

Because of its clear laminar organization and self-contained microcircuitry, the HPC is probably the most studied structure in neurophysiology. It is also the structure whose activity has been most characterized in freely moving animals. However, even though fear conditioning is one of the most widely used behavioral models in neuroscience, few studies have involved recording HPC activity during fear learning tasks (e.g. Laroche et al. 1987). This may be because early studies discovered strikingly spatially modulated firing of HPC cells (Figure 4.2) which can be sampled only in animals actively exploring their environment. Space and context encoding is critical in fear learning (cf. 1.7). However, the spatial properties of HPC neurons are harder to characterize in typical fear learning tasks where rodents are immobile most of the time, leading to a rather modest literature combining these two models.

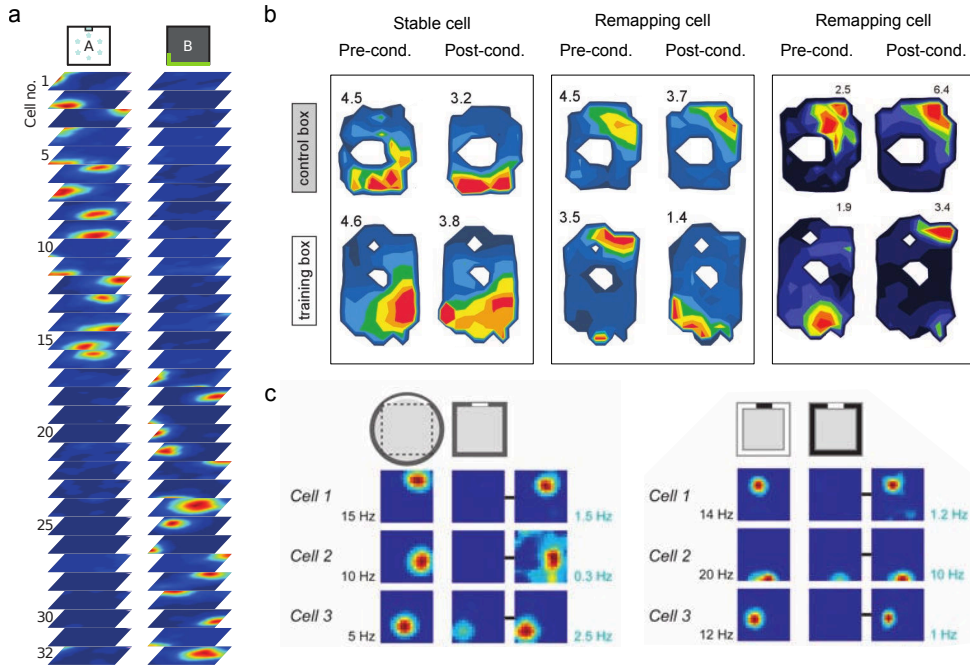

Figure 4.3: Place cell remapping. (a), Illustration of global remapping. Firing-rate maps of 32 simultaneously recorded hippocampal CA3 cells in box A (white floor lights; left) and box B (green wall lights; right). Each map shows a color-coded distribution of firing rates across the square test box (blue, silent; red, maximum). Note strong difference in firing activity of cells between box A and B. (b), Illustration of partial remapping during contextual fear conditioning paradigm. Pre-conditioning (pre-cond.) and post-conditioning (post-cond.) maps in the control box and training box of three example cells. Color-coded firing rates at each location in the box are plotted as a percentage of a scaling factor, equal to 2 SDs above the mean firing rate (Hz) of the cell, shown at top of each map (white space indicates undersampled pixels). (c), Illustration of rate remapping. Color-coded rate maps for cells recorded when the cue configuration was changed by switching either between two shapes (left, only the area common to both shapes is shown) or between two colors (right) at a constant location. Rate maps for two complete sets of simultaneously recorded CA3 neurons. In the middle columns, the data from the opposite condition are plotted at the same firing-rate scale. The right columns contain the same data as the middle but are scaled to their own maximum values (indicated to the right of the rate maps). Note that different experiences in the same place resulted in place fields similar in location and shape, but with different firing intensities, sufficient, in many cases, to make it appear that the field was absent when plotted at the same scale. Panel a reproduced from Jezeq et al. 2011, panel b adapted from Moita et al. 2004, panel c reproduced from Leutgeb et al. 2005a

4.2.1 Hippocampal Coding for Space and Context

As discussed in 1.5, animals can form a cognitive representation of the environment that is instrumental for navigation and decision making. Furthermore, this is also crucial in context encoding and retrieval that contributes to fear learning and recall (cf. 1.7). Principal cells of the HPC display firing fields restricted to specific locations of the environment explored by an animal (Figure 4.2; O'Keefe and Dostrovsky 1971; Moser et al. 2008). These neurons are called *place cells* and correspond to $\pm 50\%$ of the whole population of principal neurons of the HPC (O'Keefe 1976; Gothard et al. 1996). Thanks to firing fields that are univocal, localized, and independent from each other (Redish et al. 2001), the place cell population can form an ensemble code for space (Wilson and McNaughton 1993). This ensemble code may correspond to the neural basis of a Tolmanian cognitive map (O'Keefe and Nadel 1978).

Beyond space, hippocampal activity can respond to stimuli from a wide range of different sensorial and motivational modalities (Ranck 1973; Eichenbaum et al. 1999; Young et al. 1994a; Wiener et al. 1989; Eichenbaum 2018b; Wood et al. 2000; Pastalkova et al. 2008; Lenck-Santini et al. 2001; Smith and Mizumori 2006; Wiener 1996). The HPC associate to each location information regarding these non-spatial components of the experience. For instance, hippocampal neurons develop specific responses while the animal learns about outcomes associated with a particular object in a particular context (Komorowski et al. 2009): this combined code consists of object-specific responses among a pre-existing subpopulation of spatial representations, supporting the idea that the acquisition of context-specific memory may support these mixed representations in the hippocampus.

Therefore, hippocampal maps store location-associated experiences and place cells are hippocampal memory vectors carrying various pieces of information associated to given locations (Eichenbaum et al. 2007). Place field stability, namely the persistence of the capacity to retrieve the same firing spatial pattern across trials in the same environment (Thompson and Best 1990), provides evidence that these neuronal populations are one of the neural correlates of spatial memory (Kentros et al. 2004). Spatial firing of hippocampal neurons could support memory of environments and their features, and field stability can be viewed as successful retrieval of animal's mnemonic representation of space. However, changes in environmental stimuli can cause drastic variations in hippocampal and entorhinal spatial responses; these variations are referred to as remapping (Figure 4.3 Muller and Kubie 1987). The representation change can correspond to deformation of firing fields (O'Keefe and Burgess 1996), variation in firing rate ('rate remapping', Leutgeb et al. 2005b), or a global change both in position of fields and firing rates, with silent cells developing fields while some of the previously active cells become silent (O'Keefe and Conway 1978; Leutgeb et al. 2004). Even though remapping follows changes in the geometry and visual features of the environment (Wills

4 Neural Coding of Fear Learning and Defensive Behavior

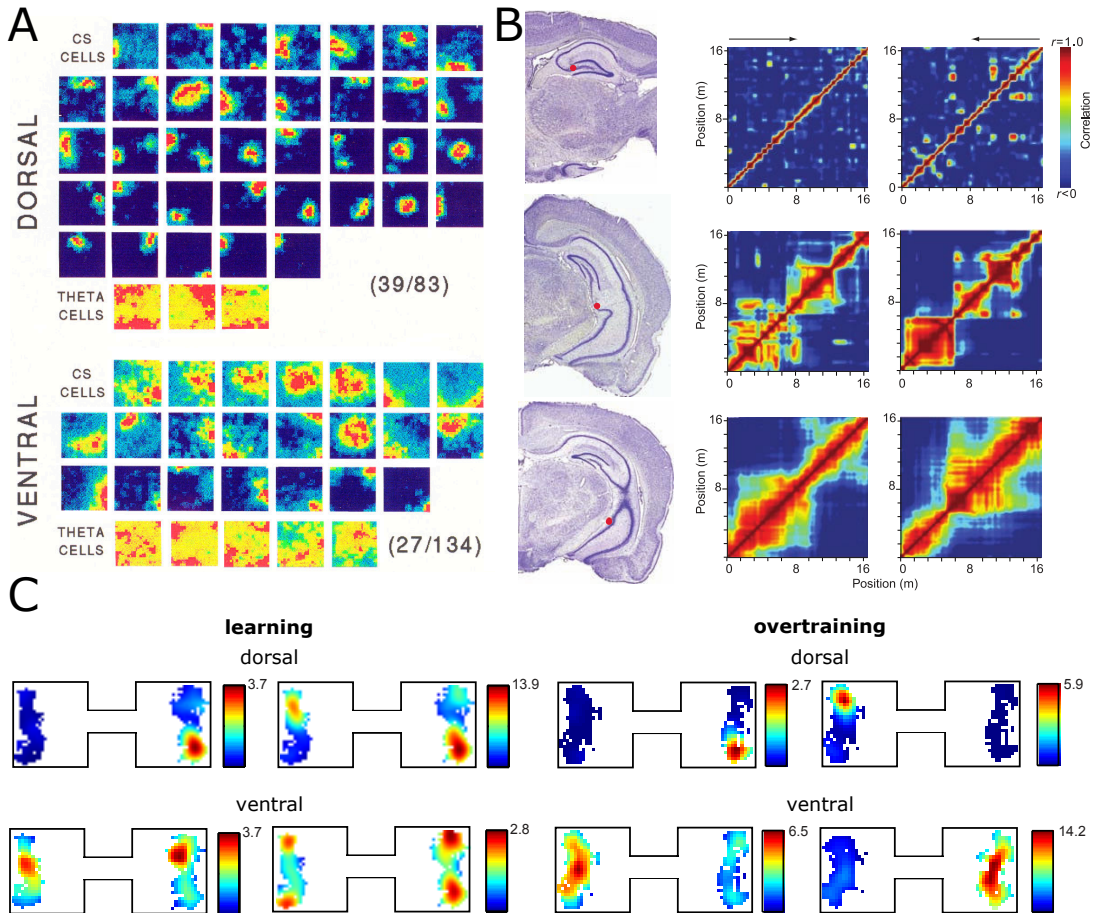

Figure 4.4: Ventral Hippocampus spatial code. (A) Spatial firing maps for place cells and theta modulated interneurons. Each panel represents the spatial distribution of the firing rate for one cell. Red indicates maximal firing rates, which are different for each cell, and dark blue indicates no firing. For each cell type, cells are arranged depending on their information content measures in the ascending order (panel from Jung et al. 1994). (B) Spatial representation scale increases linearly across hippocampal septo-temporal axis. Left, recording electrode placement in the dorsal (top), intermediate (middle), and ventral (bottom) CA3. Cells from these locations were recorded as rats transversed a linear track. Rate maps of all pyramidal cells from each location were stacked, and a population vector was defined for each 5-cm bin of the composite map. Right: Matrices show a color-coded representation of the correlation for each pair of population vectors. The width of the diagonal color band indicates the distance over which successive population vectors become decorrelated. Arrows indicate running direction (Panel adapted from Kjelstrup et al. 2008). (C) The vHPC gradually generalizes across cues with similar meaning in a given context. In this experiment (Komorowski et al. 2013), rats learned to discriminate based on odor cues between two pots either containing reward or not. [continued on the following page]

Figure 4.4: [continued from previous page] Later, in an apparatus composed of two distinct contexts connected by a central alley, in one context pot associated with odor1 contained the reward while the reverse was true in the other context. The panel shows the normalized spatial firing rate maps of dorsal and ventral HPC cells during the sampling of the pots in the learning session and after overtraining. Note how after overtraining vHPC cells acquire a context-selective but spatially unspecific representation.

et al. 2005; Muller and Kubie 1987), changes in non-spatial information such as odors (Anderson and Jeffery 2003) and task demands (Markus et al. 1995) are also effective. Therefore, the HPC may store multiple maps associated with a given physical environment, each coding for a specific contextual representation providing a potential mechanism for encoding environmental changes (Colgin et al. 2008).

Ventral vs. dorsal HPC spatial codes

The vHPC has place cells as well (Figure 4.4; Poucet et al. 1994), even though they possess larger, less stable, and less spatially selective place fields than dorsal hippocampus (dHPC) (Jung et al. 1994). The spatial scale representation along the dorsoventral HPC axis expands from less than 1m to more than 10m in the most ventral portion of HPC (Kjelstrup et al. 2008). Moreover, theta power and the proportion of theta modulated neurons are smaller in the vHPC compared to dHPC (Royer et al. 2010). Early interpretations suggested that the increase in place field size corresponds to a decrease in spatial information coded by vHPC place cells, which are also less sensitive to speed than their dorsal counterparts (Maurer et al. 2005). However, the difference of scale might not necessarily affect spatial resolution at the population level, at least in computational models (Keinath et al. 2014).

vHPC place cells also represent information about behavioral events differently from the dHPC: while dHPC neurons develop representations of specific objects and locations rapidly and maintain their geometrical selectivity over learning, vHPC cells gradually generalize across similar events to create a broader representation within meaningful spatial contexts (Komorowski et al. 2013). Therefore, vHPC place cells may code for more spatially diffuse information, and indeed are more sensitive to odor changes (Keinath et al. 2014) and traveling direction (Royer et al. 2010).

4.2.2 Modulation of Contextual Coding by Fear and Anxiety

Reward and emotional stimuli affect a greater proportion of vHPC neurons than dHPC ones, since their firing is more strongly controlled by reward loca-

4 Neural Coding of Fear Learning and Defensive Behavior

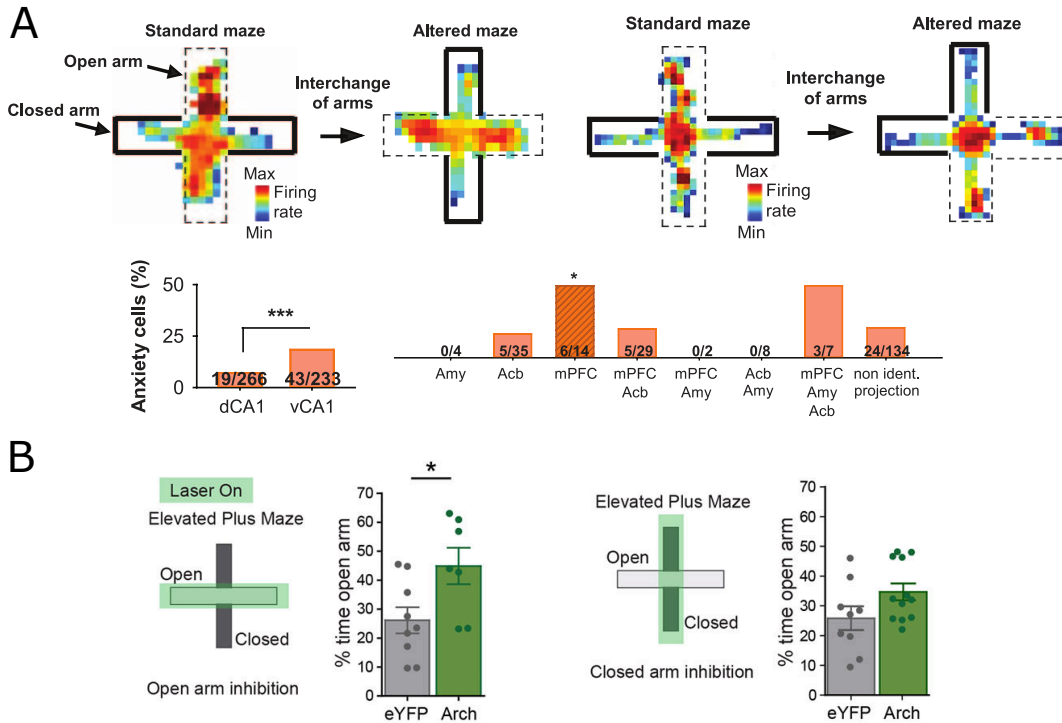

Figure 4.5: Anxiety modulation of HPC spatial code. (A) Over-representation of anxiogenic locations by the vHPC (panel adapted from Ciocchi et al. 2015). Top: Firing of individual vCA1 neurons on an elevated plus maze with changes of maze configurations. Note that ventral CA1 cells tend to follow the location of open arms. Bottom: percentage of anxiety cells in dCA1, vCA1, and optogenetically identified vCA1 projection neurons (Amy = amygdala; Acb = nucleus accumbens). vCA1→mPFC projections exhibit a larger number of anxiety cells as compared to chance. (B) Optogenetic control of avoidance behavior with vCA1 (panel adapted from Jimenez et al. 2018). In the EPM, bilateral optogenetic silencing of pyramidal vCA1 neurons when mice entered the open arm increased the time spent exploring the open arm (left); silencing in the closed arm (right) had no effect.

tion, aversive odors, and the aversiveness of a location such as open vs. closed arms in radial and plus-mazes (Figure 4.5; Royer et al. 2010; Ciocchi et al. 2015; Jimenez et al. 2018; Keinath et al. 2014). Indeed, vCA1 neurons tend to over-represent the open arms of an elevated plus-maze, which are innately anxiogenic, even though the percentage of place cell responses is significantly higher in the dCA1 (Ciocchi et al. 2015; Jimenez et al. 2018). This neural representation could be critical in shaping defensive behavior, as optogenetically silencing principal cells in vCA1 during open arm exploration increases the time spent there (Figure 4.5; Jimenez et al. 2018).

Fear conditioning radically changes the emotional valence of an environment and indeed HPC place cells remap after conditioning (Figure 4.3; Moita et al. 2004) and the new map remains stable over time (Wang et al. 2012). Similarly, extinction learning (Wang et al. 2015b), the encounter with a “predatory” robot (Kim et al. 2015a), audiogenic stress (Kim et al. 2007a), and aversive air-puffs or eye-lid stimulations while traveling on a linear track (Okada et al. 2017; Ormond et al. 2019) all induce place field remapping. Therefore, the HPC code for space is constantly updated to code for newly learned aversive experiences. Interestingly, after auditory fear conditioning, HPC place cells acquire CS-evoked firing that is expressed in a location-dependent manner. When an animal is located within the boundaries of a given place cell’s firing field, the place cell responds to the CS presentation (Moita et al. 2003). Thus the hippocampal place code can represent both the context and the occurrence of aversive stimuli, and this conjunctive representation may be transmitted from the HPC to downstream brain regions.

BLA and HPC reciprocal modulation of context specific firing The presentation of a CS after fear conditioning as an animal crosses a place field while exploring a familiar and neutral environment induces the remapping of that specific place field (Donzis et al. 2013). Critically, if the bICA is inactivated, this effect disappears, suggesting that the AMG mediates place cell plasticity. This result is consistent with previous work showing that electric stimulation of the bICA alters place field stability and thus the AMG can modulate HPC cellular plasticity (e.g., Li and Richter-Levin 2012; Nakao et al. 2004; Farmer and Thompson 2012). Conversely, the HPC can also modulate bICA firing – LA single-unit firing patterns are contextually modulated (Hobin et al. 2003), a property that is abolished by HPC inactivation (Maren and Hobin 2007).

4.2.3 Off-line Reactivation of Place Cell Sequences

Research involving recordings of place cell activity during sleep provided the first evidence that neural firing during sleep reflects previous behavior-associated firing patterns. This could underlie the off-line consolidation of memories as proposed in the two-stage model of memory consolidation (cf. 3.2.2). Wilson and McNaughton (1994) were the first to accomplish large-scale (more than 100 neurons) recordings in freely behaving animals, and showed that place cell pairs co-active during exploration were more likely to be simultaneously activated in the sleep following the behavioral task than in sleep preceding it (Figure 4.6a). Crucially, these reactivations occurred preferentially during hippocampal sharp-wave ripples. Since the number of co-firing episodes during exploration predicts the increase of co-activations in subsequent sleep (O’Neill et al. 2008), these reactivations may be the consequence of associative Hebbian-like learning processes that has taken place during behavior. The co-active cell pairs are part of entire sequences of activity observed during be-

4 Neural Coding of Fear Learning and Defensive Behavior

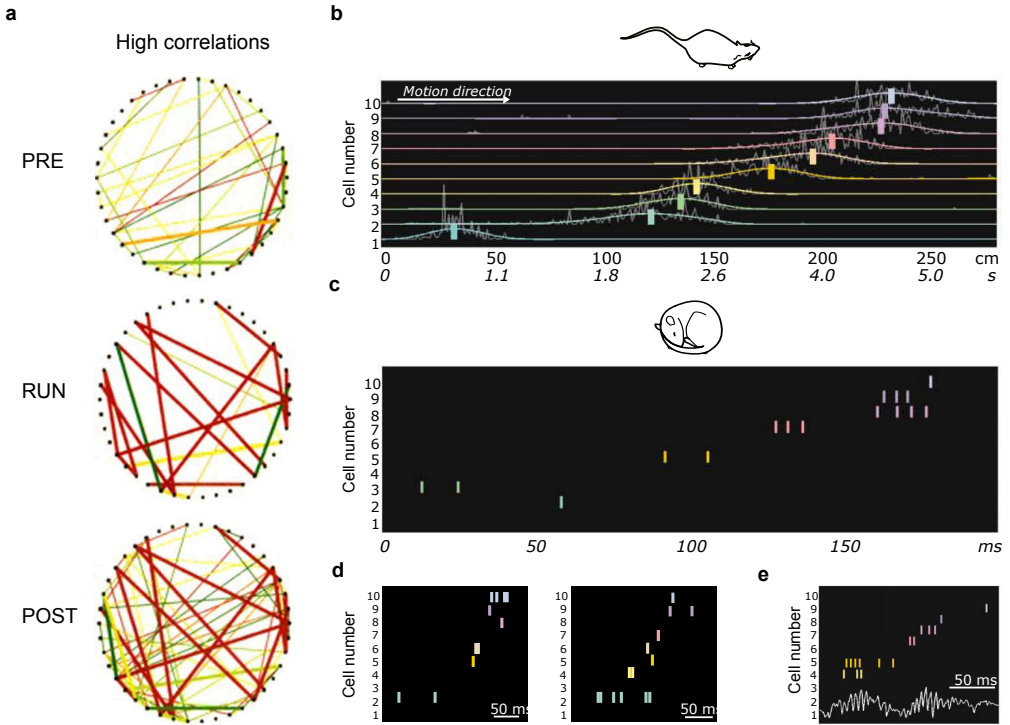

Figure 4.6: Place cell reactivations. (a), First compelling demonstration of experience-dependent replay of hippocampal activity. Diagram of the co-activation matrix of 42 simultaneously recorded neurons (dots around the perimeter of the circle). Lines indicate a small subset of all positive correlation (>0.2) between the pairs, with color reflecting the magnitude of the correlation (red, high; green, low). Bold lines indicate cell pairs that were correlated during waking activity (RUN) and also correlated during either sleep before (PRE) or after (POST). Note that most of the highly correlated pairs that are present during RUN are also present in the POST phase but less frequently during PRE phase. (b), Averaged firing rate of 10 place cells ordered by their preferred position on a linear track (30 trials; y-axis, cell number; x-axis, position on the track). Vertical ticks indicate peak firing rate spot for each cell. Time axis below shows time within an average lap (total: ~ 5 s). **c-e**, Reactivation of place cell sequences. Examples of compressed reactivations during sleep. Note the faster time scale (~ 20 -fold compression). (e) Reactivation embedded in sharp-wave-ripple complex (SPW-R) events (Wilson and McNaughton 1994), b-e from (Lee and Wilson 2002).

havior and reinstated during subsequent sleep, but absent in the sleep before (Skaggs et al. 1996). Sequences corresponding to trajectories of exploration in a linear track are replayed in a temporally compressed manner during ripple events of slow wave sleep (SWS) (Figure 4.6b–e; Lee and Wilson 2002).

Ripples also take place in awake periods. During immobility and brief pauses

from task engagement, place cells can reactivate either in the forward or reverse traveling direction, starting from the animal's current position. Awake replay is believed to play a critical role in many cognitive processes such as encoding reward (Foster and Wilson 2006; Singer and Frank 2009; Ambrose et al. 2016), context representations (O'Neill et al. 2006; Cheng and Frank 2008), goal-driven behavior (Dupret et al. 2010; Csicsvari and Dupret 2014), decision-making (evaluation of choices, prospection and planning; Singer et al. 2013; Jai and Frank 2015; Pfeiffer and Foster 2013), and episodic memory retrieval (Takahashi 2015). Furthermore, awake replay can represent future trajectories (Gupta et al. 2010) and compress long sequences over multiple SPW-R events (Davidson et al. 2009). The timescale of sequences replay is within the temporal window of neural coactivation that enables synaptic plasticity. Therefore replay may be a critical element of the mechanism by which neural activity consolidates over time to form long-lasting memories, for instance by priming synapses for further reinforcement during subsequent sleep (Foster 2017).

Hippocampal awake replay and fear memory retrieval

Wu et al. (2017) placed rats in a linear track divided into a dark zone and a light one. After a day of free exploration, the animals received a mild electric footshock in the terminal segment of the dark zone. Later when the animals explored the linear track, if they were close to beginning of the shock zone, they paused and then turned away, avoiding it. During these pauses, place cells with firing fields in the aversive zone were reactivated, accompanied by ripple oscillations (Figure 4.7). Critically, rats also paused and walked back to avoid the illuminated area of the track, but replays were more likely to occur before the avoidances of the shock zone. Since avoiding the shock zone requires the successful retrieval of the fear memory associating the location with the footshock, these awake replay events may support effective memory retrieval (Joo and Frank 2018).

In a recent study, Ormond et al. (2019) paired eye-lid shocks to entry in specific arms of a maze where rats ran in circles and at each lap could chose one among different parallel alleys. This protocol allowed the authors to change the contingencies between sessions and induced partial remapping in the place cells population at each contingency switch. When the animals learned a new contingency, awake replay events recruiting cells that have changed their firing (but not stable ones) increased. Therefore, this result suggests that place cell remapping may play a critical role in encoding and consolidating new memory during replay events (Figure 4.7).

HPC-AMG coordinated replay during sleep support aversive memory consolidation

Girardeau et al. (2017) recorded neural activity from dCA1 and

4 Neural Coding of Fear Learning and Defensive Behavior

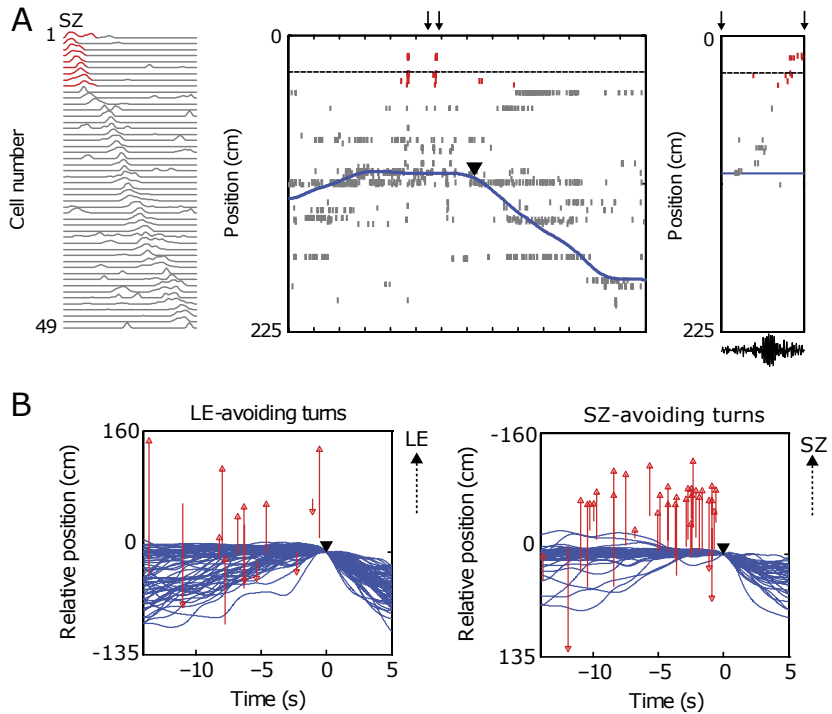

Figure 4.7: Hippocampal awake replay of frightening experiences (A) Sequential firing of place cells occurs before avoidance of a location (SZ) previously associated with a shock on a linear track. Left: firing rate curves of place cells before the shock (Pre). Middle: spike raster of the same place cells as ordered on the left and the rat's trajectory during the first SZ-avoiding turn after the shock. Right: expanded view of the spike raster within a time window in the middle (arrows) and the filtered local field potential (LFP) in the ripple band within the same window (bottom). Note the sequential firing initiated by cells with place fields close to current locations and terminating with cells with place fields in the SZ (red). Also note the simultaneous increase in ripple activity. **(B)** Increase in the replay of specific place cell sequences encoding the paths from an animal's current positions to a frightening zone before its avoidance. Comparison of Replay trajectories during pausing (red), as well as animal actual trajectories (blue), around avoidance of zone with bright light (LE-avoiding turns) before the shock compared with replay events before avoidance of the SZ. The trajectories are aligned at the animal's position and time of turning (down arrowheads). Red arrowheads, end positions of replay trajectories; upward arrows, direction to the LE or SZ. Panels adapted from Wu et al. 2017. LE:light segment end zone; SZ: shock zone.

AMG of rats while they shuttled along a linear track. While running in one direction, they could encounter an aversive air-puff at a given location of the track. Upon learning the location of the air-puff (which changed every day), rats slowed down before reaching it. During post-learning SWS, BLA and

dCA1 neuronal populations, but not CeA-CA1, engaged in cross-structural reactivation – that is, the coordinate firing that had developed during the task was reactivated in SWS. In particular, coordinated BLA-dHPC firing patterns representing the airpuff-associated running direction, but not those representing the safe direction, were significantly reactivated during dHPC SWS ripples; these coordinated reactivations relied upon BLA cells that were particularly responsive during dHPC ripples. Therefore, the reinstatement during sleep of the activity pattern representing a joint place-threat representation formed cooperatively by the BLA and dHPC may support aversive memory consolidation. Indeed, these representations were maintained also in post-sleep sessions where the air-puff was no longer present.

4.3 Medial Prefrontal Cortex

The literature about the behavioral neurophysiology of the mPFC is dominated by work investigating its role in reward-based decision making tasks (Rushworth et al. 2011) that are usually designed to study working memory, planning, relations with basal ganglia among other questions. In these tasks, changes in mPFC neurons' firing rates are correlated with reward presentation and reward expectancy (e.g., Gruber et al. 2010), the expectation of negative outcomes (e.g., Gilmartin and McEchron 2005; Takehara-Nishiuchi and McNaughton 2008), and changes in contextual contingencies (e.g., Ma et al. 2016; Karlsson et al. 2012; Morrissey et al. 2017; Guise and Shapiro 2017; Durstewitz et al. 2010; Rich and Shapiro 2009; Hyman et al. 2012; Euston and McNaughton 2006; Cowen and McNaughton 2007; Lapish et al. 2008; see also 3.3.3 and 3.4.2 about mPFC neural coding mechanisms of spatial memory). Another branch of research, dominated by studies recording neural activity in monkeys, showed that neurons in the prefrontal cortex are able to maintain task-relevant information in working memory which may exert top-down control over other brain structures (Fuster 2015; Lara and Wallis 2015; Goldman-Rakic 1990; Baddeley 2003). Furthermore, anatomically the mPFC receives information about motivational stimuli (both positive and negative) and in turn, sends projections akin to a premotor-like area with control over autonomic and motor functions (cf. 2.3.1). Therefore, the mPFC is proposed to produce and store schemas which can map context and events onto appropriate behaviors (Miller and Cohen 2001; Alexander and Brown 2011). Experience-based predictions would, therefore, be used to refine this mapping in order to obtain the most favorable outcome (Euston et al. 2012). Moreover, as discussed in 3.4.2, the replay of task-related mPFC firing activity during sleep in coordination with the HPC is critically linked to memory processes (Battaglia et al. 2011; Eichenbaum 2017). Neural reactivation may thus facilitate mPFC storage and retrieval of these schemas (Euston et al. 2012). Compared to the extensive literature concerning decision-making on the one hand and mPFC-HPC interactions supporting spatial learning on the other,

the interest in the circuit mechanisms of mPFC for regulating fear learning and defensive behavior is relatively recent.

4.3.1 mPFC Circuit Strategies to Support Emotional Learning and Fear Behavior Control

One possibility is that mPFC neurons may be able to maintain relevant information about aversive-predicting cues and orchestrate appropriate defensive responses. To this end, the information about stimulus aversiveness needs to be updated with learning. Consistently, a growing body of literature suggests that mPFC neurons encode the emotional valence of CSs during fear learning. Another branch of research, rapidly expanding in recent years, has focused on the mPFC correlates of fear behavior.

mPFC Coding for Threatening Stimuli May Support the Conditioning Memory Trace

Recordings of PL neurons during tests of innate anxiety showed that, like vHPC neurons (cf. Figure 4.5), PL single units distinguish between safe and anxiogenic locations in both the elevated plus maze and open field tests for anxiety (Adhikari et al. 2011), suggesting that mPFC neurons code for innately safe and threatening environments as well. While the neural bases of innate anxiety and conditioned fear are not necessarily identical, converging evidence suggests that mPFC circuits also code for conditioned threatening stimuli (Figure 4.8). Most single units (70-85%) recorded extracellularly in the mPFC display phasic excitatory or inhibitory responses to auditory CSs (Baeg et al. 2001; Courtin et al. 2014; Peterson 1986; Milad and Quirk 2002; Burgos-Robles et al. 2009; Sotres-Bayon et al. 2012; Chang et al. 2010; Holmes et al. 2012; Fitzgerald et al. 2014; Giustino et al. 2016; Giustino et al. 2019; Fitzgerald et al. 2015). These responses are not all simply sensorial, as some PL and IL cells acquire reactivity to auditory (Figure 4.8; Baeg et al. 2001; Burgos-Robles et al. 2009)¹ or olfactory (Laviolette et al. 2005; McGinty and Grace 2008) CSs² only after conditioning.

Nevertheless, freezing behavior in response to a CS develops after conditioning, and these CS-evoked responses are highly correlated with fear expression (Figure 4.8; Burgos-Robles et al. 2009; Courtin et al. 2014). Indeed, more cells respond to a CS previously associated with a shock in fear conditioned animals compared to controls and also in animals who received auditory conditioning in comparison to animals that received unsignaled shocks (Giustino et al. 2016).

¹Unless explicitly stated otherwise, all studies cited below used auditory CSs.

²In many studies, more than the CS associated with a shock during conditioning (CS+) also a neutral, control CS is presented (CS-). In studies using a single CS shock-associated type, the specifying suffix is typically omitted.

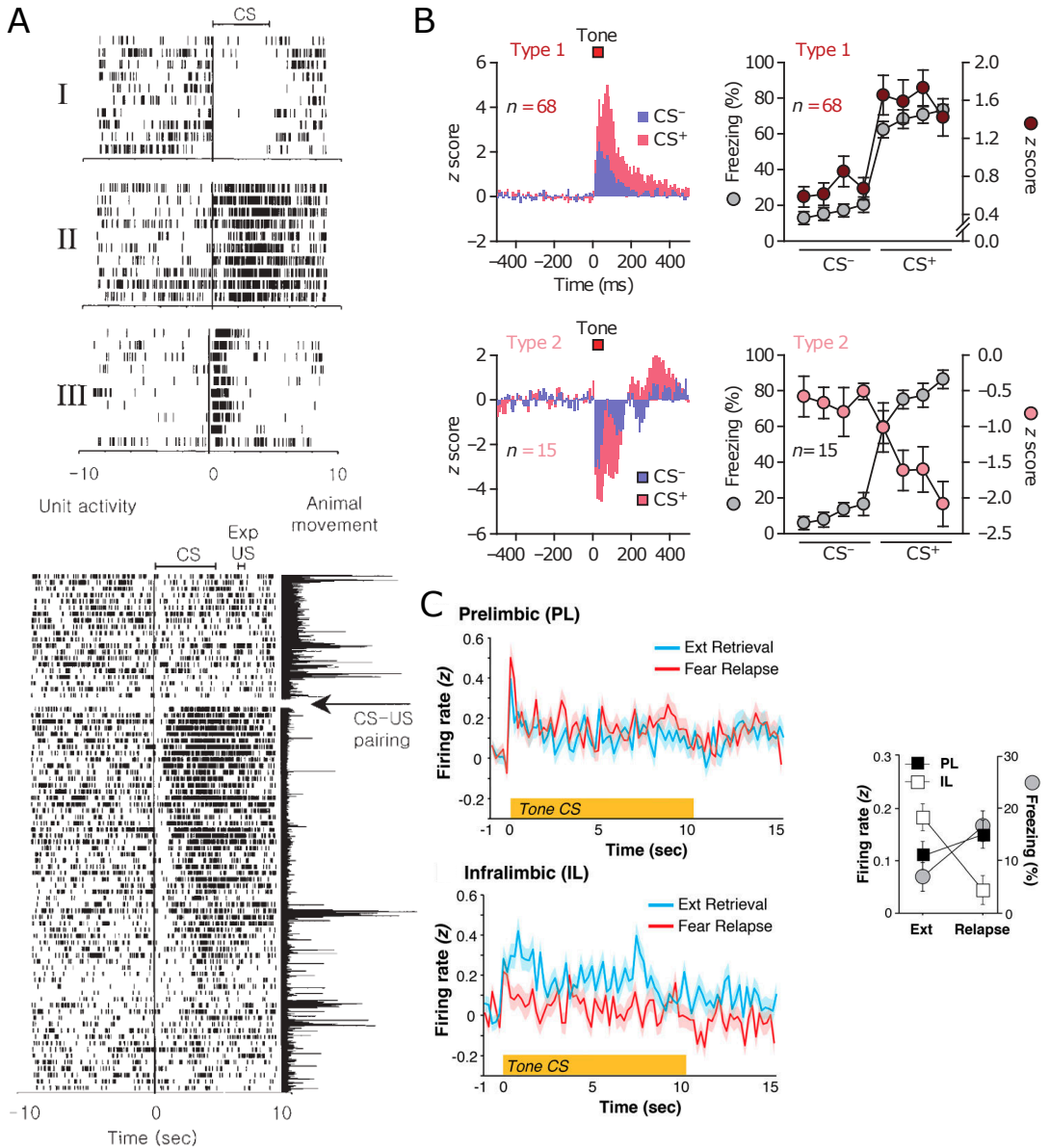

Figure 4.8: mPFC CS responses. (A) Top: Types of responses of mPFC cells. Spike rasters of representative examples of the three groups of response types of mPFC units. Bottom: Representative unit raster plot before conditioning, after conditioning and during extinction. Note that the response was acquired following conditioning and extinguished with extinction learning (panel adapted from Baeg et al. 2001). (B) CS-evoked transient responses. Left, mean z-scored firing excitatory (top, type 1) or inhibitory (bottom, type 2) responses of dmPFC interneurons to CS+ and CS- recorded after conditioning. [continued on following page]

Figure 4.8: [continued from previous page] Right, correlations between freezing during CS+ and CS- evoked firing. Note how distinct dmPFC interneurons populations oppositely correlate with fear expression (panel adapted from Courtin et al. 2014). (C) CS-evoked sustained responses. Left, CS-evoked firing in PL (top) and IL (bottom) neurons during extinction retrieval (ext retrieval) and fear renewal (fear relapse). Right, percentage of freezing across tests overlaid with the 10-s mean of the CS-evoked firing responses (panel adapted from Giustino et al. 2019).

Therefore CS-evoked increased firing could either be simply correlated with freezing behavior or reflect, at least partially, a learning-induced plasticity coding for the cue–shock contingency. Not all mPFC neurons respond in the same way to CS presentations – three major types of responses have been identified so far: inhibitory, sustained excitatory, and transient excitatory (Figure 4.8; Baeg et al. 2001). Moreover, while some mPFC units respond to both CS+ and CS- some neurons only increase their firing to CS+ (Courtin et al. 2014). Overall, significantly more neurons respond to CS+ compared to CS-, and the magnitude of the evoked response is greater for CS+. Extinction learning induces further plastic changes of these neural responses, which, in parallel with freezing behavior, are reduced at late extinction training stages (Baeg et al. 2001; Burgos-Robles et al. 2009; Chang et al. 2010). Taken together, these results show that the mPFC develops responses differentiating feared from neutral stimuli. This new response pattern may participate in the coding of an emotional memory trace of the conditioning training and modulate fear behavior.

Extinction coding in the mPFC As discussed above, extinction is believed to activate a new memory trace rather than erase the original conditioning trace. Following the PL vs. IL antagonism model (cf. 2.3.3), some authors tested the hypothesis that conditioning and extinction memory traces would be segregated in these respective mPFC subregions. In a seminal study, Milad and Quirk (2002) showed that neurons in IL, but not those in PL or medial orbital cortex (MO), display an increase in firing evoked by the CS+ at late extinction stages in animals with high but not in those with poor extinction recall performance. This was interpreted as evidence that only IL (and associated subcircuits) neural activity underlies extinction memory. However, later studies reported that both PL and IL cells increase their CS responsiveness during extinction retrieval (Chang et al. 2010; Holmes et al. 2012) and no PL–IL differences in CS-evoked spiking activity were observed at earlier extinction stages either (Baeg et al. 2001; Fitzgerald et al. 2014; Giustino et al. 2016). However, a recent report examining sustained firing responses showed that IL neurons are more active in response to CS during extinction retrieval than during fear relapse, where more PL than IL neurons respond (Figure 4.8; Giustino et al. 2019). This result shows that PL and IL firing is correlated with high and low fear states, respectively. About the coding differences between dorsal and ventral mPFC, one possible explanation of this apparent

incoherence between reports is that sustained and transient responses might represent separate coding mechanisms differentially contributing to behavior control and memory encoding.

Taken together, these results do not reach a consensus about whether the dorsal and ventral portions of the mPFC support distinct codes for threatening stimuli at different stages of learning in conditioning and extinction paradigms. It remains unknown if and how mPFC activity may simultaneously store the conditioning and extinction memory traces.

Neurophysiological Underpinnings of Fear Behavior Modulation by the dmPFC

Burgos-Robles and colleagues (2009) showed that activation of CS-responding neurons in PL precedes the freezing onset, suggesting that neural CS responsiveness in dmPFC may trigger the incoming freezing behavior. Moreover, in a behavioral paradigm where animals either freeze or flee, many mPFC neurons are selective for one of the two strategies (Halladay and Blair 2015). A now extensive literature supports the view that dmPFC circuits are critically involved in fear behavior control. Two classes of dmPFC putative inhibitory interneurons have increase or decrease their firing rates in response to CS presentations. Notably, the activity of cells excited by CSs is positively correlated with freezing behavior while the activity of those inhibited by CSs is negatively correlated with it (Figure 4.8; Courtin et al. 2014). The group decreasing their firing rates were identified as PV and inhibiting them with an optogenetically excites principal cells and increases freezing both before and after conditioning. Therefore, dmPFC may influence fearful behavior with PV interneurons controlling projection cells' interactions with downstream areas such as the amygdala.

Interestingly, dmPFC PV cells are strongly modulated by local theta (Courtin et al. 2014). Moreover, the CS tone pips³ evoke theta phase resets and amplitude increases over 2-3 cycles (Figure 4.9; Courtin et al. 2014; Stujenske et al. 2014; Likhtik et al. 2014). While one study reported that theta power as well as the precision of the phase reset is stronger following CS+ than CS- tone pips (Courtin et al. 2014), another showed that this only occurs in animals that discriminate well between the two CS types, that is, animals that significantly freeze more to CS+ compared to CS- (Likhtik et al. 2014). The discrepancy between these reports can be accounted for by the lower variability in fear responses and better discrimination performances of the animals in the former study. Another factor that could have induced the inconsistency of the results

³Frequently in behavioral electrophysiology experiments, a given auditory CS is not composed of a continuous sound lasting for many seconds, but rather of multiple evenly-spaced transient sounds, often called pips, each lasting a fraction of a second. When looking for neural correlates of the CS, this method highly increases the sampling of CS-evoked neuronal activity.

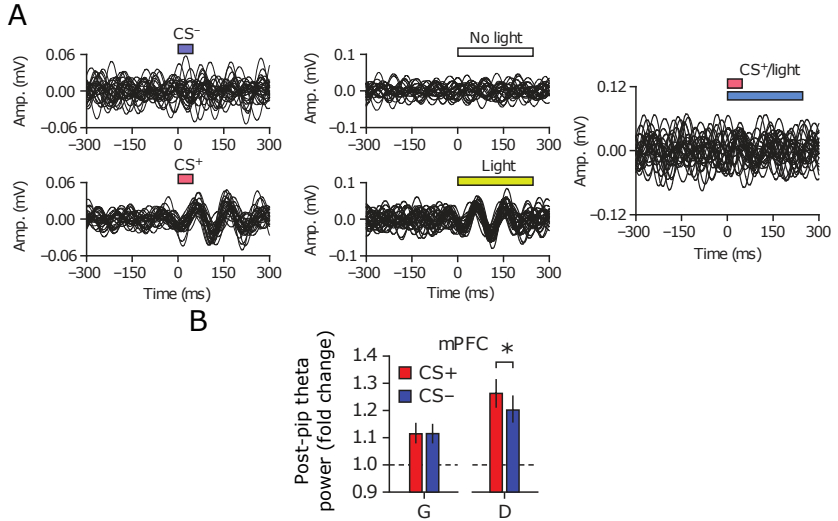

Figure 4.9: CS presentations induce the resetting of dmPFC theta oscillations. (A) dmPFC LFP traces filtered in the 8–12 Hz range illustrating theta phase resetting induced by CS+ but not CS- (left) and by the optogenetic inhibition of PV interneurons. Right, when the CS+ is presented paired with the optogenetic stimulation of PV interneurons theta reset is absent (panel adapted from Courtin et al. 2014). (B) CS evoked responses are modulated by discrimination. Pip-induced change in theta power by CS type for generalizers (G) and discriminators (panel from Likhtik et al. 2014).

is the definition of theta rhythm; indeed, this was defined as the LFP signal filtered in the 8–12 Hz band in one study (Courtin et al. 2014) and the 4–12 Hz band in the other (Likhtik et al. 2014). Theta resetting and amplitude increase may be a mechanism by which dmPFC circuits are activated in the presence of threatening stimuli, in turn triggering the behavioral response. The CS+-evoked theta reset is either blocked or induced via PV interneuron stimulation and inhibition, respectively (Figure 4.9; Courtin et al. 2014). Together with the observation that inhibiting PV interneurons induces freezing, this result suggests that PV cell activity may be crucial for the putative mechanism linking theta resetting and fear expression. The neurophysiological mechanism controlling the recognition of dangerous stimuli, which would hypothetically trigger the phase reset and activation of PV cell firing, remains to be elucidated.

dmPFC 4 Hz oscillations regulate dmPFC network firing and freezing behavior While the theta reset is linked to the onset of the behavioral response to threatening stimuli, its short duration is not compatible with a role in maintaining freezing behavior, which persists long after the theta reset. One

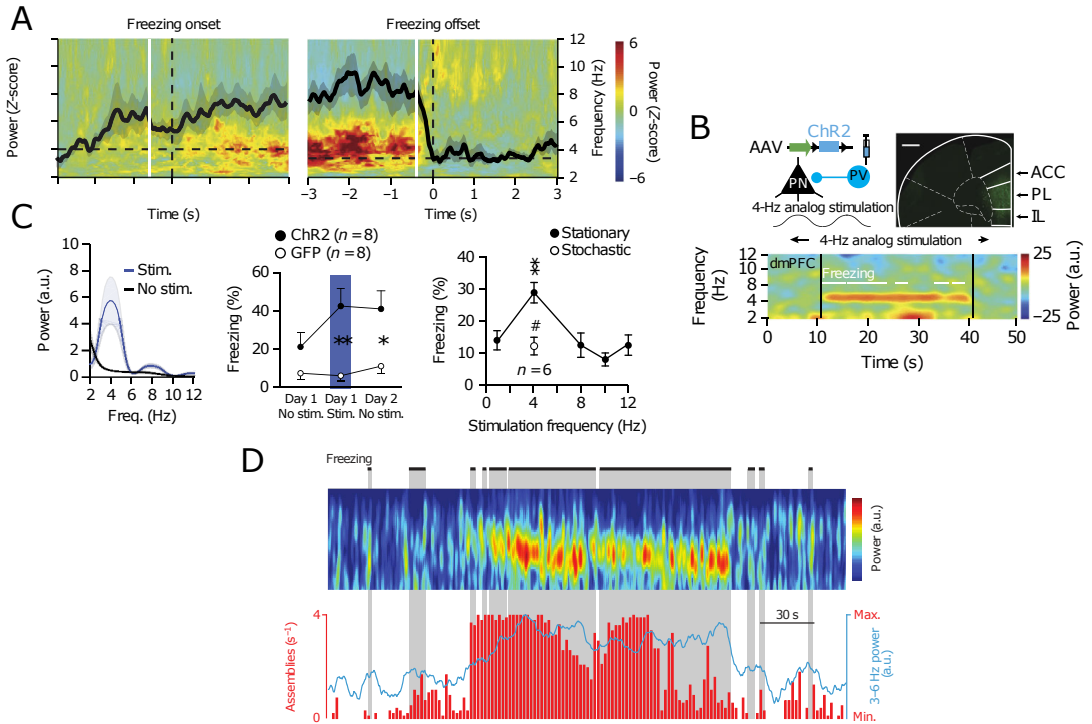

Figure 4.10: The 4 Hz oscillation and freezing behavior. (A) dmPFC 4 Hz oscillations predict freezing. Averaged freezing onset-triggered (left) and offset-triggered (right) z-scored spectrograms of dmPFC LFP. (B,C) Optogenetic induction of dmPFC 4 Hz oscillations drives freezing. The analog stimulation with ChR2 of PV interneurons at 4 Hz induces strong 4 Hz oscillations in dmPFC LFP (see spectrogram in B). (C) Left, averaged normalized LFP power spectra of dmPFC LFPs during and outside optogenetic stimulation of dmPFC PV interneurons. Middle, percentage of freezing for ChR2 or control mice before, during, and after 4-Hz induction. Right, percentage of freezing for ChR2 mice during analog stimulation at 1, 4, 8, 10, 12 Hz (Stationary) or using a 4-Hz stochastic waveform. (D) Freezing-specific cell assemblies emerge during 4 Hz oscillations. In the panel, example of freezing episodes (black thick line on top and gray squares), LFP spectrogram, 4 Hz LFP power (blue curve), and assembly activation (red bars). Panels A,B,C are from Karalis et al. 2016, and D from Dejean et al. 2016.

possibility is that other neural activations and patterns of activity following theta reset are implicated in freezing maintenance. Freezing is also associated with a prominent 4-Hz oscillatory activity which synchronizes dmPFC neurons (Moberly et al. 2018; Dejean et al. 2016; Karalis et al. 2016; Bagur et al. 2018; Karalis and Sirota 2018). As evoked in 3.3.2, the mPFC LFP can be dominated by respiration-driven 4 Hz oscillations during immobility transmitted there by the olfactory bulb (Moberly et al. 2018; Biskamp et al. 2017a; Bagur

et al. 2018; Karalis and Sirota 2018). This LFP rhythmicity emerges before the beginning and terminates before the end of freezing bouts with such fidelity that it can be used to predict them (Figure 4.10; Karalis et al. 2016).

Karalis et al. (2016) showed that this oscillatory activity could also be induced in the mPFC by exciting mPFC PV interneurons at 4 Hz, which also triggered freezing behavior. One possible role for this rhythm is to help to synchronize different areas of the limbic system whose activity is instrumental for the orchestration of fear behavior (Bagur et al. 2018). Indeed, current source analysis indicates that 4 Hz rhythmicity is transmitted synaptically to the mPFC from the olfactory bulb and not simply by volume conduction (Karalis and Sirota 2018).

The 4 Hz respiratory rhythm during freezing organizes neuronal firing in the mPFC (Dejean et al. 2016; Bagur et al. 2018; Karalis et al. 2016), which indicates that the respiration-dependent LFP oscillation is therefore not merely an epiphenomenon. Moreover, the rhythm has been associated with the emergence of freezing-specific assemblies of principal cells in the dmPFC (Dejean et al. 2016). Specifically, the activations of these assemblies follow the changes in 4 Hz oscillation power and precede freezing onsets and ends, suggesting that the 4 Hz rhythm may help to recruit cell assemblies implicated in freezing control. Accordingly, these ‘freezing assemblies’ are specifically active in the ascending phase of 4 Hz oscillations and, if dmPFC principal cells are selectively inhibited during the ascending or descending phases of 4 Hz, freezing is respectively inhibited or enhanced (Dejean et al. 2016). A later study showed that the 4 Hz rhythm is a better predictor of the end of freezing than of the freezing onset. Moreover, if during freezing the olfactory bulb is stimulated at a different frequency, freezing is interrupted, suggesting that 4 Hz may be particularly implicated in freezing maintenance (Bagur et al. 2018).

Taken together, these results suggest a possible mechanism through which the circuitry of the dorsal part of mPFC may sustain fear expression and the 4 Hz rhythm oscillations may orchestrate it. Further work is required to understand the mutual and distinct contributions of dmPFC theta resetting and 4 Hz oscillation in triggering and sustaining freezing.

dmPFC coding of contextual fear Since the mPFC orchestrates the behavioral response to threatening auditory cues, it is likely that it does so to threatening contexts as well. New activity patterns of anterior cingulate cortex (ACC) single units’ firing emerge when animals switch from one environmental context to another (Hyman et al. 2012). These contextual representations may include the emotional valence of a given environment and hence could be instrumental in guiding defensive behavior. Rozeske and colleagues (2018) recorded dmPFC neurons both in the context where the animals were conditioned and other contexts that were either similar to the conditioning setting (evoking high fear states, similarly to the conditioning context itself), or

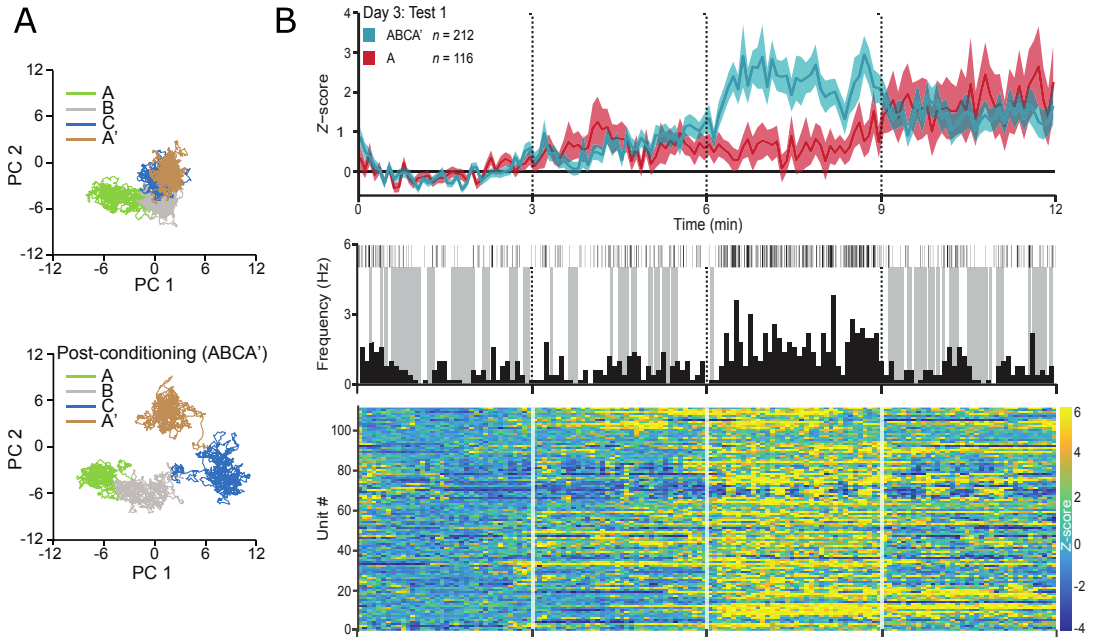

Figure 4.11: dmPFC population coding of contextual fear. (A) After fear conditioning in context A, mice were exposed to contexts resembling the conditioning context and inducing high fear (contexts B and A') and others did not (context C). The panel shows the principal component analysis (PCA) representation of the instantaneous population vector of the dmPFC activity before (top) and after (bottom) conditioning. Note that, before conditioning, the neural population code does not separate well between context as after conditioning and that, after conditioning, the population code of context C segregates on the axis of the first principal component (x-axis) from the other cluster. (B) Top: firing rate of dmPFC principal neurons across contexts ABCA' (blue curve) and in context A alone (control group, red curve). Middle: representative firing rate of a dmPFC principal neuron highly active in context C. Gray bars represent freezing epochs; top: raster plot. Bottom: heatmap of the normalized firing activity of all principal neurons that were highly active in context C. Panels adapted from Rozeske et al. 2018

different (where freezing levels were low). Population analysis characterized dmPFC network responses to the exposure to contexts with different emotional valences and showed significantly greater differences between the activity patterns for the fearful vs. safe contexts than between contexts evoking similar fear magnitude (Figure 4.11). Whether these switches in population coding reflect differences in behavior and/or changes in the neural representation of the environment remains unknown. However, these transitions were driven by a subpopulation of dmPFC cells that increase their firing in low fear contexts compared to high fear ones. Note that this firing behavior is the opposite to

the one by dmPFC cells activated during CS+ presentations (e.g., Burgos-Robles et al. 2009) or those excited by anxiogenic locations (Adhikari et al. 2011). One possible explanation for these apparently inconsistent findings is that dmPFC neurons respond differently for contextual and cued fear. Alternatively, different dmPFC neural populations may be involved in the fear expression for these two learning paradigms (Rozeske et al. 2018).

Since the ACC has been more implicated in contextual conditioning than PL, one hypothesis is that ACC neurons may be particularly responsive to contextual fear and PL cells to cued fear. However, recordings and optogenetic manipulations of the Herry lab in cued- and context-fear experiments likely involved both PL and ACC (at least in its ventral part). Hence, it is not clear whether the mechanisms described in the studies discussed above involve both of these structures. Since the ACC is believed to be implicated in context encoding and PL in fear expression, a possibility is that the results from Rozeske and colleagues may principally involve ACC, while the results of cued fear studies (Courtin et al. 2014; Karalis et al. 2016; Dejean et al. 2016) may derive from a greater sampling of PL. Alternatively, neural dynamics may be uniform within the dmPFC. Research clearly distinguishing recordings of the different mPFC subdivisions (ventromedial prefrontal cortex (vmPFC) included) may help to better clarify the anatomical specificity of the neural correlates of fear behavior modulation described here.

4.4 Dynamics of the Synchrony between the AMG, HPC, and mPFC

As discussed in chapter 3, dynamic communication between brain structures is critical for cognitive processes. It seems likely that inter-structural neurophysiological mechanisms similar to those described for spatial learning support fear memory as well. Therefore, recent years witnessed an emerging interest in the dynamics of communication between the AMG, HPC, and mPFC during fear learning. Although little is known about such dynamics supporting memory, a clearer picture has been emerging regarding the synchronization mechanisms regulating fear behavior control.

4.4.1 HPC and BA Inputs to the mPFC Modulate mPFC Coding

As discussed above, mPFC neurons display CS-evoked firing activity that may correspond to a fear memory and play an important role in the control of fear behavior. However, mPFC cells fail to encode CS+ when the blCA is inactivated during or after conditioning (Laviolette et al. 2005; Sotres-Bayon et al. 2012), and only mPFC cells receiving monosynaptic excitatory connections from the blCA respond to CS+ (Laviolette et al. 2005). As CS-responding

neurons in BA project to the mPFC (Senn et al. 2014; cf. 4.1.3), the CS responsivity may be transmitted to the mPFC from the BA. Given the fact that the BA-mPFC pathway has been critically involved in fear expression, with BA fear neurons specifically targeting PL (cf. 4.1.3), this result further corroborate the hypothesis that CS-evoked firing activity in the mPFC may be critically involved in fear behavior expression⁴.

Beside BA afferents, many other inputs converge to the mPFC. The HPC may relay relevant contextual information to modulate fear behavior and learning. Sotres-Bayon and colleagues (2012) investigated the effect of vHPC inactivation on responses of PL cells to CS during fear extinction and showed that, in contrast with blCA inactivations, vHPC inactivation increases tone responses of PL neurons, while subsequent inactivation of the blCA reverses this effect (Sotres-Bayon et al. 2012). This result suggests that PL integrates information from both structures to regulate fear responses. Furthermore, vHPC inputs may be instrumental in reducing fear during extinction by inhibiting PL responsiveness to BLA inputs. While there are no reports of IL recordings after vHPC inactivation, a recent study investigated the effect of vHPC-IL projections on extinction and revealed that pharmacogenetically activating these projections impairs CS fear extinction retrieval (without affecting context-related freezing) while silencing them decreases context-dependent fear renewal to the CS (Marek et al. 2018a). Since vHPC projections activation generates feed-forward inhibition of IL pyramidal neurons due to direct projections on PV interneurons, vHPC projections may directly modulate a PV interneuron-based mechanism like the one by which PV interneurons were shown to control fear behavior in dmPFC (4.3.1; Courtin et al. 2014).

Theta coherence between the mPFC and vHPC, but not dHPC, increases during exploration of innately fearful and anxiogenic locations such as the open arms of a plus-maze or the center of an open field (Adhikari et al. 2010). Moreover, PL single units that distinguish between safe and fearful compartments of the environment (also called ‘anxiety cells’) are also more strongly coupled to vHPC theta than dHPC theta (Adhikari et al. 2011). This synchrony may underlie the communication of contextual information from the vHPC to the mPFC. Accordingly, the inhibition of the vHPC to mPFC pathway disrupts differential firing between anxiogenic and non-anxiogenic compartments in PL single units as well as avoidance behavior (Padilla-Coreano et al. 2016). As discussed above, HPC neurons display differential firing for open vs. closed arms in an elevated plus-maze test (cf. 4.2.2), which poses the question whether PL anxiety cells are inherited from the vHPC. In an elegant study, Cioocchi et al. (2015) optogenetically identified vCA1 neurons projecting to the mPFC, AMG, or nucleus accumbens. Strikingly, the vCA1 neurons projecting to the mPFC exhibit a significant proportion of anxiety-related firing, which is not the case for vHPC cells projecting to the AMG or striatum. This indicates that vHPC-mPFC projections are selectively enriched with emotional informa-

⁴The synchronization of spiking activity between the mPFC and BA has been found to be associated with fear expression also in primates (Livneh and Paz 2012a).

tion, further corroborating the hypothesis that the vHPC sends emotionally relevant contextual information to the mPFC. Similarly, anxiety cells are also over-represented among vHPC neurons projecting to the lateral hypothalamus compared to those projecting to the BA (Jimenez et al. 2018). These results are consistent with the notion that vHPC transmits emotionally-relevant contextual information to downstream brain areas implicated in the control of behavior (cf. 4.1.3) but that the vHPC→BA pathway may not take part in such communication.

4.4.2 4 Hz vs. Theta Synchrony during Fear Behavior

Recordings in different brain structures have revealed that the respiration-modulated rhythm is a global oscillation (Karalis and Sirota 2018). During freezing, 4 Hz activity in BLA and dmPFC are strongly synchronized, with dmPFC oscillations leading BLA (Karalis and Sirota 2018). This suggests that mPFC 4 Hz synchrony may control amygdala activity and, as a consequence, the behavioral output, at least in early stages of extinction. In contrast, after extinction learning takes place, BLA 3-6 Hz oscillations lead those in the mPFC during freezing (Davis et al. 2017), suggesting that signaling from the AMG to the mPFC may cause the expression of fear after extinction.

Before the 4 Hz rhythm was first characterized and linked to respiration, various studies from the Pape lab reported theta synchrony between mPFC, BLA, and HPC during freezing behavior (Lesting et al. 2011; Lesting et al. 2013; Likhtik et al. 2014; Stujenske et al. 2014; Narayanan et al. 2007b; Narayanan et al. 2007a; Seidenbecher et al. 2003; Pape et al. 2005). Some overlap exists between the recently reported 4 Hz (3–5.5 Hz depending on species and individual breathing rate) and the previously described theta synchrony. While the studies from Pape and collaborators identified the frequency band of a sustained 4–5.5 Hz coupling during freezing as ‘theta’, in light of the more recent discoveries about respiration-induced 3–5.5 Hz oscillations, it seems likely that the previously observed sustained ‘low-theta’ synchrony represents respiration-related synchronization.

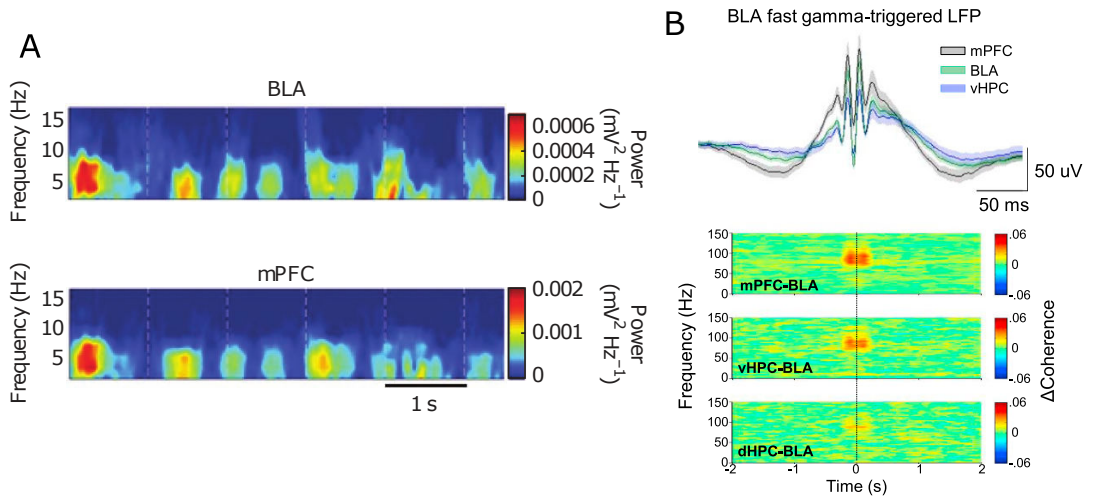

Figure 4.12: dmPFC–BLA theta and gamma synchrony. (A) Example spectrogram of BLA and mPFC responses to CS pips. Dashed white lines, pip onset. (B) Top: BLA fast gamma-triggered LFPs recorded in the mPFC (black), the BLA (green), and the vHPC (purple). Bottom: normalized (difference from mean) fast-gamma trough-triggered spectral coherence for specific region pairs.

4.4.3 Theta and Gamma Synchrony, Stimulus Discrimination and Fear Inhibition

CS-evoked theta resets (Courtin et al. 2014; Likhtik et al. 2014) seem to be a phenomenon distinct from 4 Hz synchronization, because of their transitory nature and because they were also observed when the LFP signal was filtered in the 8–12 Hz band (Courtin et al. 2014). As in dmPFC, each tone pip of CS+ and CS- triggers a phase reset of the BLA LFP filtered in a rather wide theta band (4–12 Hz, Figure 4.12; Likhtik et al. 2014). Peaks of PL–BLA theta coherence accompany these resets, which, like in dmPFC, are larger during CS+ than CS- in animals discriminating well between the two types of auditory stimuli (‘discriminators’). Therefore, transient theta synchrony may reflect recognition and discrimination of fearful stimuli, which would trigger freezing that is in turn maintained by the 4 Hz oscillation. BLA units are phase-locked to PL theta, but phase-locking increases after CS presentation only in discriminators. Moreover, BLA unit activity has a significant tendency to be phase-locked to mPFC theta with a negative lag, suggesting PL→BLA directionality of this synchrony. Crucially, this is significant only in discriminators and only during CS-, suggesting that PL entrainment of BLA spiking activity may participate in the correct discrimination between the two auditory stimuli and/or appropriate fear inhibition during CS-. Indeed, the probability of a PL

leading BLA in the theta power between PL and BLA on a trial-by-trial basis was negatively correlated with freezing (Likhtik et al. 2014). Phase locking of BLA unit activity to the mPFC LFP was also found when animals were in the periphery (safer location) of an open field (a standard anxiety test), further supporting the notion that mPFC→BLA neural coordination may participate in the discrimination between danger and safety.

Stujenske et al. (2014) provided further evidence of PL to BLA modulation, showing that PL-BLA synchrony is associated with fear discrimination during relative safety in the gamma range as well. They observed that better behavioral discrimination between the CS+ and CS- correlated with higher fast gamma power in PL and synchrony between BLA and PL during CS-presentation. This was driven by highly synchronous fast gamma (70-100 Hz) LFP events in PL and BLA. Granger causality was significantly stronger in the PL to BLA direction than the reverse, and mPFC to BLA Granger strength was also correlated with discrimination. One possibility is that fast gamma bursts and theta synchrony between PL and BLA may be related phenomena. Indeed, fast gamma oscillations in the BLA were significantly more coupled to mPFC theta oscillations than to local BLA theta oscillations. These fast gamma events also occur in PL and the vHPC, but not in the dHPC, and consistently only the gamma coupling between the ventral HPC and BLA is strong (Figure 4.12). Granger causality analysis suggested that the directionality of fast gamma synchrony is from the mPFC to the BLA and then to the vHPC. Taken together, these results suggest that the dmPFC may coordinate firing activity in the BLA and vHPC during periods of relative safety and fear discrimination. These results are somehow surprising as, following the dmPFC vs. vmPFC model, this mPFC→BLA synchrony during fear inhibition would be expected from recordings in the ventral portions of mPFC. However, these results do not exclude the possibility that synchrony could exist between vmPFC, AMG, and vHPC, possibly with even greater magnitudes.

In conclusion, while 4 Hz oscillatory activity is associated with fear expression, theta synchrony is linked with fear inhibition. Moreover, recent evidence suggests that the 3–6 Hz and 6–12 Hz bands in the BLA are separate oscillations with opposite relations to fear memory expression (Davis et al. 2017; Cambiaghi et al. 2016). Davis et al. (2017) showed that after contextual fear extinction, silencing PV interneurons in the BLA stimulates freezing behavior. Moreover, this optogenetic manipulation of BLA interneurons increases the power of 3–6 Hz oscillations there while respectively increasing and decreasing the probability that the BLA will lead the LFP of the mPFC in the 3–6 and 6–12 Hz frequency bands, respectively. In this study, non-freezing epochs are associated with the BLA leading the mPFC in the theta (6–12 Hz) band. This result is surprising because of previous observations in cued fear extinction tasks of mPFC→BLA coherence in the theta band (4–12 Hz) during CS- and fear inhibition (Likhtik et al. 2014). A possible explanation is that filtering theta between 4 and 12 Hz may have included some leakage of the 3–6 Hz band in Likhtik and colleagues' theta band. Alternatively, context fear

inhibition and cued fear inhibition may rely on communication between the BLA and mPFC in opposite directions.

4.4.4 Interstructure Communication during Sleep Supports Fear Memory Consolidation

Converging evidence shows that both theta and gamma synchrony between BLA and mPFC are associated with fear behavior control. Furthermore, some studies also suggest that oscillatory coupling between these structures, particularly during sleep, may be crucial for fear learning. Indeed, changes in mPFC–BLA and dHPC–BLA theta coherence between pre-conditioning and post-conditioning REM sleep correlate with inter-individual variations in memory consolidation after conditioning (Popa et al. 2010). However, during the paradoxical sleep following conditioning, the dominant directionality of the coherence predicting consolidation is BLA→mPFC and HPC→BLA. These data suggest that during REM sleep, the directionality of synchronization flows from the HPC to BLA and then to mPFC, the opposite of what was found for gamma synchrony during fear inhibition (Stujenske et al. 2014). This suggests that during behavioral discrimination and extinction learning neural synchronization follows a mPFC lead, while the consolidation of fear learning may rely on communications in the other direction. Consistent with this view, attenuating the theta rhythm in the HPC by selectively inhibiting the medial septum impairs contextual fear memory if the inhibition takes place during REM, but not during non-REM sleep (NREM), sleep (Boyce et al. 2016). REM sleep is also crucial for extinction training. Indeed, extinction efficacy highly correlates with the potentiation of REM sleep, although both NREM and REM sleep amounts increase after learning (Datta and O'Malley 2013).

Most of what is known about the neural mechanisms of fear expression on the one hand, and fear memory consolidation on the other, comes from recordings of the dorsal parts of the mPFC. Little is known about the communication between the vmPFC and the AMG. Since optogenetics evidence indicates distinct roles of the parallel anatomical loops between the BA and the dmPFC vs. vmPFC (cf. 4.1.3), it is now a priority to determine the fear conditioning correlates of the electrophysiological communication mechanisms between the BA and the different subdivisions of the mPFC.

4 Neural Coding of Fear Learning and Defensive Behavior

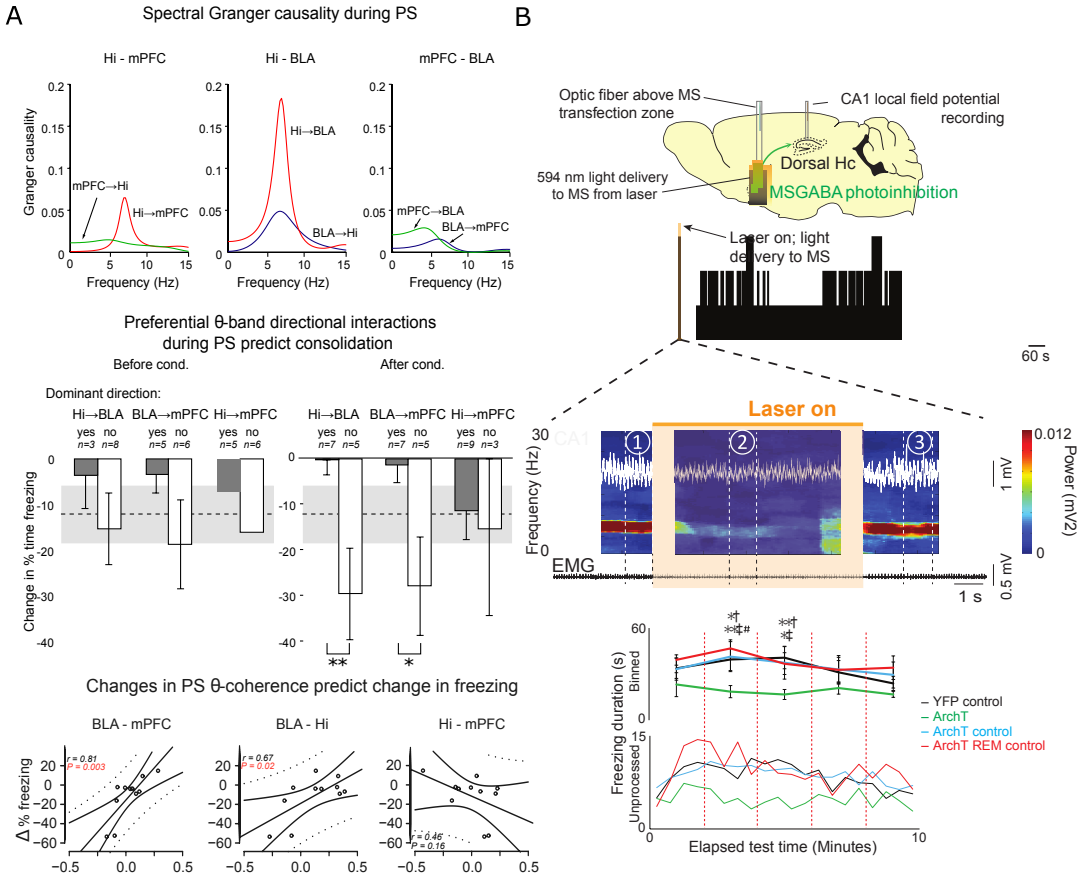

Figure 4.13: Rapid eye movement (REM) sleep and fear memory consolidation. (A) Granger causality analysis between the mPFC, the BLA, and the HPC during REM reveals a HPC→BLA→mPFC directionality of communication. Top: Granger causality index as a function of time for HPC→mPFC (left), HPC→BLA (middle), and mPFC→BLA (right) signals. Note the peaks at theta frequency. Bottom: The preferential directional interaction HPC→BLA and BLA→mPFC predicts overnight changes in freezing after conditioning but not before (panel adapted from Popa et al. 2010). (B) Causal role of REM sleep theta rhythm in fear memory consolidation. Top: an optic fiber implanted into the medial septum (MS) allows for optogenetic inhibition of MS GABAergic neurons while recording the LFP signal from electrodes implanted in dorsal CA1. Middle: selective silencing of MS GABAergic neurons results in suppression of the hippocampal theta oscillations in CA1 (spectrogram). Bottom: inhibiting MS GABAergic neurons selectively during REM after fear conditioning impairs contextual fear memory (panel adapted from Boyce et al. 2016).

Part II

Results

5 Ventral Hippocampus Terminals in Prelimbic Cortex Control Contextual Fear Expression after Extinction Learning

Adam Eckmier^{a*}, Marco N. Pompili^{a,b*}, Margot Tirole^{a,b},
Ralitsa Todorova^b, Thérèse M. Jay^a & Bill P. Godsil^a

^a Institute of Psychiatry and Neuroscience of Paris (IPNP), Hôpital Sainte-Anne, INSERM, Université Paris Descartes, 102-108 Rue de la Santé, 75014 Paris, France

^b Center for Interdisciplinary Research in Biology (CIRB), Collège de France, CNRS, INSERM, PSL Research University, 11 place Marcelin Berthelot, 75005 Paris, France

* These authors contributed equally to this work

Statement of contributions: BPG, AE, and TMJ designed the research. AE, BPG, and MNP performed surgeries for viral injections. AE and BPG carried out the behavioral experiments, the freezing scoring, and the histology. MNP and MT carried out the electrophysiology experiments, whose data were analyzed by RT, MT, and MNP. MNP analyzed the behavioral data, and wrote the current manuscript.

Acknowledgements: We thank Guillaumé Dugué for help designing the custom optrodes, Mehdi Rousset for help with the electrophysiology data analysis, and Sidney I. Wiener for comments on the manuscript. This project was funded with a grant from the Agence Nationale de la Recherche to BPG, TMJ, and SIW.

work in progress

Abstract Debilitating clinical conditions, such as post-traumatic stress disorder and generalized anxiety disorder can be caused by memories of traumatic events. These pathologies are often treated with exposure-based therapies (EBTs) where the patient is repeatedly exposed to the fear-triggering cues until pathological fear disappears. However, this reduction of fear fails to generalize outside of the context of the clinic and patients often experience in a relapse of symptoms outside the clinic. Trauma and EBT can be modelled in rodents with fear conditioning and extinction protocols. Critically, as for EBTs in humans, extinction learning in rodents is context dependent and animals's fear is renewed outside of the context where extinction takes place. One possibility is that the hippocampus (HPC) which is critically involved in

contextual processing, sends contextual information to the medial prefrontal cortex (mPFC) to regulate fear. It was recently reported that the artificial modulation of the activity of the anatomical pathway connecting the ventral HPC (vHPC) and the mPFC affects cued fear renewal behavior. However, it is still unknown whether this depends upon a direct capability of this pathway to control behavior or rather upon the transmission of contextual information to the mPFC which processes it to regulate fear. While this project was initially aimed at answering this question on cued fear, the data obtained so far show that the activity of the vHPC-mPFC pathway is implicated in the control of contextual fear expression. We observed this effect only following extinction training. However, further experiments would be required to draw final conclusions and understand the relationship between vHPC-mPFC role in regulating cued fear renewal and its implication in controlling contextual fear.

5.1 Introduction

Memories for traumatic events can help us to anticipate and prevent future threats, but they can also lead to the pathologically exaggerated emotional responses manifested in fear and anxiety disorders (Lissek and Grillon 2015). Anxiety disorders cause significant distress and impose burdens with massive social health expenses. Their lifetime prevalence rates are in the range of 25% of the population (Keane et al. 2006). Extinction of these responses is the target of increasing attention in the past decade because of its clinical significance in the treatment of various psychiatric disorders (Cuthbert 2015; Dunsmoor et al. 2015; Milad and Quirk 2012; Nees et al. 2015; Vervliet et al. 2013). Notably, extinction is the basis for exposure-based therapies, a primary behavioral treatment for stress- and trauma-related, and other anxiety disorders, as well as for addictions (Powers et al. 2010). However, contextual cues contribute crucially to the effectiveness of EBT. Indeed, therapeutic emotional regulation, including fear extinction, does not always generalize effectively beyond the specific context where the therapy takes place, and, outside the clinical setting, symptoms can be re-triggered by previously extinguished cues (Boschen et al. 2009). Understanding the factors underpinning the contextual control of fear after extinction could help better identify the ones that determine the resistance to relapse in treatments of fear and anxiety disorders.

Pavlovian fear conditioning is a well-established rodent model of fear and anxiety disorders. A conditioned stimulus (CS), for example a tone, is paired with the delivery of an aversive unconditioned stimulus (US) such as an electrical shock. When the animal is then exposed to the CS, a fear response, typically in the form of freezing, is induced. Also the context where conditioning took place acquires aversive associations with conditioning, and can later trigger fear expression (contextual fear). In cued extinction training, the CS is no longer paired with the US, and, as a result, freezing behavior declines. How-

ever, similar to EBTs, extinction learning in rodents is context dependent, and when the CS is tested in a context different from the one used for extinction, recovery of the fear behavior can occur (fear renewal; Bouton et al. 2006). Fear renewal occurs both when the animals are tested in the same context of initial conditioning (ABA experimental design) or in a novel context (ABC design). Purely contextual fear conditioning consists of associating an environment with mild shock with no discrete cue serving as a CS.

Consistent with the wide literature supporting its role in spatial memory and navigation (Eichenbaum et al. 2007; Moser et al. 2008), the hippocampus (HPC) is essential for contextual fear conditioning and the context-dependency of cue-conditioned fear extinction (Corcoran and Maren 2001; Corcoran et al. 2005; Frohardt et al. 2000; Hobin et al. 2006; LaBar and Phelps 2005; Maren et al. 2013; Matus-Amat et al. 2004; Rudy et al. 2002; Wilson et al. 1995; Young et al. 1994b; Zelikowsky et al. 2013). Furthermore, the HPC is also essential for cued extinction learning itself since its inactivation during fear extinction decreases the rate of extinction and impairs subsequent extinction memory (Corcoran et al. 2005; Sierra-Mercado et al. 2011).

Growing evidence suggests that the medial prefrontal cortex (mPFC) is critically involved in fear behavior regulation and extinction memory encoding and consolidation (Corcoran and Quirk 2007; Courtin et al. 2014; Dejean et al. 2016; Do-Monte et al. 2015a; Do-Monte et al. 2015b; Karalis et al. 2016; Laurent and Westbrook 2009; Milad and Quirk 2002; Morgan et al. 1993; Rozeske et al. 2018; Sierra-Mercado et al. 2011; Kim et al. 2016; Vidal-Gonzalez et al. 2006), with some authors reporting the prelimbic (PL) and infralimbic (IL) regions of mPFC as respectively implicated in the control of fear expression and extinction (Quirk and Mueller 2008). However, these regions are highly interconnected, and PL was recently shown to also play a role in extinction (Marek et al. 2018b).

The hippocampal formation (HF) sends monosynaptic connections to both PL and IL (Cenquizca and Swanson 2007; DeNardo et al. 2015; Ferino et al. 1987; Hoover and Vertes 2007; Jay and Witter 1991; Jay et al. 1989; Marek et al. 2018a; Padilla-Coreano et al. 2016; Parent et al. 2009; Spellman et al. 2015; Swanson 1981; Swanson and Cowan 1977; Takita et al. 2013a; Xu and Südhof 2013; Ye et al. 2016), and HPC contextual information may thus inform behavioral regulation processed in mPFC (Godsil et al. 2013; Maren et al. 2013). These projections mostly originate in the ventral HPC and subiculum (with only sparse projections reported from the dorsal portions of the HF). Moreover, the ventral HPC (vHPC), but not the dorsal HPC, is highly connected with the amygdala (Van Groen and Wyss 1990; McDonald and Mott 2017; Pitkänen 2000), which is critically implicated in fear learning and emotional regulation (Janak and Tye 2015; Krabbe et al. 2018). Pharmacological, genetic, anatomical, and lesion studies indicate that vHPC is particularly implicated in emotional regulation (Fanselow and Dong 2010; Strange et al. 2014). Indeed, vHPC inactivation impairs fear expression (Sierra-Mercado et al. 2011) and

5 Ventral Hippocampus Terminals in Prelimbic Cortex Control Contextual Fear Expression after Extinction Learning

the inhibition of the vHPC to amygdala pathway blocks context dependent fear renewal (Xu et al. 2016). The activity of vHPC to mPFC projections also affects the expression of innate fear (Padilla-Coreano et al. 2016).

Two recent pharmacogenetic experiments implicated vHPC projections to the PL and IL in context-dependent cued fear renewal and extinction recall. Stimulation of vHPC projections to IL impaired cued extinction recall (in the extinction context) while inhibiting them reduced context-dependent cued fear renewal (in the conditioning context; Marek et al. 2018a). Conversely, activating vHPC cells projecting to PL after extinction training attenuated subsequent cued fear renewal (Vasquez et al. 2019). However activation before a conditioning retention test did not affect cued fear expression. These results suggest that the projections of the vHPC to PL or IL may have opposite roles in the control of fear expression during cued fear renewal. Furthermore they show that HPC projections to the mPFC can regulate learned cued fear after extinction. What is still unknown is the functional relationship between these effects on fear regulation and the HPC role in contextual encoding. Two hypothesis can be advanced. One is that vHPC-mPFC signalling can directly control fear regulatory mechanisms within the mPFC. Alternatively, HPC transmits contextual information, perhaps during the initial contextual processing after entering an environment, and this is processed in the mPFC and is used to regulate fear behavior accordingly. The aim of this project was to test the second hypothesis. Even though the data collected so far is not conclusive, requiring further experiments, the following gives the current status of the project.

5.2 Results

Expression of Chr2 in the ventral HPC and mPFC

To selectively control vHPC projections in the PL, we used an AAV virus to induce the expression of channelrhodopsin2 (Chr2) in vHPC neurons (Figure 5.1a). Histological analysis confirmed restricted infection in the ventral hippocampal formation (vHF, vHPC and ventral subiculum; Figure 5.1b). Histological analysis also confirmed the expression of Chr2 in axon terminals in the PL ipsilateral to the injection site (Figure 5.1b and Supplementary Figure 5.4), consistent with the known projection from the vHPC to mPFC.

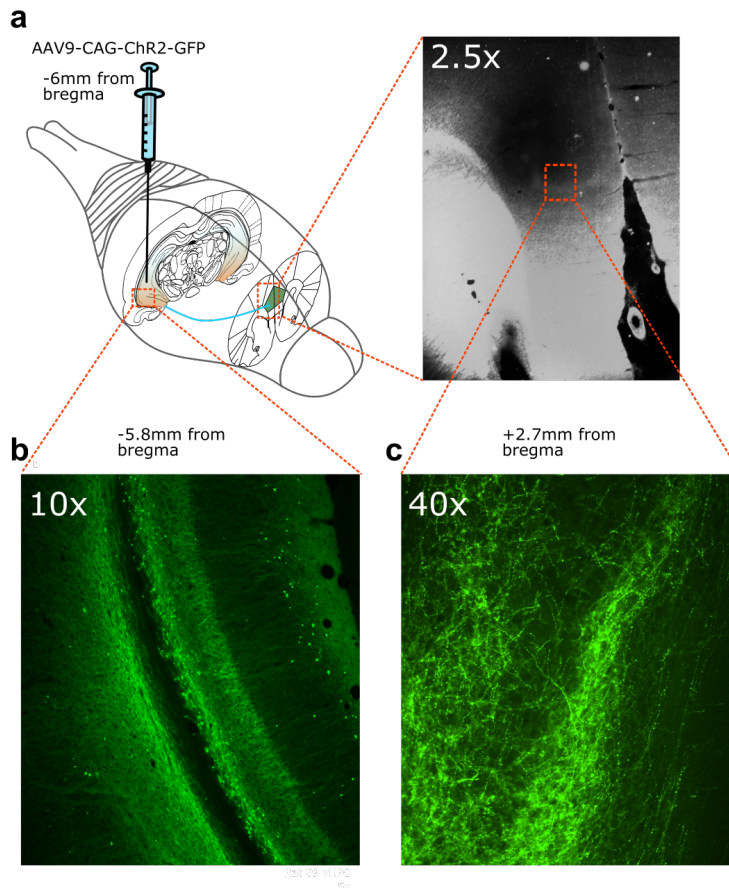

Figure 5.1: Expression of ChR2 in vHF somas and axon terminals in PL. (a) Schematic depicting the strategy used to obtain ChR2 expression in vHF efferents to PL the unilateral injection site of the AAV virus transducing ChR2 in the vHPC and the projection of infected neurons to the PL. (b) ChR2 expression in vHPC CA1 (labelled by GFP). (c) GFP-labelled ChR2 expression in vHPC axon terminals in PL.

PL neurons responded to optical stimulation of vHPC afferents to PL

In anesthetized animals, light pulses were delivered at 20 Hz in the PL of animals expressing ChR2 in vHPC terminals. Most units did not show any activity change with optogenetic stimulation, however 71 out of 597 units (Figure 5.2a) displayed some kind of electrophysiological response within 12 ms of the laser pulse onset. There were two principal response types (Figure

5 Ventral Hippocampus Terminals in Prelimbic Cortex Control Contextual Fear Expression after Extinction Learning

5.2a,c,d): initial excitation after the pulse onset, or inhibition followed by an excitatory rebound at the end of the pulse. 11.8% of cells recorded in ChR2 expressing animals significantly responded to light pulses (both excitatory and inhibitory responses) which was significantly more than chance (Figure 5.2d). Conversely, the proportion of significantly responding units recorded in a control animal was very small. Units in controls probably responded because of thermal and photoelectric artifacts which may have induced small contamination of our isolated units. However, the proportion of significantly responding units in controls was below chance levels (Figure 5.2d). Finally, the proportion of significantly responding cells in ChR2 animals was also greater than the proportion of responding units in controls (Figure 5.2d).

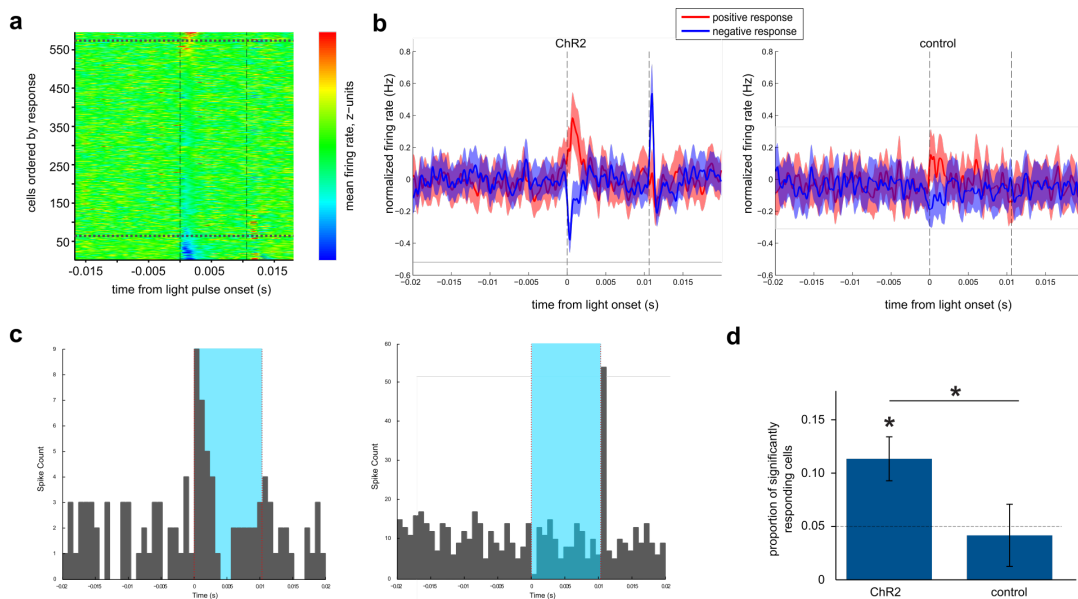

Figure 5.2: PL neural responses to vHPC terminal stimulation. (a) z-scored average firing rate of all recorded PL units in ChR2 expressing animals around light pulses stimulation. About 12% displayed excitatory or inhibitory responses to laser onset. Vertical dashed lines depict the beginning and end of the light pulses. Horizontal dashed lines segregate units which displayed a significant response within 20ms from the light pulse onset. (b) Firing rate evolution around light stimuli for significantly excited (red) and inhibited (blue) cells in ChR2 (left) and control (right) animals. (c) Peri-event time histograms for representative cells with excitatory (left) and inhibitory-rebound (right) responses. (d) Proportion of significantly responding units as assessed with the jitter analysis (see methods), $p < 0.05$, Sign rank test. $p < 0.05$

Stimulating the vHPC to PL pathway inhibits contextual fear expression after extinction

To see whether the activity of the vHPC→PL pathway during the contextual processing preceding CS presentation plays a role in context-dependent cued fear renewal, we ran a pilot experiment with a compound (ABCA) renewal design. There, an ABC fear renewal protocol was followed by a second fear renewal test in the initial conditioning context A (Supplementary Figure 5.5a). Optogenetic stimulation of vHPC→PL took place during the baseline context exposure periods prior to CS presentation in the two fear renewal tests (both in C and A). This stimulation did not affect subsequent cued fear renewal in either context, therefore suggesting that the effect obtained by Vasquez et al. (2019) with prolonged pharmacogenetic excitation was induced by increased vHPC-PL activity during and/or after CS presentation.

Surprisingly, vHPC-PL optogenetic stimulation in the pre-CS period induced decreased contextual fear in the conditioning context A, supporting vHPC-PL pathway activity having an influence on contextual fear expression. To test this, we ran an experiment where after contextual fear conditioning, we stimulated vHPC terminals in PL during a contextual fear recall test. Rats received a mild footshock in chamber A, then they were returned to the same chamber after a one day interval, and tested for contextual fear recall while the vHPC→PL pathway was optogenetically stimulated. On the recall test, no behavioral difference was observed at any time point (Figure 5.3a, unpaired t-tests, $p > 0.5$) between animals expressing ChR2 at vHPC-PL terminals who received laser stimulation during the recall test, and animals expressing the control virus who received laser stimulation, or animals expressing ChR2 with no light stimulation. Since this experiment indicated that vHPC→PL activity did not affect contextual fear at all in this paradigm, we next hypothesized that vHPC-PL pathway activity may be able to control contextual fear expression only after some kind of extinction training has taken place, similarly to cued fear expression in Vasquez et al. (2019).

Since our pilot experiment indicated an effect of vHPC→PL stimulation on contextual fear in the conditioning context but not in a different one (Figure Supplementary 5.5), we first aimed to replicate our pilot with a more simple ABA design (Figure 5.3b). The animals underwent auditory fear conditioning in chamber A, then auditory fear extinction in chamber B for 3-7 days until freezing to the CS was lower than 60%. Animals who did not meet this criterion by the 7th day were excluded from further analysis. Finally, the rats were exposed again to chamber A and the CS. In the fear renewal session the laser was ON during the baseline context processing period before CS presentation. This decreased fear expression during this period relative to control animals expressing only GFP without ChR2, and also to animals with no light stimulation (Figure 5.3b). Since there was no behavioral difference between the two control groups at any time point of the experimental

5 Ventral Hippocampus Terminals in Prelimbic Cortex Control Contextual Fear Expression after Extinction Learning

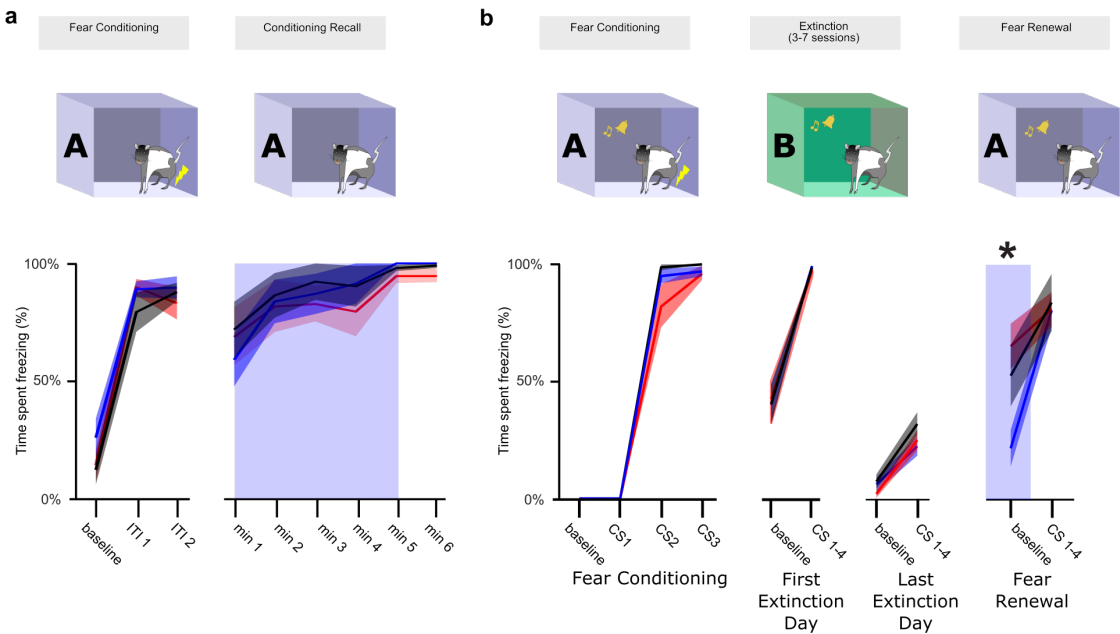

Figure 5.3: vHPC-PL pathway stimulation effects on contextual fear expression. vHPC-PL pathway stimulation effects on contextual fear expression. (a) Above, the contextual fear conditioning and recall test protocol. Below, percentage of time spent freezing during the baseline and the inter-trial intervals (ITI) of the contextual fear conditioning session (left) and during the 6 minutes of the contextual fear recall test (right). Laser stimulated ChR2 group ($n=12$, blue line), control virus and laser stimulation group ($n=14$, red line), and animals expressing ChR2 with no photic stimulation ($n=11$, black line). Shaded areas depict \pm SEM, the shaded blue rectangle indicates when laser was ON. (b) Above, The fear renewal protocol. Below, Freezing during the protocol. Same format as Figure 5.3a. Respective numbers of animals: expressing ChR2 and laser ($n=10$), control virus and laser ($n=8$), and ChR2 with no laser ($n=10$). CS 1-4 = average freezing over the first four CS presentations.

protocol (unpaired t-tests, $p>0.05$), their data were pooled. Laser-stimulated ChR2 animals' behavior was compared to pooled controls during the delivery of the laser stimulation. This confirmed the pilot result wherein optogenetic stimulation of vHPC-PL pathway decreases contextual fear expression after extinction (unpaired t-test $p=0.016$).

As a control, we tested if this vHF-PL stimulation directly affects motor behavior. Rats were allowed to forage in an open field and there were no differences in locomotor behavior between stimulated animals and controls (Supplementary Figure 5.6).

5.3 Discussion

These provisional results complete those of Vasquez et al. (2019), showing that the vHPC-PL can also control contextual fear after cued-extinction training but not right after contextual conditioning. It is important to note, however, that further experiments would be needed to draw solid conclusions. Namely, it would be important to test the effect of the optogenetic stimulation during CS presentation in our protocol.

Moreover, it would be important to further test whether vHPC-PL activity can affect contextual fear expression after some degree of contextual fear extinction training. In a suitable protocol the animals would undergo contextual fear conditioning and afterwards some contextual extinction training in the same context. Then vHPC-PL would be optogenetically stimulated during a subsequent contextual fear test. Particular attention should be dedicated to develop an extinction protocol that does not yield excessively low levels of contextual fear to avoid floor effects.

Another possibility is that the vHPC-PL pathway becomes implicated in controlling fear expression with the simple passage of time or by the simple exposure of the animals to different contexts and manipulations. Indeed, after a simple contextual fear conditioning protocol, the physical chamber where conditioning takes place may not be the most salient fearful cue for the animal. Any other aspect of the experimentation, starting from the simple fact of being taken off from the home cage may be a salient cue triggering fear. Therefore exposing the animals to different manipulations between conditioning and test sessions may allow to rule out this hypothesis.

One difference between our experiments and those performed by Marek et al. (2018) and Vasquez et al. (2019) is that our stimulations were unilateral. Our data suggest that unilateral stimulations are sufficient to induce a behavioral effect but we cannot rule out the hypothesis that bilateral stimulations would have yielded different results.

5.4 Methods

Animals

We used 152 male Long-Evans rats (260-340g at the time of surgery, 2-4 months old), which were housed in groups of 3 or 4 before surgery and then individually. They were maintained at about 21 °C in a well-ventilated room with a light/dark cycle of 12h with free access to food and water. Upon arrival in the lab the animals were allowed at least 3 days of acclimation before being

5 Ventral Hippocampus Terminals in Prelimbic Cortex Control Contextual Fear Expression after Extinction Learning

handled daily by the experimenter for at least 2 days prior to surgery. 25 and 49 animals were used for the pilot and test of the fear renewal experiment, respectively. 38 and 34 animals were used for the context freezing and ambulatory distance experiments, respectively. 6 animals were used for the acute electrophysiology recordings. All the experimental procedures were performed in accordance with institutional guidelines and the French national and European laws and policies and approved by Paris Descartes University Ethical Committee.

Virus injection and chronic fiber implantation

94 animals were injected with AAV9-CAG-ChR2-GFP, an adeno-associated virus carrying channelrhodopsin (ChR2) and tagged with a green fluorescent protein (GFP) (University of North Carolina Vector Core, USA), while 58 animals received the injection of an AAV9-CAG-GFP control virus. Rats were anaesthetized with an intraperitoneal injection of a Ketamine/Xylazine mix (90 and 15 mg/kg, respectively) and sub-cutaneously with buprenorphine hydrochloride. All animals received unilateral injections a part from those used for the electrophysiology recordings who were injected bilaterally. For each injection, 0.8 μ l of solution containing the virus were pressure-injected into the vHPC (-6mm AP, \pm 5.4mm ML, 6mm DV from dura mater) at a rate of 0.1 μ l/min. The tissue was allowed to recover for 5 min before needle retraction.

For the animals used for the acute electrophysiology recordings, the scalp was then sutured, and the animals were placed in their home cage on a heating pad until they woke up. The animals used in the behavioral experiment also received a craniotomy above the the mPFC (+3.2 mm AP/0.8mm ML of bregma) and a single mono-fiber optic cannula (Doric Lenses) was positioned in the PL and the lower edge of the cannula receptacle was positioned flush with the skull surface. Two anchoring screws were installed at 26.7 mm AP/5.4 mm ML to bregma, and 24.0mm AP/3.0mm ML to bregma. Next, bonding adhesive (Superbond L-type polymer, Sun Medical) was swabbed over the skull surface before a series of layers of self-curing composite dental resin (Dentalon Plus, Farbe, France) was built up over the skull until a cap sufficient to hold the cannula in place was formed. Rats were left to recover for 6 weeks post-injection to permit robust expression in the vHPC axon terminals in mPFC. Prior to any behavioral testing rats were handled four times per day for 3 days. Handling involved briefly removing the rat from its cage while manipulating its cannula's dust cap.

Behavioral apparatus and data processing

All training and test sessions in the conditioning experiments were conducted in a standard conditioning chamber kept inside a sound-attenuating cubicle (VCF-007, Med Associates). This chamber had the internal dimensions of $30 \times 24 \times 33$ cm, with aluminum sidewalls, an interchangeable rear wall, and a transparent Plexiglas door. The grid floor was connected to a constant current scrambled shock generator (ENV-414, Med Associates, USA), which delivered the US footshock (2 sec, 0.6 mA). The rats were placed in the chamber individually and were connected to a patch-cable/rotary-joint/ laser assembly that was controlled by Med Associates hardware and software. Three configurations of this chamber were used in the conditioning experiments. In context A the chamber was dark, except for two infrared light sources located above the training box, the rear panel was constituted by a transparent plexiglass wall, and 0.2 mL of a mint-scented cleaning solution (Simple Green, Sunshine Makers) was put in a pan underneath the grid floor. Context B was the same darkened chamber as Context A, but was scented with 1% acetic acid in the collection pan, and had white plastic floor and curved wall inserts. Context C had the same floor and wall plastic inserts of B but it was scented with 1% ammonia, the lighting was on, as well as a ventilation fan. A well trained experimenter used an instantaneous time-sampling procedure to characterize behavioral freezing from the video files. Freezing was defined as the absence of movement except for breathing.

For the locomotor control experiment, we used a 50×50 cm darkened open field (Med Associates) for 960-second sessions during which the rats were tethered by a patch cable connected to a rotary joint (Doric Lenses) positioned above the arena, which allowed rats to move freely in the environment. Activity data were collected with an automatic system (Activity Monitor, SOF-811, Med Associates), which estimated locomotor distance and rearing counts via infrared beam breaks.

The light source used in all behavioral experiments was blue light (473 nm) from a laser (BL473T3-100FC, Shanghai Laser) through the patch cable/ rotary joint assembly, and into the fiber optic cannula with a light power output measured at the fiber tip of 11 mW. The light was delivered as light pulses at 20 Hz.

Ambulatory distance protocol

Rats were placed individually in a 50×50 cm darkened open field (Med Associates) for a 540-sec session while tethered by a patch cable connected to a rotary joint (Doric Lenses) positioned above the arena, which allowed rats to move freely in the environment. After a baseline of 180 seconds, 22 rats (13 who received ChR injection and 9 with the control virus) received

5 Ventral Hippocampus Terminals in Prelimbic Cortex Control Contextual Fear Expression after Extinction Learning

light stimulation for 180 seconds. 12 rats with ChR2 did not receive any light stimulation.

Context fear protocol

The rats underwent fear auditory fear conditioning in context A for 12 minutes during which they received three footshocks at 300, 512, and 724 sec after the initiation of the control program, which was activated immediately following placement of the animal in the chamber. The following day they were exposed to context B for 25 minutes. On the third day of the protocol, the animals were placed again in context A for 6 minutes to test their context fear and 26 rats received a laser stimulation for the first 240 seconds (12 were injected with ChR2 and 14 with the control virus). 10 rats injected with ChR2 did not receive any photic stimulation during the context fear test.

Fear renewal protocol

In the fear renewal protocol the rats underwent fear auditory fear conditioning in context A for 12 minutes during which they received three 30 sec presentations of the auditory CS (2 KHz pure tone) that co-terminated with the US at 300, 512, and 724 sec after the initiation of the control program, which was activated immediately following placement of the animal in the chamber. Extinction training started the following day with daily 25 minute sessions in context B or C with 24 CS presentations starting at 300 seconds after the initiation of the session separated by 20 seconds intervals. Each day, after or before auditory extinction (the order of extinction and context exposures was counterbalanced between animals), the rats were placed for 25 minutes in context C (those undergoing extinction in context B) or C (the others). For each rat, extinction training continued until the average time spent freezing across the first four CS presentations was below 60%. The animals that did not reach this threshold by the seventh day of extinction training were excluded from further analysis. The day after the last extinction training the fear renewal test took place. Rats were placed in context A for 6 minutes where after a 300 second baseline a CS was presented. For the animals that received the injection of the control virus (n=12) and 21 rats that received the injection of the ChR2 carrying virus, light stimulation was on for 300 seconds during the baseline before the CS presentation. A second control group was composed of 15 rats that received the injection of ChR2 but did not receive any optogenetical stimulation during the fear renewal test.

Electrophysiological acute recordings

Anesthesia was induced with isoflurane in oxygen (5%) and then maintained with an IP injection of urethane (1.7 g/kg), to preserve spontaneous slow brain oscillations (Ferron et al. 2009; Toth et al. 2012). The rat was then placed in the stereotaxic frame, the skull exposed and craniotomies were drilled above PL (a 4x2 mm area above the right and left PL cortices) and above the cerebellum to place the reference electrode. Custom-made optrodes recorded and stimulated bilaterally brain activity. They consisted of two 200 μm diameter optic fibers placed 1.6 mm apart and surrounded by four octrodes made of twisted tungsten wire, cut 500 μm below the tip of the fibers. The electrodes were gold plated to reduce impedance to about $\sim 100 \text{ k}\Omega$. The implant was positioned so that the fibers were placed at $\pm 0.8 \text{ mm ML}$; $+3 \text{ mm AP}$. It was then very slowly lowered in the brain until PL was reached and a suitable spike activity was detected on both sides. At each site the optic stimulation protocol was applied, and afterwards the implant was lowered a few tens of microns to find new cells, until the ventral limit of PL.

Brain activity was recorded with a 64 channel analogic recording system with Cheetah software control (Neuralynx, USA). Signals were differentially amplified 1000 times, bandpass filtered between 0.1 and 6000 Hz and digitized at 32,556 kHz. The differential reference was manually selected from a bipolar electrode implanted in the cerebellum. A large metallic box was placed above and around the stereotaxic frame to act as a Faraday cage, protecting the implant and the pre-amplifiers from noise. Optogenetic stimulations were controlled with Power 1401 interface and spike2 software (CED, UK). Light was delivered with a MLD Laser Diode Module 473nm laser (Cobolt, Germany) and the light output was split into two beams of equal power for each hemisphere with a minicube splitter (Doric Lenses, Canada). We used 20 Hz train-pulse stimulations of 4 different durations (0.5s, 1s, 5s, 15s) at different light intensities (6.7mW and 11mW). The latter near-saturation power was equivalent to the one used for the behavioral experiment while the former was used in the eventuality of near-saturation power hiding neural responses. Each trial consisted of a 5 min baseline recording followed by the 4 durations of train pulses randomly presented with an inter-train interval of 30s.

Histology

After all experiments, rats were deeply anesthetized with a lethal dose of pentobarbital, and intracardially perfused with saline (0.9%) followed by paraformaldehyde (4%). Coronal slices (35 μm) were cut with a cryostat and slide mounted and imaged on an epifluorescence microscope. Some slices from the animals used for the electrophysiological recordings were stained with cresyl-violet to confirm electrode position. Slices were carefully analyzed to verify electrodes and fibers placement in PL and for the expression of ChR2.

5 Ventral Hippocampus Terminals in Prelimbic Cortex Control Contextual Fear Expression after Extinction Learning

Animals displaying low levels of ChR2 expression in ChR2 or misplacement of the electrodes/optic fiber were discarded from further analysis.

Electrophysiological signals processing and analysis

To extract spiking activity, wide-band signals were high-pass filtered (non-linear median-based filter) and thresholded using NDManager (Hazan et al., 2006). Extracted spike waveforms were sorted via a semi-automatic cluster cutting procedure using KlustaKwik (Harris et al., 2002) and Klusters (Hazan et al., 2006). Neurophysiological and behavioral data were explored using NeuroScope (Hazan et al., 2006). The waveform, autocorrelogram and raw traces of each cluster discriminated by the program were carefully examined, and only those showing low noise were retained for further analyses. All further analysis were performed function of the FMA toolbox (<http://fmatoolbox.sourceforge.net>) and custom-written programs in Matlab (Mathworks, USA).

We categorized cells as responsive or not responsive based on a jitter method. The timestamps of spikes in a specified window around the event of interest (e.g. a pulse of light) were jittered in time by adding a random shift extracted from a uniform distribution. The absolute value of this jitter was chosen as to not exceed 10ms. The resulting surrogate histograms (100 iterations) were then compared with the original un-jittered one. Cells with at least one bin (1ms) in the 99th percentile ($p \leq 0.01$) were considered as responsive.

5.5 Supplementary Figures

[on the following page]

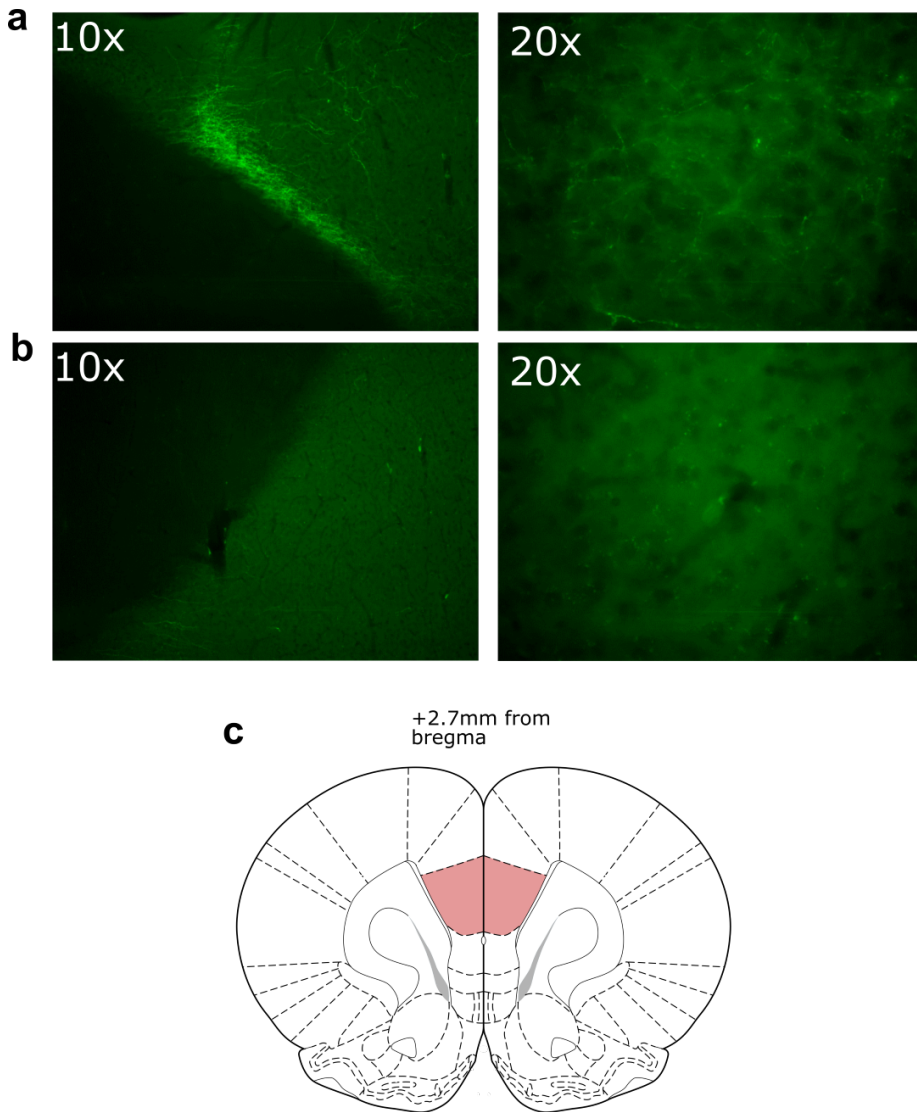

Figure 5.4: ChR2 expression in PL. GFP-labelled ChR2 expression in vHF axon terminals in the PL ipsilateral (a) but not contralateral (b) to the injection site. (c) approximate location of the imaged brain slices.

5 Ventral Hippocampus Terminals in Prelimbic Cortex Control Contextual Fear Expression after Extinction Learning

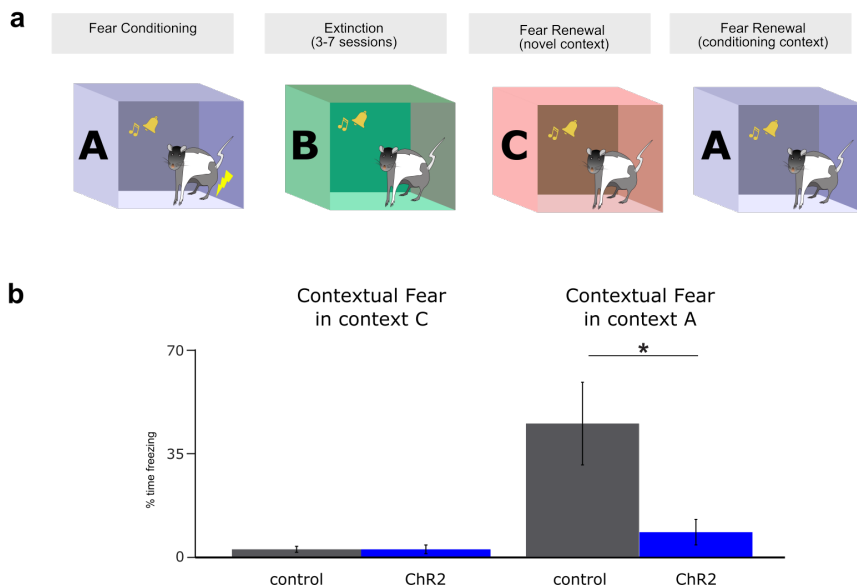

Figure 5.5: Pilot study. (a) Protocol experimental design. Optogenetical stimulation of the vHPC→PL pathway took place during the baseline pre-CS presentation periods in both renewal test sessions. All sessions took place on different days. (b) Comparison of the average time spent freezing during the baseline of the fear renewal test in context C (left) and A (right) for the optogenetically stimulated animals (ChR2, n=7) and controls (n=7). Statistical test is a paired t-test. *p<0.05

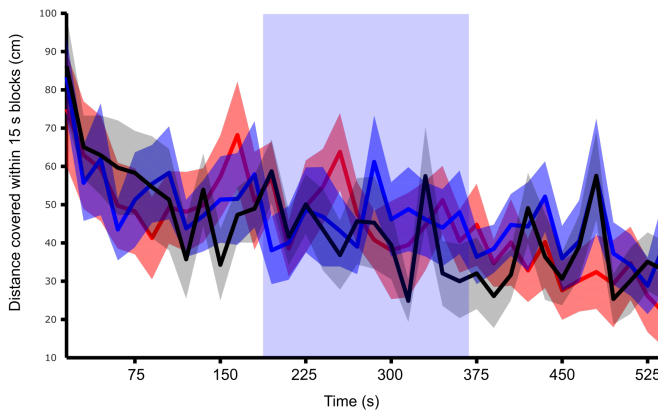

Figure 5.6: vHPC-PL pathway stimulation does not affect locomotor behavior in open field. Average distance travelled over time in an open field exploration test for laser-stimulated animals expressing ChR2 (n=13, blue line), laser-stimulated animals expressing a control virus (n=9, red line), and animals expressing ChR2 with no photic stimulation (n=12, black line). Shaded areas depict \pm SEM, the shaded blue rectangle indicates when laser was ON. No difference at any time point between groups (unpaired t-test, $p > 0.05$).

6 Wireless Inertial Measurement of Head Kinematics in Freely-Moving Rats

Matthieu O. Pasquet^{a*}, Matthieu Tihy^{b*}, Aurélie Gourgeon^b, Marco N. Pompili^{c,d}, Bill P. Godsil^d, Clément Léna^b & Guillaume P. Dugué^b

^a Institut de Neurobiologie de la Méditerranée (INMED), Institut National de la Santé et de la Recherche Médicale (INSERM), U901, Marseille, France

^b École Normale Supérieure, PSL Research University, Centre National de la Recherche Scientifique (CNRS) UMR8197, Inserm, U1024, Paris, France

^c Collège de France, Centre Interdisciplinaire de Recherche en Biologie (CIRB), Centre National de la Recherche Scientifique (CNRS) UMR7241, Institut National de la Santé et de la Recherche Médicale (INSERM) U1050, Paris, France.

^d Centre de Psychiatrie et Neurosciences (CPN), Institut National de la Santé et de la Recherche Médicale (INSERM) U894, Paris, France.

* These authors contributed equally to this work

Statement of contributions: M.O.P. designed the whole system architecture and developed the microcontroller firmware and PC client software. M.T. assembled the IMUs, external synchronization modules and battery charger. M.O.P, M.T. and G.P.D. troubleshot the device during the design phase. M.T. and A.G. performed implantation surgeries, collected data from freely moving rats and performed the acoustic startle experiment. A.G. performed the unilateral vestibular lesion experiment. B.P.G., M.N.P. and G.P.D. designed the fear conditioning experiment, M.N.P. performed the experiment and B.P.G. scored behavioral freezing. G.P.D. and B.P.G. performed the error and correlation analyses for the fear conditioning results. G.P.D. and C.L. performed the analysis of inertial data in other experiments. G.P.D., M.O.P., M.N.P. and B.P.G. wrote the manuscript.

Acknowledgements: This project was supported by grants from France's Agence Nationale de la Recherche to C.L. (ANR-12-BSV4-0027) and B.P.G. (ANR-12-SAMA-0005). This work has received support under the program "Investissements d'Avenir" launched by the French Government and implemented by the ANR, with the references ANR-10-LABX-54 MEMO LIFE and ANR-11-IDEX-0001-02 PSL* Research University. M.T. and M.N.P. were supported by fellowships from Région Île-de-France and from the Ministère de l'Éducation Nationale, respectively. We thank Gérard Paresys for his precious technical assistance and Boris Barbour and Sidney Wiener for their comments on the manuscript. We also thank Thérèse Jay for her financial and logistic support for the freezing experiment.

Published in *Scientific Reports*, 2016: 6(35689)

Abstract While miniature inertial sensors offer a promising means for precisely detecting, quantifying and classifying animal behaviors, versatile inertial sensing devices adapted for small, freely-moving laboratory animals are still lacking. We developed a standalone and cost-effective platform for performing high-rate wireless inertial measurements of head movements in rats. Our system is designed to enable real-time bidirectional communication between the headborne inertial sensing device and third party systems, which can be used for precise data timestamping and low-latency motion-triggered applications. We illustrate the usefulness of our system in diverse experimental situations. We show that our system can be used for precisely quantifying motor responses evoked by external stimuli, for characterizing head kinematics during normal behavior and for monitoring head posture under normal and pathological conditions obtained using unilateral vestibular lesions. We also introduce and validate a novel method for automatically quantifying behavioral freezing during Pavlovian fear conditioning experiments, which offers superior performance in terms of precision, temporal resolution and efficiency. Thus, this system precisely acquires movement information in freely-moving animals, and can enable objective and quantitative behavioral scoring methods in a wide variety of experimental situations.

6.1 Introduction

Inertial sensing microelectromechanical systems have opened new avenues for the measurement of body kinematics. Their small form factor has allowed the design of wearable inertial measurement units (IMUs) that can track linear accelerations and angular rates in three dimensions from specific body segments. Clinical applications of IMUs include the diagnosis of balance and gait disorders (Shull et al. 2014; Wong et al. 2007; Culhane et al. 2005) and the analysis of motor symptoms in degenerative diseases such as Parkinson's disease (Lieber et al. 2015). Ambulatory systems containing IMUs have been designed for detecting falls in the elderly (Li et al. 2009; Luštrek et al. 2011) and for guiding navigation in the sight-impaired (Riehle et al. 2013). IMUs also offer an efficient methodology for monitoring animal behavior. In animal husbandry, IMUs provide quantitative tools for general health assessment, for monitoring feeding behaviors and for estimating daily walking distances (Grégoire et al. 2013; Moreau et al. 2009; Rothwell et al. 2011). In the wild, IMUs have been used to study the behavior of more than a hundred species of marine, terrestrial and flying animals (Brown et al. 2013; Portugal et al. 2014; Chimienti et al. 2016; Graf et al. 2015; Collins et al. 2015; Shepard et al. 2008; Ravi et al. 2005; Nathan et al. 2012). In the laboratory, IMUs offer a way to obtain accurate measurements of motor responses and locomotor behavior in various animal models (Silasi et al. 2013; Shih and Young 2007; Chen et al. 2011; Ledberg and Robbe 2011; Sauerbrei et al. 2015). They could also advantageously replace tedious and subjective observational scoring techniques in a wide range of experimental situations, as shown for the automatic detection of

arousal states and behavioral sequences such as grooming, eating and rearing (Sunderam et al. 2007; Venkatraman et al. 2010).

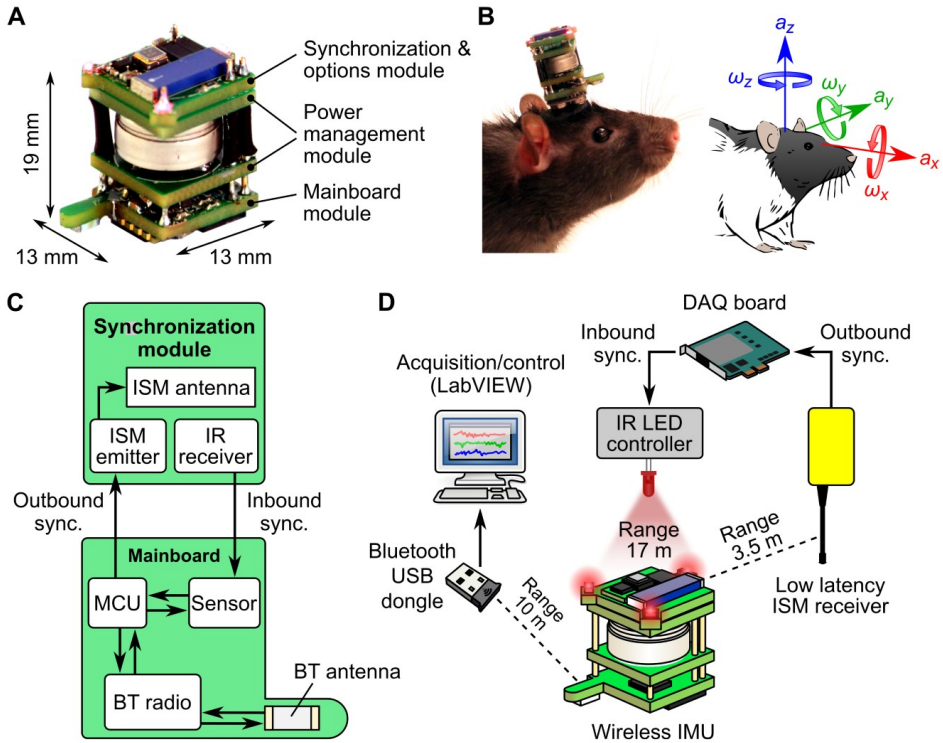

Figure 6.1: Overview of the wireless inertial measurement system. **A**, Inertial measurement unit (IMU) and its main components. **B**, Left: Photograph of an adult rat wearing the IMU. Right: sketch showing the directions of linear accelerations (a_x , a_y , a_z) and angular velocities (ω_x , ω_y , ω_z) measured by the sensor, with respect to the animal's head. **C**, Simplified diagram of the circuit managing the acquisition of inertial data and inbound/outbound synchronization on the IMU. **D**, Schematic of the whole system, that comprises an IMU, a PC equipped with a Bluetooth USB dongle, a data acquisition (DAQ) board, a custom IR LED controller for inbound synchronization and a custom low-latency ISM receiver for outbound synchronization. The transmission range is indicated for each wireless communication channel. BT: Bluetooth; IR: infrared; ISM: industrial, scientific, medical; MCU: microcontroller unit.

Measuring precisely-timed motor responses is highly relevant to many research domains in the neurosciences, particularly when combined with electrophysiological recordings. In some cases, such as vestibular research, IMUs have the potential to enable new approaches. Previous vestibular research has focused

mainly on understanding how the brain processes passively-experienced head movements, yet recent studies suggest that self-generated head movements are processed in a different way (Cullen 2012), at frequency ranges well above those examined so far (Schneider et al. 2015; Carriot et al. 2014). In future studies, IMUs will be essential for assessing the kinematics of natural, voluntary head movements, for studying how the corresponding vestibular signals are processed centrally, and ultimately for applying this knowledge to the design of vestibular prostheses (Dakin et al. 2013; Phillips et al. 2015; Golub et al. 2014).

The possibilities of inertial measurements on small laboratory animals, such as rats and mice, depend critically upon the availability of the appropriate IMUs. For many applications, lightweight wireless solutions are preferable over tethered measurement systems, as cables may hinder animal movements. In addition, laboratory applications may require real-time interactions with the IMU to implement low-latency data timestamping or motion-triggered experiment control. Here we describe a small wireless IMU that can be assembled using off-the-shelf components and be attached to a rat's head with a standard surgical procedure. Our IMU can broadcast inertial signals sampled at 300 Hz over a range of 10 m, and features advanced bidirectional synchronization capabilities. In this paper, we describe the architecture and main features of the device and provide examples illustrating its usefulness for tracking head movements and posture in freely moving rats. We propose in particular a novel method for quantifying behavioral freezing during Pavlovian fear conditioning experiments, that outperforms current scoring techniques. These examples demonstrate that our system has the potential to considerably simplify and refine the acquisition of movement information in a variety of experimental paradigms.

6.2 Results

Design of the wireless inertial sensing device

Our system is composed of a battery-powered IMU (Figure 6.1A), two external synchronization modules (Figure 6.1D), a battery charger (Supplementary Figure 6.7A) and a client software. A lightweight (6 g with battery), compact ($13 \times 13 \times 19$ cm) and cost-effective IMU design was achieved by selecting off-the-shelf electronic components available in small packages. The IMU can easily fit onto a rat's head (Figure 6.1B) and could be further miniaturized to fit onto a mouse (see Discussion). Communication with the IMU is implemented via Bluetooth, a reliable and widespread wireless communication technology that offers an excellent trade-off in terms of performances and integrability (see Discussion). Our IMU can thus be controlled over a distance

of 10 m from any PC with integrated Bluetooth support or equipped with a standard Bluetooth USB dongle.

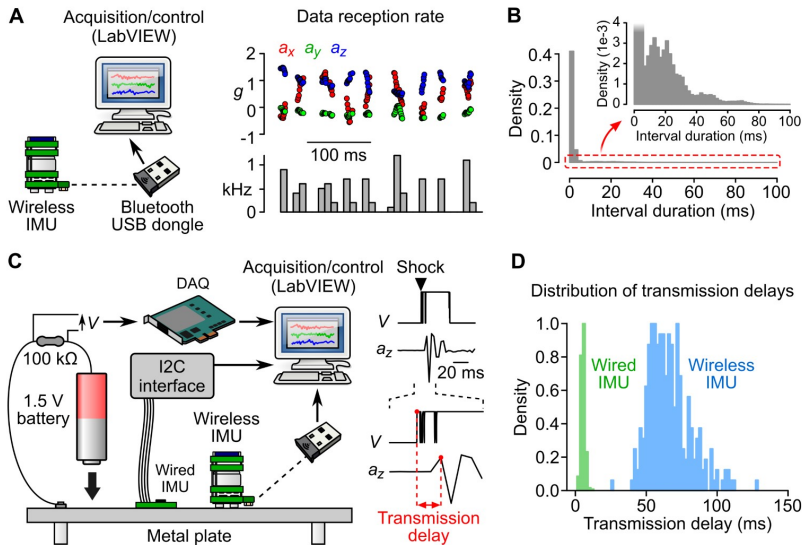

Figure 6.2: Bluetooth transmission of inertial data. **A**, Left: schematic of the recording configuration. Middle, top: accelerometer data along the 3 axes (a_x , a_y and a_z) were plotted against their reception time by the client software. Note the presence of occasional large gaps between successive data frames. Middle, bottom: corresponding instantaneous data reception rate (bin = 10 ms). **B**, Density histogram of time intervals between successive data frames in a 1 h recording. Inset: magnified view of the area delimited by a red dotted line. Note the presence of long intervals (> 10 ms). **C**, Left: schematic of the experiment used to measure transmission delays. A 1.5 V battery was hit against a metal plate, creating a voltage difference across a resistor (recorded using a DAQ) and a mechanical vibration (recorded using the wireless IMU or a wired IMU). Right: For each shock (here one shock is shown as an example), the first points significantly deviating from baseline were identified in the electrical (V , top) and inertial (a_z , bottom) signals. The interval between the two points (red points in blown up traces) was taken as a measure of the data transmission delay. **D**, Normalized histograms of transmission delays for the wired IMU (green) and the wireless IMU (blue), calculated using a total of 250 shocks (bin = 2 ms).

Transmission delays The acquisition and transmission of inertial data follow a framed traffic logic: at each acquisition cycle, information from the sensor is read, formatted into packets and sent to the Bluetooth radio. To guarantee data integrity, we selected a Bluetooth profile relying on ACL (Asynchronous Connection-Less), a protocol in which lost and corrupt data are retransmitted,

6 Wireless Inertial Measurement of Head Kinematics in Freely-Moving Rats

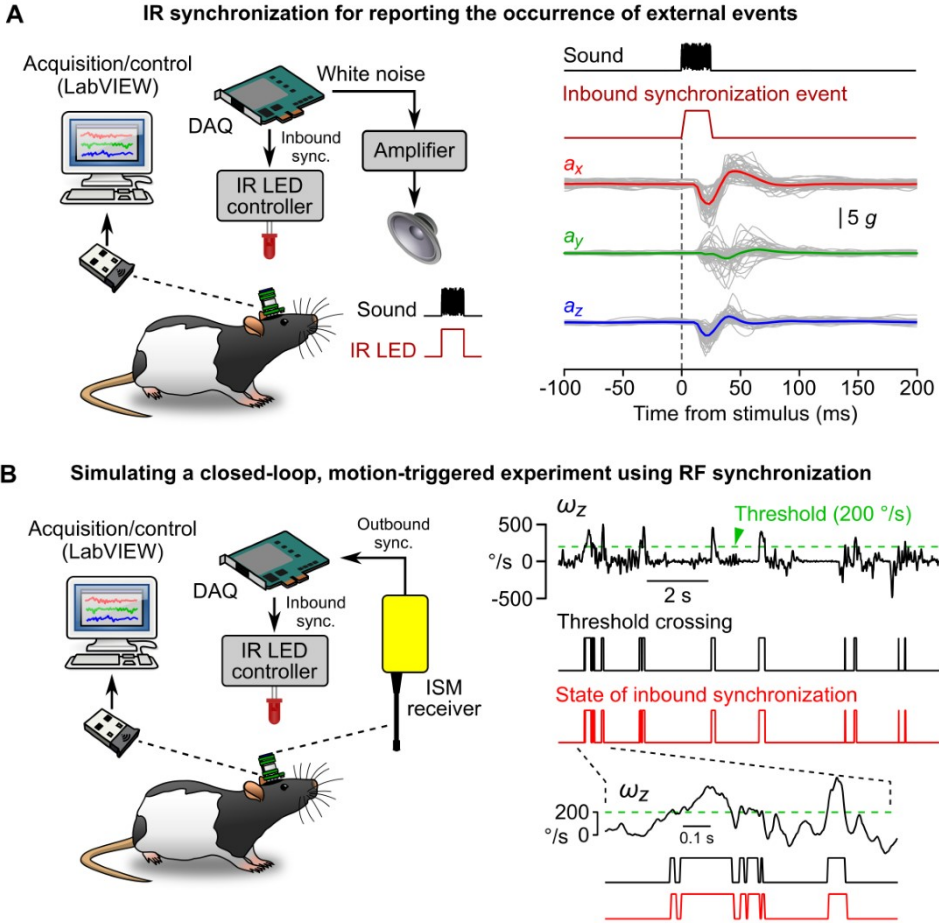

Figure 6.3: Bidirectional synchronization using two separate wireless channels. **A**, Left: schematic of the acoustic startle experiment. Bursts of white noise (25 ms) were generated by a DAQ and played by a loudspeaker. At the onset of each stimulus, a synchronous 5 V signal was used to gate the emission of an IR synchronization signal. Right: startle responses recorded in one animal. Linear acceleration along the 3 axis (a_x , a_y and a_z) was aligned on the onset of the IR event and averaged. Superimposed gray lines represent individual sweeps and color lines represent average linear accelerations. **B**, Left: schematic of the closed-loop, motion-triggered experiment. The IMU was configured to emit RF power when yaw angular speed towards the left exceeded $200^\circ/\text{s}$. The output of the RF receiver was monitored through the digital input channel of a DAQ and conditioned the execution of an analog output task. The analog output was a simple 5 V command that was used to gate the emission of IR signals. Right: Yaw angular velocity (ω_z) and outbound/inbound synchronization information recorded by the IMU during a 12 s period. The dashed green line represents the angular velocity threshold above which RF power was emitted by the IMU. The black and red lines below represent the states of the booleans reporting the detection of an angular velocity value exceeding threshold (Threshold crossing, black) and the presence of an IR signal (State of inbound synchronization, red).

introducing delays and jitters in data transmission. As a consequence, data frames are transmitted with a non-deterministic latency. When measuring data frame reception time, we observed that data were indeed received at an irregular rate (Figure 6.2A), with 15% of inter-frame intervals exceeding 3 ms (calculated from a 1 h recording; Figure 6.2B).

To measure the delay between mechanical transduction by the sensor and data reception by the client software (transmission delay), we simultaneously generated a mechanical vibration and an electric signal by touching a 1.5 V battery to a metal plate (Figure 6.2C; see Methods). Transmission delays, measured as the lag between the electrical and inertial signals for each contact, ranged from 26 to 128 ms (average delay: 66.6 ± 15.3 ms, $n = 250$ contacts; Figure 6.2D). As a comparison, the average transmission delay measured with a wired IMU (see Methods) was 12.5 times shorter (average delay: 5.3 ± 1.5 ms, ranging 1.2–12.1 ms, $n = 250$ contacts; Figure 6.2D). In conclusion, the use of a Bluetooth data transmission protocol does not allow timestamping of the acquisition of inertial data with a precision better than 50 ms, a situation that might be problematic for applications requiring precisely timed recordings. In addition, the measured transmission delays might not be adequate for implementing low-latency motion-triggered applications. These two issues are addressed in the following paragraph.

Low-latency synchronization functions Low-latency inbound synchronization was implemented using an infrared (IR) communication channel (see Methods). The IMU's circuit was designed such that the detection of IR signals is recorded directly by the sensor and transmitted together with inertial data (Figure 6.1C). Therefore IR synchronization can be used to perform accurate data timestamping, a strategy useful for recording the occurrence of external events. We illustrated this by recording responses to startling acoustic stimuli in freely moving rats (see Methods). The acoustic startle reflex corresponds to involuntary muscle contractions in response to unexpected and loud auditory stimuli, typically occurring with a latency of 5–15 ms (Koch and Schnitzler 1997). In our experiment, brief white noise auditory stimuli associated with IR signals were delivered randomly. IR synchronization events recorded by the IMU were used for offline realignment of inertial data on the onset of auditory stimuli. Startle responses were visible as sharp biphasic deflections of head linear acceleration in all 3 axes (Figure 6.3A). The response magnitude was measured as the amplitude of the first peak relative to baseline ($3.33 \pm 1.37 g$ for a_x and $2.11 \pm 0.86 g$ for a_z , $n = 4$ rats) and its latency was measured as the time of the first point significantly deviating from baseline (11.7 ± 1.9 ms for both a_x and a_z , $n = 4$ rats). This experiment shows that IR synchronization provides a way of accurately quantifying motor responses evoked by external stimuli. Data timestamping can also be employed for precisely interpolating the absolute acquisition time of individual data frames, simply by connecting the IR emitter to an external reference clock (see Supplementary Figure 6.10 and § 1.1 of the Supplementary Methods). If necessary, the

6 Wireless Inertial Measurement of Head Kinematics in Freely-Moving Rats

occurrence of external events could then be recorded by a third-party acquisition system synchronized with the same external clock. The microcontroller

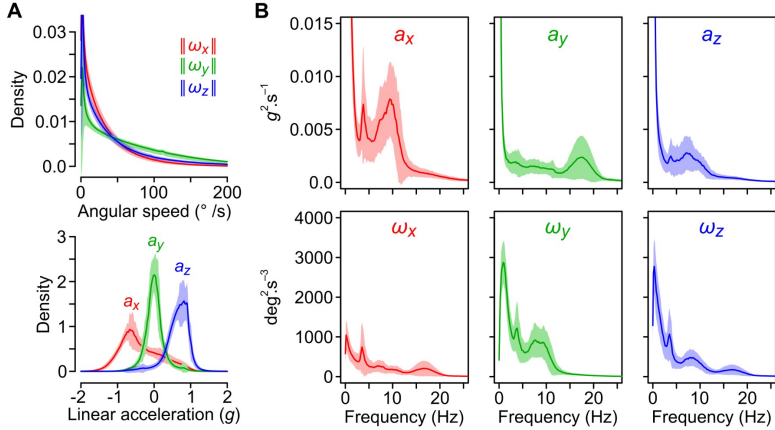

Figure 6.4: Head kinematics during free ambulation in rats. **A** Top: average density histogram of head angular speeds ($\|\omega_x\|$, $\|\omega_y\|$, $\|\omega_z\|$). Bottom: average density histogram of the head linear accelerations. The different mean values of a_x , a_y and a_z reflect the influence of gravity. **B**, Average power spectral density histograms for accelerometer and gyroscope data. Average histograms in A and B were calculated from 19 rats.

present in the IMU (see Methods) can be programmed to perform simple real-time calculations such as the detection of threshold crossing, a function that can be used to generate motion-triggered events (for closed-loop electrical or optogenetic stimulation, or for triggering specific events in a behavioral conditioning experiment). Triggers should ideally be generated from motion data with a low and constant latency. As shown above (Figure 6.2D), a Bluetooth radio link is not suited for applications requiring low-latency, deterministic data transmission. We solved this issue by designing an independent radio frequency (RF) outbound synchronization channel (see Methods). Like for the inbound IR channel, the state of the RF channel is recorded in a boolean in each data frame. To simulate a closed-loop, motion-triggered experiment, we set the IMU to emit an RF signal when the yaw angular velocity ω_z exceeded a define threshold, and configured a DAQ board to play an analog waveform every time an RF event was detected by the receiver (see Methods). In the present case, the waveform was a 5 V step used to gate the emission of an IR signal (Figure 6.3B). The system was tested in a rat exploring a circular arena. All episodes during which ω_z exceeded the defined threshold were correctly detected by the microcontroller and written in the inertial data flow ($n = 321$ events detected in 450 s; average event duration = 44.1 ± 45.1 ms) and almost all of them (96.3%) appeared as IR synchronization events in the IMU data frames (Supplementary Figure 6.10B). In 96.4% of the cases, the IR syn-

chronization event was recorded by the IMU exactly one frame after threshold crossing, indicating that the feedback loop was completed in less than 3.3 ms (the duration of an acquisition cycle).

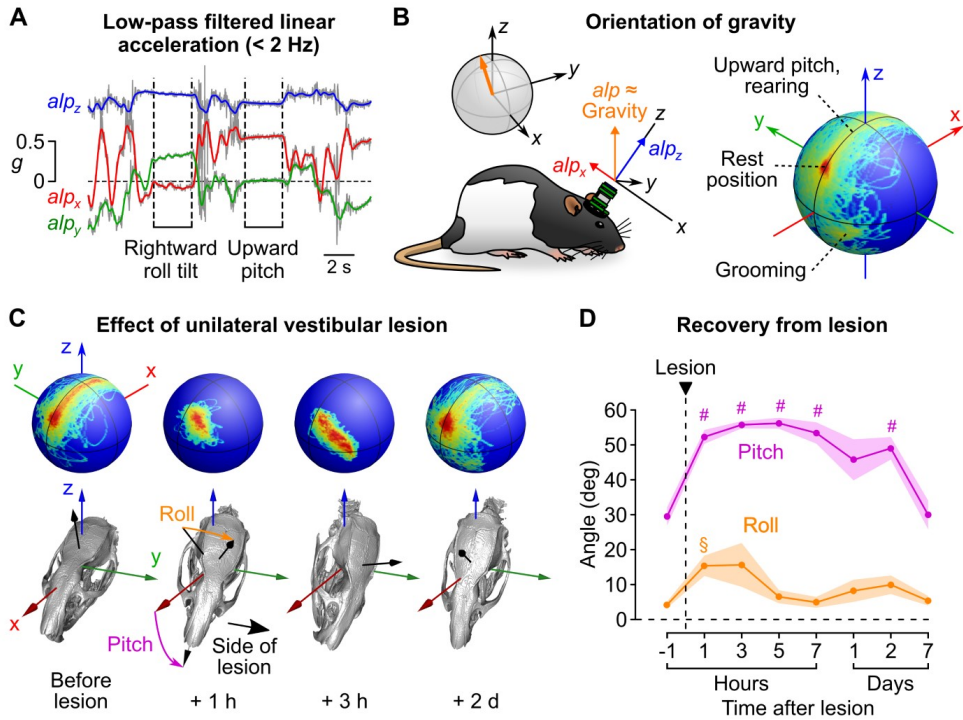

Figure 6.5: Tracking head posture in freely moving rats after a unilateral vestibular lesion. **A**, Example traces showing the slow (< 2 Hz) components of linear acceleration (alp_x , alp_y and alp_z , colored lines) superimposed on the raw linear acceleration (gray lines). These filtered signals capture the variations of linear acceleration due to reorientations of the head relative to gravity. **B**, Left: alp (the vector defined by alp_x , alp_y and alp_z) is an approximation of gravity in the sensor's coordinates. Right: density map of the different orientations of alp encountered during a 45 min recording session. **C**, Example showing the effect of a unilateral vestibular lesion in one rat. Top: alp orientation density maps. Bottom: corresponding average head postures. **D**, changes in the average pitch and roll angles (as defined in **C**) across sessions. Shaded areas represent the SEM. Symbols indicate statistically significant differences from angle values calculated before lesion (§ : $p < 0.01$, # : $p < 0.001$, paired t-test).

Inertial measurements in freely moving rats

Head kinematics during natural movements Our IMU offers a way to measure the kinematics of head movements during normal activity in rats. We observed rapid head rotations ($> 50^\circ \text{s}^{-1}$) to be more frequent in the pitch axis (ω_y) than in the roll and yaw axes (ω_x and ω_z , respectively; Figure 6.4A). The spectral power of natural head movements was concentrated at frequencies < 20 Hz, with noticeable peaks at around 4, 8 and 15–20 Hz (Figure 6.4B). During active exploration, head angular velocities reached values up to $\pm 500^\circ \text{s}^{-1}$ (in particular during vigorous orientation movements), and displayed periods of 10 Hz oscillations, potentially reflecting rhythmic oro-facial activity such as sniffing (Movie S1 and Movie S2). Large oscillations around 4 Hz were also evident during body grooming (Movie S3). Overall, accelerometer and gyroscope data provide a wealth of information that contains clear signatures of the different types of ongoing motor activities. In the future, this type of data should be appropriate to fuel robust behavioral scoring algorithms, as shown by pioneering studies that have employed wired accelerometers in mice and rats (Sunderam et al. 2007; Venkatraman et al. 2010).

Measuring head posture in freely moving rats Because accelerometers are sensitive to gravity, our IMU can be used to monitor head posture. Head orientation relative to gravity (head tilt) can change, for example, as a result of a peripheral vestibular lesion. In various animal models including rats, head tilt is a key parameter for assessing the severity of postural deficits induced by unilateral vestibular lesion (UVL) and for studying the plasticity mechanisms that underlie the recovery of normal posture (Peusner 2012; Sirkin et al. 1984). Changes in head tilt following UVL have traditionally been quantified with photographs of lightly restrained animals or direct observations logged on a discrete scale (Sirkin et al. 1984; Dyhrfjeld-Johnsen et al. 2013), a procedure that can yield imprecise measurements and may not detect small tilt angles. Our IMU can facilitate this type of experiment by enabling accurate measurements of head tilt in unrestrained animals. Because natural head movements in rats are typically brief, the low frequency component of linear acceleration should provide a reliable approximation of gravitational acceleration in the sensor's coordinates. To confirm this, we ran our inertial data through an orientation filter algorithm (Madgwick et al. 2011) in order to estimate the gravitational component of linear acceleration (see § 1.4.1 of the Supplementary Methods). As shown in Supplementary Figure 6.11, gravitational acceleration accounted for most of the raw linear acceleration at frequencies below 1–2 Hz. We therefore used the low-pass filtered linear acceleration vector (a_{lp} , calculated with a cutoff frequency of 2 Hz) as a proxy measure of gravity (Figure 6.5A). A “gravity orientation density map” can be obtained by color coding the different orientations of a_{lp} on a sphere depending on how frequently they were encountered (see § 1.4.2 of the Supplementary Methods). This type of plot provides a snapshot of the different head postures of a rat during natu-

ral behavior, with different domains of the sphere corresponding to different types of motor activities (Figure 6.5B). Rearing and grooming, for example, are associated with specific head orientations (Movie S3 and Movie S4). The calculated maps were very similar between rats (Supplementary Figure 6.12), with a mean correlation coefficient of 0.78 ± 0.14 ($n = 19$ rats).

To assess the system's ability to discriminate changes in head tilt in freely moving animals, we performed UVLs in eight rats (see Methods). This manipulation narrowed the distribution of a_{lp} orientations, indicating that head mobility was decreased, and shifted it in a direction opposite to the lesion side, corresponding to a roll tilt towards the lesion side (Figure 6.5C and Supplementary Figure 6.13). The effect of the lesion could be quantified for each rat by analyzing the changes in the components of a_{lp} (Supplementary Figure 6.14). In addition, the average a_{lp} vector could be used to calculate the average head orientation and visualize it in 3D (Figure 6.5C; see Supplementary Methods). Rats recovered a normal distribution of head postures within a week. Recovery curves were obtained by calculating the average roll and pitch angles of the head in successive recording sessions (Figure 6.5D; see § 1.4.2 of the Supplementary Methods). These data show that inertial recordings offer a way of performing quantitative measures of head postures, that can be used to precisely monitor the effect of unilateral vestibular lesions.

Automatic scoring of behavioral freezing For nearly 50 years researchers have used various forms of body immobility as a measure for estimating fear in rodents (Blanchard and Blanchard 1969a). Initially, observational methods were the most commonly applied technique for assessing rat immobility (Fanselow 1980; Bouton and Bolles 1979; Anagnostaras et al. 1999), yet various automated methods have been also been developed, based on IR beam breaks (Karalis et al. 2016), changes in pixels in video recordings (Anagnostaras 2010) and load cell platform measurements (Fitzgerald et al. 2015). Miniaturized IMUs offer a powerful alternative to these approaches, that could potentially outperform previous methods in terms of precision, temporal resolution and efficiency.

We evaluated the usefulness of the IMU for scoring behavioral freezing of rats in a Pavlovian fear conditioning experiment. We first characterized the noise in our system by recording data from an IMU placed on a mechanically isolated platform. In these measurements, the SD of the magnitude of the linear acceleration (respectively angular velocity) vector was $0.008,9g$ (respectively $0.103^\circ s^{-1}$), which represented respectively 3.78% and 0.10% of their SD measured during free ambulation ($0.235g$ and $106.8^\circ s^{-1}$ respectively, $n = 19$ rats). These data show that angular velocity measurements are more appropriate than linear acceleration measurements for detecting motion. In our automated analysis, episodes of immobility were defined as periods during which angular speed (the magnitude of the angular velocity vector) was below a selected threshold (Figure 6.6B).

6 Wireless Inertial Measurement of Head Kinematics in Freely-Moving Rats

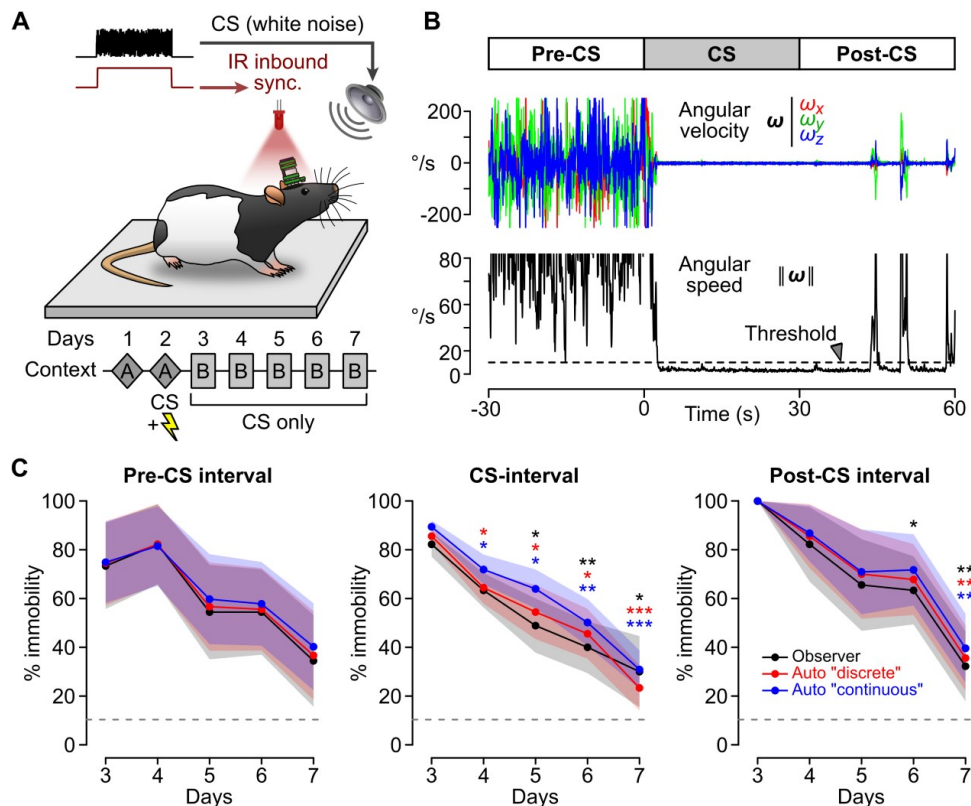

Figure 6.6: Automatic detection of behavioral freezing in a classical fear conditioning experiment. **A**, Schematic of the experiment (see also Supplementary Figure 6.12C). The conditioned stimulus (CS) was a 30 s white noise. Fear conditioning (day 2, CS + electric shock) and testing (days 3–7, CS only) occurred in two different contexts (A and B). The CS was presented 6 times during each of the 5 testing sessions, together with a synchronous IR signal that was recorded by the IMU (IR inbound sync.). **B**, Example traces showing head angular velocities (top, colored traces) and angular speed (bottom, black trace) during a *trial*, defined as a period encompassing one CS presentation and the 30 s before (Pre-CS) and after (Post-CS). The dashed line represents an immobility detection threshold set at 12°s^{-1} . **C**, Fear extinction profile for one rat. The average *per session* immobility scores (\pm SD as shaded area) were calculated using the observer's data (black line) and the "discrete" automatic scoring method (red line) for the intervals before (Pre-CS), during (CS) and after (Post-CS) CS presentation. The fraction of time spent immobile was calculated using the "continuous" automatic scoring method (blue line). The horizontal dashed line represents the fraction of time spent immobile during the first exposure to context A (day 1). No significant differences were found between curves for a given extinction session (p always greater than 0.14, unpaired t-test). For days 4 to 7 (second to fifth extinction session), asterisks (color corresponding to the type of scoring technique) indicate whether the freezing score was significantly different from day 1 (first extinction session), with $*$ = $p < 0.05$, $**$ = $p < 0.01$ and $***$ = $p < 0.001$.

Inertial data and video recordings were obtained for 4 rats during 5 daily fear extinction sessions following a fear conditioning session (see Methods and Figure 6.6A). Each extinction session contained 6 CS presentations (30 s white noise cue). Behavioral freezing was scored from videos by an experienced observer implementing an instantaneous time sampling procedure (Anagnostaras et al. 1999). This procedure consisted of the assessment of the state of the animal (1 = “freezing”, 0 = “no-freezing”) every 2 s, during *trials* which included the 30 s before (pre-CS), during (CS) and 30 s after (post-CS) each white noise presentation (Supplementary Figure 6.15C). With IMU data, for comparison, we implemented a “discrete” automatic scoring method that mimicked this procedure by comparing the local average angular speed to a threshold every 2 s (see Methods and Supplementary Figure 6.15A). Average *per trial* immobility scores were calculated using both methods, and compared by computing their correlation coefficient. Changing the duration of the observation window (from 0.1 to 2 s) did not strongly alter the correlation. In contrast, the correlation was highly dependent on the value of the detection threshold, and a maximal correlation of 0.98 was achieved for a threshold of 13°s^{-1} (Supplementary Figure 6.15E).

Individual scores assigned by the observer and the algorithm for every observation window matched in 90.3% of the cases ($n = 4878/5400$ observations, calculated with the following algorithm parameters: window width = 0.5 s, threshold = 13°s^{-1}). “Error” cases (where a mismatch was found) were often associated to observation windows in which the average angular speed was close to the threshold (Supplementary Figure 6.16A), and were more frequently encountered during CS (14.2% of observations during CS vs 6.5% and 8.3% for pre-CS and post-CS intervals). When examining angular speed traces for error cases, it appeared that a large fraction of them corresponded to ambiguous situations, when the observer may have made his judgment shortly before or after a head movement (Supplementary Figure 6.16B).

An alternative observational scoring method consists of estimating the ratio of time spent freezing by measuring the onset and offset of freezing episodes using a stopwatch (Madarasz et al. 2016). We implemented a similar “continuous” scoring method by calculating the fraction of the time during which angular speed fell below a threshold (Supplementary Figure 6.15B,D). This method was applied to the same 90 s intervals scored by the observer for each CS presentation, and the fraction of time spent below threshold was compared to the average immobility scores previously obtained by the observer using the instantaneous time sampling method. We found that a maximal correlation coefficient of 0.99 was achieved with a detection threshold of 12°s^{-1} (Supplementary Figure 6.15F).

Temporal fear extinction profiles for every rat were obtained by plotting the average immobility score (or the average fraction of time spent below threshold) in the pre-CS, CS or post-CS intervals for the 5 consecutive extinction sessions (see Figure 6.6C for an example from one rat). No significant differ-

ences were found between extinction curves calculated using the three scoring methods (observer and automatic “discrete” or “continuous” methods, p always greater than 0.14 for all rats, unpaired t-test).

We conclude that automatic scoring methods based on a simple threshold crossing analysis of head angular speed yield results that are virtually indistinguishable from those obtained by an experienced observer. Because of their ease of implementation and rapidity, these methods have the potential to considerably facilitate and refine the scoring of behavioral freezing. The scoring of behavioral freezing by an observer is a time-consuming endeavor, and most typically freezing is only estimated during limited intervals of the testing session (such as during the CS presentation). Our device can precisely approximate human scoring, and it can be used to estimate behavioral freezing continuously throughout the testing session. Hence, more data can be collected with less labor on the part of the experimenter.

6.3 Discussion

Because it allows quantitative and meaningful measurements of activity with a resolution that could not be achieved with direct observation, inertial motion sensing has become a widely recognized methodology for the study of animal behavior (Brown et al. 2013; Portugal et al. 2014; Chimienti et al. 2016; Graf et al. 2015; Collins et al. 2015; Shepard et al. 2008; Ravi et al. 2005; Nathan et al. 2012). Untethered inertial measurements are typically performed at 1–100 Hz on relatively large animals using bulky telemetric devices or accelerometers coupled to onboard data-logging systems. Surprisingly, inertial measurements on laboratory animals such as rats or mice remain relatively rare, and have mainly employed wired inertial sensors (Silasi et al. 2013; Shih and Young 2007; Ledberg and Robbe 2011; Sauerbrei et al. 2015). To our knowledge, there is currently no solution for real-time wireless monitoring of movements at high rate in freely-moving rats or mice. In this paper, we describe and benchmark a standalone platform for performing wireless inertial measurements of head movements in rats. The system was designed to satisfy the following constraints: lossless data transmission, sufficient acquisition rate, low power consumption, small hardware size and weight, low cost and ease of integration. For data transmission and communication with the IMU, Bluetooth appeared as an excellent trade-off. Bluetooth offers excellent hardware and software integrability, through the availability of miniature modules and of SPP (Serial Port Profile) for seamless serial link replacement. It allowed a rapid development using miniature off-the-shelf components while offering the necessary bandwidth and data integrity.

The one limitation of Bluetooth is the fact that it offers an asynchronous connection (Figure 6.2D). This limitation was overcome by implementing real-time bidirectional communication through two separate channels: an IR chan-

nel for data timestamping, and an RF channel for motion-triggered applications (Figure 6.3). The IR channel can be used to record the occurrence of external events (Figure 6.3A) or to synchronize the acquisition of inertial data with an external clock (Supplementary Figure 6.10). Note that the RF channel could also be used to synchronize data acquisition with external devices. The IMU can for example be programmed to emit an RF signal every N acquisition cycles (N to be determined by the user; see for example § 1.2.2 in the Supplementary Methods). Owing to the sub-millisecond latency between the emission and detection of RF signals (Supplementary Figure 6.8B), the acquisition time of the corresponding data frames (identified by a change in the state of the RF channel) could be precisely measured. The acquisition time of other data frames could then be calculated using a simple linear interpolation. This strategy would allow the user to synchronize data acquisition with other devices while saving the IR channel for the detection of external events.

Overall, our system meets the requirements of most laboratory applications, and can easily be coupled with existing third-party acquisition and control devices. Therefore it makes wireless inertial recordings of head movements accessible to any laboratory working with freely moving animals with the size of a rat. Note that Bluetooth allows for multiple devices to operate simultaneously, allowing measurements on several animals at the same time.

We demonstrated the usefulness of our IMU in several experimental situations. In a first experiment, we showed how the IR synchronization channel can be used to align inertial data to the onset of a startling auditory stimulus and to calculate average startle responses (Figure 6.3A). IR synchronization enables the characterization of any kind of stimulus-evoked head movement. It could thus be useful for quantifying motor responses evoked by external cues in a number of learning paradigms, or for characterizing motor responses evoked by electrical or optogenetic stimulations. IR data timestamping also enables the synchronization of IMU data sampling with other acquisition systems, and thus the analysis of the correlation between inertial data and other signals on a millisecond timescale.

We then simulated a closed-loop, motion-triggered experiment based on the onboard detection of threshold crossings (Figure 6.3B). Coupling the delivery of stimuli to specific head movements expands the possibilities of operant conditioning experiments. Currently, these experiments rely on a relatively limited repertoire of actions, such as nose pokes or lever presses. The diversity of natural head movements, mostly along the pitch and yaw rotation axes, could provide alternate behavioral responses for such experiments.

In a separate experiment, we showed that our IMU can be used to perform quantitative measures of head posture in unrestrained animals and to monitor precisely the effect of a unilateral vestibular lesion (Figure 6.5). Compared to traditional observational techniques that often employ subjective scoring on a discrete scale, the proposed method offers objective and quantitative measures

on a continuous scale. It also provides a richer information on the state of the animal, by fully capturing the range of head postures encountered during free behavior. By enhancing the resolution of posturographic measurements in rats, this type of measurements might help to differentiate the effects of drugs designed to improve recovery after a vestibular trauma.

Finally, we showed that our IMU can facilitate considerably the quantification of behavioral freezing in a fear conditioning experiment (Figure 6.6). The proposed method has a number of advantages compared to other automatic scoring methods, while offering the same level of concordance with a trained observer. Because movements are recorded directly from the animal's head, our IMU provides more accurate information than any conventional actimetric device (based on IR beam breaking or video). Using a simple numerical simulation, we compared the performances of our IMU with the one of a high resolution, high rate motion capture system (see § 1.6 of the Supplementary Methods and Supplementary Figure 6.17 for detailed explanations). Assuming that the goal is to detect head rotations from a rat placed in a 1 m^2 square area, our simulation shows that gyroscope signals acquired by the IMU are better at resolving small and rapid head rotations similar to the ones observed in freely moving rats (Supplementary Figure 6.17E-H). In terms of reliability and usability, our IMU also has a number of key advantages. A motion capture system could eventually be affected by cables connected to the animal, that might temporarily mask the reflectors or LEDs used for video tracking. Our IMU enables measurements in closed environment, with animals hidden behind walls (at the expense of IR synchronization using a single light source above the behavioral testing apparatus). Contrary to a video tracking system, the resolution of IMU measurements is not affected by a change in the size of the behavioral platform. Finally, the low cost of our system makes it a much cheaper solution than high resolution motion tracking systems for quantifying behavioral activity ($\simeq 370$ versus several tens of thousands of euros).

Our wireless IMU provides an attractive solution for quantifying the movements of laboratory animals in various environments, from their homecage to complex mazes containing sheltered spaces. The quantification of natural head kinematics is particularly relevant to the field of vestibular research. A primary aim in this field is to understand how inertial motion signals transduced by vestibular organs are processed by the brain. A considerable literature has described how passively experienced head rotations and translations are encoded by central vestibular neurons, but the responses of these neurons to self-motion are still largely unknown (Cullen2012a). The amplitude and frequency of the sinusoidal movements used in previous studies are typically low ($\pm 0.2g$ for translations and $\pm 30^\circ\text{s}^{-1}$ for rotations, at 0.2–2 Hz) compared to the ranges experienced during self-motion (Schneider2015a; Carriot2014a) (Figure 6.4). Our system offers the possibility of characterizing the inertial signals detected by vestibular organs during self-motion, providing the foundation for exploring vestibular circuits in their normal operating conditions.

More generally, the data collected by our IMU contain a wealth of information on head movements and posture (Figure 6.5 and Supplementary Movies). Previous studies have shown that 3-axis acceleration information is already useful for detecting and scoring various types of behavioral outputs (Sunderam et al. 2007; Venkatraman et al. 2010). Thus the 6-axis information provided by our IMU might help refine the automatic detection and quantification of behavioral outputs with a clear head movement signature, such as locomotion, sleep/wake cycles, rearing, grooming, eating or sniffing.

Our system could benefit from a number of achievable improvements. The size and weight of our IMU could be reduced. Especially, as we wished to use standard PCB manufacturing processes, we limited our design to 1.55 mm thick boards in 2 copper layers. The use of 0.2 mm thick, 4 layers boards would lead to a size reduction of at least 5.6 mm along the largest dimension and a weight reduction of 2.3 g. Extra weight could be saved by using a smaller and lighter battery such as the 201013HS10C (Full River Batteries, China). This would save an extra 1.2 g and 2.6 mm along the largest dimension, but would come at the price of a reduced battery life. Removing the synchronization/options board would save extra weight and would reduce the largest dimension by an additional 1.5 mm, while maintaining the core function of our device. By implementing these modifications and slightly redesigning our PCB to fit the new battery, our device could weight less than 2.5 g and measure $10 \times 14 \times 9$ mm. Further miniaturization could be achieved by using a more compact Bluetooth module such as the PAN1315b (Panasonic, Japan) but would require important hardware and firmware redesign as well as possibly more expansive assembly techniques.

In addition to miniaturization, our system could evolve in a number of directions. One improvement would be to perform onboard calculation of absolute 3D orientation by implementing a sensor fusion algorithm. This would require either replacing our current microcontroller with a more powerful microprocessor, or using commercially available sensor units that already perform such calculations. Future versions of our IMU could also host more than one sensor. In our design, the microcontroller is programmed to make use of an I²C bus to communicate with the sensor. The I²C protocol allows one master (here the microcontroller) to communicate with several slaves (the sensors). Additional sensors could thus be easily wired to the existing I²C channel on the mainboard module and provide access to a wide range of variables such as biopotentials (electroencephalographic and electromyographic activity), barometric pressure and temperature (which can be used to monitor sniffing activity) or ultrasound waves (to detect vocalizations). Integrating additional sensors would require a reduction of the bandwidth currently allocated to inertial data, but a reduction of at least 50% (from 300 to 150 Hz) would be acceptable given the frequency range of natural head movements (Figure 6.4B). Because our system uses a standard Bluetooth data link, client software could be implemented on various mobile devices such as tablets and smartphones. Inertial measurement could

thus be performed rapidly and easily in various types of indoor and outdoor environments.

In conclusion, our system architecture lays the ground for implementing wireless inertial motion tracking at an affordable cost, and with advanced synchronization capabilities. It could also inspire the design of similar devices for performing wireless time-resolved measurements of other biologically-relevant parameters in freely moving laboratory animals.

6.4 Methods

Design and fabrication of the system

Inertial measurement unit The IMU is composed of three modules on separate printed circuit boards (PCBs): a mainboard module, a power management module and a synchronization/options module (Figure 6.1A).

The mainboard contains a digital 9-axis inertial sensor (MPU-9150, InvenSense) that samples linear acceleration, angular velocity and magnetic field strength in three dimensions, a low-power programmable microcontroller (PIC16, Microchip) running a custom firmware and a Bluetooth radio, whose signal is transmitted through a tuned chip antenna. The microcontroller is programmed to handle the initialization and management of the sensor (via an I²C bus) and the radio, and to decode parameterization and operation commands received from the client software. Sensor data acquisition and Bluetooth data emission are scheduled by the microcontroller using interrupt mechanisms, in order to guarantee real-time performances of the system. The microcontroller firmware also implements simple data processing functions such as the detection of threshold crossing events in inertial data, which can be signaled via the emission of outbound RF signals.

The IMU is powered by a rechargeable Lithium-Ion battery (CP 1254, VARTA microbattery GMBH) inserted between the two PCBs composing the power management module (Figure 6.1A). Electrical contacts are ensured by a metallized pad on one side, and a metallic spring on the other. The battery can be easily installed and removed manually. The power management module monitors the battery, switches the system on and off, and regulates the IMU supply voltage. It contains a voltage detector that switches the system off when the battery voltage reaches its lower limit, protecting it from excessive discharge. It also contains a magnetic latch that switches the system on and off by placing a small magnet near the IMU.

The synchronization/options module implements wireless low-latency, low-jitter bidirectional synchronization between the IMU and third-party devices.

Inbound synchronization is used to timestamp IMU data frames using external triggers. Outbound synchronization is used to report the occurrence of movement-related events, such as the crossing of selected threshold values.

At the IMU level, inbound synchronization relies on the use of an integrated IR receiver that detects structured optical signals (light pulses in the 850–1,080 nm range delivered at 38 kHz). Once activated, the receiver's output is latched by a dedicated digital input channel of the sensor. The microcontroller interrogates the state of the sensor's digital input register along with the inertial data registers at each acquisition cycle, thus inbound synchronization information is available in each data frame together and synchronized with inertial data. The latch mechanism guarantees that fast-occurring synchronization events (with a duration inferior to the microcontroller's acquisition cycle duration) are not missed.

Outbound synchronization signals are computed by the microcontroller, fed to a low-power 433 MHz Industrial Scientific Medical (ISM) band emitter and radiated through its antenna (Figure 6.1C). The ISM emitter is powered through the same supply line as the rest of the system, and thus benefits from the same power supply management functions (voltage regulation, on/off switching). While it also guarantees a compact design, this configuration powers the emitter with a supply voltage slightly inferior to that specified for the component (2.8 V instead of at least 3 V), which might explain the relatively limited transmission range that we measured (3.5 m). This range, however, is acceptable in the context of most laboratory applications. If necessary, solutions exist to detect RF signals over greater distances without increasing the device's weight and volume, for example by combining several receivers.

The synchronization/options module also contains three low-power red LEDs (peak wavelength of 628 nm) for videotracking (Figure 6.1A), which can be wirelessly switched on and off by the microcontroller upon request by the client software.

To achieve a compact device, the IMU was designed as a series of vertically stacked double-sided PCBs (produced by Eurocircuits, N.V., Belgium). Almost all components were surface-mount devices and were assembled in-house using a reflow soldering oven (FT02, CIF, France).

External synchronization modules For inbound synchronization, we developed an IR emitter to activate the IR receiver located on the IMU's synchronization/options module. The emitter contains a 38 kHz oscillator (based on a HCC4047BF, STMicroelectronics) gated by an external TTL signal and controlling a set of IR LEDs (TSAL6200, Vishay; peak wavelength = 940 nm) through a MOS transistor (IRF530, Vishay). The emission of IR signals is detected by the receiver with a latency of around 130 μ s (Supplementary Figure 6.8A). The transmission range of the IR synchronization channel depends

on the type and number of LEDs in the emitter, and on their drive current. For reference, the range obtained with one 940 nm LED powered with a drive current of 100 mA was 17 m.

The outbound synchronization receiver is a standalone module that detects RF signals sent by the IMU. It is a low-latency, low-jitter 433 MHz ISM band receiver designed for the transduction of RF signals into digital signals. Its architecture relies on an RF amplifier, a set of SAW filters, a logarithmic amplifier used as an RF power detector and a data slicing circuit performing signal digitization. The latency measured between the ISM emitter input on the IMU and the RF receiver output lies in the 33–48 μs range (Supplementary Figure 6.8A).

Battery charger We developed an automatic Li-Ion battery charger that is fine-tuned to the specifications of our batteries. The charger contains five independent charging positions (Supplementary Figure 6.7A) so that batteries with different charge levels can be fully recharged at the same time. Each position contains an automatic Li-Ion battery charge management integrated circuit (Microchip Technology Inc.), that regulates the charge voltage and current, and manages the charge end so that the battery is optimally charged while remaining within its specifications. A thermal protection on each position ensures that the charge is stopped in case of battery over-heating. The charger can be powered using any computer USB port or USB power wall adapter.

The battery life was measured in different use-case examples. Each measurement was performed with a fully charged battery and consisted of streaming inertial data until the system was switched off by the voltage detector present on the power management module. The average recording durations in the different conditions tested are shown in Supplementary Figure 6.7B.

Software The MCU firmware is written in C using the MPLAB X IDE suite and compiled using the XC8 C compiler (Microchip Technology Inc.). Real-time programming techniques such as interrupts have been used to guarantee the stability of the acquisition frequency. The firmware has been intensively tested to ensure data integrity and reliability.

The client software, written under LabVIEW (National Instruments), configures IMU parameters and acquires inertial and inbound/outbound synchronization data. The software allows the following operations: setting the sensitivity range of the accelerometers (from $\pm 2g$ to $\pm 16g$) and gyroscopes (from $\pm 250^\circ \text{s}^{-1}$ to $\pm 2,000^\circ \text{s}^{-1}$), setting threshold values for the threshold crossing detection algorithm, starting and stopping data streaming, and controlling the LEDs.

Inertial measurements of head movements in freely moving rats

Animals All animals used in this study were adult male Long-Evans rats (250–300 g at surgery). Animals were housed individually in standard homecages maintained in standard laboratory conditions (12 h day/night cycle, ~21 °C with free access to food and water). The experimental procedures were conducted in conformity with the institutional guidelines and in compliance with French national and European laws and policies. All procedures were approved by the “Charles Darwin” Ethics Committee (project number 1334).

Magnetic head mount system The IMU was secured on the animals’ heads by two pairs of disk neodymium magnets (S-06-03-N, Supermagnete.com). One pair was glued to the bottom face of the mainboard module, and the other one was cemented to the skull of the animal (see Supplementary Methods). Using this system, the IMU could be easily and rapidly snapped into position on the rat’s head before each experiment. This procedure usually switched the system on by activating the IMU’s magnetic latch. We found that the proximity of the magnets, once the IMU is in place, did not cause untimely on/off switching of the system. In addition, the system could still be turned on and off by placing a magnet near the IMU. The MPU-9150 inertial sensor also includes a 3-axis magnetometer. The magnetic field data were not used. However, the presence of the mounting magnets may prevent the normal functioning of the sensor’s magnetometer. A non-magnetic mounting system could be employed in order to preserve the integrity of magnetometer measurements if desired.

Acoustic startle experiment Rats were equipped with the wireless IMU and placed inside a circular arena (118 cm diameter) with transparent plastic walls (30 cm high). The sensitivity of the IMU was configured remotely from the software interface (accelerometers: $\pm 16 g$; gyroscopes: $\pm 1,000^\circ s^{-1}$) and the acquisition of IMU data was initiated. A 25 ms analog waveform with uniform white noise distribution was generated under LabVIEW and played at random intervals (5–15 s) through the analog output of a DAQ board (PCIe-6353, National Instruments) connected to a loudspeaker via a custom amplifier (Figure 6.3A, sound amplitude: 90–110 dBA). A square 5 V waveform with the same duration was played simultaneously via a second analog output channel, and fed to the gate input of the IR LED controller. A total of 30 acoustic stimuli were delivered per rat.

Motion-triggered, closed loop experiment using bidirectional synchronization A rat carrying an IMU was placed in the same arena used for the acoustic startle experiment and was allowed to explore it for several minutes.

The client software was used to set the sensor such that outbound RF power was emitted when yaw rotation speed towards the left exceeded 200°s^{-1} . RF signals were detected and digitized by the RF receiver, and fed to one of the digital inputs of a DAQ board. A custom LabVIEW program was configured to play an analog waveform every time a digital input high state was detected and halted it when the digital input channel returned to a low state. The analog output waveform was a simple 5 V step and was fed to the gate input of the IR LED controller. Because the data transmitted by the IMU contains information on the states of the IR and RF synchronization channels, this configuration allowed us to estimate the duration of the feedback loop.

Unilateral vestibular lesion experiment Unilateral excitotoxic lesions of the inner ear were obtained in eight rats using a procedure described earlier (Dyhrfeld-Johnsen et al. 2013). Rats were laid on their side under isoflurane anesthesia, placed under a surgical microscope, and 50 μL of a solution containing 50 mM of kainic acid (0222, Tocris) dissolved in physiological saline with 10 mg mL^{-1} benzyl alcohol (305197, Sigma; used to enhance round window permeability) was injected through the tympanic membrane using a Hamilton syringe. Rats were then placed on their side in their home cage and allowed to wake up. During recording sessions (one hour before and 1, 3, 5, 7, 24, 48 and 168 h after the lesion), the IMU was attached to the rat's head and inertial signals were recorded for 45 min. To analyze head posture, low-pass filtered ($< 2\text{ Hz}$) linear acceleration was used as an approximation of the gravity vector (see Supplementary Figure 6.11 and Supplementary Methods).

Fear extinction experiment Four rats underwent a 7-day fear conditioning and extinction training procedure (see Supplementary Methods). Fear conditioning consisted of three white noise-footshock pairings (30 s white noise cue that co-terminated with a 1 s, 0.6 mA footshock) presented in the fear conditioning chamber (context A). During the next 5 days each rat was placed in the extinction chamber (context B) for a 34-minute extinction session during which 6 white noise cues were presented without footshock. Rats were equipped with the IMU and their behavior was recorded with a high definition video camera. The beginning and end of each session, as well as each noise presentation, were synchronized with the emission of an IR signal recorded by the IMU via its IR synchronization channel (Figure 6.6A), and were signaled in the video by the illumination of a red LED (see Supplementary Methods). This allowed us to realign IMU data with the videos.

An experimenter (BPG) well trained in observational behavioral inventory analyses used an instantaneous time-sampling procedure (Fanselow 1980; Anagnostaras et al. 1999) to characterize behavioral freezing from the video files. Freezing was defined as the absence of movement except for breathing. A regular beeping sound was synchronized with the video files so that obser-

vational judgements for “freezing” or “not freezing” were made every 2 s during the 30 s before, during and 30 s after each white noise presentation.

Automatic detection of immobility was performed by applying a simple threshold detection routine to the angular speed calculated from gyroscopic data (see Supplementary Methods). A “discrete” automatic scoring method was implemented to mimic the instantaneous time sampling procedure used by the observer. In this method, the average angular speed was calculated within a defined “observation” time window every 2 s, and a score (1 = immobility, 0 = movement) was attributed to each observation depending on whether the average angular speed was greater or smaller than a threshold value (Supplementary Figure 6.15A). For each noise presentation, this “discrete” automatic scoring method was applied to the same 90 s scored by the observer.

Data acquisition and analysis

Inertial and videotracking data were acquired using custom programs written in LabVIEW. Data analysis was performed using routines written in R. Movies presented as supplementary material were generated using Python. To generate these movies, the same clock was used to timestamp inertial data (through the IR channel) and the acquisition of video frames under LabVIEW. Average values are given with their SD, unless stated otherwise.

6.5 Supplementary Figures

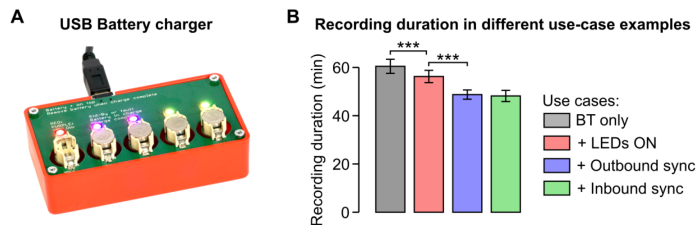

Figure 6.7: Battery charger and battery life. **A**, Photograph of the USB battery charger. The charger contains 5 independent charging positions. Each position features a tell-tale whose color indicates the charging status (red: standby or fault; purple: battery in charge; yellow: charge complete). **B**, Average battery life for different use cases. The maximal duration of recordings, using fully charged batteries, was measured in different configurations, as indicated in the legend ($n = 17$ measurements for each condition, performed with 17 different batteries). Our measurements yielded the following average recording durations: BT only (Bluetooth transmission only): 3627 ± 173 s; + LEDs (LEDs constantly on): 3374 ± 150 s; + Outbound sync. (RF outbound signal delivered at 300 Hz, duty cycle = 10%): 2924 ± 112 s; + Inbound sync. (constant IR inbound signal): 2891 ± 136 s. Asterisks indicate statistically significant differences (***: $p < 0.001$, unpaired t-test). Error bars represent the SD. Overall, the strongest determinant of battery life is the usage of the RF emitter (reduction of 13% when RF power is emitted 10% of the time).

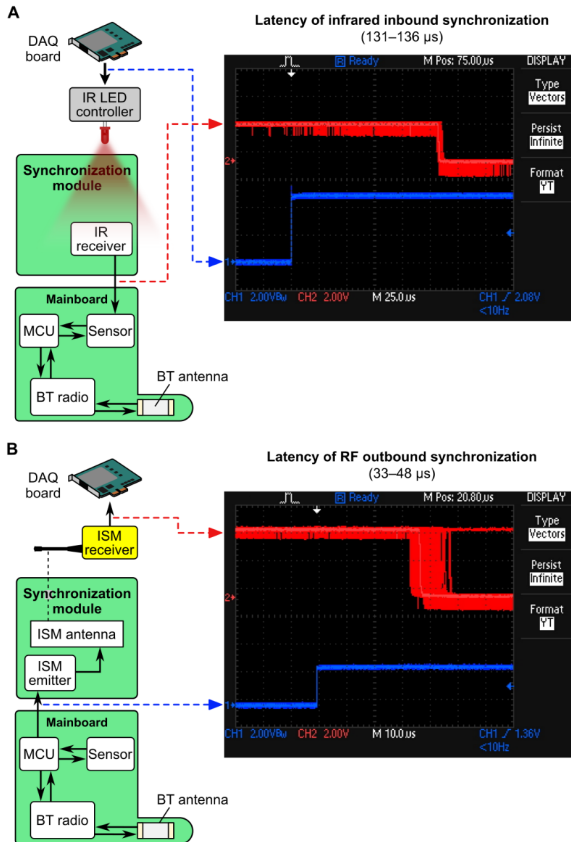

Figure 6.8: Latencies of inbound and outbound synchronization. **A**, For measuring the latency of inbound synchronization, square pulses (1 Hz, duty cycle: 10%) were generated using a DAQ board and fed to the gate input of the IR LED module. The oscilloscope screenshot (right) shows 900 pulses aligned on their rising front (blue traces) and the voltage measured simultaneously at the output of the IR receiver on the IMU (red traces). The IR receiver output switches from 2.7 to 0 V when it detects an appropriate optical stimulus and this signal is inverted before reaching the sensor’s synchronization input (not shown on circuit diagram on the left). The observed latency ranged from 131 to 136 μ s. **B**, For measuring the latency of outbound synchronization, the microcontroller was configured to deliver RF pulses every 300 acquisition cycles (duration of pulses high state: 150 cycles). The oscilloscope screenshot (right) shows 900 voltage traces measured at the input of the ISM emitter on the IMU (blue traces) and the voltage measured simultaneously at the output of the RF receiver (red traces). The observed latency ranged from 33 to 48 μ s. The receiver was positioned 60 cm away from the IMU.

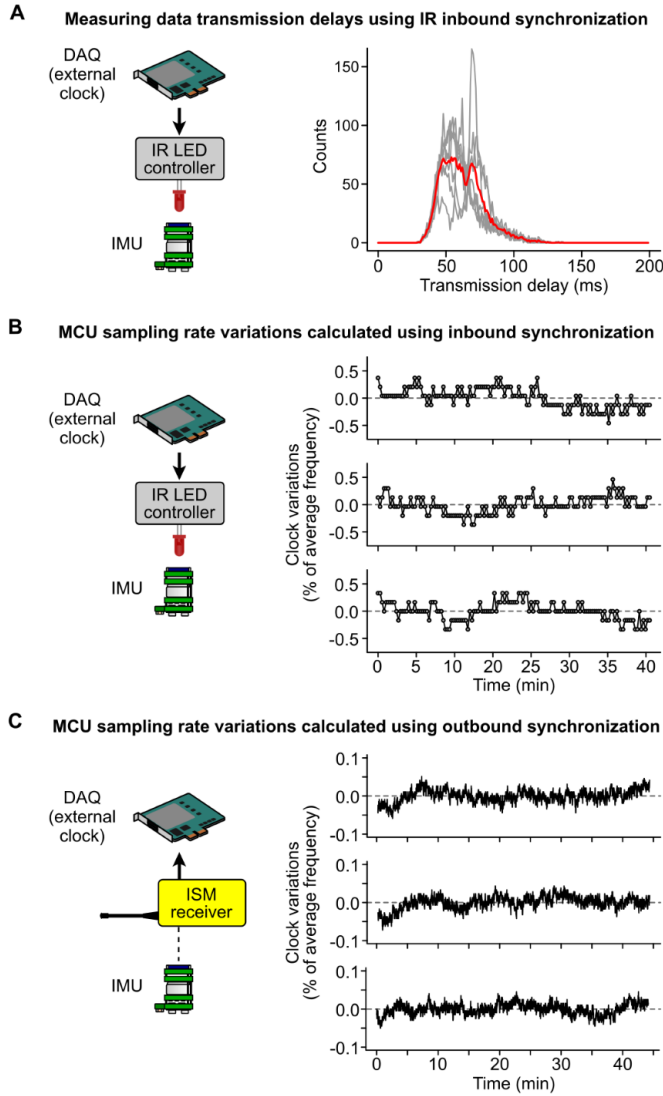

Figure 6.9: Estimating the delay of Bluetooth data transmission and the regularity of data acquisition using synchronization functions.

Figure 6.9: Estimating the delay of Bluetooth data transmission and the regularity of data acquisition using synchronization functions. **A**, Histograms of Bluetooth transmission delays calculated from 7 recording sessions (gray traces), and their average (red). The transmission delay was measured by connecting the counter of a DAQ to the IR LED controller, and by calculating the lag between individual counter ticks and the time of reception of the corresponding inbound synchronization events in the IMU data stream. Each session contained 2700 pulses delivered by the counter at 1 Hz (duty cycle: 10%). All histograms have a bin of 1 ms. The transmission delays measured using this method are comparable to those obtained in Figure 6.2D **B**, Fluctuations of the IMU data acquisition rate estimated using IR synchronization. The graph contains 3 example traces from 3 different recording sessions. In this experiment, regular IR signals were emitted at 1 Hz and the IMU acquisition frequency was calculated based on the number of frames acquired between two successive IR synchronization events. **C**, Fluctuations of the IMU data acquisition rate estimated using outbound synchronization. The graph contains 3 example traces from 3 different recording sessions. In this experiment, RF power was emitted by the IMU every 300 frames and the output of the RF receiver was monitored at 20 kHz. The calculated data acquisition rate displayed slow fluctuations comparable to those observed in **B**, and small rapid variations which correspond to the jitter of the RF synchronization channel (see Figure 6.8B).

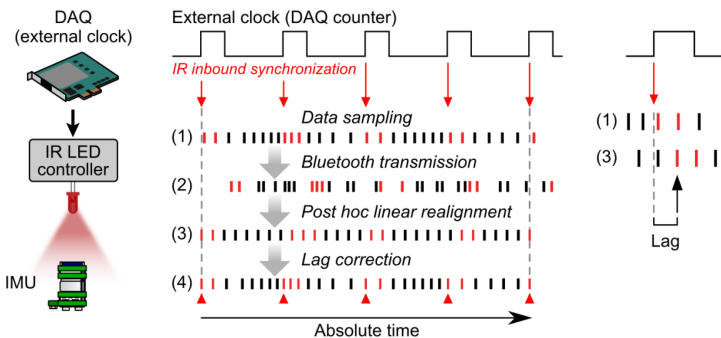

Figure 6.10: Strategy for calculating the acquisition times of IMU data frames using IR synchronization. The counter of a DAQ board was used to gate the emission of IR signals that were detected by the IMU (left). In the middle panel, individual IMU data frames are represented by vertical bars. Red bars represent data frames acquired in the presence of an IR signal. The following strategy was used to calculate the acquisition times of IMU data frames. Inertial data acquired by the IMU (step 1: *Data sampling*) and transmitted via Bluetooth with a variable delay (step 2: *Bluetooth transmission*) were realigned by assigning the time of the first and last counter ticks to the corresponding IMU data frames, and by evenly redistributing all data frames within these limits (step 3: *Post hoc linear realignment*). The misalignment (lag) between counter ticks and the corresponding IMU data frames was then calculated (inset on the right). Lag correction was performed by fitting a spline function to the time course of the lag and then subtracting spline values from the times of IMU data points (step 4: *Lag correction*). In practice, the period of the external clock has to be significantly shorter than the time scale of the fluctuations in the IMU's sampling rate. In the illustration, fluctuations of the sampling rate and transmission delay are exaggerated for the sake of the demonstration.

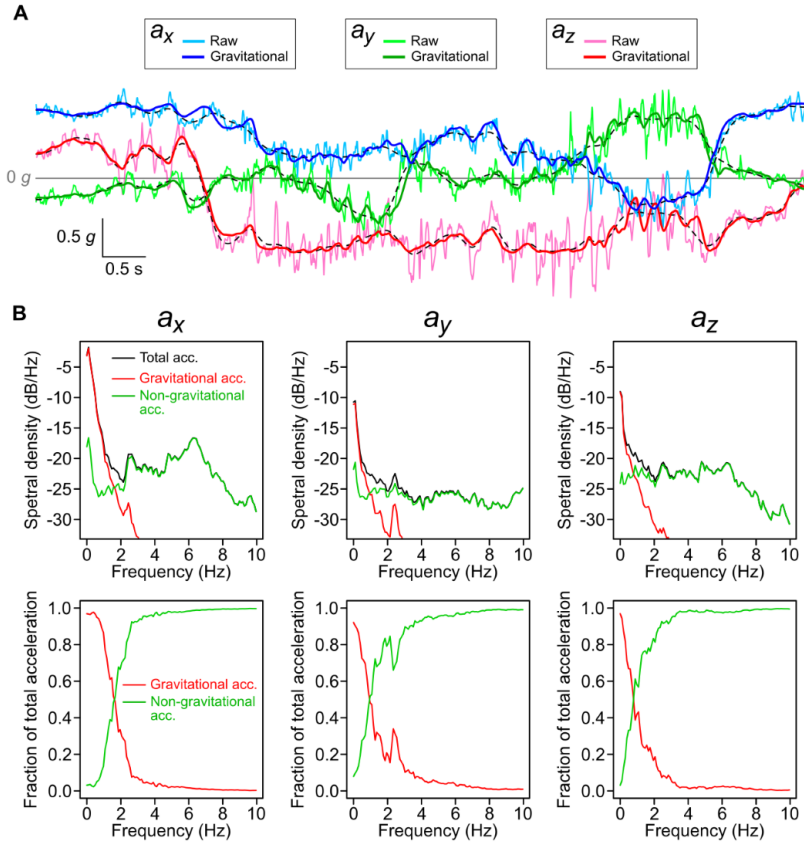

Figure 6.11: Estimation of the gravitational component of linear acceleration using an orientation filter algorithm. An orientation filter algorithm was used in 3 recordings to estimate the gravitational component of linear acceleration (see 1.4.1 for details). **A**, Example trace recorded from a freely moving rat, showing the raw linear acceleration (light colors) and the predicted gravitational acceleration (strong colors). Dashed lines represent the low-pass filtered acceleration (< 2 Hz). **B**, Top: average spectral density (in dB) of the total (black), gravitational (red) and non-gravitational (green) components of linear acceleration, calculated from 3 recordings. Bottom: average fraction of total spectral density carried by the gravitational (red) and non-gravitational (green) components of linear acceleration, calculated from 3 recordings.

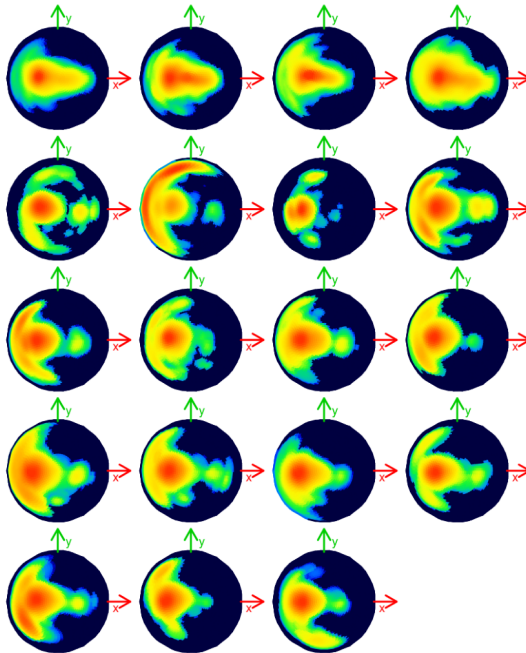

Figure 6.12: Examples of “gravity orientation density maps” calculated for 19 different rats. The plots are 2D projections of spherical orientation maps (such as the one displayed in Figure 6.6B), where the North pole of the sphere (z axis in the sensor’s reference frame) is at the center (see 1.4.2 for a description of the calculation of these maps). The color code represents the frequency at which the gravity vector was oriented in a specific direction (logarithmic scale) in the sensor’s coordinates. The red and green arrows show the directions of the x and y axes in the sensor’s reference frame. Recordings lasted between 30 and 45 min.

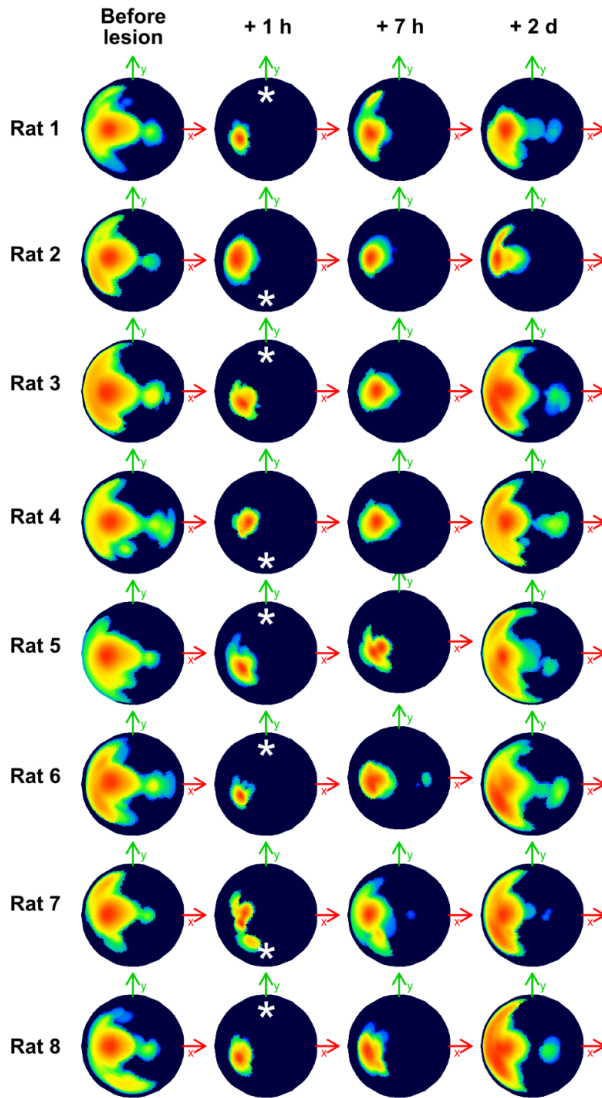

Figure 6.13: Gravity orientation density maps before and after unilateral vestibular lesion. The maps for all 8 rats that underwent a unilateral vestibular lesion are shown, before and at various intervals after the lesion (see 1.4.2 for a description of the calculation of these maps). White asterisks indicate the lesion side.

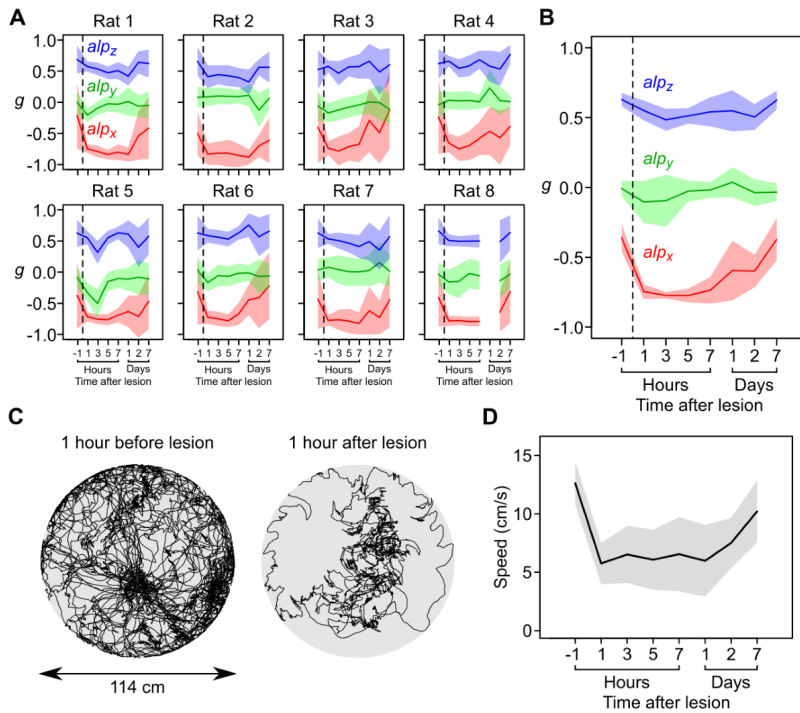

Figure 6.14: Changes in head posture and overall mobility after a unilateral vestibular lesion. **A**, Average values (\pm SD as shaded area) of the low-pass filtered (< 2 Hz) linear acceleration signals (alp_x , alp_y and alp_z) for all rats, one hour before and at various time intervals after the lesion. **B**, Average values (\pm SD as shaded area) of alp_x , alp_y and alp_z across rats. **C**, Movement trajectories within the circular arena obtained for one rat for the sessions preceding (1 h before) and following (1 h after) the lesion. Trajectories were computed online by tracking the 3 LEDs present on top of the IMU. **D**, Average speed (\pm SD as shaded area) across rats, calculated using LED videotracking data, and plotted for all recording sessions.

6 Wireless Inertial Measurement of Head Kinematics in Freely-Moving Rats

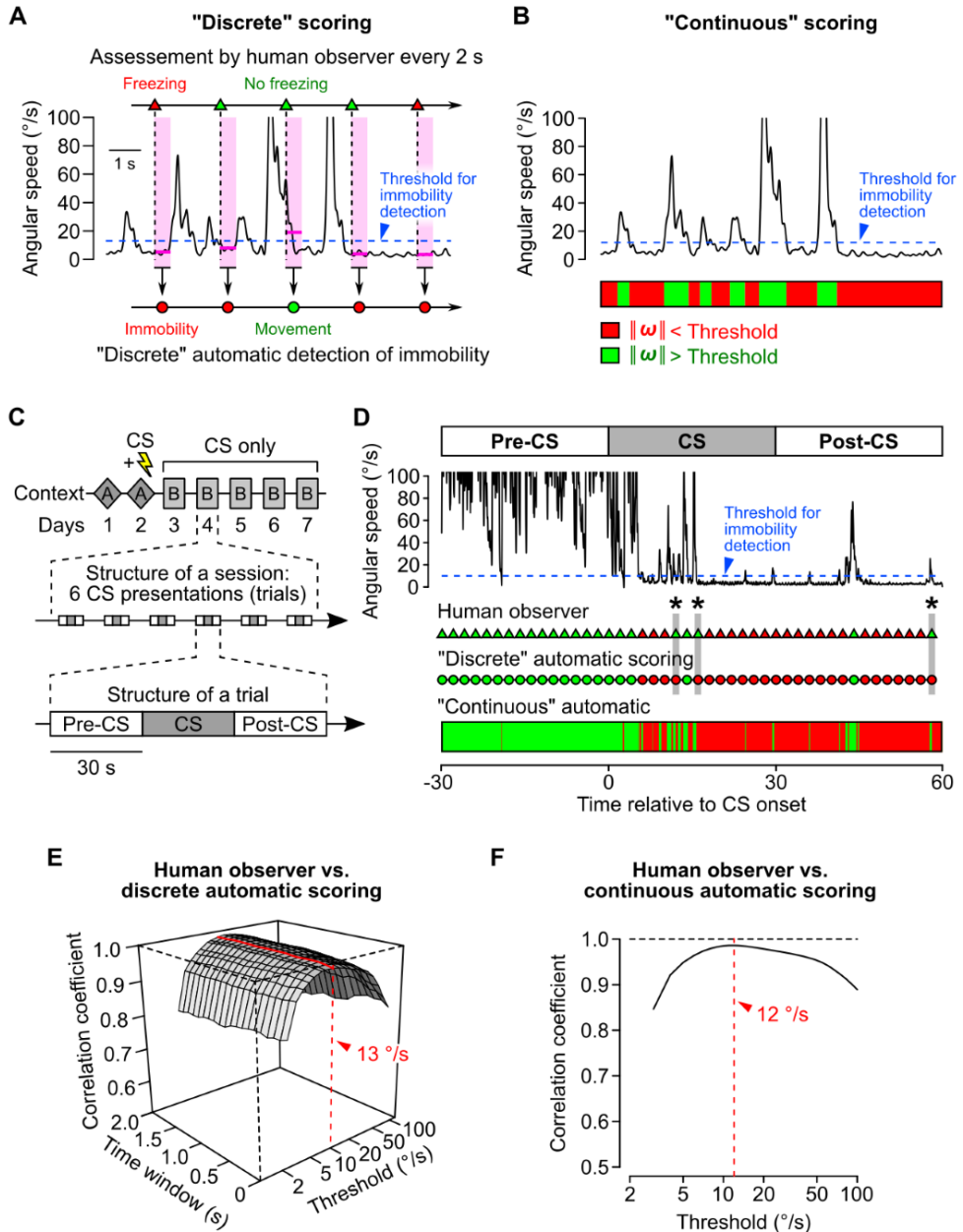

Figure 6.15: Methods for automatically scoring behavioral freezing in a fear conditioning experiment.

Figure 6.15: Methods for automatically scoring behavioral freezing in a fear conditioning experiment. **A**, Drawing depicting the observational and automatic instantaneous time sampling procedures. Freezing was assessed by a trained observer (filled triangles) every 2 s using a regular beeping sound. “Discrete” automatic scoring was performed by calculating the average angular speed $\|\bar{\omega}\|$ (horizontal purple lines) within defined time windows (purple bars) aligned to the observer’s judgement times (vertical dashed lines), and by comparing its value with a threshold (immobility if $\|\bar{\omega}\| < \text{threshold}$, represented as a dashed blue line). **B**, Drawing depicting the “continuous” automatic scoring technique, in which all data points are compared with a threshold. **C**, Schematic of the experiment. Daily extinction sessions contained 6 CS presentations. Each CS presentation was scored by considering a *trial*, defined as a period encompassing the CS presentation as well as the 30 s before (Pre-CS) and after (Post-CS). **D**, Example of a trial showing the angular speed trace and the scores obtained by the human observer and the two automatic scoring techniques. Note the occasional discrepancies (asterisks) between the scores obtained by the observer and the “discrete” automatic method. **E**, Correlation coefficients between the *per trial* immobility scores obtained by the observer and the “discrete” automatic scoring algorithm, plotted as a function of the algorithm’s parameters (width of observation time window and threshold value in log scale). For most time window values, the correlation was maximal for a threshold of 13°s^{-1} (red line). **F**, Correlation coefficients between the observer’s *per trial* immobility scores and the average fraction of time spent below threshold calculated for each trial by the “continuous” automatic scoring algorithm, plotted against the algorithm’s threshold value (log scale).

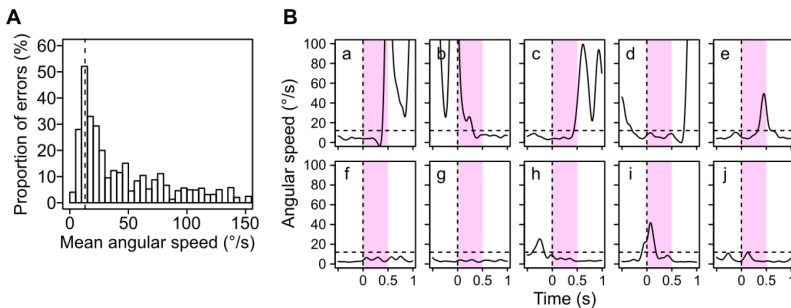

Figure 6.16: Analysis of the discrepancies between the scores obtained by the observer and the “discrete” automatic scoring method. **A**, Fraction of scores with a mismatch plotted as a function of the local average angular speed calculated by the algorithm (using a time window of 0.5 s). The highest fraction of mismatch (up to 50% of observations) was found for near-threshold angular speeds. The threshold (13°s^{-1}) is represented by a vertical dashed line. **B**, Randomly selected angular speed traces corresponding to situations with a scoring discrepancy. The vertical dashed line represents the moment that beep (used by the observer) is emitted at the start of a 2-second bin. The purple rectangle marks the time interval employed for the “discrete” automatic scoring method (threshold = 13°s^{-1} , horizontal dashed lines). In most cases, the time window fell at the beginning or end of a head movement (a–e and h,i).

6 Wireless Inertial Measurement of Head Kinematics in Freely-Moving Rats

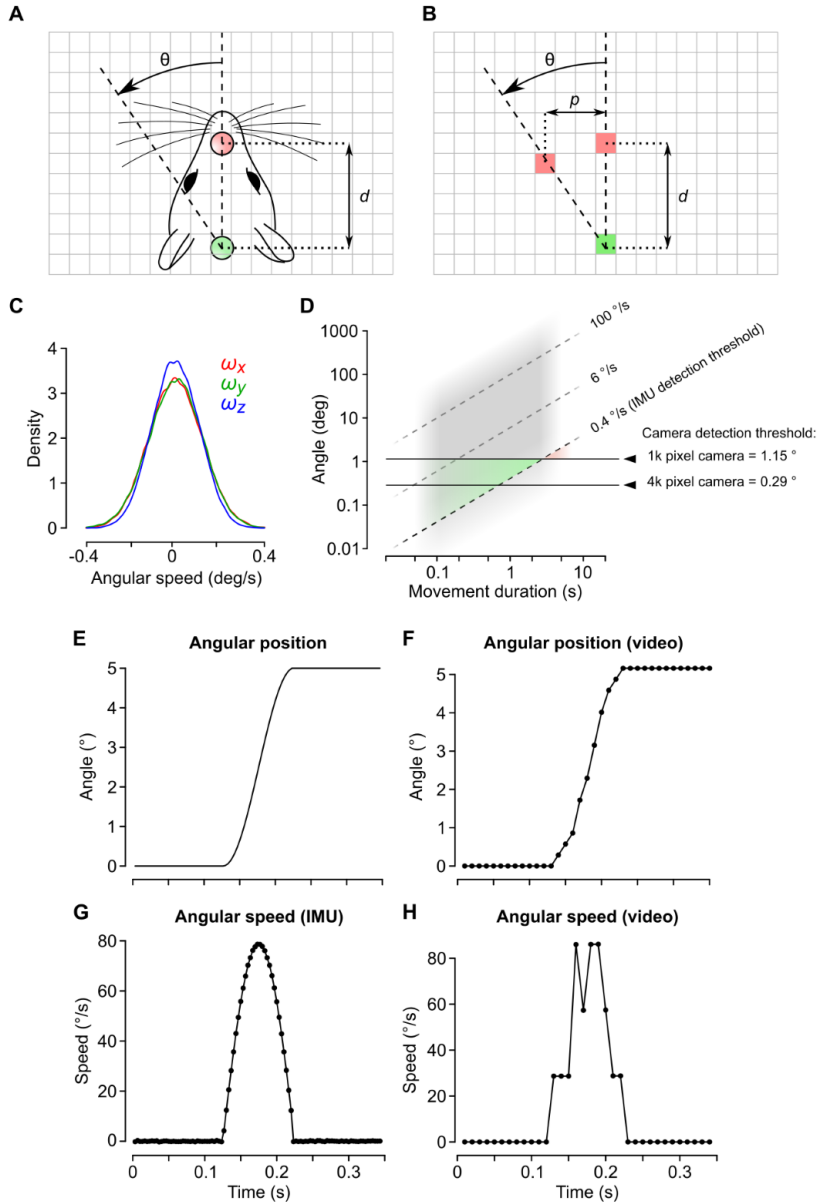

Figure 6.17: Comparison of the IMU with a motion capture system for the detection of head rotations.

Figure 6.17: Comparison of the IMU with a motion capture system for the detection of head rotations. To compare both systems, we simulated a simple yaw rotation and assumed that the video system is used to record the movements of a rat on a 1 m^2 square area, using two reflectors placed on its head. We assumed that the system is equipped with a high resolution camera (1000×1000 pixel or 4000×4000 pixel) functioning at 100 Hz. **A-B**, Drawing depicting the simulated head rotation (see 1.6.1 for detailed explanations). **C**, Centered density histogram of the angular velocities measured using the IMU placed on a mechanically isolated platform. **D**, Graph summarizing the types of rotations that will be preferentially detected by our IMU or by a video motion tracking system (see 1.6.1 for detailed explanations). **E-H**, Simulation comparing the resolution of both systems for the measurement of a small head rotation (see 1.6.1 for detailed explanations).

Supplementary Movies

Supplementary movies can be watched here.

Movie S1. Inertial signals recorded during active exploration. The upper left panel is a flow chart displaying the linear acceleration (a_x , a_y and a_z) and angular velocity signals (ω_x , ω_y and ω_z). The low-pass filtered (< 2 Hz) linear acceleration (a_{lp} , strong colors) is superimposed on the raw linear acceleration (light colors). The bottom left panel shows the current orientation of a_{lp} (green circle with a black border) on a spherical “orientation density map” (see Figure 6.5B and 1.4.2). In order to visualize all possible orientations of the vector, the density map is represented using a Mollweide projection. The trajectory of a_{lp} orientations over the last second is represented by a thick green line. The right panel shows a movie of the rat acquired with a hand-held camera. The same clock was used to timestamp inertial data (through the IR channel) and the acquisition of video frames. Therefore the flow chart displaying inertial data (top left) and the current a_{lp} orientation (bottom left) are synchronized with the video of the rat. In the flow chart (top left), the dashed line corresponds to the time of the current video frame. The movie shows large increases in head angular velocity (up to $\pm 500^\circ \text{s}^{-1}$, typically lasting 200 ms, as well as episodes of rhythmic activity at around 10 Hz.

Movie S2. Rhythmic activity during active exploration. See the legend of Movie S1 for a description of the panels. This movie shows an episode of active exploration in slow motion (slowed 3-fold). This episode contains pronounced 10 Hz oscillatory activity, mainly visible in gyroscopic data, that is apparently not correlated with gait and might reflect active sniffing.

Movie S3. Inertial signals during grooming. See the legend of Movie S1 for a description of the panels. This movie shows an episode of head and body grooming. Head grooming is associated with pseudo-rhythmic activity, while body grooming is associated with large oscillations of both accelerometer and gyroscope signals at around 4 Hz. During body grooming, the low-pass filtered linear acceleration vector points towards characteristic regions of its orientation density map.

Movie S4. Inertial signals during rearing. See the legend of Movie S1 for a description of the panels. This movie shows episodes of rearing in slow motion (slowed 3-fold), during which the low-pass filtered linear acceleration vector follows a characteristic trajectory along the midline of its orientation density map.

6.6 Supplementary Methods

Data timestamping using IR synchronization

IR synchronization was used to estimate precisely the absolute acquisition time of individual IMU data frames. To a first approximation, two distant IR synchronization events (for example at the beginning and end of data acquisition) should provide reliable temporal limits within which all data frames could be linearly realigned. This method, however, assumes that the data sampling rate

is regular. Because data acquisition is paced by the microcontroller's internal clock (instead of a crystal oscillator), we can expect that the data sampling rate will display some fluctuations over time. We therefore used a timestamping strategy based on the emission of regular IR signals (gated by the counter of a DAQ board; 1 Hz, duty cycle: 10%), allowing us to estimate variations of the local average sampling rate (the number of data frames acquired between two successive IR signals). This local sampling rate never displayed variations greater than one frame per second, indicating that the time between two acquisition cycles drifted by less than 3.3 ms over 1 s. Over several minutes, the average sampling rate displayed slow fluctuations of the order of $\pm 0.5\%$ (Supplementary Figure 6.9B). To calculate the acquisition time of individual data frames, we used the method depicted in Supplementary Figure 6.10. Data frames received from the IMU were realigned by assigning the time of the first and last counter ticks to the corresponding IMU data frames, and by linearly redistributing all other IMU data points within these limits. Because of the fluctuations in the IMU sampling rate, data points corresponding to the detection of IR events did not coincide with the occurrence of the corresponding counter ticks. This misalignment (lag) never exceeded ± 200 ms (measured for each IR event in 7 recording sessions of 45 min). By fitting a spline function to the time course of the lag, a lag value could be calculated for each data frame. Linearly interpolated acquisition times could then be corrected by subtracting this value.

Temporal performance measurements

Transmission delays To measure the delay between mechanical transduction by the sensor and data reception by the client software, the following procedure was used. The wireless IMU was attached to a metal plate connected to a 1.5 V battery through a 100 k Ω resistor (Figure 6.2C). The battery was hit against the metal plate, creating a mechanical vibration measured by the IMU and a voltage difference across the resistor monitored at 20 kHz by the analog input of a DAQ board. The data transmitted by the IMU and the voltage across the resistor were recorded simultaneously using the same LabVIEW program. The shocks between the battery and the metal plate were visible as steps in the analog input channel and as brief oscillations in the linear acceleration data (Figure 6.2C). For each step, the transmission delay was obtained by calculating the latency between the first points deviating significantly from baseline in both signals (red points in Figure 6.2C).

For comparison, the same measurement was performed with a wired IMU (built by mounting the same digital inertial sensor onto a custom PCB). In this experiment, the wired IMU was connected to the PC via a USB I²C interface (USB-8451, National Instruments).

In addition to enabling the calculation of accurate acquisition times (see 1.1),

the use of IR synchronization also allowed us to measure transmission delays by calculating the lag between the emission of IR signals and the reception of the first IMU data frames containing information regarding these signals. These measurements confirmed that transmission delays lie in the 30–120 ms range (Supplementary Figure 6.9A).

Measuring data sampling rate variations using outbound RF synchronization To obtain accurate measurements of the fluctuations of the microcontroller's acquisition rate, we programmed the microcontroller to trigger the emission of an RF signal every 300 acquisition cycles, and recorded the output of our RF receiver at 20 kHz using the analog input channel of a DAQ board. These measurements showed that variations of the acquisition rate never exceeded $\pm 0.1\%$ (Supplementary Figure 6.9C).

Surgical procedure for attaching magnets to the skull

Rats received an injection of the opioid analgesic buprenorphine (0.05 mg kg^{-1} s.c.) and were placed in a stereotaxic apparatus (model 942, David Kopf Instruments) under isoflurane anesthesia. The rat's scalp was shaved and wiped with povidone-iodine followed by 70% ethanol. Lidocaine (2%) was injected subcutaneously before incising the scalp. The skull was gently scraped with a scalpel blade and cleaned with a 3% hydrogen peroxide solution. Burr holes were drilled (two over the frontal and four over the parietal bone plates) in order to insert skull screws (#0-80 x 3/32" stainless steel screws, Plastics One). A layer of self-curing dental adhesive (Super-Bond C&B, Sun Medical) was then deposited over the skull. Two disk neodymium magnets (S-06-03-N, Supermagnete.com) glued to a small piece of glass/epoxy sheet were positioned over the screws and fixed to the rat's head using self-curing acrylic resin (Pi-Ku-Plast HP36, Bredent). Finally the skin ridges were sutured in front and at the rear of the implant and the rats were allowed to recover in their home cage.

Analysis of head posture

Orientation filter In order to isolate the gravitational component of linear acceleration, we implemented an orientation filter algorithm developed by Sebastian Madgwick Madgwick et al. 2011. This algorithm integrates gyroscope signals (angular velocity) in order to keep track of the absolute 3D orientation. Although small, the noise of gyroscope measurements introduces an accumulating error in the estimated orientation. This error is corrected using accelerometer measurements, that would provide a measure of gravity (and thus an absolute reference of orientation) in the absence of translational

acceleration. In normal operating conditions, transient translational acceleration signals add with gravity in accelerometer measurements. The task of the algorithm is to perform the optimal fusion of gyroscope and accelerometer measurements to provide a single estimate of orientation. One key parameter in the algorithm is the rate at which the estimated gravity converges toward the raw linear acceleration in order to compensate for the drift of gyroscope signal integration. Because the horizontal heading direction (azimuth) is not constrained by the filter, it tends to drift over time. This, however, does not compromise the estimation of orientation relative to gravity (attitude). A non-drifting estimate of absolute orientation could be obtained using magnetometer data (not used here), that provide a measurements of the earth's magnetic field.

To obtain a reliable estimate of orientation, it is important to subtract the offsets of gyroscopes and accelerometers. In 3 recordings, we recorded periods of total immobility (IMU on a table) before attaching it to the rat and measuring the animal's movements. This period of immobility was used to measure gyroscope offsets (typically ranging $0.1\text{--}1.3^\circ\text{s}^{-1}$), and to calculate accelerometer offsets. The calculation of accelerometer offsets is performed as follows. Well calibrated accelerometers should give a net acceleration $\|a\|$ of $1g$ during immobility in any orientations ($\|a\| = \sqrt{a_x^2 + a_y^2 + a_z^2}$, i.e. the magnitude of the acceleration vector a defined by a_x , a_y and a_z). Therefore accelerometer offsets can be calculated by minimizing $1 - \|a\|$ using data recorded from an immobile IMU in different orientations. Our calculations yielded offset values ranging $0.001\text{--}0.03g$.

For every time point in the recording, the output of the orientation filter is a quaternion representation of a rotation matrix R_θ that brings the object from an arbitrary initial orientation to the current estimated orientation. By choosing an upright initial orientation (z sensor axis aligned with gravity), it is possible to track the orientation of gravity in the sensor's coordinates (G) by applying the converse rotation: $G = R_{-\theta} \cdot z_i$, where $R_{-\theta}$ is the matrix corresponding to the converse rotation and $z_i = (0, 0, 1)$ is the initial orientation of the z axis. Supplementary Figure 6.11 shows that G follows the slow fluctuations of the measured linear acceleration (Supplementary Figure 6.11A) and that G accounts for most of the linear acceleration below $1\text{--}2\text{ Hz}$ (Supplementary Figure 6.11B). This shows that low-pass filtered linear acceleration can be used as an approximation of gravity.

Changes in head posture following a unilateral vestibular lesion The low-pass filtered ($< 2\text{ Hz}$) linear acceleration vector (a_{lp}) was used as an approximation of gravity (see 1.4.1). To obtain a density map of the different orientations of a_{lp} encountered during a recording, the cartesian coordinates of a_{lp} were transformed into polar coordinates (longitude and latitude), and a 2D histogram of these polar coordinates was calculated. The bins of this 2D histogram represent quadrangles with different areas when represented on a

sphere. In order to plot this histogram on a sphere, the number of occurrences of a_{lp} coordinates falling within a specific bin was normalized by the corresponding quadrangle area (Figure 6.5B,C). Normalized histogram data were then color coded using a logarithmic scale and wrapped onto a sphere using functions of the `sphereplot` R package. To obtain meaningful a_{lp} orientation density maps (i.e. representing the range of head postures), we took care to remove situations in which animals would lean their head against the walls of the arena or lie down on the floor for an extended period of time. Such situations could potentially artificially shift a_{lp} orientation density maps and bias our calculation of an average head posture. To achieve this, we excluded from the analysis the periods during which the IMU LEDs were less than 2 cm away from the walls, and/or the instantaneous head angular speed was less than 20° s^{-1} .

The following procedure was used to obtain 2D density maps (Supplementary Figures 6.11 and 6.12). 2000 points were uniformly distributed on a sphere or radius 1. For a given recording, our algorithm counted the number of times a_{lp} was aligned with each of these positions ($\pm 2^\circ$), yielding a vector N with 2000 values. A Delaunay triangulation was then performed around these points to obtain a set of 2000 polygons distributed over the sphere. A 2D projection of these polygons was obtained using a transformation that preserved their respective areas (using the `mapproj` R package). A color code was used to represent the value of N (on a logarithmic scale) for each location. Correlations between density maps from different rats were calculated by computing the Pearson correlation coefficient between the corresponding vectors N .

For the unilateral vestibular lesion experiment, head posture was reconstituted in 3D using the mean low-pass filtered linear acceleration vector ($\overline{a_{lp}}$) calculated for each recording session (Figure 6.5C). A 3D model of a rat's skull Pohl et al. 2013 was rotated to align $\overline{a_{lp}}$ with the vertical (z) axis of a right-handed reference frame, whose x axis was positioned such that it falls within the plane defined by z and the animal's naso-occipital axis. The roll tilt angle was defined as the angle between the head-vertical axis and this plane. The pitch angle was defined as the angle between the naso-occipital axis and the horizontal plane.

Fear conditioning experiments

Apparatus/Method Rats underwent fear conditioning and extinction training in each of two distinct chamber configurations. The fear conditioning chamber (Context A) consisted of a hexagonal-shaped transparent Plexiglas box with the dimensions of $37 \times 45 \times 37$ cm (L×H×W) with a grid floor composed of 25 stainless steel rods (0.6 cm in diameter) that were connected to a constant-current scrambled shock generator (ENV-414, Med Associates, USA). This chamber was scented with a 1% ammonium hydroxide solution in the

collection pan below the grid floor. The extinction chamber (Context B) was a rectangular-shaped box with the dimensions of $40 \times 45 \times 40$ cm (LxHxW), which had opaque grey Plexiglas rear and side walls, a transparent Plexiglas front wall, and a black plastic insert covering the floor. In addition, to ensure that the rats were fully visible to the camera, a black plastic ramp insert (40×18 cm) was installed, which slanted up from the middle of the floor to the front of the chamber. This chamber was scented with a 1% acetic acid solution. During the behavioral sessions the sound and shock generators were used to deliver white noise cues (30 s; 70 dBA) and/or footshocks (1 s; 0.6 mA) to the animals via a computer-controlled interface (Med Associates, USA). Each context was maintained inside a larger, insulated plastic cabinet that provided a degree of sound attenuation from ambient external noise. A speaker attached to a sound generator (ENV-230, Med Associates, USA) was mounted above the context (48 cm from the floor). To ensure high quality video acquisition, a 150 W halogen spotlight was used to illuminate each context from above (754 lux). The spotlight's fan and the noise emanating from the computer-controlled interface provided background noise (48 dBA).

Rat behavior was recorded with a high-definition video camera (Sony Handycam HDR-CX280) positioned 30 cm from the front wall of the testing chamber. It captured images that were converted into mp4 video files (1920×1080 pixels images captured at 50 frames per second) that were used during subsequent observational behavioral analyses. The video resolution allowed the observer to visualize motion in the rat's vibrissae easily. A red LED that was visible to the camera, but not to the rat, was positioned outside of each testing chamber, and its illumination pattern was used to synchronize the timing of the video data with the sensor measurements.

Fear conditioning and extinction procedures Rats were handled daily for 7 days prior to the magnet implantation procedure. After 14 days of recovery they were handled again for another 7 days prior to the start of the 7-day fear conditioning and extinction procedures. On day 1 each rat underwent a 34-minute habituation to Context A. On day 2, each rat returned to context A where it was fear conditioned with three white noise-footshock pairings (30 s white noise cue that co-terminated with the 1 s 0.6 mA footshock). During this session, the onset of the white noise cues occurred at 300, 630, and 960 s after the initiation of the control program. On days 3–7 each rat was placed in context B for a 34-minute extinction session during which 6 white noise cues were presented without footshock at 300, 630, 960, 1290, 1620, and 1,950 s after initiation of the control program. On day 1 and days 3–7 the sensor device was attached to the animal's head immediately before the behavioral session. The sensor was not installed on the fear conditioning day, however, to ensure device integrity.

Manual scoring of behavioral freezing An experimenter (BPG) well trained in observational behavioral inventory analyses used an instantaneous time-sampling procedure Fanselow 1980 to characterize behavioral freezing from the video files. Freezing was defined as the absence of movement except for that required for breathing. A regular beeping sound was synchronized with the video files so that observational judgements for “freezing” or “not freezing” were made every 2 seconds during the 30 s before, during and 30 s after each white noise presentation.

Analysis of gyroscopic data In these recordings, the sensitivity ranges of the IMU were set to their minimum ($\pm 2g$ and $\pm 250^\circ \text{s}^{-1}$) in order to achieve the highest resolution for small movements. Data obtained from the 3 gyroscopes (ω_x , ω_y and ω_z) provide the coordinates of the instantaneous 3D angular velocity vector ω , whose magnitude $\|\omega\|$ is the instantaneous angular speed. The angular speed signal was first smoothed by applying a low-pass filter (5 Hz), in order to remove rapid transient threshold crossings. The state of the animal (immobile or not) was then assessed by running a simple threshold crossing detection routine on the low-pass filtered angular speed. In a first type of analysis, (“discrete” automatic scoring), the average angular speed ($\|\bar{\omega}\|$) was assessed within a defined time window every 2 s, and a score (immobility or not) was attributed to each observation window depending on whether $\|\bar{\omega}\|$ was greater or smaller than the threshold (Supplementary Figure 6.12A). This method aimed at mimicking the instantaneous time sampling procedure implemented by the observer. In a second type of analysis, the threshold was simply applied to the whole angular speed trace and the fraction of immobility (% of the points below threshold) was calculated (Supplementary Figure 6.12B).

Comparison of the IMU with a motion capture system

In this section, we detail a number of calculations that were used to compare our IMU with a video motion capture system for the detection of head rotations.

Sensitivity We simulated a situation in which a high rate, high resolution camera records the movements of a rat over a 1 m^2 square area. Two reflectors (R1 and R2) are placed on the head of a rat, separated by a distance d (Supplementary Figure 6.17A). For d to be greater than the head’s length ($\simeq 3 \text{ cm}$), the two reflectors can be placed at the two extremities of a thin bar fixed to the skull. Here we postulate an ideal situation in which the video system detects the exact position of the centers of R1 and R2. The simulated movement is a simple yaw rotation centered around R1, that brings R2 to a new position located at a distance p toward the left (Supplementary Figure

6.17B). The smallest detectable rotation produces a lateral displacement of R2 corresponding to one pixel ($p = 0.25$ mm for a 4000×4000 pixel camera and $p = 1$ mm for a 1000×1000 pixels camera, assuming $d = 5$ cm). This corresponds to a minimum rotation angle θ_{min} of $\arctan(\frac{p}{d})$ (i.e. $\theta_{min} = 0.29^\circ$ for a 4000×4000 pixel camera and $\theta_{min} = 1.15^\circ$ for a 1000×1000 pixel camera).

On the IMU side, the smallest detectable rotation can be calculated based on the noise of gyroscopic measurements. This noise was quantified by recording inertial data from an immobile IMU placed on a mechanically-isolated platform, and configured to use the highest gain possible ($\pm 250^\circ \text{s}^{-1}$). The SD of the measured signal ranged 0.10 – 0.12°s^{-1} (Supplementary Figure 6.17C), meaning that a rotation speed ω greater than 0.4°s^{-1} ($\simeq 3.5$ SD) should be detectable. Note that this angular speed is extremely slow (one full turn in 15 min).

The graph in Supplementary Figure 6.17D represents a 2D space where the y axis is the rotation angle θ , and the x axis is the duration of the rotation. Given the above calculations, all rotations with $\theta > 0.29^\circ$ (for a 4000×4000 pixel camera) or with $\theta > 1.15^\circ$ (for a 1000×1000 pixel camera) are detectable by the video system (solid horizontal lines in Supplementary Figure 6.17D). As calculated above, all rotations with an angular speed $\omega > 0.4^\circ \text{s}^{-1}$ can be detected by the IMU (lower oblique dashed line in Supplementary Figure 6.17D). The gray area highlights rotations that can be considered as physiologically-relevant for studying rat behavior (0.2–20 Hz). The graph shows that the IMU can detect rotations that the video system can not discriminate Supplementary Figure 6.17D: $\theta < 0.29^\circ$ or 1.15° depending on the resolution of the camera, and $\omega > 0.4^\circ \text{s}^{-1}$). Conversely, the video system can detect slow rotations that the IMU can not capture (red area in Supplementary Figure 6.17D: $\theta > 0.29^\circ$ or 1.15° and $\omega < 0.4^\circ \text{s}^{-1}$). It is important to note that the regions where one system performs better than the other correspond to rotations that lie outside or at the edge of the physiologically-relevant range. Therefore we conclude that both systems can achieve a level of sensitivity (the ability to detect small head rotations) that is adapted to the study of behaving rats.

Resolution In the following simulation, the rotation was a 5° yaw rotation executed in 0.1 s, corresponding to the type of gyroscopic signal acquired in freely behaving rats (see Movie S2). Supplementary Figure 6.17E represents the absolute yaw angle and Supplementary Figure 6.17F shows the expected angular measurement achieved with a video tracking system equipped with a 4000×4000 pixel camera functioning at 100 Hz. Supplementary Figure 6.17G shows the expected gyroscopic signal ω acquired at 300 Hz, calculated using the noise level measured above. Supplementary Figure 6.17H shows an estimation of ω calculated from the angles measured by the video system. These graphs show that for a typical small head rotation, the IMU provides a much better resolution of angular velocity than a motion tracking system.

7 Extinction Training In a Large Open Field Reveals Inter-Individual Differences In Conditioned Fear Recovery and Relapse

Fanny Demars^a, Ralitsa Todorova^b, Gabriel Makdah^b, Thérèse M. Jay^a, Bill P. Godsil^a, Sidney I. Wiener^b & Marco N. Pompili^{a,b}

^a Institute of Psychiatry and Neuroscience of Paris (IPNP), Hôpital Sainte-Anne, INSERM, Université de Paris, 102-108 Rue de la Santé, 75014 Paris, France

^b Center for Interdisciplinary Research in Biology (CIRB), Collège de France, CNRS, INSERM, PSL Université, 11 place Marcelin Berthelot, 75005 Paris, France

Statement of contributions: MNP, BPG, FD, and TMJ designed the research. MNP conceived, assembled, and tuned the experimental setup. FD and MNP carried out the experiments. MNP, FD, RT, GM, and SIW designed data analysis, which was carried out by FD, RT, GM, and MNP. MNP supervised experiments and data analysis. FD, MNP, SIW and RT wrote the manuscript.

Acknowledgements: We thank Matthieu Pasquet and Guillaumé Dugué for help with inertial data acquisition and analysis and Cédric Colas, Benjamin Billot, and Pierre-Antoine Vigneron for help with the initial set up of the rig and protocols. This project was funded with grants from the Agence Nationale de la Recherche to BPG, TMJ, and SIW and Labex MemoLife to MNP and SIW. MNP is also supported by the Université PSL and the Fondation Pierre Deniker, FD by the Fondation pour la Recherche Médicale.

manuscript in preparation

Abstract Experimental models of extinction of conditioned fear are of clinical significance in understanding the bases and treatments of various psychiatric disorders, especially in anxiety and trauma-related pathologies. But only a fraction of individuals exposed to a traumatic event develop anxiety disorders and some of them relapse, even after successful exposure-based therapy. The pathophysiological mechanisms underlying these individual differences in vulnerability remain unknown. To improve translation of animal model studies to the clinic, a key challenge is to investigate markers of resiliency and vulnerability to fearful experiences, and this may result from using more ethologically

relevant animal models. Here, we developed and tested a new paradigm of conditioned fear extinction and renewal where animals underwent extinction training in a large-scale environment, permitting the detection of a large spectrum of behaviors. We developed an automated analysis pipeline to score various behaviors from signals from a video detection system and inertial sensors recording head movements. This revealed two distinct response profiles in open-field extinction sessions after fear conditioning: conditioned stimulus (CS) presentation tended to trigger freezing in one group ('freezers'), while the others ran between more protected areas of the open field ('runners'). Interestingly, the runners are more vulnerable to context-dependent fear renewal than freezers. These results suggest new avenues for the development of interesting alternatives to standard extinction protocols for translational research. Due to the automated nature of the data acquisition and analyses, it could be successfully applied to investigate biological markers of resiliency and vulnerability to psychopathology following fearful experiences. This could lead to future developments and exploitation for testing new pharmacological or behavioral therapies for psychiatric disorders.

7.1 Introduction

Extinction of conditioned fear has received increasing attention over the past decade because of its clinical significance for the pathophysiology and treatment of various psychiatric disorders, especially stress- and trauma-related disorders as well as for addiction, and anxiety disorders (Craske et al. 2018; Dunsmoor et al. 2015; Milad and Quirk 2012). Fear extinction has been reported to be deficient in post-traumatic stress disorders and is believed to be the basis of exposure-based therapies (Maren et al. 2013; Milad et al. 2009; Zuj et al. 2016), a major behavioral treatment for anxiety and trauma-related disorders (Powers et al. 2010). While approximately 80% of people experience a traumatic event during their lifetimes, the lifetime prevalence of PTSD is estimated at 7-9% (Kilpatrick et al. 2013). In addition, successful cognitive behavioral therapy is followed by relapse in up to 62% of patients (Vervliet et al. 2013). However, the pathophysiological mechanisms underlying these individual differences in vulnerability remain unknown. A key challenge to investigate markers of resiliency and vulnerability to fearful experiences is to improve the sensitivity of animal models. Toward this end, it is crucial to study individual differences in animals' fear conditioning behavioral responses (Headley et al. 2019; Holmes and Singewald 2013). Indeed, some biomarkers only appear when data are distinguished according to the particular response phenotypes of individuals (Cohen and Zohar 2004; Dopfel et al. 2019; Peters et al. 2010). Interindividual differences in animals' behavior during extinction have been demonstrated (Bush et al. 2007; Galatzer-Levy et al. 2013; Reznikov et al. 2015; Gruene et al. 2015). However, results are mixed and reliable predictive behavioral markers have not yet been developed. Here we attempted

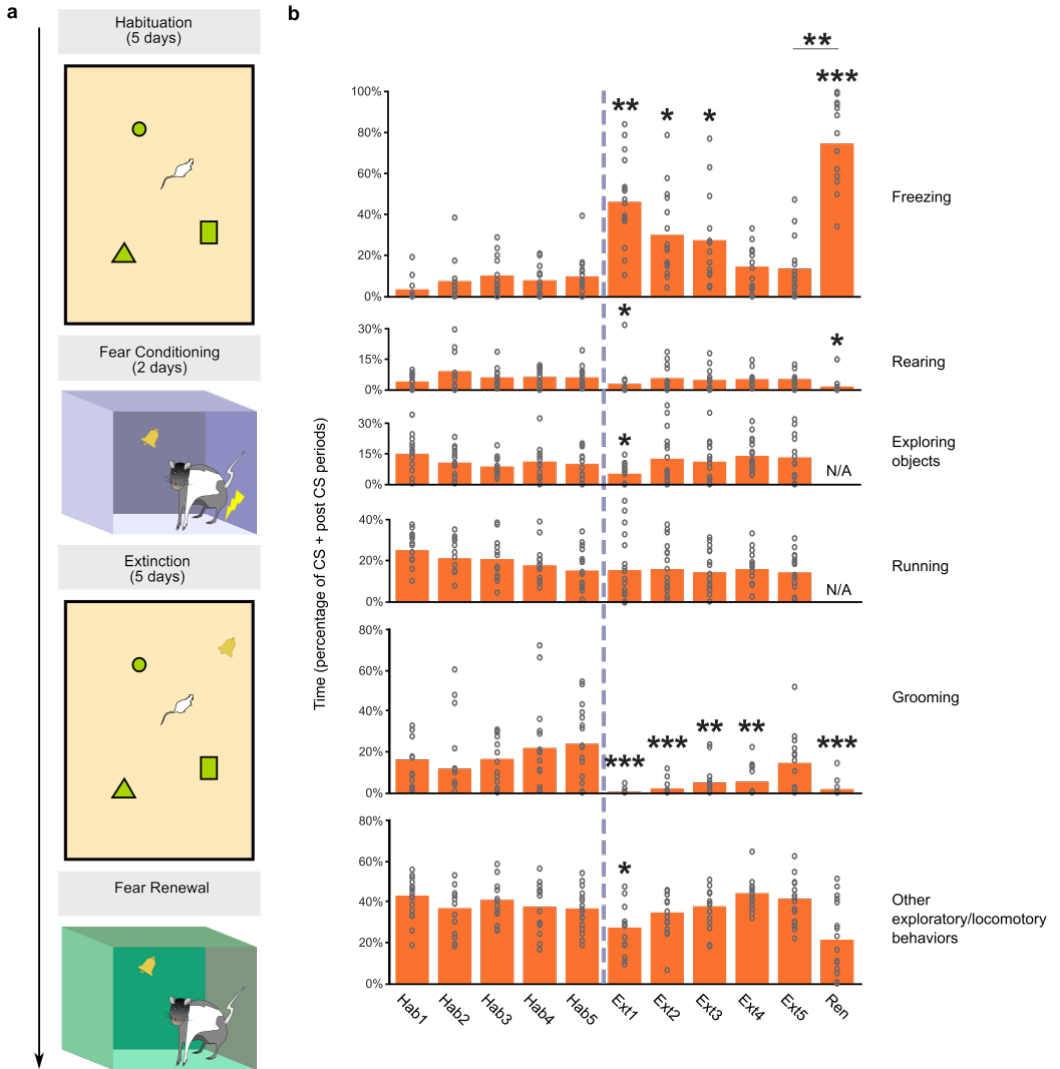

Figure 7.1: ABC fear renewal with extinction training while foraging in an open field. (a) Behavioral protocol. (b) Freezing, rearing, object exploration, running, grooming and other exploratory/locomotory behaviors during the CS and 60 seconds post-CS periods during each session of the protocol. Circles represent individual rats' averages over the three CS. Histograms represent the population means. Stars depict significant differences vs. the average of the five days of habituation. [continued on the following page]

7 Extinction Training In a Large Open Field Reveals Inter-Individual Differences In Conditioned Fear Recovery and Relapse

Figure 7.1: [continued from previous page] The violet vertical dashed line represents the two fear conditioning sessions and two days of cage rest. Statistical tests are unpaired t-tests, Bonferroni corrected for multiple comparisons (* $p < 0.05$, ** $p < 0.01$, *** $p < 0.001$).

Hab = habituation, Ext = extinction, Ren = fear renewal test.

to detect such markers with a protocol involving extinction in a large-scale environment permitting a wider range of behaviors.

Standard fear conditioning paradigms often limit behavioral measurements to ‘freezing’ and ‘not freezing’. Detailed monitoring of behavior beyond freezing is critical but remains a major challenge (Krakauer et al. 2017). To this end, typically, trained experimenters manually score behavior from video replays, but this is time consuming and thus sub-samples of the data are often taken. The number of behaviors that an experimenter can score simultaneously during a given replay is also limited. To improve accuracy and precision, automated methods of behavioral scoring have emerged in the past decade. In particular, inertial measurement units (IMUs) that record linear accelerations and angular speed in three dimensions have been successfully used in the analysis of animal behavior (Dugué et al. 2017; Meyer et al. 2018; Venkatraman et al. 2010). Hence here we use a recently developed wireless inertial sensor device adapted to freely-moving rodents to measure head movements (Pasquet et al. 2016). We apply this here, in combination with video position data, for automated classification of behavior.

7.2 Results

Eighteen rats were subjected to a behavioral protocol involving auditory fear conditioning, extinction training, and context-dependent fear renewal (Figure 7.1a). Extinction training took place in large open fields ($\sim 4 \text{ m}^2$), enriched in tactile and both proximal and distal visual cues, with three large objects and scattered food pellets released from overhead dispensers. The animals were habituated to the open field and foraged freely in it before conditioning. Fear conditioning and renewal took place in two typical rodent testing chambers. We developed an automated scoring pipeline which categorized behavior in six classes: freezing, rearing, grooming, objects exploration, running, and, finally, ‘other’, that is all other locomotor and exploratory behaviors. Pilot analyses revealed running episodes during CS presentation, characterized by high speeds and long straight trajectories (see *Methods* and Supplementary Figure 7.7). This contrasted with the locomotor patterns associated with foraging, where the animals moved about at low to medium speeds in variable directions (considered as ‘other’).

During the 5 days of habituation to the open field, the rats spent less than 10%

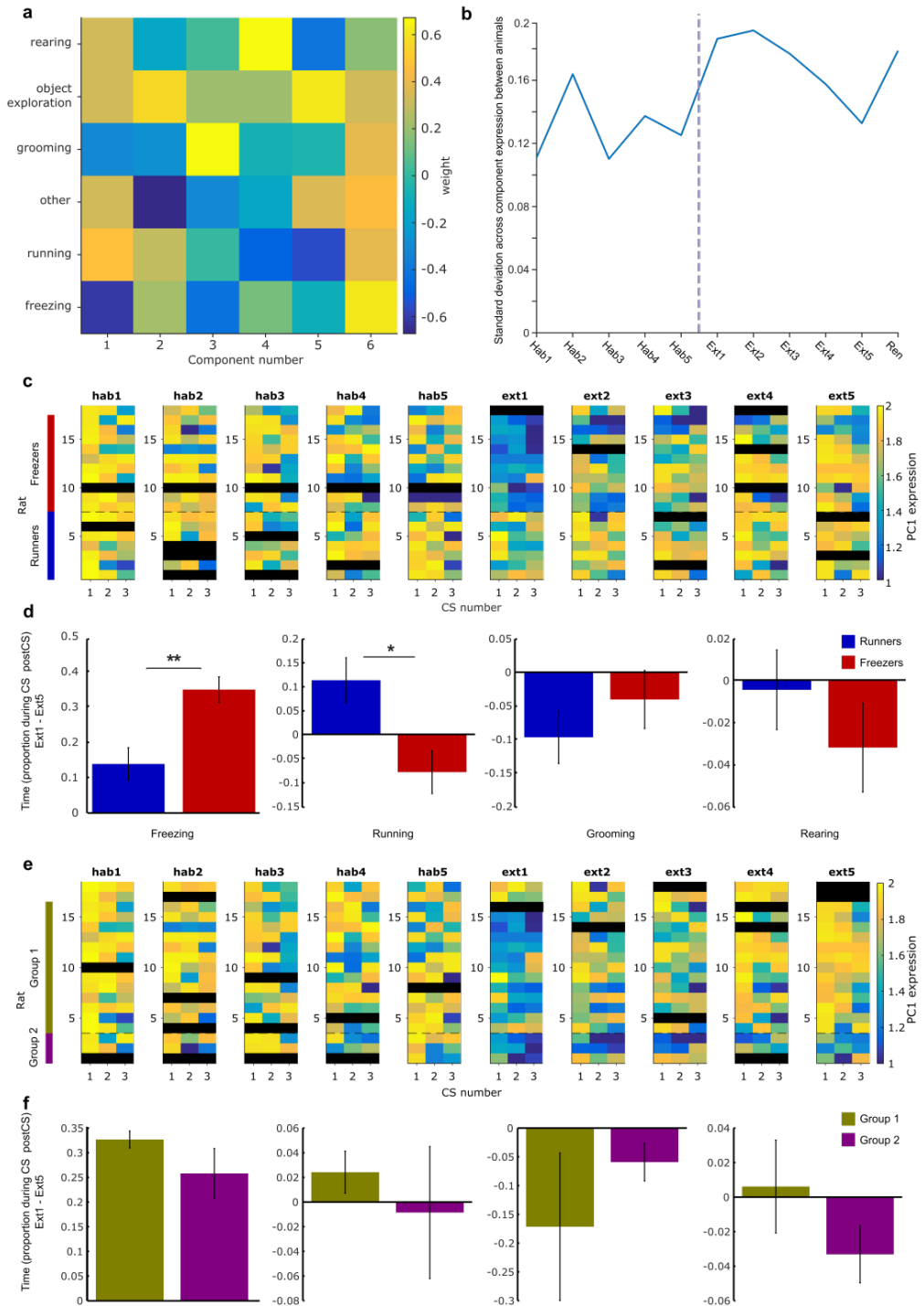

7 Extinction Training In a Large Open Field Reveals Inter-Individual Differences In Conditioned Fear Recovery and Relapse

Figure 7.2: Distinguishing behavioral phenotype categories based on behavioral responses to the CS after fear conditioning. (a) Participation of the six behavioral categories in the PCA components. Running and freezing were the strongest contributors to the first component (PC1). (b) Standard deviation of PC1 across animals, computed for each day for the whole sessions. The violet vertical dashed line represents the fear conditioning and rest days. (c) Evolution of PC1 values during the three CS periods (clustering performed on Ext1). Each row corresponds to one rat. The scale is the same as in a, but the colors represent the average expression of PC1 for the respective CS presentations. The horizontal dashed line between rats 7 and 8 marks the border separating the two groups derived from the k-means clustering with the data of Ext1. (d) Inter-group comparisons of the changes in the behaviors over extinction (levels at Ext1 minus Ext5) for the two groups (PCA on Ext1). (e) Same values as c but rows reorganized according to the control clustering computed on Ext5 data. The horizontal dashed line between rats 3 and 4 marks the border separating the two groups derived from the k-means clustering. (f) Same as d but with the control clustering on Ext5. None of the behavior changes over time were significantly different between these two groups. Data is represented as mean \pm SEM. Statistics are unpaired t-tests (* $p < 0.05$, ** $p < 0.01$, *** $p < 0.001$).

of the time freezing (mean $8.2 \pm 6.5\%$) and spent over 50% of the time running or in exploratory behaviors (Figure 7.1b). Following auditory fear conditioning, freezing responses during fear extinction training in the open field were initially significantly higher than during habituation but after three days were no longer significantly different (Figure 7.1b), demonstrating successful extinction learning. The proportion of time rats spent grooming, rearing, exploring objects and performing other behaviors was also affected by conditioning and was significantly lower in early extinction compared to habituation. However, after 1 to 4 days of extinction training the proportions of time spent performing these behaviors were no longer significantly different from mean habituation levels. Despite successful extinction, a strong fear renewal effect was obtained when the CS was presented again to the animals in a small chamber. During the renewal test, freezing increased while grooming and rearing decreased.

Interindividual differences in fear responses during extinction learning

The goal here was to characterize inter-individual behavioral differences after an aversive experience. Thus the analyses aimed at phenotyping fear behavior that have emerged after conditioning. During the first extinction session, there was a high variability among animals in the CS-evoked proportions of time spent freezing and running (Figure 7.1b). These two behaviors were dominant and occurred over 50% of the time. To investigate behavioral patterns that might underlie this inter-individual variability, principal component analysis (PCA) was performed on the six-dimensional matrix describing the amount of time spent performing the six behavior types over all extinction sessions. The main contributors to the first principal component (PC1) were freezing and running, with opposite signs (Figure 7.2a). Moreover, the variability over

all animals of the expression of PC1 was greatest on Ext1 and Ext2 (Figure 7.2b). To distinguish individual behavioral profiles, the average expression of PC1 during each CS presentation in Ext1 of each animal were subjected to an unsupervised clustering algorithm (see *Methods*). This assigned the animals to two groups (see *Methods*, Figure 7.2c), that principally differed in the changes over extinction (Figure 7.2d and Figure 7.3b) and incidence at early extinction days of CS-evoked freezing and running behavior (Figure 7.3a). There was a negative correlation between the proportion of freezing and running among animals and the two groups formed clusters (Figure 7.3d). For simplicity, animals from these groups will be colloquially referred to as ‘Freezers’ and ‘Runners’, respectively. As a control, the clustering algorithm was used on PC1 values from Ext5 and this did not lead to groups with significant differences in behavior over time (Figure 7.2e-f).

There are some tendencies for freezers to groom, rear, and explore objects less than runners following the CS presentations during early extinction (Supplementary Figure 7.5). Furthermore, these differences were specifically elicited by the CS as they were not detected when the entire sessions were taken into account (data not shown). As expected, over extinction, the proportion of time spent freezing in response to the CS decreased over time in both groups (Figure 7.3b) but significantly more in freezers through extinction sessions (Figure 7.2d). Similarly, running decreased over extinction sessions in runners (Figure 7.2d and 7.3b). Visual inspection of videos showed that the running behavior bore some resemblance to defensive responses such as escape or flight. Interestingly, the CS presentation triggered speed increases in runners while, as expected, average speed for freezers went below baseline levels (Figure 7.3c). Running trajectories appeared to start and end at parts of the open field that could be considered safer, that is, the walls and the objects (which the rats could nest above or hide beside; Supplementary Figure 7.7e). Taken together, these data support the notion that running episodes evoked by the CS among the runners could correspond to defensive responses not observable in fear conditioning chambers, but expressed in the open field by a subpopulation of animals.

Generalization of contextual fear might have accounted for the inter-group differences in behavioral responses to the CS during extinction stages. To test this, we measured the amount of time the animals spent freezing during the first 3 minutes of the first extinction session prior to CS presentation. Freezing levels were low and were not significantly different between groups (Supplementary Figure 7.6a). Consistent with this, during the baseline recordings prior to the first CS of the first extinction session, there was no significant difference between groups in the distance travelled (Supplementary Figure 7.6b), suggesting similar basal anxiety levels in the open field between groups. Another possible factor that may have contributed to the Ext1 inter-group differences, averaged across multiple CSs, would be differences in within-day extinction learning rate. However, the difference of both freezing and running

7 Extinction Training In a Large Open Field Reveals Inter-Individual Differences In Conditioned Fear Recovery and Relapse

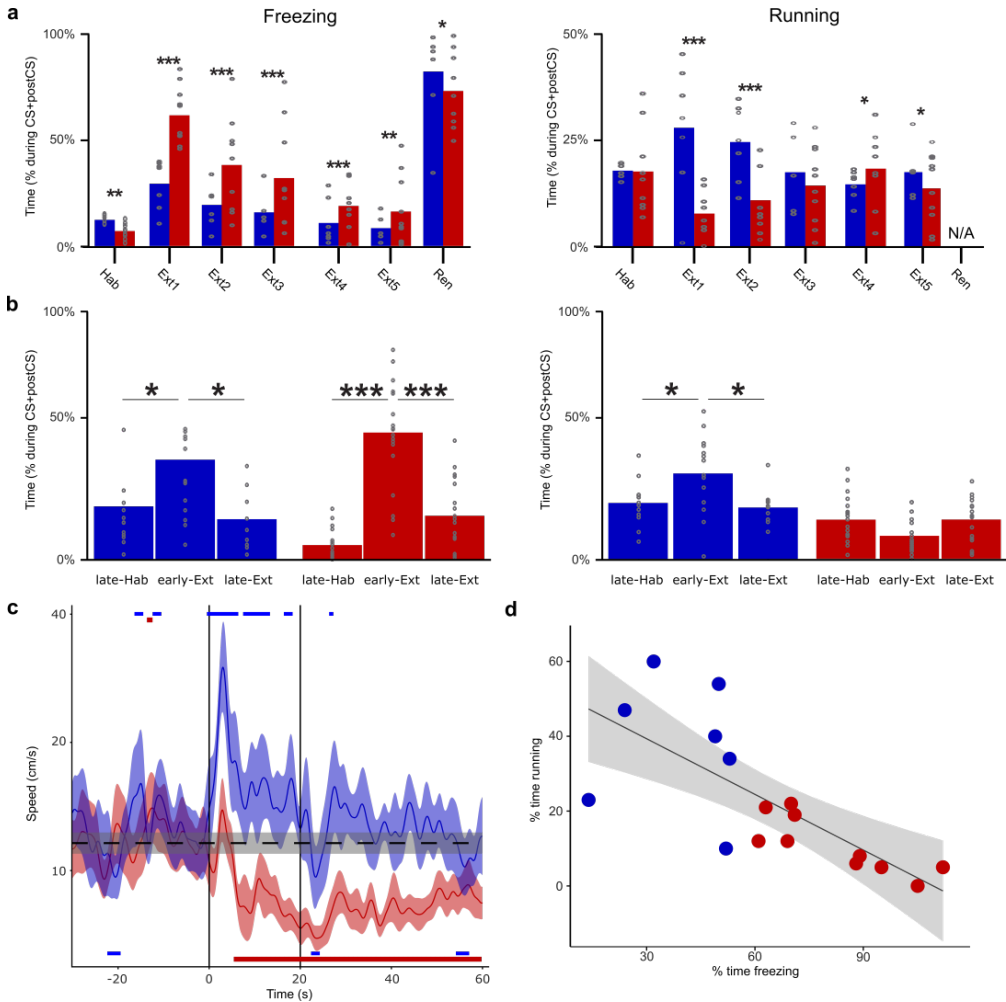

Figure 7.3: Behavioral profiles segregate in Freezers and Runners phenotypes (a) Comparisons of running vs freezing behaviors between runners (blue) and freezers (red) during each session of the protocol. Gray circles represent individual animals. Histogram bars represent population means. Stars indicate significant differences between runners and freezers (b) Same as a but with pooled data to compare learning stages: late-Hab is Hab4 and Hab5, early-Ext is Ext1 and Ext2, late-Ext is Ext4 and Ext5. Stars indicate significant differences. Gray dots represent individual data points. (c) Average speed of the animals (all runners vs all freezers) around the CS onsets on Ext1 (\pm SEM represented by the shaded areas). The horizontal dashed line represents the average baseline speed for all animals (\pm SEM, gray shaded area). Horizontal thick lines (runners in blue, freezers in red) represent the 1 s bins where the traces are significantly different from baseline (unpaired t-test). [continued on the following page]

Figure 7.3: [continued from previous page] The lines are plotted above the speed trace whenever the values are significantly above baseline and below it when lower. (d) Regression analysis of running vs. freezing during the CS and post-CS period in ext1. The average values are represented for each animal. The black line represents the result of the linear regression model (slope = -0.42, adjusted $r^2 = 0.42$, $p < 0.001$). Gray area represents the 95% confidence interval. Data are represented as mean \pm SEM. Statistical tests are unpaired t-tests Bonferroni corrected for multiple comparisons (* $p < 0.5$, ** $p < 0.01$, *** $p < 0.001$). Hab = habituation, Ext = extinction, Ren = fear renewal test.

levels between the third and the first CS presentation was not significantly different between the two groups (Supplementary Figure 7.6c).

Runners are more vulnerable to fear renewal than freezers

After entry into the fear renewal test chamber, the level of contextual fear was low: freezing averaged only 14.7% in the first three minutes there¹ and there was no significant difference between groups (Figure 7.4b). However, CS presentation elicited robust fear renewal in the form of more CS-triggered freezing compared to the end of extinction (Figure 7.1b). Surprisingly, the CS triggered significantly more freezing in runners than freezers (Figure 7.4a). Indeed, the proportion of time spent freezing was positively correlated with the proportion of time running in Ext1 (Figure 7.4d) and the data from the respective groups appear as clusterized. Learning rates during the renewal test, measured by the difference of freezing levels during the third CS presentation compared to the first one, were not different between the freezers and the runners (Figure 7.4c), and therefore was not a confound influencing these session average differences.

In order to test whether runners' greater susceptibility to fear renewal extended also to another typical defensive behavior, we measured the acoustic startle response to the CS onset with the head-mounted IMU. Consistent with freezing results, startle magnitude was greater in runners than in freezers (Figure 7.4e). Moreover, startle amplitude was positively correlated to the CS-triggered running time on Ext1 (Figure 7.4f) and was negatively correlated to freezing in Ext1 (Figure 7.4g). Therefore, the degree to which CS presentation during Ext1 in a large open field triggers freezing vs running predicts more defensive behavior to the CS presentation when confined in a small chamber resembling the initial conditioning context. Namely, animals with a low freezing phenotype in the open field are those that will display stronger fear during a fear renewal test in a small chamber.

¹Although contextual fear was high in the renewal chamber compared to the open field where it was almost zero, this value is low in absolute terms for contextual fear in a traditional conditioning chamber.

7 Extinction Training In a Large Open Field Reveals Inter-Individual Differences In Conditioned Fear Recovery and Relapse

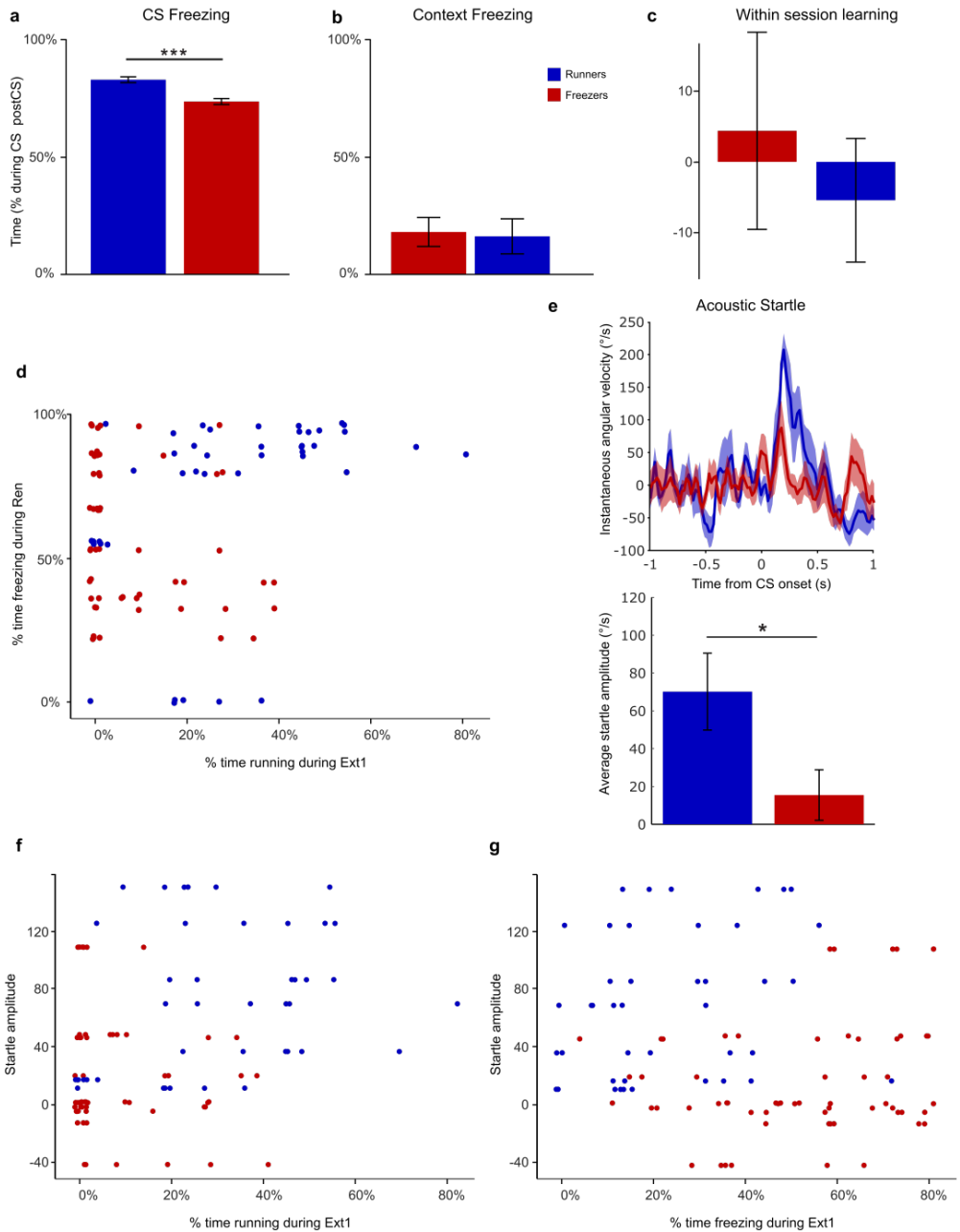

Figure 7.4: Runners express more fear renewal than freezers. (a) Percentage of time spent freezing during the CS period in the Ren session (note that here all CSs are taken into account while in Figure 7.3a only data of the first CS is shown). [continued on the following page]

Figure 7.4: [continued from previous page] **(b)** Percentage of time rat spent freezing in the renewal chamber prior to CS probe presentations. There was no significant inter-group difference in these low levels of freezing. **(c)** Evolution of CS-triggered freezing expression in this session (difference in responses during third and the first CS periods). There was no significant inter-group difference ($p > 0.05$) **(d)** The proportion of time freezing during the first CS period is positively correlated to the amount of time the animals spent running during the three CS periods in Ext1 ($r = 0.27$, $p < 0.01$, Spearman rank correlation). Each point represents a single CS or a single post-CS period. **(e)** Acoustic startle responses during Ren. Top, normalized mean angular velocity (\pm SEM, shaded area) at the onset of the first CS presentation. Bottom, average acoustic startle amplitude for the first 500ms following the presentation of the first CS in the renewal test. The startle response was significantly stronger in runners than in freezers. **(f)** Same as d but for acoustic startle amplitude ($r = 0.42$, $p < 0.001$, Spearman rank correlation). **(g)** Same as f but for time spent freezing in Ext1 ($r = -0.22$, $p < 0.05$, Spearman rank correlation). Data is represented as mean \pm SEM. Unless otherwise specified, all statistics are from unpaired t-tests (* $p < 0.05$, ** $p < 0.01$, *** $p < 0.001$).

7.3 Discussion

Here, we establish a new paradigm of fear extinction and renewal that tested mildly food-deprived rats in a semi-naturalistic environment (a large rectangular open field containing objects and scattered food) where they could display a large spectrum of behaviors including grooming, freezing and a variety of locomotor responses activity not possible in conventional conditioning chambers. We developed a completely automated analysis pipeline processing video and IMU data to score behavioral responses to CS presentation. This revealed two distinct response profiles: some animals that tended to freeze in response to CS presentation during extinction training, while others engaged more in running behavior. Interestingly, animals with these respective tendencies showed different levels of fear renewal.

Studying a wide spectrum of behaviors allows isolation of behavioral phenotypes

Measuring freezing behavior in rodents in small conditioning chambers has dramatically increased our understanding of the neurobiological bases of fear and emotional processing. However, both humans and rodents can express multiple defensive behaviors in response to a perceived threat, such as freezing, fleeing, or attacking (LeDoux and Daw 2018; Fanselow 2018a). To improve the translation of findings from experiments with animal models to the clinic, one approach is to develop more naturalistic experiments that allow distinguishing inter-individual responses as well as the expression and measure of an enlarged possibility of behaviors (Headley et al. 2019; Mobbs and Kim 2015; Paré and Quirk 2017). The present protocol allowed animals to express this variability of responses and our results support this approach. Indeed, the quantification

7 Extinction Training In a Large Open Field Reveals Inter-Individual Differences In Conditioned Fear Recovery and Relapse

of multiple behaviors revealed that individuals can display different behavioral profiles during extinction training in response to the CS presentation in the open field after conditioning. One of the behavioral phenotypes that we identified was characterised by CS-evoked running responses. Running behavior can only be expressed by animals if they have enough space to run and is of value if the environment has some areas better protected than others, which is not the case in conventional conditioning chambers. Indeed, the defensive behaviors expressed by animals following the detection of a threat may be modulated by the perceived level of safety of the current environment and, in particular, the physical and psychological distance from the perceived threat (Fanselow 2018b; Blanchard et al. 2003; Bolles and Collier 1976; Choi and Kim 2010; Godsil et al. 2005).

To highlight this, we segregated animals into two groups and observed that this distinguished other behavioral differences including correlation with differences in fear renewal which supports the validity of the above theory. However, while the various scatter plots do separate the two groups fairly well, they do not yield two clusters. Thus there may be yet other response profiles that could be revealed by further development of this protocol and analysis. Indeed, adding autonomic measures such as heart and breathing rate may provide improvements in grouping the animals. Larger experimental groups may facilitate an increased precision of the clustering process. Alternatively, animals may fall on a continuum, for which the groups ‘runners’ and ‘freezers’ highlight the extremities. Nevertheless, it appears clear that some rats were more prone to running behavior when they hear the CS while other are prompted to freeze.

Where does running map on the fear continuum?

Running behavior could be interpreted either as a defensive response or as an expression of locomotor behavior by a less frightened rat performing behaviors other than freezing. Since running was triggered by the CS onset and no differences in running were present between groups outside the CS, running behavior does not appear to be the marker of behavioral phenotypes with different general anxiety levels. We showed that running is a conditioned CS-evoked defensive behavior: 1) Running bouts had the tendency to start and end in safer spots of the environment; 2) CS-evoked running responses decreased with extinction training; 3) an inverse correlation between time spent freezing vs. time spent running appeared only during the CSs. What is unclear is whether running behavior might be assimilated to escape responses and where it would map onto the continuum of emotional fear states.

One possibility is that since the transition from freezing to flight responses may depend upon the proximity of the threat (Fanselow 2018b; Fanselow 2018a), it is possible that the configuration and characteristics of our open field fortuitously fall in this transition zone, permitting both types of responses de-

pending on the individual. Further work could investigate how changes in the physical characteristics of and the task in the open field might lead to more freezing or running. Optimally, a configuration that yielded 50% runners/50% freezers would facilitate studies of the neuroanatomical, neurophysiological and pharmacological basis of this behavioral phenotype correlated with level of fear renewal.

An alternative interpretation is that running in the open field, even being CS-evoked and likely a defensive response, is a marker of lower fear levels than freezing. Therefore runners are less frightened than freezers during extinction in the open field and this lower fear expression may indicate lower attention levels to the CS presentation and therefore poorer extinction learning than freezers. Lower extinction learning would also explain why runners are more vulnerable to fear renewal. The fact that within-session extinction learning rates are not different between freezers and runners suggest to exclude this interpretation. Nevertheless, extinction learning efficacy may rely also on post training consolidation mechanisms and therefore not be reflected by within session learning rates.

Freezing as an index of fear does not transfer linearly across contexts

Regardless of running being a marker of higher or lower fear levels compared to freezing, a remarkable finding here is the notion that individuals showing less freezing in a given context (extinction in the open field) are those showing more freezing in another. This is consistent with the notion that freezing appears to have a complex relationship to anxiety, stress and fear levels. Indeed, patients suffering from PTSD show reduced threat-induced freezing and this might be linked to impaired risk assessment, cognitive distortions and to hypersensitivity to potential threatening stimuli (Adenauer et al. 2010; Fragkaki et al. 2017). This ties in with the hypothesis that runners may represent the most anxious phenotype in the emotional state continuum.

Dopfel et al. (2019) recently observed that rats with lower freezing during predator scent exposure show more avoidance of the predator scent and higher persistent anxiety levels. Similarly, a study recently showed in female rats that darted (moved swiftly and suddenly) during fear conditioning exhibited lower freezing during a second day of extinction testing compared to rats that immediately froze (Gruene et al. 2015). Although this was interpreted to indicate that such active fear response strategies may improve extinction learning maintenance, as discussed above, it is not possible to exclude that darting and running represent less frightened behavior. Overall, our results extend these findings. With the behavioral profiling of the individuals with multiple behaviors, we identified a predictor of future behavioral responses in a different context with different contingencies.

More naturalistic protocols to study inter-individual differences in the efficacy of treatments for anxiety and trauma-related disorders

This study opens a new path to the development of interesting alternatives to classical fear extinction protocols for translational research on interindividual differences in the renewal of fear. Although here both groups expressed a high renewal rate and no resilient phenotype emerged, further adaptation of the protocol (e.g., extinction in a wider variety of environments, or renewal in a chamber less similar to the original conditioning chamber, or in an environment permitting a wider variety of behaviors) may allow this in the future.

The automated nature of our behavioral scoring protocol allows fast and reliable analysis permitting future developments and exploitation for testing new pharmacological therapies for anxiety disorders. Epigenetic, neuroanatomical, and neurophysiological correlates of vulnerability and resilience to fear relapse could also be further explored using this new approach. For instance, the identification of the neurobiological bases of the tendency for running vs. freezing, could be used to decide on alternative treatment protocols to exposure based therapies.

7.4 Methods

Animals 18 adult male Long-Evans rats (260-340 g at the time of surgery, 2-4 months old), were housed in groups of 4 or 5 in large, environmentally-enriched, clear plastic cages (80x60x40cm) before surgery. They were maintained at 21°C in a well-ventilated room with a light/dark cycle of 12h/12h and free access to food and water. Upon arrival in the lab the animals were allowed at least 3 days of acclimation before being handled daily by the experimenter for at least 5 days prior to surgery. All the experimental procedures were performed in accordance with institutional guidelines and the French national and European laws and policies and were approved by the Paris Descartes University Ethics Committee.

Surgical implantation of a magnetic base for the IMU The IMU was magnetically affixed to the animals' heads during the experiments. A pair of neodymium disk magnets (S-06-03-N, Supermagnete.com) was glued to the bottom face of the IMU, and another pair was cemented to the skull of the animals with a surgical procedure as described in (Pasquet et al. 2016). Briefly, rats were anesthetized with an intraperitoneal injection of a mixture of ketamine (Imalgene, 180 mg/kg) and xylazine (Rompun, 10 mg/kg). Analgesia was assured by subcutaneous injection of buprenorphine (Buprecaire, 0.025 mg/kg). The rats were placed in a stereotaxic frame (Narishige, Japan) and the surgical area was disinfected with povidone-iodine and 70% ethanol. The

skull was exposed and gently scraped and 3% hydrogen peroxide solution was applied. Burr holes were drilled (two in the frontal bone, five in the parietal bones, and one in the occipital bone) and miniature stainless steel screws (Phymep, France) were attached. Self-curing dental adhesive (Super-Bond C&B, Sun Medical) was deposited on the skull. A pair of disk neodymium magnets were glued to a glass/epoxy sheet and was fixed above the screws using self-curing acrylic resin (UNIFAST trad, GC Dental Products Corp.). The skin ridges were sutured in front and at the rear of the implant and the rats were allowed to recover in their home cage for one week. Then rats were placed under mild food restriction ($\bar{17}$ g/day, adjusted to allow for a 15 g weight gain per week until reaching 400 g, and then to keep this weight) to ensure proper motivation for foraging during the sessions in the open field and then were housed individually in standard large cages (58x38x20 cm).

Behavioral apparatus The behavioral protocol (Figure 1A) employed three different environments: two standard fear conditioning chambers (A and C) and one open field maze that could assume two different configurations (B and B'). A was a transparent plexiglass box (37 x 45 x 37 cm, DxHxW) placed in a noise attenuating cubicle (MedAssociates, USA). The floor consisted of 25 stainless steel rods (0.6 cm in diameter) connected to a constant-current scrambled shock generator (ENV-414, Med Associates, USA). C was a custom built PVC cubicle (40 x 40 x 40 cm) of dimensions similar to A, but with gray walls and a solid black floor. The open fields B and B' were 250 x 150 cm with 70 cm high walls. While walls and floor were composed respectively of PVC and sheets of rubber in both B and B', the two configurations were different with respect to surface textures, distal cues visible in the room, and the identities of the objects (20x20x20cm each) within the open field. In B and B' food pellets (20 mg, MLabRodent Tablet, TestDiet) were released from two ceiling-mounted automatic distributors (Camden Instruments, UK) every 20-40 seconds in each session to motivate mobility. The conditioning and fear renewal test chambers were located in different rooms on different floors of the same building.

In all environments, behavior was recorded from side-mounted cameras. In A and C, video was captured with a camcorder (Sony Handycam HDR-CX280) and, in B and B', with 4 video cameras (Basler Aca 2500-60) synchronized with Streampix 6 (Norpix, Canada). In B and B', video was also recorded at 30 Hz above the open fields with a webcam (Logitech C920) that tracked the position of red LEDs mounted on the IMU with Dacqtrack software (Axona, UK). Auditory cues (CS) were 20 s continuous pure tones at 2 kHz (62-68 dB) controlled by a Power1401 interface (CED, UK). This interface also controlled a flashing LED (invisible to the animals) that helped synchronize position data acquisition.

7 Extinction Training In a Large Open Field Reveals Inter-Individual Differences In Conditioned Fear Recovery and Relapse

Inertial signals acquisition The inertial measurement unit (IMU) is a small (19x13x13 mm) and lightweight (6 g) device (Pasquet et al. 2016). It contains accelerometers and gyroscopes that sample linear acceleration and angular velocity in three dimensions. The IMU employs Bluetooth wireless communication and the synchronization was assured by an infrared (IR) antenna that captured IR pulses emitted regularly at 0.5 Hz and recorded along with inertial data by the IMU. Sensitivity of the IMU were set to its maximum (± 2 g and ± 250 °/s) and the sampling rate was 300 Hz.

Behavioral protocol After the recovery from surgery the animals underwent a 14 days ABC fear renewal protocol (Figure 7.1a; Bouton 2004). Each day the rat had one training/testing session.

Habituation. On days 1 through 5, animals were habituated to the two configurations of the open field during 26 min sessions of free exploration and foraging. Animals underwent 3 sessions in B and 2 in B'.

Fear conditioning. On days 6 and 7, rats underwent two fear conditioning sessions in A, each composed of a 10 minute baseline recording followed by five presentations of the CS co-terminating with a footshock (1 s; 0.7 mA) at 10 minute intervals. Rats were then left in their cages for days 8 and 9.

Extinction. On days 10 to 13, rats underwent extinction training in the open fields. Half of the animals underwent extinction in B and the others in B'. Each session consisted of a 6-minute baseline recording followed by three presentations of the CS at intervals of 6 minutes. On day 14, the last day of extinction, half of the animals in B were switched to B' and vice versa. No difference in any of the behavioral measures was observed among the animals who switched configuration on day 14 and those that did not, their data were pooled.

Fear renewal test. On day 15, all rats underwent a fear renewal test in C. There the three CS were presented as in the extinction sessions.

IMU data processing Gyroscope and accelerometer signals were decomposed with wavelet transforms with the WaveletComp package in R. This yielded the signal power for 3 Hz wide bands from 0.1 to 9 Hz. The head orientations were computed via low-pass filtering of all of the accelerometer signals (Pasquet et al., 2016). A second-order Butterworth filter with a cut-off frequency of 2 Hz approximated gravity components.

Automatic scoring of behavior All of the behavioral data presented in the Figures result from this automated scoring pipeline.

Freezing. Freezing was detected as shown previously (Pasquet et al., 2016). Briefly, we computed the angular speed for every IMU data frame using the signals from the gyroscopes. Freezing was defined as each continuous period when the angular speed was under 12° /s for at least 200 ms.

Object exploration Exploration of the three objects in the open fields was estimated by the amount of time the animals spent within 5 cm around the objects normalized by the size of the concerned area.

Running. LED position data was smoothed with a 300ms gaussian window. Running periods were defined as intervals in which the animal moved at least 15 cm without changing direction (angular speed inferior to 3° in bins of 50 ms). For each animal a minimum speed was defined as the intersection of the two normal curves fitted using a Gaussian mixture model to the bimodal distribution of their speed over the whole habituation and extinction sessions (Supplementary Figure 7.7).

Startle response quantification. The amplitude of the acoustic startle response to the CS was calculated by taking the average of the angular speed during the first 500 ms following the onset of CS presentations.

Grooming and Rearing. A supervised learning algorithm scored grooming and rearing. The training and test sets were derived from 98 minutes of video recordings from two extinction sessions for each of three animals. To create the training and test data sets, an experienced experimenter manually scored behaviors into the following categories: two types of grooming (face and body), rearing, freezing, and running. Grooming was characterized by repetitive motion of the animals' head and forelimbs to its muzzle and whiskers (face grooming) or body (body grooming). Rearing was characterized as when the animal was standing on its hind limbs. A three-layer neural network with a convolutional layer and a fully connected hidden layer was implemented with custom scripts and built-in functions of the parallel computing toolbox in Matlab (Mathworks, USA). The behavioral measures provided to the algorithm included: video-detected head position, accelerometer and gyroscope raw signals smoothed using a zero-phase low-pass filter, and the movement frequency power spectrum as obtained by the wavelet analysis for each gyroscope channel. All signals were down-sampled to 30 Hz. The neural network input dataset was binned in 2 s windows with 200 ms overlap. Therefore, each bin is composed of 60 values for each variable. Bins that were contained in running episodes or were at least 50% composed of freezing or object exploration were removed from the dataset before the neural network analysis to score rearing and grooming. The network was trained on the manually scored behavior, where the behavior associated with each 2 s bin was defined as the behavior that primarily occurred in that bin. The robustness and accuracy of the classification was assessed on the test set by reiterating the training and test process 1000 times. The average accuracy of the classification was 87.7%, consistent with previous reports (Venkatraman et al. 2010). The repeated iterations of the algorithm diverged by 3.8% on average, and the majority of bins (80%) never contained errors. Errors tended to be concentrated in the same 3.9% of bins. Therefore, since the differences between the different iterations fell within chance levels, an iteration was randomly selected to classify the entire dataset.

Other exploratory/locomotory behaviors. All other behaviors were scored as 'other' and included, but were not limited to, behaviors such as stationary activity, slow locomotion, and foraging.

7 Extinction Training In a Large Open Field Reveals Inter-Individual Differences In Conditioned Fear Recovery and Relapse

Clustering of the behavioral phenotypes The behavioral classifications for each time bin were entered into a six dimensional matrix with time series of the respective classified behaviors of all the animals over the course of the protocol. The matrix was smoothed (Gaussian window of 20 s) and its dimensionality was reduced with Principal Component Analysis (PCA) of all the CS and post-CS (60 s) data from the five extinction sessions of all of the animals (Figure 7.2). Then, unsupervised clustering (k-means) separated the animals into two groups using the average values of the first component of the PCA during the three CS presentations of the first extinction session. One animal's data was excluded from this analysis because of missing inertial data points on ext1. As a control, two group k-means clustering was also done for data from the three CS presentations of the last session of extinction. The clustering and all statistical analyses were performed with custom scripts in Matlab.

7.5 Supplementary Figures

[on the following page]

7.5 Supplementary Figures

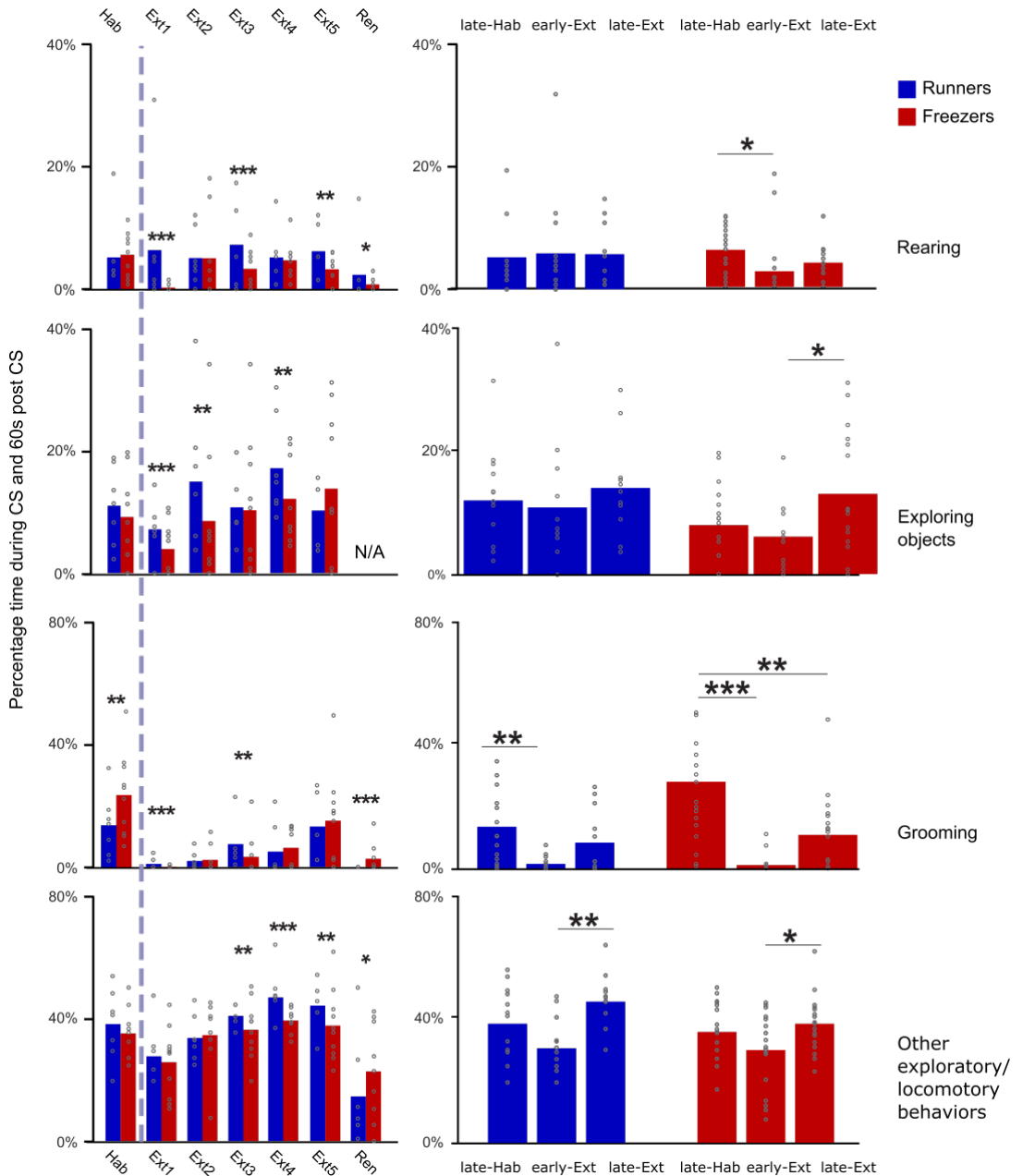

Figure 7.5: Behavioral comparison between runners and freezers (left) Comparisons between Runners (blue) vs Freezers (red) for the four behavioral categories not displayed in Figure 7.3a (from top to bottom) during the three CS and 60 seconds post CS periods for each day of the protocol. [continued on the following page]

7 Extinction Training In a Large Open Field Reveals Inter-Individual Differences In Conditioned Fear Recovery and Relapse

Figure 7.5: [continued from previous page] (**right**) Conditioning- and extinction- induced behavioral changes depicted by the comparisons between Late-Hab (pooling of Hab4 and Hab5), Early-Ext (pooling of Ext1 and Ext2) and Late-ext (pooling of Ext4 and Ext5) blocks. Data is represented as mean \pm SEM with individual data as gray dots. Statistics are unpaired t-tests (* $p < 0.5$, ** $p < 0.01$, *** $p < 0.001$).

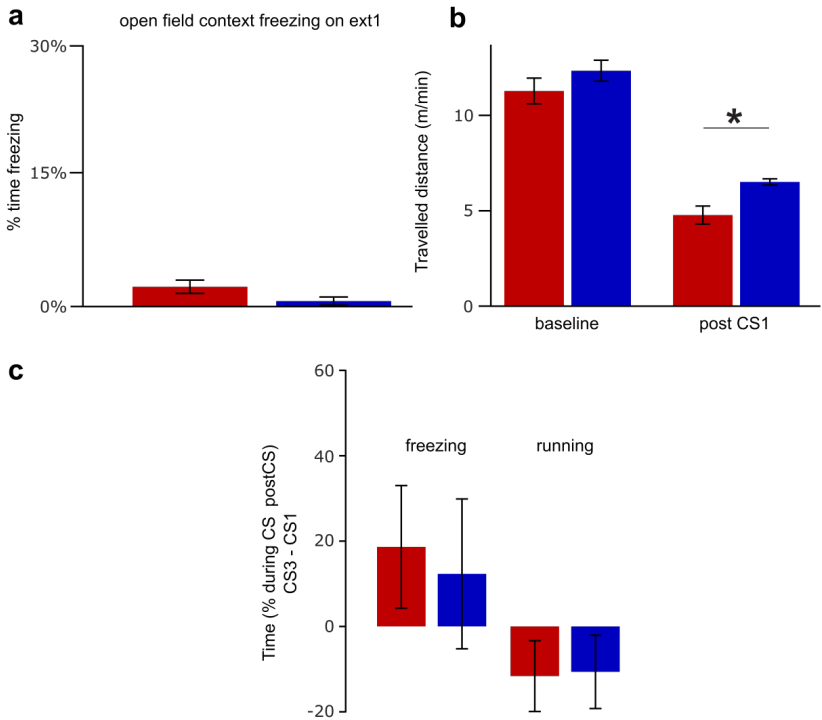

Figure 7.6: Generalization of contextual fear and differences in within-day learning rate cannot be accounted for inter-individual variability during early extinction. (a) Proportion of time the animals spent freezing prior to CS presentation in Ext1. (b) Distance travelled during Ext1. Runners travelled more than freezers after the first CS onset (right) but this was not significant during the baseline period (left). (c) Intergroup differences between CS3 and CS1 for proportion of time spent freezing (left) or running (right). No significant differences. Data are represented as mean \pm SEM. Statistics are unpaired t-tests (* $p < 0.5$, ** $p < 0.01$, *** $p < 0.001$).

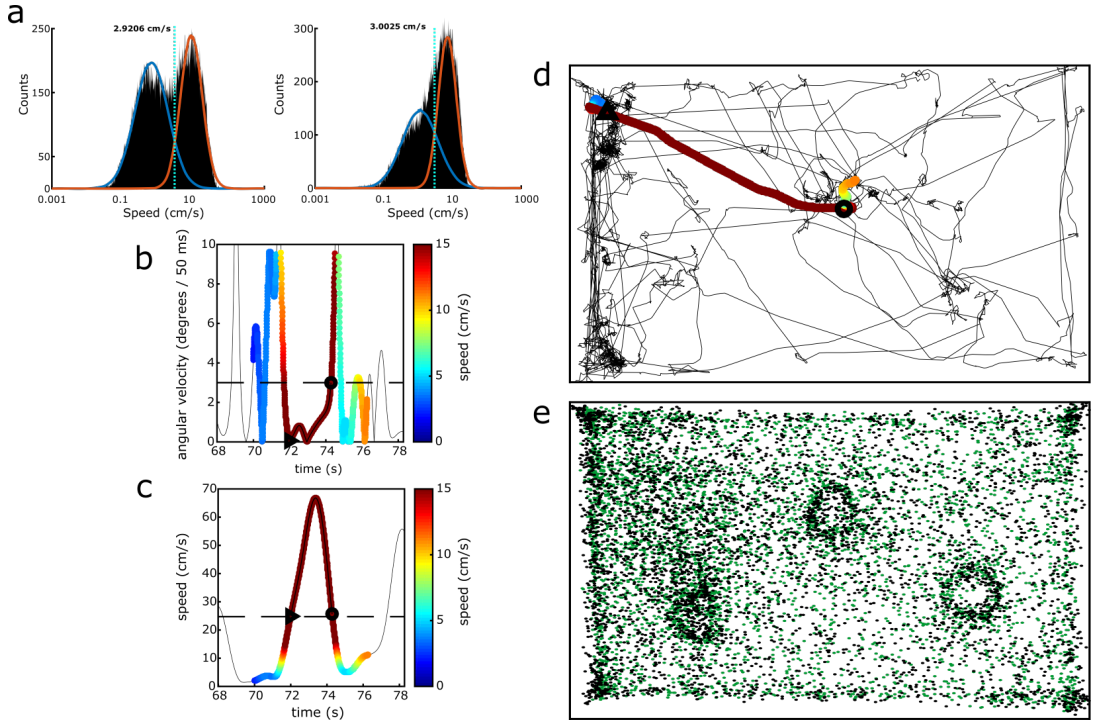

Figure 7.7: Characterization of running episodes in the open field. (a) Representative distributions of speed sampled across all Hab sessions for two rats (left and right). Each distribution was fitted with two normal curves and their intersection (black vertical dashed lines) were taken as the threshold to distinguish running episodes (see *Methods*). (b-d) Example of detection of running episodes. Evolution of angular velocity (b) and speed (c) for each example of a detected running episode (thresholds for running detection (see *Methods*) are indicated by horizontal dashed lines). (d) Overhead view of the open field environment with black traces depicting the trajectories of the animals over a single session. A representative running episode is highlighted with the dark red lines. Colors represent the speed of the animal (see scale in panel b). Black triangle: running start point; black circle: running end point (e) Overhead view of the open field environment with green and black dots respectively representing starting and ending points of detected running episodes for 8 animals in an extinction day. Note the concentration of dots next to the walls and objects.

8 A Scalable Iterative Algorithm to Accurately and Precisely Detect Cell Assemblies

Gabriel Makdah^{a,b}, Sidney I. Wiener^a, Daniel Bennequin^c, Michaël B. Zugaro^a, Marco N. Pompili^{a,d*} & Ralitsa Todorova^{a*}

^a Center for Interdisciplinary Research in Biology (CIRB), Collège de France, CNRS, INSERM, PSL Research University, 11 place Marcelin Berthelot, 75005 Paris, France

^b Hospices Civils de Lyon, Faculté de Médecine Lyon Est, Université Claude Bernard Lyon 1, 8 Avenue Rockefeller, 69008 Lyon, France

^c Equipe Géométrie et Dynamique, UFR de Mathématiques, Université Paris Diderot-Paris VII, 5 rue Thomas Mann, 75013 Paris, France

^d Institute of Psychiatry and Neuroscience of Paris (IPNP), Hôpital Sainte-Anne, INSERM, Université Paris Descartes, 102-108 Rue de la Santé, 75014 Paris, France

* These authors contributed equally to this work

Statement of contributions GM conceived the algorithm with contributions from DB, MBZ, RT, MNP, and SIW. GM, RT, and MNP designed the benchmarking and the refinement of the method, which was carried out by GM. MNP and RT supervised the project. RT, GM, MNP, and SIW wrote the current manuscript.

Acknowledgements We thank Céline Drieu for sharing hippocampal data and Céline Boucly for discussions on ICA. This project was funded with a grant from the Labex MemoLife to MNP and SIW. MNP is also supported by the Université PSL and the Fondation Pierre Deniker.

manuscript in preparation

Abstract Recent advances in simultaneous recordings of multiple neurons have rendered the analyses of population activity increasingly relevant in light of Hebb's prediction of cell assemblies. Several tools have been developed to detect synchronously active assemblies of neurons. Current methods such as PCA and ICA extract patterns of activity from the $m \times m$ neuronal activity correlation matrix. However, when the number of assemblies is large, this can result in combining or failing to detect many neuronal co-activation patterns. Here we present a novel algorithm, Recurrent Pattern Clustering (RPC), which uses the correlation of the $n \times n$ correlation matrix between timebins. The algorithm clusters similar timebins and extracts cell assemblies from the clustered recurring patterns of activity. In simulated datasets

where ICA components represented erroneously combined assemblies (>70% of components), RPC detected assemblies with false positive rates of below 5%. For improved detection of more cell assemblies in a dataset, we developed ICECAP (Iterative Clustering and Elimination of Co-Activation Patterns), a method performing RPC iteratively, setting aside the timebins of detected clusters after each iteration until no significant correlations remain. ICECAP detects over >95% of assemblies in simulated datasets with up to 1000 neurons and 750 assemblies, dramatically outperforming ICA and RPC run in only a single cycle. Finally, ICECAP is demonstrated to retrieve unprecedentedly large numbers of assemblies from electrophysiological data recorded from the prefrontal cortex and the hippocampus in rats. ICECAP should thus facilitate more comprehensive studies of cell assembly activity in the increasingly larger numbers of neurons recorded simultaneously.

8.1 Introduction

Hebb (1949) predicted the existence of cell assemblies - groups of cells that fire together, that can become interconnected during learning. Methodological advances are permitting increases in the number of simultaneously recorded neurons, providing opportunities to identify cell assembly dynamics which may give rise to a wide range of cognitive phenomena (Buzsáki 2004b). While principal and independent component analyses, PCA (Peyrache et al. 2010) and ICA (Lopes-dos-Santos et al. 2013), are widely used to this end (Peyrache et al. 2009; Gulati et al. 2014; Ramanathan et al. 2015; Dejean et al. 2016; Trouche et al. 2016; Ven et al. 2016; Rothschild et al. 2017; Sjulson et al. 2018) in order to study cell assembly formation and reactivation, as well as analyse patterns of neuronal activity in larger datasets, there is an increasing need for methods that can accurately extract assemblies on a larger scale.

In order to detect patterns of synchronous activity of m neurons over n timebins, PCA or ICA extract components from the neurons' $m \times m$ correlation matrix, where components represent co-activation patterns. In theory, the maximum number of patterns that can be detected is limited to m ; in practice, the number of ensembles reaching statistical criteria is much lower (e.g. < 10 assemblies for 50 recorded neurons in Peyrache et al., 2009). Moreover, rather than representing a recurrent activity pattern, a component may merely represent pair correlations in the data even when a group of cells with high weights never actually fire in unison (shown below).

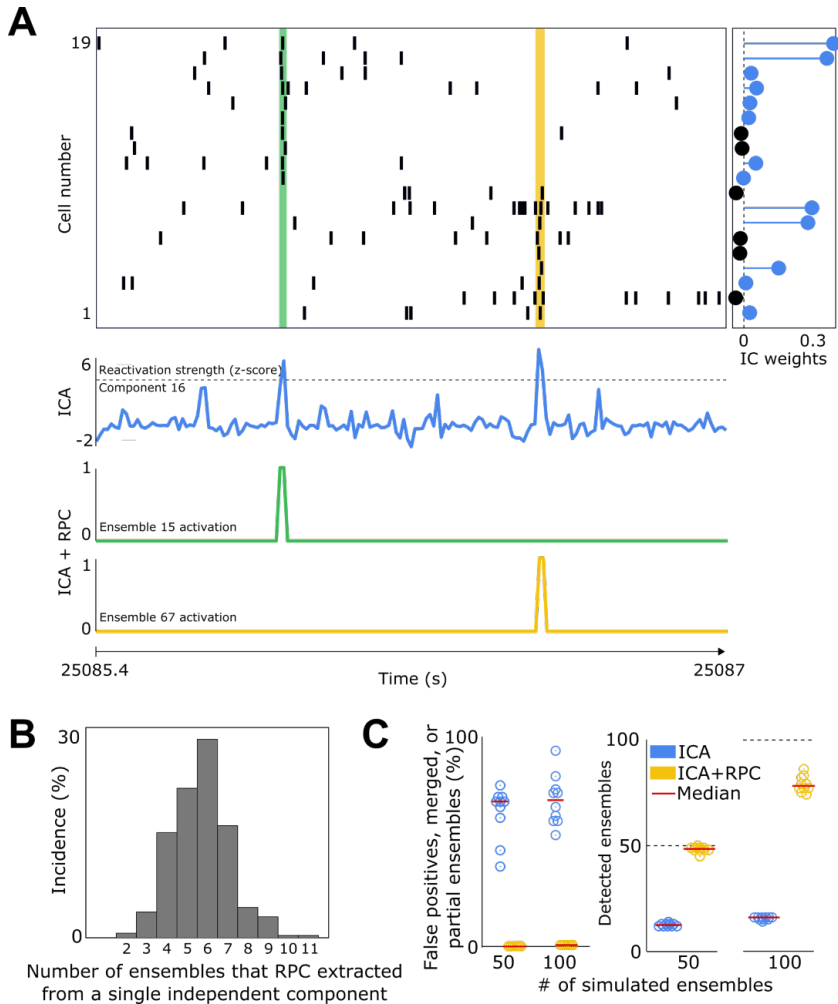

Figure 8.1: Recurrent pattern clustering separates assemblies combined by ICA. (A) Representative example of an ICA component combining two patterns which RPC recognizes. Top: raster plot of the activity of 19 prefrontal cells (out of 189) recorded during sleep. Right: ICA weights for each neuron. Middle: ICA activation strength of this example component. Note that activation strength exceeds the threshold (dashed line) twice with activation of two non-overlapping sub-groups. Bottom: Activations of RPC-detected assemblies. RPC detected the shown patterns as patterns of two distinct assemblies (green, yellow), indicating that RPC can successfully separate assemblies combined in the same ICA component. (B) Distribution of the number of RPC assemblies extracted from a single ICA components. (C) Comparison of performance of ICA and RPC in detecting assemblies of activity in simulated datasets. Dashed lines indicate perfect performance.

To directly detect recurring patterns from recording data and take advantage of the recording time duration (where n is typically multiple orders of magnitude larger than m), we developed RPC (Recurrent Pattern Clustering), a paradigm shift in detecting co-activation patterns. Rather than clustering the m *neurons* into groups of correlated units from data reduced to its $m \times m$ correlation matrix, RPC clusters the n *timebins* (i.e., unit activity vectors) into groups of correlated patterns of activity and then extracts neuronal assemblies from those clusters.

Here we show that RPC, in simulated datasets, can detect distinct patterns of activity that are erroneously combined by ICA and, in real datasets, can split non-overlapping patterns of activity mixed in ICA components. Further, to improve algorithm sensitivity, we developed ICECAP (Iterative Clustering and Elimination of Co-activation Patterns), an algorithm that detects cell assemblies from a dataset iteratively, performing RPC on each cycle to detect patterns combined in ICA components and setting aside all the clustered timebins before the next iteration. This procedure dramatically improves the algorithm's sensitivity, while still benefiting from the low false positive rate of RPC. Finally, we apply ICECAP to experimental recordings in the rat prefrontal cortex and hippocampus to demonstrate substantially greater numbers of assemblies than detected by ICA.

8.2 Results

At the outset of the study, to detect cell assemblies, we performed ICA on a 2-hour recording from 189 cells in the rat prefrontal cortex, and this yielded 24 significant components. However, on close inspection, non-overlapping patterns were attributed to the same component (Figure 8.1A). To detect recurrent patterns of activity free of amalgams of unrelated groups of cells, we developed the Recurrent Pattern Clustering algorithm (RPC). RPC computes the cosine similarity matrix between a set of timebins (unit activity vectors), and then clusters them via k-nearest neighbors, which results in similar patterns being grouped together. RPC then extracts putative cell assemblies from the clustered patterns (Figure 8.2).

Using RPC to directly cluster all the timebins in a single data set would be computationally challenging (a 1.5-hour recording would produce $n > 100,000$ bins of 50 ms, yielding a very large $n \times n$ cosine similarity matrix). Therefore, RPC was performed on a subset of the timebins. While many user-defined selection of timebins could be valid, here the IC activation score was used as the selection criterion. The timebins with highest activation signal for each component were grouped into a selection of timebins to be clustered by RPC. With this method, RPC can effectively distinguish conflated assemblies from a component (Figure 8.1B).

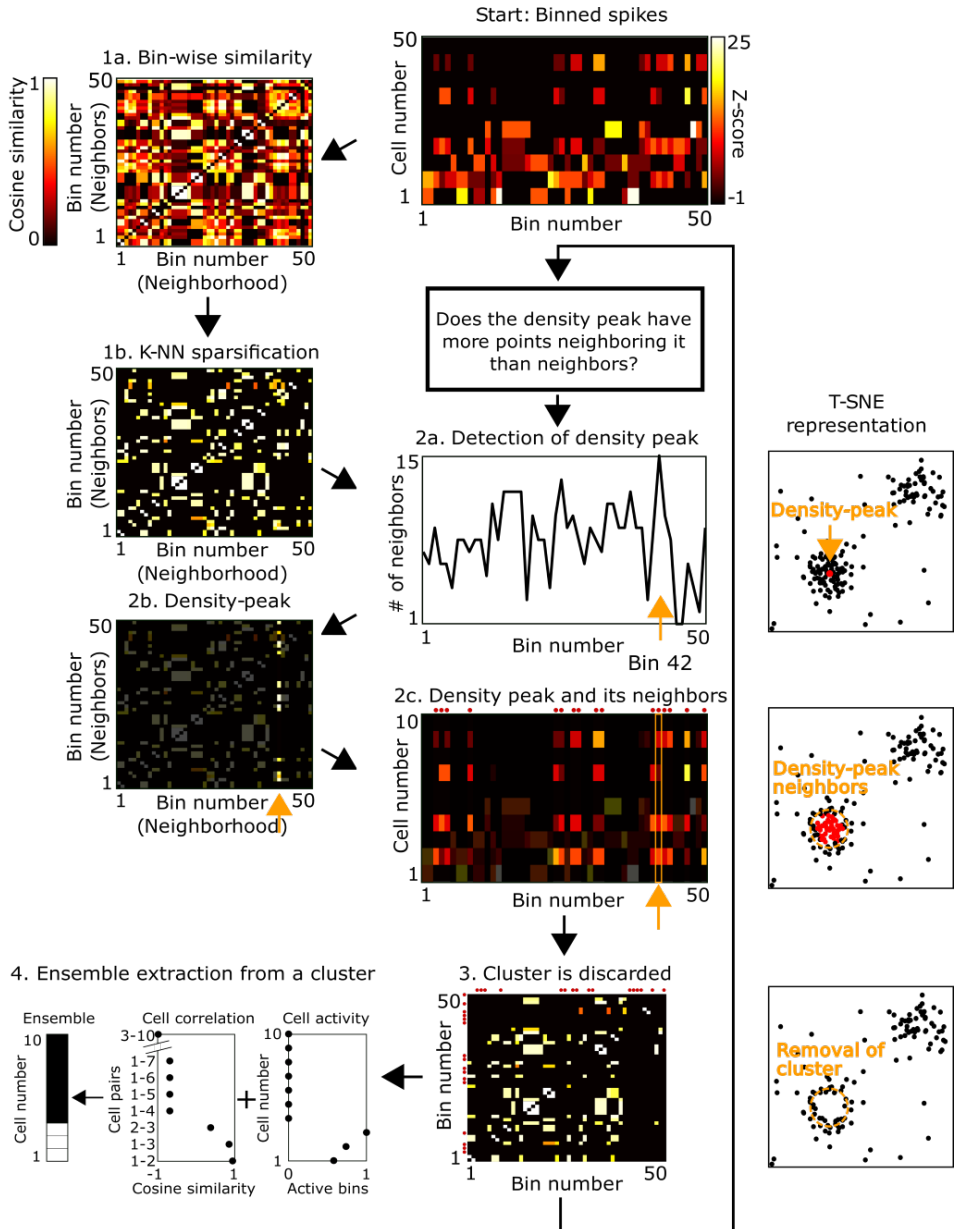

Figure 8.2: Recurrent pattern clustering (RPC) [caption on the following page]

Figure 8.2: Recurrent pattern clustering (RPC). [Figure on previous page] RPC algorithm representation. The algorithm starts with the normalized neuronal activity matrix Z' (top right), from which the cosine similarity matrix C is constructed (1a) and sparsified (1b). The density peak (2a) is defined as the timebin with most points neighboring it – non-zero numbers in column of the sparsified matrix (2b). The density peak and its neighbors comprise a detected cluster (2c). A cluster is defined as the density peak and all the timebins neighboring it. Once detected, the clustered timebins are set aside (3) and the procedure is repeated until no density-peak has more than $k + 1$ points neighboring it. From each cluster, an assembly is extracted only if criteria for cell activity (4, right) and cell correlation (4, middle) are reached, in which case the cells are considered a putative assembly (4, left). Right, T-SNE visual representation of the method steps in which similar timepoints are positioned close together.

We tested RPC on simulated datasets with cell assemblies (Figure 8.1C). The activity of 50 neurons, which were co-activated in assemblies of 3 cells, was simulated with Poisson point processes (see *Methods*). Then the respective performances of ICA and RPC in detecting the original assemblies were compared. Those neurons with component weights exceeding a 4 standard-deviation threshold were considered as an assembly detected by ICA alone. Most ICA components were not composed of a single assembly, but were rather combinations of the simulated assemblies (Figure 8.6). In contrast, virtually all of the RPC-detected assemblies were true positives (Figure 8.1C, left). In the very few cases where an RPC-detected assembly was not identical to one of the original assemblies (i.e., the $< 2\%$ false positives), it was an incomplete version of a single assembly (2 out of the 3 assembly members) rather than a combination of assemblies. This attests to the high specificity of the algorithm.

With regard to sensitivity, RPC performance was very high ($> 97\%$) when the number of simulated assemblies was low but diminished with larger numbers of simulated assemblies (Figure 8.1C, right). The reason for this is that RPC missed the assemblies whose timebins did not exceed the IC activation threshold Supplementary (Figure 8.7A). Moreover, when all assembly activations were taken into account, RPC performance was dramatically improved (Supplementary Figure 8.7B). Thus, for a large number of assemblies, the selection of the bins is critical.

Why were the activations of certain assemblies not selected by ICA activation strength? Note that this non-detect issue is separate from the issue of ICA combining distinct assemblies, which is completely solved by RPC. Due to the probabilistic nature of assembly activations in our simulation (see *Methods*), the incidence of cases when all assembly members were active was not identical across assemblies (Supplementary Figure 8.9A). This characteristic was exploited to show that assemblies with rarer activations were less likely to be detected than ‘stronger’ (i.e. more frequently active) assemblies (Supplementary Figure 8.9B). As a consequence, the activations of less frequent (‘weaker’) assemblies were less likely to be associated with a high IC activation

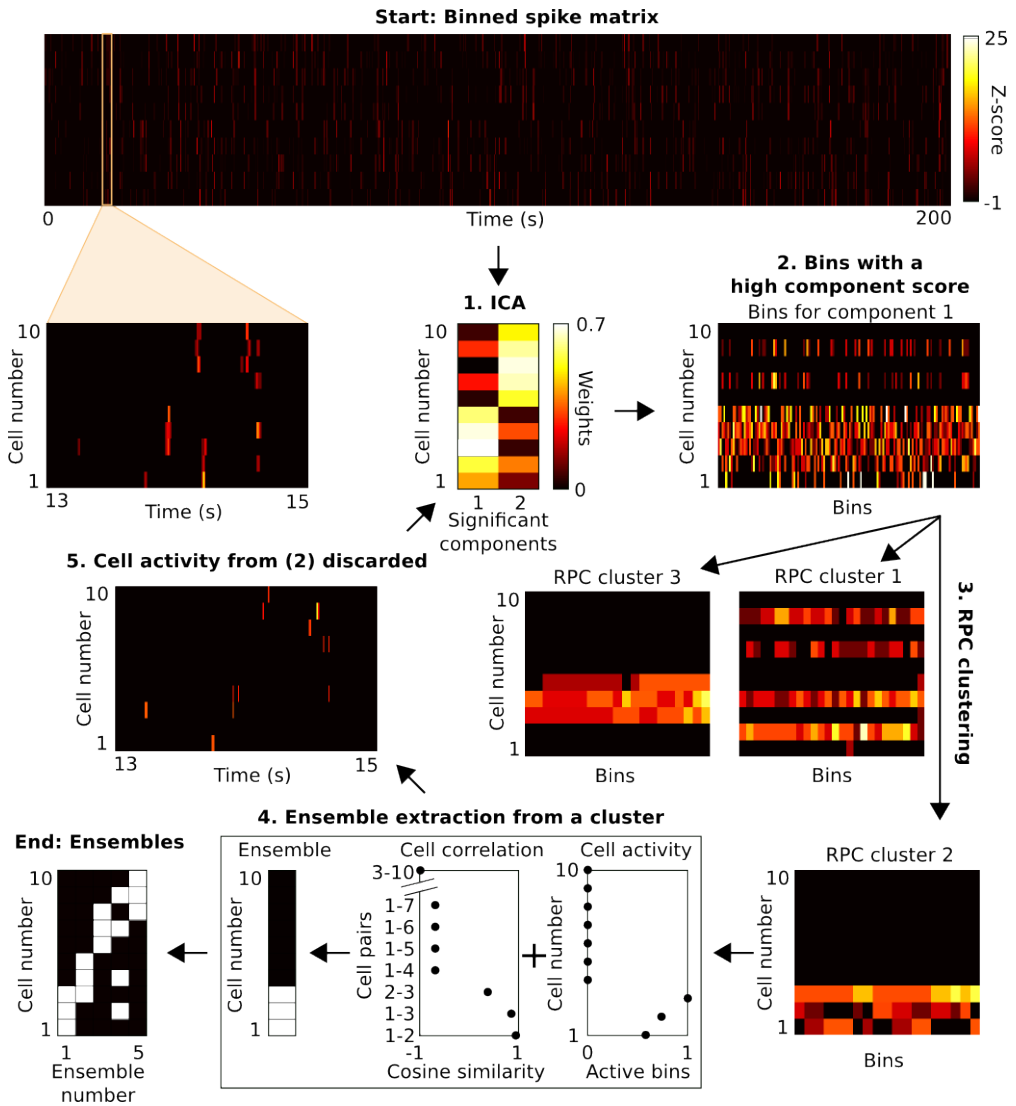

Figure 8.3: ICECAP algorithm representation. From the binned spike matrix (top), ICA is performed (1). For each component, timebins with high component scores (2) are selected for clustering by RPC (3). From each cluster, a putative cell assembly is detected if it satisfies criteria for cell activity and correlation (4). The bins with high component scores of this iteration are then set aside (5: for visualization purposes, only a small portion of the binned spike matrix is shown) and ICECAP continues on to the next cycle (1) until a complete cycle without any detected assemblies.

strength (Supplementary Figure 8.9B,D). This suggests that the presence of strong assemblies may dominate the neurons' $m \times m$ correlation matrix and thus the ICA results, preventing the detection of weaker assemblies. If this hypothesis is true, ICA should be able to detect weaker assemblies if the activations of the strong assemblies were to be set aside. Indeed, performing ICA a second time after setting aside the timebins with high activation scores of the first ICA resulted in a selection of timebins that contained the activations of weaker assemblies; this selection of timebins were successfully clustered by RPC (Supplementary Figure 8.9E).

We call this procedure ICECAP (Iterative Clustering and Elimination of Co-activation Patterns; Figure 8.3). On each iteration, ICECAP performs ICA and for each significant component (components are taken sequentially in the order of the magnitude of their respective eigenvalue), it selects the timebins with high activation scores and uses RPC to cluster distinct patterns recurrent in these timebins and extract putative assemblies from the clustered patterns. ICECAP then sets aside this selection of timebins before moving on to the next component. After extracting putative assemblies from all the significant components, ICECAP moves on to the next iteration, where ICA is performed again on the dataset excluding the timebins set aside and RPC is performed again on each of the newly revealed components. This iterative procedure is repeated until a completed iteration without any detected putative assemblies. Finally, the assemblies detected in different cycles are 'merged': a procedure wherein assemblies are pooled together and duplications and assemblies that are already contained within other assemblies are discarded.

The first cycles of ICECAP thus detect the strongest assemblies (over-represented in ICA performed on the whole dataset), while later cycles detect the weaker assemblies (captured by ICA performed on a subsample of the data; Supplementary Figure 8.9E; Figure 8.4B). ICECAP was highly (> 97%) sensitive on simulations of large datasets with a great number of assemblies (Figure 8.4A, left). Importantly, ICECAP had a very low (< 2%) false positive rate¹ in simulated datasets (Figure 8.4A, right).

While ICECAP performs well in the present simulated datasets (using Poisson point processes to model background activity and assembly activation events), does its performance translate to data containing neurons of a variety of firing rates and complex inter-spike interval statistics as well as assemblies firing on various time scales? We tested ICECAP (Figure 8.8) on a simulated dataset with statistics emulating real data (see *Methods*) with assemblies of different timescales (drawn from a Gaussian distribution with $\mu=50$ ms, $\sigma=50$ ms). When ICECAP is run in data split in timebins much smaller than a typical assembly activation (20 ms bins; Harris et al. 2003), many of the detected

¹Note that the false positive rate of ICECAP is even lower than the false positive rate of a single cycle of ICECAP. This is because assemblies detected partially (e.g. 3 out of 4 assembly members detected) on one cycle can be detected correctly on other ICECAP cycles. After merging, the final assemblies are less likely to contain partial detections.

putative assemblies are actually partial detections (which we here consider false positives). However, running ICECAP on a variety of bin sizes corrects for this problem. After merging the results for different timescales, ICECAP successfully detected a large proportion (95%) of the assemblies in this more realistic simulated dataset.

A

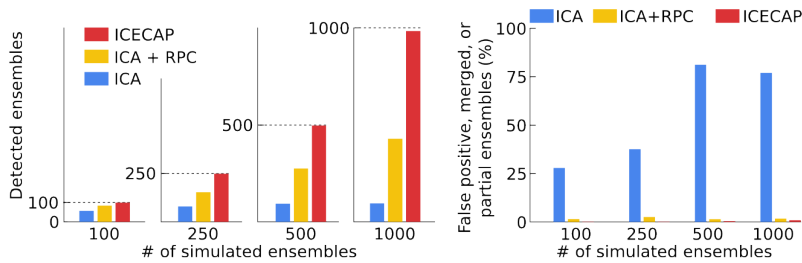

B

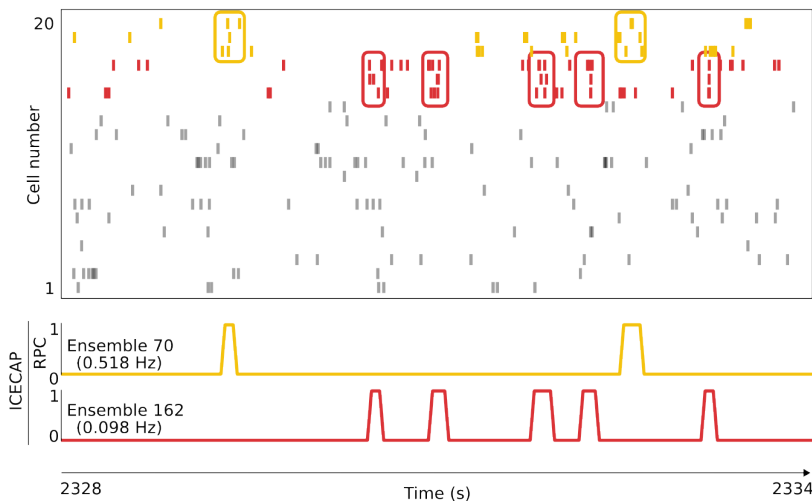

Figure 8.4: ICECAP results (A) ICECAP performance (left: sensitivity; right: false positive rate) on simulated datasets. Note the increased sensitivity of the iterative algorithm relative to performance on a single cycle. **(B)** Representative example of ICECAP-detected assemblies; the red assembly had a lower incidence rate and was only detected on later iterations of ICECAP.

We used ICECAP to detect assemblies in recordings from the rat prefrontal cortex (189 cells, two-hour recording, Figure 8.5A) and hippocampus (55 cells, five-hour recording, Figure 8.5A). Most of the detected assemblies had three

or four members and many cells participated in multiple putative assemblies (Figure 8.5C–D).

8.3 Discussion

Here we introduce Iterative Clustering and Elimination of Co-activation Patterns (ICECAP), a novel method for detecting cell assemblies and recurrent patterns of neuronal activity. Unlike methods identifying groups of correlated cells from the neurons' correlation matrix, ICECAP relies on the detection of recurrent patterns by Recurrent Pattern Clustering (RPC), whereby similar moments in time are clustered together. This allows for the detections of large numbers of overlapping assemblies while ensuring that detected assemblies are groups of cells that fire together. When applied to electrophysiological data, ICECAP detects unprecedented numbers of cell assemblies, opening perspectives for studies of cell assembly formation and activity.

While often used in studies of cell assemblies and neuronal patterns of activity (Peyrache et al. 2009; Gulati et al. 2014; Ramanathan et al. 2015; Dejean et al. 2016; Trouche et al. 2016; Ven et al. 2016; Rothschild et al. 2017; Sjulson et al. 2018), PCA and ICA-based methods combine distinct patterns of activity into the same component when large numbers of assemblies are present. Moreover, components may represent only the strongest assemblies whereas weaker assemblies with less frequent activations remain undetected.

Our method solves both of these problems. First, RPC detects recurrent patterns in the timebins expressing the components, detecting the distinct assemblies therein. Second, the iterative nature of ICECAP ensures that weaker assemblies can be detected once the activations of strong assemblies are set aside. The combination of these factors results in the low incidence of false positives (consistently below 5%) and the high level of sensitivity (consistently above 95%) demonstrated here.

We therefore propose ICECAP as a powerful tool to detect and study cell assemblies and recurrent patterns of activity. ICECAP has virtually no user-defined parameters, with the exception of the binning timescale, discussed below. The output of the algorithm are groups of assemblies, which is intuitive and easy to interpret. Crucially, the algorithm is computationally efficient making it scalable for very large datasets, where estimations of entropy and mutual information, necessary to implement alternative methods (Tavoni et al. 2017; Hidaka and Oizumi 2018), can be computationally expensive.

ICECAP relies on the activity of the network to detect cell assemblies, which results in several limitations. Cell assemblies that are not sufficiently active to be detectable from background activity will remain undetected. Moreover, detected assemblies comprise groups of cells that fire together but are not

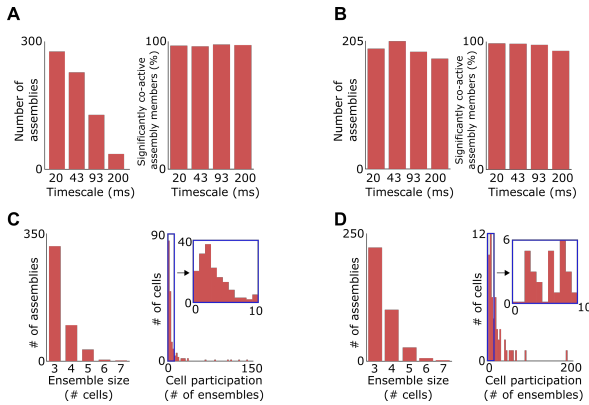

Figure 8.5: Putative assemblies detected from electrophysiological recordings. (A) Assemblies detected from a recording of 189 cells in the rat prefrontal cortex over 2 hours. Left: number of detected assemblies by timescale. Right: percent of detected assemblies that are significantly co-active (see Methods) indicating that members of the detected assemblies fire synchronously. (B) Same as (A) but for a recording of 55 cells in the rat hippocampus over 5 hours. Note the different distribution of timescales compared to prefrontal data. (C) Assembly sizes (left) and cell participation across assemblies (right) for the putative assemblies in (A). (D) Same as (C) for the recording sessions in (B).

necessarily synaptically connected. Functional connectivity due to common inputs cannot be ruled out and therefore ICECAP analysis cannot translate to conclusions about the structural wiring of the network; this should be considered when interpreting results.

ICECAP performance depends on the user choosing a bin size appropriate for the timescale of the cell assembly. To avoid making a priori assumptions of assembly characteristics, we suggest running ICECAP on a variety of timescales for a more data-driven approach.

While ICECAP can be used as described here, further modifications are possible and easy to implement. Here we use ICA activation strength to select the timebins to be clustered by RPC, but any selection criterion can be used, iterative or otherwise. Since RPC is a fast and powerful method for detecting recurring patterns of activity, it may well have applications in pattern detection beyond ICECAP and analysis of neuronal activity.

In conclusion, ICECAP is a scalable method for detecting high numbers of cell assemblies from large datasets. On datasets recorded from the prefrontal cortex or the hippocampus of rats, ICECAP detects unprecedented numbers of assemblies, exceeding the theoretical limits for PCA/ICA multi-fold. ICECAP is therefore a powerful tool for analysing co-activation patterns, and broad use of this method may allow more detailed studies of cell assembly formation

and dynamics. This may open perspectives for further work elucidating the functional role of cell assemblies in cognitive processes.

8.4 Methods

Iterative Clustering and Elimination of Co-Activation Patterns

The original dataset of raw spike times of m neurons is first binned into time windows of duration Δt (bin size, user-defined), with a $\Delta t/2$ overlap between consecutive time bins. This composes the activity matrix A with dimensions m (neurons) and n (timebins), where A_{iu} contains the spike counts for neuron i in the u th timebin. A is z-scored over the time domain, producing the matrix Z ; this is to normalize the firing rate of each neuron and prevent high firing rate cells from dominating the analysis. Next, the dataset is broken down into smaller groups of time points with similar cell activity. In ICECAP, the selection of bins is guided by the underlying inter-cell correlations within the dataset.

To extract a selection of bins from the dataset, ICA is performed (Lopes-dos-Santos et al. 2013) using the FastICA package for Matlab (<http://research.ics.aalto.fi/ica/fastica>)². In order to select timebins where cells with high component weights would be active, we adjusted the sign to each significant component so that the neurons with highest absolute weights were positive and set negative weights to zero before projecting A on each of the components. This projection was considered a component score for each timebin, representing the expression of the respective component within that bin's population activity. For subsequent clustering by RPC, the $n' = \sqrt{n}$ bins with the highest component scores were retained, where n is the total number of timebins.

RPC is then performed, clustering the n' timebins (for each component) and extracting cell assemblies from the clustered patterns. After RPC has been performed for each component (extracting assemblies from the n' timebins with highest component scores), all the timebins selected on this step (i.e. the n' time bins with the highest component score for each component) are set aside from A before the next iteration. This completes one cycle of ICECAP.

Thus on each cycle, ICECAP performs ICA and calls RPC to detect assemblies from the timebins with highest components scores for the new (updated) components. This iterative process is continued until convergence, defined as one complete cycle with no new detected assemblies detected. Note that there are three possible cases that may result in convergence: (1) there were no components that reached the significance threshold in ICA, (2) RPC returned

²Note that other selection algorithms could be used instead of ICA.

no clusters due to an insufficient number of nearest neighbors for all time bins (see *Recurrent Pattern Clustering*), or (3) no putative assemblies could be extracted from any of the clusters (see *Recurrent Pattern Clustering*).

Recurrent pattern clustering

The input to RPC is the neuronal activity matrix Z' , which is a subset of the normalized binned activity matrix Z (described above) over the n' selected timebins. The first step of RPC is to construct the pairwise cosine similarity matrix C such that, for any pairs of time bins u and v :

$$C_{kl} = \frac{\sum_{i=1}^m Z_i'^u \times Z_i'^v}{\sum_{i=1}^m Z_i'^u \times \sum_{i=1}^m Z_i'^v}$$

where $Z_i'^u$ and $Z_i'^v$ denote the normalized activity of neuron i at the u th and v th time bin, respectively.

The next step is the k -nearest neighbors (k -NN) sparsification of the similarity matrix: for each row of C , only the k highest values are retained and the rest are set to zero. Note that while each timebin u selects k neighbors (non-zero numbers in u th row), the number of bins neighboring u (i.e. bins that have selected u among their neighbors, non-zero numbers in u th column) need not be k ; indeed, outliers have few neighboring bins while patterns recurring in the dataset have many neighboring bins. To detect clusters, RPC selects the density peak, defined as the timebin with the most timebins neighboring it. A cluster is defined as the density peak and all the timebins neighboring it.

To detect multiple clusters of patterns of activity, RPC sets aside the timebins contained within a detected cluster and the next density peak is detected. This process is repeated for the remaining timebins until the density-peak has fewer than $k + 1$ points neighboring it. In line with previous works, $k = \sqrt{n'}$ by default (Loftsgaarden and Quesenberry 1965).

Candidate assemblies extracted from an obtained cluster had to satisfy two criteria: (1) assembly cells increase their activity during assembly activations more than other cells and (2) assembly members are more correlated to each other than to other cells. For each cell we computed the proportion of bins in the clustered set that surpassed its median activity through the entire dataset. The obtained proportions were sorted, and the cutoff criterion was defined as the largest difference between two successive proportions. Cells with activity surpassing this cutoff were tagged as 'active cells', satisfying criterion (1). To assess whether the active cells also satisfy criterion (2), we computed the cosine similarity between cells using their activity within the clustered set. If

the minimum cosine similarity between the active cells was larger than their similarity with any of the other cells, the active cells were considered a putative assembly. Otherwise, the cluster was discarded.

Performance of ICA alone

In order to assess the extent to which RPC aids the detection of distinct assemblies as compared to ICA alone, we quantified the detection of assemblies from ICA directly (Figure 8.1C; Figure 8.4A). Unlike RPC, ICA does not output groups of cells (with binary, yes/no group membership) but rather a component of weights, which are harder to interpret. To convert the weights to a putative ICA-detected assemblies, one solution is to consider the cells with weights exceeding 2 standard deviations as an ICA-detected assembly (Ven et al. 2016). We adopted the same approach but we set the threshold to 4 standard deviations, which maximized ICA performance (data not shown).

Simulated datasets

Artificial datasets were created to simulate neuronal activity with known assembly activity. Each cell's randomized background activity was simulated as a Poisson point process with an average $\lambda_{background}$ spike events per second. Each assembly was randomly assigned a group of cells and was active a set number of times at randomly selected moments in the dataset. At these assembly activation moments, spikes for member cells were generated following a Poisson point process, such that during each assembly activation a cell would fire an average of λ_a spikes. The spikes at assembly activations were jittered in time by a random amount sampled from a uniform distribution $[-\Delta t/2, +\Delta t/2]$, with Δt the timescale at which an assembly was active. To preserve each neuron's firing rate, for each spike fired as part of an assembly activation, one spike was discarded from the cell's randomly generated background activity

Artificial datasets simulating the activity of 50 neurons comprising 50 assemblies (Figure 8.1C; Supplementary Figure 8.6) or 50 neurons comprising 100 assemblies (Figure 8.1C; Supplementary Figure 8.7; Figure 8.9) had the following characteristics: the dataset duration was 2 hours, the assembly size was fixed at 3 members, the maximum number of activation events was 200 (note that since spikes during activation events were generated as a Poisson process, the actual number of activation events varied as shown in Supplementary Figure 8.9A for 100 simulated assemblies), $\lambda_{background}=1$ Hz, $\lambda_a=2$ spikes, and $\Delta t=20$ ms.

Artificial datasets in Figure 8.4A had durations of 1 hour, $\lambda_a=2$ spikes,

$\Delta t=20$ ms and 250 simulated cells of $\lambda_{background}=1$ Hz. The number of maximum activation events for each assembly was either 250, 500, 1000. or 2000. The assembly size varied among the datasets as follows: the 100-assembly datasets contained 40, 30, and 30 assemblies with 3, 6, and 9 members, respectively; the 250-assembly datasets contained 100, 100, and 50 assemblies of 3, 6, and 9 members, respectively; the 500-assembly datasets contained 350, 100, and 50 assemblies of 3, 4, and 5 members, respectively; the 1000-assembly datasets contained 750, 150, and 100 assemblies of 3, 4, and 5 members, respectively.

For the artificial dataset emulating statistics of real data (Supplementary Figure 8.8), we took a 2-hour recording of 189 cells in the rat prefrontal cortex and, for each neuron, shuffled the inter-spike intervals, generating an artificial spike train. Note that this procedure preserves each cell's firing rate as well as the distribution of inter-spike intervals. We then generated assembly activations using the procedure described above with $\lambda_a=2$ spikes. Assemblies had 3–10 members (randomly assigned). Assembly timescales Δt were drawn from a Gaussian distribution with $\mu=50$ ms, $\sigma=50$ ms. The number of assembly activations was drawn from a Gaussian distribution with $\mu=1000$, $\sigma=150$.

Assessing assembly members' synchrony

To assess whether the assemblies detected in real datasets constitute distinct groups of co-active cells rather than pairs of correlated cells, we devised a test of co-activity for ensemble members (Figure 8.5A, right; Figure 8.5B, right). Each of the neurons participating in a detected assembly are analyzed as follows. The firing rate of each cell a in the bins of the activity matrix A with high assembly co-activity, defined as the 5% of bins with the largest number of other (apart from a) member cells belonging to an assembly. To estimate the probability of the same firing rate of a to be observed by chance, the activity of cell a is shuffled (shuffling its inter-spike intervals), and the firing rate of this shuffled activity is computed in the same bins. If the activity is greater in the original dataset than in the shuffled dataset, the cell a is considered to be a significantly synchronous to other members of the assembly.

8.5 Supplementary Figures

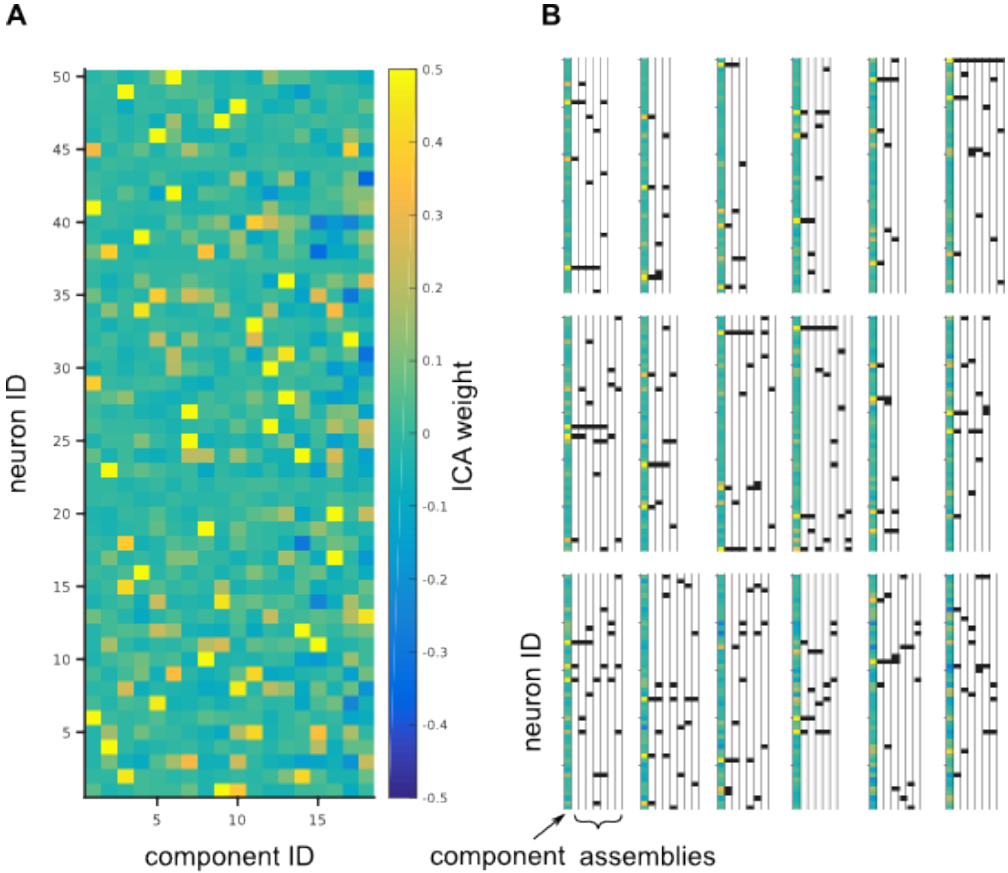

Figure 8.6: ICA combines simulated assemblies. (A) All significant components (weights, above; z-scored weights, below) after performing ICA on a simulated dataset (same simulation as Figure 8.1C; 50 assemblies). (B) For each of the components in (A), the collection of all the original assemblies (black) significantly correlated with that component’s weights. Note that each component was a combination of multiple independent assemblies.

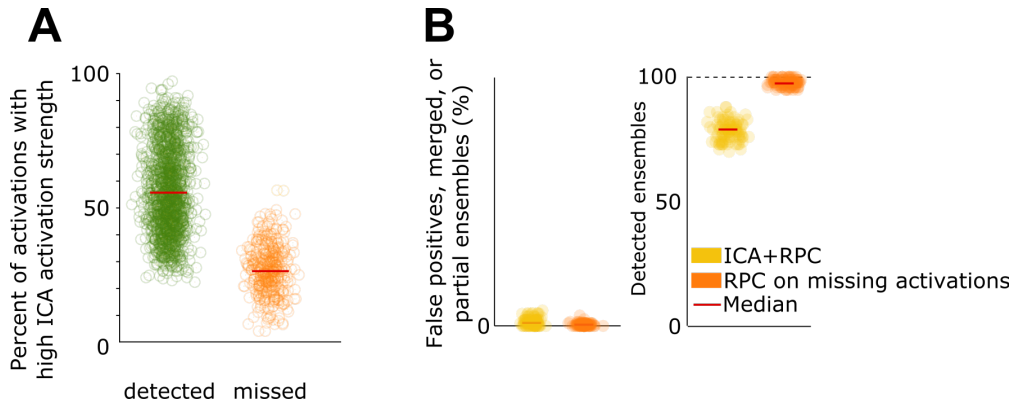

Figure 8.7: RPC performance depends on the selection of timebins. (A) Whether an assembly was detected or not depended on the proportion of its activations that were selected as times of high IC activation strength (input to RPC). (B) RPC performance (left: false positive rate; right: sensitivity) is rescued when given the activations of the missing assemblies, indicating that it can successfully detect assemblies as long as they are active in the selection of timebins given to RPC.

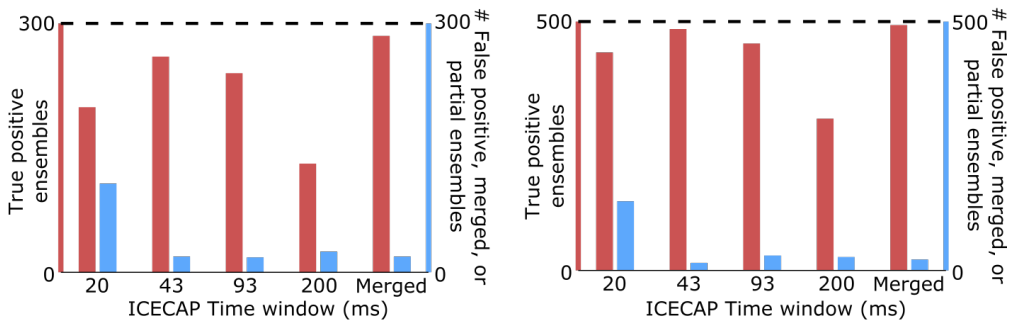

Figure 8.8: ICECAP performance on simulated dataset emulating recorded neurons' statistics. Left: 300 simulated assemblies. Right: 500 simulated assemblies. Note that while false positives, merged or partial ensemble detection rate is high on timescales shorter than the average assembly timescale (20 ms \ll 50 ms), false positive rate is low and sensitivity is high when considering assemblies after merging the results from all timescales (merged).

8 A Scalable Iterative Algorithm to Accurately and Precisely Detect Cell Assemblies

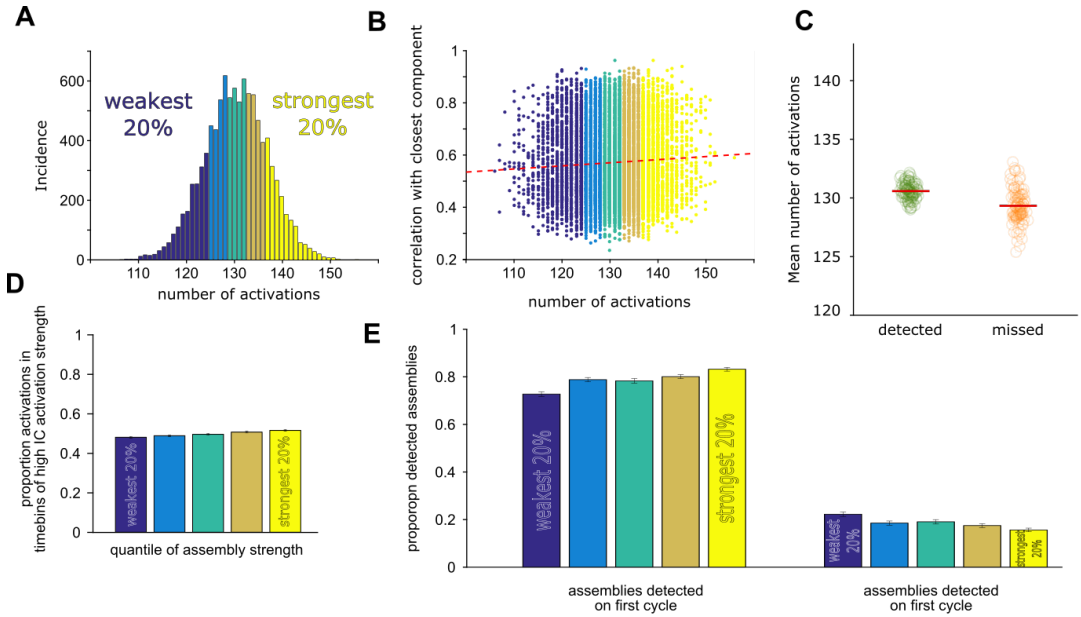

Figure 8.9: Strong assemblies dominate component analysis. (A) Distribution of the number of times simulated assemblies (100 assemblies from Figure 8.1C) were active. Assemblies have been divided in 5 quantiles, from ‘weakest’ (active least frequently) to ‘strongest’ (active most frequently). (B) Whether an assembly was detected or not depended on the number of activations, with stronger assemblies more likely to be detected. (C) Correlation between assembly strength (number of activations) and representation in ICA (correlation between assembly and its closest component). Components were more likely to be well correlated with strong assemblies, whereas weak assemblies were less likely to be correlated with (and thus be represented by) any component. (D) The activations of stronger assemblies were more likely to be selected as moments of high IC activation strength than the activation of weaker assemblies. (E) Strong assemblies were more likely to be detected after a single cycle of ICECAP. Weaker assemblies were more likely to be detected on a second cycle of ICECAP than stronger assemblies (right), indicating that setting aside the activations of strong assemblies permits the detection of weaker assemblies.

9 Consolidation of Fear Extinction Memory Traces in the Hippocampal-Amygdalo-Prefrontal Network during Sleep

Marco N. Pompili^{a,b}, Ralitsa Todorova^a, Eulalie M. Leroux^a, Gabriel Makdah^{a,c}, Thérèse M. Jay^b, Bill P. Godsil^b & Sidney I. Wiener^a

^a Center for Interdisciplinary Research in Biology (CIRB), Collège de France, CNRS, INSERM, PSL Research University, 11 place Marcelin Berthelot, 75005 Paris, France

^b Institute of Psychiatry and Neuroscience of Paris (IPNP), Hôpital Sainte-Anne, INSERM, Université Paris Descartes, 102-108 Rue de la Santé, 75014 Paris, France

^c Hospices Civils de Lyon, Faculté de Médecine Lyon Est, Université Claude Bernard Lyon 1, 8 Avenue Rockefeller, 69008 Lyon, France

Statement of contributions: MNP, SIW, BPG, and TMJ designed the research. MNP conceived, assembled, and tested the experimental setup. MNP, EML, and GM conceived and assembled the implants and performed the surgeries. MNP and EML carried out the experiments and the histological analysis. MNP, RT, GM, and EML developed and applied the cluster cutting pipeline. MNP, RT, GM, and SIW designed data analysis, which was carried out by RT, GM, and MNP. MNP and SIW supervised experiments, data analysis and wrote the current report.

Acknowledgements: We thank Matthieu Pasquet and Guillaume Dugué with inertial data acquisition and analysis and Cédric Colas, Benjamin Billot, and Pierre-Antoine Vigneron for help with the initial set up of the rig and protocols. This project was funded with grants from the Agence Nationale de la Recherche to BPG, TMJ, and SIW and Labex MemoLife to MNP and SIW. MNP is also supported by the Université PSL and the Fondation Pierre Deniker.

ongoing research

Abstract In this chapter we briefly present the current state of a project aimed at understanding the neural mechanisms of extinction memory traces encoding and consolidation in the medial prefrontal cortex (mPFC) and their

modulation by the hippocampus (HPC) and the basal amygdala (BA). To this end we performed high-density electrophysiological recordings in the mPFC, BA, and dorsal and ventral HPC of behaving rats that underwent a fear conditioning, extinction, and renewal protocol. While data acquisition finished last June, data analyses is underway. Here we present the data analyzed so far (behavior) and discuss current and future analyses of electrophysiological data.

9.1 Introduction

As discussed in Chapter 2, brain structures strongly implicated in normal and pathological fear acquisition and extinction include the amygdala (AMG, regarded as the primary locus of such emotional learning), the medial prefrontal cortex (mPFC, engaged in the control of fear behaviors) and the hippocampus (HPC). The dorsal and ventral portions of the HPC are thought to be respectively involved in the contextual and emotional aspects of information processing, therefore playing distinct roles in fear learning (see 2.2.2). Pharmacological, lesion, and optogenetic studies suggest that the various subdivisions of the mPFC are differentially implicated in fear behavior regulation and learning, but few recordings of electrophysiological activity in behaving animals have compared single unit and cell assembly activity in fear conditioning protocols between the mPFC subdivisions (see 2.3.3).

Convergent lines of evidence indicate that the medial prefrontal cortex (or at least its ventral subdivisions) is critically involved in extinction learning (see 2.3.3). However, while in recent years a growing body of literature has detailed the neurophysiological mechanisms by which dorsomedial PFC (dmPFC) neural networks regulate fear expression (see 4.3.1), notably with coordinated activity with the HPC and the AMG (see 4.4), the brain dynamics underpinning extinction learning are largely unknown. Moreover, there are still no reports revealing potential mechanisms supporting the distinct roles of the dmPFC vs. the ventromedial PFC (vmPFC) in fear regulation and learning.

Sleep is considered essential for consolidation of certain types of memories (see 3.4) and an extensive body of research has shown how the dialogue between the HPC and the mPFC may underpin systems-level consolidation (see 3.4.2) of spatial memory. Moreover, coordinated neural dynamics between the HPC, AMG, and mPFC during sleep have been shown to also support fear memory consolidation (see 4.4.4). However, whether similar dynamics also underpin fear extinction learning is still unknown. One possibility is that the emergence of cell assembly dynamics (see Chapter 7) within the mPFC (possibly in its ventral portions exclusively) and their reactivation during sleep, may underlie the formation of extinction memory traces and their consolidation, respectively. This consolidation within, or coordinated by, the mPFC may rely upon essential signals received from the HPC and the AMG which would modulate

mPFC reactivations. Furthermore, there would need to be some kind of interaction between dorsal and ventral mPFC to regulate the balance between the expression of conditioned fear and extinction recall.

To investigate this hypothesis and characterize the neural dynamics supporting fear extinction memory trace consolidation in the HPC-AMG-mPFC network we recorded neural activity in the the mPFC, nuclei of the basal amygdala (BA; basolateral, BLA, and basomedial, BMA, which are differentially connected with the dmPFC and vmPFC; see 2.3.3), and ventral and dorsal HPC. Particular attention was dedicated to differentiate between the different mPFC regions where the recordings took place.

In order to control and disambiguate between the context dependency of cued fear extinction learning and contextual fear extinction we developed a behavioral protocol where animals underwent in parallel contextual fear extinction and cued fear extinction and were finally tested for context dependent cued fear renewal (see 1.6 and 1.7). As a means to control for animals' basal anxiety levels and compare learned fear neural correlates with brain activity associated with innate fear, the animals were also recorded during tests on an elevated plus-maze before the first day and after the last day of the conditioning-extinction-renewal protocol.

This research project is still ongoing. While data acquisition is concluded, data processing is not yet finished and data analysis is underway. In the following we present the current state of the project (only behavioral data are presented) and discuss current and future analyses.

9.2 Results

We recorded neural activity in 6 rats while they were subjected to a within-subject fear renewal protocol with an ABA design (Figure 9.1a; see *Methods*; Marek et al. 2018a; Bouton 2004). Briefly, after two days where the animals were habituated to two different contexts A and B and two types of auditory cues (CS+ and CS-), they were fear conditioned in context A where CS+ presentations were coupled to mild electric footshocks. In the following days the animals underwent both cued fear extinction training in context B and contextual fear extinction in context A until cued fear behavior returned to habituation levels. The last day they underwent a context dependent fear renewal test where CS+ and CS- were presented in context A. Exposures to the two testing contexts was counter-balanced and each daily recording consisted of two training sessions (one in each context of either conditioning, extinction, or simple exposure to the context) and 3 sleep sessions (one before and after each training).

9 Consolidation of Fear Extinction Memory Traces in the Hippocampal-Amygdala-Prefrontal Network during Sleep

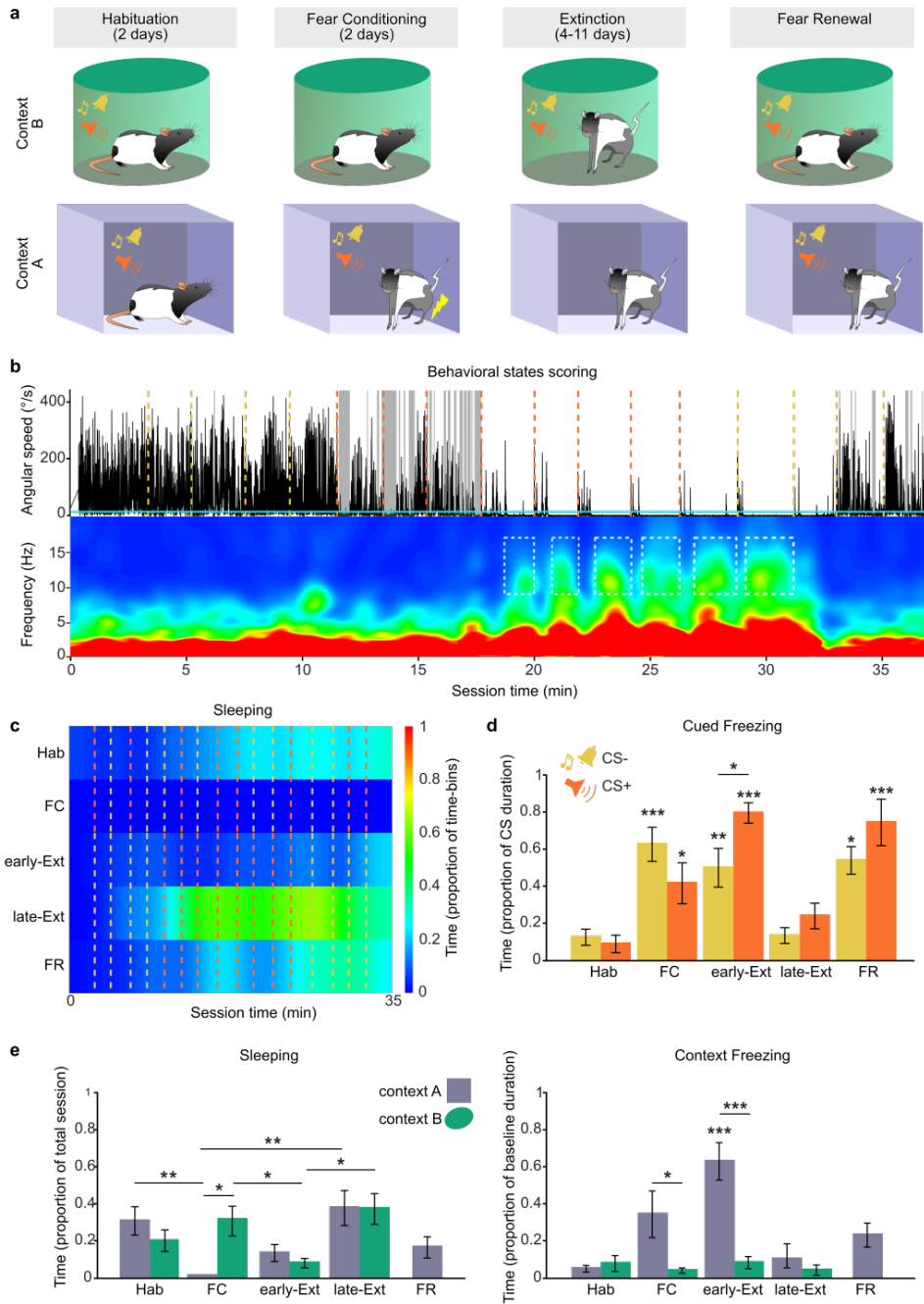

Figure 9.1: Behavioral paradigm and results. [caption on the following page]

Figure 9.1: Behavioral paradigm and results. [figure on previous page] (a), Schematic representation of the protocol. Sleep sessions are not depicted. See *Methods* and Table 2 for details. (b), Behavioral scoring in a representative late extinction session with few freezing events and much sleeping. Top: Animals movements as detected by head movements of the animal. The light green horizontal line shows the threshold for immobility. Dashed vertical lines depict CS- (ochre) and CS+ (orange) onsets. Gray shaded areas indicate the periods scored as freezing. While the animal did not freeze during CS- presentations, the onsets of the first three CS+ triggered freezing responses. Bottom: mPFC LFP spectrogram computed between 0.1 and 20 Hz. White dotted squares highlight sleep spindle power peaks. Their top and bottom boundaries depict the spindle band that was used for the sleep detection while the left and right borders depict the intervals that were scored as sleeping. The rat started to sleep in the second half of the session, every CS+ presentation awoke him but he fell asleep again in 30-40 seconds. (c), Average time spent sleeping across training sessions for all animals. Dashed vertical lines depict CS- (ochre) and CS+ (orange) onsets. (d), Average CS freezing during the first two CS+ and CS- presentations. During habituation, rats exhibited low freezing during CS+ and CS- (average of the two cued habituation sessions). After conditioning (early-Ext, average of the first two cued extinction sessions), CS+ and CS- induced increased freezing, which decreased across extinction training. Rats froze more to CS+ than CS- only during early extinction. CS+ and CS- presentation during the fear renewal test in A context induced renewed high freezing behavior. (e), Sleeping time in contexts A and B and contextual fear. Left: Quantification of panel c and between days comparison of average time spent sleeping. Right: average time spent freezing during the first 3 min baseline. Note that freezing to context A is higher than context B during FC because the average of the two FC days is represented and on the second day contextual fear to A had already risen. Rats froze more to context A than B only during fear conditioning and early extinction

For readability purposes the significant comparisons between training stages different than habituation are omitted here and represented in Supplementary Figure 9.4a,b. All data are represented as mean \pm SEM. Statistical tests are unpaired t-test Bonferroni corrected for multiple comparisons (* $p < 0.5$, ** $p < 0.01$, *** $p < 0.001$)

Stars on the top of bars depict significant differences vs. Hab and stars on the top of brackets depict significant differences between CS types or between contexts

Hab = habituation, two sessions; FC = fear conditioning, two sessions; early-Ext = first two extinction sessions; late-Ext = last two extinction sessions; FR = fear renewal test session)

A single day of the protocol consisted of ~ 8 h of recordings. Probably because of this length, all rats slept during some training sessions, and not just the sleep sessions (Figure 9.1b,c). We therefore first quantified sleep behavior across our recordings. Since slow wave sleep (SWS) oscillations share the same frequency band (delta, 1–4 Hz) as freezing-related 4 Hz rhythmic activity, we did not use the standard theta/delta ratio measure to score sleeping during immobility, but instead the power of the mPFC LFP signal in the spindle band (see *Methods*), which displayed a clear bi-modal distribution (Supplementary Figure 9.5a). The animals tended to sleep at the end of the training sessions and, critically, never slept during fear conditioning nor during CS+ presentations in early extinction sessions (Figure 9.1b,c,e). Sleep time increased across extinction and dropped during the fear renewal test. Overall, in our task, sleep appears as a good indicator of the anxiety level of the animals. The periods of awake immobility right before falling asleep were removed, all re-

9 Consolidation of Fear Extinction Memory Traces in the Hippocampal-Amygdalo-Prefrontal Network during Sleep

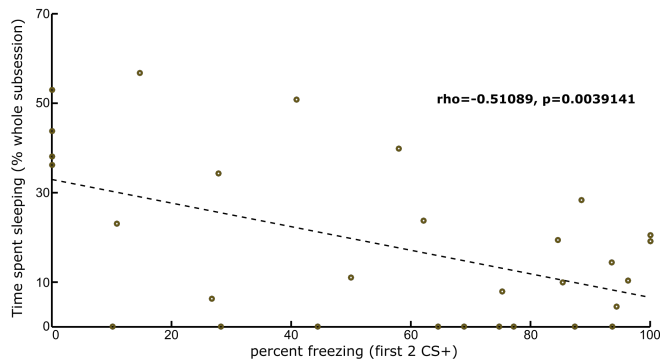

Figure 9.2: Sleeping during training is an indicator of tranquillity. Correlation between the time spent freezing during the first two CS+ presentations and time spent sleeping during a given session. Sleep time and freezing time are significantly anti-correlated (Spearman rank test, $p < 0.001$).

maintaining immobility was scored as freezing. Confirming our approach, sleeping time during a session and freezing during CS+ revealed to be highly negatively correlated (Supplementary Figure 9.2). Contextual fear was assessed by measuring the time spent freezing during the baseline (first 3 min) of each session. While contextual freezing was low in both contexts during habituation sessions, conditioning in context A induced a robust increase of freezing to context A which decreased across extinction learning (Figure 9.1e and Figure 9.4b). During CS+ presentations in context B and exposures to context A, rats displayed a robust increase of freezing behavior after conditioning, which returned to baseline levels by the end of extinction training (Figure 9.1d, Supplementary Figure 9.4a). Also freezing to CS- increased after conditioning, suggesting some degree of generalization. However, during early extinction, rats froze significantly more to CS+ than to CS- (Figure 9.1d). Extinction learning induced a robust decrease of freezing to both CS+ and CS- (Figure 9.3a and Supplementary Figure 9.3). A closer look to individual extinction curves reveals that 3 out of 6 animals did not generalize their fear behavior to the CS- (Figure 9.3b,c). Indeed, as previously shown (for instance, Likhtik et al. 2014) some animals displayed an inclination to generalize their fear towards different auditory stimuli or were not able to discriminate well between them, while others did. These will be referred to as discriminators and generalizers.

Neural data processing (cluster cutting and extraction of LFP events) is complete for mPFC recordings in 5/6 rats. Histological analysis is complete for 4/6 animals (representative histological images for one rat are presented in Figures 9.6 and 9.7).

From the four rats whose brains received histological analysis, we recorded a total of 9671 units in mPFC of which 3330 were in PL, 1554 in IL, 289 in ACC,

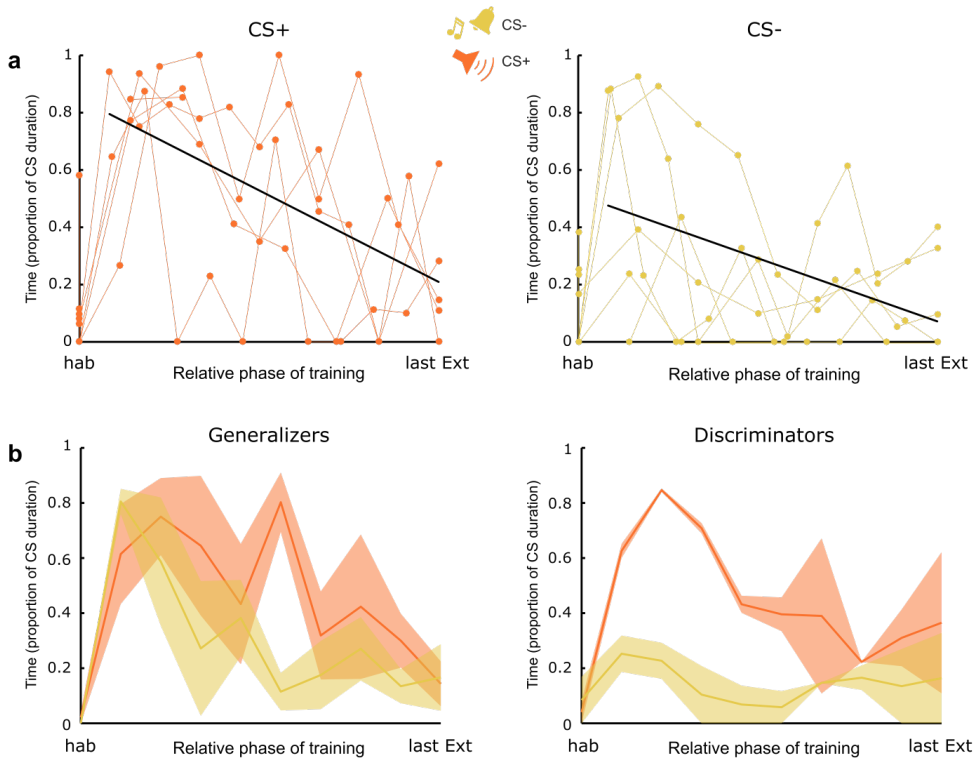

Figure 9.3: Freezing responses to CS+ vs. CS- (a) Correlation between the relative phase of extinction and the average proportion of time spent freezing during the first two CS+ (left) and CS- (right) presentations. Each dot represents the average freezing time for the first two CSs for a given rat on a given day of training. Both days of habituation are on the same position on the x axis. All other data points represent extinction data. Lines connect successive day data for each animal. Note that the number of extinction sessions varied between animals (see *Methods*). Black lines represent the linear regression model fitted on the data. Freezing to both CS+ and CS- significantly decreased over extinction training (Spearman rank test, $p < 0.001$). On the right panel note that three animals displayed low freezing levels at CS- presentations even at early stages of extinction training ('discriminators') while the other three had high levels of freezing at least the first 1-4 days of extinction training ('generalizers'). (b) Averages of the curves depicted in a for generalizers (left) and discriminators (right).

509 in DP, and 881 in MO (units recorded from electrodes whose position was not unequivocally determined were not assigned to any specific mPFC subdivision). In mPFC we recorded up to 387 units simultaneously, providing suitable data for cell assembly analysis over a large neural population.

HPC and AMG single unit data processing (cluster cutting) is finished only

for isolated sessions. From the sessions available up to ~100-150 units were recorded simultaneously in the BA, dHPC, as well as vHPC (depending on the relative number of recording channels in each structure). In a typical session we recorded simultaneously ~250-350 units in the mPFC, ~40-60 in the BA, ~80-110 in dHPC, and ~40-70 in vHPC.

9.3 Discussion

The main goal of our current data analysis is to identify possible electrophysiological correlates of extinction memory traces in the mPFC and study how extinction memory coding evolves during sleep and its relation to memory consolidation (as measured by performance on the following day). To this end we are characterizing firing behavior of mPFC units that could correspond to extinction.

Our hypothesis is that extinction learning peaks right after the CS+ presentation when an animal expects the shock but realizes that it is not delivered (the CS+ lasts 20 s and then is followed by the shock in fear conditioning). Looking at the firing rate of single units in post CS+ presentations periods, our preliminary observations suggest that some units change their firing rate from the first to the last CS presentation within each extinction session (data not shown). This difference in firing rate may signal what the animals have learnt during the given extinction session. However, there is the possible confound that the activity is a simple correlate related to freezing behavior. We are now examining whether reactivation rates during subsequent sleep predict retention of extinction training on the following day. This would support the idea that the firing rate change during an extinction session reflects extinction learning. A similar analysis will also be carried out for population coding. Indeed, we expect mPFC cell assemblies to emerge during extinction learning, perhaps during transient peaks of high theta coherence (Courtin et al. 2014; Likhtik et al. 2014) between the mPFC and the dorsal or ventral HPC, or between the mPFC and the BA. Like single units, these cell assemblies may reactivate during subsequent sleep. A similar analysis can also be conducted for contextual fear extinction, identifying cells that change their firing rate during the session or assemblies emerging towards the end of the session.

Since mPFC reactivations take place preferentially during HPC ripple events, we will analyze how the reactivations of mPFC extinction coding are modulated by HPC ripples and if this modulation can also predict future performance. We are also interested in characterising the possible differences in the consolidation mechanisms for contextual vs. cued fear extinction. Our hypothesis is that contextual extinction consolidation will be principally modulated by dorsal HPC ripples during sleep while cued extinction coding will mostly follow ventral HPC ripples. As contextual fear is particularly HPC dependant we expect contextual fear extinction related activity to be more modulated

by the HPC during extinction consolidation compared to cued fear extinction. Another possibility is that extinction-related activity patterns reactivate during REM sleep in moments of high theta coherence between the mPFC and the BA.

We will also test whether extinction coding segregates anatomically and whether extinction coding single units and members of extinction cell assemblies were preferentially recorded in specific subregions of the mPFC. In light of the literature we expect extinction encoding to preferentially take place in the vmPFC regions.

These analyses have the potential to reveal for the first time a potential mechanism by which fear extinction memory traces are encoded in the mPFC, consolidated, and modulated by the HPC and the AMG.

9.4 Methods

Animals

Six male Long-Evans rats (350 – 400 g at the time of the surgery, 2-5 months old) were housed individually in monitored conditions (21°C and 45% humidity) and maintained on a 12h light- 12h dark cycle. In order to avoid obesity, rats feeding was restricted to 13-16 g of rat chow per day, with water available *ad libitum*. To habituate the rats to human manipulation they were handled each workday. All experiments conformed to the approved protocols and regulations of the local ethics committee (Comité d’Ethique en matière d’expérimentation animale Paris Centre et Sud n°59) and the French ministries of agriculture, and higher education and research.

Surgery

Rats were deeply anesthetized using a ketamine-xylazine mixture (Imalgene and Rompun, 180 mg/kg and 10 mg/kg, respectively) and anesthesia was maintained with isoflurane (0.1-1.5% in oxygen). Analgesia was assured by subcutaneous injection of buprenorphine (Buprecaire, 0.025 mg/kg) and meloxicam (Metacam, 3 mg/kg). We implanted the animals bilaterally with a custom build microdrive with either 24, 32, or 42 bundles of independently movable twisted electrodes (12 μ m tungsten wires twisted in groups of either 6 or 8 wires and gold-plated to \sim 200 k Ω) 0.5mm above the target brain regions. Electrode bundles placement varied between rats and is summarized in the table below (Table 1). Miniature stainless steel screws (serving as electrical reference and ground) were implanted above the cerebellum.

9 Consolidation of Fear Extinction Memory Traces in the Hippocampal-Amygdalo-Prefrontal Network during Sleep

Animal	Targeted Structure	# bundles	coordinates (mm from bregma)	
			AP	ML
362	PL	7	+2.5 to +4.8	±0.3 to 0.6
	IL	9	+2.5 to +3.7	"
	dHPC	4	-5	±3.8 to 5
	vHPC	4	"	±3.8 to 5
370	PL	8	+2.5 to +4.8	±0.3 to 0.6
	IL	8	+2.5 to +3.7	"
	dHPC	4	-5	±3.8 to 5
	vHPC	4	"	±3.8 to 5
386	PL	8	+2.5 to +4.8	±0.3 to 0.6
	IL	8	+2.5 to +3.7	"
	dHPC	4	-5	±3.8 to 5
	vHPC	4	"	±3.8 to 5
	BA	8	-2.4 to -2.7	±4 to 5
392	PL	8	+2.5 to +4.8	±0.3 to 0.6
	IL	8	+2.5 to +3.7	"
	dHPC	7	-5	±3.8 to 5
	vHPC	7	"	±3.8 to 5
	BA	4	-2.4 to -2.7	±4 to 5
399	ACC	6	+2.5 to +4.8	±0.3 to 0.6
	PL	9	"	"
	IL	6	+2.5 to +3.7	"
	dHPC	8	-4.5 to 4.8	±3.8 to 5
	vHPC	7	"	±3.8 to 5
	BA	4	-2.4 to -2.7	±4 to 5
401	NR	2	-2	±0.3
	ACC	6	+2.5 to +4.8	±0.3 to 0.6
	PL	6	"	"
	IL	9	+2.5 to +3.7	"
	dHPC	7	-4.5 to 4.8	±3.8 to 5
	vHPC	8	"	±3.8 to 5
	BA	4	-2.4 to -2.7	±4 to 5
NR	2	-2	±0.3	

Table 1: Target brain areas of electrode bundles. ACC = Anterior Cingulate Cortex; BA = Basal Amygdala nuclei; dHPC = dorsal Hippocampus; IL = Infralimbic cortex; NR = Nucleus Reuniens; PL = Prelimbic cortex; vHPC = ventral Hippocampus.

During recovery from surgery (minimum 7 days), the rats received antibiotal (Marbofloxacin, 2 mg/kg) and analgesic (Meloxicam, 3 mg/kg) treatments via subcutaneous injections, and were provided with food and water ad libitum.

The recording electrodes were then progressively lowered until they reached their targets and then adjusted to optimize yield and stability. Electrode bundles dorsoventral locations were estimated in vivo using microdriver screw turn counts. For two rats (399 and 401), four electrodes were also placed in the skeletal muscles of the neck (two on each side) to allow electromyogram recordings (not shown in this report).

Behavioral apparatus

During the experiments, the rats were exposed to four different environments: 2 testing contexts (A and B), one plastic pot for sleep sessions, and an elevated plus-maze (EPM).

The **context A** was a cubicle conditioning chamber (40 x 40 x 40 cm) with gray plexiglass walls lined with ribbed black rubber sheets and a floor composed of nineteen stainless steel rods (0.48 cm diameter with 1.6 cm spacing connected to a scrambled shock generator (ENV-414S, Med Associates, USA). It was mildly scented daily with mint-perfumed cleaning solution (Simple Green, Sunshine Makers). The **context B** was a stadium-shaped PVC enclosure (30 cm of straight side and 15 cm of radius) with a black wooden floor and walls lined with light brown pieces of rope rug. It was mildly scented daily with a baking vanilla extract solution. The sleeping pot was a cloth-lined plastic flowerpot (30 cm upper diameter, 20 cm lower diameter, 25 cm high). A custom-made electronic system presented the animals with two auditory CSs (80 dB, 20 s long, each composed of 1 Hz, 250 ms long pips of either white noise, CS+, or 8 kHz pure tones, CS-). The **EPM** stood 70 cm high from the ground and was made with black PVC (the floor was lined with black rubber to avoid slippery). The four arms were 17 cm wide and 100 cm long. Closed arms had 30 cm high walls while open arms had 5 mm high railing to increase open arms exploration (Walf and Frye 2007).

Behavioral protocol

To balance the time spent in each context by the animals, every day of the experimental protocol consisted of one 37 min (n=5 rats) or 1h (n=1) session in each context. When introduced in the contexts the animals were either presented with the auditory CSs (after a baseline period of 3 min, the animals were presented to 16 CSs, 8 CS+ and 8 CS-, separated by random-duration inter-trial intervals ranging between 120 and 240 s) or received no auditory stimuli (context exposure sessions). Each day of the protocol consisted of a silent context exposure session in one context and a session with CS presentations in the other, except for the fear renewal test day where both sessions had CS presentations. Before and after each session the animals were left undisturbed for at least 2h in the sleeping pot to record sleep activity.

Habituation took place on days 1 and 2. On day 1, habituation to the CSs took place in one context while on day, 2 in the other. On days 3 and 4, the animals were fear conditioned in the BOX where CS+ presentations were coupled with foot shocks (1 s, 0.6 mA, co-terminating with CS+ presentations). During habituation and fear conditioning CS+ and CS- were presented in pseudorandom order (no more than 2 consecutive presentations of the same-type CS). Extinction training began on day 5. In the CYL, after the baseline, 4 CS- were presented followed by 8 CS+ and then 4 CS-. Extinction training was repeated every day until the rat was seen sleeping during CS+ presentations. The following day, rats had a last extinction training session in B and later underwent the fear renewal test where CSs were presented in A in the same order as extinction training (4 CS-, 8 Cs+, 4CS-). Table 2 details the exact sequence of subsessions for each animal.

For 4 out of 6 animals, before and after the conditioning-extinction-renewal protocol, recordings also took place while the animals underwent testing on the EPM. Before and after each EPM session the animals were left undisturbed for at least 2h in the sleeping pot to record sleep activity. EPM tests also took place the first day of habituation and the fear renewal test day, respectively before and after the standard training day, such that the no EPM test took place from the beginning to the end of the learning protocol described above but just before and after it.

Data acquisition and processing

An inertial measurement unit (IMU, custom made, non wireless version of the one described in Pasquet et al. 2016) recorded 3D angular velocity and linear acceleration of the animals' heads (sampled at 300 Hz). A red LED mounted on the headstage signalled the instantaneous position of the animals sampled by overhead webcams (30 Hz). Animal behavior was also recorded (50 Hz) by lateral video cameras in A and B (acA25000, Basler). Brain activity was recorded using a 256-channel digital data acquisition system (KJE-1001, Amplipex, Szeged, Hungary). The signals were digitized with three or four 64-channel headstages (Amplipex HS2) and were sampled wideband at 20,000 Hz. Off-line spike sorting was performed by a custom written Matlab program (MathWorks, Natick, MA) implementing the Kilosort algorithm (Pachitariu et al. 2016). Obtained clusters were manually inspected to reject noise and to merge erroneously discriminated units with Klusters (Hazan et al. 2006). mPFC units were characterized as putative pyramidal cells and interneurons based on half-amplitude duration and trough to peak time (Barthó et al. 2004). Neurophysiological and behavioral data were explored with NeuroScope (Hazan et al. 2006). LFPs were derived from wideband signals by downsampling all channels to 1,250 Hz.

At the end of the experiments, recording sites were marked with small elec-

trolytic lesions ($\sim 20 \mu\text{A}$ for 20 seconds, one lesion per bundle). After a delay of at least three days to permit glial scar, rats were deeply anesthetized with a lethal dose of pentobarbital, and intracardially perfused with saline (0.9%) followed by paraformaldehyde (4%). Coronal slices ($35 \mu\text{m}$) were stained with cresyl-violet.

Data analysis and statistics

Data were analyzed using FMAToolbox (<http://fmatoolbox.sourceforge.net>), Chronux (<http://chronux.org/>), and custom written programs in Matlab (MathWorks, Natick, MA).

Scoring of behavioral states We distinguished five behavioral states: slow wave sleep (SWS), rapid eye movement sleep (REM), immobile wakefulness, freezing, and wakefulness. Automatic detection of immobility was performed by applying a threshold detection routine to the angular speed calculated from gyroscopic data as described in Chapter 7 and Pasquet et al. (2016). When data from inertial sensors was not available, position data was used instead. LFP data was visualized using Neuroscope (Hazan et al. 2006) and channels with distinct spindles during sleep (mPFC) and theta oscillations during exploration (HPC) were identified. All immobility periods where the z-scored LFP signal filtered in the spindle band (9-17 Hz) exceeded a k-means identified threshold (Supplementary Figure 9.5a) were classified as SWS. The remaining immobility periods where the ratio between the theta (6-9 Hz) and delta (0.5-4Hz) power of the hippocampal LFP signal exceeded 1 and were followed by a SWS period by less than 1 min were classified as REM (Supplementary Figure 9.5b). The remaining immobility was classified as freezing, excluding those periods followed by SWS within 1 min, classified as immobile wakefulness.

Ripple detection To detect hippocampal ripple events, we first detrended the LFP signals and used the Hilbert transform to compute the ripple band (100–250 Hz) amplitude for each channel recorded from the CA1 pyramidal layer. We then averaged these amplitudes, yielding the mean instantaneous ripple amplitude. To exclude events with high spectral power not specific to the ripple band, we then subtracted the mean high-frequency (300–500 Hz) amplitude (if the difference was negative, we set it to 0). Finally, we z-scored this signal, yielding a corrected and normalized ripple amplitude $R(t)$. Ripples were defined as events where $R(t)$ crossed a threshold of 3s.d. and remained above 1s.d. for 30 to 110 ms.

9 Consolidation of Fear Extinction Memory Traces in the Hippocampal-Amygdalo-Prefrontal Network during Sleep

Rat	Day	subsession 1	subsession 2	subsession 3	subsession 4	subsession 5
362	Hab 1	Sleep 1	A (sounds)	Sleep 2	B	Sleep 3
362	Hab 2	Sleep 1	B (sounds)	Sleep 2	A	Sleep 3
362	FC 1	Sleep 1	A (sounds+shock)	Sleep 2	B	Sleep 3
362	FC 2	Sleep 1	B	Sleep 2	A (sounds+shock)	Sleep 3
362	Ext 1	Sleep 1	A	Sleep 2	B (sounds)	Sleep 3
362	Ext 2	Sleep 1	B (sounds)	Sleep 2	A	Sleep 3
362	Ext 3	Sleep 1	A	Sleep 2	B (sounds)	Sleep 3
362	Ext 4	Sleep 1	B (sounds)	Sleep 2	A	Sleep 3
362	Ext 5	Sleep 1	A	Sleep 2	B (sounds)	Sleep 3
362	Ext 6	Sleep 1	B (sounds)	Sleep 2	A	Sleep 3
362	FR	Sleep 1	A (sounds)	Sleep 2	B (sounds)	Sleep 3
370	Hab 1	Sleep 1	B (sounds)	Sleep 2	A	Sleep 3
370	Hab 2	Sleep 1	A (sounds)	Sleep 2	B	Sleep 3
370	FC 1	Sleep 1	B	Sleep 2	A (sounds+shock)	Sleep 3
370	FC 2	Sleep 1	A (sounds+shock)	Sleep 2	B	Sleep 3
370	Ext 1	Sleep 1	B (sounds)	Sleep 2	A	Sleep 3
370	Ext 2	Sleep 1	A	Sleep 2	B (sounds)	Sleep 3
370	Ext 3	Sleep 1	B (sounds)	Sleep 2	A	Sleep 3
370	Ext 4	Sleep 1	A	Sleep 2	B (sounds)	Sleep 3
370	Ext 5	Sleep 1	B (sounds)	Sleep 2	A	Sleep 3
370	Ext 6	Sleep 1	A	Sleep 2	B (sounds)	Sleep 3
370	Ext 7	Sleep 1	B (sounds)	Sleep 2	A	Sleep 3
370	Ext 8	Sleep 1	A	Sleep 2	B (sounds)	Sleep 3
370	Ext 9	Sleep 1	B (sounds)	Sleep 2	A	Sleep 3
370	Ext 10	Sleep 1	A	Sleep 2	B (sounds)	Sleep 3
370	Ext 11	Sleep 1	B (sounds)	Sleep 2	A	Sleep 3
370	FR	Sleep 1	B (sounds)	Sleep 2	A (sounds)	Sleep 3
386	Hab 1	Sleep 1	A (sounds)	Sleep 2	B	Sleep 3
386	Hab 2	Sleep 1	B (sounds)	Sleep 2	A	Sleep 3
386	FC 1	Sleep 1	A (sounds+shock)	Sleep 2	B	Sleep 3
386	FC 2	Sleep 1	B	Sleep 2	A (sounds+shock)	Sleep 3
386	Ext 1	Sleep 1	A	Sleep 2	B (sounds)	Sleep 3
386	Ext 2	Sleep 1	B (sounds)	Sleep 2	A	Sleep 3
386	Ext 3	Sleep 1	A	Sleep 2	B (sounds)	Sleep 3
386	Ext 4	Sleep 1	B (sounds)	Sleep 2	A	Sleep 3
386	Ext 5	Sleep 1	A	Sleep 2	B (sounds)	Sleep 3
386	FR	Sleep 1	B (sounds)	Sleep 2	A (sounds)	Sleep 3
392	Hab 1	Sleep 1	A (sounds)	Sleep 2	B	Sleep 3
392	Hab 2	Sleep 1	B (sounds)	Sleep 2	A	Sleep 3
392	FC 1	Sleep 1	B	Sleep 2	A (sounds+shock)	Sleep 3
392	FC 2	Sleep 1	A (sounds+shock)	Sleep 2	B	Sleep 3
392	Ext 1	Sleep 1	B (sounds)	Sleep 2	A	Sleep 3
392	Ext 2	Sleep 1	A	Sleep 2	B (sounds)	Sleep 3
392	Ext 3	Sleep 1	B (sounds)	Sleep 2	A	Sleep 3
392	Ext 4	Sleep 1	A	Sleep 2	B (sounds)	Sleep 3
⋮	⋮	⋮	⋮	⋮	⋮	⋮

Rat	Day	subsession 1	subsession 2	subsession 3	subsession 4	subsession 5
⋮	⋮	⋮	⋮	⋮	⋮	⋮
392	Ext 5	Sleep 1	B (sounds)	Sleep 2	A	Sleep 3
392	Ext 6	Sleep 1	A	Sleep 2	B (sounds)	Sleep 3
392	Ext 7	Sleep 1	B (sounds)	Sleep 2	A	Sleep 3
392	Ext 8	Sleep 1	A	Sleep 2	B (sounds)	Sleep 3
392	FR	Sleep 1	B (sounds)	Sleep 2	A (sounds)	Sleep 3
399	Hab 2	Sleep 1	B	Sleep 2	A (sounds)	Sleep 3
399	Hab 1	Sleep 1	B (sounds)	Sleep 2	A	Sleep 3
399	FC 1	Sleep 1	B	Sleep 2	A (sounds+shock)	Sleep 3
399	FC 2	Sleep 1	A (sounds+shock)	Sleep 2	B	Sleep 3
399	Ext 1	Sleep 1	B (sounds)	Sleep 2	A	Sleep 3
399	Ext 2	Sleep 1	A	Sleep 2	B (sounds)	Sleep 3
399	Ext 3	Sleep 1	B (sounds)	Sleep 2	A	Sleep 3
399	Ext 4	Sleep 1	A	Sleep 2	B (sounds)	Sleep 3
399	Ext 5	Sleep 1	B (sounds)	Sleep 2	A	Sleep 3
399	Ext 6	Sleep 1	A	Sleep 2	B (sounds)	Sleep 3
399	FR	Sleep 1	B (sounds)	Sleep 2	A (sounds)	Sleep 3
401	Hab 1	Sleep 1	B	Sleep 2	A (sounds)	Sleep 3
401	Hab 2	Sleep 1	B (sounds)	Sleep 2	A	Sleep 3
401	FC 1	Sleep 1	B	Sleep 2	A (sounds+shock)	Sleep 3
401	FC 2	Sleep 1	A (sounds+shock)	Sleep 2	B	Sleep 3
401	Ext 1	Sleep 1	B (sounds)	Sleep 2	A	Sleep 3
401	Ext 2	Sleep 1	A	Sleep 2	B (sounds)	Sleep 3
401	Ext 3	Sleep 1	B (sounds)	Sleep 2	A	Sleep 3
401	Ext 4	Sleep 1	A	Sleep 2	B (sounds)	Sleep 3
401	Ext 5	Sleep 1	B (sounds)	Sleep 2	A	Sleep 3
401	Ext 6	Sleep 1	A	Sleep 2	B (sounds)	Sleep 3
401	Ext 7	Sleep 1	B (sounds)	Sleep 2	A	Sleep 3
401	Ext 8	Sleep 1	A	Sleep 2	B (sounds)	Sleep 3
401	Ext 9	Sleep 1	B (sounds)	Sleep 2	A	Sleep 3
401	Ext 10	Sleep 1	A	Sleep 2	B (sounds)	Sleep 3
401	FR	Sleep 1	B (sounds)	Sleep 2	A (sounds)	Sleep 3

Table 2: Detailed behavioral protocol for all animals. Each recording day included 5 subsessions. Hab: habituation; FC: fear conditioning; Ext: extinction; FR: fear renewal; A: context A; B: context B; sounds: presentation of CS+ and CS-; shock: pairing of footshock (US) at the end of CS+ presentation.

9.5 Supplementary Figures

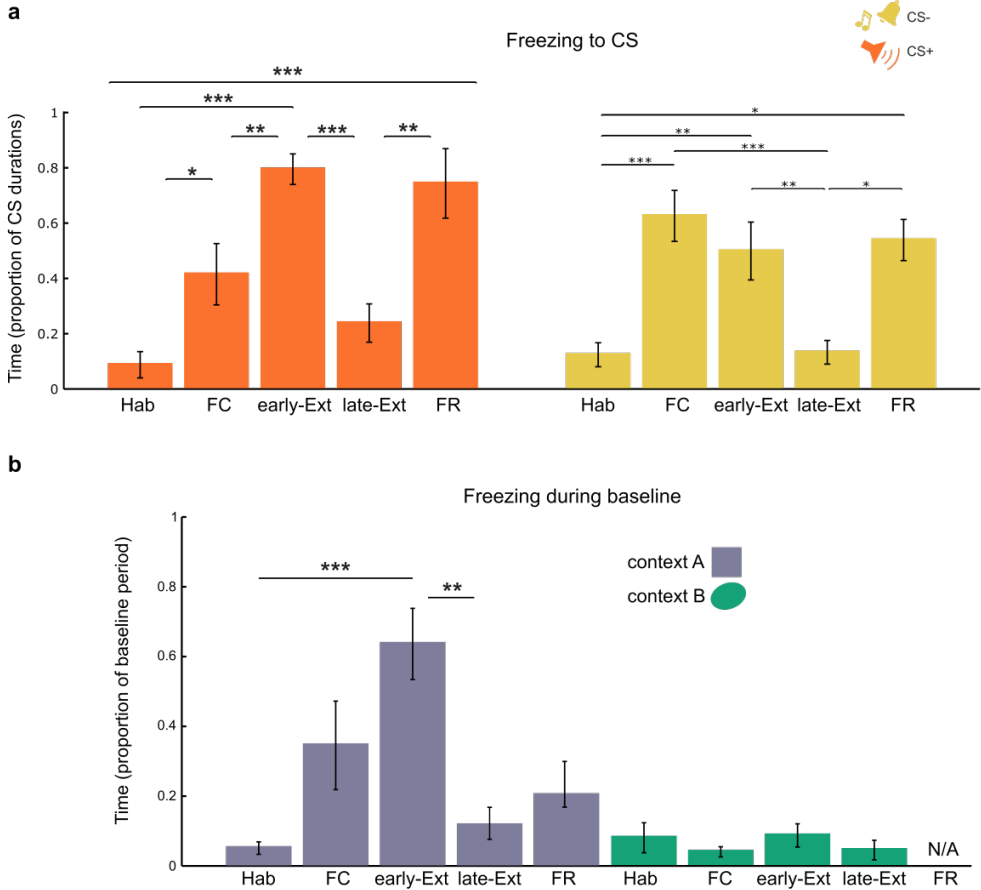

Figure 9.4: Complete results of the statistical comparisons of freezing at different stages of the protocol. (a) Proportion of time spent freezing during the first two CS+ (left) or CS- (right) presentations. Same format as in 9.1d but with all the statistical comparisons between learning stages. (b) Proportion of time spent freezing during the baseline period in contexts A and B. Same as in 9.1e but with all the statistical comparisons between learning stages. All statistical tests are paired t-tests, Bonferroni corrected for multiple comparisons. * $p < 0.05$, ** $p < 0.01$, *** $p < 0.001$

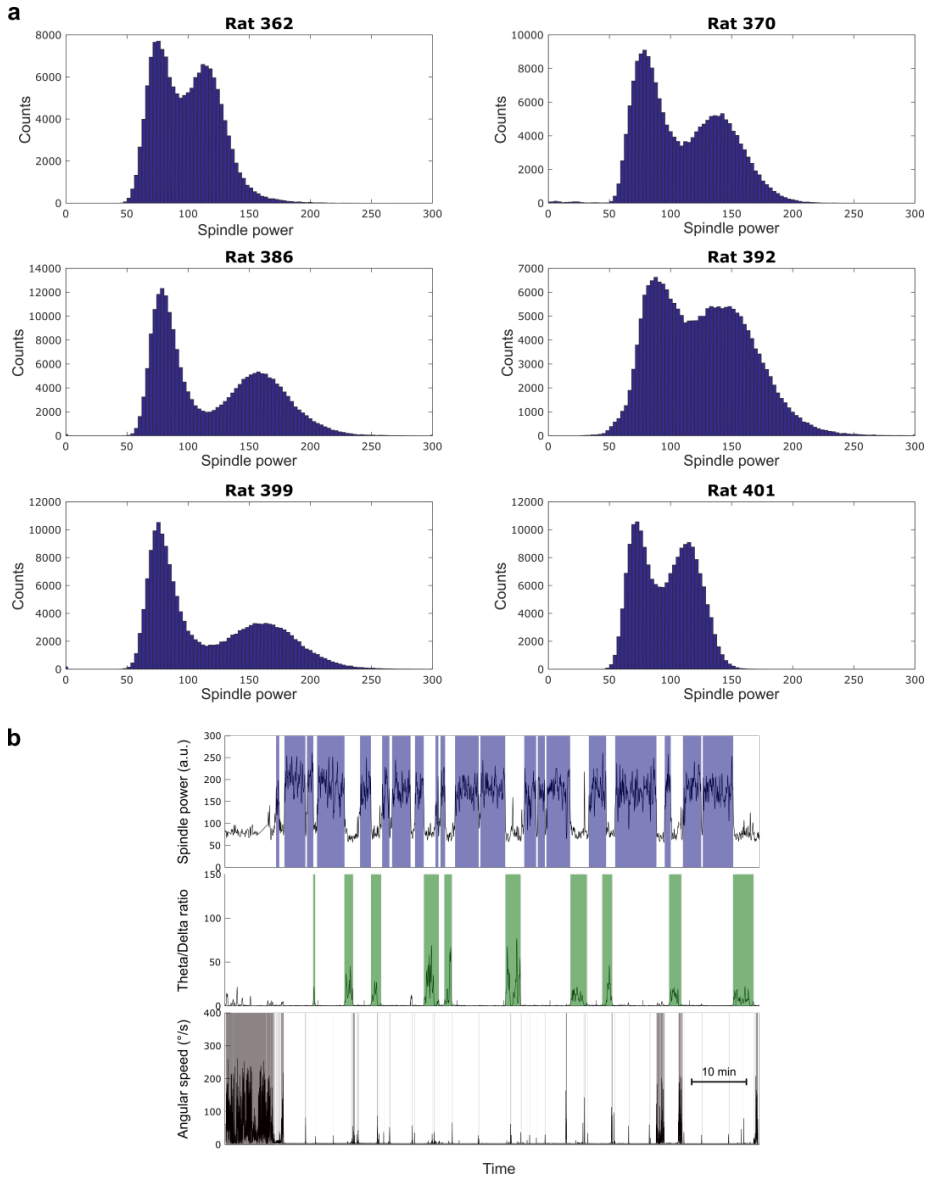

Figure 9.5: Sleep scoring. (a) Sleep threshold identification from mPFC LFP. Distributions of the spindle power. For each rat the minimum between the two peaks of the distributions was taken as the threshold for sleep detection during periods of immobility. (b) Example of sleep scoring for $\sim 1\text{h}30$ of recording in the flower pot. Top: Power of the prefrontal LFP signal filtered in the spindle band (9-17 Hz). Violet squares mark the episodes scored as SWS. Middle: Ratio between the theta (6-9 Hz) and delta (0.5-4 Hz) power of the LFP from electrode in the HPC. Green squares mark the episodes scored as REM. Bottom: Angular speed of the animal's head. Gray squares mark episodes of non-immobility.

9 Consolidation of Fear Extinction Memory Traces in the Hippocampal-Amygdalo-Prefrontal Network during Sleep

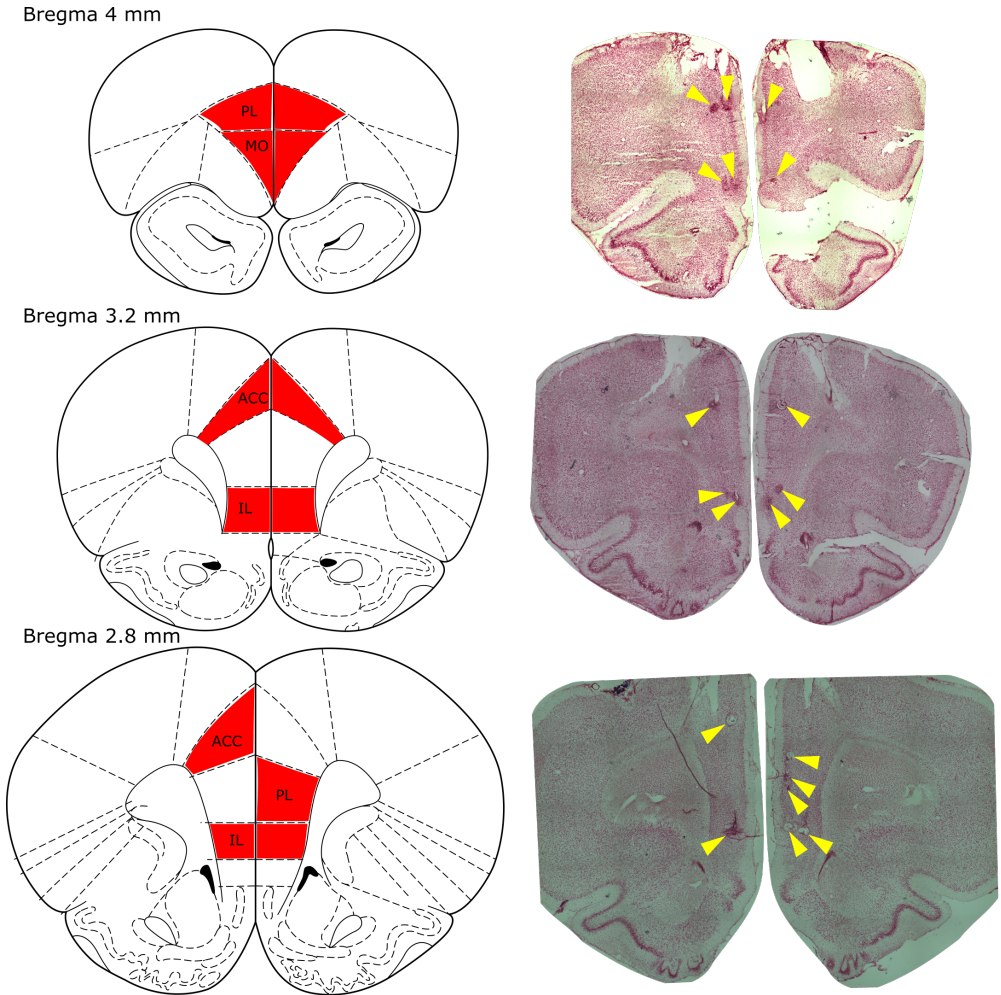

Figure 9.6: Representative electrode positions in the mPFC. (right) Three representative brain slices containing some mPFC recording sites from one of the rats. Yellow arrows indicate the sites of the electrolytic lesions and hence of the electrode bundles tips. (left) Anatomical diagrams corresponding to the the coronal slices on the right. The brain areas where the electrodes were respectively located are indicated in red.

ACC=Anterior Cingulate Cortex; IL=Infralimbic cortex; MO=Medial Orbital cortex; PL=Prelimbic Cortex

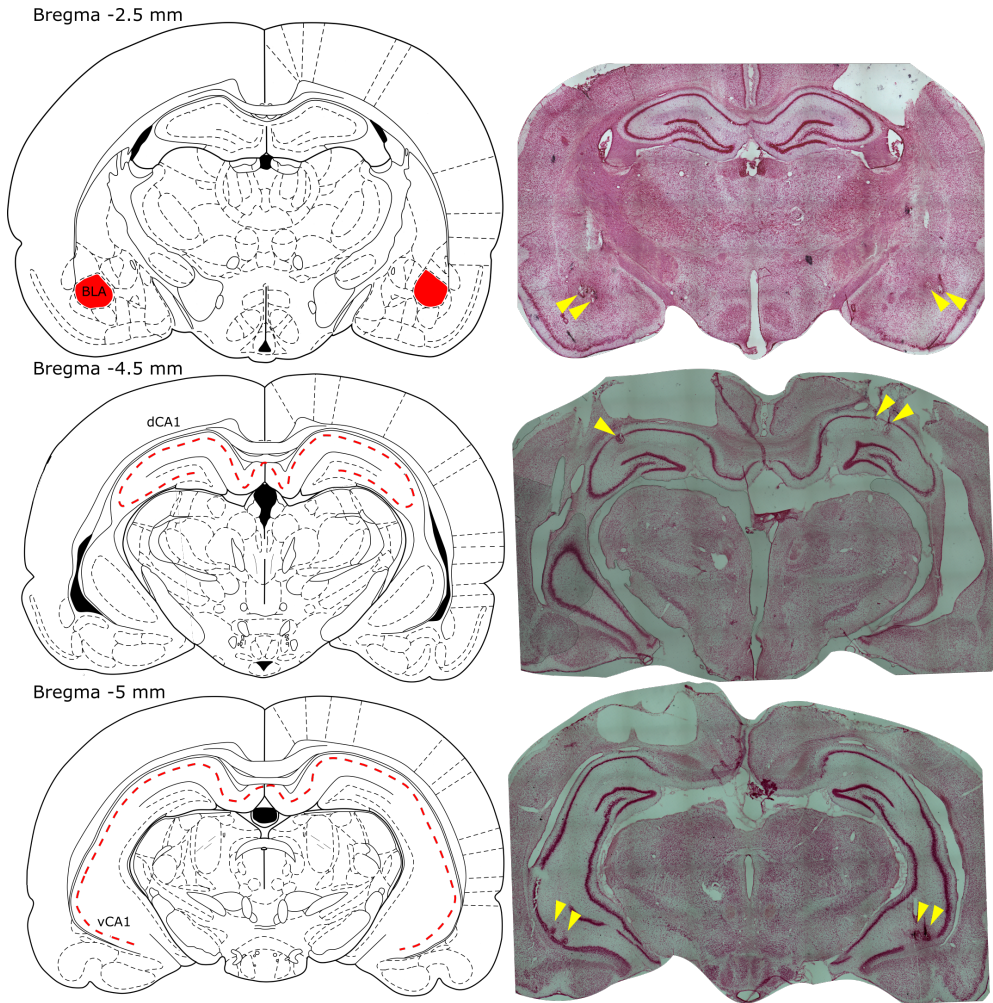

Figure 9.7: Representative electrode positions in the BA and HPC. (right) Three representative brain slices of the BA and dorsal and ventral HPC from the same rat of 9.6. The format is the same as Supplementary Figure 9.6. (left) Anatomical diagrams corresponding to the the coronal slices on the right. BLA=Basolateral Amygdala; dCA1=CA1 field of the dorsal HPC; vCA1=CA1 field of the ventral HPC

Part III

General Discussion

10 Overcoming the Limits of Current Rodent Models of Fear Learning

10.1 The Limits of Fear Behavioral Measurements

One of the aims of this thesis work was to contribute to the methodological and conceptual advancements of current rodent models of fear behavior. In this regard we worked on two issues. The first concerns the fact that in a typical fear conditioning experiment with rodents the animals are exposed to an extremely impoverished environment. The second problem concerns the predominant measure for fear, freezing, and more particularly, finding a reliable way to measure it.

10.1.1 Developing more “Naturalistic” Tasks for the Study of Fear Behavior

A standard fear conditioning experiment takes place with a rather simple behavioral protocol. There are very few parameters to control, which is also one of the reasons why fear conditioning is a reliable and powerful model. However, two major shortcomings derive from using this simple behavioral task.

The Reductionism Bias of very Simplified Behavioral Tasks

The first shortcoming is the risk of bias due to the reductionism of the behavioral test itself (Krakauer et al. 2017). Indeed, the use of non eco/etho-logically relevant tasks may induce non-natural behavioral profiles that do not occur in the real world and therefore lead experimenters to study the neural correlates of behavioral patterns that never happen¹. The approach of using simple tasks

¹It is important to note that this bias may also go in the other direction, from neural activity to behavior. Modern technologies such as optogenetics that allow us to manipulate neural activity, although an important tool for testing putative causal roles of neural dynamics over behavior, can be source of a reductionist bias. Indeed, non-physiological patterns of stimulation of neural activity may generate unknown and potentially unnatural neural patterns, in turn inducing behavioral patterns outside the natural repertoire.

can still help to answer questions about neural circuit mechanisms and to confirm how these may implement the neural computations necessary to execute real-life behaviors. However, the simplification of these models should not limit or bias our conception of the many types of fearful and anxious behavior and their underlying brain functions. Indeed, data obtained from ‘simple’ models should be compared with the results obtained employing tasks where the animals have a behavioral repertoire closer to real-life situations. This can reveal whether the identified neurophysiological mechanisms also underlie more natural behavior. In such tasks the animals should be able to perform multiple defensive behaviors, which may also prove instrumental in distinguishing the neural mechanisms of processing fearful stimuli from the neural bases of the production of specific defensive behaviors (Headley et al. 2019).

Shortcomings of an Impoverished Behavioral Readout

Another problem with the simplified environment where tests for conditioned fear and extinction usually take place is that animals have nothing to do there. Exploration of the chamber and contextual encoding and/or recognition can require some cognitive engagement in the first few minutes. However, after this, the animals become progressively less cognitively engaged (apart from the moments in which specific stimuli are presented). In such a context, a potential risk is to interpret the neural correlates of arousal and attentional responses as those of fear expression.

Furthermore, all behavior that is not a defensive response (usually only freezing is assessed) is typically interpreted as absence of fear. Therefore, analyses of the neural correlates of fearful vs. fearless states are reduced to contrasting fear expression against everything else. If one is certain that all non-assessed behaviors are fearless, then this contrast would be valid. However, many non-freezing behaviors may still be expression of fear. Ideally, to know what a given neural pattern encodes, it must be confirmed with respect to multiple behavioral variables.

These long periods of unknown behavior give rise to additional interpretation issues. Indeed, after the expression of a defensive behavior, it is hard to know whether the measured physiological variables (such as neuronal firing) underly the inhibition of defensive behaviors, fear extinction learning, a combination of these, or rather other mental and behavioral activities. This is specifically problematic when recording neural activity where the recorded biological signal is continuous and with high temporal resolution (as in electrophysiology)². In cued fear conditioning experiments, this problem is partially resolved by looking at the moments of presentation of the CS, which provide a clear temporal

²One of reasons why spatial behavior is such a successful model in behavioral neuroscience is possibly at least in part because it provides a continuous behavioral readout, the position in space of the animal, to correlate with brain activity.

marker around which to study neural activity. However, inter-trial intervals remain long periods without a clear behavioral readout.

Extinction Training while Foraging in a Large Arena

During my thesis, one aim was to develop a task where the animals could perform a spectrum of different behaviors. An ideal task would permit the emergence of additional inapprehensive behavioral patterns which could be specifically measured and used as salient controls of fearful behaviors, instead of simply lack of known behavior. Some researchers solved this problems by requiring the animals to perform a spatial task where specific locations are associated with aversive events (e.g., Wu et al. 2017; Ormond et al. 2019; Girardeau et al. 2017). Here, we wanted to be able to directly compare our results with the literature on Pavlovian conditioning in traditional chambers where only freezing behavior is assessed and which are the most widely used paradigms to asses learned fear³. Moreover, we wanted the animals to perform only spontaneous behaviors in order to also reveal potential natural biomarkers for predisposition to anxiety.

Hence, we developed the extinction foraging task described in Chapter 7. The arena was inspired by paradigms used to study the spatially-modulated activity of place cells, where the animals freely explore an environment looking for food pellets. This kind of task is comparable, for example, to the task by Moita et al. 2003, who showed that place cells acquire location specific responses to the CS after conditioning. The arena was conceived with wide dimensions, in order to be able to eventually record remapping of vHPC place cells, which have very wide place fields (Kjelstrup et al. 2008). A serendipitous outcome of this choice was the identification of the CS-evoked running behavior (cf. Chapter 7), which is likely influenced by the size of the environment and harder to observe and/or quantify in smaller ones.

We have not (yet) recorded brain activity while animals performed this task. However, as discussed in Chapter 7, a behavioral experiment allowed to show that using complex environments where the animals can display multiple behavioral profiles may be informative for studying inter-individual differences in fear behavior and relapse, a crucial issue in translational research.

10.1.2 Shortcomings of Measuring Fear with Freezing Behavior

As discussed in Chapter 1, assessing fear is a difficult endeavor, since it requires inferring an emotion from animals' behavioral patterns. Freezing is an

³Paradigms involving the conditioned suppression of behavior being less used in recent years.

ecologically and ethologically relevant behavior that was shown to be also relevant in clinical research (see 1.4.3). However, it has not been proven to be an unitary metric for fear in rodents. Critically, our results of Chapter 7 suggest that freezing may not be the best indicator of some animals' fear in certain environments and of their relative probability of being scared elsewhere.

Freezing behavior can also be difficult to measure. While reliable and precise measurement requires automatic scoring methods, all such methods reduce freezing scoring to immobility detection. However, the assumption that all periods of animal immobility correspond to fear is questionable. Indeed, in Chapter 9 we show that freezing and sleeping can be confounded. Therefore, in the framework of studying spontaneous behavior over long periods (for instance, to study memory consolidation during sleep) it is essential to find reliable methods to distinguish between resting and freezing, which are completely different brain and behavioral states.

A potential means to distinguish fearful from other types of immobility could be to measure additional physiological parameters. For instance, both skin conductivity and cardiac rhythms have been proposed to be reliable indicators of fear (cf. 1.4.3). We have started using head-mounted inertial sensors to score immobility (as described in Chapter 6), with the hope that inertial measurement could be used to detect respiratory rhythms during immobility, potential indicators of fear. Although we were able to detect breathing in some cases (data not shown), this was the exception rather than the rule. Moreover, this varied between subjects and even between immobility episodes, making it an unreliable measure.

Therefore, we still use immobility as our definition of freezing in experiments without a neural readout (Chapter 7). However, we have shown that when LFP recordings are available, it is possible to rule out sleep from the equation (Chapter 9). This is likely to be the case also with EEG recordings.

Even though inertial sensors did not change our definition of freezing in animals without LFP data, developing their use for the automatic scoring of freezing was an important step in our research program. The specific wireless system that we tested in Chapter 6 was also used in the project described in Chapter 7. Given the size of the environment in that project, the availability of a wireless system was essential. The use of inertial sensing devices to detect immobility is advantageous also for other reasons: their sensitivity to micro-movements is very high, they detect immobility onsets and offsets with very high temporal resolution, and their use is easily scalable from one environment to another (no hardware needed in the environment itself, and no need to tune detection parameters in every environment like in video-based methods, cf. 1.4.3).

10.2 Sleep as a Measure to Disambiguate between Fear Behavior and Fear Learning Neural Correlates

Another difficulty in the field of research of fear memory is that learning is measured by the expression of fear behavior. This leads to the question of whether any observed deficits are to be explained by neural substrates involving learning (the state of the memory trace) or by those required for the expression of fear-related behaviors (cf. learning vs. performance dilemma, 1.5). One possible solution to this ambiguity can be found in the neural activity during sleep, which is the aim of our project described in Chapter 9. Indeed, if a neural pattern that is correlated with learning and recorded during the awake period is reinstated during sleep (when, by definition, behavior is absent), it is possible to corroborate the hypothesis that such neural activity is learning-related.

10.2.1 Who Reads mPFC Cell Assemblies Reactivation During Sleep?

It is believed that neural patterns of co-activation such as cell assemblies, may be particularly relevant for learning and plasticity mechanisms (cf. 3.1.2). In Chapter 8, we report a novel method (ICECAP) to detect cell assemblies that outperform currently used methods. A major benefit deriving from the use of our method compared to common PCA and ICA techniques (Peyrache et al. 2010; Lopes-dos-Santos et al. 2013) is in terms of interpretation: in ICECAP, participation of single cells to an assembly is binary and therefore assembly members are known. Note that this does not mean that an assembly is active only when all its members are, but rather that the assembly has an exact identity in terms of the list of member cells among the sampled neural population.

From a dataset of 189 units, with ICECAP, we were able to detect 274 cell assemblies composed by 3-7 cells each for the 20 ms timescale alone. Even though these high numbers are far smaller than the maximum number of total combinations (1.59×10^{11} only for assemblies between 3 and 7 members), the question remains whether all detected assemblies have physiological significance. To this end, we are currently looking for potential 'readers' (see Buzsáki 2010) of mPFC cell assembly activity. An interesting candidate in the framework of extinction learning is the BA, which is bidirectionally connected with the mPFC (see 2.3.2), and whose afferent projections from the mPFC are implicated in extinction learning (cf. 2.3.3; Adhikari et al. 2015).

The BA Reads mPFC Assemblies Activations With a PhD student in the lab, Céline Boucly, we are currently analyzing BA neurons' responses to mPFC

assembly reactivations during sleep. Preliminary results show that single BA neurons respond to mPFC assembly activations. This analysis can benefit from ICECAP, in particular in providing assemblies with univocal identities, which can help to demonstrate the specificity of the BA response to a given assembly rather than to any bursts of firing activity in mPFC.

Since the parallel pathways connecting the dmPFC and vmPFC respectively to the BLA and BMA have been shown to have opposite roles on fear extinction, one possibility is that BMA and BLA preferentially read vmPFC and dmPFC assemblies. Moreover, the balance between vmPFC→BMA vs. dmPFC→BLA information exchange during sleep may underlie the strength of extinction memory consolidation, and it may predict performance levels on the following day. This would parallel the results of Adhikari et al. (2015) obtained during extinction encoding and further provide a potential mechanism by which the parallel pathways linking the BA and mPFC drive extinction memory consolidation.

11 Coding Differences between Ventral and Dorsal Hippocampus

This chapter briefly discusses potential data analysis projects that plan to undertake with the dataset collected in the experiment described in Chapter 9. These projects originate from our interest in understanding the functional differences of ventral and dorsal HPC.

As discussed in Chapters 2, 3, and 4, the hippocampus is widely considered to be a critical structure involved in certain types of learning processes (Maren et al. 2013; Battaglia et al. 2011, see 2.2). It is primarily known for its involvement with spatial memory and the general view is that HPC place cells and other spatially modulated neurons in nearby cortices form a neural representation of space. However, hippocampal place cells change their fields markedly when the environment or behavioral patterns are changed ('remapping', see 4.2.1).

As discussed in 2.2.1, while the HPC circuitry and connectivity is fairly constant along its longitudinal axis, there is nonetheless a gradual change of its extrinsic connectivity. While the dorsal HPC (dHPC) receives mostly visuospatial inputs, the ventral part (vHPC) afferents signal reward, motivation, and emotion. Furthermore, a growing body of evidence from lesioning and pharmacomodulatory approaches provides a general view of the dHPC as more implicated in contextual (that is, related to environmental sensory cues including sounds) coding while the vHPC would be more involved in emotional processing and learning (Fanselow and Dong 2010; Strange et al. 2014). The vHPC has received less attention than dHPC and fewer studies have recorded its neurons in freely moving animals, like because its pyramidal cells have larger and more unstable place fields compared to the dHPC.

11.1 Dorsal vs. Ventral HPC Neural Code for Fear Learning

During fear conditioning, dHPC place cells can develop responses to the CS and the US (Moita et al. 2003, cf. 4.2.2). Moreover, place cells' firing fields in the conditioning chamber remap after fear conditioning (Moita et al. 2004). Similarly, dHPC remapping also occurs during cued-fear extinction (Wang et al. 2015b). Since changes in the emotional valence associated with sensory cues

can influence dHPC spatially modulated cell activity, the dHPC place cell code is not solely modulated by the spatial-geometrical contextual cues. However, it is still unknown how vHPC neurons respond to changes in the emotional valence of contexts and whether the fear conditioning related changes of dHPC firing are correlated with changes in the vHPC.

Therefore, in future works we will aim to compare neural activity recorded in the dHPC and vHPC during contextual and cued fear conditioning, extinction and fear renewal in the experiment described in Chapter 9. Our hypothesis is that the neural activity responses to aversive cues or contexts during fear conditioning, extinction and renewal vary between dHPC and vHPC.

11.1.1 Population Coding Analysis to Study Contextual Representations

In order to study both the spatial and emotional representation in the HPC, one possibility is to use population analysis (principal component decomposition) to build activity vectors describing the activity of neurons recorded in the vHPC and dHPC networks (e.g. Rozeske et al. 2018). We predict that neurons in both the dHPC and the vHPC would develop representations for different contexts ('context' being used here to describe both the spatial and the emotional contexts). We expect that the population activity trajectories would form clusters representing both the different geometrical properties of the contexts and their emotional valences (for instance, whether the animal displays fear or not) together. Emotional valence of the environment will change at every learning stage: fear conditioning, extinction and renewal. Our recordings on the elevated plus maze (EPM) will be useful to assess how much the representations of learned and innate fear overlap.

The Mahalanobis distances between clusters could be used to quantify how distinct the representations are. We expect that the dHPC neuronal activity would differentiate between the two environments (contexts A and B; see Chapter 9) better than vHPC when they have the same valence. On the other hand, vHPC would rapidly adapt its population response when the emotional valence changes. More specifically, the change in vHPC population coding will correlate better with changes of the emotional valence of a context than to physical changes of spatial context. The population analysis may reveal separated clusters in the dHPC too, but they might emerge temporally after the vHPC and with shorter Mahalanobis distances. Habituation days will serve as a control for spatial changes without emotional valence and also, the data across the two days of habituation can be used as a control for the effect of time on the population coding separation.

We would also look for learning-, extinction- or renewal-related creation of cell assemblies in the vHPC and dHPC and we plan to examine their reactivations

during subsequent slow wave-sleep and REM sleep, using the sleep recordings before the session when learning took place as a control. It is possible that some of these assemblies may share members from both structures in the same assembly. Our hypothesis is that new pan-hippocampal cell assemblies would emerge following the changes in vHPC contextual representation after emotional valence changes and such pan-hippocampal cell assemblies may drive changes in the dHPC representation of the context in the sense of its emotional component.

We also hypothesize that reactivation of these pan-hippocampal assemblies will occur during SWS and will predict changes in learned behavior in the subsequent session.

Recording the same units across consecutive days Another aspect that would be interesting to investigate is how single units are recruited in the contextual representations across learning. However, to study this over extinction learning, it is necessary to record the same units across multiple days. Our preliminary analysis in this direction are promising. Indeed, identifying the same cells from consecutive days based on waveform similarity (Sosa et al. 2019; Schmitzer-Torbert and Redish 2004) indicates that we were able to record the same unit for multiple days in several hundred cases per rat, for up to 11 days (data not shown).

Hippocampal vs. Amygdalar and Prefrontal Contextual Codes While the hypotheses described above are particularly relevant for the hippocampus in light of its involvement in contextual encoding, the same analyses could also be applied to our AMG and mPFC data. Population activity outside the HPC is likely to code for both the geometrical and emotional contexts. Indeed the mPFC has been shown to process contextual information in concert with the HPC (Hyman et al. 2012; Zelikowsky et al. 2014).

Our simultaneous recordings of the HPC, AMG, and mPFC would allow us to test which structure display the most emotionally-modulated contextual coding properties. A previous report suggested that the ACC has a more efficient code than the HPC for geometrical context changes – fewer ACC neurons were needed to decode which context the animal was in (Hyman et al. 2012). However, it is possible that mPFC code may be more efficient but less specific and that HPC ensemble activity may better describe both geometrical and emotional contextual transitions, as we predict.

11.2 Dorsal vs. Ventral HPC Neural Code for Spatial Learning

Although without crucial relevance for models of psychopathology, we are also interested in characterizing the functional differences between the dHPC and vHPC in spatial memory encoding and consolidation. When exploring an environment, the activity of dHPC place cells reflects the traveled trajectories on multiple timescales (Skaggs et al. 1996; Foster and Wilson 2007). While successively crossing contiguous place fields running across the environment, place cells fire sequentially, therefore representing the animal's trajectory on a behavioral timescale (seconds). During exploratory behavior the hippocampal LFP is dominated by theta oscillations, and *theta sequences* of the same place cells are nested in a theta cycle. Thus within one cycle, place cells with overlapping firing fields fire in a sequence (~120 ms) that reflects the order of the crossed place fields on a compressed timescale.

It was recently shown that intact hippocampal theta sequences underly replay during subsequent sleep (Drieu et al. 2018). It is then possible that theta sequences are the mechanisms supporting the encoding of trajectories. However, to my knowledge, all of the studies involving theta sequences have only involved place cells in the dHPC.

What is still unknown is whether the place cells of the vHPC also participate in theta sequences and, if so, whether these sequences reflect traveled trajectories in space. To test this, we will take advantage of our simultaneous recordings in the vHPC and dHPC while the animals explored an EPM. These recordings took place the days preceding and following the fear conditioning, extinction, and renewal protocol described in Chapter 9.

Emotionally-biased spatial encoding in the vHPC Since vHPC cells tend to over-represent the anxiogenic locations of an environment to a greater extent than dHPC cells (Ciochi et al. 2015, cf. 4.2.2), one possibility is that time compression of traveled trajectories by theta sequences would over-represent the transitions between safe and open arms on the EPM. This would suggest that the vHPC encodes spatial transitions that are emotionally relevant with more precision.

11.3 Dorsal vs. Ventral HPC Communication with the mPFC

As discussed in Chapter 2, the connections between the HPC and the mPFC are asymmetric, with very sparse projections described from the mPFC to both the dorsal and ventral HPC, and with mostly the ventral portions of the HPC

directly targeting mPFC neurons (see 2.3.2). Recent studies have reported monosynaptic connections from the mPFC to both the dorsal and ventral HPC and ruled out the possibility that mPFC→HPC communication take place only via multisynaptic pathways. However, since these direct pathway appear to be very sparse, intermediary structures such as the thalamic nucleus reuniens (NR; cf. 2.4.1) are likely to play a major role in mPFC-HPC communication. NR is of notable interest as its cells send dense, bidirectional projections to both the dorsal and the ventral HPC as well as the mPFC (Vertes 2006; Varela et al. 2014). Moreover, multiple reports suggest a crucial role of the NR in relaying information between these structures (Hembrook et al. 2012; Xu and Südhof 2013; Ito et al. 2015b; Griffin 2015).

Indeed, tight functional relationships exist between the mPFC and dHPC during memory encoding, consolidation, and retrieval. However, while vHPC→mPFC projections are dense, dHPC→mPFC direct projections reported so far are very sparse. Therefore the NR is an important candidate, together with the entorhinal cortex, in mediating dHPC-mPFC communication.

11.3.1 The Nucleus Reuniens as a Communication Buffer between the HPC and mPFC during Fear Memory Consolidation

One possibility is that intermediate structures such as the NR may bias the occurrence of rhythmic events and thus enhance the temporal coordination between the HPC and mPFC; such a process might affect the dHPC and vHPC differently. Crucially, the NR has been implicated in both the acquisition and consolidation for fear memory (cf. 2.4.1) One way to test this would be to analyze HPC-mPFC coupling during sleep. It is known that memory consolidation depends upon the temporal coordination between dHPC ripples and neocortical delta waves and spindles (Maingret et al. 2016) and the NR may act as a relay between the dHPC and the mPFC.

Since the vHPC has its own dense direct projections to the mPFC, it would not necessarily require an intermediate structure such as the NR for its dialogue with the mPFC. This could be tested by examining NR firing in between HPC ripples and mPFC spindles. One possibility is that NR displays high firing after an dHPC ripple only when the latter is followed by a cortical spindle. This result would reinforce the idea that the NR acts a buffer to relay information between the dHPC and mPFC. Our hypothesis is that this relay mechanism would not be present between vHPC ripples and mPFC spindles since the inactivation of the NR impairs the acquisition of contextual, but not auditory cued, fear conditioning (Xu and Südhof 2013; Ramanathan et al. 2018). This analysis could suggest a potential mechanism by which the dHPC sends contextual information to the mPFC during fear memory consolidation.

11 Coding Differences between Ventral and Dorsal Hippocampus

Critically, our chronic electrophysiology experiment (Chapter 9) also involved electrodes targeting the NR, which will allow us to perform the above analysis in the future.

12 Conclusions

During this PhD work, we aimed to study the behavioral processes characterizing fear extinction, and the neural mechanisms supporting extinction learning. Indeed, as argued in Chapter 10, it is not possible to unveil the neurophysiology of behavior without first dissecting and drawing the boundaries of the employed behavioral model. For this reason, in the first chapter of this manuscript, I discussed in detail the dynamics of rodent behavior during fear learning paradigms.

One of the things that one might find frustrating is the ill definition of the predominant fear expression index used in rodent experimental settings: freezing. Far be it from me to contest the validity of freezing as a measure of fear, nonetheless I am convinced that current standard measures are not rigorous enough. I am moreover persuaded that there is much to gain going beyond freezing as a unitary and binary measure of fear.

These considerations motivated the experimental work described in the chapters 6, 7, and partly 9. Although our inertial measurement unit (Chapter 6) does not allow to go beyond immobility detection to score freezing, it identifies the absence of movement with very high temporal precision and provides the signal to also detect other behavioral patterns with easy portability across testing environments (Chapter 7). Moreover, we showed, to our knowledge for the first time, how to separate sleeping from freezing with inertial and LFP signals (Chapter 9). In particular, for the first time, we suggest the use of the power of the LFP signal in the spindle band to detect sleep epochs.

With the aim of developing novel paradigms to overcome the sole measurement of freezing during fear learning, extinction training while foraging in an open field is promising (Chapter 7). This protocol allowed the acquisition of a multidimensional behavioral dataset that we used to show that freezing expression does not transfer linearly across environments. Namely, individuals freezing less in a given setting may be those more susceptible to relapse elsewhere. This result is critical, since the capacity to separate animals according to different resiliency and vulnerability profiles is key in the framework of translational neuroscience.

In chapter 4, I reviewed the growing literature describing the neural processes supporting fear behavior control, with focus on major discoveries reported in

recent years. Yet the current knowledge about potential network dynamics supporting extinction learning is insufficient. That is why we are thrilled by the dataset we collected with the experiments described in Chapter 9, which will allow us to study circuit level dynamics of a large neural population across several brain structures over many days of learning.

The yield of our experiments prompted the development of the algorithm illustrated in Chapter 8, which provides us with a new method suited to analyze neural synchronization dynamics from our large dataset. Therefore, we look forward to the data analysis, which has the potential to show for the first time network mechanisms mediated by the hippocampus-medial prefrontal cortex system potentially underpinning extinction learning.

Finally, we hope that this analysis will provide us with clear electrophysiological markers and neural patterns of information exchange between the hippocampus and the medial prefrontal cortex during extinction memory consolidation. This will permit us to use our optogenetic approach (Chapter 5) to timely control the pathway connecting these structures with physiologically plausible patterns of stimulation, and test the causality of our observations.

Bibliography

- Adenauer, Hannah, Claudia Catani, Julian Keil, Hannah Aichinger, and Frank Neuner (2010): "Is freezing an adaptive reaction to threat? Evidence from heart rate reactivity to emotional pictures in victims of war and torture". In: *Psychophysiology* 47.2, pp. 315–322.
- Adhikari, Avishek, Talia N. Lerner, Joel Finkelstein, Sally Pak, Joshua H. Jennings, Thomas J. Davidson, Emily Ferenczi, Lisa A. Gunaydin, Julie J. Mirzabekov, Li Ye, Sung-yon Kim, Anna Lei, and Karl Deisseroth (2015): "Basomedial amygdala mediates top-down control of anxiety and fear". In: *Nature* 527, pp. 179–185.
- Adhikari, Avishek, Mihir A. Topiwala, and Joshua A. Gordon (2011): "Single units in the medial prefrontal cortex with anxiety-related firing patterns are preferentially influenced by ventral hippocampal activity". In: *Neuron* 71.5, pp. 898–910.
- Adhikari, Avishek, Mihir a. Topiwala, and Joshua a. Gordon (2010): "Synchronized Activity between the Ventral Hippocampus and the Medial Prefrontal Cortex during Anxiety". In: *Neuron* 65.2, pp. 257–269.
- Adolphs, R, D Tranel, and A R Damasio (1998): "The human amygdala in social judgment." eng. In: *Nature* 393.6684, pp. 470–474.
- Adolphs, R, D Tranel, H Damasio, and A Damasio (1994): "Impaired recognition of emotion in facial expressions following bilateral damage to the human amygdala." eng. In: *Nature* 372.6507, pp. 669–672.
- Adolphs, R, D Tranel, H Damasio, and AR Damasio (1995): "Fear and the human amygdala". In: *The Journal of Neuroscience* 15.9, pp. 5879–5891.
- Adolphs, Ralph and D. Tranel (2000): "Emotion recognition and the human amygdala". In: *The Amygdala: A Functional Analysis*. Ed. by John P. Aggleton. New York: Oxford University Press, pp. 587–630.
- Adrian, Edgar Douglas (1942): "Olfactory reactions in the brain of the hedgehog". In: *The Journal of physiology* 100.4, pp. 459–473.
- Akhter, F, T Haque, F Sato, T Kato, H Ohara, T Fujio, K Tsutsumi, K Uchino, B J Sessle, and A Yoshida (2014): "Projections from the dorsal peduncular cortex to the trigeminal subnucleus caudalis (medullary dorsal horn) and other lower brainstem areas in rats". In: *Neuroscience* 266, pp. 23–37.
- Akirav, Irit, Hagit Raizel, and Mouna Maroun (2006): "Enhancement of conditioned fear extinction by infusion of the GABA A agonist muscimol into the rat prefrontal cortex and amygdala". In: *European Journal of Neuroscience* 23.3, pp. 758–764.
- Alberini, Cristina M and Joseph E. LeDoux (2013): "Memory reconsolidation". In: *Current Biology* 23.17, pp. 746–750.
- Alexander, William H. and Joshua W. Brown (2011): "Medial prefrontal cortex as an action-outcome predictor". In: *Nature Neuroscience* 14.10, pp. 1338–1344.
- Allen, Timothy A and Norbert J Fortin (2013): "The evolution of episodic memory". In: *Proceedings of the National Academy of Sciences* 110.Supplement 2, pp. 10379–10386.
- Amano, T., S. Duvarci, D. Popa, and D. Pare (2011): "The Fear Circuit Revisited: Contributions of the Basal Amygdala Nuclei to Conditioned Fear". In: *Journal of Neuroscience* 31.43, pp. 15481–15489.
- Amaral, D G and J Kurz (1985): "An analysis of the origins of the cholinergic and noncholinergic septal projections to the hippocampal formation of the rat." eng. In: *The Journal of comparative neurology* 240.1, pp. 37–59.
- Amaral, David G, Norio Ishizuka, and Brenda Claiborne (1990): "Neurons, numbers and the hippocampal network". In: *Progress in brain research*. Vol. 83. Elsevier, pp. 1–11.
- Amaral, David G, Helen E Scharfman, and Pierre Lavenex (2007): "The dentate gyrus: fundamental neuroanatomical organization (dentate gyrus for

- dummies)". In: *Progress in brain research* 163, pp. 3–790.
- Amaral, David G and Menno P Witter (1989): "The three-dimensional organization of the hippocampal formation: a review of anatomical data". In: *Neuroscience* 31.3, pp. 571–591.
- Ambrogio Lorenzini, Carlo, Corrado Bucherelli, Aldo Giachetti, Laura Mugnai, and Giovanna Tassoni (1991): "Effects of nucleus basolateralis amygdalae neurotoxic lesions on aversive conditioning in the rat". In: *Physiology and Behavior* 49.4, pp. 765–770.
- Ambrose, R Ellen, Brad E Pfeiffer, and David J Foster (2016): "Reverse replay of hippocampal place cells is uniquely modulated by changing reward". In: *Neuron* 91.5, pp. 1124–1136.
- Ambrosini, M V, M Langella, U A Gironi Carnevale, and A Giuditta (1992): "The sequential hypothesis of sleep function. III. The structure of postacquisition sleep in learning and nonlearning rats". In: *Physiology & behavior* 51.2, pp. 217–226.
- Ambrosini, M V, G Mariucci, L Colarieti, G Bruscellini, C Carobi, and A Giuditta (1993): "The structure of sleep is related to the learning ability of rats". In: *European Journal of Neuroscience* 5.3, pp. 269–275.
- Amir, Alon, Drew B Headley, Seung Chan Lee, Darrell Hauffer, and Denis Paré (2018): "Vigilance-Associated Gamma Oscillations Coordinate the Ensemble Activity of Basolateral Amygdala Neurons". In: *Neuron* 97.3, 656–669.e7.
- Amir, Alon, S.-C. Lee, Drew B Headley, Mohammad M Herzallah, and Denis Pare (2015): "Amygdala Signaling during Foraging in a Hazardous Environment". In: *Journal of Neuroscience* 35.38, pp. 12994–13005.
- Amorim, Felipe E, Thiago C Moulin, and Olavo B Amaral (2019): "A freely available, self-calibrating software for automatic measurement of freezing behavior". In: *bioRxiv*, p. 645770.
- Anagnostaras, S G, S Maren, and M S Fanselow (1999): "Temporally graded retrograde amnesia of contextual fear after hippocampal damage in rats: within-subjects examination." In: *The Journal of neuroscience : the official journal of the Society for Neuroscience* 19.3, pp. 1106–1114.
- Anagnostaras, Stephan G. (2010): "Automated assessment of Pavlovian conditioned freezing and shock reactivity in mice using the VideoFreeze system". In: *Frontiers in Behavioral Neuroscience* 4.September, pp. 1–11.
- Anagnostaras, Stephan G, Greg D Gale, and Michael S Fanselow (2001): "Hippocampus and Contextual Fear Conditioning: Recent Controversies and Advances". In: *Hippocampus* 17, pp. 8–17.
- Andersen, Per, Richard Morris, David Amaral, Tim Bliss, and John O'Keefe (2006): *The hippocampus book*. Oxford university press.
- Anderson, David J and Ralph Adolphs (2014): "A framework for studying emotions across species". In: *Cell* 157.1, pp. 187–200.
- Anderson, Michael I. and Kathryn J. Jeffery (2003): "Heterogeneous modulation of place cell firing by changes in context". In: *Journal of Neuroscience* 23.26, pp. 8827–8835.
- Anglada-Figueroa, David and Gregory J Quirk (2005): "Lesions of the Basal Amygdala Block Expression of Conditioned Fear But Not Extinction". In: *Journal of Neuroscience* 25.42, pp. 9680–9685.
- Annau, Zoltan and Leon J Kamin (1961): "The conditioned emotional response as a function of intensity of the US". In: *Journal of comparative and physiological psychology* 54.4, pp. 428–432.
- Anthony, Todd E., Nick Dee, Amy Bernard, Walter Lerchner, Nathaniel Heintz, and David J. Anderson (2014): "Control of stress-induced persistent anxiety by an extra-amygdala septohypothalamic circuit". In: *Cell* 156.3, pp. 522–536.
- Antoniadis, Elena A. and Robert J. McDonald (2006): "Fornix, medial prefrontal cortex, nucleus accumbens, and mediodorsal thalamic nucleus: Roles in a fear-based context discrimination task". In: *Neurobiology of Learning and Memory* 85.1, pp. 71–85.
- Applegate, Craig D, Robert C Frysinger, Bruce S Kapp, and Michela Gallagher (1982): "Multiple unit activity recorded from amygdala central nucleus during Pavlovian heart rate conditioning in rabbit". In: *Brain research* 238.2, pp. 457–462.
- Asok, Arun, Eric R Kandel, and Joseph B Rayman (2019): "The Neurobiology of Fear Generalization". In: *Frontiers in Behavioral Neuroscience* 12.January, pp. 1–15.
- Astori, Simone, Ralf D Wimmer, and Anita Lüthi (2013): "Manipulating sleep spindle-expanding views on sleep, memory, and disease". In: *Trends in neurosciences* 36.12, pp. 738–748.
- Ayres, John J B and M J DeCosta (1971): "The truly random control as an extinction procedure". In: *Psychonomic Science* 24.1, pp. 31–33.

- Azevedo, Tatiana M, Eliane Volchan, Luiz A Imbiriba, Erika C Rodrigues, José M Oliveira, Liliam F Oliveira, Luiz G Lutterbach, and Claudia D Vargas (2005): "A freezinglike posture to pictures of mutilation". In: *Psychophysiology* 42.3, pp. 255–260.
- Bach, Dominik R. and Peter Dayan (2017): "Algorithms for survival: A comparative perspective on emotions". In: *Nature Reviews Neuroscience* 18.5, pp. 311–319.
- Baddeley, Alan (2003): "Working memory: looking back and looking forward". In: *Nature Reviews Neuroscience* 4.10, pp. 829–839.
- Badrinarayan, Aneesha, Seth A Wescott, Caitlin M Vander Weele, Benjamin T Saunders, Brenann E Couturier, Stephen Maren, and Brandon J Aragona (2012): "Aversive stimuli differentially modulate real-time dopamine transmission dynamics within the nucleus accumbens core and shell". In: *Journal of Neuroscience* 32.45, pp. 15779–15790.
- Baeg, E. H., Yun Bok Kim, Jinhwa Jang, Hyun Taek Kim, Inhee Mook-Jung, and Min Whan Jung (2001): "Fast Spiking and Regular Spiking Neural Correlates of Fear Conditioning in the Medial Prefrontal Cortex of the Rat". In: *Cerebral cortex* 11.5, pp. 441–451.
- Bagur, Sophie, Julie M Lefort, Marie M Lacroix, Gaëtan de Lavilléon, Cyril Herry, Clara Billand, Hélène Geoffroy, and Karim Benchenane (2018): "Dissociation of fear initiation and maintenance by breathing-driven prefrontal oscillations". In: *bioRxiv*, p. 468264.
- Bandler, Richard and Antoine Depaulis (1988): "Elicitation of intraspecific defence reactions in the rat from midbrain periaqueductal grey by microinjection of kainic acid, without neurotoxic effects". In: *Neuroscience Letters* 88.3, pp. 291–296.
- Bannerman, D M, R. M.J. Deacon, S Offen, J Friswell, M Grubb, and J. N.P. Rawlins (2002): "Double dissociation of function within the hippocampus: Spatial memory and hyponeophagia". In: *Behavioral Neuroscience* 116.5, pp. 884–901.
- Bannerman, D M, M. A. Good, B. K. Yee, M. J. Heupel, S. D. Iversen, and J. N.P. Rawlins (1999): "Double dissociation of function within the hippocampus: A comparison of dorsal, ventral, and complete hippocampal cytotoxic lesions". In: *Behavioral Neuroscience* 113.6, pp. 1170–1188.
- Bannerman, D. M., J. N P Rawlins, S. B. McHugh, R. M J Deacon, B. K. Yee, T. Bast, W. N. Zhang, H. H J Pothuizen, and J. Feldon (2004): "Regional dissociations within the hippocampus - Memory and anxiety". In: *Neuroscience and Biobehavioral Reviews* 28, pp. 273–283.
- Bannerman, David M, Rolf Sprengel, David J Sanderson, Stephen B McHugh, J Nicholas P Rawlins, Hannah Monyer, and Peter H Seeburg (2014): "Hippocampal synaptic plasticity, spatial memory and anxiety". In: *Nature reviews neuroscience* 15.3, p. 181.
- Baran, Sarah E, Charles E Armstrong, Danielle C Niren, and Cheryl D Conrad (2010): "Prefrontal cortex lesions and sex differences in fear extinction and perseveration." In: *Learning & Memory* 17.5, pp. 267–278.
- Barrett, Lisa Feldman and Elizabeth A Kensinger (2010): "Context is routinely encoded during emotion perception". eng. In: *Psychological science* 21.4, pp. 595–599.
- Barthas, Florent and Alex C. Kwan (2017): "Secondary Motor Cortex: Where Sensory Meets Motor' in the Rodent Frontal Cortex". In: *Trends in Neurosciences* 40.3, pp. 181–193.
- Barthó, Peter, Hajime Hirase, Lenáic Monconduit, Michael Zugaro, Kenneth D Harris, and György Buzsáki (2004): "Characterization of neocortical principal cells and interneurons by network interactions and extracellular features". In: *Journal of neurophysiology* 92.1, pp. 600–608.
- Bast, Tobias, W. N. Zhang, and Joram Feldon (2001): "The ventral hippocampus and fear conditioning in rats: Different anterograde amnesias of fear after tetrodotoxin inactivation and infusion of the GABAA agonist muscimol". In: *Experimental Brain Research* 139.1, pp. 39–52.
- Battaglia, Francesco P, Karim Benchenane, Anton Sirota, Cyriel MA Pennartz, and Sidney I Wiener (2011): "The hippocampus: hub of brain network communication for memory." In: *Trends in cognitive sciences* 15.7, pp. 310–318.
- Bauer, Elizabeth P, Glenn E Schafe, and Joseph E LeDoux (2002): "NMDA receptors and L-type voltage-gated calcium channels contribute to long-term potentiation and different components of fear memory formation in the lateral amygdala". In: *The Journal of neuroscience* 22.12, pp. 5239–5249.
- Bechara, A, D Tranel, H Damasio, R Adolphs, C Rockland, and A R Damasio (1995): "Double dissociation of conditioning and declarative knowledge relative to the amygdala and hippocam-

- pus in humans.” eng. In: *Science (New York, N.Y.)* 269.5227, pp. 1115–1118.
- Beckers, Tom, Angelos-Miltiadis Krypotos, Yannick Boddez, Marieke Effting, and Merel Kindt (2013): “What’s wrong with fear conditioning?” In: *Biological psychology* 92.1, pp. 90–6.
- Behrens, Christoph J, Leander P van den Boom, Livia de Hoz, Alon Friedman, and Uwe Heinemann (2005): “Induction of sharp waveripple complexes in vitro and reorganization of hippocampal networks”. In: *Nature neuroscience* 8.11, p. 1560.
- Bekinschtein, Tristan A, Diego E Shalom, Cecilia Forcato, Maria Herrera, Martin R Coleman, Facundo F Manes, and Mariano Sigman (2009): “Classical conditioning in the vegetative and minimally conscious state.” eng. In: *Nature neuroscience* 12.10, pp. 1343–1349.
- Belluscio, M. a., K. Mizuseki, R. Schmidt, R. Kempfer, and G. Buzsáki (2012a): “Cross-Frequency Phase-Phase Coupling between Theta and Gamma Oscillations in the Hippocampus”. In: *Journal of Neuroscience* 32.2, pp. 423–435.
- Belluscio, Mariano A, Kenji Mizuseki, Robert Schmidt, Richard Kempfer, and György Buzsáki (2012b): “Cross-frequency phasephase coupling between theta and gamma oscillations in the hippocampus”. In: *Journal of Neuroscience* 32.2, pp. 423–435.
- Benchenane, Karim, Adrien Peyrache, Mehdi Khamassi, Patrick L Tierney, Yves Giovanni, Francesco P. Battaglia, and Sidney I. Wiener (2010a): “Coherent Theta Oscillations and Reorganization of Spike Timing in the Hippocampal-Prefrontal Network upon Learning”. In: *Neuron* 66.6, pp. 921–936.
- Benchenane, Karim, Adrien Peyrache, Mehdi Khamassi, Patrick L Tierney, Yves Giovanni, Francesco P Battaglia, and Sidney I Wiener (2010b): “Coherent theta oscillations and reorganization of spike timing in the hippocampal-prefrontal network upon learning”. In: *Neuron* 66.6, pp. 921–936.
- Berényi, Antal, Zoltán Somogyvári, Anett J Nagy, Lisa Roux, John D Long, Shigeyoshi Fujisawa, Eran Stark, Anthony Leonardo, Timothy D Harris, and György Buzsáki (2013): “Large-scale, high-density (up to 512 channels) recording of local circuits in behaving animals”. In: *Journal of neurophysiology* 111.5, pp. 1132–1149.
- Berger, Hans (1929): “Über das Elektrenkephalogramm des Menschen”. In: *Archiv für Psychiatrie und Nervenkrankheiten* 87.1, pp. 527–570.
- Berger, William, Evandro Silva Freire Coutinho, Ivan Figueira, Carla Marques-Portella, Mariana Pires Luz, Thomas C Neylan, Charles R Marmar, and Mauro Vitor Mendlowicz (2012): “Rescuers at risk: a systematic review and meta-regression analysis of the worldwide current prevalence and correlates of PTSD in rescue workers”. In: *Social psychiatry and psychiatric epidemiology* 47.6, pp. 1001–1011.
- Bertoglio, Leandro José, Sâmia Regiane Lourenço Joca, and Francisco Silveira Guimarães (2006): “Further evidence that anxiety and memory are regionally dissociated within the hippocampus”. In: *Behavioural Brain Research* 175.1, pp. 183–188.
- Bi, Guo-qiang and Mu-ming Poo (1998): “Synaptic modifications in cultured hippocampal neurons: dependence on spike timing, synaptic strength, and postsynaptic cell type”. In: *Journal of neuroscience* 18.24, pp. 10464–10472.
- Bi, Guo-qiang and Mu-ming Poo (2001): “Synaptic modification by correlated activity: Hebb’s postulate revisited”. In: *Annual review of neuroscience* 24.1, pp. 139–166.
- Bian, Xin-Lan, Cheng Qin, Cheng-Yun Cai, Ying Zhou, Yan Tao, Yu-Hui Lin, Hai-Yin Wu, Lei Chang, Chun-Xia Luo, and Dong-Ya Zhu (2019): “Anterior Cingulate Cortex to Ventral Hippocampus Circuit Mediates Contextual Fear Generalization”. In: *The Journal of Neuroscience* 39.29, pp. 5728–5739.
- Biedenkapp, Joseph C and Jerry W Rudy (2009): “Hippocampal and extrahippocampal systems compete for control of contextual fear : Role of ventral subiculum and amygdala”. In: *Learning & Memory* 303, pp. 38–45.
- Bigelow, Henry J (1850): “Dr. Harlow’s Case of Recovery from the passage of an Iron Bar through the Head.” In: *The American Journal of the Medical Sciences (1827-1924)* 20.39.
- Binder, Sonja, Paul Christian Baier, Matthias Mölle, Marion Inostroza, Jan Born, and Lisa Marshall (2012): “Sleep enhances memory consolidation in the hippocampus-dependent object-place recognition task in rats”. In: *Neurobiology of learning and memory* 97.2, pp. 213–219.
- Biskamp, Jonatan, Marlene Bartos, and Jonas Frederic Sauer (2017a): “Organization of prefrontal network activity by respiration-related oscillations”. In: *Scientific Reports* 7, pp. 1–11.
- Biskamp, Jonatan, Marlene Bartos, and Jonas-Frederic Sauer (2017b): “Organization of prefrontal network activity

- by respiration-related oscillations". In: *Scientific reports* 7, p. 45508.
- Bissière, Stephanie, Nicolas Plachta, Daniel Hoyer, Kevin H. McAllister, Hans Rudolf Olpe, Anthony A Grace, and John F Cryan (2008): "The Rostral Anterior Cingulate Cortex Modulates the Efficiency of Amygdala-Dependent Fear Learning". In: *Biological Psychiatry* 63.9, pp. 821–831.
- Blair, Hugh T, Glenn E Schafe, Elizabeth P Bauer, Sarina M Rodrigues, and J. E. LeDoux (2001): *Synaptic plasticity in the lateral amygdala: A cellular hypothesis of fear conditioning*.
- Blanchard, D C, G Williams, E M C Lee, and R J Blanchard (1981): "Taming of wild *Rattus norvegicus* by lesions of the mesencephalic central gray". In: *Physiological Psychology* 9.2, pp. 157–163.
- Blanchard, D Caroline and Robert J Blanchard (1972a): "Innate and conditioned reactions to threat in rats with amygdaloid lesions." In: *Journal of comparative and physiological psychology* 81.2, p. 281.
- Blanchard, D Caroline, Robert J Blanchard, Eugene M C Lee, and Kenneth K Fukunaga (1977): "Movement arrest and the hippocampus". In: *Physiological Psychology* 5.3, pp. 331–335.
- Blanchard, D Caroline, Guy Griebel, and Robert J Blanchard (2001): "Mouse defensive behaviors: pharmacological and behavioral assays for anxiety and panic". In: *Neuroscience & Biobehavioral Reviews* 25.3, pp. 205–218.
- Blanchard, D Caroline, Jon K Shepherd, Antonio De Padua Carobrez, and Robert J Blanchard (1991): "Sex effects in defensive behavior: baseline differences and drug interactions". In: *Neuroscience & Biobehavioral Reviews* 15.4, pp. 461–468.
- Blanchard, D. Caroline and Robert J. Blanchard (1988): "Ethoexperimental approaches to the biology of emotion". In: *Annual review of psychology* 39, pp. 43–68.
- Blanchard, D. Caroline, Guy Griebel, and Robert J. Blanchard (2003): "The Mouse Defense Test Battery: Pharmacological and behavioral assays for anxiety and panic". eng. In: *European journal of pharmacology* 463.1-3, pp. 97–116.
- Blanchard, D. Caroline, Guy Griebel, Roger Pobbe, and Robert J. Blanchard (2011): "Risk assessment as an evolved threat detection and analysis process". eng. In: *Neuroscience and Biobehavioral Reviews* 35.4, pp. 991–998.
- Blanchard, R J and D C Blanchard (1989): "Antipredator defensive behaviors in a visible burrow system." eng. In: *Journal of comparative psychology (Washington, D.C. : 1983)* 103.1, pp. 70–82.
- Blanchard, Robert J. and D. Caroline Blanchard (1969a): "Crouching as an index of fear". In: *Journal of Comparative and Physiological Psychology* 67.3, pp. 370–375.
- Blanchard, Robert J., Ted E. Dielman, and D. Caroline Blanchard (1968): "Post-shock crouching: Familiarity with the shock situation". In: *Psychonomic Science* 10.11, pp. 371–372.
- Blanchard, Robert J and D Caroline Blanchard (1969b): "Passive and active reactions to fear-eliciting stimuli." In: *Journal of comparative and physiological psychology* 68.1p1, p. 129.
- Blanchard, Robert J and D Caroline Blanchard (1971): "Defensive reactions in the albino rat". In: *Learning and motivation* 2.4, pp. 351–362.
- Blanchard, Robert J and D Caroline Blanchard (1972b): "Effects of hippocampal lesions on the rat's reaction to a cat." In: *Journal of comparative and physiological psychology* 78.1, p. 77.
- Blanchard, Robert J, D Caroline Blanchard, and Ronald A Fial (1970): "Hippocampal lesions in rats and their effect on activity, avoidance, and aggression." In: *Journal of Comparative and Physiological Psychology* 71.1, p. 92.
- Blanchard, Robert J, D Caroline Blanchard, and Kevin Hori (1989): *An ethoexperimental approach to the study of defense*. Kluwer Academic/Plenum Publishers.
- Blanchard, Robert J, Kevin J Flannelly, and D Caroline Blanchard (1986): "Defensive behavior of laboratory and wild *Rattus norvegicus*". In: *Journal of Comparative Psychology* 100.2, pp. 101–107.
- Bliss, T V (1970): "Plasticity in a monosynaptic cortical pathway". In: *J Physiol* 207, p. 61.
- Bliss, Tim V P and Terje Lømo (1973): "Longlasting potentiation of synaptic transmission in the dentate area of the anaesthetized rabbit following stimulation of the perforant path". In: *The Journal of physiology* 232.2, pp. 331–356.
- Bliss, Tim and A. R. Gardner-Medwin (1973): "Long-Lasting Potentiation of synaptic transmission in the dentate area". In: *J. Physiol.* 232, pp. 357–374.
- Bloodgood, Daniel W., Jonathan A. Sugam, Andrew Holmes, and Thomas L. Kash (2018): "Fear extinction requires infralimbic cortex projections to the basolateral amygdala". In: *Translational Psychiatry* 8.1.

- Boccaro, Charlotte N, Francesca Sargolini, Veslemøy Hult Thoresen, Trygve Solstad, Menno P Witter, Edvard I Moser, and May-Britt Moser (2010): "Grid cells in pre- and parasubiculum." In: *Nature neuroscience* 13.8, pp. 987–94.
- Bolles, Robert C (1970): "Species-specific defense reactions and avoidance learning." In: *Psychological review* 77.1, p. 32.
- Bolles, Robert C and Alexis C Collier (1976): "The effect of predictive cues on freezing in rats". In: *Animal Learning & Behavior* 4.1, pp. 6–8.
- Bolles, Robert C and Michael S Fanselow (1980): "A perceptual-defensive-recuperative model of fear and pain". In: *Behavioral and Brain Sciences* 3.2, pp. 291–301.
- Bonanno, George A, Anthony D Mancini, Jaime L Horton, Teresa M Powell, Cynthia A LeardMann, Edward J Boyko, Timothy S Wells, Tomoko I Hooper, Gary D Gackstetter, and Tyler C Smith (2012): "Trajectories of trauma symptoms and resilience in deployed US military service members: Prospective cohort study". In: *The British Journal of Psychiatry* 200.4, pp. 317–323.
- Borowski, Zbigniew (2002): "Individual and seasonal differences in antipredatory behaviour of root voles field experiment". In: *Canadian Journal of Zoology* 80.9, pp. 1520–1525.
- Borszcz, George S, Jacquelyn Cranney, and Robert N Leaton (1989): "Influence of long-term sensitization on long-term habituation of the acoustic startle response in rats: Central gray lesions, pre-exposure, and extinction." In: *Journal of Experimental Psychology: Animal Behavior Processes* 15.1, pp. 54–64.
- Boschen, Mark J, David L Neumann, and Allison M Waters (2009): "Relapse of successfully treated anxiety and fear: theoretical issues and recommendations for clinical practice". In: *Australian and New Zealand Journal of Psychiatry* 43.2, pp. 89–100.
- Botta, Paolo, Lynda Demmou, Yu Kasugai, Milica Markovic, Chun Xu, Jonathan P Fadok, Tingjia Lu, Michael M Poe, Li Xu, James M Cook, Uwe Rudolph, Pankaj Sah, Francesco Ferraguti, and Andreas Luthi (2015): "Regulating anxiety with extrasynaptic inhibition." eng. In: *Nature neuroscience* 18.10, pp. 1493–1500.
- Bouton, M E (1993): "Context, time, and memory retrieval in the interference paradigms of Pavlovian learning." eng. In: *Psychological bulletin* 114.1, pp. 80–99.
- Bouton, Mark E (2004): "Context and behavioral processes in extinction". In: *Learning & Memory* 11.5, pp. 485–494.
- Bouton, Mark E. (2002): "Context, ambiguity, and unlearning: Sources of relapse after behavioral extinction". In: *Biological Psychiatry* 52.10, pp. 976–986.
- Bouton, Mark E. and Erik W. Moody (2004): "Memory processes in classical conditioning". In: *Neuroscience and Biobehavioral Reviews* 28.7, pp. 663–674.
- Bouton, Mark E., R. Frederick Westbrook, Kevin A. Corcoran, and Stephen Maren (2006): "Contextual and temporal modulation of extinction: behavioral and biological mechanisms". In: *Biological psychiatry* 60.4, pp. 352–360.
- Bouton, Mark E and Robert C Bolles (1979): "Contextual control of the extinction of conditioned fear". In: *Learning and motivation* 10.4, pp. 445–466.
- Bouton, Mark E and Robert C Bolles (1980): "Conditioned fear assessed by freezing and by the suppression of three different baselines". In: *Animal Learning & Behavior* 8.3, pp. 429–434.
- Bouton, Mark E and Douglas C Brooks (1993): "Time and context effects on performance in a Pavlovian discrimination reversal." In: *Journal of Experimental Psychology: Animal Behavior Processes* 19.2, p. 165.
- Bouton, Mark E and David A King (1983): "Contextual control of the extinction of conditioned fear: tests for the associative value of the context." In: *Journal of Experimental Psychology: Animal Behavior Processes* 9.3, p. 248.
- Bouton, Mark E and Charles A Peck (1989): "Context effects on conditioning, extinction, and reinstatement in an appetitive conditioning preparation". In: *Animal Learning & Behavior* 17.2, pp. 188–198.
- Bouton, Mark E and Sean T Ricker (1994): "Renewal of extinguished responding in a second context". In: *Animal Learning & Behavior* 22.3, pp. 317–324.
- Bouton, Mark E, Neil E Winterbauer, and Travis P Todd (2012): "Relapse processes after the extinction of instrumental learning: renewal, resurgence, and reacquisition." In: *Behavioural processes* 90.1, pp. 130–41.
- Boyce, Richard, Stephen D. Glasow, Sylvain Williams, and Antoine Adamantidis (2016): "Causal evidence for the role of REM sleep in memory formation." In: *Science* 352.6287, pp. 812–817.
- Braitenberg, V. (1977): "Cell assemblies in the cerebral cortex". In: *Theoretical Approaches to Complex Systems*. Ed. by

- R. Heim and G. Palm. Lecture No. Tübingen, pp. 171–188.
- Braitenberg, Valentino and Almut Schüz (2013): *Anatomy of the cortex: statistics and geometry*. Vol. 18. Springer Science & Business Media.
- Brankack, Jurij, Valeriy I Kukushka, Alexei L Vysotski, and Andreas Draguhn (2010): “EEG gamma frequency and sleep-wake scoring in mice: comparing two types of supervised classifiers.” eng. In: *Brain research* 1322, pp. 59–71.
- Bravo-Rivera, C., C. Roman-Ortiz, E. Brignoni-Perez, F. Sotres-Bayon, and G. J. Quirk (2014): “Neural Structures Mediating Expression and Extinction of Platform-Mediated Avoidance”. In: *Journal of Neuroscience* 34.29, pp. 9736–9742.
- Brischoux, Frédéric, Subhojit Chakraborty, Daniel I Brierley, and Mark A Ungless (2009): “Phasic excitation of dopamine neurons in ventral VTA by noxious stimuli”. In: *Proceedings of the National Academy of Sciences* 106.12, pp. 4894–4899.
- Broadbent, Nicola J and Robert E Clark (2013): “Neurobiology of Learning and Memory Remote context fear conditioning remains hippocampus-dependent irrespective of training protocol, training surgery interval, lesion size, and lesion method”. In: *Neurobiology of Learning and Memory* 106, pp. 300–308.
- Broca, Paul (1861): “Perte de la parole, ramollissement chronique et destruction partielle du lobe antérieur gauche du cerveau”. In: *Bull Soc Anthropol* 2.1, pp. 235–238.
- Broca, Paul (1878): “Anatomie comparée des circonvolutions cérébrales. Le grand lobe limbique et la scissure limbique dans la série des mammifères”. In: *Rev Anthropol* 1, pp. 385–498.
- Brooks, Douglas C (2000): “Recent and remote extinction cues reduce spontaneous recovery”. In: *The Quarterly Journal of Experimental Psychology: Section B* 53.1, pp. 25–58.
- Brooks, Douglas C and Mark E Bouton (1993): *A retrieval cue for extinction attenuates spontaneous recovery*. US.
- Brooks, Douglas C and Mark E Bouton (1994): “A retrieval cue for extinction attenuates response recovery (renewal) caused by a return to the conditioning context.” In: *Journal of Experimental Psychology: Animal Behavior Processes* 20.4, p. 366.
- Brown, Danielle D, Roland Kays, Martin Wikelski, Rory Wilson, and A Peter Klimley (2013): “Observing the unwatchable through acceleration logging of animal behavior”. In: *Animal Biotelemetry* 1.1, p. 20.
- Brown, Judson S, Harry I Kalish, and I E Farber (1951): “Conditioned fear as revealed by magnitude of startle response to an auditory stimulus.” In: *Journal of experimental psychology* 41.5, pp. 317–328.
- Brown, Ritchie E, Radhika Basheer, James T McKenna, Robert E Strecker, and Robert W McCarley (2012): “Control of sleep and wakefulness.” eng. In: *Physiological reviews* 92.3, pp. 1087–1187.
- Brown, Sanger and Edward Albert Sharpey-Schafer (1888): “An investigation into the functions of the occipital and temporal lobes of the monkey’s brain”. In: *Philosophical Transactions of the Royal Society of London.(B.)* 179, pp. 303–327.
- Bryant, Richard A (2003): “Early predictors of posttraumatic stress disorder.” eng. In: *Biological psychiatry* 53.9, pp. 789–795.
- Bukalo, Olena, Courtney R Pinard, Shana Silverstein, Christina Brehm, Nolan D Hartley, Nigel Whittle, Giovanni Colacicco, Erica Busch, Sachin Patel, Nicolas Singewald, and Andrew Holmes (2015): “Prefrontal inputs to the amygdala instruct fear extinction memory formation”. In: *Science Advances* July, pp. 1–8.
- Burgos-Robles, Anthony, Eyal Y. Kimchi, Ehsan M. Izadmehr, Mary Jane Porzenheim, William A. Ramos-Guasp, Edward H. Nieh, Ada C. Felix-Ortiz, Praneeth Namburi, Christopher A. Leppla, Kara N. Presbrey, Kavitha K. Anandalingam, Pablo A. Pagan-Rivera, Melodi Anahtar, Anna Beyeler, and Kay M. Tye (2017): “Amygdala inputs to prefrontal cortex guide behavior amid conflicting cues of reward and punishment”. In: *Nature Neuroscience* 20.6, pp. 824–835.
- Burgos-Robles, Anthony, Ivan Vidal-Gonzalez, and Gregory J Quirk (2009): “Sustained conditioned responses in prelimbic prefrontal neurons are correlated with fear expression and extinction failure”. In: *The Journal of Neuroscience* 29.26, pp. 8474–8482.
- Burman, Michael A. and Jonathan C. Gewirtz (2004): “Timing of Fear Expression in Trace and Delay Conditioning Measured by Fear-Potentiated Startle in Rats”. In: *Learning and Memory* 11.2, pp. 205–212.
- Burwell, Rebecca D, David J Bucci, Matthew R Sanborn, and Michael J Jutras (2004): “Perirhinal and Postrhinal Contributions to Remote Memory for

- Context". In: *Journal of Neuroscience* 24.49, pp. 11023–11028.
- Bush, David E A, Francisco Sotres-Bayon, and Joseph E. LeDoux (2007): "Individual differences in fear: Isolating fear reactivity and fear recovery phenotypes". In: *Journal of Traumatic Stress* 20.4, pp. 413–422.
- Buss, Kristin A, Richard J Davidson, Ned H Kalin, and H Hill Goldsmith (2004): "Context-specific freezing and associated physiological reactivity as a dysregulated fear response." In: *Developmental psychology* 40.4, p. 583.
- Butler, Robert W, David L Braff, Jeffrey L Rausch, Melissa A Jenkins, Joyce Sprock, and Mark A Geyer (1990): "Physiological evidence of exaggerated startle response in a subgroup of Vietnam veterans with combat-related PTSD". In: *Am J Psychiatry* 147.10, pp. 1308–1312.
- Butler, T., H. Pan, O. Tuescher, A. Engelien, M. Goldstein, J. Epstein, D. Weisholtz, J. C. Root, X. Protopopescu, A. C. Cunningham-Bussell, L. Chang, X. H. Xie, Q. Chen, E. A. Phelps, J. E. Ledoux, E. Stern, and D. A. Silbersweig (2007): "Human fear-related motor neurocircuitry". In: *Neuroscience* 150.1, pp. 1–7.
- Buzsáki, G (1989): "Two-stage model of memory trace formation: a role for "noisy" brain states." eng. In: *Neuroscience* 31.3, pp. 551–570.
- Buzsáki, G (1996): "The hippocamponeocortical dialogue." eng. In: *Cerebral cortex (New York, N.Y. : 1991)* 6.2, pp. 81–92.
- Buzsáki, György (1984): "Long-term changes of hippocampal sharp-waves following high frequency afferent activation". In: *Brain research* 300.1, pp. 179–182.
- Buzsáki, György (1986): "Hippocampal sharp waves: their origin and significance". In: *Brain research* 398.2, pp. 242–252.
- Buzsáki, György (2002): "Theta Oscillations in the Hippocampus". In: *Neuron* 33.3, pp. 325–340.
- Buzsáki, György (2004a): "Large-scale recording of neuronal ensembles". In: *Nature Neuroscience* 7.5, pp. 446–451.
- Buzsáki, György (2004b): "Large-scale recording of neuronal ensembles." In: *Nature neuroscience* 7.5, pp. 446–451.
- Buzsáki, György (2010): "Neural Syntax: Cell Assemblies, Synapses, and Readers". In: *Neuron* 68.3, pp. 362–385.
- Buzsáki, György, Costas a. Anastassiou, and Christof Koch (2012): "The origin of extracellular fields and currents EEG, ECoG, LFP and spikes". In: *Nature Reviews Neuroscience* 13.June, pp. 407–420.
- Buzsáki, György, Zsolt Horvath, Ronald Urioste, Jamille Hetke, and Kensall Wise (1992): "High-frequency network oscillation in the hippocampus". In: *Science* 256.5059, pp. 1025–1027.
- Buzsáki, György, Nikos Logothetis, and Wolf Singer (2013): "Perspective Scaling Brain Size , Keeping Timing : Evolutionary Preservation of Brain Rhythms". In: *Neuron* 80, pp. 751–764.
- Buzsáki, György and Erik W Schomburg (2015): *What does gamma coherence tell us about inter-regional neural communication?*
- Buzsáki, György and Cornelius H Vanderwolf (1983): "Cellular bases of hippocampal EEG in the behaving rat". In: *Brain Research Reviews* 6.2, pp. 139–171.
- Buzsáki, György and Xiao-jing Wang (2012): "Mechanisms of Gamma Oscillations". In: *Annual Review of Neuroscience* 35.1, pp. 203–225.
- Cai, Denise J., Daniel Aharoni, Tristan Shuman, Justin Shobe, Jeremy Biane, Weilin Song, Brandon Wei, Michael Veshkini, Mimi La-Vu, Jerry Lou, Sergio E. Flores, Isaac Kim, Yoshitake Sano, Miou Zhou, Karsten Baumgaertel, Ayal Lavi, Masakazu Kamata, Mark Tuszynski, Mark Mayford, Peyman Golshani, and Alcino J. Silva (2016): "A shared neural ensemble links distinct contextual memories encoded close in time". In: *Nature* 534.7605, p. 115.
- Cain, Christopher K (2019): "Avoidance problems reconsidered". In: *Current opinion in behavioral sciences* 26, pp. 9–17.
- Calhoun, Gwendolyn G and Kay M Tye (2015): "Resolving the neural circuits of anxiety". In: *Nature Neuroscience* 18.10, p. 1394.
- Cambiaghi, M., A. Grosso, E. Likhtik, R. Mazziotti, G. Concina, A. Renna, T. Sacco, J. A. Gordon, and B. Sacchetti (2016): "Higher-Order Sensory Cortex Drives Basolateral Amygdala Activity during the Recall of Remote, but Not Recently Learned Fearful Memories". In: *Journal of Neuroscience* 36.5, pp. 1647–1659.
- Campeau, Serge, Michael D Hayward, Bruce T Hope, Jeffrey B Rosen, Eric J Nestler, and Michael Davis (1991): "Induction of the c-fos proto-oncogene in rat amygdala during unconditioned and conditioned fear". In: *Brain research* 565.2, pp. 349–352.
- Campeau, Serge, Keng C Liang, and Michael Davis (1990): "Long-term retention of fear-potentiated startle fol-

- lowing a short training session". In: *Animal Learning & Behavior* 18.4, pp. 462–468.
- Cannon, W Bradford (1915): "Bodily changes in pain, hunger, fear and rage: An account of recent researches into the function of emotional excitement". In: *Appleton Century Crofts, New York/London*.
- Canteras, N S and L W Swanson (1992): "Projections of the ventral subiculum to the amygdala, septum, and hypothalamus: a PHAL anterograde tract tracing study in the rat". In: *Journal of Comparative Neurology* 324.2, pp. 180–194.
- Canteras, Newton Sabino and Cornelius T Gross (2012): "The many paths to fear". In: *Nature Reviews Neuroscience* 13.9, pp. 651–658.
- Carlén, Marie (2017): "What constitutes the prefrontal cortex?" In: *Science* 482.October, pp. 478–482.
- Carneiro, Clarissa F D, Thiago C Moulin, Malcolm R Macleod, and Olavo B Amaral (2018): "Effect size and statistical power in the rodent fear conditioning literature A systematic review". In: *PloS one*, pp. 1–27.
- Carr, David B and Susan R Sesack (2000): "Projections from the rat prefrontal cortex to the ventral tegmental area: target specificity in the synaptic associations with mesoaccumbens and mesocortical neurons". In: *Journal of neuroscience* 20.10, pp. 3864–3873.
- Carr, Margaret F, Shantanu P Jadhav, and Loren M Frank (2011): "Hippocampal replay in the awake state: a potential substrate for memory consolidation and retrieval". In: *Nature neuroscience* 14.2, p. 147.
- Carriot, Jérôme, Mohsen Jamali, Maurice J Chacron, and Kathleen E Cullen (2014): "Statistics of the vestibular input experienced during natural self-motion: implications for neural processing". In: *Journal of Neuroscience* 34.24, pp. 8347–8357.
- Carrive, Pascal (2000): "Conditioned fear to environmental context: cardiovascular and behavioral components in the rat". In: *Brain research* 858.2, pp. 440–445.
- Cassell, M D and D J Wright (1986): "Topography of projections from the medial prefrontal cortex to the amygdala in the rat". In: *Brain research bulletin* 17.3, pp. 321–333.
- Cassenaer, Stijn and Gilles Laurent (2007): "Hebbian STDP in mushroom bodies facilitates the synchronous flow of olfactory information in locusts." eng. In: *Nature* 448.7154, pp. 709–713.
- Catani, Marco, Flavio Dell, Michel Thiebaut, and De Schotten (2013): "Neuroscience and Biobehavioral Reviews A revised limbic system model for memory, emotion and behaviour". In: *Neuroscience and Biobehavioral Reviews* 37.8, pp. 1724–1737.
- Cenquizca, Lee A and Larry W Swanson (2007): "Spatial organization of direct hippocampal field CA1 axonal projections to the rest of the cerebral cortex". In: *Brain research reviews* 56.1, pp. 1–26.
- Chandler, Daniel J, Carolyn S Lamperiski, and Barry D Waterhouse (2013): "Identification and distribution of projections from monoaminergic and cholinergic nuclei to functionally differentiated subregions of prefrontal cortex". In: *Brain research* 1522, pp. 38–58.
- Chang, Chun Hui and Stephen Maren (2011): "Medial prefrontal cortex activation facilitates re-extinction of fear in rats". In: *Learning and Memory* 18.4, pp. 221–225.
- Chang, Chun hui, Joshua D. Berke, and Stephen Maren (2010): "Single-unit activity in the medial prefrontal cortex during immediate and delayed extinction of fear in rats". In: *PLoS ONE* 5.8.
- Chang, Chun hui and Stephen Maren (2010): "Strain difference in the effect of infralimbic cortex lesions on fear extinction in rats". In: *Behavioral Neuroscience* 124.3, pp. 391–397.
- Chao, Owen Y, Joseph P Huston, JayShake Li, AnLi Wang, and Maria A de Souza Silva (2016): "The medial prefrontal cortex lateral entorhinal cortex circuit is essential for episodic-like memory and associative object recognition". In: *Hippocampus* 26.5, pp. 633–645.
- Chapman, Paul F and Lisa L Bellavance (1992): "Induction of longterm potentiation in the basolateral amygdala does not depend on NMDA receptor activation". In: *Synapse* 11.4, pp. 310–318.
- Chen, C Y, Cheryl C H Yang, Y Y Lin, and Terry B J Kuo (2011): "Locomotion-induced hippocampal theta is independent of visual information in rats during movement through a pipe". In: *Behavioural brain research* 216.2, pp. 699–704.
- Cheng, Sen and Loren M Frank (2008): "New experiences enhance coordinated neural activity in the hippocampus". In: *Neuron* 57.2, pp. 303–313.
- Chhatwal, Jasmeer P., Michael Davis, Kimberly A. Maguschak, and Kerry J. Ressler (2005): "Enhancing cannabinoid neurotransmission augments the extinction of conditioned fear". In: *Neu-*

- ropsychopharmacology* 30.3, pp. 516–524.
- Chhatwal, Jasmeer P., Lisa Stanek-Rattiner, Michael Davis, and Kerry J. Ressler (2006): “Amygdala BDNF signaling is required for consolidation but not encoding of extinction”. In: *Nature Neuroscience* 9.7, pp. 870–872.
- Chi, Vivian Nguyen, Carola Müller, Thérèse Wolfenstetter, Yevgenij Yanovsky, Andreas Draguhn, Adriano B L Tort, and Jurij Brankač (2016): “Hippocampal respiration-driven rhythm distinct from theta oscillations in awake mice”. In: *Journal of Neuroscience* 36.1, pp. 162–177.
- Chimienti, Marianna, Thomas Cornulier, Ellie Owen, Mark Bolton, Ian M Davies, Justin M J Travis, and Beth E Scott (2016): “The use of an unsupervised learning approach for characterizing latent behaviors in accelerometer data”. In: *Ecology and Evolution* 6.3, pp. 727–741.
- Cho, Yoon H, Eugenia Friedman, and Alcino J Silva (1998): “Ibotenate lesions of the hippocampus impair spatial learning but not contextual fear conditioning in mice”. In: *Behavioural Brain Research* 98.1, pp. 77–87.
- Choi, June-Seek and Jeansok J Kim (2010): “Amygdala regulates risk of predation in rats foraging in a dynamic fear environment”. In: *Proceedings of the National Academy of Sciences* 107.50, pp. 21773–21777.
- Chou, Xiao Lin, Xiyue Wang, Zheng Gang Zhang, Li Shen, Brian Zingg, Junxiang Huang, Wen Zhong, Lukas Mesik, Li I. Zhang, and Huizhong Whit Tao (2018): “Inhibitory gain modulation of defense behaviors by zona incerta”. In: *Nature Communications* 9.1, pp. 1–12.
- Chrobak, James J and Gyorgy Buzsáki (1996): “High-frequency oscillations in the output networks of the hippocampal-entorhinal axis of the freely behaving rat”. In: *Journal of neuroscience* 16.9, pp. 3056–3066.
- Ciocchi, S., J. Passecker, H. Malagon-Vina, N. Mikus, T. Klausberger, H. Malagon-Vina, N. Mikus, and T. Klausberger (2015): “Selective information routing by ventral hippocampal CA1 projection neurons”. In: *Science* 348.6234, pp. 560–563.
- Ciocchi, Stephane, Cyril Herry, François Grenier, Steffen B.E. Wolff, Johannes J. Letzkus, Ioannis Vlachos, Ingrid Ehrlich, Rolf Sprengel, Karl Deisseroth, Michael B. Stadler, Christian Müller, and Andreas Lüthi (2010): “Encoding of conditioned fear in central amygdala inhibitory circuits”. In: *Nature* 468.7321, pp. 277–282.
- Clugnet, Marie-Christine and Joseph E LeDoux (1990): “Synaptic plasticity in fear conditioning circuits: induction of LTP in the lateral nucleus of the amygdala by stimulation of the medial geniculate body”. In: *Journal of Neuroscience* 10.8, pp. 2818–2824.
- Cohen, Hagit, Michael A Matar, G A L RICHTERLEVIN, and Joseph Zohar (2006): “The contribution of an animal model toward uncovering biological risk factors for PTSD”. In: *Annals of the New York Academy of Sciences* 1071.1, pp. 335–350.
- Cohen, Hagit and Joseph Zohar (2004): “An animal model of posttraumatic stress disorder: The use of cut-off behavioral criteria”. In: *Annals of the New York Academy of Sciences* 1032, pp. 167–178.
- Colgin, Laura Lee, Tobias Denninger, Marianne Fyhn, Torkel Hafting, Tora Bonnevie, Ole Jensen, May-Britt Moser, and Edvard I Moser (2009): “Frequency of gamma oscillations routes flow of information in the hippocampus”. In: *Nature* 462.7271, p. 353.
- Colgin, Laura Lee, Edvard I Moser, and May-Britt Moser (2008): “Understanding memory through hippocampal remapping”. In: *Trends in neurosciences* 31.9, pp. 469–477.
- Collier, George H (1983): “Life in a closed economy: The ecology of learning and motivation”. In: *Advances in analysis of behaviour* 3, pp. 223–274.
- Collingridge, Graham L, John T R Isaac, and Yu Tian Wang (2004): “Receptor trafficking and synaptic plasticity”. In: *Nature reviews neuroscience* 5.12, p. 952.
- Collins, Dawn R. and Denis Paré (2000): “Differential Fear Conditioning Induces Reciprocal Changes in the Sensory Responses of Lateral Amygdala Neurons to the CS+ and CS-”. In: *Learning & Memory* 7.2, pp. 97–103.
- Collins, Philip M, Jonathan A Green, Victoria WarwickEvans, Stephen Dodd, Peter J A Shaw, John P Y Arnould, and Lewis G Halsey (2015): “Interpreting behaviors from accelerometry: a method combining simplicity and objectivity”. In: *Ecology and evolution* 5.20, pp. 4642–4654.
- Condé, Françoise, Evelyne Mairelepoivre, Etienne Audinat, and Francis Crepel (1995): “Afferent connections of the medial frontal cortex of the rat. II. Cortical and subcortical afferents”. In: *Journal of Comparative Neurology* 352.4, pp. 567–593.

- Corcoran, K a and S Maren (2001): "Hippocampal inactivation disrupts contextual retrieval of fear memory after extinction." In: *The Journal of neuroscience : the official journal of the Society for Neuroscience* 21.5, pp. 1720–1726.
- Corcoran, Kevin a, Timothy J Desmond, Kirk a Frey, and Stephen Maren (2005): "Hippocampal inactivation disrupts the acquisition and contextual encoding of fear extinction." In: *The Journal of Neuroscience* 25.39, pp. 8978–8987.
- Corcoran, Kevin A, Michael D Donnan, Natalie C Tronson, Y. F. Guzman, Can Gao, Vladimir Jovasevic, Anita L Guedea, and Jelena Radulovic (2011): "NMDA Receptors in Retrosplenial Cortex Are Necessary for Retrieval of Recent and Remote Context Fear Memory". In: *Journal of Neuroscience* 31.32, pp. 11655–11659.
- Corcoran, Kevin A and Gregory J Quirk (2007): "Activity in prelimbic cortex is necessary for the expression of learned, but not innate, fears." In: *Journal of Neuroscience* 27.4, pp. 840–844.
- Corkin, Suzanne (2002): "What's new with the amnesic patient HM?" In: *Nature reviews neuroscience* 3.2, p. 153.
- Courtin, J., T. C M Bienvenu, E. Ö Einarsson, and C. Herry (2013): "Medial prefrontal cortex neuronal circuits in fear behavior". In: *Neuroscience* 240, pp. 219–242.
- Courtin, Julien, Fabrice Chaudun, Robert R Rozeske, Nikolaos Karalis, Cecilia Gonzalez-Campo, Hélène Wurtz, Azzedine Abdi, Jerome Baufretton, Thomas C M Bienvenu, and Cyril Herry (2014): "Prefrontal parvalbumin interneurons shape neuronal activity to drive fear expression." In: *Nature* 505, pp. 92–6.
- Cowansage, Kiriana K., Tristan Shuman, Blythe C. Dillingham, Allene Chang, Peyman Golshani, and Mark Mayford (2014): "Direct Reactivation of a Coherent Neocortical Memory of Context". In: *Neuron* 84.2, pp. 432–441.
- Cowen, Stephen L. and Bruce L. McNaughton (2007): "Selective delay activity in the medial prefrontal cortex of the rat: Contribution of sensorimotor information and contingency". In: *Journal of Neurophysiology* 98.1, pp. 303–316.
- Craske, Michelle G, Dirk Hermans, and Bram Vervliet (2018): "State-of-the-art and future directions for extinction as a translational model for fear and anxiety". In: *Philosophical Transactions of the Royal Society B: Biological Sciences* 373.1742.
- Craske, Michelle G and Jayson L Mystkowski (2006): "Exposure Therapy and Extinction: Clinical Studies." In:
- Csicsvari, Jozsef and David Dupret (2014): "Sharp wave/ripple network oscillations and learning-associated hippocampal maps". In: *Philosophical Transactions of the Royal Society B: Biological Sciences* 369.1635, p. 20120528.
- Csicsvari, Jozsef, Hajime Hirase, A Czurko, Akira Mamiya, and G Buzsáki (1999): "Fast network oscillations in the hippocampal CA1 region of the behaving rat". In: *J Neurosci* 19.RC20, pp. 1–4.
- Csicsvari, Jozsef, Hajime Hirase, Akira Mamiya, and György Buzsáki (2000): "Ensemble patterns of hippocampal CA3-CA1 neurons during sharp wave-associated population events". In: *Neuron* 28.2, pp. 585–594.
- Culhane, K M, M O'connor, D Lyons, and G M Lyons (2005): "Accelerometers in rehabilitation medicine for older adults". In: *Age and ageing* 34.6, pp. 556–560.
- Cullen, Kathleen E (2012): "The vestibular system: multimodal integration and encoding of self-motion for motor control". In: *Trends in neurosciences* 35.3, pp. 185–196.
- Cullen, Patrick K., T. Lee Gilman, Patrick Winiecki, David C. Riccio, and Aaron M. Jasnow (2015): "Activity of the anterior cingulate cortex and ventral hippocampus underlie increases in contextual fear generalization". In: *Neurobiology of Learning and Memory* 124, pp. 19–27.
- Cunningham, Christopher L (1979): "Alcohol as a cue for extinction: State dependency produced by conditioned inhibition". In: *Animal Learning & Behavior* 7.1, pp. 45–52.
- Curti, Margaret Wooster (1935): "Native fear responses of white rats in the presence of cats." In: *Psychological Monographs* 46.6, p. 78.
- Curti, Margaret Wooster (1942): "A further report on fear responses of white rats in the presence of cats." In: *Journal of Comparative Psychology* 34.1, p. 51.
- Cuthbert, Bruce N (2015): "Research Domain Criteria: toward future psychiatric nosologies". eng. In: *Dialogues in clinical neuroscience* 17.1, pp. 89–97.
- Cuthbert, Bruce N. and Thomas R. Insel (2010): "Toward new approaches to psychotic disorders: The NIMH research domain criteria project". In: *Schizophrenia Bulletin* 36.6, pp. 1061–1062.
- Cuthbert, Bruce N. and Thomas R. Insel (2013): "Toward the future of psychiatric diagnosis: The seven pillars of RDoC". In: *BMC Medicine* 11.1.

- Dakin, Chris J, L Caitlin Elmore, and Ari Rosenberg (2013): "One step closer to a functional vestibular prosthesis". In: *Journal of Neuroscience* 33.38, pp. 14978–14980.
- Daldrup, T., J. Remmes, J. Lesting, S. Gaburro, M. Fendt, P. Meuth, V. Kloke, H. C. Pape, and T. Seidenbecher (2015): "Expression of freezing and fear-potentiated startle during sustained fear in mice". In: *Genes, Brain and Behavior* 14.3, pp. 281–291.
- Dalley, Jeffrey W, Rudolf N Cardinal, and Trevor W Robbins (2004): "Prefrontal executive and cognitive functions in rodents: neural and neurochemical substrates." In: *Neuroscience and biobehavioral reviews* 28.7, pp. 771–84.
- Darwin, Charles (1859): *On the Origin of Species by Means of Natural Selection, or the Preservation of Favoured Races in the Struggle for Life*. John Murra. London, England: Routledge, p. 502.
- Darwin, Charles (1872): *The expression of the emotions in man and animals*. Fontana Press.
- Datta, Subimal, Guangmu Li, and Sanford Auerbach (2008): "Activation of phasic pontinewave generator in the rat: a mechanism for expression of plasticityrelated genes and proteins in the dorsal hippocampus and amygdala". In: *European Journal of Neuroscience* 27.7, pp. 1876–1892.
- Datta, Subimal and Matthew W. O'Malley (2013): "Fear extinction memory consolidation requires potentiation of pontine-wave activity during REM sleep". In: *Journal of Neuroscience* 33.10, pp. 4561–4569.
- Davidson, Thomas J, Fabian Kloosterman, and Matthew A Wilson (2009): "Hippocampal replay of extended experience". In: *Neuron* 63.4, pp. 497–507.
- Davis, M (1992): "The Role of the Amygdala in Fear and Anxiety". In: *Annual Review of Neuroscience* 15.1, pp. 353–375.
- Davis, M. and P. J. Whalen (2001): "The amygdala: Vigilance and emotion". In: *Molecular Psychiatry* 6.1, pp. 13–34.
- Davis, M, W A Falls, S Campeau, and M Kim (1993): "Fear-potentiated startle: a neural and pharmacological analysis. [Review]". In: *Behav. Brain Res* 58.1-2, pp. 175–198.
- Davis, Michael (1986): "Pharmacological and anatomical analysis of fear conditioning using the fear-potentiated startle paradigm." In: *Behavioral neuroscience* 100.6, p. 814.
- Davis, Michael (1988): "The potentiated startle response as a measure of conditioned fear and its relevance to the neurobiology of anxiety". In: *Selected models of anxiety, depression and psychosis*, pp. 61–89.
- Davis, Michael (1998): "Are Different Parts of the Extended Amygdala Involved in Fear versus Anxiety?" In: *Biological psychiatry* 44, pp. 1239–1247.
- Davis, Michael (2000): "The role of the amygdala in conditioned and unconditioned fear and anxiety". In: *The amygdala*. Ed. by John P Aggleton. Oxford, England: Oxford Univ. Press, pp. 213–287.
- Davis, Michael (2001): "Fear-Potentiated Startle in Rats". In: *Current Protocols in Neuroscience*, pp. 1–11.
- Davis, Michael and David I. Astrachan (1978): "Conditioned fear and startle magnitude: Effects of different footshock or backshock intensities used in training". In: *Journal of Experimental Psychology: Animal Behavior Processes* 4.2, pp. 95–103.
- Davis, Michael, Lee S. Schlesinger, and C. A. Sorenson (1989): "Temporal Specificity of Fear Conditioning: Effects of Different Conditioned Stimulus-Unconditioned Stimulus Intervals on the Fear-Potentiated Startle Effect". In: *Journal of Experimental Psychology: Animal Behavior Processes* 15.4, pp. 295–310.
- Davis, Michael, David L Walker, and Younglim Lee (1997): "Roles of the amygdala and bed nucleus of the stria terminalis in fear and anxiety measured with the acoustic startle reflex". In: *Annals of the New York Academy of Sciences* 821.1, pp. 305–331.
- Davis, Michael, David L Walker, Leigh Miles, and Christian Grillon (2010): "Phasic vs sustained fear in rats and humans: role of the extended amygdala in fear vs anxiety". In: *Neuropsychopharmacology* 35.1, p. 105.
- Davis, Patrick, Yosif Zaki, Jamie Maguire, and Leon G. Reijmers (2017): "Cellular and oscillatory substrates of fear extinction learning". In: *Nature Neuroscience* 20.11, pp. 1624–1633.
- Davis, S, S P Butcher, and R G Morris (1992): "The NMDA receptor antagonist D-2-amino-5-phosphonopentanoate (D-AP5) impairs spatial learning and LTP in vivo at intracerebral concentrations comparable to those that block LTP in vitro". In: *Journal of Neuroscience* 12.1, pp. 21–34.
- Davoodi, Farzaneh Ghiafehi, Fereshteh Motamedi, Nasser Naghdi, and Esmaeil Akbari (2009): "Effect of reversible inactivation of the reuniens nucleus on spatial learning and memory in rats using Morris water maze task." eng.

- In: *Behavioural brain research* 198.1, pp. 130–135.
- De Lavilléon, Gaetan, Marie Masako Lacroix, Laure Rondi-Reig, and Karim Benchenane (2015): “Explicit memory creation during sleep demonstrates a causal role of place cells in navigation”. In: *Nature neuroscience* 18.4, p. 493.
- De Martino, Benedetto, Colin F Camerer, and Ralph Adolphs (2010): “Amygdala damage eliminates monetary loss aversion.” In: *Proceedings of the National Academy of Sciences of the United States of America* 107.8, pp. 3788–92.
- De Oca, Beatrice M, Thomas R Minor, and Michael S Fanselow (2007): “Brief flight to a familiar enclosure in response to a conditional stimulus in rats”. In: *The Journal of general psychology* 134.2, pp. 153–172.
- De Vivo, Luisa, Michele Bellesi, William Marshall, Eric A. Bushong, Mark H. Ellisman, Giulio Tononi, and Chiara Cirelli (2017): “Ultrastructural evidence for synaptic scaling across the wake/sleep cycle”. In: *Science* 355.6324, pp. 507–510.
- Defelipe, Javier, Isabel Fariñas, and Isabel Farinas (1992): “The pyramidal neuron of the cerebral cortex: morphological and chemical characteristics of the synaptic inputs”. In: *Progress in neurobiology* 39.6, pp. 563–607.
- DeFelipe, Javier, Pedro L López-Cruz, Ruth Benavides-Piccione, Concha Bielza, Pedro Larrañaga, Stewart Anderson, Andreas Burkhalter, Bruno Cauli, Alfonso Fairén, and Dirk Feldmeyer (2013): “New insights into the classification and nomenclature of cortical GABAergic interneurons”. In: *Nature Reviews Neuroscience* 14.3, p. 202.
- Dejean, Cyril, Julien Courtin, Nikolaos Karalis, Fabrice Chaudun, Hélène Wurtz, Thomas C M Bienvenu, and Cyril Herry (2016): “Prefrontal neuronal assemblies temporally control fear behaviour”. In: *Nature* 535.7612, pp. 420–424.
- Dejean, Cyril, Julien Courtin, Robert R. Rozeske, Mélissa C. Bonnet, Vincent Dousset, Thomas Michelet, and Cyril Herry (2015): “Neuronal Circuits for Fear Expression and Recovery: Recent Advances and Potential Therapeutic Strategies”. In: *Biological psychiatry* 78.5, pp. 298–306.
- Delamater, Andrew R (2012): “On the nature of CS and US representations in Pavlovian learning.” eng. In: *Learning & behavior* 40.1, pp. 1–23.
- DeNardo, Laura A., Dominic S. Berns, Katherine Deloach, and Liqun Luo (2015): “Connectivity of mouse somatosensory and prefrontal cortex examined with trans-synaptic tracing”. In: *Nature Neuroscience* 18.11, pp. 1687–1697.
- DeNardo, Laura A., Cindy D. Liu, William E. Allen, Eliza L. Adams, Drew Friedmann, Lisa Fu, Casey J. Guenther, Marc Tessier-Lavigne, and Liqun Luo (2019a): “Temporal evolution of cortical ensembles promoting remote memory retrieval”. In: *Nature Neuroscience* 22.3, pp. 460–469.
- DeNardo, Laura A, Cindy D Liu, William E Allen, Eliza L Adams, Drew Friedmann, Lisa Fu, Casey J Guenther, Marc Tessier-Lavigne, and Liqun Luo (2019b): “Temporal evolution of cortical ensembles promoting remote memory retrieval”. In: *Nature neuroscience* 22.3, p. 460.
- Deng, Wei, Mark Mayford, and Fred H Gage (2013): “Selection of distinct populations of dentate granule cells in response to inputs as a mechanism for pattern separation in mice.” eng. In: *eLife* 2, e00312.
- Denny, Christine A, Mazen A Kheirbek, Eva L Alba, Kenji F Tanaka, Rebecca A Brachman, Kimberly B Laughman, Nicole K Tomm, Gergely F Turi, Attila Losonczy, and Rene Hen (2014): “Hippocampal memory traces are differentially modulated by experience, time, and adult neurogenesis.” eng. In: *Neuron* 83.1, pp. 189–201.
- Depaulis, Antoine, Richard Bandler, and Marguerite Vergnes (1989): “Characterization of pretentorial periaqueductal gray matter neurons mediating intraspecific defensive behaviors in the rat by microinjections of kainic acid”. In: *Brain Research* 486.1, pp. 121–132.
- DeRoon-Cassini, Terri A, Anthony D Mancini, Mark D Rusch, and George A Bonanno (2010): “Psychopathology and resilience following traumatic injury: a latent growth mixture model analysis.” In: *Rehabilitation psychology* 55.1, p. 1.
- DeVito, Paul L and Harry Fowler (1986): “Effects of contingency violations on the extinction of a conditioned fear inhibitor and a conditioned fear excitor.” In: *Journal of Experimental Psychology: Animal Behavior Processes* 12.2, p. 99.
- Di Scala, G, M J Mana, W J Jacobs, and A G Phillips (1987): “Evidence of Pavlovian conditioned fear following electrical stimulation of the periaqueductal grey in the rat.” eng. In: *Physiology & behavior* 40.1, pp. 55–63.
- Dias, Robbins, Trevor W Robbins, and Angela C Roberts (1996): “Dissociation in prefrontal cortex of affective and at-

- tentional shifts". In: *Nature* 380.6569, pp. 69–72.
- Dickinson, Anthony and Bernard Balleine (2002): "The role of learning in the operation of motivational systems". In: *Stevens' handbook of experimental psychology*.
- Diering, Graham H, Raja S Nirujogi, Richard H Roth, Paul F Worley, Akhlesh Pandey, and Richard L Hugarir (2017): "During Sleep". In: *Science* 515.February, pp. 511–515.
- Dityatev, Alexander E and Vadim Y Bolshakov (2005): "Amygdala, long-term potentiation, and fear conditioning". In: *The Neuroscientist* 11.1, pp. 75–88.
- Do Monte, Fabricio H., Gregory J. Quirk, B. Bo Li, and Mario A. Penzo (2016): "Retrieving fear memories, as time goes by..." In: *Molecular Psychiatry* 21.8, pp. 1027–1036.
- Dolleman-van der Weel, Margriet J, Amy L Griffin, Hiroshi T Ito, Matthew L Shapiro, Menno P Witter, Robert P Vertes, and Timothy A Allen (2019): "The nucleus reuniens of the thalamus sits at the nexus of a hippocampus and medial prefrontal cortex circuit enabling memory and behavior Running Head : RE CIRCUITS AND BEHAVIOR Number of figures : 3 Number of tables : 0 Number of text pages : 48 Word count". In: *Learning & Memory* 26, pp. 191–205.
- Domjan, Michael (2005): "Pavlovian Conditioning: A Functional Perspective". In: *Annual Review of Psychology* 56.1, pp. 179–206.
- Dong, Hong Wei (2008): *The Allen reference atlas: A digital color brain atlas of the C57Bl/6J male mouse*. John Wiley & Sons Inc.
- Donzis, E. J., R. L. Rennaker, and L. T. Thompson (2013): "Fear conditioning alters neuron-specific hippocampal place field stability via the basolateral amygdala". In: *Brain Research* 1525, pp. 16–25.
- Dopfel, David, Pablo D Perez, Alexander Verbitsky, Hector Bravo-Rivera, Yuncong Ma, Gregory J Quirk, and Nanyin Zhang (2019): "Individual variability in behavior and functional networks predicts vulnerability using an animal model of PTSD". In: *Nature communications* 10.1, p. 2372.
- Douglas, Rodney J. and Kevan A.C. Martin (2004): "Neuronal Circuits of the Neocortex". In: *Annual Review of Neuroscience* 27.1, pp. 419–451.
- Douglass, Amelia M, Hakan Kucukdereli, Marion Ponsérre, Milica Markovic, Jan Gründemann, Cornelia Strobel, Pilar L Alcalá Morales, Karl-Klaus Conzelmann, Andreas Lüthi, and Rüdiger Klein (2017): "Central amygdala circuits modulate food consumption through a positive-valence mechanism". In: *Nature neuroscience* 20.10, p. 1384.
- Doyère, Valérie and Nicole El Massioui (2016): "A subcortical circuit for time and action: Insights from animal research". In: *Current Opinion in Behavioral Sciences* 8, pp. 147–152.
- Doyère, Valérie, Pascale Gisquet-Verrier, Benedetta De Marsanich, and Martine Ammassari-Teule (2000): "Age-related modifications of contextual information processing in rats: Role of emotional reactivity, arousal and testing procedure". In: *Behavioural Brain Research* 114.1-2, pp. 153–165.
- Doyère, Valérie and Serge Laroche (1992): "Linear relationship between the maintenance of hippocampal long-term potentiation and retention of an associative memory". In: *Hippocampus* 2.1, pp. 39–48.
- Doyère, Valérie, Glenn E Schafe, Torfi Sigurdsson, and Joseph E LeDoux (2003): "Long-term potentiation in freely moving rats reveals asymmetries in thalamic and cortical inputs to the lateral amygdala". In: *European Journal of Neuroscience* 17.12, pp. 2703–2715.
- Drieu, Céline (2017): "Neurophysiological bases of memory formation and consolidation : contents and dynamics of hippocampal cell assembly sequences in rats". PhD thesis. Université Pierre et Marie Curie, p. 273.
- Drieu, Céline, Ralitsa Todorova, and Michaël Zugaro (2018): "Nested sequences of hippocampal assemblies during behavior support subsequent sleep replay". In: *Science (New York, N.Y.)* 362.6415, pp. 675–679.
- Dudai, Yadin (2004): "The Neurobiology of Consolidations, Or, How Stable is the Engram?" In: *Annual Review of Psychology* 55.1, pp. 51–86.
- Dudai, Yadin, Avi Karni, and Jan Born (2015): "The Consolidation and Transformation of Memory". In: *Neuron* 88.1, pp. 20–32.
- Dudek, S M and M F Bear (1992): "Homosynaptic long-term depression in area CA1 of hippocampus and effects of N-methyl-D-aspartate receptor blockade." eng. In: *Proceedings of the National Academy of Sciences of the United States of America* 89.10, pp. 4363–4367.
- Dugué, Guillaume P, Matthieu Tihey, Boris Gourevitch, and Clement Lena (2017): "Cerebellar re-encoding of self-generated head movements". In: *ELife* 6, e26179.

- Dunsmoor, Joseph E and Marijn C W Kroes (2019): "Episodic memory and Pavlovian conditioning : ships passing in the night". In: *Current Opinion in Behavioral Sciences* 26, pp. 32–39.
- Dunsmoor, Joseph E, Vishnu P Murty, Lila Davachi, and Elizabeth A Phelps (2015): "Emotional learning selectively and retroactively strengthens memories for related events". In: *Nature* 520.7547, pp. 345–348.
- Dupret, David, Joseph O'neill, Barty Pleydell-Bouverie, and Jozsef Csicsvari (2010): "The reorganization and reactivation of hippocampal maps predict spatial memory performance". In: *Nature neuroscience* 13.8, p. 995.
- Durstewitz, Daniel, Nicole M. Vittoz, Stan B. Floresco, and Jeremy K. Seamans (2010): "Abrupt transitions between prefrontal neural ensemble states accompany behavioral transitions during rule learning". In: *Neuron* 66.3, pp. 438–448.
- Duvarci, S., E. P. Bauer, and D. Pare (2009): "The Bed Nucleus of the Stria Terminalis Mediates Inter-individual Variations in Anxiety and Fear". In: *Journal of Neuroscience* 29.33, pp. 10357–10361.
- Duvarci, S., D. Popa, and D. Pare (2011): "Central Amygdala Activity during Fear Conditioning". In: *Journal of Neuroscience* 31.1, pp. 289–294.
- Duvarci, Sevil and Denis Pare (2014): "Amygdala microcircuits controlling learned fear". In: *Neuron* 82.5, pp. 966–980.
- Dyhrfjeld-Johnsen, Jonas, Sophie Gaboyard-Niay, Audrey Broussy, Aurélie Saleur, Aurore Brugeaud, and Christian Chabbert (2013): "Ondansetron reduces lasting vestibular deficits in a model of severe peripheral excitotoxic injury". In: *Journal of Vestibular Research* 23.3, pp. 177–186.
- EgoStengel, Valérie and Matthew A Wilson (2010): "Disruption of ripple-associated hippocampal activity during rest impairs spatial learning in the rat". In: *Hippocampus* 20.1, pp. 1–10.
- Ehrlich, Ingrid, Yann Humeau, François Grenier, Stéphane Ciochi, Cyril Herry, and Andreas Lüthi (2009): "Amygdala Inhibitory Circuits and the Control of Fear Memory". In: *Neuron* 62.6, pp. 757–771.
- Eichenbaum, H, P Dudchenko, E Wood, M Shapiro, and H Tanila (1999): "The hippocampus, memory, and place cells: is it spatial memory or a memory space?" In: *Neuron* 23.2, pp. 209–26.
- Eichenbaum, Howard (2017): "Prefrontal hippocampal interactions in episodic memory". In: *Nature Publishing Group* 18.9, pp. 547–558.
- Eichenbaum, Howard (2018a): "Neuroscience Letters Barlow versus Hebb : When is it time to abandon the notion of feature detectors and adopt the cell assembly as the unit of cognition ?" In: *Neuroscience Letters* 680, pp. 88–93.
- Eichenbaum, Howard (2018b): "Spatial, Temporal, and Behavioral Correlates of Hippocampal Neuronal Activity: A Primer for Computational Analysis". In: *Hippocampal Microcircuits*. Springer, pp. 411–435.
- Eichenbaum, Howard, A R Yonelinas, and Charan Ranganath (2007): "The medial temporal lobe and recognition memory". In: *Annual review of neuroscience* 30, p. 123.
- Eilam, David (2005): "Die hard: A blend of freezing and fleeing as a dynamic defense - Implications for the control of defensive behavior". In: *Neuroscience and Biobehavioral Reviews* 29.8, pp. 1181–1191.
- Eilam, Dayan, Ben-Eliyahu, I Schulman, Shefer, and Hendrie (1999): "Differential behavioural and hormonal responses of voles and spiny mice to owl calls." eng. In: *Animal behaviour* 58.5, pp. 1085–1093.
- Einarsson, EinarÖ, Jennifer Pors, and Karim Nader (2015): "Systems reconsolidation reveals a selective role for the anterior cingulate cortex in generalized contextual fear memory expression". In: *Neuropsychopharmacology* 40.2, pp. 480–487.
- Ekman, Paul (1999): "Facial expressions". In: *Handbook of cognition and emotion*. Vol. 16. 301. New York, e320.
- Ekstrom, Arne D, Jeremy B Caplan, Emily Ho, Kirk Shattuck, Itzhak Fried, and Michael J Kahana (2005): "Human hippocampal theta activity during virtual navigation". In: *Hippocampus* 15.7, pp. 881–889.
- Engel, Andreas K, Pascal Fries, and Wolf Singer (2001): "Dynamic predictions: Oscillations and synchrony in topdown processing". In: *Nature Reviews Neuroscience* 2.10, pp. 704–716.
- Eschenko, Oxana, Matthias Mölle, Jan Born, and Susan J. Sara (2006): "Elevated sleep spindle density after learning or after retrieval in rats". In: *Journal of Neuroscience* 26.50, pp. 12914–12920.
- Eschenko, Oxana, Wiãm Ramadan, Matthias Mölle, Jan Born, and Susan J. Sara (2008): "Sustained increase in hippocampal sharp-wave ripple activity during slow-wave sleep after learn-

- ing". In: *Learning and Memory* 15.4, pp. 222–228.
- Esclassan, Frederic, Etienne Coutureau, Georges Di Scala, and Alain R. Marchand (2009): "Differential contribution of dorsal and ventral hippocampus to trace and delay fear conditioning". In: *Hippocampus* 19, pp. 33–44.
- Estes, William K and Burrhus F Skinner (1941): "Some quantitative properties of anxiety." In: *Journal of Experimental Psychology* 29.5, p. 390.
- Euston, David R. and Bruce L. McNaughton (2006): "Apparent encoding of sequential context in rat medial prefrontal cortex is accounted for by behavioral variability". In: *Journal of Neuroscience* 26.51, pp. 13143–13155.
- Euston, David R, Aaron J Gruber, and Bruce L McNaughton (2012): "The Role of Medial Prefrontal Cortex in Memory and Decision Making". In: *Neuron* 76.6, pp. 1057–1070.
- Euston, David R, Masami Tatsuno, and Bruce L McNaughton (2007): "Fast-forward playback of recent memory sequences in prefrontal cortex during sleep". In: *science* 318.5853, pp. 1147–1150.
- Fadok, Jonathan P., Sabine Krabbe, Milica Markovic, Julien Courtin, Chun Xu, Lema Massi, Paolo Botta, Kristine Bylund, Christian Müller, Aleksandar Kovacevic, Philip Tovote, and Andreas Lüthi (2017): "A competitive inhibitory circuit for selection of active and passive fear responses". In: *Nature* 542.7639, p. 96.
- Fadok, Jonathan P., Milica Markovic, Philip Tovote, and Andreas Lüthi (2018): "New perspectives on central amygdala function". In: *Current Opinion in Neurobiology* 49, pp. 141–147.
- Fadok, Jonathan P, Tavis M K Dickerson, and Richard D Palmiter (2009): "Dopamine is necessary for cue-dependent fear conditioning". In: *Journal of neuroscience* 29.36, pp. 11089–11097.
- Faliagkas, Leonidas, Priyanka Rao-ruiz, and Merel Kindt (2018): "ScienceDirect Emotional memory expression is misleading : delineating transitions between memory processes". In: *Current Opinion in Behavioral Sciences* 19, pp. 116–122.
- Fanselow, M S (2000): "Contextual fear, gestalt memories, and the hippocampus." In: *Behavioural brain research* 110.1-2, pp. 73–81.
- Fanselow, Michael S (1991): "The Midbrain Periaqueductal Gray as a Coordinator of Action in Response to Fear and Anxiety Functional Behavior Systems and Fear". In: *The Midbrain Periaqueductal Gray Matter*, pp. 151–173.
- Fanselow, Michael S (1994): "Neural organization of the defensive behavior system responsible for fear". In: *Psychonomic bulletin & review* 1.4, pp. 429–438.
- Fanselow, Michael S. (1980): "Conditional and unconditional components of post-shock freezing". In: *The Pavlovian Journal of Biological Science: Official Journal of the Pavlovian* 15.4, pp. 177–182.
- Fanselow, Michael S. (1986): "Associative vs topographical accounts of the immediate shock-freezing deficit in rats: implications for the response selection rules governing species-specific defensive reactions". In: *Learning and Motivation* 17.1, pp. 16–39.
- Fanselow, Michael S. (2010): "From contextual fear to a dynamic view of memory systems". In: *Trends in Cognitive Sciences* 14.1, pp. 7–15.
- Fanselow, Michael S. (2018a): "Emotion, motivation and function". In: *Current Opinion in Behavioral Sciences* 19, pp. 105–109.
- Fanselow, Michael S. (2018b): "The role of learning in threat imminence and defensive behaviors". In: *Current opinion in behavioral sciences* 24, pp. 44–49.
- Fanselow, Michael S. and Zachary T. Pennington (2018): "A return to the psychiatric dark ages with a two-system framework for fear". In: *Behaviour Research and Therapy* 100.November 2017, pp. 24–29.
- Fanselow, Michael S. and Kate M. Wassum (2016): "The origins and organization of vertebrate pavlovian conditioning". In: *Cold Spring Harbor Perspectives in Biology* 8.1, pp. 1–28.
- Fanselow, Michael S and Robert C Bolles (1979): "Naloxone and shock-elicited freezing in the rat." In: *Journal of comparative and physiological psychology* 93.4, p. 736.
- Fanselow, Michael S and Joseph E Ledoux (1999): "Why We Think Plasticity Underlying Pavlovian Fear Conditioning Occurs in the Basolateral Amygdala Viewpoint". In: *Neuron* 23, pp. 229–232.
- Fanselow, Michael S and Laurie S Lester (1988): "A functional behavioristic approach to aversively motivated behavior: Predatory imminence as a determinant of the topography of defensive behavior." In:
- Fanselow, Michael S and Andrew M Poulos (2005): "The neuroscience of mammalian associative learning". In: *Annu. Rev. Psychol.* 56, pp. 207–234.

- Fanselow, MS Michael S MS and Hong-Wei H-W Hong-Wei Dong (2010): "Are the dorsal and ventral hippocampus functionally distinct structures?" In: *Neuron* 65.1, pp. 7–19.
- Farinelli, Mélissa, Olivier Deschaux, Sandrine Hugues, Aurélie Thevenet, and René Garcia (2006): "Hippocampal train stimulation modulates recall of fear extinction independently of prefrontal cortex synaptic plasticity and lesions". In: *Learning and Memory* 13.3, pp. 329–334.
- Farmer, George E and Lucien T Thompson (2012): "Learningdependent plasticity of hippocampal CA1 pyramidal neuron postburst afterhyperpolarizations and increased excitability after inhibitory avoidance learning depend upon basolateral amygdala inputs". In: *Hippocampus* 22.8, pp. 1703–1719.
- Feinstein, Justin S, Ralph Adolphs, and Antonio Damasio (2011): "Report The Human Amygdala and the Induction and Experience of Fear". In: *Current Biology* 21.1, pp. 34–38.
- Felix-Ortiz, Ada C., Anna Beyeler, Changwoo Seo, Christopher A. Leppla, Craig P. Wildes, and Kay M. Tye (2013): "BLA to vHPC inputs modulate anxiety-related behaviors." In: *Neuron* 79.4, pp. 658–64.
- Felix-Ortiz, Ada C and Kay M Tye (2014): "Amygdala inputs to the ventral hippocampus bidirectionally modulate social behavior". In: *Journal of Neuroscience* 34.2, pp. 586–595.
- Fell, Juergen and Nikolai Axmacher (2011): "The role of phase synchronization in memory processes." In: *Nature reviews. Neuroscience* 12.2, pp. 105–18.
- Fendt, Markus and Michael S Fanselow (1999): "The neuroanatomical and neurochemical basis of conditioned fear". In: *Neuroscience & Biobehavioral Reviews* 23.5, pp. 743–760.
- Fenno, Lief, Ofer Yizhar, and Karl Deisseroth (2011): "The development and application of optogenetics". In: *Annual review of neuroscience* 34, pp. 389–412.
- Ferino, F, A M Thierry, and J Glowinski (1987): "Anatomical and electrophysiological evidence for a direct projection from Ammon's horn to the medial prefrontal cortex in the rat". In: *Experimental brain research* 65.2, pp. 421–426.
- Ferrara, Nicole C., Patrick K. Cullen, Shane P. Pullins, Elena K. Rotondo, and Fred J. Helmstetter (2017): "Input from the medial geniculate nucleus modulates amygdala encoding of fear memory discrimination". In: *Learning and Memory* 24.9, pp. 414–421.
- Ferraris, Maëva, Antoine Ghestem, Ana F. Vicente, Lauriane Nallet-Khosrofiyan, Christophe Bernard, and Pascale P Quilichini (2018): "The nucleus reuniens controls long-range hippocampoprefrontal gamma synchronization during slow oscillations". In: *Journal of Neuroscience* 38.12, pp. 3026–3038.
- Ferron, Judy Fay, Daniel Kroeger, Oana Chever, and Florin Amzica (2009): "Cortical inhibition during burst suppression induced with isoflurane anesthesia". In: *Journal of Neuroscience* 29.31, pp. 9850–9860.
- Finn, D P, M D Jhaveri, S R G Beckett, A Madjd, D A Kendall, C A Marsden, and V Chapman (2006): "Behavioral, central monoaminergic and hypothalamopituitaryadrenal axis correlates of fear-conditioned analgesia in rats". In: *Neuroscience* 138.4, pp. 1309–1317.
- Fitch, Thomas, Benjamin Adams, Stephen Chaney, and Robert Gerlai (2002): "Force transducerbased movement detection in fear conditioning in mice: A comparative analysis". In: *Hippocampus* 12.1, pp. 4–17.
- Fitzgerald, Paul J., Nigel Whittle, Shaun M. Flynn, Carolyn Graybeal, Courtney R. Pinard, Ozge Gunduz-Cinar, Alexxai V. Kravitz, Nicolas Singewald, and Andrew Holmes (2014): "Prefrontal single-unit firing associated with deficient extinction in mice". In: *Neurobiology of Learning and Memory* 113, pp. 69–81.
- Fitzgerald, Paul J, Thomas F Giustino, Jocelyn R Seemann, and Stephen Maren (2015): "Noradrenergic blockade stabilizes prefrontal activity and enables fear extinction under stress". In: *Proceedings of the National Academy of Sciences* 112.28, E3729–E3737.
- Flavell, Steven W. and Michael E. Greenberg (2008): "Signaling Mechanisms Linking Neuronal Activity to Gene Expression and Plasticity of the Nervous System". In: *Annual Review of Neuroscience* 31.1, pp. 563–590.
- Floyd, Nicole S, Joseph L Price, Amon T Ferry, Kevin A Keay, and Richard Bandler (2001): "Orbitomedial prefrontal cortical projections to hypothalamus in the rat". In: *Journal of Comparative Neurology* 432.3, pp. 307–328.
- Fontanini, Alfredo and James M Bower (2005): "Variable coupling between olfactory system activity and respiration in ketamine/xylazine anesthetized rats". In: *Journal of neurophysiology* 93.6, pp. 3573–3581.
- Fontanini, Alfredo, PierFranco Spano, and James M Bower (2003): "Ketamine-xylazine-induced slow (< 1.5 Hz) os-

- cillations in the rat piriform (olfactory) cortex are functionally correlated with respiration". In: *Journal of Neuroscience* 23.22, pp. 7993–8001.
- Foster, David J. (2017): "Replay Comes of Age". In: *Annual Review of Neuroscience* 40.1, pp. 581–602.
- Foster, David J. and Matthew A. Wilson (2007): "Hippocampal Theta Sequences David". In: *Hippocampus* 17, pp. 1093–1099.
- Foster, David J and Matthew A Wilson (2006): "Reverse replay of behavioural sequences in hippocampal place cells during the awake state". In: *Nature* 440.7084, p. 680.
- Fragkaki, Iro, Karin Roelofs, John Stins, Ruud A Jongedijk, and Muriel A Hagenaaars (2017): "Reduced freezing in posttraumatic stress disorder patients while watching affective pictures". In: *Frontiers in psychiatry* 8, p. 39.
- Frankland, Paul W., Vincenzo Cestari, Robert K. Filipkowski, Robert J. McDonald, and Alcino J. Silva (1998): "The dorsal hippocampus is essential for context discrimination but not for contextual conditioning." In: *Behavioral Neuroscience* 112.4, pp. 863–874.
- Frankland, Paul W and Bruno Bontempi (2005): "The organization of recent and remote memories". In: *Nature Reviews Neuroscience* 6.2, pp. 119–130.
- Frankland, Paul W, Bruno Bontempi, Lynn E Talton, Leszek Kaczmarek, and Alcino J Silva (2004): "The involvement of the anterior cingulate cortex in remote contextual fear memory". In: *Science* 304.5672, pp. 881–883.
- Fries, Pascal (2015): "Perspective Rhythms for Cognition : Communication through Coherence". In: *Neuron* 88.1, pp. 220–235.
- Fries, Pascal, John H Reynolds, Alan E Rorie, and Robert Desimone (2001): "Modulation of oscillatory neuronal synchronization by selective visual attention". In: *Science* 291.5508, pp. 1560–1563.
- Frohhardt, Russell J, Fay A Guarraci, and Mark E Bouton (2000): "The effects of neurotoxic hippocampal lesions on two effects of context after fear extinction". In: *Behavioral Neuroscience* 114.2, pp. 227–240.
- Fryszak, Robert J and Edward J Neafsey (1991): "The effect of medial frontal cortex lesions on Respiration, "Freezing" and Ultrasonic Vocalizations during Conditioned Emotional Responses in Rats". In: *Cerebral Cortex* 1, pp. 418–425.
- Furtak, Sharon C, ShauMing Wei, Kara L Agster, and Rebecca D Burwell (2007): "Functional neuroanatomy of the parahippocampal region in the rat: the perirhinal and postrhinal cortices". In: *Hippocampus* 17.9, pp. 709–722.
- Fuster, Joaquin (2015): *The prefrontal cortex*. Academic Press, p. 460.
- Gabbott, Paul, Anthony Headlam, and Sarah Busby (2002): "Morphological evidence that CA1 hippocampal afferents monosynaptically innervate PV-containing neurons and NADPH-diaphorase reactive cells in the medial prefrontal cortex (Areas 25/32) of the rat". In: *Brain research* 946.2, pp. 314–322.
- Gabrielsen, Geir Wing, Arnoldus Schytte Blix, and Holger Ursin (1985): "Orienting and freezing responses in incubating ptarmigan hens". In: *Physiology & behavior* 34.6, pp. 925–934.
- Galatzer-Levy, Isaac R, George a Bonanno, David E a Bush, and Joseph E Ledoux (2013): "Heterogeneity in threat extinction learning: substantive and methodological considerations for identifying individual difference in response to stress." In: *Frontiers in behavioral neuroscience* 7.May, p. 55.
- GalatzerLevy, Isaac R, Anita Madan, Thomas C Neylan, Clare HennHaase, and Charles R Marmar (2011): "Peritraumatic and trait dissociation differentiate police officers with resilient versus symptomatic trajectories of post-traumatic stress symptoms". In: *Journal of traumatic stress* 24.5, pp. 557–565.
- Gale, Greg D, Stephan G Anagnostaras, Bill P Godsil, Shawn Mitchell, Takashi Nozawa, Jennifer R Sage, Brian Wiltgen, and Michael S Fanselow (2004): "Role of the basolateral amygdala in the storage of fear memories across the adult lifetime of rats". In: *The Journal of Neuroscience* 24.15, pp. 3810–3815.
- Gallup, Gordon G (1974): "Animal hypnosis: factual status of a fictional concept." In: *Psychological bulletin* 81.11, p. 836.
- Garcia, René, Chun Hui Chang, and Stephen Maren (2006): "Electrolytic lesions of the medial prefrontal cortex do not interfere with long-term memory of extinction of conditioned fear". In: *Learning and Memory* 13.1, pp. 14–17.
- Garfinkel, Sarah N, James L Abelson, Anthony P King, Rebecca K Sripada, Xin Wang, Laura M Gaines, and Israel Liberzon (2014): "Impaired Contextual Modulation of Memories in PTSD: An fMRI and Psychophysiological Study of Extinction Retention and Fear Renewal". In: *Journal of Neuroscience* 34.40, pp. 13435–13443.

- Garner, Aleena R, David C Rowland, Sang Y Hwang, Karsten Baumgaertel, Bryan L Roth, Cliff Kentros, and Mark Mayford (2012): "Generation of a Synthetic Memory Trace". In: *Science* 335.6075, pp. 1513–1516.
- Gasbarri, A, C Verney, R Innocenzi, E Campana, and C Pacitti (1994): "Mesolimbic dopaminergic neurons innervating the hippocampal formation in the rat: a combined retrograde tracing and immunohistochemical study." eng. In: *Brain research* 668.1-2, pp. 71–79.
- Gaykema, Ronald P A, Rob Van Weeghel, Louis B Hersh, and Paul G M Luiten (1991): "Prefrontal cortical projections to the cholinergic neurons in the basal forebrain". In: *Journal of Comparative Neurology* 303.4, pp. 563–583.
- George, David T., Rezvan Ameli, and George F. Koob (2019): "Periaqueductal Gray Sheds Light on Dark Areas of Psychopathology". In: *Trends in Neurosciences* 42.5, pp. 349–360.
- Gewirtz, Jonathan C., William A. Falls, and Michael Davis (1997): "Normal conditioned inhibition and extinction of freezing and fear-potentiated startle following electrolytic lesions of medial prefrontal cortex in rats". In: *Behavioral Neuroscience* 111.4, pp. 712–726.
- Ghandour, Khaled, Noriaki Ohkawa, Chi Chung Alan Fung, Hiroataka Asai, Yoshito Saitoh, Takashi Takekawa, Reiko Okubo-Suzuki, Shingo Soya, Hirofumi Nishizono, Mina Matsuo, Makoto Osanai, Masaaki Sato, Masamichi Ohkura, Junichi Nakai, Yasunori Hayashi, Takeshi Sakurai, Takashi Kitamura, Tomoki Fukai, and Kaoru Inokuchi (2019): "Orchestrated ensemble activities constitute a hippocampal memory engram". In: *Nature Communications* 10.1, pp. 1–14.
- Gilmartin, Marieke R. and Matthew D. McEchron (2005): "Single neurons in the medial prefrontal cortex of the rat exhibit tonic and phasic coding during trace fear conditioning". In: *Behavioral Neuroscience* 119.6, pp. 1496–1510.
- Giocomo, Lisa M and Michael E Hasselmo (2008): "Time constants of h current in layer ii stellate cells differ along the dorsal to ventral axis of medial entorhinal cortex." eng. In: *The Journal of neuroscience : the official journal of the Society for Neuroscience* 28.38, pp. 9414–9425.
- Giocomo, Lisa M and Michael E Hasselmo (2009): "Knock-out of HCN1 subunit flattens dorsal-ventral frequency gradient of medial entorhinal neurons in adult mice." eng. In: *The Journal of neuroscience : the official journal of the Society for Neuroscience* 29.23, pp. 7625–7630.
- Girardeau, Gabrielle, Karim Benchenane, Sidney I Wiener, György Buzsáki, and Michaël B Zugaro (2009): "Selective suppression of hippocampal ripples impairs spatial memory". In: *Nature neuroscience* 12.10, pp. 1222–1223.
- Girardeau, Gabrielle, Ingrid Inema, and György Buzsáki (2017): "Reactivations of emotional memory in the hippocampus-amygdala system during sleep". In: *Nature neuroscience* 20.11, p. 1634.
- Girardeau, Gabrielle and Michaël Zugaro (2011): "Hippocampal ripples and memory consolidation". In: *Current opinion in neurobiology* 21.3, pp. 452–459.
- Gisquet-Verrier, Pascale, Gérard Dutrieux, Paulette Richer, and Valérie Doyère (1999): "Effects of lesions to the hippocampus on contextual fear: evidence for a disruption of freezing and avoidance behavior but not context conditioning". In: *Behavioral Neuroscience* 113.3, p. 507.
- Giustino, Thomas F., Paul J. Fitzgerald, and Stephen Maren (2016): "Fear expression suppresses medial prefrontal cortical firing in rats". In: *PLoS ONE* 11.10, pp. 1–13.
- Giustino, Thomas F., Paul J. Fitzgerald, Reed L. Ressler, and Stephen Maren (2019): "Locus coeruleus toggles reciprocal prefrontal firing to reinstate fear". In: *Proceedings of the National Academy of Sciences* 116.17, p. 201814278.
- Goddard, Graham V (1964): "Functions of the amygdala." In: *Psychological bulletin* 62.2, p. 89.
- Godden, D R and A D Baddeley (1975): "Context-dependent memory in two natural environments: On land and underwater." In: *British Journal of Psychology* 66.3, pp. 325–331.
- Godsil, B P, B Bontempi, F Mailliet, P Delagrèze, M Spedding, and T M Jay (2015): "Acute tianeptine treatment selectively modulates neuronal activation in the central nucleus of the amygdala and attenuates fear extinction." In: *Molecular psychiatry* 20.January 2014, pp. 1–8.
- Godsil, B P and M S Fanselow (2012): "Motivation, w: Weiner, IB, Healy, AF, Proctor, RW". In: *Handbook of Psychology, Experimental Psychology*.
- Godsil, Bill P., Janos P. Kiss, Michael Spedding, and Thérèse M. Jay (2013): "The hippocampal-prefrontal pathway: The weak link in psychiatric disorders?" In: *European Neuropsychopharmacology* 23.10, pp. 1165–1181.

- Godsil, Bill P, Michelle A Blackmore, and Michael S Fanselow (2005): "Modulation of an activity response with associative and nonassociative fear in the rat: A lighting differential influences the form of defensive behavior evoked after fear conditioning". In: *Learning & behavior* 33.4, pp. 454–463.
- Gogolla, Nadine (2017): "The insular cortex". In: *Current Biology* 27.12, R580–R586.
- Goldman-Rakic, P S (1990): "Cellular and circuit basis of working memory in prefrontal cortex of nonhuman primates." eng. In: *Progress in brain research* 85, pp. 325–326.
- Goltz, Friedrich L. (1884): "Ueber die Verrichtungen des Grosshirns [On the functions of the emispheres]". In: *Pflügers Archiv European Journal of Physiology* 34.1, pp. 450–505.
- Goltz, Friedrich L. (1892): "Der hund ohne grosshirn [The dog without a cerebrum]". In: *Pflügers Archiv European Journal of Physiology* 51.11, pp. 570–614.
- Golub, Justin S, Leo Ling, Kaibao Nie, Amy Nowack, Sarah J Shepherd, Steven M Bierer, Elyse Jameyson, Chris R S Kaneko, James O Phillips, and Jay T Rubinstein (2014): "Prosthetic implantation of the human vestibular system". In: *Otology & neurotology: official publication of the American Otological Society, American Neurotology Society [and] European Academy of Otology and Neurotology* 35.1, p. 136.
- Gonchar, Y A, P B Johnson, and R J Weinberg (1995): "GABA-immunopositive neurons in rat neocortex with contralateral projections to ST". In: *Brain research* 697.1-2, pp. 27–34.
- Goode, Travis D, Gillian M Acca, and Stephen Maren (2019a): "Threat imminence dictates the role of the bed nucleus of the stria terminalis in contextual fear". In: *bioRxiv*, p. 696112.
- Goode, Travis D and Stephen Maren (2017): "Role of the bed nucleus of the stria terminalis in aversive learning and memory". In: *Learning & Memory*.
- Goode, Travis D, Reed L Ressler, Gillian M Acca, Olivia W Miles, and Stephen Maren (2019b): "Bed nucleus of the stria terminalis regulates fear to unpredictable threat signals". In: *eLife*, pp. 1–29.
- Goosens, Ki A., Jennifer A. Hobin, and Stephen Maren (2003): "Auditory-Evoked Spike Firing in the Lateral Amygdala and Pavlovian Fear Conditioning: Mnemonic Code or Fear Bias?" In: *Neuron* 40.5, pp. 1013–1022.
- Goosens, Ki A. and Stephen Maren (2001): "Contextual and auditory fear conditioning are mediated by the lateral, basal, and central amygdaloid nuclei in rats". In: *Learning and Memory* 8, pp. 148–155.
- Goosens, Ki A and Stephen Maren (2002): "Longterm potentiation as a substrate for memory: Evidence from studies of amygdaloid plasticity and Pavlovian fear conditioning". In: *Hippocampus* 12.5, pp. 592–599.
- Gore, Felicity, Edmund C Schwartz, Baylor C Brangers, Stanley Aladi, Joseph M Stujenske, Ekaterina Likhtik, Marco J Russo, Joshua A Gordon, C Daniel Salzman, and Richard Axel (2015): "Neural Representations of Unconditioned Stimuli in Basolateral Amygdala Mediate Innate and Learned Responses." eng. In: *Cell* 162.1, pp. 134–145.
- Gormezano, I. and John W. Moore (1964): "Yoked comparisons of contingent and noncontingent US presentations in human eyelid conditioning". In: *Psychonomic Science* 1.1-12, pp. 231–232.
- Goshen, Inbal, Matthew Brodsky, Rohit Prakash, Jenelle Wallace, Viviana Gradinaru, Charu Ramakrishnan, and Karl Deisseroth (2011): "Dynamics of retrieval strategies for remote memories." In: *Cell* 147.3, pp. 678–689.
- Goswami, Sonal, Michele Cascardi, Olga E. Rodríguez-Sierra, Sevil Duvarci, and Denis Paré (2010): "Impact of predatory threat on fear extinction in Lewis rats". In: *Learning and Memory* 17.10, pp. 494–501.
- Gothard, Katalin M, William E Skaggs, Kevin M Moore, and Bruce L McNaughton (1996): "Binding of Hippocampal CA1 Neural Activity to Multiple Reference Frames in a Landmark-Based Navigation Task". In: *Journal of Neuroscience* 16.2, pp. 823–835.
- Goutagny, Romain, Jesse Jackson, and Sylvain Williams (2009): "Self-generated theta oscillations in the hippocampus". In: *Nature neuroscience* 12.12, p. 1491.
- Graf, Patricia M, Rory P Wilson, Lama Qasem, Klaus Hackländer, and Frank Rosell (2015): "The use of acceleration to code for animal behaviours; a case study in free-ranging Eurasian beavers *Castor fiber*". In: *PLoS one* 10.8, e0136751.
- Gray, J A and N McNaughton (2000): *The neuropsychology of anxiety*. Oxford, England: Oxford University Press.
- Gray, J. A. and N. McNaughton (1982): *The Neuropsychology of Anxiety: An Enquiry into the Functions of the Septo-Hippocampal System*. Oxford University Press.

- Grégoire, Julie, Renée Bergeron, Sylvie D'Allaire, M-C Meunier-Salaün, and Nicolas Devillers (2013): "Assessment of lameness in sows using gait, footprints, postural behaviour and foot lesion analysis". In: *Animal* 7.7, pp. 1163–1173.
- Grewe, Benjamin F., Jan Gründemann, Lacey J. Kitch, Jerome A. Lecoq, Jones G. Parker, Jesse D. Marshall, Margaret C. Larkin, Pablo E. Jercog, Francois Grenier, Jin Zhong Li, Andreas Lüthi, and Mark J. Schnitzer (2017): "Neural ensemble dynamics underlying a long-term associative memory". In: *Nature* 543.7647, pp. 670–675.
- Griebel, G, D C Blanchard, A Jung, and R J Blanchard (1995a): "A model of "antipredator" in Swiss-Webster mice: Effects of benzodiazepine receptor ligands with different intrinsic activities." In: *Behavioural pharmacology*.
- Griebel, Guy, D Caroline Blanchard, Anke Jung, Camlyn K Masuda, and Robert J Blanchard (1995b): "5-HT1A agonists modulate mouse antipredator defensive behavior differently from the 5-HT2A antagonist pirenperone". In: *Pharmacology Biochemistry and Behavior* 51.2-3, pp. 235–244.
- Griebel, Guy, D. Caroline Blanchard, and Robert J. Blanchard (1996): "Evidence that the behaviors in the mouse defense test battery relate to different emotional states: A factor analytic study". In: *Physiology and Behavior* 60.5, pp. 1255–1260.
- Griffin, Amy L (2015): "Role of the thalamic nucleus reuniens in mediating interactions between the hippocampus and medial prefrontal cortex during spatial working memory". In: *Frontiers in systems neuroscience* 9, p. 29.
- Griffith, Coleman R (1919): "A possible case of instinctive behavior in the white rat". In: *Science* 50.1285, pp. 166–167.
- Griffith, Coleman R (1920): "The behavior of white rats in the presence of cats." In: *Psychobiology* 2.1, p. 19.
- Grillon, Christian (2008): "Models and mechanisms of anxiety: Evidence from startle studies". In: *Psychopharmacology* 199.3, pp. 421–437.
- Grillon, Christian, Rezvan Ameli, Andrew Goddard, Scott W Woods, and Michael Davis (1994): "Baseline and fear-potentiated startle in panic disorder patients". In: *Biological psychiatry* 35.7, pp. 431–439.
- Grillon, Christian and Johanna Baas (2003): "A review of the modulation of the startle reflex by affective states and its application in psychiatry". In: *Clinical neurophysiology* 114.9, pp. 1557–1579.
- Grillon, Christian, Charles A Morgan III, Michael Davis, and Steven M Southwick (1998): "Effects of experimental context and explicit threat cues on acoustic startle in Vietnam veterans with post-traumatic stress disorder". In: *Biological psychiatry* 44.10, pp. 1027–1036.
- Grillon, Christian, Mark Pellowski, Kathleen R Merikangas, and Michael Davis (1997): "Darkness facilitates the acoustic startle reflex in humans". In: *Biological psychiatry* 42.6, pp. 453–460.
- Groenewegen, H J, E te Vermeulen-Van der Zee, A Te Kortschot, and M P Witter (1987): "Organization of the projections from the subiculum to the ventral striatum in the rat. A study using anterograde transport of Phaseolus vulgaris leucoagglutinin". In: *Neuroscience* 23.1, pp. 103–120.
- Groenewegen, Henk J, Christopher I Wright, and Harry B M Uylings (1997): "The anatomical relationships of the prefrontal cortex with limbic structures and the basal ganglia". In: *Journal of Psychopharmacology* 11.2, pp. 99–106.
- Groessl, Florian, Thomas Munsch, Susanne Meis, Johannes Griessner, Joanna Kaczanowska, Pinelopi Pliota, Dominic Kargl, Sylvia Badurek, Klaus Kraitsys, Arash Rassoulpour, Johannes Zuber, Volkmar Lessmann, and Wulf Haubensak (2018): "associative learning of fear". In: *Nature Neuroscience* 21.July.
- Grosmark, Andres D and György Buzsáki (2016): "Diversity in neural firing dynamics supports both rigid and learned hippocampal sequences". In: *Science* 351.6280, pp. 1440–1443.
- Grosmark, Andres D, Kenji Mizuseki, Eva Pastalkova, Kamran Diba, and György Buzsáki (2012): "REM sleep reorganizes hippocampal excitability". In: *Neuron* 75.6, pp. 1001–1007.
- Gruber, Aaron J, Gwendolyn G Calhoon, Igor Shusterman, Geoffrey Schoenbaum, Matthew R Roesch, and Patricio O'Donnell (2010): "More is less: a disinhibited prefrontal cortex impairs cognitive flexibility". In: *Journal of Neuroscience* 30.50, pp. 17102–17110.
- Gruene, Tina M, Katelyn Flick, Alexis Stefano, Stephen D Shea, and Rebecca M Shansky (2015): "Sexually divergent expression of active and passive conditioned fear responses in rats". In: *Elife* 4, e11352.
- Guise, Kevin G. and Matthew L. Shapiro (2017): "Medial Prefrontal Cortex Reduces Memory Interference by Modifying Hippocampal Encoding". In: *Neuron* 94.1, 183–192.e8.

- Gulati, Tanuj, Dhakshin S Ramanathan, Chelsea C Wong, and Karunesh Ganguly (2014): "Reactivation of emergent task-related ensembles during slow-wave sleep after neuroprosthetic learning". In: *Nature Neuroscience* 17.8, pp. 1107–1113.
- Gunaydin, Lisa A, Logan Grosenick, Joel C Finkelstein, Isaac V Kauvar, Lief E Fenno, Avishek Adhikari, Stephan Lamme, Julie J Mirzabekov, Raag D Airan, and Kelly A Zalocusky (2014): "Natural neural projection dynamics underlying social behavior". In: *Cell* 157.7, pp. 1535–1551.
- Gungor, N. Z. and D. Pare (2016): "Functional Heterogeneity in the Bed Nucleus of the Stria Terminalis". In: *Journal of Neuroscience* 36.31, pp. 8038–8049.
- Gunther, Lisa M, James C Denniston, and Ralph R Miller (1998): *Conducting exposure treatment in multiple contexts can prevent relapse*. Netherlands.
- Gupta, Anoopum S, Matthijs A A van der Meer, David S Touretzky, and A David Redish (2010): "Hippocampal replay is not a simple function of experience". In: *Neuron* 65.5, pp. 695–705.
- Guzowski, John F, Bruce L McNaughton, Carol A Barnes, and Paul F Worley (1999): "Environment-specific expression of the immediate-early gene Arc in hippocampal neuronal ensembles". In: *Nature neuroscience* 2.12, p. 1120.
- Hagenaars, Muriel A., Melly Oitzl, and Karin Roelofs (2014): "Updating freeze: Aligning animal and human research". In: *Neuroscience and Biobehavioral Reviews* 47. July 2015, pp. 165–176.
- Hagenaars, Muriel A, Agnes van Minnen, Emily A Holmes, Chris R Brewin, and Kees A L Hoogduin (2008): "The effect of hypnotically induced somatoform dissociation on the development of intrusions after an aversive film". In: *Cognition and Emotion* 22.5, pp. 944–963.
- Hagenaars, Muriel A, John F Stins, and Karin Roelofs (2012): "Aversive life events enhance human freezing responses." In: *Journal of Experimental Psychology: General* 141.1, p. 98.
- Hajós, Mihály, C D Richards, Andrea D Székely, and Trevor Sharp (1998): "An electrophysiological and neuroanatomical study of the medial prefrontal cortical projection to the midbrain raphe nuclei in the rat". In: *Neuroscience* 87.1, pp. 95–108.
- Halladay, Lindsay R. and Hugh T. Blair (2015): "Distinct ensembles of medial prefrontal cortex neurons are activated by threatening stimuli that elicit excitation vs. inhibition of movement". In: *Journal of Neurophysiology* 114.2, pp. 793–807.
- Hamm, Alfons O, Almut I Weike, Harald T Schupp, Thomas Treig, Alexander Dressel, and Christof Kessler (2003): "Affective blindsight: intact fear conditioning to a visual cue in a cortically blind patient." eng. In: *Brain : a journal of neurology* 126.Pt 2, pp. 267–275.
- Han, Jin-Hee, Steven A Kushner, Adelaide P Yiu, Hwa-Lin Liz Hsiang, Thorsten Buch, Ari Waisman, Bruno Bontempi, Rachael L Neve, Paul W Frankland, and Sheena A Josselyn (2009): "Selective erasure of a fear memory." eng. In: *Science (New York, N.Y.)* 323.5920, pp. 1492–1496.
- Han, Jin-Hee, Adelaide P Yiu, Christina J Cole, Hwa-Lin Hsiang, Rachael L Neve, and Sheena A Josselyn (2008): "Increasing CREB in the auditory thalamus enhances memory and generalization of auditory conditioned fear." eng. In: *Learning & memory (Cold Spring Harbor, N.Y.)* 15.6, pp. 443–453.
- Han, Sung, Matthew T Soleiman, Marta E Soden, Larry S Zweifel, and Richard D Palmiter (2015): "Elucidating an affective pain circuit that creates a threat memory". In: *Cell* 162.2, pp. 363–374.
- Han, Wenfei, Luis A Tellez, Miguel J Rangel Jr, Simone C Motta, Xiaobing Zhang, Isaac O Perez, Newton S Canteras, Sara J Shammah-Lagnado, Anthony N van den Iden Pol, and Ivan E de Araujo (2017): "Integrated control of predatory hunting by the central nucleus of the amygdala". In: *Cell* 168.1-2, pp. 311–324.
- Harlow, John M. (1848): "Passage of an Iron Rod Through the Head". In: *Boston Medical and Surgical Journal* 39.20, pp. 389–393.
- Harlow, John M. (1868): "Recovery from the passage of an iron bar through the head". In: *Publications of the Massachusetts Medical Society* 2.3.
- Harris, John Donald (1943): *Studies on nonassociative factors inherent in conditioning*. 93. Williams & Wilkins.
- Harris, Justin A, Megan L Jones, Glynis K Bailey, and R Frederick Westbrook (2000): "Contextual control over conditioned responding in an extinction paradigm." In: *Journal of Experimental Psychology: Animal Behavior Processes* 26.2, p. 174.
- Harris, Kenneth D (2005): "Neural signatures of cell assembly organization". In: *Nature Reviews Neuroscience* 6.5, pp. 399–407.
- Harris, Kenneth D, Jozsef Csicsvari, Hajime Hirase, George Dragoi, and György Buzsáki (2003): "Organization of cell

- assemblies in the hippocampus". In: *Nature* 424.6948, pp. 552–556.
- Hartley, Catherine A and Elizabeth A Phelps (2010): "Changing fear: the neurocircuitry of emotion regulation." eng. In: *Neuropsychopharmacology : official publication of the American College of Neuropsychopharmacology* 35.1, pp. 136–146.
- Hartley, D (1801): *Observations on Man, his frame, his deity, and his expectations (1749/1966)*.
- Hasselmo (1999): "Neuromodulation: acetylcholine and memory consolidation." eng. In: *Trends in cognitive sciences* 3.9, pp. 351–359.
- Hasselmo, Michael E, Clara Bodelón, and Bradley P Wyble (2002): "A proposed function for hippocampal theta rhythm: separate phases of encoding and retrieval enhance reversal of prior learning". In: *Neural computation* 14.4, pp. 793–817.
- Haubensak, Wulf, Prabhat S Kunwar, Haijiang Cai, Stephane Ciochi, Nicholas R Wall, Ravikumar Ponnusamy, Jonathan Biag, Hong-Wei Dong, Karl Deisseroth, Edward M Callaway, Michael S Fanselow, Andreas Lüthi, and David J Anderson (2010): "Genetic dissection of an amygdala microcircuit that gates conditioned fear." eng. In: *Nature* 468.7321, pp. 270–276.
- Hawkins, Robert D and John H Byrne (2015): "Associative learning in invertebrates". In: *Cold Spring Harbor perspectives in biology* 7.5, a021709.
- Hazan, Lynn, Michaël Zugaro, and György Buzsáki (2006): "Klusters, NeuroScope, NDManager: a free software suite for neurophysiological data processing and visualization". In: *Journal of neuroscience methods* 155.2, pp. 207–216.
- Headley, Drew B, Vasiliki Kanta, Pınelopi Kyriazi, and Denis Paré (2019): "Embracing Complexity in Defensive Networks". In: *Neuron*, pp. 189–201.
- Hebb, D O (1949): *The organization of behavior; a neuropsychological theory*. Oxford, England: Wiley, pp. xix, 335–xix, 335.
- Heck, Detlef H., Robert Kozma, and Leslie M. Kay (2019): "The rhythm of memory: how breathing shapes memory function". In: *Journal of Neurophysiology* 122.2, pp. 563–571.
- Heidbreder, Christian A. and Henk J. Groenewegen (2003): "The medial prefrontal cortex in the rat: Evidence for a dorso-ventral distinction based upon functional and anatomical characteristics". In: *Neuroscience and Biobehavioral Reviews* 27.6, pp. 555–579.
- Heilbronner, Sarah R, Jose Rodriguez-romaguera, Gregory J Quirk, Henk J Groenewegen, and Suzanne N Haber (2016): "Priority Communication Circuit-Based Corticostriatal Homologies Between Rat and Primate". In: *Biological Psychiatry* 80.7, pp. 509–521.
- Helmstetter, Fred J. (1992): "Contribution of the amygdala to learning and performance of conditional fear". In: *Physiology and Behavior* 51.6, pp. 1271–1276.
- Helmstetter, Fred J. and Patrick S. Bellgowan (1994): "Effects of muscimol applied to the basolateral amygdala on acquisition and expression of contextual fear conditioning in rats". In: *Behavioral Neuroscience* 108.5, pp. 1005–1009.
- Helmstetter, Fred J and Michael S Fanselow (1993): "Aversively motivated changes in meal patterns of rats in a closed economy: The effects of shock density". In: *Animal Learning & Behavior* 21.2, pp. 168–175.
- Hembrook, Jacqueline R, Kristen D Onos, and Robert G Mair (2012): "Inactivation of ventral midline thalamus produces selective spatial delayed conditional discrimination impairment in the rat". In: *Hippocampus* 22.4, pp. 853–860.
- Hendricks, J C, S M Finn, K A Panckeri, J Chavkin, J A Williams, A Sehgal, and A I Pack (2000): "Rest in *Drosophila* is a sleep-like state." eng. In: *Neuron* 25.1, pp. 129–138.
- Henke, Peter G (1990): "Hippocampal pathway to the amygdala and stress ulcer development". In: *Brain research bulletin* 25.5, pp. 691–695.
- Hermans, Erno J, Marloes J A G Henckens, Karin Roelofs, and Guillén Fernández (2013): "Fear bradycardia and activation of the human periaqueductal grey". In: *Neuroimage* 66, pp. 278–287.
- Heron, W T and B F Skinner (1939): "An apparatus for the study of animal behavior." In: *The Psychological Record*.
- Herry, Cyril, Stephane Ciochi, Verena Senn, Lynda Demmou, Christian Müller, and Andreas Lüthi (2008): "Switching on and off fear by distinct neuronal circuits." In: *Nature* 454.7204, pp. 600–6.
- Herry, Cyril, Francesco Ferraguti, Nicolas Singewald, Johannes J Letzkus, Ingrid Ehrlich, and Andreas Lüthi (2010): "Neuronal circuits of fear extinction." In: *The European journal of neuroscience* 31.4, pp. 599–612.
- Herry, Cyril and Rene Garcia (2002): "Prefrontal cortex long-term potentiation, but not long-term depression, is asso-

- ciated with the maintenance of extinction of learned fear in mice.” In: *The Journal of neuroscience : the official journal of the Society for Neuroscience* 22.2, pp. 577–83.
- Herry, Cyril and René Garcia (2003): “Behavioral and paired-pulse facilitation analyses of long-lasting depression at excitatory synapses in the medial prefrontal cortex in mice”. In: *Behavioural Brain Research* 146.1-2, pp. 89–96.
- Herry, Cyril and Joshua P Johansen (2014): “Encoding of fear learning and memory in distributed neuronal circuits”. In: *Nature neuroscience* 17.12.
- Herry, Cyril and Nicole Mons (2004): “Resistance to extinction is associated with impaired immediate early gene induction in medial prefrontal cortex and amygdala”. In: *European Journal of Neuroscience* 20.3, pp. 781–790.
- Herry, Cyril, Pierre Trifilieff, Jacques Micheau, Andreas Lüthi, and Nicole Mons (2006): “Extinction of auditory fear conditioning requires MAPK/ERK activation in the basolateral amygdala”. In: *European Journal of Neuroscience* 24.1, pp. 261–269.
- Herry, Cyril, Rose-Marie Vouimba, and René Garcia (1999): “Plasticity in the Mediodorsal Thalamo-Prefrontal Cortical Transmission in Behaving Mice”. In: *Journal of Neurophysiology* 82.5, pp. 2827–2832.
- Hettema, John M, Michael C Neale, and Kenneth S Kendler (2001): “A review and meta-analysis of the genetic epidemiology of anxiety disorders”. In: *American Journal of Psychiatry* 158.10, pp. 1568–1578.
- Hidaka, Shohei and Masafumi Oizumi (2018): “Fast and exact search for the partition with minimal information loss”. In: *PLOS ONE* 13.9, e0201126.
- Hikosaka, Okihide, Susan R Sesack, Lucas Lecourtier, and Paul D Shepard (2008): “Habenula: Crossroad between the Basal Ganglia and the Limbic System”. In: *Journal of Neuroscience* 28.46, pp. 11825–11829.
- Hirsch, Stephen M and Robert C Bolles (1980): “On the ability of prey to recognize predators”. In: *Zeitschrift für Tierpsychologie* 54.1, pp. 71–84.
- Hitchcock, Janice and Michael Davis (1986): “Lesions of the Amygdala , but Not of the Cerebellum or Red Nucleus , Block Conditioned Fear as Measured With the Potentiated Startle Paradigm”. In: *Behavioral Neuroscience* 100.1, pp. 11–22.
- Hobin, Jennifer a., Jinzhao Ji, and Stephen Maren (2006): “Ventral hippocampal muscimol disrupts context-specific fear memory retrieval after extinction in rats.” In: *Hippocampus* 16.2, pp. 174–82.
- Hobin, Jennifer A, Ki A Goosens, and Stephen Maren (2003): “Context-dependent neuronal activity in the lateral amygdala represents fear memories after extinction”. In: *Journal of Neuroscience* 23.23, pp. 8410–8416.
- Hofer, Myron A (1996): “Multiple regulators of ultrasonic vocalization in the infant rat”. In: *Psychoneuroendocrinology* 21.2, pp. 203–217.
- Holmes, Andrew, Paul J Fitzgerald, Kathryn P MacPherson, Lauren DeBrouse, Giovanni Colacicco, Shaun M Flynn, Sophie Masneuf, Kristen E Pleil, Chia Li, and Catherine A Marcinkiewicz (2012): “Chronic alcohol remodels prefrontal neurons and disrupts NMDAR-mediated fear extinction encoding”. In: *Nature neuroscience* 15.10, pp. 1359–1361.
- Holmes, Andrew and Nicolas Singewald (2013): “Individual differences in recovery from traumatic fear.” In: *Trends in neurosciences* 36.1, pp. 23–31.
- Holson, R. Robert (1986): “Mesial prefrontal cortical lesions and timidity in rats. III. behavior in a semi-natural environment”. In: *Physiology and Behavior* 37.2, pp. 239–247.
- Holt, William and Stephen Maren (1999): “Muscimol Inactivation of the Dorsal Hippocampus Impairs Contextual Retrieval of Fear Memory”. In: *The Journal of Neuroscience* 19.20, pp. 9054–9062.
- Hoover, Walter B. and Robert P. Vertes (2007): “Anatomical analysis of afferent projections to the medial prefrontal cortex in the rat”. In: *Brain Structure and Function* 212.2, pp. 149–179.
- Hoover, Walter B. and Robert P. Vertes (2011): “Projections of the medial orbital and ventral orbital cortex in the rat”. In: *Journal of Comparative Neurology* 519.18, pp. 3766–3801.
- Huang, Yan-You and Eric R Kandel (1998): “Postsynaptic induction and PKA-dependent expression of LTP in the lateral amygdala”. In: *Neuron* 21.1, pp. 169–178.
- Hübner, Cora, Daniel Bosch, Andrea Gall, Andreas Lüthi, and Ingrid Ehrlich (2014): “Ex vivo dissection of optogenetically activated mPFC and hippocampal inputs to neurons in the basolateral amygdala: implications for fear and emotional memory.” In: *Frontiers in behavioral neuroscience* 8.March.
- Hughes, Kenneth R (1965): “Dorsal and ventral hippocampus lesions and maze learning: influence of preoperative en-

- vironment.” In: *Canadian Journal of Psychology/Revue canadienne de psychologie* 19.4, p. 325.
- Hugues, Sandrine, Aline Chessel, Isabelle Lena, Robert Marsault, and Rene Garcia (2006): “Prefrontal infusion of PD098059 immediately after fear extinction training blocks extinction-associated prefrontal synaptic plasticity and decreases prefrontal ERK2 phosphorylation”. In: *Synapse* 60.4, pp. 280–287.
- Hugues, Sandrine and Rene Garcia (2007): “Reorganization of learning-associated prefrontal synaptic plasticity between the recall of recent and remote fear extinction memory”. In: *Learning & Memory* 14.8, pp. 520–524.
- Hull, Clark L (1952): “A behavior system; an introduction to behavior theory concerning the individual organism.” In:
- Hull, Clark Leonard (1943): “Principles of behavior: An introduction to behavior theory.” In:
- Humeau, Yann, Cyril Herry, Nicola Kemp, Hamdy Shaban, Elodie Fourcaudot, Stephanie Bissière, and Andreas Lüthi (2005): “Dendritic spine heterogeneity determines afferent-specific Hebbian plasticity in the amygdala”. In: *Neuron* 45.1, pp. 119–131.
- Hunsaker, Michael R and Raymond P Kesner (2008): “Dissociations across the dorsal-ventral axis of CA3 and CA1 for encoding and retrieval of contextual and auditory-cued fear”. In: *Neurobiology of Learning and Memory* 89.1, pp. 61–69.
- Hunt, David L, Daniele Linaro, Bailu Si, Sandro Romani, and Nelson Spruston (2018): “A novel pyramidal cell type promotes sharp-wave synchronization in the hippocampus”. In: *Nature neuroscience* 21.7, p. 985.
- Hurley, Karen M, Horst Herbert, Margaret M Moga, and Clifford B Saper (1991): “Efferent projections of the infralimbic cortex of the rat”. In: *Journal of Comparative Neurology* 308.2, pp. 249–276.
- Hyman, J. M., L. Ma, E. Balaguer-Ballester, D. Durstewitz, and J. K. Seamans (2012): “Contextual encoding by ensembles of medial prefrontal cortex neurons”. In: *Proceedings of the National Academy of Sciences* 109.13, pp. 5086–5091.
- Inostroza, Marion, Sonja Binder, and Jan Born (2013): “Sleep-dependency of episodic-like memory consolidation in rats”. In: *Behavioural brain research* 237, pp. 15–22.
- Isosaka, Tomoko, Tomohiko Matsuo, Takashi Yamaguchi, Kazuo Funabiki, Shigetada Nakanishi, Reiko Kobayakawa, and Ko Kobayakawa (2015): “Htr2a-expressing cells in the central amygdala control the hierarchy between innate and learned fear”. In: *Cell* 163.5, pp. 1153–1164.
- Ito, Hiroshi T., Sheng-Jia Jia Zhang, Menno P. Witter, Edvard I. Moser, and May-Britt Britt Moser (2015a): “A prefrontal thalamohippocampal circuit for goal-directed spatial navigation”. In: *Nature* 522.7554, p. 50.
- Ito, Hiroshi T, Sheng-Jia Zhang, Menno P Witter, Edvard I Moser, and May-Britt Moser (2015b): “A prefrontal thalamohippocampal circuit for goal-directed spatial navigation”. In: *Nature* 522.7554, p. 50.
- Ito, Junji, S Roy, Yu Liu, Y Cao, Max Fletcher, Lu Lu, J D Boughter, Sonja Grün, and D H Heck (2014): “Whisker barrel cortex delta oscillations and gamma power in the awake mouse are linked to respiration”. In: *Nature communications* 5, p. 3572.
- Ito, Masao and Masanobu Kano (1982): “Long-lasting depression of parallel fiber-Purkinje cell transmission induced by conjunctive stimulation of parallel fibers and climbing fibers in the cerebellar cortex”. In: *Neuroscience letters* 33.3, pp. 253–258.
- Ito, Masao, Masaki Sakurai, and Pavich Tongroach (1982): “Climbing fibre induced depression of both mossy fibre responsiveness and glutamate sensitivity of cerebellar Purkinje cells”. In: *The Journal of Physiology* 324.1, pp. 113–134.
- Iwata, Jiro, Koichi Chida, and Joseph E LeDoux (1987): “Cardiovascular responses elicited by stimulation of neurons in the central amygdaloid nucleus in awake but not anesthetized rats resemble conditioned emotional responses”. In: *Brain research* 418.1, pp. 183–188.
- Izhikevich, Eugene M. (2007): *Dynamical Systems in Neuroscience: The Geometry of Excitability and Bursting*. Cambridge, MA: MIT Press, p. 210.
- Jacobs, W Jake, Sacha D Brown, and Lynn Nadel (2017): “Trauma and Disorders of Memory”. In: *Learning and Memory - A Comprehensive Reference Volume II*. Ed. by John T Wixted and John H Byrne. Academic press, pp. 325–336.
- Jacobson, L and R Sapolsky (1991): “The role of the hippocampus in feedback regulation of the hypothalamic-pituitary-adrenocortical axis.” eng. In: *Endocrine reviews* 12.2, pp. 118–134.
- Jai, Y Yu and Loren M Frank (2015): “Hippocampal cortical interaction in decision making”. In: *Neurobiology of learning and memory* 117, pp. 34–41.

- Janak, Patricia H and Kay M Tye (2015): "From circuits to behaviour in the amygdala". In: *Nature* 517.7534, pp. 284–292.
- Jarrard, Leonard E (1995): "What does the hippocampus really do?" In: *Behavioural brain research* 71.1-2, pp. 1–10.
- Jasnow, Aaron M., Patrick K. Cullen, and David C. Riccio (2012): "Remembering another aspect of forgetting". In: *Frontiers in Psychology* 3.JUN, pp. 1–8.
- Jay, Thérèse M, Jacques Glowinski, and Anne-Marie Thierry (1989): "Selectivity of the hippocampal projection to the prelimbic area of the prefrontal cortex in the rat". In: *Brain research* 505.2, pp. 337–340.
- Jay, Thérèse M and Menno P Witter (1991): "Distribution of hippocampal CA1 and subicular efferents in the prefrontal cortex of the rat studied by means of anterograde transport of Phaseolus vulgarisleucoagglutinin". In: *Journal of Comparative Neurology* 313.4, pp. 574–586.
- Jeffery, Kate J (2017): "Spatial Memory". In: *Learning and Memory - A Comprehensive Reference Volume III*. Ed. by Howard Eichenbaum and John H Byrne. Academic press, pp. 209–231.
- Jelen, Piotr, Stefan Soltysik, and Jolanta Zagrodzka (2003): "22-kHz ultrasonic vocalization in rats as an index of anxiety but not fear: behavioral and pharmacological modulation of affective state". In: *Behavioural Brain Research* 141.1, pp. 63–72.
- Jenkins, J G and K M Dallenbach (1924): "Obliviscence During Sleep and Waking." In: *The American Journal of Psychology* 35, pp. 605–612.
- Jennings, Joshua H, Giorgio Rizzi, Alice M Stamatakis, Randall L Ung, and Garret D Stuber (2013): "The inhibitory circuit architecture of the lateral hypothalamus orchestrates feeding". In: *Science* 341.6153, pp. 1517–1521.
- Jezek, Karel, Espen J Henriksen, Alessandro Treves, Edvard I Moser, and May-Britt Moser (2011): "Theta-paced flickering between place-cell maps in the hippocampus". In: *Nature* 478.7368, p. 246.
- Ji, Daoyun and Matthew A Wilson (2007): "Coordinated memory replay in the visual cortex and hippocampus during sleep". In: *Nature neuroscience* 10.1, p. 100.
- Ji, Guangchen and Volker Neugebauer (2012): "Modulation of medial prefrontal cortical activity using in vivo recordings and optogenetics". In: *Molecular Brain* 5.1, p. 36.
- Ji, Jinzhao and Stephen Maren (2008): "Differential roles for hippocampal areas CA1 and CA3 in the contextual encoding and retrieval of extinguished fear". In: *Learning & Memory*, pp. 244–251.
- Jiang, Li, Srikanya Kundu, James D Lederman, Gretchen Y López-Hernández, Elizabeth C Ballinger, Shaohua Wang, David A Talmage, and Lorna W Role (2016): "Cholinergic signaling controls conditioned fear behaviors and enhances plasticity of cortical-amygdala circuits". In: *Neuron* 90.5, pp. 1057–1070.
- Jimenez, Jessica C., Katy Su, Alexander R. Goldberg, Victor M. Luna, Jeremy S. Biane, Gokhan Ordek, Pengcheng Zhou, Samantha K. Ong, Matthew A. Wright, Larry Zweifel, Liam Paninski, René Hen, and Mazen A. Kheirbek (2018): "Anxiety Cells in a Hippocampal-Hypothalamic Circuit". In: *Neuron* 97.3, 670–683.e6.
- Jin, Jingji and Stephen Maren (2015): "Fear renewal preferentially activates ventral hippocampal neurons projecting to both amygdala and prefrontal cortex in rats". In: *Scientific Reports* 5, p. 8388.
- Jodo, Eiichi and Gary Aston-Jones (1997): "Activation of locus coeruleus by prefrontal cortex is mediated by excitatory amino acid inputs". In: *Brain research* 768.1-2, pp. 327–332.
- Johansen, Joshua P, Lorenzo Diaz-Mataix, Hiroki Hamanaka, Takaaki Ozawa, Edgar Yeu, Jenny Koivumaa, Ashwani Kumar, Mian Hou, Karl Deisseroth, and Edward S Boyden (2014): "Hebbian and neuromodulatory mechanisms interact to trigger associative memory formation". In: *Proceedings of the National Academy of Sciences* 111.51, E5584–E5592.
- Johansen, Joshua P, Hiroki Hamanaka, Marie H Monfils, Rudy Behnia, Karl Deisseroth, Hugh T Blair, and Joseph E LeDoux (2010a): "Optical activation of lateral amygdala pyramidal cells instructs associative fear learning." In: *Proceedings of the National Academy of Sciences of the United States of America* 107.28, pp. 12692–12697.
- Johansen, Joshua P, Jason W Tarpley, Joseph E LeDoux, and Hugh T Blair (2010b): "Neural substrates for expectation-modulated fear learning in the amygdala and periaqueductal gray." eng. In: *Nature neuroscience* 13.8, pp. 979–986.
- Johnson, Lise A, David R Euston, Masami Tatsuno, and Bruce L McNaughton (2010): "Stored-trace reactivation in

- rat prefrontal cortex is correlated with down-to-up state fluctuation density". In: *Journal of Neuroscience* 30.7, pp. 2650–2661.
- Jones, Bethany F. and Menno P. Witter (2007): "Cingulate Cortex Projections to the Parahippocampal Region and Hippocampal Formation in the Rat". In: *Hippocampus* 17, pp. 957–976.
- Jones, M W, M L Errington, P J French, A Fine, T V P Bliss, S Garell, P Charney, B Bozon, S Laroche, and S Davis (2001): "A requirement for the immediate early gene *Zif268* in the expression of late LTP and long-term memories". In: *Nature neuroscience* 4.3, p. 289.
- Jones, Matthew W and Matthew a Wilson (2005): "Theta rhythms coordinate hippocampal-prefrontal interactions in a spatial memory task." In: *PLoS biology* 3.12, e402.
- Joo, Hannah R. and Loren M. Frank (2018): "The hippocampal sharp wave-ripple in memory retrieval for immediate use and consolidation". In: *Nature Reviews Neuroscience* 19.12, pp. 744–757.
- Joshua, Mati, Avital Adler, Rea Mitelman, Eilon Vaadia, and Hagai Bergman (2008): "Midbrain dopaminergic neurons and striatal cholinergic interneurons encode the difference between reward and aversive events at different epochs of probabilistic classical conditioning trials". In: *Journal of Neuroscience* 28.45, pp. 11673–11684.
- Josselyn, Sheena A., Stefan Köhler, and Paul W. Frankland (2015): "Finding the engram". In: *Nature Reviews Neuroscience* 16.9, pp. 521–534.
- Jovanovic, Tanja and Seth Davin Norrholm (2011): "Neural mechanisms of impaired fear inhibition in posttraumatic stress disorder." eng. In: *Frontiers in behavioral neuroscience* 5, p. 44.
- Jun, James J, Nicholas A Steinmetz, Joshua H Siegle, Daniel J Denman, Marius Bauza, Brian Barbarits, Albert K Lee, Costas A Anastassiou, Alexandru Andrei, and Çağatay Aydın (2017): "Fully integrated silicon probes for high-density recording of neural activity". In: *Nature* 551.7679, p. 232.
- Jung, MW W, SI I Wiener, and BL L McNaughton (1994): "Comparison of spatial firing characteristics of units in dorsal and ventral hippocampus of the rat". In: *The Journal of Neuroscience* 14.December, pp. 7347–7356.
- Jüngling, Kay, Thomas Seidenbecher, Ludmila Sosulina, Jörg Lesting, Susan Sangha, Stewart D. Clark, Naoe Okamura, Dee M. Duangdao, Yan Ling Xu, Rainer K. Reinscheid, and Hans Christian Pape (2008): "Neuropeptide S-Mediated Control of Fear Expression and Extinction: Role of Intercalated GABAergic Neurons in the Amygdala". In: *Neuron*.
- Kaas, Jon H. (2013): "The evolution of brains from early mammals to humans". In: *Wiley Interdisciplinary Reviews: Cognitive Science* 4.1, pp. 33–45.
- Kalin, Ned H (1993): "The neurobiology of fear". In: *Scientific American* 268.5, pp. 94–101.
- Kalin, Ned H and Steven E Shelton (1989): "Defensive behaviors in infant rhesus monkeys: environmental cues and neurochemical regulation". In: *Science* 243.4899, pp. 1718–1721.
- Kalin, Ned H, Steven E Shelton, Maureen Rickman, and Richard J Davidson (1998): "Individual differences in freezing and cortisol in infant and mother rhesus monkeys." In: *Behavioral Neuroscience* 112.1, p. 251.
- Kamondi, Anita, László Acsády, XiaoJing Wang, and György Buzsáki (1998): "Theta oscillations in somata and dendrites of hippocampal pyramidal cells in vivo: Activitydependent phaseprecession of action potentials". In: *Hippocampus* 8.3, pp. 244–261.
- Kamprath, Kornelia and Carsten T. Wotjak (2004): "Nonassociative learning processes determine expression and extinction of conditioned fear in mice". In: *Learning and Memory* 11.6, pp. 770–786.
- Kandel, Eric R (2001): "Neuroscience: the molecular biology of memory storage. A dialogue between genes and synapses". In: *Science* 294, pp. 1030–1038.
- Kapp, BS, Paul J Whalen, WF Supple, and JP Pascoe (1992): "Amygdaloid contributions to conditioned arousal and sensory information processing". In: *J. P. Aggleton (Ed.), The amygdala: Neurobiological aspects of emotion, memory, and mental dysfunction*, pp. 229–254.
- Karalis, Nikolaos, Cyril Dejean, Fabrice Chaudun, Suzana Khoder, Robert R Rozeske, Hélène Hélène Hélène Hélène Wurtz, Sophie Bagur, Karim Benchenane, Anton Sirota, Julien Courtin, and Cyril Herry (2016): "4-Hz oscillations synchronize prefrontal-amygdala circuits during fear behavior." In: *Nature Neuroscience* 19.4, pp. 605–612.
- Karalis, Nikolaos and Anton Sirota (2018): "Breathing coordinates limbic network dynamics underlying memory consolidation". In: *bioRxiv*, p. 392530.
- Karlsson, Mattias P., Dougal G. R. Tervo, and Alla Y. KArpova (2012): "Net-

- work Resets in Medial Prefrontal Cortex Mark the Onset of Behavioral Uncertainty". In: *Science* 338.October, pp. 135–140.
- Kay, Leslie M, Jennifer Beshel, Jorge Brea, Claire Martin, Daniel Rojas-Lfano, and Nancy Kopell (2009): "Olfactory oscillations: the what, how and what for". In: *Trends in Neurosciences* 32.4, pp. 207–214.
- Keane, Terence M, Amy D Marshall, and Casey T Taft (2006): "Posttraumatic stress disorder: etiology, epidemiology, and treatment outcome". In: *Annu. Rev. Clin. Psychol.* 2, pp. 161–197.
- Kehoe, E James (2002): "Extinction revisited: Similarities between extinction and reductions in US intensity in classical conditioning of the rabbit's nictitating membrane response". In: *Animal learning & behavior* 30.2, pp. 96–111.
- Keinath, Alexander T., Melissa E. Wang, Ellen G. Wann, Robin K. Yuan, Joshua T. Dudman, and Isabel a. Muzzio (2014): "Precise spatial coding is preserved along the longitudinal hippocampal axis". In: *Hippocampus* 1548, pp. 1533–1548.
- Kempadoo, Kimberly A, Eugene V Mosharov, Se Joon Choi, David Sulzer, and Eric R Kandel (2016): "Dopamine release from the locus coeruleus to the dorsal hippocampus promotes spatial learning and memory". In: *Proceedings of the National Academy of Sciences* 113.51, pp. 14835–14840.
- Kennedy, Daniel P, Jan Glascher, J Michael Tyszka, and Ralph Adolphs (2009): "Personal space regulation by the human amygdala." eng. In: *Nature neuroscience* 12.10, pp. 1226–1227.
- Kentros, Clifford G., Naveen T. Agnihotri, Samantha Streater, Robert D. Hawkins, and Eric R. Kandel (2004): "Increased attention to spatial context increases both place field stability and spatial memory". In: *Neuron* 42, pp. 283–295.
- Kerr, Kristin M, Kara L Agster, Sharon C Furtak, and Rebecca D Burwell (2007): "Functional neuroanatomy of the parahippocampal region: the lateral and medial entorhinal areas". In: *Hippocampus* 17.9, pp. 697–708.
- Kheirbek, Mazen A., Liam J. Drew, Nisha S. Burghardt, Daniel O. Costantini, Lindsay Tannenholz, Susanne E. Ahmari, Hongkui Zeng, André A. Fenton, and René Henk (2013): "Differential control of learning and anxiety along the dorsoventral axis of the dentate gyrus". In: *Neuron* 77.5, pp. 955–968.
- Kiernan, Michael and Jacquelyn Cranney (1992): "Immediate-Startle Stimulus Presentation Fails to Condition Freezing Responses to Contextual Cues". In: *Behavioral Neuroscience* 106.1, pp. 121–124.
- Kilpatrick, Dean G, Heidi S Resnick, Melissa E Milanak, Mark W Miller, Katherine M Keyes, and Matthew J Friedman (2013): "National estimates of exposure to traumatic events and PTSD prevalence using DSMIV and DSM5 criteria". In: *Journal of traumatic stress* 26.5, pp. 537–547.
- Kim, Earnest, Eun Joo Kim, Regina Yeh, Minkyung Shin, Jake Bobman, Franklin B Krasne, and Jeansok J Kim (2014a): "Amygdaloid and non-amygdaloid fear both influence avoidance of risky foraging in hungry rats". In: *Proceedings of the Royal Society B: Biological Sciences* 281.1790.
- Kim, Eun Joo, Omer Horowitz, Blake A Pellman, Lancy Mimi Tan, Qiuling Li, Gal Richter-Levin, and Jeansok J Kim (2013): "Dorsal periaqueductal gray-amygdala pathway conveys both innate and learned fear responses in rats." eng. In: *Proceedings of the National Academy of Sciences of the United States of America* 110.36, pp. 14795–14800.
- Kim, Eun Joo, Mi Seon Kong, Sang Geon Park, Sheri J.Y. Mizumori, Jeiwon Cho, and Jeansok J. Kim (2018): "Dynamic coding of predatory information between the prelimbic cortex and lateral amygdala in foraging rats". In: *Science Advances* 4.4, pp. 1–10.
- Kim, Eun Joo, Mijeong Park, Mi Seon Kong, Sang Geon Park, Jeiwon Cho, and Jeansok J. Kim (2015a): "Alterations of hippocampal place cells in foraging rats facing a predatory threat". In: *Current Biology* 25.10, pp. 1362–1367.
- Kim, Eun Joo, Mijeong Park, Mi-Seon Kong, Sang Geon Park, Jeiwon Cho, and Jeansok J Kim (2015b): "Alterations of hippocampal place cells in foraging rats facing a predatory threat". In: *Current Biology* 25.10, pp. 1362–1367.
- Kim, H., I. H. Kim, Y. S. Jo, S. C. Kim, and J.-S. Choi (2010): "Lack of Medial Prefrontal Cortex Activation Underlies the Immediate Extinction Deficit". In: *Journal of Neuroscience* 30.3, pp. 832–837.
- Kim, Hyung Su, Hye Yeon Cho, George J. Augustine, and Jin Hee Han (2016): "Selective Control of Fear Expression by Optogenetic Manipulation of Infralimbic Cortex after Extinction". In: *Neuropsychopharmacology* 41.5, pp. 1261–1273.
- Kim, Jangjin, Sébastien Delcasso, and Inah Lee (2011): "Neural correlates of

- object-in-place learning in hippocampus and prefrontal cortex". In: *Journal of Neuroscience* 31.47, pp. 16991–17006.
- Kim, Jeansok J., Hongjoo J. Lee, Adam C. Weldon, Eun Young Song, Jeiwon Cho, Patricia E. Sharp, Min W. Jung, and Hugh T. Blair (2007a): "Stress-induced alterations in hippocampal plasticity, place cells, and spatial memory". In: *Proceedings of the National Academy of Sciences of the United States of America* 104.46, pp. 18297–18302.
- Kim, Jeansok J., Joseph P DeCola, Jesus Landeira-Fernandez, and Michael S Fanselow (1991): "N-methyl-D-aspartate receptor antagonist APV blocks acquisition but not expression of fear conditioning." In: *Behavioral neuroscience* 105.1, p. 126.
- Kim, Jeansok J and Michael S Fanselow (1992): "Modality-Specific Retrograde Amnesia of Fear". In: *Science* 18.
- Kim, Jeansok J and Min Whan Jung (2018): "Fear paradigms: The times they are a-changin'". In: *Current opinion in behavioral sciences* 24, pp. 38–43.
- Kim, Jeansok J, Richard A Rison, and Michael S Fanselow (1993): "Effects of Amygdala , Hippocampus , and Periaqueductal Gray Lesions on Short- and Long-Term Contextual Fear". In: *Behavioral Neuroscience* 107.6, pp. 1093–1098.
- Kim, Jeongyeon, Sukwon Lee, Kyungjoon Park, Ingie Hong, Beomjong Song, Gihoon Son, Heewoo Park, Woon Ryoung Kim, Eunjin Park, and Han Kyung Choe (2007b): "Amygdala depotentiation and fear extinction". In: *Proceedings of the National Academy of Sciences* 104.52, pp. 20955–20960.
- Kim, Jieun, Jeong-Tae Kwon, Hyung-Su Kim, Sheena A Josselyn, and Jin-Hee Han (2014b): "Memory recall and modifications by activating neurons with elevated CREB." eng. In: *Nature neuroscience* 17.1, pp. 65–72.
- Kim, Joshua, Xiangyu Zhang, Shruti Muralidhar, Sarah A LeBlanc, and Susumu Tonegawa (2017): "Basolateral to central amygdala neural circuits for appetitive behaviors". In: *Neuron* 93.6, pp. 1464–1479.
- Kim, Munsoo and Michael Davis (1992): "Electrolytic Lesions of the Amygdala Block Acquisition and Expression of Fear-Potentiated Startle Even With Extensive Training but Do Not Prevent Reacquisition". In: *Behavioral Neuroscience* 107.4, pp. 580–595.
- King, Alison J and Shelley A Adamo (2006): "The ventilatory, cardiac and behavioural responses of resting cuttlefish (*Sepia officinalis* L.) to sudden visual stimuli". In: *Journal of Experimental Biology* 209.6, pp. 1101–1111.
- King, Charles, Darrell A Henze, Xavier Leinekugel, and György Buzsáki (1999): "Hebbian modification of a hippocampal population pattern in the rat". In: *The Journal of Physiology* 521.1, pp. 159–167.
- King, Gabrielle, Elliot Scott, Bronwyn M Graham, and Rick Richardson (2017): "Individual differences in fear extinction and anxiety-like behavior". In: *Learning & Memory* 24.5, pp. 182–190.
- Kirouac, Gilbert J (2015): "Neuroscience and Biobehavioral Reviews Placing the paraventricular nucleus of the thalamus within the brain circuits that control behavior". In: *Neuroscience and Biobehavioral Reviews* 56, pp. 315–329.
- Kishi, Toshiro, Toshiko Tsumori, Shigefumi Yokota, and Yukihiko Yasui (2006): "Topographical projection from the hippocampal formation to the amygdala: A combined anterograde and retrograde tracing study in the rat". In: *Journal of Comparative Neurology* 496.3, pp. 349–368.
- Kitamura, Takashi, Sachie K Ogawa, Dheeraj S Roy, Teruhiro Okuyama, Mark D Morrissey, Lillian M Smith, Roger L Redondo, and Susumu Tonegawa (2017): "Systems Consolidation of a Memory". In: *Science* 356, pp. 73–78.
- Kitamura, Takashi, Chen Sun, Lacey J Kitch, J Mark, Takashi Kitamura, Chen Sun, Jared Martin, Lacey J Kitch, Mark J Schnitzer, and Susumu Tonegawa (2015): "Entorhinal Cortical Ocean Cells Encode Specific Contexts and Drive Context-Specific Fear Memory". In: *Neuron* 87.6, pp. 1317–1331.
- Kjelstrup, Kirsten Brun, Trygve Solstad, Vegard Heimly Brun, Torkel Hafting, Stefan Leutgeb, Menno P Witter, Edward I Moser, and May-Britt Moser (2008): "Finite scale of spatial representation in the hippocampus." In: *Science (New York, N.Y.)* 321.5885, pp. 140–3.
- Kjelstrup, Kirsten G, Frode A Tuvnes, Hill-Aina Steffenach, Robert Murison, Edward I Moser, and May-Britt Moser (2002): "Reduced fear expression after lesions of the ventral hippocampus." In: *Proceedings of the National Academy of Sciences of the United States of America* 99, pp. 10825–10830.
- Klausberger, Thomas and Peter Somogyi (2008): "Neuronal diversity and temporal dynamics: the unity of hip-

- pocampal circuit operations". In: *Science* 321.5885, pp. 53–57.
- Klavir, Oded, Matthias Prigge, Ayelet Sarel, Rony Paz, and Ofer Yizhar (2017): "Manipulating fear associations via optogenetic modulation of amygdala inputs to prefrontal cortex". In: *Nature Neuroscience* 20.6, pp. 836–844.
- Klüver, Heinrich and Paul C Bucy (1937): " " Psychic blindness" and other symptoms following bilateral temporal lobectomy in Rhesus monkeys." In: *American Journal of Physiology*.
- Knapaska, Ewelina, Matylda Macias, Marta Mikosz, Aleksandra Nowak, Dorota Owczarek, Marcin Wawrzyniak, Marcelina Pieprzyk, Iwona a Cymerman, Tomasz Werka, Morgan Sheng, Stephen Maren, Jacek Jaworski, and Leszek Kaczmarek (2012): "Functional anatomy of neural circuits regulating fear and extinction." In: *Proceedings of the National Academy of Sciences of the United States of America* 109.42, pp. 17093–8.
- Knierim, James J, Joshua P Neunuebel, and Sachin S Deshmukh (2014): "Functional correlates of the lateral and medial entorhinal cortex: objects, path integration and local/global reference frames". In: *Philosophical Transactions of the Royal Society B: Biological Sciences* 369.1635, p. 20130369.
- Knight, David C, Najah S Waters, and Peter A Bandettini (2009): "Neural substrates of explicit and implicit fear memory." eng. In: *NeuroImage* 45.1, pp. 208–214.
- Koch, Michael and Hans-Ulrich Schnitzler (1997): "The acoustic startle response in rats: circuits mediating evocation, inhibition and potentiation". In: *Behavioural brain research* 89.1-2, pp. 35–49.
- Komorowski, Robert W., Carolyn G. Garcia, Alix Wilson, Shoai Hattori, Marc W. Howard, and Howard Eichenbaum (2013): "Ventral Hippocampal Neurons Are Shaped by Experience to Represent Behaviorally Relevant Contexts". In: *Journal of Neuroscience* 33.18, pp. 8079–8087.
- Komorowski, Robert W, Joseph R Manns, and Howard Eichenbaum (2009): "Robust conjunctive item-place coding by hippocampal neurons parallels learning what happens where". In: *The Journal of neuroscience : the official journal of the Society for Neuroscience* 29.31, pp. 9918–29.
- Konorski, Jerzy (1948): *Conditioned reflexes and neuron organization*. CUP Archive.
- Konorski, Jerzy (1967): *Integrative Activity of the Brain: An Interdisciplinary Approach*. Chicago, IL: University of Chicago Press, p. 531.
- Kopec, Charles D, Helmut W H G Kessels, David E A Bush, Christopher K Cain, Joseph E LeDoux, and Roberto Malinow (2007): "A robust automated method to analyze rodent motion during fear conditioning". In: *Neuropharmacology* 52.1, pp. 228–233.
- Kötter, Rolf and Niels Meyer (1992): "The limbic system: a review of its empirical foundation". In: *Behavioural brain research* 52.2, pp. 105–127.
- Koutsikou, Stella, Jonathan J Crook, Emma V Earl, J Lianne Leith, Thomas C Watson, Bridget M Lumb, and Richard Apps (2014): "Neural substrates underlying fearevoked freezing: the periaqueductal grey-cerebellar link". In: *The Journal of physiology* 592.10, pp. 2197–2213.
- Krabbe, Sabine, Jan Gründemann, and Andreas Lüthi (2018): "Amygdala Inhibitory Circuits Regulate Associative Fear Conditioning". In: *Biological Psychiatry* 83.10, pp. 800–809.
- Krakauer, John W., Asif A. Ghazanfar, Alex Gomez-Marín, Malcolm A. MacIver, and David Poeppel (2017): "Neuroscience Needs Behavior: Correcting a Reductionist Bias". In: *Neuron* 93.3, pp. 480–490.
- Krettek, E and L Price (1977): "Projections from the amygdaloid complex to the cerebral cortex and thalamus in the rat and cat". In: *Journal of Comparative Neurology* 172.4, pp. 687–722.
- Krishnan, Vaishnav, Olivier Berton, and Eric Nestler (2008): "The use of animal models in psychiatric research and treatment". In: *American Journal of Psychiatry* 165.9, p. 1109.
- Kryptos, Angelos Miltiadis, Marieke Effting, Merel Kindt, and Tom Beckers (2015): "Avoidance learning: A review of theoretical models and recent developments". In: *Frontiers in Behavioral Neuroscience* 9. July.
- Kyriazi, Pinelopi, Drew B Headley, and Denis Pare (2018): "Multi-dimensional Coding by Basolateral Amygdala Article Multi-dimensional Coding by Basolateral Amygdala Neurons". In: *Neuron* 99.6, pp. 1315–1328.
- LaBar, Kevin S and Elizabeth A Phelps (2005): "Reinstatement of conditioned fear in humans is context dependent and impaired in amnesia." In: *Behavioral neuroscience* 119.3, p. 677.
- Lacagnina, Anthony F., Emma T. Brockway, Chelsea R. Crovetti, Francis Shue, Meredith J. McCarty, Kevin P. Sat-

- tlar, Sean C. Lim, Sofia Leal Santos, Christine A. Denny, and Michael R. Drew (2019): "Distinct hippocampal engrams control extinction and relapse of fear memory". In: *Nature Neuroscience* 22.5, pp. 753–761.
- Lacroix, Marie Masako, Gaetan de Lavilléon, Julie Lefort, Karim El Kanbi, Sophie Bagur, Samuel Laventure, Yves Dauvilliers, Christelle Peyron, and Karim Benchenane (2018): "Improved sleep scoring in mice reveals human-like stages". In: *bioRxiv*, p. 489005.
- Lammel, Stephan, Daniela I Ion, Jochen Roeper, and Robert C Malenka (2011): "Projection-specific modulation of dopamine neuron synapses by aversive and rewarding stimuli". In: *Neuron* 70.5, pp. 855–862.
- Lammel, Stephan, Byung Kook Lim, Chen Ran, Kee Wui Huang, Michael J Betley, Kay M Tye, Karl Deisseroth, and Robert C Malenka (2012): "Input-specific control of reward and aversion in the ventral tegmental area". In: *Nature* 491.7423, p. 212.
- Lamprecht, Raphael and Joseph LeDoux (2004): "Structural plasticity and memory". In: *Nature Reviews Neuroscience* 5.1, p. 45.
- Landgraf, Rainer and Alexandra Wigger (2002): "High vs low anxiety-related behavior rats: an animal model of extremes in trait anxiety". In: *Behavior genetics* 32.5, pp. 301–314.
- Landis, Carney and W Hunt (1939): "The startle pattern." In:
- Lang, Peter J, Michael Davis, and Arne Öhman (2000): "Fear and anxiety: animal models and human cognitive psychophysiology". In: *Journal of affective disorders* 61.3, pp. 137–159.
- Lansink, Carien S, Pieter M Goltstein, Jan V Lankelma, Ruud N.J.M.A. Joosten, Bruce L. McNaughton, and Cyriel M.A. Pennartz (2008): "Preferential reactivation of motivationally relevant information in the ventral striatum". In: *Journal of Neuroscience* 28.25, pp. 6372–6382.
- Lansink, Carien S, Pieter M Goltstein, Jan V Lankelma, Bruce L. McNaughton, and Cyriel M.A. Pennartz (2009): "Hippocampus leads ventral striatum in replay of place-reward information". In: *PLoS Biology* 7.8.
- Lapish, Christopher C., Daniel Durstewitz, L. Judson Chandler, and Jeremy K. Seamans (2008): "Successful choice behavior is associated with distinct and coherent network states in anterior cingulate cortex". In: *Proceedings of the National Academy of Sciences of the United States of America* 105.33, pp. 11963–11968.
- Lara, Antonio H and Jonathan D Wallis (2015): *The role of prefrontal cortex in working memory: A mini review.*
- Laroche, S, V Doyere, and V Bloch (1989): "Linear relation between the magnitude of long-term potentiation in the dentate gyrus and associative learning in the rat. A demonstration using commissural inhibition and local infusion of an N-methyl-D-aspartate receptor antagonist". In: *Neuroscience* 28.2, pp. 375–386.
- Laroche, Serge, Nicole Neuenchwander-el Massioui, Jean Marc Edeline, and Gerard Dutrieux (1987): "Hippocampal associative cellular responses: dissociation with behavioral responses revealed by a transfer-of-control technique". In: *Behavioral and Neural Biology* 47.3, pp. 356–368.
- Lashley, Karl S (1950): "In search of the engram." In: *Physiological mechanisms in animal behavior. (Society's Symposium IV.)* Oxford, England: Academic Press, pp. 454–482.
- Laubach, Mark, Linda M. Amarante, Kyra Swanson, and Samantha R. White (2018): "What, If Anything, Is Rodent Prefrontal Cortex?" In: *ENEURO* 5.5, ENEURO.0315–18.2018.
- Laurent, Vincent and R. Frederick Westbrook (2009): "Inactivation of the infralimbic but not the prelimbic cortex impairs consolidation and retrieval of fear extinction". In: *Learning and Memory* 16.9, pp. 520–529.
- Laviolette, Steven R, Witold J Lipski, and Anthony A Grace (2005): "A subpopulation of neurons in the medial prefrontal cortex encodes emotional learning with burst and frequency codes through a dopamine D4 receptor-dependent basolateral amygdala input". In: *Journal of Neuroscience* 25.26, pp. 6066–6075.
- Lazaridis, Iakovos, Ourania Tzortzi, Moritz Weglage, Antje Märtin, Yang Xuan, Marc Parent, Yvonne Johansson, Janos Fuzik, Daniel Fürth, Lief E Fenno, Charu Ramakrishnan, Gilad Silberberg, Karl Deisseroth, Marie Carlen, and Konstantinos Meletis (2019): "A hypothalamus-habenula circuit controls aversion". In: *Molecular Psychiatry* 24.9, pp. 1351–1368.
- Leaton, Robert N. and Jacquelyn Cranney (1990): "Potentiation of the Acoustic Startle Response by a Conditioned Stimulus Paired With Acoustic Startle Stimulus in Rats". In: *Journal of Experimental Psychology: Animal Behavior Processes* 16.3, pp. 279–287.

- Lebow, M. A. and A. Chen (2016): "Over-shadowed by the amygdala: The bed nucleus of the stria terminalis emerges as key to psychiatric disorders". In: *Molecular Psychiatry* 21.4, pp. 450–463.
- Lebrón, Kelimer, Mohammed R. Milad, and Gregory J. Quirk (2004): "Delayed recall of fear extinction in rats with lesions of ventral medial prefrontal cortex". In: *Learning and Memory* 11.5, pp. 544–548.
- Ledberg, Anders and David Robbe (2011): "Locomotion-related oscillatory body movements at 612 Hz modulate the hippocampal theta rhythm". In: *PloS one* 6.11, e27575.
- LeDoux, J E, J Iwata, P Cicchetti, and D J Reis (1988): "Different projections of the central amygdaloid nucleus mediate autonomic and behavioral correlates of conditioned fear". In: *The Journal of Neuroscience* 8.7, 2517 LP–2529.
- LeDoux, Joseph (1996): *The emotional brain*. Simon & Sc. New York: Simon & Schuster.
- LeDoux, Joseph (2012): "Rethinking the emotional brain." eng. In: *Neuron* 73.4, pp. 653–676.
- LeDoux, Joseph E (2017): "Semantics, Surplus Meaning, and the Science of Fear." eng. In: *Trends in cognitive sciences* 21.5, pp. 303–306.
- Ledoux, Joseph E (2000): "Emotion circuits in the brain". In: *Annual Review of Neuroscience* 23, pp. 155–184.
- LeDoux, Joseph E. (2007): "The amygdala". In: *Current Biology* 17.20, R868–R874.
- LeDoux, Joseph E. (2014): "Coming to terms with fear". eng. In: *Proceedings of the National Academy of Sciences* 111.8, pp. 2871–2878.
- LeDoux, Joseph E. and Nathaniel D. Daw (2018): "Surviving threats: Neural circuit and computational implications of a new taxonomy of defensive behaviour". In: *Nature Reviews Neuroscience* 19.5, pp. 269–282.
- LeDoux, Joseph E. and Stefan G. Hofmann (2018): "The subjective experience of emotion: a fearful view". In: *Current Opinion in Behavioral Sciences* 19, pp. 67–72.
- LeDoux, Joseph E and Richard Brown (2017): "A higher-order theory of emotional consciousness." eng. In: *Proceedings of the National Academy of Sciences of the United States of America* 114.10, E2016–E2025.
- Ledoux, Joseph E, Piera Cicchetti, M Romanski, and Andrew Xagoraris (1990): "The Lateral Amygdaloid in Fear Conditioning". In: *The Journal of Neuroscience* 10.April, pp. 1062–1069.
- LeDoux, Joseph E and Daniel S Pine (2016): "Using Neuroscience to Help Understand Fear and Anxiety: A Two-System Framework." eng. In: *The American journal of psychiatry* 173.11, pp. 1083–1093.
- LeDoux, Joseph E, Akira Sakaguchi, and Donald J Reis (1983): "Subcortical conditioned projections of the medial nucleus mediate emotional responses". In: *Journal of neuroscience* 4.3, pp. 683–698.
- Lee, Albert K and Matthew A Wilson (2002): "Memory of sequential experience in the hippocampus during slow wave sleep". In: *Neuron* 36.6, pp. 1183–1194.
- Lee, Inah and Raymond P Kesner (2004): "Different contributions of dorsal hippocampal subregions to emory acquisition and retrieval in contextual fear-conditioning". In: *Hippocampus* 14.3, pp. 301–310.
- Lee, Yeon Kyung and June-Seek Choi (2012): "Inactivation of the Medial Prefrontal Cortex Interferes with the Expression But Not the Acquisition of Differential Fear Conditioning in Rats". In: *Experimental Neurobiology* 21.1, p. 23.
- Lenck-Santini, Pierre Pascal, Etienne Save, and Bruno Poucet (2001): "Evidence for a relationship between place-cell spatial firing and spatial memory performance". In: *Hippocampus* 11.4, pp. 377–390.
- Leonard, Christiana M (1969): "The prefrontal cortex of the rat. I. cortical projection of the mediodorsal nucleus. II. efferent connections". In: *Brain Research* 12.2, pp. 321–343.
- Lesting, Jörg, Thiemo Daldrup, Venu Narayanan, Christian Himpe, Thomas Seidenbecher, and Hans-Christian Pape (2013): "Directional theta coherence in prefrontal cortical to amygdalo-hippocampal pathways signals fear extinction." In: *PloS one* 8.10, e77707.
- Lesting, Jörg, Rajeevan T Narayanan, Christian Kluge, Susan Sangha, Thomas Seidenbecher, and Hans-Christian Pape (2011): "Patterns of coupled theta activity in amygdalo-hippocampal-prefrontal cortical circuits during fear extinction." In: *PloS one* 6.6, e21714.
- Letinic, Kresimir, Roberto Zoncu, and Pasko Rakic (2002): "Origin of GABAergic neurons in the human neocortex". In: *Nature* 417.6889, p. 645.
- Letzkus, Johannes J., Steffen B.E. Wolff, Elisabeth M.M. Meyer, Philip Tovote, Julien Courtin, Cyril Herry, and Andreas Lüthi (2011): "A disinhibitory

- microcircuit for associative fear learning in the auditory cortex". In: *Nature* 480.7377, pp. 331–335.
- Leutgeb, Jill K, Stefan Leutgeb, Alessandro Treves, Retsina Meyer, Carol a Barnes, Bruce L McNaughton, May-Britt Moser, and Edvard I Moser (2005a): "Progressive transformation of hippocampal neuronal representations in "morphed" environments." In: *Neuron* 48.2, pp. 345–58.
- Leutgeb, Stefan, Jill K Leutgeb, Carol a Barnes, Edvard I Moser, Bruce L McNaughton, and May-Britt Moser (2005b): "Independent codes for spatial and episodic memory in hippocampal neuronal ensembles." In: *Science (New York, N.Y.)* 309.5734, pp. 619–23.
- Leutgeb, Stefan, Jill K Leutgeb, Alessandro Treves, May-Britt Moser, and Edvard I Moser (2004): "Distinct ensemble codes in hippocampal areas CA3 and CA1." In: *Science (New York, N.Y.)* 305.5688, pp. 1295–8.
- Levenstein, Daniel, Brendon O. Watson, John Rinzel, and György Buzsáki (2017): "Sleep regulation of the distribution of cortical firing rates". In: *Current Opinion in Neurobiology* 44, pp. 34–42.
- Li, Haohong, Mario A Penzo, Hiroki Taniguchi, Charles D Kopec, Z Josh Huang, and Bo Li (2013): "Experience-dependent modification of a central amygdala fear circuit". In: *Nature neuroscience* 16.3, p. 332.
- Li, Jian, Daniela Schiller, Geoffrey Schoenbaum, Elizabeth a Phelps, and Nathaniel D Daw (2011): "Differential roles of human striatum and amygdala in associative learning." In: *Nature neuroscience* 14.10, pp. 1250–2.
- Li, Meng, Kun Xie, Hui Kuang, Jun Liu, Deheng Wang, Grace E Fox, Zhifeng Shi, Liang Chen, Fang Zhao, Ying Mao, and Joe Z Tsien (2018): "Neural coding of cell assemblies via spike-timing self-information". In: *Cerebral Cortex* 28.7, pp. 2563–2576.
- Li, Qiang, John A Stankovic, Mark A Hanson, Adam T Barth, John Lach, and Gang Zhou (2009): "Accurate, Fast Fall Detection Using Gyroscopes and Accelerometer-Derived Posture Information." In: *BSN*. Vol. 9, pp. 138–143.
- Li, Yonghui, Xinwen Dong, Sa Li, and Gilbert Jean Kirouac (2014): "Lesions of the posterior paraventricular nucleus of the thalamus attenuate fear expression". In: *Frontiers in behavioral neuroscience* 8, p. 94.
- Li, Zexuan and Gal Richter-Levin (2012): "Stimulus intensity-dependent modulations of hippocampal long-term potentiation by basolateral amygdala priming". In: *Frontiers in cellular neuroscience* 6, p. 21.
- Lieber, Bryan, Blake E S Taylor, Geoff Appelboom, Guy McKhann, and E Sander Connolly Jr (2015): "Motion sensors to assess and monitor medical and surgical management of Parkinson disease". In: *World neurosurgery* 84.2, pp. 561–566.
- Liebman, Jeffrey M., David J. Mayer, and John C. Liebeskind (1970): "Mesencephalic central gray lesions and fear-motivated behavior in rats". In: *Brain Research* 23.3, pp. 353–370.
- Likhtik, Ekaterina, Daniela Popa, John Apergis-Schoute, George A. Fidacaro, and Denis Paré (2008): "Amygdala intercalated neurons are required for expression of fear extinction". In: *Nature* 454.7204, pp. 642–645.
- Likhtik, Ekaterina, Joseph M. Stujenske, Mihir A. Topiwala, Alexander Z. Harris, and Joshua A. Gordon (2014): "Prefrontal entrainment of amygdala activity signals safety in learned fear and innate anxiety". In: *Nature Neuroscience* 17.1, pp. 106–113.
- Lima, Steven L and Lawrence M Dill (1990): "Behavioral decisions made under the risk of predation: a review and prospectus". In: *Canadian journal of zoology* 68.4, pp. 619–640.
- Lin, Chia-Ho, Chia-Ching Lee, and Po-Wu Gean (2003): "Involvement of a calcineurin cascade in amygdala depotentiation and quenching of fear memory". In: *Molecular pharmacology* 63.1, pp. 44–52.
- Lisman, John E. and Ole Jensen (2013): "The Theta-Gamma Neural Code". In: *Neuron* 77.6, pp. 1002–1016.
- Lissek, Shmuel and Christian Grillon (2015): "Overgeneralization of conditioned fear in the anxiety disorders". In: *Journal of Psychology*.
- Lissek, Shmuel, Alice S. Powers, Erin B. McClure, Elizabeth A. Phelps, Girma Woldehawariat, Christian Grillon, and Daniel S. Pine (2005): "Classical fear conditioning in the anxiety disorders: A meta-analysis". In: *Behaviour Research and Therapy* 43.11, pp. 1391–1424.
- Liu, Xu, Steve Ramirez, Petti T. Pang, Corey B. Puryear, Arvind Govindarajan, Karl Deisseroth, and Susumu Tonegawa (2012): "Optogenetic stimulation of a hippocampal engram activates fear memory recall". In: *Nature* 484.7394, pp. 381–385.
- Liu, Yu, Samuel S McAfee, and Detlef H Heck (2017): "Hippocampal sharp-wave ripples in awake mice are en-

- trained by respiration". In: *Scientific reports* 7.1, p. 8950.
- Livneh, Uri and Rony Paz (2012a): "Amygdala-prefrontal synchronization underlies resistance to extinction of aversive memories". In: *Neuron* 75.1, pp. 133–142.
- Livneh, Uri and Rony Paz (2012b): "Aversive-Bias and Stage-Selectivity in Neurons of the Primate Amygdala during Acquisition, Extinction, and Overnight Retention". In: *Journal of Neuroscience* 32.25, pp. 8598–8610.
- Lockmann, André L. V., Diego A. Laplagne, Richardson N. Leão, and Adriano B. L. Tort (2016): "A Respiration-Coupled Rhythm in the Rat Hippocampus Independent of Theta and Slow Oscillations". In: *The Journal of Neuroscience* 36.19, pp. 5338–5352.
- Loftsgaarden, D O and C P Quesenberry (1965): "A Nonparametric Estimate of a Multivariate Density Function". en. In: *Ann. Math. Statist.* 36.3, pp. 1049–1051.
- Lonsdorf, Tina B, Mareike M Menz, Marta Andreatta, Miguel A Fullana, Armita Golkar, Jan Haaker, Ivo Heitland, Andrea Hermann, Manuel Kuhn, and Onno Kruse (2017): "Don't fear fear conditioning: Methodological considerations for the design and analysis of studies on human fear acquisition, extinction, and return of fear". In: *Neuroscience & Biobehavioral Reviews* 77, pp. 247–285.
- Loomis, A L, E N Harvey, and G Hobart (1935): "Potential rhythms of the cerebral cortex during sleep". eng. In: *Science (New York, N.Y.)* 81.2111, pp. 597–598.
- Lopes-dos-Santos, Vítor, Sidarta Ribeiro, and Adriano B L Tort (2013): "Detecting cell assemblies in large neuronal populations". In: *Journal of Neuroscience Methods* 220.2, pp. 149–166.
- Lorente de Nó, Rafael (1934): "Studies on the structure of the cerebral cortex. II. Continuation of the study of the ammonic system." In: *Journal für Psychologie und Neurologie*.
- Lorenz, K and N Tinbergen (1938): "Taxis und Instinkthandlung in der Eirollbewegung der Graugans. [Directed and instinctive behavior in the egg rolling movements of the gray goose.]" In: *Zeitschrift für Tierpsychologie* 2, pp. 1–29.
- Lorenz, Konrad (1956): "The objective theory of instinct". In: *L'Instinct dans le Comportement des Animaux et de l'Homme*. Paris: Masson et Cie.
- Lovibond, Peter F and David R Shanks (2002): "The role of awareness in Pavlovian conditioning: empirical evidence and theoretical implications." eng. In: *Journal of experimental psychology. Animal behavior processes* 28.1, pp. 3–26.
- Low, Philip Steven, Sylvan S Shank, Terrence J Sejnowski, and Daniel Margoliash (2008): "Mammalian-like features of sleep structure in zebra finches." eng. In: *Proceedings of the National Academy of Sciences of the United States of America* 105.26, pp. 9081–9086.
- Lubenov, Evgueniy V and Athanassios G Siapas (2009): "Hippocampal theta oscillations are travelling waves". In: *Nature* 459.7246, p. 534.
- Luo, Ray, Akira Uematsu, Adam Weitemier, Luca Aquili, Jenny Koivumaa, Thomas J McHugh, and Joshua P Johansen (2018): "A dopaminergic switch for fear to safety transitions". In: *Nature communications* 9.1, p. 2483.
- Luštrek, Mitja, Hristijan Gjoreski, Simon Kozina, Božidara Cvetković, Violeta Mirchevska, and Matjaž Gams (2011): "Detecting falls with location sensors and accelerometers". In: *Twenty-Third IAAI Conference*.
- Lüthi, Andreas and Christian Lüscher (2014): "Pathological circuit function underlying addiction and anxiety disorders". In: *Nature Neuroscience* 17.12, pp. 1635–1643.
- Luyten, Laura, Natalie Schroyens, Dirk Hermans, and Tom Beckers (2014): "Parameter optimization for automated behavior assessment: plug-and-play or trial-and-error?" In: *Frontiers in behavioral neuroscience* 8. February, pp. 1–4.
- Ma, Liya, James M. Hyman, Daniel Durstewitz, Anthony G. Phillips, and Jeremy K. Seamans (2016): "A quantitative analysis of context-dependent remapping of medial frontal cortex neurons and ensembles". In: *Journal of Neuroscience* 36.31, pp. 8258–8272.
- Mackintosh, J H and E C Grant (1963): "A comparison of the social postures of some common laboratory rodents". In: *Behaviour* 21.3-4, pp. 246–259.
- Mackintosh, Nicholas John (1974): "Classical conditioning: Basic operations". In: *The psychology of animal learning*, pp. 8–40.
- MacLean, Paul D (1949): "Psychosomatic disease and the "visceral brain"; recent developments bearing on the Papez theory of emotion." In: *Psychosomatic medicine*.
- Macmillan, Malcolm (2002): *An odd kind of fame: Stories of Phineas Gage*. MIT Press.

- Madarasz, Tamas J., Lorenzo Diaz-Mataix, Omar Akhand, Edgar A. Ycu, Joseph E. LeDoux, and Joshua P. Johansen (2016): "Evaluation of ambiguous associations in the amygdala by learning the structure of the environment". In: *Nature Neuroscience* 19.7, pp. 965–972.
- Madgwick, Sebastian O H, Andrew J L Harrison, and Ravi Vaidyanathan (2011): "Estimation of IMU and MARG orientation using a gradient descent algorithm". In: *2011 IEEE international conference on rehabilitation robotics*. IEEE, pp. 1–7.
- Maher, Brendan A and Roger W McIntire (1960): "The extinction of the CER following frontal ablation." In: *Journal of comparative and physiological psychology* 53.6, p. 549.
- Maingret, Nicolas (2016): *A causal role for the hippocampo-cortical dialogue in memory consolidation: temporal coupling of rhythmic patterns and cortical network reorganization during sleep in rats*. UPMC, PhD, p. 162.
- Maingret, Nicolas, Gabrielle Girardeau, Ralitsa Todorova, Marie Goutierre, and Michaël Zugaro (2016): "Hippocampo-cortical coupling mediates memory consolidation during sleep". In: *Nature Neuroscience* 19.7, pp. 959–964.
- Majchrzak, M, B Ferry, A R Marchand, K Herbeaux, A Seillier, and A Barbelivien (2006): "Entorhinal Cortex Lesions Disrupt Fear Conditioning to Background Context but Spare Fear Conditioning to a Tone in the Rat". In: *Hippocampus* 124, pp. 114–124.
- Malenka, Robert C (2003): "The long-term potential of LTP". In: *Nature Reviews Neuroscience* 4.11, p. 923.
- Malenka, Robert C and Roger A Nicoll (1999): "Long-term potentiation—a decade of progress?" In: *Science* 285.5435, pp. 1870–1874.
- Marchand, Alain R, David Luck, and Georges DiScala (2003): "Evaluation of an improved automated analysis of freezing behaviour in rats and its use in trace fear conditioning". In: *Journal of Neuroscience Methods* 126.2, pp. 145–153.
- Marek, Roger, Jingji Jin, Travis D Goode, Thomas F Giustino, Qian Wang, Gillian M Acca, Roopashri Holehonur, Jonathan E Ploski, Paul J Fitzgerald, and Timothy Lynagh (2018a): "Hippocampus-driven feed-forward inhibition of the prefrontal cortex mediates relapse of extinguished fear". In: *Nature neuroscience* 21.3, p. 384.
- Marek, Roger, Li Xu, Robert K.P. Sullivan, and Pankaj Sah (2018b): "Excitatory connections between the prelimbic and infralimbic medial prefrontal cortex show a role for the prelimbic cortex in fear extinction". In: *Nature Neuroscience* 21.5, pp. 654–658.
- Maren, S. (2000): "Auditory fear conditioning increases CS-elicited spike firing in lateral amygdala neurons even after extensive overtraining". In: *European Journal of Neuroscience* 12.11, pp. 4047–4054.
- Maren, Stephen (1998): "Overtraining Does Not Mitigate Contextual Fear Conditioning Deficits Produced by Neurotoxic Lesions of the Basolateral Amygdala". In: *The Journal of Neuroscience* 18.8, pp. 3088–3097.
- Maren, Stephen (1999a): "Neurotoxic Basolateral Amygdala Lesions Impair Learning and Memory But Not the Performance of Conditional Fear in Rats". In: *Journal of Neuroscience* 19.19, pp. 8696–8703.
- Maren, Stephen (1999b): "Neurotoxic or Electrolytic Lesions of the Ventral Subiculum Produce Deficits in the Acquisition and Expression of Pavlovian Fear Conditioning in Rats_marenBN99". In: *Behavioral Neuroscience* 113.2, pp. 283–290.
- Maren, Stephen (2001a): "Is there savings for pavlovian fear conditioning after neurotoxic basolateral amygdala lesions in rats?" In: *Neurobiology of learning and memory* 76.3, pp. 268–283.
- Maren, Stephen (2001b): "Neurobiology of Pavlovian fear conditioning". In: *Annual review of neuroscience* 24.1, pp. 897–931.
- Maren, Stephen (2005): "Building and burying fear memories in the brain". In: *The Neuroscientist* 11.1, pp. 89–99.
- Maren, Stephen (2015): "Out with the old and in with the new: Synaptic mechanisms of extinction in the amygdala". In: *Brain Research* 1621, pp. 231–238.
- Maren, Stephen (2017): "Emotional Learning : Animals". In: *Learning and Memory - A Comprehensive Reference Volume III*. Ed. by John H Byrne. Vol. 3. Oxford: Academic Press, pp. 391–410.
- Maren, Stephen M and Michael S F Fanselow (1997): "Electrolytic Lesions of the Fimbria / Fornix , Dorsal Hippocampus , or Entorhinal Cortex Produce Anterograde Deficits in Contextual Fear Conditioning in Rats". In: *Neurobiology of Learning and Memory* 149.67, pp. 142–149.
- Maren, Stephen, Gal Aharonov, and Michael S Fanselow (1996): "Retrograde Abolition of Conditional Fear After Excitotoxic Lesions in the Basolateral Amygdala of Rats : Absence of

- a Temporal Gradient". In: *Behavioral Neuroscience* 110.4, pp. 718–726.
- Maren, Stephen, Gal Aharonov, and Michael S Fanselow (1997): "Neurotoxic lesions of the dorsal hippocampus and Pavlovian fear conditioning in rats". In: *Behavioural brain research* 88, pp. 261–274.
- Maren, Stephen and Michael S. Fanselow (1996): "The amygdala and fear conditioning: Has the nut been cracked?" In: *Neuron* 16.2, pp. 237–240.
- Maren, Stephen and Jennifer a Hobin (2007): "Hippocampal regulation of context-dependent neuronal activity in the lateral amygdala." In: *Learning & memory (Cold Spring Harbor, N.Y.)* 14.4, pp. 318–24.
- Maren, Stephen and William G Holt (2004): "Hippocampus and Pavlovian Fear Conditioning in Rats : Muscimol Infusions Into the Ventral , but Not Dorsal , Hippocampus Impair the Acquisition of Conditional Freezing to an Auditory Conditional Stimulus". In: *Behavioral Neuroscience* 118.1, pp. 97–110.
- Maren, Stephen, K Luan Phan, and Israel Liberzon (2013): "The contextual brain: implications for fear conditioning, extinction and psychopathology". In: *Nature Reviews Neuroscience* 14.6, pp. 417–428.
- Maren, Stephen, Amy Poremba, and Michael Gabriel (1991): "Basolateral amygdaloid multi-unit neuronal correlates of discriminative avoidance learning in rabbits". In: *Brain research* 549.2, pp. 311–316.
- Maren, Stephen and Gregory J Quirk (2004): "Neuronal signalling of fear memory". In: *Nature Reviews Neuroscience* 5.11, p. 844.
- Markram, Henry, Joachim Lübke, Michael Frotscher, and Bert Sakmann (1997): "Regulation of synaptic efficacy by coincidence of postsynaptic APs and EP-SPs". In: *Science* 275.5297, pp. 213–215.
- Markus, E J, Y L Qin, B Leonard, W E Skaggs, B L McNaughton, and C a Barnes (1995): "Interactions between location and task affect the spatial and directional firing of hippocampal neurons." In: *The Journal of neuroscience : the official journal of the Society for Neuroscience* 15.November, pp. 7079–7094.
- Maroun, Mouna, Alexandra Kavushansky, Andrew Holmes, Cara Wellman, and Helen Motanis (2012): "Enhanced extinction of aversive memories by high-frequency stimulation of the rat infralimbic cortex". In: *PLoS ONE* 7.5, pp. 1–8.
- Marr, David (1970): "A theory for cerebral neocortex". In: *Proceedings of the Royal Society of London. Series B. Biological Sciences* 176.1043, pp. 161–234.
- Marx, Brian P, John P Forsyth, Gordon G Gallup, Tiffany Fusé, and Jennifer M Lexington (2008): "Tonic immobility as an evolved predator defense: Implications for sexual assault survivors". In: *Clinical Psychology: Science and Practice* 15.1, pp. 74–90.
- Matsumoto, Masayuki and Okihide Hikosaka (2007): "Lateral habenula as a source of negative reward signals in dopamine neurons". In: *Nature* 447.7148, p. 1111.
- Matsumoto, Masayuki and Okihide Hikosaka (2009): "Two types of dopamine neuron distinctly convey positive and negative motivational signals". In: *Nature* 459.7248, p. 837.
- Matsumoto, Nobuyoshi, Takuma Kitanishi, and Kenji Mizuseki (2019): "The subiculum: Unique hippocampal hub and more". In: *Neuroscience Research* 143, pp. 1–12.
- Matus-Amat, Patricia, Emily A Higgins, Ruth M Barrientos, and Jerry W Rudy (2004): "The Role of the Dorsal Hippocampus in the Acquisition and Retrieval of Context Memory Representations". In: *The Journal of Neuroscience* 24.10, pp. 2431–2439.
- Mátyás, Ferenc, Joonhyuk Lee, Hee Sup Shin, and László Acsády (2014): "The fear circuit of the mouse forebrain: Connections between the mediodorsal thalamus, frontal cortices and basolateral amygdala". In: *European Journal of Neuroscience* 39.11, pp. 1810–1823.
- Maurer, Andrew P., Shea R. VanRhoads, Gary R. Sutherland, Peter Lipa, and Bruce L. McNaughton (2005): "Self-motion and the origin of differential spatial scaling along the septo-temporal axis of the hippocampus". In: *Hippocampus* 15, pp. 841–852.
- Maviel, Thibault, Thomas P Durkin, Frédérique Menzaghi, and Bruno Bontempo (2004): "Sites of neocortical reorganization critical for remote spatial memory". In: *Science* 305.5680, pp. 96–99.
- Mayford, Mark and Leon Reijmers (2016): "Exploring memory representations with activity-based genetics". In: *Cold Spring Harbor Perspectives in Biology* 8.3, pp. 1–18.
- McAllister, Wallace R and Dorothy E McAllister (1971): "Behavioral measurement of conditioned fear". In: *Aversive conditioning and learning*. Elsevier, pp. 105–179.

- McCall, Jordan G, Edward R Siuda, Dionnet L Bhatti, Lamley A Lawson, Zoe A McElligott, Garret D Stuber, and Michael R Bruchas (2017): "Locus coeruleus to basolateral amygdala noradrenergic projections promote anxiety-like behavior". In: *Elife* 6, e18247.
- McCarley, Robert W (2007): "Neurobiology of REM and NREM sleep." eng. In: *Sleep medicine* 8.4, pp. 302-330.
- McClelland, James L. (2013): "Incorporating rapid neocortical learning of new schema-consistent information into complementary learning systems theory". In: *Journal of Experimental Psychology: General* 142.4, pp. 1190-1210.
- McClelland, James L, Bruce L McNaughton, and Randall C O'Reilly (1995): "Why there are complementary learning systems in the hippocampus and neocortex: insights from the successes and failures of connectionist models of learning and memory." eng. In: *Psychological review* 102.3, pp. 419-457.
- McCullough, K M, F G Morrison, and K J Ressler (2016): "Neurobiology of Learning and Memory Bridging the Gap : Towards a cell-type specific understanding of neural circuits underlying fear behaviors". In: *Neurobiology of Learning and Memory* 135, pp. 27-39.
- McDonald, A J, F Mascagni, and L Guo (1996): "Projections of the medial and lateral prefrontal cortices to the amygdala: a Phaseolus vulgaris leucoagglutinin study in the rat". In: *Neuroscience* 71.1, pp. 55-75.
- McDonald, Alexander J (1998): "Cortical pathways to the mammalian amygdala". In: *Progress in neurobiology* 55.3, pp. 257-332.
- McDonald, Alexander J. and David D. Mott (2017): "Functional neuroanatomy of amygdalohippocampal interconnections and their role in learning and memory". In: *Journal of Neuroscience Research* 95.3, pp. 797-820.
- McDonald, Robert J., Nancy S. Hong, and Bryan D. Devan (2017): "Interactions Among Multiple Parallel Learning and Memory Systems in the Mammalian Brain". In: *Learning and Memory - A Comprehensive Reference Volume III*. Ed. by Howard Eichenbaum and John H Byrne. Academic press, pp. 9-47.
- McEown, Kristopher and Dallas Treit (2010): "Inactivation of the dorsal or ventral hippocampus with muscimol differentially affects fear and memory". In: *Brain Research* 1353, pp. 145-151.
- McGaugh, James L (2018): "Emotional arousal regulation of memory consolidation". In: *Current Opinion in Behavioral Sciences* 19, pp. 55-60.
- McGaugh, James L. (2004): "The Amygdala Modulates The Consolidation Of Memories Of Emotionally Arousing Experiences". In: *Annual Review of Neuroscience* 27.1, pp. 1-28.
- McGaugh, James L. (2015): "Consolidating Memories". In: *Annual Review of Psychology* 66.1, pp. 1-24.
- McGinty, Vincent B. and Anthony A. Grace (2008): "Selective activation of medial prefrontal-to-accumbens projection neurons by amygdala stimulation and pavlovian conditioned stimuli". In: *Cerebral Cortex* 18.8, pp. 1961-1972.
- McKenzie, Sam and Howard Eichenbaum (2011): "Consolidation and reconsolidation: two lives of memories?" In: *Neuron* 71.2, pp. 224-233.
- McKernan, M G and P Shinnick-Gallagher (1997): "Fear conditioning induces a lasting potentiation of synaptic currents in vitro". In: *Nature* 390.6660, p. 607.
- McNally, Gavan P., Joshua P. Johansen, and Hugh T. Blair (2011): "Placing prediction into the fear circuit". In: *Trends in Neurosciences* 34.6, pp. 283-292.
- McNish, Kenneth A, Jonathan C Gewirtz, and Michael Davis (1997): "Evidence of contextual fear after lesions of the hippocampus: a disruption of freezing but not fear-potentiated startle". In: *Journal of Neuroscience* 17.23, pp. 9353-9360.
- Menegas, William, Korleki Akiti, Ryunosuke Amo, Naoshige Uchida, and Mitsuko Watabe-Uchida (2018): "Dopamine neurons projecting to the posterior striatum reinforce avoidance of threatening stimuli". In: *Nature Neuroscience* 21.10, pp. 1421-1430.
- Merino, Stephen M. and Stephen Maren (2006): "Hitting Ras where it counts: Ras antagonism in the basolateral amygdala inhibits long-term fear memory". In: *European Journal of Neuroscience* 23.1, pp. 196-204.
- Meyer, Arne F, Jasper Poort, John O'Keefe, Maneesh Sahani, and Jennifer F Linden (2018): "A head-mounted camera system integrates detailed behavioral monitoring with multichannel electrophysiology in freely moving mice". In: *Neuron* 100.1, pp. 46-60.
- Milad, M. R., I. Vidal-Gonzalez, and G. J. Quirk (2004): "Electrical Stimulation of Medial Prefrontal Cortex Reduces Conditioned Fear in a Temporally Specific Manner". In: *Behavioral Neuroscience* 118.2, pp. 389-394.
- Milad, Mohammed R. and Gregory J. Quirk (2012): "Fear Extinction as a Model for Translational Neuroscience: Ten Years

- of Progress". In: *Annual Review of Psychology* 63, pp. 129–151.
- Milad, Mohammed R, Roger K Pitman, Cameron B Ellis, Andrea L Gold, Lisa M Shin, Natasha B Lasko, Mohamed A Zeidan, Kathryn Handwerker, Scott P Orr, and Scott L Rauch (2009): "Neurobiological basis of failure to recall extinction memory in posttraumatic stress disorder." In: *Biological psychiatry* 66.12, pp. 1075–1082.
- Milad, Mohammed R and Gregory J Quirk (2002): "Neurons in medial prefrontal cortex signal memory for fear extinction". In: *Nature* 420.6911, pp. 70–74.
- Milad, Mohammed R, Scott L Rauch, Roger K Pitman, and Gregory J Quirk (2006): "Fear extinction in rats: implications for human brain imaging and anxiety disorders." eng. In: *Biological psychology* 73.1, pp. 61–71.
- Milanovic, Snezana, Jelena Radulovic, Olga Laban, Oliver Stiedl, Fritz Henn, and Joachim Spiess (1998): "Production of the Fos protein after contextual fear conditioning of C57BL/6N mice". In: *Brain research* 784.1-2, pp. 37–47.
- Miller, E K and J D Cohen (2001): "An integrative theory of prefrontal cortex function." In: *Annual review of neuroscience* 24, pp. 167–202.
- Milner, B (1962): "Les troubles de la memoire accompagnant des lesions hippocampiques bilaterales". In: *Physiologie de l'Hippocampe*. Ed. by P Pas-souant. Paris: Éditions Recherche Scientifique, pp. 257–272.
- Milner, Brenda, Suzanne Corkin, and H L Teuber (1968): "Further analysis of the hippocampal amnesic syndrome: 14-year follow-up study of H. M." In: *Neuropsychologia* 6.3, pp. 215–234.
- Mineka, Susan, Jayson L Mystkowski, Deanna Hladek, and Beverly I Rodriguez (1999): "The effects of changing contexts on return of fear following exposure therapy for spider fear." In: *Journal of consulting and clinical psychology* 67.4, p. 599.
- Mineka, Susan and Richard Zinbarg (2006): "A contemporary learning theory perspective on the etiology of anxiety disorders: It's not what you thought it was". In: *American Psychologist* 61.1, pp. 10–26.
- Misane, Ilga, Philip Tovote, Michael Meyer, Joachim Spiess, Sven Ove Ögren, and Oliver Stiedl (2005): "Timedependent involvement of the dorsal hippocampus in trace fear conditioning in mice". In: *Hippocampus* 15.4, pp. 418–426.
- Miserendino, Mindy J D, Catherine B Sananes, Kathleen R Melia, and Michael Davis (1990): "Blocking of acquisition but not expression of conditioned fear-potentiated startle by NMDA antagonists in the amygdala". In: *Nature* 345.6277, p. 716.
- Miyawaki, Hiroyuki and Kamran Diba (2016): "Regulation of hippocampal firing by network oscillations during sleep". In: *Current biology* 26.7, pp. 893–902.
- Miyawaki, Takeyuki, Hiroaki Norimoto, Tomoe Ishikawa, Yusuke Watanabe, Norio Matsuki, and Yuji Ikegaya (2014): "Dopamine receptor activation reorganizes neuronal ensembles during hippocampal sharp waves in vitro". In: *PLoS one* 9.8, e104438.
- Mobbs, Dean (2018): "The ethological deconstruction of fear (s)". In: *Current Opinion in Behavioral Sciences* 24, pp. 32–37.
- Mobbs, Dean, Cindy C Hagan, Tim Dalgleish, Brian Silston, and Charlotte Prévost (2015): "The ecology of human fear: survival optimization and the nervous system". In: *Frontiers in neuroscience* 9, p. 55.
- Mobbs, Dean and Jeansok J Kim (2015): "Neuroethological studies of fear, anxiety, and risky decision-making in rodents and humans". In: *Current opinion in behavioral sciences* 5, pp. 8–15.
- Mobbs, Dean, Jennifer L Marchant, Demis Hassabis, Ben Seymour, Geoffrey Tan, Marcus Gray, Predrag Petrovic, Raymond J Dolan, and Christopher D Frith (2009): "From threat to fear: the neural organization of defensive fear systems in humans". In: *Journal of Neuroscience* 29.39, pp. 12236–12243.
- Moberly, Andrew H., Mary Schreck, Janardhan P. Bhattarai, Larry S. Zweifel, Wenqin Luo, and Minghong Ma (2018): "Olfactory inputs modulate respiration-related rhythmic activity in the prefrontal cortex and freezing behavior". In: *Nature Communications* 9.1.
- Moita, Marta A P, Svetlana Rosis, Yu Zhou, Joseph E. LeDoux, and Hugh T. Blair (2003): "Hippocampal place cells acquire location-specific responses to the conditioned stimulus during auditory fear conditioning". In: *Neuron* 37, pp. 485–497.
- Moita, Marta A P, Svetlana Rosis, Yu Zhou, Joseph E LeDoux, and Hugh T Blair (2004): "Putting fear in its place: remapping of hippocampal place cells during fear conditioning." In: *The Journal of neuroscience : the official journal of the Society for Neuroscience* 24.31, pp. 7015–7023.
- Do-Monte, F. H., G. Manzano-Nieves, K. Quinones-Laracuente, L. Ramos-Medina, and G. J. Quirk (2015a): "Re-

- visiting the Role of Infralimbic Cortex in Fear Extinction with Optogenetics". In: *Journal of Neuroscience* 35.8, pp. 3607–3615.
- Do-Monte, Fabricio H., Kelvin Quiñones-Laracuente, Gregory J. Quirk, Kelvin Quiñones-Laracuente, Gregory J. Quirk, Kelvin Quiñones-Laracuente, Gregory J. Quirk, Kelvin Quiñones-Laracuente, and Gregory J. Quirk (2015b): "A temporal shift in the circuits mediating retrieval of fear memory". In: *Nature* 519.7544, pp. 460–463.
- Montgomery, Sean M, Martha I Betancur, and György Buzsáki (2009): "Behavior-dependent coordination of multiple theta dipoles in the hippocampus". In: *Journal of Neuroscience* 29.5, pp. 1381–1394.
- Moreau, Maëg, Stefan Siebert, Andreas Buerkert, and Eva Schlecht (2009): "Use of a tri-axial accelerometer for automated recording and classification of goats' grazing behaviour". In: *Applied Animal Behaviour Science* 119.3-4, pp. 158–170.
- Morgan, Maria A., Jay Schulkin, and Joseph E. LeDoux (2003): "Ventral medial prefrontal cortex and emotional perseveration: The memory for prior extinction training". In: *Behavioural Brain Research* 146.1-2, pp. 121–130.
- Morgan, Maria A, Elizabeth M Romanski, and Joseph E. LeDoux (1993): "Extinction of emotional learning: contribution of medial prefrontal cortex Maria". In: *Neuroscience letters* 163, pp. 109–113.
- Morgan, Maria and Joseph LeDoux (1995): "Differential Contribution of Dorsal and Ventral Medial Prefrontal". In: *Behavioral Neuroscience* 109.4, pp. 681–688.
- Morris, J S, B DeGelder, L Weiskrantz, and R J Dolan (2001): "Differential extrageniculostriate and amygdala responses to presentation of emotional faces in a cortically blind field." eng. In: *Brain : a journal of neurology* 124.Pt 6, pp. 1241–1252.
- Morris, R G M, Elizabeth Anderson, G S a Lynch, and Michel Baudry (1986): "Selective impairment of learning and blockade of long-term potentiation by an N-methyl-D-aspartate receptor antagonist, AP5". In: *Nature* 319.6056, p. 774.
- Morris, Richard G M, Paul Garrud, J N P al Rawlins, and John O'Keefe (1982): "Place navigation impaired in rats with hippocampal lesions". In: *Nature* 297.5868, p. 681.
- Morrissey, Mark D., Nathan Insel, and Kaori Takehara-Nishiuchi (2017): "Generalizable knowledge outweighs incidental details in prefrontal ensemble code over time". In: *eLife* 6, pp. 1–20.
- Morrow, B. A., J. D. Elsworth, A. M. Rasmusson, and R. H. Roth (1999): "The role of mesoprefrontal dopamine neurons in the acquisition and expression of conditioned fear in the rat". In: *Neuroscience* 92.2, pp. 553–564.
- Moscovitch, Morris, R Shayna Rosenbaum, Asaf Gilboa, Donna Rose Addis, Robyn Westmacott, Cheryl Grady, Mary Pat McAndrews, Brian Levine, Sandra Black, Gordon Winocur, and Lynn Nadel (2005): "Functional neuroanatomy of remote episodic, semantic and spatial memory: A unified account based on multiple trace theory". In: *Journal of Anatomy* 207.1, pp. 35–66.
- Moser, Edvard I, Emilio Kropff, and May-Britt Moser (2008): "Place cells, grid cells, and the brain's spatial representation system." In: *Annual review of neuroscience* 31.February, pp. 69–89.
- Moser, Edvard, May-Britt Moser, and Per Andersen (1993): "Spatial learning impairment parallels the magnitude of dorsal hippocampal lesions, but is hardly present following ventral lesions". In: *Journal of Neuroscience* 13.9, pp. 3916–3925.
- Moser, May-Britt, Edvard I Moser, Elma Forrest, Per Andersen, and R G Morris (1995): "Spatial learning with a minilab in the dorsal hippocampus". In: *Proceedings of the National Academy of Sciences* 92.21, pp. 9697–9701.
- Moser, MayBritt and Edvard I Moser (1998): "Functional differentiation in the hippocampus". In: *Hippocampus* 8.6, pp. 608–619.
- Mowrer, Orval (1960): "Learning theory and behavior." In:
- Muller, Jeff, Keith P. Corodimas, Zhanna Fridel, and Joseph E. LeDoux (1997): "Functional inactivation of the lateral and basal nuclei of the amygdala by muscimol infusion prevents fear conditioning to an explicit conditioned stimulus and to contextual stimuli". In: *Behavioral Neuroscience* 111.4, pp. 683–682.
- Muller, Robert U and John L Kubie (1987): "The Effects of Changes in the Environment Hippocampal Cells on the Spatial Firing of". In: *The Journal of neuroscience* 7.7, pp. 1951–1968.
- Myers, K M and M Davis (2007): *Mechanisms of fear extinction*.
- Mystkowski, Jayson L, Michelle G Craske, and Aileen M Echiverri (2002): "Treatment context and return of fear in spider phobia". In: *Behavior Therapy* 33.3, pp. 399–416.

- Nabavi, Sadegh, Rocky Fox, Christophe D. Proulx, John Y. Lin, Roger Y. Tsien, and Roberto Malinow (2014): "Engineering a memory with LTD and LTP". In: *Nature* 511.7509, pp. 348–352.
- Nadel, Lynn (1968): "Dorsal and ventral hippocampal lesions and behavior". In: *Physiology & Behavior* 3.6, pp. 891–900.
- Nadel, Lynn and Morris Moscovitch (1997): "Memory consolidation, retrograde amnesia and the hippocampal complex". In: *Current opinion in neurobiology* 7.2, pp. 217–227.
- Nader, Karim, Pedram Majidshad, Prin Amorapanth, and Joseph E Ledoux (2001): "Damage to the lateral and central, but not other, amygdaloid nuclei prevents the acquisition of auditory fear conditioning". In: *Learning and Memory* 8.3, pp. 156–163.
- Nakao, Kazuhito, Koji Matsuyama, Norio Matsuki, and Yuji Ikegaya (2004): "Amygdala stimulation modulates hippocampal synaptic plasticity". In: *Proceedings of the National Academy of Sciences* 101.39, pp. 14270–14275.
- Namburi, Praneeth, Anna Beyeler, Suzuko Yorozu, Gwendolyn G Calhoun, Sarah A Halbert, Romy Wichmann, Stephanie S Holden, Kim L Mertens, Melodi Anahtar, and Ada C Felix-Ortiz (2015): "A circuit mechanism for differentiating positive and negative associations". In: *Nature* 520.7549, p. 675.
- Narayanan, Rajeevan T, Thomas Seidenbecher, Christian Kluge, Jorge Bergado, Oliver Stork, and Hans-Christian Pape (2007a): "Dissociated theta phase synchronization in amygdalo-hippocampal circuits during various stages of fear memory." In: *The European journal of neuroscience* 25.6, pp. 1823–1831.
- Narayanan, Rajeevan T, Thomas Seidenbecher, Susan Sangha, Oliver Stork, and Hans-Christian Pape (2007b): "Theta resynchronization during reconsolidation of remote contextual fear memory." In: *Neuroreport* 18.11, pp. 1107–1111.
- Nathan, Ran, Orr Spiegel, Scott Fortmann-Roe, Roi Harel, Martin Wikelski, and Wayne M Getz (2012): "Using tri-axial acceleration data to identify behavioral modes of free-ranging animals: general concepts and tools illustrated for griffon vultures". In: *Journal of Experimental Biology* 215.6, pp. 986–996.
- Navratilova, E., J. Y. Xie, A. Okun, C. Qu, N. Eyde, S. Ci, M. H. Ossipov, T. King, H. L. Fields, and F. Porreca (2012): "Pain relief produces negative reinforcement through activation of mesolimbic reward-valuation circuitry". In: *Proceedings of the National Academy of Sciences* 109.50, pp. 20709–20713.
- Nees, Frauke, Angela Heinrich, and Herta Flor (2015): "A mechanism-oriented approach to psychopathology: The role of Pavlovian conditioning". In: *International Journal of Psychophysiology* 98.2, pp. 351–364.
- Neves, Guilherme, Sam F. Cooke, and Tim V.P. Bliss (2008): "Synaptic plasticity, memory and the hippocampus: a neural network approach to causality". In: *Nature Reviews Neuroscience* 9, pp. 65–75.
- Nicolelis, Miguel A L, Asif A Ghazanfar, Barbara M Faggin, Scott Votaw, and Laura M O Oliveira (1997a): "Reconstructing the engram: simultaneous, multisite, many single neuron recordings". In: *Neuron* 18.4, pp. 529–537.
- Nicolelis, Miguel A.L., Luiz A Baccala, Rick C.S. Lin, and John K Chapin (1995): "Sensorimotor encoding by synchronous neural ensemble activity at multiple levels of the somatosensory system". In: *Science* 268.5215, pp. 1353–1358.
- Nicolelis, Miguel A.L., Erika E Fanselow, and Asif A Ghazanfar (1997b): "Hebb's dream: The resurgence of cell assemblies". In: *Neuron* 19.2, pp. 219–221.
- Nicoll, Roger A. (2017): "A Brief History of Long-Term Potentiation". In: *Neuron* 93.2, pp. 281–290.
- Nielsen, Darci M and Linda S Crnic (2002): "Automated analysis of foot-shock sensitivity and concurrent freezing behavior in mice". In: *Journal of neuroscience methods* 115.2, pp. 199–209.
- Norrholm, Seth D, Tanja Jovanovic, Ilana W Olin, Lauren A Sands, India Karapanou, Bekh Bradley, and Kerry J Ressler (2011): "Fear extinction in traumatized civilians with posttraumatic stress disorder: relation to symptom severity." eng. In: *Biological psychiatry* 69.6, pp. 556–563.
- Novitskaya, Yulia, Susan J Sara, Nikos K Logothetis, and Oxana Eschenko (2016): "Ripple-triggered stimulation of the locus coeruleus during post-learning sleep disrupts ripple/spindle coupling and impairs memory consolidation". In: *Learning & Memory* 23.5, pp. 238–248.
- O'Brien, Jamus and Robert J Sutherland (2007): "Evidence for Episodic Memory in a Pavlovian Conditioning Procedure in Rats". In: *Hippocampus* 17, pp. 1149–1152.
- O'Keefe, John (1976): "Place units in the hippocampus of the freely moving rat". In: *Experimental neurology* 51.1, pp. 78–109.

- O'Keefe, John and Neil Burgess (1996): "Geometric determinants of the place fields of hippocampal neurons". In: *Nature* 381, pp. 425–428.
- O'Keefe, John and D H Conway (1978): "Hippocampal place units in the freely moving rat: why they fire where they fire". In: *Experimental Brain Research* 31.4, pp. 573–590.
- O'Keefe, John and Jonathan Dostrovsky (1971): "The hippocampus as a spatial map. Preliminary evidence from unit activity in the freely-moving rat". In: *Brain research* 34.1, pp. 171–175.
- O'Keefe, John and Lynn Nadel (1978): *The hippocampus as a cognitive map*. Vol. 3. Clarendon Press Oxford.
- O'Leary, Timothy P, Rhian K Gunn, and Richard E Brown (2013): "What are we measuring when we test strain differences in anxiety in mice?" In: *Behavior genetics* 43.1, pp. 34–50.
- O'Neill, Joseph, Barty Pleydell-Bouverie, David Dupret, and Jozsef Csicsvari (2010): "Play it again: reactivation of waking experience and memory". In: *Trends in neurosciences* 33.5, pp. 220–229.
- O'Neill, Joseph, Timothy J Senior, Kevin Allen, John R Huxter, and Jozsef Csicsvari (2008): "Reactivation of experience-dependent cell assembly patterns in the hippocampus". In: *Nature neuroscience* 11.2, p. 209.
- O'Neill, Joseph, Timothy Senior, and Jozsef Csicsvari (2006): "Place-selective firing of CA1 pyramidal cells during sharp wave/ripple network patterns in exploratory behavior". In: *Neuron* 49.1, pp. 143–155.
- Odling-Smee, F J (1975): "The role of background stimuli during Pavlovian conditioning". In: *Quarterly Journal of Experimental Psychology* 27.2, pp. 201–209.
- Odling-Smee, F J (1978): "The overshadowing of background stimuli by an informative CS in aversive Pavlovian conditioning with rats". In: *Animal Learning & Behavior* 6.1, pp. 43–51.
- Ohkawa, Noriaki, Yoshito Saitoh, Akinobu Suzuki, Shuhei Tsujimura, Emi Murayama, Sakurako Kosugi, Hirofumi Nishizono, Mina Matsuo, Yukari Takahashi, Masashi Nagase, Yae K Sugimura, Ayako M Watabe, Fusao Kato, and Kaoru Inokuchi (2015): "Artificial association of pre-stored information to generate a qualitatively new memory." eng. In: *Cell reports* 11.2, pp. 261–269.
- Oka, Tatsuro, Toshiko Tsumori, Shigefumi Yokota, and Yukihiko Yasui (2008): "Neuroanatomical and neurochemical organization of projections from the central amygdaloid nucleus to the nucleus retroambiguus via the periaqueductal gray in the rat". In: *Neuroscience research* 62.4, pp. 286–298.
- Okada, Sakura, Hideyoshi Igata, Takuya Sasaki, and Yuji Ikegaya (2017): "Spatial representation of hippocampal place cells in a T-maze with an aversive stimulation". In: *Frontiers in Neural Circuits* 11. December.
- Ólafsdóttir, H Freyja, Francis Carpenter, and Caswell Barry (2016): "Coordinated grid and place cell replay during rest". In: *Nature neuroscience* 19.6, p. 792.
- Olatunji, Bunmi O, Josh M Cisler, and Brett J Deacon (2010): "Efficacy of cognitive behavioral therapy for anxiety disorders: a review of meta-analytic findings". In: *Psychiatric Clinics of North America* 33.3, pp. 557–577.
- Oleson, Erik B, Ronny N Gentry, Vivian C Chioma, and Joseph F Cheer (2012): "Subsecond dopamine release in the nucleus accumbens predicts conditioned punishment and its successful avoidance". In: *Journal of Neuroscience* 32.42, pp. 14804–14808.
- Oliva, Azahara, Antonio Fernández-Ruiz, György Buzsáki, and Antal Berényi (2016): "Role of hippocampal CA2 region in triggering sharp-wave ripples". In: *Neuron* 91.6, pp. 1342–1355.
- Ongür, D and J L Price (2000): "The organization of networks within the orbital and medial prefrontal cortex of rats, monkeys and humans." In: *Cerebral cortex* 10.3, pp. 206–19.
- Ormond, Jake, Simon A. Serka, and Joshua P. Johansen (2019): "Episodic memory encoding by a place cell subpopulation". In: *bioRxiv*, p. 682831.
- Orsini, Caitlin A, Jee Hyun Kim, Ewelina Knapska, and Stephen Maren (2011): "Hippocampal and prefrontal projections to the basal amygdala mediate contextual regulation of fear after extinction". In: *The Journal of Neuroscience* 31.47, pp. 17269–17277.
- Ortiz, Samantha, Maeson S. Latsko, Julia L. Fouty, Sohini Dutta, Jordan M. Adkins, and Aaron M. Jasnow (2019): "Anterior Cingulate Cortex and Ventral Hippocampal Inputs to the Basolateral Amygdala Selectively Control Generalized Fear". In: *The Journal of Neuroscience* 39.33, pp. 6526–6539.
- Otto, Tim and Graham Cousins (1998): "Both pre- and posttraining excitotoxic lesions of the basolateral amygdala abolish the expression of olfactory and contextual fear conditioning". In: *Behavioral Neuroscience* 112.5, pp. 1092–1103.

- Oudiette, Delphine, Marie-Jose Dealberto, Ginevra Ugucioni, Jean-Louis Golmard, Milagros Merino-Andreu, Mehdi Tafti, Lucile Garma, Sophie Schwartz, and Isabelle Arnulf (2012): "Dreaming without REM sleep." eng. In: *Consciousness and cognition* 21.3, pp. 1129–1140.
- Owens, Neil Craig and Anthony J M Verberne (2001): "Regional haemodynamic responses to activation of the medial prefrontal cortex depressor region". In: *Brain research* 919.2, pp. 221–231.
- Owings, Donald H, Matthew P Rowe, and Aaron S Rundus (2002): "The rattling sound of rattlesnakes (*Crotalus viridis*) as a communicative resource for ground squirrels (*Spermophilus beecheyi*) and burrowing owls (*Athene cunicularia*)." In: *Journal of Comparative Psychology* 116.2, p. 197.
- Ozawa, Takaaki and Joshua P. Johansen (2018): "Learning rules for aversive associative memory formation". In: *Current Opinion in Neurobiology* 49, pp. 148–157.
- Ozawa, Takaaki, Edgar A. Ycu, Ashwani Kumar, Li Feng Yeh, Touqeer Ahmed, Jenny Koivumaa, and Joshua P. Johansen (2017): "A feedback neural circuit for calibrating aversive memory strength". In: *Nature Neuroscience* 20.1, pp. 90–97.
- Pachitariu, Marius, Nicholas Steinmetz, Shabnam Kadir, Matteo Carandini, and Kenneth D Harris (2016): "Kilosort: realtime spike-sorting for extracellular electrophysiology with hundreds of channels". In: *BioRxiv*, p. 61481.
- Padilla-Coreano, Nancy, Scott S. Bolkan, Georgia M. Pierce, Dakota R. Blackman, William D. Hardin, Alvaro L. Garcia-Garcia, Timothy J. Spellman, and Joshua A. Gordon (2016): "Direct Ventral Hippocampal-Prefrontal Input Is Required for Anxiety-Related Neural Activity and Behavior". In: *Neuron* 89.4, pp. 857–866.
- Padilla-Coreano, Nancy, Fabricio H Domonte, and Gregory J Quirk (2012): "A time-dependent role of midline thalamic nuclei in the retrieval of fear memory". In: *Neuropharmacology* 62.1, pp. 457–463.
- Pape, Hans Christian, Rajeevan T. Narayanan, Jan Smid, Oliver Stork, and Thomas Seidenbecher (2005): "Theta activity in neurons and networks of the amygdala related to long-term fear memory". In: *Hippocampus* 15.7, pp. 874–880.
- Pape, Hans-christian and Denis Pare (2010): "Plastic Synaptic Networks of the Amygdala for the Acquisition , Expression , and Extinction of Conditioned Fear". In: *Physiological Reviews*, pp. 419–463.
- Papez, James W (1937): "A proposed mechanism of emotion". In: *Archives of Neurology & Psychiatry* 38.4, pp. 725–743.
- Pare, D. and Y. Smith (1998): "Intrinsic circuitry of the amygdaloid complex: Common principles of organization in rats and cats [1]". In: *Trends in Neurosciences* 21.6, pp. 240–241.
- Paré, Denis and Gregory J Quirk (2017): "When scientific paradigms lead to tunnel vision: lessons from the study of fear". In: *Science of Learning* 2.1, pp. 1–8.
- Parent, Marc A, Lang Wang, Jianjun Su, Theoden Netoff, and Li-Lian Yuan (2009): "Identification of the hippocampal input to medial prefrontal cortex in vitro". In: *Cerebral cortex* 20.2, pp. 393–403.
- Pasquet, Matthieu O., Matthieu Tihy, Aurélie Gourgeon, Marco N. Pompili, Bill P. Godsil, Clément Lena, Guillaume P. Dugué, Clément Léna, Guillaume P. Dugué, Clément Lena, and Guillaume P. Dugué (2016): "Wireless inertial measurement of head kinematics in freely-moving rats". In: *Scientific Reports* 6.October, pp. 1–18.
- Pastalkova, Eva, Vladimir Itskov, Asohan Amarasingham, and György Buzsáki (2008): "Internally generated cell assembly sequences in the rat hippocampus." In: *Science (New York, N.Y.)* 321.5894, pp. 1322–7.
- Pastalkova, Eva, Peter Serrano, Deana Pinkhasova, Emma Wallace, André Antonio Fenton, and Todd Charlton Sacktor (2006): "Storage of spatial information by the maintenance mechanism of LTP". In: *science* 313.5790, pp. 1141–1144.
- Patel, Jagdish, Shigeyoshi Fujisawa, Antal Berényi, Sébastien Royer, and György Buzsáki (2012): "Traveling theta waves along the entire septotemporal axis of the hippocampus". In: *Neuron* 75.3, pp. 410–417.
- Patel, Jagdish, Erik W Schomburg, Antal Berényi, Shigeyoshi Fujisawa, and György Buzsáki (2013): "Local generation and propagation of ripples along the septotemporal axis of the hippocampus". In: *Journal of Neuroscience* 33.43, pp. 17029–17041.
- Patrick, Christopher J, Margaret M Bradley, and Peter J Lang (1993): "Emotion in the criminal psychopath: startle reflex modulation." In: *Journal of abnormal psychology* 102.1, p. 82.

- Pavlov, Ivan P (1897): *Lectures on the work of the digestive glands (translated by W. H. Thompson, 1902)*. Classics of Medicine Library, Birmingham (reprinted 1982).
- Pavlov, Ivan Petrovich (1927): "Conditional reflexes: an investigation of the physiological activity of the cerebral cortex." In:
- Pavlov, Ivan Petrovich (1928): "Croonia Lecture - Certain Problems in the Physiology of the Cerebral Hemispheres". In: *Proceedings of the Royal Society London B* 103.
- Pavlov, Ivan Petrovich (1932): "The reply of a physiologist to psychologists." In:
- Paxinos, George and Charles Watson (2007): *The rat brain in stereotaxic coordinates. 6th edition*. Academic Press, p. 463.
- Paxinos, George and Charles Watson (2013): *The Rat Brain in Stereotaxic Coordinate*. Academic Press, p. 472.
- Pearce, John M and Geoffrey Hall (1980): *A model for Pavlovian learning: Variations in the effectiveness of conditioned but not of unconditioned stimuli*. US.
- Pellman, Blake A and Jeansok J Kim (2016): "What can ethobehavioral studies tell us about the brain's fear system?" In: *Trends in neurosciences* 39.6, pp. 420-431.
- Pennartz, C. M.A., E Lee, J Verheul, P Lipa, C A Barnes, and B. L. McNaughton (2004): "The ventral striatum in off-line processing: Ensemble reactivation during sleep and modulation by hippocampal ripples". In: *Journal of Neuroscience* 24.29, pp. 6446-6456.
- Pennington, Zachary T., Zhe Dong, Regina MS Bowler, Yu Feng, Lauren Vetere, Tristan Shuman, and Denise J. Cai (2019): "ezTrack: An open-source video analysis pipeline for the investigation of animal behavior". In: *bioRxiv*.
- Pentkowski, Nathan S, D. Caroline Blanchard, Colin Lever, Yoav Litvin, and Robert J Blanchard (2006): "Effects of lesions to the dorsal and ventral hippocampus on defensive behaviors in rats". In: *European Journal of Neuroscience* 23.8, pp. 2185-2196.
- Penzo, Mario A., Vincent Robert, Jason Tucciarone, Dimitri De Bundel, Minghui Wang, Linda Van Aelst, Martin Darvas, Luis F. Parada, Richard D. Palmiter, Miao He, Z. Josh Huang, and Bo Li (2015): "The paraventricular thalamus controls a central amygdala fear circuit". In: *Nature* 519.7544, pp. 455-459.
- Penzo, Mario A, Vincent Robert, and Bo Li (2014): "Fear conditioning potentiates synaptic transmission onto long-range projection neurons in the lateral subdivision of central amygdala". In: *Journal of Neuroscience* 34.7, pp. 2432-2437.
- Perrot-Sinal, T S, K.-P. Ossenkopp, and M Kavaliers (1999): "Effects of Repeated Exposure to Fox Odor on Locomotor Activity Levels and Spatial Movement Patterns in Breeding Male and Female Meadow Voles (*Microtus pennsylvanicus*)". In: *Journal of Chemical Ecology* 25.7, pp. 1567-1584.
- Perusini, Jennifer N and Michael S Fanselow (2015): "Neurobehavioral perspectives on the distinction between fear and anxiety". In: *Learning & Memory* 22.9, pp. 417-425.
- Pessoa, Luiz and Patrick R Hof (2015): *From Paul Broca's great limbic lobe to the limbic system*.
- Peters, Jamie, Laura M Dieppa-Perea, Loyda M Melendez, and Gregory J Quirk (2010): "Induction of fear extinction with hippocampal-infralimbic BDNF". In: *Science* 328.5983, pp. 1288-1290.
- Peterson, Steven L. (1986): "Prefrontal Cortex Neuron Activity During a Discriminative Conditioning Paradigm in Unanesthetized Rats". In: *International Journal of Neuroscience* 29.3-4, pp. 245-254.
- Petrovich, G D, P Y Risold, and L W Swanson (1996): "Organization of projections from the basomedial nucleus of the amygdala: a PHAL study in the rat". In: *Journal of Comparative Neurology* 374.3, pp. 387-420.
- Petrovich, Gorica D, Newton S Canteras, and Larry W Swanson (2001): "Combinatorial amygdalar inputs to hippocampal domains and hypothalamic behavior systems". In: *Brain research reviews* 38.1-2, pp. 247-289.
- Peusner, Kenna (2012): "Basic concepts in understanding recovery of function in vestibular reflex networks during vestibular compensation". In: *Frontiers in Neurology* 3, p. 17.
- Peyrache, Adrien, Francesco P Battaglia, and Alain Destexhe (2011): "Inhibition recruitment in prefrontal cortex during sleep spindles and gating of hippocampal inputs". In: *Proceedings of the National Academy of Sciences of the United States of America* 108.41, pp. 17207-17212.
- Peyrache, Adrien, Karim Benchenane, Mehdi Khamassi, Sidney I Wiener, and Francesco P Battaglia (2010): "Principal component analysis of ensemble recordings reveals cell assemblies at high temporal resolution". In: *Journal*

- of computational neuroscience 29.1-2, pp. 309–325.
- Peyrache, Adrien, Mehdi Khamassi, Karim Benchenane, Sidney I Wiener, and Francesco P Battaglia (2009): “Replay of rule-learning related neural patterns in the prefrontal cortex during sleep.” In: *Nature neuroscience* 12.7, pp. 919–926.
- Peyrache, Adrien, Marie M Lacroix, Peter C Petersen, and György Buzsáki (2015): “Internally organized mechanisms of the head direction sense”. In: *Nature neuroscience* 18.4, p. 569.
- Peyron, Christelle, J-M Petit, Claire Rampon, Michel Jouvet, and P-H Luppi (1997): “Forebrain afferents to the rat dorsal raphe nucleus demonstrated by retrograde and anterograde tracing methods”. In: *Neuroscience* 82.2, pp. 443–468.
- Pfeiffer, Brad E and David J Foster (2013): “Hippocampal place-cell sequences depict future paths to remembered goals”. In: *Nature* 497.7447, p. 74.
- Pham, Jon, Sara M Cabrera, Carles Sanchis-Segura, and Marcelo A Wood (2009): “Automated scoring of fear-related behavior using EthoVision software”. In: *Journal of neuroscience methods* 178.2, pp. 323–326.
- Phelps, Elizabeth A and Joseph E LeDoux (2005): “Contributions of the amygdala to emotion processing: from animal models to human behavior.” In: *Neuron* 48.2, pp. 175–87.
- Phillips, Christopher, Leo Ling, Trey Oxford, Amy Nowack, Kaibao Nie, Jay T Rubinstein, and James O Phillips (2015): “Longitudinal performance of an implantable vestibular prosthesis”. In: *Hearing research* 322, pp. 200–211.
- Phillips, R G and J E LeDoux (1994): “Lesions of the dorsal hippocampal formation interfere with background but not foreground contextual fear conditioning.” In: *Learning & Memory* 1.1, pp. 34–44.
- Phillips, R G and Joseph E LeDoux (1992): “Differential Contribution of Amygdala and Hippocampus to Cued and Contextual Fear Conditioning”. In: *Behavioral Neuroscience* 106.2, pp. 274–285.
- Pignatelli, Michele and Anna Beyeler (2019): “Valence coding in amygdala circuits”. In: *Current Opinion in Behavioral Sciences* 26, pp. 97–106.
- Pikkarainen, Maria, Seppo Rönkkö, Vesa Savander, Ricardo Insausti, and Asla Pitkänen (1999): “Projections from the lateral, basal, and accessory basal nuclei of the amygdala to the hippocampal formation in rat”. In: *Journal of Comparative Neurology* 403.2, pp. 229–260.
- Pinard, C R, F Mascagni, and A. J. McDonald (2012): “Medial prefrontal cortical innervation of the intercalated nuclear region of the amygdala”. In: *Neuroscience* 205, pp. 112–124.
- Pine, Daniel S and Joseph E LeDoux (2017): “Elevating the role of subjective experience in the clinic: Response to Fanselow and Pennington”. In: *American Journal of Psychiatry* 174.11, pp. 1121–1122.
- Pitkänen, Asla, Vesa Savander, and Joseph E. LeDoux (1997): “Organization of intra-amygdaloid circuitries in the rat: An emerging framework for understanding functions of the amygdala”. In: *Trends in Neurosciences* 20.11, pp. 517–523.
- Pitkänen, Asla (2000): “Connectivity of the rat amygdaloid complex”. In: *The Amygdala: A Functional Analysis*, ed. by John P. Aggleton. Oxford, England: Oxford University Press, pp. 31–116.
- Pitkänen, Asla, Maria Pikkarainen, Nina Nurminen, and Aarne Ylinen (2000): “Reciprocal connections between the amygdala and the hippocampal formation, perirhinal cortex, and postrhinal cortex in rat: a review”. In: *Annals of the New York Academy of Sciences* 911.1, pp. 369–391.
- Ploog, Detlev (1981): “Neurobiology of primate audio-vocal behavior”. In: *Brain Research Reviews* 3.1, pp. 35–61.
- Pohl, Bernd M, Fernando Gasca, Olaf Christ, and Ulrich G Hofmann (2013): “3D printers may reduce animal numbers to train neuroengineering procedures”. In: *2013 6th International IEEE/EMBS Conference on Neural Engineering (NER)*. IEEE, pp. 887–890.
- Poo, Mu ming, Michele Pignatelli, Tomás J. Ryan, Susumu Tonegawa, Tobias Bonhoeffer, Kelsey C. Martin, Andrii Rudenko, Li Huei Tsai, Richard W. Tsien, Gord Fishell, Caitlin Mullins, J. Tiago Gonçalves, Matthew Shtrahman, Stephen T. Johnston, Fred H. Gage, Yang Dan, John Long, György Buzsáki, and Charles Stevens (2016): “What is memory? The present state of the engram”. In: *BMC Biology* 14.1, pp. 1–18.
- Popa, Daniela, Sevil Duvarci, Andrei T Popescu, Clément Léna, and Denis Paré (2010): “Coherent amygdalocortical theta promotes fear memory consolidation during paradoxical sleep”. In: *Proceedings of the National Academy of Sciences* 107.14, pp. 6516–6519.
- Portugal, Steven J, Tatjana Y Hubel, Johannes Fritz, Stefanie Heese, Daniela Trobe, Bernhard Voelkl, Stephen

- Hailes, Alan M Wilson, and James R Usherwood (2014): "Upwash exploitation and downwash avoidance by flap phasing in ibis formation flight". In: *Nature* 505.7483, p. 399.
- Poucet, Bruno, Catherine Thinus-Blanc, and Robert U Muller (1994): "Place cells in the ventral hippocampus of rats." In: *Neuroreport* 5, pp. 2045–2048.
- Poulos, Andrew M, Veronica Li, Sarah S Sterlace, Fonda Tokushige, Ravikumar Ponnusamy, and Michael S Fanselow (2009): "Persistence of fear memory across time requires the basolateral amygdala complex". In: *Proceedings of the National Academy of Sciences* 106.28.
- Powers, Mark B, Jacqueline M Halpern, Michael P Ferenschak, Seth J Gillihan, and Edna B Foa (2010): "A meta-analytic review of prolonged exposure for posttraumatic stress disorder". In: *Clinical psychology review* 30.6, pp. 635–641.
- Preston, Alison R and Howard Eichenbaum (2013): "Interplay of hippocampus and prefrontal cortex in memory". In: *Current Biology* 23.17, R764–R773.
- Preuss, Todd M (1995): "Do rats have prefrontal cortex? The Rose-Woolsey-Akert program reconsidered". In: *Journal of Cognitive Neuroscience* 7.1, pp. 1–24.
- Qin, Yu-Lin, Bruce L McNaughton, William E Skaggs, and Carol A Barnes (1997): "Memory reprocessing in corticocortical and hippocampocortical neuronal ensembles". In: *Philosophical Transactions of the Royal Society of London. Series B: Biological Sciences* 352.1360, pp. 1525–1533.
- Quinn, Jennifer J., Quang D. Ma, Matthew R. Tinsley, Christof Koch, and Michael S. Fanselow (2008): "Inverse temporal contributions of the dorsal hippocampus and medial prefrontal cortex to the expression of long-term fear memories". In: *Learning and Memory* 15.5, pp. 368–372.
- Quirk, Gregory J., Jorge L. Armony, and Joseph E. LeDoux (1997): "Fear conditioning enhances different temporal components of tone-evoked spike trains in auditory cortex and lateral amygdala". In: *Neuron* 19.3, pp. 613–624.
- Quirk, Gregory J., J. Christopher Repa, and Joseph E. LeDoux (1995): "Fear conditioning enhances short-latency auditory responses of lateral amygdala neurons: Parallel recordings in the freely behaving rat". In: *Neuron* 15.5, pp. 1029–1039.
- Quirk, Gregory J., Gregory K. Russo, Jill L. Barron, and Kelimer Lebron (2000): "The Role of Ventromedial Prefrontal Cortex in the Recovery of Extinguished Fear". In: *The Journal of Neuroscience* 20.16, pp. 6225–6231.
- Quirk, Gregory J and Devin Mueller (2008): "Neural mechanisms of extinction learning and retrieval." In: *Neuropsychopharmacology : official publication of the American College of Neuropsychopharmacology* 33.1, pp. 56–72.
- Rachman, Stanley (1989): "The return of fear: Review and prospect". In: *Clinical Psychology Review* 9.2, pp. 147–168.
- Raizen, David M, John E Zimmerman, Matthew H Maycock, Uyen D Ta, Young-jai You, Meera V Sundaram, and Allan I Pack (2008): "Lethargus is a *Caenorhabditis elegans* sleep-like state." eng. In: *Nature* 451.7178, pp. 569–572.
- Rajasethupathy, Priyamvada, Sethuraman Sankaran, James H. Marshel, Christina K. Kim, Emily Ferenczi, Soo Yeun Lee, Andre Berndt, Charu Ramakrishnan, Anna Jaffe, Maisie Lo, Conor Liston, and Karl Deisseroth (2015): "Projections from neocortex mediate top-down control of memory retrieval". In: *Nature* 526.7575, pp. 653–659.
- Ramadan, Wiãm, Oxana Eschenko, and Susan J Sara (2009): "Hippocampal sharp wave/ripples during sleep for consolidation of associative memory". In: *PLoS one* 4.8, e6697.
- Ramanathan, Dhakshin S, Tanuj Gulati, and Karunesh Ganguly (2015): "Sleep-Dependent Reactivation of Ensembles in Motor Cortex Promotes Skill Consolidation". In: *PLOS Biology* 13.9, e1002263.
- Ramanathan, Karthik R, Reed L Ressler, Jingji Jin, and Stephen Maren (2018): "Nucleus reuniens is required for encoding and retrieving precise, hippocampal-dependent contextual fear memories in rats". In: *Journal of Neuroscience* 38.46, pp. 9925–9933.
- Ramón y Cajal, Santiago (1899): *Textura del sistema nervioso del hombre y de los vertebrados*. Madrid: Imprenta y Librería de Nicolás Moya, p. 608.
- Ranck, J. B. (1973): "Studies on neurons in dorsal hippocampal formation and septum in unrestrained rats. I. Behavioral correlates and firing repertoires". In: *Experimental Neurology* 41.2, pp. 462–531.
- Rasch, Bjorn and Jan Born (2013): "About sleep's role in memory." eng. In: *Physiological reviews* 93.2, pp. 681–766.
- Rashid, Asim, Chen Yan, Valentina Mercaldo, Hwa-Lin (Liz) Hsiang, Sungmo Park, Christina J. Cole, Antonietta De Cristofaro, Julia Yu, Charu Ramakrish-

- nan, Soo Yeun Lee, Karl Deisseroth, Paul W. Frankland, and Sheena A. Josselyn (2016): "Competition between engrams influences fear memory formation and recall". In: *Science* 353.6297, pp. 383–387.
- Ratner, Stanley C (1975): "Animal's defenses: Fighting in predator-prey relations". In: *Nonverbal communication of aggression*. Springer, pp. 175–190.
- Ratner, Stanley C (1977): "Immobility of invertebrates: What can we learn?" In: *The Psychological Record* 27, p. 1.
- Rauhut, Anthony S, Brian L Thomas, and John J B Ayres (2001): "Treatments that weaken Pavlovian conditioned fear and thwart its renewal in rats: Implications for treating human phobias." In: *Journal of Experimental Psychology: Animal Behavior Processes* 27.2, p. 99.
- Ravi, Nishkam, Nikhil Dandekar, Preetham Mysore, and Michael L Littman (2005): "Activity recognition from accelerometer data". In: *Aaai*. Vol. 5. 2005, pp. 1541–1546.
- Redish, A. D., F. P. Battaglia, M. K. Chawla, A. D. Ekstrom, J. L. Gerrard, P. Lipa, E. S. Rosenzweig, P. F. Worley, J. F. Guzowski, B. L. McNaughton, and C. A. Barnes (2001): "Independence of firing correlates of anatomically proximate hippocampal pyramidal cells." In: *The Journal of neuroscience : the official journal of the Society for Neuroscience* 21.5, pp. 1–6.
- Redondo, Roger L, Joshua Kim, Autumn L Arons, Steve Ramirez, Xu Liu, and Susumu Tonegawa (2014): "Bidirectional switch of the valence associated with a hippocampal contextual memory engram." eng. In: *Nature* 513.7518, pp. 426–430.
- Reijmers, Leon G, Brian L Perkins, Naoki Matsuo, and Mark Mayford (2007): "Localization of a stable neural correlate of associative memory." eng. In: *Science (New York, N.Y.)* 317.5842, pp. 1230–1233.
- Repa, J Christopher, Jeff Muller, John Apergis, Theresa M Desrochers, Yu Zhou, and Joseph E Ledoux (2001): "Two different lateral amygdala cell populations contribute to the initiation and storage of memory". In: *Nature Neuroscience* 4.7, pp. 724–731.
- Reppucci, Christina J. and Gorica D. Petrovich (2016): "Organization of connections between the amygdala, medial prefrontal cortex, and lateral hypothalamus: a single and double retrograde tracing study in rats". In: *Brain Structure and Function* 221.6, pp. 2937–2962.
- Rescorla, Robert A and C Donald Heth (1975): "Reinstatement of fear to an extinguished conditioned stimulus." In: *Journal of Experimental Psychology: Animal Behavior Processes* 1.1, p. 88.
- Rescorla, Robert A and Richard L Solomon (1967): "Two-process learning theory: Relationships between Pavlovian conditioning and instrumental learning." In: *Psychological review* 74.3, p. 151.
- Rescorla, Robert A and Allan R Wagner (1972): "A theory of Pavlovian conditioning: Variations in the effectiveness of reinforcement and nonreinforcement". In: *Classical conditioning II: Current research and theory* 2, pp. 64–99.
- Resstel, L. B.M., S. R.L. Joca, F. G. Guimarães, and F. M.A. Corrêa (2006): "Involvement of medial prefrontal cortex neurons in behavioral and cardiovascular responses to contextual fear conditioning". In: *Neuroscience* 143.2, pp. 377–385.
- Reznikov, Roman, Mustansir Diwan, José N. Nobrega, and Clement Hamani (2015): "Towards a better preclinical model of PTSD: Characterizing animals with weak extinction, maladaptive stress responses and low plasma corticosterone". In: *Journal of Psychiatric Research* 61, pp. 158–165.
- Ribot, Théodule (1891): *Les maladies de la mémoire*. Baillière.
- Rich, Erin L. and Matthew Shapiro (2009): "Rat prefrontal cortical neurons selectively code strategy switches". In: *Journal of Neuroscience* 29.22, pp. 7208–7219.
- Richardson, Rick (2000): "Shock sensitization of startle: learned or unlearned fear?" In: *Behavioural brain research* 110.1-2, pp. 109–117.
- Richmond, M A, C A Murphy, B Pouzet, P Schmid, J N P Rawlins, and J Feldon (1998): "A computer controlled analysis of freezing behaviour". In: *Journal of neuroscience methods* 86.1, pp. 91–99.
- Richmond, M A, B K Yee, B Pouzet, L Veenman, J N P Rawlins, J Feldon, and D M Bannerman (1999): *Dissociating context and space within the hippocampus: Effects of complete, dorsal, and ventral excitotoxic hippocampal lesions on conditioned freezing and spatial learning*. US.
- Rickenbacher, Elizabeth, Rosemarie E Perry, Regina M Sullivan, and Marta A Moita (2017): "Freezing suppression by oxytocin in central amygdala allows alternate defensive behaviours and mother-pup interactions". In: *eLife* 6.e24080, pp. 1–17.

- Riehle, Timothy H, Shane M Anderson, Patrick A Lichter, William E Whalen, and Nicholas A Giudice (2013): "Indoor inertial waypoint navigation for the blind". In: *2013 35th Annual International Conference of the IEEE Engineering in Medicine and Biology Society (EMBC)*. IEEE, pp. 5187–5190.
- Riga, Danai, Mariana R. Matos, Annet Glas, August B. Smit, Sabine Spijker, and Michel C. Van den Oever (2014): "Optogenetic dissection of medial prefrontal cortex circuitry". In: *Frontiers in Systems Neuroscience* 8.December, pp. 1–19.
- Risold, P Y and L W Swanson (1996): "Structural evidence for functional domains in the rat hippocampus". In: *Science* 272.5267, pp. 1484–1486.
- Risold, P Y and L W Swanson (1997): "Connections of the rat lateral septal complex". In: *Brain research reviews* 24.2-3, pp. 115–195.
- Rizvi, Shireen L, Debra Kaysen, Cassidy A Gutner, Michael G Griffin, and Patricia A Resick (2008): "Beyond fear: The role of peritraumatic responses in posttraumatic stress and depressive symptoms among female crime victims". In: *Journal of Interpersonal Violence* 23.6, pp. 853–868.
- Robinson, Siobhan and David J Bucci (2012): "Fear Conditioning Is Disrupted by Damage to the Postsubiculum". In: *Hippocampus* 1491, pp. 1481–1491.
- Rockland, Kathleen S. (2019): "What do we know about laminar connectivity?" In: *NeuroImage* 197.July 2017, pp. 772–784.
- Roelofs, Karin (2017): "Freeze for action: Neurobiological mechanisms in animal and human freezing". In: *Philosophical Transactions of the Royal Society B: Biological Sciences* 372.1718.
- Roelofs, Karin, Muriel A Hagenaars, and John Stins (2010): "Facing freeze: Social threat induces bodily freeze in humans". In: *Psychological Science* 21.11, pp. 1575–1581.
- Rogan, Michael T., Ursula V Stäubli, Joseph E. LeDoux, U. V. Staubli, and Joseph E. LeDoux (1997): "Fear conditioning induces associative long-term potentiation in the amygdala". In: *Nature* 390.6660, pp. 604–607.
- Rogan, Michael T and Joseph E. LeDoux (1995): "LTP is accompanied by commensurate enhancement of auditory-evoked responses in a fear conditioning circuit". In: *Neuron* 15.1, pp. 127–136.
- Rogers, Jason L, Michael R Hunsaker, and Raymond P Kesner (2006): "Effects of ventral and dorsal CA1 subregional lesions on trace fear conditioning". In: *Neurobiology of Learning and Memory* 86.1, pp. 72–81.
- Rolls, Asya, Damien Colas, Antoine Adamantidis, Matt Carter, Tope Lanre-Amos, H Craig Heller, and Luis de Lecea (2011): "Optogenetic disruption of sleep continuity impairs memory consolidation." eng. In: *Proceedings of the National Academy of Sciences of the United States of America* 108.32, pp. 13305–13310.
- Rolls, Edmund T, Alessandro Treves, and Edmund T Rolls (1998): *Neural networks and brain function*. Vol. 572. Oxford university press Oxford.
- Romanski, Lizabeth M, Marie-Christine Clugnet, Fabio Bordini, and Joseph E LeDoux (1993): *Somatosensory and auditory convergence in the lateral nucleus of the amygdala*. US.
- Rosanova, Mario and Daniel Ulrich (2005): "Pattern-specific associative long-term potentiation induced by a sleep spindle-related spike train". In: *Journal of Neuroscience* 25.41, pp. 9398–9405.
- Rosas, Juan M and Mark E Bouton (1998): "Context change and retention interval can have additive, rather than interactive, effects after taste aversion extinction". In: *Psychonomic Bulletin & Review* 5.1, pp. 79–83.
- Rosas, Juan M, Travis P Todd, and Mark E Bouton (2013): "Context change and associative learning". eng. In: *Wiley interdisciplinary reviews. Cognitive science* 4.3, pp. 237–244.
- Rosen, Jeffrey B, Janice M Hitchcock, Mindy J. D. Miserendino, William A. Falls, Serge Campeau, and Michael Davis (1992): "Lesions of the perirhinal cortex but not of the frontal, medial prefrontal, visual, or insular cortex block fear-potentiated startle using a visual conditioned stimulus". In: *Journal of Neuroscience* 12.12, pp. 4624–4633.
- Rosenkranz, J Amiel and Anthony A Grace (2002): "Dopamine-mediated modulation of odour-evoked amygdala potentials during pavlovian conditioning". In: *Nature* 417.6886, p. 282.
- Rothschild, Gideon, Elad Eban, and Loren M Frank (2017): "A corticalhippocampal cortical loop of information processing during memory consolidation". In: *Nature neuroscience* 20.2, pp. 251–259.
- Rothwell, Emily S, Fred B Bercovitch, Jeff R M Andrews, and Matthew J Anderson (2011): "Estimating daily walking distance of captive African elephants using an accelerometer". In: *Zoo biology* 30.5, pp. 579–591.
- Roudi, Yasser, Benjamin Dunn, and John Hertz (2015): "Multi-neuronal activity

- and functional connectivity in cell assemblies". In: *Current Opinion in Neurobiology* 32, pp. 38–44.
- Royer, Sébastien, Anton Sirotka, Jagdish Patel, and György Buzsáki (2010): "Distinct representations and theta dynamics in dorsal and ventral hippocampus." In: *The Journal of neuroscience : the official journal of the Society for Neuroscience* 30.5, pp. 1777–1787.
- Rozeske, R R, S Valerio, F Chaudun, and C Herry (2015): "Prefrontal neuronal circuits of contextual fear conditioning". In: *Genes, Brain and Behavior* 14.1, pp. 22–36.
- Rozeske, Robert R., Daniel Jercog, Nikolaos Karalis, Fabrice Chaudun, Suzana Khoder, Delphine Girard, Nanci Winke, and Cyril Herry (2018): "Prefrontal-Periaqueductal Gray-Projecting Neurons Mediate Context Fear Discrimination". In: *Neuron* 97.4, 898–910.e6.
- Rudy, Jerry W. (2009): "Context representations, context functions, and the parahippocampal-hippocampal system". In: *Learning and Memory* 16.10, pp. 573–585.
- Rudy, Jerry W, Ruth M Barrientos, and Randall C. O'Reilly (2002): "Hippocampal formation supports conditioning to memory of a context". In: *Behavioral Neuroscience* 116.4, pp. 530–538.
- Rudy, Jerry W and Patricia Matus-Amat (2005): "The ventral hippocampus supports a memory representation of context and contextual fear conditioning: Implications for a unitary function of the hippocampus". In: *Behavioral Neuroscience* 119.1, pp. 154–163.
- Rushworth, Matthew F S, Maryann P Noonan, Erie D Boorman, Mark E Walton, and Timothy E Behrens (2011): "Frontal cortex and reward-guided learning and decision-making." In: *Neuron* 70.6, pp. 1054–69.
- Russo, Eleonora and Daniel Durstewitz (2017): "Cell assemblies at multiple time scales with arbitrary lag constellations". In: *eLife* 6, pp. 1–31.
- Sacchetti, Benedetto, Elisabetta Baldi, Carlo Ambrogi Lorenzini, and Corrado Bucherelli (2003): "Role of the neocortex in consolidation of fear conditioning memories in rats". In: *Experimental Brain Research* 152.3, pp. 323–328.
- Sadowski, Josef H L P, Matthew W Jones, and Jack R Mellor (2016): "Sharp-wave ripples orchestrate the induction of synaptic plasticity during reactivation of place cell firing patterns in the hippocampus". In: *Cell reports* 14.8, pp. 1916–1929.
- Sagar, H J, Neal J Cohen, Suzanne Corkin, and J H Growdon (1985): "Dissociations among processes in remote memory". In: *Annals of the New York Academy of Sciences* 444.1, pp. 533–535.
- Sah, Pankaj, E. S. Lopez Faber, M Lopez D E Armentia, John Power, Mikel LOPEZ DE ARMENTIA, and John Power (2003): "The amygdaloid complex: anatomy and physiology". In: *Physiological Reviews* 83.3, pp. 803–834.
- Sakurai, Yoshio, Yuma Osako, Yuta Tanisumi, Eriko Ishihara, Junya Hirokawa, and Hiroyuki Manabe (2018): "Multiple approaches to the investigation of cell assembly in memory research present and future". In: *Frontiers in Systems Neuroscience* 12.May, pp. 1–13.
- Salay, Lindsey D., Nao Ishiko, and Andrew D. Huberman (2018): "A midline thalamic circuit determines reactions to visual threat". In: *Nature* 557.7704, pp. 183–189.
- Sananes, Catherine B and Michael Davis (1992): "7V-Methyl-D-Aspartate Lesions of the Lateral and Basolateral Nuclei of the Amygdala Block Fear-Potentiated Startle and Shock Sensitization of Startle". In: *Behavioral Neuroscience* 106.1, pp. 72–80.
- Sanford, Christina A, Marta E Soden, Madison A Baird, Samara M Miller, Jay Schulklin, Richard D Palmiter, Michael Clark, and Larry S Zweifel (2017): "A central amygdala CRF circuit facilitates learning about weak threats". In: *Neuron* 93.1, pp. 164–178.
- Sara, Susan J (2000): "Retrieval and reconsolidation: toward a neurobiology of remembering". In: *Learning & memory* 7.2, pp. 73–84.
- Sara, Susan J (2010): "Reactivation, retrieval, replay and reconsolidation in and out of sleep: connecting the dots". In: *Frontiers in behavioral neuroscience* 4.
- Sauerbrei, Britton A, Evgeniy V Lubenov, and Athanassios G Siapas (2015): "Structured variability in Purkinje cell activity during locomotion". In: *Neuron* 87.4, pp. 840–852.
- Scarantino, Andrea (2018): "Are LeDoux's survival circuits basic emotions under a different name?" In: *Current Opinion in Behavioral Sciences* 24, pp. 75–82.
- Schafe, Glenn E, Valérie Doyère, and Joseph E. LeDoux (2005): "Tracking the Fear Engram: The Lateral Amygdala Is an Essential Locus of Fear Memory Storage". In: *Journal of Neuroscience* 25.43, pp. 10010–10014.

- Schenberg, Luiz Carlos LC C, Elisardo Corral EC C Vasquez, MB da Costa, Mércia Barcellos da Costa, MB da Costa, and Mércia Barcellos da Costa (1993): "Cardiac baroreflex dynamics during the defence reaction in freely moving rats." In: *Brain research* 621.1, pp. 50–58.
- Schmitzer-Torbert, Neil and A David Reish (2004): "Neuronal activity in the rodent dorsal striatum in sequential navigation: separation of spatial and reward responses on the multiple T task". In: *Journal of neurophysiology* 91.5, pp. 2259–2272.
- Schneider, Adam D, Mohsen Jamali, Jerome Carriot, Maurice J Chacron, and Kathleen E Cullen (2015): "The increased sensitivity of irregular peripheral canal and otolith vestibular afferents optimizes their encoding of natural stimuli". In: *Journal of Neuroscience* 35.14, pp. 5522–5536.
- Schneiderman, Neil, Marius C Smith, Abby C Smith, and I Gormezano (1966): "Heart rate classical conditioning in rabbits". In: *Psychonomic Science* 6.5, pp. 241–242.
- Schomburg, Erik W, Antonio Fernández-Ruiz, Kenji Mizuseki, Antal Berényi, Costas A Anastassiou, Christof Koch, and György Buzsáki (2014): "Theta phase segregation of input-specific gamma patterns in entorhinal-hippocampal networks". In: *Neuron* 84.2, pp. 470–485.
- Scoville, W B and B Milner (1957): "Loss of recent memory after bilateral hippocampal lesions." In: *Journal of neurology, neurosurgery, and psychiatry* 20.1, pp. 11–21.
- Seidenbecher, Thomas, T Rao Laxmi, and Oliver Stork (2003): "Amygdalar and Hippocampal Theta Rhythm Synchronization During Fear Memory Retrieval". In: *Science* 301.August, pp. 846–850.
- Sejnowski, Terrence J and Alain Destexhe (2000): "Why do we sleep?" In: *Brain research* 886.1-2, pp. 208–223.
- Selden, N R W, B J Everitt, L E Jarrari, and T W Robbins (1991): "Complementary roles for the amygdala and hippocampus in aversive conditioning to explicit and contextual cues". In: *Neuroscience* 42.2, pp. 335–350.
- Semon, R (1923): *Mnemic Philosophy*. Allen & Unwin.
- Semon, Richard Wolfgang (1911): *Die Mneme als erhaltendes Prinzip im Wechsel des organischen Geschehens*. Vol. 7101. Engelmann.
- Senn, Verena, Steffen B E Wolff, Cyril Herry, François Grenier, Ingrid Ehrlich, Jan Gründemann, Jonathan P. Fadok, Christian Müller, Johannes J. Letzkus, and Andreas Lüthi (2014): "Long-range connectivity defines behavioral specificity of amygdala neurons". In: *Neuron* 81.2, pp. 428–437.
- Seymour, Ben (2019): "Pain: A Precision Signal for Reinforcement Learning and Control". In: *Neuron* 101.6, pp. 1029–1041.
- Shackman, A. J. and A. S. Fox (2016): "Contributions of the Central Extended Amygdala to Fear and Anxiety". In: *Journal of Neuroscience* 36.31, pp. 8050–8063.
- Shallice, Tim (1982): "Specific impairments of planning". In: *Philosophical Transactions of the Royal Society of London. B, Biological Sciences* 298.1089, pp. 199–209.
- Sharma, Sumeet, Abigail Powers, Bekh Bradley, and Kerry J Ressler (2016): "Gene environment determinants of stress-and anxiety-related disorders". In: *Annual review of psychology* 67, pp. 239–261.
- Sharpe, Melissa and Simon Killcross (2015): "The prelimbic cortex uses contextual cues to modulate responding towards predictive stimuli during fear renewal". In: *Neurobiology of learning and memory* 118, pp. 20–29.
- Sheehan, Teige P, R Andrew Chambers, and David S Russell (2004): "Regulation of affect by the lateral septum: implications for neuropsychiatry". In: *Brain Research Reviews* 46.1, pp. 71–117.
- Shein-Idelson, Mark, Janie M Ondracek, Hua-Peng Liaw, Sam Reiter, and Gilles Laurent (2016): "Slow waves, sharp waves, ripples, and REM in sleeping dragons." eng. In: *Science (New York, N. Y.)* 352.6285, pp. 590–595.
- Shepard, Emily L C, Rory P Wilson, Flavio Quintana, Agustina Gómez Laich, Nikolai Liebsch, Diego A Albareda, Lewis G Halsey, Adrian Gleiss, David T Morgan, and Andrew E Myers (2008): "Identification of animal movement patterns using tri-axial accelerometry". In: *Endangered Species Research* 10, pp. 47–60.
- Shepherd, Jon K., Timothy Flores, R.J. Rodgers, Robert J. Blanchard, and D. Caroline Blanchard (1992): "The anxiety/defense test battery: Influence of gender and ritanserin treatment on antipredator defensive behavior". In: *Physiology & Behavior* 51.2, pp. 277–285.
- Shih, Yuan-Hsing and Ming-Shing Young (2007): "Integrated digital image and accelerometer measurements of rat locomotor and vibratory behaviour".

- In: *Journal of neuroscience methods* 166.1, pp. 81–88.
- Shoji, Hirotaka, Keizo Takao, Satoko Hattori, and Tsuyoshi Miyakawa (2014): “Contextual and Cued Fear Conditioning Test Using a Video Analyzing System in Mice”. In: *Journal of Visualized Experiments* 85, pp. 1–13.
- Shull, Pete B, Wisit Jirattigalachote, Michael A Hunt, Mark R Cutkosky, and Scott L Delp (2014): “Quantified self and human movement: a review on the clinical impact of wearable sensing and feedback for gait analysis and intervention”. In: *Gait & posture* 40.1, pp. 11–19.
- Siapas, Athanassios G, Evgueniy V Lubenov, and Matthew A Wilson (2005): “Prefrontal phase locking to hippocampal theta oscillations”. In: *Neuron* 46.1, pp. 141–151.
- Siegel, Allan (1967): “Stimulus generalization of a classically conditioned response along a temporal dimension.” In: *Journal of Comparative and Physiological Psychology* 64.3, p. 461.
- Siegel, Jerome M. (2005): “Clues to the functions of mammalian sleep”. In: *Nature* 437, pp. 1264–1271.
- Siegmund, Anja, Sebastian F Kaltwasser, Florian Holsboer, Michael Czisch, and Carsten T Wotjak (2009): “Hippocampal N-acetylaspartate levels before trauma predict the development of long-lasting posttraumatic stress disorder-like symptoms in mice”. In: *Biological psychiatry* 65.3, pp. 258–262.
- Sierra-Mercado, Demetrio, Kevin A. Corcoran, Kelimer Lebrón-Milad, and Gregory J. Quirk (2006): “Inactivation of the ventromedial prefrontal cortex reduces expression of conditioned fear and impairs subsequent recall of extinction”. In: *European Journal of Neuroscience* 24.6, pp. 1751–1758.
- Sierra-Mercado, Demetrio, Nancy Padilla-Coreano, and Gregory J Quirk (2011): “Dissociable roles of prelimbic and infralimbic cortices, ventral hippocampus, and basolateral amygdala in the expression and extinction of conditioned fear”. In: *Neuropsychopharmacology : official publication of the American College of Neuropsychopharmacology* 36.2, pp. 529–538.
- Sigmundi, Ronald A, Mark E Bouton, and Robert C Bolles (1980): “Conditioned freezing in the rat as a function of shock intensity and CS modality”. In: *Bulletin of the Psychonomic Society* 15.4, pp. 254–256.
- Sigurdsson, Torfi, Valérie Doyère, Christopher K Cain, and Joseph E LeDoux (2007): “Long-term potentiation in the amygdala: a cellular mechanism of fear learning and memory”. In: *Neuropharmacology* 52.1, pp. 215–227.
- Silasi, Gergely, Jamie D Boyd, Jeffrey LeDue, and Tim Murphy (2013): “Improved methods for chronic light-based motor mapping in mice: automated movement tracking with accelerometers, and chronic EEG recording in a bilateral thin-skull preparation”. In: *Frontiers in neural circuits* 7, p. 123.
- Silberberg, Gilad, Anirudh Gupta, and Henry Markram (2002): “Stereotypy in neocortical microcircuits”. In: *Trends in Neurosciences* 25.5, pp. 227–230.
- Silva, Alcino J., Yu Zhou, Thomas Rogerson, Justin Shobe, and J. Balaji (2009): “Molecular and cellular approaches to memory allocation in neural circuits”. In: *Science* 326.5951, pp. 391–395.
- Silva, Carlos and Neil McNaughton (2019): “Progress in Neurobiology Are periaqueductal gray and dorsal raphe the foundation of appetitive and aversive control ? A comprehensive review”. In: *Progress in Neurobiology* 177.October 2018, pp. 33–72.
- Singer, Annabelle C., Margaret F. Carr, Mattias P. Karlsson, and Loren M. Frank (2013): “Hippocampal SWR Activity Predicts Correct Decisions during the Initial Learning of an Alternation Task”. In: *Neuron* 77.6, pp. 1163–1173.
- Singer, Annabelle C and Loren M Frank (2009): “Rewarded outcomes enhance reactivation of experience in the hippocampus”. In: *Neuron* 64.6, pp. 910–921.
- Sinnamon, H M, S Freniere, and J Kootz (1978): “Rat hippocampus and memory for places of changing significance.” In: *Journal of comparative and physiological psychology* 92.1, p. 142.
- Sirkin, David W, Wolfgang Precht, and Jean-Hubert Coujon (1984): “Initial, rapid phase of recovery from unilateral vestibular lesion in rat not dependent on survival of central portion of vestibular nerve”. In: *Brain research* 302.2, pp. 245–256.
- Sirota, Anton and György Buzsáki (2005): “Interaction between neocortical and hippocampal networks via slow oscillations”. In: *Thalamus & related systems* 3.4, pp. 245–259.
- Sirota, Anton, Sean Montgomery, Shigeoishi Fujisawa, Yoshikazu Isomura, Michael Zugaro, and György Buzsáki (2008): “Entrainment of neocortical neurons and gamma oscillations by the hippocampal theta rhythm”. In: *Neuron* 60.4, pp. 683–697.
- Sjostrom, P Jesper, Ede A Rancz, Arnd Roth, and Michael Hausser (2008):

- “Dendritic excitability and synaptic plasticity”. In: *Physiological reviews* 88.2, pp. 769–840.
- Sjulson, Lucas, Adrien Peyrache, Andrea Cumpelik, Daniela Cassataro, and György Buzsáki (2018): “Cocaine Place Conditioning Strengthens Location-Specific Hippocampal Coupling to the Nucleus Accumbens”. In: *Neuron* 98.5, 926–934.e5.
- Skaggs, William E, Bruce L McNaughton, Matthew A Wilson, and Carol A Barnes (1996): “Theta phase precession in hippocampal neuronal populations and the compression of temporal sequences”. In: *Hippocampus* 6.2, pp. 149–172.
- Skinner, Burrhus Frederic (1938): *The behavior of organisms: an experimental analysis*. Oxford, England: Appleton-Century, p. 457.
- Skinner, Burrhus Frederic (1950): “Are theories of learning necessary?” In: *Psychological review* 57.4, p. 193.
- Smith, Carlyle (1995): “Sleep states and memory processes”. In: *Behavioural brain research* 69.1-2, pp. 137–145.
- Smith, Carlyle, Kunio Kitahama, Jean-Louis Valatx, and Michel Jouvet (1974): “Increased paradoxical sleep in mice during acquisition of a shock avoidance task”. In: *Brain research* 77.2, pp. 221–230.
- Smith, David M and Sheri J.Y. Mizumori (2006): “Hippocampal Place Cells, Context, and Episodic Memory”. In: *Hippocampus* 16, pp. 716–729.
- Song, Juan, Reid H.J. Olsen, Jiaqi Sun, Guo Li Ming, and Hongjun Song (2016): “Neuronal circuitry mechanisms regulating adult mammalian neurogenesis”. In: *Cold Spring Harbor Perspectives in Biology* 8.8.
- Sosa, Marielena, Hannah R. Joo, and Loren M. Frank (2019): “Dorsal and ventral hippocampus engage opposing networks in the nucleus accumbens”. In: *bioRxiv*, p. 604116.
- Sotres-Bayon, Francisco, Kevin a Corcoran, Jamie Peters, and Demetrio Sierra-Mercado (2008): “Neural correlates of individual variability in fear extinction.” In: *The Journal of neuroscience : the official journal of the Society for Neuroscience* 28.47, pp. 12147–12149.
- Sotres-Bayon, Francisco and Gregory J Quirk (2010): “Prefrontal control of fear: more than just extinction”. In: *Current opinion in neurobiology* 20.2, pp. 231–235.
- Sotres-Bayon, Francisco, Demetrio Sierra-Mercado, Enmanuelle Pardilla-Delgado, and Gregory J Quirk (2012): “Gating of fear in prelimbic cortex by hippocampal and amygdala inputs”. In: *Neuron* 76.4, pp. 804–812.
- Spear, Norman E (1973): “Retrieval of memory in animals.” In: *Psychological Review* 80.3, pp. 163–194.
- Spear, Norman E (1978): *The processing of memories: Forgetting and retention*. Oxford, England: Lawrence Erlbaum, pp. xiv, 553–xiv, 553.
- Spellman, Timothy, Mattia Rigotti, Susanne E. Ahmari, Stefano Fusi, Joseph a. Gogos, and Joshua a. Gordon (2015): “Hippocampal-prefrontal input supports spatial encoding in working memory.” In: *Nature* 522.7556, pp. 309–14.
- Spence, Kenneth Wartenbee (1956): *Behavior theory and conditioning*. Vol. 35. yale university Press New Haven.
- Spielberger, Charles Donald and Richard L Gorsuch (1983): *State-trait anxiety inventory for adults: sampler set: manual, test, scoring key*. Mind Garden.
- Squire, L R and P Alvarez (1995): “Retrograde amnesia and memory consolidation: a neurobiological perspective.” eng. In: *Current opinion in neurobiology* 5.2, pp. 169–177.
- Squire, Larry R (1987): “Memory and brain”. In:
- Squire, Larry R and John T Wixted (2011): “The cognitive neuroscience of human memory since H.M.” In: *Annual review of neuroscience* 34, pp. 259–88.
- Squire, Larry R and Stuart Zola-Morgan (1991): “The medial temporal lobe memory system”. In: *Science* 253.5026, pp. 1380–1386.
- Stamatakis, Alice M and Garret D Stuber (2012): “Activation of lateral habenula inputs to the ventral midbrain promotes behavioral avoidance”. In: *Nature neuroscience* 15.8, p. 1105.
- Stark, Eran, Lisa Roux, Ronny Eichler, and György Buzsáki (2015): “Local generation of multineuronal spike sequences in the hippocampal CA1 region”. In: *Proceedings of the National Academy of Sciences* 112.33, pp. 10521–10526.
- Steel, Zachary, Tien Chey, Derrick Silove, Claire Marnane, Richard A Bryant, and Mark Van Ommeren (2009): “Association of torture and other potentially traumatic events with mental health outcomes among populations exposed to mass conflict and displacement: a systematic review and meta-analysis”. In: *Jama* 302.5, pp. 537–549.
- Steinmetz, Nicholas A, Christof Koch, Kenneth D Harris, and Matteo Carandini (2018): “ScienceDirect Challenges and opportunities for large-scale electrophysiology with Neuropixels probes”.

- In: *Current Opinion in Neurobiology* 50, pp. 92–100.
- Steriade, Mircea, David A McCormick, and Terrence J Sejnowski (1993a): “Thalamocortical oscillations in the sleeping and aroused brain”. In: *Science* 262.5134, pp. 679–685.
- Steriade, Mircea, A Nunez, and F Amzica (1993b): “A novel slow (< 1 Hz) oscillation of neocortical neurons in vivo: depolarizing and hyperpolarizing components”. In: *Journal of neuroscience* 13.8, pp. 3252–3265.
- Stenson, Scott M. and Bryan L. Roth (2014): “Chemogenetic Tools to Interrogate Brain Functions”. In: *Annual Review of Neuroscience* 37.1, pp. 387–407.
- Stevens, Robin and Alan Cowey (1973): “Effects of dorsal and ventral hippocampal lesions on spontaneous alternation, learned alternation and probability learning in rats”. In: *Brain research* 52, pp. 203–224.
- Stevenson, Carl W. (2011): “Role of amygdala-prefrontal cortex circuitry in regulating the expression of contextual fear memory”. In: *Neurobiology of Learning and Memory* 96.2, pp. 315–323.
- Stiedl, Oliver, Jelena Radulovic, Ragna Lohmann, Karin Birkenfeld, Markki Palve, Jens Kammermeier, Farahnaz Sananbenesi, and Joachim Spiess (1999): “Strain and substrain differences in context- and tone-dependent fear conditioning of inbred mice”. In: *Behavioural brain research* 104.1-2, pp. 1–12.
- Stiedl, Oliver and Joachim Spiess (1997): “Effect of tone-dependent fear conditioning on heart rate and behavior of C57BL/6N mice.” In: *Behavioral neuroscience* 111.4, p. 703.
- Strange, Bryan A, Menno P Witter, Ed S Lein, and Edvard I Moser (2014): “Functional organization of the hippocampal longitudinal axis”. In: *Nature Reviews Neuroscience* 15.10, pp. 655–669.
- Strata, Piergiorgio, Bibiana Scelfo, and Benedetto Sacchetti (2011): “Involvement of cerebellum in emotional behavior”. In: *Physiol Res* 60.Suppl 1, S39–S48.
- Streb, Jack M and Kendon Smith (1955): “Frontal lobotomy and the elimination of conditioned anxiety in the rat.” In: *Journal of comparative and physiological psychology* 48.2, p. 126.
- Stujenske, Joseph M., Ekaterina Likhtik, Mihir A. Topiwala, and Joshua A. Gordon (2014): “Fear and Safety Engage Competing Patterns of Theta-Gamma Coupling in the Basolateral Amygdala”. In: *Neuron* 83.4, pp. 919–933.
- Sullivan, David, Kenji Mizuseki, Anthony Sorigi, and György Buzsáki (2014): “Comparison of sleep spindles and theta oscillations in the hippocampus”. In: *Journal of Neuroscience* 34.2, pp. 662–674.
- Sunderam, Sridhar, Nick Chernyy, Nathalia Peixoto, Jonathan P Mason, Steven L Weinstein, Steven J Schiff, and Bruce J Gluckman (2007): “Improved sleep-wake and behavior discrimination using MEMS accelerometers”. In: *Journal of neuroscience methods* 163.2, pp. 373–383.
- Supple, William F and Bruce S Kapp (1993): “The anterior cerebellar vermis: essential involvement in classically conditioned bradycardia in the rabbit”. In: *Journal of Neuroscience* 13.9, pp. 3705–3711.
- Sutherland, G R and B McNaughton (2000): “Memory trace reactivation in hippocampal and neocortical neuronal ensembles.” eng. In: *Current opinion in neurobiology* 10.2, pp. 180–186.
- Sutherland, R J and H Lehmann (2011): “Alternative conceptions of memory consolidation and the role of the hippocampus at the systems level in rodents”. In: *Current Opinion in Neurobiology* 21.3, pp. 446–451.
- Sutherland, R J and Robert J. McDonald (1990): “Hippocampus, amygdala, and memory deficits in rats”. In: *Behavioural brain research* 37, pp. 57–79.
- Suzuki, Hiroyuki, Makoto Uchiyama, Hirokuni Tagaya, Akiko Ozaki, Kenichi Kuriyama, Sayaka Aritake, Kayo Shibui, Xin Tan, Yuichi Kamei, and Ryuichi Kuga (2004): “Dreaming during non-rapid eye movement sleep in the absence of prior rapid eye movement sleep.” eng. In: *Sleep* 27.8, pp. 1486–1490.
- Swanson, L W (1981): “A direct projection from Ammon’s horn to prefrontal cortex in the rat”. In: *Brain research* 217.1, pp. 150–154.
- Swanson, L W and W M Cowan (1977): “An autoradiographic study of the organization of the efferent connections of the hippocampal formation in the rat”. In: *Journal of Comparative Neurology* 172.1, pp. 49–84.
- Swanson, L W and C Kohler (1986): “Anatomical evidence for direct projections from the entorhinal area to the entire cortical mantle in the rat”. In: *Journal of Neuroscience* 6.10, pp. 3010–3023.

- Swanson, Larry (2004): *Brain maps: structure of the rat brain*. Gulf Professional Publishing.
- Swanson, Larry W and Gorica D Petrovich (1998): "What is amygdala?" In: *Trends in Neuroscience* 21.8, pp. 323–331.
- Sznyi, András, Katalin E. Sos, Rita Nyilas, Dániel Schlingloff, Andor Domonkos, Virág T. Takács, Balázs Pósfai, Panna Hegedüs, James B. Priestley, Andrew L. Gundlach, Attila I. Gulyás, Viktor Varga, Attila Losonczy, Tamás F. Freund, and Gábor Nyiri (2019): "Brainstem nucleus incertus controls contextual memory formation". In: *Science (New York, N. Y.)* 364.6442, pp. 0–14.
- Tagney, Joanna (1973): "Sleep patterns related to rearing rats in enriched and impoverished environments". In: *Brain research* 53.2, pp. 353–361.
- Takagishi, Masamitsu and Tanemichi Chiba (1991): "Efferent projections of the infralimbic (area 25) region of the medial prefrontal cortex in the rat: an anterograde tracer PHA-L study". In: *Brain research* 566.1-2, pp. 26–39.
- Takahashi, Hiroaki (2004): "Automated measurement of freezing time to contextual and auditory cues in fear conditioning as a simple screening method to assess learning and memory abilities". In: *The Journal of Toxicological Sciences* 29.1, pp. 53–61.
- Takahashi, Susumu (2015): "Episodic-like memory trace in awake replay of hippocampal place cell activity sequences". In: *Elife* 4, e08105.
- Takehara-Nishiuchi, Kaori and Bruce L. McNaughton (2008): "Spontaneous changes of neocortical code for associative memory during consolidation". In: *Science (New York, N. Y.)* 322.5903, pp. 960–963.
- Takehara, Kaori, Shigenori Kawahara, and Yutaka Kirino (2003): "Time-dependent reorganization of the brain components underlying memory retention in trace eyeblink conditioning". In: *Journal of Neuroscience* 23.30, pp. 9897–9905.
- Takeuchi, Tomonori, Adrian J Duszkievicz, Alex Sonneborn, Patrick A Spooner, Miwako Yamasaki, Masahiko Watanabe, Caroline C Smith, Guillén Fernández, Karl Deisseroth, and Robert W Greene (2016): "Locus coeruleus and dopaminergic consolidation of everyday memory". In: *Nature* 537.7620, p. 357.
- Takita, Masatoshi, Sei Etsu Fujiwara, and Yoshinori Izaki (2013a): "Functional structure of the intermediate and ventral hippocampo-prefrontal pathway in the prefrontal convergent system". In: *Journal of Physiology Paris* 107.6, pp. 441–447.
- Takita, Masatoshi, Sei-Etsu Fujiwara, and Yoshinori Izaki (2013b): "Functional structure of the intermediate and ventral hippocampoprefrontal pathway in the prefrontal convergent system". In: *Journal of Physiology-Paris* 107.6, pp. 441–447.
- Tamai, Noriko and Sadahiko Nakajima (2000): "Renewal of formerly conditioned fear in rats after extensive extinction training". In: *international Journal of comparative Psychology* 13.3.
- Tanaka, Kazumasa Z, Aleksandr Pevzner, Anahita B Hamidi, Yuki Nakazawa, Jalina Graham, and Brian J Wiltgen (2014): "Cortical representations are reinstated by the hippocampus during memory retrieval." eng. In: *Neuron* 84.2, pp. 347–354.
- Tang, Jianrong, Shanelle Ko, Hoi Ki Ding, Chang Shen Qui, Amelita A. Calejesan, and Min Zhuo (2005): "Pavlovian fear memory induced by activation in the anterior cingulate cortex". In: *Molecular Pain* 1, pp. 1–16.
- Tannenholz, Lindsay, Jessica C Jimenez, and Mazen A Kheirbek (2014): "Local and regional heterogeneity underlying hippocampal modulation of cognition and mood". In: *Frontiers in Behavioral Neuroscience* 8.May, pp. 1–7.
- Tavoni, Gaia, Ulisse Ferrari, Francesco P Battaglia, Simona Cocco, and Rémi Monasson (2017): "Functional coupling networks inferred from prefrontal cortex activity show experience-related effective plasticity". In: *Network Neuroscience* 1.3, pp. 275–301.
- Taylor, Kaycie K, Kazumasa Z Tanaka, Leon G Reijmers, and Brian J Wiltgen (2013): "Reactivation of neural ensembles during the retrieval of recent and remote memory." eng. In: *Current biology : CB* 23.2, pp. 99–106.
- Teixeira, C. M., S. R. Pomedli, H. R. Maei, N. Kee, and P. W. Frankland (2006): "Involvement of the Anterior Cingulate Cortex in the Expression of Remote Spatial Memory". In: *Journal of Neuroscience* 26.29, pp. 7555–7564.
- Teuber, Hans-Lukas (1964): "The riddle of frontal lobe function in man". In: *The frontal granular cortex and behavior*. Ed. by J M Warren and K Akert. New York: McGraw Hill, pp. 410–477.
- Thierry, A M, G Blanc, A Sobel, L Stinus, and J Glowinski (1973): "Dopaminergic terminals in the rat cortex". In: *Science* 182.4111, pp. 499–501.
- Thomas, G J, G Hostetter, and D J Barker (1968): "Behavioral functions of the

- limbic system". In: *Progress in Physiological Psychology*. Ed. by Eliot Stellar. New York: Academic Press, pp. 229–311.
- Thompson, Brittany M, Michael V Baratta, Joseph C Biedenkapp, Jerry W Rudy, Linda R Watkins, and Steven F Maier (2010): "Activation of the infralimbic cortex in a fear context enhances extinction learning". In: *Learning and Memory* 17.11, pp. 591–599.
- Thompson, Carol L, Sayan D Pathak, Andreas Jeromin, Lydia L Ng, Cameron R MacPherson, Marty T Mortrud, Allison Cusick, Zackery L Riley, Susan M Sunkin, and Amy Bernard (2008): "Genomic anatomy of the hippocampus". In: *Neuron* 60.6, pp. 1010–1021.
- Thompson, L. T. and P. J. Best (1990): "Long-term stability of the place-field activity of single units recorded from the dorsal hippocampus of freely behaving rats". In: *Brain Research* 509.2, pp. 299–308.
- Thompson, Richard F (1976): "The search for the engram". In: *American Psychologist* 31.3, p. 209.
- Thompson, Richard F, Theodore W Berger, and John Madden Iv (1983): "Cellular Processes of". In: *Annual review of neuroscience* 6, pp. 447–491.
- Thorndike, Edward L (1905): *The elements of psychology*. New York: A. G. Seiler.
- Tian, S., F. Huang, J. Gao, P. Li, X. Ouyang, S. Zhou, H. Deng, and Y. Yan (2011): "Ventrolateral prefrontal cortex is required for fear extinction in a modified delay conditioning paradigm in rats". In: *Neuroscience* 189, pp. 258–268.
- Tinbergen, Niko (1951): "The study of instinct." In:
- Tinbergen, Niko (1968): "On war and peace in animals and man". In: *Science* 160.3835, pp. 1411–1418.
- Todorova, Ralitsa and Michaël Zugaro (2018): "Hippocampal ripples as a mode of communication with cortical and subcortical areas". In: *Hippocampus* June, pp. 1–11.
- Todorova, Ralitsa and Michaël B Zugaro (2019): "Isolated cortical computations during delta waves". In: *Science* in press.
- Tolman, E C (1932): *Purposive behavior in animals and men*. London, England: Century/Random House UK, pp. xiv, 463–xiv, 463.
- Tolman, E C, B F Ritchie, and D Kalish (1946): "Studies in spatial learning. I. Orientation and the short-cut." In: *Journal of Experimental Psychology* 36.1, pp. 13–24.
- Tolman, Edward C (1948): "Cognitive maps in rats and men." In: *Psychological review* 55.4, p. 189.
- Tolman, Edward Chace and Charles H Honzik (1930): "Introduction and removal of reward, and maze performance in rats." In: *University of California publications in psychology*.
- Tonegawa, Susumu, Xu Liu, Steve Ramirez, and Roger Redondo (2015): "Memory Engram Cells Have Come of Age". In: *Neuron* 87.5, pp. 918–931.
- Tononi, Giulio and Chiara Cirelli (2014): "Sleep and the Price of Plasticity: From Synaptic and Cellular Homeostasis to Memory Consolidation and Integration". In: *Neuron* 81.1, pp. 12–34.
- Tort, Adriano B.L., Jurij Brankač, and Andreas Draguhn (2018): "Respiration-Entrained Brain Rhythms Are Global but Often Overlooked". In: *Trends in Neurosciences* 41.4, pp. 186–197.
- Toth, Attila, Tunde Hajnik, and Laszlo Detari (2012): "Cholinergic modulation of slow cortical rhythm in urethane-anesthetized rats". In: *Brain Research Bulletin* 87.1, pp. 117–129.
- Tovote, Philip, Maria Soledad Esposito, Paolo Botta, Fabrice Chaudun, Jonathan P. Fadok, Milica Markovic, Steffen B.E. E Wolff, Charu Ramakrishnan, Lief Fenno, Karl Deisseroth, Cyril Herry, Silvia Arber, Andreas Lüthi, Andreas Lüthi, and Andreas Lüthi (2016): "Midbrain circuits for defensive behaviour". In: *Nature* 534.7606, pp. 206–212.
- Tovote, Philip, Jonathan Paul Fadok, and Andreas Lüthi (2015): "Neuronal circuits for fear and anxiety". In: *Nature Reviews Neuroscience* 16.6, pp. 317–331.
- Trent, Natalie L and Janet L Menard (2010): "The ventral hippocampus and the lateral septum work in tandem to regulate rats' open-arm exploration in the elevated plus-maze". In: *Physiology & behavior* 101.1, pp. 141–152.
- Tronson, Natalie C., Kevin A. Corcoran, Vladimir Jovasevic, and Jelena Radulovic (2012): "Fear conditioning and extinction: Emotional states encoded by distinct signaling pathways". In: *Trends in Neurosciences* 35.3, pp. 145–155.
- Trouche, Stéphanie, Pavel V Perestenko, Gido M van de Ven, Claire T Bratley, Colin G McNamara, Natalia Campo-Urriza, S Lucas Black, Leon G Reijmers, and David Dupret (2016): "Recoding a cocaine-place memory engram to a neutral engram in the hippocampus". In: *Nature Neuroscience* 19.4, pp. 564–567.

- Trouche, Stéphanie, Jennifer M. Sasaki, Tiffany Tu, and Leon G. Reijmers (2013): "Fear Extinction Causes Target-Specific Remodeling of Perisomatic Inhibitory Synapses". In: *Neuron* 80.4, pp. 1054–1065.
- Troyner, Fernanda, Maíra A Bicca, and Leandro J Bertoglio (2018): "Nucleus reuniens of the thalamus controls fear memory intensity, specificity and longterm maintenance during consolidation". In: *Hippocampus* 28.8, pp. 602–616.
- Tse, Dorothy, Tomonori Takeuchi, Masaki Kakeyama, Yasushi Kajii, Hiroyuki Okuno, Chiharu Tohyama, Haruhiko Bito, and Richard G M Morris (2011): "Schema-Dependent Gene Activation". In: *Science* 333.August, pp. 891–895.
- Tsien, Joe Z, Patricio T Huerta, and Susumu Tonegawa (1996): "The essential role of hippocampal CA1 NMDA receptordependent synaptic plasticity in spatial memory". In: *Cell* 87.7, pp. 1327–1338.
- Tsvetkov, Evgeny, William A Carlezon Jr, Francine M Benes, Eric R Kandel, and Vadim Y Bolshakov (2002): "Fear conditioning occludes LTP-induced presynaptic enhancement of synaptic transmission in the cortical pathway to the lateral amygdala". In: *Neuron* 34.2, pp. 289–300.
- Tsvetkov, Evgeny, Ryong-Moon Shin, and Vadim Y Bolshakov (2004): "Glutamate uptake determines pathway specificity of long-term potentiation in the neural circuitry of fear conditioning". In: *Neuron* 41.1, pp. 139–151.
- Tully, Keith, Yan Li, Evgeny Tsvetkov, and Vadim Y Bolshakov (2007): "Norepinephrine enables the induction of associative long-term potentiation at thalamo-amygdala synapses". In: *Proceedings of the National Academy of Sciences* 104.35, pp. 14146–14150.
- Tulving, Endel (1972): "Episodic and semantic memory". In: *Organization of memory* 1, pp. 381–403.
- Tulving, Endel (1993): "What is Episodic Memory?" In: *Current directions in psychological science* 2.3, pp. 67–70.
- Tulving, Endel and Donald M Thomson (1973): "Encoding specificity and retrieval processes in episodic memory." In: *Psychological Review* 80.5, pp. 352–373.
- Turkkan, Jaylan Sheila (1989): "Classical conditioning: The new hegemony." In: *Behavioral and Brain Sciences* 12.1, pp. 121–179.
- Tye, Kay M, Rohit Prakash, Sung-Yon Kim, Lief E Fenno, Logan Grosenick, Hosniya Zarabi, Kimberly R Thompson, Viviana Gradinaru, Charu Ramakrishnan, and Karl Deisseroth (2011): "Amygdala circuitry mediating reversible and bidirectional control of anxiety". In: *Nature* 471.7338, p. 358.
- Uematsu, Akira, Bao Zhen Tan, and Joshua P Johansen (2015): "Projection specificity in heterogeneous locus coeruleus cell populations: implications for learning and memory". In: *Learning & memory* 22.9, pp. 444–451.
- Uematsu, Akira, Bao Zhen Tan, Edgar A. Ycu, Jessica Sulkes Cuevas, Jenny Koivumaa, Felix Junyent, Eric J. Kremer, Ilana B. Witten, Karl Deisseroth, and Joshua P. Johansen (2017): "Modular organization of the brainstem noradrenergic system coordinates opposing learning states". In: *Nature Neuroscience* 20.11, pp. 1602–1611.
- Ulrich-Lai, Yvonne M and James P Herman (2009): "Neural regulation of endocrine and autonomic stress responses." In: *Nature reviews. Neuroscience* 10.6, pp. 397–409.
- Urcelay, Gonzalo P. and Ralph R. Miller (2010): "Two Roles of the Context in Pavlovian Fear Conditioning". In: *Journal of Experimental Psychology: Animal Behavior Processes* 36.2, pp. 268–280.
- Urcelay, Gonzalo P. and Ralph R. Miller (2014): "The functions of contexts in associative learning". In: *Behavioural Processes* 104, pp. 2–12.
- Urcelay, Gonzalo P, James E Witnauer, and Ralph R Miller (2012): "The dual role of the context in postpeak performance decrements resulting from extended training". In: *Learning & Behavior* 40.4, pp. 476–493.
- Uylings, Harry B.M., Henk J Groenewegen, and Bryan Kolb (2003): "Do rats have a prefrontal cortex?" In: *Behavioural Brain Research* 146.1-2, pp. 3–17.
- Valentinuzzi, Verónica S, Daniel E Kolker, Martha Hotz Vitaterna, Kazuhiro Shimomura, Andrew Whiteley, Sharon Low-Zeddies, Fred W Turek, Elenice A M Ferrari, Richard Paylor, and Joseph S Takahashi (1998): "Automated measurement of mouse freezing behavior and its use for quantitative trait locus analysis of contextual fear conditioning in (BALB/cJ C57BL/6J) F2 mice". In: *Learning & memory* 5.4, pp. 391–403.
- Van De Werd, H. J.J.M., G. Rajkowska, P. Evers, and H. B.M. Uylings (2010): "Cytoarchitectonic and chemoarchitectonic characterization of the prefrontal cortical areas in the mouse". In: *Brain Structure and Function* 214.4, pp. 339–353.

- Van Groen, Thomas and J Michael Wyss (1990): "Extrinsic projections from area CA1 of the rat hippocampus: olfactory, cortical, subcortical, and bilateral hippocampal formation projections". In: *Journal of Comparative Neurology* 302.3, pp. 515–528.
- Van Kesteren, Marlieke T.R., Dirk J Ruiter, Guillén Fernández, and Richard N Henson (2012): "How schema and novelty augment memory formation". In: *Trends in Neurosciences* 35.4, pp. 211–219.
- Van Strien, N M, N L M Cappaert, and M P Witter (2009): "The anatomy of memory: an interactive overview of the parahippocampalhippocampal network". In: *Nature reviews neuroscience* 10.4, p. 272.
- Vandecasteele, Marie, Viktor Varga, Antal Berényi, Edit Papp, Péter Barthó, Laurent Venance, Tamás F Freund, and György Buzsáki (2014): "Optogenetic activation of septal cholinergic neurons suppresses sharp wave ripples and enhances theta oscillations in the hippocampus". In: *Proceedings of the National Academy of Sciences* 111.37, pp. 13535–13540.
- Vander Weele, Caitlin M., Cody A. Siciliano, Gillian A. Matthews, Praneeth Namburi, Ehsan M. Izadmehr, Isabella C. Espinel, Edward H. Nieh, Evelien H.S. Schut, Nancy Padilla-Coreano, Anthony Burgos-Robles, Chia Jung Chang, Eyal Y. Kimchi, Anna Beyeler, Romy Wichmann, Craig P. Wildes, and Kay M. Tye (2018): "Dopamine enhances signal-to-noise ratio in cortical-brainstem encoding of aversive stimuli". In: *Nature* 563.7731, pp. 397–401.
- Vanderwolf, Case H (1969): "Hippocampal electrical activity and voluntary movement in the rat". In: *Electroencephalography and clinical neurophysiology* 26.4, pp. 407–418.
- Varela, C, S Kumar, J Y Yang, and M A Wilson (2014): "Anatomical substrates for direct interactions between hippocampus, medial prefrontal cortex, and the thalamic nucleus reuniens". In: *Brain Structure and Function* 219.3, pp. 911–929.
- Varela, Francisco, Jean Philippe Lachaux, Eugenio Rodriguez, and Jacques Martinerie (2001): "The brainweb: Phase synchronization and large-scale integration". In: *Nature Reviews Neuroscience* 2.4, pp. 229–239.
- Vargas-Irwin, Cristina and Jaime R Robles (2009): "Effect of sampling frequency on automatically-generated activity and freezing scores in a Pavlovian fear-conditioning preparation". In: *Revista Latinoamericana de Psicología* 41.2, pp. 187–195.
- Vasquez, J H, K C Leong, C M Gagliardi, B Harland, A. J. Apicella, and I A Muzzio (2019): "Pathway specific activation of ventral hippocampal cells projecting to the prelimbic cortex diminishes fear renewal". In: *Neurobiology of Learning and Memory* 161.March, pp. 63–71.
- Ven, Gido M. van de, Stéphanie Trouche, Colin G. McNamara, Kevin Allen, and David Dupret (2016): "Hippocampal Offline Reactivation Consolidates Recently Formed Cell Assembly Patterns during Sharp Wave-Ripples". In: *Neuron* 92.5, pp. 968–974.
- Venkataraman, Archana, Natalia Brody, Preethi Reddi, Jidong Guo, Donald Gordon Rainnie, and Brian George Dias (2019): "Modulation of fear generalization by the zona incerta". In: *Proceedings of the National Academy of Sciences* 116.18, pp. 9072–9077.
- Venkataraman, Subramaniam, Xin Jin, Rui M Costa, and Jose M Carmena (2010): "Investigating neural correlates of behavior in freely behaving rodents using inertial sensors." In: *Journal of neurophysiology* 104.1, pp. 569–575.
- Vertes, Robert P (2004): "Differential Projections of the Infralimbic and Prelimbic Cortex in the Rat". In: *Synapse* 58.July 2003, pp. 32–58.
- Vertes, Robert P. (2006): "Interactions among the medial prefrontal cortex, hippocampus and midline thalamus in emotional and cognitive processing in the rat". In: *Neuroscience* 142, pp. 1–20.
- Vertes, Robert P, Stephanie B Linley, and Walter B Hoover (2015): "Limbic circuitry of the midline thalamus". In: *Neuroscience and Biobehavioral Reviews* 54, pp. 89–107.
- Vervliet, Bram, Michelle G Craske, and Dirk Hermans (2013): "Fear extinction and relapse: state of the art". In: *Annual review of clinical psychology* 9, pp. 215–248.
- Verwer, Ronald W H, Ron J Meijer, Hanne F M Van Uum, and Menno P Witter (1997): "Collateral projections from the rat hippocampal formation to the lateral and medial prefrontal cortex". In: *Hippocampus* 7.4, pp. 397–402.
- Vetere, G., L. Restivo, C. J. Cole, P. J. Ross, M. Ammassari-Teule, S. A. Josselyn, and P. W. Frankland (2011): "Spine growth in the anterior cingulate cortex is necessary for the consolidation of contextual fear memory". In: *Proceedings of the National Academy of Sciences* 108.20, pp. 8456–8460.

- Vetere, Gisella, Justin W Kenney, Lina M Tran, Frances Xia, Patrick E Steadman, John Parkinson, Sheena A Josselyn, and Paul W Frankland (2017): "Chemogenetic interrogation of a brain-wide fear memory network in mice". In: *Neuron* 94.2, pp. 363–374.
- Vetere, Gisella, Lina M. Tran, Sara Moberg, Patrick E. Steadman, Leonardo Restivo, Filomena G. Morrison, Kerry J. Ressler, Sheena A. Josselyn, and Paul W. Frankland (2019): "Memory formation in the absence of experience". In: *Nature Neuroscience* 22.6, pp. 933–940.
- Vianna, D M L and M L Brandao (2003): "Anatomical connections of the periaqueductal gray: specific neural substrates for different kinds of fear". In: *Brazilian journal of medical and biological research* 36.5, pp. 557–566.
- Vianna, Daniel M L and Pascal Carrive (2005): "Changes in cutaneous and body temperature during and after conditioned fear to context in the rat". In: *European Journal of Neuroscience* 21.9, pp. 2505–2512.
- Vidal-Gonzalez, Ivan, Benjamín Vidal-Gonzalez, Scott L. Rauch, and Gregory J. Quirk (2006): "Microstimulation reveals opposing influences of prelimbic and infralimbic cortex on the expression of conditioned fear". In: *Learning & Memory* 13.6, pp. 728–733.
- Vogt, Brent A. and George Paxinos (2014): "Cytoarchitecture of mouse and rat cingulate cortex with human homologues". In: *Brain Structure and Function* 219.1, pp. 185–192.
- Voogd, Lycia D de, Jonathan W Kamen, David A Neville, Karin Roelofs, Guillén Fernández, and Erno J Hermans (2018): "Eye-movement intervention enhances extinction via amygdala deactivation". In: *Journal of Neuroscience* 38.40, pp. 8694–8706.
- Vouimba, Rose Marie, René Garcia, Michel Baudry, and Richard F Thompson (2000): "Potentiation of conditioned freezing following dorsomedial prefrontal cortex lesions does not interfere with fear reduction in mice". In: *Behavioral Neuroscience* 114.4, pp. 720–724.
- Vouimba, Rose-Marie and Mouna Maroun (2011): "Learning-induced changes in mPFCBLA connections after fear conditioning, extinction, and reinstatement of fear". In: *Neuropsychopharmacology* 36.11, p. 2276.
- Vyazovskiy, Vladyslav V, Umberto Olcese, Yaniv M Lazimy, Ugo Faraguna, Steve K Esser, Justin C Williams, Chiara Cirelli, and Giulio Tononi (2009): "Cortical firing and sleep homeostasis". In: *Neuron* 63.6, pp. 865–878.
- Wagner, A R and R A Rescorla (1972): "Inhibition in Pavlovian conditioning: Application of a theory". In: *Inhibition and learning*, pp. 301–336.
- Walf, Alicia A and Cheryl A Frye (2007): "The use of the elevated plus maze as an assay of anxiety-related behavior in rodents". In: *Nature protocols* 2.2, p. 322.
- Walker, David L., Kerry J. Ressler, Kwok Tung Lu, and Michael Davis (2002): "Facilitation of conditioned fear extinction by systemic administration or intra-amygdala infusions of D-cycloserine as assessed with fear-potentiated startle in rats". In: *Journal of Neuroscience* 22.6, pp. 2343–2351.
- Walker, David L and Michael Davis (1997): "Double dissociation between the involvement of the bed nucleus of the stria terminalis and the central nucleus of the amygdala in startle increases produced by conditioned versus unconditioned fear". In: *Journal of Neuroscience* 17.23, pp. 9375–9383.
- Walker, P and P Carrive (2003): "Role of ventrolateral periaqueductal gray neurons in the behavioral and cardiovascular responses to contextual conditioned fear and poststress recovery". In: *Neuroscience* 116.3, pp. 897–912.
- Walther, Fritz R (1969): "Flight behaviour and avoidance of predators in Thomson's gazelle (*Gazella thomsoni* Gunther 1884)". In: *Behaviour*, pp. 184–221.
- Wang, Dong V, Hau-Jie Yau, Carl J Brooker, Jen-Hui Tsou, Antonello Bonci, and Satoshi Ikemoto (2015a): "Mesopontine median raphe regulates hippocampal ripple oscillation and memory consolidation". In: *Nature neuroscience* 18.5, p. 728.
- Wang, M. E., E. G. Wann, R. K. Yuan, M. M. Ramos Alvarez, S. M. Stead, and I. A. Muzzio (2012): "Long-Term Stabilization of Place Cell Remapping Produced by a Fearful Experience". In: *Journal of Neuroscience* 32.45, pp. 15802–15814.
- Wang, Melissa E., Nicolas P. Fraize, Linda Yin, Robin K. Yuan, Despina Pet-sagourakis, Ellen G. Wann, Isabel a. Muzzio, and Wang E T Al (2013): "Differential roles of the dorsal and ventral hippocampus in predator odor contextual fear conditioning". In: *Hippocampus* 23, pp. 451–466.
- Wang, Melissa E., Robin K. Yuan, Alexander T. Keinath, M Ramos Manuel, Isabel A. Muzzio, M. M. Ramos Alvarez, Isabel A. Muzzio, M Ramos Manuel, and Isabel A. Muzzio (2015b): "Extinction of Learned Fear Induces Hippocampal Place Cell Remapping". In: *Journal of Neuroscience* 35.24, pp. 9122–9136.

- Wang, Szu Han, Cátia M. Teixeira, Anne L Wheeler, and Paul W Frankland (2009): "The precision of remote context memories does not require the hippocampus". In: *Nature Neuroscience* 12.3, pp. 253–255.
- Waterhouse, Ian K (1957): "Effects of prefrontal lobotomy on conditioned fear and food responses in monkeys." In: *Journal of comparative and physiological psychology* 50.1, p. 81.
- Watson, Brendon O, Daniel Levenstein, J Palmer Greene, Jennifer N Gelinias, and György Buzsáki (2016): "Network homeostasis and state dynamics of neocortical sleep". In: *Neuron* 90.4, pp. 839–852.
- Watson, John B (1913): "Psychology as the behaviorist views it." In: *Psychological review* 20.2, p. 158.
- Watson, John B (1930): *Behaviorism (Revised Edition)*. Chicago, IL: University of Chicago Press.
- Watson, John B and Rosalie Rayner (1920): "Conditioned emotional reactions." In: *Journal of experimental psychology* 3.1, p. 1.
- Watson, Thomas C, Stella Koutsikou, Nadia L Cerminara, Charlotte R Flavell, Jonathan Crook, Bridget M Lumb, and Richard Apps (2013): "The olivocerebellar system and its relationship to survival circuits". In: *Frontiers in neural circuits* 7, p. 72.
- Weeie, Caitlin M.Vander, Cody A. Siciliano, and Kay M. Tye (2019): "Dopamine tunes prefrontal outputs to orchestrate aversive processing". In: *Brain Research* 1713.August 2018, pp. 16–31.
- Weinberger, Norman M (2011): "The medial geniculate, not the amygdala, as the root of auditory fear conditioning". In: *Hearing research* 274.1-2, pp. 61–74.
- Weiskrantz, Lawrence (1956): "Behavioral changes associated with ablation of the amygdaloid complex in monkeys." In: *Journal of comparative and physiological psychology* 49.4, p. 381.
- Westbrook, R F, A J Good, and M J Kiernan (1994): "Effects of the interval between exposure to a novel environment and the occurrence of shock on the freezing responses of rats." eng. In: *The Quarterly journal of experimental psychology. B, Comparative and physiological psychology* 47.4, pp. 427–446.
- Wheeler, Anne L., Cátia M. Teixeira, Afra H. Wang, Xuejian Xiong, Natasa Kovacevic, Jason P. Lerch, Anthony R. McIntosh, John Parkinson, and Paul W. Frankland (2013): "Identification of a Functional Connectome for Long-Term Fear Memory in Mice". In: *PLoS Computational Biology* 9.1.
- Whishaw, Ian Q. and Hans C. Dringenberg (1991): "How does the rat (*Rattus norvegicus*) adjust food-carrying responses to the influences of distance, effort, predatory odor, food size, and food availability?" In: *Psychobiology* 19.3, pp. 251–261.
- Whitlock, Jonathan R, Arnold J Heynen, Marshall G Shuler, and Mark F Bear (2006): "Learning induces long-term potentiation in the hippocampus". In: *science* 313.5790, pp. 1093–1097.
- Wiener, S. I., C. A. Paul, and H. Eichenbaum (1989): "Spatial and behavioral correlates of hippocampal neuronal activity". In: *Journal of Neuroscience* 9.8, pp. 2737–2763.
- Wiener, Sidney I (1996): "Spatial, behavioral and sensory correlates of hippocampal CA1 complex spike cell activity: implications for information processing functions". In: *Progress in neurobiology* 49.4, pp. 335–361.
- Wilensky, Ann E, Glenn E Schafe, Morten P Kristensen, and Joseph E LeDoux (2006): "Rethinking the fear circuit: the central nucleus of the amygdala is required for the acquisition, consolidation, and expression of Pavlovian fear conditioning". In: *Journal of Neuroscience* 26.48, pp. 12387–12396.
- Wilensky, Ann E, Glenn E Schafe, and Joseph E Ledoux (1999): "Functional Inactivation of the Amygdala before But Not after Auditory Fear Conditioning Prevents Memory Formation". In: 19, pp. 1–5.
- Wills, Tom J., Colin Lever, Francesca Cacucci, Neil Burgess, and John O'Keefe (2005): "Attractor dynamics in the hippocampal representation of the local environment". In: *Science* 308.5723, pp. 873–876.
- Wilson, Amy, Douglas C Brooks, and Mark E Bouton (1995): "The role of the rat hippocampal system in several effects of context in extinction". In: *Behavioral Neuroscience* 109.5, pp. 828–836.
- Wilson, Matthew A. and Bruce L. McNaughton (1993): "Dynamics of the hippocampal ensemble code for space". In: *Science* 261.5124, pp. 1055–1058.
- Wilson, Matthew A and Bruce L McNaughton (1994): "Reactivation of hippocampal ensemble memories during sleep". In: *Science* 265.5172, pp. 676–679.
- Wiltgen, Brian J. and Kazumasa Z. Tanaka (2013): "Systems consolidation and the content of memory". In: *Neurobiology of Learning and Memory* 106, pp. 365–371.
- Wiltgen, Brian J, Robert A.M. Brown, Lynn E Talton, and Alcino J Silva (2004):

- “New Circuits for Old Memories”. In: *Neuron* 44.1, pp. 101–108.
- Wiltgen, Brian J, Matthew J Sanders, Stephan G Anagnostaras, Jennifer R Sage, and Michael S Fanselow (2006): “Context Fear Learning in the Absence of the Hippocampus”. In: *The Journal of Neuroscience* 26.20, pp. 5484–5491.
- Winocur, Gordon, Morris Moscovitch, and Melanie Sekeres (2007): “Memory consolidation or transformation: Context manipulation and hippocampal representations of memory”. In: *Nature Neuroscience* 10.5, pp. 555–557.
- Witter, Menno P, H J Groenewegen, F H Lopes Da Silva, and A H M Lohman (1989): “Functional organization of the extrinsic and intrinsic circuitry of the parahippocampal region”. In: *Progress in neurobiology* 33.3, pp. 161–253.
- Witter, Menno P, Floris G. Wouterlood, Pieterke A. Naber, and Theo Van Haeften (2000): “Anatomical Organization of the Parahippocampal-Hippocampal Network”. In: *Annals of the New York Academy of Sciences* 911.1, pp. 1–24.
- Wolff, Steffen B.E., Jan Gründemann, Philip Tovote, Sabine Krabbe, Gilad A. Jacobson, Christian Müller, Cyril Herry, Ingrid Ehrlich, Rainer W. Friedrich, Johannes J. Letzkus, and Andreas Lüthi (2014): “Amygdala interneuron subtypes control fear learning through disinhibition”. In: *Nature* 509.7501, pp. 453–458.
- Womelsdorf, Thilo, Jan-Mathijs Schoffelen, Robert Oostenveld, Wolf Singer, Robert Desimone, Andreas K Engel, and Pascal Fries (2007): “Modulation of neuronal interactions through neuronal synchronization.” In: *Science (New York, N.Y.)* 316.5831, pp. 1609–12.
- Wong, Wai Yin, Man Sang Wong, and Kam Ho Lo (2007): “Clinical applications of sensors for human posture and movement analysis: a review”. In: *Prosthetics and orthotics international* 31.1, pp. 62–75.
- Wood, E R, P a Dudchenko, R J Robitsek, and H Eichenbaum (2000): “Hippocampal neurons encode information about different types of memory episodes occurring in the same location.” In: *Neuron* 27, pp. 623–633.
- Wu, Chun-Ting, Daniel Haggerty, Caleb Kemere, and Daoyun Ji (2017): “Hippocampal awake replay in fear memory retrieval”. In: *Nature neuroscience* 20.4, p. 571.
- Xie, Hong, Yu Liu, Youzhi Zhu, Xinlu Ding, Yuhao Yang, and Ji-Song Guan (2014): “In vivo imaging of immediate early gene expression reveals layer-specific memory traces in the mammalian brain.” eng. In: *Proceedings of the National Academy of Sciences of the United States of America* 111.7, pp. 2788–2793.
- Xu, Chun, Sabine Krabbe, Jan Gründemann, Paolo Botta, Jonathan P. Fadok, Fumitaka Osakada, Dieter Saur, Benjamin F. Grewe, Mark J. Schnitzer, Edward M. Callaway, and Andreas Lüthi (2016): “Distinct Hippocampal Pathways Mediate Dissociable Roles of Context in Memory Retrieval”. In: *Cell* 167.4, 961–972.e16.
- Xu, Wei, Wade Morishita, Paul S. Buckmaster, Zhiping P. Pang, Robert C. Malenka, and Thomas C. Südhof (2012): “Distinct Neuronal Coding Schemes in Memory Revealed by Selective Erasure of Fast Synchronous Synaptic Transmission”. In: *Neuron* 73.5, pp. 990–1001.
- Xu, Wei and Thomas C Südhof (2013): “A neural circuit for memory specificity and generalization”. In: *Science* 339.6125, pp. 1290–1295.
- Yang, Ying and Jian-Zhi Wang (2017): “From Structure to Behavior in Basolateral Amygdala-Hippocampus Circuits”. In: *Frontiers in Neural Circuits* 11. October, pp. 1–8.
- Yang, Ying, Zhi-Hao Wang, Sen Jin, Di Gao, Nan Liu, Shan-Ping Chen, Sinan Zhang, Qing Liu, Enjie Liu, and Xin Wang (2016): “Opposite monosynaptic scaling of BLPvCA1 inputs governs hopefulness and helplessness-modulated spatial learning and memory”. In: *Nature communications* 7, p. 11935.
- Yanovsky, Yevgenij, Mareva Ciatipis, Andreas Draguhn, Adriano B L Tort, and Jurij Brankač (2014): “Slow oscillations in the mouse hippocampus entrained by nasal respiration”. In: *Journal of Neuroscience* 34.17, pp. 5949–5964.
- Yau, Joanna Oi-Yue and Gavan P McNally (2019): “Rules for aversive learning and decision-making”. In: *Current Opinion in Behavioral Sciences* 26, pp. 1–8.
- Ydenberg, R.C. and L.M. Dill (1986): “The Economics of Fleeing from Predators”. In: *Advances in the Study of Behavior* 16, pp. 229–249.
- Ye, Xiaojing, Dana Kapeller-Libermann, Alessio Travaglia, M Carmen Inda, and Cristina M Alberini (2016): “Direct dorsal hippocampal-amygdala cortex connections strengthen fear memories”. In: *Nature Neuroscience* 20.1, pp. 52–61.

- Yehuda, Rachel and Joseph LeDoux (2007): "Response variation following trauma: a translational neuroscience approach to understanding PTSD." In: *Neuron* 56.1, pp. 19–32.
- Yeomans, John S., Liang Li, Brian W. Scott, and Paul W. Frankland (2002): "Tactile, acoustic and vestibular systems sum to elicit the startle reflex". In: *Neuroscience and Biobehavioral Reviews* 26.1, pp. 1–11.
- Yiu, Adelaide P, Valentina Mercaldo, Chen Yan, Blake Richards, Asim J Rashid, Hwa-Lin Liz Hsiang, Jessica Pressey, Vivek Mahadevan, Matthew M Tran, Steven A Kushner, Melanie A Woodin, Paul W Frankland, and Sheena A Joseph (2014): "Neurons are recruited to a memory trace based on relative neuronal excitability immediately before training." eng. In: *Neuron* 83.3, pp. 722–735.
- Yizhar, Ofer, Lief E. Fenno, Matthias Prigge, Franziska Schneider, Thomas J. Davidson, Daniel J. Ogshea, Vikaas S. Sohal, Inbal Goshen, Joel Finkelstein, Jeanne T. Paz, Katja Stehfest, Roman Fudim, Charu Ramakrishnan, John R. Huguenard, Peter Hegemann, and Karl Deisseroth (2011): "Neocortical excitation/inhibition balance in information processing and social dysfunction". In: *Nature* 477.7363, pp. 171–178.
- Yizhar, Ofer and Oded Klavir (2018): "Reciprocal amygdaloprefrontal interactions in learning". In: *Current Opinion in Neurobiology* 52, pp. 149–155.
- Yoon, Taejib and Tim Otto (2007): "Differential contributions of dorsal vs. ventral hippocampus to auditory trace fear conditioning". In: *Neurobiology of Learning and Memory* 87.4, pp. 464–475.
- Young, Brian J., Gregory D. Fox, and Howard Eichenbaum (1994a): "Correlates of hippocampal complex-spike cell activity in rats performing a nonspatial radial maze task". In: *Journal of Neuroscience* 14.11 I, pp. 6553–6563.
- Young, Katherine S and Michelle G Craske (2018): "Survival circuits in affective disorders". In: *Current Opinion in Behavioral Sciences* 24, pp. 83–88.
- Young, Stacey L, Deana L Bohenek, and Michael S Fanselow (1994b): "NMDA processes mediate anterograde amnesia of contextual fear conditioning induced by hippocampal damage: Immunization against amnesia by context pre-exposure". In: *Behavioral Neuroscience* 108.1, pp. 19–29.
- Yu, Kai, Sandra Ahrens, Xian Zhang, Hillary Schiff, Charu Ramakrishnan, Lief Fenno, Karl Deisseroth, Fei Zhao, Min-Hua Luo, Ling Gong, Miao He, Pengcheng Zhou, Liam Paninski, and Bo Li (2017): "The central amygdala controls learning in the lateral amygdala." eng. In: *Nature neuroscience* 20.12, pp. 1680–1685.
- Yu, Kai, Pedro Garcia da Silva, Dinu F Albeanu, and Bo Li (2016): "Central amygdala somatostatin neurons gate passive and active defensive behaviors". In: *Journal of Neuroscience* 36.24, pp. 6488–6496.
- Yu, Shu Yan, Dong Chuan Wu, Lidong Liu, Yuan Ge, and Yu Tian Wang (2008): "Role of AMPA receptor trafficking in NMDA receptor-dependent synaptic plasticity in the rat lateral amygdala". In: *Journal of neurochemistry* 106.2, pp. 889–899.
- Zelikowsky, M., S. Bissiere, T. A. Hast, R. Z. Bennett, A. Abdipranoto, B. Vissel, and M. S. Fanselow (2013): "Prefrontal microcircuit underlies contextual learning after hippocampal loss". In: *Proceedings of the National Academy of Sciences* 110.24, pp. 9938–9943.
- Zelikowsky, Moriel, Stephanie Bissiere, and Michael S Fanselow (2012): "Contextual fear memories formed in the absence of the dorsal hippocampus decay across time." In: *The Journal of neuroscience : the official journal of the Society for Neuroscience* 32.10, pp. 3393–7.
- Zelikowsky, Moriel, Sarah Hersman, Monica K. Chawla, Carol A. Barnes, and Michael S. Fanselow (2014): "Neuronal ensembles in amygdala, hippocampus, and prefrontal cortex track differential components of contextual fear". In: *Journal of Neuroscience* 34.25, pp. 8462–8466.
- Zelinski, Erin L., Nancy S. Hong, Amanda V. Tyndall, Brett Halsall, and Robert J. McDonald (2010): "Prefrontal cortical contributions during discriminative fear conditioning, extinction, and spontaneous recovery in rats". In: *Experimental Brain Research* 203.2, pp. 285–297.
- Zhang, Sheng-Jia, Jing Ye, Chenglin Miao, Albert Tsao, Ignas Cerniauskas, Debora Ledergerber, May-Britt Moser, and Edvard I Moser (2013): "Optogenetic dissection of entorhinal-hippocampal functional connectivity". In: *Science* 340.6128, p. 1232627.
- Zhang, Wei-ning, Tobias Bast, Yan Xu, and Joram Feldon (2014): "Temporary inhibition of dorsal or ventral hippocampus by muscimol : distinct effects on measures of innate anxiety on the elevated plus maze , but similar disruption of contextual fear conditioning". In: *Be-*

-
- havioural Brain Research* 262, pp. 47–56.
- Zhong, Weiwei, Mareva Ciatipis, Thérèse Wolfenstetter, Jakob Jessberger, Carola Müller, Simon Ponsel, Yevgenij Yanovsky, Jurij Brankač, Adriano B L Tort, and Andreas Draguhn (2017): “Selective entrainment of gamma subbands by different slow network oscillations”. In: *Proceedings of the National Academy of Sciences* 114.17, pp. 4519–4524.
- Zhou, Mu, Zhihui Liu, Maxwell D Melin, Yi Han Ng, Wei Xu, and Thomas C Südhof (2018): “A central amygdala to zona incerta projection is required for acquisition and remote recall of conditioned fear memory”. In: *Nature Neuroscience* 21.11, p. 1515.
- Zhou, Yu, Jaejoon Won, Mikael Guzman Karlsson, Miou Zhou, Thomas Rogerson, Jayaprakash Balaji, Rachael Neve, Panayiota Poirazi, and Alcino J Silva (2009): “CREB regulates excitability and the allocation of memory to subsets of neurons in the amygdala.” eng. In: *Nature neuroscience* 12.11, pp. 1438–1443.
- Zimmerman, Joshua M, Christine A Rabinak, Ian G Mclachlan, and Stephen Maren (2007): “The central nucleus of the amygdala is essential for acquiring and expressing conditional fear after overtraining”. In: *Learning & Memory*, pp. 634–644.
- Zola-Morgan, S and LR Squire (1991): “The Medial Temporal Lobe Memory System Human Memory : Anatomical Findings Since”. In: *Science* 253.5026, pp. 1380–6.
- Zuj, Daniel V, Matthew A Palmer, Miriam J J Lommen, and Kim L Felmingham (2016): “The centrality of fear extinction in linking risk factors to PTSD: a narrative review”. In: *Neuroscience & Biobehavioral Reviews* 69, pp. 15–35.
- Zweifel, Larry S (2019): “Dopamine, uncertainty, and fear generalization”. In: *Current Opinion in Behavioral Sciences* 26, pp. 157–164.
- Zweifel, Larry S, Jonathan P Fadok, Emanuela Argilli, Michael G Garelick, Graham L Jones, Tavis M K Dickerson, James M Allen, Sheri J Y Mizumori, Antonello Bonci, and Richard D Palmiter (2011): “Activation of dopamine neurons is critical for aversive conditioning and prevention of generalized anxiety”. In: *Nature neuroscience* 14.5, p. 620.

List of Figures

Fear, Aversive Memory, and Defensive Behavior	3
1.1 Memory systems.	7
1.2 Measuring conditioned fear in rodents.	12
1.3 Rodents form cognitive representations of the environment.	16
1.4 Pavlovian fear paradigms.	19
1.5 Predatory Imminence Theory.	26
Neuroanatomical Substrates of Fear Memory	29
2.1 The fear learning brain network.	33
2.2 Amygdala anatomy.	35
2.3 The hippocampal formation and the parahippocampal region in the rat brain.	41
2.4 Simplified schema of the hippocampal formation and parahippocampal region connectivity.	43
2.5 Temporally graded amnesia for contextual fear.	48
2.6 Prefrontal cortex comparison across mammals.	52
2.7 Anatomy of the rodent medial prefrontal cortex.	54
2.8 Medial prefrontal cortex cytoarchitecture.	55
2.9 Anatomical terminology for rodents prefrontal cortex (PFC) areas.	58
Memory Neurophysiology	71
3.1 Classical long-term potentiation (LTP), long-term depression (LTD), and spike timing dependent plasticity (STDP) results.	75
3.2 Manipulation of memory engrams with optogenetics.	78
3.3 Cell assemblies.	79
3.4 Standard consolidation theory.	84
3.5 Recording brain rhythms and neurons.	88
3.6 Communication through coherence.	90
3.7 Sleep stages in humans and rodents.	91
3.8 Cortical NREM rhythms.	92
3.9 Hippocampal sharp wave-ripples.	94
3.10 Theta and gamma oscillations and associated hippocampal firing.	96

3.11	Respiration-Entrained LFP Oscillations.	97
3.12	Sleep SPW-Rs and memory in rats.	100
3.13	Reactivations of experience-induced patterns in cortical areas.	101
3.14	Hippocampal reactivations and memory.	103
3.15	Cortical reactivations, delta waves, HPC ripples and memory consolidation.	104
Neural Coding of Fear Learning and Defensive Behavior		105
4.1	Fear and extinction neurons in the BA.	110
4.2	Spatial correlates in the hippocampal and para-hippocampal region.	113
4.3	Place cell remapping.	114
4.4	Ventral Hippocampus spatial code.	116
4.5	Anxiety modulation of HPC spatial code.	118
4.6	Place cell reactivations.	120
4.7	Hippocampal awake replay of frightening experiences .	122
4.8	mPFC CS responses.	125
4.9	CS presentations induce the resetting of dmPFC theta oscillations.	128
4.10	The 4 Hz oscillation and freezing behavior.	129
4.11	dmPFC population coding of contextual fear.	131
4.12	dmPFC–BLA theta and gamma synchrony.	135
4.13	REM sleep and fear memory consolidation.	138
Ventral Hippocampus Terminals in Prelimbic Cortex Control Contextual Fear Expression after Extinction Learning		141
5.1	Expression of ChR2 in vHF somas and axon terminals in PL.	145
5.2	PL neural responses to vHPC terminal stimulation. . .	146
5.3	vHPC-PL pathway stimulation effects on contextual fear expression.	148
5.4	ChR2 expression in PL.	155
5.5	Pilot study.	156
5.6	vHPC-PL pathway stimulation does not affect locomotor behavior in open field.	157
Wireless Inertial Measurement of Head Kinematics in Freely-Moving Rats		159
6.1	Overview of the wireless inertial measurement system. .	161
6.2	Bluetooth transmission of inertial data.	163
6.3	Bidirectional synchronization using two separate wireless channels.	164
6.4	Head kinematics during free ambulation in rats. . . .	166
6.5	Tracking head posture in freely moving rats after a unilateral vestibular lesion.	167

6.6	Automatic detection of behavioral freezing in a classical fear conditioning experiment.	170
6.7	Battery charger and battery life.	182
6.8	Latencies of inbound and outbound synchronization.	183
6.9	Estimating the delay of Bluetooth data transmission and the regularity of data acquisition using synchronization functions.	184
6.10	Strategy for calculating the acquisition times of IMU data frames using IR synchronization.	185
6.11	Estimation of the gravitational component of linear acceleration using an orientation filter algorithm.	186
6.12	Examples of “gravity orientation density maps” calculated for 19 different rats.	187
6.13	Gravity orientation density maps before and after unilateral vestibular lesion.	188
6.14	Changes in head posture and overall mobility after a unilateral vestibular lesion.	189
6.15	Methods for automatically scoring behavioral freezing in a fear conditioning experiment.	190
6.16	Analysis of the discrepancies between the scores obtained by the observer and the “discrete” automatic scoring method.	191
6.17	Comparison of the IMU with a motion capture system for the detection of head rotations.	192
Extinction Training In a Large Open Field Reveals Inter-Individual Differences In Conditioned Fear Recovery and Relapse		203
7.1	ABC fear renewal with extinction training while foraging in an open field.	205
7.2	Distinguishing behavioral phenotype categories based on behavioral responses to the CS after fear conditioning.	208
7.3	Behavioral profiles segregate in Freezers and Runners phenotypes	210
7.4	Runners express more fear renewal than freezers.	212
7.5	Behavioral comparison between runners and freezers	221
7.6	Generalization of contextual fear and differences in within-day learning rate cannot be accounted for inter-individual variability during early extinction.	222
7.7	Characterization of running episodes in the open field.	223
A Scalable Iterative Algorithm to Accurately and Precisely Detect Cell Assemblies		225
8.1	Recurrent pattern clustering separates assemblies combined by ICA.	227
8.2	Recurrent pattern clustering (RPC)	229
8.3	ICECAP algorithm representation.	231
8.4	ICECAP results	233

8.5	Putative assemblies detected from electrophysiological recordings.	235
8.6	ICA combines simulated assemblies.	240
8.7	RPC performance depends on the selection of timebins.	241
8.8	ICECAP performance on simulated dataset emulating recorded neurons' statistics.	241
8.9	Strong assemblies dominate component analysis.	242
Consolidation of Fear Extinction Memory Traces in the Hippocampal-Amygdalo-Prefrontal Network during Sleep		243
9.1	Behavioral paradigm and results.	246
9.2	Sleeping during training is an indicator of tranquillity.	248
9.3	Freezing responses to CS+ vs. CS-	249
9.4	Complete results of the statistical comparisons of freezing at different stages of the protocol.	258
9.5	Sleep scoring.	259
9.6	Representative electrode positions in the mPFC.	260
9.7	Representative electrode positions in the BA and HPC.	261

List of Abbreviations

ACC	anterior cingulate cortex. 31, 130, 344
AMG	amygdala. iii, 31, 76, 107, 344
BA	basal amygdala. ii, 35, 107, 344
BLA	basolateral amygdala. 35, 77, 108, 344
bICA	basolateral complex of the amygdala. ii, 34, 107, 344
BMA	basomedial amygdala. 35, 109, 344
BNST	bed nucleus of the stria terminalis. 31, 344
CA	cornu Ammonis. 40, 95, 344
CA1	CA field 1. 40, 42, 344
CA2	CA field 2. 40, 344
CA3	CA field 3. 40, 344
CA4	CA field 4, also called hilus. 40, 344
CeA	central amygdalar nucleus. ii, 34, 86, 107, 344
Cing	cingulate cortex. 54, 344
CoA	cortical amygdala. 34, 344
CR	conditioned response. 7, 61, 344
CS	conditioned stimulus. 7, 38, 76, 108, 344
CS-	control CS not conditioned to an US. 110, 124–128, 135, 136, 344
CS+	conditioned stimulus associated with the US when also a control CS (CS-) is present. 110, 124–128, 132, 135, 136, 344
CSD	current source density. 94, 344
DG	dentate gyrus. 42, 80, 344
dHPC	dorsal hippocampus. 40, 45, 117, 344
dmPFC	dorsomedial prefrontal cortex. 56, 57, 107, 344
DP	dorsal peduncular cortex. 56, 344
EC	entorhinal cortex. 44, 86, 344
EEG	electroencephalogram. 87, 344
EPSP	excitatory postsynaptic potential. 74, 344
FrA	frontal association cortex. 53, 344

List of Abbreviations

GABA	γ -Aminobutyric acid. 36, 76, 344
HF	hippocampal formation. 42, 344
HPC	hippocampus. iii, 31, 74, 107, 344
ICMs	intercalated cell masses. 35, 344
IEG	immediate early gene. 80, 112, 344
IL	infralimbic cortex. 54, 56, 110, 344
IN	interneurons. 56, 344
Ins	insular cortex. 54, 344
LA	lateral amygdala. 35, 76, 108, 344
LEC	lateral entorhinal cortex. 42, 44, 344
LFP	local field potential. 87, 122, 344
LIA	large-amplitude irregular activity. 93, 344
LTD	long-term depression. 74, 341, 344
LTP	long-term potentiation. 74, 341, 344
M2	secondary motor cortex. 53, 344
MeA	medial amygdalar nucleus. 34, 344
MEC	medial entorhinal cortex. 42, 344
MO	medial orbital cortex. 56, 126, 344
mPFC	medial prefrontal cortex. ii, 31, 77, 107, 344
MUA	multiunit activity. 88, 344
NR	nucleus reuniens. 59, 81, 344
NREM	non-REM sleep. 90, 137, 344
OFC	orbitofrontal cortex. 53, 344
Orb	orbital cortex. 54, 344
PAG	periaqueductal gray. 36, 111, 344
PaS	parasubiculum. 42, 344
PCA	principal component analysis. 79, 131, 344
PER	perirhinal cortex. 42, 344
PFC	prefrontal cortex. ii, 31, 81, 341, 344
PL	prelimbic cortex. 54, 86, 110, 344
PN	projection neurons. 56, 344
POR	postrhinal cortex. 42, 344
preM	premotor cortex. 53, 344

PRH	para-hippocampal region. 42, 344
PrS	presubiculum. 42, 344
PTSD	post-traumatic stress disorder. 16, 344
PV	parvalbumin interneurons. 112, 344
PVT	paraventricular nucleus of the thalamus. 70, 344
REM	rapid eye movement sleep. 90, 138, 344
SPW	sharp waves. 93, 344
SPW-R	sharp-wave-ripple complex. 93, 120, 344
SSDR	species-specific defense reaction. 9, 344
STDP	spike timing dependent plasticity. 75, 341, 344
Sub	subiculum. 42, 344
SWS	slow wave sleep. 91, 120, 344
UR	unconditioned response. 7, 344
US	unconditioned stimulus. 7, 78, 108, 344
vHPC	ventral hippocampus. 40, 45, 80, 111, 344
vmPFC	ventromedial prefrontal cortex. 56, 57, 132, 344
VTA	ventral tegmental area. 69, 344
ZI	zona incerta. 70, 344

RÉSUMÉ

L'extinction de la peur se définit comme le déclin du comportement de peur conditionné, via l'exposition répétée à des stimuli anxiogènes. C'est un modèle expérimental pour l'étude de l'apprentissage, mais aussi la base de certaines thérapies cliniques cognitivo-comportementales utilisées pour traiter l'anxiété ou les troubles post-traumatiques. Cependant, ses versions expérimentales et cliniques sont dépendantes du contexte et il y a renouvellement de la peur en dehors de l'environnement où l'extinction a lieu. C'est pour cette raison que le présent travail de thèse a cherché à étudier les processus comportementaux qui caractérisent l'extinction de la peur ainsi que les mécanismes neuronaux sous-jacents. Au cours de cette thèse, nous avons travaillé sur 5 projets. Sur le plan de la neurophysiologie, nous nous sommes concentrés sur le cortex préfrontal médian, l'hippocampe et l'amygdale et leurs relations fonctionnelles. Il a été démontré que ces trois structures forment un réseau jouant un rôle essentiel dans l'apprentissage émotionnel et le contrôle du comportement de peur. 1) Grâce à des techniques d'optogénétique, nous avons montré que l'activité de la voie anatomique connectant l'hippocampe au cortex préfrontal médian affecte l'expression de la peur contextuelle après l'extinction. 2) Nous avons validé l'utilisation de capteurs inertiels positionnés sur la tête pour la détection du comportement d'immobilisation défensif dit freezing (indice de peur très utilisé chez le rongeur). 3) Avec un nouveau paradigme d'extinction expérimentale pour le rongeur dans un cadre permettant une expression comportementale plus variée, nous avons pu quantifier des comportements multiples et grouper les individus en fonction de leur vulnérabilité au renouvellement de la peur. 4) Afin d'analyser les assemblées cellulaires dans des enregistrements électrophysiologiques à haute densité, nous avons développé un nouvel algorithme qui détecte leurs activations avec une précision non documentée jusqu'à présent. 5) Nous avons recueilli des données électrophysiologiques afin de caractériser la dynamique neuronale sous-tendant la mémoire d'extinction dans le réseau amygdalo-hippocampo-préfrontal.

MOTS CLÉS

Conditionnement à la Peur; Extinction; Hippocampe; Cortex Préfrontal Médian; Electrophysiologie et Optogénétique chez l'Animal en Comportement

ABSTRACT

Extinction learning is defined as the decline of conditioned fear responses with the repeated exposure to feared stimuli and is thought to be the basis of common behavioral treatments for affective disorders. Critically, both its experimental and clinical versions are context-dependent, and fear reduction fails to generalize outside of the context where the training takes place (fear renewal). Emotional learning and fear behavior control depend upon a network of brain structures including notably the amygdala, the hippocampus, and the medial prefrontal cortex. The aim of the PhD work presented here was to study the behavioral processes characterizing fear extinction as well as their underpinning neural mechanisms. This PhD included five different projects. 1) We showed with optogenetics that the activity of the anatomical pathway connecting the hippocampus and the medial prefrontal cortex affects contextual fear expression after extinction. 2) We validated the use of head-mounted inertial sensors for the detection of freezing behavior (an important index of fear in rodents). 3) We established a novel extinction training paradigm in a semi-naturalistic setting that allowed separating individuals into different behavioral phenotypes predicting their vulnerability to fear renewal. 4) We developed a new algorithm for the detection of cell assemblies in high-density neural recordings with unprecedented accuracy and precision. 5) We collected the data of a still ongoing project aimed at the characterization of potential circuit dynamics supporting extinction memory consolidation in the amygdala-hippocampus-medial prefrontal cortex network.

KEYWORDS

Fear-Conditioning; Extinction Learning; Hippocampus; Medial Prefrontal Cortex; Single-Unit Recordings; Freely-Moving Rats; Optogenetics