



HAL
open science

Towards a decision support system for tactical and operational port management

Hamza Bouzekri

► **To cite this version:**

Hamza Bouzekri. Towards a decision support system for tactical and operational port management. Artificial Intelligence [cs.AI]. Université Grenoble Alpes [2020-..], 2022. English. NNT : 2022GRALI016 . tel-03917528

HAL Id: tel-03917528

<https://theses.hal.science/tel-03917528v1>

Submitted on 2 Jan 2023

HAL is a multi-disciplinary open access archive for the deposit and dissemination of scientific research documents, whether they are published or not. The documents may come from teaching and research institutions in France or abroad, or from public or private research centers.

L'archive ouverte pluridisciplinaire **HAL**, est destinée au dépôt et à la diffusion de documents scientifiques de niveau recherche, publiés ou non, émanant des établissements d'enseignement et de recherche français ou étrangers, des laboratoires publics ou privés.

THÈSE

Pour obtenir le grade de

DOCTEUR DE L'UNIVERSITÉ GRENOBLE ALPES

Spécialité : Génie Industriel

Arrêté ministériel : 25 mai 2016

Présentée par

Hamza BOUZEKRI

Thèse dirigée par **Gülgün ALPAN**

préparée au sein du **Laboratoire des Sciences pour la Conception, l'Optimisation et la Production de Grenoble** dans l'**École Doctorale I-MEP2 - Ingénierie - Matériaux, Mécanique, Environnement, Énergétique, Procédés, Production**

Vers un système d'aide à la décision pour la gestion portuaire tactique et opérationnelle

Thèse soutenue publiquement le **4 février 2022**,
devant le jury composé de :

Marie-Laure ESPINOUSE

Professeure, Université Grenoble Alpes, Présidente

Marie-Ange MANIER

Maître de conférences - HDR, Université de technologie de Belfort Montbéliard,
Rapporteuse

Éric SANLAVILLE

Professeur, Université du Havre, Rapporteur

José Fernando OLIVEIRA

Professeur, Université de Porto, Examineur

Gülgün ALPAN

Professeure, Grenoble INP, Université Grenoble Alpes, Directrice de thèse

Vincent GIARD

Professeur émérite, Université Paris-Dauphine, Invité

Nicolas CHEIMANOFF

Professeur, EMINES, Université Mohammed VI Polytechnique, Invité



Acknowledgments

First and foremost, I would like to express my deep and sincere gratitude to my supervisor Prof. Gülgün Alpan for providing me with invaluable guidance throughout my PhD studies. I also thank her trust, which allowed me to conduct research autonomously and consequently boosted my development as a researcher. It was a great privilege and honor to work and study under her guidance.

Many thanks also to Prof. Vincent Giard for his meaningful assistance, tireless guidance, and patience. This thesis would not have been possible without his help and support.

I would like to thank Prof. Nicolas Cheimanoff and Prof. Frédéric Fontane for providing me with all the necessary facilities. I also take this opportunity to record my sincere thanks to all the faculty members of EMINES-School of Industrial Management, Mohammed VI Polytechnic University for their help.

I also thank the G-SCOP laboratory for giving me the opportunity to conduct this research. Even though I did not spend the majority of my working time there, I greatly appreciated my short stays in the laboratory.

I am extremely grateful to my parents for their love, prayers, caring and sacrifices to educate and prepare me for my future. I also thank my sister Hafsa for her support and my extended family for their unceasing encouragement.

Some special words of gratitude go to my best friends Soukaina Nefaoui and Mehdi Oulakhir and to all my friends who have always been a major source of support and with whom I have shared moments of deep anxiety but also big excitement.

Finally, I place on record my sense of gratitude to one and all who, directly or indirectly, have lent their helping hand in this venture.

Abstract

The port logistics chain is a very sensitive link in a global supply chain. It strongly conditions the performance of integrated logistics chains involving maritime transport to distribute products in the global marketplace. Meeting delivery dates and reducing the costs of port operations while considering the port productivity, are essential points in the maritime sector. Consequently, the sound management and control of the port logistics chain constitute a strategic challenge and key factor of competitiveness. The problem then arises of how to improve the planning of port operations. Thus, this thesis aims to develop decision support models to ensure an effective and efficient management of tactical and operational port operations.

First, we integrate three main decision problems related to seaside operations in ports due to the strong interrelations existing between them: the Laycan Allocation Problem (LAP), the continuous dynamic Berth Allocation Problem (BAP) and the time-invariant Quay Crane Assignment Problem (QCAP). We consider several characteristics and constraints rarely studied together, such as the multiplicity of quays, the variation of water depth, navigation channel restrictions related to tides, charter party clauses and non-working periods. Then, we extend the integrated problem to the Specific Quay Crane Assignment Problem (QCASP), which includes the assignment of a set of specific quay cranes to each vessel considering the productivity of quay cranes and their maximum outreach.

Second, we integrate the LAP and the hybrid dynamic BAP in the context of bulk ports considering the common characteristics and constraints of ports cited above, as well as specific bulk port characteristics and constraints. These are mainly the conveyor routing constraints between storage hangars and berthing positions under preventive maintenance activities and the multiplicity of cargo types on the same vessel. Since each berthing position has a fixed bulk-handling crane, QCAP decisions are not addressed in the case of bulk ports.

Third, since there is a strong interaction between production, storage, and port operations, we develop a DSS for planning these three successive echelons in a fertilizer supply chain. This planning tool encapsulates an existing production scheduling model, the berth scheduling model for bulk ports, and a new model for the Storage Space Allocation Problem. The aim is to align production and storage decisions with vessel demands, ensuring consistency in decision-making.

The efficiency of our models is shown through extensive computational experiments on generated problem instances and real case studies inspired by the operations of OCP Group, a global leader in the phosphate market and its derivatives, at the Jorf Lasfar chemical platform in Morocco, the largest fertilizer complex in the world.

Keywords

Port management, Berth allocation, Laycan allocation, Quay crane assignment, Storage space allocation, Decision support system

Résumé

La chaîne logistique portuaire est un maillon très sensible au sein d'une chaîne logistique globale. Elle conditionne fortement la performance des chaînes logistiques intégrées faisant appel au transport maritime pour distribuer des produits sur un marché mondial. Le respect des délais de livraison et la réduction des coûts des différentes opérations portuaires tout en tenant compte de la productivité du port sont essentiels dans le domaine maritime. Par conséquent, la bonne gestion et la maîtrise de la chaîne logistique portuaire constituent un enjeu stratégique et facteur clé de compétitivité. Se pose alors la question de savoir comment peut-on améliorer la planification des opérations portuaires. L'objectif de cette thèse est ainsi de développer des modèles d'aide à la décision pour assurer une gestion efficace et efficiente des opérations portuaires tactiques et opérationnelles.

Premièrement, nous avons intégré trois problèmes liés à la gestion portuaire vu les fortes interrelations qui existent entre eux : le problème de l'allocation des planches, le problème de l'allocation des postes à quai sous sa version continue et dynamique et le problème de l'allocation des grues de quai sous une version ne variant pas en fonction du temps. Nous avons pris en compte plusieurs caractéristiques et contraintes rarement étudiées ensemble comme la multiplicité des quais et la variation de leur profondeur, les restrictions de passage des navires par les chenaux de navigation liées aux marées, les clauses contractuelles de la charte-partie et les périodes de non-travail. Ensuite, nous avons étendu le problème intégré au problème de l'allocation des grues de quai spécifiques. Ce dernier consiste à allouer un ensemble de grues de quai à chaque navire en tenant compte de la productivité et la portée des grues de quai.

Deuxièmement, nous avons intégré le problème de l'allocation des planches et le problème de l'allocation des postes à quai sous sa version hybride et dynamique dans le contexte des ports vraquiers. Ce problème intégré prend en compte les caractéristiques et les contraintes communes des ports, citées précédemment, ainsi que celles spécifiques aux ports vraquiers, à savoir les contraintes d'acheminement par convoyeur entre les hangars de stockage et les postes à quai avec des activités de maintenance préventive et la multiplicité des types de marchandises dans un même navire.

Troisièmement, vu la forte interaction entre les opérations de production, de stockage et du port, nous avons développé un système d'aide à la décision pour la planification de ces trois maillons successifs dans une chaîne logistique d'engrais. Cet outil de planification

encapsule un modèle existant d'ordonnancement des lignes de production d'engrais, le modèle du problème intégré de l'allocation des planches et des postes à quai pour les ports vraquiers et un nouveau modèle pour le problème de l'allocation des espaces de stockage. L'objectif est d'aligner les décisions relatives à la production et au stockage avec les demandes des navires, assurant ainsi une consistance dans la prise de décision.

L'efficacité de nos modèles est démontrée par une série de tests expérimentaux sur un ensemble de jeux de données générés et des études de cas réels inspirées par les opérations du Groupe OCP, leader mondial sur le marché des phosphates et de ses dérivés, dans le complexe chimique de Jorf Lasfar au Maroc, plus grand complexe d'engrais du monde.

Keywords

Gestion portuaire, Allocation des postes à quai, Allocation des grues de quai, Allocation des espaces de stockage, Système d'aide à la décision

Contents

List of Figures	XI
List of Tables	XIII
List of Abbreviations	XV
Chapter 1: Introduction	1
1.1. General context	1
1.2. Industrial context	8
1.3. Problem statement	11
1.4. Research outline and main contributions	12
Chapter 2: General literature review	17
2.1. General characteristic of the BAP	17
2.1.1. BAP definition	17
2.1.2. BAP attributes	18
2.1.3. BAP resolution	20
2.2. Early works and review papers on the BAP	20
2.2.1. BAP in container ports	21
2.2.2. BAP in bulk ports	22
2.3. BAP and real-world aspects	23
2.3.1. Tides and navigation channel restrictions	23
2.3.2. Ports with multiple quays, multiple terminals, or irregular layouts	24
2.3.3. Unavailability periods	25
2.3.4. Piloting and tugging constraints	26
2.3.5. Uncertainty	27
2.3.6. Environmental aspects	28
2.4. BAP in an integrated approach	30
2.4.1. BAP and quay crane decision problems	31
2.4.2. BAP and yard-side decision problems	33
2.4.3. BAP and laycan allocation	35
2.4.4. BAP and waterway scheduling	36
2.4.5. BAP and ship routing	37
2.5. Conclusion	37
Chapter 3: Integrated Laycan and Berth Allocation and time-invariant Quay Crane Assignment Problem in tidal ports with multiple quays	39
3.1. Introduction	40
3.2. Literature review	43
3.2.1. BACAP and BACASP literature	43
3.2.2. LAP literature	47
3.3. Description and formulation of the LBACAP	48
3.3.1. Description of the LBACAP	48
3.3.2. Formulation of the LBACAP	50
3.4. Description and formulation of the LBACASP	60
3.4.1. Description of the LBACASP	60
3.4.2. Formulation of the LBACASP	61
3.5. Computational experiments	65

3.5.1.	Generation of test instances	65
3.5.2.	Illustrative examples	67
3.5.3.	Evaluation of the LBACAP and the LBACASP models	72
3.6.	Conclusions	76
Chapter 4: Integrated Laycan and Berth Allocation Problem with conveyor routing constraints and preventive maintenance activities in bulk ports		79
4.1.	Introduction	80
4.2.	Literature review	81
4.2.1.	BAP Literature	81
4.2.2.	LAP Literature	86
4.3.	Problem description	86
4.3.1.	General port constraints	86
4.3.2.	Specific bulk port constraints	88
4.3.3.	Optimization criteria	91
4.4.	Model formulation	91
4.4.1.	Notation	91
4.4.2.	Representation of time	95
4.4.3.	Decision time-interval	96
4.4.4.	Predicates	96
4.4.5.	Mathematical model	100
4.5.	Case study	102
4.5.1.	Generation of test instances	103
4.5.2.	Illustrative example	105
4.5.3.	Computational results	108
4.6.	Conclusions	109
Chapter 5: An integrated Decision Support System for planning production, storage and bulk port operations in a fertilizer supply chain		111
5.1.	Introduction	112
5.2.	Literature review	114
5.3.	Problem and DSS description	117
5.3.1.	Description of the encapsulated models	119
5.3.2.	Description of the DSS functioning	121
5.4.	SSAP model formulation	124
5.4.1.	Notation	124
5.4.2.	Mathematical model	127
5.5.	Case study and managerial insights	131
5.5.1.	Case study	131
5.5.2.	Managerial insights	136
5.6.	Conclusions	138
Chapter 6: Conclusions and perspectives		139
6.1.	Conclusions	139
6.2.	Perspectives	141
Appendix A:	Adapted Production Scheduling model	145
Appendix B:	Résumé étendu	149
Appendix C:	Links to datasets	157
Bibliography		158

List of Figures

Figure 1.1: Comparison of CO ₂ emissions between vessels, trains, and trucks (Research and Traffic Group, 2013)	1
Figure 1.2: 50 years of container ship growth (Shipping and Freight Resource, 2020)	2
Figure 1.3: World fleet by principal vessel type (UNCTAD, 2020).....	3
Figure 1.4: Schematic representation of a container terminal (Galle, 2018)	4
Figure 1.5: Contractual and actual parameters of vessels	5
Figure 1.6: Vessel cycle	5
Figure 1.7: Interrelations between port planning problems	7
Figure 1.8: Different sites of OCP Group	8
Figure 1.9: Northern Axis (Khouribga – Jorf Lasfar) of OCP Group.....	9
Figure 1.10: Mapping of daily and weekly decisions in the Jorf Lasfar chemical platform....	10
Figure 1.11: Bulk port of Jorf Lasfar	11
Figure 1.12: Thesis structure	12
Figure 2.1: Graphic representation of a berth plan.....	18
Figure 2.2: Different berth layouts	19
Figure 2.3: Navigation channel restrictions	23
Figure 2.4: Weekend holiday by country	26
Figure 2.5: Tugboats assisting a container ship	27
Figure 2.6: Types of functional integration (Bierwirth & Meisel, 2010).....	31
Figure 2.7: QCAP variants (Correcher, 2017)	32
Figure 2.8: A solution of the BACAP not feasible for the BACASP (Correcher et al. 2019). 32	
Figure 3.1: Different actors involved in contracts of affreightment	41
Figure 3.2: Possible combinations between the LAP, the BAP, the QCAP and the QCASP ..	42
Figure 3.3: Example of a port with multiple quays, different water depths, and homogeneous cranes in each quay	48
Figure 3.4: Vessel scheduling update.....	56
Figure 3.5: Example of overlaps between 3 vessels (if their handling is not restricted to working periods)	60
Figure 3.6: Example of a port with multiple quays, different water depths, and heterogeneous quay cranes.....	61
Figure 3.7: Range interval (maximum outreach) of each quay crane	61
Figure 3.8: Illustration of the spatial condition	63
Figure 3.9: Part of the Gantt chart of the LBACAP model with the economic objective function.....	69
Figure 3.10: Part of the Gantt chart of the LBACASP model with the economic objective function.....	70
Figure 4.1: Hybrid berth layout.....	87
Figure 4.2: Example of a bulk port	87
Figure 4.3: Sections of the port conveyor system	89
Figure 4.4: Representation of a chartered vessel and the batches to load on it.....	91

Figure 4.5: Reservation of port resources for new vessels to charter	97
Figure 4.6: Gantt chart of vessel and batch schedule	107
Figure 5.1: A schematic representation of the conveyor system.....	118
Figure 5.2: Functioning of the DSS	124
Figure 5.3: Inventory position of fertilizers	133
Figure 5.4: Optimal production scheduling Gantt chart.....	134
Figure B.1 : Paramètres contractuels et réels des navires	150
Figure B.2 : Représentation des interactions entre les problèmes portuaires étudiés	151

List of Tables

Table 3.1: BACA(S)P literature	45
Table 3.2: Calculation of tide and non-working periods parameters	55
Table 3.3: Notation of predicates in the LBACAP model	58
Table 3.4: Notation of predicates in the LBACASP model	63
Table 3.5: Class of water depth of berthing sections	66
Table 3.6: Characteristics of groups of quay cranes	66
Table 3.7: Specifications of vessels in the test instances	67
Table 3.8: Solving the LBACAP with a computation time limited to 1 hour.....	73
Table 3.9: Solving the LBACAP with a computation time limited to 3 hours	74
Table 3.10: Optimal objective values of the LBACAP model.....	75
Table 3.11: Solving the LBACASP with the 50 meters discretization	76
Table 4.1: BAP literature in the context of bulk ports	85
Table 4.2: Calculation of non-working periods parameters	96
Table 4.3: Notation of predicates	99
Table 4.4: Characteristics of berthing positions.....	104
Table 4.5: Characteristics of sections of the port conveyor system.....	104
Table 4.6: Characteristics of vessels	105
Table 4.7: Computational results	108
Table 5.1: SSAP literature.....	117
Table 5.2: Notation of the SSAP mathematical model	125
Table 5.3: Periods of the planning horizon	131
Table 5.4: Division of EOs into EEOs	132
Table 5.5: Production initially in progress	132
Table 5.6: Initial state of SUs (Fertilizer # - Weight)	133
Table 5.7: Order book and optimal Production Plan.....	134
Table 5.8: Vessels input data and optimal Berthing Plan	135
Table 5.9: EEOs and optimal Loading Plan.....	135
Table 5.10: Events of sending and removing batches and optimal Storage Plan.....	136
Table A.1: Notation.....	145
Table A.2: Predicates	146

List of Abbreviations

BAP	Berth Allocation Problem
BACAP	Integrated Berth Allocation and Quay Crane Assignment Problem
BACASP	Integrated Berth Allocation and Specific Quay Crane Assignment Problem
DSS	Decision Support System
EEO	Elementary expedition order
EO	Expedition order
ETA	Expected time of arrival
LAP	Laycan Allocation Problem
LBAP	Integrated Laycan and Berth Allocation Problem
LBACAP	Integrated Laycan and Berth Allocation and Quay Crane Assignment Problem
LBACASP	Integrated Laycan and Berth Allocation and Specific Quay Crane Assignment Problem
MILP	Mixed-integer linear programming
MINLP	Mixed-integer nonlinear programming
MTO	Make-to-order production
MTS	Make-to-stock production
NOR	Notice of Readiness
ODI	Owner Direct Investment
OR	Operations Research
PO	Production order
QC	Quay crane
QCAP	Quay Crane Assignment Problem
QCSP	Quay Crane Scheduling Problem
QCASP	Specific Quay Crane Assignment Problem
Ro-Ro	Roll-on/Roll-off
SC	Supply chain
SSAP	Storage Space Allocation Problem
SSHEX	Saturdays/Sundays/Holidays Excluded
SSHINC	Saturdays/Sundays/Holidays Included
SU	Stock Unit
UNCTAD	United Nations Conference on Trade and Development
YAP	Yard Assignment Problem

Chapter 1

Introduction

This chapter provides a general overview of maritime transport and ports and certain optimization problems related to port management in dealing with the increasing demand for higher port efficiency and productivity. Then, we present the industrial context, the problem statement, and the objectives of this thesis. Finally, we detail the structure of this thesis and the main contributions of each chapter.

1.1. General context

Maritime transport is the most important means of transportation in the world as it is recognized as the heart of global trade and economy. Twenty-four hours a day all year round, vessels carry merchandise to the four corners of the world. Globalization as we know it today would not have been possible without maritime transport. Moreover, it will be indispensable in a sustainable future global economy as it is more climate and environment friendly when compared with other modes of transportation like rail and road freights (Figure 1.1).

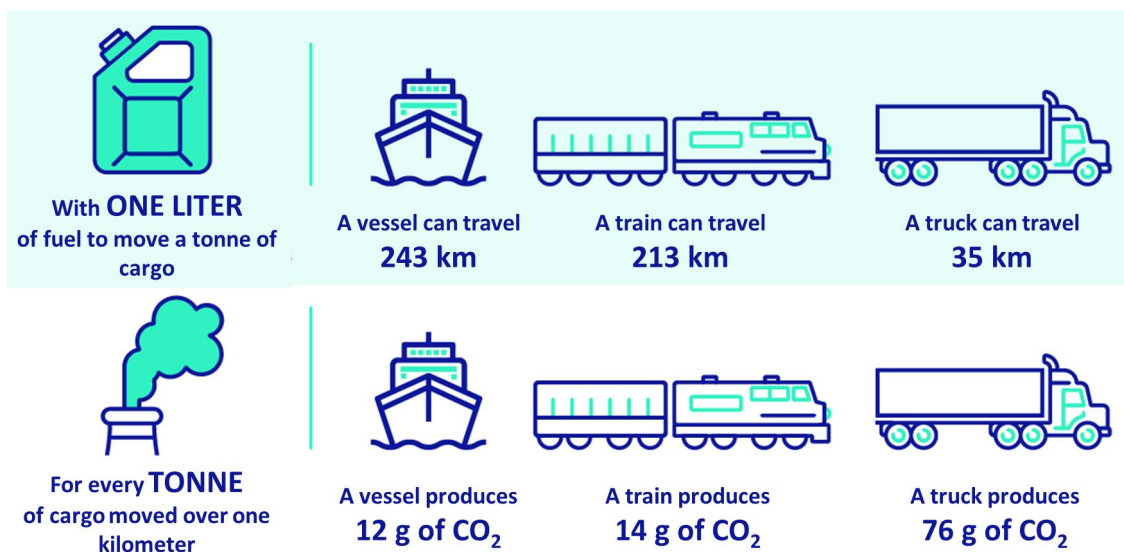

Figure 1.1: Comparison of CO₂ emissions between vessels, trains, and trucks (Research and Traffic Group, 2013)

More than 80% of world merchandise trade by volume is carried by sea and is handled by ports (UNCTAD, 2020). The role of ports is crucial in maritime transport. They constitute a major economic activity, bringing varying degrees of benefit to the international, regional, and local economies in which they operate. Furthermore, ports are facing increasingly bigger challenges particularly since there has been a spectacular growth in the size of vessels recently. Container-carrying capacity has increased by around 1 500% since 1968 and has

almost doubled over the past decade. Figure 1.2 shows the rapid evolution of container ships from 1968 until today. Moreover, according to a survey by Notteboom (2006), port congestion causes about 65% of delays in ocean shipping. Consequently, the improvement of port operation efficiency is crucial and indispensable to deal with the enormous scale of maritime trade and the growing congestion of vessels experienced at ports and to keep ports organized, supervised, and functioning.

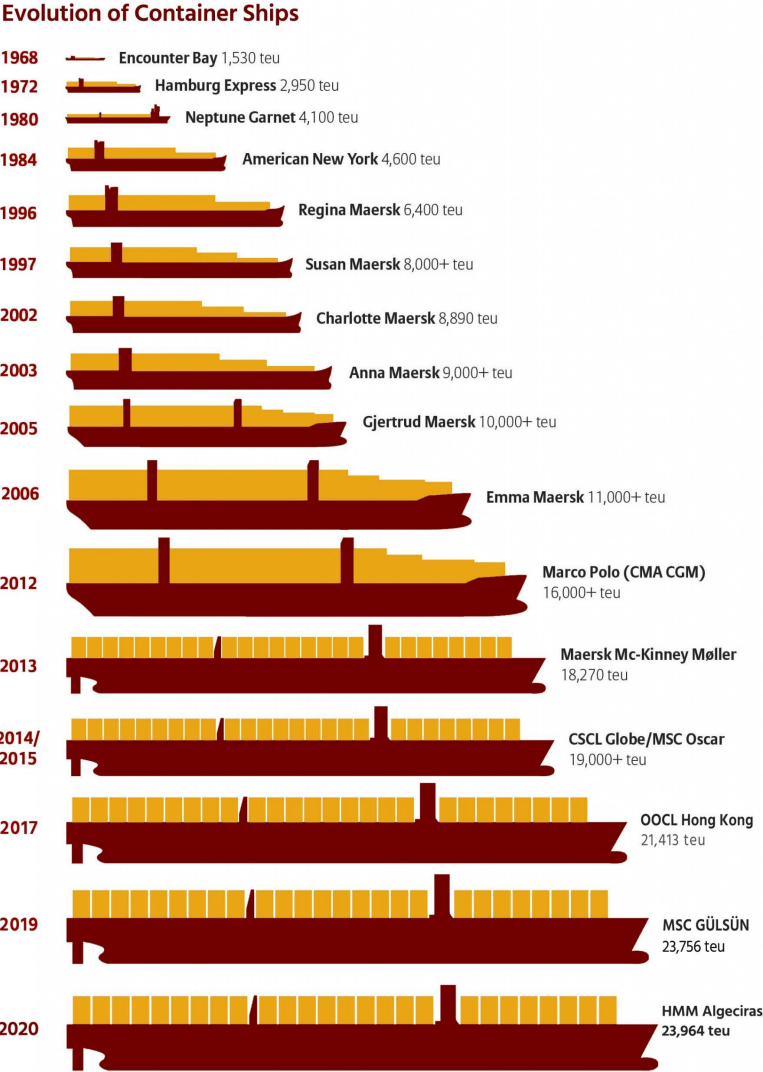

Figure 1.2: 50 years of container ship growth (Shipping and Freight Resource, 2020)

High volumes of cargoes, each with its own specific handling and storage requirements, are transported and stored in ports for export and import every day. Five types of cargo can be distinguished: dry bulk, liquid bulk, container cargo, breakbulk and Ro-Ro.

- *Dry bulk* includes goods that are transported unpackaged in the vessel’s hull, generally in large volume, such as fertilizers, minerals, cement, iron ore and coal. Bulk cargo is carried in bulk carriers, also called bulkers, that represent the largest share of the world fleet (Figure 1.3).

- *Liquid bulk* includes fuel oil, petrol, and crude oil. These hazardous goods are shipped in tankers that represent the second-largest share of the world fleet.
- *Container cargo* can be anything, from coffee beans to computers. These goods are stored in standardized containers and carried in container ships. Containerization revolutionized the shipping industry and changed the world as it made complex supply chains possible. Indeed, it has simplified the whole logistical process as containers could be moved seamlessly between vessels, trucks, and trains. Container ships represent the third-largest share of the world fleet.
- *Breakbulk cargo* refers to cargo that requires individual loading such as art, household furniture, farm machinery, and vehicle parts. These goods are shipped in general cargo ships.
- *Ro-Ro* includes rolling stock such as machines and vehicles. They are carried in Ro-Ro vessels.

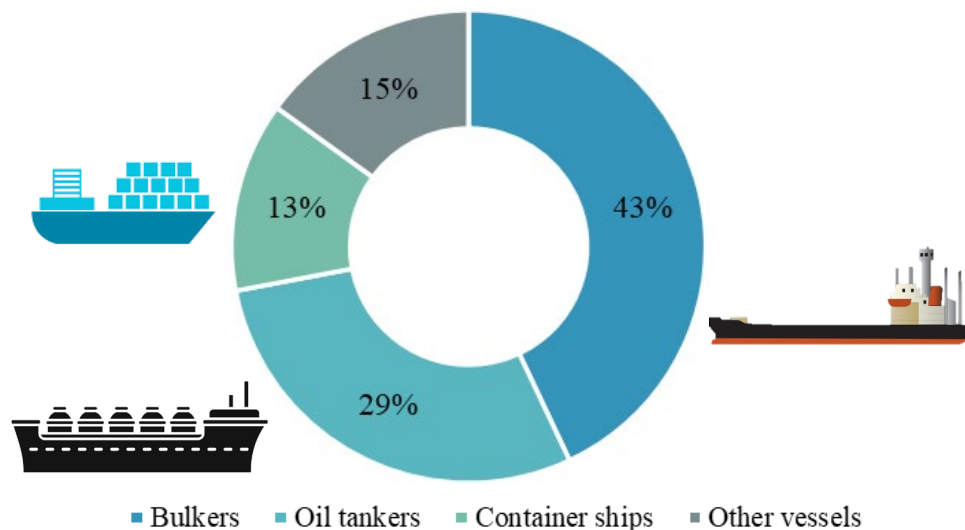

Figure 1.3: World fleet by principal vessel type (UNCTAD, 2020)

This research mainly focuses on container and dry bulk ports. Container ports or container terminals (a port may consist of one or more terminals) can be divided into three sections illustrated in Figure 1.4:

- *Seaside* includes the vessel, the berthing position in the quay and the internal transport area.
- *Yard-side* also called storage yard includes the stored containers. The latter can be destined to import, export or transshipment.
- *Landside* includes external transport area and the gate.

Each transport and handling equipment can operate in one or several sections of the container terminal.

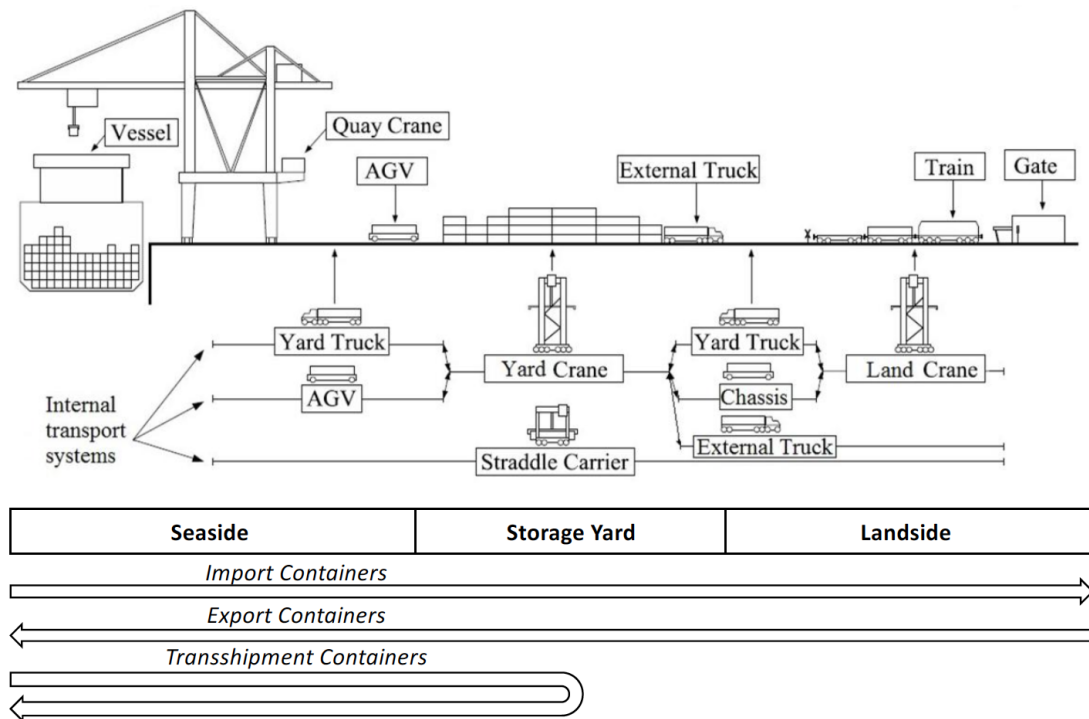

Figure 1.4: Schematic representation of a container terminal (Galle, 2018)

Bulk ports can also be divided into the same three sections as in the case of container terminals. However, the main differences lay in transport and handling equipment. In container ports, all cargo is packed into standard containers, and thus there is no need for any specialized equipment to handle any particular type of cargo. In contrast, cargo is not packaged in bulk ports, and a wide variety of transport and handling equipment is used depending on the vessel requirements and cargo properties. Indeed, dry bulk cargoes are handled using fixed ship loaders/unloaders and are transferred between the seaside and yard-side using conveyors, while liquid bulk cargoes need pipelines. Unlike bulk cargo, containers are handled using mobile quay cranes and are transferred between the seaside and yard-side using internal vehicles such as straddle carriers, yard trucks and automated guided vehicles. Another main difference is that bulk terminals are usually operated by a single company that also owns the cargo, whereas container terminals have multiple users since they handle containers for several owners.

Among the key stakeholders in the maritime transport sector are shipowners, charterers, and port operators. The freight contract which binds the shipowner, owner of the vessel, and the charterer, cargo owner, is called a “charter party”. In this chartering contract, the shipowner agrees to rent out his vessel to the charterer to move cargoes from one point to another. The laycan and the laytime are among the main clauses in a charter party.

The laycan is an abbreviation for the “Laydays and Canceling” clause that establishes the earliest and latest dates for the commencement of the charter. Once the vessel has arrived

at a port, the charterer then assumes responsibility for the loading/unloading of cargo, and he has a period of laytime in which to carry this out. If the charterer fails to complete the work during this allotted time, then a penalty called “demurrage” is incurred to the shipowner. However, if the charterer requires less than the defined laytime, the shipowner might be required to pay a refund called “despatch” to the charterer. These chartering terms are shown in Figure 1.5. Finally, the port operator is the cargo handler in the port. He manages the port resources in a way that ensures smooth transition of cargo so that it reaches its destination on time. More details about charter party clauses and the main stakeholders will be provided in Section 3.1

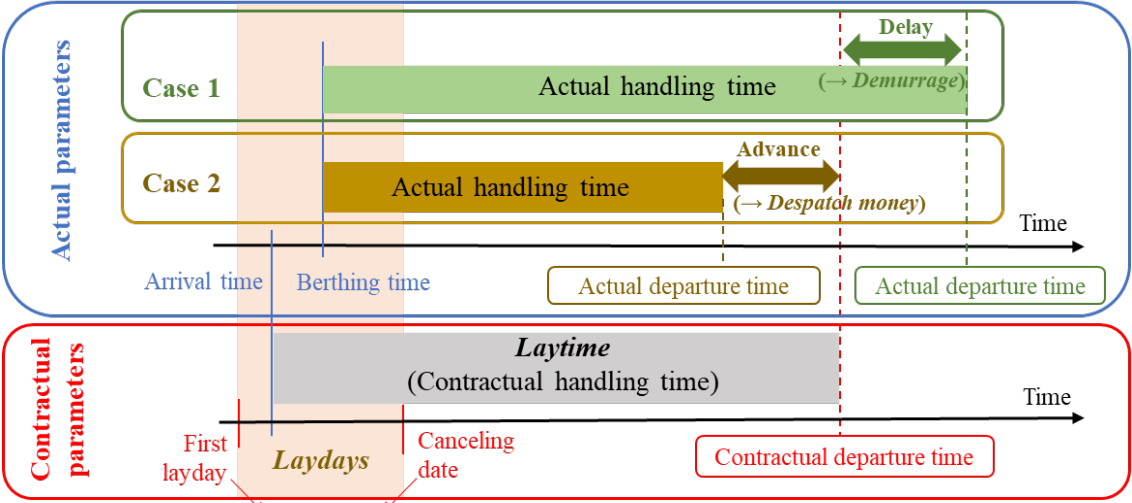

Figure 1.5: Contractual and actual parameters of vessels

Once the charter party is signed between the charterer and the shipowner, the latter must arrive at the loading port during the concluded laycan. An expected time of arrival (ETA) is sent from the shipping line of the vessel to the port operator in advance. If the port is busy, the vessel must wait outside at the harbor for a berth to become available. Otherwise, the vessel is directly berthed in its assigned berth, and then the port operator starts loading goods into it. When loading operations are completed, the vessel leaves the loading port to sail towards the unloading port. Similarly, the loaded vessel is berthed and then the port operator starts unloading goods from it. A typical vessel cycle is shown in Figure 1.6.

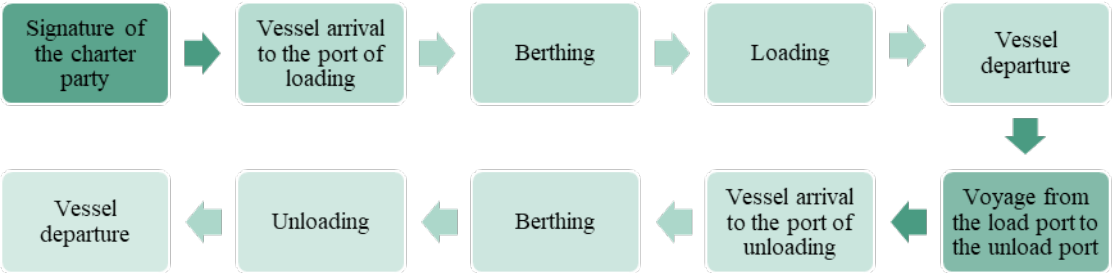

Figure 1.6: Vessel cycle

Port management performance is related to both the respect of contractual clauses and the optimal use of port resources. Considerable benefits could be gained by improving and optimizing port operations. In this thesis, we study the following decision problems related to port management.

- The *Laycan Allocation Problem* (LAP) refers to the tactical problem of assigning berthing time windows to new vessels to charter within a medium-term planning horizon considering the availability of cargo and port resources. It aims to support the negotiation process between shipowners and charterers.
- The *Berth Allocation Problem* (BAP) has three planning levels: operational, tactical, and strategic. In this thesis we focus only on the operational version of the BAP.
 - The *operational* BAP, also known as the *Berth Scheduling Problem*, refers to the problem of assigning berthing positions and times to every vessel projected to be served within a short-term planning horizon considering vessel and port constraints.
 - The *tactical* BAP, also known as the *Berth Template Problem*, generally covers a longer planning horizon. In this version, a group of berths is exclusively allocated to specific shipping company.
 - The *strategic* BAP determines the number, the length and the location of berths and quays that should be available at the port during the initial development of the port or when an expansion is considered.
- The *Quay Crane Assignment Problem* (QCAP) refers to the operational problem of assigning a set of quay cranes to every vessel projected to be served within a short-term planning horizon with the aim of making the most efficient use of them. The assignment must respect the number of cranes available at the quay and the minimum and maximum number of quay cranes allowed for each vessel. This problem is mostly considered jointly with the BAP.
- The *Specific Quay Crane Assignment Problem* (QCASP) replaces the number of quay cranes in the QCAP by a set of specific quay cranes to be assigned to each vessel. Since quay cranes are mounted on rails, they cannot cross each other. Consequently, working cranes may obstruct adjacent cranes from moving to serve other vessels. Thus, the assignment must respect non-crossing constraints of quay cranes and their maximum outreach.

- The *Storage Space Allocation Problem* (SSAP), also called the *Storage Location Assignment Problem* refers to the operational problem of assigning storage locations to goods in a way that achieves optimal space utilization. The problem determines where and when goods will be stored.

Basically, the decisions related to the problems outlined above can be made in a sequentially; however, there are strong interrelations between them that must be taken into account. Figure 1.7 illustrates the hierarchy of these decision problems in a downward direction, as well as the feedback between them in an upward direction.

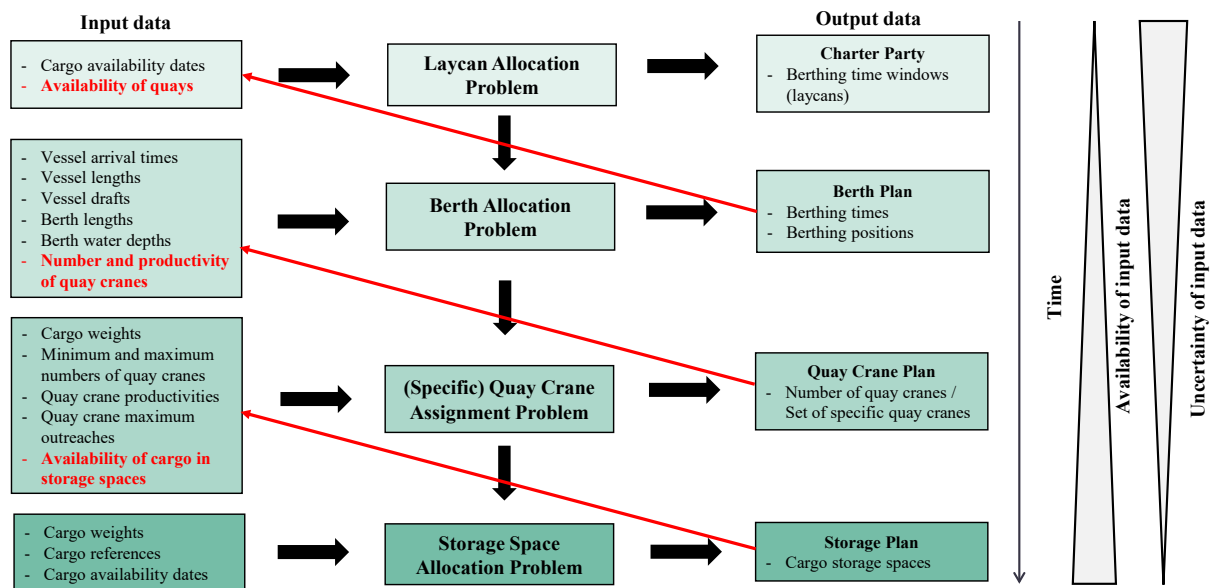

Figure 1.7: Interrelations between port planning problems

Indeed, the allocation of laycans to new vessels to charter depends on the availability of port resources, mainly quays. If laycans are fixed independently, this can cause excessive overloading in the execution of port operations and high waiting times. In addition, the number and the productivity of quay cranes and routing constraints between storage spaces and berthing positions affect vessel stay times in the quays. Failure to account for all these existing interrelations will lead to decisions of poor overall quality, hence the interest in adopting integrated approaches to ensure supply chain alignment. The latter is considered as one of the major factors in improving global performance. The difficulty does not lie in optimizing the decisions of each supply chain echelon solely, but in optimizing the decisions across all the echelons, from the production of goods to their expedition. All this makes supply chain alignment inherently challenging.

We note that there are several other planning problems related to port management that are not addressed in this thesis, such as the *Container Stowage Problem* that deals with the arrangement of containers into vessels, the *Quay Crane Scheduling Problem* (QCSP) that

defines a quay crane schedule for loading and unloading containers, the *Yard Crane Scheduling Problem* that is concerned with routing the yard crane given a sequence of storage and retrieval requests to perform, the *Container Relocation Problem* that tackles the minimization of relocations when retrieving containers in a simpler setting, the *Vehicle Dispatching Problem* that assigns vehicles to containers in order to transport them between the seaside and yard-side, and others.

1.2. Industrial context

This research was conducted under the OCP Industrial Optimization Chair¹ that was developed by OCP Group and EMINES-School of Industrial Management, Mohammed VI Polytechnic University. OCP Group is the first worldwide producer and exporter of phosphate rock and phosphoric acid. It is also one of the largest fertilizer producers in the world. The company has access to more than 70% of the world’s phosphate rock reserves. The repartition of these reserves in Morocco is shown in Figure 1.8.



Figure 1.8: Different sites of OCP Group²

¹ <https://www.emines-ingenieur.org/en/research/ocp-industrial-optimization-chair>
² <https://www.ocpgroup.ma/>

OCP is an integrated group through the value chain. The phosphate rocks extracted from the mining sites of Khouribga are transported by slurry pipeline to the Jorf Lasfar chemical platform, while those extracted from the mining sites of Youssoufia-Ben Guerir and Boucraâ are transported respectively by rail to the Safi chemical platform and by conveyor to the port of Laayoune. Once arrived at the chemical platforms, phosphate is transformed into phosphoric acid and then into phosphate fertilizers using imported raw materials (sulfur and ammonia). Finally, phosphate rock and finished products are shipped by vessels in the bulk ports of Safi and Jorf Lasfar. This research was conducted in the Jorf Lasfar chemical platform, part of OCP’s northern axis (Figure 1.9).

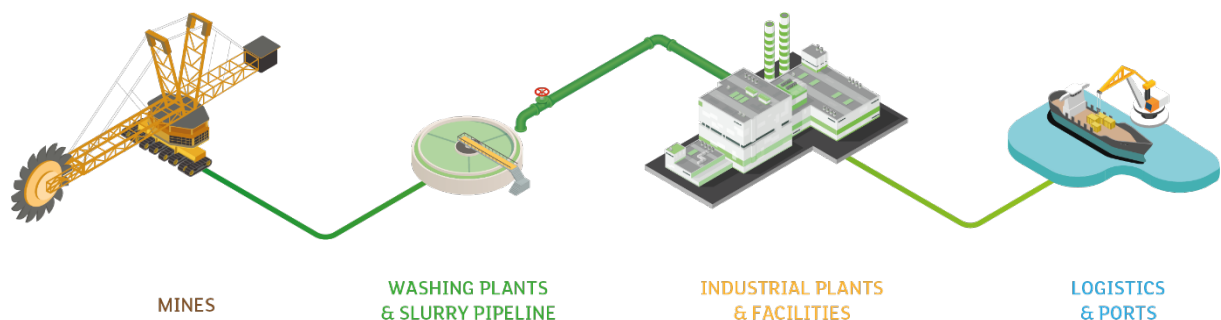

Figure 1.9: Northern Axis (Khouribga – Jorf Lasfar) of OCP Group³

The Jorf Lasfar chemical platform is recognized as the largest fertilizer complex in the world, and its bulk port is recognized as the largest port in Africa for exporting phosphate and its derivatives. The main stakeholders of this platform are the “Supply Chain” team, which is responsible for the coordination and the planning of operations; the shipping agency, which is responsible for the consignment of vessels (i.e., organizing vessels’ ports of call and tracking transported goods); the “Jorf Lasfar Phosphate Hub” team, which is responsible for the storage of raw materials, semi-finished and finished products; and finally, the production teams. These teams collaborate closely with the commercial team located in OCP’s headquarters in Casablanca, which is responsible for evaluating the needs in raw materials and finished products to meet sales commitments and the affreightment of vessels. Figure 1.10 summarizes the decisions taken by these teams on a daily and weekly basis.

Every day, the maritime agency communicates the state of berthing positions and the evolution of vessel loading and unloading operations, the production entities communicate the achievements on the production of phosphoric acid and fertilizers and the state of production lines, and the “Jorf Lasfar Phosphate Hub” team communicates the state of stocks and the achievements on maintenance operations.

³ <https://www.ocpgroup.ma/>

Every week, the “Supply Chain” team organizes a meeting called “Control Tower” between the different teams of the Jorf Lasfar chemical platform, given the strong interrelations between them. The objective of the meeting is to establish weekly production, berth, and storage plans based on the information collected from the different teams and the decisions taken by the commercial team about the needs in raw materials and finished products and the allocation of laycans to new vessels to charter. In addition, each team expresses its constraints and urgent needs during this meeting, such as the delays in receiving raw materials or the lack of storage capacities or phosphoric acid used in the production of fertilizers. The “Supply Chain” team carries out all the decisions on Excel and updates manually the production, berth, and storage plans at each new information (e.g., the laycan of a new vessel to charter) or unexpected change (e.g., change in vessel arrival times or handling times, machine breakdowns, quays, etc.), which can cause several adverse events during production, storage, and port operations. Moreover, each production team (phosphoric acid and fertilizers) tends to optimize its own performance, which disregards the benefits of the supply chain as a whole. Therefore, it is important to align planning decisions to synchronize the physical and information flows across the different supply chain echelons.

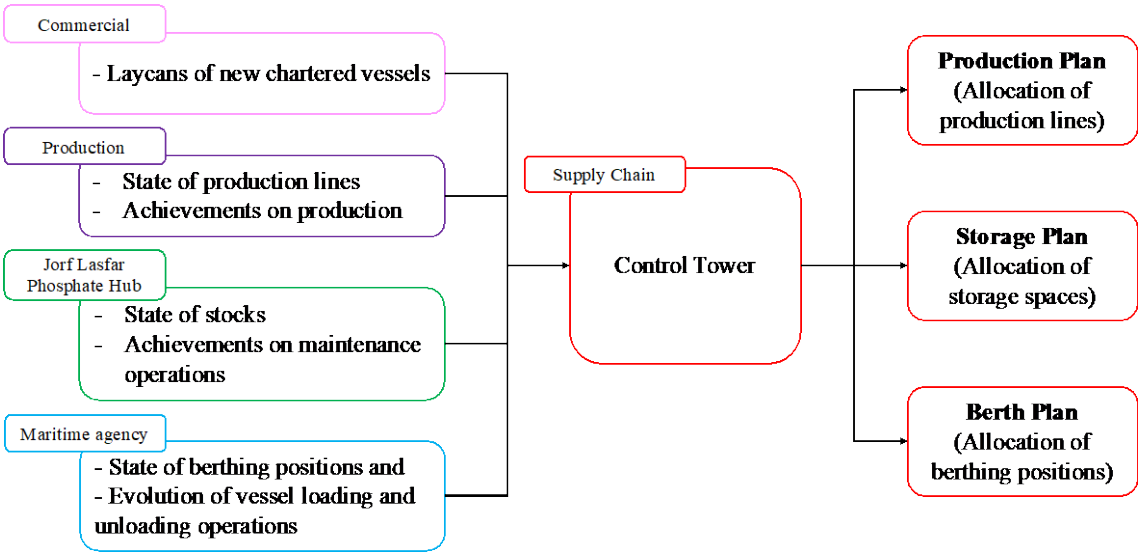

Figure 1.10: Mapping of daily and weekly decisions in the Jorf Lasfar chemical platform

Based on the bulk port of Jorf Lasfar (Figure 1.11), we study in this thesis several constraints and characteristics related to vessels and ports in general, particularly bulk ports, to be as close as possible to reality, such as the multiplicity of quays, the variation of water depth, the productivity of handling equipment, navigation channel restrictions related to tides, conveyor routing constraints between the seaside and yard-side, preventive maintenance activities, the multiplicity of cargo types on the same vessel, charter party clauses and non-working periods.



Figure 1.11: Bulk port of Jorf Lasfar⁴

Since ports are strategic and indispensable links to the performance of OCP's global supply chain, raising the efficiency of ports and thus improving their productivity is a top priority for the group. Thus, this research project was launched with the goal of assisting OCP's decision-makers in ports to make planning decisions efficiently and effectively,

1.3. Problem statement

Mismanagement of port resources increases vessel waiting times, decreases resource utilization, which impacts the whole supply chain operations and the profit margins of stakeholders, and potentially the sustainability of the maritime sector. Moreover, seaside port operations have strong interrelations with yard-side operations, and failure to account for these interrelations may lead to poor and impractical results. This thesis aims to address the following questions:

- How can port resources be used efficiently and effectively while meeting charter party clauses and port constraints in the context of container and bulk ports?
- How can berth and production scheduling and storage allocation decisions be aligned to achieve global supply chain optimization?

To answer these questions, we design new innovative models integrating tactical and operational port management decisions in ports in general (*Chapter 3*) with an application to container ports. The results are then extended to bulk ports, which have specific constraints on the yard side (*Chapter 4*). *Chapter 3* and *Chapter 4*, hence, answer the first research question.

⁴ <https://www.challenge.ma/le-port-de-jorf-lasfar-vole-de-record-en-record-118383/>

These two chapters focus on joint decisions related to the allocation of laycans, berths, quay cranes for container ports, and conveyors from hangars to berths for bulk ports. *Chapter 5* is designed to answer the second research question in the case of bulk ports. The feasibility of the port operations planning generated previously relies on the decisions of the upstream supply chain. Consequently, we propose an integrated approach implemented in a Decision Support System (DSS) to optimize production, storage and vessel berthing decisions, ensuring production and storage decisions alignment with vessel demands, illustrated on a use-case of the Jorf Lasfar chemical platform.

1.4. Research outline and main contributions

This thesis is organized as follows (Figure 1.12):

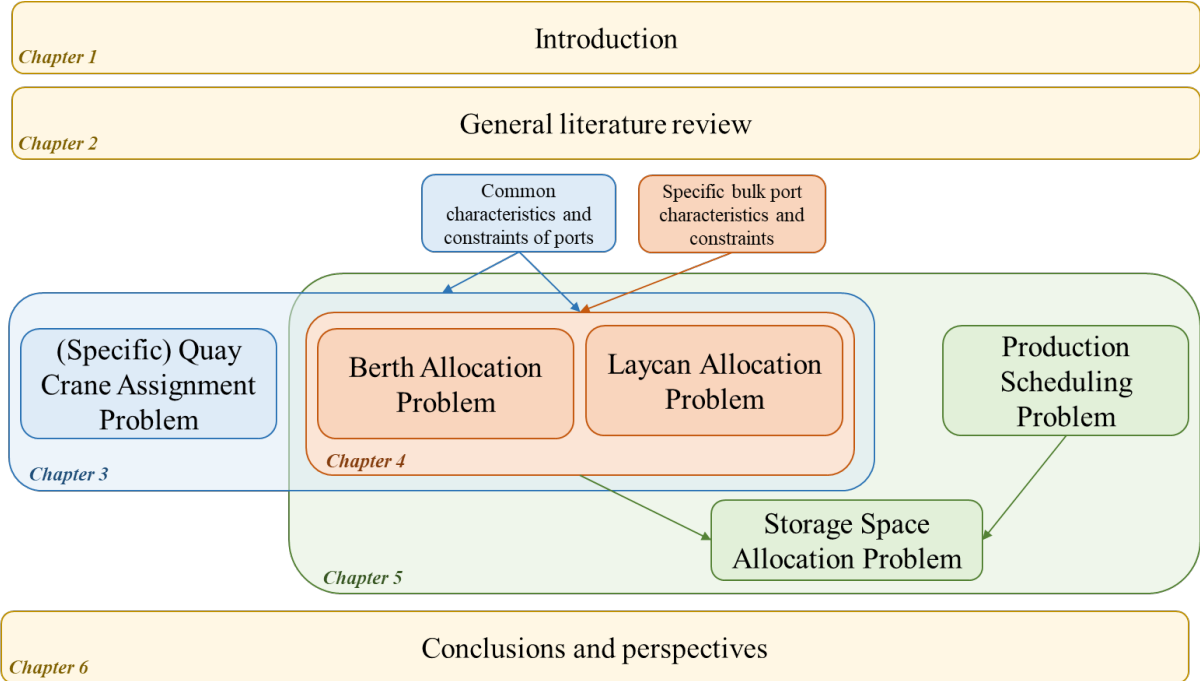

Figure 1.12: Thesis structure

Chapter 1 introduces the research work by presenting a general overview of maritime transport and ports and the optimization problems related to port management studied in this thesis. In addition, this chapter presents the industrial context, defines the problem statement, the objectives, and the contributions, and describes the structure of this thesis.

Chapter 2 describes the characteristics of the BAP and summarizes the state of the art addressing the BAP, alone or in an integrated approach, in the context of container and bulk ports. In addition, we review papers that consider real-world aspects in the BAP.

The following three chapters present the contributions of this thesis and are constituted by one accepted and two submitted papers, respectively.

As stated before, the strong interrelations between port decision problems require integrated approaches. *Chapter 3* presents two new models. The first one integrates the LAP, the continuous BAP and the time-invariant QCAP, with the objectives of finding an efficient schedule for berthing vessels and an efficient quay crane assignment and of supporting terminal managers in the negotiation process with shipping lines. This integrated problem considers several characteristics and constraints rarely studied together, such as the multiplicity of quays, the variation of water depth, navigation channel restrictions related to tides, charter party clauses and non-working periods. All these characteristics and constraints have been formulated as predicates, which has ensured maximum flexibility in the implementation of the model and significantly improved its computational performance. The second model extends the first one to the time-invariant QCASP, which includes the assignment of a set of specific quay cranes to each vessel considering the productivity of quay cranes and their maximum outreach. Integrating these decision problems with different decision levels is made possible by changing the decision time-interval inside the planning horizon. The efficiency of these two models is shown through computational experiments on generated problem instances.

Bulk ports are relevant in our industrial context. They have specific characteristics and constraints that are not studied in *Chapter 3*. Moreover, they have received less attention than container terminals in Operations Research (OR) literature. *Chapter 4* presents an extension that integrates the LAP and the hybrid BAP considering the common characteristics and constraints of ports considered in *Chapter 3* while adding specific constraints related to bulk ports, mainly conveyor routing constraints between storage hangars and berthing positions and the multiplicity of cargo types on the same vessel. Since each berthing position has a fixed ship loader, QCAP decisions are not addressed in the case of bulk ports. A case study inspired by the operations of OCP Group at the bulk port of Jorf Lasfar is also presented to validate the model.

Note that the optimal solutions proposed by the berth scheduling model for bulk ports presented in *Chapter 4* may be infeasible because of the unavailability of cargo to be exported in vessels. Indeed, there is a strong interaction between production and port operations unless an important decoupling of these problems is done by high stock levels, which is an expensive solution, and even more so in case of a wide diversity of goods. Hence the idea of integrating port operations with the upstream supply chain to ensure supply chain alignment. To this end, *Chapter 5* presents an integrated DSS for planning the production, storage and bulk port operations in a fertilizer supply chain based on OCP's fertilizer supply chain at the

Jorf Lasfar chemical platform. This planning tool encapsulates an existing production scheduling model that gives the optimal production plan of fertilizers in the Jorf Lasfar fertilizer plants, the berth scheduling model for bulk ports presented in *Chapter 4*, and a new model for allocating storage spaces. The latter model determines where produced fertilizers will be stored and from where the stored fertilizers are removed to be loaded in vessels while considering as constraints the optimal solutions of the production and berth scheduling models and conveyor routing constraints between production lines, hangars, and berthing positions. The objective of the DSS is to align production and storage decisions with vessel demands, ensuring consistency in decision-making and improving the supply chain performance.

Finally, *Chapter 6* summarizes the main conclusions drawn from this thesis and suggests several directions for future research.

Publications related to this thesis are listed below.

- **Publications in scientific journals:**

- Bouzekri, H., Alpan, G., & Giard, V. (2021). Integrated Laycan and Berth Allocation and time-invariant Quay Crane Assignment Problem in tidal ports with multiple quays. *European Journal of Operational Research*, 293(3), 892-909. <https://doi.org/10.1016/j.ejor.2020.12.056>
- Bouzekri, H., Alpan, G., & Giard, V. (2021). Integrated Laycan and Berth Allocation Problem with conveyor routing constraints and preventive maintenance activities in bulk ports. *Computers & Industrial Engineering*, submitted.
- Bouzekri, H., Bara, N., Alpan, G., & Giard, V. (2021). An integrated Decision Support System for planning production, storage and bulk port operations in a fertilizer supply chain. *International Journal of Production Economics*, submitted.

- **Publications in international conferences:**

- Bouzekri, H., Alpan, G., & Giard, V. (2019). *Modélisation des problèmes de l'allocation des planches et des postes à quai*. 13^{ème} Conférence Internationale de CIGI QUALITA, Montréal, Canada. <https://hal.archives-ouvertes.fr/hal-02277658>
- Bouzekri, H., Alpan, G., & Giard, V. (2019). Integrated Laycan and Berth Allocation Problem. *The 8th International Conference on Industrial Engineering and Systems Management (IESM)*, Shanghai, China. <https://doi.org/10.1109/IESM45758.2019.8948110>
- Bouzekri, H., Alpan, G., & Giard, V. (2020). A Dynamic Hybrid Berth Allocation Problem with Routing Constraints in Bulk Ports. *Advances in Production Management Systems. The Path to Digital Transformation and Innovation of Production Management Systems* (pp. 250–258). Springer International Publishing. https://doi.org/10.1007/978-3-030-57993-7_29
- Bouzekri, H., Alpan, G., & Giard, V. (2020). *Modélisation du problème de l'allocation des planches et des postes à quai dans les ports vraciers*. 13^{ème} Conférence Francophone de Modélisation, Optimisation et Simulation (MOSIM), Agadir, Maroc. <https://hal.archives-ouvertes.fr/hal-03005639>

-

Chapter 2

General literature review

Berth Allocation Problem (BAP) is the central problem in this thesis. Therefore, in this chapter we present a general overview of the BAP in the context of container and bulk ports, when modeled alone or in an integrated approach with other port operations problems. This chapter is not intended as a complete literature review on BAP. The aim is to present the problem characteristics in general and the various real-world constraints that are considered in recent scientific literature. We also highlight which one of these characteristics and constraints are considered in this thesis. More detailed literature reviews, specifically related to each chapter, and analysis grids to identify the research gaps are presented in the related chapters. In *Chapter 3*, the literature review focuses on papers integrating the BAP with quay crane assignment decisions; in *Chapter 4*, it focuses on papers studying the BAP in the context of bulk ports; and in *Chapter 5*, it focuses on papers integrating the BAP with storage decisions also in the context of bulk ports.

2.1. General characteristic of the BAP

In this section, we define the BAP, its main attributes, and the different methods that are used to solve it.

2.1.1. BAP definition

The BAP is one of the most relevant logistics problems arising in port management since it is a critical issue for efficient and effective seaside operations planning. It has been widely studied in OR literature. In berth allocation problems, vessels arrive over time, and the port operator needs to assign them to berths in the quay, such that a given objective function is optimized, considering vessels and port constraints. Vessels must be moored within the quay boundaries and cannot occupy the same quay space at a time. The output of the BAP is a berth plan that can be represented by a space-time diagram (Figure 2.1) in which the horizontal axis represents the time, the vertical axis represents the quay, and each vessel is represented by a rectangle whose width represents the vessel length and whose length represents the vessel handling time. The left edge of the rectangle represents the vessel arrival time, while the right edge represents its departure time.

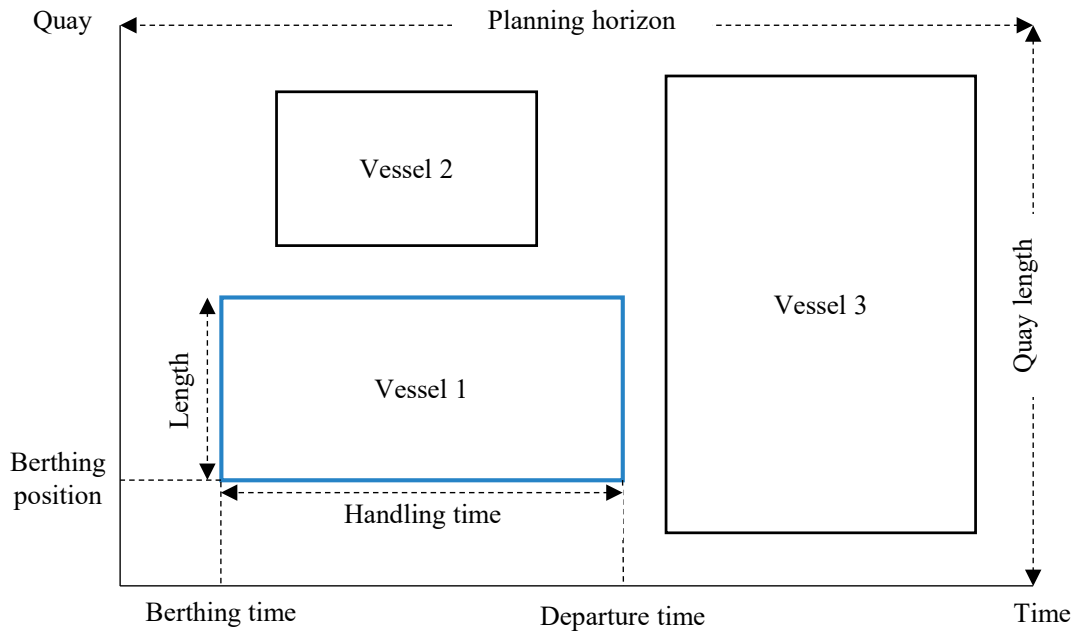

Figure 2.1: Graphic representation of a berth plan

2.1.2. BAP attributes

Several spatial and temporal constraints may be involved in berth allocation, which leads to a multitude of BAP formulations. Bierwirth and Meisel (2010, 2015) classify BAP papers according to four attributes, namely the *spatial attribute*, the *temporal attribute*, the *handling time attribute*, and the *performance measure attribute*.

Spatial attribute

This attribute concerns the berth layout, which restricts the possible berthing positions of vessels depending on a preset partitioning of the quay into berths. The following cases are distinguished (Figure 2.2):

- In the *discrete case*, the quay is partitioned into a number of berths, and each berth can receive only one single vessel at a time. This case is easier in scheduling, but the terminal usage is not fully efficient.
- In the *continuous case*, the quay is not partitioned, and thus vessels can berth anywhere within the boundaries of the quay. This case better utilizes the quay space but is more complicated in scheduling.
- Finally, in the *hybrid case*, the quay is also partitioned into berths like in the discrete case, but a large vessel may occupy more than one berth, and a berth can receive more than one small vessel.

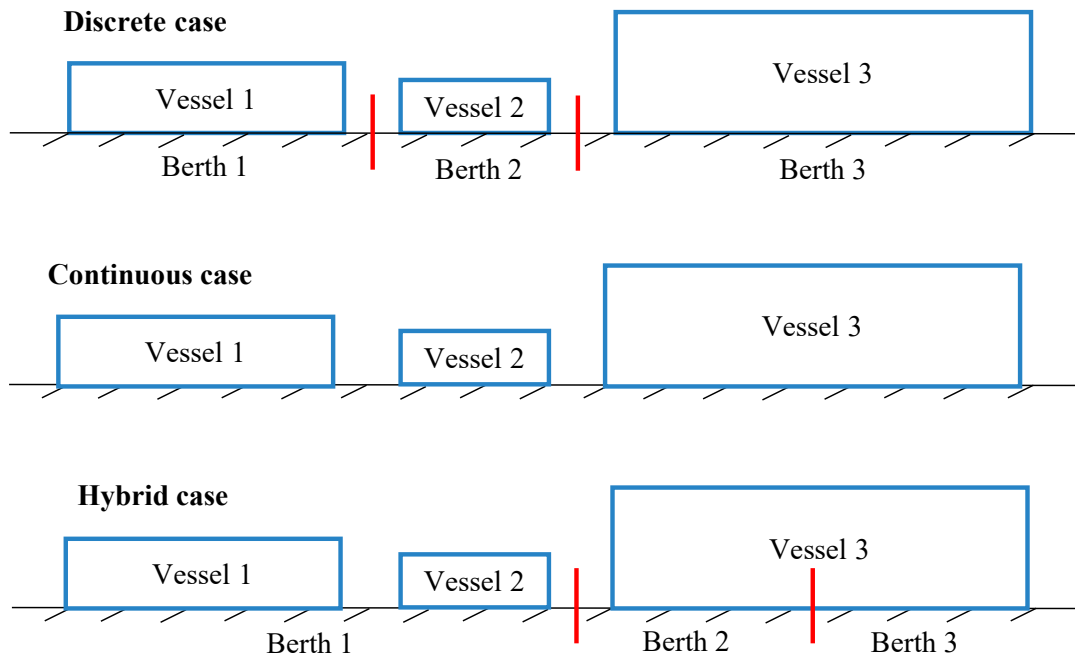

Figure 2.2: Different berth layouts

Moreover, vessels can be berthed only at positions where the water depth exceeds their draft.

Temporal attribute

This attribute describes how arrival times of vessels are given as an input to the BAP. The following cases are distinguished:

- In the case of *static arrivals*, it is assumed that all vessels are waiting in the port to be served.
- In the case of *dynamic arrivals*, vessels arrive at individual in fixed times.
- In the case of *cyclic arrivals*, vessels come to the port repeatedly in fixed times intervals.
- Finally, in the case of *stochastic arrivals*, vessel arrival times are determined from random distributions.

Additional temporal constraints may fix a maximum waiting time or a maximum departure time not to be exceeded by each vessel.

Handling time attribute

Similar to the temporal attribute, the handling time attribute describes how handling times of vessels are given as an input to the BAP. They can be either fixed or variable. In the latter case, handling times can be impacted by the distance between berths and storage spaces or by quay crane assignment or scheduling decisions. As in the case of vessel arrivals, handling times can also be considered as stochastic input parameters.

Performance measure attribute

This attribute is related to the performance measures covered by the BAP objective-function. We note that most BAP models consider minimizing vessel stay times in the port by either minimizing the waiting time of vessels in the harbor, minimizing their handling times or their departure times. Economic objective-functions are also considered with the aim of reducing the different costs incurred during the berthing of vessels, which allow combining different goals in an overall cost function. Different weights are commonly used to set priorities between the different costs considered.

2.1.3. BAP resolution

The BAP is a NP-hard problem in OR, and therefore, a computationally difficult problem. To solve the BAP, alone or integrated with other problems, researchers in OR use either exact methods (e.g., column generation, branch-and-bound, branch-and-price, cutting-plane, Bender's decomposition, Lagrangian relaxation, etc.), heuristics/metaheuristics (e.g., Tabu search, greedy algorithms, simulated annealing, genetic algorithms, evolutionary algorithms, etc.), or simulation techniques, alone or combined with optimization. Genetic and Evolutionary Algorithms are the most frequently used. We note that some authors propose only new formulations for the BAP, using commercial solvers (e.g., CPLEX, Gurobi, FICO Xpress, etc.) without specifying any new solution method. This is our case in this thesis. Indeed, the proposed mathematical formulations use many predicates to improve the computational performance of the designed models. A predicate is a logical expression that defines (restricts) the domain of an index by taking a value of "true" or "false", which binds the existence of decision variables, depending on the values of the parameters. Hence, the predicates act like a pre-treatment of the models based on the problem data and reduce the number of binary variables, and thus improve the computational performance of the models. Consequently, problems of practical sizes can be solved in a reasonable time using off-the-shelf commercial software, without a need for new solution methods.

2.2. Early works and review papers on the BAP

Nicolaou (1967) and Sabria & Daganzo (1989) are among the first works dealing with the BAP using queuing theory. However, their approach failed to capture several problem attributes, mainly the space attribute associated with berthing. By the late 1990s, various versions of the BAP were formalized as mathematical programs. Each version combines an alternative for each attribute (berth layout, vessel arrivals, vessel handling times and the performance measure).

We remind that this thesis tackles both container and bulk ports, each with its specific characteristics and constraints.

2.2.1. BAP in container ports

Imai et al. (1997) are among the first works to study the BAP in the context of container ports. They consider the discrete static BAP as a machine scheduling problem and formulate the problem as multi-objective non-linear integer program to minimize both the total time spent by vessels at the berths and the dissatisfaction with the berthing order. Imai et al. (2001) extend the model to the discrete dynamic case. Cordeau et al. (2005) also consider the discrete dynamic BAP and model it as a multi-depot vehicle-routing problem with time windows where vessels are seen as customers and berths as depots. Each depot can receive only one single vehicle, and time windows correspond to the availability periods of depots. Li et al. (1998) study the continuous static BAP as a scheduling problem with a multiple-job-on-one-processor pattern, where several jobs (vessels) can be processed by a single processor (berth) simultaneously. Lim (1998) models the continuous dynamic BAP as a 2-D bin packing problem because of the resemblance between their time-space representations. Nishimura et al. (2001) study the hybrid dynamic BAP considering the water depth of berths. Since then, different mathematical models have been designed, and several exact approaches and heuristic procedures have been proposed for the BAP with the dual objective of capturing more real-world aspects and improving the solution methods proposed. In this thesis, we mainly focus on the first objective by incorporating real-world constraints in the BAP, as much as possible, to be as close as possible to reality.

For extensive literature reviews on decision problems in the context of container terminals, we refer readers to the following papers: Vis & de Koster (2003) classify and review decision problems at container terminals. Steenken et al. (2004) also describe and classify the main logistics processes and operations in container terminals and present a survey of methods for their optimization. Similarly, Kim (2005) presents the various operations in container terminals and decision-making problems that require support by scientific methods, then he reviews and classifies models and methods according to their characteristics. Günther & Kim (2006) give a brief overview of planning problems in container terminals and their relationship to the various kinds of terminal equipment. Stahlbock & Voß (2007) update the state of the art in container terminal operations and operations research. Theofanis et al. (2009) present a comparative critical review of research works related to berth planning. They also discuss the strengths and deficiencies of the existing models in addressing real-world aspects. Carlo et al. (2015) review and classify

papers on container terminal seaside operations, published between 2004 and 2012. Bierwirth and Meisel (2010, 2015) first present a survey covering berth allocation and quay crane scheduling problems in container terminals up to 2009, and they later update this survey to cover research papers up to 2014. Finally, Gharehgozli et al. (2016) highlight recent developments in container terminals including innovative technologies and new OR directions and models.

2.2.2. BAP in bulk ports

Until recently, BAP in bulk ports has received little attention in OR literature compared to container terminals. In this type of port, cargo is transported unpackaged in large quantities and vessels are loaded/unloaded using specific handling equipment depending on the cargo properties and the vessel requirements. Barros et al. (2011) and Umang et al. (2013) are among the first authors to study the BAP in the context of bulk ports. Barros et al. (2011) model the BAP in its discrete form, giving priority for unloading to vessels related to the most critical mineral stock level to avoid any disruption of production. Umang et al. (2013) study the hybrid BAP, taking into account the cargo type on the vessel and the distance between the berthing position and the cargo location on the yard. A list of journal papers that study the BAP alone or in an integrated approach in the context of bulk ports considering real-world aspects is presented in Section 4.2.1 and summarized in Table 4.1.

In this thesis, we first consider a continuous berth layout in ports in general (*Chapter 3*) with an application to container ports where quay cranes can move all along the quays. Then we study the hybrid case in the context of bulk ports (*Chapter 4*) where the quays have fixed ship loaders, considering conveyor routing constraints between storage hangars and berthing positions. To our knowledge, we are the first to consider conveyor routing constraints in the BAP. In addition, we consider draft restrictions and the technical constraints of vessels that prohibit their berthing at some quays or oblige them to berth at a specific quay. Regarding vessel arrivals and handling times, we consider dynamic arrivals and variable handling times. Finally, we distinguish between the different stakeholders, which have conflicting objectives and interests in most cases, by considering two objective functions: one related to economic aspects and charter party clauses and the other one reflecting physical aspects of port's utilization, such as the minimization of the sum of expected vessel departure times (shipowner's interest) or vessel stay times (port operator's interest). Other considered real-world characteristics and constraints are outlined in the following section.

2.3. BAP and real-world aspects

Even though BAP has theoretical challenges, it is also a practical problem. The applicability of proposed models in a real port context depends on how well these models can integrate various constraints and issues that are faced in the industrial framework of ports. Therefore, several real-world aspects and/or constraints are considered in the BAP literature. We will expose them in this section.

2.3.1. Tides and navigation channel restrictions

The passage of vessels through the navigation channel is impacted by the tide cycle in tidal ports and by the channel's width. Indeed, large vessels can use the channel only during high tides so that the channel's water depth becomes superior to their draft (Figure 2.3). Moreover, when the channel is narrow, it can support only one-way traffic. Consequently, even when berths are available, incoming vessels may have to wait a long time at the harbor until the navigation channel becomes available for entering. Likewise, vessels having finished their handling operations at the berth and thus ready for leaving may also have to wait for some time for the navigation channel to become available for departure.

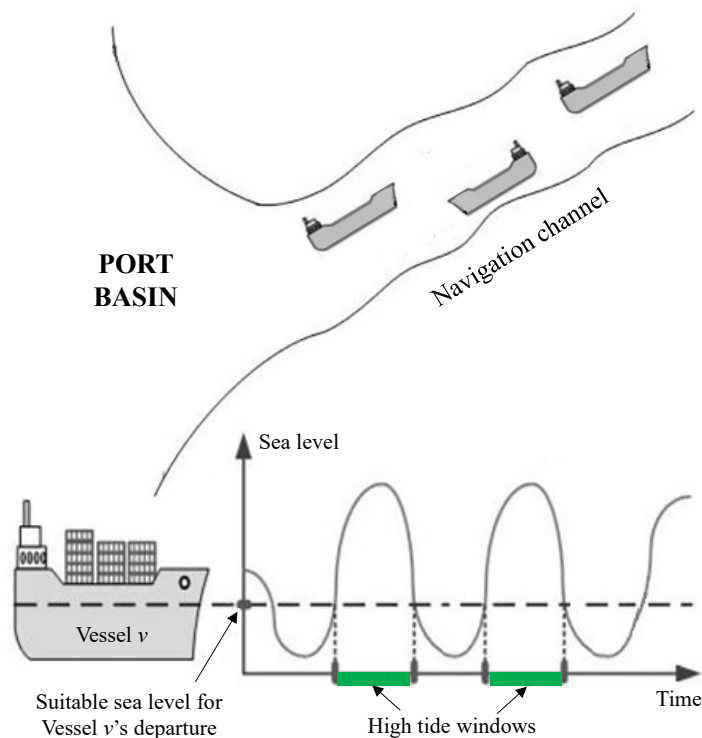

Figure 2.3: Navigation channel restrictions

Barros et al. (2011) study the discrete dynamic BAP in tidal bulk ports with stock level conditions, prioritizing the vessels related to the most critical stock level. The authors model the BAP as a transportation problem in which vessels are seen as suppliers, and favorable tidal condition windows are seen as consumers. Xu et al. (2012) study both the

static and dynamic versions of the BAP in container terminals in which the assignment of vessels to berths is limited by water depth and tidal conditions. Consequently, berths have different water depths depending on the different tide levels at different hours of the day, which restricts vessel berthing. The authors model the problem as a parallel-machine scheduling problem with inclusive processing set restrictions. To simplify the problem, they consider a short planning horizon with only one high tide and one low tide. Lalla-Ruiz et al. (2016) propose an alternative mathematical formulation that considers a multi-period planning horizon. Sheikholeslami et al. (2019) study the discrete dynamic BAP in ports with low-depth navigation channel. High-draft vessels must wait for high tides to have an appropriate water level, and then they can pass through the navigation channel.

In addition to tides, navigation channel widths also restrict the passage of vessels through the channel for the sake of navigation safety. In this vein, Xu et al. (2018) study the BAP in container terminals under channel traffic limitations including the one-way traffic rule and the temporary closure of navigation channels due to the insufficient channel width during bad weather and poor visibility.

In this thesis, we also consider navigation channel restrictions due to the tide cycle by defining the start and end time of each high tide cycle (high tide windows) that would occur during the planning horizon, which imposes some feasible berthing and departure periods for large vessels. Moreover, we limit the maximum number of vessels (inbound and outbound) that can pass simultaneously through the navigation channel to avoid channel accidents.

2.3.2. Ports with multiple quays, multiple terminals, or irregular layouts

Ports with multiple quays add the problem of assigning quays to the basic problem of determining berthing times and positions for each coming vessel. Assigning a quay to a vessel can be more advantageous than other quays if the origin or destination of cargo to be loaded or unloaded is the most closely to that quay, which will reduce transport times between the vessel and the storage space, and thus reduce the vessel's stay time in the port.

Ports with multiple quays add the problem of assigning quays to the basic problem of determining berthing times and positions for each incoming vessel. Choice of the quay impacts the transport time between a storage space and the quay, and thus impacts the vessel's stay time in the port (e.g., the closer a quay is to the storage area where cargo is to be loaded or unloaded, the lower is the transport time).

Frojan et al. (2015) are the first to study the continuous dynamic BAP in a container terminal with multiple quays. For other papers considering ports with multiple quays, we refer readers to Krimi et al. (2019, 2020), Grubisic et al. (2020) and Lujan et al. (2021).

We note that some ports have irregular layouts involving complicated berthing operations such as adjacency, oppositional and blocking restrictions between berths. Correcher et al. (2019) study the discrete dynamic BAP in this type of ports.

In this thesis, we also study ports with multiple quays. Moreover, we consider the restrictions of bulk ports where a whole quay or a part of it can be reserved to only one type of cargo (or more) due to specific handling equipment requirements or to avoid contamination between different types of cargoes. A quay can also be forbidden to some vessels for technical or contractual reasons.

Similar to ports with multiple quays, Schepler et al. (2017) go further and study the BAP along with the scheduling of trains and trucks in multi-terminal and multi-modal maritime container ports while limiting inter-terminal transport of containers.

2.3.3. Unavailability periods

Port resources such as quays and cranes require preventive maintenance to reduce their failure probabilities. Consequently, berthing schedules may be disrupted due to maintenance. Therefore, some authors consider preventive maintenance activities while modeling the BAP. Ribeiro et al. (2016) study the discrete dynamic BAP in bulk ports considering the schedule of maintenance activities to be performed at berths. They model each maintenance activity as a dummy vessel that must be handled at a precise time by a specific berth, thus forbidding the berthing of vessels at this berth during that time. For other papers considering preventive maintenance activities, see Zheng et al. (2018) and Li et al. (2020).

In this thesis, we also consider preventive maintenance activities in the context of bulk ports to be performed at the conveyors and berthing positions either over a period of time or at a fixed date. Some berthing positions can also be unavailable during periods of bad weather. In addition, we consider non-working days, which also generate unavailability periods differing from one country to another (Figure 2.4). These exception periods are either included or excluded in the counting of the contractual handling time of vessels (laytime) defined in the charter party (Tsoudis, 2015).

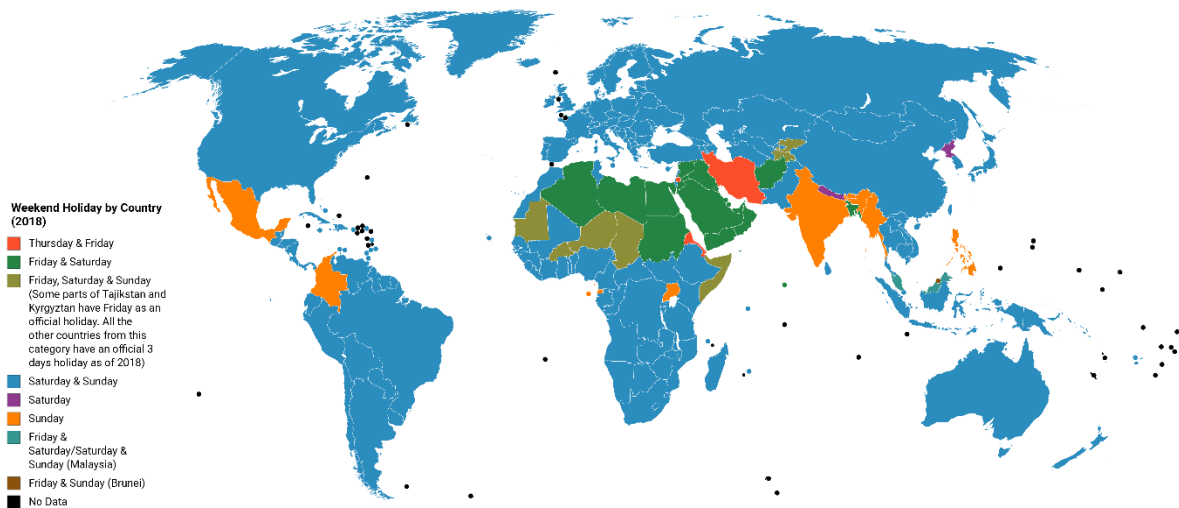

Figure 2.4: Weekend holiday by country

In the case of a *SSHEX* (Saturdays/Sundays/Holidays Excluded) agreement, the time lost in port on Saturdays, Sundays and Holidays does not count as laytime (from 5 pm on Friday until 8 am on Monday, and on Holidays from 5 pm of the day preceding a holiday until 8 am of the next working day), while in the case of a *SHEX* (Sundays/Holidays Excluded) agreement, the time lost in port on Saturdays counts as laytime. In the case of a *SSHINC* (Saturdays/Sundays/Holidays Included) agreement, no exception periods are in effect, and the laytime will count seven days a week as well as during holidays. Very large capacity vessels usually operate without exception periods being in effect. In Arab countries and Muslim countries in general, weekend holidays differ from those applicable to the Western World. Indeed, Thursdays take the place of Saturdays, and Fridays take the place of Sundays.

Agreements with exceptions favor charterers, as Weekends and Holidays are to be excepted from the counting of laytime, which gives charterers more time to complete cargo operations and finish within the laytime allowed without incurring demurrage. In some cases, charterers quote *EIU* (Even If Used), which means laytime will not be counted even if cargo operations are carried out on exception days. On the other hand, *UU* (Unless Used) means that if cargo operations are carried out during periods excepted from laytime, such time shall count. On the contrary, agreements without exceptions favor shipowners because the laytime becomes continuous, including Weekends and other Holidays.

2.3.4. Piloting and tugging constraints

In addition to berths, the berthing process requires several other resources, such as tugboats and pilot boats. Tugboats are small, powerful boats capable of steering large vessels by pulling or pushing them. They are used to assist these vessels in places where they are unable to maneuver themselves, such as the confines of the port and narrow navigation channels.

Figure 2.5 shows an example of two tugboats assisting a container ship in its berthing operation. While pilot boats are used to transport maritime pilots between land and the incoming or outgoing vessels they are piloting. Abou Kasm et al. (2021) consider vessel scheduling with piloting and tugging constraints. Their work is motivated by the high costs involved in tugboats and maritime pilots, and the complexity of berthing and unberthing operations, especially during congestion periods. The authors also consider navigation channel restrictions that forbid the passing of vessel in opposite directions through the navigation channel.



Figure 2.5: Tugboats assisting a container ship⁵

2.3.5. Uncertainty

The maritime freight transport is hardly predictable as many disturbances may occur (e.g., vessel delays due to bad weather, machine downtimes, etc.). Therefore, the consideration of uncertain problem data and the correspondent development of planning methods have recently received increasing attention in the BAP.

Umang et al. (2017) study the BAP with stochastic arrivals and handling times in the context of bulk ports. The deviation of vessel arrivals and handling times from their expected or estimated values can disrupt the original berth plan, which can make it infeasible. Based on past data, the authors model the uncertainty in the data by making appropriate assumptions about the probability distributions of the uncertain parameters. Then, they solve the BAP on a rolling planning horizon with the objective of minimizing the total realized cost of the updated berthing schedule.

⁵ <https://www.morethanshipping.com/container-ship-orders-rise-to-5-3-million-teus/>

In the context of container terminals, Schepler et al. (2019) study the discrete BAP with stochastic arrival times of vessels. The authors develop several new proactive, reactive, and proactive/reactive approaches to this problem and make a comparison between them. Guo et al. (2021) study the continuous BAP with vessel handling time uncertainty considering the impact of weather conditions. As a first step, the authors first evaluate and measure vessel handling times using a model that considers constraints related to weather effects. In the second step, they solve the BAP based on the vessel handling times obtained in the first step and using a heuristic algorithm embedded with a machine learning approach. The latter's role is to determine the relationship between vessel handling times and weather conditions by mining from historical data.

Zhen (2015) studies the tactical BAP where vessels visit the port periodically considering uncertain operation times. Due to some unpredicted factors, the number of containers that will be handled fluctuates in each period, influencing vessels' operation time and complicates the traditional berth allocation decisions. The author proposes both a stochastic model coping with arbitrary probability distributions of vessels operation time deviation and a robust model that is applicable in case limited information about probability distributions is available. Xiang & Liu (2021) also study the tactical BAP considering uncertain operation time. The authors formulate a robust optimization model based on historical data, which can well resist the possible risks in the future.

For other papers addressing the BAP (alone or in an integrated approach) with uncertainty, we refer readers to Zhou & Kang (2008), Ursavas & Zhu (2016), Nourmohammadzadeh & Voß (2020), Zhen et al. (2020), Tan & He (2021) and Rodrigues & Agra (2021).

2.3.6. Environmental aspects

In recent years, there has been growing interest within the field of OR in green maritime freight transportation by developing environmentally friendly optimization models and solution techniques that ultimately yield win-win decisions. The aim is to achieve acceptable environmental performance of the maritime supply chain while still meeting traditional economic criteria. Bektaş et al. (2019) present an overview of recent research on greening freight transportation using OR-based planning techniques.

Reducing carbon emissions during sailing and berth is a key objective in green freight maritime transportation. The following papers develop models that combine the optimization of berth allocation with the reduction of vessel carbon emissions and fuel consumption.

Since the fuel cost has become the major part of shipping lines operation cost, Golias et al. (2010) and Du et al. (2011) propose mixed integer nonlinear programming (MINLP) models for the BAP, whose objectives are reducing fuel consumption and thus vessel carbon emissions while retaining adequate levels of productivity of berthing operations. A vessel that goes slower will emit much less than the same vessel going faster. Therefore, the authors consider the possibility of changing the vessel speed, thus changing the originally estimated vessel fuel consumption and emissions while in transit. To ensure this, they introduce vessel arrival times as decision variables into the BAP model instead of considering predetermined vessel expected arrival times. This new berthing policy could provide a protentional coordination opportunity between port operators and shipping lines. Indeed, port operators may suggest to vessels that have not yet arrived at the port to slow-down, when the port is busy, in order to reduce their waiting time in the harbor, which avoids harbor congestion and the payment of contractual penalties. This will also provide the shipping lines with an opportunity to reduce their fuel consumption and carbon emissions, which leads to a win-win economic and environmental benefits for both the shipping lines and the port.

Similarly, Venturini et al. (2017) incorporate vessel speed control in the BAP, but at multiple ports instead of considering one single port. Indeed, the authors optimize berthing decisions at multiple ports along with optimizing the vessel speed between every two ports to reduce the fuel consumption and thus vessel air emissions. Consequently, both vessel arrival times and departure times are considered as decision variables in the BAP model. The authors note that the practical applicability of their model assumes a strong cooperation between shipping lines and port operators, which is very challenging, especially given the conflicting economic interest between both parties.

Green ports also play an important role in green maritime transportation by investing and encouraging environmentally friendly and sustainable port operations, guaranteeing a good balance between environmental impact and economic interests. The International Maritime Organization proposed imposing a carbon emission tax on ports as a long-term solution to reduce carbon emissions. In this context, Wang et al. (2020) introduce the carbon emission taxation imposed on ports to the time-variant BACAP. The authors formulate the problem as a bi-objective integer programming model for the trade-off between the service efficiency (i.e., minimization of berth waiting times and departure delays) and the operating costs (i.e., the cost of operating quay cranes to handle containers, namely the fuel consumption cost and the labor cost, and the carbon emission taxation incurred) of port

operators. Similarly, De et al. (2020) study the time-variant BACAP considering the fuel consumption of vessels while performing their port operations.

In the same logic of bi-objective cooperative optimization models, Peng et al. (2021) study the use of shore-side electricity to satisfy vessels electricity demand during their berthing at ports. This alternative measure reduces greenhouse gas emissions produced by the auxiliary engines of vessels at berth. These emissions contribute to the worsening of the atmospheric environment in ports located in or near densely populated areas, thus leading to dangerous health and environmental effects. The authors develop a cooperative optimization method to model the BAP with the problem of allocating shore powers to berths considering a trade-off between economic and environmental benefits. The objectives of the problem are to minimize the cost of installing and using shore power systems and the waiting time cost of vessels while minimizing emissions of different types of air pollutants in order to reduce the payment of imposed environmental taxes.

2.4. BAP in an integrated approach

Planning operations in port management are interrelated. Consequently, several works integrate the BAP with other port planning problems such as the assignment and scheduling of quay and yard cranes, the assignment of storage spaces, vehicle routing and dispatching, ship routing, etc. According to (Geoffrion, 1999), model integration can be done either by a *deep integration* or by a *functional integration*. Dolk & Kottemann (1993) have made this same distinction using different terms: *definitional integration* vs *procedural integration*.

- *Deep integration* merges two subproblems or more into one monolithic problem. Consequently, there is no longer a need to explicit the relations between the subproblems.
- *Functional integration* defines a sequence for solving subproblems and data exchanges between the base-level and top-level problems. It can be done either by a feedback loop or a preprocessing.
 - In *feedback loop* (Figure 2.6.a), the top-level problem instructs the base-level problem, then the reaction of the latter is used in the top-level to revise instructions. Once a steady-state is reached, the loop terminates.
 - In *preprocessing* (Figure 2.6.b), the base-level problem is solved first to generate more detailed input data for the top-level one; then both problems are solved sequentially.

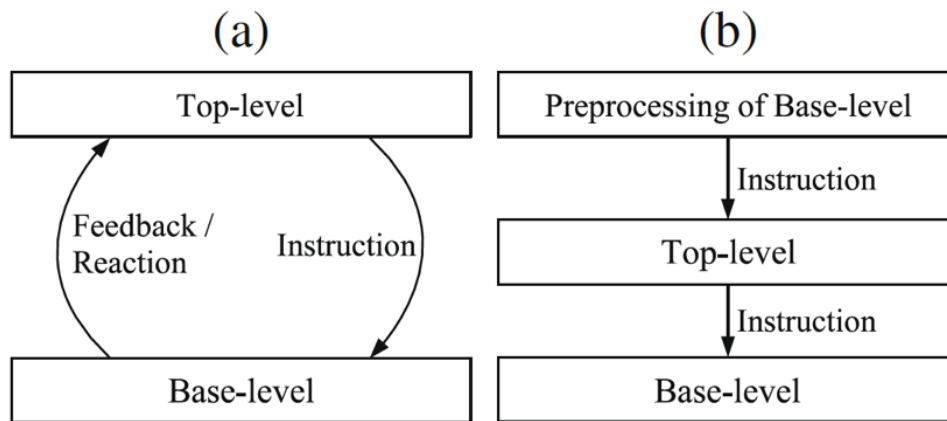

Figure 2.6: Types of functional integration (Bierwirth & Meisel, 2010)

Different designs for integrated port operations planning are possible involving the above-described integration.

2.4.1. BAP and quay crane decision problems

In addition to quays, quay cranes are also a scarce resource. As stated before, the QCAP concerns the assignment of a number of quay cranes to each vessel, the QCASP concerns the assignment of a set of specific quay cranes to each vessel, and the QCSP concerns the schedule of quay cranes for loading and unloading containers (Skaf et al., 2021a). Since the scheduling of berths and quay cranes is possibly the most important and delicate element of container terminal seaside operations, the integration of the BAP with the QCAP, the QCASP and/or the QCSP has been widely studied by researchers. The number and the productivity of quay cranes assigned to each vessel strongly impact vessel handling times during which berths are occupied.

Two versions of the integrated Berth Allocation and Quay Crane Assignment Problem (BACAP) and the integrated Berth Allocation and Specific Quay Crane Assignment Problem (BACASP) have been tackled in the literature: time-invariant and time-variant (variable-in-time). In the time-invariant version, a fixed number or group of cranes is assigned to each vessel throughout its handling time, while in the time-variant version, this number or group of cranes can be changed in each period. The latter version allows more efficient use of cranes since it allows reassignment of cranes. However, this can result in a greater number of crane movements, which is difficult for crane drives to handle. Moreover, the number of decision variables in the time-variant version is greater than the time-invariant version, which makes the problem more difficult to solve. Both versions are interesting in practice and are receiving increasing attention in OR literature. Figure 2.7 illustrates the difference between both versions.

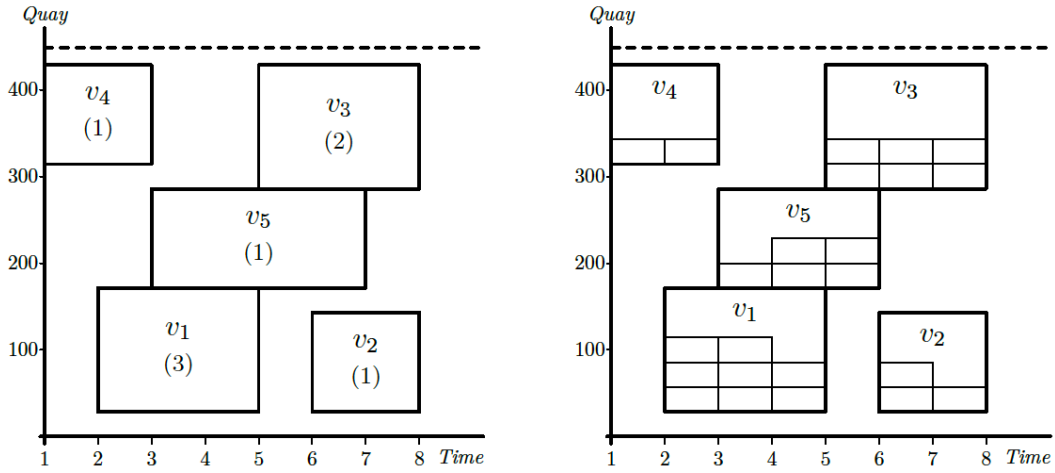

(a) Time-invariant QCAP solution for a terminal with four quay cranes. The number of cranes assigned is shown in parentheses.

(b) Variable-in-time QCAP solution. The cranes are represented as rectangles inside each vessel assignment.

Figure 2.7: QCAP variants (Correcher, 2017)

We note that the BACAP only ensures that the number of used quay cranes at each period does not exceed the number of available cranes. However, it does not guarantee that a feasible assignment of cranes to vessels is possible in such a way that each vessel can be processed without interruptions or crane changes. Correcher et al. (2019) illustrate this situation in Figure 2.8. Each vessel is represented by a rectangle; in (a), the number of cranes assigned to each vessel appears in parentheses, while in (b), the group of cranes assigned to each vessel appears in braces. With 10 cranes available at the quay, the assignment in (a) is feasible for the BACAP with 2 cranes assigned to vessel 8. However, this solution is infeasible for the BACASP, since the group of cranes $\{8,9,10\}$ is assigned to vessel 7, and thus the group of cranes $\{6,7\}$ cannot serve vessel 8 due to crane non-crossing constraints.

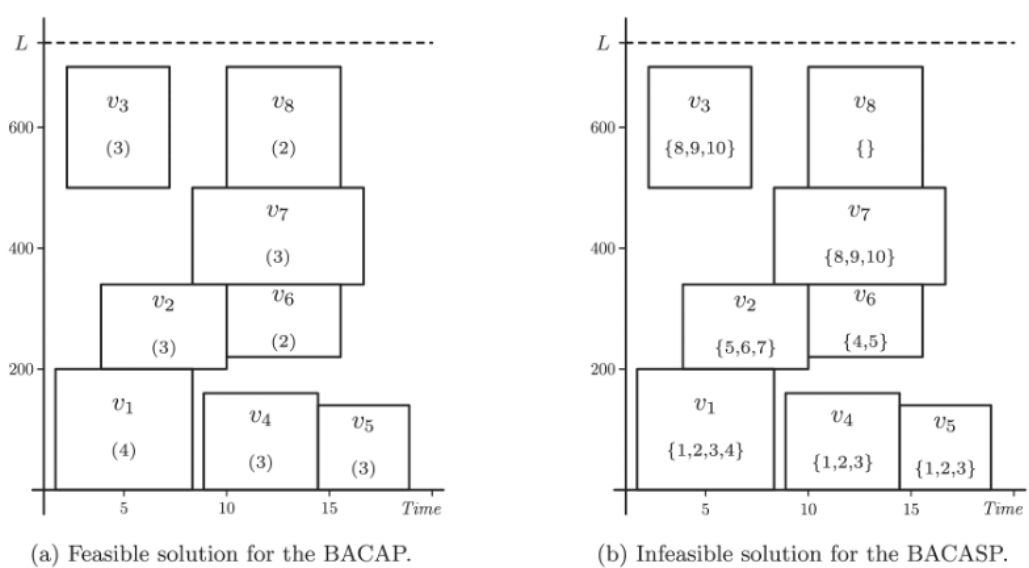

(a) Feasible solution for the BACAP.

(b) Infeasible solution for the BACASP.

Figure 2.8: A solution of the BACAP not feasible for the BACASP (Correcher et al. 2019)

A list of journal papers that propose new models for the BACAP and/or BACASP is presented in Section 3.2.1 and summarized in Table 3.1. Bierwirth & Meisel (2010, 2015) classify papers that solve jointly the BAP, the QCA(S)P and/or the QCSP in the context of container terminals according to their integrating approach (*deep integration vs functional integration*). This thesis integrates the BAP with quay crane assignment decisions under the time-invariant version using a deep integration.

Some authors combine integrated approaches. For example, Park & Kim (2003) combine deep integration with functional integration by preprocessing. They first integrate the BAP and the QCAP in a monolithic model to determine vessel berthing times and positions and the number of quay cranes assigned to each vessel. Then, at the second stage, they determine specific quay cranes for each vessel, incorporating the outcome of the first stage. Similarly, Meisel & Bierwirth (2013) integrate deep integration with functional integration by both preprocessing and feedback loop. They first calculate vessel handling times by solving the QCSP model. Second, they solve a monolithic BAP and QCAP model. Third, they seek feasible schedules for the quay crane assignments derived from the berth plan. If a least one quay crane schedule is infeasible, the invalid part of the berth plan is fed back to the former stage. The authors also evaluate the advantage promised by integrated planning approaches by comparing the results of solving the BAP, the QCAP and the QCSP sequentially with the integrated approach results.

Finally, we note that the availability and the performance of workers impact the performance of industrial systems. Failure to account for these may lead to impractical results. In this vein, Chargui et al. (2021) propose a monolithic model for the BACASP in the context of container terminals considering two challenging elements that impact the problem performance: the availability and the performance of quay crane operators and the deployment of yard trucks.

2.4.2. BAP and yard-side decision problems

Port managers are faced with the challenge of maximizing efficiency both along the seaside and the yard-side. The problems observed on both sides are often interrelated. Poor management of seaside operations can cause bottlenecks in the port yard and in horizontal transportation, and vice versa. Consequently, some authors study the integration of the BAP with routing and/or yard planning decisions.

Regarding yard planning decisions in the context of container terminals, the Yard Assignment Problem (YAP) aims to assign yard storage locations to each vessel to minimize transport distances of moving containers between berths and yard storage locations. Yard

planning is essential for efficient operations in container terminals, especially since ports have limited storage space. Therefore, flexible management of storage space planning strategies is necessary to improve the utilization of port space and the efficiency of handling equipment.

Li & Yip (2013) study the joint planning problem for berth and yard allocation in export container terminals to improve yard-to-quay services. Similarly, Tao & Lee (2015) study the integrated problem in transshipment terminals with the aim of minimizing the total distance of exchanging containers between mother vessels and feeders and the workload imbalance among yard blocks. Guo et al. (2021) also study the berth allocation and yard assignment problem with the aim of minimizing the total truck distance between berthing positions and storage positions of export containers. In addition to berths and yards, Liu (2020) also consider quay cranes considering productivity losses incurred by quay crane interference.

At the tactical level, Zhen et al. (2011) study the planning of berth and yard templates for transshipment hubs. These plans are concerned by the allocation of berth, quay cranes and yard storage locations at a tactical decision level. The Berth part is solved first, and its results are used as the input of the yard part. The aim is to minimize vessels turnaround time and the deviation from vessels best berthing positions that are determined by the yard template. The result is refined by repeating an iterative process until no improvement is found. Similarly, Hendriks et al. (2013) study the simultaneous berth allocation and yard planning problem at the tactical level in import/export container terminals. The objective is to reduce the total internal vehicle driving distance.

Other yard planning problems being investigated are the internal vehicle routing and dispatching problems. Carlo et al. (2014) present an overview of internal transport operations connecting the seaside, the yard side and the landside of container terminals. Linkosaari (2014) studies the tactical BAP including both the QCSP and the vehicle dispatching problem as sub-problems with the aim of reducing vessels turnaround time using fewer resources. The author uses a functional integration in which the sub-problems are solved sequentially and in parallel, which results in more modifiable and detailed parameters to the BAP. We note that some papers integrate quay crane scheduling and yard-side decision problems, without considering BAP decisions. As an example, Skaf et al. (2021b) study the integrated quay crane and yard truck scheduling problem.

In the context of bulk ports, the BAP is mainly integrated with the Storage Space Allocation Problem (SSAP) and the scheduling of bulk-handling equipment. The storage location and the routing of cargoes affect the travel distance between the assigned berthing

positions to vessels and the assigned storage locations to cargoes, and furthermore, determine the storage efficiency of the yard-side. Thus, these problems are very interrelated. We note that the constraints considered in the integrated problem differ from one paper to another since each bulk port and warehouse system has its own management rules, which requires specific constraints. A list of journal papers that study the BAP integrated with the SSAP in the context of bulk ports is presented in Section 5.2 and summarized in Table 5.1.

In this thesis, we integrate production, storage and vessel berthing decisions using a functional integration by a feedback loop implemented in a DSS logic. The production and berth scheduling problems are the top-level problems, and the SSAP is the base-level problem (Figure 2.6). The aim of this DSS is to align production and storage decisions with vessel demands. We note that the existence of conveyor routing constraints between the three successive echelons of the studied supply chain (production lines, storage hangars, and berthing positions) makes the alignment of decisions more difficult.

2.4.3. BAP and laycan allocation

Despite the booming OR applications in maritime studies and the importance of charter in maritime practice, there is still a lack of models dealing with charter party decisions, such as deciding on laycans (i.e., the earliest and latest dates the vessels are supposed to arrive at the port) upon the vessel chartering (i.e., an activity within the shipping industry whereby a shipowner hires out the use of his vessel to a charterer).

The LAP assigns laycans to new vessels to charter within a medium-term planning horizon, considering the availability of cargo and port resources, mainly quays. Hence, the LAP has a clear interaction with the BAP. Only one paper was found dealing with the LAP. Lorenzoni et al. (2006) develop a computational tool based on a mathematical model of a multi-mode resource-constrained scheduling problem, with the aim of improving vessels attendance. The proposed model determines laydays in a way that avoids simultaneous or nearly simultaneous arrivals of vessels competing with the same port resources, including berths, handling equipment, stock areas and the navigation channel. Therefore, the authors consider time windows for the availability of port resources. However, they assume the first-come, first-served regime of attendance, which could exclude certain solutions with better results, unlike the BAP that explores every possible berthing solution without being restricted to a certain regime of attendance.

Recently, Sun et al. (2021) classify chartering-related literature into two categories, namely charter-related studies and charterparty-based studies, depending on their contexts and objects. Studies belonging to the first category incorporate the unique features of chartering

activities into various contexts, such as the consideration of demurrage and despatch in the BAP's objective function (Mazioli et al. 2019), while studies belonging to the second category focus on the charter party itself and most of them fall into the categories of *maritime law*. This thesis is closely related to the first category, since we also incorporate charter party clauses in port decision problems and, furthermore, we determine the optimal laycans for new vessels to charter to assist stakeholders in their negotiation process upon the signature of the charter party, which makes the originality of our work.

First, we integrate the LAP with the BAP and the QCA(S)P in ports in general with an application to container ports, and then, we integrate the LAP with the BAP in bulk ports considering conveyor routing constraints between storage hangars and berthing positions. QCAP decisions are not addressed in the case of bulk ports because each berthing position has a fixed ship loader. The combined problem aims to find efficient schedules for berthing already chartered vessels and new vessels to charter to avoid any excessive overloading in the execution of port operations, thus improving the attendance of vessels and avoiding the payment of high penalties.

Since laycan allocation is a tactical problem and berth and quay crane assignment are operational ones, we propose a modular decision time-interval inside this planning horizon to easily manage the integration without placing a border between the operational and tactical problems.

2.4.4. BAP and waterway scheduling

Instead of considering navigation channel restrictions as constraints in the BAP, as shown in Section 2.3.1, some authors go further and integrate the BAP with the Waterway Scheduling Problem. The goal of the latter is to schedule incoming and outgoing vessels through the waterway for accessing or leaving the port, avoiding congestions.

Corry & Bierwirth (2019) integrate the BAP with a detailed channel scheduling problem in tidal ports with long and constrained navigation channels, especially channels that are narrow in some sections, which constrains the capability of vessels passing in opposing directions. The authors model the integrated problem based on a no-wait bidirectional flow shop with parallel machines where vessel movements correspond to jobs, channel segments correspond to machines, and channel segment transits correspond to operations.

Fatemi-Anaraki et al. (2020) study berth and waterway scheduling and quay crane assignment decisions in an integrated manner. The waterway under study is a two-way waterway characterized by width limitation for vessels moving in opposite directions. The authors include the limitations related to tides, draft limits and safety distance between vessels

moving in the same direction. As the three subproblems occur consecutively, the integrated problem is modeled based on the hybrid flow shop scheduling problem with unrelated parallel machines, machine eligibility constraints, and shared resources.

Liu et al. (2021) also integrate the BAP with Waterway Scheduling Problem, which they call the Ship Scheduling Problem, for a busy seaport with channel restrictions, in which the channel width can accommodate only one large-sized vessel or two small-sized vessels in its two-way navigation.

2.4.5. BAP and ship routing

The BAP has also been integrated with ship routing problems. The latter aim to optimize the travel distance of vessels between ports and/or the minimization of fleet size. Li & Pang (2011) present a mathematical model to support joint decisions for container ship routing between different ports and discrete berth allocation. The goal is to find routes for the vessels such that the sum of the total sailing time and the waiting time at the terminals is minimized. A realistic implementation of this model heavily depends on the coordination between shipping companies and terminal operators. Therefore, the authors consider the situation where a shipping company operates self-owned container terminals or the situation where there are dedicated container terminals that only serve this shipping company. The authors also conduct computational experiments to investigate the potential cost-saving benefits resulting from their integrated approach.

2.5. Conclusion

In this chapter, we have presented the main BAP characteristics, the early works and review papers on the BAP, the real-world aspects considered in the BAP, and the different decision problems studied together with the BAP in the context of container and bulk ports.

In this thesis, we design deterministic models for the BAP in an integrated approach, mainly with laycan allocation, quay crane assignment, and storage space allocation, in the context of container and bulk ports. We consider several characteristics and constraints rarely studied together, namely the multiplicity of quays, the variation of water depth, the productivity of quay cranes and their maximum outreach, navigation channel restrictions related to tides, charter party clauses, non-working periods, and specific bulk port constraints, mainly conveyor routing constraints between storage hangars and berthing positions, the multiplicity of cargo types on the same vessel.

In addition, papers studying the BAP in an integrated approach often integrate the BAP with operational problems. In this thesis, we integrate the BAP with a tactical problem

(laycan allocation) and operational problems (quay crane assignment and storage space allocation) thanks to an innovative approach that easily manages the integration without placing a border between the operational and tactical problems.

Finally, papers rarely integrate more than two echelons in the case of bulk supply chains (either production and storage, or storage and expedition, or production and expedition). In this thesis, we go further and integrate three supply chain echelons (production, storage, and vessel loading) in a DSS logic, ensuring a deeper alignment from the production until the expedition at the port.

Chapter 3

Integrated Laycan and Berth Allocation and time-invariant Quay Crane Assignment Problem in tidal ports with multiple quays

Abstract⁶

Efficient management of port resources plays a crucial role in reducing vessel stay times and avoiding the payment of demurrage charges. In this paper, we focus on the integrated Laycan and Berth Allocation and Quay Crane Assignment Problem, which considers three main decision problems in port management in an integrated way: the Laycan Allocation Problem, the dynamic continuous Berth Allocation Problem, and the time-invariant Quay Crane Assignment Problem. In a second part, the integrated problem is extended to the Specific Quay Crane Assignment, which includes the assignment of a set of specific quay cranes to each vessel, considering the productivity of quay cranes and their maximum outreach. The proposed integer programming models are original in several ways. First, the formulation of the models uses predicates which ensure flexibility in the implementation, and significantly improve the computational performance. The numerical study shows that the problems of practical size can be solved to optimality in a reasonable time using commercial software. Second, since the studied problems have different decision levels, a change of decision time-interval is incorporated inside the planning horizon for seamless decision-making. Third, to ensure that this integrated problem is as close as possible to reality, we consider both physical characteristics of the ports rarely studied together (tidal ports with multiple quays and different water depths) and contractual clauses (non-working periods and Charter Party clauses). The output of the models is an efficient schedule for berthing chartered vessels with an efficient quay crane assignment, and laycans to new vessels to charter.

Keywords

OR in maritime industry, Laycan allocation, Berth and quay crane assignment, Predicates, Integer programming

⁶ This chapter was published as a paper in the *European Journal of Operational Research*: <https://doi.org/10.1016/j.ejor.2020.12.056>. To facilitate the lecture of this thesis and the cross-referencing between its different chapters, section numbers of the paper are adapted.

3.1. Introduction

Maritime transport is the backbone of international trade and the global economy. Around 80% of global trade by volume and over 70% of global trade by value are carried by sea and are handled by ports (UNCTAD, 2020). Port performance management has been a focal point both in the industry and academia for the last two decades. It is related to both the respect of contractual clauses (e.g., laycan, laytime, demurrage, despatch money, etc.) between various actors in the maritime chain of transportation (e.g., shipowners, charterers, port operators, etc.) and the optimal use of port resources (e.g., quays, cranes, transfer vehicles, storage yard, manpower, etc.).

Some of the main decision problems in port management concerning quayside are: *i*) The Laycan Allocation Problem (LAP) refers to the tactical problem of assigning berthing time windows to new vessels to charter within a medium-term planning horizon (three to four weeks), by taking into consideration the availability of cargo and port resources. Hence, the LAP has a clear interaction with one of the most important operational problems in the seaside area of ports: *ii*) the Berth Allocation Problem (BAP). The latter refers to the operational problem of assigning berthing positions and times to every vessel projected to be served within a short-term planning horizon (one to two weeks) such that a given objective function is optimized. The assignment must respect the constraints of the problem such as vessel lengths and drafts, expected arrival times and projected handling times, etc. Besides berths, quay cranes are also scarce resources in ports. *iii*) The Quay Crane Assignment Problem (QCAP) refers to the operational problem of assigning a set of quay cranes to every vessel projected to be served within a short-term planning horizon (one to two weeks). The assignment must respect the constraints of the problem, such as the number of cranes available at the quay and the non-crossing constraints of quay cranes if they are mounted on rails.

Among these three problems, LAP defines some major contractual terms between shipowners, charterers, and port operators. The contract of carriage, to ship goods from one port to another, is called a *contract of affreightment*. If a full shipload is to be transported, the whole vessel (or a principal part of it) is chartered. In this case, the contract of carriage is called a *Charter Party*. This latter is contracted between a shipowner (i.e., someone who equips and exploits a vessel for delivering cargo and is not necessarily the owner of the vessel) and a charterer (i.e., someone who rents a vessel from the shipowner and might own the cargo). It can be for either a specific voyage (*Voyage Charter*), or for a certain period (*Time/Demise Charter*). If a lesser quantity of goods or individually packaged goods are

shipped along with other cargo, this is mostly done under a *bill of lading*, which details the goods being shipped on board and testifies the contract of carriage. So, the shipowner can act as a carrier or/and a lessor (the carrier undertakes to carry goods from one point to another, and the lessor hires out the use of his vessel to a charterer). Finally, the port operator is the cargo handler in the port. He manages the port resources (quays, cranes, transfer vehicles, manpower, etc.). In some cases, one entity can represent two actors (e.g., Morocco’s OCP Group, as a world leader in the phosphate industry, is at the same time, a charterer, and a port operator). Figure 3.1 and Figure 1.5 illustrate, respectively, the different actors involved in contracts of affreightment and the main chartering terms.

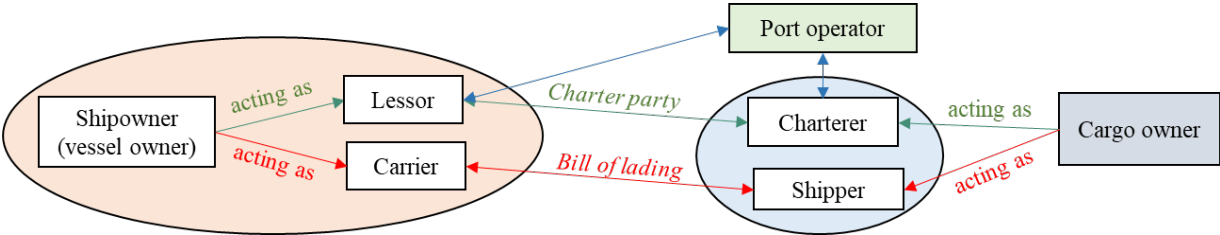

Figure 3.1: Different actors involved in contracts of affreightment

Laycan and *laytime* are the two main clauses in the Charter Party of type Voyage Charter. *Laycan* is an abbreviation for the *Laydays and Canceling* clause. This clause only concerns vessels that are going to be loaded in ports. It establishes the period during which the shipowner must issue the *Notice of Readiness* (NOR) to the charterer that the vessel has arrived at the port of loading and is ready in all respects to load. This period is expressed as two dates: the earliest date, when the vessel is required by the charterer, and the latest date for the commencement of the charter. If NOR is not issued during the laycan, the charterer has the option of canceling the charter. Once the vessel arrives at the port of loading, the charterer should be ready to start loading its cargo in order not to exceed its *laytime*. This latter is the amount of time allowed by the shipowner to the charterer in a Voyage Charter for the loading or the unloading of cargo, and it equals the cargo volume divided by the contractual rate of loading or unloading. Laytime begins at the instant NOR is received. If the charterer exceeds the laytime, a predetermined penalty called *demurrage* is incurred. This penalty equals the time exceeded multiplied by the *demurrage rate*. Otherwise, if the whole period of laytime is not needed, a refund called *despatch* may be payable by the shipowner to the charterer. This refund equals the unused time multiplied by the *despatch rate*. Despatch is usually set at 50% of the demurrage rate (*Despatch half Demurrage*), but this depends on the terms of the Charter Party. The vessel may thus be able to leave port early.

There is an increasing trend to consider the BAP and the QCAP together because the number of quay cranes assigned to a vessel determines its handling time, and hence the

berthing time of the vessel. The integrated Berth Allocation and Quay Crane Assignment Problem (BACAP) considers the BAP and the QCAP together. In the BACAP, all quay cranes have the same characteristics; hence the solution is expressed as a number of quay cranes assigned to a vessel without identifying which individual crane serves which vessel. An extension is the integrated Berth Allocation and Specific Quay Crane Assignment Problem (BACASP) where a set of specific cranes is assigned to each vessel.

Similarly, there is a strong interaction between the LAP and the BACA(S)P as well. On the one hand, the contracted laycan for a vessel has to be respected while assigning berths and quay cranes in order to avoid penalties. On the other hand, attending vessels within the agreed time limits at a port depends essentially on the efficient use of the available port resources such as quay space and cranes. An integrated approach to solve these problems is hence relevant and motivates this study. To the best of our knowledge, this is the first study to propose an integrated approach for the modeling and resolution of these problems.

In this paper, we propose two integrated solutions: for *i*) the integrated Laycan and Berth Allocation and Quay Crane Assignment Problem (LBACAP), and *ii*) the integrated Laycan and Berth Allocation and Specific Quay Crane Assignment Problem (LBACASP). These two combined problems illustrated in Figure 3.2 aim to find an efficient schedule for berthing chartered vessels and new vessels to charter with an efficient quay crane assignment and to support terminal managers in the negotiation process with shipping lines.

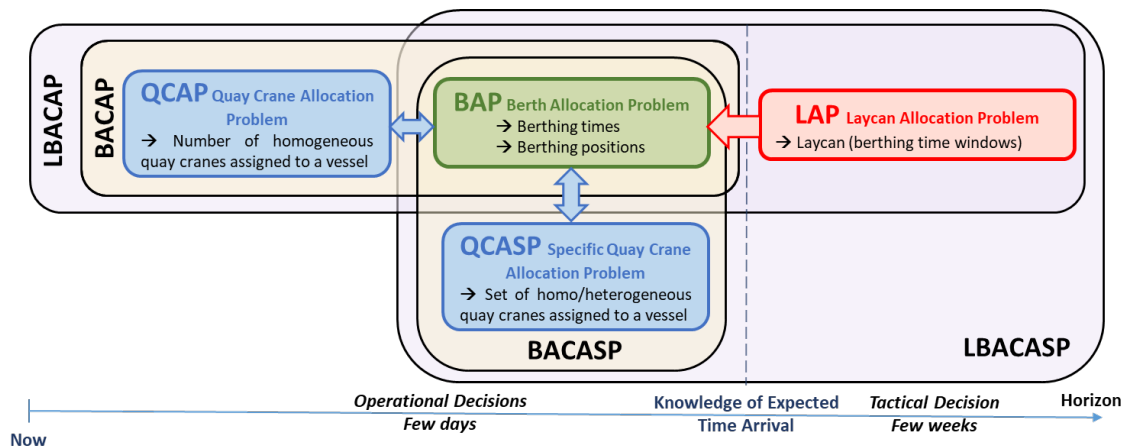

Figure 3.2: Possible combinations between the LAP, the BAP, the QCAP and the QCASP

We model the two new problems by integer programs. These models have several originalities as follows:

First of all, the idea of integrating tactical and operational level problems is new in the port management literature. The proposed models are on a tactical planning horizon. A modular decision time-interval is proposed inside this planning horizon to easily manage the integration without placing a border between the operational (BACA(S)P) and tactical (LAP) problems.

Second, the models include several port constraints rarely studied in the literature (multiple quays, tide constraints, days-off) to increase their application potential in practice. An overview of these constraints will be presented in the next section. The objective functions in the Berth Allocation Problem literature mostly aim at minimizing the sum of costs without distinguishing between the different actors involved, which makes the applicability of the problem unrealistic. In most cases, these actors have conflicting objectives and interests. Therefore, two objective functions are considered, one related to economic aspects and contract clauses and the other one reflecting physical aspects of port's utilization.

Last but not least, all the conditions are modeled as predicates. A predicate is a logical expression that can take a value of "true" or "false". In our mathematical models, we use predicates to define (restrict) the domain of an index, which in turn, binds the existence of a decision variable, depending on the values of the parameters. Hence, the predicates act like a pre-treatment of the models based on the problem data and reduce the number of binary variables. This approach significantly improves the computational performance of the models, as it is no longer necessary to introduce the conditions as constraints in the models. As a consequence, problems of practical sizes can be solved in a reasonable time using off-the-shelf commercial software.

The paper is organized as follows. In Section 3.2, we present a literature review of the LAP, the BACAP, and the BACASP with a focus on tidal ports and ports with multiple quays. The description and the formulation of the LBACAP are presented in Section 3.3. The model is extended to solve the LBACASP, and its description and formulation are presented in Section 3.4. In Section 3.5, we present an illustrative example for both models and the experiments conducted, then we discuss their results. Finally, in Section 3.6, we draw some conclusions and indicate future research directions.

3.2. Literature review

In this section, we review the academic literature on the BACAP, the BACASP, and the LAP, with a focus on tidal ports and ports with multiple quays.

3.2.1. BACAP and BACASP literature

Berth allocation and quay crane assignment are essential for efficient terminal utilization in container and bulk ports. The surveys of Bierwirth and Meisel (2010, 2015) and Carlo et al. (2015) focus on these two problems and their integration. A list of journal papers that propose new models for the BACAP and/or the BACASP is summarized in Table 3.1, in which the following information is presented. Papers focusing on stochastic issues and environmental questions are not considered. For the sake of comparison, we also excluded articles presenting

approaches such as simulation and metaheuristics without providing a mathematical model of the problem.

- Port type: either container ports or/and bulk ports.
- BAP characteristics: (1) Spatial attribute: it concerns the berth layout (either discrete, continuous or hybrid), vessel drafts (considered or not) and the quay (single or multiple quays) when deciding on vessel berthing positions. (2) Temporal attribute: it describes the arrival process of vessels (static or dynamic), the possibility of speeding up vessels if soft arrival times are given, and the consideration of tide constraints and unavailability periods. (3) Handling time attribute: it highlights if the interference among quay cranes and the berthing deviation from the desired position are considered (or not) in the calculation of vessel handling times.
- QCA(S)P characteristics column specifies the type of the problem: either time-variant or time-invariant, the productivity of quay cranes (homogeneous or heterogeneous) and the consideration of quay crane outreach.
- BACA(S)P performance measure column provides the objective function of the problem: either minimizing various times or costs.
- BACA(S)P solution approach column gives the type of the solution approach as novel mathematical models, exact methods, heuristics, metaheuristics, or/and simulation.
- BACA(S)P modeling choices specify if the conditions of the BACA(S)P (e.g., berthing time and space, tide, draft, etc.) are modeled as either constraints or predicates using binary variables.

The BACAP and the BACASP are studied under two versions: In the time-invariant case, a fixed number of quay cranes is assigned to each vessel throughout its handling, while in the time-variant case, this number can be modified during the planning horizon. This second version of the problem allows more efficient use of quay cranes, but the resulting planning can be difficult to apply in practice as it involves a greater number of quay crane movements and task assignments to quay crane drivers. In this paper, we consider the time-invariant version. Nevertheless, the literature is reviewed and summarized in Table 3.1 for both cases.

Table 3.1: BACA(S)P literature

Authors	Port type	BACAP	BACASP	BAP characteristics									QCA(S)P characteristics				BACA(S)P performance measure											BACA(S)P solution approach					BACA(S)P modeling choices																																			
				Spatial attribute			Temporal attribute				Handling time attribute		Time-variant	Time-invariant	Quay crane productivity	Quay crane outreach	Vessel departure times	Vessel stay times	Waiting times	Tardiness	Waiting costs	Delay costs	Speedup costs	Berthing deviation costs	Demurrage vs Despatch	Quay crane assignment costs	Quay crane energy consumption costs	Quay crane movements	Novel mathematical models	Exact methods	Heuristics	Metaheuristics	Simulation	Berthing time	Berthing space	Draft	Max and min quay cranes	Quay crane outreach	Tide	Unavailability periods																												
				Berth layout	Draft	Quay	Vessel arrivals	Speedup	Tide	Unavailability periods	Quay crane interference	Berthing deviation																													Time-variant	Time-invariant	Quay crane productivity	Quay crane outreach	Vessel departure times	Vessel stay times	Waiting times	Tardiness	Waiting costs	Delay costs	Speedup costs	Berthing deviation costs	Demurrage vs Despatch	Quay crane assignment costs	Quay crane energy consumption costs	Quay crane movements	Novel mathematical models	Exact methods	Heuristics	Metaheuristics	Simulation	Berthing time	Berthing space	Draft	Max and min quay cranes	Quay crane outreach	Tide	Unavailability periods
1	Park and Kim (2003)	cont	x	x	x	x	x	x										x	x	x	x				x	x	x								C	C		C																														
2	Imai et al. (2008)	cont		x	x		x		x					x													x		x								C																															
3	Meisel and Bierwirth (2009)	cont	x		x	x		x	x		x	x							x	x			x					x	x									C	C		C																											
4	Chang et al. (2010)	cont		x	x	x		x													x								x												C	C		C																								
5	Raa et al. (2011)	cont	x		x	x		x											x		x					x	x		x												P	C		C																								
6	Yang et al. (2012)	cont	x		x	x		x						x												x	x	x	x															C	C		C																					
7	Elwany et al. (2013)	cont	x		x	x	x		x	x		x	x												x		x	x																C	C		C																					
8	Türkoğulları et al. (2014)	cont	x	x	x	x		x					x														x	x																	P	P		C																				
9	Han et al. (2015)	cont	x	x	x	x		x						x											x	x		x																	C	C		C	C																			
10	Iris et al. (2015)	cont	x		x	x		x	x		x	x														x		x																	C	C		C																				
11	Hsu (2016)	cont	x		x	x	x		x																		x	x																		C	C		C																			
12	Karam and Eltawil (2016)	cont		x	x	x		x																		x	x																			P	P		C	C		C																
13	He (2016)	cont	x		x	x		x							x	x									x		x																			C	C		C																			
14	Türkoğulları et al. (2016)	cont		x	x	x		x																		x	x																			P	P		P																			
15	Zhen et al. (2017)	cont	x		x		x		x	x																	x	x																			C			C																		
16	Agra and Oliveira (2018)	cont+bulk		x	x	x		x						x													x	x																		C	C		C	C		C																
17	Krimi et al. (2019)	bulk	x		x		x		x	x																		x	x																		C	C		C		C																
18	Correcher et al. (2019)	cont	x	x	x	x		x																			x	x																			P	C		P																		
19	Malekhamdi et al. (2020)	cont		x	x	x	x		x					x																																	C	C		C		C																
20	Our paper	cont+bulk	x	x	x	x	x	x	x	x			x											x			x																				P	P		P	P		P	P		P												

P: Predicate; C: Constraint

We can make several observations regarding Table 3.1. Most of the papers consider spatial attributes of the ports, while temporal attributes, such as tide constraints or unavailability periods, are rarely addressed. As for the spatial attributes, most consider single quay problems and vessels drafts are usually disregarded. The draft is a fundamental characteristic of a vessel and forms a major constraint in the BAP, especially in case of tidal ports. There are three different kinds of vessels: Feeder, Medium and Jumbo. The largest ones are Jumbo and have deep drafts. In tidal ports (e.g., Port of Jorf Lasfar, Port of Shanghai, Port of Hamburg, etc.), large vessels can only navigate the route when the tide is sufficiently high, which make them tide-dependent, especially when they are loaded, upon entering or leaving the port. Indeed, during low tide periods, large vessels have to wait until the depth of the sea reaches the required level. Therefore, the vessel's draft must be considered to distinguish a vessel as either tide-dependent or not. For tide-dependent vessels, decision makers define feasible tidal time windows for berthing and departure. Note that tide constraints and multiple quays have recently received much attention in the BAP and BACAP literature. For instance, Barros et al. (2011) and Du et al. (2015), focusing on BAP, and Zhen et al. (2017), focusing on discrete time-variant BACAP, introduce tide constraints in their models. Dadashi et al. (2017) study the BAP in tidal ports with multiple terminals, while Frojan et al. (2015) study the continuous BAP in a container terminal with multiple quays. We note that the papers that do not integrate BAP and QCA(S)P together are not integrated into Table 3.1.

Another observation in Table 3.1 is that few papers consider unavailability periods, while this is a very common clause in the Charter Party. For instance, it is not unusual to cease cargo operations in ports during some days. These non-working days (exception periods) are either included or excluded in the counting of laytime in the Charter Party. Two examples are given below. There are numerous exception periods expressed similar to these examples. The reader can refer to Tsoudis (2015) for a list of exception period clauses. We will consider only *SSHEX* in the model, without loss of generality. The other constraints can be modeled in the same manner.

- *SSHEX* (Saturdays/Sundays/Holidays Excluded): The time lost in port on Saturdays, Sundays and holidays does not count as laytime (from 5 pm on Friday until 8 am on Monday, and on holidays from 5 pm of the day preceding a holiday until 8 am of the next working day).
- *SSHINC* (Saturdays/Sundays/Holidays Included): No exception periods are in effect and the laytime will count seven days a week as well as during holidays. Very large capacity vessels usually operate without exception periods being in effect.

Regarding the quay crane characteristics, we observe that heterogeneous quay cranes are only considered by Agra and Oliveira (2018) and quay crane movement restrictions to avoid overlapping are only addressed by Han et al. (2015), Karam and Eltawil (2016) and Agra and Oliveira (2018) again, while these are a real constraint in ports.

Finally, the objective functions mostly aim at minimizing the sum of costs without distinguishing between the different actors involved, even when these actors have conflicting objectives and interests. For example, the fuel cost is a cost supported by shipowners. Despite this, most authors (e.g., Meisel and Bierwirth (2009) and Iris et al. (2015)) consider the speedup cost of vessels as a cost supported by port operators. Some authors pointed out the importance of taking into consideration the chosen actor in the definition of the objective function. For instance, Venturini et al. (2017) defined an objective function that implies that the pool of vessels is managed in a collaborative way, where the benefits and costs are shared between shipping lines and port operators. However, they said that the realistic applicability of this objective function needs further investigation.

3.2.2. LAP literature

While berth and quay crane allocation literature is abundant, only one paper was found that deals with the LAP. Lorenzoni et al. (2006) develop a mathematical model based on a multi-mode resource-constrained scheduling problem. The model determines vessel laycans (laydays) with efficient use of port resources for the attendance of vessels, in a way that avoids simultaneous or nearly simultaneous arrivals of vessels competing with the same resources. However, they assume the first-come, first-served regime of attendance, which could exclude certain solutions with better results, unlike the BAP that explores every possible berthing solution without being restricted to a certain regime of attendance. Finally, they solve the problem using a heuristic procedure based on the Differential Evolution Algorithm. It has to be noted that the LAP concerns the determination of berthing time windows to new vessels to charter, differing from ship routing and scheduling problems. Following the definitions given by Ronen (1993), routing can be defined as the assignment of the sequence of ports to a vessel. The term scheduling is used when the temporal aspect is brought into routing.

As a conclusion to this section, we highlight that in this paper, we consider numerous conditions in the definition of the LBACA(S)P, which reduces the gap between the abstract representation of the studied problems and their applicability in real situations. Our models consider tidal ports with multiple quays, unavailability periods such as *SSHEX*, homogeneous and heterogeneous quay cranes with outreach constraints, and two objective functions, one

based on a physical criterion, and another one based on an economic criterion. This latter is based upon Charter Party clauses, to illustrate the case where ports belong to one single shipper. Mazioli et al. (2019) assessed the important impact of the Charter Party clauses on the port’s financial result.

3.3. Description and formulation of the LBACAP

In this section, we introduce a description of the LBACAP and then its formulation.

3.3.1. Description of the LBACAP

Spatial attribute

We consider a tidal port with multiple quays. It has to be noted that, depending on its size and its throughput, a port could have one or several independent terminals, in which each terminal is characterized by a number of quays. Each quay has a number of cranes and is partitioned into a set of equal-length sections. We consider a continuous berth layout since section lengths are small enough compared to vessel lengths. Overall, vessel lengths vary from 100 to 350 m, and section lengths can be set for example at 10 m. The sections of each quay start from the port yard (i.e., the mainland from which the quays extend into the sea) and are numbered in increasing order. All the sections of a quay can have the same water depth, or the water depth increases seaward by sections, as in Figure 3.3. Similarly, the productivity of quay cranes can be the same (i.e., homogeneous quay cranes) for all the quays or can be the same in each quay and different from one quay to the other, as in Figure 3.3. We also take into consideration the technical constraints of vessels that prohibit their berthing at some quays or oblige them to berth at a specific quay.

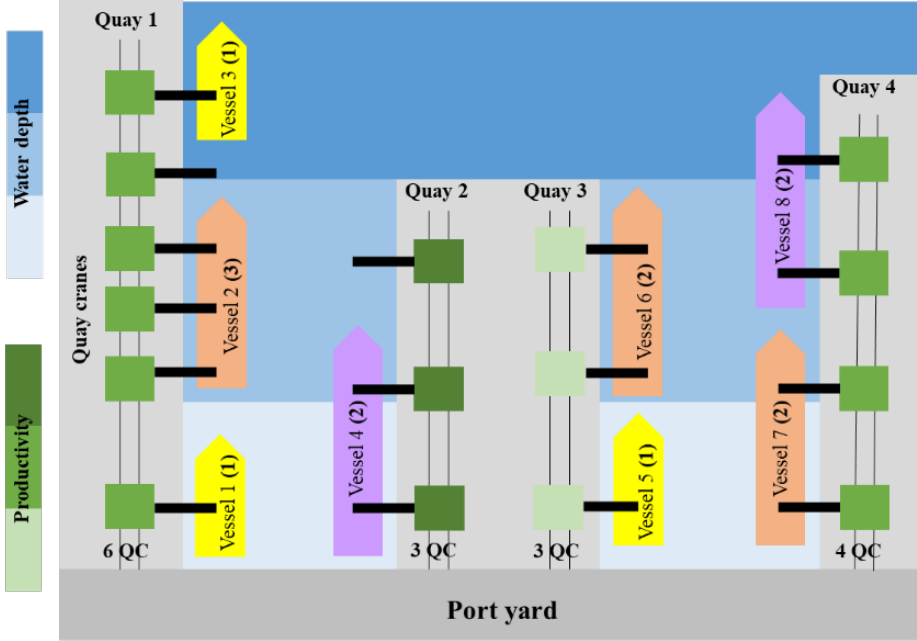

Figure 3.3: Example of a port with multiple quays, different water depths, and homogeneous cranes in each quay

Temporal attribute

Since the planning horizon is divided into time periods of equal length (one hour), the following temporal parameters are also expressed as a number of time periods. We assume dynamic vessel arrivals (i.e., fixed expected arrival times, inside the planning horizon, are given for the vessels; hence vessels cannot berth before the expected arrival time). Furthermore, a maximum waiting time in the harbor before berthing and a laytime are preset for each vessel. The role of the maximum waiting time in the harbor is to avoid unrealistic solutions with significant vessel delays. Moreover, it reduces the solution space of berthing times in the planning horizon, which significantly improves the computational performance of the model. However, new vessels to charter will have high maximum waiting times in the harbor, so as not to affect the economic results of already chartered vessels. Indeed, these latter vessels have priority over new vessels to charter because their Charter Parties are already finalized. The maximum waiting time in the harbor of already berthed vessels is equal to zero because they have already berthed.

We also take into consideration tide constraints which make the scheduling of port operations more challenging. In tidal ports, large loaded vessels can only pass through the access channel when the tide is sufficiently high, which make them tide-dependent upon entering and/or leaving the port (in our case, we consider that the same vessel can be either loaded or unloaded in the port). Indeed, during low tide periods, large loaded vessels have to wait for high tide cycles where the sea level is superior to their drafts. However, small, medium, and large empty vessels are tide-independent, as they can enter the port and leave it at any time. Therefore, the draft of vessels must be considered to distinguish a vessel as either tide-dependent or not. Tides are the rise and fall of sea levels caused by the combined effects of the gravitational forces exerted by the Moon and the Sun, and the rotation of the Earth. The Moon orbits the Earth in the same direction as the Earth rotates on its axis, so it takes slightly more than a day, about 24 hours and 50 minutes, for the Moon to return to the same location in the sky. So we define the start and end time of each high tide cycle (high tide windows) that would occur during the planning horizon, which imposes some feasible berthing and departure periods for large loaded vessels (the detailed calculation of tide parameters is shown in the file [Tide.xlsx⁷](#)).

Handling time attribute

Handling times of vessels depend on the fixed number of identical quay cranes assigned to them throughout the service process and take into account the decreasing marginal productivity

⁷ All data files of *Chapter 3* are available on Mendeley Data: <https://data.mendeley.com/datasets/3cts6wkn4f/1>

due to quay crane interferences. Each vessel has a minimum and a maximum prescribed number of quay cranes that can serve it. In our model, handling times of vessels are determined by data preprocessing.

Performance measure attribute

In the general case (i.e., in the presence of several actors with different roles, see Figure 3.1), an objective function based on a physical criterion is adopted, since the relevant actors have conflicting objectives and interests. This objective function could be the minimization of the sum of expected vessel departure times (shipowner's interest) or vessel stay times (port operator's interest). The sum in the objective function can be weighted to consider vessels priority. Solutions obtained under these physical criteria allow us to detect better the current margins for fixing laycans to new vessels to charter. In this paper, we arbitrarily choose to minimize the sum of expected vessel departure times. The consideration of the other criterion does not require any change in the model, except in the objective function's formula.

However, when ports belong to one single shipper (the charterer and the port operator are the same entity), an economic objective function, based upon Charter Party clauses established with shipowners, is adopted. In this case, we distinguish two kinds of costs, namely: the cost for exceeding the laytime (i.e., the demurrage charges), and the bonus payment offered by the shipowner for completing loading or unloading before the laytime (i.e., the despatch money). The economic objective function is to maximize the sum of the difference between the despatch money and the demurrage charges for each vessel (i.e., minimize the demurrage charges and maximize the despatch money). In both cases (physical and economic), we favor the berthing of vessels as close as possible to the port yard to select one of the optimal solutions.

3.3.2. Formulation of the LBACAP

Notation

Before presenting the LBACAP model, notations of indices, sets, parameters and decision variables used in the model are listed as follows. The sets are represented by calligraphic letters, decision and intermediary variables by italic letters, and the indices by italic lowercase letters. The indices v , t and q are always written as subscripts and the indices s_q and n_q related to the index q are always written as superscripts.

<i>Index</i>	<i>Description</i>
t	Index of time periods $\mathcal{T} = \{1, \dots, T\}$.
v	Index of vessels $\mathcal{V} = \{1, \dots, V\}$ with $\mathcal{V} = \mathcal{V}_1 \cup \mathcal{V}_2 \cup \mathcal{V}_3$ and $V = V_1 + V_2 + V_3$, where: <ul style="list-style-type: none"> • $\mathcal{V}_1 = \{1, \dots, V_1\}$ is the set of already berthed vessels. • $\mathcal{V}_2 = \{V_1 + 1, \dots, V_1 + V_2\}$ is the set of chartered vessels. • $\mathcal{V}_3 = \{V_1 + V_2 + 1, \dots, V\}$ is the set of new vessels to charter.
q	Index of quays $\mathcal{Q} = \{1, \dots, Q\}$.
s_q	Index of berthing sections at quay q $\mathcal{S}_q = \{1, \dots, S_q\}$.
n_q	Index of quay crane numbers at quay q $\mathcal{N}_q = \{1, \dots, N_q\}$. As stated before, the cranes of a same quay are assumed identical.

<i>Parameter</i>	<i>Description</i>
<u><i>Time decision restriction</i></u>	
K_t	Boolean parameter that equals 1 if a decision of berthing vessels can be taken during time period t (without considering the other constraints), 0 otherwise.
<u><i>Vessels</i></u>	
A_v	Expected time of arrival of chartered vessel v and the availability date of the cargo to be exported in new vessel to charter v , $A_v = 1, \forall v \in \mathcal{V}_1$.
M_v	Maximum waiting time in the harbor of chartered and new vessel to charter, $M_v = 0, \forall v \in \mathcal{V}_1$.
D_v	Draft of vessel v .
λ_v	Length of vessel v expressed as a number of berthing sections.
n_v^{\min}	Minimum number of identical quay cranes (technically allowable minimum number) that can be assigned to vessel v .
n_v^{\max}	Maximum number of identical quay cranes (technically allowable maximum number) that can be assigned to vessel v .

Vessels and tides

O_t	Boolean parameter that equals 1 if time period t is within a high tide cycle, 0 otherwise.
-------	--

- α_v Boolean parameter that equals 1 if vessel v is tide-dependent at its berthing, 0 otherwise.
- ω_v Boolean parameter that equals 1 if vessel v is tide-dependent at its departure, 0 otherwise ($\alpha_v + \omega_v \leq 1$).

Vessels and time framework

- γ_v Boolean parameter that equals 1 if the handling of vessel v is restricted to working periods (excluding, for example, weekends), 0 otherwise.
- Ψ_{vt} Boolean parameter that equals 1 if the handling of vessel v is not carried out during time period t , 0 otherwise.
- Γ_{vt} Relative period of the absolute time period t of vessel v .
- Υ_{vt} Absolute period of the relative time period t of vessel v .
- G_{vt} Boolean parameter that equals 0 outside high tide cycles and during non-working periods, 1 otherwise.

Vessels and quay cranes

- $\theta_{vq}^{n_q}$ Handling time of vessel v if n_q quay cranes of quay q are assigned to it.
- $\tau_{vtq}^{n_q}$ Departure time period of vessel v if this latter berths in time period t at quay q , and if n_q quay cranes are assigned to it,
- $$\tau_{vtq}^{n_q} = \Upsilon_{v(\Gamma_{vt} + \theta_{vq}^{n_q} - 1)}, \forall v \in \mathcal{V}, \forall t \in \mathcal{T}, \forall q \in \mathcal{Q}, \forall n_q \in \mathcal{N}_q.$$

Vessels, quays and sections

- I_{vq} Boolean parameter that equals 1 if vessel v can berth at quay q , 0 otherwise.
- N_q Number of quay cranes at quay q .
- $W_q^{s_q}$ Water depth of berthing section s_q at quay q .

Vessels and contractual clauses

- B_v Contractual handling time of vessel v .
- J_v Laycan days of new vessel to charter v , these days are added to its handling time $(\theta_{vq}^{n_q} + J_v - 1)$ and its contractual handling time $(B_v + J_v - 1)$.
- δ_v Contractual departure time of vessel v , $\delta_v = \Upsilon_{v(\Gamma_{vA_v} + B_v - 1)}, \forall v \in \mathcal{V}$.
- η_v Contractual demurrage by hour for chartered vessel v , $\eta_v = 0, \forall v \in \mathcal{V}_1$ and

$$\eta_v = 1, \forall v \in \mathcal{V}_3.$$

β_v Contractual despatch by hour for chartered vessel v , $\beta_v = 0, \forall v \in \mathcal{V}_1$ and $\beta_v = 1, \forall v \in \mathcal{V}_3$. Thereafter, we can assign hourly demurrage and despatch rates not equal to one to new vessels to charter to see their impact on the economic criterion of the objective function. Consequently, it is the decision maker who will see how much he can accept the deterioration of the economic results.

<i>Decision variable</i>	<i>Description</i>
$x_{vtq}^{s_q n_q}$	1 if vessel v starts berthing in time period t at section s_q of quay q , and n_q quay cranes are assigned to it, 0 otherwise. Each berthed vessel has a residual handling time with a berthing time $t=1$ and a predetermined berthing section at a quay and a predetermined number of quay cranes assigned to it.
u_v	Delay of vessel v , which is the time added to the laytime of the vessel. u_v is integer because it refers to a number of time periods.
w_v	Advance of vessel v , which is the time saved from the laytime of the vessel. Similarly, w_v is integer.

<i>Intermediary variable</i>	<i>Description</i>
ρ_{vtq}	Number of active quay cranes serving vessel v at quay q during time period t .
π_v	Expected departure time of vessel v .
ε_v	Inverse of the berthing section of vessel v . Its role is to favor the berthing of vessels as close as possible to the port yard, without impacting the main criterion value used in the objective function.

Representation of time

We define the parameter $f_v = 1 + \gamma_v + 2 \cdot \alpha_v, \forall v \in \mathcal{V}$ to specify if a vessel is tide-independent at its berthing or not and/or if its handling is restricted to working periods or not. So, this parameter can be equal to:

- 1: if vessel v is tide-independent at its berthing and its handling is not restricted to working periods ($\alpha_v = 0, \gamma_v = 0$)

- 2: if vessel v is tide-independent at its berthing and its handling is restricted to working periods ($\alpha_v = 0, \gamma_v = 1$)
- 3: if vessel v is tide-dependent at its berthing and its handling is not restricted to working periods ($\alpha_v = 1, \gamma_v = 0$)
- 4: if vessel v is tide-dependent at its berthing and its handling is restricted to working periods ($\alpha_v = 1, \gamma_v = 1$)

In order to know the index of working periods considering non-working periods, we define the parameter Γ_{vt} . The Boolean parameter Ψ_{vt} equals 1 during non-working periods for vessels whose handling is restricted to working periods ($\gamma_v = 1 \rightarrow f_v \in \{2, 4\}$), 0 otherwise. Then we write $\Gamma_{vt|\Psi_{vt}=0} = t - \sum_{t'=1}^{t'-t} \Psi_{vt'}$, $\forall t \in \mathcal{T}, \forall v \in \mathcal{V}$ and $\Gamma_{vt|\Psi_{vt}=1} = \Gamma_{vt'}$, $\forall t \in \mathcal{T}, \forall v \in \mathcal{V}$, where t' is the first working period after t , as it is the first $t' > t | \Psi_{vt'} = 0$. The operator " $|$ ", which can be read «such as», defines a restriction of an index set by predicates. Consequently, it can be used in a summation (Σ) or a quantified formula (\forall). Vessels whose handling is not restricted to working periods ($\gamma_v = 0 \rightarrow f_v \in \{1, 3\}$) always have $\Gamma_{vt} = t, \forall t \in \mathcal{T}, \forall v \in \mathcal{V}$. The reverse parameter Y_{vt} gives the calendar period of the working period t for vessel v . Vessel handling times do not change, but vessel departure times do change. The same approach can be applied to the planned non-availability periods due to the preventive maintenance of port equipment.

We also define the Boolean parameter G_{vt} that equals 0 outside high tide cycles ($O_t = 0$) for vessels that are tide-dependent at their berthing periods ($\alpha_v = 1 \rightarrow f_v \in \{3, 4\}$) or during non-working periods ($\Psi_{vt} = 1$) for vessels whose handling is restricted to working periods ($\gamma_v = 1 \rightarrow f_v \in \{2, 4\}$), or 1 otherwise. An example of these parameters is shown in Table 3.2, where each time period is one hour long and non-working periods last two hours. A realistic assignment of two-days long non-working periods is provided in the file [Time.xlsx](#).

Table 3.2: Calculation of tide and non-working periods parameters

t/f_t	O_t	Ψ_{vt}		G_{vt}				Γ_{vt}		Y_{vt}	
		{1, 3}	{2, 4}	1	2	3	4	{1, 3}	{2, 4}	{1, 3}	{2, 4}
1	0	0	0	1	1	0	0	1	1	1	1
2	0	0	0	1	1	0	0	2	2	2	2
3	1	0	1	1	0	1	0	3	3	3	5
4	1	0	1	1	0	1	0	4	3	4	6
5	1	0	0	1	1	1	1	5	3	5	7
6	1	0	0	1	1	1	1	6	4	6	8
7	0	0	0	1	1	0	0	7	5	7	9
8	0	0	0	1	1	0	0	8	6	8	12
9	0	0	0	1	1	0	0	9	7	9	13
10	0	0	1	1	0	0	0	10	8	10	14
11	0	0	1	1	0	0	0	11	8	11	15
12	0	0	0	1	1	0	0	12	8	12	16
13	1	0	0	1	1	1	1	13	9	13	19
14	1	0	0	1	1	1	1	14	10	14	20
15	1	0	0	1	1	1	1	15	11	15	21
16	1	0	0	1	1	1	1	16	12	16	22
17	0	0	1	1	0	0	0	17	13	17	23
18	0	0	1	1	0	0	0	18	13	18	0
19	0	0	0	1	1	0	0	19	13	19	0
20	0	0	0	1	1	0	0	20	14	20	0
21	0	0	0	1	1	0	0	21	15	21	0
22	1	0	0	1	1	1	1	22	16	22	0
23	1	0	0	1	1	1	1	23	17	23	0

Decision time-interval

Naturally, we consider a longer planning horizon for the LBACAP, since planning new vessels to charter (i.e., LAP) is a tactical problem. In order to reduce the computation complexity and to take into account the increasing uncertainty of inputs as the length of planning horizon increases, we define a Boolean parameter K_t that equals 1 if vessels can berth during time period t (without considering other constraints). The user of the model is free to define the values of K_t . Consequently, this parameter enables us to restrict the periods when a decision can be made inside the planning horizon, and hence to change the decision time-interval. For example, during the first week, chartered vessels can berth every hour « 1 », hence $K_t = 1, \forall t$; during the second week, every four hours « 0 – 0 – 0 – 1 », hence $K_t = 1, \forall t | (t)_{\text{mod}4} = 0$ and $K_t = 0$ otherwise; during the third week, every eight hours « 0 – 0 – 0 – 0 – 0 – 0 – 0 – 1 », hence $K_t = 1, \forall t | (t)_{\text{mod}8} = 0$ and $K_t = 0$ otherwise. New vessels to charter can be planned during the second and third week, providing for them an estimated position in the schedule. It should be noted that we can rerun the model whenever needed (e.g., when we have new and more precise information about vessels to charter or when some disturbances occur such as vessel delays, bad weather, etc.) and on a regular basis (e.g., every

Monday in a rolling horizon). Therefore, as we advance in the planning horizon, the schedule is refined: some chartered vessels (\mathcal{V}_2) will become berthed vessels (\mathcal{V}_1), and some new vessels to charter (\mathcal{V}_3) will become chartered vessels (\mathcal{V}_2).

In Figure 3.4, we show a case of vessel scheduling update over a week. White for the value 1 (the vessel can berth) and gray for the value 0 (the vessel cannot berth). The arrays show the new value of each week after one week. For example, the upper sequence shows that a vessel can be positioned on period 172 in week 2. At this point, the precise berthing period is not known but is estimated on a 4-periods range, between periods 169 and 172. When the program is rerun a week later, week 2 becomes week 1, and the precise berthing period of the vessel is obtained. Modulating decision time-interval through the planning period enables us to integrate the LAP and the BACA(S)P that are on different decision levels, without increasing the number of variables too much, and without placing a border between the operational and tactical problems. Moreover, this solution does not modify the time unit of vessel handling times and high tide cycles.

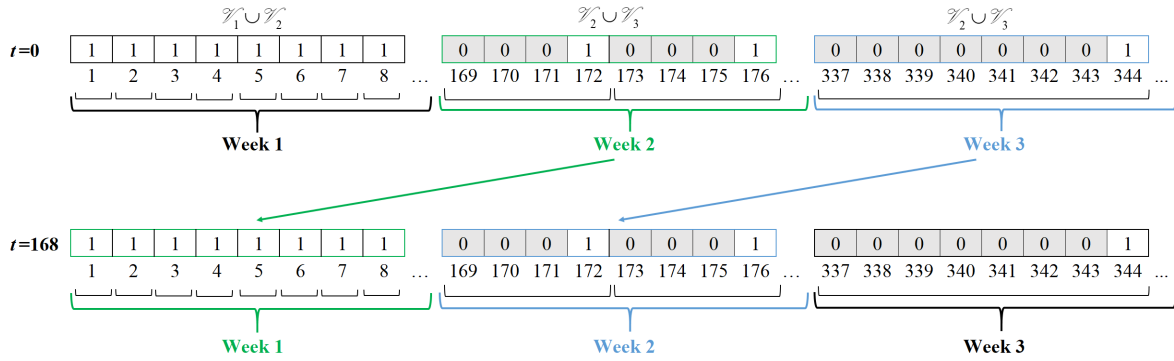

Figure 3.4: Vessel scheduling update

Mathematical model

The binary decision variable $x_{vtq}^{s_q n_q}$ determines:

- For berthed and chartered vessel v : the berthing time t , the berthing quay q , the berthing position s_q , and the assigned number of quay cranes n_q .
- For new vessel to charter v : the laycan period: $[t, t + J_v - 1]$, the berthing quay q , the berthing position s_q , and the assigned number of quay cranes n_q .

The existence of the decision variable $x_{vtq}^{s_q n_q}$ is subject to the eight conditions cited below which significantly improves the computational performance of the LBACAP model since it is no longer necessary to introduce them as constraints in the model.

1. Vessel v can berth only at quays q for which the parameter $I_{vq} = 1$.
2. The number of quay cranes n_q assigned to vessel v at quay q must be between its minimum and maximum allowed number: $n_v^{\min} \leq n_q \leq n_v^{\max}$.
3. Vessel v can berth only at time periods t for which the parameter $K_t = 1$.
4. Vessel v can berth between its expected time of arrival and its expected time of arrival increased by its maximum waiting time in the harbor: $A_v \leq t \leq A_v + M_v$.
5. Vessel v can berth only at time periods t for which the parameter $G_{vt} = 1$. In other words, vessels whose handling is restricted to working periods ($\gamma_v = 1$) can berth only during working periods ($\psi_{vt} = 0$), and vessels that are tide-dependent at their berthing ($\alpha_v = 1$) can berth only during high tide cycles ($O_t = 1$). The other vessels whose handling is not restricted to working periods ($\gamma_v = 0$) and that are tide-independent at their berthing ($\alpha_v = 0$) always respect this condition.
6. As vessel v that berths in time period t at quay q with n_q quay cranes assigned to it will leave the port at its departure time period $\left(\tau_{vtq}^{n_q} = Y_v \left(\Gamma_{vt} + \theta_{vq}^{n_q} - 1 \right), \forall v \in \mathcal{V}, \forall t \in \mathcal{T}, \forall q \in \mathcal{Q}, \forall n_q \in \mathcal{N}_q \right)$, it can leave the port only if $(1 - \omega_v) + \omega_v \cdot O_{\tau_{vtq}^{n_q}} = 1$. In other words, vessels that are tide-dependent at their departure ($\omega_v = 1$), can leave the port during high tide cycles ($O_{\tau_{vtq}^{n_q}} = 1$). The tide-independent at their departure ($\omega_v = 0$) always respect this condition.
7. The length of vessel v must not exceed the limit of its berthing quay q : $s_q \leq S_q - \lambda_v + 1$.
8. The draft of vessel v must not exceed the water depth of its berthing section s_q : $D_v \leq W_q^{s_q}$. If this condition is verified for the first section s_q , it will be implicitly verified for the other sections occupied by the vessel because the water depth of sections does not decrease seaward.

To alleviate the mathematical model and enhance its readability, each predicate, that refers to one condition or more, is represented by a simplified form given in Table 3.3. The decision variable $x_{vtq}^{s_q n_q}$ exists when all predicates are true.

Table 3.3: Notation of predicates in the LBACAP model

Index	Predicate	Notation
q	$I_{vq} = 1$	P_{vq}
n_q	$n_v^{\min} \leq n_q \leq n_v^{\max}$	$P_{vq}^{n_q}$
t	$K_t = 1 \wedge A_v \leq t \leq A_v + M_v \wedge G_{vt} = 1 \wedge (1 - \omega_v) + \omega_v \cdot O_{\tau_{vtq}^{n_q}} = 1$	$P_{vtq}^{n_q}$
s_q	$s_q \leq S_q - \lambda_v + 1 \wedge D_v \leq W_q^{s_q}$	$P_{vq}^{s_q}$

The logical conditions of the existence of the decision variable $x_{vtq}^{s_q n_q}$ are the following ones: $x_{vtq}^{s_q n_q} \in \{0, 1\}, \forall v \in \mathcal{V}, \forall q \in \mathcal{Q} \mid P_{vq}, \forall n_q \in \mathcal{N}_q \mid P_{vq}^{n_q}, \forall t \in \mathcal{T} \mid P_{vtq}^{n_q}, \forall s_q \in \mathcal{S}_q \mid P_{vq}^{s_q}$.

First, we define the intermediary variables of the LBACAP model which give respectively the number of active quay cranes serving vessel v at quay q and time period t , its expected departure time, and the inverse of its berthing section.

$$\rho_{vtq} = \sum_{n_q \in \mathcal{N}_q} P_{vq}^{n_q} \sum_{t' \in \mathcal{T}} \left| t' \leq t \leq \tau_{vt'q}^{n_q} \wedge P_{vt'q}^{n_q} \sum_{s_q \in \mathcal{S}_q} P_{vq}^{s_q} n_q x_{vt'q}^{s_q n_q}, \forall v \in \mathcal{V}, \forall t \in \mathcal{T}, \forall q \in \mathcal{Q} \mid P_{vq} \right.$$

$$\pi_v = \sum_{q \in \mathcal{Q}} P_{vq} \sum_{n_q \in \mathcal{N}_q} P_{vq}^{n_q} \sum_{t \in \mathcal{T}} \left| P_{vtq}^{n_q} \sum_{s_q \in \mathcal{S}_q} P_{vq}^{s_q} \tau_{vtq}^{n_q} \cdot x_{vtq}^{s_q n_q}, \forall v \in \mathcal{V} \right.$$

$$\varepsilon_v = \sum_{q \in \mathcal{Q}} P_{vq} \sum_{n_q \in \mathcal{N}_q} P_{vq}^{n_q} \sum_{t \in \mathcal{T}} \left| P_{vtq}^{n_q} \sum_{s_q \in \mathcal{S}_q} P_{vq}^{s_q} x_{vtq}^{s_q n_q} / s_q, \forall v \in \mathcal{V} \right.$$

The LBACAP model can be formulated as follows:

$$\text{Max} \sum_{v \in \mathcal{V}} [(\beta_v \cdot w_v - \eta_v \cdot u_v) + \varepsilon_v] \quad (1)$$

or

$$\text{Min} \sum_{v \in \mathcal{V}} (\pi_v - \varepsilon_v) \quad (2)$$

s. t.

$$\sum_{q \in \mathcal{Q}} P_{vq} \sum_{n_q \in \mathcal{N}_q} P_{vq}^{n_q} \sum_{t \in \mathcal{T}} \left| P_{vtq}^{n_q} \sum_{s_q \in \mathcal{S}_q} P_{vq}^{s_q} x_{vtq}^{s_q n_q} = 1, \forall v \in \mathcal{V} \quad (3)$$

$$\sum_{v \in \mathcal{V}} P_{vq} \sum_{n_q \in \mathcal{N}_q} P_{vq}^{n_q} \sum_{t' \in \mathcal{T}} \left| t' \leq t \leq \tau_{vt'q}^{n_q} \wedge P_{vt'q}^{n_q} \sum_{s'_q \in \mathcal{S}_q} P_{vq}^{s'_q} x_{vt'q}^{s'_q n_q} \leq 1, \right. \\ \left. \forall t \in \mathcal{T}, \forall q \in \mathcal{Q}, \forall s_q \in \mathcal{S}_q \quad (4)$$

$$\sum_{v \in \mathcal{V}} P_{vq} \rho_{vtq} \leq N_q, \forall t \in \mathcal{T}, \forall q \in \mathcal{Q} \quad (5)$$

$$u_v \geq \pi_v - \delta_v, \forall v \in \mathcal{V} \quad (6)$$

$$u_v \geq 0, \forall v \in \mathcal{V} \quad (7)$$

$$w_v \geq \delta_v - \pi_v, \forall v \in \mathcal{V} \quad (8)$$

$$w_v \geq 0, \forall v \in \mathcal{V} \quad (9)$$

$$u_v - w_v = \pi_v - \delta_v, \forall v \in \mathcal{V} \quad (10)$$

We provide the possibility to choose among two objective functions depending on the actors involved in the port operations. When ports belong to one single shipper, the objective function (1) is more appropriate to use. It is an economic function that maximizes the sum of the difference between despatch money and demurrage charges of each vessel. The final term of the objective function (1) favors the berthing of vessels as close as possible to the port yard and enables to select one of the optimal spatial solutions that have the same economic results.

In the presence of several actors with conflicting monetary objectives, a physical objective function (2) can be used to minimize the sum of expected vessel departure times, by berthing each vessel as close as possible to its arrival time, with as many quay cranes as possible. As in (1), the second term of the objective function favors the berthing of vessels as close as possible to the port yard among equivalent solutions.

In both objectives functions, laycans are proposed for each new vessel to charter by making it arrive to the port as close as possible to the availability date of its cargo to be exported and leave the port as early as possible, without impacting the results of the already chartered vessels.

Constraint (3) ensures that vessel v starts berthing in a unique time period t , at a unique section s_q of quay q , with a fixed number of quay cranes n_q assigned to it.

Constraint (4) is a disjunctive spatiotemporal constraint that avoids spatiotemporal overlapping between vessels. The spatiotemporal location of a vessel v that berths in time period t at section s_q of quay q , with n_q quay cranes assigned to it (i.e., $x_{vtq}^{s_q n_q} = 1$), can be represented by a rectangle, located between the sections $s'_q = s_q$ and $s'_q = s_q + \lambda_v - 1$ on the spatial dimension, and between the time periods $t' = t$ and $t' = \tau_{vtq}^{n_q}$ on the temporal dimension (or $t' = t + \theta_{vtq}^{n_q} - 1$ if the handling of vessel v is not restricted to working periods, which is implicitly performed in the general definition of $\tau_{vtq}^{n_q}$). Consequently, vessels that berth before or after vessel v during its handling time at the same quay q , must avoid overlaps. Figure 3.5 illustrates some forbidden overlaps once "Vessel A" has been berthed.

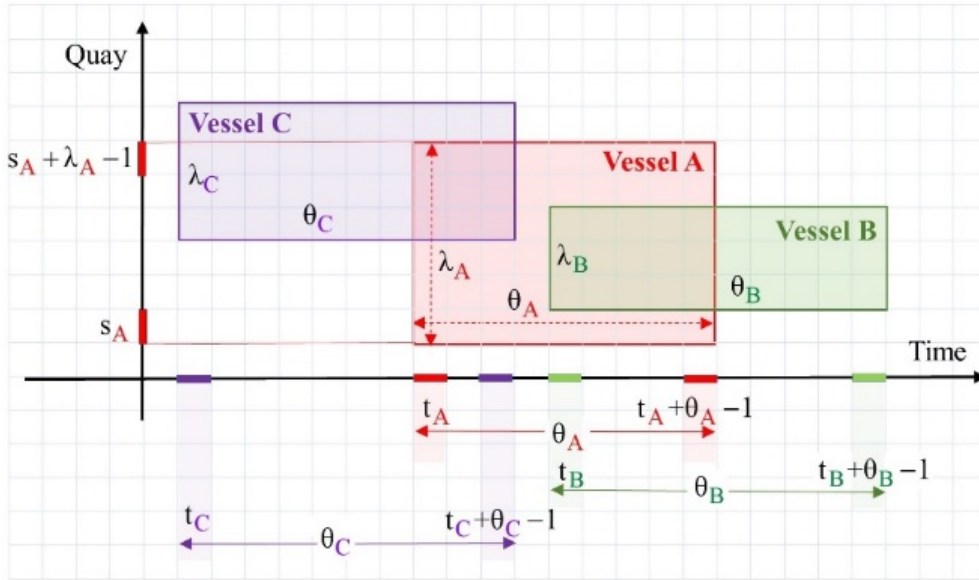

Figure 3.5: Example of overlaps between 3 vessels (if their handling is not restricted to working periods)

Constraint (5) ensures that in time period t , the number of active quay cranes serving all vessels that are present in a quay q is not greater than the available number of identical quay cranes N_q at this quay.

The difference between the expected departure time for vessel v and its contractual departure time can be written as: $\pi_v - \delta_v$. The integer variable u_v should verify the constraints (6), (7) and (10) in order to determine the delay of vessel v , and the integer variable w_v should verify the constraints (8), (9) and (10) in order to determine its advance.

When the objective function (2) is used, we only consider the binary variable $x_{viq}^{s_q n_q}$ and the constraints (3), (4) and (5). Consequently, the LBACAP model becomes a zero-one integer programming model.

3.4. Description and formulation of the LBACASP

3.4.1. Description of the LBACASP

In the LBACASP, each quay has a number of cranes with different processing rates. Therefore, a group of heterogeneous quay cranes is assigned to each vessel (Figure 3.6). For example, if a quay has 4 cranes and the maximum number of quay cranes that can be assigned to any vessel is 3, then the possible groups of quay cranes are: $\{1\}$, $\{2\}$, $\{3\}$, $\{4\}$, $\{1, 2\}$, $\{2, 3\}$, $\{3, 4\}$, $\{1, 2, 3\}$, and $\{2, 3, 4\}$. The quay cranes in each group must be sorted in increasing order. Dealing with heterogeneous quay cranes makes some berthing positions more attractive than others in the same quay due to higher performance. Consequently, a berthing position that is served by a more efficient quay crane tends to be used more often than the other positions. Moreover, each quay crane has a maximum outreach in the quay (Figure 3.7).

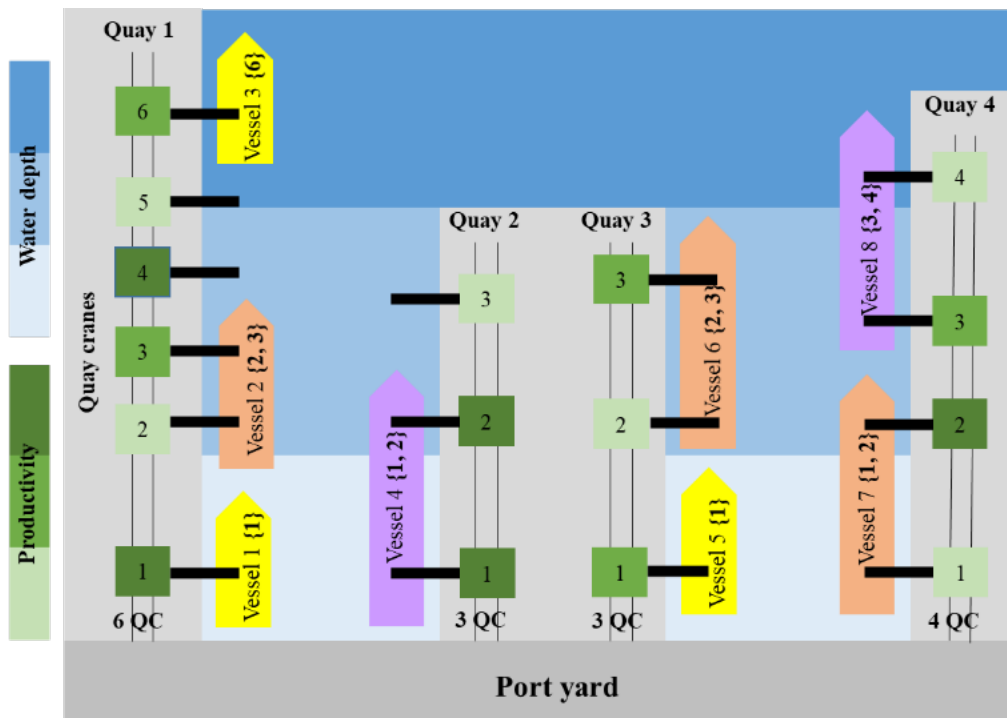

Figure 3.6: Example of a port with multiple quays, different water depths, and heterogeneous quay cranes

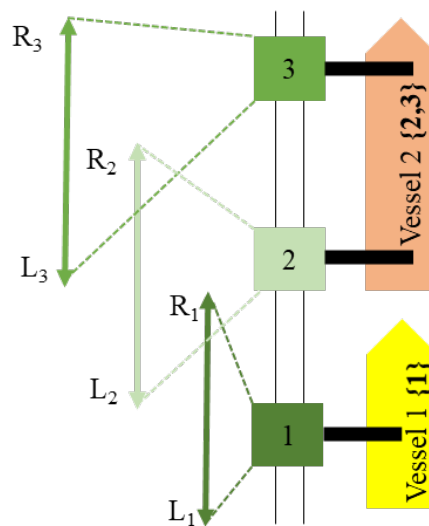

Figure 3.7: Range interval (maximum outreach) of each quay crane

3.4.2. Formulation of the LBACASP

Notation

In addition to the notations used in the LBACAP model, the following ones are used only in the LBACASP model.

Index	Description
g_q	Index of groups of quay cranes at quay q $\mathcal{G}_q = \{1, \dots, G_q\}$.
c_q	Index of quay cranes at quay q $\mathcal{C}_q = \{1, \dots, N_q\}$. A quay crane positioned closer to the port yard has a lower index.

Parameter	Description
-----------	-------------

Groups of quay cranes

$n_q^{g_q}$	Number of quay cranes in group g_q .
$l_q^{g_q}$	Index of the leftmost quay crane in group g_q (e.g., $l_q^{g_q} = 2$ in group $\{2, 3, 4\}$).
$r_q^{g_q}$	Index of the rightmost quay crane in group g_q (e.g., $r_q^{g_q} = 4$ in group $\{2, 3, 4\}$).
$L_q^{g_q}$	Index of the leftmost berthing section accessible by the leftmost quay crane in group g_q .
$R_q^{g_q}$	Index of the rightmost berthing section accessible by the rightmost quay crane in group g_q .

Vessels

B_v	Contractual handling time of vessel v .
$\theta_{vq}^{g_q}$	Handling time of vessel v if group g_q of quay cranes is assigned to it.
$\tau_{vtq}^{g_q}$	Departure time period of vessel v if this latter berths at time period t and group g_q of quay cranes is assigned to it:
$\tau_{vtq}^{g_q} = \Upsilon_{v\left(\Gamma_{vt} + \theta_{vq}^{g_q} - 1\right)}, \forall v \in \mathcal{V}, \forall t \in \mathcal{T}, \forall q \in \mathcal{Q}, \forall g_q \in \mathcal{G}_q.$	

Decision variable	Description
-------------------	-------------

$y_{vtq}^{s_q g_q}$	1 if vessel v starts berthing in time period t at section s_q of quay q , and group g_q of quay cranes is assigned to it, 0 otherwise. This decision variable replaces the binary variable $x_{vtq}^{s_q n}$ of the LBACAP model.
$z_{tq}^{c_q}$	Position of quay crane c_q at quay q in time period t . $z_{tq}^{c_q}$ is integer because it refers to a section of the quay.

Mathematical model

The existence of the decision variable $y_{vtq}^{s_q g_q}$ is also subject to eight conditions. However, condition 7 becomes more restrictive. Indeed, the new condition says that all berthing sections occupied by vessel v must be outreached by all the quay cranes in the group g_q assigned to

this vessel. In other words, the indices of the first and the last berthing sections occupied by vessel v must be within the outreach range of its assigned group of quay cranes g_q :

$$\left[s_q, s_q + \lambda_v - 1 \right] \subset \left[L_q^{g_q}, R_q^{g_q} \right] \Rightarrow L_q^{g_q} \leq s_q \leq R_q^{g_q} - \lambda_v + 1. \text{ Figure 3.8 illustrates this condition.}$$

The condition that states that the length of each vessel must not exceed the limit of its assigned quay is implicit in this condition.

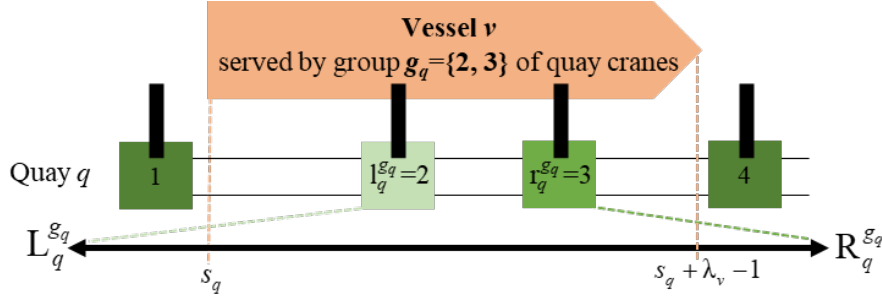

Figure 3.8: Illustration of the spatial condition

As in the LBACAP model, each predicate, that refers to one condition or more, is represented by a simplified form given in Table 3.4. The decision variable $y_{vtq}^{s_q g_q}$ exists when all predicates are true.

Table 3.4: Notation of predicates in the LBACASP model

Index	Predicate	Notation
q	$I_{vq} = 1$	P_{vq}
g_q	$n_v^{\min} \leq n_q^{g_q} \leq n_v^{\max}$	$P_{vq}^{g_q}$
t	$K_t = 1 \wedge A_v \leq t \leq A_v + M_v \wedge G_{vt} = 1 \wedge (1 - \omega_v) + \omega_v \cdot O_{\tau_{vtq}^{g_q}} = 1$	$P_{vtq}^{g_q}$
s_q	$L_q^{g_q} \leq s_q \leq R_q^{g_q} - \lambda_v + 1 \wedge D_v \leq W_q^{s_q}$	$P_{vq}^{s_q g_q}$

The logical conditions of the existence of the decision variable $y_{vtq}^{s_q g_q}$ are the following ones: $y_{vtq}^{s_q g_q} \in \{0, 1\}, \forall v \in \mathcal{V}, \forall q \in \mathcal{Q} \mid P_{vq}, \forall g_q \in \mathcal{G}_q \mid P_{vq}^{g_q}, \forall t \in \mathcal{T} \mid P_{vtq}^{g_q}, \forall s_q \in \mathcal{S}_q \mid P_{vq}^{s_q g_q}$.

In the LBACASP, the definition of the already introduced intermediate variables, π_v and ε_v , which give respectively the expected departure time and the inverse of the berthing section for vessel v become:

$$\pi_v = \sum_{q \in \mathcal{Q}} P_{vq} \sum_{g_q \in \mathcal{G}_q} P_{vq}^{g_q} \sum_{t \in \mathcal{T}} P_{vtq}^{g_q} \sum_{s_q \in \mathcal{S}_q} P_{vq}^{s_q g_q} \tau_{vtq}^{g_q} \cdot y_{vtq}^{s_q g_q}, \forall v \in \mathcal{V}$$

$$\varepsilon_v = \sum_{q \in \mathcal{Q}} P_{vq} \sum_{g_q \in \mathcal{G}_q} P_{vq}^{g_q} \sum_{t \in \mathcal{T}} P_{vtq}^{g_q} \sum_{s_q \in \mathcal{S}_q} P_{vq}^{s_q g_q} y_{vtq}^{s_q g_q} / s_q, \forall v \in \mathcal{V}$$

The LBACASP model can be formulated as follows:

$$\sum_{q \in \mathcal{Q}} \left| \mathbb{P}_{vq} \sum_{g_q \in \mathcal{G}_q} \left| \mathbb{P}_{vq}^{g_q} \sum_{t \in \mathcal{T}} \left| \mathbb{P}_{vq}^{g_q} \sum_{s_q \in \mathcal{S}_q} \left| \mathbb{P}_{vq}^{s_q g_q} \mathcal{Y}_{vq}^{s_q g_q} = 1, \forall v \in \mathcal{V} \right. \right. \right. \right. \quad (11)$$

$$\sum_{v \in \mathcal{V}} \left| \mathbb{P}_{vq} \sum_{g_q \in \mathcal{G}_q} \left| \mathbb{P}_{vq}^{g_q} \sum_{t' \in \mathcal{T}} \left| t' \leq t \leq \tau_{vq}^{g_q} \wedge \mathbb{P}_{vq}^{g_q} \sum_{s'_q \in \mathcal{S}_q} \left| s_q - \lambda_v + 1 \leq s'_q \leq s_q \wedge \mathbb{P}_{vq}^{s'_q g_q} \mathcal{Y}_{vq}^{s'_q g_q} \leq 1, \right. \right. \right. \right. \\ \forall t \in \mathcal{T}, \forall q \in \mathcal{Q}, \forall s_q \in \mathcal{S}_q \quad (12)$$

$$z_{tq}^{c_q} \leq z_{tq}^{c_q + 1}, \forall t \in \mathcal{T}, \forall q \in \mathcal{Q}, \forall c_q \in \mathcal{C}_q \mid c_q \leq N_q - 1 \quad (13)$$

$$z_{tq}^{N_q} \leq S_q, \forall t \in \mathcal{T}, \forall q \in \mathcal{Q} \quad (14)$$

$$z_{t'q}^{l_q^{g_q}} + S_q \cdot (1 - \sum_{s_q \in \mathcal{S}_q} \left| \mathbb{P}_{vq}^{s_q g_q} \mathcal{Y}_{vq}^{s_q g_q} \right|) \geq \sum_{s_q \in \mathcal{S}_q} \left| \mathbb{P}_{vq}^{s_q g_q} s_q \cdot \mathcal{Y}_{vq}^{s_q g_q} \right|, \\ \forall v \in \mathcal{V}, \forall q \in \mathcal{Q} \mid \mathbb{P}_{vq}, \forall g_q \in \mathcal{G}_q \mid \mathbb{P}_{vq}^{g_q}, \forall t \in \mathcal{T} \mid \mathbb{P}_{vq}^{g_q}, \forall t' \in \mathcal{T} \mid t \leq t' \leq \tau_{vq}^{g_q} \quad (15)$$

$$z_{t'q}^{r_q^{g_q}} \leq \sum_{s_q \in \mathcal{S}_q} \left| \mathbb{P}_{vq}^{s_q g_q} (s_q + \lambda_v - 1) \cdot \mathcal{Y}_{vq}^{s_q g_q} \right| + S_q \cdot (1 - \sum_{s_q \in \mathcal{S}_q} \left| \mathbb{P}_{vq}^{s_q g_q} \mathcal{Y}_{vq}^{s_q g_q} \right|), \\ \forall v \in \mathcal{V}, \forall q \in \mathcal{Q} \mid \mathbb{P}_{vq}, \forall g_q \in \mathcal{G}_q \mid \mathbb{P}_{vq}^{g_q}, \forall t \in \mathcal{T} \mid \mathbb{P}_{vq}^{g_q}, \forall t' \in \mathcal{T} \mid t \leq t' \leq \tau_{vq}^{g_q} \quad (16)$$

The first two constraints of the LBACASP model are similar to the first two constraints of the LBACAP model with some differences in the formulation:

Constraint (11) ensures that vessel v starts berthing in a unique time period t at a unique section s_q of quay q , with a group of quay cranes g_q assigned to it.

Constraint (12) is a disjunctive spatiotemporal constraint that avoids spatiotemporal overlapping between vessels.

Constraints (13) to (16) guarantee that quay cranes are assigned to vessels v in the correct sequence. These four constraints are inspired by Türkoğulları et al. (2014):

- Constraint (13) states that the positions of quay cranes c_q at quay q are respected by their indices. So, during time period t , the position of quay crane c_q is always less than or equal to the position of quay crane $c_q + 1$ at quay q .
- Constraint (14) ensures that the last quay crane N_q is positioned within the quay q .
- Constraint (15) ensures that the position $z_{t'q}^{l_q^{g_q}}$ of the leftmost quay crane $l_q^{g_q}$ in the group g_q assigned to vessel v is greater than or equal to its berthing section s_q , between its berthing time $t' = t$ and its end of handling $t' = \tau_{vq}^{g_q}$.

- Constraint (16) ensures that the position $z_{t'q}^{r_q^{g_q}}$ of the rightmost quay crane $r_q^{g_q}$ of group g_q assigned to vessel v is less than or equal to its last occupied berthing section $s_q + \lambda_v - 1$, between its berthing time $t' = t$ and its end of handling $t' = \tau_{vtq}^{g_q}$.

Constraints (6) to (10) of the LBACAP model that determine the delay or the advance of vessel v and the objective functions (1) and (2) are also valid for the LBACASP model.

3.5. Computational experiments

In this section, we report the computational results obtained on instances generated by our test instance generator. We also present two illustrative examples, one for the LBACAP model and one for the LBACASP model, in order to show the integration of the LAP with the BACAP and the BACASP, and all the considered characteristics (the multiplicity of quays, the variation of water depth, the productivity and the outreach of quay cranes, vessel tide-dependency, and non-working periods). The formulations are written on Mosel and implemented in Xpress-IVE Version 1.24.24, with 64 bits. All the tests are run on a computer with Intel Xeon CPU E3-1240 v5 @ 3.50 GHz - 64 GB RAM and using the Xpress Optimizer Version 33.01.05 with the default options.

3.5.1. Generation of test instances

In order to generate test instances to evaluate the quality of the proposed models, we have built an instance generator, on simulation software, which accepts all the relevant characteristics of the problems as configurable parameters and produces representative and feasible instances.

Since the LBACAP and the LBACASP integrate operational and tactical problems, 4 weeks is a reasonable time span for such problems. Therefore, for all instances, we consider a time horizon of 4 weeks discretized in units of 1 hour $|\mathcal{T}| = 672$. The operational part of the problem requires a detailed schedule with a certain precision (an hourly schedule is appropriate), while the decisions for the tactical part only need to be global (a schedule with a precision of half a day is sufficient). Therefore, the decision time-interval, arbitrarily decided by port managers, may vary inside the planning horizon. In our example, a vessel may berth at any hourly period during the first week; during the second, third and fourth week, berthing is allowed only every 4, 8 and 12 hours respectively. Whatever the decision time-interval is, the physical consequences of model decisions (departure dates, quay crane utilization, etc.) are defined using an hourly scale. The detailed characteristics of time periods are shown in the file [Time.xlsx](#).

The data related to quays and cranes are generated as follows:

- Each quay is 1000 meters long and discretized in units of 50 meters (i.e., $|\mathcal{S}_q| = 20$) or 10 meters (i.e., $|\mathcal{S}_q| = 100$). It has to be noted that the choice of the discretization unit of the lengths is linked to the length of vessels and the quays of the studied port.
- The berthing sections of each quay are characterized by 3 classes of water depth as in Table 3.5 (the water depth increases as the class number increases).

Table 3.5: Class of water depth of berthing sections

Discretization unit	50 m			10 m		
Class of water depth $W_q^{s_q}$	1	2	3	1	2	3
Range of sections of quay q	1 - 3	4 - 10	11 - 20	1 - 15	16 - 50	51 - 100

- In the LBACAP model, each quay has $|\mathcal{N}_q| = 10$ homogeneous cranes.
- In the LBACASP model, each quay has $|\mathcal{N}_q| = 10$ heterogeneous cranes with outreach conditions. Since we set the maximum number of quay cranes that can be assigned to any vessel to 3, the number of the possible groups of heterogeneous quay cranes is $|\mathcal{G}_q| = 27$. These latter are distributed as follows: 10 groups of 1 crane, 9 groups of 2 cranes and 8 groups of 3 cranes. The detailed characteristics of these groups of quay cranes are shown in Table 3.6.

Table 3.6: Characteristics of groups of quay cranes

g_q	Group of quay cranes	$n_q^{g_q}$	$l_q^{g_q}$	$r_q^{g_q}$	$L_q^{g_q}$	$R_q^{g_q}$		g_q	Group of quay cranes	$n_q^{g_q}$	$l_q^{g_q}$	$r_q^{g_q}$	$L_q^{g_q}$	$R_q^{g_q}$	
						50 m	10 m							50 m	10 m
1	{1}	1	1	1	1	11	55	11	{1, 2}	2	1	2	1	12	60
2	{2}	1	2	2	2	12	60	12	{2, 3}	2	2	3	2	13	65
3	{3}	1	3	3	3	13	65	13	{3, 4}	2	3	4	3	14	70
4	{4}	1	4	4	4	14	70	14	{4, 5}	2	4	5	4	15	75
5	{5}	1	5	5	5	15	75	15	{5, 6}	2	5	6	5	16	80
6	{6}	1	6	6	6	16	80	16	{6, 7}	2	6	7	6	17	85
7	{7}	1	7	7	7	17	85	17	{7, 8}	2	7	8	7	18	90
8	{8}	1	8	8	8	18	90	18	{8, 9}	2	8	9	8	19	95
9	{9}	1	9	9	9	19	95	19	{9, 10}	2	9	10	9	20	100
10	{10}	1	10	10	10	20	100								

g_q	Group of quay cranes	$n_q^{g_q}$	$l_q^{g_q}$	$r_q^{g_q}$	$L_q^{g_q}$	$R_q^{g_q}$	
						50 m	10 m
20	{1, 2, 3}	3	1	3	1	13	65
21	{2, 3, 4}	3	2	4	2	14	70
22	{3, 4, 5}	3	3	5	3	15	75
23	{4, 5, 6}	3	4	6	4	16	80
24	{5, 6, 7}	3	5	7	5	17	85
25	{6, 7, 8}	3	6	8	6	18	90
26	{7, 8, 9}	3	7	9	7	19	95
27	{8, 9, 10}	3	8	10	8	20	100

The data related to vessels are generated as follows:

- The interarrival times of vessels are generated through an exponential distribution with parameter $\{10, 7.5, 5\}$ in the LBACAP model and $\{15, 12.5, 10\}$ in the LBACASP model.
- The lengths of vessels are generated through the uniform distribution $U[150, 350]$. The kind of vessel depends on its length (see columns 1 and 2 of Table 3.7).
- Depending on the kind of each vessel, we define its maximum handling time $\theta_v^{\max} = \theta_{vq}^{n_q=1}$, its class of draft, and the minimum and the maximum number of quay cranes that can be assigned to it as in Table 3.7. After that, we calculate the handling time of each vessel when n_q quay cranes are assigned to it as follows:
 $\theta_{vq}^{n_q+1} = \theta_{vq}^{n_q} / (1+a)$ rounding up to the nearest integer, where the interference exponent $a = 0.4$. This latter reduces the marginal productivity of quay cranes. Since quay cranes are heterogeneous in the LBACASP model, handling times of vessels depend on the global productivity of each group of quay cranes.

Table 3.7: Specifications of vessels in the test instances

Kind of vessel	Length (m)	Maximum handling time (h)	Class of draft	n_v^{\min}	n_v^{\max}
Feeder	≤ 250	U[12, 24]	1	1	2
Medium	> 250 and ≤ 300	U[20, 32]	2	1	2
Jumbo	> 300	U[28, 40]	3	2	3

- Half of Jumbo vessels are tide-dependent while entering the port, and the other half while leaving it. Feeder and Medium vessels are tide-independent.
- 30% of vessels are handled only in working days.
- Only 5% of vessels have restricted berthing quays to let the choice of the berthing quay open.
- We consider the uniform distribution $U[50, 150]$ for the contractual demurrage per hour, and its half gives the contractual despatch per hour.
- The maximum waiting time in the harbor is 3 days for all the chartered vessels, and one week for all the new vessels to charter.
- The laycan days are either 2 or 3 days for the new vessels to charter.

3.5.2. Illustrative examples

In this section, we present two typical schedules that the port manager can obtain by using the proposed methods.

We consider the case of a tidal port of $|\mathcal{Q}| = 2$ quays with different lengths discretized in units of 50 meters ($|\mathcal{S}_1| = 17, |\mathcal{S}_2| = 20$), and different numbers of homogeneous quay cranes in the case of the LBACAP model ($|\mathcal{N}_1| = 6, |\mathcal{N}_2| = 7$) and groups of heterogeneous quay cranes in the case of the LBACASP model ($|\mathcal{G}_1| = 15, |\mathcal{G}_2| = 18$). In both examples, the number of vessels is $|\mathcal{V}| = 100$. These latter are distributed as follows: $|\mathcal{V}_1| = 3$ already berthed vessels, $|\mathcal{V}_2| = 93$ chartered vessels and $|\mathcal{V}_3| = 4$ new vessels to charter. The detailed characteristics of vessels are shown in the file [Vessels.xlsx](#).

Figure 3.9 and Figure 3.10 show, respectively, a portion of the Gantt charts of the optimal schedules obtained by the LBACAP and the LBACASP models with the economic objective function. The complete Gantt charts of both solutions with the economic and physical objective functions, and the detailed results are shown in the files [LBACAP results.xlsx](#) and [LBACASP results.xlsx](#).

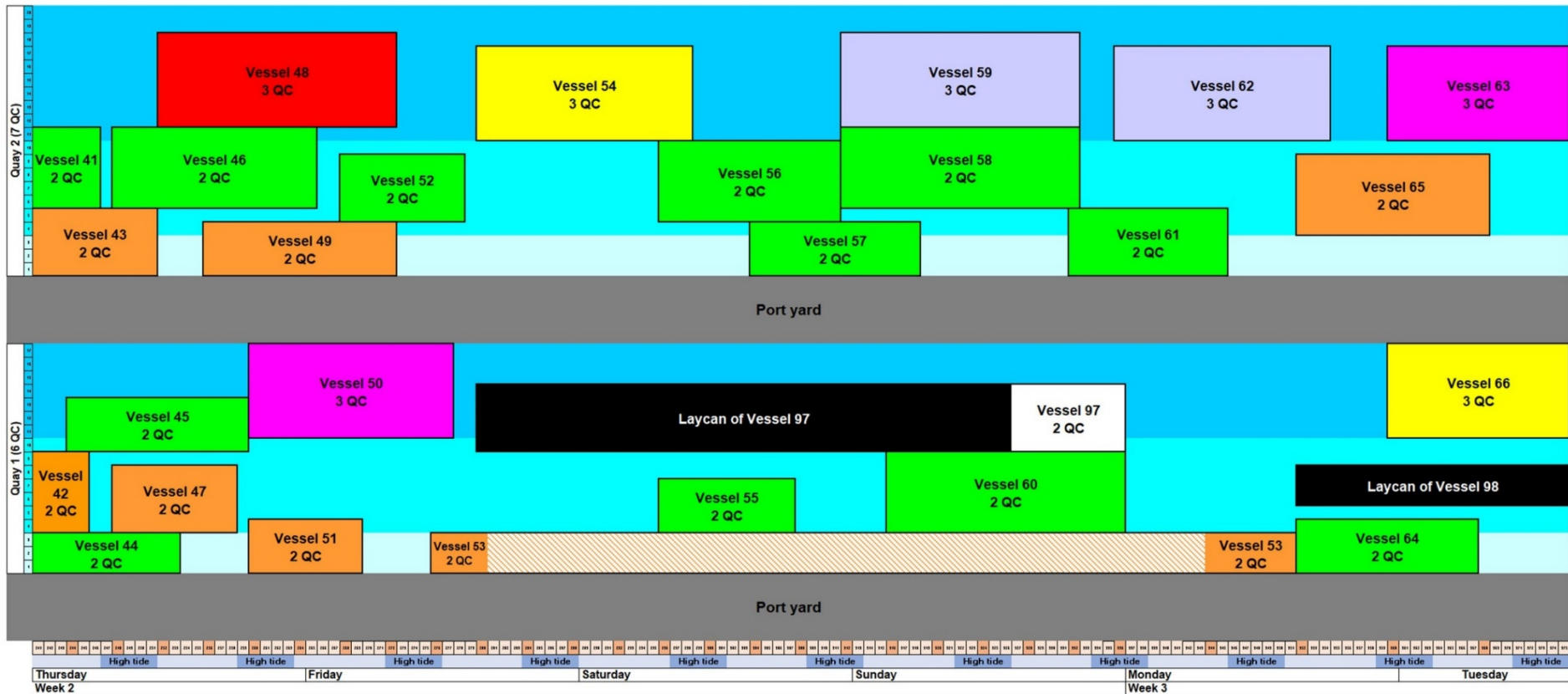

Figure 3.9: Part of the Gantt chart of the LBACAP model with the economic objective function

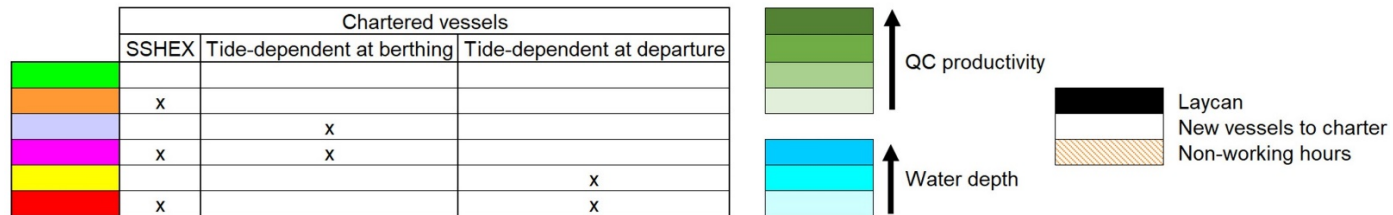
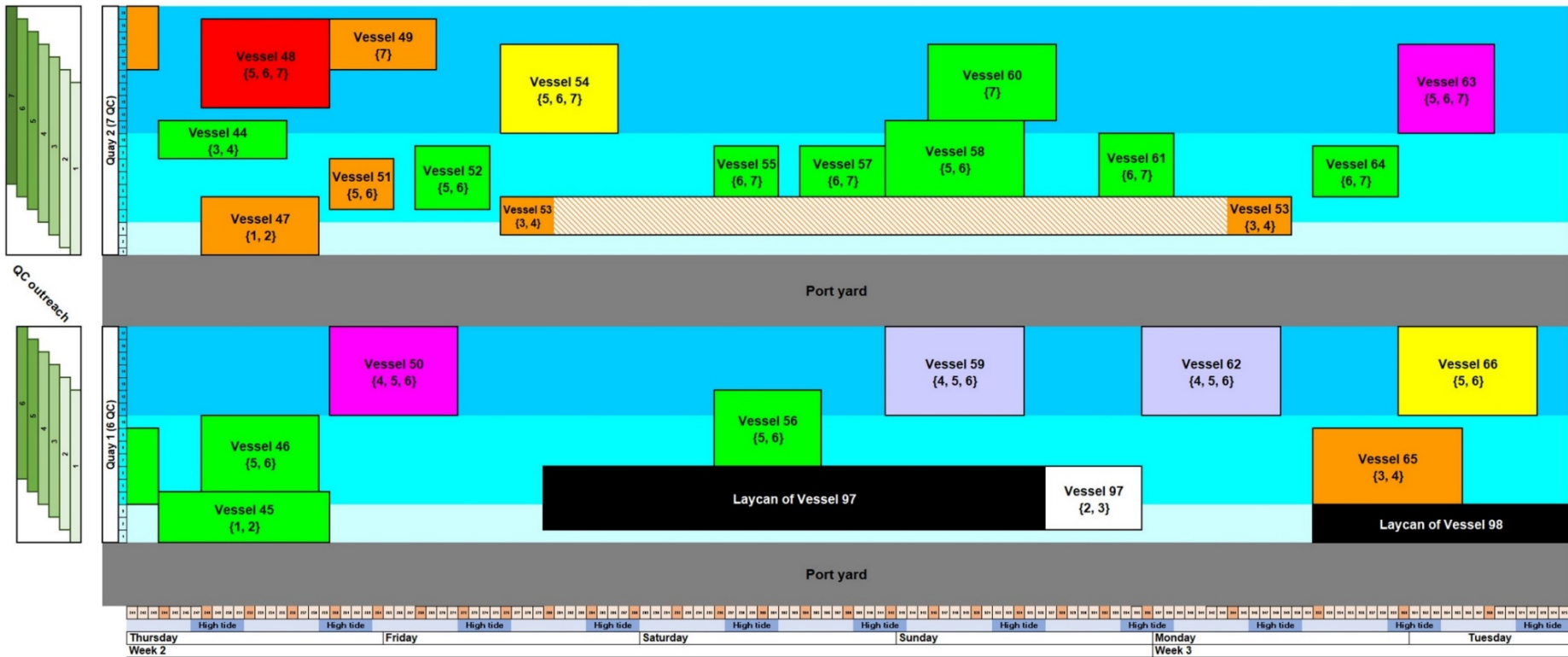

Figure 3.10: Part of the Gantt chart of the LBACASP model with the economic objective function

In Figure 3.9 (LBACAP), the legend describes the color code for each vessel subject to the set of constraints, green vessels having no constraints. At the bottom of the Gantt chart, we observe a one-week time frame (from Thursday of week 2 to Tuesday of week 3) with the high-tide periods and the timeline in hours. The decision time-intervals are highlighted every 4 hours for week 2 and every 8 hours for week 3. The solution respects all constraints:

- A number of homogeneous quay cranes is assigned to each vessel. For instance, 2 quay cranes are assigned to "Vessel 44" in quay 1 (2 QC, depicted on the rectangle representing the vessel). At no time slots, the capacity of 6 cranes for quay 1 and 7 cranes for quay 2 is overpassed.
- All vessels are berthed at restricted time periods for which a decision can be made.
- Since "Vessel 62" is a Jumbo vessel, it occupies sections with high water depth.
- "Vessel 59" is tide-dependent at berthing, so it enters to the port during high tide.
- "Vessel 54" is tide-dependent at departure, so it leaves the port during high tide.
- The handling of "Vessel 53" stops during non-working hours because it has a *SSHEX* clause.
- "Vessel 97" and "Vessel 98" are vessels for which a laycan has to be decided. For instance, for "Vessel 97" the optimal laycan is proposed between $t = 280$ and $t = 326$. "Vessel 97" can berth at any time period during the proposed laycan without impacting the economic results of the already chartered vessels. The actual berthing time will be assigned more precisely as time progresses and the status of the vessel evolves from a new vessel to charter to a chartered vessel.

The legend of Figure 3.10 (LBACASP solution) is similar. In this case, we can see which quay cranes are assigned to which vessels (e.g., "Vessel 44" will be served by cranes 3 and 4 on quay 2). On the left-hand side of the Gantt chart, the outreach and the productivity of each crane are also illustrated.

By comparing the two Gantt charts, we can see that vessel handling times are shorter in the LBACASP model. Indeed, since quay cranes are heterogeneous in each quay, the most productive quay cranes tend to be used more. Moreover, vessels are berthed in such a way that quay cranes outreach is respected. Thanks to the integration of these problems, the port managers can propose laycans for the new vessels to charter considering the allocations of already chartered vessels, thereby avoiding the payment of demurrage charges, and knowing when to accept or refuse a new vessel to charter.

3.5.3. Evaluation of the LBACAP and the LBACASP models

In this section, we explore the computational performance of the proposed models. One of the objectives is to verify if the proposed models can be solved in a reasonable time using commercial software. The other objective is to observe how some of the parameters of the models, namely, the number of quays, the number of vessels and the discretization unit of the quay and vessel lengths, impact the computation time.

For the LBACAP model, we generated two groups of test instances. The first group is for the case when the quay and vessel lengths are discretized in units of 50 meters and the second group represents a finer discretization with a base unit of 10 meters per section. Note that the discretization unit influences the observed performance. The explanation is simple and is based on observation from an independent simulation of 10 000 random scenarios, in which one seeks to saturate a 1 000 meters quay by instant arrivals of vessels of random length (Uniform distribution $U[150, 350]$). With discretization size of 1, 10, 20, 25, 40 and 50 meters for the quay and vessel lengths, the average number of vessels the quay can hold at any given time is estimated as 3.52, 3.47, 3.41, 3.38, 3.31 and 3.25 vessels, respectively. The more the discretization unit increases, the less the quay capacity can be saturated. As a result, some good solutions may be ruled out with a greater discretization. In this section, the choice of 50 and 10 meters discretization is arbitrary but inspired by Correcher et al. (2019).

In each group, we consider 3 sets of instances by varying the number of quays: $Q \in \{1, 3, 5\}$, and in each set, we consider a different number of vessels: $V \in \{50, 75, 100\}$. Consequently, we generated 18 scenarios (2 groups x 3 numbers of quays x 3 numbers of vessels). Each scenario represents a quays and vessels combination and consists of 10 instances generated using the instance generator described in Section 3.5.1. Hence, we tested 180 instances (18 scenarios x 10 instances) for the LBACAP.

In the case of the LBACASP model, a total of 90 instances (3 numbers of quays x 3 numbers of vessels x 10 instances) are generated for a combination of $Q \in \{1, 3, 5\}$ quays and $V \in \{20, 35, 50\}$ vessels in the case where the 50 meters discretization is used. All instances and their detailed results are accessible in the [Instances](#) folder. The results and discussions are provided below.

Evaluation of the LBACAP model

The results obtained for the LBACAP model are shown in Table 3.8. Results for the 50 meters discretization are at the upper part of the table, while the results for the 10 meters

discretization are presented at the lower part. The experiments are performed for both the economical objective function (LBACAP eco) and for the physical objective function (LBACAP phy). For each number of quays and number of vessels couple (Q, V), Table 3.8 shows the number of instances solved and the number of instances solved to optimality among the 10 instances tested, the average computation time in seconds, the average and maximum optimality gap, and the average time-space occupancy in percentages. Each average equals the sum of the values divided by the number of instances that are solved (the non-solved instances are not included in the calculation of the averages). For each instance, the computation time was limited to 1 hour. The empty fields for the 10 meters discretization indicate that no feasible solutions were found within the time limit and thus, it was not possible to calculate the statistics. Xpress calculates the time-space occupancy, which measures the maximum spatiotemporal occupations of vessels within the planning horizon and quay spaces, as follows: $(\sum_v \lambda_v \cdot \theta_v) / (|\mathcal{T}| \cdot \sum_q |\mathcal{S}_q|)$, and the gap as follows: $100 \cdot (ub - lb) / ub$. In the case of a minimization problem (physical criterion), lb is the value of the best lower bound obtained within the time limit, and ub is the value of the objective function corresponding to the best integer solution achieved. In the case where the objective function is maximized (economic criterion), ub is the best upper bound obtained within the time limit, and lb is the value of the objective function corresponding to the best integer solution achieved.

Table 3.8: Solving the LBACAP with a computation time limited to 1 hour

		LBACAP eco						LBACAP phy						
Q	V	Solved	Optimum	Avg.time	Avg. gap	Max. gap	Avg. occ	Solved	Optimum	Avg.time	Avg. gap	Max. gap	Avg. occ	
50 meters discretization	1	50	10	10	17.8	0	0	37.4	10	10	31.4	0	0	37.0
		75	10	10	58.1	0	0	51.5	10	10	75.8	0	0	51.2
		100	10	6	1846.0	12.5	76.9	64.0	10	6	2044.7	0.7	5.0	64.0
	3	50	10	10	45.8	0	0	12.5	10	10	60.7	0	0	12.6
		75	10	10	81.0	0	0	17.3	10	10	98.4	0	0	17.3
		100	10	10	119.8	0	0	21.6	10	10	133.5	0	0	21.6
	5	50	10	10	119.2	0	0	7.5	10	10	144.7	0	0	7.5
		75	10	10	154.9	0	0	10.4	10	10	178.8	0	0	10.4
		100	10	10	206.2	0	0	12.9	10	10	225.2	0	0	13.0
10 meters discretization	1	50	10	10	638.0	0	0	34.7	10	10	1223.8	0	0	34.3
		75	10	9	1722.1	1.7	16.6	47.4	10	7	2903.0	0.1	0.3	47.3
		100	8	4	2877.4	3.3	9.1	57.9	8	1	3608.7	0.5	0.9	57.8
	3	50	10	10	1592.1	0	0	11.6	10	10	2678.1	0	0	11.6
		75	10	10	2434.7	0	0	16.0	4	3	3589.1	0.4	1.4	16.7
		100	10	10	3248.4	0	0	20.0	0	0				
	5	50	10	10	2930.1	0	0	6.9	0	0				
		75	4	4	3481.3	0	0	9.6	0	0				
		100	0	0					0	0				

We can make several observations based on these results:

First, for a fixed number of quays, increasing the number of vessels increases the computation time for all scenarios. Note that this also increases the occupancy rate. However, increasing the number of quays for a fixed number of vessels does not always increase the computation time (see, for instance, $V=100$ for 50 meters discretization). Indeed, this results in higher resource availability and, hence, in lower congestion in the port. We conclude that the computation time is highly related to how busy the port is.

Second, we are able to solve to optimality instances up to 100 vessels and 5 quays within a time horizon of 4 weeks in the case of the 50 meters discretization in computation times not exceeding 1 hour (and in less than 5 minutes on the average in most cases). This is a significant outcome in terms of the size and the characteristics of the instances since to the best of our knowledge, there are no reported solutions in the literature for this integrated problem of this size and all these characteristics. Some instances in the case of 100 vessels and 1 quay are not optimally solved due to their high congestion (a time-space occupancy that exceeds 60%), and some instances are not solved or optimally solved in the case of the 10 meters discretization due to the time limit of 1 hour. Therefore, in Table 3.9, we report the results of the LBACAP with the 10 meters discretization and a computation time limited to 3 hours instead of 1 hour.

Table 3.9: Solving the LBACAP with a computation time limited to 3 hours

		LBACAP eco							LBACAP phy					
		Q	V	Solved	Optimum	Avg.time	Avg. gap	Max. gap	Avg. occ	Solved	Optimum	Avg.time	Avg. gap	Max. gap
10 meters discretization	1	50	10	10	638.0	0	0	34.7	10	10	1223.8	0	0	34.3
		75	10	9	2443.0	1.7	16.6	47.4	10	7	5071.3	0	0.2	47.4
		100	10	6	6861.3	9.6	70.0	59.2	10	2	10472.0	1.7	7.2	59.4
	3	50	10	10	1592.1	0	0	11.6	10	10	2678.1	0	0	11.6
		75	10	10	2434.7	0	0	16.0	10	10	4193.4	0	0	16.0
		100	10	10	3248.4	0	0	20.0	10	10	5506.7	0	0	20.0
	5	50	10	10	2930.1	0	0	7.0	10	10	5247.8	0	0	6.9
		75	10	10	4222.9	0	0	9.6	10	10	6946.3	0	0	9.6
		100	10	10	5733.4	0	0	12.0	10	10	9028.7	0	0	12.0

As can be seen, the instances that are not solved when setting the time limit to 1 hour, are now solved optimally. We believe that a computation up to 3 hours is acceptable for this size of problems, where the planning horizon is 4 weeks and the model is occasionally rerun (ideally, once a week to refine the next week's schedule and/or when a laycan needs to be determined for a new vessel to charter, or when a change occurs in the inputs of the problem).

Finally, we note that the computation times in the case of the economic objective function are shorter than the case of the physical objective function. This could be explained by the despatch and demurrage coefficients in the economic objective function and the absence of coefficients in the physical one. Indeed, the coefficients orient the problems faster to the solution.

In Table 3.10, we report the average optimal objective values of the instances that are solved to optimality when computation time is limited to 3 hours (the instances that are not solved to optimality are not included in the calculation) in the cases of the 50 meters and the 10 meters discretization unit and the difference between the two cases in percentages.

Table 3.10: Optimal objective values of the LBACAP model

		Avg. optimal objective values					
		LBACAP eco			LBACAP phy		
Q	V	50 m	10 m	Difference	50 m	10 m	Difference
1	50	-13814.6	-12627.3	8.6	13679.8	13652.7	0.2
	75	-21119.5	-17194.9	18.6	19398.6	19340.5	0.3
	100	-26783.6	-20270.7	24.3	24853.3	24788.9	0.3
3	50	-474.1	-476.7	0.6	13496.6	13498.5	0
	75	221.0	216.5	2.0	19322.4	19328.7	0
	100	182.8	177.4	3.0	25534.7	25543.4	0
5	50	-472.5	-475.3	0.6	13493.0	13495.4	0
	75	224.8	220.9	1.7	19315.9	19320.4	0
	100	189.8	185.0	2.5	25523.1	25527.6	0
				6.9			0.1

As can be seen, the average optimal objective function values in the case of the 10 meters discretization are better than in the case of the 50 meters discretization. Indeed, in the search for an optimal solution, some possible solutions may be ruled out in the case of coarse discretization, especially in problems leading to high quay saturation. This parameter needs to be fine-tuned in case of busy ports. For the instance set we have tested, we observe that the difference is 6.9% on average in the case of the economic objective function and only 0.1% on average in the case of the physical objective function, thereby the 50 meters discretization of the space seems sufficient enough for the resolution of the problem, especially if a physical objective function is used.

As a summary, we can conclude that the proposed LBACAP model can be solved, most of the time, optimally in a reasonable time using commercial software. The discretization unit of the quay and vessel lengths, the objective function and the occupancy rate have a strong influence on the computation time and/or the quality of the solution. The occupancy rate is an external factor, and the choice of the objective function depends on the relationship between the port actors. However, the decision maker can play with the discretization unit to balance between the quality of the solution and the computation time.

Evaluation of the LBACASP model

In this section, we discuss the results of the LBACASP model. Table 3.11 shows the results obtained for the LBACASP model with the 50 meters discretization.

Table 3.11: Solving the LBACASP with the 50 meters discretization

		LBACASP eco						LBACASP phy						
Q	V	Solved	Optimum	Avg.time	Avg. gap	Max. gap	Avg. occ	Solved	Optimum	Avg.time	Avg. gap	Max. gap	Avg. occ	
50 meters discretization	1	20	10	10	85.0	0	0	14.2	10	10	110.5	0	0	14.2
		35	10	10	288.2	0	0	23.6	10	10	322.4	0	0	23.7
		50	10	10	605.3	0	0	34.3	10	10	782.2	0	0	34.1
	3	20	10	10	392.1	0	0	4.7	10	10	476.7	0	0	4.7
		35	10	10	748.3	0	0	7.9	10	10	905.0	0	0	7.8
		50	10	10	1190.5	0	0	11.3	10	10	1390.6	0	0	11.2
	5	20	10	10	584.5	0	0	2.8	10	10	695.2	0	0	2.8
		35	10	10	1885.7	0	0	4.8	10	10	2146.6	0	0	4.7
		50	10	10	2728.1	0	0	6.8	10	10	3125.5	0	0	6.7

As can be seen, we are able to solve to optimality instances up to 50 vessels and 5 quays within a time horizon of 4 weeks in short times. All the instances of the LBACASP are solved to optimality. It has to be noted that the LBACASP model is more difficult than the LBACAP model, especially since the heterogeneous quay cranes are considered. Indeed, as the number of heterogeneous quay cranes increases, the combination of groups of quay cranes increases, which increases the number of variables and constraints (e.g., see Table 3.6, where 10 quay cranes result in 27 groups of quay cranes).

3.6. Conclusions

The Laycan Allocation Problem has a clear interaction with one of the most important operational problems in the seaside area of ports: the Berth Allocation Problem. This latter also has a strong link with the assignment of quay cranes. Consequently, in this paper, we have introduced first a new integer programming model for the integrated Laycan and continuous Berth Allocation and time-invariant Quay Crane Assignment Problem (LBACAP). This latter integrates three problems with different decision levels (tactical and operational); therefore, a change of decision time-interval is made inside the planning horizon. Since the time-variant Quay Crane Assignment Problem usually introduces important shortcomings in the optimization process, we have chosen the time-invariant version, which gives solutions that are easier and more realistic to implement in port terminals. However, a little sacrifice is made in the optimal use of quay cranes. Two different objective functions are proposed: one based on a physical criterion since the actors involved in the port operations have conflicting objectives and interests and one economic objective function, based upon Charter Party clauses established with shipowners, such as despatch money and demurrage, when ports belong to a single shipper. We also considered many characteristics in the definition of the integrated problem to make it as close as possible to the reality, such as tidal ports with multiple quays and different water depths, and non-working periods. All the conditions related to these characteristics have been formulated as predicates, which has ensured

maximum flexibility in the implementation of the model, thereby significantly improving its computational performance. As the computational study shows, the LBACAP model can be used to obtain the optimal solution in reasonable computation times for different classes of instances with up to 100 vessels and 5 quays within a time horizon of 4 weeks.

Since the LBACAP assigns only homogeneous cranes to vessels per quay, we have also introduced a new integer programming model for the integrated Laycan and Berth Allocation and Specific Quay Crane Assignment Problem (LBACASP). This latter assigns a set of specific quay cranes to each vessel in the same quay, considering the maximum outreach of each quay crane, and thus produces more realistic solutions. Despite its complexity, we can solve instances with up to 50 vessels and 5 quays within a time horizon of 4 weeks.

Our models could be extended to the time-variant version of the Quay Crane Allocation Problem while limiting quay cranes changes between each period. It has to be noted that the optimal solutions proposed by both models may be infeasible because of the unavailability of cargo to be exported in vessels. Indeed, in practice, there is a strong interaction between vessels' loading and production, unless an important decoupling of these problems is done by high stock levels, which is an expensive solution. So, as a perspective, we would develop a decision support system (DSS) to integrate the different port problems of allocation and scheduling, all in considering the constraints of the upstream supply chain.

Chapter 4

Integrated Laycan and Berth Allocation Problem with conveyor routing constraints and preventive maintenance activities in bulk ports

Abstract⁸

In this paper, we study the integrated Laycan and Berth Allocation Problem (LBAP) in the context of bulk ports, which considers two problems in an integrated way: the tactical Laycan Allocation Problem and the dynamic hybrid case of the operational Berth Allocation Problem. To make the LBAP closer to reality, we consider tidal bulk ports with conveyor routing constraints between storage hangars and berthing positions, preventive maintenance activities, multiple quays with different water depths and fixed heterogeneous bulk-handling cranes, navigation channel restrictions, vessels with multiple cargo types, charter party clauses and non-working periods. The aim of the proposed integer programming model is to define an efficient schedule for berthing chartered vessels and optimal laycans to new vessels to charter. The model is formulated with predicates that guarantee maximum flexibility in the implementation and greatly improve the computational performance. Finally, the model is tested and validated through a relevant case study inspired by the operations of OCP Group at the bulk port of Jorf Lasfar in Morocco. The results show that the model can be used to solve to optimality instances with up to 60 vessels for a 4-week planning horizon in very reasonable computational time using commercial software.

Keywords

Laycan allocation, Berth allocation, Tidal bulk ports, Conveyors, Preventive maintenance, Integer programming

⁸ This chapter is a paper submitted for potential publication.

4.1. Introduction

With an estimated 80 per cent of the volume of world merchandise trade by sea, international shipping and ports provide crucial linkages in global supply chains and are essential to enable all countries to access global markets (UNCTAD, 2020). Although containerization has revolutionized the shipping industry, bulk cargoes are still the fundamental and enduring trades that support the dynamism of maritime transport. Five cargo types can be distinguished: container cargo, liquid bulk, dry bulk, break-bulk cargo, and ro-ro. In container terminals, all cargo is packed into standard containers, and thus there is no need for any specialized equipment to handle any particular type of cargo. In contrast, cargo is not packaged in bulk ports and a wide variety of loading/unloading equipment and means of transport is used depending on the vessel requirements and cargo properties. For example, dry bulk goods are handled using fixed bulk-handling cranes and are transferred using conveyors between storage hangars and bulkers considering conveyor routing constraints, while liquid bulk goods need pipelines to be handled and transferred between storage tanks and tankers. On the other hand, containers are handled using mobile cranes and are transferred between storage areas and container ships using internal vehicles.

Despite their importance in maritime logistics, bulk ports have received less attention than container terminals in the scientific literature. This research considers tidal bulk ports in which dry bulk goods are transferred from storage hangars to berthing positions using conveyors. Our approach integrates two important decision problems in port management: the tactical Laycan Allocation Problem (LAP) and the operational Berth Allocation Problem (BAP). The LAP assigns berthing time windows to new vessels to charter within a medium-term planning horizon (three to four weeks), considering the availability of cargo and port resources (berthing positions, handling equipment, etc.). Hence, the LAP has a clear interaction with one of the most important operational problems in the seaside area of ports: the BAP. The latter assigns berthing positions and times to every vessel projected to be served within a short-term planning horizon (one to two weeks) such that a given objective function is optimized. To easily manage the integration between these two problems that have different decision levels, we consider a modular decision time-interval inside the planning horizon. This approach was first proposed in *Chapter 3* to integrate the LAP with the integrated Berth Allocation and Quay Crane Assignment Problem (BACAP) in the context of container terminals. To the best of our knowledge, the current paper is the first research to integrate the

LAP and the BAP in the context of bulk ports, considering conveyor routing constraints with preventive maintenance activities between storage hangars and berthing positions.

This study also considers all common constraints of port management listed below and never considered altogether in bulk ports modeling. These constraints relate to 1) the multiplicity of quays, 2) navigation channel restrictions, 3) the variation of water depth, 4) vessel tide-dependency, 5) the productivity of loading equipment, 6) charter party clauses and 7) non-working periods. These constraints are quite common in real port operations. Including them in the model increases the application potential of the resulting solutions.

Finally, we use predicates in the proposed integer linear programming model to define the feasibility zone of decision variables. This approach permits reducing the number of variables and constraints and hence makes it possible to solve real size problems using commercial software. This type of formulation has successfully been used in *Chapter 3*. The current paper confirms its efficiency.

The remainder of this paper is organized as follows. In Section 4.2, we present a literature review of the BAP and the LAP in the context of bulk ports. Section 4.3 is dedicated to the description of the LBAP, while Section 4.4 is dedicated to its mathematical formulation. In Section 4.5, we present a case study with an illustrative example, then we discuss the results. Finally, in Section 4.6, we draw some conclusions and indicate future research directions.

4.2. Literature review

In this section, we review the academic literature on the BAP and the LAP in the context of bulk ports.

4.2.1. BAP Literature

The BAP in bulk ports has received little attention in OR literature compared to container terminals until recently. A list of papers that propose new models for the BAP in the context of bulk ports, as an individual problem or using an integrated approach, are described below.

The berth layout can be either discrete, continuous, or hybrid. Barros et al. (2011) propose an integer linear programming model for the discrete BAP considering homogeneous berthing positions with tide and stock level constraints, prioritizing vessels related to the most critical mineral stock level. The authors then propose a Simulated Annealing-based algorithm as a valid alternative to the commercial solver to find good and fast solutions for hard instances. Ribeiro et al. (2016) also solve the discrete BAP by proposing a mixed-integer linear programming model considering maintenance activities. The authors model each

maintenance activity as a dummy vessel which must be handled at a precise time by a specific berthing position, which means that this berthing position cannot receive vessels during that time. They then develop an adaptive large neighborhood search heuristic that finds good solutions within low computational times on all instances.

Ernst et al. (2017) solve the continuous BAP with tidal constraints that limit the departure of fully loaded vessels from dry bulk terminals using a commercial solver. The authors propose two new mixed-integer linear programming models, and then they provide several valid inequalities for both models, which improve both their solution quality and run time. To solve efficiently medium to large-sized instances of Ernst et al. (2017), Cheimanoff et al. (2020) develop a metaheuristic approach based on the Reduced Variable Neighborhood Search. The authors also develop a machine-learning algorithm to tune the metaheuristic's hyper parameters.

Umang et al. (2013) study the hybrid BAP by proposing two exact methods based on mixed-integer programming and generalized set partitioning and a heuristic method based on squeaky wheel optimization. The authors consider the fixed equipment facilities, such as conveyors and pipelines, which are installed at only certain sections along the quay, the cargo type on the vessel and its draft. They also consider the time taken to transfer cargo between its location on the yard and the berthing position of the vessel. de León et al. (2017) propose a Machine-Learning-based system to select the best algorithm for solving the BAP model proposed by Umang et al. (2013) in each particular case. The latter depends on factors such as the percentage of vessels that need specialized handling equipment and the congestion level, which is influenced by the distribution of the estimated time of arrival of vessels and their workload.

Most authors consider dynamic vessel arrivals, while Tang et al. (2016) consider static vessel arrivals. The authors implement a multi-phase particle swarm optimization algorithm to minimize the total service time of vessels or their makespan.

Since the operational problems observed in port terminals are often interrelated, some authors study the BAP using an integrated approach. Indeed, Robenek et al. (2014) extend the work of Umang et al. (2013) by integrating berth allocation and yard assignment problems. The authors propose an exact solution algorithm based on a branch and price framework and a metaheuristic approach based on the critical-shaking neighborhood to solve this integrated problem. Al-Hammadi and Diabat (2017) apply the model proposed by Robenek et al. (2014) for Mina Zayed Port in Abu Dhabi in order to test different scenarios as a means of sensitivity analysis, concerning certain factors such as the congestion level, in terms of the relative

arrival time of vessels, the unavailability of certain resources and the addition of new resources.

In the same logic of integrating problems, Unsal and Oguz (2019) propose an exact solution procedure for an integrated problem that consists of three operations: berth allocation, reclaimer (a large machine used to recover bulk material from a stockpile) scheduling and stockyard allocation, considering tide and reclaimers non-crossing constraints. The authors develop a novel logic-based Bender's decomposition algorithm in which a master problem and a subproblem are modeled using mixed-integer programming and constraint programming, respectively. The subproblem's role is either to find a feasible schedule for reclaimer schedules and yard allocations given mooring and departure times of vessels or to prove that the problem instance is infeasible.

Note that few papers consider tide with navigation channel restrictions such as the maximum number of vessels to pass simultaneously through the navigation channel and the vessels' incapability to pass in opposing directions. These restrictions are considered by Zhen et al. (2017) and Corry and Bierwirth (2019) in the context of container terminals. In the context of bulk ports, Pratap et al. (2017) develop a decision support system to solve the integrated problem of berth and ship unloader allocation, under the condition that the channel allows only one vessel to pass at a time, using metaheuristics. The authors consider two different approaches: either solving the problem sequentially as a two-phase optimization model, berth allocation and ship unloader allocation or integrating the two phases in a single-phase problem. The integrated approach gives a better result than the sequential approach, but the latter is useful for the port authorities to revise their contract with their clients. Liu et al. (2021) propose a mixed-integer linear programming model for integrated planning of berth allocation and vessel sequencing in tidal seaports with one-way navigation channel, which obliges vessels to queue up to enter or leave the port alternately. The authors also develop a tailored adaptive large neighborhood search algorithm to solve the integrated problem within a reasonable time.

Krimi et al. (2019, 2020) study the integrated Berth allocation and Quay Crane Assignment Problem in tidal bulk ports with multiple quays, vessels with multiple cargo types, and unavailability constraints due to preventive maintenance of quay cranes and bad weather conditions. The authors develop a general variable neighborhood search-based approach to solve instances the commercial solver failed to solve optimally.

We also note that we found no papers that consider the BAP with conveyor routing constraints between storage hangars and berthing positions. Some authors consider conveyor

routing constraints in other problems. For example, Menezes et al. (2017) study the production planning and scheduling problem in bulk ports which defines the amount and destination of each product and simultaneously establishes a set of feasible routes from storage subareas to vessels, where there is no conflict regarding equipment allocation. However, the authors consider the berthing positions of vessels as inputs in the problem.

The journal papers cited above are summarized in Table 4.1, in which the following information is presented.

- Port type: either import or/and export ports.
- Spatial attribute: it concerns the berth layout (either discrete, continuous or hybrid), the number of quays (either a single quay or multiple quays), and it specifies if the BAP considers the draft of berthing positions and the restrictions of the navigation channel and the conveyor system when deciding on a vessel's berthing position.
- Temporal attribute: it describes the arrival process of vessels (either static or dynamic), and it specifies if the BAP considers tide constraints and non-working periods (e.g., non-working days and maintenance activities) when deciding on a vessel's berthing time.
- Handling time attribute: it describes the productivity of handling equipment (either homogeneous or heterogeneous). In the case of homogeneous handling equipment, handling time of vessels is fixed, while it is variable in the case of heterogeneous handling equipment. The attribute also specifies if the BAP considers the distance between berthing positions and storage locations when calculating a vessel's handling time.
- Performance measure attribute: it specifies the optimization criteria used in the objective function (either efficiency or effectiveness). Most models consider minimizing various times or costs.
- Vessel cargo types: it specifies if a vessel carries only a single type or multiple types of cargo.
- Problems integrated with the BAP: it specifies the problems that are integrated with the BAP when the latter is studied using an integrated approach.
- Resolution approach: either exact methods, heuristics, or/and metaheuristics.
- Modeling choices: it specifies if the conditions of the BAP (berthing time and space, draft, tide, navigation channel, non-working periods) are modeled as either constraints or predicates using binary variables.

Table 4.1: BAP literature in the context of bulk ports

Authors	Port type		Spatial attribute							Temporal attribute					Handling time attribute		Performance measure attribute		Vessel cargo types		Problems integrated with the BAP					Resolution approach		Modeling choices						
	import	export	number of quays		berth layout			draft	navigation channel	conveyor system	vessel arrivals		tide	maintenance	non-working periods	handling equipment			efficiency	effectiveness	mono	multi	laycan allocation	quay equipment assignment	yard equipment scheduling	yard assignment	vessel sequencing	exact methods	heuristics/metaheuristics	berthing time	berthing space	draft	tide	non-working periods
			mono	multi	discrete	continuous	hybrid				static	dynamic				homogeneous	heterogeneous	distance																
Barros et al. (2011)	x	x	x		x						x	x						V			x							x		C	C		C	
Umang et al. (2013)	x	x	x			x	x				x								S		x						x	x	C	C	C			
Robenek et al. (2014)	x	x	x			x	x				x								S		x				x		x	x	C	C	C			
Ribeiro et al. (2016)	x	x	x		x						x		x						V		x						x		C	C			C	
Tang et al. (2016)	x	x	x		x						x								S, M		x						x		C	C				
Pratap et al. (2017)	x		x		x			x			x								W, H, R		x			x			x		C	C				
Al-Hammadi and Diabat (2017)	x	x	x			x	x				x								S		x			x			x		C	C	C			
Ernst et al. (2017)		x	x		x						x	x							D		x					x		C	C		C			
Unsal and Oguz (2019)		x	x		x						x	x							D		x			x	x		x		C	C		C		
Krimi et al. (2019, 2020)		x		x	x						x	x	x						T			x					x		C	C		C	C	
Cheimanoff et al. (2020)		x	x		x						x	x							D		x						x		C	C		C		
Liu et al. (2021)	x	x	x		x			x	x		x	x							S		x				x		x		C	C	P	C		
Our paper		x		x			x	x	x	x	x	x	x	x					V		D		x	x				x		P	P	P	P	P

Performance measure attribute: D: Departure times; T: Tardiness; W: Waiting times; H: Handling times; S: Total service times; M: Makespan; R: Priority deviation; V: Demurrage vs despatch
 Modelling choices: P: Predicate; C: Constraint

For detailed reviews of the BAP literature in the context of container terminals, we refer readers to Bierwirth and Meisel (2010, 2015).

4.2.2. LAP Literature

While BAP literature is abundant, only one work was found that deals with the LAP.

Lorenzoni et al. (2006) develop a mathematical model, based on a multi-mode resource-constrained scheduling problem improving the attendance of vessels. The proposed model determines laycans in a way that avoids simultaneous or nearly simultaneous arrivals of vessels competing with the same port resources (berthing positions, handling equipment, etc.). However, the authors assume the first-come, first-served regime of attendance, which could exclude certain solutions with better results, unlike the BAP that explores every possible berthing solution without being restricted to a certain regime of attendance.

In *Chapter 3*, we study the integrated Laycan and Berth Allocation and time-invariant Quay Crane Assignment Problem in tidal ports with multiple quays. Then, we extend the integrated problem to the Specific Quay Crane Assignment, which includes the assignment of a set of specific quay cranes to each vessel. We note that this research is more suitable for container terminals since it does not specify the cargo type, which is an important point in bulk ports.

As a conclusion to this section, we highlight that in this paper, we propose a new integer linear programming model for a new integrated problem: the LBAP in the context of bulk ports. Moreover, we consider numerous conditions related to port management in the definition of the LBAP, which reduces the gap between the abstract representation of the studied problem and its applicability in real situations. Indeed, our model considers tidal bulk ports that have conveyor routing constraints between storage hangars and berthing positions with preventive maintenance activities, a navigation channel, multiple quays with different water depths and heterogeneous loading equipment, vessels with multiple cargo types, charter party clauses and non-working periods.

4.3. Problem description

In this section, we present all the constraints considered in the problem modelling. These constraints include both general port constraints and specific bulk port constraints. Then we present some possible optimization criteria related either to efficiency or to effectiveness.

4.3.1. General port constraints

We consider a tidal port with multiple quays. Each quay has a hybrid layout where large vessels may occupy more than one berthing position, however, small vessels cannot share a

berthing position. In Figure 4.1, the vessel 3 occupies the berthing position 5 that is the union of the berthing positions 3 and 4, however, the vessels 2 and 2' cannot share the berthing position 2.

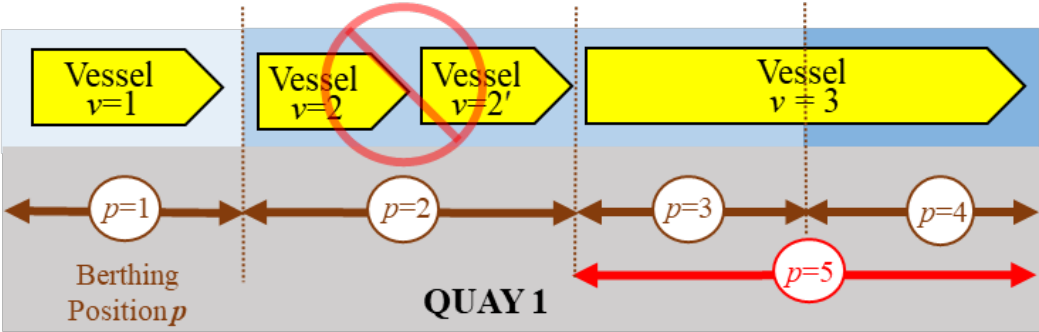

Figure 4.1: Hybrid berth layout

Each berthing position is characterized by a length and a water depth. All the berthing positions of a quay can have the same water depth, or the water depth increases seaward by berthing positions, as in Figure 4.2. The indexation of berthing positions is independent of the quays.

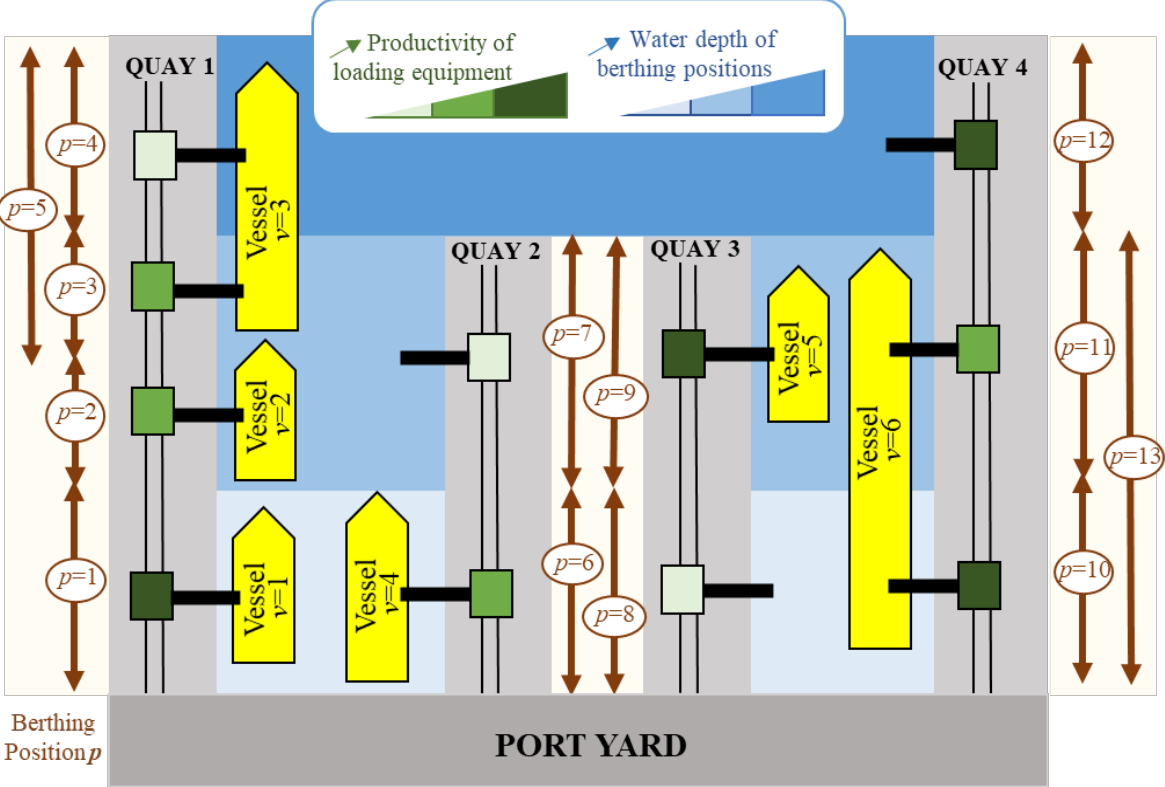

Figure 4.2: Example of a bulk port

We consider three types of vessels:

- Already berthed vessels: these vessels have residual handling time and a predetermined berthing time and position.

- Chartered vessels: the charter party of these vessels is already signed. Consequently, their expected arrival time is fixed. The decisions remaining to take are when and where to berth.
- New vessels to charter: the charter party of these vessels is under negotiation. Consequently, their laycan is not yet fixed. The decisions to take are the first layday and where to berth.

We assume dynamic vessel arrivals which means that expected arrival times are given for chartered vessels. Each vessel is characterized by a length and a draft. A maximum waiting time in the harbor per vessel is also introduced to circumvent solutions with very high waiting times. The port manager can fix this parameter based on what he judges acceptable. Besides this practical relevance, it also plays an interesting role in the computational performance by limiting the search space. We also consider the technical constraints of vessels that prohibit their berthing at some berthing positions or oblige them to berth at a specific berthing position.

In tidal ports, the use of the navigation channel is impacted by the tide cycle. We assume that large loaded vessels that have deep drafts are not able to pass through the navigation channel, while leaving the port during low tides, and thus have to wait for high tide cycles where the sea level is superior to their drafts. The detailed calculation of tide parameters is shown in the file [Tide.xlsx](#)⁹. Moreover, a maximum number of vessels must not be exceeded in each period of time while passing simultaneously through the navigation channel.

We also consider non-working periods, which can either be included or excluded in the counting of the laytime. For example, in *SSHEX* (Saturdays/Sundays/Holidays Excluded), the time lost in port on Saturdays, Sundays and Holidays does not count as laytime (from 5 pm on Friday until 8 am on Monday, and on holidays from 5 pm of the day preceding a holiday until 8 am of the next working day), while in *SSHINC* (Saturdays/Sundays/Holidays Included), no exception periods are in effect and the laytime will count seven days a week as well as during holidays.

4.3.2. Specific bulk port constraints

Each berthing position in the port is characterized by a fixed bulk-handling crane also characterized by a productivity (see Figure 4.2). Berthing positions are linked to storage hangars by a conveyor system, which can be divided into sections composed of identical

⁹ All data files of *Chapter 4* are available on Mendeley Data: <https://data.mendeley.com/datasets/9b3kdwwkvv/1>

parallel conveyors. The number of the latter differs from the number of conveyors linked directly before each section (e.g., in Figure 4.3, the section 1 is linked upstream to four storage hangars by four conveyors but has only three identical parallel conveyors).

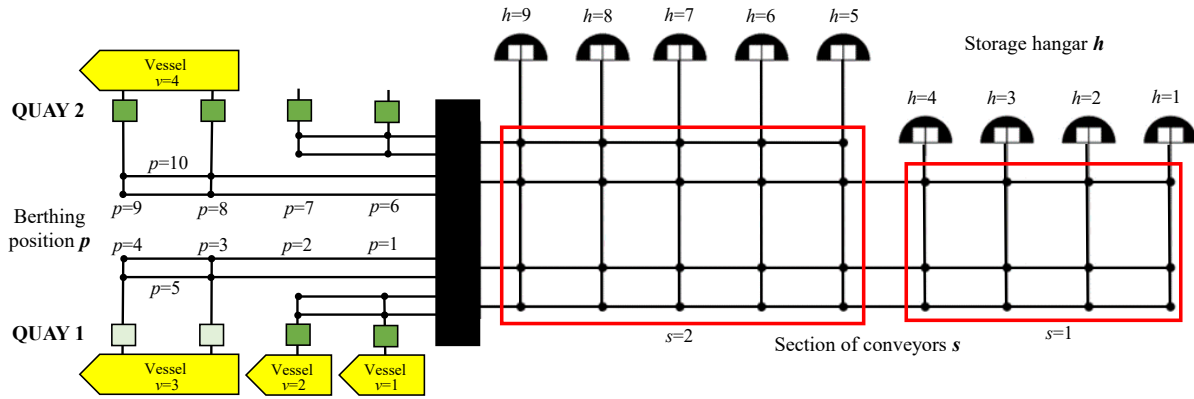

Figure 4.3: Sections of the port conveyor system

Berthing positions are linked to storage hangars by a conveyor system, as shown in Figure 4.3. The conveyor system is a set of identical parallel conveyors (represented by horizontal bars) connected together by switches (represented by dots) and identical feeding/transfer conveyors (represented by vertical bars). The black box represents a flexible transfer system that connects the upstream conveyors linked to the hangars to the downstream conveyors linked to each berthing position on the quays. A route is a collection of interconnected horizontal and vertical conveyors that links a hangar to a berthing position. The number of possible routes is quite high (e.g., more than 1.3 million combinations in the example of Figure 4.3). It must be noted that all potential routes cannot be operational at the same time since a conveyor cannot transport two different bulk products at a time. This particularity is used to circumvent the combinatorial nature of the problem by defining compatible routes Menezes et al. (2017). Two routes are said to be compatible if and only if they do not share a conveyor (or a switch). This reduces considerably the number of routes to consider in assigning conveyors. However, it is a delicate task to list all compatible routes without errors.

Therefore, in this paper, we adapt another approach. Instead of considering a conveyor assignment problem, we consider conveyor capacity allocation. To this end, we divide the port conveyor system into sections (for example, two sections, $s=1$ and 2 , in Figure 4.3). We define two parameters: the first one gives the number of identical parallel conveyors in each section that expresses the maximum number of bulk products that can be transported simultaneously in the given section (e.g. in Figure 4.3, maximum 3 in section 1 and 4 in section 2). The second one is a Boolean parameter with three indices (storage hangars,

berthing positions and sections) that specifies which section is needed to transfer a product from a given hangar to a given berthing position (e.g., in Figure 4.3, the conveyors of any route between berthing position 1 and storage hangar 3 belong to sections 1 and 2). This allows replacing a list of compatible routes that is hard to build free of errors, by a simple constraint that limits the number of identical parallel conveyors to use simultaneously in a section, at a given time period. The solution to our model will provide which bulk product to be transported from which hangar to which berthing position at a time, respecting this capacity constraint. Given this solution, the allocation of conveyors and the maintenance of the model in case of infrastructural changes in the conveyor system can be done easily a posteriori.

We also consider scheduled preventive maintenance activities to be performed at the conveyors and berthing positions over a period of time or at a fixed date. Maintenance activities at conveyors in the same section can overlap with each other while they are disjoint at a berthing position. Some berthing positions can also be unavailable due to bad weather. We note that the conveyor system is the bottleneck of the port since it limits the number of vessels that can be handled simultaneously (e.g., in Figure 4.3, only four out of ten vessels can be handled simultaneously).

Handling times of vessels depend on loading equipment's productivity in the berthing positions, and a vessel can be served by more than one loading equipment depending on its length. Each vessel is also characterized by a number of cargo types with different amounts to load on it. These amounts of cargo types can be expressed as batches. Each batch is characterized by an availability date and a storage hangar. It has to be noted that the batches to load on a single vessel can be stored in the same hangar or different hangars. We assume that only one batch at most can leave a storage hangar at a time and that two (or more) batches cannot be loaded at the same time on a vessel, but they can be loaded in any order without downtime. This assumption favors the waiting of vessels in the harbor until their continuous loading is guaranteed to minimize their berthing time in the port.

In Figure 4.4, the vessel 3 is a chartered vessel that is berthed in berthing position 5. The vessel is represented by a large rectangle placed in the area of berthing position 5 starting from its berthing time with a length equal to its handling time. Small rectangles inside the big rectangle represent the batches to load on the vessel according to a loading sequence chosen by the optimal solution. Each small rectangle starts from the loading start time of the batch with a length equal to its handling time. Vertical bars represent high tide windows.

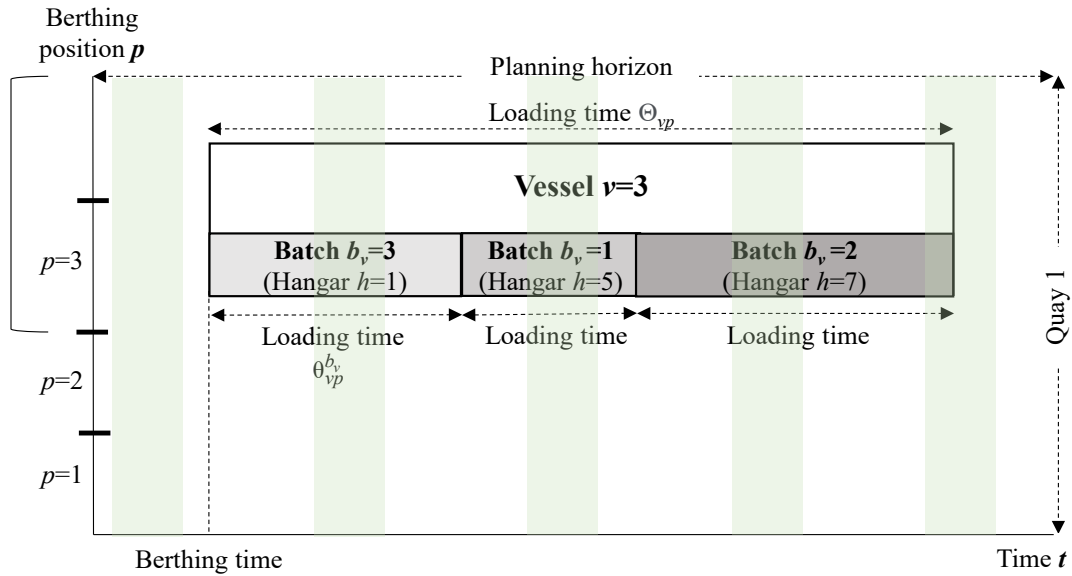

Figure 4.4: Representation of a chartered vessel and the batches to load on it

4.3.3. Optimization criteria

Efficiency criteria

The LAP defines some major contractual terms that are found in a maritime contract between a *shipowner* and a *charterer* for the hire of a vessel (called *charter party*). Some of these contractual terms are the following: *laycan*, *laydays*, *laytime*, *demurrage*, and *despatch*. All these chartering terms are shown in Figure 1.5 and will be used for expressing the objective function and some decision variables in the mathematical model proposed in this paper.

One of the efficiency criteria that could be applied is to find an efficient schedule for berthing chartered vessels that maximizes the sum of the difference between the despatch money and the demurrage charges for each vessel (i.e., minimize the demurrage charges and maximize the despatch money) while proposing optimal laycans for new vessels to charter considering all the characteristics and constraints described above.

Effectiveness criteria

We note that other objective functions based on physical criteria could be considered such as the minimization of the sum of expected vessel departure times or vessel stay times. These sums can be weighted to consider vessels priority. This does not require any change in the model, except in the objective function's formula.

4.4. Model formulation

4.4.1. Notation

The sets are represented by calligraphic letters, the parameters by Greek letters or capital Latin letters, the variables by italic letters, and the indices by italic lowercase letters. The latter are

always written as subscripts, except for the indices b_v , m_p and m_s , that are related to the indices v , p and s , which are always written as superscripts.

<i>Index</i>	<i>Description</i>
t	Index of time periods $\mathcal{T} = \{1, \dots, T\}$.
v	Index of vessels $\mathcal{V} = \{1, \dots, V\}$ with $\mathcal{V} = \mathcal{V}_1 \cup \mathcal{V}_2 \cup \mathcal{V}_3$ and $V = V_1 + V_2 + V_3$, where: <ul style="list-style-type: none"> • $\mathcal{V}_1 = \{1, \dots, V_1\}$ is the set of already berthed vessels. • $\mathcal{V}_2 = \{V_1 + 1, \dots, V_1 + V_2\}$ is the set of chartered vessels. • $\mathcal{V}_3 = \{V_1 + V_2 + 1, \dots, V\}$ is the set of new vessels to charter.
b_v	Index of batches to load on vessel v $\mathcal{B}_v = \{1, \dots, B_v\}$.
p	Index of berthing positions $\mathcal{P} = \{1, \dots, P\}$.
m_p	Index of maintenance activities to be performed at berthing position p $\mathcal{M}_p = \{1, \dots, M_p\}$.
s	Index of sections composed of identical parallel conveyors $\mathcal{S} = \{1, \dots, S\}$.
m_s	Index of maintenance activities to be performed at a conveyor in section s $\mathcal{M}_s = \{1, \dots, M_s\}$.
h	Index of storage hangars $\mathcal{H} = \{1, \dots, H\}$.

<i>Parameter</i>	<i>Description</i>
<u>Navigation channel</u>	
G	Maximum number of vessels allowed to pass simultaneously through the navigation channel.
<u>Time decision restriction</u>	
K_t	Boolean parameter that equals 1 if a decision of berthing vessels can be taken during time period t , 0 otherwise.
<u>Tide cycle</u>	
O_t	Boolean parameter that equals 1 if time period t is within a high tide cycle, 0 otherwise.
<u>Berthing positions</u>	
Q_p	Length of berthing position p .

W_p	Minimum water depth of berthing position p .
$E_p^{p'}$	Boolean parameter that equals 1 if berthing positions p and p' share a berthing position, 0 otherwise (e.g., in Figure 4.1, berthing positions 3 and 5 share berthing position 3). When $p = p'$, $E_p^{p'} = 1$.

Sections

U_s	Number of identical parallel conveyors in section s .
F_{sh}	Boolean parameter that equals 1 if one of the conveyors belonging to the route that links a berthing position to storage hangar h belongs to section s , 0 otherwise.

Preventive maintenance activities

$R_p^{m_p}$	Duration of maintenance m_p to be performed at berthing position p .
$\underline{R}_p^{m_p}$	Earliest time to perform maintenance m_p at berthing position p .
$\overline{R}_p^{m_p}$	Latest time to perform maintenance m_p at berthing position p .
$R_s^{m_s}$	Duration of maintenance m_s to be performed at a conveyor in section s .
$\underline{R}_s^{m_s}$	Earliest time to perform maintenance m_s at a conveyor in section s .
$\overline{R}_s^{m_s}$	Latest time to perform maintenance m_s at a conveyor in section s .

Vessels

A_v	Expected arrival time of chartered vessel v and earliest time a new vessel to charter v can arrive to the port.
I_v	Maximum waiting time in the harbor of vessel v .
λ_v	Length of vessel v .
D_v	Draft of vessel v when it is fully loaded.
ω_v	Boolean parameter that equals 1 if vessel v is tide-dependent, 0 otherwise.
γ_v	Boolean parameter that equals 1 if the handling of vessel v is restricted to working periods, 0 otherwise.
L_v	Laydays of vessel v .
J_v	Contractual handling time of vessel v .
δ_v	Contractual finishing time of vessel v , $\delta_v = A_v + J_v - 1, \forall v \in \mathcal{V}$.

η_v	Contractual demurrage by hour of vessel v . $\eta_v = 0, \forall v \in \mathcal{V}_1$ and $\eta_v = 1, \forall v \in \mathcal{V}_3$.
β_v	Contractual despatch by hour of vessel v . $\beta_v = 0, \forall v \in \mathcal{V}_1$ and $\beta_v = 1, \forall v \in \mathcal{V}_3$.
N_{vp}	1 if vessel v can berth at berthing position p , 0 otherwise.

Batches

$H_v^{b_v}$	Storage hangar of batch b_v to load on vessel v .
$C_v^{b_v}$	Date of availability of batch b_v to load on vessel v .
$\theta_{vp}^{b_v}$	Loading time of batch b_v on vessel v when the latter is berthed at berthing position p . $\theta_{vp}^{b_v} = \text{tonnage of batch } b_v / \text{productivity of berthing position } p$.
Θ_{vp}	Loading time of vessel v when the latter is berthed at berthing position p , which equals the sum of loading times of all the batches to load on this vessel, in any order without downtime: $\Theta_{vp} = \sum_{b_v \in \mathcal{B}_v} \theta_{vp}^{b_v}, \forall v \in \mathcal{V}, \forall p \in \mathcal{P}$.

Time framework

Ψ_{vt}	Boolean parameter that equals 1 if the handling of vessel v should not be carried out during time period t , 0 otherwise.
Γ_{vt}	Relative period of the absolute time period t of vessel v considering non-working periods.
Υ_{vt}	Absolute period of the relative time period t of vessel v considering non-working periods.

<i>Decision variable</i>	<i>Description</i>
x_{vpt}	1 if vessel v starts berthing at berthing position p in time period t , 0 otherwise.
$y_{vpth}^{b_v}$	1 if batch b_v stored in hangar h starts loading on vessel v at berthing position p in time period t , 0 otherwise.
$z_{pt}^{m_p}$	1 if maintenance m_p starts performing at berthing position p in time period t , 0 otherwise.
$z_{st}^{m_s}$	1 if maintenance m_s starts performing at a conveyor in section s in time

	period t , 0 otherwise.
u_v	Delay of vessel v , which is the number of time periods exceeding its laytime, $u_v \in \mathbf{Z}^+$ (since the planning horizon is divided into equal-sized time periods).
w_v	Advance of vessel v , which is the number of time periods saved in its laytime, $w_v \in \mathbf{Z}^+$.

<i>Intermediary variable</i>	<i>Description</i>
------------------------------	--------------------

$\mu_v, \tau_v^{b_v}$	Berthing position of vessel v in the decision variables x_{vpt} and $y_{vpth}^{b_v}$ respectively.
ε_v	Berthing time of vessel v .
π_v	Finishing time of vessel v .
$\rho_v^{b_v}$	Loading start time of batch b_v .
$\sigma_v^{b_v}$	Loading finishing time of batch b_v .

4.4.2. Representation of time

Port operations might be unavailable at some periods for some vessels (e.g. non-working days). If such periods coincide with the berthing period of the related vessel, they must be considered to estimate the ending time of berthing for this vessel. This requires adjusting index t for this vessel in the mathematical model. We use the approach proposed in *Chapter 3* to this end. An example of the time framework parameters is shown in Table 4.2, where each time period is one hour long and non-working periods last two hours. A realistic assignment of two day-long non-working periods is provided in the file [Time.xlsx](#).

To consider non-working periods in the calculation of the contractual finishing time of vessel v , $\delta_v = A_v + J_v - 1$ becomes $\delta_v = Y_{v(\Gamma_{vA_v} + J_v - 1)}$. Indeed, Γ_{vA_v} gives the relative period of the absolute expected arrival time of vessel v considering non-working periods, then $Y_{v(\Gamma_{vA_v} + J_v - 1)}$ gives the absolute period of the relative contractual finishing time of vessel v also considering non-working periods. If vessel v is not restricted to working periods, $Y_{v(\Gamma_{vA_v} + J_v - 1)} = A_v + J_v - 1$, therefore $\delta_v = Y_{v(\Gamma_{vA_v} + J_v - 1)}$ is used in both cases.

Table 4.2: Calculation of non-working periods parameters

t/γ_v	Ψ_{vt}		Γ_{vt}		Υ_{vt}	
	0	1	0	1	0	1
1	0	0	1	1	1	1
2	0	0	2	2	2	2
3	0	1	3	3	3	5
4	0	1	4	3	4	6
5	0	0	5	3	5	7
6	0	0	6	4	6	8
7	0	0	7	5	7	9
8	0	0	8	6	8	12
9	0	0	9	7	9	13
10	0	1	10	8	10	14
11	0	1	11	8	11	15
12	0	0	12	8	12	16
13	0	0	13	9	13	19
14	0	0	14	10	14	20
15	0	0	15	11	15	21
16	0	0	16	12	16	22
17	0	1	17	13	17	23
18	0	1	18	13	18	0
19	0	0	19	13	19	0
20	0	0	20	14	20	0
21	0	0	21	15	21	0
22	0	0	22	16	22	0
23	0	0	23	17	23	0

4.4.3. Decision time-interval

To reduce the computational complexity and consider the increasing uncertainty of inputs as the length of planning horizon increases, we follow the approach proposed in *Chapter 3*, which modulates decision time-interval throughout the planning horizon. So, we define a Boolean parameter K_t , that equals 1 if vessels can berth during time period t (without considering other constraints). Thanks to this parameter, we are able to restrict berthing decision periods inside the planning horizon, and hence to change the decision time-interval.

Modulating time interval in this manner helps integrating short-term decisions (BAP) and medium-term decisions (LAP) in a single model. As time approaches to present, the decisions are taken in a finer granularity (every hour), while for decisions that concern the planning in a few weeks from now a rough decision is taken (every 8 hours) (Figure 3.4). Besides facilitating integration of LAP and BAP, this approach also helps controlling the number of variables (i.e., the number of variables is lower for medium-term decisions).

4.4.4. Predicates

A predicate is a logical statement that returns either a value of “True” or “False”, based on the parameter values used in the statement. We will use these logical statements to describe the validity domain of decision variables. In our model, a decision variable exists only when the

associated set of predicates returns “True”. In this section, we present how predicates are implemented in our mathematical model.

The decision variable x_{vpt} determines for each chartered vessel ($v \in \mathcal{V}_2$), the berthing time t and berthing position p . Each already berthed vessel ($v \in \mathcal{V}_1$) has a residual handling time and a predetermined berthing position. For the sake of simplicity, we assume that the berthing time $t = 1$ for these latter vessels.

The decision variable $y_{vpth}^{b_v}$ determines for each chartered vessel ($v \in \mathcal{V}_2$) berthed in berthing position p , the loading start time t of batch b_v , stored in hanger h . The first batch to load on each already berthed vessel ($v \in \mathcal{V}_1$) has a residual handling time with a loading start time assumed at $t = 1$.

For each new vessel to charter ($v \in \mathcal{V}_3$), the berthing position will be reserved from its latest berthing time decreased by its laydays, $t - L_v + 1$, until its latest finish date, $Y_{v(\Gamma_{vt} + \Theta_{vp} - 1)}$ (Figure 4.5). Similarly, the conveyors used to transport each batch b_v from storage hanger h to berthing position p will be reserved from the latest loading start time of the batch decreased by the vessel’s laydays, $t - L_v + 1$, until the latest finish date of the batch, $Y_{v(\Gamma_{vt} + \Theta_{vp} - 1)}$, depending on the loading sequence chosen by the optimal solution. This assures that, any time during their laydays, new vessels to charter can be berthed at the reserved berthing position, and thus all the batches can be loaded, in any order without downtime, using the reserved conveyors.

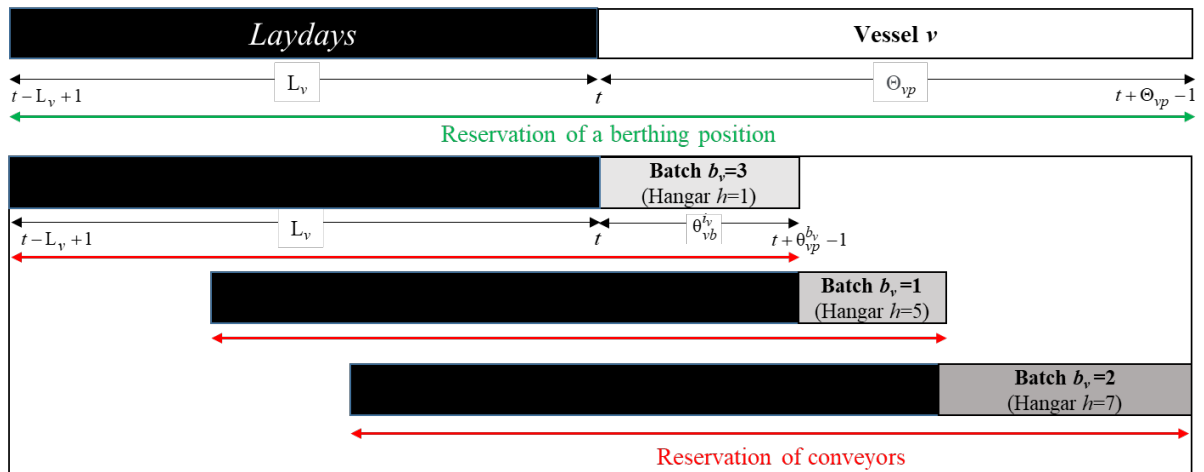

Figure 4.5: Reservation of port resources for new vessels to charter

The existence of the decision variable x_{vpt} is subject to seven conditions:

1. Vessel v must be able to berth at berthing position p : $N_{vp} = 1$.
2. The length of vessel v must not exceed the length of berthing position p : $\lambda_v \leq Q_p$.
3. The draft of vessel v must not exceed the water depth of berthing position p : $D_v \leq W_p$.
4. Vessel v can berth only after its expected arrival time without exceeding its maximum waiting time in the harbor: $A_v \leq t \leq A_v + I_v$. To allow new vessels to charter ($v \in \mathcal{V}_3$) to berth at their first layday, t is replaced by $t - L_v + 1$, then condition 4 becomes $A_v \leq t - L_v + 1 \leq A_v + I_v$. Already berthed and chartered vessels have fictitious laydays equal to one hour ($L_v = 1$) since they have fixed expected arrival times, and hence they are not concerned by the decision of fixing laycans as in the case of new vessels to charter. Hence, the new condition is valid for all the types of vessels. The same applies to the following conditions. This modelling approach allows to merge LAP and BAP decision.
5. Vessel v can berth only during time periods where a decision of berthing vessels can be taken: $K_{(t-L_v+1)} = 1$.
6. If the handling of vessel v is restricted to working periods ($\gamma_v = 1$), it can enter the port only during working periods: $\Psi_{v(t-L_v+1)} = 0$.
7. If vessel v is tide-dependent ($\omega_v = 1$), it can leave the port at time period $t = Y_{v(\Gamma_v + \Theta_{vp} - 1)}$ if the latter is within a high tide ($O_t = 1$): $(1 - \omega_v) + \omega_v \cdot O_{Y_{v(\Gamma_v + \Theta_{vp} - 1)}} = 1$.

Similarly, the existence of the decision variable $y_{vpth}^{b_v}$ is subject to seven conditions:

1. Conditions 1, 2 and 3 of the existence of the decision variable x_{vpt} : $N_{vp} = 1 \wedge \lambda_v \leq Q_p \wedge D_v \leq W_p$.

2. Batch b_v can be loaded on vessel v between the expected arrival time of this vessel and its finishing time as it reaches its maximum waiting time in the harbor, minus the loading time of this batch: $A_v \leq t - L_v + 1 \leq \Upsilon_{v(\Gamma_{v(A_v+I_v)}+\Theta_{vp}-\theta_{vp}^{b_v})}$.
3. Batch b_v can be loaded on vessel v only after its date of availability: $t - L_v + 1 \geq C_v^{b_v}$.
4. If the handling of vessel v is restricted to working periods ($\gamma_v = 1$), batches can start loading only during working periods: $\Psi_{v(t-L_v+1)} = 0$.
5. Batch b_v is loaded on vessel v from its storage hangar h : $h = H_v^{b_v}$.

Regarding the preventive maintenance activities, the decision variables $z_{pt}^{m_p}$ and $z_{st}^{m_s}$ determine the starting time t of performing maintenance m_p at berthing position p and maintenance m_s at a conveyor in section s , respectively. The existence of these two decision variables is subject to only one condition, each which states that each maintenance must be performed between its earliest and latest time: $\underline{R}_p^{m_p} \leq t \leq \overline{R}_p^{m_p}$ for berthing positions and $\underline{R}_s^{m_s} \leq t \leq \overline{R}_s^{m_s}$ for sections. When the maintenance has a fixed date, the indices of the decision variables are predetermined.

To facilitate the readability of the mathematical model, we represent each predicate by a simplified notation given in Table 4.3.

Table 4.3: Notation of predicates

Predicate	Notation
$N_{vp} = 1 \wedge \lambda_v \leq Q_p \wedge D_v \leq W_p$	P_{vp}
$A_v \leq t - L_v + 1 \leq A_v + I_v \wedge K_{(t-L_v+1)} = 1 \wedge \Psi_{v(t-L_v+1)} = 0 \wedge (1-\omega_v) + \omega_v \cdot O_{\Upsilon_{v(\Gamma_{vt}+\Theta_{vp}-1)}} = 1$	P_{vpt}
$A_v \leq t - L_v + 1 \leq \Upsilon_{v(\Gamma_{v(A_v+I_v)}+\Theta_{vp}-\theta_{vp}^{b_v})} \wedge t - L_v + 1 \geq C_v^{b_v} \wedge \Psi_{v(t-L_v+1)} = 0$	$P_{vpt}^{b_v}$
$h = H_v^{b_v}$	$P_{vh}^{b_v}$
$\underline{R}_p^{m_p} \leq t \leq \overline{R}_p^{m_p}$	$P_{pt}^{m_p}$
$\underline{R}_s^{m_s} \leq t \leq \overline{R}_s^{m_s}$	$P_{st}^{m_s}$

The logical conditions of the existence of the decision variables x_{vpt} , $y_{vpth}^{b_v}$, $z_{pt}^{m_p}$ and $z_{st}^{m_s}$ are the following ones. For instance, the variable x_{vpt} exists only when the predicates P_{vp} and P_{vpt} are both “True”.

$$x_{vpt} \in \{0,1\}, \forall v \in \mathcal{V}, \forall p \in \mathcal{P} \mid P_{vp}, \forall t \in \mathcal{T} \mid P_{vpt}$$

$$y_{vpth}^{b_v} \in \{0,1\}, \forall v \in \mathcal{V}, \forall b_v \in \mathcal{B}_v, \forall p \in \mathcal{P} \mid P_{vp}, \forall t \in \mathcal{T} \mid P_{vpt}^{b_v}, \forall h \in \mathcal{H} \mid P_{vh}^{b_v}$$

$$z_{pt}^{m_p} \in \{0,1\}, \forall p \in \mathcal{P}, \forall m_p \in \mathcal{M}_p, \forall t \in \mathcal{T} \mid P_{pt}^{m_p}$$

$$z_{st}^{m_s} \in \{0,1\}, \forall s \in \mathcal{S}, \forall m_s \in \mathcal{M}_s, \forall t \in \mathcal{T} \mid P_{st}^{m_s}$$

4.4.5. Mathematical model

First, we define the intermediary variables μ_v and $\tau_v^{b_v}$, which give for each vessel v the berthing position in the decision variables x_{vpt} and $y_{vpth}^{b_v}$, respectively.

$$\mu_v = \sum_{p \in \mathcal{P} \mid P_{vp}} \sum_{t \in \mathcal{T} \mid P_{vpt}} p \cdot x_{vpt}, \forall v \in \mathcal{V}$$

$$\tau_v^{b_v} = \sum_{p \in \mathcal{P} \mid P_{vp}} \sum_{t \in \mathcal{T} \mid P_{vpt}^{b_v}} \sum_{h \in \mathcal{H} \mid P_{vh}^{b_v}} p \cdot y_{vpth}^{b_v}, \forall v \in \mathcal{V}, \forall b_v \in \mathcal{B}_v$$

Similarly, we define for each vessel v the berthing and finishing times ε_v and π_v , by replacing $b \cdot x_{vpt}$ in μ_v by $t \cdot x_{vpt}$ and $\Upsilon_{v(\Gamma_v(t-L_v+1)+\Theta_{vp}-1)} \cdot x_{vpt}$, respectively. Likewise, we

define for each batch b_v to load on vessel v , the loading start and finishing times $\rho_v^{b_v}$ and $\sigma_v^{b_v}$ by replacing $p \cdot y_{vpth}^{b_v}$ in $\tau_v^{b_v}$, respectively, by $t \cdot y_{vpth}^{b_v}$ and $\Upsilon_{v(\Gamma_v(t-L_v+1)+\Theta_{vp}^{b_v}-1)} \cdot y_{vpth}^{b_v}$.

The mathematical model can be formulated as follows:

$$\text{Max} \sum_{v \in \mathcal{V}} (\beta_v \cdot w_v - \eta_v \cdot u_v) \quad (1)$$

$$\text{or Min} \sum_{v \in \mathcal{V}} \pi_v \quad (1')$$

$$\sum_{p \in \mathcal{P} \mid P_{vp}} \sum_{t \in \mathcal{T} \mid P_{vpt}} x_{vpt} = 1, \forall v \in \mathcal{V} \quad (2)$$

$$\sum_{p \in \mathcal{P} \mid P_{vp}} \sum_{t \in \mathcal{T} \mid P_{vpt}^{b_v}} \sum_{h \in \mathcal{H} \mid P_{vh}^{b_v}} y_{vpth}^{b_v} = 1, \forall v \in \mathcal{V}, \forall b_v \in \mathcal{B}_v \quad (3)$$

$$\sum_{t \in \mathcal{T}} \mathbb{P}_{pt}^{m_p} z_{pt}^{m_p} = 1, \forall p \in \mathcal{P}, \forall m_p \in \mathcal{M}_p \quad (4)$$

$$\sum_{t \in \mathcal{T}} \mathbb{P}_{st}^{m_s} z_{st}^{m_s} = 1, \forall s \in \mathcal{S}, \forall m_s \in \mathcal{M}_s \quad (5)$$

$$\mu_v = \tau_v^{b_v}, \forall v \in \mathcal{V}, \forall b_v \in \mathcal{B}_v \quad (6)$$

$$\rho_v^{b_v} \geq \varepsilon_v, \forall v \in \mathcal{V}, \forall b_v \in \mathcal{B}_v \quad (7)$$

$$\sigma_v^{b_v} \leq \pi_v, \forall v \in \mathcal{V}, \forall b_v \in \mathcal{B}_v \quad (8)$$

$$\sum_{b_v \in \mathcal{B}_v} \sum_{p \in \mathcal{P}} \mathbb{P}_{vp} \sum_{t' \in \mathcal{T}} \left| \mathbb{P}_{vpt'}^{b_v} \wedge \Gamma_{vt'} + \theta_{vp}^{b_v} - 1 \leq T \wedge t' \leq t \leq \Upsilon_{v(\Gamma_{vt'} + \theta_{vp}^{b_v} - 1)} \right| \sum_{h \in \mathcal{H}} \mathbb{P}_{vh}^{b_v} y_{vpt'h}^{b_v} \leq 1, \quad \forall t \in \mathcal{T}, \forall v \in \mathcal{V} \quad (9)$$

$$\sum_{v \in \mathcal{V}} \sum_{b_v \in \mathcal{B}_v} \mathbb{P}_{vh}^{b_v} \sum_{p \in \mathcal{P}} \mathbb{P}_{vp} \sum_{t' \in \mathcal{T}} \left| \mathbb{P}_{vpt'}^{b_v} \wedge \Gamma_{vt'} + \theta_{vp}^{b_v} - 1 \leq T \wedge t' - L_v + 1 \leq t \leq \Upsilon_{v(\Gamma_{vt'} + \theta_{vp}^{b_v} - 1)} \right| y_{vpt'h}^{b_v} \leq 1, \quad \forall t \in \mathcal{T}, \forall h \in \mathcal{H} \quad (10)$$

$$\sum_{v \in \mathcal{V}} \sum_{b_v \in \mathcal{B}_v} \sum_{p \in \mathcal{P}} \mathbb{P}_{vp} \sum_{t' \in \mathcal{T}} \left| \mathbb{P}_{vpt'}^{b_v} \wedge \Gamma_{vt'} + \theta_{vp}^{b_v} - 1 \leq T \wedge t' - L_v + 1 \leq t \leq \Upsilon_{v(\Gamma_{vt'} + \theta_{vp}^{b_v} - 1)} \right| \sum_{h \in \mathcal{H}} \mathbb{P}_{sh}^{b_v} \mathbb{1}_{F_{sh}=1 \wedge \mathbb{P}_{vh}^{b_v}} y_{vpt'h}^{b_v} \leq U_s - \sum_{m_s \in \mathcal{M}_s} \sum_{t' \in \mathcal{T}} \mathbb{1}_{t - R_s^{m_s} + 1 \leq t' \leq t \wedge \mathbb{P}_{st'}^{m_s}} z_{st'}^{m_s}, \forall t \in \mathcal{T}, \forall s \in \mathcal{S} \quad (11)$$

$$\sum_{v \in \mathcal{V}} \sum_{p' \in \mathcal{P}} \mathbb{E}_p^{p'} = 1 \wedge \mathbb{P}_{vp'} \sum_{t' \in \mathcal{T}} \left| \mathbb{P}_{vpt'} \wedge \Gamma_{vt'} + \Theta_{vp'} - 1 \leq T \wedge t' - L_v + 1 \leq t \leq \Upsilon_{v(\Gamma_{vt'} + \Theta_{vp'} - 1)} \right| x_{vpt'} \leq 1 - \sum_{p' \in \mathcal{P}} \mathbb{E}_p^{p'} = 1 \sum_{m_{p'} \in \mathcal{M}_{p'}} \sum_{t' \in \mathcal{T}} \mathbb{1}_{t - R_{p'}^{m_{p'}} + 1 \leq t' \leq t \wedge \mathbb{P}_{p't'}^{m_{p'}}} z_{p't'}^{m_{p'}}, \forall t \in \mathcal{T}, \forall p \in \mathcal{P} \quad (12)$$

$$\left[\sum_{v \in \mathcal{V}_2 \cup \mathcal{V}_3} \sum_{p \in \mathcal{P}} \mathbb{P}_{vp} \sum_{t' \in \mathcal{T}} \mathbb{1}_{\mathbb{P}_{vpt'} \wedge t' = t + L_v - 1} x_{vpt'} \right] + \left[\sum_{v \in \mathcal{V}} \sum_{p \in \mathcal{P}} \mathbb{P}_{vp} \sum_{t' \in \mathcal{T}} \left| \mathbb{P}_{vpt'} \wedge \Gamma_{vt'} - \Theta_{vp} \geq 0 \wedge t' = \Upsilon_{v(\Gamma_{vt'} - \Theta_{vp} + 1)} \right| x_{vpt'} \right] \leq G, \forall t \in \mathcal{T} \quad (13)$$

$$u_v \geq \pi_v - \delta_v, \forall v \in \mathcal{V} \quad (14)$$

$$w_v \geq \delta_v - \pi_v, \forall v \in \mathcal{V} \quad (15)$$

$$u_v - w_v = \pi_v - \delta_v, \forall v \in \mathcal{V} \quad (16)$$

$$u_v, w_v \geq 0, \forall v \in \mathcal{V} \quad (17)$$

Objective function (1) is based on an efficiency criteria that maximizes the difference between the despatch money and the demurrage charges of each vessel v while objective

function (1') is based on an effectiveness criteria that minimizes the finishing time (departure time) of each vessel v . Equation (2) ensures that each vessel v starts berthing at a unique berthing position p , and in a unique time period t . Equation (3) ensures that each batch b_v starts loading in a unique vessel v at a unique berthing position p , in a unique time period t , and is stored in a unique hangar h . Equation (4) ensures that maintenance m_p to be performed at a berthing position p has a unique start time. Similarly, equation (5) ensures that maintenance m_s to be performed at a conveyor in section s has a unique start time. Equation (6) ensures that berthing position p is the same in both decision variables x_{vtp} and $y_{vtp}^{b_v}$. Equation (7) ensures that the loading of each batch b_v can only begin once vessel v has been berthed. Equation (8) ensures that each vessel v can only leave the port when all batches have been loaded. Equation (9) ensures that at most one batch can be loaded at the same time on each vessel v . Equation (10) ensures that only one batch at most can leave at a time each storage hangar h . Equation (11) limits the number of identical parallel conveyors used simultaneously in a section s during the loading time of each batch due to the limit or/and the maintenance of conveyors. Equation (12) avoids the overlapping of vessels in each berthing position p , the simultaneous use of berthing positions that share a space of the quay since the berth layout of each quay is hybrid and the use of berthing positions where maintenance activities are performed (e.g., in Figure 4.1, berthing positions 3 and 5 share berthing position 3, consequently, they cannot be used simultaneously. Moreover, if maintenance is performed at berthing position 3, it will also be formed at berthing position 5. The opposite is also true.). Equation (13) limits the number of incoming and outgoing vessels to pass simultaneously through the navigation channel. Equations (14-17) determine the delay and the advance of each vessel.

4.5. Case study

In this section, we describe the test instances of the case study and report the computational results. An example schedule obtained using the model is also given to illustrate a typical output. The formulations are written on Mosel and implemented in Xpress IVE Version 1.24.24, with 64 bits. All the tests are run on a server with an Intel® Xeon® Gold 6138 processor (8 cores) of 2.00 GHz processing speed and 32 GB of memory using the Xpress Optimizer Version 33.01.05 with the default options.

4.5.1. Generation of test instances

Test instances are based on a sample of data obtained from OCP group, a world leader in the phosphate industry, which operates six quays in the bulk port of Jorf Lasfar in Morocco, recognized as the largest bulk port in Africa. We focus on the first two quays that are dedicated to the export of phosphate rock and fertilizers. The data provides information about all the vessels that were berthed during the first half of 2016, such as the arrival time, the berthing time and position, the cargo type and tonnage, and the handling time of vessels. Given the limited access to real bulk port data, test instances are designed to have the same characteristics as the sample of data obtained from OCP group, to test and validate the effectiveness of the proposed model.

Three sets are designed for $V = \{20, 40, 60\}$. Each set is composed of 15 instances. Hence, we have 45 instances in total. Every 5 instances in a set represent a level of congestion (congested, mildly congested, and uncongested), which is determined by the interarrival time of vessels. Indeed, for the same number vessels, the level of congestion in the port increases as the interarrival time of vessels decreases and then the problem becomes harder to solve.

For all instances:

- We assume a 4-week planning horizon discretized into 1-hour intervals, hence $T=672$. We vary the decision time interval inside this planning horizon to handle short term and medium-term decisions as explained in Section 4.4.3. For the short-term planning (e.g. during the first week in our instances) the accuracy of the planning is set to every hour. The decision time interval is set to four, eight and twelve hours for weeks two, three and four, respectively. Characteristics related to time periods (decision time-intervals, high-tide cycles and non-working periods) can be found in [Time.xlsx](#).
- We consider a navigation channel in which the maximum number of vessels allowed to pass simultaneously is limited to three vessels. We also consider two quays with hybrid berth layout, partitioned into five berthing positions each. Table 4.4 gives respectively for each berthing position the length (m), the minimum water depth (m), the productivity (t/h), the incompatibilities and the number of maintenance activities with the duration (h), the earliest and latest time (h) to perform each one.

Table 4.4: Characteristics of berthing positions

	p	Q_p	W_p	Productivity	$E_p^{p'}$										M_p	$R_p^{m_p}$		$\underline{R}_p^{m_p}$		$\overline{R}_p^{m_p}$		
					$p'=1$	$p'=2$	$p'=3$	$p'=4$	$p'=5$	$p'=6$	$p'=7$	$p'=8$	$p'=9$	$p'=10$		$m_p=1$	$m_p=2$	$m_p=1$	$m_p=2$	$m_p=1$	$m_p=2$	
					Quay 1	1	180	13.5	2000	1	0	0	0	0		0	0	0	0	0	0	2
	2	255	14.5	2000	0	1	0	0	0	0	0	0	0	0	0	1	7	0	405	0	450	0
	3 _U	150	15.6	1000	0	0	1	0	1	0	0	0	0	0	0	0	0	0	0	0	0	0
	4	150	15.6	1000	0	0	0	1	1	0	0	0	0	0	0	0	0	0	0	0	0	0
	5 (3-4)	300	15.6	2000	0	0	1	1	1	0	0	0	0	0	0	0	0	0	0	0	0	0
Quay 2	6	180	13.5	2000	0	0	0	0	0	1	0	0	0	0	0	2	29	14	266	320	266	320
	7	235	14.5	2000	0	0	0	0	0	0	1	0	0	0	0	0	0	0	0	0	0	0
	8 _U	125	14.5	2000	0	0	0	0	0	0	0	0	1	0	1	0	0	0	0	0	0	0
	9	125	15.6	2000	0	0	0	0	0	0	0	0	0	1	1	2	10	6	10	360	53	382
	10 (8-9)	250	14.5	4000	0	0	0	0	0	0	0	0	0	1	1	1	23	0	300	0	320	0

- We consider nine storage hangars which are linked to all the berthing positions via a conveyor system (Figure 4.3). The latter is divided into two sections composed of different numbers of identical parallel conveyors. Table 4.5 gives respectively for each section of the port conveyor system the number of identical parallel conveyors, the conveyors that belong to it and the number of maintenance activities with the duration (h), the earliest and latest time (h) to perform each one.

Table 4.5: Characteristics of sections of the port conveyor system

s	F_{sh}								U_s	M_s	$R_s^{m_s}$			$\underline{R}_s^{m_s}$			$\overline{R}_s^{m_s}$			
	$h=1$	$h=2$	$h=3$	$h=4$	$h=5$	$h=6$	$h=7$	$h=8$			$h=9$	$m_s=1$	$m_s=2$	$m_s=3$	$m_s=1$	$m_s=2$	$m_s=3$	$m_s=1$	$m_s=2$	$m_s=3$
	1	1	1	1	1	0	0	0			0	0	3	2	12	8	0	282	284	0
2	1	1	1	1	1	1	1	1	1	4	3	6	10	9	213	290	362	213	290	390

- The length of vessels varies between 100 and 300 meters.
- The draft of vessels varies between 5 and 15 meters. Vessels that have a draft over 14 meters are tide-dependent while leaving the port.
- The number of batches to load on each vessel varies between one and three batches.
- The tonnage of batches varies between 2,000 and 36,000 tones.
- 10% of vessels have a *SSHEX* clause.
- The laydays are set arbitrarily at 48 hours for new vessels to charter, while already berthed and chartered vessels have fictitious laydays equal to one hour.
- For chartered vessels, the contractual demurrage is chosen randomly from a Uniform distribution between 50 and 150. The contractual dispatch is assumed half the demurrage. For new vessels to charter, we assume negligible demurrage and dispatch per hour. Note that these are fictitious values and are only used in order not to impact the economic results of already chartered vessels. Finally, for already berthed vessels, hourly demurrage and dispatch rates are assumed zero since no decisions need to be made for this group of vessels; they are already berthed.
- The maximum waiting time in the harbor is set arbitrarily at 72 hours for all the chartered vessels and one week for all the new vessels to charter. The latter have high

maximum waiting times in the harbor in order not to affect the economic results of chartered vessels.

Thanks to these conventions, all the vessels are dealt with together since there is no need to define specific constraints for each type of vessels (already berthed vessels, chartered vessels, and new vessels to charter). All instances are accessible in the file [Instances.xlsx](#).

4.5.2. Illustrative example

In this section, we present a typical schedule that the port manager can obtain by using the proposed model. We consider the same characteristics of time periods, berthing positions, conveyor sections and vessels presented in the previous section. Table 4.6 gives the characteristics of six chartered vessels and one new vessel to charter.

Table 4.6: Characteristics of vessels

v	A _v	I _v	λ _v	D _v	ω _v	γ _v	L _v	J _v	η _v	β _v	N _{vp}										B _v	b _v	H _v ^{b_v}	C _v ^{b_v}	θ _{vp} ^{b_v}									
											p=1	p=2	p=3	p=4	p=5	p=6	p=7	p=8	p=9	p=10					p=1	p=2	p=3	p=4	p=5	p=6	p=7	p=8	p=9	p=10
1	245	48	170	12.5	0	0	1	22	105	52.5	1	1	1	1	0	1	1	1	1	0	2	1	6	277	12	12	24	24	12	12	12	12	12	6
											2	2	2	268	10	10	20	20	10	10	10	10	10	5										
											3	0	0	0	0	0	0	0	0	0	0	0	0	0										
2	264	48	245	13.0	1	0	1	66	132	66	0	0	0	0	0	0	0	0	0	1	3	1	3	250	28	28	56	56	28	28	28	28	28	14
											3	2	7	284	14	14	28	28	14	14	14	14	14	7										
											3	9	277	24	24	48	48	24	24	24	24	24	12											
3	268	48	290	15.5	1	1	1	16	76	38	0	0	0	0	1	0	0	0	0	0	2	1	5	269	7	7	14	14	7	7	7	7	7	4
											2	2	8	260	9	9	18	18	9	9	9	9	9	5										
											3	0	0	0	0	0	0	0	0	0	0	0	0											
4	298	48	100	10.1	0	0	1	21	67	33.5	1	1	1	1	0	1	1	1	1	0	1	1	4	297	21	21	42	42	21	21	21	21	21	11
											1	2	0	0	0	0	0	0	0	0	0	0	0											
											3	0	0	0	0	0	0	0	0	0	0	0	0											
5	308	48	250	11.5	0	0	1	34	149	74.5	1	1	1	1	0	1	1	1	1	0	3	1	6	320	8	8	16	16	8	8	8	8	8	4
											3	2	7	332	6	6	12	12	6	6	6	6	6	3										
											3	9	308	20	20	40	40	20	20	20	20	20	10											
6	320	48	120	15.3	0	0	1	23	134	67	1	1	1	1	0	1	1	1	1	0	2	1	3	316	10	10	20	20	10	10	10	10	10	5
											2	2	8	331	13	13	26	26	13	13	13	13	13	7										
											3	0	0	0	0	0	0	0	0	0	0	0	0											
7	274	168	210	14.2	0	0	48	25	1	1	1	1	1	1	0	1	1	1	1	0	1	1	1	274	25	25	50	50	25	25	25	25	25	13
											1	2	0	0	0	0	0	0	0	0	0	0	0											
											3	0	0	0	0	0	0	0	0	0	0	0	0											

Figure 4.6 shows the Gantt chart of vessel and batch schedule. A complete Gantt chart of 60 vessels and a 4-week planning horizon is shown in the file [Gantt.xlsx](#). At its bottom, there is a timeline in hours and a one-week time frame (from Friday of week 2 to Monday of week 3) with high tide hours. The decision time-intervals are highlighted every four hours for week 2 and every eight hours for week 3. All constraints are respected by the solution given by the LBAP model:

- All vessels are berthed at restricted time periods for which a decision can be made and do not occupy berthing positions where a maintenance is performed.
- The batches of each vessel are loaded in any order without downtime after their date of availability and only one batch at most leaves at a time each storage hangar.
- Vessels 2 and 3 have high drafts and thereby are tide-dependent, so they occupy berthing sections with high water depth and leave the port during high tides.

- The handling of vessel 3 stops during non-working hours because it has a *SSHEX* clause.
- The handling time of vessel 2 is shorter than its contractual handling time since it occupies a berthing position with high productive loading equipment.
- The number of vessels passing through the navigation channel and used parallel conveyors per section do not exceed their limits. The number of allowed parallel conveyors per section can decrease due to maintenance.
- The optimal laycan proposed for the new vessel to charter 7 is [276, 323]. This vessel can berth at any time period during its laydays. We note that, a precise berthing time will be assigned to this vessel as its status changes from new vessel to chartered one and as the time progresses from week two towards week one.

Thanks to the integration of the LAP and the BAP, the port managers can propose laycans for the new vessels to charter considering the allocation of berthing positions to already chartered vessels and conveyors to batches, thereby avoiding the payment of demurrage charges, and knowing when to accept or refuse a new vessel to charter.

4.5.3. Computational results

In this section, we explore the computational performance of the proposed model. One of the objectives is to verify if the proposed model can be solved in a reasonable time using commercial software. The other objective is to test the sensitivity of the results with respect to the different input parameters in the model,

For each instance, Table 4.7 shows the number of already berthed and chartered vessels and the new ones to charter, the level of congestion, the computation time in seconds, and the optimality gap in percentages. The computation time was limited to 1 hour. The empty fields indicate that no feasible solutions were found within the time limit, and thus, it was not possible to calculate the statistics. Xpress calculates the gap as follows: $100 \cdot (ub - lb) / ub$, where ub is the best upper bound obtained within the time limit, and lb is the value of the objective function corresponding to the best integer solution achieved. The detailed results of each instance are shown in the file [Results.xlsx](#).

Table 4.7: Computational results

Instance	Congestion	V=20		V=40		V=60	
		V ₁ =2, V ₂ =16, V ₃ =2		V ₁ =3, V ₂ =34, V ₃ =3		V ₁ =4, V ₂ =52, V ₃ =4	
		Time	Gap	Time	Gap	Time	Gap
1	No	3.1	0	13.0	0	52.7	0
2		6.3	0	13.9	0	453.3	0
3		6.1	0	15.4	0	243.6	0
4		8.5	0	79.1	0	1366.0	0
5		6.4	0	10.2	0	163.4	0
Average		6.1	0	26.3	0	455.8	0
6	Mild	14.9	0	23.0	0	1356.6	0
7		3.0	0	26.5	0	84.6	0
8		2.9	0	31.7	0	320.8	0
9		2.4	0	35.4	0	63.6	0
10		9.6	0	30.7	0	840.3	0
Average		6.6	0	29.5	0	533.2	0
11	Yes	12.4	0	9.0	0	2722.1	0
12		13.1	0	106.6	0	3231.9	0
13		17.7	0	37.4	0	235.3	0
14		23.9	0	27.2	0	3603.5	7.9
15		6.0	0	15.9	0	263.6	0
Average		14.6	0	39.22	0	1706.1	1.6

We can make several observations based on these results:

First, for a fixed number of vessels, increasing the level of congestion increases the average computation time. Similarly, for a fixed level of congestion, increasing the number of vessels increases the average computation time. Hence, we can conclude that the computation time is very related to the busyness of the port.

Second, we are able to solve to optimality instances of realistic size, up to 60 vessels, 10 berthing positions, and 9 storage hangars for a 4-week planning horizon in computation times not exceeding one hour. For only one instance, Xpress could not find an optimal solution due to the time limit. We note that the maximum number of vessels that were berthed in the port of Jorf Lasfar during a period of 4 weeks in the first half of 2016 is 30 vessels. Hence, we can conclude that the integer linear programming model proposed for the LBAP can easily be used in bulk ports where such decisions need to be made frequently, with only commercial software. Thus, developing a heuristic for the problem is not necessary.

4.6. Conclusions

In this paper, we integrate the Laycan Allocation Problem and the dynamic hybrid Berth Allocation Problem in the context of tidal bulk ports with multiple quays and a conveyor system between storage hangars and berthing positions. While laycans concern only vessels for export, a symmetric approach can be applied for berthing decisions in the context of import ports. Our research is motivated by the bulk port of Jorf Lasfar, but it is also valid for any other bulk port. A new integer linear programming model is proposed to solve this integrated problem. The latter integrates two problems with different decision levels (tactical and operational) thanks to the modulation of the time-interval between decisions and the introduction of fictitious laydays for already berthed and chartered vessels.

Several characteristics are addressed in the definition of the LBAP to make it closer to reality, such as the multiplicity of quays, navigation channel restrictions, conveyor routing constraints with preventive maintenance activities, the variation of water depth, vessel tide-dependency, the productivity of bulk-handling cranes, the multiplicity of cargo types on the same vessel, charter party clauses and non-working periods. Instead of expressing these characteristics by a set of constraints in the model, we used predicates to formulate them. This approach is quite handy since predicates are easy to modify in the model. Furthermore, they reduce the number of variables and constraints in the model and improve the computational performance. Moreover, the port conveyor system is modeled in a new way that does not list each route of conveyors between storage hangars and berthing positions, which makes easier the formulation of the problem.

Computational tests of a case study are performed using a commercial solver. The results show that our model is able to solve problem instances of realistic size, up to 60 vessels, 10 berthing positions, and 9 storage hangars for a 4-week planning horizon, in a reasonable computation time.

In this study, we assumed that the cargo to load on vessels is always available in the hangars. In practice, this depends on the upstream supply chain. An extension to this study could be to integrate storage locations decisions and inventory management at the hangars.

Chapter 5

An integrated Decision Support System for planning production, storage and bulk port operations in a fertilizer supply chain

Abstract¹⁰

Effective and efficient management of resources plays a crucial role in supply chains. This paper presents an integrated Decision Support System (DSS) for planning the operations of three successive echelons in a fertilizer supply chain: production, storage and vessel loading. It encapsulates a production scheduling model, a berth scheduling model, and a new integer linear programming model for allocating storage spaces. Considering the whole perimeter of these planning operations within a monolithic optimization problem is much too huge to be solvable. Therefore, the proposed DSS aims to align production and storage decisions with vessel demands, ensuring consistency in decision-making. The research was motivated by the operations of OCP Group at the Jorf Lasfar chemical platform in Morocco, but it is also valid for any other phosphate fertilizer producer that ship fertilizers using maritime transport.

Keywords

Storage space allocation, Production scheduling, Berth scheduling, Bulk ports, Decision Support System, Integrated planning

¹⁰ This chapter is a paper submitted for potential publication.

5.1. Introduction

A phosphate supply chain (SC) consists of numerous processes, from the extraction of phosphate ores up to the expedition of final products, such as phosphoric acid and fertilizers. In this paper, we integrate three sequential processes at the downstream of a phosphate SC, namely, the production of fertilizers, their storage, and their loading on vessels at the port. The upstream SC (from extraction to production of phosphoric acid) is decoupled from this downstream section by stocks of phosphoric acid and will not be considered in this paper. This research is motivated by the operations of OCP Group, a global leader in the phosphate market and its derivatives, at the Jorf Lasfar chemical platform in Morocco, the largest fertilizer complex in the world¹¹. In 2019, Morocco ranked fifth worldwide in phosphate fertilizer production (share of 5.8%¹²) after China, the United States, India, and Russia and second worldwide in phosphate fertilizer exports (share of 15.9%²) after China; so, around the world, one can find several fertilizer SCs similar to the one of the Jorf Lasfar chemical platform. Consequently, the integrated planning approach that we propose in this paper can be applied to any phosphate fertilizer producer that ship fertilizers using maritime transport.

OCP's SC is vertically integrated from extracting phosphate ores in several mines and importing raw materials (sulfur and ammonia) to chemical processing and shipment of phosphoric acid and fertilizers. The fertilizer plant under study produces about thirty references of fertilizers to be distributed in the international market. The demand is seasonal, whereas production capacity is fixed. OCP's production planning process starts by programming the make-to-order production (MTO), considering existing stocks, to ensure the loading of fertilizers in vessels expected to arrive in a few weeks. In the case of residual production capacity, a make-to-stock production (MTS) of highly demanded fertilizers or subsequent deliveries may be added to the production program. We note that, in a lean perspective, this MTS is only justified if the fertilizer plant is expected to be soon under capacity (peak demand), or to anticipate a decrease in production in the case of heavy maintenance that may lead to a momentary capacity decrease.

The decisions to make concern the scheduling of production orders and vessel berthing, and the allocation of storage spaces. The problem hence involves three successive echelons in the SC dedicated to the production of fertilizers, their storage, and their removal for shipment by vessels. Two approaches are possible for solving the problem in an integrated

¹¹ <https://corpo.ocpgroup.ma/en/our-strategy-our-industrial-and-commercial-strategy/jorf-lasfar-largest-fertilizer-complex-world>

¹² NationMaster data base: <https://www.nationmaster.com/nmx/sector/fertilizer>

manner: The first one is considering the whole perimeter of these scheduling operations within a monolithic optimization problem. The advantage is that no further coordination is necessary among echelons since all decisions will be taken at a time. This is also referred to as *Deep Integration* (Geoffrion, 1999). However, the resulting optimization model is often too complex to be solvable in a reasonable time, which makes this approach impractical for most industrial applications. The second approach is modeling the problem at each echelon separately and assuring coordination among them. The advantage is that the modeling of each sub-problem is entrusted to specialized experts in their domain, which ensures the integration of all real operational constraints in the model. Furthermore, the complexity of the problem stays affordable for each sub-problem. In industries, focusing on sub-problems by functional entities is a widespread practice. Unfortunately, this organization leads to local visions of performance, and potential shift of costs from one functional entity to another along the chain (Solis, 2001), unless the decisions taken at each sub-problem of the functional units are aligned. This corresponds to the horizontal alignment of the SC (Kathuria et al., 2007).

In this paper, we propose to use the second approach for two reasons; first of all, in our case each sub-problem has its specific constraints, and multiple interrelations exist between them, including conveyor routing restrictions, which add a high level of complexity. Considering the whole perimeter of these scheduling operations within a monolithic optimization problem is too complex to be solvable. Secondly, specialized optimization tools already exist for upstream (production planning of fertilizers) and downstream (port operations) functional units in our industrial context, but these models are not currently aligned. The storage spaces are natural decoupling points in SCs. We, hence, propose to align the upstream and downstream decisions at the storage unit. Therefore, we propose a Decision Support System (DSS) to find a feasible Storage Plan compatible with the optimal solutions of production and berth scheduling decisions. This DSS encapsulates three models: a mixed-integer linear programming (MILP) model to schedule fertilizer production lines proposed by (Azzamouri et al., 2020), the integer linear programming model to schedule berthing positions presented in *Chapter 4*, and a new integer linear programming model for allocating storage spaces presented in Section 5.4. We note that our proposal corresponds to a *functional integration* that defines a sequence for solving subproblems and data exchanges between the base-level and top-level problems (Geoffrion, 1999). It can be done either by a feedback loop or a preprocessing: In *feedback loop*, the top-level problem instructs the base-level problem, then the latter's reaction is used in the top-level to revise instructions. Once a steady-state is reached, the loop terminates. In *preprocessing*, the base-level problem is solved first to

generate more detailed input data for the top-level one, and then both problems are solved sequentially. In this paper, we consider a functional integration by a feedback loop implemented in a DSS logic, where the production and berth scheduling problems are the top-level problems and the SSAP is the base-level problem.

The Storage Space Allocation Problem (SSAP), also called the Storage Location Assignment Problem, is an operational decision that concerns the optimal allocation of goods into a storage space (product volume maximization, operational costs minimization, etc.). It determines where and when incoming goods will be stored in a way that achieves optimal space utilization. In this paper, we also determine from where the required goods will be removed to be shipped. The start-dates of storage and removal are constraints given respectively by the optimal solutions of the production and berth scheduling models. Moreover, we consider a wide variety of bulk goods, making the SSAP more complex since bulk goods require specific handling equipment.

The rest of this paper is organized as follows. In Section 5.2, we review the previous studies on the SSAP in the context of bulk ports. In Section 5.3, we describe the problem and the proposed DSS with the specific assumptions of our approach. In Section 5.4, we present a new MILP model for the SSAP. In Section 5.5, we present the results of a case study and outline the managerial implications of the proposed integrated planning approach. Finally, in Section 5.6, we draw some conclusions and indicate future research.

5.2. Literature review

Warehouse management systems are critical to all SCs since they are the link between production and delivery. The SSAP depends on several parameters, such as the design and the capacity of the warehouse system and the diversity of goods to be stored. When the latter increases, the problem becomes increasingly complex. The SSAP has a wide literature. We do not have the ambition to provide an exhaustive literature review in this section. The interested reader can refer to the following papers: Berg & Zijm (1999) and Gu et al. (2007) review research on warehouse operation planning problems and Reyes et al. (2019) summarize the published literature on the SSAP. Leal Gomes Leite et al. (2020) present a bibliographical review of papers involving OR applications in the integrated mine-to-client SC. The authors detail the planning models of each link in the SC, including the port with stockyard planning and conveyor routing operations. In this section, we only focus on papers that are closely related to our industrial context (bulk ports) and propose new models for the SSAP in this context.

Ago et al. (2007) study the allocation of storage yards to the unloaded raw materials from vessels considering storage capacity constraints, jointly with the transportation routing of raw materials using belt conveyors starting from the quay to storage yards, ending with steel production plants. The belt conveyor can transport only one type of raw materials at once, which adds complexity to the integrated problem. The aim is to achieve a production that is flexible to changes in demand and thus improve the production rate. Therefore, the authors propose a MILP model for the simultaneous storage allocation and routing problem. Regarding the solution methodology, they propose a Lagrangian decomposition and coordination method to decompose the integrated problem into two subproblems. The authors also investigate the effectiveness of the proposed method by comparing its performance with a hierarchical planning method. They demonstrate that the proposed method can derive better solutions without significantly increasing the total computation time.

Boland et al. (2012) study stockyard management in coal export terminals considering the rail system transporting coal from mines to the terminal. Cargoes of typically blended coal products are assembled in stockpiles and then are reclaimed for transport via conveyor belts to berths. Thus, the decisions to be taken include berth allocation with tide constraints, stockpile location, and the start times of stockpile assembly and reclaiming decisions. Similarly, Savelsbergh and Smith (2015) focus on managing a stockyard at a coal export terminal. The authors analyze and compare potential stockyard management strategies to quantify the impact of their parameters and decision rules. In the same context of coal export terminals, Rocha de Paula et al. (2019) optimize stockyard management decisions in a port with multiple terminals and shared resources (the rail network and the navigation channel) with the aim of maximizing the port's throughput in a way that avoids unacceptable vessel delays.

Regarding coal import terminals, Babu et al. (2015) integrate vessel and train scheduling with stockyard management, including stacking and storage operations. Coal is brought to the stockyard via vessels to be stored and then is transported by train. Integrating these decisions is motivated by their high interdependence. The aim of the study is to improve the efficiency of the port terminal, minimizing delays in port operations and reducing the congestion to tackle the increasing number of vessels and trains.

Robenek et al. (2014) solve the integrated berth allocation and yard assignment problem in both import and export bulk ports as a single large-scale optimization problem. They consider a wide variety of specialized equipment depending on the vessel requirements and cargo types (e.g., conveyors for dry bulk, pipelines for liquid bulk). They also consider storage location restrictions that forbid two or more cargo types to be stored in adjacent yard

locations to avoid intermixing. However, the authors consider only vessels that have a single cargo type, which limits the problem. Indeed, a vessel can carry more than one cargo type, and each one of them can be stored in a different storage yard. Similarly, Tang et al. (2016) address the integrated berth scheduling and storage space allocation problem in the context of bulk raw material ports of large iron and steel companies. The authors propose a MILP model that aims to achieve high space utilization with low material loss and transportation costs.

Menezes et al. (2016, 2017) integrate the production planning and scheduling decisions in export bulk ports. The integrated problem defines the amount and destination of each production order and simultaneously establishes a set of feasible routes between the three subsystems of the port complex (i.e., reception, stockyards, and berths), where there is no conflict regarding equipment allocation. The aim is to guarantee that products are stored and shipped on schedule while minimizing operational costs. De Andrade and Menezes (2021) extend this problem integrating berth allocation and yard assignment decisions.

Unsal and Oguz (2019) integrate three planning problems in the context of export dry bulk ports: berth allocation with tide constraints, reclaimer scheduling with non-crossing constraints, and stockyard allocation with multiple stocking pads. First, the authors develop a monolithic model to solve the integrated problem. However, this formulation can only solve small-sized instances. Therefore, they identify some key relationships between the three problems and then propose a logic-based Bender's decomposition algorithm to solve instances of practical sizes to the optimality.

Ouhaman et al. (2020) study the SSAP in an export dry bulk terminal. The authors formulate the problem as a MILP and propose a heuristic method to solve large scale data sets. They limit the problem to the material flow from the production plant to storage hangars, and thus they do not consider retrieval operations.

The papers cited above are summarized in Table 5.1, in which information about the consideration of feeding/removing operations and conveyor routing constraints, the diversity of goods, the cover of SC echelons and the integration approach are presented.

Table 5.1: SSAP literature

Papers	Feeding and/ or Removing operations	Conveyor routing constraints	Diversity of goods	SC echelon optimization			Integration approach
				Production	Storage	Port	
Ago et al. (2007)	F & R	x			x		
Boland et al. (2012)	F & R				x	x	FI, DI
Robenek et al. (2014)	F / R		x		x	x	DI
Babu et al. (2015)	F				x	x	FI
Savelsbergh and Smith (2015)	F & R				x		
Tang et al. (2016)	F				x	x	DI
Menezes et al. (2016, 2017)	F & R	x			x	x	DI
Ouhaman et al. (2020)	F		x		x		
Rocha de Paula et al. (2019)	F & R				x	x	FI
Unsal and Oguz (2019)	R				x	x	FI, DI
De Andrade and Menezes (2021)	F & R	x			x	x	DI
Our paper	F & R	x	x	x	x	x	FI

F: Feeding; **R:** Removing

DI: Deep Integration; **FI:** Functional Integration

We can conclude from the above state-of-the-art that the constraints considered in decision support models for warehouse operations differ from one paper to another since each warehouse system has its own management rules, which requires specific constraints. We clearly see that our work is the only one integrating three SC echelons considering both feeding and removing operations under conveyor routing constraints and a wide diversity of goods.

In the context of container terminals, the SSAP is better known as the Yard Assignment Problem (YAP), which assigns yard storage locations to each container ship with the aim of minimizing transport distances of moving containers between berths and yard storage locations. For papers integrating the BAP with the YAP, we refer the reader to Zhen et al. (2011), Chen & Lu (2012), Li and Yip (2013), Hendriks et al. (2013), Zhen (2014), Tao and Lee (2015), Liu (2020), Guo et al. (2021), Karakas et al. (2021) and Prayogo et al. (2021).

5.3. Problem and DSS description

The Jorf Lasfar chemical platform includes OCP and ODIs (Owner Direct Investments). The latter are independent and autonomous units created by OCP to keep up with increasing demand for fertilizers on the international market and to attract investors through possible capital interests coupled with commercial contracts. The OCP fertilizer plant contains two groups of parallel heterogenous fertilizer production lines, each one linked to a unique group of hangars. Each hangar is divided into separated subareas that we call stock units (SU). Only one reference of fertilizers can be stored in a SU; however, different references can be stored in the same hangar provided that the safety distance between SUs is respected to prevent the contamination between fertilizers of different references. Each hangar is equipped with one stacker used to store the fertilizers coming from the production lines and

one reclaimer used to reclaim the stored fertilizers toward berthed vessels after a minimum resting time. We note that stacking and reclaiming operations can occur simultaneously in the same hangar if the concerned fertilizers are stored in different SUs. Furthermore, the stacking operations take longer than reclaiming ones due to the relative feeding rates of incoming and outgoing flows to a hangar: production line productivity is less than 10% of the ship loader productivity. Figure 5.1 illustrates the conveyor system between production lines, hangars, and berthing positions.

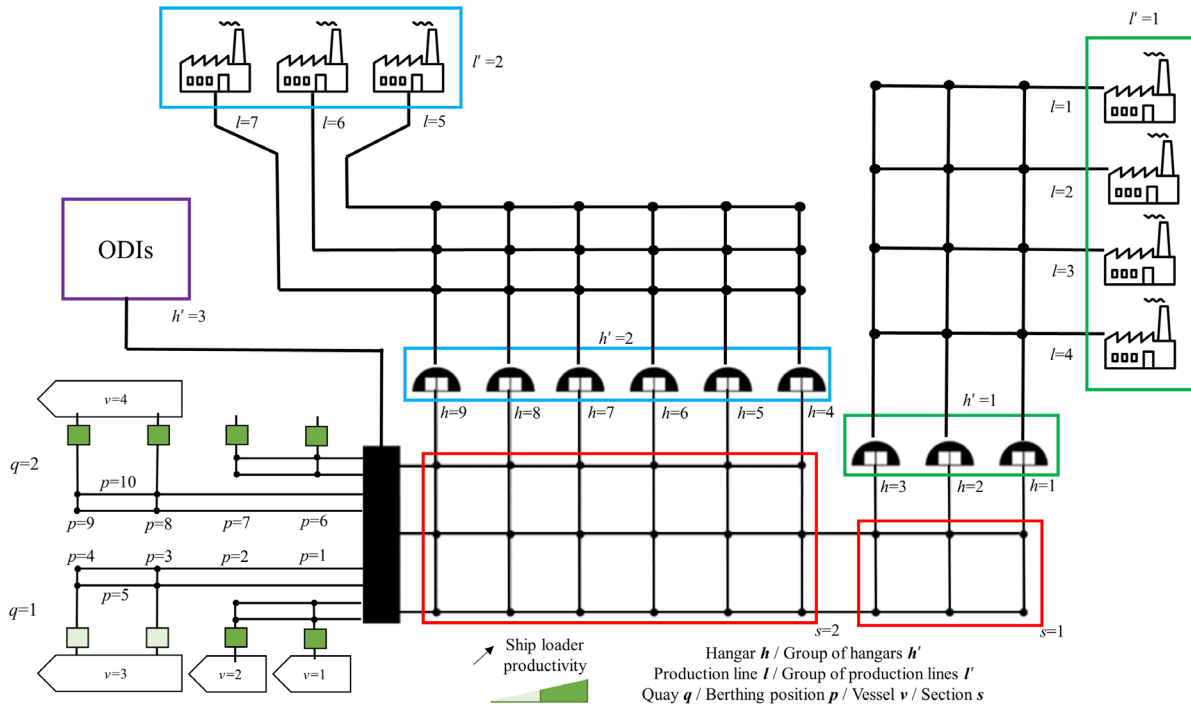

Figure 5.1: A schematic representation of the conveyor system

In this paper, we propose a DSS that aligns production, storage, and port operation decisions for the OCP fertilizer platform described above. We note that similar configurations can be found in other phosphate fertilizer producers that ship fertilizers using maritime transport. This DSS encapsulates a production scheduling model (Production model), a berth scheduling model (Port model) and a new integer linear programming model for allocating storage spaces (Hangar model). We note that the Production model does not specify the exact hangars of production orders, whereas the Port model requires the exact hangars of expedition orders. These two scheduling models are independent; therefore, the proposed DSS seeks to make compatible their optimal solutions by proposing a Storage Plan without adversely affecting the efficiency and the effectiveness of both models. The proposed approach is to be used in a rolling horizon planning. The three models encapsulated in this DSS are described below.

5.3.1. Description of the encapsulated models

Production model

The optimization model proposed in (Azzamouri et al., 2020) provides the optimal scheduling of an order book in the Jorf Lasfar fertilizer plants (OCP and ODIs); its DSS functioning is described in (Azzamouri et al., 2019) and its economic foundation is presented in (Bara et al., 2021). The OCP Jorf Lasfar fertilizer plant is composed of two groups of parallel heterogeneous production lines, ensuring the production of fertilizers within predetermined delivery time windows. The OCP fertilizer plant covers a wide fertilizer diversity with costly setups during changeovers between two different references of fertilizers to produce. For each production order, the model determines its start and end-dates of production on an assigned production line. The production start-dates of production orders constitute the list of production events to be used in the Hangar model. The Production model considers the constraints related to the quantities of production orders, their delivery time windows, the heterogeneity of production lines (one group is more performant than the other), the fact that production lines are partially specialized (certain fertilizer references cannot be produced in certain production lines), the predefined maintenance program (the possibility to interrupt production for maintenance operations).

In this paper, we adapt the Production model to consider the maximum number of fertilizer references produced simultaneously in a group of production lines (see Appendix A). This adaptation is motivated by the fact that the first group of production lines is composed of four lines linked to a group of hangars composed of only three hangars. Since fertilizers with different references cannot be sent simultaneously to the same hangar, the maximum number of fertilizer references produced simultaneously in the first group of production lines must be limited to three.

Port model

The optimization model proposed in *Chapter 4* deals with the integrated Laycan and Berth Allocation Problem in the context of bulk ports for a 4-week planning horizon. The decisions taken concern the assignment of berthing times and positions to chartered vessels during the first three weeks and berthing time windows (laycans) and positions to new vessels to charter during the last two weeks (there can be overlap between chartered vessels and new vessels to charter during the third week). This assignment respects several port and vessels constraints, such as conveyor routing constraints between berthing positions and hangars, preventive maintenance activities, navigation channel restrictions related to tides, the multiplicity of

quays and of fertilizer references to load on the same vessel, the availability of fertilizers, the variation of water depth, the productivity of ship loaders, non-working days, and charter party clauses. The economic objective function of the integrated problem is to maximize the difference between the despatch money and the demurrage charges of vessels. The Port model is tested on a real case study in the bulk port of Jorf Lasfar. It can solve instances optimally up to 60 vessels, 10 berthing positions, and 9 storage hangars with a commercial software.

Each fertilizer reference to load on a vessel is divided into one batch or more, and each one is characterized by a weight and an availability date. The batches are either stored in the same hangar or different hangars without specifying their exact SUs. The model requires only the hangar of each batch to consider conveyor routing constraints that say that one stored batch at most can leave at a time a hangar and a limited number of stored batches can be removed simultaneously from each group of hangars. For example, in Figure 5.1, only two stored batches can be removed simultaneously from group 1 of hangars, which comprises three hangars. Since the exact allocation of SUs and then hangars will be determined by the Hangar model, the berth scheduling model is relaxed to consider only the conveyor routing constraint related to groups of hangars. The other constraint that forbids the simultaneous expedition of batches from a hangar is added to the Hangar model described below.

The outputs of the Port model are as follows: berthing times of chartered vessels, berthing time windows of new vessels to charter, berthing positions of all vessels, and loading start times of batches. The latter constitute the list of loading events to be used in the Hangar model.

Hangar model

The perimeter of this model starts from the exit of production lines and ends with the beginning of vessel berthing positions passing through hangars. It aims to determine where produced batches will be stored and from where the required batches are removed to be loaded in vessels.

Each expedition date of a batch from a production line to a hangar or from a hangar to a vessel is considered as an event. These events are merged into one list and ranked in ascending order according to their expedition dates. Produced batches can be sent to empty SUs or SUs that contain the same fertilizer reference, provided that these SUs belong to hangars linked to the production lines of batches. On the other hand, required batches can be removed from any SU that contains the same fertilizer reference. Once the used capacity of a

SU becomes less than a defined minimum threshold, this SU is cleaned to receive a new fertilizer reference avoiding contamination with the previously stored reference.

The Hangar model considers all the conveyor routing constraints between production lines, hangars, and berthing positions. Since there is only one stacker and one reclaimer per hangar, one produced batch at most can be sent at a time to a hangar and one stored batch at most can leave at a time a hangar. In addition, a limited number of stored batches can be removed simultaneously from each group of hangars due to the limited number of conveyors linked to each group. Moreover, a SU cannot receive and send a batch simultaneously to ensure that the batch is completely removed from the SU before receiving a new one. To this end, we define three Boolean matrices that determine overlaps in the transfer of batches between each SC echelon. Overlap between two batches occurs if the transfer of a batch starts before ending the transfer of the other batch. This representation of time made of events and overlap matrices inherited from production and berth scheduling decisions makes the originality of the Hangar model.

5.3.2. Description of the DSS functioning

In this section, we explain the functioning of the presented DSS. First, we introduce its general environment; then, we present the different steps involved in its functioning. The success of this DSS relies on the processing of each model input data and the connection between the encapsulated models.

The capacity of the Jorf Lasfar fertilizer plant is fixed. Due to seasonal demand fluctuations, aligning production with demand becomes difficult when only MTO is considered. OCP's SC relies on rolling planning horizon and may combine MTO with MTS, in case of residual production capacity. We consider a 4-week planning horizon. OCP's production planning process defines a set of firm orders to be shipped during the first week and a set of forecasted orders to be shipped in expected dates during the last three weeks. The DSS is then based on a frozen horizon of one week. It is utilized in a rolling horizon way in which the three encapsulated models are run each week periodically. The objective of this DSS is to coordinate the three sequential echelons of OCP's SC (production, storage, and vessel loading) to satisfy the demand achieving the best possible economic results.

Batches of produced fertilizers are conveyed to SUs of identical capacity (9 000t) belonging to a set of hangars. Each SU can contain only one reference. The capacity of 9 000t corresponds to approximately three or four days of continuous production in a single production line according to its productivity and about three hours of vessel loading according to conveyor and ship loader productivities. The firm and forecasted demands constitute

expedition orders (EOs) to be delivered by vessels on defined and forecasted dates, respectively. The weight of an EO is generally higher than the capacity of a SU. Therefore, to carry out production, we switch from EOs to elementary expedition orders (EEOs), each one with a maximum weight equal to a SU capacity (e.g., an EO of 22.000t is divided into three EEOs of 9 000t, 9 000t, and 4 000t respectively).

In what follows, we present the list of steps involved in the DSS functioning, summarized in Figure 5.2.

1. The *first step* is to build an order book for MTO that will be used as an input to the Production model. Each SU belongs to a group of hangars and is characterized, when occupied, by a fertilizer reference and a weight. In addition, it is also characterized, when fed by MTO, by the EEO that will pick up from it. When the DSS is launched, several SUs are already occupied (previously filled or feeding in progress). In the context of MTO, the definition of production orders (POs) satisfying EEOs must consider initial stocks and ongoing production to ensure production is consistent with demand. In the frozen horizon, EOs are assumed already available in SUs; consequently, their corresponding EEOs, already stored in SUs, are not considered in the production order book. At the end of the first week, some SUs may contain fertilizers previously produced by anticipated MTO or by MTS (and thus without an attached EEO), which are then required by new berthed vessels. Each remaining EEO, not satisfied with the available stocks, will pick up from a PO whose delivery dates (production end-dates) and weight are specified as follows:
 - The latest delivery date of all POs associated with EEOs of a given EO is equal to the expected arrival time (due date) of the vessel issuing that EO minus a 3-day cooling time.
 - The earliest delivery dates are defined in a way that allows a sequential production of POs on the same production line. POs are arbitrarily ranked for production convenience, since all POs associated with EEOs of a given EO are produced before the expected arrival time of the vessel issuing that EO. The earliest delivery date of the first PO is equal to the latest delivery date minus one day to relax the Production model and thus ensuring a feasible solution, while the earliest delivery date of PO_i is equal to the earliest delivery date of PO_{i+1} minus its production time (calculated using the lowest available production rate), where i is the index of POs associated with EEOs of a given EO.

- The weights of the POs corresponding to the first EEOs of a given EO are defined such that incompletely filled SUs containing the requested fertilizer reach its maximum capacity; the following POs will have a weight equal to SUs capacity, except the last one that may have a weight less than SU capacity.
2. The *second step* is to execute the Production model considering the weight and delivery time windows of POs determined in step 1, and the fertilizer reference to produce. The Production model will generate the optimal Production Plan that gives each PO its assigned production line and its production start and end-dates (production start-dates of POs constitute the first list of events to be used in step 4); it also yields a Boolean square matrix crossing all POs where 1 indicates an overlap in their production time. Since each group of hangars is linked to a unique group of production lines, the group of hangars of each PO is determined.
 3. The *third step* is to execute the Port model considering the input data of vessels, namely the expected arrival time, the length, and the draft of vessels, and the input data of EEOs: their weights, the groups of hangars that contain their corresponding POs (determined in step 2), and the effective dates of availability of these POs by adding the cooling time to their end-dates of production (also determined in step 2). The Port model will generate the optimal Berthing Plan that determines the berthing date and position of each vessel and the loading start and end-dates of each EEO. The loading start-dates of EEOs constitute the second list of events to be merged with the one created in step 2 and then ranked in ascending order to be used in step 4. The Port model also yields a Boolean square matrix crossing all EEOs where 1 indicates an overlap in their loading time. Then both the Production and Port models yield a Boolean matrix crossing all POs and EEOs where 1 indicates an overlap in their production and loading times.
 4. The *fourth step* is to execute the Hangar model considering as inputs the resulting outputs of both the Production model (i.e., the production start date and production line of each PO) and the Port model (i.e., the loading start date of each EEO and the group of hangars from where it will be removed) and the three Boolean matrices. The Hangar model will generate a feasible Storage Plan aligned with optimal production and vessel loading programs. The Storage Plan defines the SU where each PO will be stored and the SU from where each EEO will be removed. When the Hangar model does not find a feasible solution, it will be relaxed by removing the most binding conveyor routing constraint that says that two POs or more cannot be sent at a time to

a hangar, unless they have the same fertilizer reference. Consequently, we can detect the POs leading up to the conflict. The relocation of these conflicting POs to another group of production lines can be done easily using the interactive production scheduling Gantt chart presented in (Azzamouri et al., 2020) while respecting technical and time constraints of the Production model. Then, the DSS is rerun starting from step 4. That being said, the adopted approach considerably limits the risk of having this loopback, since POs are defined in a way that limits the dispersion of stocks (i.e., POs are stored in priority in the SU that already stores the same reference as the PO, provided that the SU has sufficient remaining capacity).

5. *The fifth and final step* is to include MTS in the order book in case of overcapacity. It concerns highly demanded fertilizers or fertilizers that are expected to be soon requested by the OCP sales department. The weight of all MTS orders is set at 9 000t. These orders are included in the interactive production scheduling Gantt chart according to free time slots while considering the Production model constraints and the availability of SUs.

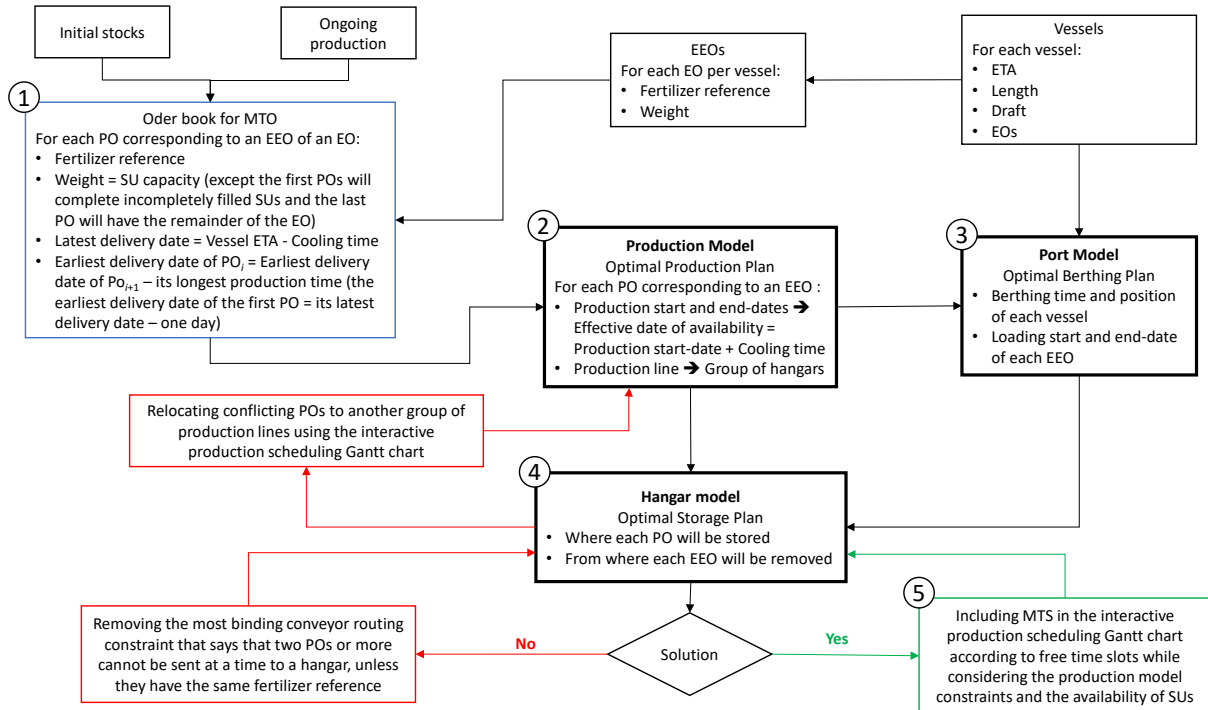

Figure 5.2: Functioning of the DSS

5.4. SSAP model formulation

5.4.1. Notation

The sets, indices, parameters, and decision variables of the SSAP mathematical model are presented in Table 5.2.

Table 5.2: Notation of the SSAP mathematical model

<i>Index</i>	<i>Description</i>
e	Index of events (sending a batch either from a production line to a hangar or from a hangar to a vessel) $\mathcal{E} = \{0, \dots, E\}$.
i	Index of stored batches to load on vessels (EEOs) $\mathcal{I} = \{1, \dots, I\}$.
j	Index of produced batches to store on hangars (POs) $\mathcal{J} = \{1, \dots, J\}$.
h	Index of hangars $\mathcal{H} = \{1, \dots, H\}$.
s_h	Index of SUs belonging to hangar h $\mathcal{S}_h = \{1, \dots, S_h\}$.
h'	Index of groups of hangars $\mathcal{H}' = \{1, \dots, H'\}$.
l	Index of production lines $\mathcal{L} = \{1, \dots, L\}$.
l'	Index of groups of production lines $\mathcal{L}' = \{1, \dots, L'\}$.

<i>Parameter</i>	<i>Description</i>
<u>Constants</u>	
K_{\min}	Minimum threshold below which a SU can receive a new fertilizer reference.
K_{\max}	Maximum capacity of SUs.
F	Number of fertilizer references.
<u>Hangars and production lines</u>	
G_h	Group of hangars including hangar h .
$N_{h'}$	Maximum number of batches that can leave simultaneously group of hangars h' .
$P_{hh'}$	Boolean parameter that equals 1 if one of the conveyors used to transport a batch from hangar h to a berthing position is linked to group of hangars h' .
g_l	Group of production lines including production line l .
$C_{l'h'}$	Boolean parameter that equals 1 if group of production lines l' is linked to group of hangars h' .
<u>Production lines \rightarrow Hangars</u>	
d_j	Index of the event in which batch j starts coming from a production line to a hangar.
l_j	Production line of batch j .
f_j	Fertilizer reference of batch j .

q_j	Weight of batch j .
$b_{jj'}$	Boolean parameter that equals 1 if there is an overlap in the transfer of batches j and j' . When $j = j'$, $b_{jj'} = 0$.

Hangars \rightarrow Vessels

D_i	Index of the event in which batch i starts coming from a hangar to a vessel.
h'_i	Group of hangars of batch i .
F_i	Fertilizer reference of batch i .
Q_i	Weight of batch i .
$B_{ii'}$	Boolean parameter that equals 1 if there is an overlap in the transfer of batches i and i' . When $i = i'$, $B_{ii'} = 0$.

Production lines \rightarrow Hangars \rightarrow Vessels

β_{ij}	Boolean parameter that equals 1 if there is an overlap in the transfer of batches i and j .
--------------	---

<i>Decision variable</i>	<i>Description</i>
--------------------------	--------------------

Hangars

$z_{he}^{s_h}$	Fertilizer reference stored in SU s_h of hangar h at the end of event e , $z_{he}^{s_h} \in \{0, 1, \dots, F\}$. When the SU is empty, $z_{he}^{s_h} = 0$.
$\omega_h^{s_h}$	1 if SU s_h of hangar h is used during the planning horizon, 0 otherwise.
$\pi_{he}^{s_h}$	Used capacity of SU s_h of hangar h at the end of event e before considering K_{\min} , $\pi_{he}^{s_h} \in \mathbf{Z}^+$.
$r_{he}^{s_h}$	Used capacity of SU s_h of hangar h at the end of event e after considering K_{\min} , $r_{he}^{s_h} \in \mathbf{Z}^+$.
$\delta_{he}^{s_h}$	1 when the capacity of SU s_h of hangar h becomes less than K_{\min} at the end of event e when a batch leaves it, 0 otherwise.

Production lines → Hangars

$y_{jh}^{s_h}$ 1 if batch j is sent to SU s_h of hangar h , 0 otherwise.

$v_{jh}^{s_h}$ 1 if batch j can be sent to SU s_h of hangar h because it contains the same fertilizer reference.

$v'_{jh}^{s_h}$ Absolute value of the difference between the fertilizer references of batch j and SU s_h of hangar h , $v'_{jh}^{s_h} \in \mathbf{Z}^+$.

$w_{jh}^{s_h}$ 1 if batch j can be sent to SU s_h of hangar h because it is empty.

Hangars → Vessels

$x_{ih}^{s_h}$ 1 if batch i leaves SU s_h of hangar h , 0 otherwise.

$u_{ih}^{s_h}$ 1 if batch i can leave SU s_h of hangar h because it contains the same fertilizer reference.

$u'_{ih}^{s_h}$ Absolute value of the difference between the fertilizer references of batch i and SU s_h of hangar h , $u'_{ih}^{s_h} \in \mathbf{Z}^+$.

5.4.2. Mathematical model

The SSAP mathematical model can be formulated as follows:

Objective function (1) minimizes the number of used SUs during the planning horizon to maintain a high availability of empty SUs, which is justified for a model used periodically in a rolling planning approach or in case of unexpected events.

$$\text{Min} \sum_{h \in \mathcal{H}} \sum_{s_h \in \mathcal{S}_h} \omega_h^{s_h} \tag{1}$$

Production lines → Hangars

Equation (2) ensures that a produced batch j is sent to a unique SU s_h belonging to hangar h , provided that the group of hangars G_h including hangar h is linked to the group of production lines g_{l_j} including production line l_j where batch j is produced and thus if $C_{g_{l_j} G_h} = 1$. Equations (3) calculate the absolute value of the difference between the fertilizer reference of each produced batch and the reference of the fertilizer already stored in each SU. Equations (4-6) ensure that each produced batch can be sent to a SU if it contains the same fertilizer reference or if it is empty.

$$\sum_{h \in \mathcal{H}} \left| C_{g_j, G_h} = 1 \sum_{s_h \in \mathcal{S}_h} y_{jh}^{s_h} = 1, \forall j \in \mathcal{J} \right. \quad (2)$$

$$\left| \begin{array}{l} v_{jh}^{s_h} \geq z_{h,d_j-1}^{s_h} - f_j \cdot y_{jh}^{s_h} \\ v_{jh}^{s_h} \geq f_j \cdot y_{jh}^{s_h} - z_{h,d_j-1}^{s_h} \end{array} \right. , \forall j \in \mathcal{J}, \forall h \in \mathcal{H} \left| C_{g_j, G_h} = 1, \forall s_h \in \mathcal{S}_h \quad (3)$$

$$\left| \begin{array}{l} v_{jh}^{s_h} \leq F \cdot (1 - v_{jh}^{s_h}) \\ v_{jh}^{s_h} \geq 1 - v_{jh}^{s_h} \end{array} \right. , \forall j \in \mathcal{J}, \forall h \in \mathcal{H} \left| C_{g_j, G_h} = 1, \forall s_h \in \mathcal{S}_h \quad (4)$$

$$\left| \begin{array}{l} z_{h,d_j-1}^{s_h} \leq F \cdot (1 - w_{jh}^{s_h}) \\ z_{h,d_j-1}^{s_h} \geq 1 - w_{jh}^{s_h} \end{array} \right. , \forall j \in \mathcal{J}, \forall h \in \mathcal{H} \left| C_{g_j, G_h} = 1, \forall s_h \in \mathcal{S}_h \quad (5)$$

$$y_{jh}^{s_h} \leq v_{jh}^{s_h} + w_{jh}^{s_h}, \forall j \in \mathcal{J}, \forall h \in \mathcal{H} \left| C_{g_j, G_h} = 1, \forall s_h \in \mathcal{S}_h \quad (6)$$

Hangars → Vessels

Equation (7) ensures that a stored batch i leaves from a unique SU s_h belonging to hangar h , provided that the group of hangars G_h including hangar h is the same as the group of hangars h'_i where batch i is stored and thus if $G_h = h'_i$. Equations (8) calculate the absolute value of the difference between the fertilizer reference of each stored batch and the reference of the fertilizer already stored in each SU. Equations (9-10) ensure that each stored batch can leave a SU if it contains the same fertilizer reference asked by the destined vessel.

$$\sum_{h \in \mathcal{H}} \left| G_h = h'_i \sum_{s_h \in \mathcal{S}_h} x_{ih}^{s_h} = 1, \forall i \in \mathcal{I} \right. \quad (7)$$

$$\left| \begin{array}{l} u_{ih}^{s_h} \geq z_{h,D_i-1}^{s_h} - F_i \cdot x_{ih}^{s_h} \\ u_{ih}^{s_h} \geq F_i \cdot x_{ih}^{s_h} - z_{h,D_i-1}^{s_h} \end{array} \right. , \forall i \in \mathcal{I}, \forall h \in \mathcal{H} \left| G_h = h'_i, \forall s_h \in \mathcal{S}_h \quad (8)$$

$$\left| \begin{array}{l} u_{ih}^{s_h} \leq F \cdot (1 - u_{ih}^{s_h}) \\ u_{ih}^{s_h} \geq 1 - u_{ih}^{s_h} \end{array} \right. , \forall i \in \mathcal{I}, \forall h \in \mathcal{H} \left| G_h = h'_i, \forall s_h \in \mathcal{S}_h \quad (9)$$

$$x_{ih}^{s_h} \leq u_{ih}^{s_h}, \forall i \in \mathcal{I}, \forall h \in \mathcal{H} \left| G_h = h'_i, \forall s_h \in \mathcal{S}_h \quad (10)$$

Updating used capacities of stocks and stored fertilizer references

Equation (11) updates the used capacity of a SU when a batch leaves it before considering the minimum threshold K_{\min} . Equations (12) determine if the used capacity of a SU becomes less than the minimum threshold K_{\min} when a batch leaves it. Equation (13) sets to zero the used capacity of a SU if it becomes less than the minimum threshold K_{\min} when a batch

leaves it, so that the SU can receive a new fertilizer reference avoiding contamination between fertilizers with different references, and also updates the used capacity of a SU when a new batch is stored in it. Equations (14) ensure that the used capacity of SUs remains greater than or equal to zero without exceeding the maximum capacity. Equation (15) ensures that the fertilizer reference of a SU stays the same with only two exceptions: if the SU becomes empty, the fertilizer reference of the SU becomes zero, and if an empty SU is filled with a new batch, the fertilizer reference of the SU takes the value of the fertilizer reference of the new batch. Equation (16) determines if a SU is used or not during the planning horizon.

$$\pi_{he}^{S_h} = \pi_{h,e-1}^{S_h} - \sum_{i \in \mathcal{I} | e=D_i} Q_i \cdot x_{ih}^{S_h}, \forall h \in \mathcal{H} | G_h = h'_i, \forall s_h \in \mathcal{S}_h, \forall e \in \mathcal{E} | e > 0 \quad (11)$$

$$\begin{cases} \pi_{he}^{S_h} - K_{\min} \leq K_{\max} \cdot (1 - \delta_{he}^{S_h}) \\ \pi_{he}^{S_h} - K_{\min} \geq 1 - \delta_{he}^{S_h} \end{cases}, \forall h \in \mathcal{H}, \forall s_h \in \mathcal{S}_h, \forall e \in \mathcal{E} | e > 0 \quad (12)$$

$$\begin{aligned} r_{he}^{S_h} = & \left(r_{h,e-1}^{S_h} - \sum_{i \in \mathcal{I} | G_h=h'_i \wedge e=D_i} Q_i \cdot x_{ih}^{S_h} \right) \cdot (1 - \delta_{he}^{S_h}) + \\ & \sum_{j \in \mathcal{J} | C_{gl_j, G_h} = 1 \wedge e=D_j} q_j \cdot y_{jh}^{S_h}, \forall h \in \mathcal{H}, \forall s_h \in \mathcal{S}_h, \forall e \in \mathcal{E} | e > 0 \end{aligned} \quad (13)$$

$$\begin{cases} r_{he}^{S_h} \geq 0 \\ r_{he}^{S_h} \leq K_{\max} \end{cases}, \forall h \in \mathcal{H}, \forall s_h \in \mathcal{S}_h, \forall e \in \mathcal{E} \quad (14)$$

$$\begin{aligned} z_{he}^{S_h} = & z_{h,e-1}^{S_h} + \sum_{j \in \mathcal{J} | C_{gl_j, G_h} = 1 \wedge e=D_j} F_j \cdot y_{jh}^{S_h} \cdot w_{jh}^{S_h} - \\ & \sum_{i \in \mathcal{I} | G_h=h'_i \wedge e=D_i} f_i \cdot x_{ih}^{S_h} \cdot \delta_{he}^{S_h}, \forall h \in \mathcal{H}, \forall s_h \in \mathcal{S}_h, \forall e \in \mathcal{E} | e > 0 \end{aligned} \quad (15)$$

$$F \cdot \omega_h^{S_h} \geq z_{he}^{S_h}, \forall h \in \mathcal{H}, \forall s_h \in \mathcal{S}_h, \forall e \in \mathcal{E} \quad (16)$$

Equations (13) and (15) are non-linear, and their linearization is obtained as follows:

- Let u , v and w be three binary variables. Then we have: $w = uv \Rightarrow \begin{cases} w \geq u + v - 1 \\ w \leq \frac{u + v}{2} \end{cases}$.

Since $x_{ih}^{S_h}$, $\delta_{he}^{S_h}$, $y_{jh}^{S_h}$ and $w_{jh}^{S_h}$ are binary variables, we put: $\begin{cases} w_1 = y_{jh}^{S_h} \cdot w_{jh}^{S_h} \\ u_1 = y_{jh}^{S_h} \\ v_1 = w_{jh}^{S_h} \end{cases}$ and

$$\begin{cases} w_2 = x_{ih}^{S_h} \cdot \delta_{he}^{S_h} \\ u_2 = x_{ih}^{S_h} \\ v_2 = \delta_{he}^{S_h} \end{cases}.$$

- let x and z be two real variables where $0 \leq x \leq X^{\max}$ and y be a binary variable. Then

$$\text{we have: } z = xy \Rightarrow \begin{cases} z \geq 0 \\ z \leq yX_{\max} \\ z \leq x \\ z \geq x - (1-y)X_{\max} \end{cases} . \text{ Since } \delta_{he}^{S_h} \text{ is a binary variable and } r_{h,e-1}^{S_h} \text{ a}$$

$$\text{real one with } 0 \leq r_{h,e-1}^{S_h} \leq K_{\max}, \text{ we put } \begin{cases} z = r_{h,e-1}^{S_h} \cdot \delta_{he}^{S_h} \\ x = r_{h,e-1}^{S_h} \\ X_{\max} = K_{\max} \\ y = \delta_{he}^{S_h} \end{cases} .$$

Conveyor routing constraints

Equation (17) ensures that a SU cannot receive and send a batch simultaneously ($\beta_{ij} = 1$ in case of overlap in the transfer of batches i and j). Equation (18) ensures that batch j cannot be sent simultaneously with batch j' to the same hangar ($\mathbf{b}_{jj'} = 1$ in case of overlap in the transfer of batches j and j' , with $\mathbf{b}_{jj'} = 0$ when $j = j'$), unless these batches have the same fertilizer reference ($f_j = f_{j'}$); note that batch j is sent to hangar h if $\sum_{s_h \in \mathcal{S}_h} y_{jh}^{S_h} = 1$. Similarly, equation (19) ensures that batch i cannot leave simultaneously with batch i' the same hangar ($\mathbf{B}_{ii'} = 1$ in case of overlap in the transfer of batches i and i' , with $\mathbf{B}_{ii'} = 0$ when $i = i'$), unless these batches have the same fertilizer reference ($F_i = F_{i'}$); note that batch i leaves hangar h if $\sum_{s_h \in \mathcal{S}_h} x_{ih}^{S_h} = 1$. Equation (20) limits the number of batches that can leave simultaneously a group of hangars; note that $\mathbf{P}_{hh'} = 1$ if one of the conveyors used to transport a batch from hangar h to a berthing position is linked to group of hangars h' .

$$x_{ih}^{S_h} + y_{jh}^{S_h} \leq 1, \forall h \in \mathcal{H}, \forall s_h \in \mathcal{S}_h, \forall j \in \mathcal{J} \mid C_{g_1, G_h} = 1, \forall i \in \mathcal{I} \mid G_h = h'_i \wedge \beta_{ij} = 1 \quad (17)$$

$$\begin{aligned} \sum_{s_h \in \mathcal{S}_h} y_{jh}^{S_h} + y_{j'h}^{S_h} \leq 1, \forall h \in \mathcal{H}, \forall j \in \mathcal{J} \mid C_{g_1, G_h} = 1, \\ \forall j' \in \mathcal{J} \mid j' > j \wedge \mathbf{b}_{jj'} = 1 \wedge f_{j'} \neq f_j \wedge C_{g_1, G_h} = 1 \end{aligned} \quad (18)$$

$$\sum_{s_h \in \mathcal{S}_h} x_{ih}^{S_h} + x_{i'h}^{S_h} \leq 1, \forall h \in \mathcal{H}, \forall i \in \mathcal{I} \mid G_h = h'_i, \forall i' \in \mathcal{I} \mid i' > i \wedge \mathbf{B}_{ii'} = 1 \wedge F_{i'} \neq F_i \wedge G_h = h'_i \quad (19)$$

$$\begin{aligned} \sum_{h \in \mathcal{H}} \mid \mathbf{P}_{hh'} = 1 \wedge G_h = h'_i \wedge G_h = h'_i \sum_{s_h \in \mathcal{S}_h} (x_{ih}^{S_h} + x_{i'h}^{S_h}) \leq N_{h'}, \\ \forall h' \in \mathcal{H}', \forall i \in \mathcal{I}, \forall i' \in \mathcal{I} \mid i' > i \wedge \mathbf{B}_{ii'} = 1 \wedge F_{i'} \neq F_i \end{aligned} \quad (20)$$

5.5. Case study and managerial insights

In this section, we present a case study and report its computational results, then we outline the managerial implications of the proposed integrated planning approach. The formulations of the three models are written on Mosel and implemented in Xpress IVE Version 1.25.06, with 64 bits. The models are run on a computer with an Intel® Core™ i7-8665U CPU of 1.90 GHz 2.11 GHz processing speed and 16 GB of memory using the Xpress Optimizer Version 37.01.01 with the default options.

5.5.1. Case study

The case study is based on a sample of data obtained from OCP group. It provides information about vessels loaded with fertilizers in the bulk port of Jorf Lasfar during the first half of 2016. The used inventory positions are consistent with a "lean" functioning of the SC's links (production, storage, and expedition) in a steady-state. We consider a 4-week planning horizon discretized in hourly periods and 28 vessels. Table 5.3 gives the equivalent period of each hour in the planning horizon, and Table 5.4 gives the weights of EEOS of each EO¹³. The order book considered in the Production model includes only the production orders of the OCP Jorf Lasfar fertilizer plant. The same approach is applied to the production orders of ODIs.

Table 5.3: Periods of the planning horizon

Period		
Start	End	Period number
01/03 - 00 h	01/03 - 01 h	1
01/03 - 01 h	01/03 - 02 h	2
...
14/03 - 23 h	15/03 - 00 h	336
15/03 - 00 h	15/03 - 01 h	337
...
28/03 - 22 h	28/03 - 23 h	671
28/03 - 23 h	29/03 - 00 h	672

¹³ The complete tables of the case study presented in *Chapter 5* are available on Mendeley Data: <https://data.mendeley.com/datasets/69dmgvvyh6/1>

Table 5.4: Division of EOs into EEOs

	Vessel #	Date of arrival	Fertilizer #	Producer	Weight of EOs (t)	Weight of batches to load (EEOs) (t)
Berthed vessels	1	1	F1	OCP	11.000	9.000 + 2.000
	2	1	F2	OCP	2.200	2.200
			F3	OCP	2.200	2.200
3	1	F4	OCP	36.900	9.000 + 9.000 + 9.000 + 9.000 + 900	
		F5	OCP	22.000	9.000 + 9.000 + 4.000	
Vessels expected to arrive during the first week	4	27	F1	OCP	10.640	9.000 + 1.640
	5	41	F1	OCP	2.030	2.030
	6	50	F6	OCP	27.500	9.000 + 9.000 + 9.000 + 500
	7	58	F4	OCP	15.530	9.000 + 6.530
			F1	OCP	6.889	6.889
			F15	ODI	5.364	5.364
	8	98	F4	OCP	18.000	9.000 + 9.000
			F7	OCP	10.500	9.000 + 1.500
			F5	ODI	22.000	9.000 + 9.000 + 4.000
	9	120	F1	OCP	3.300	3.300
Vessels expected to arrive during the following weeks	10	220	F1	OCP	3.040	3.040
	11	226	F3	OCP	6.930	6.930
			F16	ODI	4.700	4.700
	12	239	F8	OCP	1.650	1.650
			F3	OCP	1.650	1.650

	20	451	F10	OCP	45.000	9.000 + 9.000 + 9.000 + 9.000 + 9.000
	21	503	F1	OCP	3.150	3.150

	27	610	F6	OCP	27.500	9.000 + 9.000 + 9.000 + 500
28	625	F14	OCP	11.025	9.000 + 2.025	

Table 5.5 and Table 5.6 give respectively the residual weight of production orders initially in progress and the initial state of SUs.

Table 5.5: Production initially in progress

	Production line	Batch # to produce	Fertilizer #	Weight (t)	Production start-date	Production end-date
Group 1	1A	1	F4	8.800	1	98
	1B	2	F10	8.000	1	89
	1C	3	F9	7.000	1	78
	1D	4	F10	1.000	1	12
Group 2	2A	5	F1	2.500	1	21
	2B	6	F4	8.900	1	75
	2C	7	F4	8.300	1	70

Table 5.6: Initial state of SUs (Fertilizer # - Weight)

		Hangar	Stock Units in the hangar							
			1	2	3	4	5	6	7	8
Group 1	A	F4-9.000	F4-9.000			F4-9.000		F4-9.000		
	B		F4-200			F4-9.000		F4-9.000		
	C			F10-1.000		F10-9.000				
Group 2	D	F1-8.541	F1-8.919	F1-9.000	F1-540		F1-9.000			
	E	F2-2.200			F7-1.500					
	F	F5-9.000			F5-4.000	F5-9.000				
	G		F6-9.000	F6-9.000				F6-9.000	F6-500	
	H		F3-2.200	F4-9.000	F4-700					
	I				F4-100	F4-9.000	F7-9.000			
Group 3	J	F15-5.364	F15-7.525	F16-4.700	F5-8.000					
	K	F5-9.000					F5-9.000	F5-9.000	F5-9.000	
	L	F4-9.000	F4-9.000			F4-4.000				

Figure 5.3 gives the inventory position of each fertilizer reference as a function of each vessel loading, considering the production initially in progress, the initial state of SUs and EEOs. The objective is to detect at what point a fertilizer reference becomes out of stock. It appears clear that vessels to be loaded during the first week are filled by available stocks.

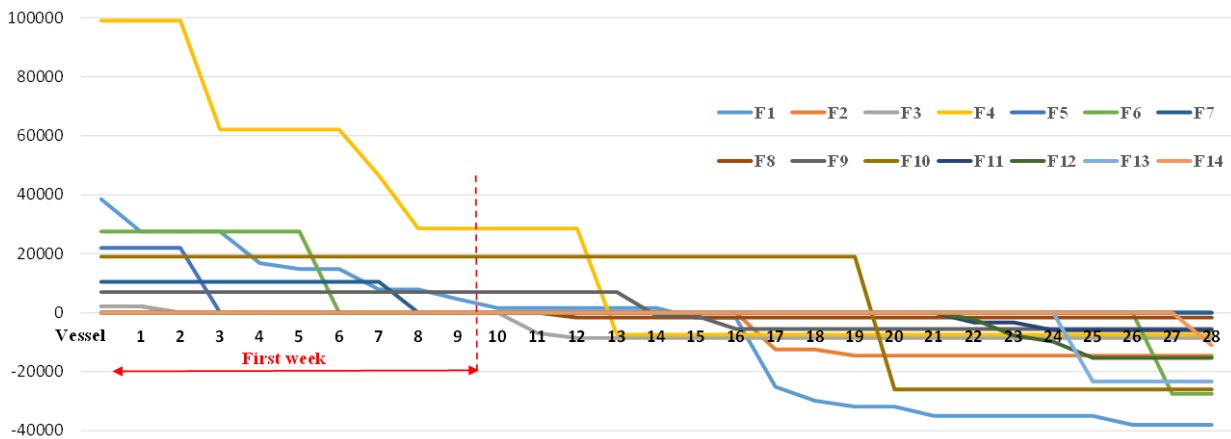

Figure 5.3: Inventory position of fertilizers

Table 5.7 gives the order book built in the first step of the DSS (on the left) and the optimal Production Plan generated by the Production model (on the right) in a computation time of 67.9s. The production start-dates of POs constitute the list of production events¹⁴. Figure 5.4 gives the optimal production scheduling Gantt chart.

¹⁴ The matrix of overlaps between production times is also generated from the production start and end-dates of POs to be used in the Hangar model. See Mendeley Data: <https://data.mendeley.com/datasets/69dmgvvyh6/1>

Table 5.7: Order book and optimal Production Plan

Vessel #	Batch # to produce (PO)	Fertilizer #	Weight (t)	Due date ¹	Longest production time ²	Production end-date		Production start-date	Production line	Production time ²	Production end-date
						Earliest ³	Latest ⁴				
11	8	F3	6.930	226	77	131	155	74	2C	58	131
12	9	F8	1.650	239	19	144	168	131	2A	14	144
	10	F3	1.650	239	19	144	168	132	2C	14	145
...
20	23	F10	8.000	451	89	356	380	268	1B	89	356
	24	F10	9.000	451	100	267	380	193	2B	75	267
	25	F10	9.000	451	100	167	380	118	2B	75	192
21	26	F1	3.150	503	35	408	432	374	1D	35	408
...
27	37	F6	9.000	610	100	515	539	441	2B	75	515
	38	F6	9.000	610	100	415	539	366	2B	75	440
	39	F6	9.000	610	100	315	539	291	2B	75	365
	40	F6	500	610	6	215	539	286	2B	5	290
28	41	F14	9.000	625	100	530	554	456	2A	75	530
	42	F14	2.025	625	23	430	554	439	2A	17	455

¹ Due date = Vessel arrival date

² Longest production time is calculated using the lowest production rate (90t/h), while production time is calculated using the production rate of the assigned production line (90t/h or 120t/h)

³ Earliest production end-date of PO_i = Earliest production end-date of PO_{i-1} - Production time of PO_{i-1} (Earliest production end-date of PO₁ = Latest production end-date of PO₁ - one day (24) +1)

⁴ Latest production end-date = Due date - Cooling time (72) + 1

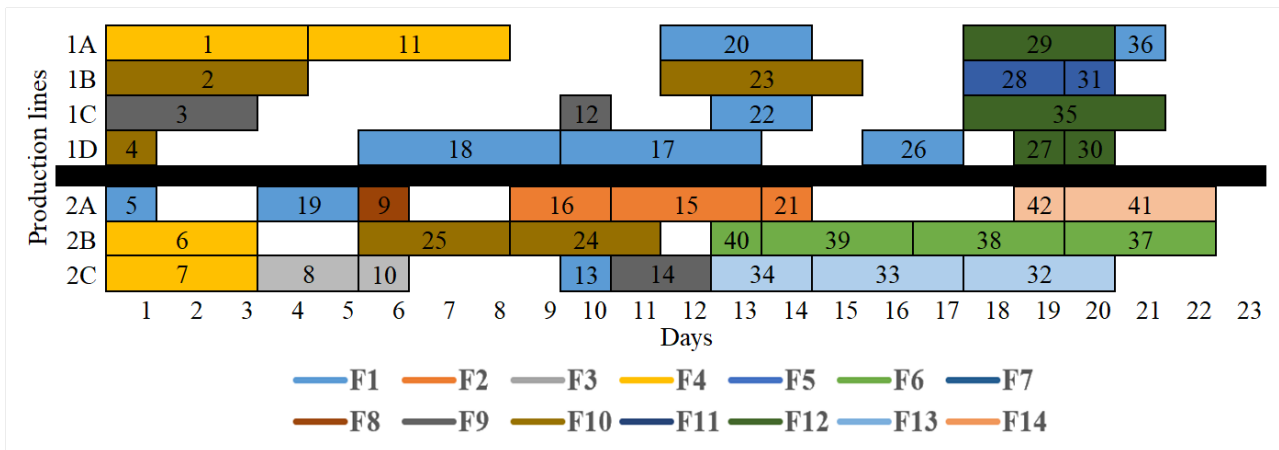

Figure 5.4: Optimal production scheduling Gantt chart

Table 5.8 gives the input data of vessels (on the left) and the optimal Berthing Plan generated by the Port model (on the right) in a computation time of 2.4s, while Table 5.9 gives the input data of EEOs and the optimal Loading Plan also generated by the Port model. The loading start-dates of EEOs constitute the list of loading events¹⁵.

¹⁵ The matrix of overlaps between loading times is also generated from the loading start and end-dates of EEOs to be used in the Hangar model. See Mendeley Data: <https://data.mendeley.com/datasets/69dmgvvyh6/1>

Table 5.8: Vessels input data and optimal Berthing Plan

Vessel #	Number of batches	Date of arrival	Length (m)	Draft (m)	Tonnage (t)	Contractual loading time ¹	Demurrage rate ²	Berthing date	Berthing position	Loading time	Loading end-date	Advance - Delay ³
1	2	1	135	12.2	11.000	6	0	1	1	6	6	0
2	2	1	115	11.3	4.400	3	0	1	6	4	4	-1
...
11	2	226	140	11	11.630	6	109	226	7	7	232	-1
12	2	239	150	12.3	3.300	2	54	239	7	2	240	0
...
20	5	451	230	14.3	45.000	23	92	451	10	15	465	8
21	1	503	105	10	3.150	2	74	503	2	2	504	0
...
27	4	610	180	13.4	27.500	14	71	610	1	16	625	-2
28	2	625	140	12.8	11.025	6	94	625	2	7	631	-1

¹ Contractual loading time = Tonnage / Contractual loading rate (2.000t/h)

² Despatch rate = Demurrage rate / 2

³ Advance - Delay = Date of arrival + Contractual loading time - Loading end-date - 1

Table 5.9: EEOs and optimal Loading Plan

Vessel #	Batch # to load (EEO)	Fertilizer #	Weight (t)	Group of hangars ¹	Effective date of availability ²	Batch loading start-date	Batch loading time	Batch loading end-date
1	1	F1	9.000	2	1	1	5	5
	2	F1	2.000	2	1	6	1	6
2	3	F2	2.200	2	1	1	2	2
	4	F3	2.200	2	1	3	2	4
...
11	33	F3	6.930	2	202	226	4	229
	34	F16	4.700	3	1	230	3	232
12	35	F8	1.650	2	215	239	1	239
	36	F3	1.650	2	216	240	1	240
...
20	56	F10	9.000	1	1	451	3	453
	57	F10	9.000	1	160	454	3	456
	58	F10	9.000	1	427	457	3	459
	59	F10	9.000	2	338	460	3	462
	60	F10	9.000	2	263	463	3	465
21	61	F1	3.150	1	479	503	2	504
...
27	76	F6	9.000	2	586	610	5	614
	77	F6	9.000	2	511	615	5	619
	78	F6	9.000	2	436	620	5	624
	79	F6	500	2	361	625	1	625
28	80	F14	9.000	2	601	625	5	629
	81	F14	2.025	2	526	630	2	631

¹ Production lines 1A to 1D are linked to the group 1 of hangars - Production lines 2A to 2C are linked to the group 2 of hangars - Production lines of ODIs are linked to the group 3 of hangars

² Effective date of availability = Production end-date + Cooling time (72) - 1

The lists of production and loading events are merged in one list and ranked in ascending order. Table 5.10 gives the information related to each event and the optimal Storage Plan generated by the Hangar model, namely the SU of POs and EEOs, in a computation time of 573.2s.

Table 5.10: Events of sending and removing batches and optimal Storage Plan

Event	Batch # to produce (PO) / to load (EEO)	Fertilizer #	Weight (t)	Batch production / loading start-date	Batch production / loading end-date	Production line / Group of hangars	SU
1	3	F2	2.200	1	2	2	E1
2	1	F1	9.000	1	5	2	D3
3	5	F4	9.000	1	5	1	A7
...
61	38	F4	9.000	281	285	2	B2
62	40	F6	500	286	290	2B	D4
63	39	F4	9.000	286	290	1	K8
...
121	79	F6	500	625	625	2	D4
122	80	F14	9.000	625	629	2	F4
123	81	F14	2.025	630	631	2	F1

Finally, MTS can be included in the order book, if needed, considering the free time slots detected in the production scheduling Gantt chart (Figure 5.4) and the availability of SUs. We note that Production and Hangar models can easily be used either separately for OCP and ODIs (as done in this case study) or jointly; in the latter case, account must be taken of the transfer prices involved when an order received by OCP is produced by an ODI (or vice versa).

5.5.2. Managerial insights

We can draw several managerial insights from this study:

- Currently, OCP Group possesses several powerful optimization tools to plan operations at separate functional units, namely the optimization models for port operations and fertilizer production, regardless of storage and conveyor routing constraints, thus involving costly adjustments. Despite their efficiency and effectiveness for the perimeter that they model individually, these are stand-alone decision tools. Hence the decisions taken are not aligned along the SC. The proposed approach provides the alignment from production until expedition of fertilizers at the port. This integrated solution is effective, as it respects all constraints, and efficient, as it consolidates the economic optima of port management and production management through a rational storage policy that seeks to avoid waste.
- The proposed approach provides a lean operations scheduling all along the fertilizer SC, pulled by downstream operations. The demands of expected vessels are satisfied in priority according to their berthing schedule in the port. In case of remaining production capacity, DSS also permits producing to stock, compatible with the management of hangars, to anticipate peaks in demand that cannot be satisfied in a

just-in-time manner due to limited production capacity. In such a context of fully pulled management, tactical planning may be useless.

- The fertilizer order book is defined based on the early arrival of the vessels. Hence the optimal production program respects these availability constraints so that the required fertilizers are available at the hangars as early as needed. This leads to an extension of the stay time of fertilizers in the hangars, resulting in additional storage costs. However, this strategy is advantageous from a risk management point of view. Indeed, port operations are subject to many uncertainties on the seaside (e.g., weather conditions). Having the merchandise ready as early as needed helps to avoid additional uncertainties from the yard-side and unnecessary delays for loading operations (and ultimately delay for the final customer). This is also very costly. Here, the priority is given to loading the vessels as early as possible.
- The storage function is necessary due to technical reasons: First, the difference between the feeding and the removal rates, and second, the need for a minimum cooling time of fertilizers after production. The choice of the fertilizer reference to produce is an important decision (if a make-to-stock strategy is used). If the turnover of the chosen references is low, this leads to obsolete products, unjustified use of storage, and further the potential unavailability of storage space for references on demand. We note that the lean approach leads to the shortest possible stay in stock of fertilizers produced to order or to stock to anticipate demand peaks, which frees the storage space in hangars as much as possible.
- On a strategical level, increasing the storage capacity does not necessarily require building new hangars. The following strategies (not mutually exclusive) can increase the capacity usage: *i*) Reducing the size of SUs (e.g., from 9 000t to 4 500t) leads to a reduction in the neutralization time of these SUs, and also a better usage of the storage space since this strategy does not incur any additional costs on the field. It might, however, impact the DSS process time, since the number of variables in the hangar model increases; *ii*) doubling the feeding machines (stackers) would make it possible to supply a hangar with two different fertilizers simultaneously. This will incur additional costs but is still less than the investment required on a new hangar. Moreover, this lean management implies a high involvement of the top management to convince the production managers not to produce more in case of occasional overcapacity.

- We recommend the managers run the DSS every week, on a rolling horizon, to generate the next week's planning. Nevertheless, the DSS can be used more often to allow good reactivity in the event of a hazard or incident since the computation times of the models encapsulated in the DSS are short.

5.6. Conclusions

This work proposes a Decision Support System (DSS) to integrate effectively and efficiently decisions related to scheduling production orders and vessel berthing, and allocating storage spaces in case of bulk products, which can be found in several supply chains. In a context of mainly make-to-order production, the proposed DSS helps to design the lean management of a pull system at the end of a phosphoric supply chain by encapsulating and monitoring three models: a production scheduling model, a berth scheduling model, and a new integer linear programming model for the Storage Space Allocation Problem. The aim of the latter is to find a feasible Storage Plan compatible with the optimal solutions of production and berth scheduling decisions considering conveyor routing constraints between production lines, storage hangars and berthing positions, and a wide diversity of bulk goods making the studied problem more complex. In addition, it presents two technical originalities: *i*) its representation of time made of events and overlap matrices inherited from production and berth scheduling decisions; *ii*) its ability, with binary decision variables, to dynamically manage stocks which contain only one reference at a time that can change over time.

Our research is motivated by the operations of OCP Group at the Jorf Lasfar chemical platform in Morocco, but it is also valid for any other phosphate fertilizer producer that ship fertilizers using maritime transport. This work is a proof of concept and a preliminary step to demonstrate the interest of a DSS to assist managers in making their decisions effectively and efficiently, as shown in the managerial insights section. It is also to be noted that computation times are short enough to design a successful DSS, usable as often as needed.

In the managerial insights, we have mentioned several strategies to optimize the storage capacity usage (i.e., increasing the number of stackers and reclaimers, and reducing stock units' capacity). As a perspective, it is worth investigating more in depth the impact of these strategies on the overall supply chain performance. Another perspective could be to study other supply chains where bulk cargo is shipped using rail transport alone or combined with maritime transport.

Chapter 6

Conclusions and perspectives

In this chapter, we conclude this thesis, emphasizing our contributions. Then, we discuss some future research directions, which could further improve the proposed models.

6.1. Conclusions

The Berth Allocation Problem is one of the most critical seaside operations in ports. The objective of this thesis is the design of new models to help decision-makers in ports better perform tactical and operational seaside and yard side planning operations and thus improve the efficiency and effectiveness of the port resources mobilized during these operations. To this end, we study different variants of the BAP, in an integrated approach, in the context of container and bulk terminals, considering real-world constraints.

In *Chapter 3*, we integrate berth allocation with laycan and quay crane assignment problems incorporating charter party clauses in port decision problems (demurrage, despatch, laytime) and considering several real-world constraints rarely studied together, such as the multiplicity of quays, the variation of water depth, navigation channel restrictions related to tides, the productivity of quay cranes and their maximum outreach, and non-working periods. The objective of this integrated problem is to find efficient schedules for berthing already chartered vessels and new vessels to charter with efficient quay crane assignments, improving port resource utilization and helping stakeholders in the negotiation process upon the signature of the charter party.

In *Chapter 4*, we focus mainly on bulk ports. We integrate berth and laycan allocation problems considering specific constraints related to bulk ports, mainly conveyor routing constraints between storage hangars and berthing positions and the multiplicity of cargo types on the same vessel, in addition to the common characteristics and constraints of ports considered in *Chapter 3*. Quay crane assignment decisions are not addressed in the case of bulk ports since each berthing position has a fixed ship loader.

In *Chapter 5*, we integrate the operations of three successive echelons of a fertilizer supply chain under a DSS logic, namely production, storage, and vessel loading. For the production echelon, a production scheduling model was proposed by (Azzamouri et al., 2020) to find the optimal scheduling of production orders considering the constraints related to the quantities and delivery time windows of production orders and the heterogeneity and specialization of production lines. However, this model is limited since it does not consider

downstream constraints related to storage, which can cause high levels of overstocking. For the vessel loading echelon, we considered the Integrated Laycan and Berth Allocation Problem in the context of bulk ports presented in *Chapter 4*. This model is also limited since it does not consider upstream constraints related to the availability of cargoes to be loaded on vessels, which can cause high delays and thus the payment of high penalties. Consequently, we develop a new model for the storage echelon to find a feasible storage plan compatible with the solutions of both the production and port models. This model assigns storage spaces to inbound and outbound products considering conveyor routing constraints between production lines, storage hangars, and berthing positions. These three models are encapsulated in a DSS to capture the strong interrelations existing between the different supply chain echelons and align production and storage decisions with vessel demands, thus ensuring consistency in decision-making. The benefits of this alignment can be huge and can help achieve higher levels of vessel demands satisfaction at a lower total cost.

All the models cited above can solve optimally realistic instances of the studied problems in short computation times using commercial solvers.

Some of the main scientific and managerial contributions of this thesis are summarized below:

Scientific contributions

We make use of predicates in the proposed mathematical formulations to define the feasibility zone of decision variables, which permits reducing the number of variables and constraints, and thus improving the computational performance of the designed models. Consequently, problems of practical sizes can be solved in a reasonable time using commercial solvers.

We model spatiotemporal constraints related to quay occupancy by disjunctive constraints using binary variables. In addition, we model non-working days, where cargo operations must be stopped in the port, by the definition of a second-time scale that keeps track of non-working days and accounts for them in advancing time. The proposed modeling is general and thus can be applied to any type of unavailability period.

We propose a new approach to easily manage the integration between decision problems with different decision levels (tactical and operational) seamlessly. This approach is to modulate the decision time-interval throughout the planning horizon. It has the advantage of reducing the number of variables without modifying the time unit of parameters. In addition, it is used under a rolling horizon planning to update the decisions weekly or at each change in the input data of the problems. Thanks to this approach, we integrate smoothly the

tactical laycan allocation problem with operational port decision problems (berth allocation and quay crane assignment) without placing a border between them.

We model the conveyor system in a new way that does not list each route of conveyors between storage hangars and berthing positions. This makes easier the allocation of conveyors and the maintenance of the model in case of infrastructural changes in the conveyor system.

We represent time in the storage space allocation model by events and overlap matrices inherited from production and berth scheduling decisions. Each event is equivalent either to a transfer of goods from production lines to hangars, or from hangars to berthing positions, while the matrices define overlaps between these events. This representation of time makes the originality of the storage model since it allows for the consideration of the optimal solutions of production and berth scheduling models and the conveyor routing constraints that exist between production lines, hangars, and berthing positions.

All these scientific contributions will provide new insights and search strategies, which can be useful for similar combinatorial optimization problems.

Managerial contributions

The proposed models are aimed at helping decision-makers in ports to better perform seaside and yard-side operational planning and easily negotiate charter party clauses. In addition, our integrated approach provides the alignment of decisions, from production until vessel loading operations, ensuring effective and efficient solutions that respect all constraints and ensure a better propagation at both the upstream and downstream of the adopted decisions.

The proposed DSS provides a lean operations scheduling all along the supply chain, pulled by downstream operations. Moreover, in case of remaining production capacity, the DSS permits producing to stock, compatible with the management of hangars, to anticipate peaks in demand that cannot be satisfied in a just-in-time manner due to limited production capacity.

Finally, since computation times of the models encapsulated in the DSS are short, the DSS can be used more often by the concerned managers to allow good reactivity in the event of a hazard or incident.

6.2. Perspectives

Research conducted in this thesis opens up several short- and long-term perspectives.

Short-term perspectives

In *Chapter 3*, we study only the time-invariant version of quay crane assignment problems, where a fixed number (QCAP) or group (QCASP) of cranes is assigned to each vessel throughout its handling time. It would be interesting to study the time-variant version of the

problems, where the number or group of cranes can be changed in each period, while limiting the number of crane movements, and then, compare the results and limits of both versions.

In *Chapter 3* and *Chapter 4*, we conduct several tests to assess the impact of several parameters related to ports and vessels (e.g., the number of quays and vessels, the discretization unit of quays, etc.) on the computation time of our models. It would also be interesting to study the impact of charter party clauses (mainly despatch and demurrage) and port's characteristics on the port's financial results. This will furthermore bring light to the port's managerial decisions and future investments (e.g., adding a new berth or quay crane, extending a quay, etc.). Furthermore, instead of considering the laytime as an input parameter in our models, it would be interesting to see how it can be transformed into a resulting decision, as in the case of the laycan clause. This would help decision-makers even more during the negotiation process upon the signature of the charter party.

In *Chapter 5*, we fix the capacity of stock units at 9 000t. So, it would be interesting to test other values and see the impact of this parameter on the resulting storage plans. Another perspective is to investigate the impact of the number of hangars and handling equipment per hangar. We note that we did not consider production exchanges between OCP and ODIs. Consequently, it would be interesting to study how much these exchanges can improve vessel loading operations and impact financial results.

Long-term perspectives

Many of the input parameters considered in our models as deterministic are stochastic in nature (e.g., vessel expected arrival time, vessel handling time, quay crane productivity, etc.). Therefore, it would be interesting to investigate how we can incorporate stochastic parameters in the modeling of the studied problems to improve the robustness of the solutions when faced with uncertainty and unexpected contingencies, like bad weather or machine downtimes. Furthermore, this stochastic approach could be compared with the rolling horizon approach proposed for our deterministic models.

In the light of the various challenges of climate change, it is very important to carry out port operations in an environmentally sustainable way. So, another perspective would be to find new ways of greening the BAP making it environmentally friendly, as several researchers have been doing recently by considering fuel consumption and emissions during vessels' sailing and berthing. The final goal is to establish a trade-off between the operating costs of ports and environmental objectives. In addition, since stakeholders have conflicting objectives, a coordination strategy could be researched and developed for them to combine the various efforts at ensuring environmental sustainability.

Finally, we note that the work presented in *Chapter 5* is a proof of concept and a preliminary step towards developing a DSS for an integrated supply chain. To make this integration a success, all concerned actors must be involved, and all information needed by the algorithms implemented in the DSS must be centralized.

Appendix A

Adapted Production Scheduling model

The production scheduling model proposed in (Azzamouri et al., 2020) is adapted by introducing constraints (A3-A5).

Table A.1: Notation

<i>Index</i>	<i>Description</i>
l	Index of parallel lines $\mathcal{L} = \{1, \dots, L\}$, with $\mathcal{L}' = \{1, 2\}$.
o	Index of orders $\mathcal{E} = \{1, \dots, O\}$, where: <ul style="list-style-type: none"> $\mathcal{E}_1 = \{1, \dots, L\}$ is the set of the L first orders that are in progress at the beginning of the scheduling; $\mathcal{E}_2 = \{L+1, \dots, L+O\}$ is the set of the $(O-L)$ new orders and L fictitious orders. The latter are added, one per line, to be the last scheduled order on each line (they correspond to the fictitious tasks in the classic MILP formulation of project scheduling problems).
i, j	Index of scheduled orders on a given line, order i being directly followed by order j .
r	Index of fertilizer references $\mathcal{R} = \{1, \dots, R\}$.
p	Index of absolute periods $\mathcal{P} = \{1, \dots, P\}$.

<i>Parameter</i>	<i>Description</i>
<i>Technical parameters</i>	
β_{lj}	Boolean parameter that equals 1 if order j can be produced by line l , 0 otherwise.
a_j	Fertilizer reference of order j .
τ_{lij}	Processing time of order j produced on line l after order i , calculated as the quotient of the quantity required by order j by the production rate of that fertilizer on line l .
θ_{lij}	Total processing time of order j produced on line l after order i ; calculated as the sum of the setup time, involved by a change of fertilizer reference produced on line l , and of the processing time.
L_{lj}	Lower boundary of the last period of production for order j .

U_{lj}	Upper boundary of the last period of production of order j .
Ψ_{lp}	Boolean parameter that equals 1 if line l is unavailable during period p , 0 otherwise.
π_{lp}	Relative period for line l corresponding to the absolute period p ; it considers the periods during which line l is not available due to preventive maintenance
	$\pi_{lp \Psi_{lp}=0} = p - \sum_{p'=1}^{p'=p} \Psi_{lp'}, \forall l \in \mathcal{L}, \forall p \in \mathcal{P}.$

Costs

γ_{lij}	Production cost of order j in line l , after producing order i , calculated as the sum of the setup cost, required by a change of fertilizer reference produced on line l , and of the direct variable cost of producing fertilizer j on line l .
ρ_j	Coefficient used to drag the schedule of order j towards its earliest value or its latest possible value in case of slack; $0 \leq \rho_j \leq 1, \forall j \in \mathcal{J}_2$.

<i>Decision variable</i>	<i>Description</i>
x_{lijp}	1 if order j is processed on line l just after order i and is delivered at period p , 0 otherwise.
z_p	1 if lines 1 and 2 (\mathcal{L}') produce the same fertilizer reference at period p , 0 otherwise.
z'_p	Absolute value of the difference between the fertilizer references produced on lines 1 and 2 (\mathcal{L}') at period p , $z'_p \in \mathbf{Z}^+$.
<i>Intermediary variable</i>	<i>Description</i>
y_j	Last period of production of order j .
w_{lp}	Fertilizer reference produced by line l ($l \in \mathcal{L}'$) at period p .

Table A.2: Predicates

<i>Predicate</i>	<i>Notation</i>
$i \neq j \wedge \beta_{li} = 1 \wedge \beta_{lj} = 1$	P_{lij}
$L_{lj} \leq p \leq U_{lj}$	P_{ljp}

The intermediary variables are defined as follows:

$$y_j = \sum_{l \in \mathcal{L}} \sum_{i \in \mathcal{E}} \mathbf{1}_{\mathbf{P}_{ij}} \sum_{p \in \mathcal{P}} \mathbf{1}_{\mathbf{P}_{lp}} p \cdot x_{lijp}, \forall j \in \mathcal{E}_2$$

$$w_{lp} = \sum_{i \in \mathcal{E}} \sum_{j \in \mathcal{E}_2} \mathbf{1}_{\mathbf{P}_{ij}} \sum_{p' \in \mathcal{P}} \mathbf{1}_{\mathbf{P}_{lp'} \wedge p \leq p' \leq p + \tau_{lij}} a_j \cdot x_{lijp'}, \forall p \in \mathcal{P}, \forall l \in \mathcal{L}'$$

The adapted production scheduling model is formulated as follows:

Equations (A.1) ensure that: *i*) a new or fictitious order j ($j \in \mathcal{E}_2$) is assigned to a single line ($l = 1, \dots, L$), *ii*) an order in progress at the beginning of the scheduling ($i \in \mathcal{E}_1$) cannot be followed by more than one new order and may be followed by no order if that line is not included in the schedule.

$$\left| \begin{array}{l} \sum_{l \in \mathcal{L}} \sum_{i \in \mathcal{E}} \mathbf{1}_{\mathbf{P}_{ij}} \sum_{p \in \mathcal{P}} \mathbf{1}_{\mathbf{P}_{lp}} x_{lijp} = 1, \forall j \in \mathcal{E}_2 \\ \sum_{l \in \mathcal{L}} \sum_{j \in \mathcal{E}_2} \mathbf{1}_{\mathbf{P}_{ij}} \sum_{p \in \mathcal{P}} \mathbf{1}_{\mathbf{P}_{lp}} x_{lijp} \leq 1, \forall i \in \mathcal{E}_1 \end{array} \right. \quad (\text{A.1})$$

A new order j produced on line l must have a predecessor i (in progress or new) produced on the same line. Equation (A.2) enforces order i to be produced on line l if j is produced on line l .

$$\sum_{k \in \mathcal{E}} \mathbf{1}_{\mathbf{P}_{kj}} \sum_{p \in \mathcal{P}} \mathbf{1}_{\mathbf{P}_{lp}} x_{lkjp} = \sum_{h \in \mathcal{E}_2} \mathbf{1}_{\mathbf{P}_{jh}} \sum_{p \in \mathcal{P}} \mathbf{1}_{\mathbf{P}_{lh}} x_{ljhp}, \forall l \in \mathcal{L}, \forall j \in \mathcal{E}_2 \quad (\text{A.2})$$

Equations (A.3) calculate the absolute value of the difference between the fertilizer references produced on lines 1 and 2 (\mathcal{L}') at period p . Equations (A.4-A.5) ensure that only one fertilizer reference at most can be produced on lines 1 and 2 (\mathcal{L}') at period p .

$$\left| \begin{array}{l} z'_p \leq w_{l=1,p} - w_{l=2,p} \\ z'_p \geq w_{l=1,p} - w_{l=2,p} \end{array} \right., \forall p \in \mathcal{P} \quad (\text{A.3})$$

$$\left| \begin{array}{l} z'_p \leq R \cdot (1 - z_p) \\ z'_p \geq 1 - z_p \end{array} \right., \forall p \in \mathcal{P} \quad (\text{A.4})$$

$$\sum_{l \in \mathcal{L}'} \sum_{i \in \mathcal{E}} \sum_{j \in \mathcal{E}_2} \mathbf{1}_{\mathbf{P}_{ij}} \sum_{p' \in \mathcal{P}} \mathbf{1}_{\mathbf{P}_{lp'} \wedge p \leq p' \leq p + \tau_{lij}} x_{lijp'} \leq 1 + z_p, \forall p \in \mathcal{P} \quad (\text{A.5})$$

Equation (A.6) prevents order j from being produced as long as the production of order i is in progress, when both orders are produced on the same line. The number of periods P plays the role of the “big M” constant.

$$y_j - y_i \geq \sum_{l \in \mathcal{L}} \mathbf{1}_{\mathbf{P}_{ij}} \sum_{p \in \mathcal{P}} \mathbf{1}_{\mathbf{P}_{lp}} \theta_{lij} \cdot x_{lijp} - P \cdot \left(1 - \sum_{l \in \mathcal{L}} \mathbf{1}_{\mathbf{P}_{ij}} \sum_{p \in \mathcal{P}} \mathbf{1}_{\mathbf{P}_{lp}} \theta_{lij} \cdot x_{lijp} \right), \forall i \in \mathcal{E}, \forall j \in \mathcal{E}_2 \quad (\text{A.6})$$

Optimization criteria

The production cost C_1 induced by the schedule of orders is given by Equation (A.7). Several schedules may have the same minimum value of the production cost C_1 because slacks can exist between orders sequenced on the same line. Among them, schedules with the earliest delivery dates are usually preferred to keep the productive system busy in the short term. This is obtained by adding a penalty K (A.8), weighted by the coefficient α to C_1 , which gives the criterion C_2 (A.9). The value of the coefficient α must be low enough not to alter the values of the decision variable x_{lijp} . The aim is to drive the choice of schedule from the set of optimal schedules. The value of the coefficient ρ_j ($0 \leq \rho_j \leq 1$) aims to pull order j toward its earliest schedule when $\rho_j = 1$ and to push it toward its earliest schedule; when $\rho_j = 0$. The desired result is not achieved when conflicts occur between orders scheduled on the same line; in this case, one needs to work out the best schedule among the optimal ones.

$$C_1 = \sum_{l \in \mathcal{L}} \sum_{i \in \mathcal{E}} \sum_{j \in \mathcal{J}_2} \sum_{p \in \mathcal{P}_{lij}} \gamma_{lij} \cdot x_{lijp} \quad (\text{A.7})$$

$$K = \sum_{j \in \mathcal{J}_2} \left[\rho_j \cdot (y_j - \sum_{l \in \mathcal{L}} \sum_{i \in \mathcal{E}} \sum_{p \in \mathcal{P}_{lij}} L_{lj} \cdot x_{lijp}) \right] + \left[(1 - \rho_j) \cdot (\sum_{l \in \mathcal{L}} \sum_{i \in \mathcal{E}} \sum_{p \in \mathcal{P}_{lij}} U_{lj} \cdot x_{lijp} - y_j) \right] \quad (\text{A.8})$$

$$C_2 = C_1 + \alpha \cdot K \quad (\text{A.9})$$

Appendix B

Résumé étendu

Le transport maritime joue un rôle crucial dans la mondialisation des économies et la globalisation des entreprises. Aujourd'hui, plus de 80% du commerce mondial en volume est acheminé par la mer et manutentionné par les ports (UNCTAD, 2020). Ces derniers cherchent à améliorer leur performance et maintenir leur compétitivité tout en réduisant leurs coûts afin de capturer une part de marché très importante. Atteindre ces objectifs nécessite une gestion efficace et efficiente des ressources portuaires assurant une transition fluide des marchandises, de manière qu'elles arrivent à temps à destination. Au cours de cette thèse, nous avons développé de nouveaux modèles innovateurs pour la gestion portuaire tactique et opérationnelle. L'objectif final est d'encapsuler ces modèles dans un système d'aide à la décision pour aider les gestionnaires des ports à prendre des décisions efficaces et efficientes.

La performance de la gestion portuaire est liée à la fois à l'utilisation optimale de son potentiel productif (quais, grues, convoyeurs, véhicules internes, main d'œuvre, etc.) et au respect des clauses contractuelles. La charte-partie (*charter party*) est un contrat d'affrètement conclu entre l'armateur (*shipowner*) (le fréteur qui équipe le navire) et l'affréteur (*charterer*) (propriétaire de la marchandise) et a pour objet l'engagement de l'armateur à mettre à disposition de l'affréteur un navire pendant un trajet donné. Parmi les clauses présentes dans ce type de contrat, nous citons la planche et le temps de planche. La planche (*laycan*), encore désignée dans les contrats maritimes sous le terme de « Jours de planche/Date de résiliation » (*Laydays/Cancelling*) est une plage de temps datée pendant laquelle, l'armateur est tenu de mettre un navire à la disposition de l'affréteur dans le port indiqué. Ce dernier doit être capable de commencer le chargement durant cette plage de temps. Il n'est pas tenu d'accepter le navire et de commencer les opérations de chargement avant la date marquant le début de la planche, et est en droit de le refuser s'il se présente après la date de résiliation marquant la fin de cette période. Quant au temps de planche (*laytime*), il s'agit du temps alloué à l'affréteur dans une charte-partie pour charger/décharger sa cargaison sans qu'il ait à payer à l'armateur d'autres sommes que celle convenue pour l'affrètement du navire. Quand le temps de chargement/déchargement dépasse le temps de planche prévu dans le contrat d'affrètement, l'affréteur doit payer une pénalité financière nommée « surestaries » (*demurrage*) à l'armateur. Les surestaries ne sont applicables que lorsque le navire du client arrive au port dans sa planche. A contrario, toute fin de traitement antérieure à cette date cible générera une

prime de célérité (*dispatch money*, *despatch money* ou simplement *despatch*) pour l'affréteur. Ces éléments contractuels sont représentés à la Figure B.1.

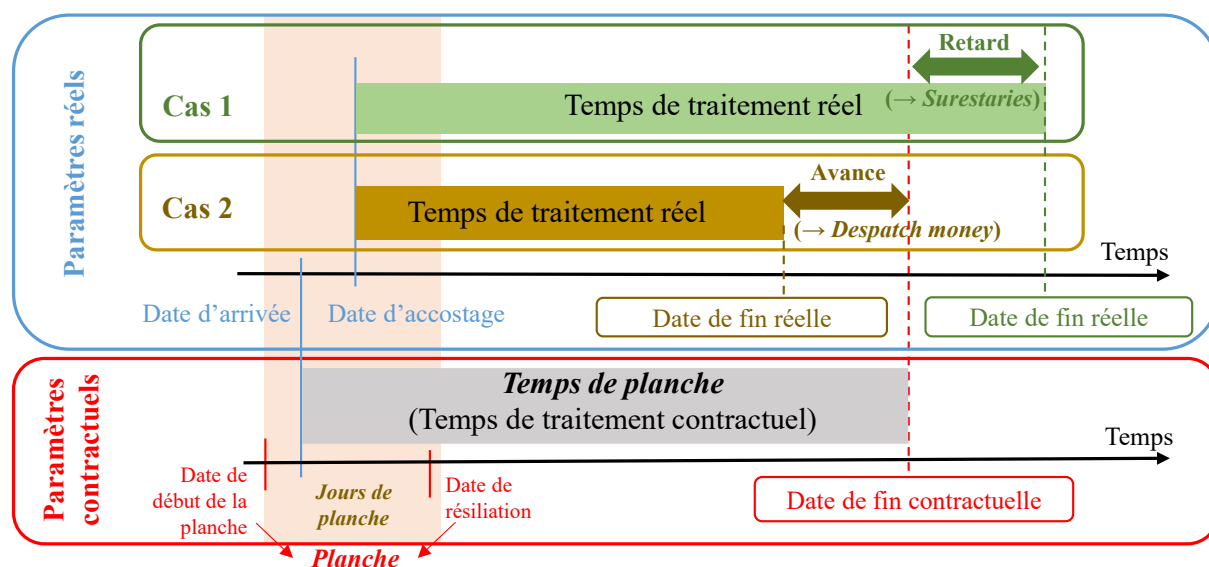

Figure B.1 : Paramètres contractuels et réels des navires

Dans le cadre de cette thèse, nous avons étudié quatre principaux problèmes liés à la gestion portuaire à la fois hiérarchiques et interdépendants : le problème de l'allocation des planches, le problème de l'allocation des postes à quai, le problème de l'allocation des grues de quai et le problème de l'allocation des espaces de stockage. La Figure B.2 illustre la hiérarchie de ces quatre problèmes portuaires dans un sens descendant, ainsi que la rétroaction qui existe entre eux, dans un sens ascendant. En effet, l'output d'un niveau de planification peut être à la fois un input pour le niveau suivant et une contrainte pour le niveau précédent. Le problème tactique de l'allocation des planches (*Laycan Allocation Problem*) génère une affectation de plages de temps aux nouveaux navires à affréter durant lesquelles leur accostage est possible sur un horizon de planification à moyen terme de quelques semaines. Cette affectation doit prendre en considération la disponibilité des quais et des marchandises à charger dans les navires, d'où son interaction avec le problème opérationnel de l'allocation des postes à quai (*Berth Allocation Problem*). Ce dernier génère un programme d'accostage qui détermine où un navire doit accoster dans le port et sur quelle plage de temps, sur un horizon de planification à court terme de quelques jours. Ce programme doit optimiser le séjour des navires en rade et à quai en prenant en compte la disponibilité datée des quais, leurs caractéristiques (longueur, profondeur, etc.) et celles des navires (taille, tirant d'eau, etc.). Le temps de traitement d'un navire dépend fortement du nombre et de la productivité des grues de quai qui lui sont allouées. D'où l'étude du troisième problème intitulé le problème opérationnel de l'allocation des grues de quai (*Quay Crane Assignment Problem*) qui détermine combien de grues de quai vont servir chaque navire. Ce problème peut être étendu

à l'allocation des grues de quai spécifiques (*Specific Quay Crane Assignment Problem*) pour déterminer exactement quelles grues de quai vont servir chaque navire. Enfin le quatrième problème étudié est le problème de l'allocation des espaces de stockage (*Storage Space Allocation Problem*) qui permet de déterminer les espaces de stockage des produits.

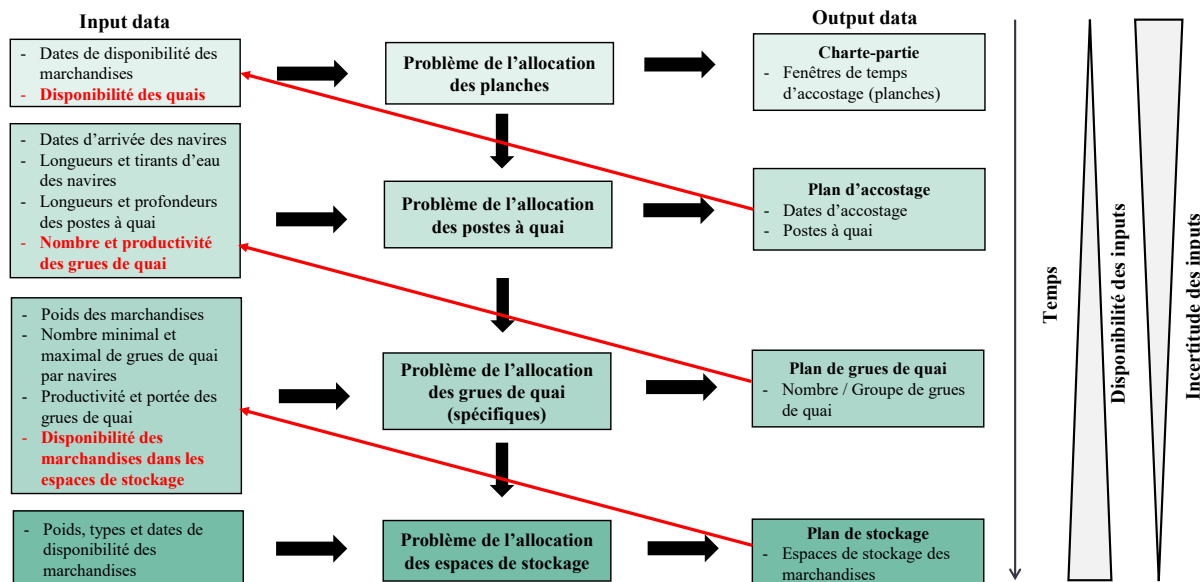

Figure B.2 : Représentation des interactions entre les problèmes portuaires étudiés

Premièrement, nous avons étudié un nouveau problème intégré dans la littérature de la recherche opérationnelle que nous avons nommé le problème intégré de l'allocation de planches, des postes à quai et des grues de quai (*Integrated Laycan and Berth Allocation and Quay Crane Assignment Problem*) dans les ports en général, en particulier dans le contexte des ports à conteneurs. Cette intégration est motivée par la forte interdépendance qui existe entre ces différents problèmes. En effet, les décisions d'allocation des planches aux nouveaux navires à affréter dépendent de la disponibilité des quais tout au long de l'horizon de planification, de même, le temps de séjour des navires à quai dépend du nombre et du type de grues de quai qui lui sont allouées. La non prise en compte de ces interrelations entraînerait des décisions de qualité médiocre, voire des solutions infaisables. L'objectif de ce nouveau problème intégré est ainsi d'optimiser l'utilisation des quais et des grues de quai et de proposer des planches optimales aux nouveaux navires à affréter. Ensuite nous avons remplacé le problème de l'allocation des grues de quai par le problème de l'allocation des grues de quai spécifiques pour prendre en compte les différentes caractéristiques des grues de quai à savoir leur productivité et leur portée. Cette extension rend le problème intégré plus difficile à résoudre mais donne des solutions plus réalistes.

Différentes caractéristiques des ports et des navires sont considérées pour s'approcher le plus possible de la réalité, à savoir : la multiplicité des quais, la variabilité de la profondeur des quais et des tirants d'eau des navires, les restrictions du chenal de navigation liées aux

marées, la productivité et la portée des grues de quai et les périodes de non-travail. Toutes les contraintes liées à ces caractéristiques ont été modélisées sous forme de prédicats lors de la définition du domaine d'existence des variables de décision, ce qui a permis de réduire l'espace de recherche des solutions et par la suite améliorer la performance des modèles. De plus, nous avons comparé les résultats de deux fonction-objectifs, une basée sur un critère physique qui minimise le retard des navires et une autre basée sur un critère économique qui maximise la différence entre les primes de célérité et les pénalités de retard des navires.

L'intégration de ces problèmes de différents niveaux décisionnels (tactique et opérationnel) dans un même modèle est réalisée grâce à l'adoption d'un intervalle de temps décisionnel variable au sein de l'horizon de planification sans affecter la modélisation du comportement du système qui est défini à la maille horaire.

Afin d'évaluer la qualité des deux modèles (le premier modèle alloue un nombre de grues de quai à chaque navire tandis que le deuxième modèle alloue des grues de quai spécifiques), nous avons développé un générateur d'instances sur le logiciel de simulation Simul8. Dans ce générateur, nous avons modélisé certaines caractéristiques du port et des navires, à savoir le nombre de quais et de navires et l'unité de discrétisation de leurs longueurs, sous forme de paramètres configurables. Les résultats ont montré que le premier modèle est capable de résoudre des instances à l'optimal pouvant atteindre 100 navires et 5 quais pour un horizon de planification de 4 semaines dans un temps de calcul raisonnable en utilisant le solveur Xpress, tandis que le deuxième modèle est capable de résoudre des instances pouvant atteindre 50 navires pour le même nombre de quais et le même horizon de planification.

Deuxièmement, nous avons étudié le problème intégré de l'allocation des planches et des postes à quai (*Integrated Laycan and Berth Allocation Problem*) soumis aux contraintes de convoyage et de maintenance prédictive dans le contexte des ports vraquiers. Puisque chaque poste à quai est doté d'une seule grue fixe, le problème de l'allocation des grues de quai n'est pas considéré dans le cas des ports vraquiers. Nous notons que le problème de l'allocation des postes à quai a été largement traité par la communauté scientifique, mais les ports dédiés aux marchandises en vrac ont reçu moins d'attention dans la littérature de la recherche opérationnelle que les ports dédiés aux marchandises en conteneur. Les opérations dans les ports vraquiers sont très différentes de celles des ports à conteneurs. Dans ces derniers, les marchandises sont stockées dans des conteneurs standards avec des dimensions normalisées alors que dans les ports vraquiers, les marchandises ne sont pas emballées. D'où la nécessité d'utiliser des équipements de transport et de manutention spécifiques selon le

besoin des navires vraquiers et de la nature des produits en vrac à charger ou décharger (convoyeurs pour vrac solide et pipelines pour vrac liquide).

Afin de valider notre modèle des ports vraquiers, nous avons mené des tests sur une étude de cas basée sur le port de Jorf Lasfar opéré par le Groupe OCP, leader mondial sur le marché de phosphates et de ses dérivés. Ce dernier ambitionne de doubler ses capacités d'extraction et de production du phosphate et de tripler sa capacité de transformation chimique. En conséquence, la complexité actuelle de la planification du déchargement des matières premières et du chargement des produits finis devrait s'accroître rapidement. Dans cette perspective, une grande pression est exercée sur les ports de l'OCP pour adapter leurs capacités et fournir des services performants. Les résultats ont montré que notre modèle est capable de résoudre à l'optimal des instances de taille réelle pouvant atteindre 60 navires, 10 postes à quai et 9 hangars de stockage pour un horizon de planification de 4 semaines dans un temps de calcul raisonnable en utilisant le solveur Xpress.

Nous précisons que même si le modèle des ports vraquiers est basé sur le cas du port de Jorf Lasfar, il pourrait être appliqué à d'autres ports vraquiers doté d'un système de convoyage. En effet, nous avons modélisé les contraintes d'acheminement des marchandises par convoyeur entre les hangars de stockage et les postes à quai sans avoir à expliciter les différents chemins possibles. Ceci permet d'appliquer le modèle sur d'autres ports vraquiers en jouant seulement sur les jeux de données. De plus, la modélisation proposée permet de faciliter la maintenance du modèle en cas de changements d'infrastructure.

Enfin, nous avons développé un système d'aide à la décision (SAD) pour intégrer les différents problèmes portuaires d'allocation et d'ordonnancement tout en tenant compte des contraintes de l'amont de la supply chain dans le site de Jorf Lasfar, considéré comme le plus grand complexe au monde de valorisation du phosphate et de production de fertilisant. En effet les solutions optimales proposées par le modèle des ports vraquiers peuvent ne pas être réalisables à cause de la non-disponibilité des marchandises à charger dans les navires car en pratique, il y a une forte interaction entre le chargement des navires et la production. D'où l'idée d'un SAD intégré encapsulant un modèle existant de l'ordonnancement des lignes de production des engrais, le modèle de l'allocation des planches et des postes à quai soumis aux contraintes de convoyage dans les ports vraquiers et un nouveau modèle pour l'allocation des espaces de stockage (*Storage Space Allocation Problem*). Le périmètre du SAD s'étend ainsi depuis les lignes de production jusqu'aux postes à quai en passant par les hangars de stockage. La prise en compte du périmètre global de toutes ces opérations de planification au sein d'un problème d'optimisation monolithique serait très difficile, voire impossible à résoudre. De plus la grande variété des produits à stocker rend le problème étudié encore plus

complexe. L'objectif du SAD est ainsi de trouver un plan de stockage compatible avec les solutions optimales de la production et de l'accostage des navires afin d'assurer une consistance dans la prise de décision.

En conclusion, cette thèse porte, dans un premier temps, sur la conception de nouveaux modèles intégrés pour la gestion portuaire tactique (allocation des planches) et opérationnelle (allocation des postes à quai et des grues de quai) dans le contexte des ports à conteneurs et vraquiers. Dans un deuxième temps, elle porte sur le développement d'une approche d'optimisation globale pour résoudre le problème de planification intégrée des opérations de production, de stockage et de chargement des navires dans le cadre des chaînes logistiques intégrées faisant appel au transport maritime.

Grâce aux différents modèles proposés dans cette thèse, les gestionnaires des ports pourront planifier d'une manière efficace et efficiente les différentes opérations portuaires d'allocation et d'ordonnancement tout en tenant compte de leurs contraintes opérationnelles, assurant ainsi une amélioration de la capacité des ports à répondre aux demandes des navires et une utilisation optimale des différentes ressources portuaires. En effet, les quais, les grues de quai et les espaces de stockage sont alloués de manière à garantir le départ des navires à temps tout en minimisant les différents coûts encourus. De plus, l'incorporation des clauses contractuelles dans la planification des opérations portuaires permettra aux différentes parties prenantes de fixer des planches optimales pour les nouveaux navires à affréter lors de la signature de leur charte partie. Ceci permettra d'améliorer les arrivées des navires et par la suite éviter toute surcharge excessive dans l'exécution des opérations portuaires et ainsi tout retard pouvant engendrer des pénalités importantes.

Malgré la complexité des problèmes intégrés que nous étudions dans cette thèse, nos modèles mathématiques sont capables de résoudre à l'optimal des instances de taille réelle dans des temps de calcul raisonnable en utilisant le solveur Xpress. Ceci est dû en grande partie à l'usage massif des prédicats dans nos modèles. Par conséquent, vu la rapidité des temps de calcul, nos modèles peuvent être relancés à tout moment suite à la survenance d'évènements imprévus (mauvais temps, arrêt des machines, retard des navires, etc.) pour mettre à jour rapidement les décisions prises au départ et éviter par la suite tout retard important.

Enfin, notre approche d'optimisation globale qui intègre les différentes opérations de production, stockage et chargement des navires dans un SAD a pour but d'aligner les décisions relatives à la production et au stockage avec les demandes des navires, assurant ainsi une consistance dans la prise de décision. Elle a aussi pour avantage de produire des solutions synchronisées qui évitent les incohérences et les conflits susceptibles d'avoir lieu dans le

cadre d'une démarche locale de planification, ce qui permet d'améliorer la flexibilité, l'efficacité et la rentabilité du système étudié et de promouvoir la synergie entre ses différentes composantes. Or, pour réussir cette intégration, il faut impliquer les différents services concernés pour faciliter la centralisation et la normalisation des données, éléments essentiels dans tout système intégré de gestion.

Une première perspective de recherche qui nous semble judicieuse est de considérer la consommation du carburant et les émissions polluantes comme des coûts engendrés par le port et les navires pour relever les défis du réchauffement climatique et la forte dépendance des combustibles fossiles.

Une autre direction de recherche possible concerne la mise en évidence de l'influence de certains paramètres clés de nos modèles sur la qualité des solutions produites, à savoir le nombre de stocks par hangar et leur capacité.

En dernier lieu, vu que le domaine du transport maritime est difficile à prévoir et plusieurs perturbations peuvent se produire, nous avons l'intention de tester la réactivité de nos modèles selon une approche d'horizon glissant pour voir à quel point nos modèles sont capables de mettre à jour rapidement les plans de départ en cas d'événements imprévus.

Appendix C

Links to datasets

Chapter 3

<https://data.mendeley.com/datasets/3cts6wkn4f/1>

Chapter 4

<https://data.mendeley.com/datasets/9b3kdwwkvv/1>

Chapter 5

<https://data.mendeley.com/datasets/69dmgvvyh6/1>

Bibliography

- Abou Kasm, O., Diabat, A., & Bierlaire, M. (2021). Vessel scheduling with pilotage and tugging considerations. *Transportation Research Part E: Logistics and Transportation Review*, 148, 102231. <https://doi.org/10.1016/j.tre.2021.102231>
- Ago, M., Nishi, T., & Konishi, M. (2007). Simultaneous Optimization of Storage Allocation and Routing Problems for Belt-conveyor Transportation. *Journal of Advanced Mechanical Design, Systems, and Manufacturing*, 1(2), 250–261. <https://doi.org/10.1299/jamdsm.1.250>
- Agra, A., & Oliveira, M. (2018). MIP approaches for the integrated berth allocation and quay crane assignment and scheduling problem. *European Journal of Operational Research*, 264(1), 138–148. <https://doi.org/10.1016/j.ejor.2017.05.040>
- Al-Hammadi, J., & Diabat, A. (2017). An integrated berth allocation and yard assignment problem for bulk ports: Formulation and case study. *RAIRO - Operations Research*, 51(1), 267–284. <https://doi.org/10.1051/ro/2015048>
- Azzamouri, A., Bara, N., Elfirdoussi, S., Essaadi, I., Fontane, F., & Giard, V. (2020). DSS approach for heterogeneous parallel machines scheduling considering proximate supply chain constraints. *International Journal of Production Research*, 58(18), 5502–5520. <https://doi.org/10.1080/00207543.2019.1661539>
- Azzamouri, A., Essaadi, I., Elfirdoussi, S., & Giard, V. (2019). Interactive Scheduling Decision Support System a Case Study for Fertilizer Production on Supply Chain. In *ICT for a Better Life and a Better World: The Impact of Information and Communication Technologies on Organizations and Society* (pp. 131–146). Springer International Publishing. https://doi.org/10.1007/978-3-030-10737-6_9
- Babu, S. A. K. I., Pratap, S., Lahoti, G., Fernandes, K. J., Tiwari, M. K., Mount, M., & Xiong, Y. (2015). Minimizing delay of ships in bulk terminals by simultaneous ship scheduling, stockyard planning and train scheduling. *Maritime Economics & Logistics*, 17(4), 464–492. <https://doi.org/10.1057/mel.2014.20>
- Bara, N., Gautier, F., & Giard, V. (2021). An economic evaluation of operational decisions – an application in scheduling evaluation in fertilizer plants. *Production Planning & Control*, 32(9), 699–714. <https://doi.org/10.1080/09537287.2020.1751891>
- Barros, V. H., Costa, T. S., Oliveira, A. C. M., & Lorena, L. A. N. (2011). Model and heuristic for berth allocation in tidal bulk ports with stock level constraints. *Computers & Industrial Engineering*, 60(4), 606–613. <https://doi.org/10.1016/j.cie.2010.12.018>

- Bektaş, T., Ehmke, J. F., Psaraftis, H. N., & Puchinger, J. (2019). The role of operational research in green freight transportation. *European Journal of Operational Research*, 274(3), 807–823. <https://doi.org/10.1016/j.ejor.2018.06.001>
- Berg, J. P. van den, & Zijm, W. H. M. (1999). Models for warehouse management: Classification and examples. *International Journal of Production Economics*, 59(1–3), 519–528. [https://doi.org/10.1016/S0925-5273\(98\)00114-5](https://doi.org/10.1016/S0925-5273(98)00114-5)
- Bierwirth, C., & Meisel, F. (2010). A survey of berth allocation and quay crane scheduling problems in container terminals. *European Journal of Operational Research*, 202(3), 615–627. <https://doi.org/10.1016/j.ejor.2009.05.031>
- Bierwirth, C., & Meisel, F. (2015). A follow-up survey of berth allocation and quay crane scheduling problems in container terminals. *European Journal of Operational Research*, 244(3), 675–689. <https://doi.org/10.1016/j.ejor.2014.12.030>
- Boland, N., Gulczynski, D., & Savelsbergh, M. (2012). A stockyard planning problem. *EURO Journal on Transportation and Logistics*, 1(3), 197–236. <https://doi.org/10.1007/s13676-012-0011-z>
- Carlo, H. J., Vis, I. F. A., & Roodbergen, K. J. (2014). Transport operations in container terminals: Literature overview, trends, research directions and classification scheme. *European Journal of Operational Research*, 236(1), 1–13. <https://doi.org/10.1016/j.ejor.2013.11.023>
- Carlo, H. J., Vis, I. F. A., & Roodbergen, K. J. (2015). Seaside operations in container terminals: Literature overview, trends, and research directions. *Flexible Services and Manufacturing Journal*, 27(2–3), 224–262. <https://doi.org/10.1007/s10696-013-9178-3>
- Chang, D., Jiang, Z., Yan, W., & He, J. (2010). Integrating berth allocation and quay crane assignments. *Transportation Research Part E: Logistics and Transportation Review*, 46(6), 975–990. <https://doi.org/10.1016/j.tre.2010.05.008>
- Chargui, K., Zouadi, T., El Fallahi, A., Reghioui, M., & Aouam, T. (2021). Berth and quay crane allocation and scheduling with worker performance variability and yard truck deployment in container terminals. *Transportation Research Part E: Logistics and Transportation Review*, 154, 102449. <https://doi.org/10.1016/j.tre.2021.102449>
- Cheimanoff, N., Fontane, F., Kitri, M. N., & Tchernev, N. (2021). A reduced VNS based approach for the dynamic continuous berth allocation problem in bulk terminals with tidal constraints. *Expert Systems with Applications*, 168, 114215. <https://doi.org/10.1016/j.eswa.2020.114215>

- Chen, L., & Lu, Z. (2012). The storage location assignment problem for outbound containers in a maritime terminal. *International Journal of Production Economics*, 135(1), 73–80. <https://doi.org/10.1016/j.ijpe.2010.09.019>
- Cordeau, J.-F., Laporte, G., Legato, P., & Moccia, L. (2005). Models and Tabu Search Heuristics for the Berth-Allocation Problem. *Transportation Science*, 39(4), 526–538. <https://doi.org/10.1287/trsc.1050.0120>
- Correcher, J. F., Alvarez-Valdes, R., & Tamarit, J. M. (2019). New exact methods for the time-invariant berth allocation and quay crane assignment problem. *European Journal of Operational Research*, 275(1), 80–92. <https://doi.org/10.1016/j.ejor.2018.11.007>
- Correcher, J. F., Van den Bossche, T., Alvarez-Valdes, R., & Vanden Berghe, G. (2019). The berth allocation problem in terminals with irregular layouts. *European Journal of Operational Research*, 272(3), 1096–1108. <https://doi.org/10.1016/j.ejor.2018.07.019>
- Correcher, J. F. (2019). *Models and algorithms for berth allocation problems in port terminals* [Doctoral dissertation, University of Valencia].
- Corry, P., & Bierwirth, C. (2019). The Berth Allocation Problem with Channel Restrictions. *Transportation Science*, trsc.2018.0865. <https://doi.org/10.1287/trsc.2018.0865>
- Dadashi, A., Dulebenets, M. A., Golias, M. M., & Sheikholeslami, A. (2017). A novel continuous berth scheduling model at multiple marine container terminals with tidal considerations. *Maritime Business Review*. <https://doi.org/10.1108/MABR-02-2017-0010>
- De, A., Pratap, S., Kumar, A., & Tiwari, M. K. (2020). A hybrid dynamic berth allocation planning problem with fuel costs considerations for container terminal port using chemical reaction optimization approach. *Annals of Operations Research*, 290(1–2), 783–811. <https://doi.org/10.1007/s10479-018-3070-1>
- de Andrade, J. L. M., & Menezes, G. C. (2021). An Integrated Planning, Scheduling, Yard Allocation and Berth Allocation Problem in Bulk Ports: Model and Heuristics. In M. Mes, E. Lalla-Ruiz, & S. Voß (Eds.), *Computational Logistics* (Vol. 13004, pp. 3–20). Springer International Publishing. https://doi.org/10.1007/978-3-030-87672-2_1
- de León, A. D., Lalla-Ruiz, E., Melián-Batista, B., & Marcos Moreno-Vega, J. (2017). A Machine Learning-based system for berth scheduling at bulk terminals. *Expert Systems with Applications*, 87, 170–182. <https://doi.org/10.1016/j.eswa.2017.06.010>
- Dolk, D. R., & Kottemann, J. E. (1993). Model integration and a theory of models. *Decision Support Systems*, 9(1), 51–63. [https://doi.org/10.1016/0167-9236\(93\)90022-U](https://doi.org/10.1016/0167-9236(93)90022-U)
- Du, Y., Chen, Q., Lam, J. S. L., Xu, Y., & Cao, J. X. (2015). Modeling the Impacts of Tides and the Virtual Arrival Policy in Berth Allocation. *Transportation Science*, 19. <https://doi.org/10.1287/trsc.2014.0568>

- Du, Y., Chen, Q., Quan, X., Long, L., & Fung, R. Y. K. (2011). Berth allocation considering fuel consumption and vessel emissions. *Transportation Research Part E: Logistics and Transportation Review*, 47(6), 1021–1037. <https://doi.org/10.1016/j.tre.2011.05.011>
- Elwany, M. H., Ali, I., & Abouelseoud, Y. (2013). A heuristics-based solution to the continuous berth allocation and crane assignment problem. *Alexandria Engineering Journal*, 52(4), 671–677. <https://doi.org/10.1016/j.aej.2013.09.001>
- Ernst, A. T., Oğuz, C., Singh, G., & Taherkhani, G. (2017). Mathematical models for the berth allocation problem in dry bulk terminals. *Journal of Scheduling*, 20(5), 459–473. <https://doi.org/10.1007/s10951-017-0510-8>
- Fatemi-Anaraki, S., Tavakkoli-Moghaddam, R., Abdolhamidi, D., & Vahedi-Nouri, B. (2020). Simultaneous waterway scheduling, berth allocation, and quay crane assignment: A novel matheuristic approach. *International Journal of Production Research*, 1–18. <https://doi.org/10.1080/00207543.2020.1845412>
- Frojan, P., Correcher, J. F., Alvarez-Valdes, R., Koulouris, G., & Tamarit, J. M. (2015). The continuous Berth Allocation Problem in a container terminal with multiple quays. *Expert Systems with Applications*, 42(21), 7356–7366. <https://doi.org/10.1016/j.eswa.2015.05.018>
- Galle, V. (2018). *Optimization Models and Methods for Storage Yard Operations in Maritime Container Terminals*. [Doctoral dissertation, Massachusetts Institute of Technology].
- Geoffrion, A. M. (1999). Structured Modeling: Survey and Future Research Directions. *ITORMS: Interactive Transactions of Operations Research and Management Science*, 1(3). <https://www.anderson.ucla.edu/faculty/art.geoffrion/home/csts/index.htm>
- Gharehgozli, A. H., Roy, D., & de Koster, R. (2016). Sea container terminals: New technologies and OR models. *Maritime Economics & Logistics*, 18(2), 103–140. <https://doi.org/10.1057/mel.2015.3>
- Golias, M., Boile, M., Theofanis, S., & Efstathiou, C. (2010). The Berth-Scheduling Problem: Maximizing Berth Productivity and Minimizing Fuel Consumption and Emissions Production. *Transportation Research Record: Journal of the Transportation Research Board*, 2166(1), 20–27. <https://doi.org/10.3141/2166-03>
- Grubisic, N., Krljan, T., & Maglic, L. (2020). The Optimization Process for Seaside Operations at Medium-Sized Container Terminals with a Multi-Quay Layout. *Journal of Marine Science and Engineering*, 8(11), 891. <https://doi.org/10.3390/jmse8110891>
- Gu, J., Goetschalckx, M., & McGinnis, L. F. (2007). Research on warehouse operation: A comprehensive review. *European Journal of Operational Research*, 177(1), 1–21. <https://doi.org/10.1016/j.ejor.2006.02.025>

- Günther, H.-O., & Kim, K.-H. (2006). Container terminals and terminal operations. *OR Spectrum*, 28(4), 437–445. <https://doi.org/10.1007/s00291-006-0059-y>
- Guo, L., Wang, J., & Zheng, J. (2021). Berth allocation problem with uncertain vessel handling times considering weather conditions. *Computers & Industrial Engineering*, 158, 107417. <https://doi.org/10.1016/j.cie.2021.107417>
- Guo, W., Ji, M., & Zhu, H. (2021). Multi-Period Coordinated Optimization on Berth Allocation and Yard Assignment in Container Terminals Based on Truck Route. *IEEE Access*, 9, 83124–83136. <https://doi.org/10.1109/ACCESS.2021.3086185>
- Han, X., Gong, X., & Jo, J. (2015). A new continuous berth allocation and quay crane assignment model in container terminal. *Computers & Industrial Engineering*, 89, 15–22. <https://doi.org/10.1016/j.cie.2015.04.033>
- He, J. (2016). Berth allocation and quay crane assignment in a container terminal for the trade-off between time-saving and energy-saving. *Advanced Engineering Informatics*, 30(3), 390–405. <https://doi.org/10.1016/j.aei.2016.04.006>
- Hendriks, M. P. M., Lefeber, E., & Udding, J. T. (2013). Simultaneous berth allocation and yard planning at tactical level. *OR Spectrum*, 35(2), 441–456. <https://doi.org/10.1007/s00291-012-0305-4>
- Hsu, H.-P. (2016). A HPSO for solving dynamic and discrete berth allocation problem and dynamic quay crane assignment problem simultaneously. *Swarm and Evolutionary Computation*, 27, 156–168. <https://doi.org/10.1016/j.swevo.2015.11.002>
- Imai, A., Chen, H. C., Nishimura, E., & Papadimitriou, S. (2008). The simultaneous berth and quay crane allocation problem. *Transportation Research Part E: Logistics and Transportation Review*, 44(5), 900–920. <https://doi.org/10.1016/j.tre.2007.03.003>
- Imai, A., Nagaiwa, K., & Tat, C. W. (1997). Efficient planning of berth allocation for container terminals in Asia. *Journal of Advanced Transportation*, 31(1), 75–94. <https://doi.org/10.1002/atr.5670310107>
- Imai, A., Nishimura, E., & Papadimitriou, S. (2001). The dynamic berth allocation problem for a container port. *Transportation Research Part B: Methodological*, 35(4), 401–417. [https://doi.org/10.1016/S0191-2615\(99\)00057-0](https://doi.org/10.1016/S0191-2615(99)00057-0)
- Iris, Ç., Pacino, D., Ropke, S., & Larsen, A. (2015). Integrated Berth Allocation and Quay Crane Assignment Problem: Set partitioning models and computational results. *Transportation Research Part E: Logistics and Transportation Review*, 81, 75–97. <https://doi.org/10.1016/j.tre.2015.06.008>
- Karakas, S., Kirmizi, M., & Kocaoglu, B. (2021). Yard block assignment, internal truck operations, and berth allocation in container terminals: Introducing carbon-footprint

- minimisation objectives. *Maritime Economics & Logistics*.
<https://doi.org/10.1057/s41278-021-00186-7>
- Karam, A., & Eltawil, A. B. (2016). Functional integration approach for the berth allocation, quay crane assignment and specific quay crane assignment problems. *Computers & Industrial Engineering*, *102*, 458–466. <https://doi.org/10.1016/j.cie.2016.04.006>
- Kathuria, R., Joshi, M. P., & Porth, S. J. (2007). Organizational alignment and performance: Past, present and future. *Management Decision*, *45*(3), 503–517. <https://doi.org/10.1108/00251740710745106>
- Kim, K. H. (2005). Models and Methods for Operations in Port Container Terminals. In A. Langevin & D. Riopel (Eds.), *Logistics Systems: Design and Optimization* (pp. 213–243). Springer US. https://doi.org/10.1007/0-387-24977-X_7
- Krimi, I., Benmansour, R., Cadi, A. A. E., Deshayes, L., Duvivier, D., & Elhachemi, N. (2019). A rolling horizon approach for the integrated multi-quays berth allocation and crane assignment problem for bulk ports. *International Journal of Industrial Engineering Computations*, *577*–591. <https://doi.org/10.5267/j.ijiec.2019.4.003>
- Krimi, I., Todosijević, R., Benmansour, R., Ratli, M., El Cadi, A. A., & Aloullal, A. (2020). Modelling and solving the multi-quays berth allocation and crane assignment problem with availability constraints. *Journal of Global Optimization*, *78*(2), 349–373. <https://doi.org/10.1007/s10898-020-00884-1>
- Lalla-Ruiz, E., Expósito-Izquierdo, C., Melián-Batista, B., & Moreno-Vega, J. M. (2016). A Set-Partitioning-based model for the Berth Allocation Problem under Time-Dependent Limitations. *European Journal of Operational Research*, *250*(3), 1001–1012. <https://doi.org/10.1016/j.ejor.2015.10.021>
- Leal Gomes Leite, J. M., Arruda, E. F., Bahiense, L., & Marujo, L. G. (2020). Modeling the integrated mine-to-client supply chain: A survey. *International Journal of Mining, Reclamation and Environment*, *34*(4), 247–293. <https://doi.org/10.1080/17480930.2019.1579693>
- Li, C. L., & Pang, K. W. (2011). An integrated model for ship routing and berth allocation. *International Journal of Shipping and Transport Logistics*, *3*(3), 245. <https://doi.org/10.1504/IJSTL.2011.040797>
- Li, C.-L., Cai, X., & Lee, C.-Y. (1998). Scheduling with multiple-job-on-one-processor pattern. *IIE Transactions*, *30*(5), 433–445. <https://doi.org/10.1080/07408179808966484>
- Li, M. K., & Yip, T. L. (2013). Joint planning for yard storage space and home berths in container terminals. *International Journal of Production Research*, *51*(10), 3143–3155. <https://doi.org/10.1080/00207543.2012.760852>

- Li, Y., Chu, F., Zheng, F., & Liu, M. (2020). A Bi-Objective Optimization for Integrated Berth Allocation and Quay Crane Assignment With Preventive Maintenance Activities. *IEEE Transactions on Intelligent Transportation Systems*, 1–18. <https://doi.org/10.1109/TITS.2020.3023701>
- Lim, A. (1998). The berth planning problem. *Operations Research Letters*, 22(2), 105–110. [https://doi.org/10.1016/S0167-6377\(98\)00010-8](https://doi.org/10.1016/S0167-6377(98)00010-8)
- Linkosaari, T. (2014). A Functional Mathematical Optimization Algorithm for the Integration of the Tactical Berth, Quay Crane and Vehicle Scheduling. In *Chapters from the Proceedings of the Hamburg International Conference of Logistics (HICL)* (Vol. 19, pp. 85–97). Hamburg University of Technology (TUHH), Institute of Business Logistics and General Management. <https://ideas.repec.org/h/zbw/hiclch/209226.html>
- Liu, B., Li, Z.-C., Sheng, D., & Wang, Y. (2021). Integrated planning of berth allocation and vessel sequencing in a seaport with one-way navigation channel. *Transportation Research Part B: Methodological*, 143, 23–47. <https://doi.org/10.1016/j.trb.2020.10.010>
- Liu, B., Li, Z.-C., Wang, Y., & Sheng, D. (2021). Short-term berth planning and ship scheduling for a busy seaport with channel restrictions. *Transportation Research Part E: Logistics and Transportation Review*, 154, 102467. <https://doi.org/10.1016/j.tre.2021.102467>
- Liu, C. (2020). Iterative heuristic for simultaneous allocations of berths, quay cranes, and yards under practical situations. *Transportation Research Part E: Logistics and Transportation Review*, 133, 101814. <https://doi.org/10.1016/j.tre.2019.11.008>
- Lorenzoni, L. L., Ahonen, H., & Alvarenga, A. G. de. (2006). A multi-mode resource-constrained scheduling problem in the context of port operations. *Computers & Industrial Engineering*, 50(1–2), 55–65. <https://doi.org/10.1016/j.cie.2005.11.001>
- Lujan, E., Vergara, E., Rodriguez-Melquiades, J., Jiménez-Carrión, M., Sabino-Escobar, C., & Gutierrez, F. (2021). A Fuzzy Optimization Model for the Berth Allocation Problem and Quay Crane Allocation Problem (BAP + QCAP) with n Quays. *Journal of Marine Science and Engineering*, 9(2), 152. <https://doi.org/10.3390/jmse9020152>
- Malekahmadi, A., Alinaghian, M., Hejazi, S. R., & Assl Saidipour, M. A. (2020). Integrated continuous berth allocation and quay crane assignment and scheduling problem with time-dependent physical constraints in container terminals. *Computers & Industrial Engineering*, 147, 106672. <https://doi.org/10.1016/j.cie.2020.106672>
- Mazioli, F. C., Rosa, R. de A., Sagrilo, R. G. V., Vitorugo, L. R., & Neves, B. dos S. (2019). Assessment of the impact of Charter Party clauses and port's characteristics on the port's

- financial result. *Computers & Industrial Engineering*, 128, 70–90. <https://doi.org/10.1016/j.cie.2018.12.027>
- Meisel, F., & Bierwirth, C. (2009). Heuristics for the integration of crane productivity in the berth allocation problem. *Transportation Research Part E: Logistics and Transportation Review*, 45(1), 196–209. <https://doi.org/10.1016/j.tre.2008.03.001>
- Meisel, F., & Bierwirth, C. (2013). A Framework for Integrated Berth Allocation and Crane Operations Planning in Seaport Container Terminals. *Transportation Science*, 47(2), 131–147. <https://doi.org/10.1287/trsc.1120.0419>
- Menezes, G. C., Mateus, G. R., & Ravetti, M. G. (2016). A hierarchical approach to solve a production planning and scheduling problem in bulk cargo terminal. *Computers & Industrial Engineering*, 97, 1–14. <https://doi.org/10.1016/j.cie.2016.04.007>
- Menezes, G. C., Mateus, G. R., & Ravetti, M. G. (2017). A branch and price algorithm to solve the integrated production planning and scheduling in bulk ports. *European Journal of Operational Research*, 258(3), 926–937. <https://doi.org/10.1016/j.ejor.2016.08.073>
- Nicolaou, S. N. (1967). Berth Planning by Evaluation of Congestion and Cost. *Journal of the Waterways and Harbors Division*, 93(4), 107–132. <https://doi.org/10.1061/JWHEAU.0000522>
- Nishimura, E., Imai, A., & Papadimitriou, S. (2001). Berth allocation planning in the public berth system by genetic algorithms. *European Journal of Operational Research*, 131(2), 282–292. [https://doi.org/10.1016/S0377-2217\(00\)00128-4](https://doi.org/10.1016/S0377-2217(00)00128-4)
- Notteboom, T. E. (2006). The Time Factor in Liner Shipping Services. *Maritime Economics & Logistics*, 8(1), 19–39. <https://doi.org/10.1057/palgrave.mel.9100148>
- Nourmohammadzadeh, A., & Voß, S. (2020). A Pareto Simulated Annealing for the Integrated Problem of Berth and Quay Crane Scheduling at Maritime Container Terminals with Multiple Objectives and Stochastic Arrival Times of Vessels. In I. S. Kotsireas & P. M. Pardalos (Eds.), *Learning and Intelligent Optimization* (pp. 324–340). Springer International Publishing. https://doi.org/10.1007/978-3-030-53552-0_30
- Ouhaman, A. A., Benjelloun, K., Kenné, J. P., & Najid, N. (2020). The storage space allocation problem in a dry bulk terminal: A heuristic solution. *IFAC-PapersOnLine*, 53(2), 10822–10827. <https://doi.org/10.1016/j.ifacol.2020.12.2868>
- Park, Y.-M., & Kim, K. H. (2003). A scheduling method for Berth and Quay cranes. *OR Spectrum*, 25(1), 1–23. <https://doi.org/10.1007/s00291-002-0109-z>
- Peng, Y., Dong, M., Li, X., Liu, H., & Wang, W. (2021). Cooperative optimization of shore power allocation and berth allocation: A balance between cost and environmental benefit.

- Journal of Cleaner Production*, 279, 123816.
<https://doi.org/10.1016/j.jclepro.2020.123816>
- Pratap, S., Nayak, A., Kumar, A., Cheikhrouhou, N., & Tiwari, M. K. (2017). An integrated decision support system for berth and ship unloader allocation in bulk material handling port. *Computers & Industrial Engineering*, 106, 386–399.
<https://doi.org/10.1016/j.cie.2016.12.009>
- Prayogo, D. N., Hidayatno, A., & Komarudin. (2021). Bi-objective optimization model for integrated planning in container terminal operations. *IOP Conference Series: Materials Science and Engineering*, 1072(1), 012022. <https://doi.org/10.1088/1757-899X/1072/1/012022>
- Raa, B., Dullaert, W., & Schaeren, R. V. (2011). An enriched model for the integrated berth allocation and quay crane assignment problem. *Expert Systems with Applications*.
<https://doi.org/10.1016/j.eswa.2011.04.224>
- Reyes, J. J. R., Solano-Charris, E. L., & Montoya-Torres, J. R. (2019). The storage location assignment problem: A literature review. *International Journal of Industrial Engineering Computations*, 199–224. <https://doi.org/10.5267/j.ijiec.2018.8.001>
- Ribeiro, G. M., Mauri, G. R., Beluco, S. de C., Lorena, L. A. N., & Laporte, G. (2016). Berth allocation in an ore terminal with demurrage, despatch and maintenance. *Computers & Industrial Engineering*, 96, 8–15. <https://doi.org/10.1016/j.cie.2016.03.005>
- Robenek, T., Umang, N., Bierlaire, M., & Ropke, S. (2014). A branch-and-price algorithm to solve the integrated berth allocation and yard assignment problem in bulk ports. *European Journal of Operational Research*, 235(2), 399–411.
<https://doi.org/10.1016/j.ejor.2013.08.015>
- Rocha de Paula, M., Boland, N., Ernst, A. T., Mendes, A., & Savelsbergh, M. (2019). Throughput optimisation in a coal export system with multiple terminals and shared resources. *Computers & Industrial Engineering*, 134, 37–51.
<https://doi.org/10.1016/j.cie.2019.05.021>
- Rodrigues, F., & Agra, A. (2021). An exact robust approach for the integrated berth allocation and quay crane assignment problem under uncertain arrival times. *European Journal of Operational Research*, S037722172100206X. <https://doi.org/10.1016/j.ejor.2021.03.016>
- Ronen, D. (1993). Ship scheduling: The last decade. *European Journal of Operational Research*, 71(3), 325–333. [https://doi.org/10.1016/0377-2217\(93\)90343-L](https://doi.org/10.1016/0377-2217(93)90343-L)
- Sabria, F., & Daganzo, C. F. (1989). Approximate Expressions for Queueing Systems with Scheduled Arrivals and Established Service Order. *Transportation Science*, 23(3), 159–165. <https://www.jstor.org/stable/25768375>

- Savelsbergh, M., & Smith, O. (2015). Cargo assembly planning. *EURO Journal on Transportation and Logistics*, 4(3), 321–354. <https://doi.org/10.1007/s13676-014-0048-2>
- Schepler, X., Absi, N., Feillet, D., & Sanlaville, E. (2019). The stochastic discrete berth allocation problem. *EURO Journal on Transportation and Logistics*, 8(4), 363–396. <https://doi.org/10.1007/s13676-018-0128-9>
- Schepler, X., Balev, S., Michel, S., & Sanlaville, É. (2017). Global planning in a multi-terminal and multi-modal maritime container port. *Transportation Research Part E: Logistics and Transportation Review*, 100, 38–62. <https://doi.org/10.1016/j.tre.2016.12.002>
- Sheikholeslami, A., Mardani, M., Ayazi, E., & Arefkhani, H. (2019). A Dynamic and Discrete Berth Allocation Problem in Container Terminals Considering Tide Effects. *Iranian Journal of Science and Technology, Transactions of Civil Engineering*. <https://doi.org/10.1007/s40996-019-00239-1>
- Skaf, A., Lamrous, S., Hammoudan, Z., & Manier, M.-A. (2021a). Solving methods for the quay crane scheduling problem at port of Tripoli-Lebanon. *RAIRO - Operations Research*, 55(1), 115–133. <https://doi.org/10.1051/ro/2020135>
- Skaf, A., Lamrous, S., Hammoudan, Z., & Manier, M.-A. (2021b). Integrated quay crane and yard truck scheduling problem at port of Tripoli-Lebanon. *Computers & Industrial Engineering*, 159, 107448. <https://doi.org/10.1016/j.cie.2021.107448>
- Solis, A.O. (2001). Supply chain integration and coordination. *The Criterion*, 1–3.
- Stahlbock, R., & Voß, S. (2007). Operations research at container terminals: A literature update. *OR Spectrum*, 30(1), 1–52. <https://doi.org/10.1007/s00291-007-0100-9>
- Steenken, D., Voß, S., & Stahlbock, R. (2004). Container terminal operation and operations research—A classification and literature review. *OR Spectrum*, 26(1), 3–49. <https://doi.org/10.1007/s00291-003-0157-z>
- Sun, Q., Meng, Q., & Chou, M. C. (2021). Optimizing voyage charterparty (VCP) arrangement: Laytime negotiation and operations coordination. *European Journal of Operational Research*, 291(1), 263–270. <https://doi.org/10.1016/j.ejor.2020.09.032>
- Tan, C., & He, J. (2021). Integrated proactive and reactive strategies for sustainable berth allocation and quay crane assignment under uncertainty. *Annals of Operations Research*. <https://doi.org/10.1007/s10479-020-03891-3>
- Tang, L., Sun, D., & Liu, J. (2016). Integrated storage space allocation and ship scheduling problem in bulk cargo terminals. *IIE Transactions*, 48(5), 428–439. <https://doi.org/10.1080/0740817X.2015.1063791>

- Tang, M., Gong, D., Liu, S., & Zhang, H. (2016). Applying multi-phase particle swarm optimization to solve bulk cargo port scheduling problem. *Advances in Production Engineering & Management*, 11(4), 299–310. <https://doi.org/10.14743/apem2016.4.228>
- Tao, Y., & Lee, C.-Y. (2015). Joint planning of berth and yard allocation in transshipment terminals using multi-cluster stacking strategy. *Transportation Research Part E: Logistics and Transportation Review*, 83, 34–50. <https://doi.org/10.1016/j.tre.2015.08.005>
- Theofanis, S., Boile, M., & Golias, M. M. (2009). Container Terminal Berth Planning: Critical Review of Research Approaches and Practical Challenges. *Transportation Research Record: Journal of the Transportation Research Board*, 2100(1), 22–28. <https://doi.org/10.3141/2100-03>
- Tsoudis, G. N. (2015). *The Shipbroker's Working Knowledge: Dry Cargo Chartering in Practice*. AKAKIA Publications.
- Türkoğulları, Y. B., Taşkın, Z. C., Aras, N., & Altınel, İ. K. (2014). Optimal berth allocation and time-invariant quay crane assignment in container terminals. *European Journal of Operational Research*, 235(1), 88–101. <https://doi.org/10.1016/j.ejor.2013.10.015>
- Türkoğulları, Y. B., Taşkın, Z. C., Aras, N., & Altınel, İ. K. (2016). Optimal berth allocation, time-variant quay crane assignment and scheduling with crane setups in container terminals. *European Journal of Operational Research*, 254(3), 985–1001. <https://doi.org/10.1016/j.ejor.2016.04.022>
- Umang, N., Bierlaire, M., & Erera, A. L. (2017). Real-time management of berth allocation with stochastic arrival and handling times. *Journal of Scheduling*, 20(1), 67–83. <https://doi.org/10.1007/s10951-016-0480-2>
- Umang, N., Bierlaire, M., & Vacca, I. (2013). Exact and heuristic methods to solve the berth allocation problem in bulk ports. *Transportation Research Part E: Logistics and Transportation Review*, 54, 14–31. <https://doi.org/10.1016/j.tre.2013.03.003>
- UNCTAD (2020). *Review of Maritime Transport*. United Nations Conference on Trade and Development. https://unctad.org/system/files/official-document/rmt2020_en.pdf
- Unsal, O., & Oguz, C. (2019). An exact algorithm for integrated planning of operations in dry bulk terminals. *Transportation Research Part E: Logistics and Transportation Review*, 126, 103–121. <https://doi.org/10.1016/j.tre.2019.03.018>
- Ursavas, E., & Zhu, S. X. (2016). Optimal policies for the berth allocation problem under stochastic nature. *European Journal of Operational Research*, 255(2), 380–387. <https://doi.org/10.1016/j.ejor.2016.04.029>

- Venturini, G., Iris, Ç., Kontovas, C. A., & Larsen, A. (2017). The multi-port berth allocation problem with speed optimization and emission considerations. *Transportation Research Part D: Transport and Environment*, 54, 142–159. <https://doi.org/10.1016/j.trd.2017.05.002>
- Vis, I. F. A., & de Koster, R. (2003). Transshipment of containers at a container terminal: An overview. *European Journal of Operational Research*, 147(1), 1–16. [https://doi.org/10.1016/S0377-2217\(02\)00293-X](https://doi.org/10.1016/S0377-2217(02)00293-X)
- Wang, T., Du, Y., Fang, D., & Li, Z.-C. (2020). Berth Allocation and Quay Crane Assignment for the Trade-off Between Service Efficiency and Operating Cost Considering Carbon Emission Taxation. *Transportation Science*, 54(5), 1307–1331. <https://doi.org/10.1287/trsc.2019.0946>
- Xiang, X., & Liu, C. (2021). An expanded robust optimisation approach for the berth allocation problem considering uncertain operation time. *Omega*, 102444. <https://doi.org/10.1016/j.omega.2021.102444>
- Xu, D., Li, C.-L., & Leung, J. Y.-T. (2012). Berth allocation with time-dependent physical limitations on vessels. *European Journal of Operational Research*, 216(1), 47–56. <https://doi.org/10.1016/j.ejor.2011.07.012>
- Xu, Y., Xue, K., & Du, Y. (2018). Berth Scheduling Problem Considering Traffic Limitations in the Navigation Channel. *Sustainability*, 10(12), 4795. <https://doi.org/10.3390/su10124795>
- Yang, C., Wang, X., & Li, Z. (2012). An optimization approach for coupling problem of berth allocation and quay crane assignment in container terminal. *Computers & Industrial Engineering*, 63(1), 243–253. <https://doi.org/10.1016/j.cie.2012.03.004>
- Zhen, L. (2014). Storage allocation in transshipment hubs under uncertainties. *International Journal of Production Research*, 52(1), 72–88. <https://doi.org/10.1080/00207543.2013.828166>
- Zhen, L. (2015). Tactical berth allocation under uncertainty. *European Journal of Operational Research*, 247(3), 928–944. <https://doi.org/10.1016/j.ejor.2015.05.079>
- Zhen, L., Chew, E. P., & Lee, L. H. (2011). An Integrated Model for Berth Template and Yard Template Planning in Transshipment Hubs. *Transportation Science*, 45(4), 483–504. <https://doi.org/10.1287/trsc.1100.0364>
- Zhen, L., Liang, Z., Zhuge, D., Lee, L. H., & Chew, E. P. (2017). Daily berth planning in a tidal port with channel flow control. *Transportation Research Part B: Methodological*, 106, 193–217. <https://doi.org/10.1016/j.trb.2017.10.008>

- Zhen, L., Sun, Q., Zhang, W., Wang, K., & Yi, W. (2020). Column generation for low carbon berth allocation under uncertainty. *Journal of the Operational Research Society*, 1–16. <https://doi.org/10.1080/01605682.2020.1776168>
- Zheng, F., Li, Y., Chu, F., Liu, M., & Xu, Y. (2018). Integrated berth allocation and quay crane assignment with maintenance activities. *International Journal of Production Research*, 1–26. <https://doi.org/10.1080/00207543.2018.1539265>
- Zhou, P., & Kang, H. (2008). Study on Berth and Quay-crane Allocation under Stochastic Environments in Container Terminal. *Systems Engineering - Theory & Practice*, 28(1), 161–169. [https://doi.org/10.1016/S1874-8651\(09\)60001-6](https://doi.org/10.1016/S1874-8651(09)60001-6)