



HAL
open science

The macroeconomics of degrowth: conditions, Choices, and Implications

Antoine Monserand

► **To cite this version:**

Antoine Monserand. The macroeconomics of degrowth: conditions, Choices, and Implications. Sociology. Université Paris-Nord - Paris XIII, 2022. English. NNT: 2022PA131005 . tel-03921258

HAL Id: tel-03921258

<https://theses.hal.science/tel-03921258>

Submitted on 3 Jan 2023

HAL is a multi-disciplinary open access archive for the deposit and dissemination of scientific research documents, whether they are published or not. The documents may come from teaching and research institutions in France or abroad, or from public or private research centers.

L'archive ouverte pluridisciplinaire **HAL**, est destinée au dépôt et à la diffusion de documents scientifiques de niveau recherche, publiés ou non, émanant des établissements d'enseignement et de recherche français ou étrangers, des laboratoires publics ou privés.

Université Sorbonne Paris Nord

Doctoral School **Erasme**

University Department **Centre d'Économie de l'Université Paris Nord**

Thesis presented by **Antoine Monserand**

Defended on **June 8, 2022**

In order to become Doctor from Université Sorbonne Paris Nord

Academic Field **Economics**

The macroeconomics of degrowth Conditions, choices, and implications.

Thesis supervised by Marc LAVOIE Supervisor
Christophe GOUPIL Co-Supervisor

Committee members

<i>Referees</i>	Éric BERR	Associate Professor at Université de Bordeaux	
	Peter VICTOR	Professor emeritus at York University (Canada)	Not in jury
<i>Examiners</i>	Florence JANY-CATRICE	Professor at Université de Lille	Committee President
	Hélène TORDJMAN	Associate Professor at Université Sorbonne Paris Nord	
	Robert GUTTMANN	Professor at Hofstra University (USA), Université Sorbonne Paris Nord	
<i>Supervisors</i>	Marc LAVOIE	Professor emeritus at University of Ottawa, Université Sorbonne Paris Nord	
	Christophe GOUPIL	Professor at Université de Paris	

COLOPHON

Doctoral dissertation entitled “The macroeconomics of degrowth”, written by Antoine MONSERAND, completed on June 14, 2022, typeset with the document preparation system \LaTeX and the `yathesis` class dedicated to theses prepared in France.

Université Sorbonne Paris Nord

Doctoral School **Erasme**

University Department **Centre d'Économie de l'Université Paris Nord**

Thesis presented by **Antoine Monserand**

Defended on **June 8, 2022**

In order to become Doctor from Université Sorbonne Paris Nord

Academic Field **Economics**

The macroeconomics of degrowth

Conditions, choices, and implications.

Thesis supervised by Marc LAVOIE Supervisor
Christophe GOUPIL Co-Supervisor

Committee members

<i>Referees</i>	Éric BERR	Associate Professor at Université de Bordeaux	
	Peter VICTOR	Professor emeritus at York University (Canada)	Not in jury
<i>Examiners</i>	Florence JANY-CATRICE	Professor at Université de Lille	Committee President
	Hélène TORDJMAN	Associate Professor at Université Sorbonne Paris Nord	
	Robert GUTTMANN	Professor at Hofstra University (USA), Université Sorbonne Paris Nord	
<i>Supervisors</i>	Marc LAVOIE	Professor emeritus at University of Ottawa, Université Sorbonne Paris Nord	
	Christophe GOUPIL	Professor at Université de Paris	

Université Sorbonne Paris Nord

École doctorale **Erasmus**

Unité de recherche **Centre d'Économie de l'Université Paris Nord**

Thèse présentée par **Antoine Monserand**

Soutenue le **8 juin 2022**

En vue de l'obtention du grade de docteur de l'Université Sorbonne Paris Nord

Discipline **Sciences économiques**

Macroéconomie de la décroissance Conditions, choix, implications.

Thèse dirigée par Marc LAVOIE directeur
Christophe GOUPIL co-directeur

Composition du jury

<i>Rapporteurs</i>	Éric BERR	MCF HDR à l'Université de Bordeaux	
	Peter VICTOR	professeur émérite à York University (Canada)	hors jury
<i>Examineurs</i>	Florence JANY-CATRICE	professeure à l'Université de Lille	présidente du jury
	Hélène TORDJMAN	MCF HDR à l'Université Sorbonne Paris Nord	
	Robert GUTTMANN	professeur à Hofstra University (USA), Université Sorbonne Paris Nord	
<i>Directeurs de thèse</i>	Marc LAVOIE	professeur émérite à University of Ottawa, Université Sorbonne Paris Nord	
	Christophe GOUPIL	professeur à l'Université de Paris	

Université Sorbonne Paris Nord neither endorses nor censures authors' opinions expressed in the theses: these opinions must be considered to be those of their authors.

Keywords: degrowth, ecological macroeconomics, post-keynesian economics, transition, inequality, stock-flow consistent modelling

Mots clés: décroissance, macroéconomie écologique, économie post-keynésienne, transition, inégalités, modélisation stock-flux cohérente

This thesis has been prepared at

Centre d'Économie de l'Université Paris Nord

99 avenue Jean-Baptiste Clément

93430 Villetaneuse

France

Web Site <https://cepn.univ-paris13.fr/>

*À mes grands-parents, devant qui j'aurais aimé pouvoir présenter ce travail.
Vous me manquez.*

*À mes parents, qui ont tout donné pour l'épanouissement de leurs enfants et m'ont
ainsi permis de tracer ma propre voie. Je vous aime.*

À Sarah, avec qui la vie est plus joyeuse, plus belle et plus heureuse. <3

*À Gauthier et Zhao Xia, Bertrand et Amélie, Valentine et Coralie.
Longue vie à vos amours !*

*À Hugo, Lucas et Romi. Je vous souhaite d'assister et de participer au
réenchantement du monde, plutôt qu'à son réchauffement.*

*À toutes les victimes, directes et indirectes, humaines et non-humaines, de toutes
les formes de productivisme et de consumérisme, de science sans conscience et de
technique sans esprit critique, de capitalisme et d'exploitation, et aux victimes des
extractivismes et des impérialismes qui en découlent.
Que les luttes continuent !*

*Enfin à l'infime minorité de personnes qui défend, perpétue et tire le plus profit du
système actuel, à ceux pour qui tout n'est jamais assez, et aux contremaîtres qui les
soutiennent. Profitez, vos privilèges ne dureront pas éternellement.*

My intuition is that degrowth would begin by intensifying inequalities, and would lead us straight to something resembling a civil war. I don't understand how some smart people, with ecological sensitivity, have not understood this. Degrowth, either we suffer it, and it is a catastrophe, or we cause it, and it is worse. Therefore, it is excluded. For reasons of public order.

Michel Rocard (French Prime Minister 1988-1991)

Without growth, incomes do not increase, and thus there is no improvement in living standards. It is not desirable, therefore we do not teach it in economics.

Anne-Laure Delatte (Economist, Former Deputy Director at CEPII)

**The macroeconomics of degrowth
Conditions, choices, and implications.****Abstract**

This thesis investigates an ecological and social paradigm, degrowth, from the perspective of macroeconomics. The decrease in production and consumption that a degrowth transition represents requires anticipating and analysing its potential macroeconomic consequences, in order to prevent any detrimental effects. For this, the thesis mobilises post-Keynesian economic theory. The first chapter looks at issues of macroeconomic stability, rate of profit, and changes in income distribution. The second chapter shows how ecological investments and changes in lifestyles and consumption patterns can be complementary, and analyses the macroeconomic consequences of these transformations. The third chapter looks at the phenomenon of accelerated obsolescence and establishes its link with interpersonal inequalities between workers and capitalists. Finally, the fourth chapter examines the possibility of guaranteeing the financing of a pay-as-you-go pension system, of social protection in general and of public services in a degrowing economy. This thesis demonstrates that degrowth can be environmentally, socially, and economically beneficial. These results run counter to the assertions that degrowth can only produce economic and social catastrophe.

Keywords: degrowth, ecological macroeconomics, post-keynesian economics, transition, inequality, stock-flow consistent modelling

**Macroéconomie de la décroissance
Conditions, choix, implications.****Résumé**

Cette thèse aborde un paradigme écologique et social, la décroissance, sous l'angle de la macroéconomie. La diminution de la production et de la consommation qu'une transition de décroissance représente nécessite d'anticiper et d'analyser ses potentielles conséquences macroéconomiques, afin d'en prévenir les effets délétères. Pour cela, la thèse mobilise la théorie économique post-keynésienne. Le premier chapitre se penche sur les questions de stabilité macroéconomique, de taux de profit, et de modifications dans la répartition des revenus. Le second chapitre montre comment investissements écologiques et changements dans les modes de vie et de consommation peuvent être complémentaires, et analyse les conséquences macroéconomiques de ces transformations. Le troisième chapitre se penche sur le phénomène d'obsolescence accélérée et établit un lien avec les inégalités interpersonnelles entre travailleurs et capitalistes. Le quatrième chapitre examine la possibilité de garantir le financement d'un système de retraites par répartition, de la protection sociale en général et des services publics dans une économie en décroissance. Cette thèse démontre que la décroissance peut être bénéfique sur les plans environnemental, social et économique. Elle donne ainsi tort aux assertions selon lesquelles la décroissance ne peut mener qu'à des catastrophes économiques et sociales.

Mots clés : décroissance, macroéconomie écologique, économie post-keynésienne, transition, inégalités, modélisation stock-flux cohérente

Centre d'Économie de l'Université Paris Nord

99 avenue Jean-Baptiste Clément – 93430 Villetaneuse – France

Remerciements

Mes années de doctorat resteront dans ma mémoire comme une période pleine de rencontres. Seul, je n'aurais pas réussi à mener ce travail jusqu'au bout. Heureusement, j'ai été entouré de personnes bienveillantes, encourageantes et passionnantes. Je remercie chaleureusement :

Marc Lavoie, mon directeur de thèse, pour avoir soutenu mon projet de thèse en quelque sorte hétérodoxe parmi les hétérodoxes, pour l'entière liberté qu'il m'a laissée dans le choix des sujets traités, pour ses conseils toujours précis et avisés, pour sa disponibilité, pour toutes les suggestions de lecture qu'il m'a envoyées, et pour son attitude bienveillante et amicale.

Christophe Goupil, mon codirecteur de thèse, que j'ai moins sollicité du fait de l'orientation finalement purement macroéconomique de ma thèse, mais avec qui j'apprécie toujours de discuter de physique, d'économie, et de bien d'autres sujets notamment pendant les séjours aux Houches !

Les membres de mon comité de suivi : Alexis Jeamet, Olivier Allain et Jacques Mazier, pour leur soutien amical et leurs précieux conseils notamment en termes d'organisation et de planification du travail.

Les membres de mon jury de soutenance : Eric Berr, Robert Guttman, Florence Jany-Catrice et Hélène Tordjman, pour avoir accepté d'examiner mon travail malgré un envoi pour le moins tardif du manuscrit.

I am deeply grateful to Peter Victor for agreeing to be an examiner for this thesis.

I extend my warm thanks to Yannis Dafermos and Maria Nikolaidi for agreeing to receive me at their universities in Bristol and London as a visiting student. Although they did not know me before I arrived, Yannis and Maria were immediately very friendly and devoted a lot of time to me and to my research.

Je remercie aussi vivement :

Catherine Mathieu, Henri Sterdyniak et Dany Lang, qui m'ont guidé et épaulé dans la phase d'élaboration de mon projet de thèse et dans la recherche de financement.

Toutes les personnes qui m'ont apporté de précieux conseils lors de conférences (trop nombreuses pour être nommées ici) et qui ont relu attentivement des parties

de mon travail : Olivier Allain, Jeffrey Althouse, Sarah Bebawy, Rudy Bouguelli, Louison Cahen-Fourot, Quentin Couix, Valeria Jimenez et Birte Strunk.

Tout le personnel administratif et non-administratif de l'UFR SEG, du CEPN, de l'école doctorale Erasme et du Bureau de la Recherche et des Etudes Doctorales. J'adresse des remerciements spéciaux à Corinne Gauthier, Jean-Pierre Kokossou, Maryline Odadan, Viviane Birard et Fatiha Necibi, qui ont grandement participé à la bonne ambiance de travail sur le site de Villetaneuse.

Les nombreux membres du CEPN qui ont à cœur de considérer les doctorantes et doctorants comme des collègues à part entière. Je n'aurais pas autant apprécié ces années si le cadre de travail n'avait pas été aussi agréable et intellectuellement stimulant.

Les membres du département CLES de l'Ecole Centrale de Lyon, en particulier Laure Flandrin, Nicolas Hourcade et Sylvie Mira-Bonnardel pour leur accueil chaleureux lors de mon année à leurs côtés en tant qu'ATER.

Sylvie Collet, pour avoir organisé, malgré les difficultés budgétaires, un merveilleux stage intitulé « Du sport pendant le doctorat ». En plus d'avoir encouragé les doctorants à prendre soin de soi par le sport pendant les années parfois difficiles de la thèse, Sylvie et les intervenants nous ont appris des techniques de relaxation et de gestion du stress qui m'auront été bien utiles.

Denis Bitouzé, pour la formation à l'utilisation du logiciel LaTeX qui facilite l'écriture de documents scientifiques mais, disons-le, dont l'usage n'est pas de tout repos et m'a parfois fait perdre quelques cheveux. Merci Denis pour la création de la classe yathesis et pour l'aide rapide et rassurante que tu m'as apportée lorsque je t'ai contacté, peu de temps avant mon rendu de thèse, inquiet et désespéré par le nombre de messages d'erreurs renvoyés par TeX Studio.

Les étudiants de Paris 13 et de Centrale Lyon, à qui j'ai eu le plaisir d'enseigner, pour m'avoir encouragé et donné envie de poursuivre dans la voie de l'enseignement et de la recherche. J'ai une pensée spéciale pour Vadim Richon, brillant étudiant empli de curiosité avec qui je suis heureux d'avoir lié une amitié.

Enfin, je tiens à remercier tout particulièrement les merveilleuses personnes que j'ai la chance d'avoir autour de moi :

Sarah, avec qui je partage des moments de bonheur tous les jours. Merci de m'avoir quasiment sauvé la vie en janvier 2019 – il aurait été dommage de ne pas finir cette thèse à cause d'un accident de tamango ! Merci pour ton soutien, tes encouragements, tes taquineries, la traduction des épigraphes et de plusieurs passages d'introduction et de conclusion, la trouvaille du sujet de bac 2022 et l'incitation à le mettre en épigraphe. Merci aussi à Ghada pour son hospitalité, ses bons petits plats et ses encouragements.

Mes parents, frères et sœur, belles-sœurs, neveux et nièce : merci de m'avoir entouré de votre amour.

Les doctorantes et doctorants du CEPN, cœur battant du laboratoire, pour la camaraderie, l'entraide et la bonne humeur - c'était un plaisir de vous retrouver au quotidien : Rudy, Jeff, Simona, Hector, Léo, Abdessamad, Nader, Hamed, Louison, Nicolas, l'autre Nicolas, Ludwig, Cecilia, Federico, Serge, Benjamin, Victor, Alexis, Wadid, Gyowon, Paul, Loubna, Nutsa, Joao Pedro, Alex, Yasemin, Adriano, Manuela, Ana Carolina, Joël, Ana Sofia, Cristiano, Italo, Lidia, Fouad, Besiana, Lilian, Laura, Evan, Colin, Jonas, Luisa, David, Matthieu, et Sterenn. Une mention spéciale pour Jeff et Ana Carolina, qui m'ont accueilli et soutenu pendant plusieurs semaines de boulot intense avant le rendu du manuscrit, et une deuxième mention encore plus spéciale pour Jeff, qui m'a aidé à tenir la pression et a relu et amélioré de nombreux passages de ma thèse et en a même traduit certains alors qu'il était lui aussi dans les dernières semaines avant le rendu.

Un grand merci à l'équipe de sauvetage qui a répondu présent quand, à quelques jours de la date limite officielle de rendu de manuscrit, j'ai appelé à l'aide pour des conseils et suggestions qui me faciliteraient l'écriture d'une introduction encore largement inexistante. . . Merci à Romain, Timothée, Jeff, Quentin, Louison et Paul. Un énorme merci à Tim qui est allé jusqu'à rédiger des suggestions pour plusieurs courts passages et transitions de mon introduction et m'a également fourni plusieurs des épigraphes que j'ai utilisées.

Enfin, merci à Fatma, Sofia, Quentin, Hadrien, Margarita, Benjamin, Romain, Malo, Simina, Manu le violoniste, à mes anciens coloc Lala et Erwan, aux centraliens Palich', Linh, Claire, Antonin, JN, Laetitia, et enfin aux hommes sensibles Rémi, Théo, Alex et Seb. Merci à vous toutes et tous !

Foreword

This thesis contains four chapters. Each of them was first written as an independent article. I have then integrated them into the thesis in an order that allows the best possible logical sequence. Chapter 2 is a collaborative effort with researchers Yannis Dafermos (SOAS University of London) and Maria Nikolaidi (University of Greenwich). The order in which they were (chronologically) written is different from the one presented here. Moreover, the order of the chapters does not follow the complexity of the models. The reader can therefore choose the logical sequence [1, 2, 3, 4] or base their reading on the complexity of the models [1, 3, 4, 2]. Both the topics covered and the structure of the models overlap in chapters 2, 3 and 4. I apologize in advance for any redundancies and the fact that the notations are not fully harmonized between the chapters. The articles have been written using the academic "we". However, I wanted to write the introduction and conclusion in the first-person singular. This seemed more appropriate because I expressed more personal opinions and preferences in them than in the chapters.

List of Tables

2.1	Balance sheet matrix	72
2.2	Transactions matrix	73
2.3	Features of the two types of green public investment	74
2.4	Symbols for endogenous variables used in chapter 2	96
2.5	Symbols for parameters and exogenous variables used in chapter 2	99
3.1	Balance sheet matrix	109
3.2	Transactions-flow matrix	109
4.1	Splitting of household consumption goods and services into three stylised categories	135
4.2	Balance sheet matrix	137
4.3	Transactions-flow matrix	138
4.4	The six scenarios considered	144

List of Figures

1.1	The canonical neo-Kaleckian model in the case of Keynesian stability.	40
1.2	Stable equilibrium with zero growth in a neo-Kaleckian model of growth and distribution with capital depreciation and depressed animal spirits.	42
1.3	Optimistic or pessimistic animal spirits leading to stable equilibria of positive, zero or negative rates of growth in a neo-Kaleckian model of growth and distribution with capital depreciation.	46
1.4	Extensions in the neo-Kaleckian model of growth and distribution provide greater space for stable negative growth equilibria.	50
1.5	Dynamics of autonomous consumption expenditures in a degrowth transition led by voluntary simplicity.	56
1.6	A highly schematised degrowth transition driven by changes in the rate of growth of autonomous consumption expenditures.	56
1.7	Short and medium-run macroeconomic effects of an increase in the tax rate on capital in an extended neo-Kaleckian model.	60
2.1	Transmission channels of green public investment (Type I) and sufficiency	87
2.2	Effects of the different types of green public investment	88
2.3	Effects of green public investment and sufficiency	92
3.1	Differentiated income effects on workers and capitalists of accelerated obsolescence in the very short run.	114
3.2	Evolution of key variables after an acceleration of obsolescence in different scenarios: no government response (solid lines), increase in government spending (dashed lines), tax cuts on both classes (dotted lines) and tax cuts on workers only (dotted-and-dashed lines). . . .	116

3.3	(continued from previous page) Evolution of key variables after an acceleration of obsolescence in different scenarios: no government response (solid lines), increase in government spending (dashed lines), tax cuts on both classes (dotted lines) and tax cuts on workers only (dotted-and-dashed lines).	117
3.4	Evolution of key variables after a slow-down of obsolescence in different scenarios: no government response (solid lines), tax increases on both classes (dotted lines) and tax increases on workers only (dotted-and-dashed lines)	123
3.5	(continued from previous page) Evolution of key variables after a slow-down of obsolescence in different scenarios: no government response (solid lines), tax increases on both classes (dotted lines) and tax increases on workers only (dotted-and-dashed lines)	124
4.1	The mechanism explaining how the public deficit appears and how active people can increase their consumption of “karaoke ” while their total income is reduced.	145
4.2	Evolution of key variables for scenario 1a	147
4.3	Evolution of key variables for scenario 1b	148
4.4	Evolution of key variables for scenario 2a	149
4.5	Evolution of key variables for scenario 3a	150
4.6	Synthesis of outcomes from the six scenarios according to three main criteria.	154
A.1	Change in the equilibrium rates of accumulation and of capacity utilisation when the rate of capital depreciation is introduced. . . .	202

Introduction

“Question 1 (4 points)

With two arguments, demonstrate that work is a source of social integration.

Question 2 (3 points)

With the help of an example, you will demonstrate that innovation can help push back the ecological limits to growth.

Question 3 (3 points)

With the help of an example, you will demonstrate that public action in favour of social justice can produce perverse effects.”

Excerpt from subject B of the Social and Economic Sciences test for the French Baccalaureate, May 13th, 2022.

[Journalist from ‘Paris Match’: Some think that the price to pay in order to adjust to renewable energies is degrowth: no more travels, driving less, etc.]
“Certainly not! This has been the great mistake of environmentalists for fifty years. We must depoliticise this story and disconnect the issue of energy from that of the environment. Let’s forget for a moment about CO2, COP21... Climate change is a totally profitable opportunity right now. ‘Cleantech’ is a technological revolution, in the same way as the industrial and the IT revolutions. COP21 must become a catalogue of solutions, not an anxiety-provoking gathering with a philosophy of fear and coercion.”

Bertrand Piccard, 2015¹

¹In his own words, Bertrand Piccard is an “Explorer, Psychiatrist, Inspirational speaker, and Chairman of the Solar Impulse Foundation.”

Outline of the current chapter

Degrowth: a brief overview	3
Why not green growth or a-growth?	5
Green growth	5
A-growth	7
Why study the macroeconomics of degrowth?	9
Degrowth remains under-researched within ecological macroeconomics	9
Macroeconomics remains under-researched within degrowth studies	12
Restricting the scope of the thesis: research questions and stylised approach	14
What this thesis is not about	14
Focusing on the economics	15
A stylised vision of a degrowth transition: two phases, and two kinds of processes	17
Theoretical and methodological choices	20
The choice of post-Keynesian economic theory	20
The modelling approach	22
The choice of neo-Kaleckian and stock-flow consistent models .	24
Remarks on population issues	25
Structure of the thesis	26

422 ppm. Massive floods, extreme drought, devastating tornadoes, deadly heat waves... Climate is changing. But affluent lifestyles are still not.

A few months preceding the publication of this thesis, the Intergovernmental Panel on Climate Change published its sixth series of assessment reports on climate change: the physical science behind it (working group I), the impacts, adaptation and vulnerability related to it (working group II), and the possibilities to mitigate it (working group III). As expected, these reports are even more alarming than the previous ones. Greenhouse gas (GHG) emissions continue to rise and mitigation pledges are far from sufficient to avoid a disastrous level of climate change. Even if the Nationally Determined Contributions (NDCs) of the Paris Agreement were implemented, the increase in global temperatures would reach 3.2°C by 2100.² The pledges are insufficient and the reality of climate action even more. This is one of the main messages of the sixth Assessment Report (AR6): “Policies implemented by the end of 2020 are projected to result in higher global GHG emissions than

²Source: <https://www.climateinteractive.org/ci-topics/climate-energy/scoreboard/scoreboard-science-and-data/>

those implied by NDCs (*high confidence*)” (W. G. I. IPCC 2022, headline statement B6). Yet, the call for more radical mitigation actions that the IPCC gave in their 2018 special report on limiting global warming to 1.5°C was clear:

Pathways limiting global warming to 1.5°C with no or limited overshoot would require rapid and far-reaching transitions in energy, land, urban and infrastructure (including transport and buildings), and industrial systems (*high confidence*). These systems transitions are unprecedented in terms of scale, but not necessarily in terms of speed, and imply deep emissions reductions in all sectors, a wide portfolio of mitigation options and a significant upscaling of investments in those options (*medium confidence*). (IPCC 2018, p. 15)

Unfortunately, four years later these systemic transitions have still not seen the light of day.

The current mode of living in rich countries is ecologically unsustainable (Brand and Wissen 2013, 2021). As production and consumption levels grew exponentially over the last several decades, environmental problems kept worsening at faster and faster rates. Today climate change is more problematic than ever before, but, out of nine in total, five other 'planetary boundaries' (Rockström et al. 2009; Steffen et al. 2015) have been crossed: biodiversity loss, land-system change, altered biogeochemical cycles (phosphorus and nitrogen), introduction of novel entities (chemical pollutions), and freshwater use (the last two were crossed in 2022).

The dominant responses to this environmental chaos have remained the same: delay action, claim that new technologies will solve the problem, and strive for faster economic growth and for an ever more unequal distribution of income and wealth. The stubborn clinging to the same economic model is irresponsible. Claiming that new results will arise from an old model is like a chef announcing that the cake will be different despite using the same recipe.

The term of French president François Hollande between 2012 and 2017 gives us an example of that same-recipe-different-cake pattern. Mr. Hollande had announced that his main objective was to reverse the trend of rising unemployment. Although ostensibly a socialist, he implemented economic measures mostly similar to those of his conservative predecessors: public spending cuts, liberalisation of the labor market, and lowering of corporate taxes. Unsurprisingly, the same causes always produce the same effects: the cuts in public spending dragged economic activity down. As the unemployment rate continued rising, corporate profits climbed to new heights.

The good thing with institutions, is that they can be deconstructed as quickly as they have been constructed. This is not the case for ecosystems however. A misfitted labour law can be undone; a destabilised climate or extinguished specie cannot. For Mr. Hollande, the consequences of his decisions were not that dramatic.

He simply preferred not to run again in the next election. Generally speaking, when it comes to social problems, the laws that are passed by one government may one day be repealed or modified by the next one. Despite the social hardships associated with high rates of unemployment and high levels of inequalities, the unequal distribution of income and wealth can be corrected, and the unemployment rate may decrease again.

However, on the other hand, the GHG concentration levels in the atmosphere are very unlikely to come down again for centuries. Any increase is irreversible, and the consequences are disastrous. The trajectory has to be changed quickly and drastically. This thesis explores an alternative solution to that of economic growth and the now dominant belief that technological progress will solve all environmental problems. A rising number of scholars and activists have come to call this alternative paradigm “degrowth”. Perhaps a different recipe can give a smaller but healthier and tastier cake.

Degrowth: a brief overview

After emerging in France at the beginning of the 2000s as “*décroissance*”, the idea of degrowth has grown in popularity, especially in the last decade. There are now more than 500 peer-reviewed articles on the topic, and the term has even been mentioned in two reports of the AR6.³ In the adaptation report, degrowth is mentioned as “a solution for achieving environmental sustainability and socio-economic progress. Such concepts are a deliberate response to concerns about ecological limits to growth and the compatibility between growth-oriented development and sustainability. Sustainable degrowth is not the same as negative GDP growth which is typically referred to as a recession. Degrowth goes beyond criticizing economic growth; it explores the intersection among environmental sustainability, social justice, and well-being” (AR6, WGII, Chap 18, pp. 81-82). The mitigation report mentions: “systems-dynamics models linking strong emissions-reducing policies and strong social equity policies show that a low-carbon transition in conjunction with social sustainability is possible, even without economic growth [...] Such degrowth pathways may be crucial in combining technical feasibility of mitigation with social development goals” (AR6, WGIII, Ch.5 p.32). It is a great achievement of the degrowth community that such a previously marginalised concept is now presented as legitimate and worth of attention by an institution as respected as the IPCC.

The most cited definition in the literature defined *degrowth* as “an equitable downscaling of production and consumption that increases human well-being

³For more details on degrowth in the AR6, see the analyses produced by Timothée Parrique : <https://timotheeparrique.com/degrowth-in-the-ipcc-ar6-wgii/>
<https://timotheeparrique.com/degrowth-in-the-ipcc-ar6-wgiii/>

and enhances ecological conditions at the local and global level, in the short and long term.” (Schneider, Kallis, and Martinez-Alier 2010, p. 511) Kallis et al. (2018) provide an extensive literature review of research on degrowth. There exist many definitions of the term, but they all stress the idea of social justice. For example, the collective Research & Degrowth (2010, p. 524) defines degrowth as a “voluntary transition towards a just, participatory, and ecologically sustainable society”, and Giorgos Kallis (2011, p. 874) presents it as a “socially sustainable and equitable reduction (and eventually stabilisation) of society’s throughput.” Kallis goes on explaining: “Throughput refers to the materials and energy a society extracts, processes, transports and distributes, to consume and return back to the environment as waste”.

Of course, “degrowing” an economy does not mean reducing all kinds of production and consumption. Degrowth as a mitigation strategy should focus in priority on goods and services with a high carbon footprint: “Sustainable degrowth does not mean across the board degrowth. Certain social qualities, small/medium-scale economic activities (e.g. renewable energies, shared transportation systems), and impoverished groups or regions may still selectively need to grow” (Schneider, Kallis, and Martinez-Alier 2010, p. 512). Moreover, the idea is not to produce and consume less of the same, but “less and differently” (Kallis 2018).

The field of degrowth is vast and the term is used as an activist slogan, a transition strategy, and an umbrella term for a broader paradigm of development (D’Alisa, Demaria, and Kallis 2014; Treu, Schmelzer, and Burkhart 2020). As an alternative vision of prosperity, the idea of degrowth ramifies into a plethora of concepts like voluntary simplicity, post-development, post-work, diverse economies, just transition, deglobalization, and nowtopias (for theoretical works that have tried to articulate all these concepts together, see Kallis (2018), Parrique (2019), Hickel (2020), and Schmelzer, Vetter, and Vansintjan (2022)). This buffet of subversive ideas add themselves to an older tradition of anti-systemic thought, what Serge Latouche (2016) calls the “*précurseurs de la décroissance*”, ranging from the ecosocialism of André Gorz, the critique of technology of Jacques Ellul, the ecofeminism of Françoise d’Eaubonne, the criticisms of national accounting of Marilyn Waring, the call for smallness of Leopold Kohr and Ernest F. Schumacher, and the conviviality of Ivan Illich. This wide diversity of anti-productivist, anti-imperialist, anti-capitalist, and anti-utilitarist ideas form together a complex conceptual tapestry.

In the context of this dissertation, I decided to concentrate on just a few of the numerous dimensions of the degrowth paradigm. I explain further down why and how I restricted the focus to macroeconomic issues. But first, I shall briefly say why I preferred to study degrowth over “green growth” or “a-growth”.

Why not green growth or a-growth?

Green growth

Before diving too deep into degrowth, one might want to justify why it is needed in the first place. Indeed, why reducing production and consumption if we could simply decouple production from environmental pressures? This idea of *decoupling* is absolutely central to the currently dominant paradigm called “green growth”. Essentially, decoupling relies on the following assumptions: production processes and the economy overall can be highly decarbonised, efficiency gains can allow to make more goods with less resources (gradual improvements), humans will invent new technologies that will quickly solve environmental problems (disruptive improvements), and economies will become more and more “dematerialised” as consumption and production will shift from goods to services. Under these assumptions, it is possible to produce ever more, while extracting and polluting ever less. These ideas were put forward and promoted by powerful institutions for at least one decade (Bank 2012; OECD 2011) and have become widespread across modern societies.

The problem with green growth and decoupling is that empirical evidence in support of it is much more scarce than the discourses in favour of it. On the contrary, there is now a multitude of theoretical and empirical evidence demonstrating that there is little reason to hope for an absolute decoupling of economic production from environmental degradation in the aggregate. Whereas the quantity of greenhouse gases emitted per dollar of output has fallen consistently over time in wealthy countries (i.e. ‘relative decoupling’), the total volume of global emissions has kept rising alongside exponential economic growth, indicating an absence of ‘absolute decoupling’ (Hickel and Kallis 2019). Moreover, research indicates that much of the perceived ‘greening’ of high income countries is linked to their ability to shift resource-intensive and pollution-intensive sectors to low-income countries (Althouse, Guarini, and Porcile 2020; Sovacool 2021).

From a meta-analysis conducted on 835 peer-reviewed articles, Haberl et al. (2020) conclude that “large rapid absolute reductions of resource use and GHG emissions cannot be achieved through observed decoupling rates, hence decoupling needs to be complemented by sufficiency-oriented strategies and strict enforcement of absolute reduction targets.” The reasons why decoupling, if happening at all, is likely to be *too little, too slow*, are numerous. Parrique et al. (2019) give an extensive account of these reasons and propose seven categories: “rising energy expenditures”, “rebound effects”, “problem shifting”, “the underestimated impact of services”, “limited potential of recycling”, “insufficient and inappropriate technological change”, and “cost shifting”.

In fact, even the IPCC now recognises that decoupling alone is an insufficient strategy to mitigate climate change. Analysing the mitigation report from April 2022 in detail, Timothée Parrique showed that the section of the report on decoupling is more skeptical than the political summary suggests.⁴ In the main study used by Claus Hubacek, the lead author of Chapter 2 of the mitigation report, the authors reach the following conclusion:⁵

absolute decoupling is insufficient to avoid consuming the remaining CO₂ emission budget under the global warming limit of 1.5°C or even 2°C and avoid potential climate breakdown (Hickel and Kallis, 2020). Overwhelming efforts are needed to reduce global emissions in line with Paris Agreement targets, and the evidence seems to be mounting that even widespread and rapid absolute decoupling alone might not suffice to achieve these goals without some form of economic degrowth (Hickel et al., 2021; Keyßer and Lenzen 2021; Stoknes and Rockström, 2018). (Hubacek et al. 2021, p. 7)

On top of the decoupling problem, the “solutions” proposed within the “green growth” paradigm do not aim at changing the logic of the current unfair socio-economic order. In a compelling account and critique of these “solutions”, Tordjman (2021) demonstrates how “green growth” continues to apply a logic of extractivism, of control over nature by humans, and of commodification of nature. In fact, this is the perpetuation of the current globalised and financialised capitalist system in which power is concentrated in the hands of a minority of actors, especially large multinational companies who are increasingly appropriating nature.

Thus, “green growth” seems to be a misleading paradigm.⁶ If producing more while polluting less is highly unlikely, then the logical conclusion that should be drawn is that we should produce less, in order to pollute less. Of course, responsibilities are differentiated across the globe and within countries. “We” does not refer to every country and category of population. In a crucial paper, Wiedmann et al. (2020) warn about affluence: “For over half a century, worldwide growth in affluence has continuously increased resource use and pollutant emissions far more rapidly than these have been reduced through better technology. The affluent citizens of the world are responsible for most environmental impacts and are central to any future prospect of retreating to safer environmental conditions.” In high-income countries, overall economic production and consumption may well need to shrink for a certain amount of time before stabilising at an ecologically sustainable level. Said differently, the rate of growth of these economies may need to become negative for some time before stabilising around zero.

⁴<https://timotheeparrique.com/decoupling-in-the-ipcc-ar6-wgiii/>

⁵Cited in Parrique 2022: <https://timotheeparrique.com/decoupling-in-the-ipcc-ar6-wgiii/>

⁶One may even think of it as a contraction of “greenwashing” and “economic growth”.

A-growth

The term *degrowth*, because it contains *growth*, can be confusing. Indeed, *growth* alone usually refers to economic growth, i.e. the increase in Gross Domestic Product (GDP). For *degrowth* however, different people might have different things in mind. van den Bergh (2011, p. 881) mentions for instance five interpretations of the term: GDP degrowth, consumption degrowth, work-time degrowth, radical degrowth, and physical degrowth. This author argued that the word *degrowth* is not only ambiguous but may also be unappealing and therefore politically ineffective. He suggested replacing the term *degrowth* with *a-growth*, which means being simply “indifferent” to growth (van den Bergh 2011, p. 881). This sparked a debate with degrowth scholars which I am not reproducing here. For the main arguments in defence of the term *degrowth*, see (Kallis 2011). As a matter of fact, the community of activists and researchers that identifies itself with the word *degrowth* has decided to keep this term. International conferences on the topic are called *degrowth* conferences, and a new journal called *Degrowth journal* has just been created.

Nevertheless, beyond the controversy on the wording, it is important to be clear about the relations between “degrowth” and GDP, in order to prevent confusion. In fact, degrowth proponents generally agree with Van den Bergh’s proposal to abandon GDP as a goal and even as an indicator of success for socio-economic policies. Instead, numerous better indicators can and should be used (Gadrey and Jany-Catrice 2010; Van der Slycken 2021). However, while sharing the same broad attitude towards GDP with proponents of *a-growth*, *degrowth* proponents are generally more convinced that GDP would actually decrease during a degrowth transition:

Sustainable degrowth will involve a decrease in GDP as currently measured, because of a reduction in the large-scale, resource intensive productive and consumptive activities that constitute a big portion of GDP. However, what happens to GDP is of secondary importance; the goal is the pursuit of well-being, ecological sustainability and social equity. Qualitative differences, typically not captured in GDP, could even permit socio-environmental improvements while GDP falls. Degrowth takes seriously the Easterlin “paradox”, that GDP per capita does not correlate with happiness above certain levels of satisfaction of basic needs. (Schneider, Kallis, and Martinez-Alier 2010, p. 512)

While Easterlin only studied subjective well-being, a recent study by Fanning et al. (2022) confirms the existence of a GDP satiation level for a wider diversity of measures of social performance. Kallis (2011, p. 874) clarifies further on degrowth and GDP - reducing GDP is not the goal but one of the outcomes: “The goal of sustainable degrowth is not to degrow GDP. GDP will inevitably decline as an

outcome of sustainable degrowth, but the question is whether this can happen in a socially and environmentally sustainable way.”

In my opinion, nobody knows for sure that the GDP of a high-income country will decrease if this country goes for a true degrowth transition and reaches ecological and social sustainability. Yet, given all the reasons to doubt about sufficient and fast enough decoupling explained above, it seems reasonable to at least consider the possibility of a reduction in GDP and anticipate the problems it may cause, rather than going unprepared and having bad surprises. Admittedly, a revolutionary scientific breakthrough that would enable fast decoupling is not absolutely impossible. But radical uncertainty should imply that we apply a strong precautionary principle (Berr 2009). Moreover, even when innovations appear, it takes many years for them to become mature and widespread, and we are running out of time. In other words, we should make plans that are applicable without delay and with the existing technologies, without counting on hypothetical breakthroughs. If, on the way, useful inventions come out, then the outcome is just going to be better (or less catastrophic, actually).

The dissertation of François Briens (2015) is the work that I consider to be the most thorough and reliable to this day in terms of scenario analysis for sustainability. It seeks to reach a state of sustainability in which the reduction in GHG emissions is not the only environmental goal ; numerous types of chemical pollutions and environmental degradations are taken into account (for instance pollutants related to the acidification of oceans, to eutrophication, emissions of suspended particules, water use and generation of waste). In the scenarios that do not rely on hypothetical new technologies or over-optimistic efficiency gains, yet lead to the most satisfying sustainability outcomes, the result for GDP is a decrease of -17% (degrowth scenario B) or -50% (degrowth scenario C) (Briens 2015, pp. 271–80). In my opinion, these results give a strong and well argued support to the statements recalled above according to which a decrease in GDP is a likely outcome of degrowth. Briens’ modelling exercise is based on a detailed but relatively rigid “engineer” type of model. It is highly useful, yet I think it should be complemented with macroeconomic models that can explore more specifically the economic dynamics at play during a degrowth transition. This is the main purpose of this dissertation. In the next paragraphs, I explain in more detail why more work on the macroeconomics of degrowth is needed.

Why study the macroeconomics of degrowth?

Degrowth remains under-researched within ecological macroeconomics

Over the 2010 decade, a field of research called *ecological macroeconomics* has emerged. This field stems from the encounter between ecological economics and other heterodox schools of thought, first and foremost post-Keynesian economics (Fontana and Sawyer 2013, 2016; Hardt and O’Neill 2017; Harris 2008; Rezai and Stagl 2016; Røpke 2011; Stagl 2014).⁷ The dialogue between the ecological and post-Keynesian economics was established thanks to common theoretical grounds (Holt, Pressman, and Spash 2009; Jackson 2009a; Kronenberg 2010), which I briefly explain further down in this introduction.

Ecological macroeconomics is a recent and flourishing field of research, and its scope is still in expansion. Among its numerous topics one can find: sustainable consumption (Jackson 2005; Røpke 2001, 2005, 2009), work-sharing, productivity, and work itself (Jackson and P. Victor 2011; Schor 2005; Stagl 2013; Zwickl, Disslbacher, and Stagl 2016), interest rates and debt (Cahen-Fourot and Lavoie 2016; Jackson and Peter A. Victor 2015; Richters and Siemoneit 2017), the monetary system (Dittmer 2013, 2014, 2015), economy-environment interactions and green monetary policy (Dafermos, Nikolaidi, and Galanis 2017a, 2018), employer-of-last-resort policies (Alcott 2013; Godin 2012), the integration of energy, the environment, and the macroeconomy (Berg, Hartley, and Richters 2015; Dafermos, Nikolaidi, and Galanis 2017a; Naqvi 2015; Taylor, Rezai, and Duncan K. Foley 2016b), and the study of zero-growth economics (Cahen-Fourot and Lavoie 2016; Jackson and Peter A. Victor 2015, 2016; Lange 2016; Padalkina 2012; Rosenbaum 2015).

This list of topics is far from being complete. Hardt and O’Neill (2017) propose a literature review of the models used in ecological macroeconomics. Althouse (2022, Ch. 2) provides a more recent and exhaustive account of the field. He suggests a classification in five “branches”, with one representative article for each: “Green Keynesianism” (Dafermos, Nikolaidi, and Galanis 2017a), “Financial Stability and Socio-Environmental Change” (Mercure et al. 2018), “Socio-Metabolic Dynamics and Constraints” (Cahen-Fourot, Campiglio, et al. 2020), “Capitalist Growth Imperatives” (Jackson and Peter A. Victor 2015), and “Postgrowth/ Degrowth Futures” (D’Alessandro et al. 2020).

Althouse (2022, Ch. 3) also proposes a friendly critique of ecological macroeconomics that highlights its shortcomings and biases, and calls for a better integration with political ecology. The field had already been criticised in the past: for instance, Svartzman, Dron, and Espagne (2019, p. 109) deplore that “ecological

⁷Marxian economics and political economy are not far from it (Pirgmaier 2020).

macroeconomists have failed to revisit their own approach to macroeconomics by integrating notions emerging from ecological economics and related fields such as political ecology, environmental history and “world-ecology” approaches (Moore, 2015). The persistent consideration of ecological issues as an ad hoc topic of enquiry has prevented endogenous monetary theorists from questioning their pre-analytical views of a “world of abundance”, and suggest that institutional approaches to the understanding of money and value be incorporated into the field of ecological macroeconomics. Magalhaes (2021, p. 1) describes the “green investment paradigm” (which is broader than green Keynesianism but includes it) as a “reductionist, normative, disembodied, ahistorical and depoliticizing vision”.

In addition to these qualitative critiques, I would add that the five categories identified by Althouse (2022) are quite unequal in size. Green Keynesianism is by far the largest category ; followed by financial stability and socio- environmental change and capitalist growth imperatives. The latter has certainly been inflated by the “monetary growth imperative” controversy, which is still ongoing despite several articles (Cahen-Fourot and Lavoie 2016; Jackson and Peter A. Victor 2015) that provided analyses which, in my opinion, were sufficiently clear and well argued so as to settle the debate and move forward. Concerning the large size of the first two categories, I suggest a few possible reasons why green investment and on monetary and financial issues have attracted so much attention:⁸

- studying green investment is comfortable because one does not need to question the growth paradigm;
- when departing for the exploration of a new territory (ecological issues), post-Keynesians might have prepared their backpacks with their favorite books (knowledge), tools (models and methods), and lenses (ways of approaching the problems). Of course post-Keynesians deal with much more than investment or monetary and financial issues, but this could be one element explaining a certain bias in favour of them when studying ecological matters;
- current capitalism is highly financialised, therefore financial issues should necessarily be in the spotlight;
- the trauma of the great financial crisis makes systemic financial risks appear as a great economic threat;
- central banks, via the creation of the “Network of Central Banks and Supervisors for Greening the Financial System” (NGFS), have poured substantial financial resources into research on the threats to financial stability posed

⁸These are only personal assumptions based on my subjective and partial knowledge of the research field and community.

by climate change and other environmental damage and by the transition towards a more sustainable economic system;

- a modelling bias: macroeconomic modellers might find it easier to model financial assets and liabilities or a “green” sector and a “brown” sector than to model lifestyles, social norms or consumption patterns.

One of the greatest problems with paying too much attention to financial issues (financial stability, green finance, stranded assets...), and not enough to the reality of what is produced and consumed, is that one could end up saving the financial system from climate disasters - and thereby, mostly saving the interests of the wealthy - instead of saving the climate and the environment themselves. Financialised capitalism and high inequalities would then be *preserved* while the environment would *go bust*.⁹

Overall, the macroeconomics of degrowth represents a tiny share of ecological macroeconomics. As of 2022, only a couple of researchers have put efforts in developing it (Briens 2015; D’Alessandro et al. 2020; Nieto et al. 2020; Sers 2021; P. Victor 2012). Jackson and Peter A Victor (2020) is close to it but remains on the side of “post-growth” with a stagnation of output rather than a decrease. All of these works provide scenarios, elaborated and simulated with large models, that suggest that degrowth (or post-growth) transition give better socio-environmental outcomes than business-as-usual or green growth scenarios. These results are important, however, the scenarios that are considered and compared against each other are generally very different from each other. This does not allow for detailed and thorough theoretical analyses of the effects of changes in one parameter at a time, nor for communicating the mechanisms at play in a simple and effective manner. This dissertation seeks to develop this missing type of relatively simple theoretical analysis.

⁹Without claiming that financial issues are easy to tackle, they are ultimately reversible. The same does not hold for the environmental degradations. Moreover, since financial issues depend on the balance of power between debtors and creditors, they can be settled in different ways. Accordingly, they can also be seen as opportunities to dramatically reduce wealth inequalities, if the political and economic reactions are conducted in the interests of the majority. This is generally not the case, and past financial crises have led to increases in inequalities. But the strong and rapid deflation in asset prices that takes place during financial crises could lead to a sharp decrease in the excessive and unduly inflated wealth of the richest categories of people, if the financial system is thoroughly transformed and regulated in order to prevent a return to the *status quo ante*. Such massive reductions in wealth inequality might be difficult to obtain otherwise, except for drastic measures such as the seizure and redistribution or the collectivisation of assets. Of course, financial assets are not entirely in the hands of the wealthy, there are also “small savers” and savings for pensions (Semieniuk et al. 2021). However, a fair allocation of the losses is always technically feasible, and the bankruptcy of pension funds may be an opportunity to replace a system of private pensions with a public pay-as-you-go pension scheme. The crucial point is to have the appropriate balance of power and political conditions to do so.

Macroeconomics remains under-researched within degrowth studies

Slowly but steadily, degrowth ideas seem to catch increasing attention from public opinion. However, the idea that degrowth is economically risky or impossible remains. Indeed, when production declines, national income shrinks. The income of households, the sales of businesses, and employment decrease all together, especially in the sectors whose activity is reduced the most. Unemployment increases, and the poverty rate and levels of inequality follow. Aggregate demand shrinks, businesses become pessimistic about future sales and stop investing. This aggravates the situation, and negative anticipations become reinforced. Without automatic stabilisers or government intervention to sustain demand, the economy as a whole faces the risk of never-ending recessionary spiral.

This scheme is well-known among economists but also among politicians, business owners and managers, journalists and the general public. This can explain the popularity of the idea that degrowth can only lead to economic collapse, business closures, bankruptcies, unemployment and poverty. But what I just described is called recession and depression, not degrowth. They are very different concepts and schemes, and advocates of degrowth have kept explaining it since the early stages of the development of this paradigm. Probably some people believe in this confusing association for lack of information and economic literacy, some others have the intuition that degrowth could be much brighter than recession but doubt its feasibility or are afraid of its potential negative economic consequences, and a third category of people do not want to clarify things because it is in their political, economic, and class interest to maintain and spread the confusion and the fear that comes with it.¹⁰

Certainly, the arguments put forward by degrowth advocates regarding the economic viability of this paradigm have not been convincing enough, and macroeconomic expertise is still missing. This is one of the main lessons drawn by Delphine Batho, a member of the parliament in France, from her 2021 pro-degrowth campaign for nomination as the candidate of the Green party for the 2022 presidential election.¹¹

In his influential 2009 book titled “Prosperity without growth”, Tim Jackson warned about the lack of research on macroeconomics without growth:

what we still miss is the ability to establish economic stability under

¹⁰Note that belonging to the third category is not incompatible with being quite economically illiterate as well.

¹¹Delphine Batho gave feedback on her campaign at the Intitute Momentum on January 8, 2022 (in French): <https://www.institutmomentum.org/faire-campagne-pour-le-decroissance-retours-critiques-dexperience/>

For an analysis of degrowth discussions during this campaign, see: <https://timotheeparrique.com/reponse-aux-verts-qui-parlent-de-decroissance/>

these conditions [without growth]. We have no model for how common macro-economic ‘aggregates’ (production, consumption, investment, trade, capital stock, public spending, labour, money supply and so on) behave when capital doesn’t accumulate. [...] In fact, this call for a robust, ecologically-literate macroeconomics is probably the single most important recommendation to emerge from this book. (Jackson 2009b, p. 123)

Obviously, since 2010, some progress has been made. Yet, in my opinion, the macroeconomics of degrowth remains one of the least researched areas both within ecological macroeconomics and degrowth studies.

I hope the contents of this dissertation can start filling this gap, help clarify some debates, and thereby broaden the scope of what can possibly be envisioned in the future and for our future, in terms of economic and political choices.

Restricting the scope of the thesis. From the need to operate a broad paradigm shift to the choice of specific research questions and a stylised approach to degrowth

In the following paragraphs, I explain the general approach of this work. To begin with, I briefly mention some important points and approaches to degrowth that this dissertation does not deal with. Then, I expose the specific focus and research questions of this thesis. Finally, before turning to a part dedicated to the theoretical and methodological choices I made, I expose a stylised approach to degrowth in which I categorise and simplify the numerous socio-economic and technical changes involved in such a broad paradigm shift.

What this thesis is not about

There are important issues related to degrowth that I decided to leave aside in order to obtain research questions that are sufficiently narrow to be treated in depth. Here is a non-exhaustive list of them:

- Among the institutions and forms of social organisations currently in place in various countries, which ones are compatible with a degrowth transition, and which ones should be transformed and reinvented? This includes questions regarding democratic rules and practices, as well as issues of organisation and power within firms and other productive entities.

- Is degrowth compatible with capitalism? My approach is to start from the existing system, imagine that consumption and production are reduced, and study how the economic system may react.
- How can behaviours and mindsets change? What are the psychological or social barriers that stand in the way towards changes in lifestyles and in consumption norms? How to make more people accept the concept of limits?
- Which policies and regulations can foster reductions in production and consumption? In several chapters, I explore or simply mention some potential drivers of consumption reduction. However, I do not go into the detail of the policies. For instance, in chapter 3, I investigate the macroeconomic impacts of an acceleration or slowing down of obsolescence, but I do not look at the precise policies and regulations that could actually reduce the pace of obsolescence.
- I do not try to give a precise description of which sectors and categories of goods and services should grow and which should shrink. I do not look for precise estimates of the required changes in the composition and quantity of production and consumption. The aim of this work is not to propose a quantified and ready-to-use plan for a degrowth transition.

Focusing on the economics

The reader might expect that, in a dissertation on degrowth, environmental concerns be omnipresent. She/he might be surprised, when going through the chapters and over the models, not to find detailed analyses nor plentiful variables related to environmental impacts and interactions between socio-economic systems and their environment. Focusing on the economics, and in particular on macroeconomics, is a deliberate choice of mine. I decided to take this approach because, as I explained above, macroeconomic considerations represent one of the least explored areas in degrowth studies. I chose to conduct theoretical rather than empirical work for two reasons: i) to some extent, a personal preference for theory over empirics, although I recognise that both are important and complementary, and ii) there is not really any suitable data for macroeconomic analysis, since no experience of degrowth has ever happened at sufficiently large scale.

Even if theoretical and focused on macroeconomic issues, the models I designed could have included more environmental variables and economy-environment interactions. However, as I explain in more detail in the section below on theoretical and methodological choices, my approach is to keep the models as simple as possible in order to be able to clearly follow and check each step of the reasonings. Moreover, since the topics I investigated had mostly never been explored before, I thought

there was already a lot to do with “purely” macroeconomic reasoning. In a sense, *start simple, complicate later*.

Yet, the environment is far from being absent from this work. In fact, it *is* omnipresent, but behind the scenes. First, environmental concerns are the principal reason for this work, whose goal is to explore transition paths towards environmental sustainability that are socio-economically viable. Second, in all of the chapters, I envision consumption reductions. Not for the sake of reducing consumption, but for environmental reasons.

Focusing on the reduction of consumption is not equivalent to focusing on individual behaviour, nor to placing the responsibility of the change in consumption practices on individuals. Indeed, I consider reductions in *constrained* consumption, as opposed to *discretionary* consumption. This type of expenditures are determined by lifestyles, social norms, infrastructure and other systemic factors over which individuals have little control. Thus, reductions in consumption can result from production-side and systemic changes. I explain this further in the parts below on “a stylised vision of a degrowth transition”.

Analysing in detail which type of consumption can or should be reduced and how to achieve such changes is not the purpose of this work, however. Instead, I imagine that constrained consumption expenditures are gradually reduced, and I focus on the macroeconomic implications of it. This is one of the originalities of my approach. Also, I put the emphasis on the period of *transition*, rather than on the stationary state that comes afterwards.

Each of the chapters has its own focus, however all of them provide some elements of response to the following broad research questions of this work:

- If, at the aggregate level, consumption were to decrease during a degrowth transition, what macroeconomic problems could possibly arise?
- What are the policy options, their complementarities, and their implications?
- Is it possible to simultaneously obtain positive outcomes in environmental, social, and economic dimensions?

To be sure, some personal preferences do appear throughout this dissertation. However, my research approach is mainly positive, not normative. The goal is to explore new paths, to broaden the horizons, not to pretend finding an optimal and ready-to-use transition plan. On the way, I try to clarify some debates and disprove a few arguments advanced by opponents to degrowth.

Achieving profound transformations in a socially and economically viable manner is a great challenge. The 2019 ‘Gilets Jaunes’ movement in France showed that if an environmental measure is perceived as inequitable and is not accompanied with social and economic measures to make it fair and effective, the risk of popular

rejection is high. Moreover, the 2020-21 coronavirus lock-downs showed that when production slows down while economic structures remain mostly unchanged, inequalities can rise, especially if containing and reducing them is not the highest priority of the government. In order to design a viable degrowth transition, it is necessary to understand better its potential socio-economic consequences and to ensure that the negative impacts are attenuated and compensated for. Therefore, in this work, the question of inequalities is central. I pay attention to inequality of both income *and* wealth, between active and retired households, between employed and unemployed workers, and between workers and capitalists.

I would like to conclude this paragraph with a short remark on the place of GDP in this work. The reader might find that I give too much importance to it, given how misleading this indicator is. In fact, the goal is never to reduce GDP. Instead, it is to reduce the environmental damages caused by the contents and the size of GDP. Moreover, GDP remains a useful indicator. Not for well-being, but for the tax base. For instance, when GDP decreases, the amount of contributions paid by workers and firms is reduced, and the financing of social protection schemes may be at risk. The fourth chapter of this dissertation deals with this precise issue in the case of a public pension scheme.

A stylised vision of a degrowth transition: two phases, and two kinds of processes

Two phases

A degrowth transition is multidimensional and highly complex. Some degree of simplification is needed, in order to conduct and communicate reasoning in an understandable manner. Thus, I conceive a separation between two phases of the transition, which in reality would partially overlap.

During the first phase, key systemic changes and so-called “enabling” investments are carried out. This includes investment in green infrastructure for transportation and for energy production, housing refurbishment, the extension of the lifetime of durable goods, and material and energy efficiency improvements in all possible production processes. Because of the widespread and systemic nature of these changes, and because they require a pace and a degree of coordination that market forces have not been able to deliver so far, the intervention of public authorities seems highly necessary.¹² This first phase, therefore, is close to what has been

¹²With respect to rapid widespread thermal insulation of buildings for instance, it is both illusionary and highly inefficient to expect hundreds of millions of people around the world to individually look for and compare technical solutions and companies to carry out the work, look for and take out a loan, bear the risks etc. This would be much slower, more expensive and technically less efficient than coordinated actions where for instance, a whole shared building is

termed the “Green New Deal”. GDP may increase over this period of time. This is not an issue however, since the increase is only temporary (maintaining infrastructure requires much less work than building or converting it) and the subsequent decrease in the CO_2 and material intensity of the economy makes the overall ecological and climate impact of these investments positive in the medium and long-run.

This part of the ecological transition has been thoroughly studied already and several limits have been pointed out, showing that it is a necessary but not sufficient component of the overall transition. First, it has been shown that rebound effects can cancel out part of or all the benefits of systemic changes (Barker, Dagoumas, and Rubin 2009a; Saunders 2000), if collective and individual behaviours do not substantially depart from those promoted and adopted in modern consumer societies. Typically, if the money saved on heating homes is spent on long-distance travels on air-planes, the ecological balance is negative. Second, efficient and widespread infrastructure for public and smooth modes of transport may exist while a majority of people still prefer to use their car. Third, the pace and extent of the required changes make it highly unlikely if not impossible to happen without a complementary reduction in material and energy demand which, due to the difficulty or impossibility of absolute decoupling, can only come with a reduction in aggregate demand (Hickel and Kallis 2019). In this respect, the issue of ecological damage due to the extraction of minerals is key to understand the limits of a strategy that would focus only on the first phase and therefore decide on the size of the “green” investments without anticipating nor planning a reduction in the demand for energy and materials (Svartzman, Dron, and Espagne 2019). This is particularly true for widespread, privately owned electric vehicles, which cannot provide an ecologically satisfying means of transportation for several billion people on Earth. Hence, in order to achieve sustainability the first phase should be thought upon and designed in a systemic ecological approach and in accordance with a necessary second phase of changes in consumption patterns and modes of living.

Consumption patterns and modes of living can (and should) start evolving during the first phase, but the extent to which they can is limited as long as some “enabling” investments coming from the first phase have not been completed: “consumers are, for a large part, ‘locked-in’ in infrastructures, social norms, and habits that severely limit consumer choice, in practice.” (Tukker et al. 2008).

entirely refurbished at once rather than bit by bit. Moreover, renters generally do not want to refurbish a home they do not own, and landowners generally do not want to pay for it when the benefits of lower energy bills are going to renters. Public authorities can organise, finance and potentially carry out this Herculean task, just as they are currently doing for the installation of smart-meters for electricity, gas and water across Europe for much lower expected ecological benefits than the insulation of buildings.

Summarising results from a research program on sustainable consumption and production, Tukker et al. (2008) come to the following conclusion:

“[...] all evidence shows that since actors are trapped in systemic interdependencies, such routes for change have limits. Bottom-up and market based action can only result in lasting fundamental change if backed up by top-down support and framework changes”.

To sum-up, the first phase is necessary but not sufficient, the complementary second phase is necessary as well and can start partly during the first phase but can only really “take-off” once the first phase is close to being completed. Because of this dependence of the second on the first, and because consumption patterns and modes of living will take time to evolve, the second phase will continue for a while after the first one is finished.

The second chapter of this thesis investigates how both phases can be integrated together and proposes a macroeconomic analysis of it. In the three other chapters (1, 3 and 4), I assume that the first phase has been completed and I focus on the later stage of the transition. During this period, the economy is said to be “degrowing” and its rate of growth is negative. Then, a stationary state is reached and the rate of growth remains equal to zero.

Two kinds of processes during the second phase

During this degrowth transition, GDP is assumed to go down as a result of two types of processes.¹³ Despite the previous emphasis on the fact that the “second phase” has to do with consumption patterns, the first process is supposed to take place uniformly across society - regardless of individual and collective behaviours, since it results from production-side changes. It is mostly linked to the extension of the lifetime of durable goods such as large and small household appliances, furniture and other equipment. As time passes by and equipment is worn out, built-in obsolescence and low-quality goods are replaced by long lifetime, higher-quality goods.¹⁴ In a sense, this first process is the “passive”, inertial result of changes conducted on the production side during the first phase. As a simplification, I will not make the two types of durable goods (with respect to their quality), their lifetimes and their prices explicit. The result of this progressive replacement,

¹³This categorisation and the following descriptions are not meant to be a precise and exhaustive account of all the changes that a degrowth transition entails. It should be understood as a simplification that is meant to illustrate the abstract idea of transition with a few examples.

¹⁴This does not necessarily mean expensive, luxury goods. For instance, large household appliances made before the era of built-in obsolescence were not luxury goods. In other words, when comparing these low and high quality goods, the ratio of lifetimes is much higher than the ratio of prices.

however, is that the overall nominal demand for durable goods goes down over time.¹⁵

The second process, as opposed to the first one, highly depends on individual and collective choices. As said before, so-called “enabling” investments have been completed during the first phase of the ecological transition. The remaining issue is whether people will embrace the newly available ecological mode of living or go on with their previous consumption and transportation habits. Simply said, will people keep using their cars or abandon them and use the new and efficient public transport system, coupled with smooth modes of transport like cycling? The first option means that the car industry, and all the activities associated with it (maintenance, advertisement, fuelling, electronic devices, insurance...) are maintained, despite the existence of ecological alternatives. The second option means that a substantial part of the economic activity of modern industrialised countries is progressively winded down.

Theoretical and methodological choices

The choice of post-Keynesian economic theory

Surely, theoretical research is easier to do with a theoretical framework. Since reinventing macroeconomic theory within my PhD time would have been a little too ambitious, I preferred using an already existing framework. Why choosing post-Keynesian theory?

Mainstream macroeconomics was never an option. For decades, heterodox economists of all schools of thought have pointed out and demonstrated how “conventional” macro is based on unrealistic assumptions and uses dubious methods. Mainstream macroeconomics, whose adepts simply call macroeconomics, is so wrong that some of their most prominent figures have called for a serious rethinking of it (Romer 2016; Stiglitz 2018). The following quote from Paul Romer, former Chief Economist of the World Bank and co-recipient of the 2018 prize of the Royal Bank of Sweden in memory of Alfred Nobel, gives an idea of how dysfunctional this framework has become: “In the last three decades, the methods and conclusions of macroeconomics have deteriorated to the point that much of the work in this area no longer qualifies as scientific research.” (Romer 2016) In a recent assessment Jeremy B. Rudd, a member of the Federal Reserve Board since 1999, and former economist and Deputy Assistant Secretary at the U.S. Department of the Treasury, is not any less harsh: “Mainstream economics is replete with ideas that ‘everyone

¹⁵It should be noted that some services, linked to maintenance and repairing of appliances, would probably increase in size. The assumption is made here that the net GDP balance of the decrease in production of these goods and the increase in associated services is negative.

knows' to be true, but that are actually arrant nonsense.” (Rudd 2022, p. 25) Moreover, Rudd warns about the dangerous and harmful use of such a nonsensical theory in the real world:

One natural source of concern is if dubious but widely held ideas serve as the basis for consequential policy decisions. I leave aside the deeper concern that the primary role of mainstream economics in our society is to provide an apologetics for a criminally oppressive, unsustainable, and unjust social order. [The second sentence is a footnote] (Rudd 2022, p. 26)

Among the most crucially wrong elements of mainstream macroeconomic theory, one finds the loanable funds view concerning the link between saving and investment. According to this view, in order to be financed, investment is dependent on pre-existing amounts of savings that are channeled from lenders to borrowers through the banking and financial system. The interest rate is the variable that adjusts in order to equate the demand for investment from borrowers with the supply of funds from lenders. In the perspective of growth, this theory implies that in order to grow at a faster rate, consumers need to accept consuming less in the short run in order to save more and thus lend more funds to investors, achieve a higher rate of investment and a higher rate of growth. Post-Keynesian economists have explained in great detail and for a long time why this view is wrong. Money is endogenous, “credits make deposits”, and investment does not require pre-existing loanable funds in order to be financed. The reason why I take the loanable funds view as an example of misleading mainstream theory is that it generates obvious nonsensical reasoning. In reality, reducing consumption does not boost economic growth because when firms see their sales going down, their expectations about future sales decrease, they decide to produce and invest less and as a result aggregate demand shrinks and the rate of growth decreases. Reversing the dynamics, in a degrowth perspective, shows even more clearly how mainstream theory leads to absurd reasonings. In order to lower the rate of growth, consumers would need to supply less funds to investors, hence save less and consume more. Said differently and in a condensed form: *In order to reduce the size of an economy, consumption should increase.* With this in mind, I was confident that I would not miss much by ignoring mainstream macroeconomics.

Economics outside the mainstream is rich and diverse. Several heterodox schools of thought provide useful insights for the understanding of macroeconomic dynamics, for instance Marxian economics, world system and dependency theories, and social structures of accumulation and French regulation theories. Yet, I did not select post-Keynesian theory by chance. Post-Keynesian Economics (PKE) and Ecological Economics (EE) have a number of points in common and, at the same time, they are complementary since each of them developed knowledge on

separate topics (Kronenberg 2010). This makes PKE particularly adapted for the study of the macroeconomics of degrowth.

More precisely, Kronenberg (2010) finds that EE and PKE share a “dislike of aggregation”, that both schools tend to use fixed technology coefficients for the description of production processes, and that they stress the importance of “path dependence and the irreversibility of decisions”. Based on the analysis of Lavoie (2006), Kronenberg (2010) recalls that both EE and PKE “stress the importance of fundamental uncertainty”, and “believe that consumer behaviour is very much driven by habits as long as no fundamental changes occur”. Finally, Kronenberg (2010) explains: “ecological economists argue that people may have lexicographic preferences, especially with respect to choices that involve the extinction of a species or some such thing. Lavoie argues that this perspective is closely related to what post-Keynesians call the subordination of needs.”

Many of these elements are present in one or several of the models that I design and use in this dissertation: the disaggregation of production sectors, the use of fixed technology coefficients, path dependence, the need to operate systemic changes in order to allow consumption patterns to change, and consumption behaviours that distinguish and prioritise between different categories of goods and services.

In addition to the theoretical compatibility between ecological economics and post-Keynesian economics, several key elements of post-Keynesian theory are particularly useful to produce sensible macroeconomic analyses of a degrowth transition.

First, PKE emphasises that the distribution of income has a great influence on the level of economic activity. In chapter 1 I distinguish between three categories of households with different propensities to consume: “blue-collar” workers, “white-collar” workers, and capitalists. Among other things, I study the macroeconomic impacts of taxes and changes in the income of some of these categories.

Second, the theory of endogenous money, combined with the recognition that productive capacities are generally under-utilised, give very different macroeconomic outcomes in the context of massive public and private investments (the first phase described above). While mainstream theory indicates that households should accept to cut on consumption in order to finance and free up productive capacity for these investments, post-Keynesian theory shows that these investments can add extra economic activity and therefore create macroeconomic rebound effects. Chapter 2 explains this in more detail. It also shows how a reduction in consumption can be the *result* of green investments, instead of the *condition* for them to take place.

Third, the “paradox of thrift”, which is a cornerstone of post-Keynesian macroeconomics, is key to understand correctly the macroeconomic impacts of reductions in consumption. I emphasise it particularly in the first chapter, however this paradox plays a role in all parts of this work.

Fourth, post-Keynesian economics has a tradition of formalising the theory with models. This is obviously not the only way to do theory, but I find that formalisation can sometimes help clarify and check the consistency of theoretical reasonings.

The modelling approach

The transitions that are needed in order to degrow an economy in a just and convivial way to a state where it can be ecologically sustainable are numerous and far-reaching. Nearly all aspects of our mode of living will be affected: the kind of resources we extract, what we produce and how, the ways we value and exchange goods and services, our cultures of consumption, and the relation we have with waste. In order to study such complex systems and changes, two main approaches can be distinguished.

The first approach consists in integrating complexity in the models and therefore try to integrate as many dimensions as possible in generally very large models such as the well-known Integrated Assessment Models (IAMs). The use of IAMs has become the bread and butter of environmental economics. For instance, the scenarios that the working group III of the IPCC considers for its assessment of the possibilities to mitigate climate change are produced by IAMs. These models can probably be useful, especially when it comes to the design of transitions in complex systems like energy, agriculture or transportation, and for studying the interdependencies between sectors. However, they all generally suffer from the so-called “black box” syndrome, meaning it is so complex that the understanding of simultaneously interacting mechanisms and the interpretation of results can become highly difficult or uncertain. The model “works” (meaning it gives a result), but no one really knows how it reaches the result. In *The Entropy Law and the Economic Process* (1971), Georgescu-Roegen, one of the founding fathers of the heterodox school of ecological economics, raised this concern, arguing that such complex models move beyond “our mental control”, which is problematic in social sciences where one cannot rely on perfectly precise measurements (Georgescu-Roegen 1971).

The second approach is referred to by Georgescu-Roegen as “simple-minded” models which he considers to be more informative. This approach requires to “pick up a few but significant elements from the multitude of cluttering facts” (Georgescu-Roegen 1971, p. 340).¹⁶

I tend to agree with Georgescu-Roegen’s views on modelling. Therefore, in this dissertation, I follow the second approach. For each question that I raise, I build the simplest model that is able to illustrate the issues and mechanisms at

¹⁶For a detailed presentation of Georgescu-Roegen’s contribution to economic methodology, see Couix (2021).

play. The parts of the economy that are not directly related to the question are left as simple as possible in the model in order to keep clear the interpretation of results and the narrative, without hampering the pertinence of the mechanisms put forward.¹⁷ Thus, the models presented in this work remain theoretical tools which I use for a limited number of purposes only. Morgan (2008) proposes a typology of the functions of models: “fitting theories to the world”, “modelling as theorising” and “investigative instruments”. My position here is to use the last two functions only, both because of scepticism with respect to the first function in social sciences, and because there is no such thing, yet, as an experience of degrowth at a macroeconomic scale. More precisely, I use a model in order to (i) check the theoretical consistency of a reasoning, (ii) explore various assumptions and parameter values for which it would not necessarily be straightforward to guess the results in a dialectical approach, (iii) illustrate the narratives with simulation graphs, and (iv) make more explicit some potentially counter-intuitive results.

As usual for toy models, numerical values for parameters and initial conditions for exogenous variables are chosen without aiming for a precise representation of the reality of any particular economy. Nevertheless, in order to show that the models are not absurd abstractions totally decorrelated from reality, they are calibrated with realistic data. They represent, roughly, a country or group of countries from continental Western Europe.¹⁸ As a result, the final numerical results should not be treated too seriously, quantitatively speaking. The interest of the results lie in the qualitative observations, comparisons and discussions.

The choice of neo-Kaleckian and stock-flow consistent models

Each of the chapters of this dissertation presents a specific macroeconomic model, adapted for each issue considered. In chapter 1 I build a neo-Kaleckian model, with equations and graphs but no numerical simulations. In the three other chapters, I (we, in chapter 2) build Stock-Flow Consistent (SFC) models and produce numerical simulations of scenarios with different dynamics of consumption and investment, and different budgetary policies. I explain below the reasons why I chose to use these kinds of macroeconomic models.

Neo-Kaleckian models of growth and distribution are somehow the “workhorse” type of models of many post-Keynesian macroeconomists. They are simple and easily transposed into graphs that can help with the analysis and the communication of macroeconomic mechanisms. Yet, they contain several essential elements of

¹⁷This approach is in line with the one adopted by Godley and Lavoie (2012) and Le Heron and Mouakil (2008). The latter focuses on the banking system and therefore unfolds this sector in great detail, leaving the rest of the model as simple as possible in order to keep it workable and understandable

¹⁸In chapter 2, we conduct a more precise calibration, based on data for the EU-27.

Keynesian and post-Keynesian theory, like the principle of effective demand, the paradox of costs, and the paradox of thrift. They are at the centre of many books of post-Keynesian theory, for instance Hein (2014). Moreover, neo-Kaleckian models have the following additional advantages: (i) they integrate demand and supply considerations, yet preserve the idea that economic activity is demand-led, (ii) they articulate short-run and medium-run dynamics, and can provide insights regarding the stability of macroeconomic equilibria, and (iii) they can be extended while remaining simple.

As a first step in my exploration of the macroeconomics of degrowth with the use of post-Keynesian theory, and as I was concerned with issues related to macroeconomic stability and to the rate of profit, it seemed logical to me to start with this simple yet very informative kind of model. Then, as I felt the need to integrate various types of stocks into my analyses (stocks of public debt, of private wealth, of different kinds of capital, and of durable goods), I decided to turn to a type of model specially designed for the integration of stocks with flows: the so-called Stock-Flow Consistent (SFC) models.

Developed in a systematic manner by Godley and Lavoie (2012),¹⁹ the SFC approach has proved useful to explain complex macroeconomic and financial dynamics, among which the Great Financial Crisis of 2007-08. It has recently started to become popular in the ecological macroeconomics literature (Dafermos and Nikolaidi 2021; Dafermos, Nikolaidi, and Galanis 2017b; Hafner et al. 2020; Jackson 2019; Monasterolo and Raberto 2018; Naqvi and Stockhammer 2018).

Stock-flow consistent models have many advantages. I list a few of them:

- they keep explicit track of all monetary flows between sectors and categories of agents (like most macroeconomic models do), but also take monetary stocks into account (assets and liabilities). The latter feature is less common in macroeconomics, and allows the modeller to study elaborate dynamics. For instance, flows of income and spending have effects on stocks of wealth but, conversely, it is also possible to account for the effects of changes in stocks (including revaluation due to changes in asset prices) on consumption and investment spending decisions. Moreover, one can study wealth inequality, on top of income inequality;
- besides monetary stocks, it is also possible to include physical stocks in SFC models and to represent interactions between them and economic variables. Physical stocks can refer to energy, matter, or durable goods, and allow for detailed assessments of sustainability through the use of ecological indicators that complement the more traditional socio-economic indicators;

¹⁹For a detailed description of the origins and the principles of stock-flow consistent modelling, see Godley and Lavoie (2012).

- SFC models allow for complex dynamics to take place: out-of-equilibrium dynamics, instability, rebound effects and path dependence, which play a key role in the structural changes that are expected to take place as a result of the ecological transition.

The SFC models I design in this dissertation do not feature all of these characteristics and dynamics at the same time. In particular, they are very stable kinds of models and do not produce unstable trajectories. Still, I exploit a fair share of the possibilities that SFC models can offer. The phenomenons of path dependence and rebound effects take place, one model features stocks of durable goods, and the interactions between stocks and flows are key for the dynamics of the three models, especially with respect to the stocks of private wealth, public debt, and private and public capital.

Remarks on population issues

I would like to finish this section on theoretical and methodological choices with two remarks related to population.

First, let me briefly explain why I decided not to include population growth in my investigations and models. The main reason is that the degrowth transitions I deal with are intended to take place in high-income countries, in which population growth is generally close to zero or even slightly negative. Therefore, it seems reasonable to take this variable as a constant and focus on other drivers of economic dynamics.

Second, I would like to warn against an idea that may arise in the mind of someone looking coldly at the “Kaya” or “IPAT” equation (Impact = Population x Affluence x Technology). According to this idea, a decrease in global population is unavoidable in order to reduce environmental pressures and solve the environmental problems humanity is facing. Unless in the case of extremely numerous premature deaths, which I hope is not what advocates of reductions in population are supporting in reality, global population is going to remain above seven billion for many decades even if fertility rates were immediately shrinking across the globe. Environmental pressures need to be dramatically curbed within a couple of years. Moreover, the distribution of ecological footprint across countries and across population groups is highly unequal. In the countries or regions in which population is still growing today, per capita ecological footprints are tiny compared to the regions in which population remains constant.²⁰ To put it in a provocative

²⁰To realise the extent of these differences, a few numbers may prove useful. Timothée Parrique gathered some telling comparisons: “the poorest half of humanity causes only 12% of global greenhouse gas emissions while the richest 10% generate almost half of all emissions. Let that sink in: the top 1% richest individuals (16.8% of global emissions) emit more than the 2.5 billion

manner, if population is an issue with respect to environmental degradation, then the problem is that the United States are too populated, not that the fertility rates in Sub-Saharan Africa are too high. I doubt this is what advocates of a decline in global population have in mind. This is just a provocative statement because, in reality, population is not the issue. Affluence is. From this, the fairest way forward is not to prevent people from migrating from poor to rich countries, but rather to reduce affluence in the latter.

With respect to global population like for the issue of technology, we need to find pathways towards sustainability that take some constraints into account rather than imagining that they could be magically removed. Population and technology are not as flexible variables as some people would like them to be.

Structure of the thesis

The four chapters of this thesis are organised in such a way as to present a logical progression. The first chapter explores some basic theoretical conditions that must be met for a degrowth transition to have a chance of occurring, in the context of a capitalist economic system.²¹ It checks whether an economy can remain stable while its rate of growth is negative. It looks at stability with respect to production and consumption (i.e. to the goods market), rather than dealing with financial stability. It also verifies that the rate of profit can remain positive during the transition.

Indeed, if small fluctuations in aggregate demand could make the economy diverge from a trajectory of progressive downscaling and push it onto a path of undesired, spiralling, and accelerating recession, it would perhaps not be worth exploring other issues before finding ways to prevent such catastrophic dynamics. Or if the rate of profit could not remain positive while the economy degrows, then it would make no sense to continue exploring a transition within current economic structures.

After showing that these conditions can be met, chapter 1 suggests and illustrates two complementary transition mechanisms: adopting more simple and ecological

poorest individuals. [...] The one billion richest individuals consume 72% of global resources, while the 1.2 billion poorest accounts for just 1%. The bottom half of the population uses only 20% of the world's final energy footprint, which is less than what the top 5% consume."

Source: <https://parole.cc/none/look-up-climate-change-is-not-a-crisis-its-a-beating/>

²¹In order to avoid any misunderstanding, let me clarify again this point. Preserving or remaining within the capitalist system is far from being an objective of the degrowth movement/paradigm, which, instead, tends to promote anti-capitalist values and to aim at the extinction of capitalism. My approach is simply to check whether a degrowth transition can begin to occur within the existing system.

modes of living can pull the economy toward a sustainable composition and size; income and fiscal policies can prevent from going back to anti-ecological growth.

The second chapter explores in more detail how the two phases I mentioned earlier (the green investment phase and the change in consumption patterns phase) can be integrated together in an original way. Thus, it focuses on the combination of different drivers of the transition. It is argued that the dynamics of investment and consumption are not opposed to each other, and can instead form two complementary parts of a degrowth transition. In a sense, we propose a ground for reconciling the proponents of a “Green New Deal” type of programme and the advocates of a shift towards the degrowth paradigm. In this chapter, we make a distinction between different types of green public investment based on their effects on economic activity, carbon intensity and the consumption patterns of households. Some of these investments can enable more simple lifestyles and sufficiency-oriented consumption patterns, thus lead to a reduction in the consumption of environmentally harmful goods. We analyse the macroeconomic implications of both the increase in investments and the decrease in consumption, paying particular attention to the role of macroeconomic rebound effects. We show that, although these changes can impact employment and the profitability of firms negatively, the effects are only transitory ; the sector that is downscaled remains viable.

The third chapter continues to link together the driving factors of the transition and their possible socio-economic consequences. It looks at the specific case of the fast obsolescence of goods, and establishes a theoretical link between accelerated obsolescence and interpersonal inequality of effective disposable income and of wealth between workers and capitalists. Thanks to this link, it shows that fighting against accelerated obsolescence does not necessarily lead to an opposition between economic and environmental objectives, provided one accepts that the accumulation of wealth for capitalists is not part of these objectives. In fact, slowing down obsolescence may be sensible both socio-economically and environmentally. It would be beneficial to wage-earners while reducing pressures on the environment; the only losers would be profit-earners. Importantly, this result holds despite the fact that capitalist households can benefit from the reduction in their constrained expenditures like worker households do.

Last but not least, the fourth chapter investigates the possibilities for maintaining a fully financed public pension scheme in an economy that is gradually downscaled. Hence, after having checked for some conditions of feasibility in chapter 1, and after having analysed how the transition could happen and explained some of its socio-economic implications in chapters 2 and 3, the dissertation tackles one of the key dimensions of the question raised by Kallis (2011, p. 874): “whether this [sustainable degrowth] can happen in a *socially* and environmentally sustainable way” (own emphasis).

This last chapter demonstrates that an increase in the contribution rates for pensions can simultaneously satisfy ecological, economic and social criteria. More precisely, such an increase allows for (i) taming the rebound effect that can otherwise appear when constrained consumption is reduced - hence, the positive ecological outcome of the initial reduction in consumption is preserved, (ii) a full financing of the pension scheme, where the level of pensions is maintained without relying on public deficits, and the debt-to-GDP ratio is stabilised, and (iii) a satisfying outcome in terms of intergenerational fairness. The logic is then extended to show that it is possible to guarantee the full financing of a much broader range of social protection and any kind of public services, for instance education, health, sanitation, safety, justice, and administration.

This thesis demonstrates that a degrowth transition can reduce the environmental impacts of human activities while preserving and even improving socio-economic conditions and quality of life. These results run counter to the claims of opponents of degrowth that degrowth can only produce social and economic distress.

Bibliography of the current chapter

- Alcott, Blake (Jan. 2013). “Should Degrowth Embrace the Job Guarantee?” In: *Journal of Cleaner Production* 38, pp. 56–60.
- Althouse, Jeffrey (2022). “Ecological Macroeconomics for a Shared Planet: Towards a Global Political Ecology of Money, Finance and Production”. Université Sorbonne Paris Nord.
- Althouse, Jeffrey, Giulio Guarini, and Jose Gabriel Porcile (2020). “Ecological Macroeconomics in the Open Economy: Sustainability, Unequal Exchange and Policy Coordination in a Center-Periphery Model”. In: *Ecological Economics* 172, p. 106628.
- Bank, World (2012). *Inclusive Green Growth: The Pathway to Sustainable Development*. World Bank Publications.
- Barker, Terry, Athanasios Dagoumas, and Jonathan Rubin (Nov. 2009a). “The Macroeconomic Rebound Effect and the World Economy”. In: *Energy Efficiency* 2.4, pp. 411–427.
- Berg, Matthew, Brian Hartley, and Oliver Richters (Jan. 20, 2015). “A Stock-Flow Consistent Input–Output Model with Applications to Energy Price Shocks, Interest Rates, and Heat Emissions”. In: *New Journal of Physics* 17.1, p. 015011.
- Berr, Eric (2009). “Le Développement Soutenable Dans Une Perspective Post Keynésienne: Retour Aux Sources de l’écodéveloppement”. In: *Économie appliquée* 62.3, pp. 221–244.

- Brand, Ulrich and Markus Wissen (2013). “Crisis and Continuity of Capitalist Society-Nature Relationships: The Imperial Mode of Living and the Limits to Environmental Governance”. In: *Review of International Political Economy* 20.4, pp. 687–711.
- (2021). *The Imperial Mode of Living: Everyday Life and the Ecological Crisis of Capitalism*. Verso Books.
- Briens, François (2015). “La Décroissance Au Prisme de La Modélisation Prospective: Exploration Macroéconomique d’une Alternative Paradigmatique”. Ecole Nationale Supérieure des Mines de Paris.
- Cahen-Fourot, Louison, Emanuele Campiglio, et al. (2020). “Looking for the Inverted Pyramid: An Application Using Input-Output Networks”. In: *Ecological Economics* 169, p. 106554.
- Cahen-Fourot, Louison and Marc Lavoie (June 2016). “Ecological Monetary Economics: A Post-Keynesian Critique”. In: *Ecological Economics* 126, pp. 163–168.
- Coux, Quentin (2021). “Models as ‘Analytical Similes’: On Nicholas Georgescu-Roegen’s Contribution to Economic Methodology”. In: *Journal of Economic Methodology* 28.2, pp. 165–185.
- D’Alisa, Giacomo, Federico Demaria, and Giorgos Kallis (2014). *Degrowth: A Vocabulary for a New Era*. Routledge.
- D’Alessandro, Simone et al. (2020). “Feasible Alternatives to Green Growth”. In: *Nature Sustainability* 3.4, pp. 329–335.
- Dafermos, Yannis and Maria Nikolaidi (2021). “How Can Green Differentiated Capital Requirements Affect Climate Risks? A Dynamic Macrofinancial Analysis”. In: *Journal of Financial Stability* 54, p. 100871.
- Dafermos, Yannis, Maria Nikolaidi, and Giorgos Galanis (Jan. 2017a). “A Stock-Flow-Fund Ecological Macroeconomic Model”. In: *Ecological Economics* 131, pp. 191–207.
- (2017b). “A Stock-Flow-Fund Ecological Macroeconomic Model”. In: *Ecological Economics* 131, pp. 191–207.
- (Oct. 2018). “Climate Change, Financial Stability and Monetary Policy”. In: *Ecological Economics* 152, pp. 219–234.
- Dittmer, Kristofer (Sept. 2013). “Local Currencies for Purposive Degrowth? A Quality Check of Some Proposals for Changing Money-as-Usual”. In: *Journal of Cleaner Production* 54, pp. 3–13.
- (2014). “Alternatives to Money-as-usual in Ecological Economics: A Study of Local Currencies and 100 Percent Reserve Banking”. ICTA & UAB.
- (Jan. 2015). “100 Percent Reserve Banking: A Critical Review of Green Perspectives”. In: *Ecological Economics* 109, pp. 9–16.

- Fanning, Andrew L et al. (2022). “The Social Shortfall and Ecological Overshoot of Nations”. In: *Nature Sustainability* 5.1, pp. 26–36.
- Fontana, Giuseppe and Malcolm Sawyer (Sept. 2013). “Post-Keynesian and Kaleckian Thoughts on Ecological Macroeconomics”. In: *European Journal of Economics and Economic Policies: Intervention* 10.2, pp. 256–267.
- (Jan. 2016). “Towards Post-Keynesian Ecological Macroeconomics”. In: *Ecological Economics* 121, pp. 186–195.
- Gadrey, Jean and Florence Jany-Catrice (2010). *Les Nouveaux Indicateurs de Richesse*. La découverte.
- Georgescu-Roegen, Nicolas (1971). *The Entropy Law and the Economic Process*. Harvard University Press.
- Godin, Antoine (2012). “Guaranteed Green Jobs: Sustainable Full Employment”. In: *Levy Economics Institute of Bard College Working Paper* 722.
- Godley, Wynne and Marc Lavoie (2012). *Monetary Economics: An Integrated Approach to Credit, Money, Income, Production and Wealth*. Basingstoke: Palgrave Macmillan.
- Haberl, Helmut et al. (2020). “A Systematic Review of the Evidence on Decoupling of GDP, Resource Use and GHG Emissions, Part II: Synthesizing the Insights”. In: *Environmental Research Letters* 15.6, p. 065003.
- Hafner, Sarah et al. (2020). “Emergence of New Economics Energy Transition Models: A Review”. In: *Ecological Economics* 177, p. 106779.
- Hardt, Lukas and Daniel W. O’Neill (Apr. 2017). “Ecological Macroeconomic Models: Assessing Current Developments”. In: *Ecological Economics* 134, pp. 198–211.
- Harris, Jonathan M. (2008). *Ecological Macroeconomics: Consumption, Investment, and Climate Change*.
- Hein, Eckhard (2014). *Distribution and Growth after Keynes: A Post-Keynesian Guide*. Cheltenham, UK: Edward Elgar Publishing. 551 pp.
- Hickel, Jason (2020). *Less Is More: How Degrowth Will Save the World*. Random House.
- Hickel, Jason and Giorgos Kallis (Apr. 17, 2019). “Is Green Growth Possible?” In: *New Political Economy*, pp. 1–18.
- Holt, Richard PF, Steven Pressman, and Clive L Spash (2009). *Post Keynesian and Ecological Economics: Confronting Environmental Issues*. Cheltenham: Edward Elgar.
- Hubacek, Klaus et al. (2021). “Evidence of Decoupling Consumption-Based CO₂ Emissions from Economic Growth”. In: *Advances in Applied Energy* 4, p. 100074.
- IPCC (2018). *Global Warming of 1.5 C: Summary for Policy Makers*. Intergovernmental Panel on Climate Change.

- IPCC, Working Group III (2022). *Climate Change 2022 - Mitigation of Climate Change - Summary for Policymakers*.
- Jackson, Tim (2005). “Live Better by Consuming Less?: Is There a “Double Dividend” in Sustainable Consumption?” In: *Journal of Industrial Ecology* 9.1-2, pp. 19–36.
- (2009a). *Prosperity without Growth: Economics for a Finite Planet*. Routledge.
- (2009b). *Prosperity without Growth: Economics for a Finite Planet*. London: Earthscan. 264 pp. ISBN: 978-1-84407-894-3.
- (2019). “The Post-Growth Challenge: Secular Stagnation, Inequality and the Limits to Growth”. In: *Ecological Economics* 156, pp. 236–246.
- Jackson, Tim and Peter Victor (June 2011). “Productivity and Work in the ‘Green Economy’”. In: *Environmental Innovation and Societal Transitions* 1.1, pp. 101–108.
- Jackson, Tim and Peter A Victor (2020). “The Transition to a Sustainable Prosperity—a Stock-Flow-Consistent Ecological Macroeconomic Model for Canada”. In: *Ecological Economics* 177, p. 106787.
- (Dec. 2015). “Does Credit Create a Growth Imperative? A Quasi-Stationary Economy with Interest-Bearing Debt”. In: *Ecological Economics* 120, pp. 32–48.
- (Jan. 2016). “Does Slow Growth Lead to Rising Inequality? Some Theoretical Reflections and Numerical Simulations”. In: *Ecological Economics* 121, pp. 206–219.
- Kallis, Giorgos (Mar. 2011). “In Defence of Degrowth”. In: *Ecological Economics* 70.5, pp. 873–880.
- (2018). *Degrowth. The Economy - Key Ideas*. Newcastle upon Tyne: Agenda.
- Kallis, Giorgos et al. (2018). “Research on Degrowth”. In: *Annual Review of Environment and Resources* 43, pp. 291–316.
- Kronenberg, Tobias (2010). “Finding Common Ground between Ecological Economics and Post-Keynesian Economics”. In: *Ecological Economics* 69.7, pp. 1488–1494.
- Lange, Steffen (2016). “Macroeconomics Without Growth - Sustainable Economies in Neoclassical, Post-keynesian and Marxian Theories”. PhD thesis. University of Hamburg. 549 pp.
- Latouche, Serge (2016). *Les Précurseurs de La Décroissance: Une Anthologie*. Le passager clandestin.
- Lavoie, Marc (2006). “Do Heterodox Theories Have Anything in Common? A Post-Keynesian Point of View”. In: *European Journal of Economics and Economic Policies: Intervention* 3.1, pp. 87–112.
- Le Heron, Edwin and Tarik Mouakil (2008). “A Post-Keynesian Stock-Flow Consistent Model for Dynamic Analysis of Monetary Policy Shock on Banking Behaviour”. In: *Metroeconomica* 59.3, pp. 405–440.

- Magalhaes, Nelo (2021). “The Green Investment Paradigm: Another Headlong Rush”. In: *Ecological Economics* 190, p. 107209.
- Mercure, J-F et al. (2018). “Macroeconomic Impact of Stranded Fossil Fuel Assets”. In: *Nature Climate Change* 8.7, pp. 588–593.
- Monasterolo, Irene and Marco Raberto (2018). “The EIRIN Flow-of-Funds Behavioural Model of Green Fiscal Policies and Green Sovereign Bonds”. In: *Ecological Economics* 144 (July), pp. 228–243.
- Morgan, Mary (2008). “Models”. In: *The New Palgrave Dictionary of Economics*. Palgrave Macmillan. London, pp. 1–14.
- Naqvi, Asjad (2015). *Modeling Growth, Distribution, and the Environment in a Stock-Flow Consistent Framework*.
- Naqvi, Asjad and Engelbert Stockhammer (2018). “Directed Technological Change in a Post-Keynesian Ecological Macromodel”. In: *Ecological Economics* 154, pp. 168–188.
- Nieto, Jaime et al. (2020). “An Ecological Macroeconomics Model: The Energy Transition in the EU”. In: *Energy Policy* 145, p. 111726.
- OECD (2011). *Towards Green Growth*. Paris: Organisation for Economic Cooperation and Development.
- Padalkina, Dina (2012). “The Macroeconomics of Degrowth - Can a Degrowth Strategy Be Stable”. In: Montreal International Conference on Degrowth in the Americas.
- Parrique, Timothée (2019). “The Political Economy of Degrowth”. Université Clermont Auvergne.
- Parrique, Timothée et al. (2019). *Decoupling Debunked - Evidence and Arguments against Green Growth as a Sole Strategy for Sustainability*. Brussels: European Environmental Bureau, p. 80.
- Pirgmaier, Elke (2020). “Consumption Corridors, Capitalism and Social Change”. In: *Sustainability: Science, Practice and Policy* 16.1, pp. 274–285.
- Research & Degrowth (2010). “Degrowth Declaration of the Paris 2008 Conference”. In: *Journal of Cleaner Production* 18.6, pp. 523–524.
- Rezai, Armon and Sigrid Stagl (2016). “Ecological Macroeconomics: Introduction and Review”. In.
- Richters, Oliver and Andreas Siemoneit (June 2017). “Consistency and Stability Analysis of Models of a Monetary Growth Imperative”. In: *Ecological Economics* 136, pp. 114–125.
- Rockström, Johan et al. (2009). “Planetary Boundaries: Exploring the Safe Operating Space for Humanity”. In: *Ecology and Society* 14.2.
- Romer, Paul (2016). “The Trouble with Macroeconomics”. The Commons Memorial Lecture of the Omicron Delta Epsilon Society/Stern School of Business.

- Røpke, Inge (2001). “The Environmental Impact of Changing Consumption Patterns: A Survey”. In: *International Journal of Environment and Pollution* 15.2, pp. 127–145.
- (2005). “Consumption in Ecological Economics”. In: *Online Encyclopaedia of Ecological Economics*.
- (2009). “Theories of Practice—New Inspiration for Ecological Economic Studies on Consumption”. In: *Ecological economics* 68.10, pp. 2490–2497.
- (2011). “Ecological Macroeconomics-Calling for a Shift from Consumption to Investment”. In: *Socio-Technical Transitions, Social Practices, and the New Economics: Meeting the Challenges of a Constrained World: SCORAI Workshop*.
- Rosenbaum, Eckehard (May 19, 2015). “Zero Growth and Structural Change in a Post Keynesian Growth Model”. In: *Journal of Post Keynesian Economics* 37.4, pp. 623–647.
- Rudd, Jeremy B (2022). “Why Do We Think That Inflation Expectations Matter for Inflation?(And Should We?)” In: *Review of Keynesian Economics* 10.1, pp. 25–45.
- Saunders, Harry D (2000). “A View from the Macro Side: Rebound, Backfire, and Khazzoom-Brookes”. In: *Energy Policy*, p. 11.
- Schmelzer, Matthias, Andrea Vetter, and Aaron Vansintjan (2022). *The Future Is Degrowth: A Guide to a World Beyond Capitalism*. Verso. 320 pp.
- Schneider, François, Giorgos Kallis, and Joan Martinez-Alier (2010). “Crisis or Opportunity? Economic Degrowth for Social Equity and Ecological Sustainability. Introduction to This Special Issue”. In: *Journal of cleaner production* 18.6, pp. 511–518.
- Schor, Juliet B. (2005). “Sustainable Consumption and Worktime Reduction”. In: *Journal of Industrial Ecology* 9.1-2, pp. 37–50.
- Semieniuk, Gregor et al. (2021). *Stranded Fossil-Fuel Assets Translate into Major Losses for Investors in Advanced Economies*. UMass Working Paper, Forthcoming. Amherst, MA: University of Massachusetts . . .
- Sers, Martin Robert (2021). “Towards an Ecological Macroeconomics: Linking Energy and Climate in a Stock-Flow Consistent Input-Output Framework”. York University (Canada).
- Sovacool, Benjamin K (2021). “Who Are the Victims of Low-Carbon Transitions? Towards a Political Ecology of Climate Change Mitigation”. In: *Energy Research and Social Science* 73, p. 101916.
- Stagl, Sigrid (2013). “Work in a Sustainable Economy”. In.
- (Sept. 1, 2014). “Ecological Macroeconomics: Reflections on Labour Markets”. In: *European Journal of Economics and Economic Policies* 2, pp. 171–181.
- Steffen, Will et al. (2015). “Planetary Boundaries: Guiding Human Development on a Changing Planet”. In: *Science* 347.6223, p. 1259855.

- Stiglitz, Joseph E (2018). “Where Modern Macroeconomics Went Wrong”. In: *Oxford Review of Economic Policy* 34.1-2, pp. 70–106.
- Svartzman, Romain, Dominique Dron, and Etienne Espagne (2019). “From Ecological Macroeconomics to a Theory of Endogenous Money for a Finite Planet”. In: *Ecological Economics* 162, pp. 108–120.
- Taylor, Lance, Armon Rezai, and Duncan K. Foley (2016b). “An Integrated Approach to Climate Change, Income Distribution, Employment, and Economic Growth”. In: *Ecological Economics* 121, pp. 196–205.
- Tordjman, H el ene (2021). *La Croissance Verte Contre La Nature: Critique de l’ cologie Marchande*. Paris: La D ecouverte.
- Treu, Nina, Matthias Schmelzer, and Corinna Burkhart (2020). *Degrowth in Movement (s): Exploring Pathways for Transformation*. John Hunt Publishing.
- Tukker, Arnold et al. (July 2008). “Fostering Change to Sustainable Consumption and Production: An Evidence Based View”. In: *Journal of Cleaner Production* 16.11, pp. 1218–1225.
- Van den Bergh, Jeroen C.J.M. (2011). “Environment versus Growth — A Criticism of “Degrowth” and a Plea for “a-Growth””. In: *Ecological Economics* 70.5, pp. 881–890.
- Van der Slycken, Jonas (2021). “Beyond GDP: Alternative Measures of Economic Welfare for the EU-15”. Ghent University.
- Victor, Peter (2012). “Growth, Degrowth and Climate Change: A Scenario Analysis”. In: *Ecological Economics* 84, pp. 206–212.
- Wiedmann, Thomas et al. (2020). “Scientists’ Warning on Affluence”. In: *Nature communications* 11.1, pp. 1–10.
- Zwickl, Klara, Franziska Disslbacher, and Sigrid Stagl (Jan. 2016). “Work-Sharing for a Sustainable Economy”. In: *Ecological Economics* 121, pp. 246–253.

Chapter 1

Degrowth in a neo-Kaleckian model of growth and distribution? A theoretical analysis of compatibility, stability, and transition dynamics

“Degrowth, a utopia even more dangerous for our nation, goes beyond mere sobriety. Sobriety presupposes measure, restraint, and temperance without which life in society can quickly become difficult. But degrowth is something else: it does not want to moderate, it wants to take off. It does not just restrict, it wants to cut back, trim, take away. We produce too much, we have to produce less. There are too many of us, we must stop reproducing. The proponents of degrowth sometimes have messianic notes: the world is running to its loss, we must stop this race to the abyss. They are suspicious of everything. They see conspiracies everywhere, pharmaceutical companies with their vaccines, car manufacturers with their CO2 emissions, billionaires with their hidden interests.”

Bruno Lemaire, 2021¹

¹Bruno Lemaire is a right-wing French politician. He was Minister of Agriculture from 2009 to 2012 and Minister of Economy and Finance from 2017 to 2022.

Outline of the current chapter

1.1 Introduction	38
1.2 The neo-Kaleckian model of growth and distribution	39
1.3 Zero growth in Kaleckian models: a short review	40
1.3.1 Zero growth and the rate of profit: Cahen-Fourot and Lavoie (2016)	40
1.3.2 Animal spirits and the taxation of saving: Padalkina (2012)	41
1.3.3 The depreciation of capital: Rosenbaum (2015)	43
1.4 A more complex neo-Kaleckian model for the study of a degrowing economy	47
1.4.1 Setting the model out	47
1.4.2 Analysing the model	49
1.5 Dynamics of the degrowth transition	52
1.5.1 Pulling the transition - The voluntary side	53
1.5.2 Pushing the transition - The coercive side	59
1.6 A few side remarks on public debt and deficits	61
1.7 Conclusion	61
1.A Calculations and analytical expressions	62

1.1 Introduction

This chapter investigates the theoretical possibilities for a degrowth transition to take place while preserving macroeconomic stability. More precisely, the objectives are to find (i) whether in a neo-Kaleckian model of growth and distribution an equilibrium with a zero or negative rate of accumulation can exist while the Keynesian stability condition is verified and (ii) which mechanisms could bring the rate of growth from positive to negative values and eventually to a stationary state.

There are two primary reasons to focus on stability: first, a degrowing economy is often thought of as uncontrollable and leading to widespread economic collapse. Second, without short-run (Keynesian) stability, the considered equilibria are not reached at all, and further analyses may become dubious. If on the contrary equilibria with zero or negative growth can be stable, it is possible to envision a degrowth transition during which, even in the face of external shocks, production can decrease smoothly rather than collapse and can eventually stabilise at a sustainable level. The choice of the neo-Kaleckian model is motivated by its ability to (i) integrate supply and demand considerations, yet give effective demand its

full importance,² (ii) articulate short-run and medium-run dynamics, and (iii) be extended while remaining simple.

This chapter is organised as follows. Section 1.2 presents the core of the neo-Kaleckian model and the notations used throughout the chapter. Section 1.3 exposes the principal investigations conducted so far, and highlights some shortcomings of them. In section 1.4, we build and analyse a more complex neo-Kaleckian model that provides both more space for a stable equilibrium of negative growth and more possibilities for the dynamics of transition. Section 1.5 proposes and illustrates two complementary ways to achieve a degrowth transition. One is a progressive voluntary reduction in consumption along with ecological modes of living enabled by public investments. Another deals with income and fiscal policies that can reduce the ability of the wealthy to pursue anti-ecological modes of living and thereby to offset the ecological improvements achieved by a majority of people. Section 1.7 concludes.

1.2 The neo-Kaleckian model of growth and distribution

The core of the neo-Kaleckian model of growth and distribution is composed of three main equations dealing with the rates of profit, saving, and investment (Dutt 1984; Rowthorn 1981). In this canonical version, firms and the capitalists owning them are merged. They employ only direct labour (no overhead labour), produce a unique type of good in a closed economy with no government, and technological change is assumed away.

The gross profit rate is given by:

$$r = \frac{P}{pK} = \frac{P}{pq} \frac{q}{q_{fc}} \frac{q_{fc}}{K} = \frac{\pi u}{\nu} \quad (1.1)$$

where P stands for nominal gross profits, p for the price level, K for real productive capital, q for real output, q_{fc} for real output at full capacity utilisation, π for the profit share, u for the rate of capacity utilisation and ν for the capital to capacity ratio. The price level p is set with a mark-up θ on unit direct costs, thus the profit share $\pi = P/(pq)$ remains constant as long as there is no change in the mark-up:

$$\pi = \frac{\theta}{1 + \theta} \quad (1.2)$$

²The apparent predominance of saving in the model should not hide the fact that its complementary aggregate (consumption) holds a place of equivalent importance.

Since only capitalists are assumed to be able to save (Kalecki 1971), s_p being their propensity to save out of profits, the ratio of aggregate saving S to the nominal capital stock is:

$$g^s = \frac{S}{pK} = \frac{s_p P}{pK} = s_p r \quad (1.3)$$

As for the investment function, we use the 'Kalecki-Steindl' version (Dutt 1990):

$$g^i = \frac{I}{pK} = \gamma + \gamma_u u + \gamma_r r \quad (1.4)$$

At the equilibrium on the goods market, $I = S$, the rate of utilisation and rate of accumulation are:

$$u^* = \frac{\gamma}{(s_p - \gamma_r)\pi/\nu - \gamma_u} \quad (1.5)$$

$$g^* = \frac{\gamma s_p \pi/\nu}{(s_p - \gamma_r)\pi/\nu - \gamma_u} \quad (1.6)$$

For the Keynesian stability condition to hold, the denominator has to be positive:

$$s_p > \gamma_r + \frac{\nu}{\pi} \gamma_u \quad (1.7)$$

which represents the usual condition that aggregate saving needs to react more to a change in utilisation rate than aggregate investment. Said differently, the slope of the saving curve should be greater than that of the investment curve. Figure 1 illustrates this canonical model in the case of Keynesian stability.

1.3 Zero growth in Kaleckian models: a short review

This section proposes a short critical review of recent works that investigate zero or negative growth equilibria in Kaleckian models.

1.3.1 Zero growth and the rate of profit: Cahen-Fourot and Lavoie (2016)

In the canonical model presented above and in some more elaborate models (Sawyer 2017), the rates of growth, utilisation and profit are all proportional to each other. Hence, a zero (resp. negative) rate of growth implies that the rates of utilisation and profit are equal to zero (resp. negative). Such a counter-intuitive result

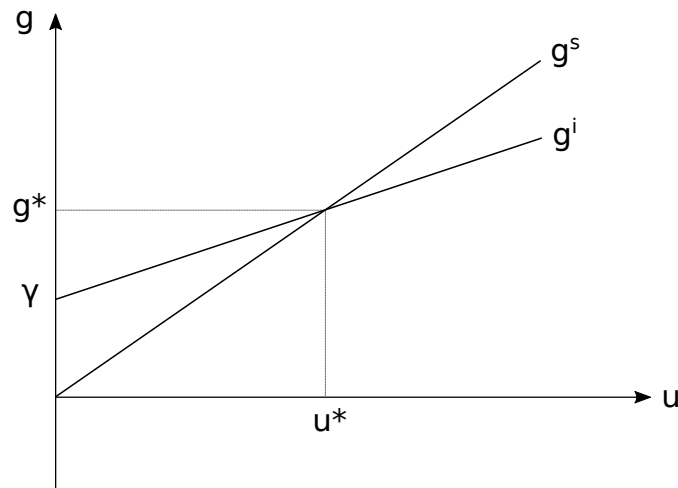

Figure 1.1: The canonical neo-Kaleckian model in the case of Keynesian stability.

suggests that these models must be missing something useful for the study of zero or negative growth. Within a similar simple Cambridge-Kaleckian framework, Cahen-Fourot and Lavoie (2016) show that in a zero-growth full stationary state, profits net of depreciation do not have to be equal to zero but instead can be strictly positive. The critical feature allowing for this is the consumption out of wealth from capitalists. By cancelling out their saving out of profits, it brings overall net saving to zero,³ which is consistent with the requirement of a net investment rate equal to zero in order to have no net accumulation.

Alongside Jackson and Peter A. Victor (2016), Cahen-Fourot and Lavoie show that having positive profits while the rate of growth is zero (therefore $r > g$) does not necessarily imply that the wealth of capitalists grows over time nor that inequality keeps increasing.

However, Cahen-Fourot and Lavoie do not specify any investment function. Thus their model is static in the sense that they cannot conduct a stability analysis to determine the reaction of the economy in case of fluctuations in the rate of utilisation around the state of zero growth. The same holds in Sawyer (2017). To our knowledge, Padalkina (2012) provides the first attempt at such an investigation.

³Saving should not be confused with savings, which refer to a stock of wealth and remain positive.

1.3.2 Animal spirits and the taxation of saving: Padalkina (2012)

In this subsection, we discuss part of the contribution made by Padalkina (2012)⁴ and highlight its limitations.

An essential result of Padalkina is that in the canonical neo-Kaleckian model presented in section 1.2, it is impossible to reconcile zero growth, Keynesian stability, and a positive rate of utilisation.⁵ Indeed the equilibrium rate of growth can be zero in only two cases, both of them being problematic. One option is that animal spirits are depressed to the point where the investment curve has a zero intercept (the parameter γ in the investment function (1.4) is equal to zero) while the slope of the saving curve can remain positive, but this implies zero production.⁶ The other option is that animal spirits are even more depressed (γ is negative, the investment curve shifts further down) and either the propensity to save s_p or the profit share π is equal to zero (for the curves to cross at a point of zero growth). However, in that case, the Keynesian stability condition is violated as g^s is flat while g^i has a positive slope.

Padalkina is aware that to overcome this apparent impossibility one must depart from the canonical model and consider more complex versions of it, especially regarding the saving function. Indeed as long as the intercept of the saving curve is zero one cannot avoid the problem of either Keynesian instability or zero utilisation rate, when looking for an equilibrium with no growth.⁷ The curve g^s needs to shift downwards, so that the rate of growth g^* and the rate of utilisation u^* are no longer proportional to each other. In such a configuration g^* can be equal to zero while u^* remains positive, as illustrated in Figure 1.2.

Yet, we see a problem in the way Padalkina proposes to make the saving curve move downwards. The author proposes to do so through a tax on saving out of profits and wages that would not depend on the rate of utilisation. The issue is that this tax scheme is, in fact, not independent from the rate of utilisation since its revenues depend on the amounts of profits and wages, which themselves depend on the rate of utilisation. Alternatively, Padalkina briefly mentions a tax on factors of production following the idea of Henry George (1879) of a tax on land but does

⁴This author explores the conditions for a zero-growth equilibrium to be stable in both neo-Kaleckian and post-Kaleckian models of growth and distribution. Here we only analyse the neo-Kaleckian work.

⁵To be exact, the neo-Kaleckian model Padalkina uses is slightly different from the one presented in section 1.2 since the investment function in her model does not include the rate of profit. Nonetheless, regarding the question we examine in this chapter, it is straightforward to see that the conclusions are identical.

⁶This becomes evident after noticing that in this configuration g^* and u^* are proportional to each other (see equations (1.5) and (1.6)).

⁷Moreover, as long as the intercept of the saving curve is zero, the model cannot show a negative rate of growth at all.

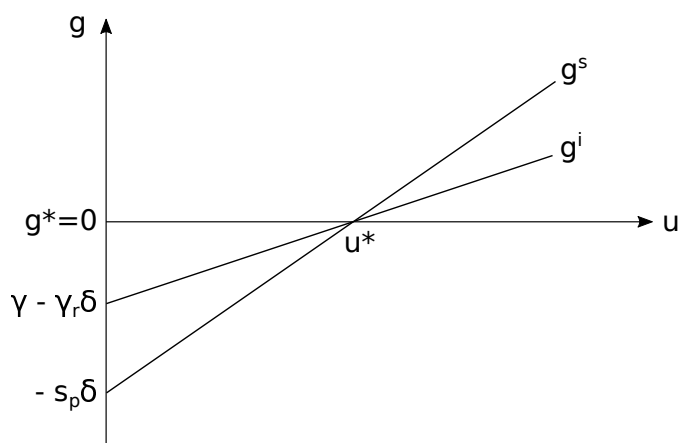

Figure 1.2: Stable equilibrium with zero growth in a neo-Kaleckian model of growth and distribution with capital depreciation and depressed animal spirits.

not develop on it. In this chapter we show that a tax on fixed capital can increase the possibilities for a stable zero-growth equilibrium to exist (section 1.4.2) and can be a driver for a degrowth transition (section 1.5.2). Before moving on, however, it is important to investigate the role of capital depreciation for non-growing or degrowing economies.

1.3.3 The depreciation of capital: Rosenbaum (2015)

In this section, we first present how Rosenbaum (2015) finds the possibility of a zero-growth equilibrium that features Keynesian (i.e., short-run) stability. Then we explain why his attempt to study the medium-run dynamics around zero growth is unsatisfactory and show that his model remains inappropriate for thinking about a transition towards zero growth and *a fortiori* about a degrowth transition.

Short-run dynamics: Finding a stable zero-growth equilibrium

As made clear above, both the saving and investment curves need to shift downwards in order to 'leave space' for the existence of a stable zero-growth equilibrium. Rosenbaum (2015) finds a piece that Padalkina (2012) was missing to progress in the puzzle: while keeping the idea that depressed animal spirits can move the investment curve downwards, he proposes to introduce the depreciation of capital in the model.⁸ On top of enabling the physical disaccumulation of productive capital, depreciation is a cost that reduces the net rate of profit r^n and therefore tends to i) slow down the eagerness to invest and ii) reduce the amount of saving

⁸This feature was already present in Rowthorn (1981).

that capitalists can achieve for a given level of economic activity. Both curves move downwards.

More precisely, the net profit rate reads:

$$r^n = \frac{P - D}{pK} = \frac{\pi u}{\nu} - \delta \quad (1.8)$$

where P still stands for nominal gross profits. Capital depreciation is represented with D in nominal terms and with δ as a share of existing capital pK . Like in the simple model of section 1.2, the gross profit share π remains constant and equal to $\theta/(1 + \theta)$ under simple markup pricing. Saving and investment equations now take this net rate of profit as an argument instead of the gross rate, and g^s and g^i represent the *net* saving rate and *net* investment rate:⁹

$$g^s = s_p r^n \quad (1.9)$$

$$g^i = \gamma + \gamma_u u + \gamma_r r^n \quad (1.10)$$

At the equilibrium on the goods market, net saving equals net investment. One can compute the analytical expressions for the equilibrium rates of utilisation and growth as functions of the parameters of the model, including the rate of depreciation.

There are various ways to think about the rate of depreciation δ . It can be regarded as positively related to technological change, as positively or negatively linked to the rate of utilisation u , or just as a constant rate.¹⁰ Rosenbaum chooses to model it as dependent on technological change only, therefore independent from u . Thus, δ appears in the intercepts of both curves, and introducing it in the model or increasing its value provokes a downward translation (with no rotation) of both lines. For a given value of sufficiently pessimistic animal spirits ($\gamma < 0$), Rosenbaum is able to calculate the value for δ that yields the theoretical possibility for a stable zero-growth equilibrium to exist (see Figure 1.2).

⁹For clarity, we shall explain a few points that are left aside in Rowthorn (1981) and Rosenbaum (2015). Regarding saving, capitalists put aside an amount D as a depreciation allowance, and their net saving is a proportion s_p of their net profits $P - D$. Hence g^s is a net saving rate. As for the investment function, it seems logical to think that i) when gauging the rate of profit today as a proxy for the future rate in order to make investment decisions, firms look at the net rate, and ii) the investment rate g^i they desire, given the state of the economy and their animal spirits, is a rate net of depreciation.

¹⁰For a discussion on this see for instance Lavoie (1992, p. 318).

Medium-run dynamics: The lack of possibilities for a transition

According to Rosenbaum (2015), if public authorities were to set a policy objective that consists of reaching a state of zero growth and preventing to depart from it, they would be able to do so by tuning the depreciation factor. Increasing (resp. decreasing) the latter would push the equilibrium rate of growth down (resp. up): exogenous shocks could be countered. In our view, this is problematic in two regards.

First, as explained in detail in Appendix A (at the end of the dissertation, not to be confused with Appendix 1.A), due to the phenomenon of the paradox of costs, an increase in the depreciation factor moves the equilibrium rate of growth *up*, not down like Rosenbaum suggests. Essentially, the reason is that if physical capital is scrapped faster, then gross investment needs to be larger for firms to maintain the excess capacity they desire, and capitalists are able to save less. This higher gross investment rate and subsequent multiplier effect boost aggregate demand and the rate of growth. This phenomenon can also be checked graphically by noticing that, when δ varies, the shift is not of the same magnitude for the two curves.

Arguably, authorities could still manage the rate of growth by changing the depreciation factor if using the policy tool correctly (i.e., taking the paradox of costs into account). However, here comes the second issue: Rosenbaum (2015) argues that because 'tax rules and technical regulations and norms' can affect the decisions of withdrawal of pieces of equipment, 'depreciation can indeed be a policy variable' (Rosenbaum 2015, p. 642). In our opinion, this is not convincing. For a policy tool to be useful, the time before its effects appear should be adapted to the pace at which its target is varying. Elaborating and implementing new technical regulations and norms is a slow process, and the subsequent effects on capital withdrawal and investment decisions also require time to take place. It cannot be used to manage the rate of growth, which varies quarterly or yearly. Finally, the effects of such processes are only indirect, and it seems difficult to estimate their magnitude, if not their existence at all. For these reasons, we think that the rate of capital depreciation cannot be considered as a policy variable for the purpose of reaching and maintaining a stationary state, nor for driving a degrowth transition.

We should add here that when studying the macroeconomics of zero growth, one should not forget the reason why no growth could be desirable: it is to reduce our environmental impacts as much as possible. With this in mind, a tax, regulation, or norm that speeds up the adoption of the cleanest technologies should always be welcome, even if the corresponding investments cause additional economic activity, as long as the overall effect is environmentally beneficial. It would not make sense to restrain from making these investments for the sake of keeping the rate of growth at zero. In other words, the 'macroeconomic rebound effect' (Barker, Dagoumas, and Rubin 2009a; Rezai, Taylor, and Mechler 2013; Saunders 2000) of green investments

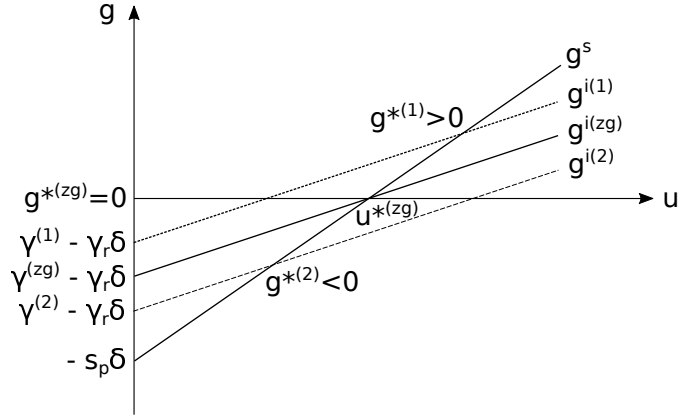

Figure 1.3: Optimistic or pessimistic animal spirits leading to stable equilibria of positive, zero or negative rates of growth in a neo-Kaleckian model of growth and distribution with capital depreciation.

should not be a reason for not engaging in the ecological transition.

In the rest of this subsection we will examine whether the neo-Kaleckian model, in its simple versions presented so far, can nevertheless be appropriate for the study of a zero growth or degrowth transition.

If the rate of capital depreciation cannot be used as a policy variable, one alternative is to alter animal spirits. One can compute the equilibrium rates of utilisation and growth as functions of their level γ :

$$u^* = \frac{\gamma + (s_p - \gamma_r)\delta}{(s_p - \gamma_r)\pi/\nu - \gamma_u} \quad (1.11)$$

$$g^* = s_p \frac{\gamma\pi/\nu + \gamma_u\delta}{(s_p - \gamma_r)\pi/\nu - \gamma_u} \quad (1.12)$$

and, from that, deduce the level of animal spirits ($\gamma^{(zg)} = -\nu\gamma_u\delta/\pi < 0$) that brings about zero growth.

As shown in Figure 1.3, if investors are more optimistic than this level ($\gamma^{(1)} > \gamma^{(zg)}$) the equilibrium rate of growth becomes positive; if they are more pessimistic ($\gamma^{(2)} < \gamma^{(zg)}$) the rate of growth becomes negative. At zero growth, the rate of utilisation remains positive:¹¹ $u^{*(zg)} = \nu\delta/\pi$.

Thus if animal spirits could be managed sufficiently precisely, one could consider using this lever to drive a transition from a regime of positive growth to a regime

¹¹A rough approximation with $\nu = 3$, $\delta = 10\%$ and $\pi = 0.33$ gives the value 91% for the rate of utilisation at zero growth. Since the model is rudimentary, numerical values should not be given too much importance. Nevertheless this approximation suggests that in a non-growing economy the rate of utilisation does not need to be particularly low.

of zero growth, possibly with a phase of negative growth in between. However, in a capitalist economy, public authorities have difficulties in steering business confidence and sentiment in the direction they wish. By nature, animal spirits are unpredictable, untameable, and subject to exogenous shocks. In fact, they are not more appropriate than the depreciation rate for driving an ecological transition.

Lastly, unlike the model in Cahen-Fourot and Lavoie (2016), Rosenbaum's does not allow for positive net profits in a stationary state (as demonstrated in Appendix A), which is problematic in a capitalist economy.

This brief literature review suggests that relatively simple models can provide useful insights regarding the possibilities for macroeconomic stability or positive net profits in equilibria of zero or negative growth. Yet within this Kaleckian framework there is no model which features equilibria of zero or negative growth rates with both Keynesian stability *and* positive net profits. Behavioural and policy variables that could drive the dynamics of a degrowth transition are missing as well. In the next two sections we propose to build and use such a model.

1.4 A more complex neo-Kaleckian model for the study of a degrowing economy

This section sets out a more complex model that gives greater possibilities for a stable negative equilibrium rate of growth to be reached. Our model provides at the same time more 'space' for such an equilibrium and variables that make more satisfying transition dynamics possible. Section 1.4.1 presents the structure of this model and section 1.4.2 analyses its main characteristics. Transition dynamics are explored further down in section 1.5.

1.4.1 Setting the model out

The core of the model is taken from the seminal work of Rowthorn (1981), which consists of an extended version of the canonical neo-Kaleckian model of growth and distribution presented in section 1.2. Rowthorn's model features the depreciation of capital but also managerial labour, public spending and a tax on profits.¹² A budget deficit or surplus can therefore appear. To this we add the possibility for white-collar workers to save part of their income (following Lavoie 1992, p. 344) and the same possibility for blue-collar workers, although the latter are able to save a smaller share of their salaries.¹³ As we explain in section 1.5.1, the fact that

¹²The tax on profits introduced by Rowthorn (1981) is in fact proportional to the stock of physical capital. For this reason we use the term 'tax on capital' in the rest of the chapter.

¹³According to a critique from Pasinetti (1962), if workers have savings they should get a revenue from them - a share of profits for instance. We could make workers own a fraction of

workers do not necessarily consume the entirety of their income is vital for the dynamics of a degrowth transition.

Production requires both direct (blue-collar, variable) labour L_v and indirect (white-collar, fixed) labour L_f . Indirect labour is paid a constant multiplicative premium σ on the base wage rate w . The total wage bill is thus:

$$W = W_v + W_f = wL_v + \sigma wL_f \quad (1.13)$$

The number of overhead workers is in fixed proportion f to the number of variable labour required when the economy operates at full capacity (Rowthorn 1981).

Like in the canonical model, prices are set with a fixed mark-up θ on direct unit costs (i.e. blue-collar labour costs in this model). As a result, the share of gross profits in *marginal* output, $\pi = \theta/(1 + \theta)$, remains constant.

Profits are now reduced by depreciation costs but also by overhead labour costs and the tax on capital. We follow Lavoie (1992, p. 318) in considering the rate of depreciation δ as a constant and Rowthorn (1981) in making the tax on capital T_K equal to a constant tax rate t_K times nominal capital stock pK . The net rate of profit thus reads:¹⁴

$$r^n = \frac{pq - W - D - T_K}{pK} = \frac{\pi u}{\nu} - \sigma f(1 - \pi)/\nu - \delta - t_K \quad (1.14)$$

Denoting by ϕ the sum of all fixed costs expressed as a share of nominal capital: $\phi = \sigma f(1 - \pi)/\nu + \delta + t_K$, we get the following condensed expression for r^n :

$$r^n = \frac{\pi u}{\nu} - \phi \quad (1.15)$$

The investment function is the same as in section 1.3.3, (i.e., with the net rate of profit as an argument), g^i being the net investment rate:

$$g^i = \gamma + \gamma_u u + \gamma_r r^n \quad (1.16)$$

To facilitate the correspondance with the graphs, let us rewrite it as an affine

capital (following Ederer and Rehm (2020a,b)) or introduce public debt and make workers own bonds, and study the evolution of inequality more in depth. However in order to keep our model simple we prefer assuming that workers hold their savings in the form of hoarded money and non-yielding deposits, which seems relatively realistic given their low propensities to save.

¹⁴Beware, the expressions in Eq. (1.14) do not match exactly term to term. See Rowthorn (1981, p. 8) for a more detailed derivation of this equation. For a clear exposition of the Kaleckian model with overhead costs, see for instance Lavoie (2014a, pp. 322–328).

function of the rate of utilisation:

$$g^i = (\gamma_u + \gamma_r \pi / \nu) u + \gamma - \gamma_r \phi \quad (1.17)$$

The saving function is more substantially modified compared to the previous models. Private saving now comes from capitalists and from workers of both types. We assume the consumption function of workers, taken all together, to be of the following form:

$$C_{workers} = (1 - s_{wv})W_v + (1 - s_{wf})W_f + Z_{workers} \quad (1.18)$$

where s_{wv} and s_{wf} are the propensities of variable and fixed labour to save out of their wages, and $Z_{workers}$ stands for the autonomous consumption expenditures of all workers taken together.¹⁵ Saving from workers is thus equal to:

$$S_{workers} = W - C_{workers} = s_{wv}W_v + s_{wf}W_f - Z_{workers} \quad (1.19)$$

The consumption function of capitalists is of a similar form:

$$C_{capitalists} = (1 - s_p)P^{net} + Z_{capitalists} \quad (1.20)$$

with P^{net} being nominal net profits. Hence their saving function:

$$S_{capitalists} = P^{net} - C_{capitalists} = s_p P^{net} - Z_{capitalists} \quad (1.21)$$

Saving (or rather dissaving) also occurs from the public sector, the deficit of which we call B . Denoting by Z the sum of autonomous consumption expenditures from workers and capitalists, total saving reads:

$$S = s_p P^{net} - B + s_{wv}W_v + s_{wf}W_f - Z \quad (1.22)$$

Expressing it as a share of the stock of nominal capital, with $z = Z/(pK)$ and $b = B/(pK)$, we obtain the new saving function:

$$g^s = s_p r^n - b + s_{wv}(1 - \pi)u/\nu + s_{wf}(1 - \pi)\sigma f/\nu - z \quad (1.23)$$

Rearranging as an affine function of the rate of utilisation gives:

$$g^s = [s_p \pi + s_{wv}(1 - \pi)]u/\nu - [s_p \phi + b + z - s_{wf}(1 - \pi)\sigma f/\nu] \quad (1.24)$$

Finally, we shall explain how the public deficit B arises. Neo-Kaleckian models

¹⁵By autonomous (or constrained) consumption expenditures we refer to the component of consumption that is inelastic to income in the short run.

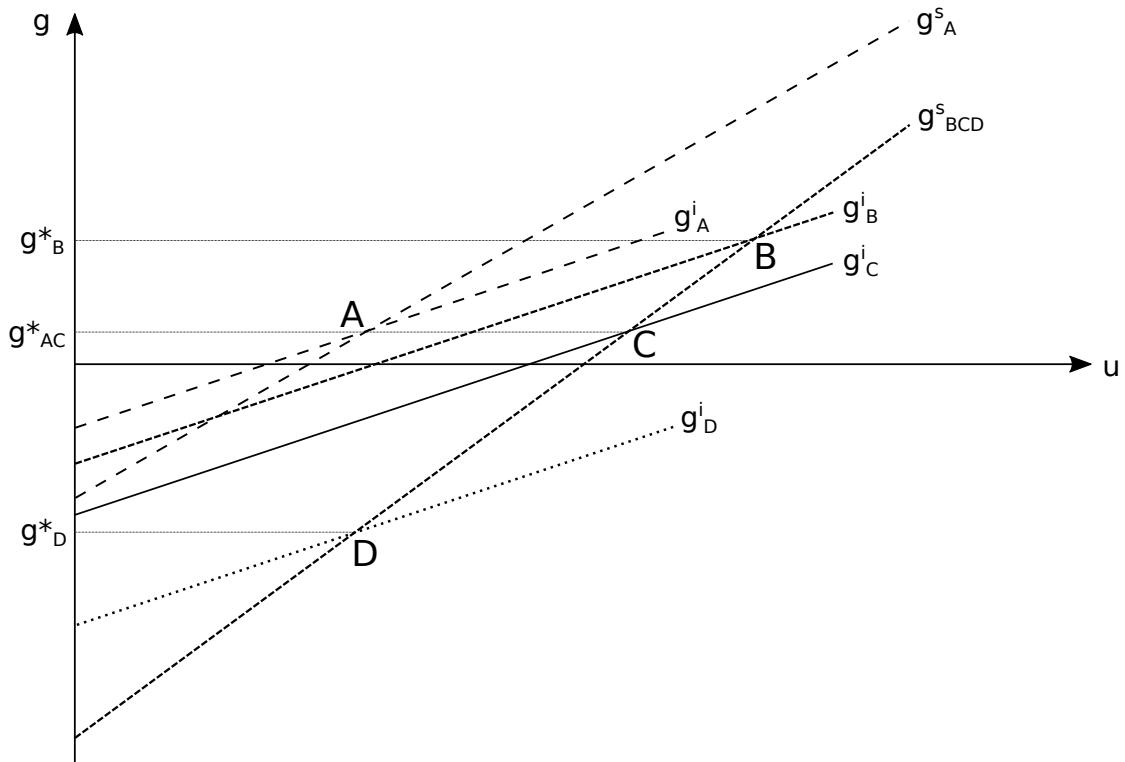

Figure 1.4: Extensions in the neo-Kaleckian model of growth and distribution provide greater space for stable negative growth equilibria.

allow for relatively elaborate tax schemes (Franke 2016), but to keep our exposition readable, we choose to make it very simple with the tax T_K being the only source of government revenue. The public deficit reads $B = G - T_K$, or $b = G/(pK) - t_K$ expressed as a share of nominal capital, where G represents aggregate government spending.

1.4.2 Analysing the model

Effects of the new variables

Each new variable induces movements in the g^s and g^i curves. Let us review the consequences for the equilibrium. In Figure 1.4, the curves and equilibrium points labelled A and B represent our model before and after its complexification.

Saving out of variable workers' wages s_{wv} makes the saving curve steeper and has a recessive thriftiness effect. The case of overhead workers is more complex. Like depreciation, they are a fixed cost $\sigma f(1 - \pi)/\nu$ for firms, thereby reducing saving and investment tendencies (g^s and g^i shift down). Opposite to this, their

saving behaviour pushes g^s upwards. Overall, under the usual assumption $s_p > s_{wf}$, the saving curve goes down. To know the total effect of the presence of overhead labour on demand and growth, one needs to calculate $\partial g^* / \partial(\sigma f)$.¹⁶ This derivative is positive under the condition $\gamma_u \nu (s_p - s_{wf}) > \gamma_r [(1 - \pi) s_{wv} + \pi s_{wf}]$, which is verified for an extensive range of plausible parameter values.¹⁷ In economic terms, the higher propensity to spend of managers compared to capitalists has stronger effects than the disincentive to invest due to the lower net profit rate. Introducing overhead labour in the model results in a boost in demand and growth. Increasing the wage premium σ or the proportion f of managers relative to variable workers would yield an even greater boost.

The presence of the budgetary variables G, T_K , and B is overall expansionary unless in the case of a substantial budget surplus. Indeed, one can imagine starting from zero public resources and spending, like in section 1.3. From there, in a closed economy, both extending a balanced budget (i.e. raising T_K along with G) and letting a positive deficit arise have well-known expansionary effects. The effects of changes in the tax rate t_K alone are detailed in section 1.5.2.

Finally, similarly to the deficit b , the dissaving coming from autonomous consumption z shifts the saving curve downwards and increases the equilibrium rates of growth and utilisation.

To sum up, introducing these variables in the model has various effects, mostly expansionary. Thus, it may seem unclear why and how this could help to make 'more space' for a zero or negative growth stable equilibrium to exist. In fact, the point is not to go from situation A to B in Figure 1.4, but to consider that situation C , where animal spirits are slightly less optimistic, represents better the recent economic context of rich countries. It is more realistic than A since it includes the essential variables added in this section, but unlike B , it features the low (yet positive) rate of growth experienced on average by high consumption economies since the 2010s. Then, situation C offers a larger space than A for the economy to evolve toward a regime of zero or negative growth. Situation D illustrates one possibility, with more depressed animal spirits. Section 1.5 presents more articulate ways to obtain a transition with negative growth followed by a stationary state.

Characteristics of the complete model

At equilibrium, $I = S$, we can derive the analytical expressions for the rates of utilisation u^* , net profit r^{n*} and growth g^* (see appendix 1.A). The Keynesian stability condition now reads $s_p > \gamma_r + \gamma_u \nu / \pi - s_{wv} (1 - \pi) / \pi$. The presence of saving out of wages from variable labour makes it more easily verified than in the

¹⁶To do so, we used Eq. (1.33) in appendix 1.A. We do not display the calculation steps here.

¹⁷For instance, with $\nu = 3$, $\pi = 0.33$, $s_{wv} = 0.2$, $s_{wf} = 0.3$, $s_p = 0.4$ and $\gamma_u / \gamma_r = 2$, the left-hand side term is 2.5 times larger than the right-hand side one.

models of section 1.3. Like in Rosenbaum's model, Keynesian stability, a positive rate of utilisation and a rate of growth equal to zero or even negative are compatible altogether (exemplified by point D in Figure 1.4; see equation (1.34) in appendix 1.A for the expression of u^* at zero growth).

Like in Cahen-Fourot and Lavoie (2016), our model allows for maintaining a positive rate of profit while the rate of growth is zero or negative. Combining equations (1.15) on the rate of profit and (1.34) on $u^{*(zg)}$ gives the net rate of profit at an equilibrium with zero growth, $r^{n*(zg)}$, and the following condition:

$$r^{n*(zg)} > 0 \Leftrightarrow b + z > s_{wv}\phi(1 - \pi)/\pi + s_{wf}(1 - \pi)\sigma f/\nu \quad (1.25)$$

We see that $r^{n*(zg)}$ is positive on condition that elements of dissaving (budget deficit and autonomous consumption) are sufficiently high compared to elements relative to saving out of wages. Richters and Siemoneit (2017) also find that a dissaving factor (in their case the propensity to consume out of wealth) should be high enough. For reasons of continuity, if r^{n*} can be positive when g^* equals zero, it can remain positive when the rate of growth is slightly negative. In a situation of strongly negative growth the rate of profit would be reduced further and may become negative, especially in the sectors for which demand is shrinking the most. However, temporary sector-specific negative rates of profit are not necessarily synonymous with a widespread economic breakdown or the end of capitalism. In the most affected sectors, investment would stop, and firms would sell assets and downsize. By definition of a sustainable degrowth transition, the most affected sectors would be the most anti-ecological ones. Thus this structural change may be more of a benefit to society than a catastrophe.

After a period during which the economy partially shrinks and reaches an ecologically sustainable level comes the full-stationary state. Net saving needs to be zero in every sector: the budget is balanced (Cahen-Fourot and Lavoie 2016; Sawyer 2017); for workers, saving out of wages offsets autonomous consumption; for capitalists, positive net profits are fuelled and offset by autonomous consumption.

Following these general remarks, we now turn to more detailed analyses of how the dynamics of a degrowth transition may operate.

1.5 Dynamics of the degrowth transition

The model presented and analysed in section 1.4 offers greater space and more variables to think about possible degrowth transition dynamics. Here we propose two kinds of dynamics that complement each other, and we expose the associated mechanisms and policies. On one side, voluntary reductions in consumption can pull the economy toward degrowth (section 1.5.1). On the other side, because

anti-ecological behaviour may offset the benefits of the former, income-related policies are used to push the transition forward (section 1.5.2). We shall explain here an assumption that runs throughout the scenarios, although it is not modelled explicitly. Whenever aggregate production decreases, a working time reduction scheme is supposed to occur to prevent unemployment from rising. Workers see their monthly income reduced but, as we argue, the decrease in constrained expenditures more than compensates for it. Hence workers are not severely hit by such measures.

1.5.1 Pulling the transition - The voluntary side

We start this subsection with a technical exposition of the mechanism by which the dynamics of autonomous consumption expenditures manage to drive the rate of accumulation in the medium-run (the so-called 'Sraffian supermultiplier effect' (Serrano 1995a,b)). Then we explain how autonomous consumption, which is constrained, can paradoxically decrease when voluntary simplicity is enabled. Finally, we apply this mechanism in our model to illustrate a first way of driving the transition.

Autonomous consumption expenditures and the rate of accumulation in the medium run

Section 1.4 introduced autonomous consumption expenditures Z and the notation $z = Z/pK$ for more convenient analysis. The equilibrium values we found for the rates of utilisation, profit and accumulation were calculated considering that z is a constant. Therefore, we will call them short-run equilibrium values. In contrast, in the medium run, both the stock of capital pK and the value of autonomous consumption expenditures Z can vary. Thus z becomes a variable that influences the equilibrium values of the rates of utilisation, profit and accumulation. These values are different in the medium run and in the short run. In the rest of the chapter, variables written with a two-star exponent represent medium-run equilibrium values. We use the same notations and follow the same steps as Lavoie (2016, pp. 178–184) to show how in our model, through the Sraffian supermultiplier effect, the rate of accumulation of the whole economy converges toward the rate of growth of autonomous expenditures (Serrano 1995a,b; Serrano and Freitas 2015). Here we deal with autonomous consumption expenditures, but similar conclusions can be derived from the study of autonomous government expenditures (Allain 2015). Let us denote by \bar{g}_Z the exogenous rate of growth of autonomous consumption expenditures: $\bar{g}_Z = \hat{Z} = \dot{Z}/Z$, where \dot{Z} represents the time derivative of Z . Because both direct unit costs and the mark-up over them are assumed to remain constant, prices remain constant as well ($\hat{p} = 0$). Hence, the rate of growth of the z variable

is given by:

$$\hat{z} = \hat{Z} - \hat{K} = \bar{g}_Z - g^* \quad (1.26)$$

We shall now check 'whether the behaviour of z is dynamically stable or not, that is, whether it will converge to a stable value' (Lavoie 2016, p. 178). In order to do so we need to compute $d\hat{z}/dz$. Using equations (1.26) and (1.33) we find:

$$\frac{d\hat{z}}{dz} = - \frac{\gamma_u \nu + \gamma_r \pi}{(s_p - \gamma_r)\pi + s_{wv}(1 - \pi) - \gamma_u \nu} \quad (1.27)$$

This expression is strictly negative as long as there is short-run Keynesian stability. In that case, the model is dynamically stable, and the variable z converges in the medium run toward a specific value z^{**} (Lavoie 2016, p. 179). Consequently, the medium-run equilibrium rate of accumulation g^{**} is equal to the rate of growth \bar{g}_Z of autonomous consumption expenditures (Lavoie 2016, p. 179).¹⁸

Replacing the left member in the investment and saving equations by this rate of growth \bar{g}_Z , we can derive the medium-run equilibrium values for the rate of utilisation and the z variable:

$$u^{**} = \frac{\bar{g}_Z - \gamma + \gamma_r \phi}{\gamma_u + \gamma_r \pi / \nu} \quad (1.28)$$

$$z^{**} = [s_p \pi + s_{wv}(1 - \pi)]u^{**} / \nu - [s_p \phi + b + \bar{g}_Z - s_{wf}(1 - \pi)\sigma f / \nu] \quad (1.29)$$

So far, we have shown that in the medium run the rate of accumulation of the whole economy is drawn to equate the rate of growth of autonomous consumption expenditures, and we have derived the medium-run equilibrium values for the rate of utilisation and the z variable. In order to illustrate this mechanism more easily with the movements of the saving curve, we shall examine how the equilibrium value of z varies when the rate of growth \bar{g}_Z changes:

$$\frac{dz^{**}}{d\bar{g}_Z} = \frac{(s_p - \gamma_r)\pi + s_{wv}(1 - \pi) - \gamma_u \nu}{\gamma_u \nu + \gamma_r \pi} \quad (1.30)$$

As long as the short-run Keynesian stability condition is verified, this expression is positive. Hence, whenever the rate of growth of autonomous consumption expenditures \bar{g}_Z decreases (increases), the medium-run equilibrium value of z decreases (increases) and, as a result, the saving curve progressively shifts upwards (downwards). Indeed, z^{**} appears in the intercept of the saving curve (with a minus sign, cf. equation (1.24) and Figure 1.6).

Section 1.5.1 illustrates and discusses the use of this supermultiplier mechanism

¹⁸Cf. equation (1.26) with the left member equal to zero.

for the transition in less mathematical and more economic terms.

Enabling voluntary simplicity

As briefly mentioned in the introduction of this chapter, the phase of the degrowth transition we focus on is the period coming after an ambitious kind of 'Green New Deal' (GND) has taken place. A GND is necessary, yet it may not be sufficient if the mindsets do not change since productivism, anti-ecological lifestyles, and rebound effects remain possible. The central idea in our scenario is that such systemic change (GND) makes it possible, for those who want it, to leave the mindset and mode of living of the consumer society behind and embrace more ecological modes of living.

It may be impossible or even undesirable to define exactly what 'more ecological' or 'simple' lifestyles would look like, yet one of the required feature is a lower level of consumption. We argue that the expenditures that are constrained in the short run within a non-ecological system and mode of living can progressively be reduced as systemic change is conducted and the enabled ecological modes of living are adopted. For instance, people (and businesses and other institutions) will not need to buy, insure, fuel, maintain and eventually replace individual cars any longer since new transportation infrastructure will have enabled ecological mobility.¹⁹ They will not need to heat or cool their buildings as much or replace broken non-repairable appliances and furniture since buildings will be retrofitted, obsolescence will be slowed down, and manufacturers will design goods that are ecologically sourced and made, long-lasting and repairable. Finally, as the advertisement industry will have shrunk and social norms will have evolved, 'socially constrained' expenditures will also diminish.

To sum up, the level of autonomous expenditures (which varies across income groups – richer people have larger cars and houses) is constrained in the short run but can evolve in the medium run. This explains our choice to model the shift from non-ecological (NE) to ecological (E) modes of living as a progressive reduction in overall autonomous consumption Z (see Figure 1.5 and section 1.5.1). A key claim in the degrowth paradigm is that this diminution can translate into a gain of well-being, not a loss, particularly thanks to environmental and health improvements and stronger social bonds.

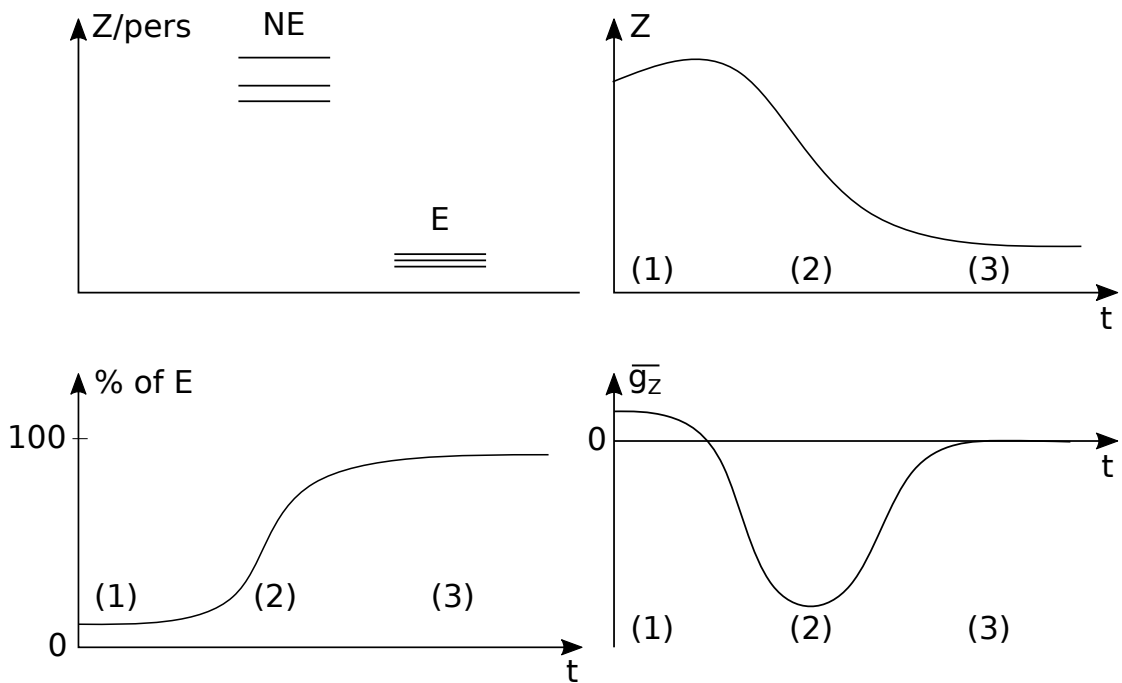

Figure 1.5: Dynamics of autonomous consumption expenditures in a degrowth transition led by voluntary simplicity.

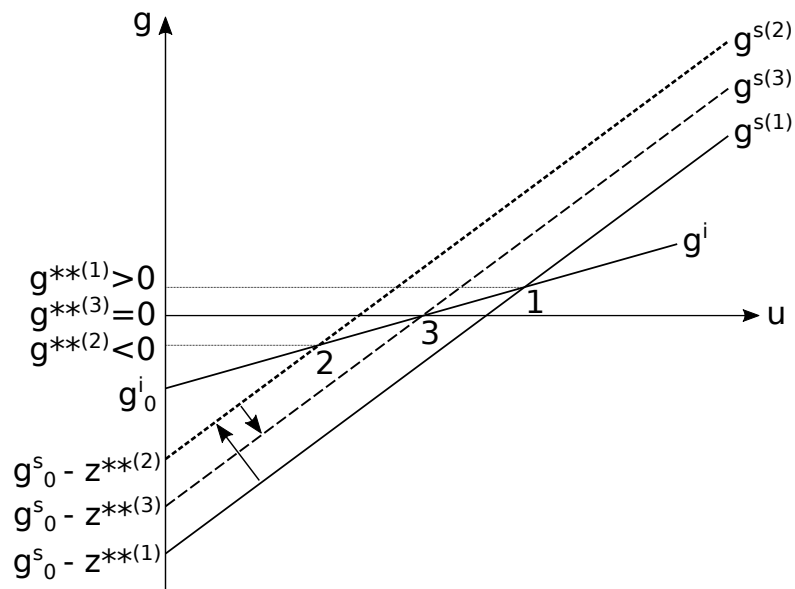

Figure 1.6: A highly schematised degrowth transition driven by changes in the rate of growth of autonomous consumption expenditures.

Supermultiplying simplicity

We consider a transition scenario composed of three phases across which the dynamics of autonomous consumption Z evolve (Figure 1.5). In phase (1), most people are embedded in non-ecological modes of living (NE). The associated levels of autonomous consumption are multiple (they vary across socio-economic classes) and increasing over time, following the current upward tendency for constrained needs. The rate of growth \bar{g}_Z is positive. During phase (2), an increasing proportion of the population adopts ecological modes of living (E) and the associated lower levels of autonomous consumption per person (which do not increase with time). The rate \bar{g}_Z is negative, Z decreases. Once most people have shifted from (NE) to (E), autonomous consumption remains constant, $\bar{g}_Z = 0$ (phase (3)).

Figure 1.6 depicts how this transition plays out in our neo-Kaleckian model.²⁰ As explained in section 1.5.1, in the medium run, changes in the rate of growth \bar{g}_Z of autonomous consumption induce movements for the saving curve (mathematically, z^{**} evolves) so that the rate of growth of the economy g^{**} equates \bar{g}_Z . Hence, starting from a positive rate of growth (equilibrium point 1), the decrease in consumption 'pulls' the economy toward negative rates of accumulation (like point 2) and the stabilisation of consumption leads to an equilibrium with zero growth (point 3).

It is worth elaborating on three important issues regarding this scenario. First, we shall stress that this is an 'ideal' type of transition. In reality, some people will resist switching to more ecological modes of living. Therefore, let us make the following (simplifying) assumptions: i) given the improvements in quality of life made available to them, most direct workers and part of overhead workers end up switching to (E); (ii) due to their class interests and identity, most top managers and capitalists remain within (NE). Consequently the scenario could be modified, especially in the third phase: steadily increasing autonomous consumption from top managers and capitalists could boost demand and the rates of growth \bar{g}_Z and g^{**} , thereby preventing the economy from remaining within ecological boundaries. Said differently, the effects of the 'ecological simplicity supermultiplier' could be partly or entirely offset by those of a 'destructive opulence supermultiplier'. Section 1.5.2 proposes mechanisms and policies to prevent this.

Second, let us detail the complex dynamics of consumption and saving underlying this transition. National accounting and macroeconomic consistency imply that in

¹⁹Ecological mobility necessitates abandoning the private car, dramatically reducing road freight, and switching to rail freight, low-carbon public transport, cycling and other human-powered means of transport.

²⁰For clarity of exposition, in Figure 1.6 we grouped together all the terms making up the intercept of the investment curve in the term g_0^i and did the same for the saving curve except for the term $-z^{**}$ which is written apart.

a state of negative (resp. zero) growth, aggregate net saving S is negative (resp. zero). The consumption ratio C/Y is higher than in a state of positive growth. This may be misleading by giving the impression that economic agents should save less and consume more. Examining the conditions and implications of slow growth, Sawyer (2017, p. 46) states that 'slower growth would need to go alongside the discouragement of savings rather than encouragement', and 'lower growth would be associated with a lower national savings ratio whether through lower private savings (s in the equations) or through public dissavings (budget deficit). Expenditure on consumption of goods and services whether private or public would be higher'. These points require clarification. When moving toward slower, zero or negative growth, the consumption ratio C/Y must increase, and the saving ratio S/Y must decrease. Nonetheless, this does not mean that saving should be discouraged and consumption encouraged; what is needed is the exact opposite.

Indeed, in the transition described above, the well-known 'paradox of thrift' is operating: by deciding to consume less (meaning, *in the short run and at the micro-level*, save more - the saving curve in Figure 1.6 translates upwards), workers shifting to voluntary simplicity are slowing down economic activity Y , leading progressively to a lower level of saving S at the macro-level (negative at point 2). Compared to situations of higher growth (phase (1)), in phases (2) and (3), *realised macroeconomic* saving and the national saving ratio S/Y are lower, the consumption ratio C/Y is higher, yet consumption C is lower. The downward evolution of national income Y allows both S and C to move in the same downward direction while S/Y and C/Y evolve in opposite directions.

Together with considering evolutions in autonomous consumption, this clarification shows how to obtain the required lower saving ratios while departing from the inappropriate requirement of reducing *marginal* propensities to save (s_{wv} , s_{wf} and s_p). By reducing their autonomous consumption, workers increase their *desired average* propensity to save. However, because both total profits and the wage bill are reduced, the result is a decrease in the *realised average* propensity to save for households as a whole.

A third and last point regards the evolution of wealth distribution. For instance, when the rate of accumulation is negative, aggregate net saving is negative too. Which classes of household are disaccumulating wealth, and in which proportions? When workers decide to consume less, their aggregate income (the wage bill) decreases, but so does the level of profits. In a sense, the 'de-consumption' behaviour of workers forces the income, consumption, and saving of capitalists downwards. It seems that for workers the loss of income is smaller than the reduction in autonomous consumption, so that they may increase their saving. On the contrary, capitalists who maintain their autonomous consumption and lose profits would be forced to save less. Thus, inequality of wealth might decrease. To study this more

precisely, our model would need to account for monetary stocks. Chapter 3 explores this issue with a theoretical stock-flow consistent model in which constrained expenditures are linked to the replacement of obsolete goods. It shows that wealth inequality can decrease when constrained expenditures are reduced, even if this reduction benefits both workers *and* capitalists. As for now, with the model of the current chapter, we know that since productive capital K is disaccumulating, the owners of this capital are losing, at least in terms of physical capital.

1.5.2 Pushing the transition - The coercive side

Given its core values of equity, social justice and anti-accumulation, it seems reasonable to think that not everyone in society will eventually embrace the degrowth paradigm. In particular, top managers and capitalists have no interest in reversing capital accumulation and abandoning luxury modes of living. Nevertheless their ecological footprint is considerable and needs to be reduced (Barros and Wilk 2021; Chancel 2021; Otto et al. 2019; Wiedmann et al. 2020). For this, we propose two complementary policies.

Reducing high compensations

As exposed in section 1.4.2, the effects of changes in the number or in the remuneration of overhead labour depend on the following condition: $\gamma_u \nu (s_p - s_{wf}) > \gamma_r [(1 - \pi) s_{wv} + \pi s_{wf}]$. If verified, then reducing the wage premium σ would reduce aggregate demand and the equilibrium rate of growth.²¹ Indeed, value-added would be transferred from managers to capitalists, and the induced increase in the desire to invest from capitalists would not compensate for the reduction in consumption coming from differences in propensities to save. Thus, reducing high compensations would bring down the overall consumption of wealthy households (managers and capitalists taken together) and its associated harmful ecological consequences.

In the medium run, lowering the income level of managers could also help reverse the upward trend in their autonomous consumption (linked to the 'standard of living'), thereby preventing an economic expansion pulled through the Sraffian supermultiplier mechanism.

However, the condition stated above is particularly sensitive to the difference in propensities to save ($s_p - s_{wf}$). For top managers, this difference may be too small for the condition to be verified. Transferring resources from top managers to capital owners would not make a difference regarding aggregate consumption and ecological damage, unless the income of capitalists is simultaneously reduced. This leads to our second policy proposal.

²¹We focus here on reductions in remunerations, for it seems a more sensible and applicable economic policy than trying to change the proportion of overhead labour.

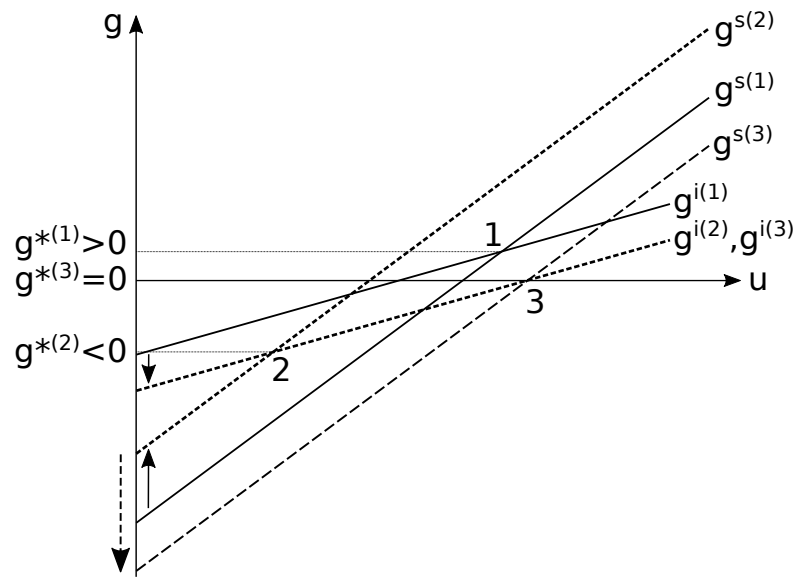

Figure 1.7: Short and medium-run macroeconomic effects of an increase in the tax rate on capital in an extended neo-Kaleckian model.

Taxing capital

A necessary - though not sufficient - means to curb the ecological footprint of capitalists is to lower their purchasing power. Increasing the tax rate t_K on capital not only does this but can also help drive the transition from accumulation to disaccumulation followed by stabilisation (points 1, 2 and 3 in Figure 1.7).

Indeed, it tames the eagerness of firms to invest (g^i shifts downwards) and increases aggregate saving since part of the resources withdrawn would have been spent otherwise (g^s shifts upwards). These contractionary effects (solid-line arrows) push the economy from situation 1 to situation 2. Then, a stabilising mechanism operates:²² as productive capital pK disaccumulates, the deficit $b = G/(pK) - t_K$ relative to the size of the economy increases mechanically (since in a degrowth scenario, government spending G is not to be reduced unless, for instance, health improvements reduce corresponding expenses). Hence, the saving curve progressively translates downwards (dashed-line arrow), slowly pushing the negative rate of growth upward and eventually leading to stabilisation (situation 3).

Like for managers, reducing the income level of capitalists could, in the medium-run, force them into changing their mode of living and prevent what we call the 'destructive opulence supermultiplier' effect.

²²To our knowledge, this mechanism has never been identified and described before. It represents one of the theoretical contributions of this chapter.

1.6 A few side remarks on public debt and deficits

Before concluding this chapter, let us address a possible warning regarding debts. During the degrowth transition, shrinking aggregate output may increase the public deficit if the tax level is not adjusted. Moreover, due to the denominator effect, the public debt-to-GDP ratio may reach levels that 'conventional wisdom' considers excessively high. We propose several answers to this. First, a government which has enough control over its central bank should not fear high debt-to-GDP ratios. Second, the ratio of public assets to GDP would also increase mechanically. Third, if still 'requested' to decrease its debt ratio a government could apply an exceptional one-off tax on the assets of the wealthiest businesses and individuals. This would deflate both the public debt and the corresponding high private assets-to-GDP ratio, thereby reducing wealth inequality. After the transition, in a stationary state, the deficit should be brought to zero. Some tax rates may need to increase in order to close the deficit that most growing economies feature, at least until the benefits of the new socio-economic and ecological setting reach their full potential. Once the spending requirements on health or security have shrunk, tax rates can decrease again. However, ensuring the financing of the recurrent flows of public spending does not dispense from considering potential issues regarding balance sheet effects and stocks. For instance the case of private debt, articulated with banks' balance sheets, would need closer attention. Depending on the pace of the transition, restructurations may be unavoidable.

1.7 Conclusion

This chapter investigates both the existence possibilities for and the ways toward stable equilibria of zero or negative accumulation rates within neo-Kaleckian models of growth and distribution. This type of model has been studied extensively by many post-Keynesian scholars, but only a couple of authors have used it to look in this direction. Reviewing the literature reveals that zero growth is compatible with positive net profits on one side and with Keynesian stability on the other side. However the verification that both of these features are compatible in a neo-Kaleckian model was still missing. What is more, authors have tended to focus on zero growth and to leave negative growth unexplored, and no satisfactory transition dynamics have been proposed. This work helps fill these gaps.

First, the model we build provides more 'space' for stable equilibria with negative rates of accumulation, compared to the neo-Kaleckian models used so far to study zero growth.

Second, we show that disaccumulation (i.e. a negative rate of growth) is simultaneously compatible with macroeconomic stability and with a positive net

profit rate.

Third, we propose and illustrate two complementary ways to achieve a degrowth transition. On the one hand, voluntary simplicity and changes in modes of living enabled by system-wide investments could make the most ecologically problematic activities shrink and make the economy reach a sustainable composition and size. On the other hand, reducing high compensations and taxing capital could help prevent the wealthy from pursuing non-sustainable modes of living, from making the economy become oversized again and from offsetting the ecological improvements achieved by a majority of people.

Idealistic or improbable as our proposals may seem, we believe it is crucial to investigate unexplored paths to widen the possibilities among which modern societies need to choose to avoid ecological distress as much as possible. This work showed that degrowth does not necessarily lead to catastrophic economic consequences such as never-ending fall in output and increase in unemployment. Instead, it may be a path to a more just and sustainable future.

Finally, we pointed out that since disaccumulation decreases the wealth of capital owners, it has the potential to reduce inequality of wealth. However, the issue of income and wealth inequality needs to be examined further. Far from being an example of sustainable degrowth, the Covid-19 crisis has yet shown that a reduction in production can lead to rising inequality if economic policies are inappropriate and in particular if the income and the wealth of the very well-off are not limited or taxed adequately.

Appendix 1.A Calculations and analytical expressions

Equating investment (1.17) and saving (1.23) and solving for u (using eq. (1.15)) yields:

$$u^* = \frac{(\gamma + b + z)\nu + (s_p - \gamma_r)\phi\nu - s_{wf}(1 - \pi)\sigma f}{(s_p - \gamma_r)\pi + s_{wv}(1 - \pi) - \gamma_u\nu} \quad (1.31)$$

Using equation 1.15 and rearranging, one obtains the equilibrium net profit rate:

$$r^{n*} = \frac{(\gamma + b + z)\nu + \gamma_u\phi\nu - s_{wv}(1 - \pi)\phi - s_{wf}\pi(1 - \pi)\sigma f/\nu}{(s_p - \gamma_r)\pi + s_{wv}(1 - \pi) - \gamma_u\nu} \quad (1.32)$$

Making use of the saving equation 1.23, after some calculation we get the expression for the equilibrium rate of growth:

$$g^* = \frac{1}{(s_p - \gamma_r)\pi + s_{wv}(1 - \pi) - \gamma_u\nu} * \left[[s_p\gamma + (b + z)\gamma_r]\pi + (b + z + s_p\phi)\gamma_u\nu + s_{wv}(1 - \pi)(\gamma - \gamma_r\phi) - s_{wf}(1 - \pi)(\gamma_u\nu + \gamma_r\pi)\sigma f/\nu \right] \quad (1.33)$$

Using equation (1.24) in a case where g^* is brought to zero (for instance due to an increase in the tax on capital) gives u^* at zero growth:

$$u^{*(zg)} = \frac{[s_p(\delta + t_K) + b + z]\nu + (s_p - s_{wf})(1 - \pi)\sigma f}{s_p\pi + s_{wv}(1 - \pi)} \quad (1.34)$$

This expression is positive for any positive value of the government deficit as well as in the case of a balanced budget or of a not-too-large surplus. The utilisation rate at zero growth may hit the theoretical lower bound of zero only if the government runs a too large budget surplus.

Bibliography of the current chapter

- Allain, Olivier (2015). “Tackling the Instability of Growth: A Kaleckian-Harrodian Model with an Autonomous Expenditure Component”. In: *Cambridge Journal of Economics* 39.5, pp. 1351–1371.
- Barker, Terry, Athanasios Dagoumas, and Jonathan Rubin (Nov. 2009a). “The Macroeconomic Rebound Effect and the World Economy”. In: *Energy Efficiency* 2.4, pp. 411–427.
- Barros, Beatriz and Richard Wilk (2021). “The Outsized Carbon Footprints of the Super-Rich”. In: *Sustainability: Science, Practice and Policy* 17.1, pp. 316–322.
- Cahen-Fourot, Louison and Marc Lavoie (June 2016). “Ecological Monetary Economics: A Post-Keynesian Critique”. In: *Ecological Economics* 126, pp. 163–168.
- Chancel, Lucas (2021). *Climate Change and the Global Inequality of Carbon Emissions*.
- Dutt, Amitava Krishna (1984). “Stagnation, Income Distribution and Monopoly Power”. In: *Cambridge Journal of Economics* 8, pp. 25–40.
- (1990). *Growth, Distribution and Uneven Development*. CUP.
- Ederer, Stefan and Miriam Rehm (2020a). “Making Sense of Piketty’s ‘Fundamental Laws’ in a Post-Keynesian Framework: The Transitional Dynamics of Wealth Inequality”. In: *Review of Keynesian Economics* 8.2, pp. 195–219.

- Ederer, Stefan and Miriam Rehm (2020b). “Will Wealth Become More Concentrated in Europe? Evidence from a Calibrated Post-Keynesian Model”. In: *Cambridge Journal of Economics* 44.1, pp. 55–72.
- Franke, Reiner (2016). “A Simple Approach to Overcome the Problems Arising from the Keynesian Stability Condition”. In: *European Journal of Economics and Economic Policies: Intervention* 14.1, pp. 48–69.
- George, Henry (1879). *Progress and Poverty: An Enquiry into the Cause of Industrial Depressions, and of Increase of Want with Increase of Wealth. The Remedy*. San Francisco: Author’s edition.
- Jackson, Tim and Peter A. Victor (Jan. 2016). “Does Slow Growth Lead to Rising Inequality? Some Theoretical Reflections and Numerical Simulations”. In: *Ecological Economics* 121, pp. 206–219.
- Kalecki, Michal (1971). *Selected Essays on the Dynamics of the Capitalist Economy 1933-1970*. CUP Archive.
- Lavoie, Marc (1992). *Foundations of Post-Keynesian Economic Analysis*. Cheltenham: Edward Elgar Publishing.
- (2014a). *Post-Keynesian Economics: New Foundations*. Cheltenham: Edward Elgar.
- (Feb. 2016). “Convergence Towards the Normal Rate of Capacity Utilization in Neo-Kaleckian Models: The Role of Non-Capacity Creating Autonomous Expenditures”. In: *Metroeconomica* 67.1, pp. 172–201.
- Otto, Ilona M et al. (2019). “Shift the Focus from the Super-Poor to the Super-Rich”. In: *Nature Climate Change* 9.2, pp. 82–84.
- Padalkina, Dina (2012). “The Macroeconomics of Degrowth - Can a Degrowth Strategy Be Stable”. In: Montreal International Conference on Degrowth in the Americas.
- Pasinetti, Luigi L. (Oct. 1962). “Rate of Profit and Income Distribution in Relation to the Rate of Economic Growth”. In: *The Review of Economic Studies* 29.4, pp. 267–279.
- Rezai, Armon, Lance Taylor, and Reinhard Mechler (Jan. 2013). “Ecological Macroeconomics: An Application to Climate Change”. In: *Ecological Economics* 85, pp. 69–76.
- Richters, Oliver and Andreas Siemoneit (June 2017). “Consistency and Stability Analysis of Models of a Monetary Growth Imperative”. In: *Ecological Economics* 136, pp. 114–125.
- Rosenbaum, Eckehard (May 19, 2015). “Zero Growth and Structural Change in a Post Keynesian Growth Model”. In: *Journal of Post Keynesian Economics* 37.4, pp. 623–647.
- Rowthorn, Bob (1981). “Demand, Real Wages and Economic Growth”. In: *Thames Papers in Political Economy*.

- Saunders, Harry D (2000). “A View from the Macro Side: Rebound, Backfire, and Khazzoom-Brookes”. In: *Energy Policy*, p. 11.
- Sawyer, Malcolm (2017). “Some Simple Macroeconomic Remarks on Slower Economic Growth”. In: *Evolutionary Political Economy in Action: A Cyprus Symposium*. Hardy Hanappi, Savvas Katsikides and Manuel Scholz-Wäckerle. Routledge Advances in Heterodox Economics. Abingdon and New York: Routledge, pp. 41–55.
- Serrano, Franklin (1995a). “Long Period Effective Demand and the Sraffian Supermultiplier”. In: *Contributions to Political Economy* 14.1, pp. 67–90.
- (1995b). “The Sraffian Supermultiplier”. Faculty of Economics and Politics, University of Cambridge.
- Serrano, Franklin and Fabio Freitas (2015). “Growth Rate and Level Effects, the Stability of the Adjustment of Capacity to Demand and the Sraffian Supermultiplier”. In: *Review of Political Economy* 27.3, pp. 258–281.
- Wiedmann, Thomas et al. (2020). “Scientists’ Warning on Affluence”. In: *Nature communications* 11.1, pp. 1–10.

Chapter 2

Green public investment, consumption patterns, and the ecological transition: a macroeconomic analysis

“Degrowth? This is what we have seen over the past year. And what did we get? 8% less CO2 emissions, that have cost tens of thousands of company bankruptcies and hundreds of millions of unemployed. It cannot be the solution.”

Bertrand Piccard, 2021¹

“It is also a civilization of growth. And that, growth, is our DNA. And that’s not going to change. So we have to find a way to be also in our growth DNA, I tell you that BPI France does not believe in degrowth; moreover the Covid proved it well. We now know that we would have to do a lockdown every two years to have a chance, through degrowth, to achieve a minimum of the objectives of the Paris Agreement. So it’s just unfeasible. So the growth DNA, it’s going to stay; the carbon-based society, it will enter the past, and it must enter the past as soon as possible.”

Nicolas Dufourcq, 2022²

¹In his own words, Bertrand Piccard is an “Explorer, Psychiatrist, Inspirational speaker, and Chairman of the Solar Impulse Foundation.”

²Nicolas Dufourcq is the President of the French Public Investment Bank. The quote comes from his presentation of the ‘plan for the climate’ of the Bank.

Outline of the current chapter

2.1 Introduction	68
2.2 The model	70
2.2.1 Households	74
2.2.2 Firms	78
2.2.3 Public sector	81
2.2.4 Emissions and inequality	84
2.3 Effects of the different types of green public investment	85
2.4 Effects of green public investment and sufficiency	90
2.5 Conclusion	94
2.A Symbols for endogenous variables used in chapter 2	96
2.B Symbols for parameters and exogenous variables used in chapter 2	99

This chapter is a collaborative effort with researchers Yannis Dafermos (SOAS University of London) and Maria Nikolaidi (University of Greenwich). The three co-authors shared the work as follows: all co-authors decided together on the general purpose of the article and the broad design of the model, Antoine Monserand did a large part of the modelling (precise design, programming and analysis of simulation results) and smaller parts of the writing, Yannis Dafermos and Maria Nikolaidi carried out a large part of the writing, and Maria Nikolaidi improved parts of the modelling and produced the well-presented graphs.

2.1 Introduction

Recent years have seen a growing support of the use of green public investment as a tool for enabling the transition to a low-carbon economy. For example, investments in low-carbon public transport, electricity grids and the energy efficiency of government-owned buildings have been put at the core of proposals for the fight against climate change, especially in the context of a Green New Deal (e.g. (Pettifor 2019); (Pollin 2019); (UNCTAD 2019)). At the same time, increasing attention has been paid to the need to change consumption patterns in the Global North and achieve sufficiency in the context of degrowth/post-growth approaches (e.g. (Cosme, Santos, and O’Neill 2017); (Jackson 2019); (Jackson 2019); (Mastini, Kallis, and Hickel 2021); (Sandberg 2021)).

A few macroeconomic studies have explored the implications of green public investment. Using input-output techniques, Pollin, Heidi Garrett-Peltier, et al. (2014), Pollin, Garrett-Peltier, and Chakraborty (2015) and Pollin (2020) have

examined the effects of green public investment on employment in the US and several EU countries. Batini et al. (2022) have estimated econometrically the value of green investment multipliers, showing that they are higher than the multipliers of non-green investment. Dafermos and Nikolaidi (2019) have used an ecological stock-flow consistent (SFC) model to examine how green public investment can affect macroeconomic activity as well as environmental variables, such as carbon emissions, material use and waste generation.

Recent studies have also explored the potential macroeconomic and environmental effects of consumption reduction. Using a dynamic macro-simulation model for France, D'Alessandro et al. (2020) have shown that a voluntary reduction in consumption can lead to lower inequality and lower emissions, but a higher public deficit. Based on a post-Keynesian ecological model, Nieto et al. (2020) have shown that a reduction in intermediate consumption would be conducive to higher employment and the achievement of climate goals in the EU.

However, the implications of a combined increase in green public investment and changes in consumption norms are still under-explored in the macroeconomic literature. Moreover, the ways by which different forms of green public investment affect the environmental footprint of our economies, as well as social and macroeconomic indicators, is not yet well-understood. The latter is particularly important for the design of green investment programmes. First, from a consumption norms perspective, different forms of green public spending are not identical. Some forms of green public investment can induce households to reduce the consumption of environmentally harmful goods. For instance, the expansion of public transport infrastructure can reduce the use of cars;³ or the creation of non-commercial public places for socialising can reduce environmentally harmful consumption linked with leisure. Other forms of green public investment do not have this property, like investments in renewable energies. The latter do not tend to change consumption behaviour and norms but instead can reduce the ecological intensity of our economies (i.e. the environmental footprint for a given level of GDP) for the same type of goods and services produced.

Second, different forms of public investment do not affect macroeconomic activity in the same way. Some forms of green public investment need to take place on top of existing investments (e.g. investments that expand public infrastructure), while other forms of green public investment can be undertaken instead of conventional carbon-intensive investment (e.g. investment related to electricity generation). This has implications for the way that green public investment affects macroeconomic activity. Green investment that replaces existing conventional investment has lower expansionary effects compared to investment that needs to take place on top of

³For the effects of public transport on car use, see e.g. Buehler et al. (2017) and Mugion et al. (2018). See also Mattioli et al. (2020) for the political economy of car dependence.

other public investment. This means that they also have different macroeconomic rebound effects – the latter reflect the increase in the environmental footprint that is caused by the green investment-induced increase in economic activity.⁴

In this chapter, we investigate the macroeconomic, social and environmental effects of different forms of green public investment, focusing on how they can interact with a more widespread use of sufficiency practices that are directly linked with changes in consumption patterns. We do so by developing an ecological stock-flow consistent (SFC) model.⁵ The SFC framework allows us to explore the dynamic effects of changes in investment and consumption, including macroeconomic rebound effects and the interaction between income and wealth. This is particularly important for an integrated evaluation of policies that aim at achieving the ecological transition. We use our SFC model to explore a wide range of scenarios whereby different types of green public investment and a shift to sufficiency practices take place either in isolation or in combination.

The remainder of this chapter is organised as follows. Section 2.2 describes the model. Section 2.3 presents our simulation results where we compare the effects of different forms of green public investment. Section 2.4 analyses the effects of a combined increase in green public investment and an increase in the use of sufficiency practices. Section 2.5 summarises and concludes.

2.2 The model

Our stylised model has been constructed such that it captures the key issues about the environmental and social implications of consumption norms and green public investment from a macroeconomic perspective. The model consists of two firm sectors, three household groups and a public sector, which for simplicity includes both the government and the central bank. The balance sheet matrix and the transactions matrix of the model are shown in Table 2.1 and Table 2.2, respectively. The second firm sector produces equipment goods for businesses (fixed capital goods), households (durable goods), and the government (public equipment and infrastructure). The first sector produces the rest of the goods. For simplicity, there is no interaction between the first and the second sector.

People can be employed in sector one or two, or they can be unemployed and receive unemployment benefits. We have made the simplifying assumptions that

⁴For the role of macroeconomic rebound effects, see Barker, Dagoumas, and Rubin (2009b), Taylor, Rezai, and Duncan K Foley (2016a) and Dafermos and Nikolaidi (2019).

⁵For a detailed description of the SFC approach, see Godley and Lavoie (2012). For the use of SFC modelling in the analysis of ecological macroeconomic issues, see, for example, Dafermos, Nikolaidi, and Galanis (2017a), Monasterolo and Raberto (2018), Naqvi and Stockhammer (2018), Hafner et al. (2020), Jackson (2019) and Dafermos and Nikolaidi (2021).

(i) all households have the same size and composition, (ii) the same number of people work per household and (iii) people who belong to the same household always have the same employment status and, when they are employed, they work in the same sector. An implication of these assumptions is that household income inequality and personal income inequality coincide (i.e. the model does not capture intra-household inequalities). The two types of employed households receive wage income and distributed profits by the two firm sectors and hold high-powered money. The public sector can undertake either conventional investment, such as investment in highways, airports, and fossil energy systems, or green investment (the different types of green investment are described below and are summarised in Table 3). It also collects contributions by the two types of employed households and the two firm sectors and provides unemployment benefits to unemployed households. To finance its deficit, the public sector issues high-powered money, which is the only financial asset/financial liability in the model.

In terms of environmental effects, we have opted to focus only on carbon emissions: we do not explicitly model the effects on material use, waste generation or biodiversity.⁶ However, several of the channels through which carbon emissions are affected by climate policies and macroeconomic activity can be easily extended to include environmental impacts that move beyond emissions. We also assume that all carbon emissions are generated by firms when they produce goods. Moreover, we assume that the carbon intensity of the second sector is on average higher than the carbon intensity of the first sector.

One important aspect of our model is the distinction that we make between two types of green public investment based on three criteria: (1) the impact of investment on consumption norms; (2) the expansionary effects of investment; and (3) the effects of investment on carbon intensity. Type I green investment can reduce environmentally harmful consumption, takes place on top of existing green investment (it, thus, has expansionary effects) and does not have a direct impact on carbon intensity. On the contrary, type II green investment does not have an impact on consumption patterns, replaces existing investment – having thereby no expansionary effects – and can lead to a reduction in carbon intensity. Table 2.3 summarises the differences between the two types of investment.

In the context of our model, examples of Type I green public investments are investments in electric buses, public trains and bike lanes, which can induce workers to do business travelling by relying less on cars. Type II green investment are, for example, investments in electricity grids, or investments in solar panels, wind farms and other renewable energy sources by public utilities. Needless to say, some of the

⁶For an ecological SFC model that incorporates explicitly the impact of economic activity and green investment on material intensity and waste generation, see Dafermos, Nikolaidi, and Galanis (2017b).

investment that we classify as Type I investments can have an impact on carbon intensity (e.g. electric buses can reduce the Scope 3 emissions of firms for the same level of production) and some Type II investments might take place on top of other public investment. However, we have, for simplicity, assumed away this overlapping. This allows us to have a clearer presentation of the different channels by which green public investment can affect emissions and macroeconomic performance.

We proceed to describe the equations of our model. Table 2.4 and Table 2.5 in the Appendix report the symbols for all the variables and parameters of the model.

Table 2.3: Features of the two types of green public investment

Green public investment	Environmentally harmful consumption	Macroeconomic activity	Carbon intensity
Type I	↓	↑	-
Type II	-	-	↓

2.2.1 Households

The three household groups consume both good 1 and good 2 produced by the two different firm sectors. We assume that there is a number of ‘socially determined’ necessary goods that each household has to consume. These include both Sector 1 and Sector 2 goods. Once these goods have been consumed, households estimate their remaining disposable income (which we call ‘effective’ disposable income) and consume part of it by buying Sector 1 goods. When households change group (e.g. they move from the group of employed people to the group of unemployed ones) they bring with them their wealth. Therefore, following Dafermos and Papatheodorou (2015)), we have explicitly incorporated in the model wealth transfers from one household group to another, which take place when unemployment changes. This is necessary to ensure that the wealth dynamics in the groups are properly captured.

The disposable income ($YD_{ei,t}$) of employed people in sector i ($i \in \{1,2\}$) is equal to their wage bill ($WB_{i,t}$) plus the distributed profits ($DFP_{i,t}$) that households receive from the firm sector i minus the contributions that they have to provide to the government (Eq. (2.1)); $\tau_{w,t}$ is the contribution rate which is applied to wages and is paid by workers. The effective disposable income of employed people ($YD_{ei,t}^{eff}$) is equal to their overall income minus the necessary consumption for good 1 and good 2 (Eq. (2.2)); $N_{i,t}$ is the number of people employed in the i sector; $cc_{1,t}$ and $cc_{2,t}$ are the necessary consumption of good 1 and good 2, respectively. The change in high-powered money of employed people ($H_{ei,t}$) is equal to their disposable income plus wealth transfers ($WT_{i,t}$), defined in Eq. (2.9), minus their consumption ($C_{ei,t}$) (Eq. (2.3)). Recall that high-powered money is the only form of financial asset in our stylised economy.

$$YD_{ei,t} = (1 - \tau_{w,t})WB_{i,t} + DFP_{i,t} \quad (2.1)$$

$$YD_{ei,t}^{eff} = YD_{ei,t} - N_{i,t}(cc_{1,t} + cc_{2,t}) \quad (2.2)$$

$$H_{ei,t} = H_{ei,t-1} + YD_{ei,t} - C_{ei,t} + WT_{i,t} \quad (2.3)$$

Unemployment benefits per unemployed person (ub_t) are set a proportion (ξ) of wage rate per worker, which is equal to the hourly wage rate (w_t) times the working hours per person (h_t) (Eq. (2.4)). Eq. (2.5) shows the unemployed benefits for unemployed people as a whole (UB_t); $N_{u,t}$ is the number of unemployed people. The disposable income of the unemployed people ($YD_{u,t}$) is equal to their unemployment benefits (Eq. (2.6)). Eq. (2.7) gives the effective disposable income of the unemployed ($YD_{u,t}^{eff}$). The rest of the disposable income that is not consumed (once the wealth transfers have been taken into account) is saved in the form of high-powered money (Eq. (2.8)); $H_{u,t}$ is the high-powered money held by unemployed households and $C_{u,t}$ is their consumption.

$$ub_t = \xi w_t h_t \quad (2.4)$$

$$UB_t = N_{u,t} ub_t \quad (2.5)$$

$$YD_{u,t} = UB_t \quad (2.6)$$

$$YD_{u,t}^{eff} = YD_{u,t} - N_{u,t}(cc_{1,t} + cc_{2,t}) \quad (2.7)$$

$$H_{u,t} = H_{u,t-1} + YD_{u,t} - C_{u,t} - (WT_{1,t} + WT_{2,t}) \quad (2.8)$$

Wealth transfers take place between the employed ($N_{ei,t}$) and the unemployed ($N_{u,t}$). We assume that people switch from unemployment to a production sector or the other way around, but not directly from one firm sector to the other. The wealth transfers shown in (Eq. (2.9)) are defined as transfers of wealth from the group of the employed to the group of the unemployed. Hence, when $WT_{i,t} > 0$, wealth is transferred from the group of unemployed households to the group of employed households; the opposite holds when $WT_{i,t} < 0$.

$$WT_{i,t} = z_{eiu} \frac{(N_{ei,t} - N_{ei,t-1})H_{ei,t-1}}{N_{ei,t-1}} + z_{uei} \frac{(N_{ei,t} - N_{ei,t-1})H_{u,t-1}}{N_{u,t-1}} \quad (2.9)$$

with

$z_{eiu} = 1$ if and only if $N_{ei,t} < N_{ei,t-1}$, otherwise $z_{eiu} = 0$.

$z_{uei} = 1$ if and only if $N_{ei,t} > N_{ei,t-1}$, otherwise $z_{uei} = 0$.

The consumption of good 1 ($C_{1,j,t}$) per each household group j (for $j \in \{u, e1, e2\}$) is defined according to Eq. (2.10). Households consume a specific number of goods ($cc_{1,t}$) that are considered as necessary and increase at an exogenous rate, g_0 (Eq. (2.11)), a proportion of their expected effective disposable income ($YD_{j,t}^{eff,exp}$) and a proportion of their expected wealth ($H_{j,t}^{exp}$).⁷ Note that unemployed people are assumed to spend all their effective disposable income ($c_{yde,u} = 1$), while employed people are able to save part of it, with identical propensities for both groups of employed households (i.e. $c_{yde,e1} = c_{yde,e2} < 1$).

$$C_{1,j,t} = N_{j,t} \left[cc_{1,t} + c_{yde,j} \frac{YD_{j,t}^{eff,exp}}{N_{j,t}} + c_{h,j} \frac{H_{j,t}^{exp}}{N_{j,t}} \right] \quad (2.10)$$

$$cc_{1,t} = cc_{1,t-1}(1 + g_0) \quad (2.11)$$

The consumption of good 2 ($C_{2,j,t}$) per each household group j (for $j \in \{u, e1, e2\}$) is given by Eq. (2.12). We assume that the consumption of good 2 depends on two factors. The first factor is the level of type I green capital: the higher the level of green public capital compared to total capital ($K_{I,pg,t}/K_{I,p,t}$) the less necessary the consumption of good 2 is. The second factor is how widespread the use of sufficiency practices is in the society. A more widespread use of sufficiency practices is linked with a lower consumption of good 2 (for a given level of green capital Type I).⁸ We denote as $cc_{2WE,t}$ the consumption that would take place if there were no sufficiency practices and no type I green capital (i.e. the level of consumption without environmental considerations). We assume that some

⁷We assume that households have adaptive expectations whereby the expected disposable income and expected wealth are determined as $YD_{j,t-1}^{eff}(1+g_{Y,t-1})$ and $H_{j,t-1}(1+g_{Y,t-1})$, respectively (see (van Treeck 2009) for a similar formulation). We assume that households expect their income and wealth to grow in line with the growth rate of the economy.

⁸Broadly speaking, sufficiency reflects both changes in consumption patterns and a reduction in consumption levels. For a discussion of sufficiency-related consumption changes and an overview of sufficient practices, see e.g. Sandberg (2021).

socially determined consumer needs tend to increase because new products are regularly invented and because the advertising industry makes sure consumers want to buy them. As a result, $cc_{2WE,t}$ increases at an exogenous rate, g_0 (Eq. (2.13)). This assumption also explains why the term $cc_{1,t}$ for the consumption of good 1 keeps increasing at the rate g_0 . The adoption of sufficiency practices can be the result of both voluntary decisions taken by households about the decline of their ecological footprint and of the use of environmental regulation by the government aiming at reducing environmentally harmful consumption. The role of sufficiency practices and green public capital is captured by σ_t , which we call the ‘ecologically driven consumption adjustment factor’. The higher the value of σ_t the lower the consumption of good 2, as shown in Eq. (2.14) ($0 \leq \sigma_t \leq 1$). Green investment determines the potential value that σ_t can take, denoted by $\sigma_{pot,t}$ (Eq. (2.15)). As shown in Eq. (2.16), this potential value materialises only when the sufficiency indicator (SI_t), which takes values between 0 and 1, is at its maximum level (i.e. $SI_t = 1$).

$$C_{2,j,t} = N_{j,t} cc_{2,t} \quad (2.12)$$

$$cc_{2WE,t} = cc_{2WE,t-1}(1 + g_0) \quad (2.13)$$

$$cc_{2,t} = cc_{2WE,t}(1 - \sigma_t) \quad (2.14)$$

$$\sigma_{pot,t} = f\left(\frac{K_{I,pg,t-1}^+}{K_{I,p,t-1}}\right) \quad (2.15)$$

$$\sigma_t = SI_t \sigma_{pot,t} \quad (2.16)$$

The total consumption of each household group j (for $j \in \{u, e1, e2\}$) is the sum of good 1 and good 2 (Eq. (2.17)); $C_{j,t}$ is total consumption for household j .

$$C_{j,t} = C_{1,j,t} + C_{2,j,t} \quad (2.17)$$

The private consumption of the first good ($C_{1,h,t}$) is equal to the sum of the

consumption of employed and unemployed households (Eq. (2.18)). The same holds for the private consumption of the second good ($C_{2,h,t}$) (Eq. (2.19)). The total private consumption ($C_{h,t}$) is equal to the sum of the private consumption of the first good and the private consumption of the second good (Eq. (2.20)).

$$C_{1,h,t} = C_{1,e1,t} + C_{1,e2,t} + C_{1,u,t} \quad (2.18)$$

$$C_{2,h,t} = C_{2,e1,t} + C_{2,e2,t} + C_{2,u,t} \quad (2.19)$$

$$C_{h,t} = C_{1,h,t} + C_{2,h,t} \quad (2.20)$$

2.2.2 Firms

The firms of Sector 1 and Sector 2 take similar decisions. According to Eq. (2.21), the gross investment ($I_{i,f,t}$) in sector i depends positively on the discrepancy between the actual rate of capacity utilisation ($u_{i,t}$) and the target capacity utilisation rate (u^T).⁹ Eq. (2.22) shows the evolution of the stock of capital of sector i ; δ is the rate of capital depreciation and $K_{i,f,t}$ is the capital stock of firm sector i .

$$I_{i,f,t} = [\alpha_0 i + \alpha_1 (u_{i,t-1} - u^T)] K_{i,f,t-1} + \delta K_{i,f,t-1} \quad (2.21)$$

$$K_{i,f,t} = K_{i,f,t-1} + I_{i,f,t} - \delta K_{i,f,t-1} \quad (2.22)$$

The gross profits (FP_{it}) of each firm i (for $i \in \{1, 2\}$) are equal to firm sales ($Y_{i,t}$) minus the wage bill (WB_{it}) (Eq. (2.23)). Eq. (2.24) defines the wage bill, which is equal to the number of employed people ($N_{ei,t}$) times the hourly wage rate (w_t) times the working hours (h_t). The profits ($NFP_{i,t}$), net of contributions and capital depreciation, are given by Eq. (2.25); $\tau_{f,t}$ is the contribution rate of firms. Firms' investment is fully funded through retained profits ($RFP_{i,t}$). Therefore,

⁹We have opted to use a simple investment function whereby investment depends only on the rate of capacity utilisation. The inclusion of the profit rate or the profit share would not change the essence of our analysis since the profit share is exogenous in our model and no shock to the profit share is imposed in our simulation analysis. For more complicated investment functions, see e.g. Blecker (2002), van Treeck (2009) and Skott and Zipperer (2012).

firms' retained profits are equal to the amount that is necessary to fund investment. This is reflected in Eq. (2.26). The remaining profits are distributed to households, as shown in Eq. (2.27).

$$FP_{i,t} = Y_{i,t} - WB_{i,t} \quad (2.23)$$

$$WB_{i,t} = N_{ei,t}w_t h_t \quad (2.24)$$

$$NFP_{i,t} = FP_{i,t} - \tau_{f,t}WB_{i,t} - \delta K_{i,f,t-1} \quad (2.25)$$

$$RFP_{i,t} = I_{i,f,t} - \delta K_{i,f,t-1} \quad (2.26)$$

$$DFP_{i,t} = NFP_{i,t} - RFP_{i,t} \quad (2.27)$$

Output in our model is demand-determined and is overall equal to the sum of total consumption plus total investment demand. The output produced in the first sector ($Y_{1,t}$) is equal to the (private and public) consumption demand plus the private investment demand for the good of this sector (Eq. (2.28)). The output produced in the second sector ($Y_{2,t}$) is equal to the consumption and investment demand for this good by both the private and the public sector (Eq. (2.29)); $C_{i,p,t}$ is the public consumption spending for good i and public investment is denoted by $I_{p,t}$. Total output (Y_t) is the sum of the output in the first and the second sector (Eq. (2.30)).

$$Y_{1,t} = C_{1,h,t} + I_{1,f,t} + C_{1,p,t} \quad (2.28)$$

$$Y_{2,t} = C_{2,h,t} + I_{2,f,t} + C_{2,p,t} + I_{p,t} \quad (2.29)$$

$$Y_t = Y_{1,t} + Y_{2,t} \quad (2.30)$$

The full-capacity output of sector i ($Y_{i,f,c,t}$) is equal to the capital stock in sector i ($K_{i,f,t}$) divided by the potential-to-output ratio (ν_i) (Eq. (2.31)). The capacity utilisation of sector i ($u_{i,t}$) is defined in Eq. (2.32).

$$Y_{i,f,c,t} = K_{i,f,t}/\nu_i \quad (2.31)$$

$$u_{i,t} = Y_{i,t}/Y_{i,f,c,t} \quad (2.32)$$

The hourly nominal wage rate (w_t) is given by hourly productivity (pr_t) times the wage share (s_W) (Eq. (2.33)).¹⁰ We assume that hourly productivity increases in line with the growth rate of the economy ($g_{Y,t}$), as shown in Eqs. (2.34) and (2.35); $g_{pr,t}$ is the growth rate of labour productivity. This is broadly consistent with the Kaldor-Verdoorn law (see (Lavoie 2014b) ch. 6).

$$w_t = pr_t s_W \quad (2.33)$$

$$pr_t = pr_{t-1}(1 + g_{pr,t}) \quad (2.34)$$

$$g_{pr,t} = pr_0 + pr_1 g_{Y,t-1} \quad (2.35)$$

The number of people employed in sector i ($N_{ei,t}$) is defined by Eq. (2.36); $Y_{i,t}$ is the output in sector i , and h_t is the number of hours worked per employee over a given period. We assume that firms hire people based on the output of the sector in the previous period. The total number of people employed in the economy ($N_{e,t}$) is the sum of the employment in the first and second firm sector (Eq. (2.37)); $N_{u,t}$ is the number of unemployed defined in Eq. (2.38) and N denotes the labour force which is constant. Eq. (2.39) defines the unemployment rate (ur_t).

$$N_{ei,t} = Y_{i,t-1}/(h_t pr_t) \quad (2.36)$$

¹⁰This reflects our assumption that the price level in the model, which is given by the mark-up rule, $p_t = (1+\varphi)w_t/pr_t$, is equal to 1; φ is the mark-up.

$$N_{e,t} = N_{e1,t} + N_{e2,t} \quad (2.37)$$

$$N_{u,t} = N - N_{e,t} \quad (2.38)$$

$$ur_t = N_{u,t}/N \quad (2.39)$$

2.2.3 Public sector

Eqs. (2.40) and (2.41) show that green public investment of type I ($I_{I,pg,t}$) is determined as a proportion of the green type I capital stock, while conventional public investment of type I ($I_{I,pc,t}$) is defined as a proportion of the conventional type I capital stock (we assume that the public sector replaces the depreciated capital stock). The total amount of public investment type I ($I_{I,p,t}$) is the sum of green and conventional investment.

$$I_{I,pg,t} = gov_{Ig} K_{I,pg,t-1} + \delta K_{I,pg,t-1} \quad (2.40)$$

$$I_{I,pc,t} = gov_{Ic} K_{I,pc,t-1} + \delta K_{I,pc,t-1} \quad (2.41)$$

$$I_{I,p,t} = I_{I,pg,t} + I_{I,pc,t} \quad (2.42)$$

The total public investment of type II ($I_{II,p,t}$) is defined in Eq. (2.43). According to Eqs. (2.44) and (2.45) the total amount of type II public investment is split into green and conventional public investment; $I_{II,pc,t}$ is conventional public investment type II, $I_{II,pg,t}$ is green public investment type II and λ is the proportion of green public investment type II to total public investment type II. Our formulation for type II investment allows for depreciated conventional capital stock to be replaced

by green capital stock.¹¹

$$I_{II,p,t} = gov_{II} K_{II,p,t-1} + \delta K_{II,pc,t-1} + \delta K_{II,pg,t-1} \quad (2.43)$$

$$I_{II,pg,t} = \lambda I_{II,p,t} \quad (2.44)$$

$$I_{II,pc,t} = (1 - \lambda) I_{II,p,t} \quad (2.45)$$

Total public investment ($I_{p,t}$) is the sum of type I and type II public investment (Eq. (2.46)).

$$I_{p,t} = I_{I,p,t} + I_{II,p,t} \quad (2.46)$$

Conventional public capital ($K_{\kappa,pc,t}$) and green public capital ($K_{\kappa,pg,t}$) for both κ types of investment ($\kappa \in \{I, II\}$) evolve according to Eqs. (2.47) and (2.48), respectively. Total public capital ($K_{p,t}$) is the sum of conventional and green public capital (Eq. (2.49)) and captures transport infrastructure and equipment (Type I) and energy infrastructure and power plants (Type II), which can be either green or conventional.

$$K_{\kappa,pc,t} = K_{\kappa,pc,t-1} + I_{\kappa,pc,t} - \delta K_{\kappa,pc,t-1} \quad (2.47)$$

$$K_{\kappa,pg,t} = K_{\kappa,pg,t-1} + I_{\kappa,pg,t} - \delta K_{\kappa,pg,t-1} \quad (2.48)$$

$$K_{p,t} = K_{I,pc,t} + K_{II,pg,t} + K_{II,pc,t} + K_{II,pg,t} \quad (2.49)$$

Public consumption spending ($C_{p,t}$) is set as a proportion (gov) of output (Eq. (2.50)) and refers to the goods of both Sector 1 and Sector 2. Each sector supplies a proportion, $prop_{i,cp}$, of this spending (Eq. (2.51)).

¹¹This does not happen in the case of Type I capital stock, unless the public sector decides to do so.

$$C_{p,t} = govY_{t-1} \quad (2.50)$$

$$C_{i,p,t} = prop_{i,cp} C_{p,t} \quad (2.51)$$

The contributions that the government collects from workers and firms (CO_t) are given by Eq. (2.52).

$$CO_t = (\tau_{w,t} + \tau_{f,t})WB_t \quad (2.52)$$

Eq. (2.53) shows that contributions minus the sum of unemployment benefits and consumption government spending stands for government net saving (GNS_t). The government net saving represents flows of funds between the current account of the public sector and its capital account.¹² According to Eq. (2.54), the change in high-powered money is equal to the expenditures of the government (unemployment benefits, public consumption and total public investment) minus the revenues (which are equal to the contributions received from workers and firms). Eq. (2.55)-red reflects the fact that the change in total high-powered money is equal to the change in high-powered money of the unemployed and employed. The change in high-powered money is equal to the deficit of the government (Eq. (2.56)). The deficit-to-GDP ratio ($DEFR_t$) is defined in Eq. (2.57); DEF_t is the deficit of the government and H_t is total high-powered money.

$$GNS_t = CO_t - UB_t - \delta K_{p,t-1} - C_{p,t} \quad (2.53)$$

$$H_t = H_{t-1} - GNS_t + I_{p,t} - \delta K_{p,t-1} \quad (2.54)$$

$$H_{red,t} = H_{t-1} + (H_{u,t} - H_{u,t-1}) + (H_{e1,t} - H_{e1,t-1}) + (H_{e2,t} - H_{e2,t-1}) \quad (2.55)$$

¹²Broadly speaking, the current account captures the flows related to revenues and expenditures, while the capital account reflects the financing of investment and the changes in financial assets and liabilities.

$$DEF_t = H_t - H_{t-1} \quad (2.56)$$

$$DEFR_t = DEF_t/Y_t \quad (2.57)$$

The government can change the working hours in an endogenous way in order to keep the unemployment rate close to ur^T (Eqs. (2.58)-(2.59)); ur^T is the target rate of unemployment and $\eta_h \leq 0$ is the responsiveness of hours to changes in the unemployment rate (see Jackson and Peter A. Victor (2019) for a similar equation). The policy response is asymmetric: hours per employee cannot increase, they can only stagnate or decrease.¹³ Note that in the baseline scenario the working hours remain constant (i.e. $\eta_h = 0$).

$$h_t = h_{t-1}(1 + g_{h,t}) \quad (2.58)$$

$$g_{ht} = \min[0, \eta_h(ur_{t-1} - ur^T)] \quad (2.59)$$

2.2.4 Emissions and inequality

An increase in the level of production in the first or in the second sector tends to increase emissions ($EMIS_t$) (Eq. (2.60)); $\beta_{1,t}$ and $\beta_{2,t}$ capture the carbon intensity of the first and the second sector, respectively. $\beta_{i,t}$, for i ($i \in \{1, 2\}$), declines as the green public capital of type II increases compared to total public capital of the same type (Eq. (2.61)).¹⁴

$$EMIS_t = \beta_{1,t}Y_{1,t} + \beta_{2,t}Y_{2,t} \quad (2.60)$$

¹³We assume that when working hours change through government regulation, the hourly wage rate does not change and the wage share remains thereby the same. The overall result is that each worker receives a lower total wage. The investigation of the implications of the case in which the hourly wage rate increases is beyond the scope of this chapter. For an analysis of the interplay between the wage share and the reduction in working hours, see Cieplinski, D'Alessandro, and Guarnieri (2021).

¹⁴For similar equations that connect ecological efficiency with green capital, see Dafermos, Nikolaidi, and Galanis (2017b).

$$\beta_{i,t} = f\left(\frac{K_{II,pg,t-1}^+}{K_{II,p,t-1}}\right) \quad (2.61)$$

Two simple indicators are used to capture the inequality between employed and unemployed households. Eq. (2.62) defines the first indicator which is the ratio of the per capita disposable income of employed people to the income of the unemployed ones ($YD_{p\text{ratio},t}$). Eq. (2.63) defines the second indicator, which is the ratio of the per capita effective disposable income of employed people to that of the unemployed ones ($YD_{p\text{ratio},t}^{\text{eff}}$). The second indicator is particularly important in the context of our analysis. It shows the differences in the income of employed and unemployed people after they spent for their ‘necessary’ consumption.

$$YD_{\text{ratio},t} = \frac{(YD_{e1,t} + YD_{e2,t})/N_{e,t}}{YD_{u,t}/N_{u,t}} \quad (2.62)$$

$$YD_{\text{ratio},t}^{\text{eff}} = \frac{(YD_{e1,t}^{\text{eff}} + YD_{e2,t}^{\text{eff}})/N_{e,t}}{YD_{u,t}^{\text{eff}}/N_{u,t}} \quad (2.63)$$

2.3 Effects of the different types of green public investment

The model has been calibrated by using data for EU-27 countries and, when necessary, parameters have been selected from a reasonable range of values. Our purpose is not to produce trajectories that correspond to the pathways of EU macroeconomic and environmental data; it is rather to get realistic values for a steady state that acts as our baseline scenario.

Our first aim is to illustrate the different effects of Type I and Type II green public investment. In the first scenario (*Green Public Investment (GPI) I*), we assume that at $t=10$ Type I green investment becomes higher compared to the baseline scenario; at the same time, to accelerate the transition towards a greener public infrastructure, the conventional investment that is depreciated is replaced by green capital. At $t=50$ the growth rate of green public investment of Type I goes back to its pre-shock value and the replacement of depreciated conventional capital of Type I by green capital stops. In the second scenario (*Green Public Investment (GPI) II*), Type II green investment increases replacing directly Type II conventional

green investment. The shocks have been designed such that the cumulative increases in Type I and Type II green investment are of similar magnitudes.

As Figure 2.2 shows, Type II investment has only a favourable effect on carbon intensity (Figure 2.2e), which leads to a reduction of carbon emissions compared to the baseline scenario (Figure 2.2f).¹⁵ Since Type II green public investment replaces conventional investment, it has no impact on macroeconomic variables. On the contrary, Type I green investment has significant macroeconomic effects since, by design, it leads to additional investment demand. At the same time, the increase in Type I investment leads households to reduce their consumption of good 2, since the expansion of Type I green public capital (Figure 2.2a) makes this good less necessary. This is reflected in the increase in the ecologically driven consumption adjustment factor (Figure 2.2b). However, since households consume less of good 2 (Figure 2.2h), their effective disposable income increases (Figure 2.2i and 2.2j), inducing them to increase the consumption of good 1 (Figure 2.2g). This effect takes place in combination with the increase in the production of good 2 that is caused by the rise in Type I green public investment. In our simulations, the expansionary effects related to the higher consumption of good 1 and the higher investment demand overcompensate the contractionary effects that come from the lower consumption of good 2. As a result, economic growth increases (Figure 2.2c) and the unemployment rate goes down (Figure 2.2d).

The channels through which the increase in green public investment of Type I affects emissions are depicted in Figure 2.1. The increase in economic growth that stems from the increase in Type I green public investment results in a macroeconomic rebound effect that tends to increase emissions. However, emissions also have a tendency to go down since (i) there is a reallocation of consumption from good 2 to good 1 (recall that the carbon intensity of good 1 is lower than the carbon intensity of good 2) and (ii) total consumption declines since the fall in the consumption of good 2 is not fully offset by the increase in the consumption of good 1. Figure 2.2f shows that in our simulations the macroeconomic rebound effects on emissions dominate, and thus emissions slightly increase compared to the baseline scenario.

It is important, however, to note that the overall impact on emissions depends on the strength of the conflicting effects, which in turn depend on specific parameter values. The key parameters that determine the overall impact on emissions are the responsiveness of $\sigma_{pot,t}$ to the increase in Type I green capital and the propensity to consume out of disposable income. Moreover, in our simulations the favourable effects of Type I green public investment are underestimated due to our simplifying assumption that this type of investment has no impact on the carbon intensity of production.

¹⁵Figure 2.2e shows the carbon intensity of Sector 1. The decline in the intensity of Sector 2 is similar.

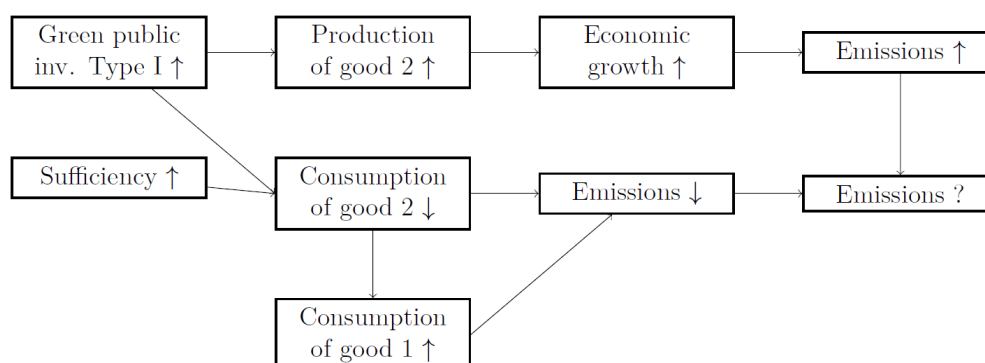

Figure 2.1: Transmission channels of green public investment (Type I) and sufficiency

The income gap that is calculated based on effective incomes declines (Figure 2.2k). This is due to the decline in the need of all households to consume good 2. Since this consumption is a higher proportion of the income of unemployed people, their gains in relative terms are higher compared to the employed groups (see Figure 2.2i and Figure 2.2j).

Sector 2 is affected both positively and negatively under the *GPI I* scenario. On the one hand, higher public investment increases the demand for the goods of this sector. On the other hand, the decline in consumption of good 2 places downward pressures on the demand for good 2. Figure 2.2e shows that the profit rate in this sector initially increases and then declines as the reduction in the consumption of good 2 is enhanced by the expansion of green capital.¹⁶ The increase in Type I green public investment places upward pressures on the deficit-to-GDP ratio and the public debt-to-GDP ratio. Both ratios increase (see Figure 2.2m and Figure 2.2n) and stabilise at slightly higher levels relative to the baseline scenario.¹⁷

¹⁶Recall that the profit share is constant, so changes in the profit rate coincide with changes in the rate of capacity utilisation.

¹⁷The macroeconomic rebound effects that stem from our policy scenarios could be restricted via an increase in the contribution rates for workers and firms. In that case, the public deficit and debt-to-GDP ratios would also depart less from the baseline scenario.

Figure 2.2: Effects of the different types of green public investment

(a) Ratio of green public capital to total capital (Type I)

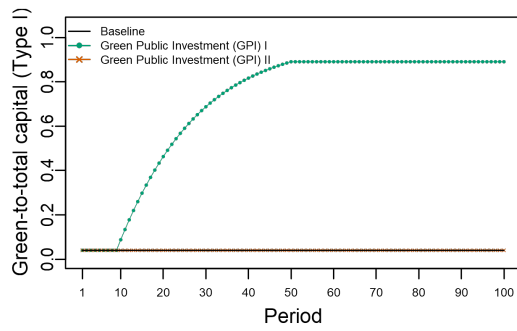

(b) Consumption adjustment factor

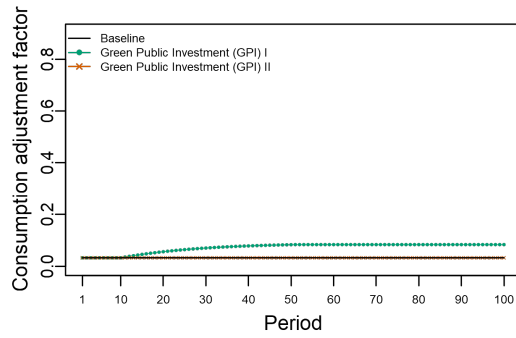

(c) Growth rate of output (%)

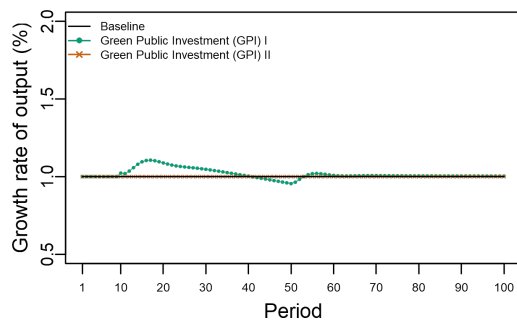

(d) Unemployment rate (%)

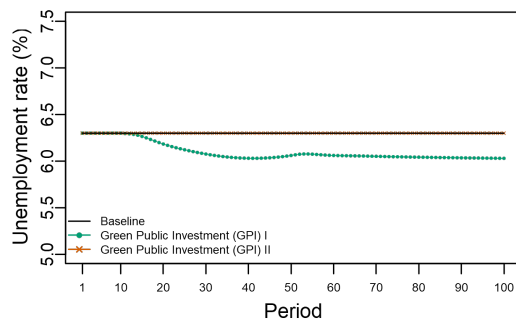

(e) Carbon intensity of sector 1

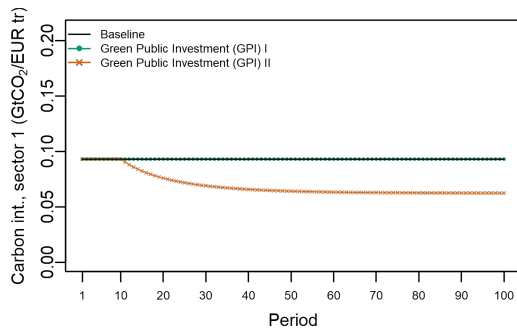

(f) CO₂ emissions

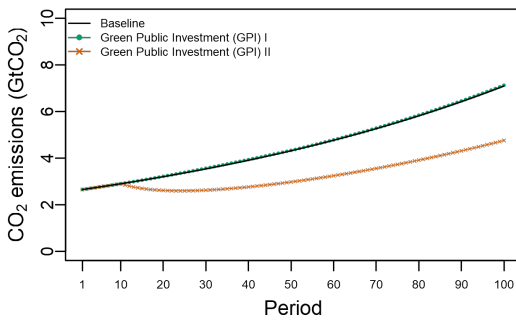

(g) Total consumption of good 1

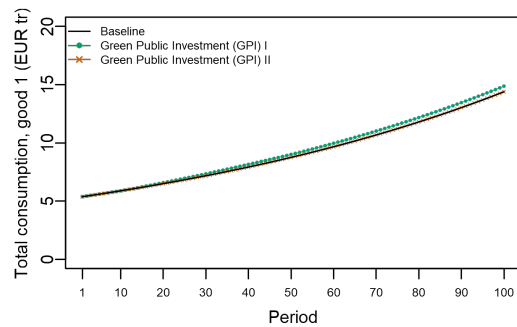

(h) Total consumption of good 2

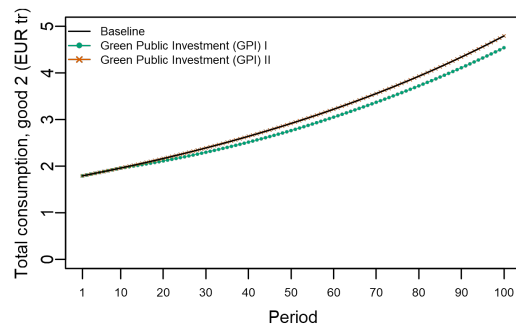

(continued from the previous page)

(i) Effective disposable income of employed

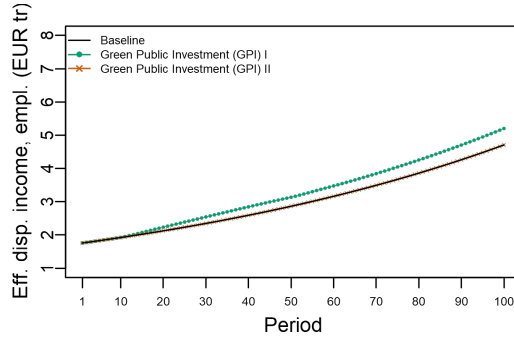

(j) Effective disposable income of unemployed

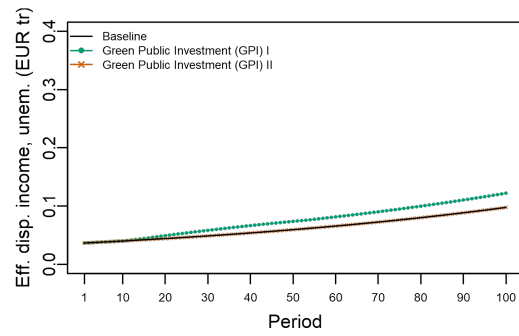

(k) Effective income gap ratio

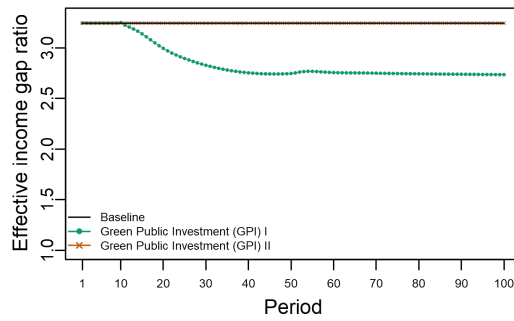

(l) Profit rate (%) in sector 2

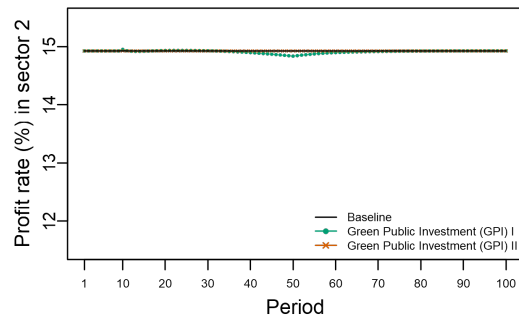

(m) Deficit-to-GDP ratio (%)

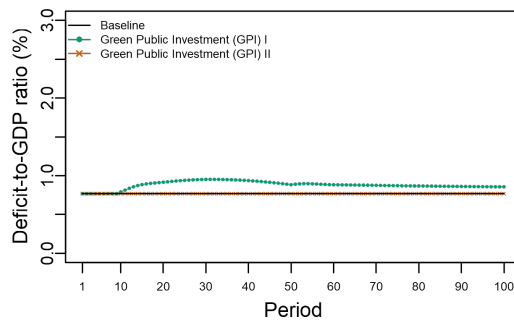

(n) Debt-to-GDP ratio (%)

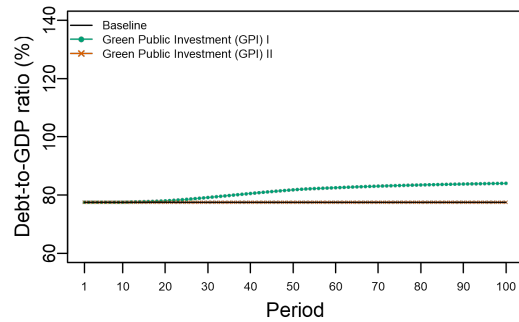

Note: All shocks start in period 10 and stop in period 50. In the GPI (Green Public Investment) I scenario, green public investment Type I becomes higher via an increase in gov_{gI} (see Eq. (2.40)); moreover, Type I depreciated conventional capital is replaced by Type I green capital. In the GPI II scenario, green public investment type II becomes higher via an increase in λ in Eq. (2.44).

2.4 Effects of green public investment and sufficiency

We now explore the combined effects of green public investment and a more widespread use of sufficiency practices. We consider three scenarios. In the *Green Public Investment (GPI) I+II* scenario we assume that in period 10 both Type I and Type II green investment increase as in Figure 2.2. In the *Transition to Sufficiency (TS)* scenario there is an exogenous increase in SI from 0.1 to 1, reflecting an increase in the adoption of sufficiency practices in the society. This increase takes place in period 10 and there is a gradual change: it takes 40 periods until SI reaches its new maximum value. At the same time, the government decreases the working hours to avoid an increase in the unemployment rate. Lastly, in the *GPI I+II & TS* scenario, the increase in green public investment and the higher use of sufficiency practices take place simultaneously.

In the GPI scenario the results are similar to those presented in Figure 2.2 under the *GPI I* scenario. The only difference is that, since the increase in green public investment of Type I is combined with an increase in green public investment of Type II, carbon emissions decline (Figure 2.3f).

In the *TS* scenario, the reduction in the consumption of good 2 has four main implications. First, the total consumption of good 2 declines, as shown in Figure 2.3h. This is so because of the increase in the ecologically driven consumption adjustment factor (Figure 2.3b). This leads to a decline in economic growth (Figure 2.3c) and an increase in the unemployment rate (Figure 2.3d) – which is, however, tamed by the decline in working hours. Second, there are some macroeconomic rebound effects that materialise because the increase in the effective disposable income leads to a rise in the consumption of good 1 (Figure 2.3g). Third, the macroeconomic rebound effects partially offset the favourable effects on carbon emissions that stem from the decline in the consumption of good 2. Fourth, the gap between the effective incomes of employed and unemployed goes down (Figure 2.3k). This is explained by the fact that the unemployed people benefit more in relative terms by the decline in the consumption of good 2.

When the increase in green investment and the sufficiency transition take place at the same time, the decline in the consumption of good 2 is reinforced. Figure 2.3b shows that the effects on the consumption adjustment factor do not simply add up: the change in this factor is higher than the sum of the changes observed when scenarios *GPI I+II* and *TS* are implemented in isolation. Said differently, the changes implemented in scenarios *GPI I+II* and *TS* need one another in order to develop their full potential. On the one hand, without green public investment, the potential of reducing carbon emissions from a shift to sufficiency is restricted by the lack of sufficient infrastructure: even though a substantial part of the population wishes to shift away from the consumption of good 2, consuming it

remains necessary. On the other hand, investment in green public infrastructure is necessary but not sufficient; it enables changes in modes of living, but cannot enforce them. For instance, many people could continue using their cars and leave public transport under-utilised. The *GPI I+II & TS* scenario illustrates this positive complementarity between the capability and the willingness to change consumption patterns.

Interestingly, in the *GPI I+II & TS* scenario the favourable effects on income inequality are also higher compared to the other scenarios, as shown in Figure 2.3k. In all scenarios public deficit and public debt increase, but stabilise over time (Figure 2.3m and Figure 2.3n). As for the viability of Sector 2, the decline in its profitability that is caused by the fall in the consumption of good 2 is only temporary and of relatively small magnitude (Figure 2.3l). The profit rate goes gradually back to its initial level as the consumption adjustment factor stabilises at a new higher level (Figure 2.3b). Hence, the sector remains economically sustainable.

Figure 2.3: Effects of green public investment and sufficiency

(a) Ratio of green public capital to total capital (Type I)

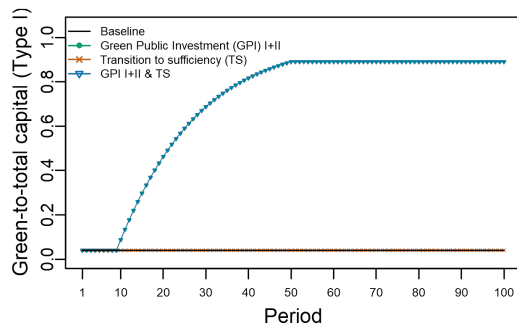

(b) Consumption adjustment factor

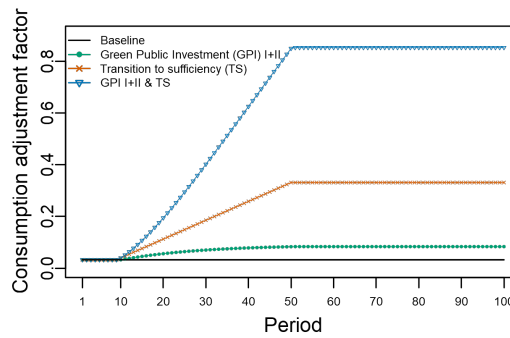

(c) Growth rate of output (%)

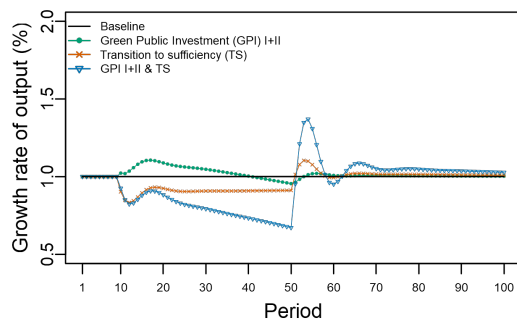

(d) Unemployment rate (%)

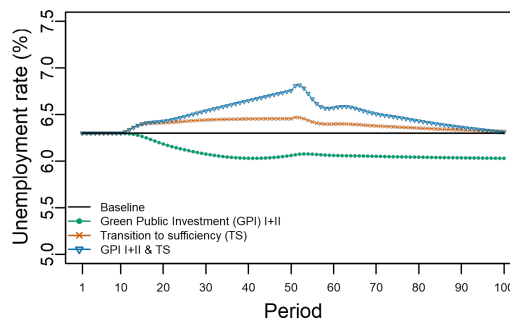

(e) Carbon intensity of sector 1

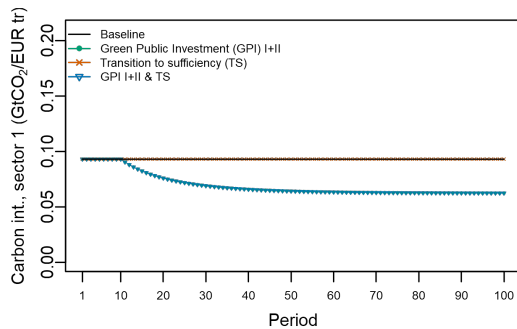

(f) CO₂ emissions

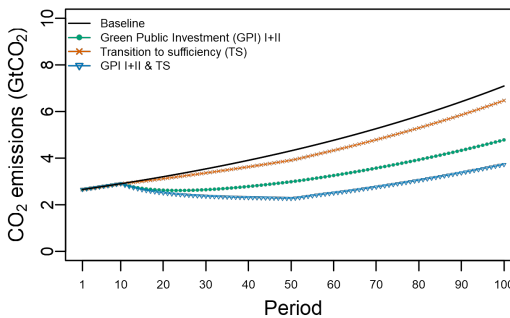

(g) Total consumption of good 1

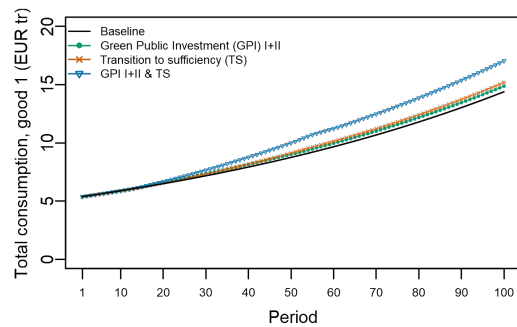

(h) Total consumption of good 2

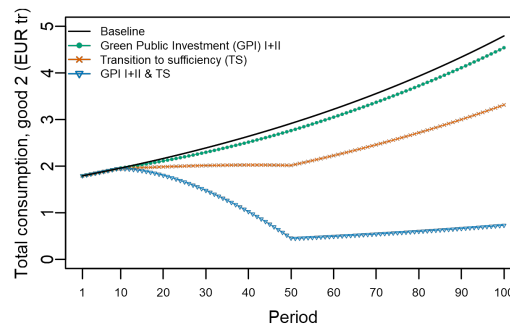

(continued from the previous page)

- (i) Effective disposable income of employed
- (j) Effective disposable income of unemployed

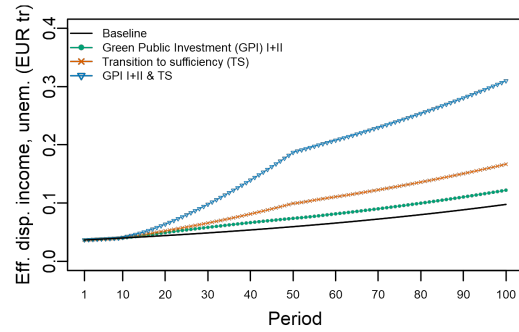
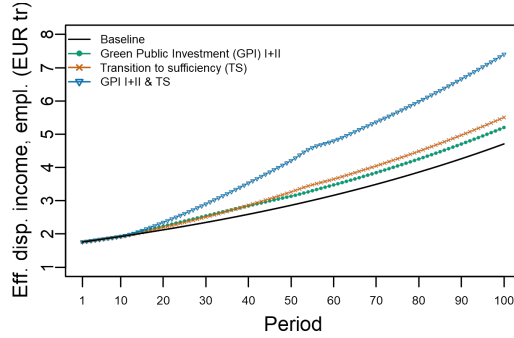

- (k) Effective income gap ratio

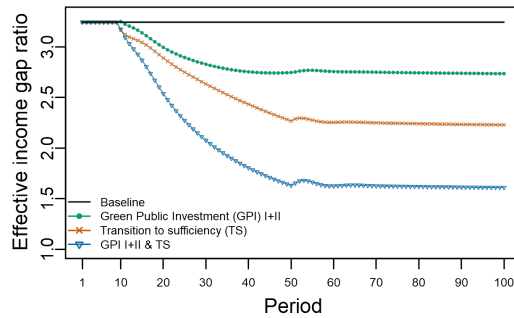

- (l) Profit rate (%) in sector 2

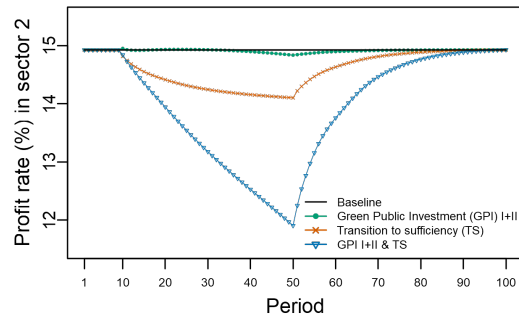

- (m) Deficit-to-GDP ratio (%)

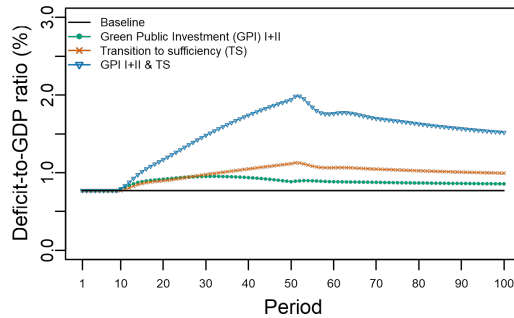

- (n) Debt-to-GDP ratio (%)

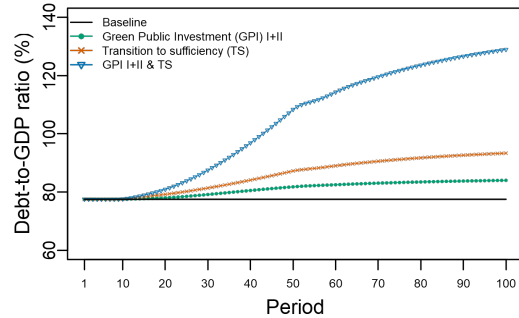

Note: All shocks start in period 10 and stop in period 50. In the GPI (Green Public Investment) I+II scenario, green public investment Type I becomes higher via an increase in gov_{gI} (see Eq. (2.40)) and green public investment type II becomes higher via an increase in λ in Eq. (2.44); moreover, Type I depreciated conventional capital is replaced by Type I green capital. In the Transition to Sufficiency (TS) scenario, SI in Eq. (2.16) increases gradually to 1 and η_h in Eq. (2.59) becomes positive. In the GPI I+II & TS scenario, GPI I+II and TS are implemented simultaneously.

2.5 Conclusion

One under-explored issue in the debates about the Green New Deal and degrowth is the environmental complementarities that can arise from the combined implementation of green public investment programmes and changes in consumption patterns that can be driven by a shift to sufficiency practices. Using an SFC macroeconomic model, this chapter investigated the nature and the implications of these complementarities. We made a distinction between different types of green public investment based on their effects on economic activity, carbon intensity and the consumption patterns of households. We analysed the channels via which both green public investment and autonomous changes in consumption patterns can affect emissions, paying particular attention to the role of macroeconomic rebound effects. The results of our simulations illustrate how a simultaneous increase in the capability and in the willingness to change consumption patterns can lead to a substantial reduction in carbon emissions, despite the macroeconomic rebound effects that appear during the transition.

Our simulation analysis of the interactions between green public investment and sufficiency practices also shows that ecology-oriented profound changes in the structure and composition of the economy are not necessarily conducive to social and economic distress. First, although the unemployment rate initially increases as a result of the decline in the consumption of environmentally harmful goods, the reduction in working time brings the unemployment rate back to its initial level. Second, even though the decrease in overall hours worked can reduce the income per household, the provision of green public infrastructure allows for a change in modes of living that reduces the necessity of specific types of consumption. As a result, the income effectively available to households is maintained and even slightly increases. This, in conjunction with the reduction of working hours, has the potential to improve the average quality of life. Crucially, the inequality between the effective incomes of employed and unemployed people declines as well. Third, despite the fact that the sector that produces the more environmentally harmful consumption goods experiences a decline in its sales, its profitability is only temporarily impacted. This means that in our simulations this sector remains viable despite its downscale.

However, in our scenarios the reduction in emissions obtained thanks to the change in consumption patterns is gradually offset over time. First, during the extra investment period, the consumption of good 1 continues to increase in parallel with reduced consumption of good 2. Second, after the transition, the same upward trend in the consumption of good 1 continues indefinitely. Moreover, the consumption of good 2 starts increasing once again. This effect comes from our assumption that socially determined consumer needs tend to increase because new products are regularly invented and because the advertising industry makes sure consumers want

to buy them. At the end of our simulation period, total carbon emissions are above their initial level. P. Victor (2012) obtains a comparable result in his 'selective growth' scenario, and concludes in favor of a 'degrowth' trajectory. To prevent this rise in emissions, the production and consumption of goods and services with medium and even low carbon intensities cannot increase indefinitely. Fortunately, we can imagine that if a transition to sufficiency is genuinely successful, then the norms, institutions, culture, behaviour, values and power relations promoted and embodied in the consumer society are abandoned and replaced by more sustainable alternatives. If so, the consumption of both types of goods would not keep increasing. The environmental gains would then be more significant and more durable than what we show in our scenarios. In this spirit, we imagine in chapters 3 and 4 that the drivers of continuous growth have been stopped. We design simpler, stationary state models in which we envision reductions in aggregate consumption. Moreover, in chapter 4 we propose an original consumption function that reflects a behaviour of satiety, and we study its macroeconomic implications.

Due to the stylised nature of our model, the chapter has inevitably taken a number of shortcuts, many of which constitute interesting areas for future research. We list some of those that we consider as particularly important. First, we have confined our attention only to one source of environmental problem: carbon emissions. We did not include in our analysis other significant environmental effects of economic activity, like material depletion, ocean pollution and biodiversity loss. Second and related, our analysis did not capture all the potential forms of green public investment. The channels described in the chapter are directly linked with public investment in transport and power, but do not explicitly capture investments in natural areas restoration, the circular economy or the energy efficiency of state-owned buildings. Third, we abstracted from employment in the public sector, which did not allow us to fully explore the employment effects of green public investment. Fourth, the absence of a banking sector did not permit us to investigate the financial stability implications of changes in consumption patterns, as well as of macrofinancial feedback loops.¹⁸ Finally, the chapter did not analyse intra-household inequality and justice issues. For example, green public investment in the Global North can reinforce the exploitation of workers in industries that extract raw materials in the Global South (Althouse, Guarini, and Porcile 2020); or the reduction in the consumption of environmentally harmful imported goods in the Global North can have implications for employment and social conditions in the Global South (see also (Perry 2021)). These issues need to be examined in detail for an integrated understanding of the implications of the ecological transition drivers explored in this chapter.

¹⁸For the importance of these loops in the analysis of climate policies, see e.g. Dafermos and Nikolaidi (2021) and Dunz, Naqvi, and Monasterolo (2021).

Appendix 2.A Symbols for endogenous variables used in chapter 2

Table 2.4: Symbols for endogenous variables used in chapter 2

Symbol	Description
C_{e1}	Consumption by people employed in Sector 1 (€ trillion)
C_{e2}	Consumption by people employed in Sector 2 (€ trillion)
C_h	Total private consumption (€ trillion)
C_p	Total public consumption (€ trillion)
C_u	Consumption by unemployed (€ trillion)
$C_{1,e1}$	Consumption of good 1 by people employed in Sector 1 (€ trillion)
$C_{1,e2}$	Consumption of good 1 by people employed in Sector 2 (€ trillion)
$C_{1,h}$	Total household consumption of good 1 (€ trillion)
$C_{1,p}$	Public consumption of good 1 (€ trillion)
$C_{1,u}$	Consumption of good 1 by unemployed (€ trillion)
$C_{2,e1}$	Consumption of good 2 by people employed in Sector 1 (€ trillion)
$C_{2,e2}$	Consumption of good 2 by people employed in Sector 2 (€ trillion)
$C_{2,h}$	Total household consumption of good 2 (€ trillion)
$C_{2,p}$	Public consumption of good 2 (€ trillion)
$C_{2,u}$	Consumption of good 2 by unemployed (€ trillion)
cc_1	Total ‘necessary’ consumption of good 1 (€ trillion)
cc_2	Total ‘necessary’ consumption of good 2 (€ trillion)
cc_{2WE}	Consumption of good 2 when environmental considerations are absent (€ trillion)
CO	Contributions of workers and firms collected by the government (€ trillion)
DEF	Public deficit (€ trillion)
$DEFR$	Public deficit-to-GDP ratio
DFP_1	Distributed profits of Sector 1 (€ trillion)
DFP_2	Distributed profits of Sector 2 (€ trillion)
$EMIS$	CO ₂ emissions (GtCO ₂)
FP_1	Profits of Sector 1 (€ trillion)
FP_2	Profits of Sector 2 (€ trillion)
GNS	Government net saving
g_h	Growth rate of working hours
g_{pr}	Growth rate of productivity
g_Y	Growth rate of output
h	Annual working hours per employee
H	Total high-powered money
H_{e1}	High-powered money held by people employed in Sector 1
H_{e2}	High-powered money held by people employed in Sector 2

H_u	High-powered money held by unemployed
I_f	Firm investment (€ trillion)
I_p	Total public investment (€ trillion)
I_{pg}	Green public investment (€ trillion)
$I_{1,f}$	Firm investment in Sector 1 (€ trillion)
$I_{2,f}$	Firm investment in Sector 2 (€ trillion)
$I_{I,p}$	Public investment of Type I (€ trillion)
$I_{I,pc}$	Conventional public investment of Type I (€ trillion)
$I_{I,pg}$	Green public investment of Type I (€ trillion)
$I_{II,p}$	Public investment of Type II (€ trillion)
$I_{II,pc}$	Conventional public investment of Type II (€ trillion)
$I_{II,pg}$	Green public investment of Type II (€ trillion)
K	Total capital stock (€ trillion)
K_f	Capital stock of firms (€ trillion)
K_p	Capital stock of the public sector (€ trillion)
$K_{1,f}$	Capital stock of firms in Sector 1 (€ trillion)
$K_{2,f}$	Capital stock of firms in Sector 2 (€ trillion)
$K_{I,p}$	Type I capital stock of the public sector (€ trillion)
$K_{I,pc}$	Type I conventional capital stock of the public sector (€ trillion)
$K_{I,pg}$	Type I green capital stock of the public sector (€ trillion)
$K_{II,p}$	Type II capital stock of the public sector (€ trillion)
$K_{II,pc}$	Type II conventional capital stock of the public sector (€ trillion)
$K_{II,pg}$	Type II green capital stock of the public sector (€ trillion)
N_e	Total number of employees (billion people)
N_{e1}	Number of employees in Sector 1 (billion people)
N_{e2}	Number of employees in Sector 2 (billion people)
N_u	Number of unemployed (billion people)
NFP_1	Net profits in Sector 1 (€ trillion)
NFP_2	Net profits in Sector 2 (€ trillion)
pr	Hourly labour productivity (€ trillion/(billions of employees annual hours worked per employee))
RFP_1	Retained profits of Sector 1 (€ trillion)
RFP_2	Retained profits of Sector 2 (€ trillion)
SI	Sufficiency indicator
u_1	Rate of capacity utilisation in Sector 1
u_2	Rate of capacity utilisation in Sector 2
ur	Unemployment rate
UB	Total unemployment benefits
ub	Unemployment benefits per unemployed
w	Hourly wage rate (€ trillion/billions of employees)

WB_1	Wage bill of employed people in Sector 1 (€ trillion)
WB_2	Wage bill of employed people in Sector 2 (€ trillion)
WT_1	Wealth transfers taking place between households employed in Sector 1 and unemployed households (€ trillion)
WT_2	Wealth transfers taking place between households employed in Sector 2 and unemployed households (€ trillion)
Y	Total output (€ trillion)
Y_1	Output in Sector 1 (€ trillion)
$Y_{1,fc}$	Full-capacity output in Sector 1 (€ trillion)
Y_2	Output in Sector 2 (€ trillion)
$Y_{2,fc}$	Full-capacity output in Sector 2 (€ trillion)
YD_{e1}	Disposable income of people employed in Sector 1 (€ trillion)
YD_{e2}	Disposable income of people employed in Sector 2 (€ trillion)
YD_u	Disposable income of unemployed (€ trillion)
YD_{e1}^{eff}	Effective disposable income of employed in Sector 1 (€ trillion)
YD_{e2}^{eff}	Effective disposable income of employed in Sector 2 (€ trillion)
YD_u^{eff}	Effective disposable income of unemployed (€ trillion)
$YD_{pcratio}$	Income gap ratio
$YD_{pcratio}^{eff}$	Effective income gap ratio
β_1	Carbon intensity of Sector 1
β_2	Carbon intensity of Sector 2
σ	Consumption adjustment factor
σ_{pot}	Potential value of the consumption adjustment factor

Appendix 2.B Symbols for parameters and exogenous variables used in chapter 2

Table 2.5: Symbols for parameters and exogenous variables used in chapter 2

Symbol	Description
$c_{h,e1}$	Propensity to consume out of wealth, people employed in Sector 1
$c_{h,e2}$	Propensity to consume out of wealth, people employed in Sector 2
$c_{h,u}$	Propensity to consume out of wealth, unemployed
$c_{yde,e1}$	Propensity to consume out of effective disposable income, people employed in Sector 1
$c_{yde,e2}$	Propensity to consume out of effective disposable income, people employed in Sector 2
$c_{yde,u}$	Propensity to consume out of effective disposable income, unemployed
g_0	Exogenous growth rate of output
gov	Share of public consumption in total output
gov_{cI}	Autonomous component of conventional investment of Type I
gov_{gI}	Autonomous component of green investment of Type I
gov_{II}	Share of public investment of Type II in total public investment
N	Number of employees (billion people)
p	Price level
pr_0	Autonomous growth rate of labour productivity
pr_1	Sensitivity of labour productivity growth to the growth rate of output
$prop_{1,cp}$	Share of public consumption of good 1 in total output
$prop_{2,cp}$	Share of public consumption of good 2 in total output
s_W	Wage income share
u^T	Target capacity utilisation rate
ur^T	Target unemployment rate determined by the government
v_1	Potential-to-output ratio in Sector 1
v_2	Potential-to-output ratio in Sector 2
α_{01}	Autonomous investment of Sector 1
α_{02}	Autonomous investment of Sector 2
α_1	Parameter in the investment function of Sector 1 and 2 (related to the sensitivity of investment to the capacity utilisation)
δ	Depreciation rate of capital stock
η_h	Responsiveness of working hours to the deviations of the actual unemployment rate from the target unemployment rate
λ	Ratio of green public capital to total capital (Type II)
ξ	Ratio of the unemployed benefits per worker to the wage rate
τ_f	Firms' contribution rate
τ_w	Workers' contribution rate

Bibliography of the current chapter

- Althouse, Jeffrey, Giulio Guarini, and Jose Gabriel Porcile (2020). “Ecological Macroeconomics in the Open Economy: Sustainability, Unequal Exchange and Policy Coordination in a Center-Periphery Model”. In: *Ecological Economics* 172, p. 106628.
- Barker, Terry, Athanasios Dagoumas, and Jonathan Rubin (2009b). “The Macroeconomic Rebound Effect and the World Economy”. In: *Energy Efficiency* 2.4, pp. 411–427.
- Batini, Nicoletta et al. (2022). “Building Back Better: How Big Are Green Spending Multipliers?” In: *Ecological Economics* 193.107305.
- Blecker, Robert A (2002). “Distribution, Demand and Growth in Neo-Kaleckian Macro-Models”. In: *The Economics of Demand-Led Growth*. Ed. by M. Setterfield. Cheltenham, UK and New York, US: Edward Elgar, pp. 129–152.
- Buehler, Ralph et al. (2017). “Reducing Car Dependence in the Heart of Europe: Lessons from Germany, Austria, and Switzerland”. In: *Transport Reviews* 37.1, pp. 4–28.
- Cieplinski, André, Simone D’Alessandro, and Pietro Guarnieri (2021). “Environmental Impacts of Productivity-Led Working Time Reduction”. In: *Ecological Economics* 179, p. 106822.
- Cosme, Inês, Rui Santos, and Daniel W O’Neill (2017). “Assessing the Degrowth Discourse: A Review and Analysis of Academic Degrowth Policy Proposals”. In: *Journal of Cleaner Production* 149, pp. 321–334.
- D’Alessandro, Simone et al. (2020). “Feasible Alternatives to Green Growth”. In: *Nature Sustainability* 3.4, pp. 329–335.
- Dafermos, Yannis and Maria Nikolaidi (2019). “Fiscal Policy and Ecological Sustainability: A Post-Keynesian Perspective”. In: *Frontiers of Heterodox Macroeconomics*. Ed. by Philip Arestis and Malcolm Sawyer. Basingstoke, UK and New York, US: Palgrave Macmillan, pp. 277–322. ISBN: 978-3-030-23929-9.
- (2021). “How Can Green Differentiated Capital Requirements Affect Climate Risks? A Dynamic Macroeconomic Analysis”. In: *Journal of Financial Stability* 54, p. 100871.
- Dafermos, Yannis, Maria Nikolaidi, and Giorgos Galanis (Jan. 2017a). “A Stock-Flow-Fund Ecological Macroeconomic Model”. In: *Ecological Economics* 131, pp. 191–207.
- (2017b). “A Stock-Flow-Fund Ecological Macroeconomic Model”. In: *Ecological Economics* 131, pp. 191–207.

- Dafermos, Yannis and Christos Papatheodorou (2015). “Linking Functional with Personal Income Distribution: A Stock-Flow Consistent Approach”. In: *International Review of Applied Economics* 29.6, pp. 787–815.
- Dunz, Nepomuk, Asjad Naqvi, and Irene Monasterolo (2021). “Climate Sentiments, Transition Risk, and Financial Stability in a Stock-Flow Consistent Model”. In: *Journal of Financial Stability* 54, p. 100872.
- Godley, Wynne and Marc Lavoie (2012). *Monetary Economics: An Integrated Approach to Credit, Money, Income, Production and Wealth*. Basingstoke: Palgrave Macmillan.
- Hafner, Sarah et al. (2020). “Emergence of New Economics Energy Transition Models: A Review”. In: *Ecological Economics* 177, p. 106779.
- Jackson, Tim (2019). “The Post-Growth Challenge: Secular Stagnation, Inequality and the Limits to Growth”. In: *Ecological Economics* 156, pp. 236–246.
- Jackson, Tim and Peter A. Victor (2019). “Low-Grow SFC: A Stock-Flow-Consistent Model Ecological Macroeconomic Model for Canada”. In: *CUSP Working Paper* 16.
- Lavoie, Marc (2014b). *Post-Keynesian Economics: New Foundations*. Cheltenham, UK and New York, US: Edward Elgar.
- Mastini, Riccardo, Giorgos Kallis, and Jason Hickel (2021). “A Green New Deal without Growth?” In: *Ecological Economics* 179, p. 106832.
- Mattioli, Giulio et al. (2020). “The Political Economy of Car Dependence: A Systems of Provision Approach”. In: *Energy Research & Social Science* 66, p. 101486.
- Monasterolo, Irene and Marco Raberto (2018). “The EIRIN Flow-of-Funds Behavioural Model of Green Fiscal Policies and Green Sovereign Bonds”. In: *Ecological Economics* 144 (July), pp. 228–243.
- Mugion, Roberta Guglielmetti et al. (2018). “Does the Service Quality of Urban Public Transport Enhance Sustainable Mobility?” In: *Journal of Cleaner Production* 174, pp. 1566–1587.
- Naqvi, Asjad and Engelbert Stockhammer (2018). “Directed Technological Change in a Post-Keynesian Ecological Macromodel”. In: *Ecological Economics* 154, pp. 168–188.
- Nieto, Jaime et al. (2020). “An Ecological Macroeconomics Model: The Energy Transition in the EU”. In: *Energy Policy* 145, p. 111726.
- Perry, Keston (2021). “Financing a Global Green New Deal: Greening Capitalism or Taming Financialization for a New ‘Civilizing’ Multilateralism?” In: *Development and Change* 52.4, pp. 1022–1044.
- Pettifor, Ann (2019). *The Case for the Green New Deal*. London, UK and Brooklyn, US: Verso.

- Pollin, Robert (2019). “Advancing a Viable Global Climate Stabilization Project: Degrowth versus the Green New Deal”. In: *Review of Radical Political Economics* 51.2, pp. 311–319.
- (2020). “Green Recovery: Europe and the World”. In: *Intereconomics* 55.6, pp. 360–363.
- Pollin, Robert, H Garrett-Peltier, and S Chakraborty (2015). “An Egalitarian Clean Energy Investment Program for Spain”. In: *PERI Working Paper* 390.
- Pollin, Robert, Heidi Garrett-Peltier, et al. (2014). *Green Growth: A US Program for Controlling Climate Change and Expanding Job Opportunities*. Center for American Progress and PERI.
- Sandberg, Maria (2021). “Sufficiency Transitions: A Review of Consumption Changes for Environmental Sustainability”. In: *Journal of Cleaner Production* 293, p. 126097.
- Skott, Peter and Ben Zipperer (2012). “An Empirical Evaluation of Three Post-Keynesian Models”. In: *European Journal of Economics and Economic Policies: Intervention* 9.2, pp. 277–308.
- Taylor, Lance, Armon Rezai, and Duncan K Foley (2016a). “An Integrated Approach to Climate Change, Income Distribution, Employment, and Economic Growth”. In: *Ecological Economics* 121, pp. 196–205.
- UNCTAD (2019). *Trade and Development Report 2019: Financing a Global Green New Deal*. Geneva: United Nations.
- Van Treeck, Till (2009). “A Synthetic, Stock–Flow Consistent Macroeconomic Model of ‘Financialisation’”. In: *Cambridge Journal of Economics* 33.3, pp. 467–493.
- Victor, Peter (2012). “Growth, Degrowth and Climate Change: A Scenario Analysis”. In: *Ecological Economics* 84, pp. 206–212.

Chapter 3

Buying into inequality. A macroeconomic analysis linking accelerated obsolescence, interpersonal inequality, and potential for degrowth

“Degrowth means impoverishment of the French. [...] If you have degrowth, you will have less wealth, and you will have more poor people. Or we must impoverish everyone with an egalitarian logic that is not mine.”

Bruno Lemaire, 2022¹

“If you have degrowth, the shares [of the cake] will decrease, and what we have understood in reality is that, in addition, the shares do not decrease in the same way for different people. And if you own limited resources, if you own land and capital, your income may increase, while if you are not a landlord, if you are a worker or a farmer, your income will decrease.”

Anne-Laure Delatte, 2019²

¹Bruno Lemaire is a right-wing French politician. He was Minister of Agriculture from 2009 to 2012 and Minister of Economy and Finance from 2017 to 2022.

²Anne-Laure Delatte is an economist. She is a tenured Researcher at the French Institute for Scientific Research (CNRS), a fellow at OFCE-Sciences Po, a former Deputy Director at CEPPII, and has taught at Princeton University.

Outline of the current chapter

3.1 Introduction	104
3.2 Accelerated obsolescence: some definitions and a brief history	105
3.3 The model	107
3.3.1 General structure	107
3.3.2 Behavioural equations and other assumptions	109
3.3.3 Economic well-being, inequality and ecological damage	111
3.4 Acceleration of obsolescence	113
3.4.1 Without government response (scenario 1)	113
3.4.2 With government responses (scenarios 2 and 3)	119
3.5 A potential for degrowth	121
3.6 Conclusion	125

Note: This chapter was published in the *European Journal of Economics and Economic Policies: Intervention* in 2022:

Monserand, A. (2022). Buying into inequality: a macroeconomic analysis linking accelerated obsolescence, interpersonal inequality and potential for degrowth. *European Journal of Economics and Economic Policies: Intervention*, 19(1), 119-137.

3.1 Introduction

Environmental and economic goals are often perceived as opposed to each other. From environmental regulations that may incur costs to businesses and reduce their competitiveness to transitions away from entire sectors of activity such as coal extraction, reconciling the two types of objectives can appear as a challenging task. This chapter investigates the economy-environment opposition in the case of accelerated obsolescence. By 'accelerated obsolescence' we mean the disposal and replacement of goods at a faster rate than what could be feasible in a different socio-economic and technological system. We do not assume or suggest that obsolescence has accelerated over the past decades or century. Because it leads to higher levels of production, accelerated obsolescence implies higher negative impacts on the environment but also more employment, wages and profits. Yet are we really facing a 'social dilemma' as Guiltinan (2009) presents it, or is it possible to somehow satisfy both environmental and economic objectives? The answer depends on the economic objectives that are considered since there can be conflicting interests between various categories of economic agents. If the increase in income that goes with the increase in economic activity is in fact not beneficial to workers but instead

benefits only capitalists, who are already wealthier than workers, then the positive economic aspect of obsolescence can be questioned. Hence tackling these issues requires to carry out an analysis at the macroeconomic level (in order to account for second-round multiplicative effects) and to include inequality dimensions in it.

Despite a rich literature on the topic of obsolescence and on the issue of inequality, both strands have remained separate and the connection between the two has not been identified so far by economic theory. It is also absent from the numerous articles that explore and explain the links between inequality and the environment (Berthe and Elie 2015). On the one hand theories on planned obsolescence have remained at the microeconomic level, showing for instance that asymmetry of information, profit maximisation, and competition and innovation dynamics are drivers of fast obsolescence (Kurz 2015) and that monopolist firms and colluding oligopolists also have an incentive to practice planned obsolescence (Bulow 1986; Waldman 1993). On the other hand the causes and consequences of inequality have been studied by nearly all economic schools of thought, including the two this chapter is concerned with: post-Keynesian and ecological economics. Post-Keynesians have emphasised the role of a fair distribution of functional income (the shares of wages and profits in national income) for growth, employment and other macroeconomic variables (Hein and L. Vogel 2008; Kaldor 1955; Kalecki 1971; Onaran and Obst 2016; Pasinetti 1962); more recently Ederer and Rehm (2020b) showed that interpersonal inequality of wealth (i.e. the distribution of wealth at the level of deciles, percentiles or individuals) is likely to increase in Europe over the next years. Ecological economists have started to address concerns regarding the risks of rising inequality in the specific context of slower growth. Jackson and Peter A. Victor (2016) show that inequality can decrease even when the rate of growth goes to zero and the rate of return on capital is positive, a result that contradicts the 'fundamental law' of Piketty (2013). However Stratford (2020) argues that low growth perspectives may lead to the intensification of rent-seeking behaviour, and that increases in rentier power would lead to rising inequality between rentiers and the rest of the population.

Bringing macroeconomic expertise and methodology from post-Keynesian economics together with environmental concerns from ecological economics, this chapter suggests and explains an original theoretical link between accelerated obsolescence (with its negative environmental consequences) and interpersonal inequality. In section 3.2 we briefly lay out the different categories of obsolescence and some historical and empirical facts about this phenomenon. In section 3.3 we present our theoretical macroeconomic model built using the stock-flow consistent (SFC) framework of Godley and Lavoie (2012). In section 3.4 we show simulations for an acceleration of obsolescence under various budgetary and fiscal policy scenarios. We show that faster obsolescence exacerbates inequality between workers and

capitalists (in relative or absolute terms depending on the scenario), on top of degrading the environment. Conversely, in line with the degrowth paradigm, we show in section 3.5 how slowing down obsolescence may be both socio-economically and environmentally sensible. It would benefit wage-earners while reducing pressures on the environment; the only losers would be profit-earners.

3.2 Accelerated obsolescence: some definitions and a brief history

Obsolescence can refer both to physical wear and tear and to what Butt et al. (2015, p. 24) describe as 'depreciation in value, impairment of desirability and/or usefulness caused by new inventions, current changes in design, improved processes of production, or external factors that make a system less desirable and valuable for a continued use'. Thus obsolescence has two sides: users of goods can either suffer it completely involuntarily (when goods become no longer useable) or they can participate in the process (when their desire to use the goods vanishes). In other words, the technical lifetime of a product can be shorter than what is technically feasible, than customers' expectations or than what would be sustainable, but the economic lifetime (the actual duration before disposal or replacement) can also be 'even shorter' than the technical lifetime (Kurz 2015).

In a sense obsolescence is a 'normal' phenomenon, however it can happen more or less rapidly. There exist many ways through which producers can obtain shorter replacement cycles from consumers, which is generally called 'planned' obsolescence. Guiltinan (2009, p. 20) identifies five of them: 'limited functional life design (or "death dating")', 'design for limited repair', 'design æsthetics that lead to reduced satisfaction', 'design for fashion' and 'design for functional enhancement through adding or upgrading product features'. Regarding information technology, premature obsolescence can also come from firms that stop updating their software or from hardware whose performance cannot keep up with more demanding new software (Satyro et al. 2018). Although the expression 'planned obsolescence' is the most widely used in the literature, we prefer the adjectives 'accelerated' or 'premature' which are purposefully broader. Indeed in our view 'planned obsolescence' may appear too deterministic and associated with direct interventions from the producer, like in the case of 'death-dating' or non-maintenance of software.

Premature obsolescence is far from being a new phenomenon. Back in the 1930s, Bernard London (1932) proposed to set a maximum lifetime for each object and to ban the use of items which have passed the threshold. The aim was to boost demand, sales and employment and help the economy out of the Great Depression. Galbraith (1958) warned about the wasteful nature of annual design changes in

the automobile industry. Indeed the average duration of the replacement cycle for cars was only 8 years before the Second World War and 11 years after the war (Hundy 1976, in Wieser 2017). In the 1950s and 1960s, 'death-dating' was common practice in the United States (Slade 2006, in Guiltinan 2009).

Despite repeated criticism of this phenomenon over decades, a few authors have supported the idea that accelerating obsolescence could have positive economic effects. Blonigen et al. (2017) argue that planned obsolescence is good both for profits and for consumer welfare (because consumers like to have new products), while Waldman (1993) claims that it accelerates innovation. One can also find the argument that new products are more efficient, therefore replacing old ones could be environmentally positive. This was put forward by governments during the 2008/09 crisis in the case of bonuses for scrapping old cars (Kurz 2015). Yet, in order to assess environmental impacts, looking at fuel or energy efficiency is not sufficient since embodied energy, resource extraction and associated pollutions can offset efficiency gains. Full life-cycle analyses should be used (Kurz 2015). For instance in the case of refrigerators and laptops the increase in the energy efficiency of new models is too small to justify premature discarding. Accordingly, they should be used for longer durations (Bakker et al. 2014).

Since premature obsolescence has been practiced for decades, one may wonder whether or not it has intensified over time. Unfortunately, data is very scarce and 'there is a striking dearth of research on historical changes in replacement cycles' (Wieser 2017, p. 426). A few studies show that the average lifespan of electric and electronic devices and household appliances has been declining in the 2000s, from a few percentage points up to 20% for some appliances (Huisman et al. 2012; Wang et al. 2013). However, the evolution is estimated for short periods of time only. By looking at a few products for which data is available for longer timespans, Wieser (2017) finds no evidence supporting the idea of an acceleration. For instance, from before the Second World War to the 2000s, the long term trend in the average lifespan of a car is an upward trend. And for mobile phones, 'even the orchestrated efforts of leading manufacturers, retailers, and operators at accelerating the replacement of mobile phones had limited success so far, as replacement cycles continued to increase in most recent years' (Wieser 2017, p. 429).

Given the lack of evidence regarding the idea of a historical acceleration of obsolescence, we prefer not to take such an evolution as granted. When speaking of accelerated obsolescence, we do not refer to a historical evolution but rather to the idea that, arguably, obsolescence is currently faster than what could be possible in a different socio-economic and technological system. Indeed we know from experience that washing-machines can last for 40 years or more, that cars from the 1960s are still used and repaired today in many poor countries, that robust furniture can last

for decades or centuries etc.

In the next section we lay out the macroeconomic model with which we study the effects on inequality and on the environment of an acceleration (section 3.4) and of a slow-down (3.5) of obsolescence.

3.3 The model

3.3.1 General structure

Our simple closed-economy model is composed of three institutional sectors: i) households, with a distinction between workers and capitalists, ii) firms, aggregated into a single sector which produces two types of goods and iii) a public sector that gathers a government and its central bank. Table 3.1 and Table 3.2 represent respectively the balance sheet and transactions matrices.

Firms own a stock of physical, productive capital K that we assume not to depreciate over time. In this chapter we focus on consumption, thus to keep the model as simple as possible we omit investment. The liabilities of firms are equities Q , assumed to be constant in volume and in price. In nominal terms, $K = Q$ so that the net worth of firms remains equal to zero. This is consistent with the fact that profits P are entirely distributed (to capitalist households, who own the firms). The price of goods, the mark-up and productivity are constant. As a result, the shares of profits and wages in value added do not evolve. Total output, or national income Y , is equal to consumption of both goods C_1 and C_2 plus government spending G ($Y = C_1 + C_2 + G$).

Households are composed of workers and capitalists in fixed numbers N_w and N_c . Apart from equities (owned only by capitalists) the wealth of households is made of one financial asset, high-powered money H_j , and various tangible assets grouped in the category of 'equipment goods'. By 'equipment goods' we think of all the goods that can be used more than once, as opposed for instance to food and drinks. This category encompasses what is generally considered as 'durable consumption goods' (vehicles, furniture, light and heavy appliances, leisure equipment, tools) plus what is considered as 'semi-durable consumption goods' (clothes, footwear and small objects). These goods are subject to depreciation and obsolescence (more details on this in the next subsection). Equations (3.1) and (3.2) show the after tax disposable income of households YD_w and YD_c (WB stands for the wage bill, T_w and T_c for taxes on workers and on capitalists):

$$YD_w = WB - T_w \tag{3.1}$$

	Households		Firms	Gvt/CB	Σ
	Workers	Capitalists			
High-pow. money	$+H_w$	$+H_c$		$-H$	0
Equipment goods	$+N_w E$	$+N_c E$			$+NE$
Productive capital			$+K$		$+K$
Equities		$+Q$	$-Q$		0
Balance (net worth)	$-V_w$	$-V_c$	0	$-V_g$	$-\Sigma V_i$
Σ	0	0	0	0	0

Table 3.1: Balance sheet matrix

$$YD_c = P - T_c \quad (3.2)$$

The difference between disposable income and expenditure constitutes households' saving, which incurs variations in their money balances $H_j, j \in \{w, c\}$:

$$\Delta H_j = YD_j - (C_{1,j} + C_{2,j}) \quad (3.3)$$

The public sector is kept simple: it spends an amount G on goods and services provided by firms; its revenues T come from taxes $T_w = \tau_w WB$ and $T_c = \tau_c P$ levied on the income of households. The difference $G - T$ constitutes the budget deficit DEF , which is financed by the issuance of high-powered money $\Delta H = DEF$; H represents the public debt. Note that, although the government can run a budget surplus (in which case $\Delta H < 0$), this will only happen momentarily in our simulations. As a result, the net worth of the public sector remains negative at all times and we do not need to include a public asset in the model.

3.3.2 Behavioural equations and other assumptions

We now specify a few assumptions and behavioural functions.

The determinants of consumption for equipment goods and for other goods differ. Regarding the first, we assume that each household holds an amount E of equipment goods, which for simplicity is the same for workers and for capitalists. These goods depreciate at a rate δ that can evolve over time (when obsolescence is accelerated or slowed down).³ Our key assumption here is that, whatever the value of the

³Being out of fashion can reduce the value of goods, just as physical deterioration does. In

	Households		Firms	Gvt/CB	Σ
	Workers	Capitalists			
Consumpt. (equipment)	$-C_{1,w}$	$-C_{1,c}$	$+C_1$		0
Consumpt. (other)	$-C_{2,w}$	$-C_{2,c}$	$+C_2$		0
Government spending			$+G$	$-G$	0
Wages	$+WB$		$-WB$		0
Profits		$+P$	$-P$		0
Taxes	$-T_w$	$-T_c$		$+T$	0
Change in cash	$-\Delta H_w$	$-\Delta H_c$	0	$+\Delta H$	0
Σ	0	0	0	0	0

Table 3.2: Transactions-flow matrix

depreciation rate, households need to replace worn out or obsolete goods with new ones. In other words, in a given socio-technological environment households cannot but replace a broken vehicle or appliance, or renew an outfashioned smartphone or piece of clothes. Therefore the consumption of equipment goods does not depend on income, it is autonomous (constrained):⁴

$$C_{1,j} = N_j \delta E_{t-1} \quad (3.4)$$

The consumption of 'other goods', on the other hand, depends on past levels of income and wealth (equation (3.5)). This feature is consistent with the composition of the category: on top of immediate consumption goods such as food and drinks (the demand for which is relatively inelastic) it includes all kinds of services, for instance tourism and leisure activities, the demand for which is very income elastic.

$$C_{2,j} = \alpha_{yde,j} Y D_{j,t-1}^{eff} + \alpha_H H_{j,t-1} \quad (3.5)$$

This specification is slightly different from usual (post-)Keynesian consumption functions found for instance in Godley and Lavoie (2012), since it features a concept we call 'effective disposable income' ($Y D^{eff}$) instead of disposable income. This concept refers to the income that households effectively have at their disposal for discretionary expenditures once tax payments but also constrained expenditures

most cases the more out of fashion a product, the lower its price.

⁴This specification ensures that the nominal stock E of equipment goods per household remains constant.

have been carried out. In our model, we have:

$$YD_j^{eff} = YD_j - C_{1,j} \quad (3.6)$$

We explain in sections 3.3.3 and 3.4 the reasons why, in our view, effective disposable income is a useful concept and is more appropriate than usual disposable income.

One simplifying assumption we make is that hours worked per worker are proportional to output and that the overall amount of hours is distributed evenly among all workers. As a result, there is no unemployment. Moreover, our assumption that the wage share and productivity remain constant requires that the hourly pay is fixed. This implies that when aggregate output Y fluctuates, income per household varies not only for capitalists but also for workers.

Finally, the behaviour of the government with respect to budget deficits or surpluses can change according to different scenarios. It can modify its spending or the tax rates, in line with the following dynamics:

$$G = G_{t-1}(1 + g_G) \quad (3.7)$$

$$g_G = -\eta_G DEF/Y \quad (3.8)$$

$$\tau_w = \tau_{w,t-1}(1 + g_{\tau_w}) \quad (3.9)$$

$$g_{\tau_w} = \eta_{\tau_w} DEF/Y \quad (3.10)$$

$$\tau_c = \tau_{c,t-1}(1 + g_{\tau_c}) \quad (3.11)$$

$$g_{\tau_c} = \eta_{\tau_c} DEF/Y \quad (3.12)$$

When the government chooses not to react to a budget deficit or surplus, we have $\eta_G = \eta_{\tau_w} = \eta_{\tau_c} = 0$. When it wishes to bring the deficit-to-GDP ratio or the budget surplus ratio to zero, one (or several) of the η parameters is (are) set strictly positive.

3.3.3 Economic well-being, inequality and ecological damage

Given that in our model the consumption of 'equipment goods' is forced and only serves the replacement or renewal of previous goods, we consider that it does not bring economic well-being to consumers. For instance, we think that buying a new refrigerator when the one currently in use breaks down does not increase well-being (one could even argue that it decreases well-being). Conversely, we assume that consumption of the second type (category 'other goods') is correlated with economic well-being. Thus effective disposable income and wealth, as determinants of this consumption, are correlated with well-being as well.⁵ In our view, this is one advantage of the concept of effective disposable income over traditional disposable income.

In line with these ideas, when analysing the evolution of inequalities between workers and capitalists we will focus mainly on effective disposable income and wealth.⁶ Our results will illustrate how, although functional income inequality remains unchanged, wealth and interpersonal (effective disposable) income inequality can evolve. The indicators are the following ('pcratio' stands for 'per capita ratio'):

$$YD_{pcratio} = \frac{YD_c/N_c}{YD_w/N_w} \quad (3.13)$$

$$YD_{pcratio}^{eff} = \frac{YD_c^{eff}/N_c}{YD_w^{eff}/N_w} \quad (3.14)$$

$$H_{pcratio} = \frac{H_c/N_c}{H_w/N_w} \quad (3.15)$$

Since workers and capitalists own the same kind and amount of equipment goods, their difference of wealth only comes from financial wealth H_j . As a result, we will refer to $H_{pcratio}$ as a measure of wealth inequality while strictly speaking it represents financial wealth inequality.

The calibration of our model is such that inequality between workers and capitalists is pre-existing. This comes from the discrepancy between the proportion of capitalists in the population ($N_c/N = 1/10$) and the share of national income they receive ($P/Y = 1/3$). In terms of primary income, a capitalist household

⁵We are not dealing with the numerous non-economic dimensions of well-being, or with life satisfaction in general, which are more complex issues.

⁶We also keep track of inequality of disposable income in order to show how it differs from inequality of effective disposable income.

earns 4.5 times more than a worker household. With progressive tax rates $\tau_w = 0.2$ and $\tau_c = 0.4$, the ratio of per capita disposable income drops to 3.4 but since the consumption of equipment goods represents a larger share of income for workers than for capitalists, the ratio of per capita effective disposable income $YD_{pcratio}^{eff}$ is equal to 4 in our calibration. As for wealth, the ratio of wealth per capita $H_{pcratio}$ is equal to 6.4.⁷

Finally, we keep track of the negative effects of production, consumption and disposal on the environment with an indicator we call *ecological damage* (ED). Studies on obsolescence often mention the unnecessary generation of waste, focusing on downstream environmental impacts of production. However the environmental consequences of producing more goods go far beyond the generation of waste, since it implies almost always extracting more non-renewable resources from the ground, using more energy, machines and vehicles to make and transport the goods, opening more stores (air-conditioned with doors open) to sell them etc. Hence we consider our variable ED to be a synthetic indicator that encompasses greenhouse gases emissions but also resource use and emissions of water, soil and air pollutants.⁸ For simplicity, its relationship with the consumption of each type of good is linear:

$$ED = \beta_1 C_1 + \beta_2 C_2 \quad (3.16)$$

In our calibration, $\beta_1/\beta_2 = 2$ to reflect the fact that the production of equipment goods is generally energy and material intensive.

3.4 Acceleration of obsolescence

In this section we use our model to simulate an acceleration of obsolescence. For the first ten periods, before the acceleration, the economy is at a stationary state. The level of output at this state Y^* is determined and equal to the ratio of public spending G^* to the average tax rate $\tau^* = (\tau_w^*WB + \tau_c^*P)/Y$.⁹ In period 11 the rate of depreciation, initially equal to 20%, increases to 30% and remains at this value for the rest of the simulation. This acceleration of obsolescence forces the

⁷The values for the propensities to consume are the following: $\alpha_{yde,w} = 0.75$; $\alpha_{yde,c} = 0.6$; $\alpha_H = 0.15$. The former two are 'reasonable' values compatible with standard estimates, the latter is calibrated so as to get a plausible initial debt-to-GDP ratio.

⁸Our indicator should not be confused with damage functions of environmental economists who try and estimate damage on production, capital or productivity incurred by climate change.

⁹The expression for Y^* can be easily derived from the condition $\Delta H^* = 0 = G^* - \tau^*$ necessarily verified at the stationary state. The stationary state values for all variables can then be deduced analytically, which allows us to initialise the model exactly at the stationary state. For subsequent timesteps, the values for all variables are found numerically through a simple iteration algorithm which can deal with the simultaneity of equations.

consumption of equipment goods upward both for workers and for capitalists. As a result, output increases beyond its initial stationary state level and a budget surplus appears. The next subsections explain the evolution of the economy, and especially of inequalities, in different scenarios regarding the response from the government to the budget surplus: no government response in the first main scenario, an increase in public spending in the second and tax cuts in alternative scenarios.

3.4.1 Without government response (scenario 1)

In this scenario, the government does not react in any manner to a budget surplus or deficit. Our simulation results show that the economic impacts of the acceleration of obsolescence are different in the short run and in the medium to long run (hereafter called medium run, since the *long run* is a tricky concept).

The very short run

Figure 3.1 shows the very first effects of an acceleration of obsolescence (period 11 of the simulation). An increase in consumption of good 1 by 100 monetary units adds 67.7 units to wage income and 33.3 units to profits. In terms of primary income, both classes benefit. After-tax disposable income increases respectively by 53.3 and 20 units, while government revenues increase by 26.7 units (recall that $\tau_w = 0.2$ and $\tau_c = 0.4$). Stopping the reasoning at this stage would give the impression that every actor but the environment are better off: economic activity, wages, profits and tax revenues all increase. However, by simply looking at effective disposable income instead of usual disposable income one can realise that the issue is more complex. After subtracting the constrained expenditures to examine the income effectively at the disposal of households to consume other goods and services, it appears that workers are losing 36.7 units of purchasing power while capitalists still enjoy a 10 unit increase of effective disposable income. In the very short run these amounts are directly impacting the wealth of households: workers are forced to dissave while capitalists see their stock of savings increase. Coherently with our macroeconomic framework, the improvement of the financial position of the public sector corresponds to the overall deterioration of the position of the private sector (26.7 units).

Let us emphasise this crucial result: at least in the very short run, an acceleration of obsolescence increases inequalities of effective disposable income and of wealth. This is an 'absolute' increase in inequality, since workers are losing out while capitalists are winning.

Here a few remarks need to be made. First, this result is closely tied to the fact that inequalities pre-exist to the acceleration of obsolescence. The dynamics explained above take place because the extra spending on good 1 comes in majority

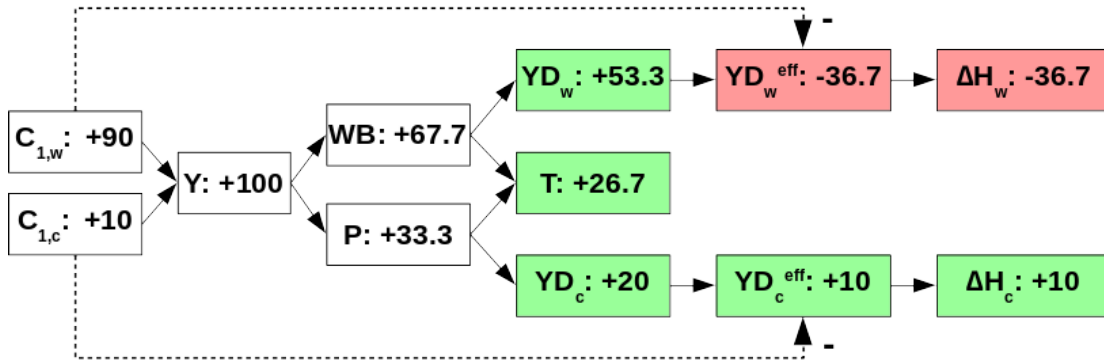

Figure 3.1: Differentiated income effects on workers and capitalists of accelerated obsolescence in the very short run.

from workers (in line with their proportion in population: 90%) while despite the progressive tax system capitalists are able to receive a larger share of the extra after-tax income ($20/73.3 = 27\%$) compared to their contribution to the extra initial spending (10%). Thus our qualitative results are robust to changes in parameter values, as long as pre-existing inequalities are sufficiently high. A very high tax rate on the income of capitalists, for instance, would change the outcome.

Second, we think our results may be conservative. Indeed in reality wealthy people generally own high-quality equipment goods which have longer lifetimes and are less subject to obsolescence, although this is more the case for physical durability than for the fashion and software-related dimensions of obsolescence. As a result, the increase in forced expenditures could be lower for capitalists than for workers. Levels of inequality could increase even more.

The short and the medium run

While the 'very short run' described the moment of acceleration of obsolescence, we understand the short run as the couple of periods that follow (less than ten periods) and the medium run as the rest of the simulation periods.

The solid lines in Figures 3.2 and 3.3 show how key variables evolve over time in this first scenario. We have explained why, when obsolescence accelerates in period 11, effective disposable income and wealth diminish for workers and rise for capitalists. Thus, in period 12, workers decide to reduce their consumption of good 2 while capitalists are able to step it up (recall equation (3.5)). Importantly, the decrease in $C_{2,w}$ is larger than the increase in $C_{2,c}$.¹⁰ Overall consumption of good 2 starts going down, along with total output and the budget surplus. This

¹⁰This result does not rely upon our assumption that the propensity to consume $\alpha_{yde,w}$ is larger than $\alpha_{yde,c}$. It holds also in the case where $\alpha_{yde,w}$ and $\alpha_{yde,c}$ are equal.

contractionary effect reduces both wage and profit income. Thus the trend for primary incomes, which spiked in period 11, is reversed in period 12. On one side the situation of workers, whose effective disposable income and wealth had already started to diminish, worsens period after period. They are forced to continue both reducing consumption $C_{2,w}$ and drawing on their dwindling savings H_w . Note that the increase in $C_{2,c}$ in period 12, and thereby the additional wage revenues it generates, is not sufficient to prevent $C_{2,w}$ from continuing to fall. On the other side, capitalists see their initial upward trend in consumption of good 2 and in wealth accumulation being reversed. Yet in the short run $C_{2,c}$ and H_c remain higher than their initial levels.

As time passes the fall in overall consumption of good 2 continues, along with its negative impacts on incomes, consumption and wealth described above. This recessionary loop goes on until the level of output Y is brought back to its initial stationary state level. The composition of output has changed though: the increase in consumption of equipment goods due to the acceleration of obsolescence has forced an equivalent reduction in consumption of other goods. Hence, given our assumptions regarding the relative intensities of ecological damage and the economic well-being (or 'usefulness') associated with the consumption of goods 1 and 2, the final stationary state is worse both for the environment and for economic well-being. Due to the budget surplus during the transitional phase, the final level of the public debt is lower than the initial level ; the counterpart is that total private wealth is lower than initially.

Here we shall stress that whereas in the short run capitalists could enjoy an increase in their effective disposable income and wealth, this does not hold in the medium run. Importantly, it is the decrease in consumption of good 2 by workers that forces the income of capitalists downwards and eventually brings YD_c^{eff} and H_c to values below their initial levels.

Further remarks

It is worth emphasising one key aspect of our results. When reflecting about accelerated obsolescence one could think that, even if the useless nature of consumption of replacement or renewal is acknowledged, the extra income generated by this spending allows for increases in consumption of goods and services that improve economic well-being. In other words, obsolescence would have a bad side (its environmental impacts) and a good side (its economic impacts). In this first scenario in which the government does not react to a budget surplus, our macroeconomic analysis shows quite the contrary. In the short run the extra income generated is not sufficient to provoke an overall increase in 'useful' consumption. If any economic benefits are to be expected, capitalist households, not workers, would receive them. In the medium run the increase in national income vanishes

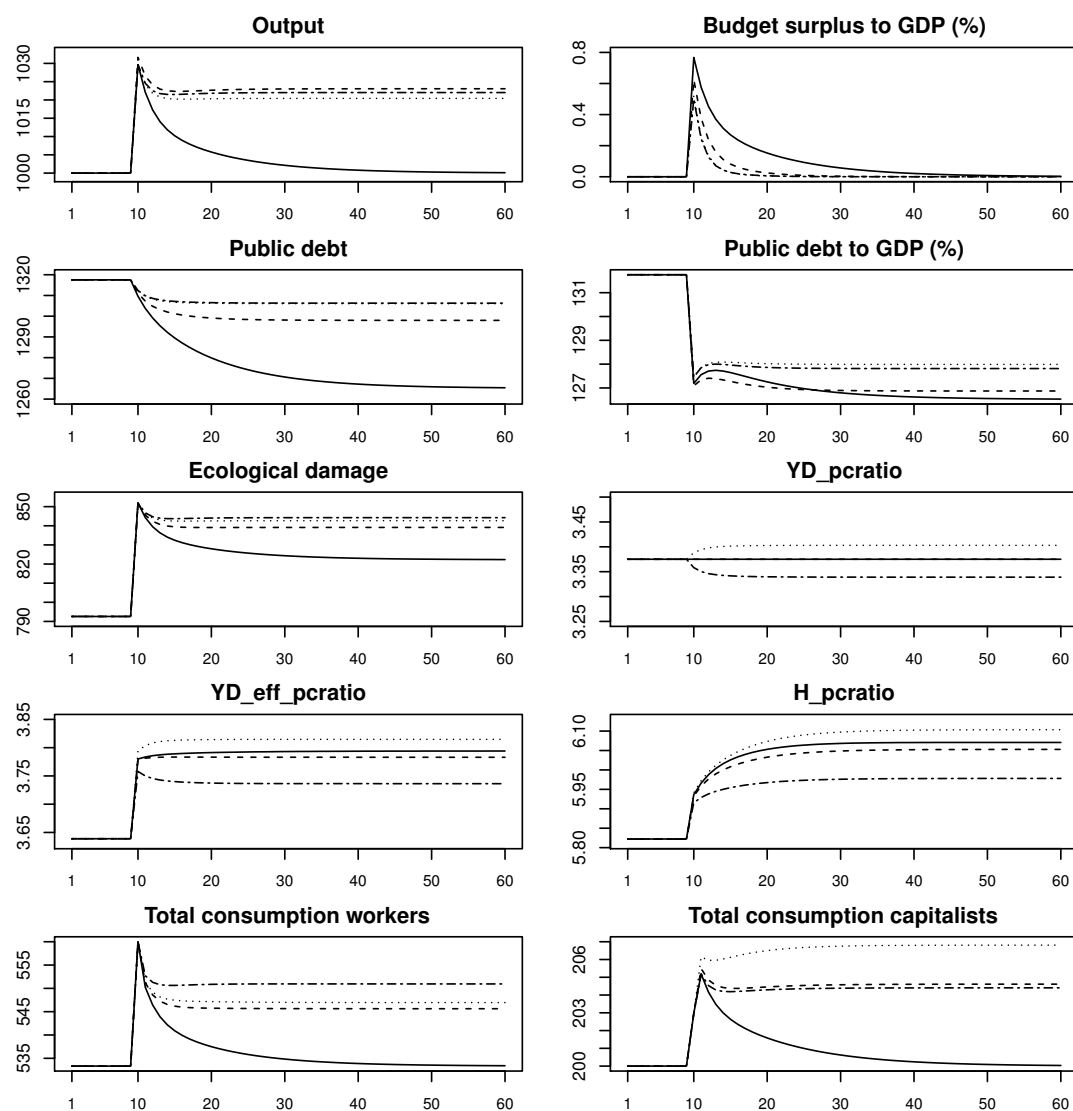

Figure 3.2: Evolution of key variables after an acceleration of obsolescence in different scenarios: no government response (solid lines), increase in government spending (dashed lines), tax cuts on both classes (dotted lines) and tax cuts on workers only (dotted-and-dashed lines).

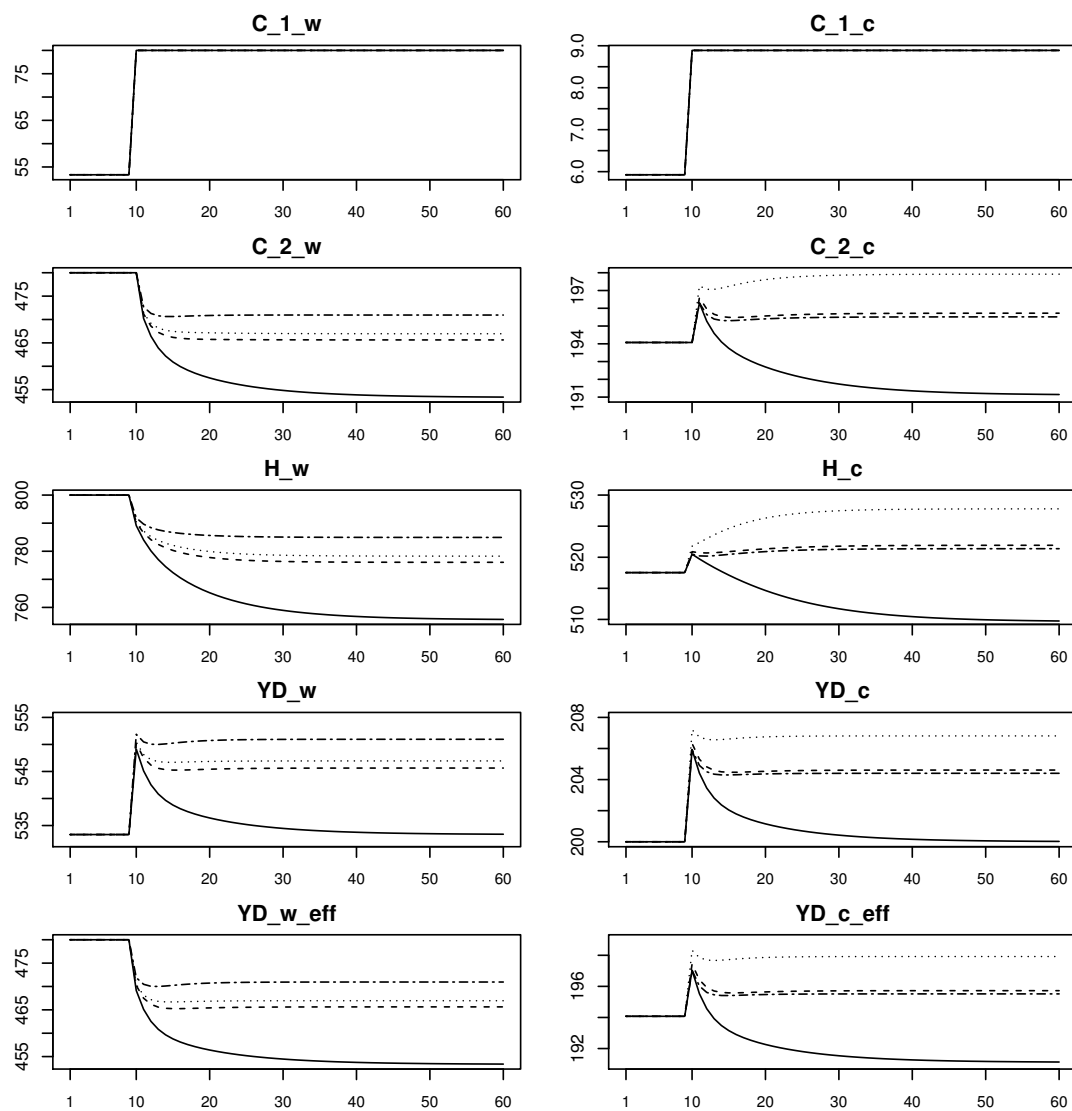

Figure 3.3: (continued from previous page) Evolution of key variables after an acceleration of obsolescence in different scenarios: no government response (solid lines), increase in government spending (dashed lines), tax cuts on both classes (dotted lines) and tax cuts on workers only (dotted-and-dashed lines).

and economic well-being worsens for both classes.

Finally, through our analysis we can demonstrate how important it is to look at inequalities with the right indicators. Figure 3.2 shows that by only looking at the ratio $YD_{pcratio}$ one could believe that the pace of obsolescence has no impact on inequality. The levels of disposable income YD_w and YD_c (on Figure 3.3) are even more misleading since they reveal no change in inequality but also seem to indicate that the economic situation of both workers and capitalists improves momentarily. The ratio of per capita effective disposable income $YD_{pcratio}^{eff}$, however, makes it clear that inequality - understood in terms of income effectively at the disposal of households after having carried out constrained expenditures - increases when obsolescence accelerates. Importantly, wealth inequality also rises (see $H_{pcratio}$). Moreover, looking at the levels YD_w^{eff} and YD_c^{eff} complements the analysis made with the ratio $YD_{pcratio}^{eff}$ because it makes it possible to distinguish absolute from relative evolutions in inequality. On Figure 3.3 we can see that in the short run effective income inequality increases in absolute terms (YD_w^{eff} falls while YD_c^{eff} rises) whereas in the medium run it increases only in relative terms (both YD_w^{eff} and YD_c^{eff} go down, but the drop is stronger for workers (per capita) than for capitalists). Ultimately the relative increase in inequality of effective disposable income comes from the fact that the expenditures on equipment goods represent a larger share of income for worker households than for capitalist households, which in turn is linked to pre-existing inequality.

3.4.2 With government responses (scenarios 2 and 3)

In this subsection, we investigate how the results obtained in the previous scenario may change when the government decides to respond to the rise of a budget surplus either by increasing public spending or by cutting taxes.

Increase in public spending (scenario 2)

For this scenario the parameter η_G is set equal to 1.2. It represents the pace at which the government will increase its public spending in response to the budget surplus.¹¹ The simulation results are shown on Figures 3.2 and 3.3 (dashed lines).

The main difference with the previous scenario is that, by boosting aggregate demand and therefore wage and profit income, the government is able to break the recessionary loop described in section 3.4.1. Effective disposable income, after falling for workers and rising for capitalists just when obsolescence accelerates, does

¹¹Our model is a toy model designed to explain some mechanisms qualitatively, not quantitatively. Thus the parameter η_G is simply calibrated so that the simulation graphs illustrate these mechanisms clearly. Our qualitative results are robust to changes in the value of η_G . Only one of them is altered when the pace of government response is too slow, as explained in section 3.4.2.

not decrease as much as in the first scenario, thanks to the government stimulus. The decrease does take place but it is rapidly stopped. Accordingly, consumption of good 2 is not forced downwards as much either. Overall the inequality indicators $YD_{pcratio}^{eff}$ and $H_{pcratio}$ increase slightly less than in scenario 1.

Given our model specification (Equations (3.7) and (3.8)) public spending continues to step up until the budget surplus is brought to zero, and its level is maintained thereafter. As a result the economy reaches a new stationary state in which output stabilises at a higher level than in the initial stationary state (recall $Y^* = G^*/\tau^*$). Like in the case without government response the public debt stabilises below its initial level, but due to the rise in public spending the budget surplus disappears more quickly and the final debt level is higher than in scenario 1. Since output is higher, though, the public debt-to-GDP ratio stabilises at a value close to the case of scenario 1.

These results may appear all positive at first sight. However some elements need to be underlined. Admittedly, workers are not forced to cut their consumption of good 2 as much after the increase in their constrained expenditures. Yet they do need to reduce it and they still see their effective disposable income and their savings dwindling. Conversely, part of the initial increase in the effective disposable income of capitalists is maintained. These households can keep consuming more of good 2 compared to their situation before the acceleration of obsolescence, while at the same time being able to accumulate more wealth. Clearly their economic well-being improves. Therefore, contrary to scenario 1 in which absolute increases in inequalities quickly transformed into relative increases (both classes were losing out but workers more than capitalists), here absolute increases are maintained in the new stationary state. On top of this, as final aggregate output is higher than in scenario 1, so is ecological damage.

Summing up, despite the partial reduction in workers' losses when compared to scenario 1, the following must be considered: the increases in inequality are comparable to scenario 1 in relative terms, but in this case they remain absolute increases, not just relative. Ecological damage rises more than without the reaction from the government. Arguably, the increase in public spending considered here does not solve the problems created by the acceleration of obsolescence.

Tax cuts (scenario 3)

In this last scenario of accelerated obsolescence, the government takes the apparition of a budget surplus as an opportunity to cut taxes. We explore the cases of tax cuts for workers and for capitalists ($\eta_{\tau_w} = \eta_{\tau_c} = 1.8$) and of tax cuts for workers only ($\eta_{\tau_w} = 4, \eta_{\tau_c} = 0$). Comparing the simulation results quantitatively with scenario 2 would require to calibrate these parameter values so as to get an equivalent budget expansion. Here we only do a qualitative comparison.

The simulation results show that the outcome is similar to scenario 2 for almost all variables. For instance, aggregate output and ecological damage stabilise above their initial values. Since fiscal policy can affect one class more than the other, one clear difference with scenarios 1 and 2 is the possibility for inequality of disposable income to evolve (not only the effective, also the usual measure of it).

Figures 3.2 and 3.3 (dotted-and-dashed lines) show a remarkable result: even when tax cuts target only workers and not capitalists, inequalities of effective disposable income and of wealth rise. Moreover, this is an absolute increase (workers lose out while capitalists are better off). The explanation for this is twofold. On the one hand, although the tax cut prevents the effective disposable income of workers from continuing to fall after the initial drop, the situation of workers remains worse after the acceleration of obsolescence than before it. On the other hand, as the tax cut breaks the recessionary loop described in section 3.4.1, the effective disposable income of capitalists is not pushed downwards and its initial increase is mostly maintained.

This quick analysis demonstrates that cutting taxes is not a satisfactory response to an acceleration of obsolescence either. There might be no satisfactory response apart from preventing obsolescence itself.

Further remarks

First, we tested for different values for the parameters η_G , η_{τ_w} and η_{τ_c} that represent the responsiveness of the government to budget deficits or surpluses. When the reactions are too small and too slow, only part of the results described above can be observed. The final level of output is still higher than before the acceleration of obsolescence, but the increase is smaller than in the case of strong and fast reactions. More importantly, in the medium run the increases in inequalities of effective disposable income and of wealth are only relative (like in the scenario without government response), whereas they remain absolute increases when the reactions of the government are stronger.

Second, we shall stress that the increase in economic activity observed in scenarios 2 and 3 means an increase in total hours worked. Economists generally consider this to be a positive outcome, because of its effect on employment. In fact, more time is dedicated to the production of soon-to-be obsolete goods while the production of other goods diminishes. Overall this means that more time is devoted to production and less to non-commodified activities. Only a minority of people benefit from this situation. The rest simply work more and have access to less non-obsolescence-related goods. Such a society is dysfunctioning and it should reverse the dynamics as shown in section 3.5.

3.5 A potential for degrowth

The analysis conducted above can be symmetrically transposed to the case of a slow-down of obsolescence. This opens an interesting potential for a transition in line with the degrowth paradigm, provided obsolescence can indeed be curbed. In our opinion, slowing down obsolescence requires to implement regulatory measures. These can include the obligation for manufacturers to make products repairable by design and to ensure spare parts are available during many years, as well as the obligation for technological firms to continue updating softwares for long periods of time. Advertising should be strongly limited, and second-hand markets should be facilitated. One could also think of changes in pricing schemes, for instance to prevent hiding the high price of smartphones in the price of the phone contracts. However, the existing research on the behaviour of consumers with respect to the replacement of durable goods is insufficient (Guiltinan 2009). A proper analysis of how obsolescence could be curbed would require a transdisciplinary approach and is beyond the scope of this chapter.

In this section we assume that obsolescence can be slowed down, and we use our model to simulate the economic and environmental effects of it. Let us briefly outline the key features of such a transition.

As the rate of depreciation δ is brought from 20% down to 10%, the flow of consumption of equipment goods is reduced both for worker and for capitalist households.¹² The simulation results are shown on Figures 3.4 and 3.5. Output drops and a budget deficit arises. Workers and capitalists see their disposable income falling, yet for workers effective disposable income goes up while for capitalists it diminishes, at least in the short run. Workers are able to both increase their consumption of other goods and accumulate wealth, whereas capitalists are forced to reduce their consumption $C_{2,c}$ and to draw on their stock of wealth. In the short run, society undergoes an absolute reduction in inequalities of effective disposable income and of wealth.

If the government does not react to the budget deficit (solid lines on Figures 3.4 and 3.5), a 'rebound effect' takes place. Workers continue to increase their consumption of good 2 ; output grows as well as wage and profit income. The situation of capitalists, initially negatively impacted, quickly improves. These households can also increase their consumption of good 2 and the reduction in inequalities becomes relative rather than absolute (both classes are better off, but workers more than capitalists). Eventually output is brought back to its initial level, the deficit is closed and public debt stabilises above its initial level. Production has partly shifted from good 1 to good 2, thus despite the rebound effect ecological

¹²This has no impact on the stock of equipment goods that each household can enjoy at any period of time, which remains unchanged.

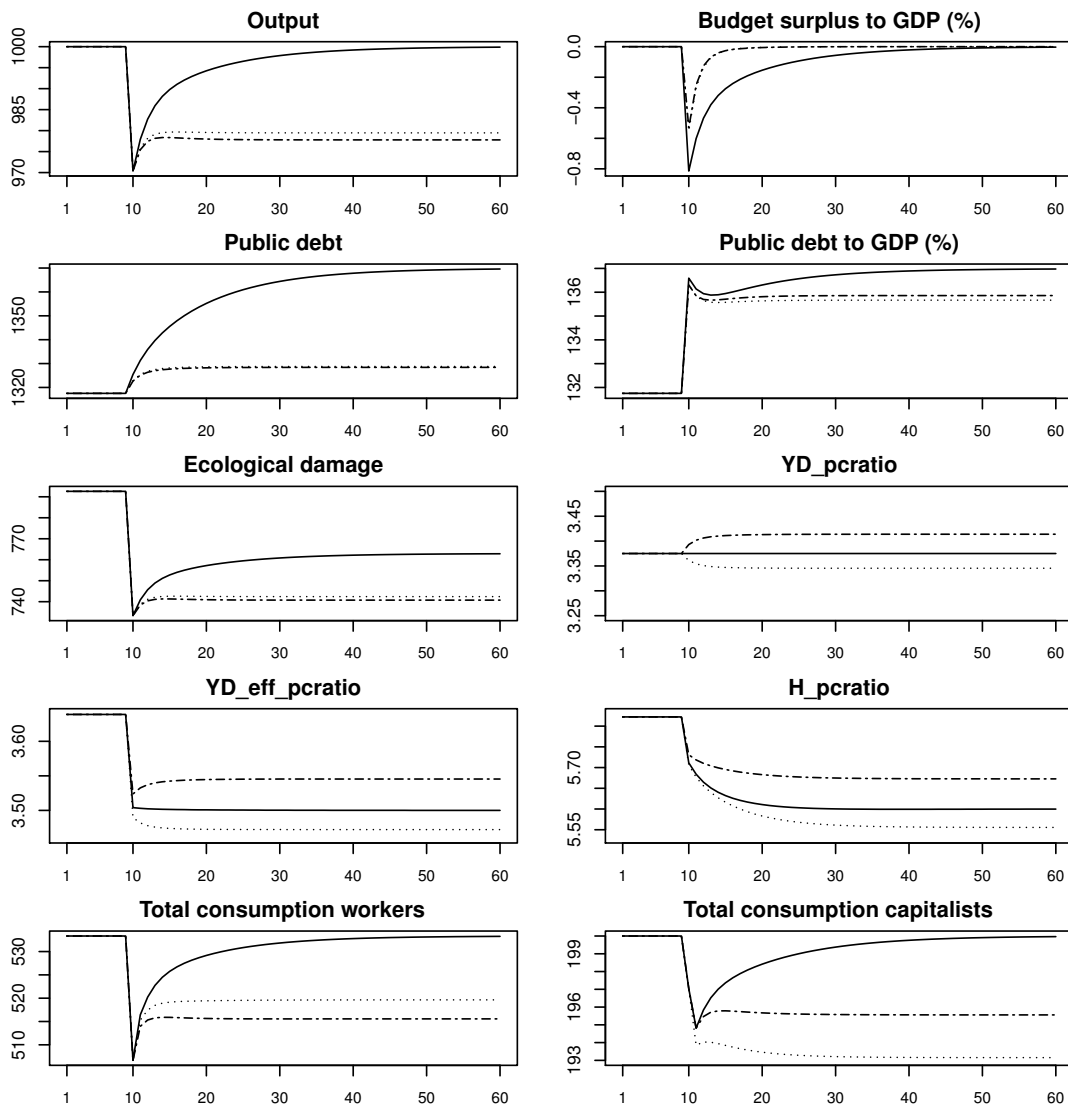

Figure 3.4: Evolution of key variables after a slow-down of obsolescence in different scenarios: no government response (solid lines), tax increases on both classes (dotted lines) and tax increases on workers only (dotted-and-dashed lines)

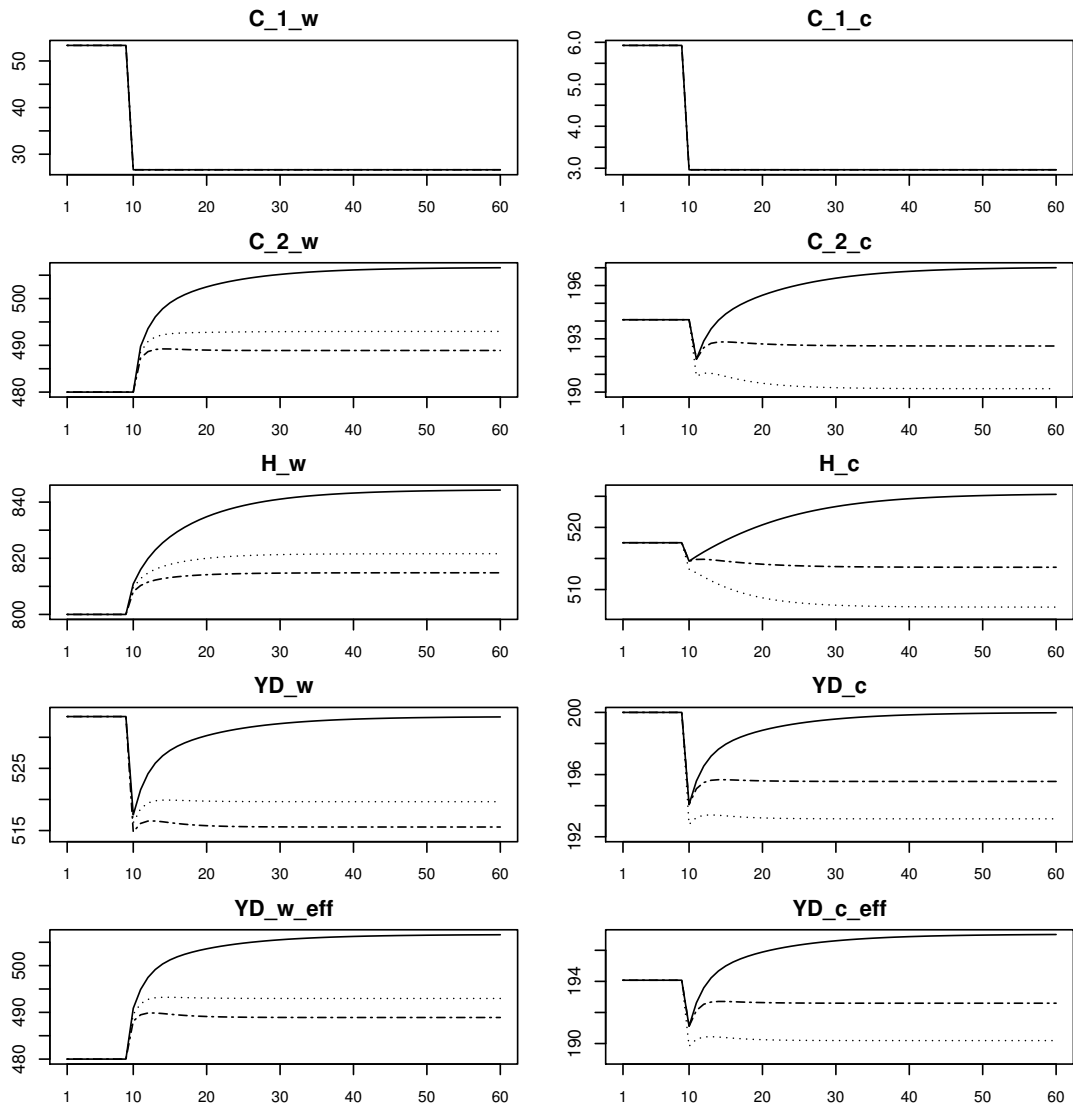

Figure 3.5: (continued from previous page) Evolution of key variables after a slow-down of obsolescence in different scenarios: no government response (solid lines), tax increases on both classes (dotted lines) and tax increases on workers only (dotted-and-dashed lines)

damage is slightly lower than in the initial state.¹³

If the government decides to increase tax rates (dotted and dotted-and-dashed lines on Figures 3.4 and 3.5),¹⁴ the rebound effect can be tamed. Output does not grow back to its initial level, thus the reduction in ecological damage is offset less and the environmental situation improves more than it did without government response. Importantly, the reduction in inequalities remains absolute even in the medium run: the effective disposable income and wealth of capitalists is reduced whereas the contrary holds for workers. Even in the extreme case where tax increases are beared by workers only (dotted-and-dashed lines on Figures 3.4 and 3.5), capitalists still lose out and workers are still able to increase both their consumption of good 2 and their stock of savings. All this holds despite the fact that the primary (i.e. before-tax) income of workers shrinks due to the reduction in aggregate output. The working-time reduction scheme ensures that the diminution of the collective workload benefits every worker instead of creating unemployment. Overall, and despite higher tax rates, workers can increase their discretionary consumption slightly, enjoy more time outside paid work *and* benefit from a less damaged environment. The crucial element making this possible is the reduction in the needs of people, that came in the first place from the slow-down of obsolescence.

This scenario shows that fighting against accelerated obsolescence does not necessarily lead to an opposition between economic and environmental objectives (Gultinan's (2009) 'social dilemma'), provided we accept that the accumulation of wealth for capitalists is not part of these objectives.

3.6 Conclusion

This chapter establishes a theoretical link between accelerated obsolescence and interpersonal inequality of effective disposable income and of wealth between workers and capitalists. Thanks to this link we show that fighting against accelerated obsolescence does not necessarily lead to an opposition between economic and environmental objectives, provided we accept that the accumulation of wealth for capitalists is not part of these objectives.

These results are obtained and illustrated with the help of a simple stock-flow consistent macroeconomic model, with which we simulate an acceleration and a slow-down of obsolescence in different budgetary and fiscal policy scenarios. Our conclusions can be summarised as follows.

¹³This result relies on our assumption that consuming good 2 pollutes less than consuming good 1. Yet if the substitution takes place with the most polluting components of good 2, such as airplane travels, the environmental situation could worsen instead of improving.

¹⁴Here we rule out the case of a diminution of public spending, since it is less in line with the values of the degrowth paradigm.

First, we challenge the idea that by boosting economic activity, faster obsolescence could increase economic well-being for workers. In fact the increase in workers' income is insufficient to compensate extra constrained expenditure. Workers see their effective disposable income dwindling, and are forced to draw on their savings and to reduce discretionary consumption.

Second, capitalists are either hit less badly relatively to workers or they benefit from faster obsolescence. As a result, an acceleration of obsolescence exacerbates pre-existing inequalities of income and of wealth between workers and capitalists. Importantly, identifying these dynamics requires to look at inequality with the right indicators. Traditional measures based on after-tax disposable income show no impact of the pace of obsolescence on inequality, and are even more misleading as they indicate that the economic situation of workers improves in absolute terms. When needs evolve, using measures based on effective disposable income is crucial.

Finally, our scenario of slowing down obsolescence draws positive prospects for a degrowth transition. Inequality of effective disposable income and of wealth can be reduced and at the same time the environmental situation can improve. If tax increases are implemented, the rebound effect can be tamed and environmental gains can be higher than without fiscal reaction. Following the reduction in aggregate output, a working-time reduction scheme ensures that the diminution of the collective workload benefits every worker instead of creating unemployment. Despite higher tax rates workers can increase their discretionary consumption slightly, enjoy more time outside paid work, and benefit from a less damaged environment. Capitalists, on the other side, are the only losers in such a transition. Therefore putting an end to the socially and environmentally wasteful dynamics of accelerated obsolescence means going against their interests, and may require changing the capitalist system at its roots.

Bibliography of the current chapter

- Bakker, Conny et al. (2014). "Products That Go Round: Exploring Product Life Extension through Design". In: *Journal of cleaner Production* 69, pp. 10–16.
- Berthe, Alexandre and Luc Elie (2015). "Mechanisms Explaining the Impact of Economic Inequality on Environmental Deterioration". In: *Ecological economics* 116, pp. 191–200.
- Blonigen, Bruce A, Christopher R Knittel, and Anson Soderbery (2017). "Keeping It Fresh: Strategic Product Redesigns and Welfare". In: *International Journal of Industrial Organization* 53, pp. 170–214.
- Bulow, Jeremy (1986). "An Economic Theory of Planned Obsolescence". In: *The Quarterly Journal of Economics* 101.4, pp. 729–749.

- Butt, Talib E et al. (2015). “Obsolescence Types and the Built Environment—Definitions and Implications”. In: *International Journal of Environment and Sustainable Development* 14.1, pp. 20–39.
- Ederer, Stefan and Miriam Rehm (2020b). “Will Wealth Become More Concentrated in Europe? Evidence from a Calibrated Post-Keynesian Model”. In: *Cambridge Journal of Economics* 44.1, pp. 55–72.
- Galbraith, John Kenneth (1958). *The Affluent Society*. Boston: Houghton Mifflin Company. 368 pp.
- Godley, Wynne and Marc Lavoie (2012). *Monetary Economics: An Integrated Approach to Credit, Money, Income, Production and Wealth*. Basingstoke: Palgrave Macmillan.
- Guiltinan, Joseph (2009). “Creative Destruction and Destructive Creations: Environmental Ethics and Planned Obsolescence”. In: *Journal of business ethics* 89.1, pp. 19–28.
- Hein, Eckhard and Lena Vogel (2008). “Distribution and Growth Reconsidered: Empirical Results for Six OECD Countries”. In: *Cambridge journal of Economics* 32.3, pp. 479–511.
- Huisman, J. et al. (2012). “The Dutch WEEE Flows”. In: *United Nations University, ISP-SCYCLE, Bonn, Germany*.
- Hundy, BB (1976). “The Durability of Automobiles”. In: *Resources Policy* 2.3, pp. 179–192.
- Jackson, Tim and Peter A. Victor (Jan. 2016). “Does Slow Growth Lead to Rising Inequality? Some Theoretical Reflections and Numerical Simulations”. In: *Ecological Economics* 121, pp. 206–219.
- Kaldor, Nicholas (1955). “Alternative Theories of Distribution”. In: *The review of economic studies* 23.2, pp. 83–100.
- Kalecki, Michal (1971). *Selected Essays on the Dynamics of the Capitalist Economy 1933-1970*. CUP Archive.
- Kurz, Rudi (2015). “Quality, Obsolescence and Unsustainable Innovation”. In: *Review of Contemporary Business, Entrepreneurship and Economic Issues* 28.2, pp. 511–522.
- London, Bernard (1932). *Ending the Depression through Planned Obsolescence*.
- Onaran, Ozlem and Thomas Obst (2016). “Wage-Led Growth in the EU15 Member-States: The Effects of Income Distribution on Growth, Investment, Trade Balance and Inflation”. In: *Cambridge Journal of Economics* 40.6, pp. 1517–1551.
- Pasinetti, Luigi L. (Oct. 1962). “Rate of Profit and Income Distribution in Relation to the Rate of Economic Growth”. In: *The Review of Economic Studies* 29.4, pp. 267–279.
- Piketty, Thomas (2013). *Le Capital Au XXIe Siècle*. Paris: Editions du Seuil.

- Satyro, Walter Cardoso et al. (2018). “Planned Obsolescence or Planned Resource Depletion? A Sustainable Approach”. In: *Journal of cleaner production* 195, pp. 744–752.
- Slade, Giles (2006). *Made to Break: Technology and Obsolescence in America*. Cambridge, Massachusetts: Harvard University Press.
- Stratford, Beth (2020). “The Threat of Rent Extraction in a Resource-Constrained Future”. In: *Ecological Economics* 169, p. 106524.
- Waldman, Michael (1993). “A New Perspective on Planned Obsolescence”. In: *The Quarterly Journal of Economics* 108.1, pp. 273–283.
- Wang, Feng et al. (2013). “Enhancing E-Waste Estimates: Improving Data Quality by Multivariate Input–Output Analysis”. In: *Waste management* 33.11, pp. 2397–2407.
- Wieser, Harold (2017). “Ever-Faster, Ever-Shorter? Replacement Cycles of Durable Goods in Historical Perspective”. In: *Product Lifetimes And The Environment - Conference Proceedings*. PLATE Conference. Delft University of Technology: IOS Press, pp. 426–431.

Carrots, Cars and Karaoke: Funding pensions in a degrowing economy

“Degrowth is a myth that induces painful consequences from a social point of view – for example, the impossibility of financing retirement pensions, unemployment and more generally our social protection system. In addition, those who will pay the price for degrowth are SMEs and generally the most disadvantaged, on the contrary the most advantaged or large companies always get by. From a philosophical point of view, I think that humans are meant to have projects, we must rethink growth that does not consist in producing always more but better.”

Matthieu Verry, 2021¹

“We are in a country where we produce, as in all major developed countries. And to produce, indeed, we have done it, whether it is our agricultural model, our industrial model, with practices that have sometimes exhausted biodiversity and have consequences on the climate. All of this is now established. That is what the IPCC are telling us. And they tell us: you can’t keep doing this anymore. You have to change your model very quickly. Confronted with this, there is a very fast model: it is to stop everything. The fastest model is this one. I don’t believe in it. I would even say that I am totally opposed to it. Why ? Because everything we have just said that is very important does not exist with degrowth. Because we produce to finance a social model and a welfare state. And so, all those who say ‘there is a climate emergency, and therefore we must stop everything that pollutes, stop overnight everything that our old model consists of because of the climate.’ I tell them, fine, what is your social schema? Who pays for the old age? Who pays

¹Matthieu Verry is spokesperson and in charge of the green finance team for the think-tank ‘Ecologie Responsable’. In parallel, he works in market finance at the bank Edmond de Rothschild.

for the diseases? Who funds education? No one. Because you have to produce. And so, the challenge that is ours is not to leave our young people this climate debt and so we must change the model even quicker, that's our challenge. So the answer must not be anxiety or withdrawal, it must be to say we must continue to produce, we must even produce more, innovate faster. But we must put faster constraints to fundamentally change our system.”

Emmanuel Macron, 2022²

²Investment banker at Rothschild & Co 2008-2012, French Minister of Economy 2014-2016, President of the French Republic 2017-..

Outline of the current chapter

4.1 Introduction	131
4.2 The model	133
4.2.1 Three categories of goods and services	133
4.2.2 Basic structure: the balance sheet matrix	136
4.2.3 Transactions	136
4.2.4 Further presentation of the model	139
4.2.5 Analysis of the model without any shock	141
4.3 Scenario analysis: consumption behaviours and policy responses to deficits	143
4.3.1 Six scenarios	144
4.3.2 Comparison and discussion of results	154
4.4 Extending the logic to other spheres of social protection and public spending	155
4.5 Conclusion	157
4.A Derivation of the stationary state	158
4.B Stability analysis	159

4.1 Introduction

Although GDP is nearly irrelevant in rich countries as an indicator for well-being, a reduction of it may pose some strain on socio-economic and political systems that have been designed during periods of growth, with the aim of fostering growth. For instance national social protection systems, where they exist, have been designed and calibrated so that their budgets are kept relatively balanced over time, *under the assumption of economic growth*. Keeping the setting and parameters of socio-economic systems constant and reducing economic activity, on which the financing of social protection is mostly based, would lead to higher public deficits. As post-Keynesian economic theory shows, such deficits may not be an issue for growing economies³ - or even be required in order to reach a steady state with growth (Godley and Lavoie 2012, pp. 95–98). In a non-growing or de-growing economy however, public deficits lead to ever-increasing levels of public debt to GDP ratios. While there is no theoretical limit to this ratio, the political sustainability of its constant increase is questionable and one might prefer finding a way to stabilise it and reach a proper stationary state after the degrowth transition has been

³This is more the case for countries (i) which can issue their own currency, (ii) whose currency is high enough in the international hierarchy of currencies (de Paula, Fritz, and Prates 2017) and (iii) which have an economy that is structurally less dependent on imports of capital goods.

completed.⁴ This requires finding ways to finance social protection without relying on an ever-increasing public debt.

The issue of social protection in a degrowing economy has not yet been dealt with from a macroeconomic perspective. This chapter intends to give a start to this area of research and to propose a first contribution in the direction of filling the gap. It is done in the spirit of investigating a “third way” beyond austerity and stimulus policies (Røpke 2016), with the aim of opening up space for academic debate as well as political space.

We focus on one aspect of social protection: the pension system. The reason for this choice is that considerable issues of distribution are involved. In countries where they are part of a social security system (as opposed to a private system), pensions are the largest transfer of income between two categories of households. Although the model and discussion are theoretical and do not correspond to one country in particular, the analysis is meant to deal with the case of rich industrialised economies in which the pension system is mostly organised as a pay-as-you-go scheme, like continental Western Europe.

The questions we raise are the following: (i) Can a pay-as-you-go pension scheme be financially sustained in the context of a degrowing economy? (ii) What are the different policy options, and their implications especially in terms of inequality⁵ and environmental damage?⁶ (iii) Is it possible to simultaneously satisfy ecological, social and economic criteria?

To explore these issues, we build a simple macroeconomic model rooted in post-Keynesian economic theory, enriched with ecological and distributional variables. The focus is put on a change in consumption patterns and mode of living, resulting in a progressive reduction in the consumption of the most ecologically damaging goods and services. Consumption is partially disaggregated and divided into three categories of goods and services which, for the purpose of clarity of exposition, we will refer to as “carrots”, “cars” and “karaoke”. These categories are presented in section 4.2.1. The economy is assumed to undergo an exogenous negative shock in the consumption of “cars”, the most ecologically damaging category of goods and services. Initially this provokes a reduction in total contributions for pensions from active people, resulting in the apparition of a public deficit. We investigate

⁴The distinction is made between a steady state, in which some variables or ratios may increase or decrease steadily, and a stationary state where all flow and stock variables remain constant over time.

⁵We focus on intergenerational inequality and leave the issue of intragenerational inequality aside.

⁶By environmental, or ecological damage, we mean a much broader concept than the emissions of greenhouse gases alone. This would include issues like air, water and soil pollution, deforestation etc. However since the analysis is conducted at an aggregate macroeconomic level, we will simply use general “ecological damage intensities” as theoretical composite indicators.

three types of government behaviour with respect to this deficit: (i) no particular response, (ii) a reduction in the pensions given to retirees and (iii) an increase in contribution rates for active households. We find that increasing contribution rates provides a satisfying response to the challenge described above. This policy choice makes it possible to simultaneously avoid the rebound effect and the associated rise in ecological damage, stabilise the debt-to-GDP ratio, and reach a stationary state with no deficit in the pension scheme. The income of pensioners is preserved and intergenerational inequality is not substantially affected. A complementary policy of working time reduction prevents unemployment from increasing. Thus, we show that in the case of pay-as-you-go pension schemes considered here, there is no necessary trade-off between ecological, social and economic concerns.

This chapter is organised as follows: section 4.2 lays out the model and its endogenous behaviour in the absence of transition. Section 4.3 presents six transition scenarios with various behaviours for the government and for households, and discusses the simulation results. Section 4.4 explains how these results can be extended to the financing of a broader range of social protection and public spending. Section 4.5 concludes.

4.2 The model

The model is built upon the principles and methodology of Stock-Flow Consistent (SFC) modelling developed by Godley and Lavoie (2012) ; the layout and conventions we use are taken from that framework.

If theoretical, our model is yet meant to represent the economy of a rich industrialised country in which the pension system is mostly organised as a pay-as-you-go scheme, like continental Western Europe. Our calibration provides enough realism for the reasoning to be sensible but not enough to give numerical results a great importance, thus we do not claim any quantitative relevance. The interest of our results lie in qualitative observations, comparisons and discussions.

4.2.1 Three categories of goods and services

As explained in the introduction of this thesis, the decrease in aggregate consumption that appears during a degrowth transition is not a uniform reduction for all goods and services. Table 4.1 shows, on an indicative basis, how we split household consumption into three stylised categories of goods and services, which we call “carrots”, “cars”, and “karaoke”.

This categorisation reflects the following logic: “carrots” more or less refers to basic needs, and should not decrease. “Cars” refers to the goods and services that have a high ecological footprint and the consumption of which should be

reduced. The decrease in this type of consumption is linked to the systemic changes that enable more ecological lifestyles, as we described in the introduction of this dissertation and in chapters 1 and 2. “Karaoke” are all the other goods and services, the consumption of which may or may not increase.

Clothing and footwear surely correspond at least in part to the category of basic needs, however we chose to put it in the “karaoke” category because of the differences we make between the three categories in terms of specification of consumption functions. Indeed, C_1 will be modelled as autonomous expenditure, meaning that the level of this consumption does not depend on the income of households. On the contrary, C_3 represent all the goods and services for which the levels of consumption depend on income.

Given the nature of goods and services contained in C_2 , it seems reasonable to consider the corresponding expenditures as autonomous, or constrained, like for C_1 . Indeed, they tend not to depend on occasional consumption decisions but rather on structural matters (e.g. having a washing machine for the first type of process, having a car or not for the second). The differences between “cars” and “carrots” lie in (i) their relative ecological damage intensities and (ii) the fact that the latter should stay untouched while the former need to decrease.⁷

The shock that the economy will undergo, therefore, is a progressive reduction in autonomous consumption expenditures (of the C_2 type) arising from households. The main case we explore is one where only active people progressively change for the ecological mode of living (ie. reducing their level of C_2), and retirees do not. This case is conservative in the sense that if the “old” lifestyle of retirees can be sustained, financially wise, then it is likely that a more ecological lifestyle that requires less expenses can also be so sustained.

Finally, we shall stress that although we model the degrowth transition as essentially a GDP degrowth, this is a modelling choice made to reflect in a stylised manner more subtle changes in the mode of living as described previously, rather than a blind uniform reduction in GDP. This is one of the many aspects of degrowth that make it very distinct from a recession.

⁷The assumption made here is that overall, an ecologically-oriented transportation system (i.e. public transport articulated with all possible smooth modes of transport and some amount of non-privately owned car system) entails a lower level of economic activity than a system that is mostly based on the privately owned car.

Category	“Carrots” (C_1)	“Cars” (C_2)	“Karaoke” (C_3)
Income elasticity	Inelastic/autonomous	Inelastic/autonomous	Elastic
Policy objective	Should not decrease	Should decrease	Would preferably not decrease
Composition	Food and non-alcoholic beverages; Housing, water, electricity, gas and other fuels; Health; Communications; Education.	Furnishings, household equipment and routine household maintenance; Transport.	Alcoholic beverages, tobacco and narcotics; Clothing and footwear; Recreation and culture; Restaurants and hotels; Other miscellaneous goods and services.

Table 4.1: Splitting of household consumption goods and services into three stylised categories

4.2.2 Basic structure: the balance sheet matrix

The economy is divided into three sectors: households (subdivided into active and retired), firms, and an aggregate public sector made of government and central bank. Throughout the chapter, subscript a stands for *active households*, subscript r for *retired households*; i and j are used as generic subscripts applicable to multiple categories of goods or people. As a first approach and in order to isolate our problem from the one of ageing population, we assume away both population growth and the evolution in the active to retired ratio. Thus, each category is made of a constant number of people N_j .

The asset and liability structure is highly stylised as there is only one type of financial asset - high-powered money (HPM) - and one kind of physical, productive, asset. As shown in the balance sheet matrix (Table 4.2), productive capital is owned by firms.⁸ Since firms are supposed not to have retained earnings, at any time their net worth V_f is equal to the value of physical capital K .

The public sector is indebted and its only liability is made of cash H ,⁹ which is made possible by the consolidation of the government with its central bank. As a counterpart of the public debt H , households hold money deposits which constitute their net wealth V_a and V_r . From Table 4.2 we draw the following identities: $V_a = H_a; V_r = H_r; V_g = -H$ and

$$H = H_a + H_r \tag{4.1}$$

4.2.3 Transactions

Table 4.3 illustrates the monetary transactions which take place in this closed economy. The firm sector produces all three types of goods and services. Its gross profits P are equal to total sales Y minus the gross wage bill WB . Active

⁸This simplifying assumption is made in order to avoid the issue of distribution of equity capital, and therefore of dividends, between the two types of households. It allows for the study of the financing of pensions in a pure pay-as-you-go scheme without mixing it with a system of privately-funded pensions. As a simplification one should imagine that due to their participation in the production process, workers are entitled to receiving profits in the form of dividends even though they do not own the capital, neither in its physical nor in its financial form. Thus in our model, there are no transfers of capital between various agents.

⁹This is formally equivalent to having bills as a liability, with a zero nominal interest rate. Introducing a positive interest rate would have required, for a minimum of realism, to also add an extra source of revenue for the public sector (different from contributions for pensions) and therefore a general public spending component as well. In addition, inflation should probably have been introduced then in order to avoid an unduly high real interest rate. Because we do not intend to conduct a detailed analysis of the evolution of public debt, this would have added unnecessary complexity to the model. Hence the choice made of a cash-only economy.

	Households		Firms	Gvt/CB	Σ
	Active	Retired			
High-powered money	$+H_a$	$+H_r$		$-H$	0
Fixed capital			$+K$		$+K$
Balance (net worth)	$-V_a$	$-V_r$	$-V_f$	$-V_g$	$-\Sigma_i V_i$
Σ	0	0	0	0	0

Table 4.2: Balance sheet matrix

households receive wages and profits, part of which is given out to the public sector in the form of contributions for the financing of pensions. Contributions on both wages and profits are calculated on the base of the gross wage bill WB , with the rates κ_w and κ_p respectively. Hence, disposable income for active households YD_a is given by Eq. (4.2):

$$YD_a = (1 - \kappa_w)WB + NP \quad (4.2)$$

where $NP = P - \kappa_p WB$ stands for profits net of contributions. Disposable income for retired households YD_r is made of pensions Π received from the public sector. The difference between the pensions paid to retirees and total contributions represents the public deficit DEF , which is financed by an issue of cash $+\Delta H = DEF = \Pi - (\kappa_w + \kappa_p)WB$.

Eq. (4.3) and (4.4) show the subtotals of consumption by type of good and category of households.

$$C_i = C_{i,a} + C_{i,r} \quad (4.3)$$

$$C_j = C_{1,j} + C_{2,j} + C_{3,j} \quad (4.4)$$

For each type of household the difference between disposable income YD_j and expenses C_j is equal to the flow of saving ΔH_j . The latter is written with a minus sign in Table 4.3 since the action of saving is considered as a *use of funds* rather than a *source of funds*. The flow consistency of the model implies that all the variations in cash sum up to zero:

$$\Delta H = \Delta H_a + \Delta H_r \quad (4.5)$$

This redundant equation of our SFC model (Eq. (4.5)) confirms the macroeconomic

	Households		Firms	Gvt/CB	Σ
	Active	Retired			
Consumpt. (carrots)	$-C_{1,a}$	$-C_{1,r}$	$+C_1$		0
Consumpt. (cars)	$-C_{2,a}$	$-C_{2,r}$	$+C_2$		0
Consumpt. (karaoke)	$-C_{3,a}$	$-C_{3,r}$	$+C_3$		0
Wages & Contrib.	$+(1 - \kappa_w)WB$		$-WB$	$+\kappa_w WB$	0
Profits & Contrib.	$+NP$		$-P$	$+\kappa_p WB$	0
Pensions		$+\Pi$		$-\Pi$	0
Change in cash	$-\Delta H_a$	$-\Delta H_r$	0	$+\Delta H$	0
Σ	0	0	0	0	0

Table 4.3: Transactions-flow matrix

identity between public dissaving and private saving.

Since there is no pure government expenditure, investment nor imports/exports, nominal gross domestic product (or national income) Y is only equal to total nominal consumption C :

$$Y = C = C_a + C_r = C_1 + C_2 + C_3 \quad (4.6)$$

The choice of not modelling government expenditure explicitly (except for pension transfers) has been explained previously. One may wonder, however, why firms do not carry out any investment. This is a simplifying assumption as we wish to focus on consumption dynamics. Thus firms are supposed to have inherited from a stock of productive capital K from previous periods. As this capital is assumed not to depreciate and aggregate production will not rise (as we shall see when conducting simulations of the shock and of various policy responses), there is no indispensable need for an explicit modelling of investment.¹⁰

¹⁰Due to this absence of depreciation and investment dynamics, our results will tend to overestimate the drop in the rate of profit that is caused by the reduction in economic activity. Indeed, the stock of capital is assumed to be constant whereas in reality it would decrease since, following the drop in the utilisation rate, firms would invest at a rate lower than the rate of depreciation.

4.2.4 Further presentation of the model

Prices, productivity and hours worked

As commonly assumed in post-Keynesian models, the price level p (which is the same for all three types of goods) is constant and determined according to a mark-up procedure: $p = (1 + \varphi)W/pr$. W stands for nominal wage rate, pr for hourly productivity measured in nominal terms and φ for mark-up percentage.

For simplicity, work is evenly shared among all active people (there is no unemployment). Productivity and the number of workers remain constant over time. As a result, workers, who are all involved in the production of the three types of goods and services, work shorter or longer hours h depending on aggregate demand, as reflected in Eq. (4.7):

$$h = Y/(N_a \cdot pr) \quad (4.7)$$

The wage bill is equal to the constant hourly wage rate W multiplied by the total number of hours worked: $WB = WN_a h$. Let us emphasise here that under the assumptions just mentioned, whenever aggregate demand drops, a working time reduction takes place. This comes with a reduction in the monthly or annual wage received by each worker, which in turn has macroeconomic consequences that are accounted for in the model.

Consumption functions and pensions

Eqs. (4.8) and (4.9) describe how constrained consumptions are calculated:

$$C_{1,j} = pN_j c_1 \quad (4.8)$$

$$C_{2,j} = p(1 - \sigma_j)N_j c_2 \quad (4.9)$$

with c_1 and c_2 being the real consumptions of “carrots” and “cars” per person and σ_j representing the extent to which the modes of living of active and retired households have changed compared to the initial situation (reflecting the net effect of the two processes presented in section 1).

Consumption of “karaoke” (Eq. (4.10)) is assumed to depend on lagged wealth $V_{j,-1}$ and on a slightly modified version of disposable income, which we call “effective disposable income” YD_j^{eff} and define as disposable income minus constrained expenditures (Eq (4.11)):

$$C_{3,j} = \alpha_{yde,j} YD_j^{eff} + \alpha_{v,j} V_{j,-1} \quad (4.10)$$

$$YD_j^{eff} = YD_j - (C_{1,j} + C_{2,j}) \quad (4.11)$$

Due to the distinction made between several types of goods, a standard consumption function for SFC models (featuring “regular” disposable income and wealth, as can be found in Godley and Lavoie (2012)) would give unrealistic results. Indeed, because the reduction in consumption of “cars” translates into a reduction of disposable income for active households, such specification would lead to an initial *decrease* in consumption of “karaoke”. Instead, given that households are getting some spare purchasing power from the reduction in constrained expenditures, we should expect them to *increase* their discretionary expenditures on “karaoke”. By introducing the concept of effective disposable income, our specification generates this substitution effect from cars to karaoke, which is more realistic.

Eq. (4.12) indicates how pensions are determined: a coefficient $(1 + \gamma)$, allowing retirees to consume some “karaoke” and possibly subject to changes decided by the government, is applied to the “needs” for “carrots” and “cars” per person, in turn multiplied by the number of retired households.

$$\Pi = N_r(1 + \gamma)(pc_1 + pc_2) \quad (4.12)$$

Ecological and distributional variables

Ecological damage is modelled in a highly stylised manner (Eq. (4.13)). Each category of goods and services i presents a certain intensity β_i of ecological damage. This damage can be viewed as an aggregate measure of emissions of various pollutants and greenhouse gases, of material extraction, and of impacts on biodiversity and land use.

$$ED = \beta_1 C_1 + \beta_2 C_2 + \beta_3 C_3 \quad (4.13)$$

With respect to distributional issues, or intergenerational fairness, we propose three indicators (Eq. (4.14)-(4.16)). The first one represents the ratio of disposable income per capita for active households to disposable income per capita for retired households (the subscript “pcratio” stands for “per capita ratio”). The same is done for consumption of “karaoke” and wealth.

$$YD_{pcratio} = \frac{YD_a/N_a}{YD_r/N_r} \quad (4.14)$$

$$C_{3_{pcratio}} = \frac{C_{3,a}/N_a}{C_{3,r}/N_r} \quad (4.15)$$

$$H_{pcratio} = \frac{H_a/N_a}{H_r/N_r} \quad (4.16)$$

We find two reasons for focusing on the (absolute and relative) levels of consumption of “karaoke” rather than on the consumption of “carrots” and “cars”. First, in all scenarios the consumption of “carrots” will remain constant and the consumption of “cars” will evolve exogenously. Only the consumption of “karaoke” will evolve differently according to macroeconomic effects and policy decisions. Second, due to the discretionary (as opposed to constrained) nature of these expenditures the level of consumption of “karaoke” is thought to be, to a certain extent only, linked to well-being and quality of life. For instance expenditures on culture, leisure or restaurants are included in “karaoke”.¹¹

4.2.5 Analysis of the model without any shock

Before turning to the analysis of various shocks and policy responses (section 4.3) let us examine the basic endogenous behaviour of our model.

Most importantly, the model features a stationary state, denoted with star superscripts.¹² Let us note $ws = WB/Y$ the (constant) wage share, and $\kappa = ws(\kappa_w + \kappa_p)$ a “meta” contribution rate. Since total contributions $(\kappa_w + \kappa_p)WB$ can be rewritten as κY , the parameter κ corresponds to the income share of the government. In this model the level of national income at the stationary state only depends on budgetary and fiscal parameters set by the government, as presented in Eq. (4.17):¹³

$$Y^* = \Pi^*/\kappa^* \quad (4.17)$$

Eqs. (4.18) and (4.19) show how active and retired households’ disposable

¹¹We fully acknowledge that well-being and quality of life are not determined by consumption levels only. Moreover, the goods and services suggested here are mentioned only for an illustrative, non-normative purpose.

¹²For a detailed derivation of the stationary state and of the following equations, see Appendix 4.A.

¹³This result is comparable to what Godley and Lavoie obtain for model SIM (ch.3) in which the stationary level of national income is determined by the “fiscal stance” (Godley and Lavoie 2012, pp. 71–72), defined as the ratio of government expenditure G to its income share θ (the tax rate). Indeed, the structures of both models are very similar.

incomes constitute shares of national income:

$$YD_a^* = (1 - \kappa^*)Y^* \quad (4.18)$$

$$YD_r^* = \kappa^*Y^* \quad (4.19)$$

Subtracting constrained expenditures one gets effective disposable incomes YD_j^{eff*} , from which the stationary stocks of private savings can be deducted according to Eq. (4.20):

$$H_j^* = \frac{1 - \alpha_{yde,j}}{\alpha_{v,j}} \cdot YD_j^{eff*} \quad (4.20)$$

Then Eq. (4.1) taken at the stationary state gives the stationary level of public debt:

$$H^* = H_a^* + H_r^* \quad (4.21)$$

The existence of a stationary state is an important result, but the question of whether the economy can reach this state if it starts away from it or can return to it after some perturbations is crucial. This is the issue of stability. Given the simplicity of the model, we are able to conduct a formal stability analysis of it.¹⁴ We show that, for any meaningful set of parameter values (e.g. propensities to consume between zero and one), the model is stable. The only condition is that for active households, the propensity to consume out of wealth $\alpha_{v,a}$ must be lower than the propensity to consume out of disposable income $\alpha_{yde,a}$, which is a generally verified, common assumption.

It should be noted that we conducted a stability analysis only in the case where the government does not respond to budget deficits. When the government does respond, the dynamics of the model is more complex due to an extra dynamic equation, and on top of that the stationary state itself is modified. Nevertheless, our analysis shows that the underlying core dynamics of the model is stable. The simulations we present in section 4.3 corroborate this result.

¹⁴See Appendix 4.B.

4.3 Scenario analysis: consumption behaviours and policy responses to deficits

Cases can be distinguished along the behaviour of the two main sectors: households and government (firms only play the role of supplying the demanded quantities of goods and services). On the one hand, households can either have no satiety behaviour as described in section 4.2.4, or they can have a satiety threshold in terms of level of consumption of “karaoke”. Beyond this threshold, households increase their saving instead of consuming more “karaoke”. On the other hand, the government can choose between not responding to budget deficits at all (“passive” case) or implement policies to try and reduce the deficit: (i) decrease pensions or (ii) increase contribution rates.¹⁵

The policy of reducing pensions to close down the deficit translates into the following two equations, with $\eta_\gamma > 0$:

$$\gamma = \gamma_{-1}(1 + g_\gamma) \quad (4.22)$$

$$g_\gamma = -\eta_\gamma DEF/Y \quad (4.23)$$

The policy of increasing contributions is modelled with equations (4.25) to (4.27):

$$\kappa_w = \kappa_{w,-1}(1 + g_{\kappa_w}) \quad (4.24)$$

$$g_{\kappa_w} = \eta_{\kappa_w} DEF/Y \quad (4.25)$$

$$\kappa_p = \kappa_{p,-1}(1 + g_{\kappa_p}) \quad (4.26)$$

¹⁵Since all profits are distributed to households and these households are not separated according to levels of income (and therefore to different propensities to consume), it does not matter whether it is the contribution rate on wages or on profits that is increased. In a more complex model one could distinguish between wage-earner and profit-earner households and consider uneven increases in contribution rates. For instance, population ageing could be introduced and the need for an increase in contribution rates that would arise from it could be met by a stronger increase in the contribution rate on profits than in the contribution rate on wages. This would help with the financing of pensions of an ageing population, while reducing intragenerational inequality.

$$g_{\kappa_p} = \eta_{\kappa_p} DEF/Y \quad (4.27)$$

4.3.1 Six scenarios

Simulations are conducted for six scenarios, corresponding to the combination of the three types of responses from the government (including "no response") and the two types of household behaviour, as shown in Table 4.4. For all scenarios, simulations start from the steady state described earlier. After five periods, the progressive negative shock on the consumption of "cars" by active households takes place. This shock is spread over ten periods, during which the parameter σ_a increases from zero to 0.8. There is no shock on the consumption of "cars" by retired households.

	No response	Pensions diminish	Contributions increase
Without satiety	1a	2a	3a
With satiety	1b	2b	3b

Table 4.4: The six scenarios considered

In the following subsections, we present and compare the results of the simulations of these six scenarios.

Scenario 1a: no policy response from the government, no satiety behaviour

In this scenario, pensions remain untouched. As a result, nothing happens to retired households. They are able to consume the same amounts of "carrots", "cars" and "karaoke". Their level of wealth stays constant as well.

On the side of active households, what happens is a substitution from the consumption of "cars" to the consumption of "karaoke". Indeed as active people see their constrained expenditures go down, their purchasing power available for discretionary consumption tends to increase. However this increase in purchasing power is smaller than the money saved on reduced constrained expenditures. The reason for this is that by consuming less cars, active people lower the level of activity and therefore the total wage bill as well as the profits of firms. This means the income of active households is reduced as a consequence of their change in consumption pattern. Yet, the net macroeconomic effect of these two phenomena is an increase in effective disposable income for active households.

Let us take a numeric example to illustrate the reasoning, which for the purpose of clarity is also shown on figure 4.1. By consuming 100 units less of cars, active

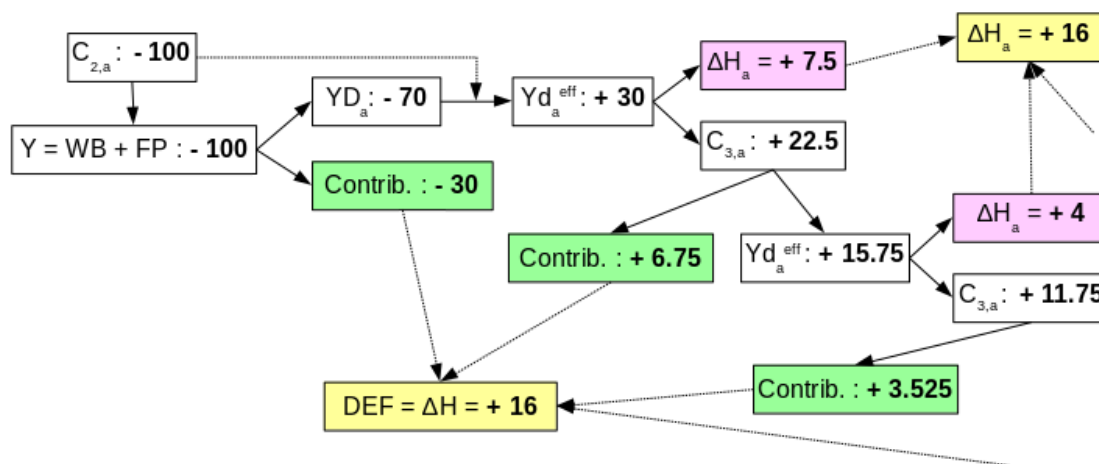

Figure 4.1: The mechanism explaining how the public deficit appears and how active people can increase their consumption of “karaoke” while their total income is reduced.

households make the sales of firms go down by 100 units (top left corner of the figure). As a result, firms pay less wages and less dividends to active households. But there is also less contributions paid to the government. With a contribution rate of 0.3 on wages and profits, the result is that total contributions paid go down by 30 units and the disposable income of active households (made up of wages and profits minus the contributions) go down by 70 units. But active households see their *effective* disposable income *increase* (by 30 units), not decrease: the drop of 70 units in their disposable income is more than compensated by the 100 unit reduction in their constrained expenditures. In parallel to this, since contributions have dropped by 30 units while pensions have not been modified, a public deficit of 30 units would appear.

As shown in figure 4.1, the deficit that will actually be observed, even in the very short run, will be smaller than 30 units. This is because of the traditional Keynesian multiplier effect: as active households see their effective disposable income increase, they start consuming more “karaoke” (recall their consumption function). In turn, as economic activity rebounds, this increase in consumption of “karaoke” creates additional disposable income for active people themselves and contributions for the government. This partly counterbalances the loss of disposable income that resulted from the reduction in consumption of cars, and the initial loss of contributions. In parallel, part of the extra *effective* disposable income is saved since the propensity $\alpha_{yde,a}$ to consume out of it for active households is strictly lower than one. As a result, the level of wealth of active people H_a increases. When taking into account

the full effect of the multiplier that happens in the very short run, with a marginal propensity to consume equal to 0.75, the observed initial public deficit as well as the saving of active households would be equal to 16 (rather than 30 without the multiplier effect).

The additional wealth of active people coming from this saving will now trigger a second-round effect of increase in consumption. Indeed, consumption of “karaoke” is assumed to depend positively on accumulated wealth. By further increasing their level of consumption of “karaoke”, active people fill the contribution gap that arose initially and the public deficit starts closing down. Overall, $C_{3,a}$ increases up to the point where the public deficit is back to zero, as can be seen on figure 4.2. Total consumption of active households C_a comes back to its initial level, as the substitution from $C_{2,a}$ to $C_{3,a}$ is total. In terms of macroeconomic flows, the economy returns to the same stationary state as before the shock. Apart from the change in the proportion of the goods and services consumed, the main change is to be found in the public debt H , which stabilises at a higher level. Ecological damage (ED) has decreased and stabilised at a lower level: the substitution (or rebound effect), although total in nominal terms, has a positive effect on ecological damage. This is due to the assumption that “karaoke” carries a lower ecological damage intensity than “cars”.¹⁶

Finally in terms of intergenerational fairness, the outcome of this scenario is an absolute improvement of the situation of active households (their consumption of “karaoke” and their wealth increase) while the situation of retired households is unchanged. In relative terms, active people are the beneficiaries of the economic transition: the ratios $C_{3pcratio}$ and $H_{pcratio}$ increase. As none of the two categories of people is worse-off, one can argue that this scenario yields a rather positive outcome in terms of intergenerational fairness.

However, the ecological outcome of scenario 1 is not the best one could expect: because of the rebound effect, ecological damage “rebounds” too. We shall see that some scenarios can yield better ecological outcomes.

Scenario 1b: no policy response from the government, with satiety behaviour

We now examine the results of scenario 1b, a variation based on the previous case, where active households now have a consumption behaviour featuring a satiety threshold. The simulation results are presented in figure 4.3.

In the beginning of the transition after the negative consumption shock, everything evolves like in scenario 1a. Active households substitute “karaoke” for “cars”.

¹⁶It should be noted, however, that if the rebound effect is directed towards more consumption of electronic goods or high-carbon-content leisure activities for instance, the result would be reversed. Therefore, consumption patterns should evolve according to a general increase in environmental awareness in order to prevent such counter-productive evolutions.

4.3. Scenario analysis: consumption behaviours and policy responses to deficits¹⁴⁹

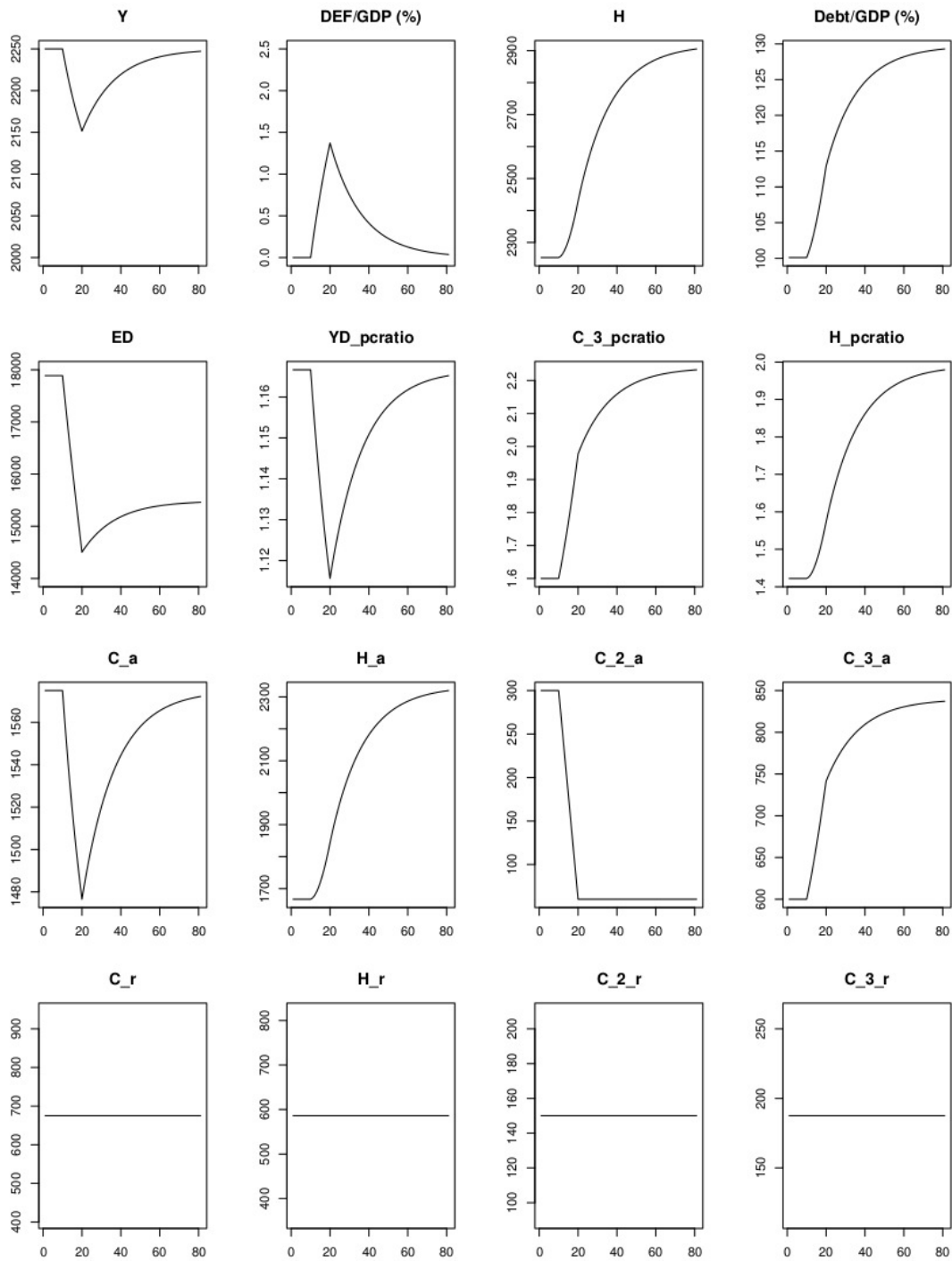

Figure 4.2: Evolution of key variables for scenario 1a

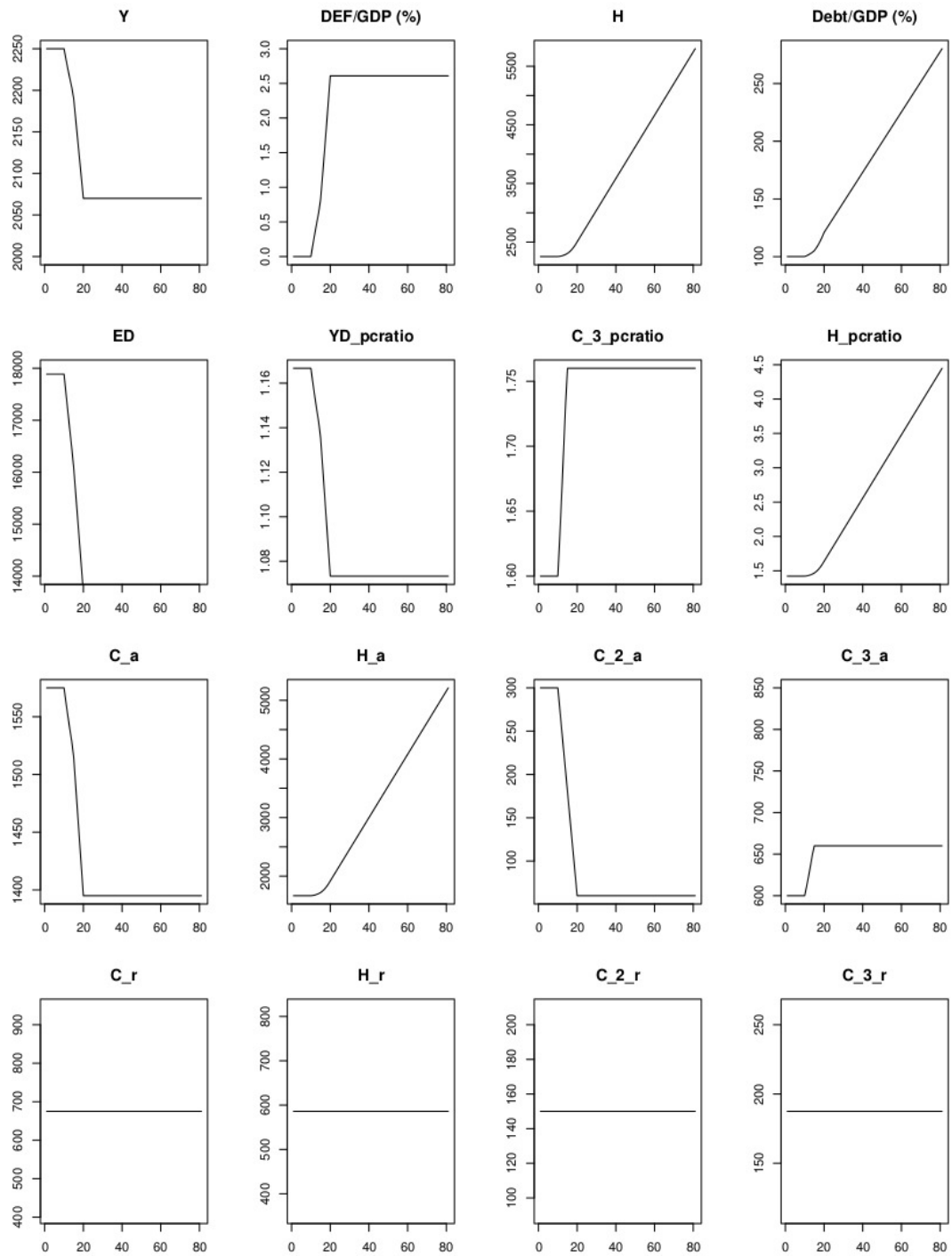

Figure 4.3: Evolution of key variables for scenario 1b

4.3. Scenario analysis: consumption behaviours and policy responses to deficits¹⁵¹

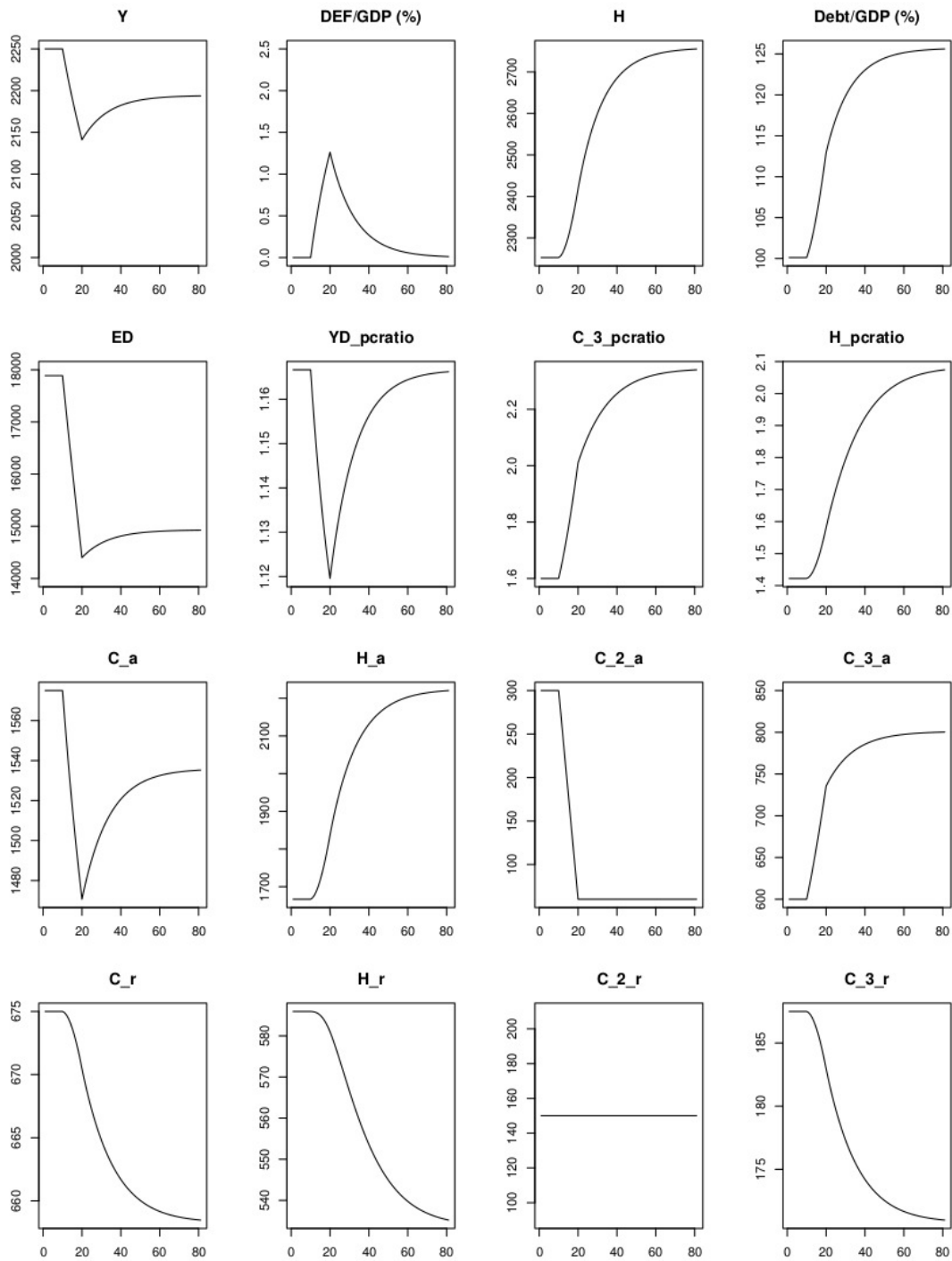

Figure 4.4: Evolution of key variables for scenario 2a

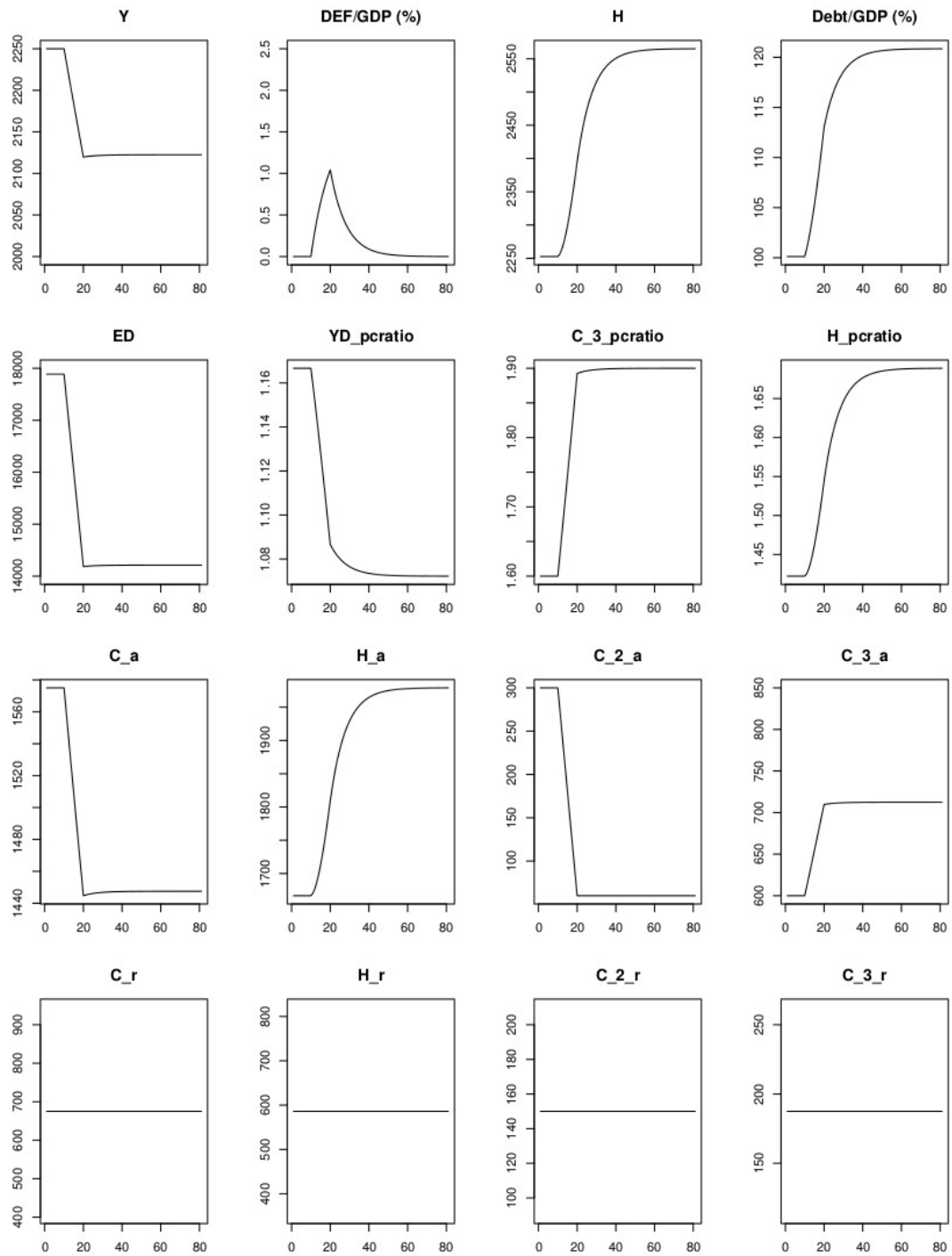

Figure 4.5: Evolution of key variables for scenario 3a

But once they have reached their satiety level of consumption of “karaoke”, these households stop “rebounding” and keep saving. As a result, the public deficit does not close down entirely and remains significantly positive. No stationary state is reached, as the stock of public debt increases steadily just as the stock of private wealth does. This is a steady but not stationary state. Flow variables are stabilised but not stock variables.

In this setting with satiety behaviour, such a steady increase in public debt and private wealth has no consequence on ecological damage, which stabilises at a given level. Technically speaking, for an economy in which the government has enough control on the central bank and can make sure that the bank plays the role of lender of last resort if needed, an ever-increasing public debt is not a problem. However, the political sustainability of such an increase in stocks may be questioned and, for this reason, we will consider that this scenario is not satisfying with respect to the criterion of the financing of the pension scheme.

Scenario 2a: reduction in pensions, no satiety behaviour

This scenario is relatively straightforward. The simulation results are presented in figure 4.4. In response to the apparition of a public deficit, the government implements a gradual reduction in pensions. This reduces the effective disposable income of pensioners, who have to cut on their discretionary expenditures $C_{3,r}$. Active people, on the other hand, benefit from the increase in purchasing power for “karaoke” presented in the description of scenario 1a. Consuming less cars allows them to consume more “karaoke”. The rebound effect, however, is not complete as it was in scenario 1a. The reason for this is the multiplier effect coming from the reduction in consumption by retired households. Indeed, this reduction of $C_{3,r}$ impacts negatively the wages and profits received by active households.

The reduction in pensions progressively closes down the deficit and a new stationary state is reached, with a level of debt that is higher than initial but lower than in the case of no response from the government. Overall, pensioners are worse-off both in absolute terms and in relative terms. The ratios of intergenerational fairness show that active people are the “winners” from this type of policy, but unlike in scenario 1a, there are people whose situation worsens. The level of consumption and the savings of retired are forced downwards. The ecological outcome is slightly better than in scenario 1a, but not by a significant amount.

Scenario 2b: reduction in pensions, with satiety behaviour

Here active households do not rebound much. As a result the deficit closes down more slowly and, more importantly, pensions are decreased more than when the rebound effect brings revenues for the government. In this scenario, pensioners

bear a double burden from the fact that active households (i) consume less “cars” and (ii) do not wish to consume much more of “karaoke”. Public debt stabilises at a higher level than when active households do not have the satiety behaviour. With the calibration chosen, public debt stabilises around 200% (this depends on the speed of reduction of pensions) compared to 125% without satiety, and consumption of “karaoke” by retirees has to decrease by 40% instead of just 14%.¹⁷

Scenario 3a: increase in contributions, no satiety behaviour

In this third type of scenario, the government responds to public deficits by increasing the contribution rates on wages and profits. The simulation results are presented in figure 4.5.

Because pensions remain unchanged, the situation of retired households remains unchanged as well, as it was in scenarios 1a and 1b. For active households, the same substitution and rebound effect takes place as in previous scenarios. However the increase in contributions tends to reduce their disposable income and therefore tames the rebound effect. $C_{3,a}$ still increases somewhat, but less than in the case of no government response. Active people accumulate wealth while its counterpart, the public debt, increases before stabilising (as it is the case in scenarios 1a and 2a-2b). The public debt to GDP ratio stabilises at a lower level than in other scenarios.

Although each of the scenarios 2a and 3a can be compared quantitatively with scenario 1a, such a comparison is not relevant between scenarios 2a and 3a. The reason for this is that the outcome of both these scenarios depend on the pace at which the government decreases pensions or increases contributions. There is a phenomenon of path dependence.¹⁸ For instance, the faster the government increases contributions, the faster the deficit is closed down and the less active people can accumulate wealth. As a result, their tendency to rebound on their consumption of “karaoke” is dampened, since the “wealth effect” is lower. The final levels of the fiscal stance (and of production) depends on the pace of its change, it is not pre-determined. Overall, the fastest the government increases contributions, the lower the public debt increases, the better the ecological outcome, and the lower the “divergence” between active and retired households.

Another important remark should be made here. As shown clearly in figure 4.5, all indicators of intergenerational fairness do not always evolve in the same direction. In this scenario the ratio of disposable incomes decreases, giving the impression that active people are relatively worse-off. On the contrary, the ratios

¹⁷One should keep in mind that these figures are only a basis for comparison and should not be given more meaning, especially with respect to the level of public debt.

¹⁸Path dependence is well understood and put forward in post-Keynesian economic theory. However, it is relatively rare to find models in which this phenomenon can actually be observed.

for consumption of “karaoke” and wealth increase, indicating that active people are relatively better-off. Which indicator is more relevant, and what can be said in terms of intergenerational fairness?

Here one should notice that because constrained expenditures evolve, disposable income is not as relevant an indicator as it is normally the case. This relates to the discussion about the relevance of the concept of *effective* disposable income. In reality, active people see their relative situation improving compared to retired households (and in absolute terms as well). The same can be said about the share of national income that each category of household receives, which are equal to $(1 - \kappa^*)$ for active and κ^* for retired households. As κ is progressively increased, active people get a lower share of national income and retired households a higher share. Again one could draw the conclusion that active people are getting worse-off. Looking at these shares without a closer look at what is happening is misleading, since in reality the effective disposable income and levels of wealth and of consumption of “karaoke” for retired households is unchanged, whereas these variables increase for active households, who end up better-off in relative and in absolute terms.

Let us stress one of the crucial results of this work. Active people are able to increase both their consumption of “karaoke” and their stock of savings. They can do so despite both their loss of primary income (that comes from the reduction in the production of “cars”) and the increase in their contribution rate. This can appear illogical or impossible to the reader. Yet the numbers add up and our simulations show and illustrate these results. The solution to the puzzle comes from the fact that the reduction in constrained expenditures frees up additional disposable income. As explained above, this increase in disposable income is larger than the decrease in disposable income coming from lower production. The subsequent increase in *effective* disposable income provides resources that can be used partly for a higher consumption of “karaoke” and partly for an increase in savings. It also enables active people to cope with the increase in contribution rate without losing effective purchasing power overall. Note that the rate increases in order to compensate for the reduction in the tax base, but the volume of contributions remains constant.

Scenario 3b: increase in contributions, with satiety behaviour

This scenario leads to quite similar results as its companion scenario 3a. Therefore, we will not comment on it in details. The main difference with scenario 3a is that the rebound effect from the part of active households is voluntarily tamed, rather than curbed by the increase in contributions.

Contributions do increase as well though, since in the absence of a substantial rebound effect the government does need to implement its policy in order to close

		Ecological damage	Distribution (Intergenerational)	Financing (Public deficit & debt)
1a	No response No satiety	Rebound effect		
1b	No response Satiety		Wealth divergence But no loser	Ever-increasing debt/GDP
2a	Pensions reduction No satiety	Rebound effect	Retirees lose purchasing power & wealth	
2b	Pensions reduction Satiety		Retirees lose purchasing power & wealth	Stabilisation at high level of debt/GDP
3a	Contrib. increase No satiety			
3c	Contrib. increase Satiety			

Figure 4.6: Synthesis of outcomes from the six scenarios according to three main criteria.

down the deficit. Active people are not hit really negatively by this increase since they are able to reach their satiety threshold and the increase in contributions only prevents them from accumulating more and more wealth.

4.3.2 Comparison and discussion of results

The criteria we choose for the comparison of the outcomes of the 6 scenarios are the following: (i) ecological damage should be curbed as much as possible, (ii) if possible, no category of people (active or retired) should be worse-off in absolute terms, meaning their consumption of “karaoke” should not be forced downwards, (iii) the pension system should be fully financed, meaning that the public deficit should be progressively brought to zero and thus the debt-to-GDP ratio should be stabilised after some possible variation.

Figure 4.6 presents a synthesis of the outcomes of the six scenarios, with respect to the three main criteria mentioned above.

Scenario 1a satisfies criteria (ii) and (iii) but the rebound effect is substantial and therefore criterion (i) is not fully respected. Introducing a satiety behaviour (scenario 1b) solves the rebound effect issue but prevents the debt ratio from stabilising (and as a result, the wealth of active people keeps increasing and diverging from the wealth of retirees).

Scenario 2a satisfies criteria (iii) but neither criterion (i) nor (ii) active people do increase their consumption (rebound effect), and pensioners lose income, effective purchasing power and wealth. A satiety behaviour (scenario 2b) would reduce the rebound effect, but slow down the closing up of the public deficit and therefore lead to a much higher debt ratio.

Scenario 3a satisfies all three criteria: because the rebound effect is tamed by the increase in contributions, the ecological outcome is better than for scenario 1a. Scenario 3b gives similar positive results: as opposed to scenario 1b, the deficit is closed down and the debt ratio is stabilised, thanks to the increase in contributions.

From this comparison, the conclusion we draw is that the increase in contribution rates is the best way to manage the degrowth transition in a socially and environmentally sustainable manner. Whether this takes place with or without a satiety behaviour from active households does not radically change the outcomes. One could argue, however, that it is preferable and politically more sustainable to have people restraining themselves from "rebounding", thanks to their environmental awareness, rather than having the rebound effect tamed in a more passive manner through the increase in contribution rates (although contribution rates would increase even in the case where active people have a satiety behaviour).

As a side remark, it should be noted that the rate of utilisation and the rate of profit¹⁹ both go down during the transition, and remain at a lower value (except for cases of full rebound effect). However, these changes do not seem to be particularly problematic: in the calibration we made, the rate of utilisation drops from 0.8 to about 0.76 and the rate of profit from 8.9% to 8.2-8.5%.²⁰

4.4 Extending the logic to other spheres of social protection and public spending

This chapter examined the possibility of maintaining social protection in an economy that is gradually downscaled. We focused on one specific component of social protection: the case of pensions. However, our results can easily be extended to a much broader range of social protection and public spending. This is one of the advantages of carrying out research at the theoretical level and of using toy models. Let us explain briefly how we can obtain extended results.

Instead of considering that the government expenditures Π represent pensions, one can imagine that they represent other types of transfers. For instance, Π could

¹⁹Defined respectively as the ratio of output to full capacity output, and the ratio of profits to the value of productive capital.

²⁰Moreover, both rates would return to their initial values if investment and the depreciation of capital were included in the model like in chapter 2.

represent unemployment benefits (like in chapter 2), and would be handed out to unemployed workers instead of pensioners. The financing scheme would remain the same. The amount $(\kappa_w + \kappa_p)WB$ would be understood as contributions for unemployment benefits instead of contributions for the pension scheme.

Importantly, we can go further than this relatively straightforward extension, still without changing anything to the structure of the model. The second category of people, who represent pensioners in the main version, can also be understood as public servants of any kind. In such a configuration, the amount Π represents the total wage bill distributed to this category of the population, and π represents the wage that each public servant receives. Public employees provide free public services to every person in society. In the configuration we are discussing here, this means that people employed in both the private and public sectors benefit from these services. However, we can also keep pensioners in the model as a third category who would also have free access to public services. Since the services are provided for free, there is no payment between categories of people. The model can remain unchanged. Public servants spend their income on the three categories of goods like pensioners do in the main version.

Just as we assumed for pensioners as a kind of “limit case” in the main body of the chapter, we can imagine that public servants do not change their lifestyles (i.e. their constrained consumption of “cars” does not decrease). Alternatively, we can consider that public servants will change it and consume less “cars”.²¹ In the first case, everything plays out like in the main body of the chapter. Increasing the contribution rate on the first category of population (private employees) allows for maintaining the amount of public expenditures (public employees’ compensations), without reducing the *effective* disposable income of private employees. In the second case, in order to preserve fairness between private and public employees, the increase in the contribution rate should be applied to both categories of population, not just to employees of the private sector. This requires a minor amendment to the model: adding the fact that public servants also pay contributions, that are used to finance part of their own compensations. If the increases in contribution rates are distributed fairly, the effective disposable income of both categories of people are preserved and can increase slightly. The same reasoning as explained in the main part of the chapter applies.

The public servants we mentioned can be of any type: teachers, hospital staff and care workers, municipal workers and administrative staff, public servants in the legal system, sanitation workers, public safety officers etc. Therefore, this chapter shows that, in an economy that is degrowing as a result of reduced constrained

²¹The second case is a more realistic situation, since there is no reason why public employees would not change their lifestyle in the same way as private employees. For pensioners the idea was to explore a situation where pensioners are reluctant to changing their habits.

expenditures for households, it is possible to guarantee a full financing of pensions but also of a much broader range of social protection and public spending. This result is of high importance since social protection and public spending have strong positive impacts on social justice and equality. It is also important with respect to ecological concerns because public services are able to provide higher need satisfaction while entailing lower energy requirements, compared to other types of provisioning systems J. Vogel et al. (2021).

4.5 Conclusion

Using a stock-flow consistent macroeconomic model featuring rebound and multiplier effects, and looking at the consequences of a negative consumption shock of "cars" by active households, we showed that there is a way to satisfy all the criteria we have set for the economy and the environment in this thought experiment. An increase in contribution rates allows at the same time for (i) a positive ecological outcome arising from the reduction in consumption combined with a tamed rebound effect, (ii) a full financing of the pension scheme without relying on public deficits and therefore we achieve a stabilisation of the debt-to-GDP ratio, and (iii) a satisfying outcome in terms of intergenerational fairness. Although active people are the "winners" in this type of scenario, there are no absolute "losers".

Thus, we showed that there is no problem for the financing of a pay-as-you-go pension scheme in a context of reduction of consumption and production, even in the case where retired people go on with their previous non-ecological lifestyle. If they decide to reduce their consumption of "cars" like active people do, it can only be better for the environment and for their financial situation.

Moreover, we were able to extend these results. We showed that it is possible to guarantee the full financing of a much broader range of social protection and any kind of public services, for instance education, health, sanitation, safety, justice, and administration.

To wind up, this chapter suggests and explores a path toward strong sustainability, where one ecological problem is not replaced with another one since the rebound effect is tamed and aggregate production is not just stabilised but actually goes down. This is done without impacting negatively the well-being of people, since their needs keep being met, and without triggering a distributional conflict between categories of people such as retired and active households. Contrary to a frequent critique made to degrowth-related ideas, such a systemic change does not lead to an economic collapse, nor to an explosion of public debt. Finally, the reduction in working time associated with the reduction of aggregate production prevents unemployment from increasing and improves the quality of life of active people, which increases the acceptability of such dramatic changes.

Appendix 4.A Derivation of the stationary state

At the stationary state the level of public debt must remain constant, thus public deficit should be zero. Recalling that the deficit DEF is equal to public expenditures Π minus contributions κY , the condition $DEF = 0$ yields immediately Eq. (4.17): $Y^* = \Pi^*/\kappa^*$.

Since pensions Π are equal to disposable income for retirees YD_r , rearranging Eq. (4.17) gives Eq. (4.19): $YD_r^* = \kappa^* Y^*$.

As for the disposable income for active households ($YD_a = (1 - \kappa_w)WB + NP$), let us use the lines on wages and profits in the transactions-flow matrix (table 4.3). Because each line sums to zero, we can see that YD_a is equal to total wages WB plus total profits P (the sum of which represents national income Y) minus total contributions κY . We obtain the following simple expression for YD_a :

$$YD_a = (1 - \kappa)Y \quad (4.28)$$

Applying this expression in the case of the stationary state yields Eq. (4.18):

$$YD_a^* = (1 - \kappa^*)Y^*$$

In order to get the levels of private wealth H_j^* , let us recall Eq. (4.4) for total consumption C_j of households j and Eq.(4.10) for their consumption $C_{3,j}$ of “karaoke”:

$$\begin{aligned} C_j &= C_{1,j} + C_{2,j} + C_{3,j} \\ C_{3,j} &= \alpha_{yde,j} YD_j^{eff} + \alpha_{v,j} V_{j,-1} \end{aligned}$$

Knowing that $V_{j,-1}^* = V_j^* = H_j^*$, and that consumption at the stationary state C_j^* is equal to disposable income YD_j^* (no variation in wealth means no flow of saving), combining the two equations above at the stationary state gives:

$$YD_j^* = C_{1,j}^* + C_{2,j}^* + \alpha_{yde,j} YD_j^{eff*} + \alpha_{v,j} H_j^*$$

Recalling the definition $YD_j^{eff} = YD_j - (C_{1,j} + C_{2,j})$ and rearranging yields Eq. (4.20):

$$H_j^* = \frac{1 - \alpha_{yde,j}}{\alpha_{v,j}} \cdot YD_j^{eff*}$$

Appendix 4.B Stability analysis

The simplicity of our model makes it possible to conduct a formal stability analysis. Only two variables (H_a and H_r) intervene with lagged values in the equations of the model. Moreover, as shown below, at each time period it is possible to express any variable (not just H_a and H_r) as a function of the stocks of wealth in the previous period, $H_{a,-1}$ and $H_{r,-1}$. Thus the model can ultimately be reduced to a dynamic system of difference equations for two interdependent main variables (H_a and H_r). All other variables can be considered as auxiliary variables for which the values can be derived from the values taken by the two main variables.

Given this, we can proceed to the stability analysis by using knowledge and tools from algebra and difference equation systems. We follow the same procedure as in Godley and Lavoie (2012, pp. 233–7).

The first step is to establish the system of difference equations mentioned above, i.e. to express H_a and H_r as functions of $H_{a,-1}$, $H_{r,-1}$, and model parameters. To keep equations as readable as possible, let us denote $\alpha_{c,j}$ the total constrained consumption for each type of household: $\alpha_{c,j} = C_{1,j} + C_{2,j}$. We start with the retired households' accounting equation $\Delta H_r = \Pi - C_r$:

$$\begin{aligned}\Delta H_r &= \Pi - (\alpha_{c,r} + \alpha_{yde,r} Y D_r^{eff} + \alpha_{v,r} H_{r,-1}) \\ &= (1 - \alpha_{yde,r})(\Pi - \alpha_{c,r}) - \alpha_{v,r} H_{r,-1}\end{aligned}$$

Using the definition $\Delta H_r = H_r - H_{r,-1}$ gives the first half of the system, equation (4.29):

$$H_r = (1 - \alpha_{yde,r})(\Pi - \alpha_{c,r}) + (1 - \alpha_{v,r})H_{r,-1} \quad (4.29)$$

Obtaining the second half of the system requires more intermediary computations. The accounting equation for the public sector is helpful (recall from section 4.2.5 that contributions can be expressed simply as κY):

$$H = \Pi - \kappa Y + H_{-1} \quad (4.30)$$

Since $H = H_a + H_r$ and H_r can be expressed as a function of $H_{r,-1}$, we only need to expand Y in order to express H_a as a function of $H_{a,-1}$ and $H_{r,-1}$. We start with the definition of output and expand the part relative to the consumption of active households:

$$\begin{aligned}Y &= C_a + C_r \\ &= \alpha_{c,a} + \alpha_{yde,a}(Y D_a - \alpha_{c,a}) + \alpha_{v,a} H_{a,-1} + C_r\end{aligned}$$

Substituting $Y D_a$ in the above equation with $(1 - \kappa)Y$ (Eq. (4.28)) and rearranging gives:

$$Y = \frac{1}{1 - (1 - \kappa)\alpha_{yde,a}} [((1 - \alpha_{yde,a})\alpha_{c,a} + \alpha_{v,a}H_{a,-1} + C_r)] \quad (4.31)$$

We can in turn substitute national income Y in Eq. (4.30) with Eq. (4.31):

$$H_a + H_r = \Pi - \frac{\kappa}{1 - (1 - \kappa)\alpha_{yde,a}} [(1 - \alpha_{yde,a})\alpha_{c,a} + \alpha_{v,a}H_{a,-1} + C_r] + H_{a,-1} + H_{r,-1} \quad (4.32)$$

Using $\Pi - H_r + H_{r,-1} = \Pi - \Delta H_r = C_r$ and grouping the terms respectively with C_r and with $H_{a,-1}$, we get:

$$H_a = \left(1 - \frac{\kappa}{1 - (1 - \kappa)\alpha_{yde,a}}\right) C_r - \frac{\kappa(1 - \alpha_{yde,a})\alpha_{c,a}}{1 - (1 - \kappa)\alpha_{yde,a}} + \left(1 - \frac{\kappa\alpha_{v,a}}{1 - (1 - \kappa)\alpha_{yde,a}}\right) H_{a,-1} \quad (4.33)$$

Some last few transformations lead to the second part of system of difference equations. After expanding C_r with $C_r = \alpha_{c,r} + \alpha_{yde,r}(\Pi - \alpha_{c,r}) + \alpha_{v,r}H_{r,-1}$, factorising everything by $\beta = 1/(1 - (1 - \kappa)\alpha_{yde,a})$ and sorting the terms by constant, factor of $H_{r,-1}$, and factor of $H_{a,-1}$, we obtain:

$$H_a = \beta \left[(1 - \kappa)(1 - \alpha_{yde,a})[\alpha_{c,r} + \alpha_{yde,r}(\Pi - \alpha_{c,r})] - \kappa(1 - \alpha_{yde,a})\alpha_{c,a} \right. \\ \left. + \alpha_{v,r}(1 - \kappa)(1 - \alpha_{yde,a})H_{r,-1} + [1 - (1 - \kappa)\alpha_{yde,a} - \kappa\alpha_{v,a}]H_{a,-1} \right] \quad (4.34)$$

The second step of this stability analysis consists in writing the system composed of Eqs. (4.34) and (4.29) in the following recursive algebraic form:

$$z_t = A \cdot z_{t-1} + c \quad (4.35)$$

where z_t is the 2×1 vector composed of the main variables H_a and H_r at time t , A is a 2×2 matrix with constant coefficients and c is a 2×1 vector with constant components.²² Since the vector c has no importance for the study of stability, we

²²During the transition phase when active people reduce their consumption of “cars”, the first element in the c vector is not constant since it depends on the constrained consumption $\alpha_{c,a}$. Thus our analysis may not hold for this period of time ; we cannot guarantee that the model

do not show its components and concentrate on the A matrix:

$$A = \begin{pmatrix} \beta[1 - (1 - \kappa)\alpha_{yde,a} - \kappa\alpha_{v,a}] & \beta\alpha_{v,r}(1 - \kappa)(1 - \alpha_{yde,a}) \\ 0 & 1 - \alpha_{v,r} \end{pmatrix} \quad (4.36)$$

A necessary condition for stability is that the absolute value of the determinant of A be strictly smaller than one ($|detA| < 1$ which we call condition 1). If this is verified, then having a positive discriminant Δ is sufficient to ensure stability for the system ($\Delta = (trA)^2 + 4detA \geq 0$ which we call condition 2).²³

Let us check condition 1. Because of the bottom left zero in A , $detA$ is simply equal to the product of the terms of the first diagonal and can be written in the following form:

$$detA = [1 - \alpha_{yde,a} + \kappa(\alpha_{yde,a} - \alpha_{v,a})](1 - \alpha_{v,r})/[1 - (1 - \kappa)\alpha_{yde,a}] \quad (4.37)$$

Having $\alpha_{yde,a} > \alpha_{v,a}$ and κ , $\alpha_{yde,a}$ and $\alpha_{v,r}$ smaller than one are sufficient conditions to guarantee that $detA$ is positive. Consequently, condition 1 is reduced to $detA < 1$ and can be written as follows:

$$(1 - \alpha_{v,r})[1 - \alpha_{yde,a} + \kappa(\alpha_{yde,a} - \alpha_{v,a})] < 1 - (1 - \kappa)\alpha_{yde,a} \quad (4.38)$$

which after simplification boils down to:

$$\kappa\alpha_{v,a} + \alpha_{v,r}[1 - \alpha_{yde,a} + \kappa(\alpha_{yde,a} - \alpha_{v,a})] > 0 \quad (4.39)$$

Under the same assumptions as stated above to guarantee that the determinant is positive, this condition, and hence condition 1, is verified.

We shall now check condition 2. This is straightforward since we have shown that the determinant of A is positive: condition 2 is verified.

To sum up, under the assumptions that i) the income share κ of the government and the propensities to consume $\alpha_{yde,a}$ and $\alpha_{v,r}$ are smaller than unity, and ii) for active households, the propensity to consume out of effective disposable income is greater than the propensity to consume out of wealth, our model is stable.

remains stable. However, stability is ensured before and after the transition in consumption patterns, and the simulations presented in section 4.3 tend to show that in practice the model does remain stable during the transition despite the sustained perturbation. Indeed the trajectories do not start diverging and rather converge smoothly toward a new stationary state.

²³The determinant of a 2×2 matrix is equal to the difference between the product of the elements on the primary diagonal (top left to bottom right) and the product of the elements on the secondary diagonal (bottom left to top right). The trace tr is equal to the sum of all elements on the primary diagonal.

Bibliography of the current chapter

- De Paula, Luiz Fernando, Barbara Fritz, and Daniela M Prates (2017). “Keynes at the Periphery: Currency Hierarchy and Challenges for Economic Policy in Emerging Economies”. In: *Journal of Post Keynesian Economics* 40.2, pp. 183–202.
- Godley, Wynne and Marc Lavoie (2012). *Monetary Economics: An Integrated Approach to Credit, Money, Income, Production and Wealth*. Basingstoke: Palgrave Macmillan.
- Røpke, Inge (2016). “Complementary System Perspectives in Ecological Macroeconomics—the Example of Transition Investments during the Crisis”. In: *Ecological economics* 121, pp. 237–245.
- Vogel, Jefim et al. (2021). “Socio-Economic Conditions for Satisfying Human Needs at Low Energy Use: An International Analysis of Social Provisioning”. In: *Global Environmental Change* 69, p. 102287.

Conclusion

“For reasons that I don’t understand well, and that I understand less the more evidence I look at, degrowthers want to make us turn around and start walking back down the path, away from higher prosperity. Their vision seems to be one of a centrally planned, ever-deepening recession throughout the rich world for the sake of the environment. Thanks to Covid-19, we have an inkling of how this would feel. A “degrowth recession” wouldn’t have the virus’ deaths and sickness, and it wouldn’t require us to practice social distancing. But it would have all the economic contractions’ job losses, business closures, mortgage defaults, and other hardships and uncertainties. And it would have them without end—after all, growth can’t be allowed to restart. Corporate and government revenue would decrease permanently, and therefore so would innovation and R&D.”

Andrew McAfee, 2020²⁴

“Obstinate ignorance is usually a manifestation of underlying political motives.”

Michal Kalecki, 1943

²⁴“Andrew McAfee is the Co-Founder and Co-Director of the Initiative on the Digital Economy and a Principal Research Scientist at the MIT Sloan School of Management. He studies how digital technologies are changing the world. [...] McAfee and Brynjolfsson are the only people named to both the Thinkers50 list of the world’s top management thinkers and the Politico 50 group of people transforming American politics. [...] McAfee was educated at MIT and Harvard.” Sources: <https://www.wired.com/story/opinion-why-degrowth-is-the-worst-idea-on-the-planet/> and <https://andrewmcafee.org/about>

Outline of the current chapter

Summary of the results	164
Stability, profits, poverty, employment: degrowth is not economic collapse	164
Drivers of transition and contradictory dynamics	166
The reduction of inequalities: a condition, a driver, and a possible outcome of a degrowth transition	167
Financing pensions, social protection in general, and free public services in a degrowing economy is possible	168
On the importance of disaggregation and the use of the correct indicators	170
Implications for (post-Keynesian) macroeconomics	170
The question of economic objectives	171
Changing the perspective on public finances	173
Consumption, saving, investment	177
A comment on the practice of research	178
A side remark on the Covid-19 crisis and degrowth	179
Avenues for further research	180

The conclusion of this dissertation is organised as follows. To begin with, I summarise the principal results obtained. Then, I explain a couple of implications for (post-Keynesian) macroeconomics that my analyses suggest. Finally, after making a side remark on the Covid-19 crisis and degrowth, I propose some possible avenues for future research.

Summary of the results

Stability, profits, poverty, employment: degrowth is not economic collapse

As I explained in the introduction of this dissertation and as exemplified by some of the quotes I put forward in the epigraphs, negative ideas and opinions about degrowth are widespread. Supposedly, a degrowing economy could only be unstable and lead to economic collapse, bankruptcies, unemployment and poverty. The results of my investigations tend to show the contrary.

First, I showed that disaccumulation (i.e. a negative rate of growth) is simultaneously compatible with macroeconomic stability and with a positive net profit rate. I achieved this result within the framework of neo-Kaleckian models of growth

and distribution. In chapter 1, I built a model that provides more 'space' for stable equilibria with negative rates of accumulation, compared to the neo-Kaleckian models used so far to study zero growth.

In this model, equilibria with negative rates of growth can exist, and they can be stable. The stability condition for such equilibria is neither fundamentally different nor more stringent than for equilibria with positive growth. The reactivity of investment to a change in the rate of utilisation needs to be lower than the responsiveness of aggregate saving. Stability in the production sphere (as opposed to financial stability) means that a shock to the economy would gradually resorb, instead of getting amplified over time. As a result, even though production is on a decreasing path during the degrowth transition, a negative shock would not push the economy into a never-ending spiral of recession and depression with a larger and larger negative rate of growth. Symmetrically, a positive shock would not permanently deviate the economy from its degrowth path.

Just as for situations of positive growth, stability is possible but is not guaranteed in all circumstances: the stability condition can be violated at times. This can be the case if businesses, for some reason, become over-reactive to the rate of capacity utilisation when making their investment decisions. However, the theoretical analysis of chapter 1 demonstrated that profits net of depreciation can remain positive in an equilibrium with negative growth. Moreover, the numerical simulations conducted in chapter 2 corroborated this result. We showed that, for a sector that produces environmentally harmful goods and experiences a decline in sales, profitability is only temporarily impacted. The rate of profit can remain positive throughout the transition and return to its initial level once the sales of the sector stop decreasing and stabilise (at a lower level than initially). This means that in our simulations this sector remains viable despite its downscale. Again, these results do not guarantee that no crisis would ever happen, but they tend to indicate that businesses would not necessarily fall into panic or go bankrupt for lack of profitability, and that phasing out for some sectors can possibly take place smoothly rather than abruptly.²⁵

Second, the fact that economic production decreases during a degrowth transition does not mean that this goes on indefinitely. It may be evident to many readers but, given the misunderstandings or the attacks that degrowth ideas are subjected to, it goes better with saying. More importantly, chapter 1 described and illustrated two mechanisms that can lead to the stabilisation of output at the end of the transition. The first mechanism operates as follows. Once the pioneers and then the bulk of the population have adopted ecological modes of living, when

²⁵For the most dramatically polluting sectors, fast phase-out may be necessary and may involve negative profit rates and capital losses. These are specific issues which I did not deal with in this work.

the laggards are finally changing as well, autonomous consumption expenditures stop decreasing. The rate of change of this component of aggregate demand tends towards zero. This brings the rate of growth of the economy as a whole from negative values up to zero. The second mechanism is linked to the public deficit. If public spending is kept constant while government income decreases along with economic activity, the size of the public deficit relative to the size of the economy increases mechanically during the disaccumulation period. This has expansionary effects and can gradually bring the rate of growth of the economy from negative values up to zero, in parallel with the first mechanism.

Third, I dealt with the issues of unemployment and loss of income for workers. In chapter 3 I explored and analysed a phenomenon that runs contrary to the ideas of degrowth but is supposedly positive for economic activity: the fast obsolescence of goods. This allowed me to show how a narrow focus on employment and income without a broader perspective on the purpose of economic activity and of consumption can be misleading or even absurd. Indeed, accelerating the pace of obsolescence can trigger more replacement purchases, boost aggregate production, and thus increase total hours worked. Economists generally consider this to be a positive outcome, because of its effect on employment. In fact, more time is dedicated to the production of soon-to-be obsolete goods while, as I demonstrated, the production of other goods diminishes. Overall this means that more time is devoted to production and less to non-commodified activities. According to my results, only a minority of people benefit from this situation. The rest simply work more and have access to less non-obsolescence-related goods. I argued that such a society is dysfunctional and that it should reverse the dynamics.

By going beyond the simple reasoning according to which less production is equivalent to less employment and income and therefore more poverty, I was able to reach some different conclusions. Crucially, the reductions in production I considered do not come from exogenous, external shocks. Instead, they are the result of lower constrained consumption expenditures. And when these expenditures get reduced, traditional measures of income (and therefore traditional measures of poverty based on disposable income) are misleading. Thanks to working time reduction schemes, the decrease in total hours worked can be spread among workers instead of increasing unemployment (this is modelled explicitly in chapter 2 and implicitly in the other chapters). As a result, the disposable income of workers is reduced. However, since households need to spend less on constrained consumption, the income that is effectively available to them is maintained and can even increase slightly. Hence, *in such a situation where constrained consumption is curbed*, working time reduction is a policy that can prevent unemployment *without impacting the effective purchasing power of workers negatively*.

In a nutshell, a degrowth transition can be macroeconomically stable and does

not necessarily lead to economic collapse. It can increase the income that is effectively disposable for households, which is the opposite of a spike in poverty. It can also free up time that can be spent outside paid work, which has the potential to improve the average quality of life.

Drivers of transition and contradictory dynamics

Throughout this thesis, I envisioned reductions in consumption, especially of constrained expenditures. The drivers of these reductions are multiple and of different kinds. I explained that these reductions can take place “passively” (i.e. without any specific decisions from households), when the durability of goods is improved and obsolescence is slowed down. They can also come from voluntary shifts towards simple lifestyles and sufficiency-oriented consumption patterns, and these shifts can be enabled and made more accessible to a majority of people through green public investments, for instance in transportation infrastructures. Chapter 2 illustrated the complementarities between capability and willingness to change consumption patterns, and how combining these two elements can lead to augmented positive environmental effects. I also pointed out that, since voluntary simplicity might not be adopted by everyone, some coercive measures might be needed in order to prevent and counter the dynamics of ever more opulent lifestyles of the wealthy.

In terms of macroeconomic dynamics, I found that the Sraffian supermultiplier effect can be a useful mechanism for the understanding of the transition. It shows how the evolution of autonomous components of demand can drive the economy as a whole and determine its rate of growth in the medium run. Simplicity can thus be ‘supermultiplied’, in the sense that by translating into lower levels of autonomous consumption expenditures, adopting simple and ecological lifestyles has the potential to ‘degrow’ the economy as a whole and bring it to a sustainable composition and size. However, the ecological benefits of a ‘voluntary simplicity supermultiplier effect’ can be offset by the environmental consequences of a ‘destructive opulence supermultiplier effect’. Reducing high compensations and taxing capital could help prevent the wealthy from pursuing ever-more non-sustainable modes of living and thus prevent them from making the economy become oversized again and from offsetting the ecological improvements achieved by a majority of people. In addition to this, by making the wealthy less well-off, such measures have the potential not only to slow down or stop the trend in ever-more destructive lifestyles but also to force the ecological footprint of the rich downwards. In this sense, reducing the income and the wealth of the most well-off is also a driver of a degrowth transition.

The reduction of inequalities: a condition, a driver, and a possible outcome of a degrowth transition

The question of inequalities is central in this thesis. It is present in each of the chapters, in different manners. As argued in chapter 1 and recalled in the above paragraphs, reducing income and wealth for those at the top of the distribution is both a condition and a potential driver of a degrowth transition.

In addition to this, a decrease in inequalities is also a possible outcome of the transition. The key channel for this is the reduction of constrained expenditures. The lower the income of a household, the higher the share of these expenditures in their total consumption. Therefore, any decrease in constrained expenditures is a relatively more significant improvement for the less well-off households compared to the wealthy (for instance, unemployed compared to employed workers as illustrated in chapter 2, or workers compared to capitalists as exposed in chapter 3). As a result, inequality, measured in terms of income available for discretionary consumption, is reduced.

In chapter 3, I explore these dynamics in more detail. I illustrate the issue of constrained expenditures with the case of the replacement and renewal of obsolete goods. I show that an acceleration of obsolescence can increase inequalities between workers and capitalists in absolute terms, even when households from both classes are forced to replace their goods faster (not just workers). This means that effective disposable income and wealth can simultaneously decrease for workers and increase for capitalists, not just decrease for both categories in different proportions. Conversely, slowing down obsolescence can result in an absolute decrease in inequalities. The situation of capitalists would worsen and that of workers would improve. Inequalities would be reduced from both ends of the distribution at the same time. It is possible to extend this analysis to other types of constrained expenditures. In fact, if households could reduce their energy bills thanks to better insulated homes or if they were not obliged to own a car in order to commute to work and to conduct most of their daily activities, inequalities could be reduced further.

To sum up, this thesis provides arguments that contradict the idea that degrowth would lead to increasing inequalities. However, it did not cover all the potential mechanisms through which inequalities may increase or decrease. Opponents of the degrowth alternative often claim, without explaining always why, that inequalities would necessarily rise. In addition to the demonstrations this thesis provides, we shall recall that the distribution of income and wealth is a political matter. It is not entirely and naturally determined by economic processes. Even if some dynamics of degrowth had a tendency to cause a more unfair distribution of income and wealth, political decisions could always change the situation through both redistribution schemes and regulations relative to primary income distribution.

Financing pensions, social protection in general, and free public services in a degrowing economy is possible

In the fourth chapter of this dissertation, I tackled what I consider to be one of the most crucial issues in the macroeconomics of degrowth: the possibility of maintaining the financing of social protection and public services even as production and consumption decline. Several of the quotes I placed in the epigraphs show that fierce opponents of degrowth claim that such financing is impossible. They use this alleged impossibility to rule out the degrowth alternative, pure and simple. I think their argument is very effective in scaring people (including many economists) away from the ideas of degrowth. Yet, the argument is flawed and can be debunked relatively easily.

I designed a macroeconomic model and conducted numerical simulations in order to check the validity of my reasoning, to show that numbers add up consistently and to illustrate it graphically. However, my argument is ultimately fairly simple. What the opponents of degrowth like Emmanuel Macron are saying (recall the epigraphs of chapter 4²⁶) is that in order to finance social protection or public services, society needs to produce a lot. A lot of anything, polluting or supposedly clean stuff, but basically, produce a lot.

To this, I oppose that as long as an economy is able to *physically* produce a certain quantity Q of goods and services that are needed or desired by the members of society, there is no need to produce more goods or other goods in order to *finance* the acquisition of the quantity Q of goods and services. The demonstration is perhaps clearer with the categories of chapter 4 and the example of pensions. The reasoning presented by Emmanuel Macron can be summarised as follows: for pensioners to be able to afford the “carrots” they need and the “karaoke” they desire, society must produce enough “cars”. What I essentially showed is that, as long as the “carrots” and the “karaoke” can be physically produced, allowing pensioners to access their share of these goods is a question of distribution, not a question of having enough “cars”.

Obviously, the results of chapter 4 are richer and more elaborate than the above description. I dealt specifically with pay-as-you-go pension schemes. I showed that an increase in the contribution rates for pensions simultaneously satisfies ecological,

²⁶The quote from Emmanuel Macron is taken from a speech he gave in 2022 during the campaign for the presidential election. He used the same line of arguments to dismiss degrowth ideas already in 2018, in front of the “Convention citoyenne pour le climat”, when this assembly of citizens selected at random presented the results of their work and proposals to reduce carbon emissions in France. In my opinion, the fact that such high-ranking people (Presidents, Prime Ministers and Ministers) take the trouble to criticise the ideas of degrowth, which are still far from widespread in society, shows that these people are actually quite afraid of these ideas and believe they are strongly against their interests.

economic and social criteria. More precisely, it allows for (i) taming the rebound effect that can otherwise appear when constrained consumption is reduced - hence, the positive ecological outcome of the initial reduction in consumption is preserved, (ii) a full financing of the pension scheme, where the level of pensions is maintained without relying on public deficits, and the debt-to-GDP ratio is stabilised, and (iii) a satisfying outcome in terms of intergenerational fairness. Although active people can benefit from the situation, retired people are not worse-off. Pensioners can improve their situation as well if they accept to adopt the lifestyles that imply lower levels of constrained consumption.

I shall stress again one of the crucial results of chapter 4. During a degrowth transition in which the constrained consumption of active households is reduced, active people are able to increase both their discretionary consumption and their stock of savings. They can do so despite both their loss of primary income (that comes from the reduction in the production of goods related to constrained consumption) and the increase in their contribution rate. This can appear illogical or impossible to the reader. Yet the numbers add up and the simulations show and illustrate these results.

Moreover, I was able to extend these results. I showed that it is possible to guarantee the full financing of a much broader range of social protection and any kind of public services, for instance education, health, sanitation, safety, justice, and administration.

On the importance of disaggregation and the use of the correct indicators

I would like to finish this summary of results by stressing how important it is to conduct analyses at disaggregated levels and to use the correct indicators to evaluate outcomes. If all types and purposes of consumption are merged into a single variable, then escaping the “more is better, less is worse” trap is difficult. Aggregate analysis can also lead to absurd reasoning such as the one recalled above regarding the financing of pensions, whereas disaggregation can help disprove such a dubious argument.

Moreover, when needs evolve, using measures based on effective disposable income is crucial in order to avoid drawing wrong conclusions. For instance, in chapter 3, I found that traditional measures based on after-tax disposable income show no impact of the pace of obsolescence on inequality. Looking at effective disposable income is necessary to reveal the hidden link. Traditional measures are in fact even more misleading since they indicate that the economic situation of workers improves in absolute terms when obsolescence accelerates, whereas, in reality, the opposite holds. Thus, using the indicator of effective disposable income

is important to evaluate correctly *both* the relative *and* absolute evolutions in the situations of different categories of population.

Implications for (post-Keynesian) macroeconomics

In the introduction of this dissertation, I explained briefly why the numerous and intertwined ecological challenges humanity is facing imply that the paradigm of economic growth should be questioned. Moreover, these challenges suggest that there should be a major reduction in the overall size of economies that have the highest per capita production and consumption levels. Accepting this analysis is not an easy step to take, especially for (macro)economists who were educated within a growth paradigm, have devoted significant parts of their research career and efforts in understanding how to foster economic growth, and who have been teaching these ideas to generations of students in economics. Despite these strong barriers, an increasing number of economists are either steering or completely changing their research focus in order to take ecological constraints into account, and are breaking free from the obsession with economic growth.

Abandoning the growth objective necessarily has far-reaching consequences for both the theories and the practice of macroeconomics, and for macroeconomic policies. In the following paragraphs, I suggest several elements of macroeconomic theory, policy and practice that, in my opinion, need to be reconsidered when ecological constraints are seriously taken into account. Some of these suggestions are intended for macroeconomics in general, and some are more closely related to post-Keynesian macroeconomics. They are certainly not meant to be provocations or patronising statements. Instead, they should be understood as friendly proposals of ‘food for thought’ for a community within which I feel I belong.

The question of economic objectives

When the Gross Domestic Product was invented, it was meant to be one economic indicator among others, and GDP growth was not an objective in itself. However, economic growth quickly transformed from a means of achieving high employment and living standards into the main goal any society or country should strive for. The Organisation for Economic Cooperation and Development played a key role in this process (Schmelzer 2016). In economics, almost all schools of thought consider growth as desirable, if not an objective in itself. This holds with post-Keynesian economics, for which most of the thinkers have been promoting economic growth for decades. For instance, economic growth was one of the four objectives put forward by Kaldor (1971) in his famous and influential article about ‘conflicts in national economic objectives’, together with low unemployment, low inflation, and

balanced trade. Kaldor's framework became widely used by economists to evaluate and compare the performance of various economies at different periods of time (e.g. Fitoussi and Saraceno 2013), and was also used by several governments as a compass in order to guide economic policies (Teixeira et al. 2014).

In my view, the long-standing research agenda on wage-led growth and profit-led growth illustrates how important economic growth has been for post-Keynesians. Without going as far as saying that this whole field of research was useless, in my opinion it has occupied too much space and mobilised too much resources, for too long a period of time, in relation to its theoretical and economic policy contributions. Crucially, it participated in reinforcing and in perpetuating the importance of economic growth as a policy objective. It is a pity, since I guess boosting growth was meant to be an argument that could convince policy makers to increase wages, while the real objective of the researchers was to foster an increase in the wage share.

I think economists should stop using positive effects on growth as an argument to back a policy measure. First, because it conveys the idea that growth is an intrinsically positive dynamic. Second, because in my view hiding the real objective that lies behind a policy measure is not a good strategy. For instance, if one thinks women and men should have equal pay for equal work, this should be an objective in itself rather than being associated with the idea that it could boost economic growth. Indeed, on the one hand, one would still push for it even if it had negative effects on growth. On the other hand, one would not support any policy measure on the ground that it can boost growth (lowering wages in a profit-led economy, for example).

To be fair, economic growth is not always stated as a primary objective. Lavoie (2014a, p. 581) summarises the economic policy objectives put forward by post-Keynesians with five main points: a fair distribution of income and wealth, financial stability, full employment of labour, a sustainable rate of inflation, and external balance. The absence of economic growth from this list is remarkable. However, although growth is not stated as a final objective, increases in employment remain mostly tied to increases in economic activity. Indeed, Lavoie examines the means that are put forward in order to achieve the five objectives. He finds that, in general, post-Keynesians propose that full employment should be achieved by using the concept of functional finance and the levers of fiscal policy and public investment spending in relation to social, health or environmental issues (Lavoie 2014a, p. 582). More recently, job guarantee schemes were suggested as powerful means to directly increase employment (Tcherneva 2020). Overall, all these policy tools remain tied to increases in economic production. They are meant to increase employment either indirectly by boosting aggregate demand and production, or directly, in the case of public employment, but this case also involves extra economic production as the

direct result of the activity of publicly employed people.

To get out of this impasse, there are not many options. The solution cannot be anything but a reduction in the number of working hours per person. In this regard, it is useful to recall the following thoughts of Keynes:

The full employment policy by means of investment is only one particular application of an intellectual theorem. You can produce the result just as well by consuming more or working less. Personally I regard the investment policy as first aid. In U.S. it almost certainly will not do the trick. Less work is the ultimate solution (a 35 hour week in U.S. would do the trick now [1943]). How you mix up the three ingredients of a cure is a matter of taste and experience, i.e. of morals and knowledge. (Keynes 1945, p. 384)

Taking seriously into account the repeated warnings of ecological economists and other scientists about ecological issues and the need to slow down economic growth, Lavoie's 'taste' seems to be on the side of 'less work':

The challenge is to reconcile the full-employment objective of post-Keynesians with the no-growth objective of environmentalists. This challenge must also incorporate a constraint: the fact that most members of our consumer society wish to improve their living standards or their relative living standards. Voluntary simplicity may not be so easy to generalize (Kallis et al., 2012). To square the circle, there are not many solutions: income inequalities need to be reduced, the world population has to decrease or at least to stop growing, and consumers have to be convinced that more leisure is preferable to the accumulation of material goods. This will also require the legislated reduction of working hours. (Lavoie 2014a, pp. 580–1)

I wish more economists were taking a similar stance (with caution on the issue of world population) in the reconciliation between full-employment and environmental objectives. Among the three ingredients of the cure mentioned by Keynes, we will certainly need a dose of investment. However, as argued in chapter 2, this will only be a temporary phase. We are now living in a period that corresponds to 'the long term', from Keynes' point of view (the people of his generation are dead). In my opinion, our common 'knowledge' of the ecological situation and our 'morals' with respect to the consequences of ecological degradation shall command that we design and push for a cure from which the 'consuming more' ingredient is absent (on average, in rich countries). 'Working less' should form a good part of the mix. However, there is a fourth ingredient that Keynes did not mention: reducing productivity. At his time it was probably contraindicated. Nowadays,

it deserves attention. I explain why in a further section dedicated to avenues for further research.

Changing the perspective on public finances

Austerity? Perhaps, but on the rich!

In several chapters of this dissertation, I put forward ideas and fiscal policies that could be understood as budgetary austerity. Aiming at balanced budgets or reducing the level of the public debt to GDP ratio sound like objectives of neoliberal governments, which post-Keynesian economists have been opposing for decades. However, the reasons behind this kind of stance regarding public finances are very much different from those generally advanced by proponents of austerity. As a result, the tools that are most appropriate for managing the budget also differ strongly from those implemented by neoliberal governments. The consequences are totally different, especially in terms of inequalities.

The main reason for aiming at balanced budgets is that *in a stationary state*, if the deficit is positive, then the ratios of public debt to GDP and private assets to GDP increase forever. This was the case in the scenario of chapter 4 in which households had a satiety consumption behaviour and the government was not trying to close down the deficit. According to Hein and Jimenez (2022), ever-increasing ratios of financial assets and financial liabilities to GDP represent a risk of systemic financial instability. The idea that in a stationary state the public budget should be balanced was already put forward in Sawyer (2017) and in Cahen-Fourot and Lavoie (2016).

The second reason why one could wish to reduce public deficits in relation to ecological concerns is that a positive deficit is a source of increasing resources in the hands of the private sector (households for instance). This can produce rebound effects during an ecological transition, and therefore a rebound in negative environmental impacts. On the contrary, reducing the deficit when it appears can help tame and avoid rebound effects.

Let me now explain why, from an ecological macroeconomics perspective, some fiscal measures that have the effect of lowering the level of public debt (or its ratio to GDP) may be welcome. I shall make clear that reducing the public debt should not be an objective in itself. However, it can be a strategic move in order to prevent conservative political parties from accusing a government that organises and facilitates degrowth of being financially irresponsible and of putting future generations in danger of debt crises or other 'terrible' consequences. In addition, reducing a so-called 'excessive' public debt can in fact be the result and the counterpart of measures aimed at reducing what I would term 'excessive' private wealth. Each person can have her/his opinion on what exactly is an 'excessive' level.

Yet, I see at least three reasons for curbing high levels of private wealth. First, one can be in favour of a reduction in inequality on ethical, philosophical, or moral grounds. Second, withdrawing resources from the wealthy can have the positive effect of reducing their power to destroy and pollute the environment. It can force them to abandon some of the most anti-ecological parts of their lifestyles. However, the effectiveness of taxes on people who would remain relatively well-off can be limited, and regulations should also be put in place. Third, people generally want to imitate the behaviour and the way of life of the richest persons, or of the people who belong to the classes above them. Given the high environmental footprint of the rich, inequality can induce higher ecological damage (Berthe and Elie 2015). Therefore, reducing inequality can yield positive environmental outcomes.

It stems from these considerations that the levers used to reduce budget deficits and public debts should preferably be increases in taxes rather than cuts in public spending. Such tax increases should be designed in a progressive and equitable manner. Nevertheless, taxing the rich may not provide sufficient resources to compensate for all possible drops in government revenues. Therefore, I should stress an important result of chapters 3 and 4. In both chapters, I analysed the consequences of reductions in constrained consumption expenditures. When simulating increases in contribution and tax rates as a response to arising public deficits, I examined cases in which the increase in contribution or in tax rates were beared partially or even entirely by active workers (as opposed to retired workers and to capitalists). I showed that, even in these cases, it is possible to increase contribution and tax rates without reducing the purchasing power effectively available to the workers. They could maintain their consumption of “carrots”, and could even enjoy more “karaoke” or goods that are not subject to obsolescence. Recall that the rates increase in order to compensate for the reductions in the tax base. Overall, the volume of contributions or taxes remains constant. This allows to keep financing public expenditures that can remain constant while the economy as a whole is degrowing. Thus, I demonstrated that a decrease in GDP and therefore a reduction of the tax base does not necessarily require cuts in public spending.

A warning about reductions in public expenditures

Besides considering cuts in public spending as a necessity in order to balance budgets in a degrowing economy, such reductions have also been suggested as possible drivers for reducing the size of an economy overall. It may be clear to the reader that decreasing public expenditures is not quite in line with the degrowth paradigm. However, in the past, authors designing degrowth scenarios have used it as one of the main exogenous drivers of transition. For instance, P. Victor (2012, p. 212) designed a ‘degrowth’ scenario in which the volume of

public expenditures is divided by four within 30 years. This was one of the first works, if not the first ever, that explored macroeconomic scenarios featuring strong reductions in production and consumption. This could explain why the scenario was somewhat unrealistic. The author acknowledged that further work was needed in order to include more dimensions, like distributional and social considerations (P. Victor 2012, p. 211). Yet, a decade later, Sers applied the same logic within his own integrated assessment model. In a scenario called ‘degrowth’, the drivers of transition are an exogenous decrease in government expenditures and household energy demand at an annual rate of -2% for 30 years (Sers 2021, p. 222). As a result, total government expenditures are roughly halved, in absolute terms, between 2020 and 2050. Moreover, in the eyes of a post-Keynesian economist who told me about it after reading Sers’ dissertation, this idea did not seem to be shocking and could even be a source of inspiration. Consequently, I think waiving a few warnings may not prove so pointless.

First, the content of public spending is generally very different from the composition of private expenditures. From a pure aggregate macroeconomic perspective, an exogenous reduction in G or in C may have similar effects.²⁷ Yet, it should be made very clear that the carbon content and the social usefulness of G and of some parts of C are totally different. Behind the abstract G variable there is health, education, justice, administration etc., while behind C one can find for example cars, oil, expenditures for the replacement of obsolete goods, and luxury consumption. From a socio-ecological perspective, there is no doubt which of the two variables should go down.

Second, it may appear more reasonable to some people to consider that G can be acted upon exogenously by a single entity (the government), rather than envisioning an exogenous decrease in C that would come from the decisions of millions of different households. However, in my opinion, it is more reasonable to think that consumption could decrease (even though it is far from being the trend we can currently observe) than to imagine that public spending could be reduced substantially. Cutting on G cannot really be anything but an antisocial programme. After 40 years of implementation of neoliberal reforms in most “developed” countries, one can doubt whether there remains any “inefficient” expenditures. Even these reforms have not really succeeded in reducing public spending in absolute terms. At most, they have slightly reduced the public expenditure to national income ratio G/Y , by containing the increase in G while Y was growing. Lowering G in absolute and significant terms would be a social disaster and could probably only be applied in an even more authoritarian system than the current authoritarian

²⁷For instance, in a paper on demographic growth and Harrodian instability, Allain (2019) shows that the dynamics of the supermultiplier effect (which I used in chapter 1 with autonomous consumption) can work with autonomous changes in government expenditures.

neoliberal capitalism. This could call into question the remnants of democracy still in force in most rich countries. But the degrowth paradigm is very attached to democracy. I believe that large-scale changes will only take place if the majority of the population in one or more countries is convinced of the need for these changes. Through the ballot box and/or social movements if the electoral processes are too blocked, this majority will then be able to take decisions that will legitimately force the recalcitrant in order to achieve ambitious social and environmental objectives. I believe the dynamics and drivers of transition that I envisioned, analysed and illustrated in my thesis reflect this point of view. The reasons presented above explain why I did not consider a reduction in public spending as a possible driver of a degrowth transition.

Let me finish this section with a remark on why public expenditures might nevertheless decrease during a degrowth transition. Indeed, if ultimately GDP is to be reduced by 30% to 50%, one can imagine that the volume of public spending could end up slightly below its initial level. However, reductions in G shall appear *ex-post*, rather than *ex-ante*. They would be the result of the decline in the needs for them. For instance, if retirees benefit from the reduction in constrained expenditures like active households do, one can imagine that the level of pensions could be slightly reduced without hurting retired households. In addition, degrowth implies many profound transformations whose result could be a decrease in the need for health spending. These include a reduction in air pollution, less poisoned food, more physical activity (especially for transportation purposes), less stress at work and less other occupational diseases, and a decrease in mental illnesses and chronic diseases, the prevalence of which is currently high in the so-called “developed” countries.

Consumption, saving, investment

In the following paragraphs, I lay down some reflections on the dynamics of consumption, saving and investment. They are not fully developed and are intended to be discussed with the readers of this dissertation. They might as well not be as original as I think they are, and have been already explored.

Could saving possibly drive investment?

When it comes to the dynamics of saving and investment, post-Keynesian theory generally stresses that causality ranges from investment to saving, not the other way around. However, the mechanism of the Sraffian supermultiplier effect challenges this view. Indeed, investment becomes fully induced in the long run, and the dynamics of accumulation or disaccumulation are driven by the rate of change of non-capacity creating autonomous expenditures (consumption or government

spending). Said differently, since saving is just the other side of the consumption coin, the dynamics of saving ultimately drive the rate of investment. Does this mean that (neo)classical theory and the loanable funds view are valid, in the long run? I think not. The channel through which investment adjusts to saving is not a channel of availability of funds. Instead, investment adjusts according to the level of economic activity (capacity utilisation), which is itself determined to a great extent by consumption.

Arguments for the centrality of consumption over investment in the dynamics of a degrowth transition

The adjustment mechanism presented just above is well-known among post-Keynesian economists. The originality is to present it as a reversal of the causality between the dynamics of investment and saving. The link between these reflections and the topic of this thesis is the following. It seems to me that post-Keynesians have a tendency to consider that the dynamics of investment are somehow more determinant than consumption for the evolution of an economy. Indeed, investment is necessarily central in the dynamics of positive growth. Moreover, investment can be thought of as partly autonomous, and can potentially induce consumption. From what I observed when discussing about the dynamics of degrowth with some post-Keynesian authors, I feel that they keep this view of investment as a necessarily central element. However, I think that investment cannot really be the main driver of the downscaling of an economy. I am not contradicting the logic explained in chapter 2: investments that lead to reductions in consumption can indeed drive the transition. But ultimately, it is the dynamics of consumption that determine the size of an economy, especially in the direction of downscaling.

In the context of growth, consumption can be limited by the budget constraint of households and therefore investment, financed through credit, can be considered less constrained than consumption and thus deemed a more important driver of economic dynamics (in fact, consumption can also be boosted by credit). However, in a context of degrowth, the budget of households cannot be a *binding* constraint that would prevent them from consuming *less*. If a household decides not to buy something despite all the incentives it receives for buying the good, then there is nothing to prevent it from doing so. Investment and the size of the economy will then adjust. On the other hand, trying to bring the rate of investment down in order to obtain a reduction in the size of an economy would be pointless if households are not ready to cut consumption. Indeed, capacity utilisation would gradually come closer to one and investment would start increasing again.

To conclude, I believe reducing consumption is the ultimate driver of the downscale of an economy. As a result, consumption should replace investment as the focus of attention of macroeconomists, when they turn around and leave the

growth target behind.

A comment on the practice of research

In this section, I argued that reorienting economic objectives away from growth has important theoretical implications. It has also practical requirements. For researchers who have specialised in very specific branches of economics, reorienting their research agenda necessitates that they keep an open mind, be ready to change their habits and their mindset, and in some cases accept that their past or current research questions were not or are not anymore as pertinent as they thought they were. This is a difficult task. A professor of economics once told me about a discussion with a very prominent post-Keynesian economist. When asked why he would not stop his quest for higher growth, the person answered that recognising that growth is not anymore the right solution to social and economic problems would be tantamount to admitting that a significant part of the research he produced during his career is, in the end, not useful, and he was not ready for that. Nobody knows to what extent this kind of reasoning is present in the minds of economists, but surely it is one of the barriers to the necessary evolutions in macroeconomics.

With a definitely larger sample than the anecdote above (i.e. a questionnaire answered by 13 prominent post-Keynesian economists, all of which were members of journal editorial boards), Mearman (2005) explored the reasons why post-Keynesians had neglected environmental issues in their work until then. The four main reasons were the following (in decreasing order) : ‘focus on fighting neoclassicism’, ‘post-Keynesians have had little to say on the environment’, ‘focus on growth’, and ‘post-Keynesians do not value natural resources’ (Mearman 2005, p. 133). The second element caught my attention the most. Indeed, post-Keynesians often claim that they are more open than orthodox economists to disciplines outside economics. An extensive literature in ecological economics has already pointed out many links between socio-economic systems and the environment. Discovering it, choosing one or a couple of topics, and looking for researchers from other disciplines to collaborate with could be a way of putting one’s principles into practice! Moreover, in my opinion, producing research in economics that does not ignore environmental problems is possible without being at the same time an environmental scientist, and without valuing natural resources. The recent field of ecological macroeconomics provides many examples, and I believe my own work is also a demonstration of it. There is a lot more to be done. In the next section, I suggest a few avenues for future research. I hope they can be inspiring to some post-Keynesian and other heterodox colleagues!

A side remark on the Covid-19 crisis and degrowth

Since the outbreak of the Covid-19 crisis, many opponents to degrowth ideas have emphasised the fact that stopping a significant part of economic activity during the lockdowns did not give satisfactory environmental results (less than 10% decrease in CO_2 emissions). They have used this argument to claim that solving the environmental crisis through degrowth would be similar to having regular lockdowns and would therefore have catastrophic economic, social and psychological consequences. I am unsure whether such dubious reasoning deserves a proper debunking or not, and if it does, this dissertation is probably not the right place to do it. Thus, I will simply quote Timothée Parrique: “Equating a pandemic with degrowth just because it causes a drop in GDP is as absurd as describing an amputation as a diet just because it causes weight loss.”²⁸

However, the Covid-19 pandemic forced people and governments to take a step back and rethink their priorities, at least temporarily. This echoed some of the ideas associated with the degrowth paradigm. I can see two channels.

First, for those who were able to stop working or to work remotely during the lockdowns, and perhaps also for those forced to put their safety at risk by continuing to work, the crisis was a shock that made everyone reflect on their own lives. Some realised what was going wrong with their lives, some found what they were missing. For some people, the pandemic was the trigger they needed in order to radically change their lifestyles, especially to quit their life in large cities and to go and settle in the countryside or in small cities. This opportunity was not available to everyone though, since such a dramatic change required financial means and the possibility to either work remotely after the crisis or to easily find another job. This echoes chapter 2, in which we argued that systemic change is necessary in order to enable changes in lifestyles. Note that living in small cities or in the countryside is *potentially* more ecological, it is not a guarantee for lower consumption levels and lower ecological footprints.

Second, the gravity and intensity of the Covid-19 crisis forced most governments to decide, for virtually all sectors, which economic activities would be considered ‘essential’ and which would be considered ‘non-essential’. Degrowth advocates had argued for a long time that we, as societies, should have collective discussions about which activities we consider as important for well-being and which activities are nefast. The case of the advertising industry is a good topic for such collective deliberation. It brings benefits for the businesses who can afford it, but it does so at the expense of other businesses, and overall it has negative environmental consequences. In my opinion, during the pandemic, thinking about the relative

²⁸His full post on the differences between degrowth and recession can be found here (in French): <https://timotheeparrique.com/decroissance-et-recession/>

importance of various sectors of activity was a good thing. Decisions were made mostly on public health and economic grounds. Obviously, the split between 'essential' and 'non-essential' activities should be very different in an ecological transition that spreads over several years than in an urgent reaction to a pandemic. The discussions need to continue, with social and environmental criteria. They should happen through democratic processes, not as top-down authoritarian decisions as it was the case in several countries during the pandemic, especially in France.

Avenues for further research

The macroeconomics of degrowth is a nascent field of research. There is ample room for future work ; not simply for improving and extending existing research, there are also important questions and areas that remain largely unexplored.

I dealt with the financing of pensions in a degrowing economy, in the case of pay-as-you-go systems. Yet, in many countries the pension system is mostly organised as a private system in which individuals put their savings in pension funds. These funds then buy assets, get returns from them, take a fee and give the rest back to the pensioners. The financial viability of this pattern requires pension funds to be able to extract a sufficient amount of profits from the economy. The results obtained in this dissertation show that, although the rate of profit of firms can be more or less maintained during a degrowth transition, the total *volume* of profits shrinks. Hence, the financial viability of private pension funds might be at risk. Perhaps the solution is to competely overhaul the system and switch to a pay-as-you-go system. In this case, the transition between the two needs to be well thought out.

Another avenue for future research is to better understand how a shift from the consumer society to a culture of sufficiency could occur. Drastic limitations to advertising are probably necessary. From the very beginnings of the consumer society era, Galbraith (1958) argued that advertising is not anecdotal to the current capitalist system. It is an essential part of it, which is necessary to ensure that the gigantic capacities of production that the system generates are used at a sufficient rate so as to give sufficiently high rates of return. Limiting advertising would have significant consequences on relative prices and perhaps on the sharing of added-value. This calls for a macroeconomic analysis that would take several elements into account, including i) a reduction in propensity to consume, ii) a reduction in eagerness to invest, iii) a cost reduction for the firms that used to advertise their products, iv) a loss of activity for the advertisement industry and related sectors. For this, multisectoral input-output models may prove useful.

A degrowth transition also involves a shift of consumption patterns away from high quantities of low-quality products towards lower quantities of high-

quality goods (understood as longer lifetime, repairable goods). Importantly, such a consumption shift could induce changes in the structure of production that might have consequences for inequality, and thus back to consumption and the environment. Indeed the characteristics of firms specialised in ‘quality’ would differ fundamentally from those of firms specialised in ‘quantity’: decentralised, smaller and less automated production units require less energy, but more labour. There may also be less wage dispersion across employees, and possibly a higher price of goods. To me, integrating these socio-economic changes together in a consistent manner looks like a promising area of research.

In this thesis, I argued that disaggregation is important in order to establish elaborate reasoning. I distinguished between different categories of households and goods, and between public and multiple private sectors. Yet, each of these categories remained homogenous. In reality, there are strong heterogeneities between households in terms of wages, skills, estate, family situation, geographic situation, and therefore important differences in terms of needs and capacity to change consumption patterns. There are also important differences between firms in terms of size, profitability, production processes and technologies, composition of assets and liabilities... The economic policies I mentioned and analysed (related to taxes, to working time...) should therefore be thought out more thoroughly, calibrated and adapted to different situations. This could be an avenue for more empirical and applied research.

The question of working time needs to be investigated further. Indeed, working time reduction is one of the main policies put forward by degrowth scholars and activists. It is present throughout my work. Yet, some factors would tend to reduce productivity during a degrowth transition, and thus push in the direction of an increase in working time. I see three main factors of reduction in productivity:

- producing and consuming locally implies that production units become smaller. Therefore, diseconomies of scale are to be expected.
- changes in the organisation of work would reduce or remove hierarchical and shareholder pressure to boost the productivity of workers. The intensity and pace of work, as well as stress at work would decrease. The quality of work would improve, and illnesses and accidents would be reduced.
- highly mechanised, motorised, and automated production processes enable high levels of productivity, but are highly capital and energy intensive. Artisanal types of production may require less machines, therefore less materials and energy, but imply lower levels of productivity.²⁹ If, for environmental reasons, we shift from the former to the latter, productivity would decrease.

²⁹Semieniuk (2016) shows that between 1950 and 2012, increases in labour productivity have been strongly correlated with the increasing energy intensity of production techniques.

Anticipating the net effect on working time of the reduction in aggregate production and these factors of reduction in productivity is a great challenge. It would probably be necessary to combine very detailed degrowth scenarios like those found in Briens (2015) with studies that address the three factors above. Yet, with these factors in mind, it seems to me that both the prediction of Keynes (1930) in *Economic possibilities for our grandchildren* (15 hour working week) and the simulation results of P. Victor (2012) for his degrowth scenario (−75% reduction in working time, which represents less than 10 hours per week) are quite unrealistic. Further research on this topic is needed.

Finally, research on the macroeconomics of degrowth should address open-economy issues. I see three reasons why the international competitiveness of a degrowing economy may deteriorate. First, a reduction in productivity may entail an increase in prices. Second, an increase in the minimum wage may be desirable for reasons of social justice and to reduce inequality, and may be necessary to scale up the transition from low to high-quality goods mentioned above (low wages should increase in order for more/all people to be able to afford the high-quality goods). Third, environmental regulations may incur additional costs to firms.

Of course, in the degrowth paradigm, economies are not supposed to participate in the race for international competitiveness. Instead, economies would become less interconnected globally, international trade would dwindle, and international competitiveness would not be such a big concern anymore. However, during the transition towards more local production and consumption, if exports shrink faster (due to the loss of competitiveness) than imports are reduced (through less and more local consumption), issues related to the balance of payment may arise. The value of the domestic currency may fall, which could cause imported inflation and capital flight. In order to prevent such kinds of economic crises, regulations on international trade and capital movements may be necessary. This comes in strong opposition to *both* the dominant free trade paradigm *and* the views, widely shared within the degrowth community, that nation-states should not have as much power as they do today or even disappear,³⁰ and that borders should not exist.

From my point of view, there are reasons why states and governments might still be needed. For example, the following actions might be more easy to organise and implement with the capacities of a state than without: conducting large investments to decarbonise and enable large-scale lifestyle changes, setting and enforcing social and environmental norms and rules, implementing income and tax policies to generalise virtuous practices and prevent recalcitrants from harming.

Moreover, for the reasons I explained above regarding balance of payment and

³⁰This topic is the subject of great debates within the degrowth community, especially between anarchist tendencies and eco-socialist or Marxist tendencies.

currency issues, border regulations and protections might be necessary.³¹ All the more so if we think that the transitions of degrowth will first appear in certain places while on the rest of the planet wild capitalism will continue to rage.

To sum up the few paragraphs above, I think there are many avenues for research on the open-economy aspects of the macroeconomics of degrowth.

Finally, before concluding this dissertation, I would like to digress a little bit on the strategy for change, in terms of international relations. There is a very widespread idea spoken of in society, and even between researchers, especially at academic conferences. This idea is as follows: because environmental issues and especially climate change are global problems, they can only be dealt with on a global scale, through international cooperation. I think that this reasoning is incorrect. And I think that history proves that it is so. 35 years after the Brundtland report, 30 years after the Rio Summit, and after 27 COPs, even if the commitments made in 2015 were respected, global warming would reach +3.2°C in 2100.³² Moreover, the current trajectory of global emissions takes us even beyond. Any country can decide at any time to withdraw from international agreements, without having to bear any significant consequences.

Faced with the recognition of the failure of international cooperation, I think it is time to consider unilateral decision-making for change. This does not mean we have to give up all hope and all cooperative efforts, which must continue meanwhile. But we no longer have time to wait for the wishes of all countries to align and converge before finally acting. A degrowth transition must therefore be experienced where people are most ready. And it is by example, by showing that this is possible and that it does not lead to disaster (economic, social, diplomatic or security), that more and more people elsewhere in the world will be convinced of the need and the possibility of change, and will in turn decide to embark on this path without having to wait for the perfect alignment of the stars to obtain effective international cooperation.

I wish to conclude this dissertation by quoting a statement that Marc Lavoie made at the end of his 2014 book “Post-Keynesian economics - New foundations”. This statement, together with many others of Marc’s (especially with respect to the need for more work on ecological issues within post-Keynesian economics), inspired me and motivated me to start a PhD (ideally, with Marc as a supervisor!). Here are Marc’s words:

Many of these policy proposals seem to be out of line with what is

³¹Moreover, it is easier to promote local production, exchange and energy consumption processes in an economy whose main territory is already delimited, on which rules favouring local processes can be applied, than in an economy open to globalisation and governed by economic liberalism.

³²<https://www.climateinteractive.org/ci-topics/climate-energy/scoreboard/scoreboard-science-and-data/>

acceptable now to decision-makers. Such an agenda needs, however, to be put forward, detailed and debated, even if it appears to be unfashionable. The ideas defended by Hayek and Friedman were also out of fashion in the 1940s and in the 1950s: still they continued pressing for them. It is the social duty of post-Keynesian economists to keep promoting alternative views on economic theory and economic policy, whatever the likelihood of their adoption, because these views are based on real-world economics, and not on some speculative idealization of markets. (Lavoie 2014a, pp. 583–4)

I think that the exact same reasoning holds for degrowth ideas. Only the second half of the statement needs to be adapted: “It is the social duty of degrowth researchers and activists to keep promoting alternative views on social and environmental justice and sustainability, whatever the likelihood of their adoption, because these views are based on real-world biophysics and social and political ecological economics, and not on some speculative idealisation of technological progress.”

I hope that the ideas supported in this thesis will quickly spread so that from 2023 onwards, the questions asked in the social and economic sciences test for the French Baccalaureate look less like a justification for Emmanuel Macron’s 2022 presidential election platform.

Bibliography of the current chapter

- Allain, Olivier (2019). “Demographic Growth, Harrodian (in) Stability and the Supermultiplier”. In: *Cambridge Journal of Economics* 43.1, pp. 85–106.
- Berthe, Alexandre and Luc Elie (2015). “Mechanisms Explaining the Impact of Economic Inequality on Environmental Deterioration”. In: *Ecological economics* 116, pp. 191–200.
- Briens, François (2015). “La Décroissance Au Prisme de La Modélisation Prospective: Exploration Macroéconomique d’une Alternative Paradigmatique”. Ecole Nationale Supérieure des Mines de Paris.
- Cahen-Fourot, Louison and Marc Lavoie (June 2016). “Ecological Monetary Economics: A Post-Keynesian Critique”. In: *Ecological Economics* 126, pp. 163–168.
- Fitoussi, Jean-Paul and Francesco Saraceno (2013). “European Economic Governance: The Berlin–Washington Consensus”. In: *Cambridge Journal of Economics* 37.3, pp. 479–496.
- Galbraith, John Kenneth (1958). *The Affluent Society*. Boston: Houghton Mifflin Company. 368 pp.

- Hein, Eckhard and Valeria Jimenez (2022). “The Macroeconomic Implications of Zero Growth: A Post-Keynesian Approach”. In: *European Journal of Economics and Economic Policies: Intervention* 19.1, pp. 41–60.
- Kaldor, Nicholas (1971). “Conflicts in National Economic Objectives”. In: *The Economic Journal* 81.321, pp. 1–16.
- Keynes, John Maynard (1930). “Economic Possibilities for Our Grandchildren”. In: *Essays in Persuasion*. New York: Norton.
- (1945). *Collected Writings*. D. Moggridge (ed.) Vol. 27. Cambridge.
- Lavoie, Marc (2014a). *Post-Keynesian Economics: New Foundations*. Cheltenham: Edward Elgar.
- Mearman, Andrew (2005). “Why Have Post-Keynesians Had (Relatively) Little to Say on the Economics of the Environment?” In: *International Journal of Environment, Workplace and Employment* 1.2, pp. 131–154.
- Sawyer, Malcolm (2017). “Some Simple Macroeconomic Remarks on Slower Economic Growth”. In: *Evolutionary Political Economy in Action: A Cyprus Symposium*. Hardy Hanappi, Savvas Katsikides and Manuel Scholz-Wäckerle. Routledge Advances in Heterodox Economics. Abingdon and New York: Routledge, pp. 41–55.
- Schmelzer, Matthias (2016). *The Hegemony of Growth: The OECD and the Making of the Economic Growth Paradigm*. Cambridge University Press.
- Semieniuk, Gregor (2016). “Fossil Energy in Economic Growth: A Study of the Energy Direction of Technical Change, 1950-2012.” In: *SPRU Working Paper Series*.
- Sers, Martin Robert (2021). “Towards an Ecological Macroeconomics: Linking Energy and Climate in a Stock-Flow Consistent Input-Output Framework”. York University (Canada).
- Tcherneva, Pavlina R (2020). *The Case for a Job Guarantee*. John Wiley & Sons.
- Teixeira, Joanio Rodolpho et al. (2014). “Index of Macroeconomic Performance for a Subset of Countries: A Kaldorian Analysis from the Magic Square Approach Focusing on Brazilian Economy in the Period 1997-2012”. In: *Panoeconomicus* 61.5, pp. 527–542.
- Victor, Peter (2012). “Growth, Degrowth and Climate Change: A Scenario Analysis”. In: *Ecological Economics* 84, pp. 206–212.

Bibliography

- Alcott, Blake (Jan. 2013). “Should Degrowth Embrace the Job Guarantee?” In: *Journal of Cleaner Production* 38, pp. 56–60.
- Allain, Olivier (2015). “Tackling the Instability of Growth: A Kaleckian-Harrodian Model with an Autonomous Expenditure Component”. In: *Cambridge Journal of Economics* 39.5, pp. 1351–1371.
- (2019). “Demographic Growth, Harrodian (in) Stability and the Supermultiplier”. In: *Cambridge Journal of Economics* 43.1, pp. 85–106.
- Althouse, Jeffrey (2022). “Ecological Macroeconomics for a Shared Planet: Towards a Global Political Ecology of Money, Finance and Production”. Université Sorbonne Paris Nord.
- Althouse, Jeffrey, Giulio Guarini, and Jose Gabriel Porcile (2020). “Ecological Macroeconomics in the Open Economy: Sustainability, Unequal Exchange and Policy Coordination in a Center-Periphery Model”. In: *Ecological Economics* 172, p. 106628.
- Bakker, Conny et al. (2014). “Products That Go Round: Exploring Product Life Extension through Design”. In: *Journal of cleaner Production* 69, pp. 10–16.
- Bank, World (2012). *Inclusive Green Growth: The Pathway to Sustainable Development*. World Bank Publications.
- Barker, Terry, Athanasios Dagoumas, and Jonathan Rubin (Nov. 2009a). “The Macroeconomic Rebound Effect and the World Economy”. In: *Energy Efficiency* 2.4, pp. 411–427.
- (2009b). “The Macroeconomic Rebound Effect and the World Economy”. In: *Energy Efficiency* 2.4, pp. 411–427.
- Barros, Beatriz and Richard Wilk (2021). “The Outsized Carbon Footprints of the Super-Rich”. In: *Sustainability: Science, Practice and Policy* 17.1, pp. 316–322.
- Batini, Nicoletta et al. (2022). “Building Back Better: How Big Are Green Spending Multipliers?” In: *Ecological Economics* 193.107305.
- Berg, Matthew, Brian Hartley, and Oliver Richters (Jan. 20, 2015). “A Stock-Flow Consistent Input–Output Model with Applications to Energy Price Shocks, Interest Rates, and Heat Emissions”. In: *New Journal of Physics* 17.1, p. 015011.

- Berr, Eric (2009). “Le Développement Soutenable Dans Une Perspective Post Keynésienne: Retour Aux Sources de l’écodéveloppement”. In: *Économie appliquée* 62.3, pp. 221–244.
- Berthe, Alexandre and Luc Elie (2015). “Mechanisms Explaining the Impact of Economic Inequality on Environmental Deterioration”. In: *Ecological economics* 116, pp. 191–200.
- Blecker, Robert A (2002). “Distribution, Demand and Growth in Neo-Kaleckian Macro-Models”. In: *The Economics of Demand-Led Growth*. Ed. by M. Setterfield. Cheltenham, UK and New York, US: Edward Elgar, pp. 129–152.
- Blonigen, Bruce A, Christopher R Knittel, and Anson Soderbery (2017). “Keeping It Fresh: Strategic Product Redesigns and Welfare”. In: *International Journal of Industrial Organization* 53, pp. 170–214.
- Brand, Ulrich and Markus Wissen (2013). “Crisis and Continuity of Capitalist Society-Nature Relationships: The Imperial Mode of Living and the Limits to Environmental Governance”. In: *Review of International Political Economy* 20.4, pp. 687–711.
- (2021). *The Imperial Mode of Living: Everyday Life and the Ecological Crisis of Capitalism*. Verso Books.
- Briens, François (2015). “La Décroissance Au Prisme de La Modélisation Prospective: Exploration Macroéconomique d’une Alternative Paradigmatique”. Ecole Nationale Supérieure des Mines de Paris.
- Buehler, Ralph et al. (2017). “Reducing Car Dependence in the Heart of Europe: Lessons from Germany, Austria, and Switzerland”. In: *Transport Reviews* 37.1, pp. 4–28.
- Bulow, Jeremy (1986). “An Economic Theory of Planned Obsolescence”. In: *The Quarterly Journal of Economics* 101.4, pp. 729–749.
- Butt, Talib E et al. (2015). “Obsolescence Types and the Built Environment—Definitions and Implications”. In: *International Journal of Environment and Sustainable Development* 14.1, pp. 20–39.
- Cahen-Fourot, Louison, Emanuele Campiglio, et al. (2020). “Looking for the Inverted Pyramid: An Application Using Input-Output Networks”. In: *Ecological Economics* 169, p. 106554.
- Cahen-Fourot, Louison and Marc Lavoie (June 2016). “Ecological Monetary Economics: A Post-Keynesian Critique”. In: *Ecological Economics* 126, pp. 163–168.
- Chancel, Lucas (2021). *Climate Change and the Global Inequality of Carbon Emissions*.
- Cieplinski, André, Simone D’Alessandro, and Pietro Guarnieri (2021). “Environmental Impacts of Productivity-Led Working Time Reduction”. In: *Ecological Economics* 179, p. 106822.

- Cosme, Inês, Rui Santos, and Daniel W O'Neill (2017). "Assessing the Degrowth Discourse: A Review and Analysis of Academic Degrowth Policy Proposals". In: *Journal of Cleaner Production* 149, pp. 321–334.
- Coux, Quentin (2021). "Models as 'Analytical Similes': On Nicholas Georgescu-Roegen's Contribution to Economic Methodology". In: *Journal of Economic Methodology* 28.2, pp. 165–185.
- D'Alisa, Giacomo, Federico Demaria, and Giorgos Kallis (2014). *Degrowth: A Vocabulary for a New Era*. Routledge.
- D'Alessandro, Simone et al. (2020). "Feasible Alternatives to Green Growth". In: *Nature Sustainability* 3.4, pp. 329–335.
- Dafermos, Yannis and Maria Nikolaidi (2019). "Fiscal Policy and Ecological Sustainability: A Post-Keynesian Perspective". In: *Frontiers of Heterodox Macroeconomics*. Ed. by Philip Arestis and Malcolm Sawyer. Basingstoke, UK and New York, US: Palgrave Macmillan, pp. 277–322. ISBN: 978-3-030-23929-9.
- (2021). "How Can Green Differentiated Capital Requirements Affect Climate Risks? A Dynamic Macroeconomic Analysis". In: *Journal of Financial Stability* 54, p. 100871.
- Dafermos, Yannis, Maria Nikolaidi, and Giorgos Galanis (Jan. 2017a). "A Stock-Flow-Fund Ecological Macroeconomic Model". In: *Ecological Economics* 131, pp. 191–207.
- (2017b). "A Stock-Flow-Fund Ecological Macroeconomic Model". In: *Ecological Economics* 131, pp. 191–207.
- (Oct. 2018). "Climate Change, Financial Stability and Monetary Policy". In: *Ecological Economics* 152, pp. 219–234.
- Dafermos, Yannis and Christos Papatheodorou (2015). "Linking Functional with Personal Income Distribution: A Stock-Flow Consistent Approach". In: *International Review of Applied Economics* 29.6, pp. 787–815.
- De Paula, Luiz Fernando, Barbara Fritz, and Daniela M Prates (2017). "Keynes at the Periphery: Currency Hierarchy and Challenges for Economic Policy in Emerging Economies". In: *Journal of Post Keynesian Economics* 40.2, pp. 183–202.
- Dittmer, Kristofer (Sept. 2013). "Local Currencies for Purposive Degrowth? A Quality Check of Some Proposals for Changing Money-as-Usual". In: *Journal of Cleaner Production* 54, pp. 3–13.
- (2014). "Alternatives to Money-as-usual in Ecological Economics: A Study of Local Currencies and 100 Percent Reserve Banking". ICTA & UAB.
- (Jan. 2015). "100 Percent Reserve Banking: A Critical Review of Green Perspectives". In: *Ecological Economics* 109, pp. 9–16.

- Dunz, Nepomuk, Asjad Naqvi, and Irene Monasterolo (2021). “Climate Sentiments, Transition Risk, and Financial Stability in a Stock-Flow Consistent Model”. In: *Journal of Financial Stability* 54, p. 100872.
- Dutt, Amitava Krishna (1984). “Stagnation, Income Distribution and Monopoly Power”. In: *Cambridge Journal of Economics* 8, pp. 25–40.
- (1990). *Growth, Distribution and Uneven Development*. CUP.
- Ederer, Stefan and Miriam Rehm (2020a). “Making Sense of Piketty’s ‘Fundamental Laws’ in a Post-Keynesian Framework: The Transitional Dynamics of Wealth Inequality”. In: *Review of Keynesian Economics* 8.2, pp. 195–219.
- (2020b). “Will Wealth Become More Concentrated in Europe? Evidence from a Calibrated Post-Keynesian Model”. In: *Cambridge Journal of Economics* 44.1, pp. 55–72.
- Fanning, Andrew L et al. (2022). “The Social Shortfall and Ecological Overshoot of Nations”. In: *Nature Sustainability* 5.1, pp. 26–36.
- Fitoussi, Jean-Paul and Francesco Saraceno (2013). “European Economic Governance: The Berlin–Washington Consensus”. In: *Cambridge Journal of Economics* 37.3, pp. 479–496.
- Fontana, Giuseppe and Malcolm Sawyer (Sept. 2013). “Post-Keynesian and Kaleckian Thoughts on Ecological Macroeconomics”. In: *European Journal of Economics and Economic Policies: Intervention* 10.2, pp. 256–267.
- (Jan. 2016). “Towards Post-Keynesian Ecological Macroeconomics”. In: *Ecological Economics* 121, pp. 186–195.
- Franke, Reiner (2016). “A Simple Approach to Overcome the Problems Arising from the Keynesian Stability Condition”. In: *European Journal of Economics and Economic Policies: Intervention* 14.1, pp. 48–69.
- Gadrey, Jean and Florence Jany-Catrice (2010). *Les Nouveaux Indicateurs de Richesse*. La découverte.
- Galbraith, John Kenneth (1958). *The Affluent Society*. Boston: Houghton Mifflin Company. 368 pp.
- George, Henry (1879). *Progress and Poverty: An Enquiry into the Cause of Industrial Depressions, and of Increase of Want with Increase of Wealth. The Remedy*. San Francisco: Author’s edition.
- Georgescu-Roegen, Nicolas (1971). *The Entropy Law and the Economic Process*. Harvard University Press.
- Godin, Antoine (2012). “Guaranteed Green Jobs: Sustainable Full Employment”. In: *Levy Economics Institute of Bard College Working Paper* 722.
- Godley, Wynne and Marc Lavoie (2012). *Monetary Economics: An Integrated Approach to Credit, Money, Income, Production and Wealth*. Basingstoke: Palgrave Macmillan.

- Guiltinan, Joseph (2009). “Creative Destruction and Destructive Creations: Environmental Ethics and Planned Obsolescence”. In: *Journal of business ethics* 89.1, pp. 19–28.
- Haberl, Helmut et al. (2020). “A Systematic Review of the Evidence on Decoupling of GDP, Resource Use and GHG Emissions, Part II: Synthesizing the Insights”. In: *Environmental Research Letters* 15.6, p. 065003.
- Hafner, Sarah et al. (2020). “Emergence of New Economics Energy Transition Models: A Review”. In: *Ecological Economics* 177, p. 106779.
- Hardt, Lukas and Daniel W. O’Neill (Apr. 2017). “Ecological Macroeconomic Models: Assessing Current Developments”. In: *Ecological Economics* 134, pp. 198–211.
- Harris, Jonathan M. (2008). *Ecological Macroeconomics: Consumption, Investment, and Climate Change*.
- Hein, Eckhard (2014). *Distribution and Growth after Keynes: A Post-Keynesian Guide*. Cheltenham, UK: Edward Elgar Publishing. 551 pp.
- Hein, Eckhard and Valeria Jimenez (2022). “The Macroeconomic Implications of Zero Growth: A Post-Keynesian Approach”. In: *European Journal of Economics and Economic Policies: Intervention* 19.1, pp. 41–60.
- Hein, Eckhard and Lena Vogel (2008). “Distribution and Growth Reconsidered: Empirical Results for Six OECD Countries”. In: *Cambridge journal of Economics* 32.3, pp. 479–511.
- Hickel, Jason (2020). *Less Is More: How Degrowth Will Save the World*. Random House.
- Hickel, Jason and Giorgos Kallis (Apr. 17, 2019). “Is Green Growth Possible?” In: *New Political Economy*, pp. 1–18.
- Holt, Richard PF, Steven Pressman, and Clive L Spash (2009). *Post Keynesian and Ecological Economics: Confronting Environmental Issues*. Cheltenham: Edward Elgar.
- Hubacek, Klaus et al. (2021). “Evidence of Decoupling Consumption-Based CO2 Emissions from Economic Growth”. In: *Advances in Applied Energy* 4, p. 100074.
- Huisman, J. et al. (2012). “The Dutch WEEE Flows”. In: *United Nations University, ISP–SCYCLE, Bonn, Germany*.
- Hundy, BB (1976). “The Durability of Automobiles”. In: *Resources Policy* 2.3, pp. 179–192.
- IPCC (2018). *Global Warming of 1.5 C: Summary for Policy Makers*. Intergovernmental Panel on Climate Change.
- IPCC, Working Group III (2022). *Climate Change 2022 - Mitigation of Climate Change - Summary for Policymakers*.

- Jackson, Tim (2005). “Live Better by Consuming Less?: Is There a “Double Dividend” in Sustainable Consumption?” In: *Journal of Industrial Ecology* 9.1-2, pp. 19–36.
- (2009a). *Prosperity without Growth: Economics for a Finite Planet*. Routledge.
- (2009b). *Prosperity without Growth: Economics for a Finite Planet*. London: Earthscan. 264 pp. ISBN: 978-1-84407-894-3.
- (2019). “The Post-Growth Challenge: Secular Stagnation, Inequality and the Limits to Growth”. In: *Ecological Economics* 156, pp. 236–246.
- Jackson, Tim and Peter Victor (June 2011). “Productivity and Work in the ‘Green Economy’”. In: *Environmental Innovation and Societal Transitions* 1.1, pp. 101–108.
- Jackson, Tim and Peter A Victor (2020). “The Transition to a Sustainable Prosperity—a Stock-Flow-Consistent Ecological Macroeconomic Model for Canada”. In: *Ecological Economics* 177, p. 106787.
- (Dec. 2015). “Does Credit Create a Growth Imperative? A Quasi-Stationary Economy with Interest-Bearing Debt”. In: *Ecological Economics* 120, pp. 32–48.
- (Jan. 2016). “Does Slow Growth Lead to Rising Inequality? Some Theoretical Reflections and Numerical Simulations”. In: *Ecological Economics* 121, pp. 206–219.
- (2019). “Low-Grow SFC: A Stock-Flow-Consistent Model Ecological Macroeconomic Model for Canada”. In: *CUSP Working Paper* 16.
- Kaldor, Nicholas (1955). “Alternative Theories of Distribution”. In: *The review of economic studies* 23.2, pp. 83–100.
- (1971). “Conflicts in National Economic Objectives”. In: *The Economic Journal* 81.321, pp. 1–16.
- Kalecki, Michal (1971). *Selected Essays on the Dynamics of the Capitalist Economy 1933-1970*. CUP Archive.
- Kallis, Giorgos (Mar. 2011). “In Defence of Degrowth”. In: *Ecological Economics* 70.5, pp. 873–880.
- (2018). *Degrowth. The Economy - Key Ideas*. Newcastle upon Tyne: Agenda.
- Kallis, Giorgos et al. (2018). “Research on Degrowth”. In: *Annual Review of Environment and Resources* 43, pp. 291–316.
- Keynes, John Maynard (1930). “Economic Possibilities for Our Grandchildren”. In: *Essays in Persuasion*. New York: Norton.
- (1945). *Collected Writings*. D. Moggridge (ed.) Vol. 27. Cambridge.
- Kronenberg, Tobias (2010). “Finding Common Ground between Ecological Economics and Post-Keynesian Economics”. In: *Ecological economics* 69.7, pp. 1488–1494.

- Kurz, Rudi (2015). “Quality, Obsolescence and Unsustainable Innovation”. In: *Review of Contemporary Business, Entrepreneurship and Economic Issues* 28.2, pp. 511–522.
- Lange, Steffen (2016). “Macroeconomics Without Growth - Sustainable Economies in Neoclassical, Post-keynesian and Marxian Theories”. PhD thesis. University of Hamburg. 549 pp.
- Latouche, Serge (2016). *Les Précurseurs de La Décroissance: Une Anthologie*. Le passager clandestin.
- Lavoie, Marc (1992). *Foundations of Post-Keynesian Economic Analysis*. Cheltenham: Edward Elgar Publishing.
- (2006). “Do Heterodox Theories Have Anything in Common? A Post-Keynesian Point of View”. In: *European Journal of Economics and Economic Policies: Intervention* 3.1, pp. 87–112.
- (2014a). *Post-Keynesian Economics: New Foundations*. Cheltenham: Edward Elgar.
- (2014b). *Post-Keynesian Economics: New Foundations*. Cheltenham, UK and New York, US: Edward Elgar.
- (Feb. 2016). “Convergence Towards the Normal Rate of Capacity Utilization in Neo-Kaleckian Models: The Role of Non-Capacity Creating Autonomous Expenditures”. In: *Metroeconomica* 67.1, pp. 172–201.
- Le Heron, Edwin and Tarik Mouakil (2008). “A Post-Keynesian Stock-Flow Consistent Model for Dynamic Analysis of Monetary Policy Shock on Banking Behaviour”. In: *Metroeconomica* 59.3, pp. 405–440.
- London, Bernard (1932). *Ending the Depression through Planned Obsolescence*.
- Magalhaes, Nelo (2021). “The Green Investment Paradigm: Another Headlong Rush”. In: *Ecological Economics* 190, p. 107209.
- Mastini, Riccardo, Giorgos Kallis, and Jason Hickel (2021). “A Green New Deal without Growth?” In: *Ecological Economics* 179, p. 106832.
- Mattioli, Giulio et al. (2020). “The Political Economy of Car Dependence: A Systems of Provision Approach”. In: *Energy Research & Social Science* 66, p. 101486.
- Mearman, Andrew (2005). “Why Have Post-Keynesians Had (Relatively) Little to Say on the Economics of the Environment?” In: *International Journal of Environment, Workplace and Employment* 1.2, pp. 131–154.
- Mercure, J-F et al. (2018). “Macroeconomic Impact of Stranded Fossil Fuel Assets”. In: *Nature Climate Change* 8.7, pp. 588–593.
- Monasterolo, Irene and Marco Raberto (2018). “The EIRIN Flow-of-Funds Behavioural Model of Green Fiscal Policies and Green Sovereign Bonds”. In: *Ecological Economics* 144 (July), pp. 228–243.

- Morgan, Mary (2008). “Models”. In: *The New Palgrave Dictionary of Economics*. Palgrave Macmillan. London, pp. 1–14.
- Mugion, Roberta Guglielmetti et al. (2018). “Does the Service Quality of Urban Public Transport Enhance Sustainable Mobility?” In: *Journal of Cleaner Production* 174, pp. 1566–1587.
- Naqvi, Asjad (2015). *Modeling Growth, Distribution, and the Environment in a Stock-Flow Consistent Framework*.
- Naqvi, Asjad and Engelbert Stockhammer (2018). “Directed Technological Change in a Post-Keynesian Ecological Macromodel”. In: *Ecological economics* 154, pp. 168–188.
- Nieto, Jaime et al. (2020). “An Ecological Macroeconomics Model: The Energy Transition in the EU”. In: *Energy Policy* 145, p. 111726.
- OECD (2011). *Towards Green Growth*. Paris: Organisation for Economic Cooperation and Development.
- Onaran, Ozlem and Thomas Obst (2016). “Wage-Led Growth in the EU15 Member-States: The Effects of Income Distribution on Growth, Investment, Trade Balance and Inflation”. In: *Cambridge Journal of Economics* 40.6, pp. 1517–1551.
- Otto, Ilona M et al. (2019). “Shift the Focus from the Super-Poor to the Super-Rich”. In: *Nature Climate Change* 9.2, pp. 82–84.
- Padalkina, Dina (2012). “The Macroeconomics of Degrowth - Can a Degrowth Strategy Be Stable”. In: Montreal International Conference on Degrowth in the Americas.
- Parrique, Timothée (2019). “The Political Economy of Degrowth”. Université Clermont Auvergne.
- Parrique, Timothée et al. (2019). *Decoupling Debunked - Evidence and Arguments against Green Growth as a Sole Strategy for Sustainability*. Brussels: European Environmental Bureau, p. 80.
- Pasinetti, Luigi L. (Oct. 1962). “Rate of Profit and Income Distribution in Relation to the Rate of Economic Growth”. In: *The Review of Economic Studies* 29.4, pp. 267–279.
- Perry, Keston (2021). “Financing a Global Green New Deal: Greening Capitalism or Taming Financialization for a New ‘Civilizing’ Multilateralism?” In: *Development and Change* 52.4, pp. 1022–1044.
- Pettifor, Ann (2019). *The Case for the Green New Deal*. London, UK and Brooklyn, US: Verso.
- Piketty, Thomas (2013). *Le Capital Au XXIe Siècle*. Paris: Editions du Seuil.
- Pirgmaier, Elke (2020). “Consumption Corridors, Capitalism and Social Change”. In: *Sustainability: Science, Practice and Policy* 16.1, pp. 274–285.

- Pollin, Robert (2019). “Advancing a Viable Global Climate Stabilization Project: Degrowth versus the Green New Deal”. In: *Review of Radical Political Economics* 51.2, pp. 311–319.
- (2020). “Green Recovery: Europe and the World”. In: *Intereconomics* 55.6, pp. 360–363.
- Pollin, Robert, H Garrett-Peltier, and S Chakraborty (2015). “An Egalitarian Clean Energy Investment Program for Spain”. In: *PERI Working Paper* 390.
- Pollin, Robert, Heidi Garrett-Peltier, et al. (2014). *Green Growth: A US Program for Controlling Climate Change and Expanding Job Opportunities*. Center for American Progress and PERI.
- Research & Degrowth (2010). “Degrowth Declaration of the Paris 2008 Conference”. In: *Journal of Cleaner Production* 18.6, pp. 523–524.
- Rezai, Armon and Sigrid Stagl (2016). “Ecological Macroeconomics: Introduction and Review”. In.
- Rezai, Armon, Lance Taylor, and Reinhard Mechler (Jan. 2013). “Ecological Macroeconomics: An Application to Climate Change”. In: *Ecological Economics* 85, pp. 69–76.
- Richters, Oliver and Andreas Siemoneit (June 2017). “Consistency and Stability Analysis of Models of a Monetary Growth Imperative”. In: *Ecological Economics* 136, pp. 114–125.
- Rockström, Johan et al. (2009). “Planetary Boundaries: Exploring the Safe Operating Space for Humanity”. In: *Ecology and society* 14.2.
- Romer, Paul (2016). “The Trouble with Macroeconomics”. The Commons Memorial Lecture of the Omicron Delta Epsilon Society/Stern School of Business.
- Røpke, Inge (2001). “The Environmental Impact of Changing Consumption Patterns: A Survey”. In: *International Journal of Environment and Pollution* 15.2, pp. 127–145.
- (2005). “Consumption in Ecological Economics”. In: *Online Encyclopaedia of Ecological Economics*.
- (2009). “Theories of Practice—New Inspiration for Ecological Economic Studies on Consumption”. In: *Ecological economics* 68.10, pp. 2490–2497.
- (2011). “Ecological Macroeconomics—Calling for a Shift from Consumption to Investment”. In: *Socio-Technical Transitions, Social Practices, and the New Economics: Meeting the Challenges of a Constrained World: SCORAI Workshop*.
- (2016). “Complementary System Perspectives in Ecological Macroeconomics—the Example of Transition Investments during the Crisis”. In: *Ecological economics* 121, pp. 237–245.
- Rosenbaum, Eckehard (May 19, 2015). “Zero Growth and Structural Change in a Post Keynesian Growth Model”. In: *Journal of Post Keynesian Economics* 37.4, pp. 623–647.

- Rowthorn, Bob (1981). “Demand, Real Wages and Economic Growth”. In: *Thames Papers in Political Economy*.
- Rudd, Jeremy B (2022). “Why Do We Think That Inflation Expectations Matter for Inflation?(And Should We?)” In: *Review of Keynesian Economics* 10.1, pp. 25–45.
- Sandberg, Maria (2021). “Sufficiency Transitions: A Review of Consumption Changes for Environmental Sustainability”. In: *Journal of Cleaner Production* 293, p. 126097.
- Satyro, Walter Cardoso et al. (2018). “Planned Obsolescence or Planned Resource Depletion? A Sustainable Approach”. In: *Journal of cleaner production* 195, pp. 744–752.
- Saunders, Harry D (2000). “A View from the Macro Side: Rebound, Backfire, and Khazzoom-Brookes”. In: *Energy Policy*, p. 11.
- Sawyer, Malcolm (2017). “Some Simple Macroeconomic Remarks on Slower Economic Growth”. In: *Evolutionary Political Economy in Action: A Cyprus Symposium*. Hardy Hanappi, Savvas Katsikides and Manuel Scholz-Wäckerle. Routledge Advances in Heterodox Economics. Abingdon and New York: Routledge, pp. 41–55.
- Schmelzer, Matthias (2016). *The Hegemony of Growth: The OECD and the Making of the Economic Growth Paradigm*. Cambridge University Press.
- Schmelzer, Matthias, Andrea Vetter, and Aaron Vansintjan (2022). *The Future Is Degrowth: A Guide to a World Beyond Capitalism*. Verso. 320 pp.
- Schneider, François, Giorgos Kallis, and Joan Martinez-Alier (2010). “Crisis or Opportunity? Economic Degrowth for Social Equity and Ecological Sustainability. Introduction to This Special Issue”. In: *Journal of cleaner production* 18.6, pp. 511–518.
- Schor, Juliet B. (2005). “Sustainable Consumption and Worktime Reduction”. In: *Journal of Industrial Ecology* 9.1-2, pp. 37–50.
- Semieniuk, Gregor (2016). “Fossil Energy in Economic Growth: A Study of the Energy Direction of Technical Change, 1950-2012.” In: *SPRU Working Paper Series*.
- Semieniuk, Gregor et al. (2021). *Stranded Fossil-Fuel Assets Translate into Major Losses for Investors in Advanced Economies*. UMass Working Paper, Forthcoming. Amherst, MA: University of Massachusetts . . .
- Serrano, Franklin (1995a). “Long Period Effective Demand and the Sraffian Super-multiplier”. In: *Contributions to Political Economy* 14.1, pp. 67–90.
- (1995b). “The Sraffian Supermultiplier”. Faculty of Economics and Politics, University of Cambridge.

- Serrano, Franklin and Fabio Freitas (2015). “Growth Rate and Level Effects, the Stability of the Adjustment of Capacity to Demand and the Sraffian Supermultiplier”. In: *Review of Political Economy* 27.3, pp. 258–281.
- Sers, Martin Robert (2021). “Towards an Ecological Macroeconomics: Linking Energy and Climate in a Stock-Flow Consistent Input-Output Framework”. York University (Canada).
- Skott, Peter and Ben Zipperer (2012). “An Empirical Evaluation of Three Post-Keynesian Models”. In: *European Journal of Economics and Economic Policies: Intervention* 9.2, pp. 277–308.
- Slade, Giles (2006). *Made to Break: Technology and Obsolescence in America*. Cambridge, Massachusetts: Harvard University Press.
- Sovacool, Benjamin K (2021). “Who Are the Victims of Low-Carbon Transitions? Towards a Political Ecology of Climate Change Mitigation”. In: *Energy Research and Social Science* 73, p. 101916.
- Stagl, Sigrid (2013). “Work in a Sustainable Economy”. In. — (Sept. 1, 2014). “Ecological Macroeconomics: Reflections on Labour Markets”. In: *European Journal of Economics and Economic Policies* 2, pp. 171–181.
- Steffen, Will et al. (2015). “Planetary Boundaries: Guiding Human Development on a Changing Planet”. In: *Science* 347.6223, p. 1259855.
- Stiglitz, Joseph E (2018). “Where Modern Macroeconomics Went Wrong”. In: *Oxford Review of Economic Policy* 34.1-2, pp. 70–106.
- Stratford, Beth (2020). “The Threat of Rent Extraction in a Resource-Constrained Future”. In: *Ecological Economics* 169, p. 106524.
- Svartzman, Romain, Dominique Dron, and Etienne Espagne (2019). “From Ecological Macroeconomics to a Theory of Endogenous Money for a Finite Planet”. In: *Ecological Economics* 162, pp. 108–120.
- Taylor, Lance, Armon Rezai, and Duncan K Foley (2016a). “An Integrated Approach to Climate Change, Income Distribution, Employment, and Economic Growth”. In: *Ecological Economics* 121, pp. 196–205.
- (2016b). “An Integrated Approach to Climate Change, Income Distribution, Employment, and Economic Growth”. In: *Ecological Economics* 121, pp. 196–205.
- Tcherneva, Pavlina R (2020). *The Case for a Job Guarantee*. John Wiley & Sons.
- Teixeira, Joanio Rodolpho et al. (2014). “Index of Macroeconomic Performance for a Subset of Countries: A Kaldorian Analysis from the Magic Square Approach Focusing on Brazilian Economy in the Period 1997-2012”. In: *Panoeconomicus* 61.5, pp. 527–542.
- Tordjman, Helene (2021). *La Croissance Verte Contre La Nature: Critique de l’ecologie Marchande*. Paris: La Decouverte.

- Treu, Nina, Matthias Schmelzer, and Corinna Burkhart (2020). *Degrowth in Movement (s): Exploring Pathways for Transformation*. John Hunt Publishing.
- Tukker, Arnold et al. (July 2008). “Fostering Change to Sustainable Consumption and Production: An Evidence Based View”. In: *Journal of Cleaner Production* 16.11, pp. 1218–1225.
- UNCTAD (2019). *Trade and Development Report 2019: Financing a Global Green New Deal*. Geneva: United Nations.
- Van den Bergh, Jeroen C.J.M. (2011). “Environment versus Growth — A Criticism of “Degrowth” and a Plea for “a-Growth””. In: *Ecological Economics* 70.5, pp. 881–890.
- Van der Slycken, Jonas (2021). “Beyond GDP: Alternative Measures of Economic Welfare for the EU-15”. Ghent University.
- Van Treeck, Till (2009). “A Synthetic, Stock–Flow Consistent Macroeconomic Model of ‘Financialisation’”. In: *Cambridge Journal of Economics* 33.3, pp. 467–493.
- Victor, Peter (2012). “Growth, Degrowth and Climate Change: A Scenario Analysis”. In: *Ecological Economics* 84, pp. 206–212.
- Vogel, Jefim et al. (2021). “Socio-Economic Conditions for Satisfying Human Needs at Low Energy Use: An International Analysis of Social Provisioning”. In: *Global Environmental Change* 69, p. 102287.
- Waldman, Michael (1993). “A New Perspective on Planned Obsolescence”. In: *The Quarterly Journal of Economics* 108.1, pp. 273–283.
- Wang, Feng et al. (2013). “Enhancing E-Waste Estimates: Improving Data Quality by Multivariate Input–Output Analysis”. In: *Waste management* 33.11, pp. 2397–2407.
- Wiedmann, Thomas et al. (2020). “Scientists’ Warning on Affluence”. In: *Nature communications* 11.1, pp. 1–10.
- Wieser, Harold (2017). “Ever-Faster, Ever-Shorter? Replacement Cycles of Durable Goods in Historical Perspective”. In: *Product Lifetimes And The Environment - Conference Proceedings*. PLATE Conference. Delft University of Technology: IOS Press, pp. 426–431.
- Zwickl, Klara, Franziska Disslbacher, and Sigrid Stagl (Jan. 2016). “Work-Sharing for a Sustainable Economy”. In: *Ecological Economics* 121, pp. 246–253.

A note on "Zero growth and structural change in a post Keynesian growth model"

Outline of the current chapter

A.1 Introduction	199
A.2 Profit-led growth in a neo-Kaleckian model	200
A.3 Depreciation and the paradox of costs	201
A.4 Implications for the discussion on stability	203
A.5 Zero growth and the net rate of profit	204
A.6 Conclusion	205

This note was published in 2020 in the *Journal of Post Keynesian Economics*:

Monserand, Antoine (2020). "A note on « zero growth and structural change in a post Keynesian growth model »". In: *Journal of Post Keynesian Economics* 43, pp. 131-138.

A.1 Introduction

This note is a critique of the results found by Rosenbaum (2015) concerning zero growth and structural change in a post-Keynesian growth model, some of which are shown to be problematic. First, the (im)possibility for a neo-Kaleckian model of growth and distribution to generate a profit-led growth regime is discussed. Next, we review the role played by the “paradox of costs” when introducing the depreciation of capital and how this changes the stability characteristics of the

model presented by Rosenbaum. Finally we show that, contrary to what is claimed in the article, the proposed model is not able to show that zero growth is compatible with a positive net rate of profit.

A.2 Profit-led growth in a neo-Kaleckian model

Rosenbaum builds a neo-Kaleckian model, with the following specifications for the saving and investment functions:

$$\sigma = s \cdot r^n \tag{A.1}$$

$$g = \alpha + \beta u + \tau r^n + \varphi \lambda \tag{A.2}$$

where r^n is the rate of profit net of depreciation and λ is the rate of technical progress. With the rate of depreciation being proportional to λ , the net rate of profit is given by:

$$r^n = \frac{\pi u}{\nu} - d_1 \lambda \tag{A.3}$$

As usual with this type of model, these three equations lead to the equilibrium rate of accumulation g^* :

$$g^* = s \left(\frac{\pi}{\nu} \right) \frac{\alpha + (s - \tau) d_1 \lambda + \varphi \lambda}{(s - \tau) \pi / \nu - \beta} - s d_1 \lambda \tag{A.4}$$

From this, Rosenbaum argues that the effect of a change in the profit share π on g^* "depends on the specific parameter configuration", and therefore growth can be either profit-driven or wage-driven. This is at odds with the usual results for neo-Kaleckian models of growth and distribution in a closed economy and with no saving out of wages - which is the case here: they can only show wage-led growth (Hein 2014, p. 271). However, since Rosenbaum's model is more complex as it features productivity growth and capital depreciation, it might be the case that a profit-led growth regime is possible. But instead of leaving the question open and examining the properties of this regime, its plausibility should first be examined. In the rest of this section, we do this check and show that the profit-led growth regime is implausible in Rosenbaum's model.

Computing the partial derivative of g^* with respect to π , one obtains:

$$\frac{\partial g^*}{\partial \pi} = -s\beta \frac{\alpha + (s - \tau)d_1\lambda + \varphi\lambda}{\nu[(s - \tau)\pi/\nu - \beta]^2} \quad (\text{A.5})$$

The sign of this expression depends on the signs of $s\beta$ and on that of the numerator of the fraction. Rosenbaum implicitly assumes the propensity to save out of profits to be positive, since he looks at cases where the Keynesian stability condition is verified (p.632), and a negative propensity would clearly violate this condition. Obviously, β must be positive for the model to make economic sense, since it represents the sensitivity of investment to the rate of capacity utilisation. Rosenbaum supports this view himself, as can be seen from his discussion on page 633 where he discards his "Case 1" precisely because it requires β to be negative. Then, could the numerator of the fraction in equation (A.5) be negative? Looking at Rosenbaum's equation (18), the expression for the equilibrium rate of capacity utilisation u^* :

$$u^* = \frac{\alpha + (s - \tau)d_1\lambda + \varphi\lambda}{(s - \tau)\pi/\nu - \beta}, \quad (\text{A.6})$$

we see that this cannot be the case. Otherwise, u^* would be negative since the numerator is the same as the one from equation (A.5) and the denominator is assumed to be positive for the Keynesian stability condition to hold.

Thus, the model used by Rosenbaum does not allow for any profit-led growth regime, and thereby the whole discussion of pages 636-40 on the profit-driven case and its (in)stability is in fact irrelevant.

A.3 Depreciation and the paradox of costs

The second substantial problem we find in Rosenbaum's article is in the effect of the rate of depreciation of capital on the rate of accumulation. According to him, a higher (lower) rate of depreciation entails a lower (higher) rate of accumulation, seemingly because it would decrease (increase) net investment, for a given amount or rate of gross investment. This is what we understand from the footnote 4 of his article, where he discusses a departure from a zero growth state:

Of course, if the actual depreciation factor is set at a lower value, growth would be positive since investment now exceeds depreciation whereas for higher depreciation factors, growth would become negative. [...] In Figure 3 and Figure 4, different depreciation factors would be captured by shifting the g and σ schedules upward or downward considering that the depreciation factor d_1 enters as a constant in Equations (16) and (17). (Rosenbaum 2015)

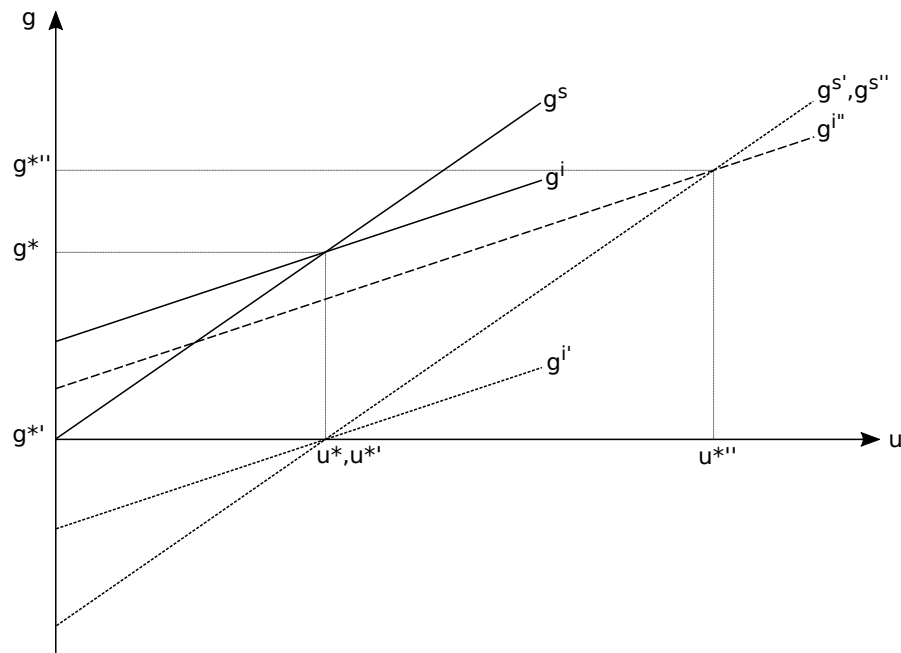

Figure A.1: Change in the equilibrium rates of accumulation and of capacity utilisation when the rate of capital depreciation is introduced.

These equations (16) and (17) are the saving and investment functions of the model (Eqs. (A.1) and (A.2) in this note), both of which indeed contain the depreciation factor as a constant, coming from the rate of profit net of depreciation. But Rosenbaum is mistaken in assuming that both the saving (σ) and investment (g) schedules shift upward or downward together by the same distance when the depreciation factor is included (or changes). In his Figure 3, Rosenbaum presumes that both schedules shift down by a height d due to depreciation, therefore allowing a zero growth equilibrium to be reached while maintaining a constant rate of capacity utilisation.

In fact, the coefficients in front of the depreciation term $d_1\lambda$ in Rosenbaum's equations (16) and (17) are not the same: it is $-s$ in the saving equation (s being the propensity to save out of profits), and $-\tau$ in the investment equation (τ being the sensitivity of investment to the net rate of profit). The assumption made that the Keynesian stability condition holds necessarily implies that s is bigger than τ . Hence, if the depreciation factor d_1 increases (decreases), the saving curve σ will shift downward (upward) by a larger amount than the investment curve g . This is not anecdotal, since instead of reducing the equilibrium rate of accumulation while keeping the rate of capacity utilisation constant, as is shown by Rosenbaum, an increase in the depreciation factor would lead to an *increase* in the equilibrium rate of accumulation, as well as in the rate of capacity utilisation.

Figure A.1 illustrates this phenomenon: the solid lines g^s and g^i represent the situation of departure (without depreciation costs); the dotted lines $g^{s'}$ and $g^{i'}$ show the situation after taking depreciation into account, as it is proposed by Rosenbaum (the value of the depreciation factor is set in such a way that the equilibrium rate of growth is zero), and the dashed line $g^{i''}$ and dotted line $g^{s''}$ illustrate the situation when depreciation is properly taken into account (with the same value for the depreciation factor as in Rosenbaum's proposal).

What we observe in the correct representation is the well-known "paradox of costs" (Rowthorn 1981), applied here to depreciation costs,¹ that plays the decisive role. In order to meet a given level of aggregate demand, firms need to maintain a certain level of productive capital. If depreciation accelerates, gross investment will have to increase in order to compensate. This higher gross investment generates additional economic activity and therefore a higher rate of capacity utilisation, triggering in turn an increase in investment and in the rate of accumulation.

It should be noted that the mechanism described above (that has to do with the shift of the saving curve) more than compensates the disincentive to invest caused by the initial reduction in the net rate of profit (the shift of the investment curve). The overall effect can be checked mathematically by taking the first derivative of the equilibrium rate of accumulation g^* (recall Eq. (A.4)) with respect to the depreciation factor d_1 :

$$\frac{\partial g^*}{\partial d_1} = \frac{s\beta\lambda}{(s-\tau)\pi/\nu - \beta} \quad (\text{A.7})$$

This expression cannot but be positive, considering our previous remarks on the signs of β and of the denominator, plus the fact that the rate of technical progress λ has to be positive for all the discussions concerning this article. Indeed, from Rosenbaum's saving equation (16) we see that the equilibrium rate of capacity utilisation u^* , in the case of zero growth, is equal to $\nu d_1 \lambda / \pi$. Thus, $\lambda > 0$ is required in order to ensure $u^* > 0$.

A.4 Implications for the discussion on stability

Several implications that Rosenbaum claims have to do with the stability analysis of a zero growth economy in various configurations. He distinguishes the cases of "laissez-faire" and "forced" zero growth on one hand, and of profit-driven and wage-driven growth on the other hand, as summarised in his Table 1. As we have already argued, the profit-driven cases are irrelevant for this model. But what of

¹Rowthorn (1981) presents the paradox of costs and shows that the phenomenon holds for any "real cost of production" (wages, fixed capital requirements, taxes, and capital depreciation).

the stability analysis conducted for a wage-driven economy?

According to Rosenbaum, a wage-driven economy is generally unstable. For instance it is destabilised by an increase in the markup, because of a spiral of falling wages and employment in the absence of automatic stabilisers. But by forcing zero growth through a rapid monitoring of the depreciation factor, the unstable economy is said to be stabilised. The idea is that following an increase in the markup and therefore a fall in the rate of growth, public authorities would change tax rules and/or technical regulations and norms so that the depreciation factor d_1 would decrease, in an attempt to increase the rate of growth. Rosenbaum describes the stabilizing effect in the following way: because depreciation is lower, renewal of capital is slower. As a result, technical progress is slowed, meaning less labour is "saved". This has a positive effect on employment and wages, which in turn tends to increase growth.

One could doubt the strength of this stabilising effect, since the effect of a slight acceleration or deceleration of technical progress on overall employment, and above all the subsequent effect on wages, seems to be of secondary order in our view. But more importantly, the mechanism described here does not work the same way once we take into account the paradox of costs mentioned above. Indeed, after an increase in the markup and a fall in the rate of growth, public authorities should now try to raise the rate of depreciation, since this would bring about higher growth. By doing so, however, the mechanism is reversed: faster renewal of capital would speed up labor saving processes, reducing employment. Wages would fall along with the rate of growth. In the terms of the article's narrative, this would be an unstable economy, and we should then conclude that a wage-driven economy cannot be stable at zero growth, no matter how "free" or "forced" this zero growth is. Future work should put forward other stabilising mechanisms that would allow for a wage-led economy to be stable at zero growth.

A.5 Zero growth and the net rate of profit

Our last concern has to do with the discussion on the net rate of profit in the case of zero growth presented in the section "Further considerations" of Rosenbaum's article, on page 643. Starting from the definition of the rate of profit net of depreciation, inserting the condition for zero growth regarding the depreciation factor and using the expression for the equilibrium rate of capacity utilisation, Rosenbaum arrives at a surprising condition which if verified allows for the net rate of profit to be positive while the rate of growth is zero. The condition is the

following:

$$\beta \frac{\nu (1 - \beta^2)}{\pi (1 - \beta)} < s - \tau \quad (\text{A.8})$$

We have not ascertained whether this result is due to a typo in Rosenbaum's equation (33) where, on its right-hand side, a coefficient β is missing in front of u in the numerator, or is due to some erroneous calculation, but we can assert that the result is incorrect. Indeed, using the correct expression for the net rate of profit:

$$r^n = \frac{\beta u + \alpha + \varphi \lambda}{\beta \nu / \pi}, \quad (\text{A.9})$$

replacing u with its value at the zero growth equilibrium and then using Rosenbaum's zero growth condition (23) on d_1 , we get:

$$r^n = \frac{\beta d_1 \lambda \nu / \pi + \alpha + \varphi \lambda}{\beta \nu / \pi} = \frac{-\alpha - \varphi \lambda + \alpha + \varphi \lambda}{\beta \nu / \pi} = 0$$

This result is unsurprising and can be obtained even more easily, by directly using the saving equation (A.1) taken with $\sigma = 0$, since at equilibrium $\sigma = g$, yielding:

$$0 = s \cdot r^n \quad (\text{A.10})$$

Therefore $r^n = 0$ since $s \neq 0$.² Thus we show that the model presented by Rosenbaum does *not* prove that a positive rate of net profit is compatible with zero growth. This compatibility, however, is a standard feature of stock-flow consistent models and has been put forward more explicitly in recent articles related to the "monetary growth imperative" controversy (Cahen-Fourot and Lavoie 2016; Jackson and Peter A. Victor 2015).

A.6 Conclusion

In this note, we have formulated several critiques regarding Rosenbaum's article. First, we showed that the model presented cannot produce the profit-driven growth regime the author studies in parallel to the wage-driven one. Then we demonstrated that, because of the phenomenon of the "paradox of costs", the only remaining stable case (namely the "forced zero growth" wage-driven regime) is in fact unstable.

²In the particular case where $s = 0$, the net rate of profit could be positive. However, as we have argued in the first section, this case is implicitly dismissed by Rosenbaum. Indeed he assumes that the Keynesian stability condition is verified, and in his model this is only possible when $s > 0$.

Finally we pointed out that, contrary to the author's claim, the model proposed is not able to show that zero growth is compatible with a positive net rate of profit.

Bibliography of the current chapter

- Cahen-Fourot, Louison and Marc Lavoie (June 2016). "Ecological Monetary Economics: A Post-Keynesian Critique". In: *Ecological Economics* 126, pp. 163–168.
- Hein, Eckhard (2014). *Distribution and Growth after Keynes: A Post-Keynesian Guide*. Cheltenham, UK: Edward Elgar Publishing. 551 pp.
- Jackson, Tim and Peter A. Victor (Dec. 2015). "Does Credit Create a Growth Imperative? A Quasi-Stationary Economy with Interest-Bearing Debt". In: *Ecological Economics* 120, pp. 32–48.
- Rosenbaum, Eckehard (May 19, 2015). "Zero Growth and Structural Change in a Post Keynesian Growth Model". In: *Journal of Post Keynesian Economics* 37.4, pp. 623–647.
- Rowthorn, Bob (1981). "Demand, Real Wages and Economic Growth". In: *Thames Papers in Political Economy*.

Contents

Abstract	xvii
Remerciements	xix
Foreword	xxiii
List of Tables	xxv
List of Figures	xxvii
Introduction	1
Degrowth: a brief overview	3
Why not green growth or a-growth?	5
Green growth	5
A-growth	7
Why study the macroeconomics of degrowth?	9
Degrowth remains under-researched within ecological macroeconomics	9
Macroeconomics remains under-researched within degrowth studies	12
Restricting the scope of the thesis: research questions and stylised approach	14
What this thesis is not about	14
Focusing on the economics	15
A stylised vision of a degrowth transition: two phases, and two kinds of processes	17
Theoretical and methodological choices	20
The choice of post-Keynesian economic theory	20
The modelling approach	22
The choice of neo-Kaleckian and stock-flow consistent models . . .	24
Remarks on population issues	25
Structure of the thesis	26

1 Degrowth in a neo-Kaleckian model of growth and distribution? A theoretical analysis of compatibility, stability, and transition dynamics	37
1.1 Introduction	38
1.2 The neo-Kaleckian model of growth and distribution	39
1.3 Zero growth in Kaleckian models: a short review	40
1.3.1 Zero growth and the rate of profit: Cahen-Fourot and Lavoie (2016)	40
1.3.2 Animal spirits and the taxation of saving: Padalkina (2012)	41
1.3.3 The depreciation of capital: Rosenbaum (2015)	43
1.4 A more complex neo-Kaleckian model for the study of a degrowing economy	47
1.4.1 Setting the model out	47
1.4.2 Analysing the model	49
1.5 Dynamics of the degrowth transition	52
1.5.1 Pulling the transition - The voluntary side	53
1.5.2 Pushing the transition - The coercive side	59
1.6 A few side remarks on public debt and deficits	61
1.7 Conclusion	61
1.A Calculations and analytical expressions	62
2 Green public investment, consumption patterns, and the ecological transition: a macroeconomic analysis	67
2.1 Introduction	68
2.2 The model	70
2.2.1 Households	74
2.2.2 Firms	78
2.2.3 Public sector	81
2.2.4 Emissions and inequality	84
2.3 Effects of the different types of green public investment	85
2.4 Effects of green public investment and sufficiency	90
2.5 Conclusion	94
2.A Symbols for endogenous variables used in chapter 2	96
2.B Symbols for parameters and exogenous variables used in chapter 2	99
3 Buying into inequality. A macroeconomic analysis linking accelerated obsolescence, interpersonal inequality, and potential for degrowth	103
3.1 Introduction	104
3.2 Accelerated obsolescence: some definitions and a brief history . .	105
3.3 The model	107
3.3.1 General structure	107
3.3.2 Behavioural equations and other assumptions	109

3.3.3 Economic well-being, inequality and ecological damage . . .	111
3.4 Acceleration of obsolescence	113
3.4.1 Without government response (scenario 1)	113
3.4.2 With government responses (scenarios 2 and 3)	119
3.5 A potential for degrowth	121
3.6 Conclusion	125
4 Carrots, Cars and Karaoke: Funding pensions in a degrowing economy	129
4.1 Introduction	131
4.2 The model	133
4.2.1 Three categories of goods and services	133
4.2.2 Basic structure: the balance sheet matrix	136
4.2.3 Transactions	136
4.2.4 Further presentation of the model	139
4.2.5 Analysis of the model without any shock	141
4.3 Scenario analysis: consumption behaviours and policy responses to deficits	143
4.3.1 Six scenarios	144
4.3.2 Comparison and discussion of results	154
4.4 Extending the logic to other spheres of social protection and public spending	155
4.5 Conclusion	157
4.A Derivation of the stationary state	158
4.B Stability analysis	159
Conclusion	163
Summary of the results	164
Stability, profits, poverty, employment: degrowth is not economic collapse	164
Drivers of transition and contradictory dynamics	166
The reduction of inequalities: a condition, a driver, and a possible outcome of a degrowth transition	167
Financing pensions, social protection in general, and free public services in a degrowing economy is possible	168
On the importance of disaggregation and the use of the correct indicators	170
Implications for (post-Keynesian) macroeconomics	170
The question of economic objectives	171
Changing the perspective on public finances	173
Consumption, saving, investment	177
A comment on the practice of research	178

A side remark on the Covid-19 crisis and degrowth	179
Avenues for further research	180
Bibliography	187
A A note on "Zero growth and structural change in a post Keynesian growth model"	199
A.1 Introduction	199
A.2 Profit-led growth in a neo-Kaleckian model	200
A.3 Depreciation and the paradox of costs	201
A.4 Implications for the discussion on stability	203
A.5 Zero growth and the net rate of profit	204
A.6 Conclusion	205
Contents	207

**The macroeconomics of degrowth
Conditions, choices, and implications.**

Abstract

This thesis investigates an ecological and social paradigm, degrowth, from the perspective of macroeconomics. The decrease in production and consumption that a degrowth transition represents requires anticipating and analysing its potential macroeconomic consequences, in order to prevent any detrimental effects. For this, the thesis mobilises post-Keynesian economic theory. The first chapter looks at issues of macroeconomic stability, rate of profit, and changes in income distribution. The second chapter shows how ecological investments and changes in lifestyles and consumption patterns can be complementary, and analyses the macroeconomic consequences of these transformations. The third chapter looks at the phenomenon of accelerated obsolescence and establishes its link with interpersonal inequalities between workers and capitalists. Finally, the fourth chapter examines the possibility of guaranteeing the financing of a pay-as-you-go pension system, of social protection in general and of public services in a degrowing economy. This thesis demonstrates that degrowth can be environmentally, socially, and economically beneficial. These results run counter to the assertions that degrowth can only produce economic and social catastrophe.

Keywords: degrowth, ecological macroeconomics, post-keynesian economics, transition, inequality, stock-flow consistent modelling

**Macroéconomie de la décroissance
Conditions, choix, implications.**

Résumé

Cette thèse aborde un paradigme écologique et social, la décroissance, sous l'angle de la macroéconomie. La diminution de la production et de la consommation qu'une transition de décroissance représente nécessite d'anticiper et d'analyser ses potentielles conséquences macroéconomiques, afin d'en prévenir les effets délétères. Pour cela, la thèse mobilise la théorie économique post-keynésienne. Le premier chapitre se penche sur les questions de stabilité macroéconomique, de taux de profit, et de modifications dans la répartition des revenus. Le second chapitre montre comment investissements écologiques et changements dans les modes de vie et de consommation peuvent être complémentaires, et analyse les conséquences macroéconomiques de ces transformations. Le troisième chapitre se penche sur le phénomène d'obsolescence accélérée et établit un lien avec les inégalités interpersonnelles entre travailleurs et capitalistes. Le quatrième chapitre examine la possibilité de garantir le financement d'un système de retraites par répartition, de la protection sociale en général et des services publics dans une économie en décroissance. Cette thèse démontre que la décroissance peut être bénéfique sur les plans environnemental, social et économique. Elle donne ainsi tort aux assertions selon lesquelles la décroissance ne peut mener qu'à des catastrophes économiques et sociales.

Mots clés : décroissance, macroéconomie écologique, économie post-keynésienne, transition, inégalités, modélisation stock-flux cohérente

Centre d'Économie de l'Université Paris Nord

99 avenue Jean-Baptiste Clément – 93430 Villetaneuse – France