



HAL
open science

Cyclic bar constructions and low-dimensional topology

Ivan Bartulović

► **To cite this version:**

Ivan Bartulović. Cyclic bar constructions and low-dimensional topology. Algebraic Topology [math.AT]. Université de Lille, 2022. English. NNT : 2022ULILB005 . tel-03935238

HAL Id: tel-03935238

<https://theses.hal.science/tel-03935238>

Submitted on 11 Jan 2023

HAL is a multi-disciplinary open access archive for the deposit and dissemination of scientific research documents, whether they are published or not. The documents may come from teaching and research institutions in France or abroad, or from public or private research centers.

L'archive ouverte pluridisciplinaire **HAL**, est destinée au dépôt et à la diffusion de documents scientifiques de niveau recherche, publiés ou non, émanant des établissements d'enseignement et de recherche français ou étrangers, des laboratoires publics ou privés.

THÈSE

présentée pour obtenir le grade de
DOCTEUR DE L'UNIVERSITÉ DE LILLE

École Doctorale MADIS-631

Spécialité : Mathématiques et leurs interactions

par

IVAN BARTULOVIĆ

CYCLIC BAR CONSTRUCTIONS AND
LOW-DIMENSIONAL TOPOLOGY

CONSTRUCTIONS BAR CYCLIQUES ET
TOPOLOGIE DE BASSE DIMENSION

Soutenue publiquement le 04/05/2022 devant le jury composé de :

JULIEN BICHON	Président du jury	Université Clermont Auvergne
FRANÇOIS CONSTANTINO	Examineur	Université Toulouse III
BENOIT FRESSE	Codirecteur de thèse	Université de Lille
CHRISTOPH SCHWEIGERT	Rapporteur	Université de Hambourg
ANDREA SOLOTAR	Rapporteur	Université de Buenos Aires
ALEXIS VIRELIZIER	Directeur de thèse	Université de Lille

Cette thèse a été préparée au **Laboratoire Paul Painlevé (UMR 8524)** de l'Université de Lille grâce à un financement du **Labex CEMPI** et de la **Région Hauts-de-France**.

Remerciements

Tout d'abord, je tiens à remercier mon directeur de thèse, Alexis Virelizier, pour sa disponibilité et sa bonne humeur. En particulier, je lui suis très reconnaissant pour ses nombreux commentaires, relectures et réponses à mes questions. Merci à mon codirecteur Benoit Fresse pour son aide administrative.

Ensuite, je remercie Andrea Solotar et Christoph Schweigert d'avoir accepté d'être les rapporteurs de cette thèse. Je remercie également Julien Bichon et François Constantino d'avoir accepté de faire partie de mon jury.

Enfin, je tiens à remercier les nombreux collègues du bureau 318/320 ainsi que les autres (post)doctorants et invités que j'ai rencontrés au cours de ces années. Je suis reconnaissant à Justine pour sa relecture du résumé en français.

U slučaju da citate ovaj red: roditelji, hvala na savjetima i moralnoj podršci.

Contents

Remerciements	
Introduction	i
Notations and conventions	v
Chapter I. Simplicial and cyclic objects	1
I.1. Simplicial objects	1
I.2. Cyclic objects	2
I.3. Paracyclic objects	4
I.4. Some relevant functors related to the (para)cyclic category	6
I.5. The (co)chain complexes and (co)simplicial objects	8
I.6. The (co)chain bicomplexes and (co)cyclic objects	8
Chapter II. Monoidal categories and braided Hopf algebras	13
II.1. Monoidal categories	13
II.2. Hopf algebras in braided monoidal categories	19
II.3. Coends	24
Chapter III. Cyclic theories from (co)algebras	31
III.1. Cyclic objects from coalgebras	31
III.2. Cyclic objects from algebras	40
III.3. Dualities	47
III.4. Some computations and examples	49
Chapter IV. On the braided Connes-Moscovici construction	53
IV.1. Modular pairs and braided Connes-Moscovici construction	53
IV.2. Categorical Connes-Moscovici trace	57
IV.3. Proof of Theorem IV.1	60
IV.4. Proof of Theorem IV.5	72
IV.5. Verification of the remaining relations	76
Chapter V. Paracyclicity and braided Hochschild complex	81
V.1. Categorical bi(co)modules	81
V.2. Braided Hochschild complex	81
V.3. Braided coHochschild complex	90
Chapter VI. (Co)cyclic sets from ribbon string links	93
VI.1. String links and their evaluations	93
VI.2. (Co)cyclic sets from ribbon string links	96
VI.3. The cyclic and cocyclic duals of \mathcal{SL}_\bullet and $\widetilde{\mathcal{SL}}_\bullet$	105
Chapter VII. Cyclic objects from surfaces and TQFTs	109
VII.1. 3-cobordisms and their presentations	110

CONTENTS

VII.2. The Reshetikhin-Turaev TQFT via coends	115
VII.3. Proof of Theorem VII.1	116
VII.4. Proof of Theorem VII.2	131
VII.5. Future perspectives	138
Bibliography	139

Introduction

In this thesis we describe an interplay between constructions related to cyclic homology of algebras and constructions of quantum invariants of knots and 3-manifolds. Cyclic (co)homology of algebras was introduced independently by Connes [7] and Tsygan [34]. Connes formalized [6] his construction by means of the cyclic category (which contains the simplicial category). This led to the definition of a (co)cyclic object in a category, which is a generalization of the (co)simplicial object in a category. Cyclic (co)homology is intimately related to Hochschild (co)homology. Namely, there is a long exact sequence relating the two theories. Besides the Connes' original motivation in noncommutative differential geometry, cyclic homology has been also used in algebraic topology [17] and more particularly in homological algebra [32] and K -theory [19]. This theory appeared in many versions and generalizations. For example, Connes and Moscovici [8, 9] introduced cyclic cohomology of Hopf algebras, which is related to the cyclic cohomology of associative algebras via the Connes-Moscovici trace.

Quantum topology is born with the discovery of Jones polynomial [18] which is an isotopy invariant of knots and links. Shortly after, this invariant had been related to the quantum groups introduced by Drinfeld [10] and to the methods of quantum field theory by Witten [39]. Topological quantum field theories, or briefly TQFTs, are a framework that organizes the so called quantum invariants of links and 3-manifolds. These invariants are often constructed by using an algebraic ingredient (for example the category of representations of a quantum group) together with a combinatorial presentation of the topological object of interest. A fundamental construction of a 3-dimensional TQFT is the Reshetikhin-Turaev TQFT [33, 35] which uses modular categories as algebraic ingredient and surgery on framed links as combinatorial presentation.

This monograph contains seven chapters. The first two chapters are preliminary. In Chapter I, we recall the notions of a simplicial, paracyclic, and cyclic object in a category. These are defined as functors from certain indexing categories: the simplicial category Δ , the paracyclic category ΔC_∞ , and the cyclic category ΔC . Note that Δ is a non full subcategory of both ΔC_∞ and ΔC , and ΔC is a quotient of ΔC_∞ . We also explicit some important functors related to these categories, such as the cyclic duality isomorphism $L: \Delta C^{\text{op}} \xrightarrow{\sim} \Delta C$ and the reindexing involution $\Phi: \Delta C \xrightarrow{\sim} \Delta C$. At the end of the chapter, we recall the chain complexes and chain bicomplexes associated to simplicial and cyclic objects in an abelian category, as well as the Connes long exact sequence.

Chapter II is dedicated to monoidal categories and categorical (co)algebras. We first review several classes of monoidal categories: pivotal, braided, ribbon, fusion, and modular categories. We also describe the Penrose graphical calculus, which we intensively use throughout the monograph. We next review categorical (co)algebras, Hopf algebras, and their (co)modules. We finish the chapter with a discussion on the coend of a braided pivotal category. The latter is an important example of a categorical Hopf algebra and plays a central role in the study of quantum invariants of links and 3-manifolds [29, 4].

After these preliminary chapters, we work mostly in the framework of braided categories, which often come with additional structure such as duals and/or twists. We sometimes suppose that monoidal categories are \mathbb{k} -linear (meaning that hom-sets are \mathbb{k} -modules such that the composition and monoidal products of morphisms are \mathbb{k} -bilinear), where \mathbb{k} denotes a commutative ring.

Chapter III is devoted to the constructions of para(co)cyclic objects from categorical algebras and coalgebras in a braided \mathbb{k} -linear category \mathcal{B} with a twist. Our constructions are highly inspired by the work of Akrami-Majid [1] on braided cyclic cohomology of ribbon algebras. More precisely, we associate a paracyclic object $\mathbf{A}_\bullet(A)$ to any algebra A in \mathcal{B} and we associate a paracocyclic object $\mathbf{C}_\bullet(C)$ to any coalgebra C in \mathcal{B} . When \mathcal{B} is symmetric with trivial twist, these objects turn out to be (co)cyclic. In particular, we recover the well-known constructions of (co)cyclic \mathbb{k} -modules [28, 38, 11] when $\mathcal{B} = \text{Mod}_{\mathbb{k}}$ is the symmetric category of \mathbb{k} -modules. In the general case (when \mathcal{B} is braided \mathbb{k} -linear), we describe the (co)cyclic \mathbb{k} -modules derived from $\mathbf{A}_\bullet(A)$ and $\mathbf{C}_\bullet(C)$ by postcomposing them with the Hom functors $\text{Hom}_{\mathcal{B}}(-, \mathbb{1})$ and $\text{Hom}_{\mathcal{B}}(\mathbb{1}, -)$, where $\mathbb{1}$ denotes the monoidal unit of \mathcal{B} . We next explore duality relations between our various constructions. We end the chapter with some computations.

In Chapter IV, we study the braided version of the cocyclic object governing the Hopf cyclic cohomology of Connes-Moscovici [9], as proposed by Khalkhali-Pourkia [20]. More precisely, we study the paracocyclic object $\mathbf{CM}_\bullet(H, \delta, \sigma)$ associated to a Hopf algebra H in a braided category \mathcal{B} endowed with a pair (δ, σ) made of an algebra morphism $\delta: H \rightarrow \mathbb{1}$ and a coalgebra morphism $\sigma: \mathbb{1} \rightarrow H$ such that $\delta\sigma = \text{id}_{\mathbb{1}}$. Such pair is called a modular pair for H . For example, the counit $\varepsilon: H \rightarrow \mathbb{1}$ and the unit $u: \mathbb{1} \rightarrow H$ of H form a modular pair (ε, u) . The first main result of Chapter IV is an inductive computation of the paracocyclic operator $\tau_n(\delta, \sigma)$ of $\mathbf{CM}_\bullet(H, \delta, \sigma)$:

Theorem 1 (see Theorem IV.1). *The k -th power $\tau_n(\delta, \sigma)^k$ of the paracocyclic operator is computed in terms of $\tau_1(\delta, \sigma)$ and $\tau_{n-1}(\varepsilon, u)$.*

Given a twist $\theta = \{\theta_X: X \rightarrow X\}_{X \in \text{Ob}(\mathcal{B})}$ for \mathcal{B} , we introduce the notion of a θ -twisted modular pair in involution (see Section IV.1.1). When \mathcal{B} is symmetric with trivial twist $\text{id}_{\mathcal{B}}$, then $\text{id}_{\mathcal{B}}$ -twisted modular pairs in involution correspond to braided modular pairs in involution introduced in [20]. Theorem 1 implies the following corollary:

Corollary 1 (see Corollaries IV.3 and IV.4). *If (δ, σ) is a θ -twisted modular pair in involution for H , then $\tau_n(\delta, \sigma)^{n+1} = \theta_{H^{\otimes n}}$. Consequently, when \mathcal{B} is \mathbb{k} -linear, $\text{Hom}_{\mathcal{B}}(\mathbb{1}, -) \circ \mathbf{CM}_\bullet(H, \delta, \sigma)$ is a cocyclic \mathbb{k} -module and $\text{Hom}_{\mathcal{B}}(-, \mathbb{1}) \circ \mathbf{CM}_\bullet(H, \delta, \sigma)$ is a cyclic \mathbb{k} -module.*

The second main result of Chapter IV concerns a categorical version of the Connes-Moscovici trace.

Theorem 2 (see Theorem IV.5). *For a Hopf algebra H in a braided category \mathcal{B} with a twist, a modular pair (δ, σ) for H , and a coalgebra in the category of H -modules, there is a natural transformation from the paracocyclic object $\mathbf{CM}_\bullet(H, \delta, \sigma)$ to the paracocyclic object $\mathbf{C}_\bullet(C)$.*

If we additionally suppose that \mathcal{B} is a \mathbb{k} -linear category, we obtain:

Corollary 2 (see Corollary IV.6). *If (δ, σ) is a θ -twisted modular pair in involution for H , then there is a natural transformation of cocyclic \mathbb{k} -modules from $\text{Hom}_{\mathcal{B}}(\mathbb{1}, -) \circ \mathbf{CM}_\bullet(H, \delta, \sigma)$ to $\text{Hom}_{\mathcal{B}}(\mathbb{1}, -) \circ \mathbf{C}_\bullet(C)$, and there is a natural transformation of cyclic \mathbb{k} -modules from $\text{Hom}_{\mathcal{B}}(-, \mathbb{1}) \circ \mathbf{C}_\bullet(C)$ to $\text{Hom}_{\mathcal{B}}(-, \mathbb{1}) \circ \mathbf{CM}_\bullet(H, \delta, \sigma)$.*

In Chapter V, we study a braided version of the (co)simplicial \mathbb{k} -module that governs the twisted (co)Hochschild (co)homology of a Hopf \mathbb{k} -algebra with coefficients in a bi(co)module over it [15]. More precisely, given a categorical Hopf algebra H and a bimodule M over H , we consider the simplicial object $\text{Hoch}_\bullet(H, M)$, introduced by Hadfield-Krähmer in their work on braided homology of quantum groups [16]. In particular, using H as a bimodule over itself (via multiplication), $\text{Hoch}_\bullet(H, H)$ equals to the underlying simplicial object of Akrami-Majid from [1] (by using the square of the antipode of H as ribbon automorphism). Dually, for a bicomodule N over H , we define the cosimplicial object $\text{coHoch}_\bullet(H, N)$ in \mathcal{B} . The main result of Chapter V is the following:

Theorem 3 (see Theorems V.3 and V.6). *The simplicial object $\text{Hoch}_\bullet(H, M)$ in \mathcal{B} extends to a paracyclic object in \mathcal{B} . The cosimplicial object $\text{coHoch}_\bullet(H, N)$ in \mathcal{B} extends to a paracocyclic object in \mathcal{B} .*

The construction of the para(co)cyclic operators in Theorem 3 is inspired by formulas from work of Fiorenza-Kowalzig [13]. For example, the monoidal unit $\mathbb{1}$ of \mathcal{B} is a bicomodule (via the unit of H) and $\text{coHoch}_\bullet(H, \mathbb{1})$ is naturally isomorphic to the paracocyclic object $\text{CM}_\bullet(H^{\text{op}}, \varepsilon, u)$.

The last two chapters are of topological flavor. In particular, we construct cyclic objects from ribbon string links and surfaces. Recall that an n -string link is a disjoint union of n smoothly embedded arc components in $\mathbb{R}^2 \times [0, 1]$ such that the i -th arc joins $(i, 0, 0)$ to $(i, 0, 1)$ for each $1 \leq i \leq n$. For example, 1-string links are long knots. An n -string link is ribbon if each of its components is endowed with a normal vector field. Ribbon string links can be presented by planar diagrams (with blackboard framing). For example, the following diagram represents a ribbon 2-string link:

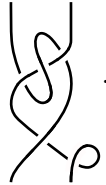

For $n \geq 0$, we denote by \mathcal{SL}_n be the set of isotopy classes of ribbon $(n+1)$ -string links. If \mathcal{B} is a ribbon category with a coend C , then there are maps $\phi_{\mathcal{B}, n}: \mathcal{SL}_n \rightarrow \text{Hom}_{\mathcal{B}}(C^{\otimes n+1}, \mathbb{1})$. According to [4], these maps extend to a functor $\phi_{\mathcal{B}}: \mathbf{RSL} \rightarrow \text{Conv}_{\mathcal{B}}(C, \mathbb{1})$, where \mathbf{RSL} is the category of ribbon string links and $\text{Conv}_{\mathcal{B}}(C, \mathbb{1})$ is the convolution category associated to C (see Section VI.1.4). The main result of Chapter VI is the following:

Theorem 4 (see Theorem VI.1). *The family $\{\mathcal{SL}_n\}_{n \geq 0}$ has a structure of a cocyclic set denoted \mathcal{SL}_\bullet and a structure of cyclic set denoted $\widetilde{\mathcal{SL}}_\bullet$. Moreover, when \mathcal{B} is \mathbb{k} -linear, the evaluation functor $\phi_{\mathcal{B}}$ induces a natural transformation from \mathcal{SL}_\bullet to the cocyclic set $\text{Hom}_{\mathcal{B}}(-, \mathbb{1}) \circ \mathbf{C}_\bullet(C) \circ (L^{\text{op}})^{-1}$ and a natural transformation from $\widetilde{\mathcal{SL}}_\bullet$ to the cyclic set $\text{Hom}_{\mathcal{B}}(-, \mathbb{1}) \circ \mathbf{A}_\bullet(C) \circ L^{-1}$, where L is the cyclic duality isomorphism.*

The cocyclic set \mathcal{SL}_\bullet and the cyclic set denoted $\widetilde{\mathcal{SL}}_\bullet$ from Theorem 4 are constructed as follows. In degree n , both (co)cyclic sets \mathcal{SL}_\bullet and $\widetilde{\mathcal{SL}}_\bullet$ are equal to \mathcal{SL}_n . The cocyclic set \mathcal{SL}_\bullet is equipped with the following cofaces, codegeneracies, and cocyclic operators

(which are the images of the canonical generators of the cyclic category ΔC):

$$\begin{aligned} \delta_0(T) &= \left| \begin{array}{c} \dots \\ \boxed{T} \\ \dots \\ 1 \quad n \end{array} \right|, & \delta_i(T) &= \left| \begin{array}{c} \dots \\ \boxed{T} \\ \dots \\ 1 \quad i \quad i+1 \quad n \end{array} \right|, & \delta_n(T) &= \left| \begin{array}{c} \dots \\ \boxed{T} \\ \dots \\ 1 \quad n \end{array} \right|, \\ \sigma_j(T) &= \left| \begin{array}{c} \dots \\ \boxed{T} \\ \dots \\ 0 \quad j+1 \quad n+1 \end{array} \right|, & \tau_n(T) &= \left| \begin{array}{c} \dots \\ \boxed{T} \\ \dots \\ 0 \quad n-1 \quad n \end{array} \right|. \end{aligned}$$

Here δ_i is defined by inserting a trivial component between i -th and $(i+1)$ -th component and σ_j is defined by “concatenating” (as in the picture) the j -th and $(j+1)$ -st component. The cyclic set $\widetilde{\mathcal{SL}}_\bullet$ comes with the following faces, degeneracies, and cyclic operators (which are the images of the canonical generators of the category ΔC^{op}):

$$\begin{aligned} d_i(T) &= \left| \begin{array}{c} \dots \\ \boxed{T} \\ \dots \\ 0 \quad i \quad n \end{array} \right|, & s_j(T) &= \left| \begin{array}{c} \dots \\ \boxed{T} \\ \dots \\ 0 \quad j \quad n \end{array} \right|, & t_n(T) &= \left| \begin{array}{c} \dots \\ \boxed{T} \\ \dots \\ 0 \quad 1 \quad n \end{array} \right|. \end{aligned}$$

Here d_i is defined by removing the i -th component and s_j is defined by duplicating the j -th component along its framing. Note that the removal and duplication operations for string links appeared in the work of Habiro [14].

Chapter VII is dedicated to the construction of (co)cyclic objects in the category \mathbf{Cob}_3 whose objects are closed oriented surfaces and morphisms are 3-dimensional cobordisms. The category \mathbf{Cob}_3 is of a great interest in quantum topology. In particular, a 3-dimensional TQFT (over \mathbb{k}) is a symmetric monoidal functor $Z: \mathbf{Cob}_3 \rightarrow \text{Mod}_{\mathbb{k}}$. The first result of this chapter is the following:

Theorem 5 (see Theorem VII.1). *For $g \geq 1$, consider a closed oriented surface Σ_g of genus g . The family $\{\Sigma_g\}_{g \geq 1}$ has a structure of a cocyclic object in \mathbf{Cob}_3 denoted Σ_\bullet and a structure of a cyclic object in \mathbf{Cob}_3 denoted $\widetilde{\Sigma}_\bullet$. Consequently, if Z is a 3-dimensional TQFT, then $Z \circ \Sigma_\bullet$ is a cocyclic \mathbb{k} -module and $Z \circ \widetilde{\Sigma}_\bullet$ is a cyclic \mathbb{k} -module.*

We prove Theorem 5 by explicitly presenting the (co)faces, (co)degeneracies, and (co)cyclic operators (which are 3-dimensional cobordisms) using surgery [35]. A fundamental construction of a 3-dimensional TQFT is the Reshetikhin-Turaev TQFT $\text{RT}_{\mathcal{B}}: \mathbf{Cob}_3 \rightarrow \text{Mod}_{\mathbb{k}}$ associated to an anomaly free modular category \mathcal{B} . Such a category always has a coend C which is a Hopf algebra in \mathcal{B} . This Hopf algebra, the cyclic duality L , and the reindexing involution Φ induce the cocyclic \mathbb{k} -module $\widehat{\mathbf{D}}_\bullet(C) \circ \Phi = \text{Hom}_{\mathcal{B}}(-, \mathbb{1}) \circ \mathbf{C}_\bullet(C) \circ (L^{\text{op}})^{-1} \circ \Phi$ and the cyclic \mathbb{k} -module $\widehat{\mathbf{B}}_\bullet(C) \circ \Phi^{\text{op}} = \text{Hom}_{\mathcal{B}}(-, \mathbb{1}) \circ \mathbf{A}_\bullet(C) \circ L^{-1} \circ \Phi^{\text{op}}$. The following theorem relates these modules with those obtained from Theorem 5 for $Z = \text{RT}_{\mathcal{B}}$:

Theorem 6 (see Theorem VII.2). *The cocyclic \mathbb{k} -modules $\text{RT}_{\mathcal{B}} \circ \Sigma_\bullet$ and $\widehat{\mathbf{D}}_\bullet(C) \circ \Phi$ are isomorphic. The cyclic \mathbb{k} -modules $\text{RT}_{\mathcal{B}} \circ \widetilde{\Sigma}_\bullet$ and $\widehat{\mathbf{B}}_\bullet(C) \circ \Phi^{\text{op}}$ are isomorphic.*

Another fundamental construction of a 3-dimensional TQFT is the Turaev-Viro TQFT $\text{TV}_{\mathcal{C}}: \mathbf{Cob}_3 \rightarrow \text{Mod}_{\mathbb{k}}$ associated to a spherical fusion \mathbb{k} -linear category \mathcal{C} with invertible dimension (see [36]). Moreover, when \mathcal{C} is additive and \mathbb{k} an algebraically closed field, the

center $\mathcal{Z}(\mathcal{C})$ of \mathcal{C} is an anomaly free modular category and the TQFTs $\mathrm{TV}_{\mathcal{C}}$ and $\mathrm{RT}_{\mathcal{Z}(\mathcal{C})}$ are isomorphic (see [36, Theorem 17.1]). Denote by D the coend of $\mathcal{Z}(\mathcal{C})$. These results and Theorem 6 imply the following corollary:

Corollary 3 (See Corollary VII.4). *The cocyclic \mathbb{k} -modules $\mathrm{TV}_{\mathcal{C}} \circ \Sigma_{\bullet}$ and $\widehat{\mathbf{D}}_{\bullet}(D) \circ \Phi$ are isomorphic. The cyclic \mathbb{k} -modules $\mathrm{TV}_{\mathcal{C}} \circ \widetilde{\Sigma}_{\bullet}$ and $\widehat{\mathbf{B}}_{\bullet}(D) \circ \Phi^{\mathrm{op}}$ are isomorphic.*

Notations and conventions

By roman numerals such as I, II, \dots , we refer to chapters. By IV.2, we refer to the second section of the fourth chapter. By IV.2.1, we mean the first subsection of Section IV.2, but we will simply refer to it as Section IV.2.1. Theorems, lemmas, corollaries and remarks are numbered by chapters.

If not stated otherwise, \mathbb{k} will denote a commutative ring. By a calligraphic letter such as $\mathcal{A}, \mathcal{B}, \mathcal{C}, \dots$, we denote a category. By $\mathrm{Ob}(\mathcal{C})$, we will denote the class of objects of a category \mathcal{C} . By $[\mathcal{A}, \mathcal{B}]$, we denote the category of functors from \mathcal{A} to \mathcal{B} . We denote by \mathbf{Set} the category of sets, and by $\mathrm{Mod}_{\mathbb{k}}$ the category of left \mathbb{k} -modules. A simplicial object in \mathbf{Set} (respectively, in $\mathrm{Mod}_{\mathbb{k}}$) will often be called a simplicial set (respectively, simplicial \mathbb{k} -module). Similar vocabulary applies in the cosimplicial, para(co)cyclic, and (co)cyclic setting.

CHAPTER I

Simplicial and cyclic objects

In this chapter, we first recall the notion of a (co)simplicial, (co)cyclic, and para(co)cyclic object in a category \mathcal{C} (Sections I.1, I.2 and I.3). Further, we outline definitions of some relevant functors related to (para)cyclic category (Section I.4). Finally, we discuss the chain complexes associated to simplicial objects (Section I.5) and chain bicomplexes associated to cyclic objects (Section I.6). In what follows, for every $n \in \mathbb{N}$, we will denote by $[n]$ the set $\{0, 1, \dots, n\}$ endowed with its standard order.

I.1. Simplicial objects

In this section we recall the notion of (co)simplicial objects in a category \mathcal{C} .

I.1.1. The simplicial category. One defines the *simplicial category* Δ as follows. The objects of Δ are the nonnegative integers $n \in \mathbb{N}$. A morphism $n \rightarrow m$ in Δ is an increasing map between sets $[n]$ and $[m]$. For $n \in \mathbb{N}^*$ and $0 \leq i \leq n$ the *i*-th *coface* is a morphism $\delta_i^n: [n-1] \rightarrow [n]$ in Δ that is given by the unique injection from $[n-1]$ into $[n]$ which misses i . More precisely, this is the function $\delta_i^n: [n-1] \rightarrow [n]$ defined by

$$\delta_i^n: [n-1] \rightarrow [n], \quad j \mapsto \begin{cases} j & \text{if } j < i, \\ j+1 & \text{if } j \geq i. \end{cases}$$

For $n \in \mathbb{N}$ and $0 \leq j \leq n$ the *j*-th *codegeneracy* is a morphism $\sigma_j^n: [n+1] \rightarrow [n]$ in Δ which is given by the unique surjection from $[n+1]$ onto $[n]$ which sends both j and $j+1$ to j . More precisely, this is the function $\sigma_j^n: [n+1] \rightarrow [n]$ defined by

$$\sigma_j^n: [n+1] \rightarrow [n], \quad i \mapsto \begin{cases} i & \text{if } i \leq j, \\ i-1 & \text{if } i > j. \end{cases}$$

We will sometimes omit the upper indices and simply write δ_i and σ_j . It is well known (see [25]) that morphisms in Δ are generated by cofaces $\{\delta_i^n\}_{0 \leq i \leq n, n \in \mathbb{N}^*}$ and codegeneracies $\{\sigma_j^n\}_{0 \leq j \leq n, n \in \mathbb{N}}$ subject to Relations (1)-(3):

$$\delta_j \delta_i = \delta_i \delta_{j-1} \quad \text{for } i < j, \tag{1}$$

$$\sigma_j \sigma_i = \sigma_i \sigma_{j+1} \quad \text{for } i \leq j, \tag{2}$$

$$\sigma_j \delta_i = \begin{cases} \delta_i \sigma_{j-1} & \text{for } i < j, \\ \text{id}_n & \text{for } i = j, \quad i = j+1, \\ \delta_{i-1} \sigma_j & \text{for } i > j+1. \end{cases} \tag{3}$$

When considered as morphisms in the opposite category Δ^{op} , every coface δ_i^n and every codegeneracy σ_j^n are respectively denoted by

$$d_i^n: n \rightarrow n-1 \quad \text{and} \quad s_j^n: n \rightarrow n+1.$$

I.1.2. Simplicial objects. A *simplicial object* in \mathcal{C} is a functor $X: \Delta^{\text{op}} \rightarrow \mathcal{C}$. A morphism between two simplicial objects in \mathcal{C} is a natural transformation between them. Simplicial objects in \mathcal{C} and morphisms between them form the category denoted by $[\Delta^{\text{op}}, \mathcal{C}]$. We will often denote the image $X(\phi)$ of morphism ϕ in Δ^{op} under functor X from $[\Delta^{\text{op}}, \mathcal{C}]$ by ϕ .

By using the presentation of simplicial category Δ , a simplicial object X in \mathcal{C} can be described as a family $\{X_n\}_{n \in \mathbb{N}}$ of objects of \mathcal{C} , endowed for $n \in \mathbb{N}^*$ with morphisms $\{d_i: X_n \rightarrow X_{n-1}\}_{0 \leq i \leq n}$, called *faces*, and for $n \in \mathbb{N}$ with morphisms $\{s_j: X_n \rightarrow X_{n+1}\}_{0 \leq j \leq n}$, called *degeneracies*, such that the following relations hold:

$$d_i d_j = d_{j-1} d_i \quad \text{for } i < j, \quad (4)$$

$$s_i s_j = s_{j+1} s_i \quad \text{for } i \leq j, \quad (5)$$

$$d_i s_j = \begin{cases} s_{j-1} d_i & \text{for } i < j, \\ \text{id}_{X_n} & \text{for } i = j \text{ and } i = j + 1, \\ s_j d_{i-1} & \text{for } i > j + 1. \end{cases} \quad (6)$$

In this characterization, a morphism between two simplicial objects X and Y in \mathcal{C} is a family $\{\alpha_n: X_n \rightarrow Y_n\}_{n \in \mathbb{N}}$ of morphisms in \mathcal{C} such that

$$\alpha_{n-1} d_i = d_i \alpha_n \quad \text{for } n \in \mathbb{N}^* \text{ and } 0 \leq i \leq n \quad \text{and} \quad (7)$$

$$\alpha_{n+1} s_j = s_j \alpha_n \quad \text{for } n \in \mathbb{N} \text{ and } 0 \leq j \leq n. \quad (8)$$

I.1.3. Cosimplicial objects. A *cosimplicial object* in \mathcal{C} is a functor $F: \Delta \rightarrow \mathcal{C}$. A morphism between two cosimplicial objects is a natural transformation between them. Cosimplicial objects and morphisms in \mathcal{C} form a category denoted $[\Delta, \mathcal{C}]$. We will often denote the image $F(\phi)$ of morphism ϕ in Δ under functor F from $[\Delta, \mathcal{C}]$ by ϕ .

A cosimplicial object F in \mathcal{C} may be described as a family $\{F_n\}_{n \in \mathbb{N}}$ of objects of \mathcal{C} equipped for $n \in \mathbb{N}^*$ with morphisms $\{\delta_i: F_{n-1} \rightarrow F_n\}_{0 \leq i \leq n}$, called *cofaces*, and for $n \in \mathbb{N}$ with morphisms $\{\sigma_j: F_{n+1} \rightarrow F_n\}_{0 \leq j \leq n}$, called *codegeneracies*, such that the following relations hold:

$$\delta_j \delta_i = \delta_i \delta_{j-1} \quad \text{for } i < j, \quad (9)$$

$$\sigma_j \sigma_i = \sigma_i \sigma_{j+1} \quad \text{for } i \leq j, \quad (10)$$

$$\sigma_j \delta_i = \begin{cases} \delta_i \sigma_{j-1} & \text{for } i < j, \\ \text{id}_{F_n} & \text{for } i = j, \quad i = j + 1, \\ \delta_{i-1} \sigma_j & \text{for } i > j + 1. \end{cases} \quad (11)$$

In this characterization, a morphism between two cosimplicial objects F and G in \mathcal{C} is a family $\{\beta_n: F_n \rightarrow G_n\}_{n \in \mathbb{N}}$ of morphisms in \mathcal{C} such that

$$\delta_i \beta_{n-1} = \beta_n \delta_i \quad \text{for } n \in \mathbb{N}^* \text{ and } 0 \leq i \leq n \quad \text{and} \quad (12)$$

$$\sigma_j \beta_{n+1} = \beta_n \sigma_j \quad \text{for } n \in \mathbb{N} \text{ and } 0 \leq j \leq n. \quad (13)$$

I.2. Cyclic objects

In this section we recall the notion of (co)cyclic objects in a category \mathcal{C} .

I.2.1. The cyclic category. The *cyclic category* ΔC is defined as follows. The objects of ΔC are nonnegative integers $n \in \mathbb{N}$. The morphisms in ΔC are generated by cofaces $\{\delta_i^n: n-1 \rightarrow n\}_{0 \leq i \leq n, n \in \mathbb{N}^*}$, codegeneracies $\{\sigma_j^n: n+1 \rightarrow n\}_{0 \leq j \leq n, n \in \mathbb{N}}$ and *cocyclic operators* $\{\tau_n: n \rightarrow n\}_{n \in \mathbb{N}}$ subject to Relations (1)-(3) and (14)-(18):

$$\tau_n \delta_i = \delta_{i-1} \tau_{n-1} \quad \text{for } 1 \leq i \leq n, \quad (14)$$

$$\tau_n \delta_0 = \delta_n, \quad (15)$$

$$\tau_n \sigma_i = \sigma_{i-1} \tau_{n+1} \quad \text{for } 1 \leq i \leq n, \quad (16)$$

$$\tau_n \sigma_0 = \sigma_n \tau_{n+1}^2, \quad (17)$$

$$\tau_n^{n+1} = \text{id}_n. \quad (18)$$

The condition (18) is called the *cocyclicity* condition.

Denote by ΔC^{op} the category opposite to ΔC . When considered as morphisms in ΔC^{op} , every coface $\delta_i^n: n-1 \rightarrow n$, every codegeneracy $\sigma_j^n: n+1 \rightarrow n$, and every cocyclic operator $\tau_n: n \rightarrow n$ are respectively denoted by

$$d_i^n: n \rightarrow n-1, \quad s_j^n: n \rightarrow n+1 \quad \text{and} \quad t_n: n \rightarrow n.$$

I.2.2. Remark. The relation (15) is a consequence of Relations (18) and (14). Similarly, the relation (17) is a consequence of Relations (18) and (16).

I.2.3. Cyclic objects. A *cyclic object* in \mathcal{C} is a functor $X: \Delta C^{\text{op}} \rightarrow \mathcal{C}$. A morphism between two cyclic objects X and Y in a category \mathcal{C} is a natural transformation α from X to Y . Cyclic objects and morphisms in \mathcal{C} form a category, which is denoted by $[\Delta C^{\text{op}}, \mathcal{C}]$. Often, we will denote the image $X(\phi)$ of a morphism ϕ in ΔC^{op} under functor X from $[\Delta C^{\text{op}}, \mathcal{C}]$ by ϕ .

More explicitly, a cyclic object X in \mathcal{C} can be described as a family $\{X_n\}_{n \in \mathbb{N}}$ of objects of \mathcal{C} equipped for $n \in \mathbb{N}^*$ with morphisms $\{d_i: X_n \rightarrow X_{n-1}\}_{0 \leq i \leq n}$, called *faces*, for $n \in \mathbb{N}$ with morphisms $\{s_j: X_n \rightarrow X_{n+1}\}_{0 \leq j \leq n}$, called *degeneracies*, and with morphisms $t_n: X_n \rightarrow X_n$, called *cyclic operators*, which satisfy Relations (4)-(6),

$$d_i t_n = t_{n-1} d_{i-1} \quad \text{for } 1 \leq i \leq n, \quad (19)$$

$$d_0 t_n = d_n, \quad (20)$$

$$s_i t_n = t_{n+1} s_{i-1} \quad \text{for } 1 \leq i \leq n, \quad (21)$$

$$s_0 t_n = t_{n+1}^2 s_n \quad (22)$$

and the following *cyclicity* condition:

$$t_n^{n+1} = \text{id}_{X_n}. \quad (23)$$

In this characterization, a morphism between two cyclic objects X and Y in \mathcal{C} is described by a family $\{\alpha_n: X_n \rightarrow Y_n\}_{n \in \mathbb{N}}$ of morphisms in \mathcal{C} such that (7), (8), and

$$\alpha_n t_n = t_n \alpha_n \quad (24)$$

holds for any $n \in \mathbb{N}$.

I.2.4. Cocyclic objects. A *cocyclic object* in \mathcal{C} is a functor $F: \Delta C \rightarrow \mathcal{C}$. A morphism between two cocyclic objects F and G in a category \mathcal{C} is a natural transformation α from F to G . Cocyclic objects and morphisms in \mathcal{C} form a category, which is denoted by $[\Delta C, \mathcal{C}]$. Often, we will denote the image $F(\phi)$ of a morphism ϕ in ΔC under the functor F from $[\Delta C, \mathcal{C}]$ by ϕ .

More explicitly, a cocyclic object in \mathcal{C} can be described as a family $\{F_n\}_{n \in \mathbb{N}}$ of objects of \mathcal{C} , equipped for $n \in \mathbb{N}^*$ with morphisms $\{\delta_i: F_{n-1} \rightarrow F_n\}_{0 \leq i \leq n}$, called *cofaces*, and for $n \in \mathbb{N}$ with morphisms $\{\sigma_j: F_{n+1} \rightarrow F_n\}_{0 \leq j \leq n}$, called *codegeneracies*, and $\tau_n: F_n \rightarrow F_n$, called *cocyclic operators*, which satisfy Relations (9)-(11),

$$\tau_n \delta_i = \delta_{i-1} \tau_{n-1} \quad \text{for } 1 \leq i \leq n, \quad (25)$$

$$\tau_n \delta_0 = \delta_n, \quad (26)$$

$$\tau_n \sigma_i = \sigma_{i-1} \tau_{n+1} \quad \text{for } 1 \leq i \leq n, \quad (27)$$

$$\tau_n \sigma_0 = \sigma_n \tau_{n+1}^2 \quad \text{and} \quad (28)$$

$$\tau_n^{n+1} = \text{id}_{F_n}. \quad (29)$$

In this characterization, a morphism of cocyclic objects F and G in \mathcal{C} is seen as a family $\{\beta_n: F_n \rightarrow G_n\}_{n \in \mathbb{N}}$ of morphisms in \mathcal{C} satisfying (12), (13), and

$$\beta_n \tau_n = \tau_n \beta_n \quad (30)$$

for any $n \in \mathbb{N}$.

I.3. Paracyclic objects

In this section we recall the notion of para(co)cyclic objects in a category \mathcal{C} .

I.3.1. The paracyclic category. The *paracyclic category* ΔC_∞ is defined as follows. The objects of ΔC_∞ are the nonnegative integers $n \in \mathbb{N}$. The morphisms in ΔC_∞ are generated by cofaces $\{\delta_i\}_{0 \leq i \leq n, n \in \mathbb{N}^*}$, codegeneracies $\{\sigma_j\}_{0 \leq j \leq n, n \in \mathbb{N}}$, and the family of isomorphisms $\{\tau_n: n \rightarrow n\}_{n \geq 0}$, called *paracyclic operators*, subject to relations (1)-(3) and (14)-(17). Note that one does not require (18) to hold.

Denote by $\Delta C_\infty^{\text{op}}$ the category opposite to ΔC_∞ . When considered as morphisms in $\Delta C_\infty^{\text{op}}$, every coface $\delta_i: n-1 \rightarrow n$, every codegeneracy $\sigma_j: n+1 \rightarrow n$ and every paracyclic operator $\tau_n: n \rightarrow n$ are respectively denoted by

$$d_i: n \rightarrow n-1, \quad s_j: n+1 \rightarrow n \quad \text{and} \quad t_n: n \rightarrow n.$$

I.3.2. Paracyclic objects. A *paracyclic object* in \mathcal{C} is a functor $X: \Delta C_\infty^{\text{op}} \rightarrow \mathcal{C}$. A morphism between two paracyclic objects X and Y in \mathcal{C} is a natural transformation between them. Paracyclic objects in \mathcal{C} and morphisms between them form the category denoted by $[\Delta C_\infty^{\text{op}}, \mathcal{C}]$. We will often denote the image $X(\phi)$ of morphism ϕ in $\Delta C_\infty^{\text{op}}$ under functor X from $[\Delta C_\infty^{\text{op}}, \mathcal{C}]$ by ϕ .

A paracyclic object X in \mathcal{C} can be explicitly described as a family $\{X_n\}_{n \in \mathbb{N}}$ of objects of \mathcal{C} equipped for any $n \in \mathbb{N}^*$ with morphisms $\{d_i: X_n \rightarrow X_{n-1}\}_{0 \leq i \leq n}$, called *faces*, for any $n \in \mathbb{N}$ with morphisms $\{s_j: X_n \rightarrow X_{n+1}\}_{0 \leq j \leq n}$, called *degeneracies*, and *isomorphisms* $t_n: X_n \rightarrow X_n$, called *paracyclic operators*, which satisfy Relations (4)-(6) and (19)-(22). Note that here we do not require the cyclicity condition (23) to hold. In this characterization, a morphism between two paracyclic objects X and Y in \mathcal{C} is a family $\{\alpha_n: X_n \rightarrow Y_n\}_{n \in \mathbb{N}}$ of morphisms in \mathcal{C} satisfying (7), (8) and (24).

Let X_\bullet be a paracyclic object in \mathcal{C} , equipped with faces $\{d_i^n\}_{0 \leq i \leq n, n \in \mathbb{N}^*}$, degeneracies $\{s_j^n\}_{0 \leq j \leq n, n \in \mathbb{N}}$ and paracyclic operators $\{t_n\}_{n \in \mathbb{N}}$. If $F: \mathcal{C} \rightarrow \mathcal{D}$ is a functor, then $F(X_\bullet) = \{F(X_n)\}_{n \in \mathbb{N}}$ is a paracyclic object in \mathcal{D} . The faces, degeneracies and the paracyclic operators of $F(X_\bullet)$ are given by $\{F(d_i^n)\}_{0 \leq i \leq n, n \in \mathbb{N}^*}$, $\{F(s_j^n)\}_{0 \leq j \leq n, n \in \mathbb{N}}$ and $\{F(t_n)\}_{n \in \mathbb{N}}$, respectively.

The following lemma offers a useful way of passing from paracyclic object to a (co)cyclic module. The notions of \mathbb{k} -linear categories and braided categories with a twist are recalled in Section II.1.

Lemma I.1. *If \mathcal{B} is a \mathbb{k} -linear braided category with a twist θ and if $X_\bullet = \{X_n\}_{n \in \mathbb{N}}$ is a paracyclic object in \mathcal{B} such that its paracyclic operator satisfies $t_n^{n+1} = (\theta_{X_n})^{-1}$ for each $n \in \mathbb{N}$, then*

- a) $\text{Hom}_{\mathcal{B}}(\mathbb{1}, X_\bullet) = \{\text{Hom}_{\mathcal{B}}(\mathbb{1}, X_n)\}_{n \in \mathbb{N}}$ is a cyclic \mathbb{k} -module,
- b) $\text{Hom}_{\mathcal{B}}(X_\bullet, \mathbb{1}) = \{\text{Hom}_{\mathcal{B}}(X_n, \mathbb{1})\}_{n \in \mathbb{N}}$ is a cocyclic \mathbb{k} -module.

The statement of Lemma I.1 is dual to the one of Lemma I.2, which is proven in Section I.3.3.

I.3.3. Paracocyclic objects. A *paracocyclic* object in \mathcal{C} is a functor $F: \Delta C_\infty \rightarrow \mathcal{C}$. A morphism between paracocyclic objects is a natural transformation between them. Paracocyclic objects and morphisms in \mathcal{C} form a category denoted by $[\Delta C_\infty, \mathcal{C}]$. Often, we will denote the image $F(\phi)$ of a morphism ϕ in ΔC_∞ under functor F from $[\Delta C_\infty, \mathcal{C}]$ by ϕ .

A paracocyclic object F in \mathcal{C} may be described more explicitly as a family $F = \{F_n\}_{n \in \mathbb{N}}$ of objects of \mathcal{C} equipped for $n \in \mathbb{N}^*$ with morphisms $\{\delta_i: F_{n-1} \rightarrow F_n\}_{0 \leq i \leq n}$, called *cofaces*, for $n \in \mathbb{N}$ with morphisms $\{\sigma_j: F_{n+1} \rightarrow F_n\}_{0 \leq j \leq n}$, called *codegeneracies*, and isomorphisms $\tau_n: F_n \rightarrow F_n$, called *paracyclic operators*, satisfying (9)-(11) and (25)-(28). Note that we require only that $\tau_n: F_n \rightarrow F_n$ is an isomorphism in \mathcal{C} , but we do not demand the cocyclicity relation (29) to hold. In this characterization, a morphism between two paracocyclic objects F and G in \mathcal{C} is a family $\{\beta_n: F_n \rightarrow G_n\}_{n \in \mathbb{N}}$ of morphisms in \mathcal{C} satisfying (12), (13), and (30).

Let Y_\bullet be a paracocyclic object in \mathcal{C} , equipped with cofaces $\{\delta_i^n\}_{0 \leq i \leq n, n \in \mathbb{N}^*}$, codegeneracies $\{\sigma_j^n\}_{0 \leq j \leq n, n \in \mathbb{N}}$ and paracyclic operators $\{\tau_n\}_{n \in \mathbb{N}}$. If $F: \mathcal{C} \rightarrow \mathcal{D}$ is a functor, then $F(Y_\bullet) = \{F(Y_n)\}_{n \in \mathbb{N}}$ is a paracyclic object in \mathcal{D} . The cofaces, codegeneracies and the paracyclic operators of $F(Y_\bullet)$ are given by $\{F(\delta_i^n)\}_{0 \leq i \leq n, n \in \mathbb{N}^*}$, $\{F(\sigma_j^n)\}_{0 \leq j \leq n, n \in \mathbb{N}}$ and $\{F(\tau_n)\}_{n \in \mathbb{N}}$, respectively.

The following lemma offers a useful way of passing from paracyclic object to a (co)cyclic module.

Lemma I.2. *Let \mathcal{B} be a \mathbb{k} -linear braided category with a twist θ . If $Y_\bullet = \{Y_n\}_{n \in \mathbb{N}}$ is a paracyclic object in \mathcal{B} such that its paracyclic operator satisfies $\tau_n^{n+1} = \theta_{Y_n}$ for each $n \in \mathbb{N}$, then*

- a) $\text{Hom}_{\mathcal{B}}(\mathbb{1}, Y_\bullet) = \{\text{Hom}_{\mathcal{B}}(\mathbb{1}, Y_n)\}_{n \in \mathbb{N}}$ is a cocyclic \mathbb{k} -module,
- b) $\text{Hom}_{\mathcal{B}}(Y_\bullet, \mathbb{1}) = \{\text{Hom}_{\mathcal{B}}(Y_n, \mathbb{1})\}_{n \in \mathbb{N}}$ is a cyclic \mathbb{k} -module.

PROOF. We prove only the part a), since the same arguments applies for b). The family $\{\text{Hom}_{\mathcal{B}}(\mathbb{1}, Y_n)\}_{n \in \mathbb{N}}$ has a priori a structure of a paracyclic \mathbb{k} -module. Indeed, it can be seen as the composite of functors $Y_\bullet: \Delta C_\infty \rightarrow \mathcal{B}$ and $\text{Hom}(\mathbb{1}, -): \mathcal{B} \rightarrow \text{Mod}_{\mathbb{k}}$. In order to show that it is a cocyclic \mathbb{k} -module, it remains to show the relation (29). For any $n \in \mathbb{N}$, by functoriality and the hypothesis that $Y_\bullet(\tau_n^{n+1}) = \theta_{Y_n}$ we have

$$(\text{Hom}_{\mathcal{B}}(\mathbb{1}, Y_\bullet)(\tau_n))^{n+1} = \text{Hom}_{\mathcal{B}}(\mathbb{1}, -)(Y_\bullet(\tau_n^{n+1})) = \text{Hom}_{\mathcal{B}}(\mathbb{1}, -)(\theta_{Y_n}).$$

In order to show that the relation (29) holds, we shall check that

$$(\text{Hom}_{\mathcal{B}}(\mathbb{1}, Y_\bullet)(\tau_n))^{n+1} = \text{id}_{\text{Hom}_{\mathcal{B}}(\mathbb{1}, Y_n)}.$$

Consequently, it suffices to prove that $\text{Hom}_{\mathcal{B}}(\mathbb{1}, -)(\theta_{Y_n})$ is exactly the identity morphism of $\text{Hom}_{\mathcal{B}}(\mathbb{1}, Y_n)$. Indeed, $\text{Hom}_{\mathcal{B}}(\mathbb{1}, -)(\theta_{Y_n}): \text{Hom}_{\mathcal{B}}(\mathbb{1}, Y_n) \rightarrow \text{Hom}_{\mathcal{B}}(\mathbb{1}, Y_n)$ is a \mathbb{k} -linear morphism given by $f \mapsto \theta_{Y_n} f$. By naturality of twist θ and the fact that $\theta_{\mathbb{1}} = \text{id}_{\mathbb{1}}$, we have $\theta_{Y_n} f = f \theta_{\mathbb{1}} = f$ for any $f \in \text{Hom}_{\mathcal{B}}(\mathbb{1}, Y_n)$. So $\text{Hom}_{\mathcal{B}}(\mathbb{1}, -)(\theta_{Y_n}) = \text{id}_{\text{Hom}_{\mathcal{B}}(\mathbb{1}, Y_n)}$. \square

I.4. Some relevant functors related to the (para)cyclic category

In this section, we recall the cyclic duality $\Delta C^{\text{op}} \cong \Delta C$ and some functors related to (para)cyclic category. These will be of much use in Chapters III, VI and VII.

I.4.1. (Para)cyclic and (para)cocyclic duals. Connes established in [6] an isomorphism between categories

$$\Delta C \cong \Delta C^{\text{op}},$$

called *cyclic duality*. The key ingredient of proof in [28] is the existence of the so called *extra degeneracies*, which relies only on the invertibility of (co)cyclic operators. Therefore, the cyclic duality descends to the paracyclic category:

$$\Delta C_{\infty} \cong \Delta C_{\infty}^{\text{op}}.$$

Remark I.3. (1) This property does not hold for the simplicial category Δ and its opposite Δ^{op} . For example, the sets $\text{Hom}_{\Delta}(1, 0)$ and $\text{Hom}_{\Delta^{\text{op}}}(1, 0)$ do not have same cardinality.

(2) Let $\Delta C'_{\infty}$ be the category defined as ΔC_{∞} in Section I.3.1, but by asking *only* (14)-(17) and (19)-(22) to hold. In $\Delta C'_{\infty}$, the condition of invertibility of para(co)cyclic operators is dropped. In this case, $\Delta C'_{\infty} \not\cong \Delta C'_{\infty}{}^{\text{op}}$, as pointed out in [2].

Let \mathcal{C} be a category and let functors $E: \Delta C \rightarrow \Delta C^{\text{op}}$ and $E': \Delta C^{\text{op}} \rightarrow \Delta C$ be isomorphisms of categories. Given a cyclic object X in \mathcal{C} , $X \circ E$ is a cocyclic object in \mathcal{C} . We call $X \circ E$ the *cocyclic dual* of X with respect to E . Similarly, given a cocyclic object Y in \mathcal{C} , $Y \circ E'$ is a cyclic object in \mathcal{C} . We call $Y \circ E'$ the *cyclic dual* of Y . Similar definitions apply for isomorphisms between ΔC_{∞} and $\Delta C_{\infty}^{\text{op}}$.

I.4.2. The Connes-Loday duality. In this section, we recall the definition of the functor $L: \Delta C^{\text{op}} \rightarrow \Delta C$ from [28]. It is identity on objects and it is defined on morphisms as follows. For $n \geq 1$ and $0 \leq i \leq n$, define

$$L(d_i^n) = \begin{cases} \sigma_i^{n-1} & \text{if } 0 \leq i \leq n-1, \\ \sigma_0^{n-1} \tau_n^{-1} & \text{if } i = n. \end{cases}$$

For $n \geq 0$ and $0 \leq j \leq n$, define

$$L(s_j^n) = \delta_{j+1}^{n+1}$$

and for $n \geq 0$, set

$$L(t_n) = \tau_n^{-1}.$$

We outline the definition of the inverse $M: \Delta C \rightarrow \Delta C^{\text{op}}$ of the functor L . It is identity on objects and it is defined on morphisms as follows. For $n \geq 1$ and $0 \leq i \leq n$, define

$$M(\delta_i^n) = \begin{cases} t_n s_{n-1}^{n-1} & \text{for } i = 0, \\ s_{i-1}^{n-1} & \text{for } 1 \leq i \leq n. \end{cases}$$

For $n \geq 0$ and $0 \leq j \leq n$, define

$$M(\sigma_j^n) = d_j^{n+1}$$

and for $n \geq 0$, set

$$M(\tau_n) = t_n^{-1}.$$

The same formulas apply to the paracyclic case.

I.4.3. The functors L^{op} and M^{op} . In this section, we explicit the mutually inverse functors $L^{\text{op}}: \Delta C \rightarrow \Delta C^{\text{op}}$ and $M^{\text{op}}: \Delta C^{\text{op}} \rightarrow \Delta C$ which will be used in the Chapters III, VI, and VII.

The functor $L^{\text{op}}: \Delta C \rightarrow \Delta C^{\text{op}}$ is given as follows. It is identity on objects. For $n \geq 1$ and $0 \leq i \leq n$, set

$$L^{\text{op}}(\delta_i^n) = \begin{cases} s_i^{n-1} & \text{if } 0 \leq i \leq n-1, \\ t_n^{-1} s_0^{n-1} & \text{if } i = n. \end{cases}$$

For $n \geq 0$ and $0 \leq j \leq n$, set

$$L^{\text{op}}(\sigma_j^n) = d_{j+1}^{n+1},$$

and for $n \geq 0$, set

$$L^{\text{op}}(\tau_n) = t_n^{-1}.$$

The functor $M^{\text{op}}: \Delta C^{\text{op}} \rightarrow \Delta C$ is given as follows. It is identity on objects. For $n \geq 1$ and $0 \leq i \leq n$, set

$$M^{\text{op}}(d_i^n) = \begin{cases} \sigma_{n-1}^{n-1} \tau_n & \text{if } i = 0, \\ \sigma_{i-1}^{n-1} & \text{if } 1 \leq i \leq n. \end{cases}$$

For $n \geq 0$ and $0 \leq j \leq n$, set

$$M^{\text{op}}(s_j^n) = \delta_j^{n+1},$$

and for $n \geq 0$, set

$$M^{\text{op}}(t_n) = \tau_n^{-1}.$$

The same formulas apply to the paracyclic case.

I.4.4. Some automorphisms of the (para)cyclic category. In this section, we define particular automorphisms of ΔC and ΔC^{op} . First, we recall the automorphism Φ of the cyclic category, which introduced in [28]. It sends n to n for each $n \in \mathbb{N}$ and it is given by

$$\begin{aligned} \delta_i^n &\mapsto \delta_{n-i}^n & \text{for } n \geq 1 \text{ and } 0 \leq i \leq n, \\ \sigma_j^n &\mapsto \sigma_{n-j}^n & \text{for } n \geq 0 \text{ and } 0 \leq j \leq n, \\ \tau_n &\mapsto \tau_n^{-1} & \text{for } n \geq 0 \end{aligned}$$

on morphisms. It follows by definition that Φ is involutive. We sometimes refer to Φ as reindexing involution automorphism. Second, consider the automorphism $\Psi: \Delta C^{\text{op}} \rightarrow \Delta C^{\text{op}}$, which is defined as follows. It sends n to n for each $n \in \mathbb{N}$ and it is given by

$$\begin{aligned} d_i^n &\mapsto \begin{cases} d_{n-i-1}^n & \text{for } 0 \leq i \leq n-1, \\ d_{n-1}^n t_n^{-1} & \text{for } i = n, \end{cases} \\ s_j^n &\mapsto \begin{cases} s_{n-j-1}^n & \text{for } 0 \leq i \leq n-1, \\ t_{n+1} s_n^n & \text{for } j = n, \end{cases} \\ t_n &\mapsto t_n^{-1} & \text{for } n \geq 0 \end{aligned}$$

on morphisms. Note that it follows by definition that Ψ is involutive. The same definitions apply to the paracyclic category ΔC_∞ .

I.5. The (co)chain complexes and (co)simplicial objects

In this section we briefly recall the standard constructions of (co)chain complexes associated to (co)simplicial objects in an abelian category \mathcal{A} .

I.5.1. The categories of chain and cochain complexes. The category $\mathbf{Ch}(\mathcal{A})$ of *chain complexes* in \mathcal{A} is defined as follows. The objects are pairs

$$(\{X_n\}_{n \in \mathbb{N}}, \{b_n: X_n \rightarrow X_{n-1}\}_{n \in \mathbb{N}^*}),$$

where X_n is an object of \mathcal{A} for any $n \in \mathbb{N}$ and the equation $b_n b_{n+1} = 0$ holds for any $n \in \mathbb{N}^*$. A morphism $f: (X, b) \rightarrow (X', b')$ is given by a family $f = \{f_n: X_n \rightarrow X'_n\}_{n \in \mathbb{N}}$ such that $b'_n f_n = f_{n-1} b_n$ for each $n \in \mathbb{N}^*$. The category $\mathbf{coCh}(\mathcal{A})$ of *cochain complexes* in \mathcal{A} is defined as $\mathbf{Ch}(\mathcal{A}^{\text{op}})$.

I.5.2. A (co)chain complex associated to a (co)simplicial object. To a simplicial object X in \mathcal{A} one can associate the chain complex

$$(\{X_n\}_{n \in \mathbb{N}}, \{b_n = \sum_{i=0}^n (-1)^i d_i: X_n \rightarrow X_{n-1}\}_{n \in \mathbb{N}^*}).$$

This construction is functorial, i.e., it extends to a functor $[\Delta^{\text{op}}, \mathcal{A}] \rightarrow \mathbf{Ch}(\mathcal{A})$.

To a cosimplicial object F in \mathcal{A} one can associate the cochain complex

$$(\{F_n\}_{n \in \mathbb{N}}, \{\beta_n = \sum_{i=0}^n (-1)^i \delta_i: F_{n-1} \rightarrow F_n\}_{n \in \mathbb{N}^*}).$$

This construction is functorial, i.e., it extends to a functor $[\Delta, \mathcal{A}] \rightarrow \mathbf{coCh}(\mathcal{A})$.

I.6. The (co)chain bicomplexes and (co)cyclic objects

In this section we briefly recall the standard constructions of (co)chain bicomplexes associated to (co)cyclic objects in an abelian category \mathcal{A} . These permit one to define (co)cyclic homology of a (co)cyclic object in an abelian category.

I.6.1. The categories of (co)chain bicomplexes. For an abelian category \mathcal{A} , the category of chain complexes $\mathbf{Ch}(\mathcal{A})$ is also abelian (see [38]). Furthermore, the category \mathcal{A}^{op} is also an abelian category. These facts allow to iterate the definitions given in Section I.5.1. The category $\mathbf{BiCh}(\mathcal{A})$ of *chain bicomplexes* in \mathcal{A} is defined as $\mathbf{Ch}(\mathbf{Ch}(\mathcal{A}))$. The category $\mathbf{BicoCh}(\mathcal{A})$ of *cochain bicomplexes* in \mathcal{A} is defined as $\mathbf{coCh}(\mathbf{coCh}(\mathcal{A}))$.

More explicitly, a *chain bicomplex* in \mathcal{A} may be seen as a triple $C = (C_{\bullet\bullet}, d_{\bullet\bullet}^h, d_{\bullet\bullet}^v)$, where $C_{\bullet\bullet} = \{C_{p,q}\}_{p,q \in \mathbb{N}}$ is a family of objects in \mathcal{A} and

$$\{d_{p,q}^h: C_{p,q} \rightarrow C_{p-1,q}\}_{p \in \mathbb{N}^*} \quad \text{and} \quad \{d_{p,q}^v: C_{p,q} \rightarrow C_{p,q-1}\}_{q \in \mathbb{N}^*},$$

are two families of morphisms in \mathcal{A} such that:

- (1) $d_{p,q}^h d_{p+1,q}^h = 0$ for all $p \in \mathbb{N}^*$ and $q \in \mathbb{N}$,
- (2) $d_{p,q}^v d_{p,q+1}^v = 0$ for all $p \in \mathbb{N}$ and $q \in \mathbb{N}^*$,
- (3) $d_{p,q+1}^v d_{p+1,q+1}^h = d_{p+1,q}^h d_{p+1,q+1}^v$ for all $p, q \in \mathbb{N}$.

The morphisms $d_{p,q}^h$ and $d_{p,q}^v$ are called *horizontal* and *vertical differentials*, respectively. We often visualize a chain bicomplex as the lattice given in the Figure 1.

Similarly, a *cochain bicomplex* in \mathcal{A} may be described as a triple $C = (C_{\bullet\bullet}, \delta_{\bullet\bullet}^h, \delta_{\bullet\bullet}^v)$, where $C_{\bullet\bullet} = \{C_{p,q}\}_{p,q \in \mathbb{N}}$ is a family of objects in \mathcal{A} and

$$\{\delta_{p,q}^h: C_{p-1,q} \rightarrow C_{p,q}\}_{p \in \mathbb{N}^*} \quad \text{and} \quad \{\delta_{p,q}^v: C_{p,q-1} \rightarrow C_{p,q}\}_{q \in \mathbb{N}^*},$$

$$\begin{array}{ccccccc}
 \vdots & & \vdots & & \vdots & & \\
 \downarrow d^v & & \downarrow d^v & & \downarrow d^v & & \\
 C_{0,2} & \xleftarrow{d^h} & C_{1,2} & \xleftarrow{d^h} & C_{2,2} & \xleftarrow{d^h} & \dots \\
 \downarrow d^v & & \downarrow d^v & & \downarrow d^v & & \\
 C_{0,1} & \xleftarrow{d^h} & C_{1,1} & \xleftarrow{d^h} & C_{2,1} & \xleftarrow{d^h} & \dots \\
 \downarrow d^v & & \downarrow d^v & & \downarrow d^v & & \\
 C_{0,0} & \xleftarrow{d^h} & C_{1,0} & \xleftarrow{d^h} & C_{2,0} & \xleftarrow{d^h} & \dots
 \end{array}$$

 FIGURE 1. The diagram of chain bicomplex $C = (C_{\bullet\bullet}, d_{\bullet\bullet}^h, d_{\bullet\bullet}^v)$.

are two families of morphisms in \mathcal{A} such that:

- (1) $\delta_{p+1,q}^h \delta_{p,q}^h = 0$ for all $p \in \mathbb{N}^*$ and $q \in \mathbb{N}$,
- (2) $\delta_{p,q+1}^v \delta_{p,q}^v = 0$ for all $p \in \mathbb{N}$ and $q \in \mathbb{N}^*$,
- (3) $\delta_{p+1,q+1}^h \delta_{p,q+1}^v = \delta_{p+1,q+1}^v \delta_{p+1,q}^h$ for all $p, q \in \mathbb{N}$.

The morphisms $\delta_{p,q}^h$ and $\delta_{p,q}^v$ are still called *horizontal* and *vertical differentials*, respectively. We often visualize a cochain bicomplex as the lattice given in the Figure 2.

$$\begin{array}{ccccccc}
 \vdots & & \vdots & & \vdots & & \\
 \uparrow \delta^v & & \uparrow \delta^v & & \uparrow \delta^v & & \\
 C_{0,2} & \xrightarrow{\delta^h} & C_{1,2} & \xrightarrow{\delta^h} & C_{2,2} & \xrightarrow{\delta^h} & \dots \\
 \uparrow \delta^v & & \uparrow \delta^v & & \uparrow \delta^v & & \\
 C_{0,1} & \xrightarrow{\delta^h} & C_{1,1} & \xrightarrow{\delta^h} & C_{2,1} & \xrightarrow{\delta^h} & \dots \\
 \uparrow \delta^v & & \uparrow \delta^v & & \uparrow \delta^v & & \\
 C_{0,0} & \xrightarrow{\delta^h} & C_{1,0} & \xrightarrow{\delta^h} & C_{2,0} & \xrightarrow{\delta^h} & \dots
 \end{array}$$

 FIGURE 2. The diagram of cochain bicomplex $C = (C_{\bullet\bullet}, \delta_{\bullet\bullet}^h, \delta_{\bullet\bullet}^v)$.

I.6.2. A (co)chain bicomplex and (co)cyclic homology. To any cyclic object X of an abelian category \mathcal{A} is associated a chain bicomplex as follows. Define

$$\begin{aligned}
 b'_n &= \sum_{i=0}^{n-1} (-1)^i d_i: X_n \rightarrow X_{n-1} \quad \text{for } n \geq 1 \quad \text{and} \\
 N_n &= \sum_{i=0}^n (-1)^{in} t_n^i: X_n \rightarrow X_n \quad \text{for } n \geq 0.
 \end{aligned}$$

These morphisms satisfy the following equations:

$$b'_n b'_{n+1} = 0 \quad \text{for } n \geq 1, \quad (31)$$

$$(\text{id}_{X_n} - (-1)^n t_n) N_n = 0 \quad \text{for } n \geq 0, \quad (32)$$

$$N_n (\text{id}_{X_n} - (-1)^n t_n) = 0 \quad \text{for } n \geq 0, \quad (33)$$

$$N_{n-1} b_n = b'_n N_n \quad \text{for } n \geq 1, \quad (34)$$

$$b_n (\text{id}_{X_n} - (-1)^n t_n) = (\text{id}_{X_{n-1}} + (-1)^n t_{n-1}) b'_n \quad \text{for } n \geq 1. \quad (35)$$

By using the equations (31)-(35), we associate to X the following chain bicomplex:

$$\begin{array}{ccccccc}
\vdots & & \vdots & & \vdots & & \vdots \\
\downarrow b_3 & & \downarrow -b'_3 & & \downarrow b_3 & & \downarrow -b'_3 \\
X_2 & \xleftarrow{\text{id}_{X_2} - t_2} & X_2 & \xleftarrow{N_2} & X_2 & \xleftarrow{\text{id}_{X_2} - t_2} & X_2 \xleftarrow{N_2} \dots \\
\downarrow b_2 & & \downarrow -b'_2 & & \downarrow b_2 & & \downarrow -b'_2 \\
X_1 & \xleftarrow{\text{id}_{X_1} + t_1} & X_1 & \xleftarrow{N_1} & X_1 & \xleftarrow{\text{id}_{X_1} + t_1} & X_1 \xleftarrow{N_1} \dots \\
\downarrow b_1 & & \downarrow -b'_1 & & \downarrow b_1 & & \downarrow -b'_1 \\
X_0 & \xleftarrow{\text{id}_{X_0} - t_0} & X_0 & \xleftarrow{N_0} & X_0 & \xleftarrow{\text{id}_{X_0} - t_0} & X_0 \xleftarrow{N_0} \dots
\end{array}$$

By following the notations as in the Figure 1, $C_{p,q} = X_q$ for $p, q \in \mathbb{N}$. This construction is functorial, i.e., it extends to a functor $[\Delta C^{\text{op}}, \mathcal{A}] \rightarrow \mathbf{BiCh}(\mathcal{A})$.

To any cocyclic object F of an abelian category \mathcal{A} is associated a cochain bicomplex as follows. Define

$$\beta'_n = \sum_{i=0}^{n-1} (-1)^i \delta_i: F_{n-1} \rightarrow F_n \quad \text{for } n \geq 1 \quad \text{and}$$

$$\hat{N}_n = \sum_{i=0}^n (-1)^{in} \tau_n^i: F_n \rightarrow F_n \quad \text{for } n \geq 0.$$

These morphisms satisfy the following equations:

$$\beta'_{n+1} \beta'_n = 0 \quad \text{for } n \geq 1, \quad (36)$$

$$(\text{id}_{F_n} - (-1)^n \tau_n) \hat{N}_n = 0 \quad \text{for } n \geq 0, \quad (37)$$

$$\hat{N}_n (\text{id}_{F_n} - (-1)^n \tau_n) = 0 \quad \text{for } n \geq 0, \quad (38)$$

$$\beta_n \hat{N}_{n-1} = \hat{N}_n \beta'_n \quad \text{for } n \geq 1, \quad (39)$$

$$\beta'_n (\text{id}_{F_{n-1}} + (-1)^n \tau_{n-1}) = (\text{id}_{F_n} - (-1)^n \tau_n) \beta_n \quad \text{for } n \geq 1. \quad (40)$$

By using the equations (36)-(40), we associate to F the following cochain bicomplex:

$$\begin{array}{ccccccc}
 \vdots & & \vdots & & \vdots & & \vdots \\
 \uparrow \beta_3 & & \uparrow -\beta'_3 & & \uparrow \beta_3 & & \uparrow -\beta'_3 \\
 F_2 & \xrightarrow{\text{id}_{F_2} - \tau_2} & F_2 & \xrightarrow{\hat{N}_2} & F_2 & \xrightarrow{\text{id}_{F_2} - \tau_2} & F_2 \xrightarrow{\hat{N}_2} \dots \\
 \uparrow \beta_2 & & \uparrow -\beta'_2 & & \uparrow \beta_2 & & \uparrow -\beta'_2 \\
 F_1 & \xrightarrow{\text{id}_{F_1} + \tau_1} & F_1 & \xrightarrow{\hat{N}_1} & F_1 & \xrightarrow{\text{id}_{F_1} + \tau_1} & F_1 \xrightarrow{\hat{N}_1} \dots \\
 \uparrow \beta_1 & & \uparrow -\beta'_1 & & \uparrow \beta_1 & & \uparrow -\beta'_1 \\
 F_0 & \xrightarrow{\text{id}_{F_0} - \tau_0} & F_0 & \xrightarrow{\hat{N}_0} & F_0 & \xrightarrow{\text{id}_{F_0} - \tau_0} & F_0 \xrightarrow{\hat{N}_0} \dots
 \end{array}$$

By following the notations as in the Figure 2, $C_{p,q} = F_q$ for $p, q \in \mathbb{N}$. This construction is functorial, i.e., it extends to a functor $[\Delta C, \mathcal{A}] \rightarrow \mathbf{BicoCh}(\mathcal{A})$.

I.6.3. Hochschild and cyclic homology. Given a cyclic object X in \mathcal{A} , its n -th *cyclic homology* $HC_n(X)$ is the n -th homology of the total complex of the associated chain bicomplex. Its n -th *Hochschild homology* $HH_n(X)$ is the n -th homology of a chain complex associated to the underlying simplicial object in \mathcal{A} .

Similarly, the n -th *cocyclic homology* $HC^n(F)$ of a cocyclic object F in \mathcal{A} is the n -th cohomology of the total complex of the associated cochain bicomplex. Its n -th *Hochschild cohomology* $HH^n(F)$ is the n -th cohomology of a cochain complex associated to the underlying cosimplicial object in \mathcal{A} .

One of the fundamental relations between the cyclic and Hochschild homology is the Connes' long periodicity exact sequence:

Theorem I.4 ([38, Proposition 9.6.11]). *We have:*

(1) *If X is a cyclic object in \mathcal{A} , then there is a long exact sequence*

$$\dots \longrightarrow HH_n(X) \longrightarrow HC_n(X) \longrightarrow HC_{n-2}(X) \longrightarrow HH_{n-1}(X) \longrightarrow \dots$$

(2) *If F is a cocyclic object in \mathcal{A} , then there is a long exact sequence*

$$\dots \longrightarrow HH^{n+1}(F) \longrightarrow HC^n(F) \longrightarrow HC^{n+2}(F) \longrightarrow HH^{n+2}(F) \longrightarrow \dots$$

Remark I.5. Recall the indexing involution $\Phi: \Delta C \rightarrow \Delta C$ from Section I.4.4. If X is a cyclic object in \mathcal{A} , then cyclic homology of X equals to cyclic homology of $X \circ \Phi^{\text{op}}$. Namely, chain complexes associated to $X \circ \Phi^{\text{op}}$ and X are equal. Thus, $HH_n(X \circ \Phi^{\text{op}}) = HH_n(X)$ for any n . By the well-known 5-Lemma (see [38]) and part 1 of Theorem I.4, we get that $HC_n(X \circ \Phi^{\text{op}}) = HC_n(X)$ for any n . Similarly, if F is a cocyclic object in \mathcal{A} , cocyclic homology of F equals to cocyclic homology of $F \circ \Phi$.

CHAPTER II

Monoidal categories and braided Hopf algebras

In this chapter we recollect some facts about monoidal categories (Section II.1), categorical Hopf algebras (Section II.2), graphical calculus (Section II.1.9), and coends (Section II.3). Some acquaintance with generalities on monoidal categories is assumed. For details, one may consult [36].

II.1. Monoidal categories

For a complete definition of a monoidal category, see [26]. In this monograph, we suppress in our formulas the associativity and unitality constraints of the monoidal category. This does not lead to any ambiguity since the Mac Lane's coherence theorem (see [24]) implies that all possible ways of inserting these constraints give the same results. We will denote by \otimes and $\mathbb{1}$ the monoidal product and unit object of a monoidal category. For any objects X_1, \dots, X_n of a monoidal category with $n \geq 2$, we set

$$X_1 \otimes X_2 \otimes \cdots \otimes X_n = (\dots((X_1 \otimes X_2) \otimes X_3) \otimes \cdots \otimes X_{n-1}) \otimes X_n$$

and similarly for morphisms.

II.1.1. Braided categories. A *braiding* of monoidal category $(\mathcal{C}, \otimes, \mathbb{1})$ is a family $\tau = \{\tau_{U,V}: U \otimes V \rightarrow V \otimes U\}_{U,V \in \text{Ob}(\mathcal{C})}$ of natural isomorphisms such that

$$\tau_{U,V \otimes W} = (\text{id}_V \otimes \tau_{U,W})(\tau_{U,V} \otimes \text{id}_W) \text{ and} \quad (41)$$

$$\tau_{U \otimes V, W} = (\tau_{U,W} \otimes \text{id}_V)(\text{id}_U \otimes \tau_{V,W}) \quad (42)$$

for all objects U, V, W of \mathcal{C} . A *braided category* is a monoidal category endowed with a braiding.

A braiding τ of monoidal category \mathcal{C} is *symmetric* if for all objects X, Y of \mathcal{C}

$$\tau_{Y,X} \tau_{X,Y} = \text{id}_{X \otimes Y}.$$

A *symmetric category* is a monoidal category endowed with a symmetric braiding. For example, the category of left \mathbb{k} -modules is symmetric. The symmetric braiding is given by the flips

$$X \otimes_{\mathbb{k}} Y \rightarrow Y \otimes_{\mathbb{k}} X, \quad x \otimes_{\mathbb{k}} y \mapsto y \otimes_{\mathbb{k}} x$$

for all $X, Y \in \text{Ob}(\text{Mod}_{\mathbb{k}})$ and all $x \in X, y \in Y$. Here $\otimes_{\mathbb{k}}$ denotes the standard tensor product over \mathbb{k} .

II.1.2. Mirror of a braided category. Let \mathcal{C} be a braided category with a braiding τ . The *mirror* of the braiding τ is the braiding in \mathcal{C}

$$\bar{\tau} = \{\bar{\tau}_{U,V} = \tau_{V,U}^{-1}\}_{U,V \in \text{Ob}(\mathcal{C})}.$$

The braided category \mathcal{C} with the braiding $\bar{\tau}$ is called the mirror of the braided category \mathcal{C} with the braiding τ .

II.1.3. Braided categories with a twist. A *twist* for a braided monoidal category \mathcal{C} is a natural isomorphism $\theta = \{\theta_X: X \rightarrow X\}_{X \in \text{Ob}(\mathcal{C})}$ such that

$$\theta_{X \otimes Y} = \tau_{Y,X} \tau_{X,Y} (\theta_X \otimes \theta_Y) \quad (43)$$

holds for all objects X, Y of \mathcal{C} .

For example, the family $\text{id}_{\mathcal{C}} = \{\text{id}_X: X \rightarrow X\}_{X \in \text{Ob}(\mathcal{C})}$ is a twist for a \mathcal{C} if and only if \mathcal{C} is symmetric. Also, any ribbon category (see Section II.1.8) is a braided category with a twist.

II.1.4. Rigid categories. A *left duality* of an object X in a monoidal category \mathcal{C} is a pair $({}^\vee X, \text{ev}_X)$, where ${}^\vee X$ is an object in \mathcal{C} and $\text{ev}_X: {}^\vee X \otimes X \rightarrow \mathbb{1}$ is a nondegenerate pairing, i.e., there exists a morphism $\text{coev}_X: \mathbb{1} \rightarrow X \otimes {}^\vee X$ in \mathcal{C} such that

$$(\text{id}_X \otimes \text{ev}_X)(\text{coev}_X \otimes \text{id}_X) = \text{id}_X \quad \text{and} \quad (\text{ev}_X \otimes \text{id}_{{}^\vee X})(\text{id}_{{}^\vee X} \otimes \text{coev}_X) = \text{id}_{{}^\vee X}.$$

The object ${}^\vee X$ is called a *left dual of X* , ev_X and coev_X are the *left evaluation* and the *left coevaluation* respectively. A left dual of X , if it exists, is unique up to a unique isomorphism preserving the left evaluation.

A *right duality* of an object X in a monoidal category \mathcal{C} is a pair $(X^\vee, \tilde{\text{ev}}_X)$, where X^\vee is an object in \mathcal{C} , $\tilde{\text{ev}}_X: X \otimes X^\vee \rightarrow \mathbb{1}$ and is a nondegenerate pairing, i.e., there exist a morphism $\widetilde{\text{coev}}_X: \mathbb{1} \rightarrow X^\vee \otimes X$ in \mathcal{C} , such that

$$(\tilde{\text{ev}}_X \otimes \text{id}_X)(\text{id}_X \otimes \widetilde{\text{coev}}_X) = \text{id}_X \quad \text{and} \quad (\text{id}_{X^\vee} \otimes \tilde{\text{ev}}_X)(\widetilde{\text{coev}}_X \otimes \text{id}_{X^\vee}) = \text{id}_{X^\vee}.$$

The object X^\vee is called a *right dual of X* , $\tilde{\text{ev}}_X$ and $\widetilde{\text{coev}}_X$ are the *right evaluation* and the *right coevaluation* respectively. A right dual of X , if it exists, is unique up to a unique isomorphism preserving the right evaluation.

A *rigid category* is a monoidal category in which every object has a left duality and a right duality. The choice of duals defines the left and the right duality functors.

The *left duality functor* ${}^\vee?: (\mathcal{C}^{\text{op}}, \otimes^{\text{op}}, \mathbb{1}) \rightarrow (\mathcal{C}, \otimes, \mathbb{1})$ sends each object X of \mathcal{C} to its left dual ${}^\vee X$ and any morphism $f: X \rightarrow Y$ in \mathcal{C} to

$${}^\vee f = (\text{ev}_Y \otimes \text{id}_{{}^\vee X})(\text{id}_{{}^\vee Y} \otimes f \otimes \text{id}_{{}^\vee X})(\text{id}_{{}^\vee Y} \otimes \text{coev}_X): {}^\vee Y \rightarrow {}^\vee X.$$

The left duality functor is strong monoidal with monoidal constraints ${}^\vee?_0 = \text{coev}_{\mathbb{1}}: \mathbb{1} \rightarrow {}^\vee \mathbb{1}$ and ${}^\vee?_2(X, Y): {}^\vee X \otimes {}^\vee Y \rightarrow {}^\vee (Y \otimes X)$ defined by

$${}^\vee?_2(X, Y) = (\text{ev}_X \otimes \text{id}_{{}^\vee (Y \otimes X)})(\text{id}_{{}^\vee X} \otimes \text{ev}_Y \otimes \text{id}_{X \otimes {}^\vee (Y \otimes X)})(\text{id}_{{}^\vee X \otimes {}^\vee Y} \otimes \text{coev}_{Y \otimes X}).$$

The *right duality functor* $?^\vee: (\mathcal{C}^{\text{op}}, \otimes^{\text{op}}, \mathbb{1}) \rightarrow (\mathcal{C}, \otimes, \mathbb{1})$ sends each object X of \mathcal{C} to its right dual X^\vee and any morphism $f: X \rightarrow Y$ in \mathcal{C} to

$$f^\vee = (\text{id}_{X^\vee} \otimes \tilde{\text{ev}}_Y)(\text{id}_{X^\vee} \otimes f \otimes \text{id}_{Y^\vee})(\widetilde{\text{coev}}_X \otimes \text{id}_{Y^\vee}): Y^\vee \rightarrow X^\vee.$$

The right duality functor is strong monoidal with monoidal constraints $?^\vee_0 = \widetilde{\text{coev}}_{\mathbb{1}}: \mathbb{1} \rightarrow \mathbb{1}^\vee$ and $?^\vee_2(X, Y): X^\vee \otimes Y^\vee \rightarrow (Y \otimes X)^\vee$ defined by

$$?^\vee_2(X, Y) = (\text{id}_{(Y \otimes X)^\vee} \otimes \tilde{\text{ev}}_Y)(\text{id}_{(Y \otimes X)^\vee \otimes Y} \otimes \tilde{\text{ev}}_X \otimes \text{id}_{Y^\vee})(\widetilde{\text{coev}}_{Y \otimes X} \otimes \text{id}_{X^\vee \otimes Y^\vee}).$$

II.1.5. Pivotal categories. A pivotal category \mathcal{C} is a rigid category with a choice of left and right dualities of objects so that the associated left and right duality functors coincide as monoidal functors. More precisely, a *pivotal category* is a monoidal category \mathcal{C} such that any object X of \mathcal{C} is endowed with a pivotal duality, that is, a triple $(X^*, \text{ev}_X, \tilde{\text{ev}}_X)$, such that (X^*, ev_X) is a left duality, $(X^*, \tilde{\text{ev}}_X)$ is a right duality and the left and the right duality functors form the single functor $*?: (\mathcal{C}^{\text{op}}, \otimes^{\text{op}}, \mathbb{1}) \rightarrow (\mathcal{C}, \otimes, \mathbb{1})$. The functor $*?$ carries any object X of \mathcal{C} to its dual X^* and any morphism $f: X \rightarrow Y$ of \mathcal{C} is sent to the

morphism $f^* = {}^\vee f = f^\vee: Y^* \rightarrow X^*$. The functor $*?$, also called the *dual functor* of \mathcal{C} , is strong monoidal with monoidal constraints $*?_2 = {}^\vee?_2 = ?_2^\vee$ and $*?_0 = {}^\vee?_0 = ?_0^\vee$.

II.1.6. Categorical traces and dimensions. Let \mathcal{C} be a pivotal category. The *left trace* $\text{tr}_l(f)$ and the *right trace* $\text{tr}_r(f)$ of a morphism $f: X \rightarrow X$ in \mathcal{C} , are respectively defined as

$$\begin{aligned}\text{tr}_l(f) &= \text{ev}_X(\text{id}_{X^*} \otimes f)\widetilde{\text{coev}}_X \in \text{End}(\mathbb{1}) \quad \text{and} \\ \text{tr}_r(f) &= \widetilde{\text{ev}}_X(f \otimes \text{id}_{X^*})\text{coev}_X \in \text{End}(\mathbb{1}).\end{aligned}$$

The left dimension $\text{dim}_l(X)$ and the right dimension $\text{dim}_r(X)$ of an object X of \mathcal{C} , are respectively defined as

$$\text{dim}_l(X) = \text{tr}_l(\text{id}_X) \quad \text{and} \quad \text{dim}_r(X) = \text{tr}_r(\text{id}_X).$$

II.1.7. Spherical categories. A *spherical category* is a pivotal category \mathcal{C} such that $\text{tr}_l(f) = \text{tr}_r(f)$ for any morphism $f: X \rightarrow X$ in \mathcal{C} . Then $\text{dim}_l(X) = \text{dim}_r(X)$ for all objects X of \mathcal{C} . In a spherical category, we omit l and r from the notation for trace and dimension.

II.1.8. Ribbon categories. Let \mathcal{C} be a braided pivotal category. The *left twist* of an object X in \mathcal{C} is defined by

$$\theta_X^l = (\text{id}_X \otimes \widetilde{\text{ev}}_X)(\tau_{X,X} \otimes \text{id}_{X^*})(\text{id}_X \otimes \text{coev}_X): X \rightarrow X,$$

while the *right twist* of X is defined by

$$\theta_X^r = (\text{ev}_X \otimes \text{id}_X)(\text{id}_{X^*} \otimes \tau_{X,X})(\widetilde{\text{coev}}_X \otimes \text{id}_X): X \rightarrow X.$$

The left and the right twist are natural isomorphisms with inverses

$$\begin{aligned}(\theta_X^l)^{-1} &= (\text{id}_X \otimes \widetilde{\text{ev}}_X)(\tau_{X,X}^{-1} \otimes \text{id}_{X^*})(\text{id}_X \otimes \text{coev}_X): X \rightarrow X \quad \text{and} \\ (\theta_X^r)^{-1} &= (\text{ev}_X \otimes \text{id}_X)(\text{id}_{X^*} \otimes \tau_{X,X}^{-1})(\widetilde{\text{coev}}_X \otimes \text{id}_X): X \rightarrow X,\end{aligned}$$

respectively. Note that $\theta_{\mathbb{1}}^l = \text{id}_{\mathbb{1}} = \theta_{\mathbb{1}}^r$.

A *ribbon category* is a braided pivotal category \mathcal{C} such that $\theta_X^l = \theta_X^r$ for all object X of \mathcal{C} . In this case, the family $\theta = \{\theta_X = \theta_X^l = \theta_X^r: X \rightarrow X\}_{X \in \text{Ob}(\mathcal{C})}$ is a twist in the sense of Section II.1.3 and is called the *twist* of \mathcal{C} . Any ribbon category is spherical (see [36]).

II.1.9. Graphical calculus. We will often use the *Penrose graphical calculus*, which allows us to avoid lengthy algebraic computations by using topological arguments. The diagrams are to be read from bottom to top. In a monoidal category \mathcal{B} , the diagrams are made of arcs colored by objects of \mathcal{B} and of boxes, colored by morphisms of \mathcal{B} . Arcs colored by $\mathbb{1}$ are deleted from the pictures. The identity morphism of an object X , the morphism $f: X \rightarrow Y$ in \mathcal{B} and its composition with the morphism $g: Y \rightarrow Z$ in \mathcal{B} are represented respectively as follows:

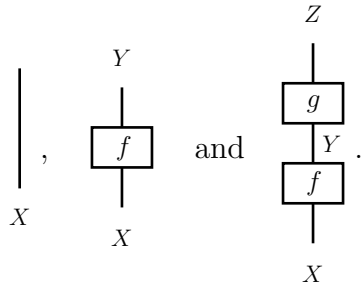

We will sometimes draw circles instead of boxes. For example, to depict morphisms of the form $X \rightarrow \mathbb{1}$ or $\mathbb{1} \rightarrow X$ for some object X of \mathcal{B} . The tensor product of two morphisms $f: X \rightarrow Y$ and $g: U \rightarrow V$ is represented by placing a picture of f to the left of the picture of g :

$$\begin{array}{c}
 Y \quad V \\
 | \quad | \\
 \boxed{f \otimes g} \\
 | \quad | \\
 X \quad U
 \end{array}
 =
 \begin{array}{c}
 Y \\
 | \\
 \boxed{f} \\
 | \\
 X
 \end{array}
 \begin{array}{c}
 V \\
 | \\
 \boxed{g} \\
 | \\
 U
 \end{array}
 .$$

As depicted above, the equality between two pictures means that both of them represent the same morphism in the category. A particularly useful rule is the *level-exchange property*: If $f: X \rightarrow Y$ and $g: U \rightarrow V$ are two morphisms in \mathcal{C} , then

$$\begin{array}{c}
 Y \\
 | \\
 \boxed{f} \\
 | \\
 X
 \end{array}
 \begin{array}{c}
 V \\
 | \\
 \boxed{g} \\
 | \\
 U
 \end{array}
 =
 \begin{array}{c}
 Y \\
 | \\
 \boxed{f} \\
 | \\
 X
 \end{array}
 \begin{array}{c}
 V \\
 | \\
 \boxed{g} \\
 | \\
 U
 \end{array}
 =
 \begin{array}{c}
 Y \\
 | \\
 \boxed{f} \\
 | \\
 X
 \end{array}
 \begin{array}{c}
 V \\
 | \\
 \boxed{g} \\
 | \\
 U
 \end{array}
 .$$

This pictorial argument reflects the well known property

$$f \otimes g = (f \otimes \text{id}_V)(\text{id}_X \otimes g) = (\text{id}_Y \otimes g)(f \otimes \text{id}_U).$$

If \mathcal{B} is a braided category, the braiding $\{\tau_{X,Y}\}_{X,Y \in \text{Ob}(\mathcal{B})}$ and its inverse $\{\tau_{X,Y}^{-1}\}_{X,Y \in \text{Ob}(\mathcal{B})}$ are respectively depicted as

$$\begin{array}{c}
 Y \quad X \\
 \curvearrowright \\
 X \quad Y
 \end{array}
 \quad \text{and} \quad
 \begin{array}{c}
 X \quad Y \\
 \curvearrowleft \\
 Y \quad X
 \end{array}
 .$$

Let \mathcal{B} be a braided category with a twist $\theta = \{\theta_X: X \rightarrow X\}_{X \in \text{Ob}(\mathcal{B})}$. For an object X of \mathcal{B} , we denote the twist morphism $\theta_X: X \rightarrow X$ and its inverse by

$$\theta_X = \begin{array}{c} | \\ \text{loop} \\ | \\ X \end{array} \quad \text{and} \quad (\theta_X)^{-1} = \begin{array}{c} | \\ \text{loop} \\ | \\ X \end{array} .$$

The defining condition (43) for the twist says that for any objects X, Y of \mathcal{B} we have

$$\begin{array}{c} | \\ \text{loop} \\ | \\ X \otimes Y \end{array}
 =
 \begin{array}{c} \text{braiding} \\ | \\ X \quad Y \end{array}
 .$$

We warn the reader that this notation should not be confused with notation of twist in a ribbon category, which is depicted below. We made this choice since any ribbon category is an example of a braided category with a twist.

In a pivotal category \mathcal{C} , the diagrams are made of oriented arcs colored by objects of \mathcal{C} and of boxes, colored by morphisms of \mathcal{C} . If an arc colored by X is oriented upwards, the represented object in source/target of corresponding morphism is X^* . For example, id_{X^*} and a morphism $f: X \otimes Y^* \otimes Z \rightarrow U \otimes V^*$ may be respectively depicted as

$$\text{id}_{X^*} = \begin{array}{c} \uparrow \\ | \\ X \end{array} = \begin{array}{c} \downarrow \\ | \\ X^* \end{array} \quad \text{and} \quad f = \begin{array}{c} \downarrow U \quad \uparrow V \\ \boxed{f} \\ \downarrow X \quad \uparrow Y \quad \downarrow Z \end{array} .$$

The morphisms $\text{ev}_X, \widetilde{\text{ev}}_X, \text{coev}_X,$ and $\widetilde{\text{coev}}_X$ are respectively depicted as follows:

$$\begin{array}{c} \curvearrowright \\ \downarrow \\ X \end{array}, \quad \begin{array}{c} \curvearrowleft \\ \downarrow \\ X \end{array}, \quad \begin{array}{c} \downarrow \\ \curvearrowright \\ X \end{array} \quad \text{and} \quad \begin{array}{c} \downarrow \\ \curvearrowleft \\ X \end{array} .$$

Note that a ribbon left and right twists of a braided pivotal category are then depicted as

$$\theta_X^l = \begin{array}{c} \downarrow \\ \text{loop} \\ X \end{array}, \quad (\theta_X^l)^{-1} = \begin{array}{c} \downarrow \\ \text{loop} \\ X \end{array}, \quad \theta_X^r = \begin{array}{c} \text{loop} \\ \downarrow \\ X \end{array} \quad \text{and} \quad (\theta_X^r)^{-1} = \begin{array}{c} \text{loop} \\ \downarrow \\ X \end{array} .$$

II.1.10. Linear categories. Recall that in this monograph \mathbb{k} is a commutative ring. A category \mathcal{C} is \mathbb{k} -linear if for all objects X, Y of \mathcal{C} the set $\text{Hom}_{\mathcal{C}}(X, Y)$ is endowed with a structure of \mathbb{k} -module such that the composition of morphisms is \mathbb{k} -bilinear. A functor $F: \mathcal{C} \rightarrow \mathcal{D}$ between \mathbb{k} -linear categories is \mathbb{k} -linear if for all objects X, Y in \mathcal{C} , the map

$$\text{Hom}_{\mathcal{C}}(X, Y) \rightarrow \text{Hom}_{\mathcal{D}}(F(X), F(Y)) \quad f \mapsto F(f)$$

is \mathbb{k} -linear. For shortness, we will often use the term \mathbb{k} -category instead of \mathbb{k} -linear category. By a monoidal (respectively, pivotal, spherical, braided, ribbon) \mathbb{k} -category, we mean a \mathbb{k} -linear category which is monoidal (respectively, pivotal, spherical, braided, ribbon) and such that the monoidal product of morphisms is \mathbb{k} -bilinear.

II.1.11. (Pre)fusion categories. An object X of a \mathbb{k} -linear category \mathcal{C} is *simple* if the \mathbb{k} -module $\text{End}_{\mathcal{C}}(X)$ is free of rank 1. In that case, the map $\mathbb{k} \rightarrow \text{End}_{\mathcal{C}}(X), k \mapsto k \text{id}_X$ is an isomorphism of \mathbb{k} -algebras.

A *prefusion \mathbb{k} -category* is a monoidal \mathbb{k} -linear category \mathcal{C} such that there is a set I of simple objects of \mathcal{C} satisfying the following conditions:

- (a) For any distinct i, j of I , $\text{Hom}_{\mathcal{C}}(i, j) = 0$;
- (b) The unit object $\mathbb{1}$ of \mathcal{C} is an element of I ;
- (c) Any object of \mathcal{C} is a finite direct sum of elements of I .

The set I is called a *representative set of simple objects* of \mathcal{C} . A *fusion \mathbb{k} -category* is a rigid prefusion \mathbb{k} -category such that the set of isomorphism classes of simple objects is finite.

II.1.12. Dimension of a fusion category. Let \mathcal{C} be a pivotal fusion \mathbb{k} -category. We identify \mathbb{k} and $\text{End}_{\mathcal{C}}(\mathbb{1})$ via the \mathbb{k} -linear isomorphism $k \mapsto k \text{id}_{\mathbb{1}}$. Pick a representative set I of simple objects of \mathcal{C} . The *dimension of the category \mathcal{C}* is the element of $\text{End}_{\mathcal{C}}(\mathbb{1}) \simeq \mathbb{k}$, defined by

$$\dim(\mathcal{C}) = \sum_{i \in I} \dim_l(i) \dim_r(i).$$

The dimension of \mathcal{C} does not depend on the choice of I since isomorphic objects of \mathcal{C} have the same left/right dimensions. Note that if \mathcal{C} is spherical, then

$$\dim(\mathcal{C}) = \sum_{i \in I} (\dim(i))^2.$$

II.1.13. Modular categories. Let \mathcal{C} be a ribbon fusion \mathbb{k} -category. Pick a representative set I of simple objects of \mathcal{C} . The scalars

$$\Delta_{\pm} = \sum_{i \in I} \dim(i) \operatorname{tr}(\theta_i^{\pm 1}) \in \operatorname{End}_{\mathcal{C}}(\mathbb{1}) \simeq \mathbb{k},$$

where θ is the twist of \mathcal{C} , do not depend on the choice of I . The S -matrix $[S_{i,j}]_{i,j \in I}$ of \mathcal{C} is defined by

$$S_{i,j} = \operatorname{tr}(\tau_{i,j} \tau_{j,i}) \in \operatorname{End}_{\mathcal{C}}(\mathbb{1}) \simeq \mathbb{k}.$$

Note that the invertibility of S does not depend on the choice of I .

A *modular \mathbb{k} -category* is a ribbon fusion \mathbb{k} -category whose S -matrix is invertible. The scalars Δ_+ , Δ_- , and $\dim(\mathcal{C})$ associated with a modular \mathbb{k} -category \mathcal{C} are invertible in \mathbb{k} and are related by $\dim(\mathcal{C}) = \Delta_- \Delta_+$ (see [35, p. 89]).

A modular \mathbb{k} -category is *anomaly free* if $\Delta_+ = \Delta_-$.

II.1.14. The center of a monoidal category. The *center* $\mathcal{Z}(\mathcal{C})$ of a monoidal category $\mathcal{C} = (\mathcal{C}, \otimes, \mathbb{1})$ is a braided monoidal category defined as follows. The objects of $\mathcal{Z}(\mathcal{C})$ are the so called *half-braidings*, that is, pairs (A, σ) , where A is an object of \mathcal{C} and σ , given by a family

$$\sigma = \{\sigma_X: A \otimes X \rightarrow X \otimes A\}_{X \in \operatorname{Ob}(\mathcal{C})},$$

is a natural isomorphism of functors $\otimes(A, ?)$ and $\otimes(? , A)$, which is multiplicative in the sense that for all objects X, Y in \mathcal{C} ,

$$\sigma_{X \otimes Y} = (\operatorname{id}_X \otimes \sigma_Y)(\sigma_X \otimes \operatorname{id}_Y).$$

A morphism $f: (A, \sigma) \rightarrow (B, \tau)$ in $\mathcal{Z}(\mathcal{C})$ is given by a morphism $f: A \rightarrow B$ in \mathcal{C} such that for any object X in \mathcal{C} ,

$$\tau_X(f \otimes \operatorname{id}_X) = (\operatorname{id}_X \otimes f)\sigma_X.$$

The unit object of $\mathcal{Z}(\mathcal{C})$ is $\mathbb{1}_{\mathcal{Z}(\mathcal{C})} = (\mathbb{1}, \{\operatorname{id}_X\}_{X \in \operatorname{Ob}(\mathcal{C})})$ and the monoidal product of two objects (A, σ) and (B, τ) of $\mathcal{Z}(\mathcal{C})$ is defined by

$$(A, \sigma) \otimes (B, \tau) = (A \otimes B, (\sigma_X \otimes \operatorname{id}_B)(\operatorname{id}_A \otimes \tau_X)).$$

The braiding τ of $\mathcal{Z}(\mathcal{C})$ is defined by

$$\tau_{(A,\sigma),(B,\tau)} = \sigma_B: A \otimes B \rightarrow B \otimes A.$$

If \mathcal{C} is rigid (respectively pivotal, \mathbb{k} -linear, additive), then $\mathcal{Z}(\mathcal{C})$ is also rigid (respectively pivotal, \mathbb{k} -linear, additive). The center of a spherical prefusion \mathbb{k} -linear category is ribbon. For more details, see [36]. Examples of anomaly free ribbon fusion \mathbb{k} -categories are provided by the centers of spherical fusion \mathbb{k} -categories:

Theorem II.1 ([36], Section 9.5). *Let \mathcal{C} be an additive spherical fusion \mathbb{k} -linear category such that $\dim(\mathcal{C}) \neq 0$, where \mathbb{k} is an algebraically closed field. The center $\mathcal{Z}(\mathcal{C})$ is anomaly free additive modular \mathbb{k} -linear category and $\Delta_- = \Delta_+ = \dim(\mathcal{C})$.*

II.2. Hopf algebras in braided monoidal categories

In this section we recall categorical (co)algebras, Hopf algebras and categorical (co)modules. Throughout the section, we outline graphical notations and conventions which are used in this monograph.

II.2.1. Categorical (co)algebras. An *algebra* in a monoidal category \mathcal{C} is given by a triple (A, m, u) , where A is an object of \mathcal{C} , $m: A \otimes A \rightarrow A$ and $u: \mathbb{1} \rightarrow A$ are morphisms in \mathcal{C} , called *multiplication* and *unit* respectively, which satisfy

$$m(m \otimes \text{id}_A) = m(\text{id}_A \otimes m) \quad \text{and} \quad m(u \otimes \text{id}_A) = \text{id}_A = m(\text{id}_A \otimes u).$$

An *algebra morphism* between algebras (A, m, u) and (A', m', u') in a monoidal category \mathcal{C} is a morphism $f: A \rightarrow A'$ in \mathcal{C} such that $fm = m'(f \otimes f)$ and $fu = u'$.

A *coalgebra* in a monoidal category \mathcal{C} is a triple (C, Δ, ε) , where C is an object of \mathcal{C} , $\Delta: C \rightarrow C \otimes C$ and $\varepsilon: C \rightarrow \mathbb{1}$ are morphisms in \mathcal{C} , called *comultiplication* and *counit* respectively, which satisfy

$$(\Delta \otimes \text{id}_C)\Delta = (\text{id}_C \otimes \Delta)\Delta \quad \text{and} \quad (\text{id}_C \otimes \varepsilon)\Delta = \text{id}_C = (\varepsilon \otimes \text{id}_C)\Delta.$$

A *coalgebra morphism* between coalgebras (C, Δ, ε) and $(C', \Delta', \varepsilon')$ in a monoidal category \mathcal{C} is a morphism $f: C \rightarrow C'$ in \mathcal{C} such that $\Delta'f = (f \otimes f)\Delta$ and $\varepsilon f = \varepsilon'$.

II.2.2. Categorical Hopf algebras. Let \mathcal{C} be braided monoidal category. A *bialgebra* in \mathcal{C} is a quintuple $(A, m, u, \Delta, \varepsilon)$ such that (A, m, u) is an algebra in \mathcal{C} , (A, Δ, ε) is a coalgebra in \mathcal{C} and such that the following additional relations hold:

$$\Delta m = (m \otimes m)(\text{id}_A \otimes \tau_{A,A} \otimes \text{id}_A)(\Delta \otimes \Delta), \quad \varepsilon m = \varepsilon \otimes \varepsilon, \quad \Delta u = u \otimes u, \quad \text{and} \quad \varepsilon u = \text{id}_{\mathbb{1}}.$$

These relations will be sometimes called *bialgebra compatibility axioms*. A *bialgebra morphism* between bialgebras $(A, m, u, \Delta, \varepsilon)$ and $(A', m', u', \Delta', \varepsilon')$ is a morphism $f: A \rightarrow A'$ in \mathcal{C} which is both an algebra and a coalgebra morphism.

A *Hopf algebra* in \mathcal{C} is a sextuple $(A, m, u, \Delta, \varepsilon, S)$, where $(A, m, u, \Delta, \varepsilon)$ is a bialgebra in \mathcal{C} and $S: A \rightarrow A$ is an isomorphism in \mathcal{C} , called the *antipode*, which satisfies the equation

$$m(S \otimes \text{id}_A)\Delta = u\varepsilon = m(\text{id}_A \otimes S)\Delta.$$

The former equation will be sometimes called *the antipode axiom*. The antipode of a Hopf algebra is antimultiplicative and anticomultiplicative in the sense that

$$Sm = m\tau_{A,A}(S \otimes S) \quad \text{and} \quad \Delta S = (S \otimes S)\tau_{A,A}\Delta.$$

A *Hopf algebra morphism* between Hopf algebras $(A, m, u, \Delta, \varepsilon, S)$ and $(A', m', u', \Delta', \varepsilon', S')$ is a bialgebra morphism between them.

If A is a Hopf algebra in a braided category \mathcal{C} , its multiplication, unit, comultiplication, counit, antipode, and inverse of the antipode are respectively depicted as:

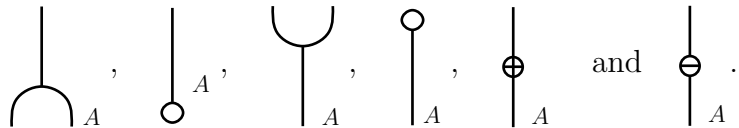

Sometimes, if it is clear from the context what is the underlying (co)algebra we work with, the labels on its structural morphisms will be omitted.

Remark II.2. If $(H, m, \Delta, \varepsilon, u, S)$ is a Hopf algebra in a braided category \mathcal{C} with a braiding τ , then $H^{\text{op}} = (H, m\bar{\tau}, \Delta, \varepsilon, u, S^{-1})$ is a Hopf algebra in the mirror (see Section II.1.2) of the braided category \mathcal{C} . Similarly, $H^{\text{cop}} = (H, m, \bar{\tau}\Delta, \varepsilon, u, S^{-1})$ is a Hopf algebra in the mirror of the braided category \mathcal{C} .

II.2.3. Graphical calculus and iterated (co)products. Let (A, m, u) and (C, Δ, ε) be an algebra and a coalgebra in a monoidal category \mathcal{C} . For an $n \in \mathbb{N}$, one inductively defines the n -th product $m^n: A^{\otimes n+1} \rightarrow A$ by:

$$m^0 = \text{id}_A \quad \text{and} \quad m^n = m(\text{id}_A \otimes m^{n-1}) \quad \text{for } n \geq 1.$$

For an $n \in \mathbb{N}$, one inductively defines the n -th coproduct $\Delta^n: C \rightarrow C^{\otimes n+1}$ by:

$$\Delta^0 = \text{id}_C \quad \text{and} \quad \Delta^n = (\text{id}_C \otimes \Delta^{n-1})\Delta \quad \text{for } n \geq 1.$$

The associativity of m and coassociativity of Δ imply that

$$m^k(m^{n_0} \otimes \cdots \otimes m^{n_k}) = m^{n_0+\cdots+n_k+k} \quad \text{and} \quad (\Delta^{n_0} \otimes \cdots \otimes \Delta^{n_k})\Delta^k = \Delta^{n_0+\cdots+n_k+k}$$

for all $k \in \mathbb{N}$ and $n_0, \dots, n_k \in \mathbb{N}$. For $n \geq 2$, we denote m^n and Δ^n as

$$m^n = \underbrace{\begin{array}{c} | \\ \text{A} \\ \dots \\ \text{A} \\ \text{---} \\ \text{n+1 times} \end{array}} \quad \text{and} \quad \Delta^n = \overbrace{\begin{array}{c} \text{---} \\ \text{n+1 times} \\ | \\ \text{C} \end{array}}.$$

Let us give two typical examples of usage of such notation. By using the associativity of the algebra A , one has:

$$m^3 = \begin{array}{c} \text{---} \\ \text{---} \\ \text{---} \\ \text{---} \\ \text{A} \quad \text{A} \quad \text{A} \quad \text{A} \end{array} = \begin{array}{c} \text{---} \\ \text{---} \\ \text{---} \\ \text{---} \\ \text{A} \quad \text{A} \quad \text{A} \quad \text{A} \end{array} = \begin{array}{c} \text{---} \\ \text{---} \\ \text{---} \\ \text{---} \\ \text{A} \quad \text{A} \quad \text{A} \quad \text{A} \end{array}.$$

By using the coassociativity and counitality of the coalgebra C , one has:

$$\Delta^2 = \begin{array}{c} \text{---} \\ \text{---} \\ \text{---} \\ \text{---} \\ \text{C} \end{array} = \begin{array}{c} \text{---} \\ \text{---} \\ \text{---} \\ \text{---} \\ \text{C} \end{array} = \begin{array}{c} \text{---} \\ \text{---} \\ \text{---} \\ \text{---} \\ \text{C} \end{array}.$$

II.2.4. Integrals and cointegrals. Consider a bialgebra $(A, m, \Delta, u, \varepsilon)$ in \mathcal{C} . A *left* (respectively *right*) *integral* of A is a morphism $\Lambda: \mathbb{1} \rightarrow A$ such that

$$m(\text{id}_A \otimes \Lambda) = \Lambda\varepsilon, \quad \text{respectively} \quad m(\Lambda \otimes \text{id}_A) = \Lambda\varepsilon.$$

The defining equalities for a left or a right integral of A are respectively depicted as

$$\begin{array}{c} \text{---} \\ \text{---} \\ \text{---} \\ \text{---} \\ \text{A} \end{array} = \begin{array}{c} \text{---} \\ \text{---} \\ \text{---} \\ \text{---} \\ \text{A} \end{array} \quad \text{and} \quad \begin{array}{c} \text{---} \\ \text{---} \\ \text{---} \\ \text{---} \\ \text{A} \end{array} = \begin{array}{c} \text{---} \\ \text{---} \\ \text{---} \\ \text{---} \\ \text{A} \end{array}.$$

A *left* (respectively *right*) *cointegral* of A is a morphism $\lambda: A \rightarrow \mathbb{1}$ such that

$$(\text{id}_A \otimes \lambda)\Delta = u\lambda, \quad \text{respectively} \quad (\lambda \otimes \text{id}_A)\Delta = u\lambda.$$

The defining equalities for a left or a right cointegral of A are respectively depicted as

$$\begin{array}{c} \textcircled{\lambda} \\ \text{---} \\ \cup \\ \text{---} \\ A \end{array} = \begin{array}{c} \textcircled{\lambda} \\ \text{---} \\ \text{---} \\ A \end{array} \quad \text{and} \quad \begin{array}{c} \textcircled{\lambda} \\ \text{---} \\ \cup \\ \text{---} \\ A \end{array} = \begin{array}{c} \textcircled{\lambda} \\ \text{---} \\ \text{---} \\ A \end{array} .$$

II.2.5. Bialgebra pairings. Let $(A, m, u, \Delta, \varepsilon)$ be a bialgebra in \mathcal{C} . A *bialgebra pairing* for A is a morphism $\omega: A \otimes A \rightarrow \mathbb{1}$ such that:

$$\begin{aligned}
 \omega(m \otimes \text{id}_A) &= \omega(\text{id}_A \otimes \omega \otimes \text{id}_A)(\text{id}_{A \otimes A} \otimes \Delta), & \omega(u \otimes \text{id}_A) &= \varepsilon, \\
 \omega(\text{id}_A \otimes m) &= \omega(\text{id}_A \otimes \omega \otimes \text{id}_A)(\Delta \otimes \text{id}_{A \otimes A}), & \omega(\text{id}_A \otimes u) &= \varepsilon.
 \end{aligned}$$

Graphically, the above axioms rewrite as

$$\begin{array}{ccc}
 \begin{array}{c} \omega \\ \text{---} \\ \cup \\ \text{---} \\ A \quad A \quad A \end{array} & = & \begin{array}{c} \omega \\ \text{---} \\ \omega \\ \text{---} \\ \cup \\ \text{---} \\ A \quad A \quad A \end{array}, & \begin{array}{c} \omega \\ \text{---} \\ \textcircled{\lambda} \\ \text{---} \\ A \end{array} & = & \begin{array}{c} \textcircled{\lambda} \\ \text{---} \\ A \end{array}, \\
 \begin{array}{c} \omega \\ \text{---} \\ \text{---} \\ \cup \\ \text{---} \\ A \quad A \quad A \end{array} & = & \begin{array}{c} \omega \\ \text{---} \\ \omega \\ \text{---} \\ \cup \\ \text{---} \\ A \quad A \quad A \end{array}, & \begin{array}{c} \omega \\ \text{---} \\ \textcircled{\lambda} \\ \text{---} \\ A \end{array} & = & \begin{array}{c} \textcircled{\lambda} \\ \text{---} \\ A \end{array}.
 \end{array}$$

If A is Hopf algebra, the pairing ω for the underlying bialgebra is called a *Hopf pairing*.

A bialgebra pairing ω for A is nondegenerate if there exist a morphism $\Omega: \mathbb{1} \rightarrow A \otimes A$ such that

$$(\omega \otimes \text{id}_A)(\text{id}_A \otimes \Omega) = \text{id}_A \quad \text{and} \quad (\text{id}_A \otimes \omega)(\Omega \otimes \text{id}_A) = \text{id}_A.$$

The morphism Ω is called the *inverse* of the pairing ω . It has properties dual to those of ω .

II.2.6. Categorical (co)modules. Let (A, m, u) an algebra in a monoidal category \mathcal{C} . A *left A -module* is a pair (M, l) , where $l: A \otimes M \rightarrow M$ is a morphism in \mathcal{C} , called *action of A on M* , which satisfies

$$l(m \otimes \text{id}_M) = l(\text{id}_A \otimes l) \quad \text{and} \quad l(u \otimes \text{id}_M) = \text{id}_M.$$

Graphically, the action $l: A \otimes M \rightarrow M$ is denoted by

$$l = \begin{array}{c} \text{---} \\ \text{---} \\ \cup \\ \text{---} \\ A \quad M \end{array} .$$

The axioms of a left A -module rewrite graphically as

$$\begin{array}{ccc}
 \begin{array}{c} \text{---} \\ \text{---} \\ \cup \\ \text{---} \\ A \quad A \quad M \end{array} & = & \begin{array}{c} \text{---} \\ \text{---} \\ \cup \\ \text{---} \\ A \quad A \quad M \end{array} & \text{and} & \begin{array}{c} \text{---} \\ \text{---} \\ \cup \\ \text{---} \\ \textcircled{\lambda} \\ \text{---} \\ M \quad M \end{array} & = & \begin{array}{c} \text{---} \\ \text{---} \\ \text{---} \\ M \quad M \end{array} .
 \end{array}$$

A morphism $f: (M, l) \rightarrow (M', l')$ between left A -modules (M, l) and (M', l') is given by a morphism $f: M \rightarrow M'$ in \mathcal{C} such that $fl = l'(id_A \otimes f)$. With composition inherited

Similarly, the right diagonal action of H on $H^{\otimes n}$ is defined by

$$\begin{array}{c} \mathbb{1} \end{array} \begin{array}{c} \curvearrowright \\ H \end{array} = \begin{array}{c} \circ \\ H \end{array}, \quad \begin{array}{c} \curvearrowright \\ H \end{array} \begin{array}{c} \curvearrowright \\ H \end{array} = \begin{array}{c} \curvearrowright \\ H \end{array} \begin{array}{c} \curvearrowright \\ H \end{array} \quad \text{and} \quad \begin{array}{c} \curvearrowright \\ H^{\otimes n} \end{array} \begin{array}{c} \curvearrowright \\ H \end{array} = \begin{array}{c} \curvearrowright \quad \dots \quad \curvearrowright \\ 1 \quad 2 \quad \dots \quad n \quad H \end{array} \quad \text{for } n \geq 2.$$

Remark that for any $n \geq 1$, one has an inductive definition of left and right diagonal actions via

$$\begin{array}{c} \curvearrowright \\ H \end{array} \begin{array}{c} \curvearrowright \\ H^{\otimes n} \end{array} = \begin{array}{c} \curvearrowright \\ H \end{array} \begin{array}{c} \curvearrowright \\ H \end{array} \begin{array}{c} \curvearrowright \\ H^{\otimes n-1} \end{array} \quad \text{and} \quad \begin{array}{c} \curvearrowright \\ H^{\otimes n} \end{array} \begin{array}{c} \curvearrowright \\ H \end{array} = \begin{array}{c} \curvearrowright \\ H^{\otimes n-1} \end{array} \begin{array}{c} \curvearrowright \\ H \end{array} \begin{array}{c} \curvearrowright \\ H \end{array}.$$

By induction, one can show that for any coalgebra morphism $\sigma: \mathbb{1} \rightarrow H$ and any $m \geq 1$,

$$\begin{array}{c} \curvearrowright \\ H^{\otimes m} \end{array} \begin{array}{c} \sigma \\ H \end{array} = \underbrace{\begin{array}{c} \curvearrowright \\ H \end{array} \begin{array}{c} \sigma \\ H \end{array} \dots \begin{array}{c} \curvearrowright \\ H \end{array} \begin{array}{c} \sigma \\ H \end{array}}_{m \text{ times}} \quad \text{and} \quad \begin{array}{c} \curvearrowright \\ H^{\otimes m} \end{array} \begin{array}{c} \sigma \\ H \end{array} = \underbrace{\begin{array}{c} \curvearrowright \\ H \end{array} \begin{array}{c} \sigma \\ H \end{array} \dots \begin{array}{c} \curvearrowright \\ H \end{array} \begin{array}{c} \sigma \\ H \end{array}}_{m \text{ times}}.$$

II.2.8. Example: Adjoint actions and coadjoint coactions. The left and right adjoint action of H on itself are given by

$$\begin{array}{c} \curvearrowright \\ H \end{array} \begin{array}{c} \curvearrowright \\ H \end{array} = \begin{array}{c} \curvearrowright \\ H \end{array} \begin{array}{c} \oplus \\ H \end{array} \begin{array}{c} \curvearrowright \\ H \end{array} \begin{array}{c} \curvearrowright \\ H \end{array} \quad \text{and} \quad \begin{array}{c} \curvearrowright \\ H \end{array} \begin{array}{c} \curvearrowright \\ H \end{array} = \begin{array}{c} \curvearrowright \\ H \end{array} \begin{array}{c} \oplus \\ H \end{array} \begin{array}{c} \curvearrowright \\ H \end{array} \begin{array}{c} \curvearrowright \\ H \end{array}.$$

Similarly, the left and right coadjoint coaction of H on itself are given by

$$\begin{array}{c} \curvearrowright \\ H \end{array} \begin{array}{c} \curvearrowright \\ H \end{array} = \begin{array}{c} \curvearrowright \\ H \end{array} \begin{array}{c} \oplus \\ H \end{array} \begin{array}{c} \curvearrowright \\ H \end{array} \begin{array}{c} \curvearrowright \\ H \end{array} \quad \text{and} \quad \begin{array}{c} \curvearrowright \\ H \end{array} \begin{array}{c} \curvearrowright \\ H \end{array} = \begin{array}{c} \curvearrowright \\ H \end{array} \begin{array}{c} \oplus \\ H \end{array} \begin{array}{c} \curvearrowright \\ H \end{array} \begin{array}{c} \curvearrowright \\ H \end{array}.$$

In the same way as written for the diagonal actions in the Example II.2.7, one can write for any $n \geq 1$ an inductive definition of left and right adjoint actions (or coadjoint coactions) of H on $H^{\otimes n}$. Both left and right adjoint actions on $\mathbb{1}$ are given by counit. Similarly, both left and right coadjoint coactions on $\mathbb{1}$ are given by unit. By induction one can show that for any algebra morphism $\delta: H \rightarrow \mathbb{1}$, any coalgebra morphism $\sigma: \mathbb{1} \rightarrow H$, and any $m \geq 1$,

$$\begin{array}{c} \delta \\ H^{\otimes m} \end{array} \begin{array}{c} \curvearrowright \\ H \end{array} = \underbrace{\begin{array}{c} \delta \\ H \end{array} \begin{array}{c} \curvearrowright \\ H \end{array} \dots \begin{array}{c} \delta \\ H \end{array} \begin{array}{c} \curvearrowright \\ H \end{array}}_{m \text{ times}} \quad \text{and} \quad \begin{array}{c} \delta \\ H^{\otimes m} \end{array} \begin{array}{c} \curvearrowright \\ H \end{array} = \underbrace{\begin{array}{c} \delta \\ H \end{array} \begin{array}{c} \curvearrowright \\ H \end{array} \dots \begin{array}{c} \delta \\ H \end{array} \begin{array}{c} \curvearrowright \\ H \end{array}}_{m \text{ times}}.$$

II.3. Coends

A fundamental example of a categorical Hopf algebra in the sense of Section II.2.2 is given by a coend of a braided pivotal category. In this section we first recall some generalities on coends and outline structural morphisms of a coend of a braided pivotal category. At the end of section, we state some properties related to categorical centers and modularity. This object will be very much exploited in Chapters VI and VII.

II.3.1. Coend of a functor. Let \mathcal{C} and \mathcal{D} be any categories and $F: \mathcal{C}^{\text{op}} \times \mathcal{C} \rightarrow \mathcal{D}$ a functor. A *dinatural transformation* between F and an object D in \mathcal{D} is a function d that assigns to any object X in \mathcal{C} a morphism $d_X: F(X, X) \rightarrow D$ such that for all morphisms $f: X \rightarrow Y$ in \mathcal{C} the following diagram commutes:

$$\begin{array}{ccc} F(Y, X) & \xrightarrow{F(f, \text{id}_X)} & F(X, X) \\ F(\text{id}_Y, f) \downarrow & & \downarrow d_X \\ F(Y, Y) & \xrightarrow{d_Y} & D. \end{array}$$

A *coend of a functor* $F: \mathcal{C}^{\text{op}} \times \mathcal{C} \rightarrow \mathcal{D}$ is a pair (C, i) where C is an object of \mathcal{D} and i is a dinatural transformation from F to C , which is universal among all dinatural transformations. More precisely, for any dinatural transformation d from F to D , there exists a unique morphism $\varphi: C \rightarrow D$ in \mathcal{D} such that for all object X in \mathcal{C} , $d_X = \varphi i_X$. A coend (C, i) of a functor F , if it exists, is unique up to a unique isomorphism commuting with the dinatural transformation.

II.3.2. Coend of a category. The *coend of a pivotal category* \mathcal{C} , if it exists, is defined as the coend (C, i) of the functor $F: \mathcal{C}^{\text{op}} \times \mathcal{C} \rightarrow \mathcal{C}$ defined by

$$F(X, Y) = X^* \otimes Y \quad \text{and} \quad F(f, g) = f^* \otimes g.$$

We depict the dinatural transformation $i = \{i_X: X^* \otimes X \rightarrow C\}_{X \in \text{Ob}(\mathcal{C})}$ as

An important factorization property is given in the following lemma.

Lemma II.3 (Fubini theorem for coends, [26]). *Let (C, i) be a coend of a braided pivotal category \mathcal{C} . If $d = \{d_{X_1, \dots, X_n}: X_1^* \otimes X_1 \otimes \dots \otimes X_n^* \otimes X_n \rightarrow D\}_{X_1, \dots, X_n \in \text{Ob}(\mathcal{C})}$ is a family of morphisms in \mathcal{C} , which is dinatural in each X_i for $1 \leq i \leq n$, then there exists a unique morphism $\varphi: C^{\otimes n} \rightarrow D$ in \mathcal{C} such that*

$$d_{X_1, \dots, X_n} = \varphi(i_{X_1} \otimes \dots \otimes i_{X_n})$$

for all $X_1, \dots, X_n \in \text{Ob}(\mathcal{C})$.

Coend of braided pivotal category provides an example of braided Hopf algebras:

Theorem II.4 ([30],[31]). *Let \mathcal{B} be a braided pivotal category having a coend (C, i) . The object C is a Hopf algebra in \mathcal{B} . Moreover, if \mathcal{B} is ribbon, then C is endowed with a canonical Hopf pairing and canonical twist forms.*

We detail below the structure maps of the Hopf algebra of Theorem II.4. Multiplication m , unit u , comultiplication Δ , counit ε , and antipode S are defined universally (via Lemma II.3) by using the following formulas, respectively:

$$i_{Y \otimes X}({}_2^*(Y, X) \otimes \text{id}_{Y \otimes X})(\text{id}_{X^*} \otimes \tau_{X, Y^* \otimes Y}) = m(i_X \otimes i_Y): X^* \otimes X \otimes Y^* \otimes Y \rightarrow C, \quad (44)$$

$$u = (\text{id}_{\mathbb{1}} \otimes i_{\mathbb{1}})(\text{coev}_{\mathbb{1}} \otimes \text{id}_{\mathbb{1}}): \mathbb{1} \rightarrow C, \quad (45)$$

$$(i_X \otimes i_X)(\text{id}_{X^*} \otimes \text{coev}_X \otimes \text{id}_X) = \Delta i_X: X^* \otimes X \rightarrow C \otimes C, \quad (46)$$

$$\text{ev}_X = \varepsilon i_X: X^* \otimes X \rightarrow \mathbb{1}, \quad (47)$$

$$(\text{ev}_X \otimes i_{X^*})(\text{id}_{X^*} \otimes \tau_{X^*, X} \otimes \text{id}_{X^*})(\text{coev}_{X^*} \otimes \tau_{X^*, X}) = S i_X: X^* \otimes X \rightarrow C. \quad (48)$$

Here X and Y are any objects of \mathcal{B} and ${}_2^*(Y, X): Y^* \otimes X^* \rightarrow (X \otimes Y)^*$ is the isomorphism coming from the pivotal structure of \mathcal{B} . Moreover, if \mathcal{B} is a ribbon category, one can show that $S^2 = \theta_C$. In this case C is equipped with morphisms $\omega: C \otimes C \rightarrow \mathbb{1}$, $\theta_+: C \rightarrow \mathbb{1}$ and $\theta_-: C \rightarrow \mathbb{1}$, defined universally by the formulas, respectively:

$$(\text{ev}_X \otimes \text{ev}_Y)(\text{id}_{X^*} \otimes \tau_{Y^*, X} \tau_{X, Y^*} \otimes \text{id}_Y) = \omega(i_X \otimes i_Y): X^* \otimes X \otimes Y^* \otimes Y \rightarrow \mathbb{1}, \quad (49)$$

$$\text{ev}_X(\text{id}_{X^*} \otimes \theta_X) = \theta_+ i_X: X^* \otimes X \rightarrow \mathbb{1}, \quad (50)$$

$$\text{ev}_X(\text{id}_{X^*} \otimes \theta_X^{-1}) = \theta_- i_X: X^* \otimes X \rightarrow \mathbb{1}, \quad (51)$$

where X and Y are any objects of \mathcal{B} . The morphism ω , called the *canonical pairing* of C , is a Hopf pairing (see Section II.2.5). The morphisms θ_+ and θ_- are called *twist forms*. The formulas (44)-(51) rewrite graphically as follows:

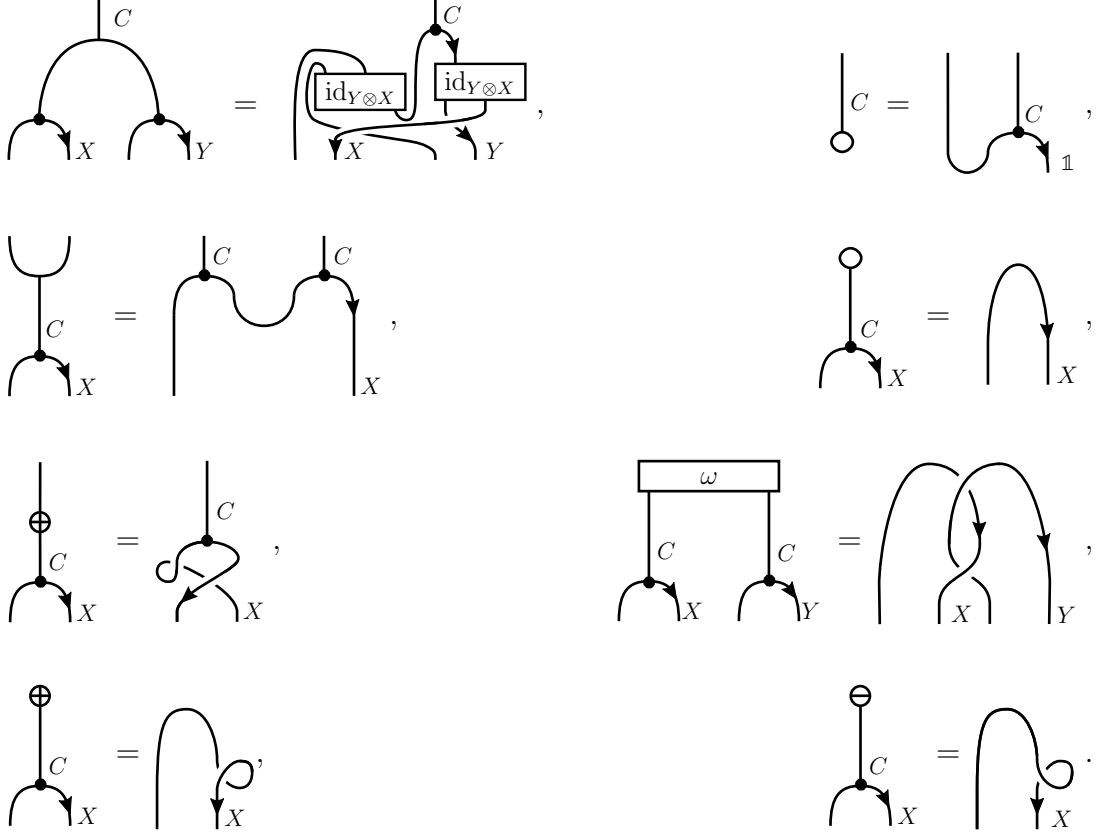

II.3.3. Universal action of coend. The universal coaction of the coend (C, i) of a pivotal category \mathcal{C} is the natural transformation $\delta = \{\delta_X: X \rightarrow X \otimes C\}_{X \in \text{Ob}(\mathcal{C})}$ defined by

$$\delta_X = (\text{id}_X \otimes i_X)(\text{coev}_X \otimes \text{id}_X).$$

We depict δ_X as:

$$\delta_X = \begin{array}{c} \text{---} C \\ | \\ \bullet \\ | \\ X \end{array} .$$

The structural morphisms of \mathcal{C} are characterized in terms of the universal coaction as follows: for all $X, Y \in \text{Ob}(\mathcal{C})$

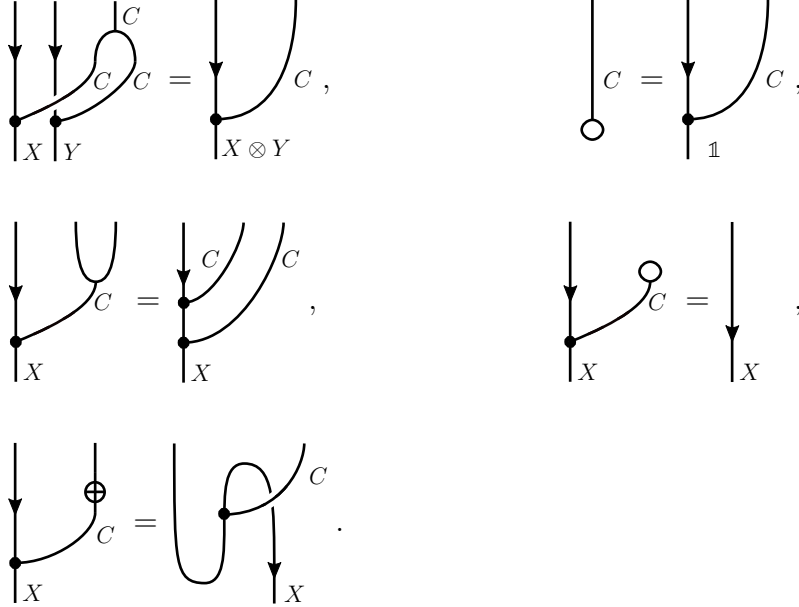

Moreover, if \mathcal{C} is ribbon, then the canonical pairing ω and twist forms θ_+ and θ_- are characterized as follows: for all $X, Y \in \text{Ob}(\mathcal{C})$

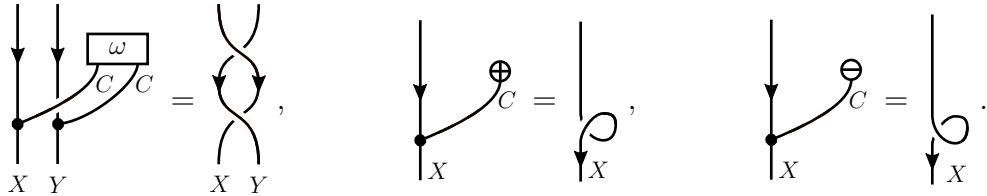

II.3.4. Computation of the categorical center. Let \mathcal{C} be a braided pivotal category with the coend (C, i) . The coend C is a Hopf algebra in \mathcal{C} (see Theorem II.4) and the category Mod_C of right modules over C (see Section II.2.6) and the categorical center $\mathcal{Z}(\mathcal{C})$ of \mathcal{C} (see Section II.1.14) are isomorphic as braided monoidal categories. The braiding in Mod_C is given by

$$\tau_{(M,r),(N,s)} = \begin{array}{c} N \quad M \\ | \quad | \\ \text{---} C \\ | \\ \bullet \\ | \\ M \quad N \end{array} .$$

Notice that in the expression of $\tau_{(M,r),(N,s)}$, we use only (N, s) and the universal coaction of the coend, which is described in Section II.3.3.

Now let us describe the construction of mutually inverse functors $K: \text{Mod}_C \rightarrow \mathcal{Z}(\mathcal{C})$ and $K^{-1}: \mathcal{Z}(\mathcal{C}) \rightarrow \text{Mod}_C$. For any right C -module (M, r) and any object X of \mathcal{C} , one defines the family $\sigma = \{\sigma_X: M \otimes X \rightarrow X \otimes M\}_{X \in \text{Ob}(\mathcal{C})}$ by setting

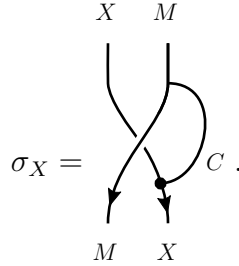

The functor K is defined by

$$K(M, r) = (M, \sigma) \quad \text{and} \quad K(f) = f$$

for any right C -module (M, r) and any morphism f between right C -modules.

The inverse K^{-1} of K is computed by

$$K^{-1}(M, \sigma) = (M, r^{(M, \sigma)}) \quad \text{and} \quad K^{-1}(f) = f$$

for any half-braiding (M, σ) of $\mathcal{Z}(\mathcal{C})$ and any morphism f of half-braidings of $\mathcal{Z}(\mathcal{C})$. Here

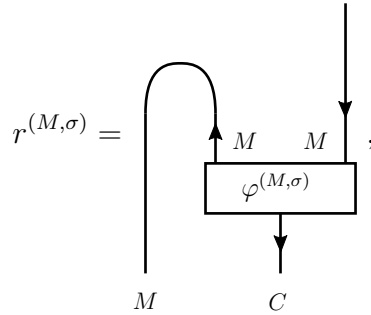

where $\varphi^{(M, \sigma)}: C \rightarrow M^* \otimes M$ is a unique morphism such that for all objects X of \mathcal{C} ,

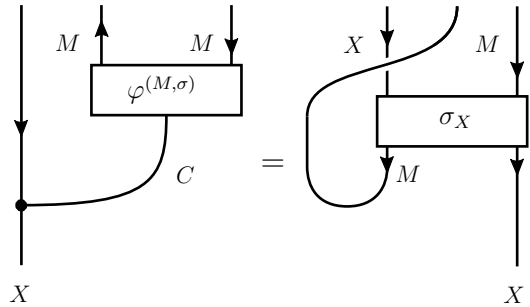

II.3.5. Modularity and pairing of a coend. Let \mathcal{C} be an additive ribbon \mathbb{k} -category with a coend (C, i) . By [36, Section 6.7], the category \mathcal{C} is modular (in the sense of Section II.1.13) if and only if the canonical pairing $\omega: C \otimes C \rightarrow \mathbb{1}$ associated to \mathcal{C} is nondegenerate. Moreover, according to [36, Section 6.4], $C = \bigoplus_{i \in I} i^* \otimes i$, where I is a representative set of simple objects of \mathcal{C} . For $i \in I$, we denote the projection associated with the direct sum decomposition by $p_i: C \rightarrow i^* \otimes i$. However, we drop inclusions $q_i: i^* \otimes i \rightarrow C$ in our notation. By [36], any integral of C is a scalar multiple of the universal integral

$$\Lambda = \sum_{i \in I} \dim(i) \widetilde{\text{coev}}_i: \mathbb{1} \rightarrow C \tag{52}$$

and any cointegral of C is a scalar multiple of the universal cointegral

$$\lambda = \text{ev}_1 p_1: C \rightarrow \mathbb{1}. \tag{53}$$

Universal (co)integrals λ and Λ satisfy $\lambda\Lambda = \text{id}_{\mathbb{1}}$.

In the following lemma, we compute the inverse of the nondegenerate pairing ω of the coend C of a category \mathcal{C} using an integral of C .

Lemma II.5. *Let \mathcal{C} be a ribbon \mathbb{k} -category with a coend C and suppose that the pairing $\omega: C \otimes C \rightarrow \mathbb{1}$ associated to the coend is nondegenerate.*

- a) *If $\alpha: \mathbb{1} \rightarrow C$ is a right integral of a coend, then $\omega(\alpha \otimes \text{id}_C): C \rightarrow \mathbb{1}$ is a left cointegral of C .*
- b) *Let α be a right integral of the coend C of \mathcal{C} . Suppose that the element $\omega(\alpha \otimes \alpha)$ is invertible. The inverse of the pairing ω is given by the copairing $\Omega: \mathbb{1} \rightarrow C \otimes C$, which is computed by*

$$\Omega = \left(\begin{array}{c} \omega \\ \hline C \quad C \\ \alpha \quad \alpha \end{array} \right)^{-1} \oplus \begin{array}{c} \omega \\ \hline C \\ \alpha \\ \hline C \\ \alpha \end{array}$$

PROOF. a) By the property of the bialgebra pairing and the fact that α is a right integral for C , we have

The conclusion follows, since ω is nondegenerate.

- b) By properties of bialgebra pairing, (co)unitality, the part (a), bialgebra compatibility axiom, (co)associativity, the antipode axiom, naturality of the braiding, and the fact that α is a right integral for C , we have

This further implies the equation (54):

$$\omega(\alpha \otimes \alpha)\text{id}_C = \begin{array}{c} \omega \\ \hline C \quad C \\ \alpha \quad \alpha \end{array} \text{id}_C = \begin{array}{c} \circ \\ | \\ \oplus \\ | \\ \text{id}_C \\ | \\ \oplus \\ | \\ C \end{array} = \begin{array}{c} \circ \\ | \\ \oplus \\ | \\ \omega \\ \hline \omega \\ \hline \alpha \\ | \\ \alpha \\ | \\ \oplus \\ | \\ C \end{array} = \begin{array}{c} \omega \\ \hline \omega \\ \hline \alpha \\ | \\ \alpha \\ | \\ \oplus \\ | \\ C \end{array} .$$

□

Remark II.7. Let \mathcal{C} be an additive ribbon fusion \mathbb{k} -category. Recall the universal integral Λ and the universal cointegral λ of the coend C , defined in equations (52) and (53), respectively. Let us calculate $\omega(\Lambda \otimes \Lambda)$. By Lemma II.5 a), $\omega(\Lambda \otimes \text{id}_C)$ is a left cointegral of C . By universality of λ , $\omega(\Lambda \otimes \text{id}_C) = k\lambda$, for some $k \in \mathbb{k} \simeq \text{End}(\mathbb{1})$. This further implies that

$$\omega(\Lambda \otimes \Lambda) = k\lambda\Lambda = k\text{id}_{\mathbb{1}}.$$

Now, remark also that

$$\omega(\Lambda \otimes u) = \varepsilon\Lambda = \dim(\mathcal{C}).$$

Hence

$$\omega(\Lambda \otimes \Lambda) = k\text{id}_{\mathbb{1}} = k(\lambda u) = (k\lambda)u = \omega(\Lambda \otimes u) = \varepsilon\Lambda = \dim(\mathcal{C}).$$

whence the relation (19). Further, by the naturality of the braiding in \mathcal{B} and naturality of twist morphism, we have

$$d_0 t_n = \begin{array}{c} \circ \\ | \\ \text{---} \\ | \\ 0 \quad \dots \quad n-1 \quad n \end{array} = \begin{array}{c} | \\ | \\ | \\ | \\ 0 \quad \dots \quad n-1 \quad n \end{array} = \begin{array}{c} | \\ | \\ | \\ | \\ 0 \quad \dots \quad n-1 \quad n \end{array} = d_n,$$

whence the relation (20).

Let us show Relations (21) and (22). Let $n \geq 1$ and $1 \leq j \leq n$. By the naturality of braiding in \mathcal{B} , we have

$$s_j t_n = \begin{array}{c} | \\ | \\ | \\ | \\ 0 \quad \dots \quad j-1 \quad n-1 \quad n \end{array} = \begin{array}{c} | \\ | \\ | \\ | \\ 0 \quad \dots \quad j-1 \quad n-1 \quad n \end{array} = t_{n+1} s_{j-1},$$

whence the relation (21). By the braiding axioms, the naturality of braidings in \mathcal{B} , and the naturality of twist morphism, we have

$$\begin{aligned} s_0 t_n &= \begin{array}{c} | \\ | \\ | \\ | \\ 0 \quad \dots \quad n-1 \quad n \end{array} = \begin{array}{c} | \\ | \\ | \\ | \\ 0 \quad \dots \quad n-1 \quad n \end{array} = \\ &= \begin{array}{c} | \\ | \\ | \\ | \\ 0 \quad \dots \quad n-1 \quad n \end{array} = \begin{array}{c} | \\ | \\ | \\ | \\ 0 \quad \dots \quad n-1 \quad n \end{array} = t_{n+1}^2 s_n, \end{aligned}$$

whence the relation (22) in the case when $n \geq 1$. For $n = 0$, this follows by the equation (43).

It remains to check that t_n is an isomorphism for any $n \in \mathbb{N}$. Clearly, $t_0^{-1} = \theta_C$. For $n \geq 1$, the inverse of t_n is the morphism

$$T_n = \begin{array}{c} | \\ | \\ | \\ | \\ 0 \quad 1 \quad \dots \quad n \end{array} : C^{\otimes n+1} \rightarrow C^{\otimes n+1}.$$

III.1.4.4. *The cocyclic \mathbb{k} -module $\tilde{\mathbf{D}}_{\bullet}(C)$.* We explicit formulas for the functor

$$\tilde{\mathbf{D}}_{\bullet}(C) = \mathrm{Hom}_{\mathcal{B}}(\mathbb{1}, -) \circ \mathbf{C}_{\bullet}(C): \Delta C_{\infty} \rightarrow \mathrm{Mod}_{\mathbb{k}}.$$

It follows by definition of $\mathbf{C}_{\bullet}(C)$ that $\tilde{\mathbf{D}}_{\bullet}(C) = \mathrm{Hom}_{\mathcal{B}}(\mathbb{1}, C^{\otimes n+1})$ for any $n \geq 0$. For $n \geq 1$, the cofaces $\{\delta_i^n: \mathrm{Hom}_{\mathcal{B}}(\mathbb{1}, C^{\otimes n}) \rightarrow \mathrm{Hom}_{\mathcal{B}}(\mathbb{1}, C^{\otimes n+1})\}_{0 \leq i \leq n}$ are computed by setting for any $f \in \mathrm{Hom}_{\mathcal{B}}(\mathbb{1}, C^{\otimes n})$,

$$\delta_i^n(f) = \begin{cases} \begin{array}{c} \text{---} \cup \text{---} \\ | \quad | \\ \dots \quad i+1 \quad \dots \\ | \quad | \\ \text{---} \\ f \end{array} & \text{if } 0 \leq i \leq n-1, \\ \begin{array}{c} \text{---} \text{---} \text{---} \\ | \quad | \quad | \\ \dots \quad \dots \quad \dots \\ | \quad | \quad | \\ \text{---} \\ f \end{array} & \text{if } i = n. \end{cases}$$

For $n \geq 0$, the codegeneracies $\{\sigma_j^n: \mathrm{Hom}_{\mathcal{B}}(\mathbb{1}, C^{\otimes n+2}) \rightarrow \mathrm{Hom}_{\mathcal{B}}(\mathbb{1}, C^{\otimes n+1})\}_{0 \leq j \leq n}$ are computed by setting for any $f \in \mathrm{Hom}_{\mathcal{B}}(\mathbb{1}, C^{\otimes n+2})$,

$$\sigma_j^n(f) = \begin{array}{c} 0 \quad | \quad | \quad | \quad | \quad \dots \\ \dots \quad j \quad 1 \quad \dots \quad n+1 \\ | \quad | \quad | \quad | \\ \text{---} \\ f \end{array}.$$

For $n \geq 0$, the paracocyclic operators $\tau_n: \mathrm{Hom}_{\mathcal{B}}(\mathbb{1}, C^{\otimes n+1}) \rightarrow \mathrm{Hom}_{\mathcal{B}}(\mathbb{1}, C^{\otimes n+1})$ are computed by setting for any $f \in \mathrm{Hom}_{\mathcal{B}}(\mathbb{1}, C^{\otimes n+1})$,

$$\tau_n(f) = \begin{cases} \mathrm{id}_{\mathrm{Hom}_{\mathcal{B}}(\mathbb{1}, C)} & \text{if } n = 0, \\ \begin{array}{c} \text{---} \text{---} \text{---} \\ | \quad | \quad | \\ 0 \quad 1 \quad n \\ | \quad | \quad | \\ \text{---} \\ f \end{array} & \text{if } n \geq 1. \end{cases}$$

The following lemma follows directly from Lemma III.1 and Lemma I.2.

Lemma III.8. *The paracocyclic \mathbb{k} -module $\tilde{\mathbf{D}}_{\bullet}(C)$ is a cocyclic \mathbb{k} -module.*

III.2. Cyclic objects from algebras

In this section, we introduce para(co)cyclic objects in \mathcal{B} associated to categorical algebras. Furthermore, by postcomposing with $\mathrm{Hom}_{\mathcal{B}}(-, \mathbb{1})$ or $\mathrm{Hom}_{\mathcal{B}}(\mathbb{1}, -)$, we obtain (co)cyclic \mathbb{k} -modules. In this section, A denotes an algebra in \mathcal{B} .

III.2.1. Construction of Akrami and Majid. In this section we recall the construction of a paracocyclic object in \mathcal{B} associated to an algebra A in \mathcal{B} . This is an adaptation of the work of Akrami and Majid [1] in the setting of braided categories with a twist. Namely, they considered the so called *ribbon algebras* in monoidal Ab-categories. As noticed in [1], any algebra in ribbon category is automatically a ribbon algebra. This clearly generalizes to braided categories with a twist. However, we warn the reader that in what follows, instead of the positive braiding and positive twists, we use the negative ones. This is completely innocuous and we choose this convention in order to explain the relation with the objects introduced in the Chapter VI in an easier way.

For $n \geq 0$, set $\mathbf{A}_n(A) = A^{\otimes n+1}$. For $n \geq 1$, define the faces $\{d_i^n : A^{\otimes n+1} \rightarrow A^{\otimes n}\}_{0 \leq i \leq n}$ by

$$d_i^n = \begin{cases} \begin{array}{c} \left| \dots \right| \quad \left| \quad \right| \quad \left| \quad \right| \\ \vdots \quad \vdots \quad \vdots \\ \text{---} \quad \text{---} \quad \text{---} \\ \left| \quad \right| \quad \left| \quad \right| \\ 0 \quad i \quad i+1 \quad n \end{array} & \text{if } 0 \leq i \leq n-1, \\ \begin{array}{c} \left| \quad \right| \quad \dots \quad \left| \quad \right| \\ \vdots \quad \vdots \quad \vdots \\ \text{---} \quad \text{---} \quad \text{---} \\ \left| \quad \right| \quad \left| \quad \right| \\ 0 \quad n-1 \quad n \end{array} & \text{if } i = n. \end{cases}$$

For $n \geq 0$, define the degeneracies $\{s_j^n : A^{\otimes n+1} \rightarrow A^{\otimes n+2}\}_{0 \leq j \leq n}$ by

$$s_j^n = \begin{array}{c} \left| \quad \right| \quad \left| \quad \right| \quad \left| \quad \right| \\ \vdots \quad \vdots \quad \vdots \\ \text{---} \quad \text{---} \quad \text{---} \\ \left| \quad \right| \quad \left| \quad \right| \quad \left| \quad \right| \\ 0 \quad j \quad j+1 \quad n \end{array}$$

For $n \geq 0$, define the paracyclic operators $t_n : A^{\otimes n+1} \rightarrow A^{\otimes n+1}$ by

$$t_n = \begin{cases} \theta_A^{-1}, & \text{if } n = 0, \\ \begin{array}{c} \left| \quad \right| \quad \left| \quad \right| \quad \left| \quad \right| \\ \vdots \quad \vdots \quad \vdots \\ \text{---} \quad \text{---} \quad \text{---} \\ \left| \quad \right| \quad \left| \quad \right| \quad \left| \quad \right| \\ 0 \quad n-1 \quad n \end{array} & \text{if } n \geq 1. \end{cases}$$

Lemma III.9. *A family $\{A^{\otimes n+1}\}_{n \in \mathbb{N}}$ of objects of \mathcal{B} , endowed with the above faces, degeneracies, and cyclic operators defines a paracyclic object $\mathbf{A}_\bullet(A)$ in \mathcal{B} . Moreover, for any $n \in \mathbb{N}$, $t_n^{n+1} = (\theta_{A^{\otimes n+1}})^{-1}$.*

We prove Lemma III.9 in Section III.2.3.

Remark III.10. As in Section III.1.1, when $\mathcal{B} = \text{Mod}_{\mathbb{k}}$, one recovers the usual cyclic \mathbb{k} -module for algebras in the sense of [38].

III.2.2. The paracyclic object $\widehat{\mathbf{A}}_\bullet(A)$. For $n \geq 0$, define $\widehat{\mathbf{A}}_n(A) = A^{\otimes n+1}$. For $n \geq 1$, define the cofaces $\{\delta_i^n : A^{\otimes n} \rightarrow A^{\otimes n+1}\}_{0 \leq i \leq n}$ by

$$\delta_i^n = \begin{cases} \begin{array}{c} \left| \quad \right| \quad \dots \quad \left| \quad \right| \\ \vdots \quad \vdots \quad \vdots \\ \text{---} \quad \text{---} \quad \text{---} \\ \left| \quad \right| \quad \left| \quad \right| \\ 0 \quad n-1 \end{array} & \text{if } i = 0, \\ \begin{array}{c} \left| \quad \right| \quad \left| \quad \right| \quad \left| \quad \right| \\ \vdots \quad \vdots \quad \vdots \\ \text{---} \quad \text{---} \quad \text{---} \\ \left| \quad \right| \quad \left| \quad \right| \quad \left| \quad \right| \\ 0 \quad i-1 \quad i \quad n-1 \end{array} & \text{if } 1 \leq i \leq n-1, \\ \begin{array}{c} \left| \quad \right| \quad \dots \quad \left| \quad \right| \\ \vdots \quad \vdots \quad \vdots \\ \text{---} \quad \text{---} \quad \text{---} \\ \left| \quad \right| \quad \left| \quad \right| \\ 0 \quad n-1 \end{array} & \text{if } i = n. \end{cases}$$

For $n \geq 0$, define the codegeneracies $\{\sigma_j^n: A^{\otimes n+2} \rightarrow A^{\otimes n+1}\}_{0 \leq j \leq n}$ by

$$\sigma_j^n = \left| \begin{array}{c} \cdots \\ \vdots \\ \cdots \end{array} \right|_0 \left| \begin{array}{c} \vdots \\ \vdots \\ \vdots \end{array} \right|_j \left| \begin{array}{c} \vdots \\ \vdots \\ \vdots \end{array} \right|_{j+1} \left| \begin{array}{c} \cdots \\ \vdots \\ \cdots \end{array} \right|_{n+1}.$$

For $n \geq 0$, define the paracyclic operators $\tau_n: A^{\otimes n+1} \rightarrow A^{\otimes n+1}$ by

$$\tau_n = \begin{cases} \theta_A, & \text{if } n = 0, \\ \left| \begin{array}{c} \vdots \\ \vdots \\ \vdots \end{array} \right|_0 \left| \begin{array}{c} \vdots \\ \vdots \\ \vdots \end{array} \right|_1 \cdots \left| \begin{array}{c} \vdots \\ \vdots \\ \vdots \end{array} \right|_n \end{cases} \text{ if } n \geq 1.$$

Lemma III.11. *A family $\{A^{\otimes n+1}\}_{n \in \mathbb{N}}$ of objects of \mathcal{B} , equipped with the above cofaces, codegeneracies, and cocyclic operators defines a paracyclic object $\widehat{\mathbf{A}}_\bullet(A)$ in \mathcal{B} . Moreover, for any $n \in \mathbb{N}$, $\tau_n^{n+1} = \theta_{A^{\otimes n+1}}$.*

The proof is similar to the proof of Lemma III.3, given in Section III.1.3.

III.2.3. Proof of Lemma III.9. Instead of checking Relations (4)-(6) and (19)-(23), we rather show that

$$\widehat{\mathbf{A}}_\bullet(A) \circ L = \mathbf{A}_\bullet(A),$$

where $L: \Delta C_\infty^{\text{op}} \rightarrow \Delta C_\infty$ denotes the isomorphism of categories from Section I.4.2 and $\widehat{\mathbf{A}}_\bullet(A)$ denotes the paracyclic object in \mathcal{B} from Section III.2.2.

Clearly, the functor $\widehat{\mathbf{A}}_\bullet(A) \circ L: \Delta C_\infty^{\text{op}} \rightarrow \mathcal{B}$ defines a paracyclic object in \mathcal{B} . One easily computes that for any $n \geq 1$ and $0 \leq i \leq n$ its face d_i^n coincides with the morphism $\mathbf{A}_\bullet(A)(d_i^n)$. Indeed, for $0 \leq i \leq n-1$,

$$\begin{aligned} \widehat{\mathbf{A}}_\bullet(A) \circ L(d_i^n) &= \widehat{\mathbf{A}}_\bullet(A)(\sigma_i^{n-1}) \\ &= \left| \begin{array}{c} \cdots \\ \vdots \\ \cdots \end{array} \right|_0 \left| \begin{array}{c} \vdots \\ \vdots \\ \vdots \end{array} \right|_i \left| \begin{array}{c} \vdots \\ \vdots \\ \vdots \end{array} \right|_{i+1} \left| \begin{array}{c} \cdots \\ \vdots \\ \cdots \end{array} \right|_n = \mathbf{A}_\bullet(A)(d_i^n), \end{aligned}$$

and for $i = n$,

$$\begin{aligned} \widehat{\mathbf{A}}_\bullet(A) \circ L(d_n^n) &= \widehat{\mathbf{A}}_\bullet(A)(\sigma_0^{n-1} \tau_n^{-1}) = \\ &= \widehat{\mathbf{A}}_\bullet(A)(\sigma_0^{n-1}) \left(\widehat{\mathbf{A}}_\bullet(A)(\tau_n) \right)^{-1} = \\ &= \left| \begin{array}{c} \vdots \\ \vdots \\ \vdots \end{array} \right|_0 \left| \begin{array}{c} \vdots \\ \vdots \\ \vdots \end{array} \right|_1 \cdots \left| \begin{array}{c} \vdots \\ \vdots \\ \vdots \end{array} \right|_{n-1} \left| \begin{array}{c} \vdots \\ \vdots \\ \vdots \end{array} \right|_n = \mathbf{A}_\bullet(A)(d_n^n). \end{aligned}$$

Similarly, for any $n \geq 0$ and $0 \leq j \leq n$ the degeneracy s_j^n of $\widehat{\mathbf{A}}_\bullet(A) \circ L$ coincides with the morphism $\mathbf{A}_\bullet(A)(s_j^n)$. Indeed, for $n \geq 0$ and $0 \leq j \leq n$,

$$\begin{aligned} \widehat{\mathbf{A}}_\bullet(A) \circ L(s_j^n) &= \widehat{\mathbf{A}}_\bullet(A)(\delta_{j+1}^{n+1}) = \\ &= \left| \begin{array}{c} \cdots \\ \vdots \\ \cdots \end{array} \right|_0 \left| \begin{array}{c} \vdots \\ \vdots \\ \vdots \end{array} \right|_j \left| \begin{array}{c} \vdots \\ \circ \\ \vdots \end{array} \right|_{j+1} \left| \begin{array}{c} \cdots \\ \vdots \\ \cdots \end{array} \right|_n = \mathbf{A}_\bullet(A)(s_j^n). \end{aligned}$$

For $n \geq 0$, the paracyclic operators $t_n: \text{Hom}_{\mathcal{B}}(A^{\otimes n+1}, \mathbb{1}) \rightarrow \text{Hom}_{\mathcal{B}}(A^{\otimes n+1}, \mathbb{1})$ are computed by setting for any $f \in \text{Hom}_{\mathcal{B}}(A^{\otimes n+1}, \mathbb{1})$,

$$t_n(f) = \begin{cases} \text{id}_{\text{Hom}_{\mathcal{B}}(A, \mathbb{1})} & \text{if } n = 0, \\ \begin{array}{c} \boxed{f} \\ \text{---} \\ \rho \quad \dots \\ 0 \quad 1 \quad \dots \quad n \end{array} & \text{if } n \geq 1. \end{cases}$$

The following lemma follows directly from Lemma III.11 and Lemma I.2.

Lemma III.12. *The paracyclic \mathbb{k} -module $\widehat{\mathbf{B}}_{\bullet}(A)$ is a cyclic \mathbb{k} -module.*

III.2.4.2. *The cocyclic \mathbb{k} -module $\mathbf{B}_{\bullet}(A)$.* We explicit formulas for the functor

$$\mathbf{B}_{\bullet}(A) = \text{Hom}_{\mathcal{B}}(-, \mathbb{1}) \circ \mathbf{A}_{\bullet}(A): \Delta C_{\infty} \rightarrow \text{Mod}_{\mathbb{k}}.$$

It follows from the definition of $\mathbf{A}_{\bullet}(A)$ that $\mathbf{B}_n(A) = \text{Hom}_{\mathcal{B}}(A^{\otimes n+1}, \mathbb{1})$ for any $n \geq 0$. For $n \geq 1$, the cofaces $\{\delta_i^n: \text{Hom}_{\mathcal{B}}(A^{\otimes n}, \mathbb{1}) \rightarrow \text{Hom}_{\mathcal{B}}(A^{\otimes n+1}, \mathbb{1})\}_{0 \leq i \leq n}$ are computed by setting for any $f \in \text{Hom}_{\mathcal{B}}(A^{\otimes n}, \mathbb{1})$,

$$\delta_i^n(f) = \begin{cases} \begin{array}{c} \boxed{f} \\ \text{---} \\ \dots \quad \text{---} \quad \dots \\ 0 \quad i \quad i+1 \quad n \end{array} & \text{if } 0 \leq i \leq n-1, \\ \begin{array}{c} \boxed{f} \\ \text{---} \\ \text{---} \quad \dots \quad \text{---} \\ 0 \quad \dots \quad n-1 \quad n \end{array} & \text{if } i = n. \end{cases}$$

For $n \geq 0$, the codegeneracies $\{\sigma_j^n: \text{Hom}_{\mathcal{B}}(A^{\otimes n+2}, \mathbb{1}) \rightarrow \text{Hom}_{\mathcal{B}}(A^{\otimes n+1}, \mathbb{1})\}_{0 \leq j \leq n}$ are computed by setting for any $f \in \text{Hom}_{\mathcal{B}}(A^{\otimes n+2}, \mathbb{1})$,

$$\sigma_j^n(f) = \begin{array}{c} \boxed{f} \\ \text{---} \\ \dots \quad \text{---} \quad \text{---} \quad \text{---} \\ 0 \quad j \quad j+1 \quad n \end{array}.$$

For $n \geq 0$, the paracyclic operators $\tau_n: \text{Hom}_{\mathcal{B}}(A^{\otimes n+1}, \mathbb{1}) \rightarrow \text{Hom}_{\mathcal{B}}(A^{\otimes n+1}, \mathbb{1})$ are computed by setting for any $f \in \text{Hom}_{\mathcal{B}}(A^{\otimes n+1}, \mathbb{1})$,

$$\tau_n(f) = \begin{cases} \text{id}_{\text{Hom}_{\mathcal{B}}(A, \mathbb{1})} & \text{if } n = 0, \\ \begin{array}{c} \boxed{f} \\ \text{---} \\ \text{---} \quad \dots \quad \text{---} \\ 0 \quad \dots \quad n-1 \quad n \end{array} & \text{if } n \geq 1. \end{cases}$$

The following lemma follows directly by Lemma III.9 and Lemma I.1.

Lemma III.13. *The paracyclic \mathbb{k} -module $\mathbf{B}_{\bullet}(A)$ is a cocyclic \mathbb{k} -module.*

Recall the isomorphism of categories $L^{\text{op}}: \Delta C \rightarrow \Delta C^{\text{op}}$ from Section I.4.3. In the following lemma we relate the cocyclic modules $\mathbf{B}_\bullet(A)$ and $\widehat{\mathbf{B}}_\bullet(A) \circ L^{\text{op}}$.

Lemma III.14. *The cocyclic \mathbb{k} -modules $\widehat{\mathbf{B}}_\bullet(A) \circ L^{\text{op}}$ and $\mathbf{B}_\bullet(A)$ are equal.*

PROOF. Clearly, the composition $\widehat{\mathbf{B}}_\bullet(A) \circ L^{\text{op}}$ defines a cocyclic \mathbb{k} -module. One computes that for any $n \geq 1$ and $0 \leq i \leq n$ its coface δ_i^n coincides with the morphism $\mathbf{B}_\bullet(A)(\delta_i^n)$. Indeed, let $f \in \text{Hom}_{\mathcal{B}}(C^{\otimes n+1}, \mathbb{1})$. For $n \geq 1$ and $0 \leq i \leq n-1$,

$$\begin{aligned} \widehat{\mathbf{B}}_\bullet(A) \circ L^{\text{op}}(\delta_i^n)(f) &= \widehat{\mathbf{B}}_\bullet(A)(s_i^{n-1})(f) = \\ &= \begin{array}{c} \boxed{f} \\ | \\ \dots \quad \cup \quad \dots \\ 0 \quad i \quad i+1 \quad n \end{array} = \mathbf{B}_\bullet(A)(\delta_i^n)(f), \end{aligned}$$

and for $i = n$,

$$\begin{aligned} \widehat{\mathbf{B}}_\bullet(A) \circ L^{\text{op}}(\delta_n^n)(f) &= \widehat{\mathbf{B}}_\bullet(A)(t_n^{-1} s_0^{n-1})(f) = \\ &= \widehat{\mathbf{B}}_\bullet(A)(t_n^{-1}) \widehat{\mathbf{B}}_\bullet(A)(s_0^{n-1})(f) = \\ &= \begin{array}{c} \boxed{f} \\ | \\ \circ \quad \dots \\ 0 \quad n-1 \quad n \end{array} = \mathbf{B}_\bullet(A)(\delta_n^n)(f). \end{aligned}$$

Similarly, for any $n \geq 0$ and $0 \leq j \leq n$ the codegeneracy σ_j^n of $\widehat{\mathbf{B}}_\bullet(A) \circ L^{\text{op}}$ coincides with the morphism $\mathbf{B}_\bullet(A)(\sigma_j^n)$. Indeed, for $n \geq 0$, $0 \leq j \leq n$ and $f \in \text{Hom}_{\mathcal{B}}(C^{\otimes n+2}, \mathbb{1})$,

$$\begin{aligned} \widehat{\mathbf{B}}_\bullet(A) \circ L^{\text{op}}(\sigma_j^n)(f) &= \widehat{\mathbf{B}}_\bullet(A)(d_{j+1}^{n+1})(f) = \\ &= \begin{array}{c} \boxed{f} \\ | \\ \dots \quad \circ \quad \dots \\ 0 \quad j \quad j+1 \quad n \end{array} = \mathbf{B}_\bullet(A)(\sigma_j^n)(f). \end{aligned}$$

Likewise, for any $n \geq 0$, the cocyclic operator τ_n of $\widehat{\mathbf{B}}_\bullet(A) \circ L^{\text{op}}$ coincides with the morphism $\mathbf{B}_\bullet(A)(\tau_n)$. Indeed, let $f \in \text{Hom}_{\mathcal{B}}(C^{\otimes n+1}, \mathbb{1})$. If $n = 0$,

$$\widehat{\mathbf{B}}_\bullet(A) \circ L^{\text{op}}(\tau_0)(f) = \widehat{\mathbf{B}}_\bullet(A)(t_0^{-1})(f) = \left(\widehat{\mathbf{B}}_\bullet(A)(t_0) \right)^{-1}(f) = \text{id}_{\widehat{\mathbf{B}}_0(A)}(f) = f,$$

and in the case when $n \geq 1$,

$$\begin{aligned} \widehat{\mathbf{B}}_\bullet(A) \circ L^{\text{op}}(\tau_n)(f) &= \widehat{\mathbf{B}}_\bullet(A)(t_n^{-1})(f) = \\ &= \left(\widehat{\mathbf{B}}_\bullet(A)(t_n) \right)^{-1}(f) = \\ &= \begin{array}{c} \boxed{f} \\ | \\ \dots \quad \cup \quad \dots \\ 0 \quad n-1 \quad n \end{array} = \mathbf{B}_\bullet(A)(\tau_n)(f). \end{aligned}$$

We conclude that the cocyclic \mathbb{k} -module $\mathbf{B}_\bullet(A)$ is equal to the composition $\widehat{\mathbf{B}}_\bullet(A) \circ L^{\text{op}}$, that is, $\mathbf{B}_\bullet(A)$ is the cocyclic dual of $\widehat{\mathbf{B}}_\bullet(A)$ with respect to L^{op} . \square

III.2.4.3. *The cocyclic \mathbb{k} -module $\check{\mathbf{B}}_{\bullet}(A)$.* We explicit formulas for the functor

$$\check{\mathbf{B}}_{\bullet}(A) = \text{Hom}_{\mathcal{B}}(\mathbb{1}, -) \circ \widehat{\mathbf{A}}_{\bullet}(A): \Delta C_{\infty} \rightarrow \text{Mod}_{\mathbb{k}}.$$

It follows from the definition of $\widehat{\mathbf{A}}_{\bullet}(A)$ that $\check{\mathbf{B}}_n(A) = \text{Hom}_{\mathcal{B}}(\mathbb{1}, A^{\otimes n+1})$ for any $n \in \mathbb{N}$. For each $n \geq 1$, the cofaces $\{\delta_i^n: \text{Hom}_{\mathcal{B}}(\mathbb{1}, A^{\otimes n}) \rightarrow \text{Hom}_{\mathcal{B}}(\mathbb{1}, A^{\otimes n+1})\}_{0 \leq i \leq n}$ are computed by setting for any $f \in \text{Hom}_{\mathcal{B}}(\mathbb{1}, A^{\otimes n})$,

$$\delta_i^n(f) = \begin{cases} \begin{array}{c} \text{---} | \text{---} | \text{---} | \text{---} | \\ \circ \quad 0 \quad \dots \quad n-1 \\ \hline f \end{array} & \text{if } i = 0, \\ \begin{array}{c} \text{---} | \text{---} | \text{---} | \text{---} | \text{---} | \\ 0 \quad i-1 \quad 1 \quad \circ \quad i \quad n-1 \\ \hline f \end{array} & \text{if } 1 \leq i \leq n-1, \\ \begin{array}{c} \text{---} | \text{---} | \text{---} | \text{---} | \\ 0 \quad n-1 \quad 1 \quad \circ \\ \hline f \end{array} & \text{if } i = n. \end{cases}$$

For $n \geq 0$, the codegeneracies $\{\sigma_j^n: \text{Hom}_{\mathcal{B}}(\mathbb{1}, A^{\otimes n+2}) \rightarrow \text{Hom}_{\mathcal{B}}(\mathbb{1}, A^{\otimes n+1})\}_{0 \leq j \leq n}$ are computed by setting for any $f \in \text{Hom}_{\mathcal{B}}(\mathbb{1}, A^{\otimes n+2})$,

$$\sigma_j^n(f) = \begin{array}{c} \text{---} | \text{---} | \text{---} | \text{---} | \\ \dots \quad j \quad \text{---} \quad j+1 \quad \dots \\ \hline f \end{array}$$

For $n \geq 0$, the paracocyclic operators $\tau_n: \text{Hom}_{\mathcal{B}}(\mathbb{1}, A^{\otimes n+1}) \rightarrow \text{Hom}_{\mathcal{B}}(\mathbb{1}, A^{\otimes n+1})$ are computed by setting for all $f \in \text{Hom}_{\mathcal{B}}(\mathbb{1}, A^{\otimes n+1})$

$$\tau_n(f) = \begin{cases} \text{id}_{\text{Hom}_{\mathcal{B}}(\mathbb{1}, A)} & \text{if } n = 0, \\ \begin{array}{c} \text{---} | \text{---} | \text{---} | \text{---} | \\ \text{---} \text{---} \text{---} \text{---} \text{---} \\ \hline f \end{array} & \text{if } n \geq 1. \end{cases}$$

The following lemma follows by Lemma III.11 and Lemma I.2.

Lemma III.15. *The paracocyclic \mathbb{k} -module $\check{\mathbf{B}}_{\bullet}(A)$ is a cocyclic \mathbb{k} -module.*

III.2.4.4. *The cyclic \mathbb{k} -module $\tilde{\mathbf{B}}_{\bullet}(A)$.* We explicit formulas for the functor

$$\tilde{\mathbf{B}}_{\bullet}(A) = \text{Hom}_{\mathcal{B}}(\mathbb{1}, -) \circ \mathbf{A}_{\bullet}(A): \Delta C_{\infty}^{\text{op}} \rightarrow \text{Mod}_{\mathbb{k}}.$$

It follows from the definition of $\mathbf{A}_{\bullet}(A)$ that $\tilde{\mathbf{B}}_n(A) = \text{Hom}_{\mathcal{B}}(\mathbb{1}, A^{\otimes n+1})$ for any $n \geq 0$. For $n \geq 1$, the faces $\{d_i^n: \text{Hom}_{\mathcal{B}}(\mathbb{1}, A^{\otimes n+1}) \rightarrow \text{Hom}_{\mathcal{B}}(\mathbb{1}, A^{\otimes n})\}_{0 \leq i \leq n}$ are computed by setting

transformation $\Omega_\bullet = \{\Omega_n: \text{Hom}_{\mathcal{B}}(H^{\otimes n+1}, \mathbb{1}) \rightarrow \text{Hom}_{\mathcal{B}}(\mathbb{1}, H^{\otimes n+1})\}_{n \in \mathbb{N}}$ defined by setting for any $n \in \mathbb{N}$ and $f \in \text{Hom}_{\mathcal{B}}(H^{\otimes n+1}, \mathbb{1})$,

$$\Omega_n(f) = \begin{array}{c} \dots \\ | \\ | \\ \boxed{f} \\ | \\ \boxed{\Omega} \\ | \\ \boxed{\Omega} \end{array} : \text{Hom}_{\mathcal{B}}(H^{\otimes n+1}, \mathbb{1}) \rightarrow \text{Hom}_{\mathcal{B}}(\mathbb{1}, H^{\otimes n+1}),$$

where $\Omega: \mathbb{1} \rightarrow H \otimes H$ is the inverse of the pairing $\omega: H \otimes H \rightarrow \mathbb{1}$. The family Ω_\bullet commutes with the cofaces and codegeneracies due to properties of a pairing and its inverse. In order to show that the family Ω_\bullet commutes with cocyclic operators, one shall use the fact that $\omega(\text{id}_H \otimes \text{id}_H) = \omega(\text{id}_H \otimes \theta_H)$, which follows by the fact that $\theta_{H^*} = (\theta_H)^*$ holds in a ribbon category (see the Chapter 3 of [36]). Indeed, using the latter together with naturality of twists and definition of dual of a morphism, we have

$$\begin{array}{c} \omega \\ \downarrow \\ H \end{array} = \begin{array}{c} \omega \\ \downarrow \\ H \end{array} = \begin{array}{c} \omega \\ \downarrow \\ H \end{array} = \begin{array}{c} \omega \\ \downarrow \\ H \end{array},$$

which implies that $\omega(\theta_H \otimes \text{id}_H) = \omega(\text{id}_H \otimes \theta_H)$. \square

III.3.2. Summary on comparing different objects and dualities. Throughout this chapter, we have introduced para(co)cyclic or (co)cyclic objects in a category and established several relations between them. In this section we first summarize these results. We finish Section with a comparison of constructions applied to a coalgebra C in a ribbon category and those applied on algebra C^* .

If C is a coalgebra in a braided category \mathcal{B} with a twist, then

$$\mathbf{C}_\bullet(C) = \widehat{\mathbf{C}}_\bullet(C) \circ L^{\text{op}} \quad \text{and} \quad \mathbf{D}_\bullet(C) = \widehat{\mathbf{D}}_\bullet(C) \circ L.$$

If A is an algebra in a braided category \mathcal{B} with a twist, then

$$\mathbf{A}_\bullet(A) = \widehat{\mathbf{A}}_\bullet(A) \circ L \quad \text{and} \quad \mathbf{B}_\bullet(A) = \widehat{\mathbf{B}}_\bullet(A) \circ L^{\text{op}}.$$

If H is a Hopf algebra with a nondegenerate pairing in a ribbon category \mathcal{B} , then there are isomorphisms between:

- (1) $\widehat{\mathbf{D}}_\bullet(H)$ and $\check{\mathbf{B}}_\bullet(H) \circ \Phi$,
- (2) $\widehat{\mathbf{B}}_\bullet(H)$ and $\check{\mathbf{D}}_\bullet(H) \circ \Phi^{\text{op}}$,
- (3) $\mathbf{D}_\bullet(H)$ and $\check{\mathbf{B}}_\bullet(H) \circ \Phi \circ L$,
- (4) $\mathbf{B}_\bullet(H)$ and $\check{\mathbf{D}}_\bullet(H) \circ \Phi^{\text{op}} \circ L^{\text{op}}$.

The isomorphisms (3) and (4) follow by combining Theorem III.17 with the above stated relations between para(co)cyclic objects from algebras and coalgebras.

PROOF. For $n \geq 1$,

$$\begin{aligned}
h_n b_{n+1} + b_{n+2} h_{n+1} &= h_n \sum_{i=0}^n (-1)^i \left| \begin{array}{c} \cdots \\ 0 \end{array} \right| \left| \begin{array}{c} \circ \\ i \end{array} \right| \left| \begin{array}{c} \cdots \\ n \end{array} \right| + b_{n+2} \left| \begin{array}{c} \circ \\ 0 \end{array} \right| \left| \begin{array}{c} \cdots \\ n \end{array} \right| \\
&= \sum_{i=0}^n (-1)^i \left| \begin{array}{c} \circ \\ 0 \end{array} \right| \left| \begin{array}{c} \cdots \\ i \end{array} \right| \left| \begin{array}{c} \circ \\ n \end{array} \right| + \left| \begin{array}{c} \circ \\ 0 \end{array} \right| \left| \begin{array}{c} \cdots \\ n \end{array} \right| + \sum_{i=0}^n (-1)^{i+1} \left| \begin{array}{c} \circ \\ 0 \end{array} \right| \left| \begin{array}{c} \cdots \\ i \end{array} \right| \left| \begin{array}{c} \circ \\ n \end{array} \right| \\
&= \text{id}_{C^{\otimes n+1}}.
\end{aligned}$$

The equation (56) holds since

$$b_1 h_1 + u\varepsilon = \text{id}_C - u\varepsilon + u\varepsilon = \text{id}_C.$$

□

An immediate corollary of the preceding lemma is the following.

Corollary III.19. *Consider the cochain complex*

$$\text{Hom}_{\mathcal{B}}(C, \mathbb{1}) \xrightarrow{\beta_2} \text{Hom}_{\mathcal{B}}(C^{\otimes 2}, \mathbb{1}) \xrightarrow{\beta_3} \text{Hom}_{\mathcal{B}}(C^{\otimes 3}, \mathbb{1}) \xrightarrow{\beta_4} \dots$$

with $\beta_{n+1} = \sum_{i=0}^n (-1)^i \delta_i^n : \text{Hom}_{\mathcal{B}}(C^{\otimes n}, \mathbb{1}) \rightarrow \text{Hom}_{\mathcal{B}}(C^{\otimes n+1}, \mathbb{1})$, associated to the underlying cosimplicial \mathbb{k} -module of the cocyclic \mathbb{k} -module $\widehat{\mathbf{D}}_{\bullet}(C)$. The family $\{\chi_n : \text{Hom}_{\mathcal{B}}(C^{\otimes n+1}, \mathbb{1}) \rightarrow \text{Hom}_{\mathcal{B}}(C^{\otimes n}, \mathbb{1})\}_{n \in \mathbb{N}^*}$, defined by setting for any $f \in \text{Hom}_{\mathcal{B}}(C^{\otimes n+1}, \mathbb{1})$,

$$\chi_n(f) = \begin{array}{c} \boxed{f} \\ \circ \quad | \quad \cdots \quad | \\ 1 \quad n \end{array},$$

satisfies the equalities

$$\text{id}_{\text{Hom}_{\mathcal{B}}(C^{\otimes n+1}, \mathbb{1})} = \beta_{n+1} \chi_n + \chi_{n+1} \beta_{n+2} \quad \text{for } n \geq 1 \quad \text{and} \quad (57)$$

$$\text{id}_{\text{Hom}_{\mathcal{B}}(C, \mathbb{1})} = \chi_1 \beta_2 + \text{Hom}_{\mathcal{B}}(u\varepsilon, \mathbb{1}). \quad (58)$$

PROOF. One applies the functoriality on the equations (55) and (56). □

Corollary III.20.

$$\begin{aligned}
HH^n(\widehat{\mathbf{D}}_{\bullet}(C)) &= \begin{cases} \ker(\beta_2) & \text{for } n = 0, \\ 0 & \text{for } n \geq 1. \end{cases} \\
HC^n(\widehat{\mathbf{D}}_{\bullet}(C)) &\cong \begin{cases} \ker(\beta_2) & \text{for } n \text{ even,} \\ 0 & \text{for } n \text{ odd.} \end{cases}
\end{aligned}$$

PROOF. The statement about Hochschild cohomology is clear from the definition and the equation (57). Consequently, the statement for cocyclic homology is clear from the cohomological form of the Connes' long exact sequence (see the part 2 of Theorem I.4):

$$\dots \longrightarrow HH^{n+1}(\widehat{\mathbf{D}}_{\bullet}(C)) \longrightarrow HC^n(\widehat{\mathbf{D}}_{\bullet}(C)) \longrightarrow HC^{n+2}(\widehat{\mathbf{D}}_{\bullet}(C)) \longrightarrow HH^{n+2}(\widehat{\mathbf{D}}_{\bullet}(C)) \longrightarrow \dots$$

Recall that the beginning of this long exact sequence writes as follows:

$$0 \longrightarrow HC^0(\widehat{\mathbf{D}}_{\bullet}(C)) \longrightarrow HH^0(\widehat{\mathbf{D}}_{\bullet}(C)) \longrightarrow 0 \longrightarrow HC^1(\widehat{\mathbf{D}}_{\bullet}(C)) \longrightarrow HH^1(\widehat{\mathbf{D}}_{\bullet}(C)) \longrightarrow \dots$$

Remark that from the equation (58), we get that

$$\ker(\beta_2) = \{f \in \text{Hom}_{\mathcal{B}}(C, \mathbb{1}) \mid f = fu\varepsilon\}.$$

□

Remark III.21. One could state an analogous result by supposing that C is only a coalgebra in \mathcal{B} and assuming the existence of a morphism $\alpha: \mathbb{1} \rightarrow C$ in \mathcal{B} such that $\varepsilon\alpha = \text{id}_{\mathbb{1}}$.

III.4.2. HC_0 of some (co)cyclic modules associated to coends. Let \mathcal{B} be any \mathbb{k} -linear ribbon category and C its coend. Let X be any object of \mathcal{B} . From the calculations that have been done in Section IV.2.2, the morphism $\kappa^X = i_X \widetilde{\text{coev}}_X: \mathbb{1} \rightarrow C$ is in $HC_0(\widetilde{\mathbf{D}}_{\bullet}(C))$. Indeed, in the aforementioned section, we show that κ_X satisfies the trace-like condition (62). If \mathcal{B} is a ribbon fusion category and I the representative set of simple objects of \mathcal{B} , then the family $\{\kappa^i\}_{i \in I}$ is a basis for $\text{Hom}_{\mathcal{B}}(\mathbb{1}, C)$ (see the Chapter 6 of [36]). Consequently, in the case of a ribbon fusion category \mathcal{B} , $HC_0(\widetilde{\mathbf{D}}_{\bullet}(C))$ consists precisely of the classes of κ^i .

Dually, if \mathcal{B} is a ribbon category such that the Hopf pairing ω of its coend C is a nondegenerate pairing, then the morphism $\zeta^X = \omega(\kappa^X \otimes \text{id}_C): C \rightarrow \mathbb{1}$ is in $HC_0(\mathbf{B}_{\bullet}(C))$.

III.4.3. (Co)cyclic vector spaces from the coend of the representation category of a Hopf algebra. Let \mathbb{k} be a field. Let H be a finite dimensional ribbon Hopf algebra over \mathbb{k} . For the comultiplication, we will use the usual Sweedler notation, i.e., $\Delta(x) = x_{(1)} \otimes x_{(2)}$ for any $x \in H$. Denote by R, u, θ the R -matrix, the Drinfeld element, and the twist element of H , respectively. In what follows, write

$$R = \sum_i a_i \otimes b_i \in H \otimes H \quad \text{and} \quad R^{-1} = \sum_i \alpha_i \otimes \beta_i \in H \otimes H.$$

To recall these notions and their properties, one may consult [37]. The category rep_H is a ribbon category. Denote the coend of the category rep_H by A . We recall (see [36]) that as a vector space, it is equal to H^* and as a left H -module, it is given by the coadjoint action, i.e., for all $h \in H$ and $f \in A$,

$$h \triangleright f = f(S(h_{(1)})h_{(2)}).$$

According to Lemma 4.5(d) from [37], $\text{Hom}_{\text{rep}_H}(A^{\otimes n}, \mathbb{k})$ is isomorphic, via the map induced by the evaluation of $A^{\otimes n}$ on $H^{\otimes n}$, to the \mathbb{k} -vector space

$$V_n(H) = \{X \in H^{\otimes n} \mid X \triangleleft h = \varepsilon(h)X \text{ for any } h \in H\}.$$

We recall for any $n \in \mathbb{N}^*$, the right H -action \triangleleft on $H^{\otimes n}$ is defined by the formula

$$X \triangleleft h = S(h_{(1)})X_1h_{(2)} \otimes S(h_{(3)})X_2h_{(4)} \otimes \cdots \otimes S(h_{(2n-1)})X_nh_{(2n)},$$

where $h \in H$ and $X = X_1 \otimes X_2 \otimes \cdots \otimes X_n \in H^{\otimes n}$ is an elementary tensor. Remark that the vector space $V_n(H)$ is exactly the 0-th usual Hochschild homology $HH_0(H, H^{\otimes n})$ of H with coefficients in $H^{\otimes n}$, where $H^{\otimes n}$ is the bimodule over H (the left action is given by trivial action via counit).

III.4.3.1. $\mathbf{D}_{\bullet}(\text{coend}(\text{rep}_H))$. The cyclic \mathbb{k} -vector space $\mathbf{D}_{\bullet}(A)$ may be identified with the cyclic \mathbb{k} -vector space

$$\begin{aligned} \mathbf{V}_{\bullet}(H): \Delta C^{\text{op}} &\rightarrow \text{Vect}_{\mathbb{k}} \\ n &\mapsto V_{n+1}(H). \end{aligned}$$

For $n \geq 1$, the faces $\{d_i^n: \mathbf{V}_n(H) \rightarrow \mathbf{V}_{n-1}(H)\}_{0 \leq i \leq n}$ are given by setting for any elementary tensor $h_1 \otimes \cdots \otimes h_{n+1} \in \mathbf{V}_n(H)$,

$$d_i^n(h_1 \otimes \cdots \otimes h_{n+1}) = h_1 \otimes h_2 \otimes \cdots \otimes h_{i+1} h_{i+2} \otimes \cdots \otimes h_{n+1} \text{ for } 0 \leq i \leq n-1 \text{ and}$$

$$d_n^n(h_1 \otimes \cdots \otimes h_{n+1}) = \sum_i (h_{n+1} \triangleleft a_i \theta)(h_1 \triangleleft (b_i)_{(1)}) \otimes h_2 \triangleleft (b_i)_{(2)} \otimes \cdots \otimes h_n \triangleleft (b_i)_{(n)}.$$

For $n \geq 0$, the degeneracies $\{s_j^n: \mathbf{V}_n(H) \rightarrow \mathbf{V}_{n+1}(H)\}_{0 \leq j \leq n}$ are given by setting for any elementary tensor $h_1 \otimes \cdots \otimes h_{n+1} \in \mathbf{V}_n(H)$,

$$s_j(h_1 \otimes \cdots \otimes h_{n+1}) = \begin{cases} h_1 \otimes \cdots \otimes h_{j+1} \otimes 1_H \otimes h_{j+2} \otimes \cdots \otimes h_{n+1} & \text{for } 0 \leq j \leq n-1, \\ h_1 \otimes \cdots \otimes h_{n+1} \otimes 1_H, & \text{for } j = n. \end{cases}$$

For $n \geq 0$, the cyclic operators $t_n: \mathbf{V}_n(H) \rightarrow \mathbf{V}_n(H)$ are given by setting for any elementary tensor $h_1 \otimes \cdots \otimes h_{n+1} \in \mathbf{V}_n(H)$,

$$t_n(h_1 \otimes \cdots \otimes h_{n+1}) = \begin{cases} h_1 & \text{for } n = 0, \\ \sum_i h_{n+1} \triangleleft a_i \theta \otimes h_1 \triangleleft (b_i)_{(1)} \otimes \cdots \otimes h_n \triangleleft (b_i)_{(n)} & \text{for } n \geq 1. \end{cases}$$

III.4.3.2. $\mathbf{B}_\bullet(\text{coend}(\text{rep}_H))$. The cocyclic \mathbb{k} -vector space may be identified with the cocyclic \mathbb{k} -vector space

$$\begin{aligned} \tilde{\mathbf{V}}_\bullet(H): \Delta C &\rightarrow \text{Vect}_{\mathbb{k}} \\ n &\mapsto V_{n+1}(H). \end{aligned}$$

For $n \geq 1$, the cofaces $\{\delta_i^n: \mathbf{V}_{n-1}(H) \rightarrow \mathbf{V}_n(H)\}_{0 \leq i \leq n}$ are given by setting for any elementary tensor $h_1 \otimes \cdots \otimes h_n \in \mathbf{V}_{n-1}(H)$,

$$\delta_i^n(h_1 \otimes \cdots \otimes h_n) = h_1 \otimes h_2 \otimes \cdots \otimes \Delta^{\text{Bd}}(h_{i+1}) \otimes \cdots \otimes h_n \text{ for } 0 \leq i \leq n-1 \text{ and}$$

$$\delta_n^n(h_1 \otimes \cdots \otimes h_n) = \sum_i (h_1)_{(2)}^{\text{Bd}} \triangleleft (\beta_i)_{(1)} \otimes h_2 \triangleleft (\beta_i)_{(2)} \otimes \cdots \otimes h_n \triangleleft (\beta_i)_{(n)} \otimes (h_1)_{(1)}^{\text{Bd}} \triangleleft (\alpha_i \theta^{-1}),$$

where Δ^{Bd} is a comultiplication on the braided Hopf algebra H^{Bd} (see [37] or [31]) associated to H . As algebras $H^{\text{Bd}} = H$. But the comultiplication and antipode in H^{Bd} are different. Explicitly,

$$\Delta^{\text{Bd}}(x) = x_{(2)} a_i \otimes S((b_i)_{(1)}) x_{(1)} (b_i)_{(2)} \text{ for any } x \in H.$$

For $n \geq 0$, the codegeneracies $\{\sigma_j^n: \mathbf{V}_{n+1}(H) \rightarrow \mathbf{V}_n(H)\}_{0 \leq j \leq n}$ are given by setting for any elementary tensor $h_1 \otimes \cdots \otimes h_{n+2} \in \mathbf{V}_{n+1}(H)$,

$$\sigma_j(h_1 \otimes \cdots \otimes h_{n+2}) = h_1 \otimes \cdots \otimes h_{j+1} \otimes \varepsilon(h_{j+2}) \otimes \cdots \otimes h_{n+2}.$$

For $n \geq 0$, the cocyclic operators $\tau_n: \mathbf{V}_n(H) \rightarrow \mathbf{V}_n(H)$ are given by setting for any elementary tensor $h_1 \otimes \cdots \otimes h_{n+1} \in \mathbf{V}_n(H)$,

$$\tau_n(h_1 \otimes \cdots \otimes h_{n+1}) = \begin{cases} h_1 & \text{for } n = 0, \\ \sum_i h_2 \triangleleft (\beta_i)_{(1)} \otimes \cdots \otimes h_{n+1} \triangleleft (\beta_i)_{(n)} \otimes h_1 \triangleleft (\alpha_i \theta^{-1}) & \text{for } n \geq 1. \end{cases}$$

CHAPTER IV

On the braided Connes-Moscovici construction

In this chapter, we study and generalize the braided version of the Connes-Moscovici Hopf cyclic cohomology introduced by Khalkhali and Pourkia [20]. First, we compute all the powers of the paracocyclic operator (Section IV.1) and then we introduce a categorical version of the Connes-Moscovici trace (Section IV.2). Sections IV.3 and IV.4 are devoted to proofs of the main theorems. Finally, we use our computations to verify all the relations of the paracocyclic object à la Connes-Moscovici (Section IV.5).

In this chapter, \mathcal{B} is a braided monoidal category and H is a Hopf algebra in \mathcal{B} (see Section II.2.2).

IV.1. Modular pairs and braided Connes-Moscovici construction

In this section, we introduce a generalized version of a modular pair in involution and compute the powers of the paracocyclic operator associated to such a pair (see Theorem IV.1 and its corollaries).

IV.1.1. Modular pairs. A *modular pair* for H is a pair (δ, σ) where $\delta: H \rightarrow \mathbb{1}$ is an algebra morphism and $\sigma: \mathbb{1} \rightarrow H$ is a coalgebra morphism such that $\delta\sigma = \text{id}_{\mathbb{1}}$. For instance, the pair (ε, u) , where $\varepsilon: H \rightarrow \mathbb{1}$ is the counit of H and $u: \mathbb{1} \rightarrow H$ is the unit of H , is a modular pair.

If \mathcal{B} is a braided category with a twist $\theta = \{\theta_X: X \rightarrow X\}_{X \in \text{Ob}(\mathcal{B})}$, a *θ -twisted modular pair in involution* for H is a modular pair (δ, σ) for H such that

$$\begin{array}{c} \oplus \\ | \\ \oplus \\ H \end{array} = \begin{array}{c} \oplus \quad \oplus \\ \sigma \quad \sigma \\ \delta \quad \delta \\ \oplus \\ H \end{array} .$$

Note that the morphism on the right hand side of the above defining equation uses a twist θ_H . To recall graphical conventions for braided categories with a twist, see Section II.1.9.

Note that when \mathcal{B} is symmetric, then $\text{id}_{\mathcal{B}} = \{\text{id}_X: X \rightarrow X\}_{X \in \text{Ob}(\mathcal{B})}$ is a twist for \mathcal{B} , a θ -twisted modular pair in involution is the same as *braided modular pair in involution* in the sense of [20]. If H is an involutive Hopf algebra in a ribbon category \mathcal{B} (in the sense that $S^2 = \theta_H$), then (ε, u) is a θ -twisted modular pair in involution, where θ is the canonical twist of \mathcal{B} .

PROOF. We show the equality (61) by induction. For $n = 0$, this follows since the adjoint action on $\mathbb{1}$ is given by counit, since the coadjoint coaction on $\mathbb{1}$ is given by unit, and the fact that $\tau_0(\varepsilon, u) = \tau_0(\delta, \sigma) = \text{id}_{\mathbb{1}}$. Let us check the case $n = 1$. By the equality (60) of Theorem IV.1 and the fact that $\tau_1(\varepsilon, u) = S$, we have

$$(\tau_1(\delta, \sigma))^2 = \begin{array}{c} \begin{array}{c} \text{---} \oplus \text{---} \sigma \\ | \\ \oplus \text{---} \delta \\ | \\ H \end{array} \\ = \\ \boxed{(\tau_1(\varepsilon, u))^2} \end{array} .$$

Suppose that the equality (61) is true for an $n \geq 1$ and let us show it for $n + 1$. Indeed, by applying the equality (60) for the modular pair (δ, σ) , the equality (61) for $n = 1$, and the equality (60) for the modular pair (ε, u) , we have

$$(\tau_{n+1}(\delta, \sigma))^{n+2} = \begin{array}{c} \begin{array}{c} H^{\otimes n} \\ \text{---} \sigma \\ | \\ \text{---} \delta \\ | \\ H^{\otimes n} \end{array} \\ \boxed{(\tau_1(\delta, \sigma))^2} \\ \text{---} \\ \boxed{(\tau_n(\varepsilon, u))^{n+1}} \\ \text{---} \\ \begin{array}{c} H^{\otimes n} \\ \text{---} \sigma \\ | \\ \text{---} \delta \\ | \\ H \end{array} \end{array} = \begin{array}{c} \begin{array}{c} H^{\otimes n} \\ \text{---} \sigma \\ | \\ \text{---} \delta \\ | \\ H^{\otimes n} \end{array} \\ \boxed{(\tau_1(\varepsilon, u))^2} \\ \text{---} \\ \boxed{(\tau_n(\varepsilon, u))^{n+1}} \\ \text{---} \\ \begin{array}{c} H^{\otimes n} \\ \text{---} \sigma \\ | \\ \text{---} \delta \\ | \\ H \end{array} \end{array} = \begin{array}{c} \begin{array}{c} H^{\otimes n} \\ \text{---} \sigma \\ | \\ \text{---} \delta \\ | \\ H^{\otimes n} \end{array} \\ \boxed{(\tau_{n+1}(\varepsilon, u))^{n+2}} \\ \text{---} \\ \begin{array}{c} H \\ \text{---} \sigma \\ | \\ \text{---} \delta \\ | \\ H \end{array} \end{array} .$$

This concludes the proof of the equality (61). \square

By using the equality (60) of Theorem IV.1, one recovers the result of Khalkhali and Pourkia [20, Remark 7.4]:

Corollary IV.3. *If \mathcal{B} is a braided category with twist $\theta = \{\theta_X : X \rightarrow X\}_{X \in \text{Ob}(\mathcal{B})}$ and if (δ, σ) is a twisted modular pair in involution for H , then $(\tau_n(\delta, \sigma))^{n+1} = \theta_{H^{\otimes n}}$. In particular, if \mathcal{B} is a symmetric monoidal category with a trivial twist, then $(\tau_n(\delta, \sigma))^{n+1} = \text{id}_{H^{\otimes n}}$.*

PROOF. The equality $(\tau_n(\delta, \sigma))^{n+1} = \theta_{H^{\otimes n}}$ is easily shown by induction. For $n = 0$, this follows by definition and the fact that $\theta_{\mathbb{1}} = \text{id}_{\mathbb{1}}$. Indeed, $\tau_0(\delta, \sigma) = \text{id}_{\mathbb{1}} = \theta_{\mathbb{1}} = \theta_{H^{\otimes 0}}$. For $n = 1$, we have

$$(\tau_1(\delta, \sigma))^2 \stackrel{(i)}{=} \begin{array}{c} \text{---} \oplus \text{---} \sigma \\ | \\ \oplus \text{---} \delta \\ | \\ H \end{array} \stackrel{(ii)}{=} \begin{array}{c} \text{---} \oplus \text{---} \sigma \\ | \\ \oplus \text{---} \sigma \\ | \\ \oplus \text{---} \delta \\ | \\ \oplus \text{---} \delta \\ | \\ H \end{array} \stackrel{(iii)}{=} \begin{array}{c} \text{---} \oplus \text{---} \sigma \\ | \\ \oplus \text{---} \sigma \\ | \\ \oplus \text{---} \delta \\ | \\ \oplus \text{---} \delta \\ | \\ H \end{array} \stackrel{(iv)}{=} \begin{array}{c} \text{---} \oplus \text{---} \sigma \\ | \\ \oplus \text{---} \delta \\ | \\ \oplus \text{---} \sigma \\ | \\ \oplus \text{---} \delta \\ | \\ H \end{array} \stackrel{(v)}{=} \theta_H .$$

Here (i) follows by the equality (60) of Theorem IV.1, (ii) follows by the fact that (δ, σ) is a twisted modular pair in involution for H , (iii) follows by naturality of the twist and the definitions of left coadjoint coaction and right adjoint action, (iv) follows by (co)associativity

and the fact that δ is an algebra morphism and σ is a coalgebra morphism. Finally, (v) follows by the antipode axiom and (co)unitality.

Suppose that the statement is true for an $n \geq 1$ and let us show it for $n + 1$. By the equality (60) of Theorem IV.1, Remark 61, the statement for $n = 1$, the induction hypothesis, naturality of twists, and the condition (43), we have

$$(\tau_{n+1}(\delta, \sigma))^{n+2} = \boxed{(\tau_1(\delta, \sigma))^2} \boxed{(\tau_n(\varepsilon, u))^{n+1}} = \boxed{(\tau_1(\delta, \sigma))^2} \boxed{(\tau_n(\delta, \sigma))^{n+1}} = \theta_{H^{\otimes n+1}},$$

which finishes the proof. \square

IV.1.3. The paracocyclic object $\mathbf{CM}_\bullet(H, \delta, \sigma)$. Let (δ, σ) be a modular pair for a Hopf algebra H in \mathcal{B} . Let us recall the paracocyclic object $\mathbf{CM}_\bullet(H, \delta, \sigma)$ in \mathcal{B} from [20] associated to this data. For any $n \geq 0$, we set $\mathbf{CM}_n(H, \delta, \sigma) = H^{\otimes n}$. For any $n \geq 1$, define the cofaces $\{\delta_i^n(\sigma): H^{\otimes n-1} \rightarrow H^{\otimes n}\}_{0 \leq i \leq n}$ by setting $\delta_0^1 = u$, $\delta_1^1 = \sigma$ and

$$\delta_i^n(\sigma) = \begin{cases} \begin{array}{c} | \quad | \quad \dots \quad | \\ \circ \quad \quad \quad \quad \quad \\ 1 \quad \quad \quad \quad n-1 \end{array} & \text{if } i = 0, \\ \begin{array}{c} | \quad \dots \quad | \quad \cup \quad | \quad \dots \quad | \\ | \quad \quad \quad \quad \quad \quad \quad \quad \quad \quad \quad \quad \quad \\ 1 \quad \quad \quad \quad i \quad \quad \quad \quad n-1 \end{array} & \text{if } 1 \leq i \leq n-1 \text{ and} \\ \begin{array}{c} | \quad \dots \quad | \quad \circ \\ | \quad \quad \quad \quad \quad \quad \quad \quad \quad \quad \quad \quad \quad \\ 1 \quad \quad \quad \quad n-1 \end{array} & \text{if } i = n \end{cases}$$

for any $n \geq 2$. For any $n \geq 0$, define the codegeneracies $\{\sigma_j^n: H^{\otimes n+1} \rightarrow H^{\otimes n}\}_{0 \leq j \leq n}$ by

$$\sigma_j^n = \begin{array}{c} | \quad \dots \quad | \quad \circ \quad | \quad \dots \quad | \\ | \quad \quad \quad \quad \quad \quad \quad \quad \quad \quad \quad \quad \quad \\ 1 \quad \quad \quad \quad j+1 \quad \quad \quad \quad n+1 \end{array}.$$

For any $n \geq 0$ the paracocyclic operators $\tau_n(\delta, \sigma): H^{\otimes n} \rightarrow H^{\otimes n}$ of the paracocyclic object $\mathbf{CM}_\bullet(H, \delta, \sigma)$ in \mathcal{B} are described in Section IV.1.2.

Having the result of Theorem IV.1 at hand, it is easy to check the paracocyclic relation $\tau_n(\delta, \sigma)\sigma_0^n = \sigma_n^n \tau_{n+1}(\delta, \sigma)^2$ for the paracocyclic object $\mathbf{CM}_\bullet(H, \delta, \sigma)$. For details, see Section IV.5. We finish this section by a simple discussion on how to pass from $\mathbf{CM}_\bullet(H, \delta, \sigma)$ to a (co)cyclic \mathbb{k} -module.

The following corollary follows directly by Lemma I.2 and Corollary IV.3.

Corollary IV.4. *If \mathcal{B} is a braided \mathbb{k} -linear category with a twist and (δ, σ) a twisted modular pair in involution, then*

- (a) $\text{Hom}_{\mathcal{B}}(\mathbb{1}, -) \circ \mathbf{CM}_\bullet(H, \delta, \sigma)$ is a cocyclic \mathbb{k} -module,

(b) $\mathrm{Hom}_{\mathcal{B}}(-, \mathbb{1}) \circ \mathbf{CM}_{\bullet}(H, \delta, \sigma)$ is a cyclic \mathbb{k} -module.

IV.2. Categorical Connes-Moscovici trace

We first introduce the notion of a categorical trace between the paracocyclic object à la Connes-Moscovici associated to Hopf algebra H and the paracocyclic object associated to a coalgebra in the category of H -modules. Next, we explicit an example of such a trace (Section IV.2.2).

In this section, \mathcal{B} denotes a braided category with a twist, $H = (H, m, u, \Delta, \varepsilon, S)$ is a Hopf algebra in \mathcal{B} , $\delta: H \rightarrow \mathbb{1}$ is an algebra morphism, and $\sigma: \mathbb{1} \rightarrow H$ is a coalgebra morphism.

IV.2.1. Traces. Let $(C, \Delta_C, \varepsilon_C)$ be a coalgebra in the category of right H -modules in \mathcal{B} , that is, a coalgebra in \mathcal{B} endowed with a right action $r: C \otimes H \rightarrow C$ of H on C such that the comultiplication $\Delta_C: C \rightarrow C \otimes C$ and the counit $\varepsilon_C: C \rightarrow \mathbb{1}$ are both H -linear morphisms. In other words, by depicting the right action by

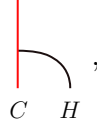

we require that

$$\begin{array}{c} \text{C} \\ \text{H} \end{array} = \begin{array}{c} \text{C} \\ \text{H} \end{array} \quad \text{and} \quad \begin{array}{c} \text{C} \\ \text{H} \end{array} = \begin{array}{c} \text{C} \\ \text{H} \end{array}.$$

A categorical δ -invariant σ -trace is a morphism $\alpha: \mathbb{1} \rightarrow C$ in \mathcal{B} satisfying

$$\begin{array}{c} \text{C} \\ \text{H} \end{array} = \begin{array}{c} \text{C} \\ \text{H} \end{array} \quad \text{and} \quad \begin{array}{c} \text{C} \\ \text{H} \end{array} = \begin{array}{c} \text{C} \\ \text{H} \end{array}.$$

Given such a morphism, define for any $n \in \mathbb{N}$ the morphism $\alpha_n: H^{\otimes n} \rightarrow C^{\otimes n+1}$ in \mathcal{B} by setting

$$\alpha_0 = \alpha \quad \text{and} \quad \alpha_n = \begin{array}{c} \text{C} \\ \text{H} \end{array} \quad \text{for } n \geq 1.$$

Now recall the construction from Section III.1. The main theorem of this section is the following.

Theorem IV.5. *The family $\{\alpha_n: H^{\otimes n} \rightarrow C^{\otimes n+1}\}_{n \in \mathbb{N}}$ is a morphism between paracocyclic objects $\mathbf{CM}_{\bullet}(H, \delta, \sigma)$ and $\mathbf{C}_{\bullet}(C)$ in \mathcal{B} .*

The proof of Theorem IV.5 is postponed to Section IV.4. The main corollary of Theorem IV.5 is the following.

Corollary IV.6. *If \mathcal{B} is a braided \mathbb{k} -linear category with a twist and (δ, σ) a twisted modular pair in involution, then*

(a) *the family $\{\mathrm{Hom}_{\mathcal{B}}(\mathbb{1}, \alpha_n)\}_{n \in \mathbb{N}}$ induces a morphism in cocyclic homology*

$$\alpha^*: HC^*(\mathrm{Hom}_{\mathcal{B}}(\mathbb{1}, \mathbf{CM}_{\bullet}(H, \delta, \sigma))) \rightarrow HC^*(\mathrm{Hom}_{\mathcal{B}}(\mathbb{1}, \mathbf{C}_{\bullet}(C))).$$

Lemma IV.7. *If a morphism $\kappa: \mathbb{1} \rightarrow H$ in \mathcal{B} satisfies*

$$\begin{array}{c} \text{twist} \\ \downarrow H \\ \text{cap} \end{array} = \begin{array}{c} \text{cup} \\ \downarrow H \\ \text{cap} \end{array}, \quad (62)$$

then the morphism $\alpha = (\varepsilon^* \otimes \text{id}_H)\kappa: \mathbb{1} \rightarrow C$ is an ε -invariant u -trace.

PROOF. Denote $f = \varepsilon^* \otimes \text{id}_H: H \rightarrow C$. The morphism $\alpha = f\kappa$ is ε -invariant, since f is a morphism between the trivial right H -module (C, ε) and the right H -module (C, a) , meaning that $a(f \otimes \text{id}_H) = f \otimes \varepsilon$. The morphism $\alpha = f\kappa$ is a u -trace, since κ is supposed to satisfy the condition (62) and since f is a coalgebra morphism. Note that the comultiplication $\Delta_C: C \rightarrow C \otimes C$ and the counit $\varepsilon_C: C \rightarrow \mathbb{1}$ on C are given by

$$\Delta_C = \begin{array}{c} H \quad H \quad H \quad H \\ \text{curly lines} \\ H \quad H \end{array} \quad \text{and} \quad \varepsilon_C = \begin{array}{c} \text{cup} \\ \downarrow H \\ \text{cap} \end{array}.$$

The expressions for Δ_C and ε_C are derived from Theorem 9.4 of [36]. Having Δ_C and ε_C at hand, it is easy to check that f is indeed a coalgebra morphism. \square

For example, one can take κ to be a coalgebra morphism. Another family of examples of κ is obtained as follows. We claim that any object X of \mathcal{B} defines an ε -invariant u -trace α^X . Namely, one can define for any object X of \mathcal{B} ,

$$\kappa^X = i_X \widetilde{\text{coev}}_X: \mathbb{1} \rightarrow H.$$

Graphically, κ^X is depicted as

$$\kappa^X = \begin{array}{c} \downarrow \\ H \\ \text{loop} \\ X \end{array}.$$

Furthermore, κ^X satisfies the condition (62) from Lemma IV.7. Indeed, by definition of κ^X and comultiplication on the coend, by naturality of twists, and the braiding, we have

$$\begin{array}{c} \text{twist} \\ \downarrow H \\ \text{cap} \end{array} = \begin{array}{c} \text{twist} \\ \downarrow H \\ \text{loop} \end{array} = \begin{array}{c} \text{twist} \\ \downarrow H \quad H \\ \text{cap} \end{array} = \begin{array}{c} H \\ \text{curly lines} \\ X \end{array} = \begin{array}{c} \text{cup} \\ \downarrow H \quad H \\ \text{cap} \end{array} = \begin{array}{c} \text{cup} \\ \downarrow H \\ \text{loop} \end{array} = \begin{array}{c} \text{cup} \\ \downarrow H \\ \text{cap} \end{array}.$$

Remark IV.8. An interesting example of an ε -invariant u -trace comes from topological field theory. Let \mathcal{B} be in addition a fusion category. Denote I a representative set of simple objects of \mathcal{B} . The morphism $\kappa = \sum_{l \in I} \text{dim}_r(l) \kappa^l$ satisfies the condition (62). Here $\kappa^l = i_l \widetilde{\text{coev}}_l$ (as above) and $\text{dim}_r(l) = \widetilde{\text{ev}}_l \text{coev}_l$ is the *right dimension* of l (see Section II.1.6). Notice that κ is precisely the universal integral from the equation (52).

IV.3. Proof of Theorem IV.1

Our strategy to compute the $(n + 1)$ -th power of the paracocyclic operator $\tau_n(\delta, \sigma)$ is similar to the proof of cocyclicity condition from Connes and Moscovici in [9], where Hopf algebras over \mathbb{C} are considered. We proceed by induction. However, the difficulty in categorical generalization proposed by Khalkhali and Pourkia in [20] is that paracocyclic operators involve braiding. In our approach, based on graphical calculus, we manage to keep track the powers of paracocyclic operators.

Recall that $H = (H, m, u, \Delta, \varepsilon, S)$ denotes a Hopf algebra in the braided monoidal category \mathcal{B} , $\delta: H \rightarrow \mathbb{1}$ is an algebra morphism, and $\sigma: \mathbb{1} \rightarrow H$ is a coalgebra morphism such that $\delta\sigma = \text{id}_{\mathbb{1}}$. Given such a pair, one defines the *twisted antipode* $\tilde{S}: H \rightarrow H$ by

$$\tilde{S} = \begin{array}{c} \delta \\ \oplus \\ H \end{array} .$$

For brevity, we denote the twisted antipode \tilde{S} graphically by . With this notation, we will rewrite

$$\tau_n(\delta, \sigma) = \begin{array}{c} \delta \\ \oplus \\ H \end{array} \begin{array}{c} \sigma \\ \oplus \\ H^{\otimes n-1} \end{array} \quad \text{if } n \geq 1.$$

Similarly, the equation (59), which is to be proven, rewrites as

$$(\tau_n(\delta, \sigma))^k = \begin{array}{c} H^{\otimes n-k} \quad H^{\otimes k-1} \\ \delta \quad \oplus \quad \sigma \quad \sigma \\ \oplus \\ (\tau_{n-1}(\varepsilon, u))^{k-1} \\ \delta \quad \oplus \quad \oplus \quad \dots \\ H^{\otimes k-2} \quad k-1 \quad k \quad n \end{array} .$$

In Section IV.3.1 we list algebraic properties needed to prove the equalities from Theorem IV.1. In Section IV.3.2 we show the equality (59). In Section IV.3.3 we show the equality (60).

IV.3.1. Preliminary facts. In this section we state several lemmas, which are used in the proof of Theorem IV.1. We mention that equalities (a) and (b) from Lemma IV.9 and the equality from Remark IV.15 are already stated in [20]. In Lemma that follows, some properties of the twisted antipode are established.

Lemma IV.9. *The following equalities hold:*

$$\begin{array}{ccc}
 \begin{array}{c} \text{---} \\ \cup \\ \text{---} \\ \oplus \\ \text{---} \\ \sim \\ \text{---} \\ H \end{array} = \begin{array}{c} \oplus \\ \text{---} \\ \cup \\ \text{---} \\ \oplus \\ \text{---} \\ \sim \\ \text{---} \\ H \end{array}, & \begin{array}{c} \text{---} \\ \sim \\ \text{---} \\ \cup \\ \text{---} \\ H \quad H \end{array} = \begin{array}{c} \text{---} \\ \cup \\ \text{---} \\ \oplus \\ \text{---} \\ \sim \\ \text{---} \\ H \quad H \end{array}, & \begin{array}{c} \text{---} \\ \cup \\ \text{---} \\ \oplus \\ \text{---} \\ \sim \\ \text{---} \\ H \end{array} = \begin{array}{c} \text{---} \\ \oplus \\ \text{---} \\ \delta \\ \text{---} \\ H \end{array} \quad , \\
 (a) & (b) & (c)
 \end{array}$$

$$\begin{array}{ccc}
 \begin{array}{c} \oplus \\ \text{---} \\ \cup \\ \text{---} \\ \oplus \\ \text{---} \\ \sim \\ \text{---} \\ H \end{array} = \begin{array}{c} \text{---} \\ \oplus \\ \text{---} \\ \delta \\ \text{---} \\ H \end{array}, & \begin{array}{c} \text{---} \\ \sim \\ \text{---} \\ \oplus \\ \text{---} \\ \sim \\ \text{---} \\ H \end{array} = \begin{array}{c} \oplus \\ \text{---} \\ \oplus \\ \text{---} \\ \delta \\ \text{---} \\ H \end{array}, & \begin{array}{c} \text{---} \\ \cup \\ \text{---} \\ \oplus \\ \text{---} \\ \sim \\ \text{---} \\ H \quad H \quad H \end{array} = \begin{array}{c} \oplus \\ \text{---} \\ \delta \\ \text{---} \\ \cup \\ \text{---} \\ \oplus \\ \text{---} \\ \sim \\ \text{---} \\ H \quad H \quad H \end{array}. \\
 (d) & (e) & (f)
 \end{array}$$

PROOF. Let us first show the relation (a). Indeed, by definition of \tilde{S} , anticomultiplicativity of the antipode, coassociativity, and naturality of the braiding, we have

$$\begin{array}{c} \text{---} \\ \cup \\ \text{---} \\ \oplus \\ \text{---} \\ \sim \\ \text{---} \\ H \end{array} = \begin{array}{c} \oplus \\ \text{---} \\ \cup \\ \text{---} \\ \oplus \\ \text{---} \\ \delta \\ \text{---} \\ H \end{array} = \begin{array}{c} \oplus \\ \text{---} \\ \cup \\ \text{---} \\ \oplus \\ \text{---} \\ \delta \\ \text{---} \\ H \end{array} = \begin{array}{c} \oplus \\ \text{---} \\ \cup \\ \text{---} \\ \oplus \\ \text{---} \\ \delta \\ \text{---} \\ H \end{array} = \begin{array}{c} \oplus \\ \text{---} \\ \cup \\ \text{---} \\ \oplus \\ \text{---} \\ \sim \\ \text{---} \\ H \end{array}.$$

Let us show the relation (b). Indeed, by definition of \tilde{S} , bialgebra compatibility axiom, the fact that δ is an algebra morphism, and naturality of the braiding we have

$$\begin{array}{c} \text{---} \\ \sim \\ \text{---} \\ \cup \\ \text{---} \\ H \quad H \end{array} = \begin{array}{c} \oplus \\ \text{---} \\ \cup \\ \text{---} \\ \oplus \\ \text{---} \\ \delta \\ \text{---} \\ H \quad H \end{array} = \begin{array}{c} \oplus \\ \text{---} \\ \cup \\ \text{---} \\ \oplus \\ \text{---} \\ \delta \\ \text{---} \\ H \quad H \end{array} = \begin{array}{c} \oplus \\ \text{---} \\ \cup \\ \text{---} \\ \oplus \\ \text{---} \\ \delta \\ \text{---} \\ H \quad H \end{array} = \begin{array}{c} \text{---} \\ \cup \\ \text{---} \\ \oplus \\ \text{---} \\ \sim \\ \text{---} \\ H \quad H \end{array}.$$

Let us show the relation (c). Indeed, this relation follows by the definition of \tilde{S} , coassociativity, the antipode axiom, and counitality:

$$\begin{array}{c} \text{---} \\ \cup \\ \text{---} \\ \oplus \\ \text{---} \\ \sim \\ \text{---} \\ H \end{array} = \begin{array}{c} \oplus \\ \text{---} \\ \cup \\ \text{---} \\ \oplus \\ \text{---} \\ \delta \\ \text{---} \\ H \end{array} = \begin{array}{c} \oplus \\ \text{---} \\ \cup \\ \text{---} \\ \oplus \\ \text{---} \\ \delta \\ \text{---} \\ H \end{array} = \begin{array}{c} \oplus \\ \text{---} \\ \cup \\ \text{---} \\ \oplus \\ \text{---} \\ \delta \\ \text{---} \\ H \end{array} = \begin{array}{c} \oplus \\ \text{---} \\ \cup \\ \text{---} \\ \oplus \\ \text{---} \\ \delta \\ \text{---} \\ H \end{array}.$$

Now we show the equality (d). It follows by the part (a), naturality of the braiding, the definition of \tilde{S} , the fact that δ is an algebra morphism, and the definition of left coadjoint coaction:

$$\begin{array}{c} \oplus \\ \text{---} \\ \cup \\ \text{---} \\ \oplus \\ \text{---} \\ \sim \\ \text{---} \\ H \end{array} = \begin{array}{c} \oplus \\ \text{---} \\ \cup \\ \text{---} \\ \oplus \\ \text{---} \\ \sim \\ \text{---} \\ H \end{array} = \begin{array}{c} \oplus \\ \text{---} \\ \cup \\ \text{---} \\ \oplus \\ \text{---} \\ \delta \\ \text{---} \\ H \end{array} = \begin{array}{c} \oplus \\ \text{---} \\ \cup \\ \text{---} \\ \oplus \\ \text{---} \\ \delta \\ \text{---} \\ H \end{array} = \begin{array}{c} \text{---} \\ \oplus \\ \text{---} \\ \delta \\ \text{---} \\ H \end{array}.$$

The equality (e) is a consequence of the equality (d). To see this, compose the left hand side of (d) with the antipode S of H and use the definition of \tilde{S} .

Finally, let us show the equation (f). Indeed, this equation follows by the part (b), bialgebra compatibility axiom, (co)associativity, naturality of the braiding, the part (c), and

unitality:

□

Remark IV.10. Another useful property of the twisted antipode \tilde{S} is that $\varepsilon\tilde{S} = \delta$. It follows by the definition of \tilde{S} , the fact that $\varepsilon S = \varepsilon$, and counitality.

The following lemma gives the expression of the paracocyclic operator $\tau_n(\delta, \sigma)$ in terms of $\tau_{n-1}(\varepsilon, u)$.

Lemma IV.11. *If $n \geq 2$, then*

(a) $\tau_n(\delta, \sigma) =$ and

(b) $\tau_n(\delta, \sigma) =$

PROOF. Let us first show the equation (a). Indeed, by definition of $\tau_n(\delta, \sigma)$, Lemma IV.9 (a), naturality of the braiding, inductive definition of the left diagonal action, and the definition of $\tau_{n-1}(\varepsilon, u)$, we have

Further, we show the part (b). For $n = 2$, the statement follows by definition. From now on, suppose that $n \geq 3$. By the definition of $\tau_n(\delta, \sigma)$, the definition of the left diagonal action, coassociativity, and the definition of $\tau_{n-1}(\varepsilon, u)$, we have:

□

The equalities stated in the following lemma are used during computation of squares of the paracocyclic operator $\tau_n(\delta, \sigma)$ in the case $n \geq 3$.

Lemma IV.12. *For any $n \geq 2$, we have:*

(a) $\tau_n(\varepsilon, u)$ with a cup on top and a cap on bottom, equal to $\tau_n(\varepsilon, u)$ with a cap on top and a cup on bottom, with a \oplus symbol on the left.

(b) $\tau_n(\varepsilon, u)$ with a cap on top and a cup on bottom, equal to $\tau_n(\varepsilon, u)$ with a cup on top and a cap on bottom, with a \oplus symbol on the left.

(c) $\tau_n(\varepsilon, u)$ with a cap on top and a cup on bottom, equal to $\tau_{n-1}(\varepsilon, u)$ with a cap on top and a cup on bottom, with a \oplus symbol on the left.

(d) $\tau_n(\varepsilon, u)$ with a cap on top and a cup on bottom, equal to $\tau_{n-1}(\varepsilon, u)$ with a cap on top and a cup on bottom, with a \oplus symbol on the left.

PROOF. We begin by showing the equality (a). Let us first inspect the case $n = 2$. To see that the equality is true in this case, we use the definition of $\tau_2(\varepsilon, u)$, bialgebra axiom, coassociativity, antimultiplicativity of the antipode, and naturality of the braiding:

A sequence of six string diagrams for $n=2$ showing the proof of equality (a). The diagrams involve $H^{\otimes 2}$, H , and $\tau_2(\varepsilon, u)$ boxes, with various braiding and cup/cap operations.

From now on, suppose that $n \geq 3$. By definition of $\tau_n(\varepsilon, u)$, bialgebra axiom, naturality of the braiding, coassociativity, and antimultiplicativity of the antipode we have:

A sequence of six string diagrams for $n \geq 3$ showing the proof of equality (a). The diagrams involve $H^{\otimes n-1}$, $H^{\otimes n}$, and $\tau_n(\varepsilon, u)$ boxes, with various braiding and cup/cap operations, and indices 1, 2, ..., n-1, n.

Let us show the equality (b). Indeed, it follows by definition of $\tau_n(\varepsilon, u)$, naturality of the braiding and associativity:

A sequence of four string diagrams for $n \geq 3$ showing the proof of equality (b). The diagrams involve $H^{\otimes n-1}$, $H^{\otimes n}$, and $\tau_n(\varepsilon, u)$ boxes, with various braiding and cup/cap operations, and indices 1, 2, ..., n, n+1.

PROOF. Let us prove the part (a). Indeed, we have:

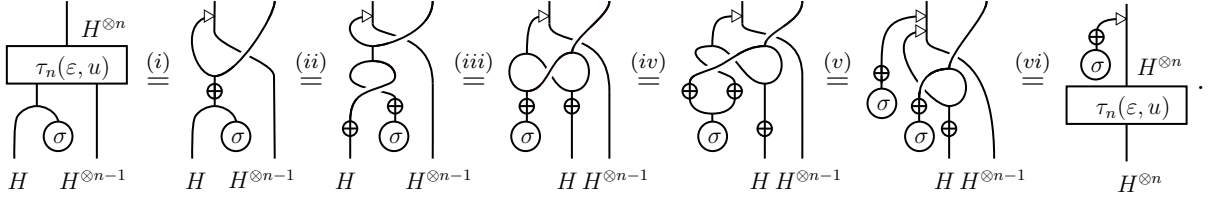

Here (i) follows by definition of $\tau_n(\varepsilon, u)$, (ii) follows by antimultiplicativity of antipode, (iii) follows by naturality of the braiding and bialgebra axiom, (iv) follows by antimultiplicativity of antipode, (v) follows by the fact that σ is a coalgebra morphism and by the axiom of a module, and (vi) follows by definition of $\tau_n(\varepsilon, u)$ and naturality of the braiding.

Let us now show the part (b). Indeed, by definition of $\tau_n(\varepsilon, u)$ and the left diagonal action, by naturality of the braiding, and associativity, we have:

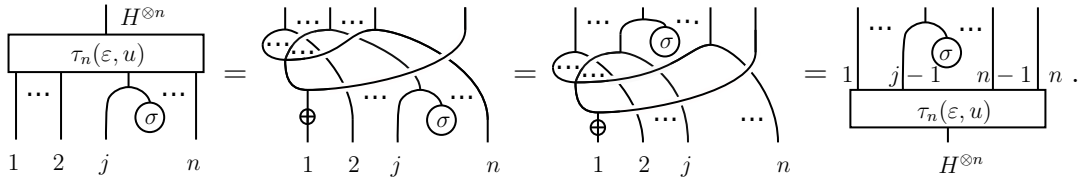

□

Before passing to the proof of Theorem IV.1, let us state another auxiliary lemma.

Lemma IV.14. *We have the following assertions:*

(a) The morphism $\begin{array}{c} \delta \\ \circlearrowleft \\ \downarrow \\ H \end{array} : H \rightarrow H$ is a bialgebra morphism.

(b) For all $n \geq 1$,

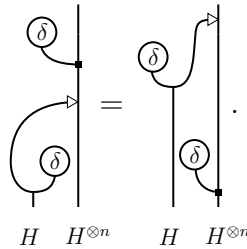

(c) For all $n \geq 1$,

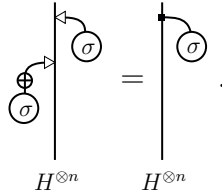

The equality (b) from Lemma IV.14 is intensively used while proving both of the equalities from Theorem IV.1. The equality (c) from Lemma IV.14 is particularly used in final steps of the computation of $\tau_n(\delta, \sigma)^{n+1}$.

PROOF. Let us first show the part (a). We first show that the morphism from part (a) is an algebra morphism. By using definition of the left coadjoint coaction, the bialgebra

compatibility axiom, the fact that δ is an algebra morphism, antimultiplicativity of the antipode of H , and naturality of the braiding, we have:

Similarly, by using definition of the left coadjoint coaction, the fact that unit is a coalgebra morphism, the fact that δ is an algebra morphism, and by the fact that $Su = u$, we have:

Let us now show that the morphism from (a) is a coalgebra morphism. Indeed, by definition of the left coadjoint coaction, the fact that δ is an algebra morphism, naturality of the braiding, coassociativity, the antipode axiom, and (co)unitality, we have:

Furthermore, by definition of the left coadjoint coaction, the fact that δ is an algebra morphism, naturality of the braiding, (co)unitality, and the antipode axiom we have:

This completes the proof of the part (a).

Let us show the part (b) by induction. For $n = 1$, we prove the statement as follows. By using the part (a), the definition of the coadjoint coaction, the fact that δ is an algebra morphism, naturality of the braiding, coassociativity, the antipode axiom, and (co)unitality we have:

Suppose that the statement is true for an $n \geq 1$ and let us show it for $n + 1$. We have:

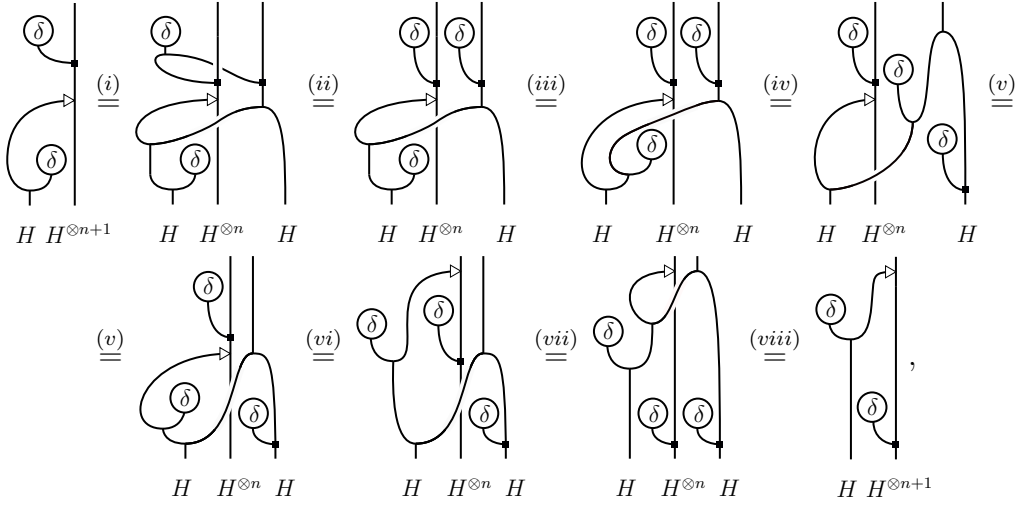

which shows the desired statement. Here (i) and (viii) both follow by inductive definition of left diagonal action and left coadjoint coaction, (ii) follows by the fact that δ is an algebra morphism, (iii) follows by coassociativity, (iv) follows by naturality of the braiding and the case $n = 1$, (v) and (vii) both follow by naturality of the braiding and by coassociativity, and (vi) follows by the induction hypothesis.

Finally, we show the part (c) by induction. For $n = 1$, the statement follows by definition of right adjoint action and the fact that σ is a coalgebra morphism. Suppose that the statement is true for $n \geq 1$ and let us show it for $n + 1$. Indeed, by using inductive definition of the left and the right diagonal actions, antimultiplicativity of the antipode, the fact that σ is a coalgebra morphism, naturality of the braiding, and the induction hypothesis, we have:

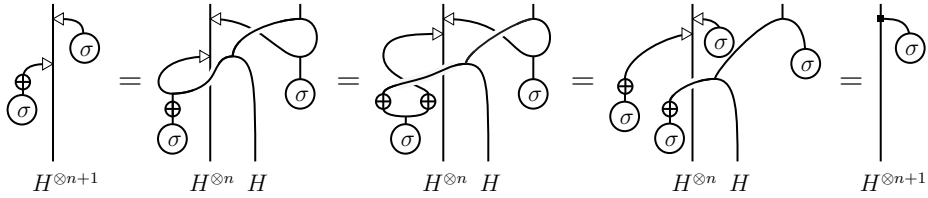

□

Remark IV.15. If (δ, σ) is a modular pair, then $\begin{array}{c} \sim \\ | \\ \sigma \end{array} H = \begin{array}{c} \oplus \\ | \\ \sigma \end{array} H$. Indeed, this follows by the definition of \tilde{S} , the fact that σ is a coalgebra morphism, and since the (δ, σ) is a modular pair:

$$\begin{array}{c} \sim \\ | \\ \sigma \end{array} H = \begin{array}{c} \delta \oplus \\ | \\ \sigma \end{array} H = \begin{array}{c} \delta \\ | \\ \sigma \end{array} H \begin{array}{c} \oplus \\ | \\ \sigma \end{array} H = \begin{array}{c} \oplus \\ | \\ \sigma \end{array} H.$$

IV.3.2. Proof of the equality (59). The proof of the equality (59) of Theorem IV.1 is divided into several steps. For $n = k = 2$, it suffices to calculate the square of $\tau_2(\delta, \sigma)$. For $n \geq 3$, we first calculate the square and then derive formulas for the remaining powers.

IV.3.2.1. *Squares of $\tau_n(\delta, \sigma)$ for $n \geq 2$.* Let us first show that the equality (59) is true in the case $n = k = 2$. Indeed, we have:

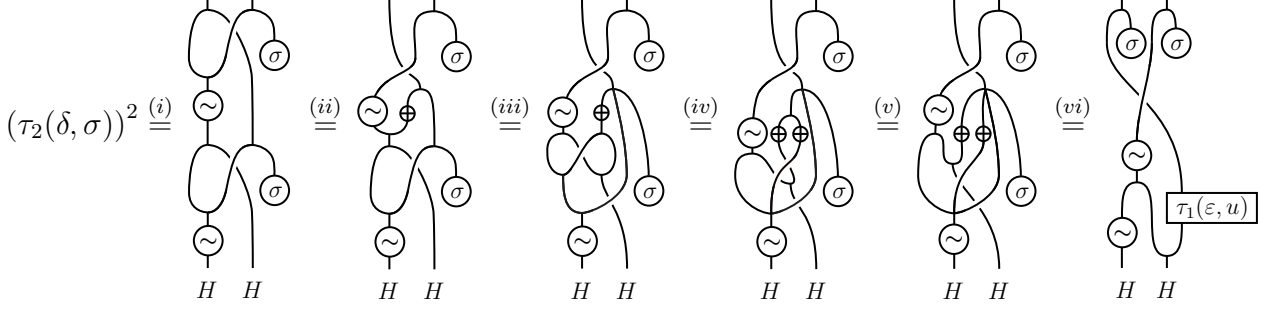

Here (i) follows by definition of $\tau_2(\delta, \sigma)$, (ii) follows by Lemma IV.11 (a) for $n = 2$ and since $\tau_1(\varepsilon, u) = S$, (iii) follows by bialgebra compatibility axiom and associativity, (iv) by antimultiplicativity of the antipode, (v) follows by associativity and naturality of the braiding, and (vi) follows by the antipode axiom, naturality of the braiding, (co)unitality, and the fact that $\tau_1(\varepsilon, u) = S$.

From now on, let us assume that $n \geq 3$. Let us calculate the square of $\tau_n(\delta, \sigma)$. We have

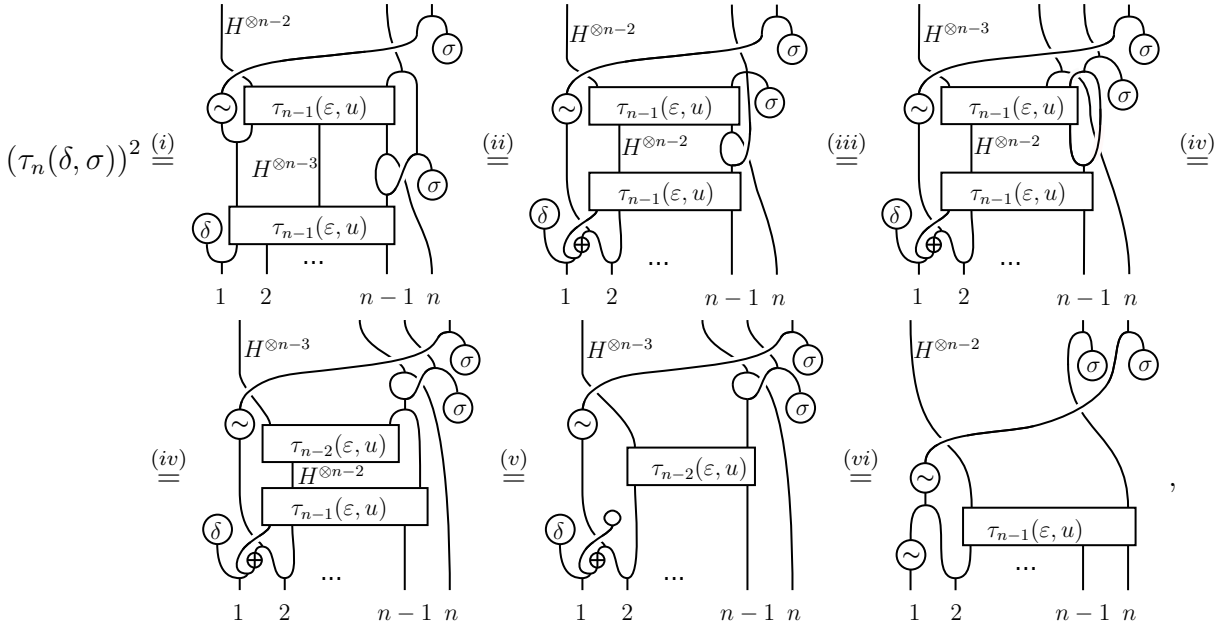

which indeed shows the equality (59) in the case $n \geq 3$ and $k = 2$. Here (i) follows by parts (a) and (b) of Lemma IV.11, (ii) follows by associativity and by Lemma IV.12 (a) for $n - 1$, (iii) follows by associativity and by Lemma IV.12 (b) for $n - 1$, (iv) follows by Lemma IV.12 (c) for $n - 1$, (v) follows by Lemma IV.12 (d) for $n - 1$, and (vi) follows by counitality, definition of the twisted antipode \tilde{S} , and by Lemma IV.11 (b) applied on $\delta = \varepsilon$ and $\sigma = u$ for $n - 1$.

IV.3.2.2. *Passing from $(\tau_n(\delta, \sigma))^2$ to $(\tau_n(\delta, \sigma))^3$, $n \geq 3$.* From the calculation which has been done in the section IV.3.2.1, one can easily deduce the equality (59) for $n \geq 3$

and $k = 3$.

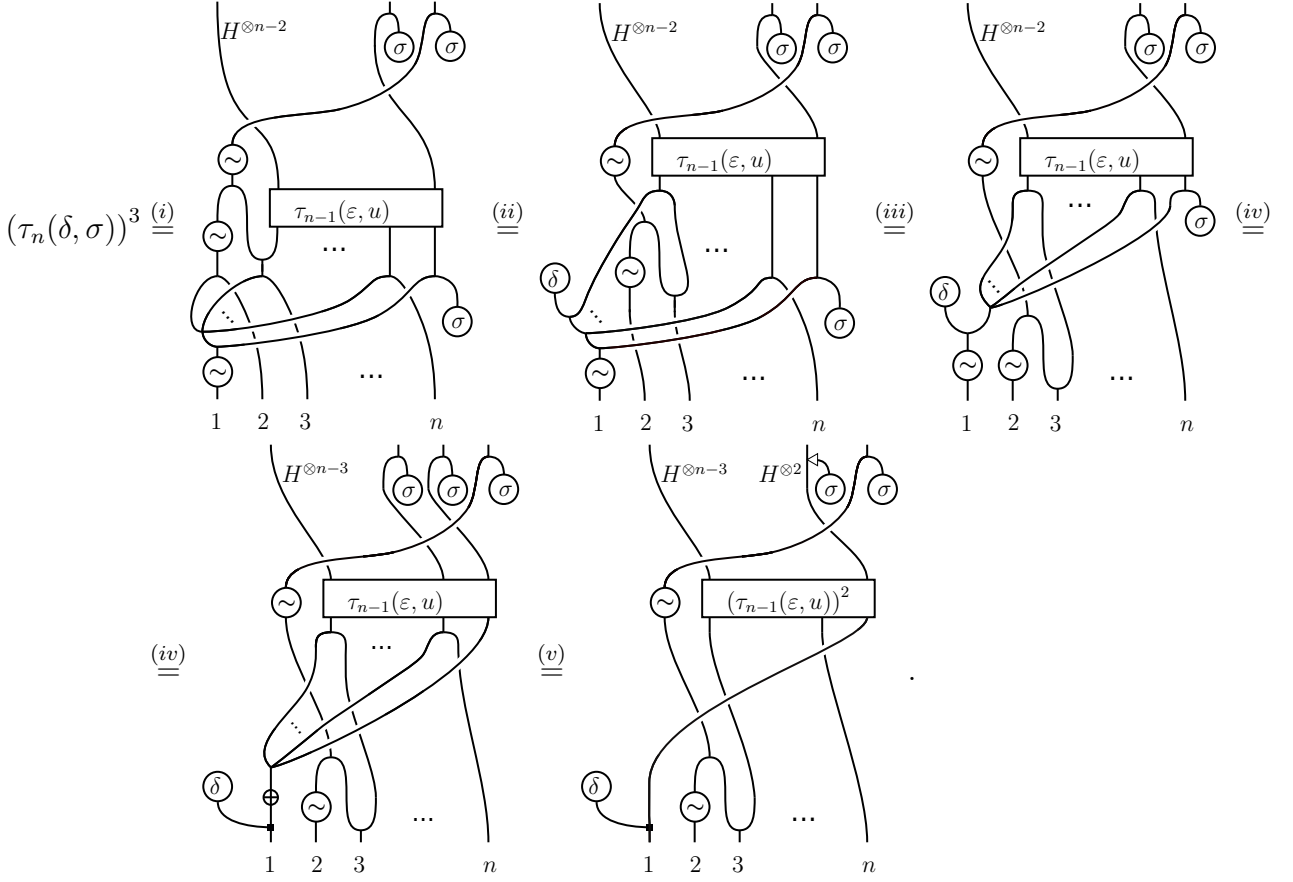

Here (i) follows by developing $\tau_n(\delta, \sigma)^3$ as $\tau_n(\delta, \sigma)^2\tau_n(\delta, \sigma)$, by definition of $\tau_n(\delta, \sigma)$, and by the computation of $\tau_n(\delta, \sigma)^2$ that has been done in IV.3.2.1, (ii) follows by coassociativity and Lemma IV.9 (f), (iii) follows by naturality of the braiding and coassociativity, (iv) follows by Lemma IV.13 (b) for $j = n - 1$ and Lemma IV.9 (d). Finally, (v) follows by naturality of the braiding and the definition of $\tau_{n-1}(\epsilon, u)$.

IV.3.2.3. *Computation of $(\tau_n(\delta, \sigma))^{j+1}$, $2 \leq j \leq n - 1$.* Note that by now we have completely shown the equality (59) in the cases $n = 2$ and $n = 3$. Also, the square and the cube of $\tau_n(\delta, \sigma)$ are calculated for each $n \geq 3$. In this section, we finish the proof of (59), by focusing on the case $n \geq 4$. As it has been already noted, for $j = 2$, $(\tau_n(\delta, \sigma))^{j+1}$ is already computed in Section IV.3.2.2. From now on, we assume that $3 \leq j \leq n - 1$. If (59) is established for $k = j$, then:

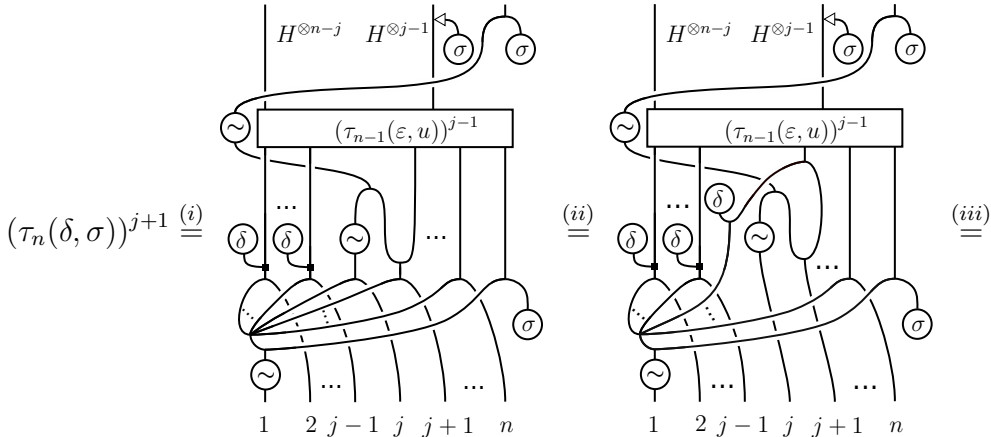

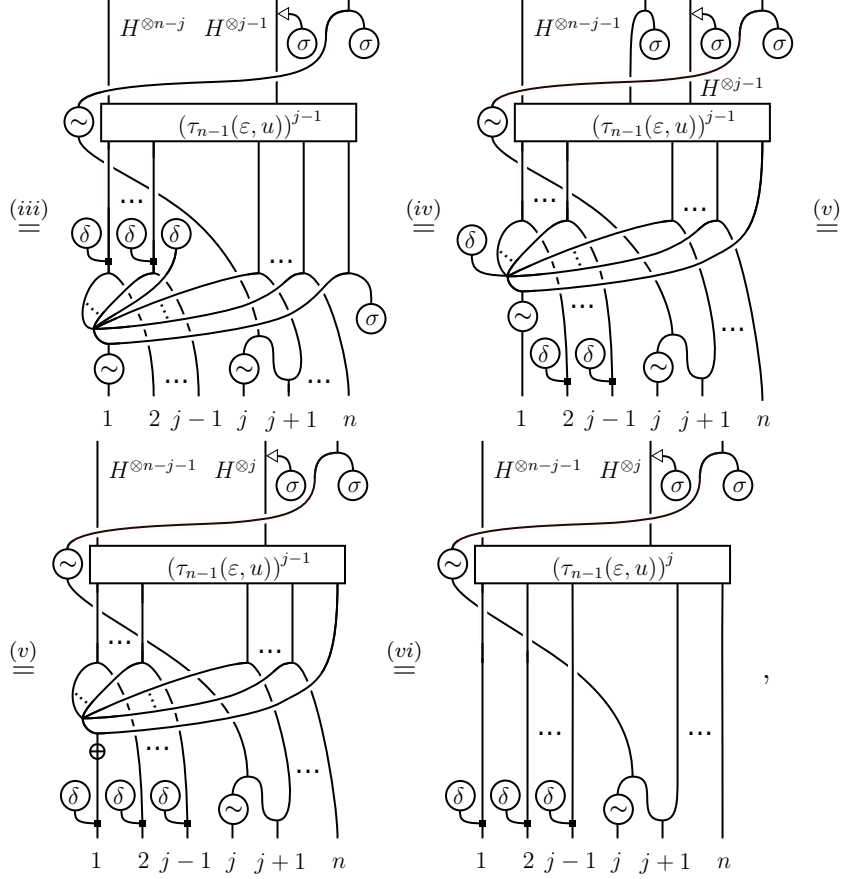

which finishes the proof of (59). Here (i) follows by decomposing $(\tau_n(\delta, \sigma))^{j+1}$ in the composition $(\tau_n(\delta, \sigma))^j \tau_n(\delta, \sigma)$, by definition of $\tau_n(\delta, \sigma)$, and by the hypothesis that (59) is established for $k = j$, (ii) follows by coassociativity and Lemma IV.9 (f), (iii) follows by naturality of the braiding and coassociativity, (iv) follows by Lemma IV.14 (b) and by applying $j - 1$ times Lemma IV.13 (b), (v) follows by Lemma IV.9 (d) and coassociativity and finally, (vi) follows by naturality of the braiding and the definition of $\tau_{n-1}(\varepsilon, u)$.

IV.3.3. Proof of the equality (60). In order to show the equality (60) of Theorem IV.1, we will separately consider three cases: $n = 1$, $n = 2$, and $n \geq 3$.

If $n = 1$, then we have

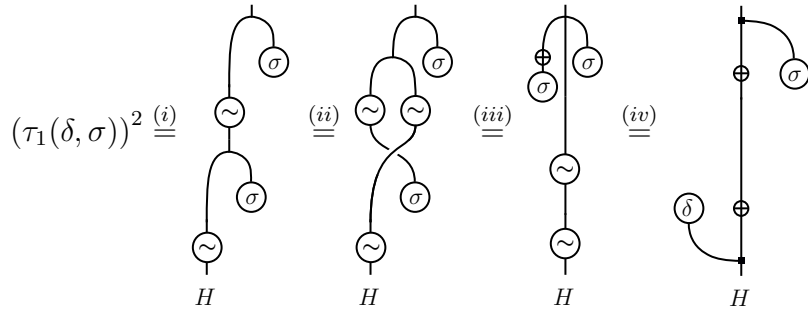

Here (i) follows by definition $\tau_1(\delta, \sigma)$, (ii) follows by the Lemma IV.9 (b), (iii) follows by naturality of the braiding, associativity, and Remark IV.15. Finally, (iv) follows by definition of right adjoint action, the fact that σ is a coalgebra morphism, and Lemma IV.9 (e).

If $n = 2$, then we have

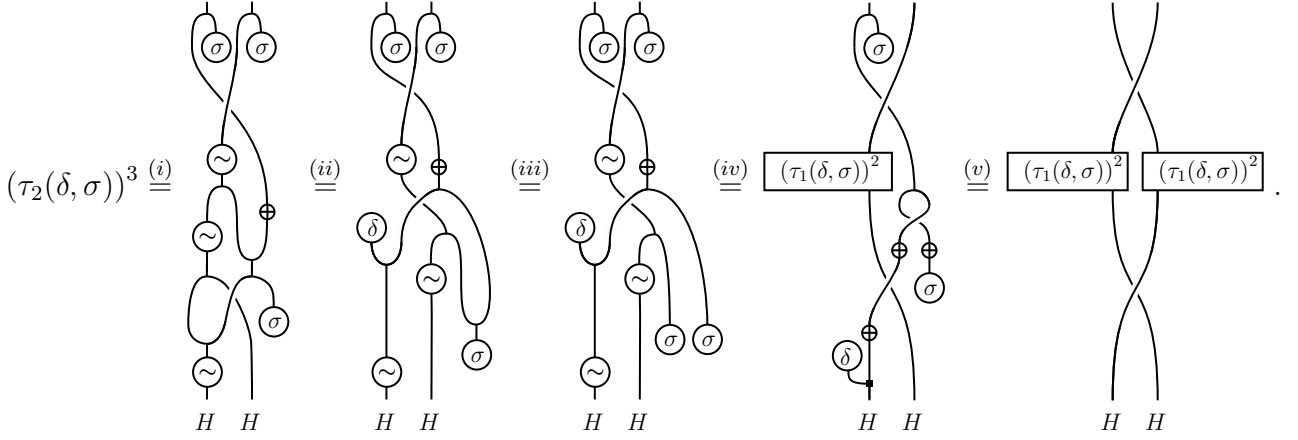

Here (i) follows by expanding $(\tau_2(\delta, \sigma))^3$ as $(\tau_2(\delta, \sigma))^2\tau_2(\delta, \sigma)$, using the definition of $\tau_2(\delta, \sigma)$, and the equality (59) in the case $n = k = 2$, (ii) follows by Lemma IV.9 (f), (iii) by using the fact that σ is a coalgebra morphism, (iv) by naturality of the braiding, definition of $\tau_1(\delta, \sigma)$ and antimultiplicativity of the antipode. Finally, (v) follows by naturality of the braiding, by definition of right adjoint action, and the case $n = 1$ of the equality (60), which is shown above.

From now on, let us assume that $n \geq 3$. We have

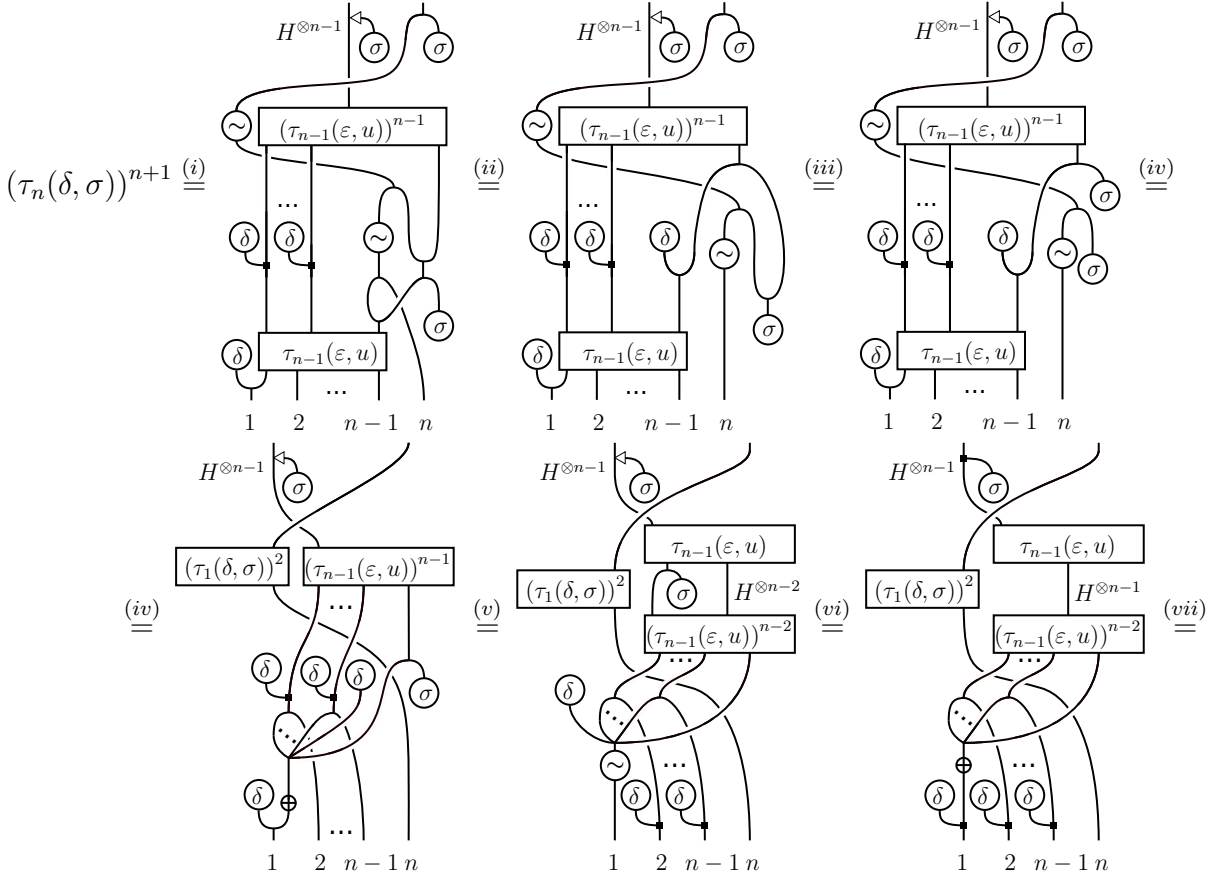

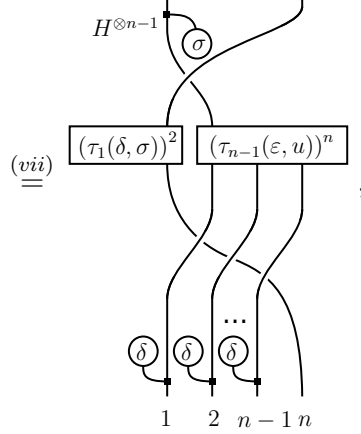

which shows the equality (60). Here (i) follows by decomposing $(\tau_n(\delta, \sigma))^{n+1}$ in the composition $(\tau_n(\delta, \sigma))^n \tau_n(\delta, \sigma)$, by using Lemma IV.11 (b), and the equality (59) for $k = n$, (ii) follows by Lemma IV.9 (f), (iii) by the fact that σ is a coalgebra morphism, (iv) by definition of $\tau_{n-1}(\varepsilon, u)$, naturality of the braiding, definition of $\tau_1(\delta, \sigma)$, and coassociativity, (v) by definition of the twisted antipode, Lemma IV.14 (b) and by applying $n-2$ times Lemma IV.13 (b), (vi) follows by naturality of the braiding, by combining Lemma IV.13 (a) and Lemma IV.14 (c) for $n-1$, by coassociativity and Lemma IV.9 (d). Finally, (vii) follows by naturality of the braiding and definition of $\tau_{n-1}(\varepsilon, u)$.

IV.4. Proof of Theorem IV.5

In order to show that the family $\{\alpha_n: H^{\otimes n} \rightarrow C^{\otimes n+1}\}_{n \in \mathbb{N}}$ is a morphism between the paracocyclic objects $\mathbf{CM}_\bullet(H, \delta, \sigma)$ and $\mathbf{C}_\bullet(C)$ in \mathcal{B} , we will directly check that

$$\alpha_n \delta_i^n(\sigma) = \delta_i^n \alpha_{n-1} \quad \text{for } 0 \leq i \leq n, n \geq 1, \quad (63)$$

$$\alpha_n \sigma_j^n = \sigma_j^n \alpha_{n+1} \quad \text{for } 0 \leq j \leq n, n \geq 0, \quad (64)$$

$$\alpha_n \tau_n(\delta, \sigma) = \tau_n \alpha_n \quad \text{for } n \geq 0. \quad (65)$$

Notice that we abusively use the same notation for cofaces, codegeneracies, and paracocyclic operators of two different constructions. These should be understood from context. Roughly described, the equalities (63) and (64) follow by the fact that C is a coalgebra in the category of right H -modules. In order to show the equality (65) in the case $n \geq 2$, we will need the following computation:

Lemma IV.16. *If $n \geq 2$, then*

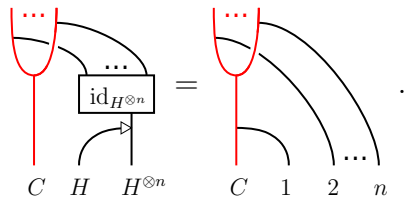

PROOF. We prove the claim by induction. Let us first show it for $n = 2$. Indeed, by the right module axiom, naturality of braiding, and the fact that the comultiplication $\Delta_C: C \rightarrow C \otimes C$ is an H -linear morphism, we have

Suppose that the claim is true for an $n \geq 2$ and let us show it for $n + 1$. We have

which indeed proves the claim for $n + 1$. Here (i) follows by the inductive definition of the left diagonal action, (ii) follows by the induction hypothesis, (iii) follows by the right module axiom, and (iv) follows by naturality of the braiding and the fact that the comultiplication $\Delta_C: C \rightarrow C \otimes C$ is an H -linear morphism. \square

IV.4.1. Proof of the equality (63). Let us show the equality (63). For $n = 1$ and $i = 0$, the equality (63) rewrites as $\alpha_1 \delta_0^1 = \delta_0^1 \alpha_0$, which follows by definitions and the right module axiom. Let $n = i = 1$. In this case, the equality (63) writes as $\alpha_1 \delta_1^1 = \delta_1^1 \alpha_0$, which is exactly the condition that $\alpha: \mathbb{1} \rightarrow C$ is a σ -trace. This shows the equality (63) for $n = 1$ and $0 \leq i \leq 1$.

Now let $n \geq 2$ and $i = 0$. By definitions, naturality of the braiding, the axiom of a right module, and coassociativity, we have:

Let $n \geq 2$ and $1 \leq i \leq n - 1$. In this case, the equation (63) follows by definitions, coassociativity, and the fact that $\Delta_C: C \rightarrow C \otimes C$ is an H -linear morphism:

$$= \begin{array}{c} \text{Diagram with red arcs and black lines} \\ \text{Label } C \text{ and } \alpha \\ \text{Indices } 1, i, n-1 \end{array} = \delta_i^n \alpha_{n-1}.$$

Finally, let $n \geq 2$ and $i = n$. The equation (63) in this case follows by the case $n \geq 2$ and $i = 0$, which is written above, the equation (65), which is proven in Section IV.4.3, and by the paracyclic compatibility relation $\tau_n \delta_0^n = \delta_n^n$. Indeed, we have

$$\begin{aligned} \alpha_n \delta_n^n &= \alpha_n (\tau_n(\delta, \sigma) \delta_0^n) = (\alpha_n \tau_n(\delta, \sigma)) \delta_0^n = (\tau_n \alpha_n) \delta_0^n = \\ &= \tau_n(\alpha_n \delta_0^n) = \tau_n(\delta_0^n \alpha_{n-1}) = (\tau_n \delta_0^n) \alpha_{n-1} = \delta_n^n \alpha_{n-1}. \end{aligned}$$

IV.4.2. Proof of the equality (64). Let us show the equality (64). We consider the three following cases: $j = 0$, $1 \leq j \leq n-1$, and $j = n$. In each case, the desired equality follows by definition, counitality, the fact that the counit $\varepsilon_C: C \rightarrow \mathbb{1}$ is an H -linear morphism, and naturality of the braiding.

Indeed, if $j = 0$, then we have

$$\alpha_n \sigma_0^n = \begin{array}{c} \text{Diagram 1} \\ \text{Label } C \text{ and } \alpha \\ \text{Indices } 0, 1, n \end{array} = \begin{array}{c} \text{Diagram 2} \\ \text{Label } C \text{ and } \alpha \\ \text{Indices } 0, 1, n \end{array} = \begin{array}{c} \text{Diagram 3} \\ \text{Label } C \text{ and } \alpha \\ \text{Indices } 0, 1, n \end{array} = \sigma_0^n \alpha_{n+1}.$$

If $1 \leq j \leq n-1$, then

$$\begin{aligned} \alpha_n \sigma_j^n &= \begin{array}{c} \text{Diagram 1} \\ \text{Label } C \text{ and } \alpha \\ \text{Indices } 1, j, j+1, j+2, n+1 \end{array} = \begin{array}{c} \text{Diagram 2} \\ \text{Label } C \text{ and } \alpha \\ \text{Indices } 1, j, j+1, j+2, n+1 \end{array} = \\ &= \begin{array}{c} \text{Diagram 3} \\ \text{Label } C \text{ and } \alpha \\ \text{Indices } 1, j, j+1, j+2, n+1 \end{array} = \sigma_j^n \alpha_{n+1}. \end{aligned}$$

Finally, if $j = n$, then we have

$$\alpha_n \sigma_n^n = \begin{array}{c} \text{Diagram 1} \\ \text{Label } C \text{ and } \alpha \\ \text{Indices } 1, n, n+1 \end{array} = \begin{array}{c} \text{Diagram 2} \\ \text{Label } C \text{ and } \alpha \\ \text{Indices } 1, n, n+1 \end{array} = \begin{array}{c} \text{Diagram 3} \\ \text{Label } C \text{ and } \alpha \\ \text{Indices } 1, n, n+1 \end{array} = \sigma_n^n \alpha_{n+1}.$$

IV.4.3. Proof of the equality (65). Let us verify that the equation (65) holds. In the case when $n = 0$, this holds since twist morphisms are natural, $\theta_{\mathbb{1}} = \text{id}_{\mathbb{1}}$, and since $\tau_0(\delta, \sigma) = \text{id}_{\mathbb{1}}$. Indeed,

$$\tau_0 \alpha_0 = \theta_C \alpha_0 = \alpha_0 = \alpha_0 \tau_0(\delta, \sigma).$$

Let us check it for the case $n = 1$. Indeed, we have

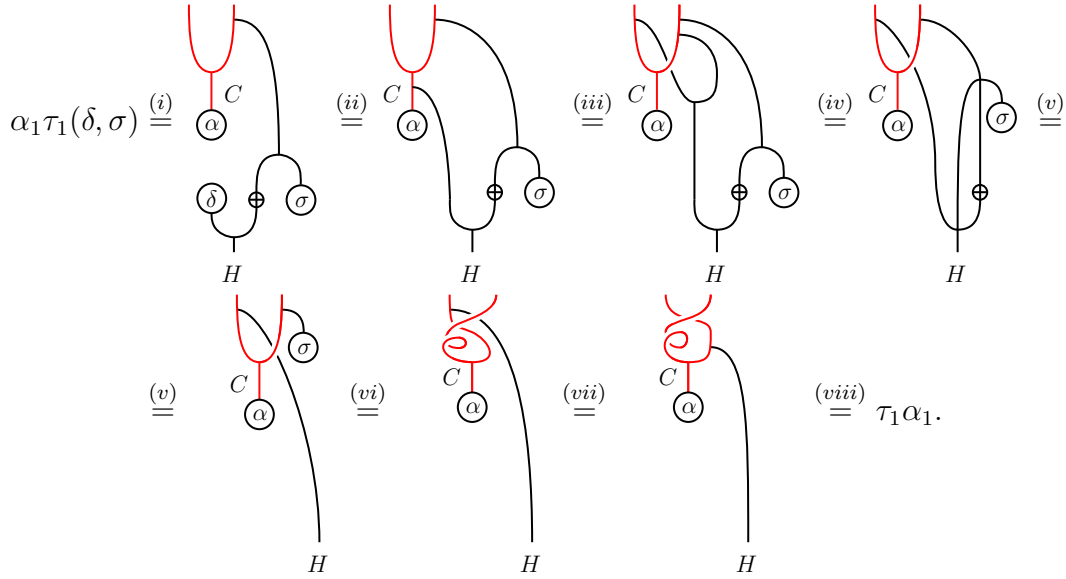

Here (i) and (viii) follow by definition, (ii) follows by the fact that α is δ -invariant, (iii) follows from the fact that the comultiplication $\Delta_C: C \rightarrow C \otimes C$ is H -linear. The equality (iv) follows by (co)associativity, (v) follows by the antipode axiom and (co)unitality, (vi) follows from the fact that α is a σ -trace, and (vii) follows by naturality of the braiding.

Finally, let us check the equality (65) when $n \geq 2$. Indeed, we have

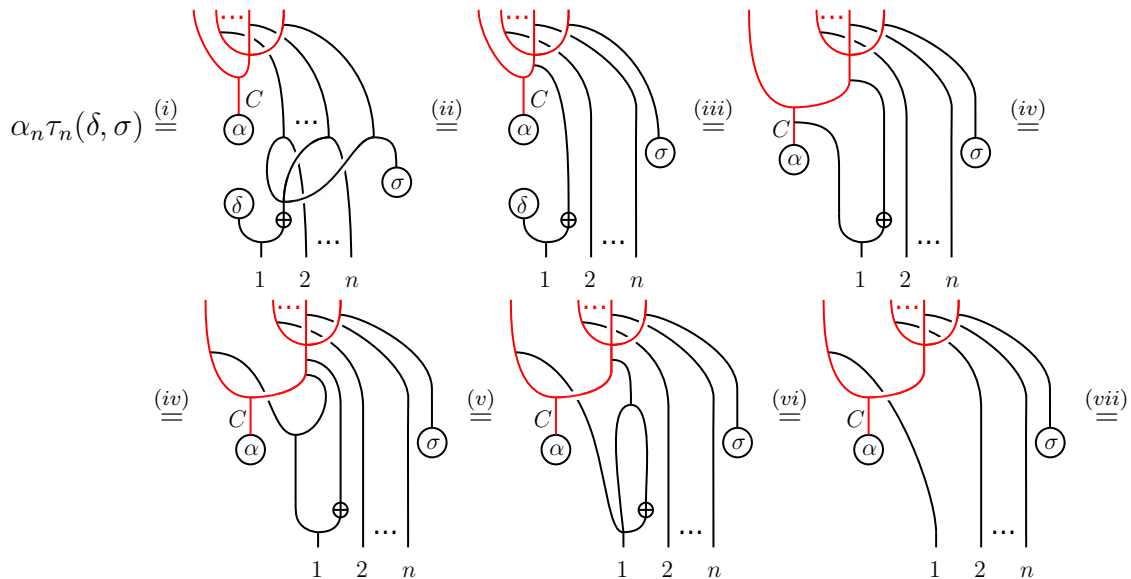

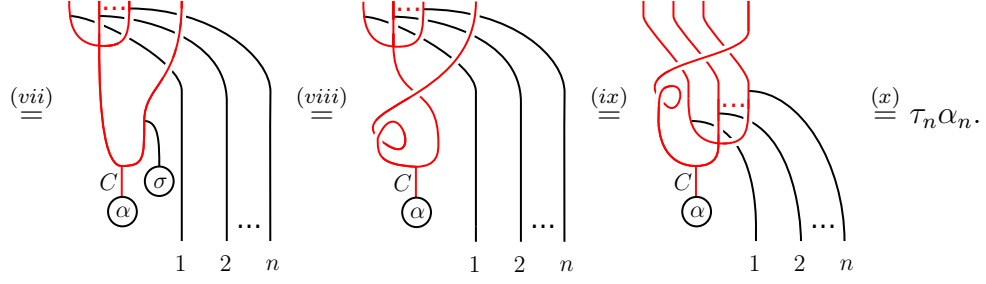

Here (i) and (x) follow by definition, (ii) follows by applying Lemma IV.16, (iii) follows from the fact that α is δ -invariant, (iv) follows from the fact that the comultiplication $\Delta_C: C \rightarrow C \otimes C$ is H -linear. The equality (v) follows from coassociativity and the right module axiom, (vi) follows by the antipode axiom, (co)unitality and the right module axiom, (vii) follows by coassociativity and naturality of the braiding, (viii) follows from the fact that α is a σ -trace and finally, (ix) follows by naturality of the braiding.

IV.5. Verification of the remaining relations

In this section we comment on how to verify paracyclic compatibility relations of the paracyclic object $\mathbf{CM}_\bullet(H, \delta, \sigma)$. Note that the verification of simplicial relations for this object is a rather easy task. One can show it graphically, by using the level-exchange property (see the section II.1.9), coassociativity, and counitality. Also, the relation $\tau_n \sigma_i^n = \sigma_{i-1}^n \tau_{n+1}$ for $1 \leq i \leq n$ follows from the bialgebra axiom and by naturality of the braiding. In what follows, we show the relations where verifications are somewhat more involved: we show that $\tau_n \delta_i^n = \delta_{i-1}^n \tau_{n-1}$ holds for $1 \leq i \leq n$, that $\tau_n \delta_0^n = \delta_n^n$ holds for $n \in \mathbb{N}^*$, and that $\tau_n(\delta, \sigma) \sigma_0^n = \sigma_n^n (\tau_{n+1}(\delta, \sigma))^2$ holds for $n \in \mathbb{N}$. Some of these verifications had been done in [20]. For example, $\tau_2(\delta, \sigma) \sigma_0^2 = \sigma_2^2 (\tau_3(\delta, \sigma))^2$ is verified. Having our Theorem IV.1 at hand, this computation is much simpler, even in the general case. To recall the notion of twisted antipodes and the corresponding notation, see the beginning of Section IV.3.

Let us check the relation $\tau_n \delta_i^n = \delta_{i-1}^n \tau_{n-1}$ for $1 \leq i \leq n$. If $n = 1$ and $i = 1$, the relation rewrites as $\tau_1 \delta_1^1 = \delta_0^1 \tau_0$ and it follows by definitions, the fact that σ is a coalgebra morphism, the fact that (δ, σ) is a modular pair, and by the antipode axiom:

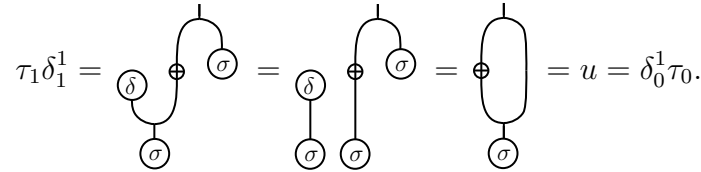

If $n = 2$ and $i = 1$, the relation rewrites as $\tau_2 \delta_1^2 = \delta_0^2 \tau_1$ and it follows by definitions, Lemma IV.9 a), coassociativity, the antipode axiom, and naturality of the braiding:

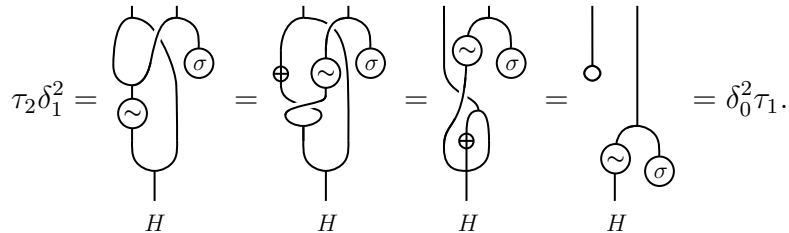

Now let $n \geq 2$. By definition, the fact that δ is an algebra morphism, by $\varepsilon S = \varepsilon$, the bialgebra axiom, the left module axiom, and naturality of the braiding, we have

$$\tau_n \delta_0^n = \begin{array}{c} \text{Diagram 1} \\ \text{Diagram 2} \\ \text{Diagram 3} \\ \text{Diagram 4} \end{array} = \delta_0^n.$$

The diagrams show a sequence of four equivalent braided diagrams. Each diagram has a box labeled $\text{id}_{H^{\otimes n-1}}$ with $n-1$ input lines labeled 1 to $n-1$. The first diagram shows a δ node with a σ node and a \oplus node. The second diagram shows a δ node with a \oplus node. The third diagram shows a δ node. The fourth diagram shows a δ node with a σ node.

Let us check the relation $\tau_n(\delta, \sigma)\sigma_0^n = \sigma_n^n(\tau_{n+1}(\delta, \sigma))^2$ for $n \in \mathbb{N}$. In order to show this relation, one can use Theorem IV.1. We first prove the case $n = 0$. It is true since

$$\sigma_0^0(\tau_1(\delta, \sigma))^2 \stackrel{(i)}{=} \text{Diagram 1} \stackrel{(ii)}{=} \text{Diagram 2} \stackrel{(iii)}{=} \text{Diagram 3} \stackrel{(iv)}{=} \text{Diagram 4} \stackrel{(v)}{=} \text{Diagram 5} \stackrel{(vi)}{=} \tau_0(\delta, \sigma)\sigma_0^0.$$

The diagrams show a sequence of six equivalent braided diagrams. Diagram 1 has a δ node and a σ node. Diagram 2 has two σ nodes and two δ nodes. Diagram 3 has two σ nodes and two δ nodes. Diagram 4 has two δ nodes. Diagram 5 has a δ node. Diagram 6 has a δ node.

Here (i) follows by using the equality (60) of Theorem IV.1 and the definition of σ_0^0 , (ii) follows from definition of right adjoint action and left coadjoint action of H on itself, naturality of the braiding, and the fact that δ is an algebra morphism and σ is a coalgebra morphism. The equality (iii) follows by applying twice the fact that the counit is an algebra morphism, (iv) follows by the fact that $\varepsilon S = \varepsilon$, and since σ is a coalgebra morphism, (v) follows by the fact that δ is an algebra morphism and by the antipode axiom. Finally, (vi) follows by definition of $\tau_0(\delta, \sigma)$ and σ_0^0 . Let us now consider the case when $n \geq 1$. Indeed, the relation still holds since

$$\sigma_n^n(\tau_{n+1}(\delta, \sigma))^2 \stackrel{(i)}{=} \text{Diagram 1} \stackrel{(ii)}{=} \text{Diagram 2} \stackrel{(iii)}{=} \text{Diagram 3} \stackrel{(iv)}{=} \text{Diagram 4} \stackrel{(v)}{=} \text{Diagram 5}$$

The diagrams show a sequence of five equivalent braided diagrams. Diagram 1 has a box labeled $\tau_n(\varepsilon, u)$ with $n+1$ input lines labeled 1 to $n+1$. Diagram 2 has a box labeled $\tau_n(\varepsilon, u)$ with $n+1$ input lines labeled 1 to $n+1$. Diagram 3 has a box labeled $\tau_n(\varepsilon, u)$ with $n+1$ input lines labeled 1 to $n+1$. Diagram 4 has a box labeled $\tau_n(\varepsilon, u)$ with $n+1$ input lines labeled 1 to $n+1$. Diagram 5 has a box labeled $\tau_n(\varepsilon, u)$ with $n+1$ input lines labeled 1 to $n+1$.

$$\begin{array}{ccc}
 \begin{array}{c} \underline{(v)} \\ \hline \hline \end{array} & \begin{array}{c} \begin{array}{c} H^{\otimes n-1} \\ \vdots \\ \tau_n(\varepsilon, u) \\ \vdots \\ \delta \\ \vdots \\ 1 \quad 2 \quad \dots \quad n+1 \end{array} \end{array} & \begin{array}{c} \underline{(vi)} \\ \hline \hline \end{array} & \begin{array}{c} \begin{array}{c} H^{\otimes n-1} \quad H \\ \vdots \\ \tau_n(\delta, \sigma) \\ \vdots \\ 1 \quad 2 \quad \dots \quad n+1 \end{array} \end{array} & \begin{array}{c} \underline{(vii)} \\ \hline \hline \end{array} \tau_n(\delta, \sigma) \sigma_0^n.
 \end{array}$$

Here (i) follows by Theorem IV.1 applied for $n + 1$ and $k = 2$ and by definition of σ_n^n . The equality (ii) follows by the fact that counit is an algebra morphism and naturality of the braiding, (iii) follows by Lemma IV.9 (b) and the fact that σ is a coalgebra morphism, (iv) follows by Lemma IV.9 (e), by the fact that counit is an algebra morphism, and by naturality of the braiding. The equality (v) follows by the fact that $\varepsilon S = \varepsilon$, by Remark IV.10 and Lemma IV.14 (a), (vi) follows by definition of the paracyclic operator $\tau_n(\delta, \sigma)$, and finally, (vii) follows by definition of $\tau_n(\delta, \sigma)$ and σ_0^n .

the faces $\{d_i^n : M \otimes H^{\otimes n} \rightarrow M \otimes H^{\otimes n-1}\}_{0 \leq i \leq n}$ are defined by

$$d_i^n = \begin{cases} \begin{array}{c} \text{---} \text{---} \text{---} \\ | \quad | \quad | \\ M \quad H \quad H^{\otimes n-1} \end{array} & \text{if } i = 0, \\ \begin{array}{c} | \quad | \quad \dots \quad | \quad | \\ | \quad | \quad \dots \quad | \quad | \\ M \quad 1 \quad i \quad i+1 \quad n \end{array} & \text{if } 1 \leq i \leq n-1 \quad \text{and} \\ \begin{array}{c} \text{---} \text{---} \text{---} \\ | \quad | \quad | \\ M \quad H^{\otimes n-1} \quad H \end{array} & \text{if } i = n. \end{cases}$$

For $n \geq 0$, the degeneracies $\{s_j^n : M \otimes H^{\otimes n} \rightarrow M \otimes H^{\otimes n+1}\}_{0 \leq j \leq n}$ are defined by

$$s_j^n = \begin{cases} \begin{array}{c} | \quad | \quad | \\ | \quad \circ \quad | \\ M \quad H^{\otimes n} \end{array} & \text{if } j = 0, \\ \begin{array}{c} | \quad | \quad \dots \quad | \quad | \quad | \\ | \quad | \quad \dots \quad | \quad \circ \quad | \quad | \\ M \quad 1 \quad j \quad j+1 \quad n \end{array} & \text{if } 1 \leq j \leq n-1 \quad \text{and} \\ \begin{array}{c} | \quad | \quad | \\ | \quad | \quad \circ \\ M \quad H^{\otimes n} \end{array} & \text{if } j = n. \end{cases}$$

Remark V.1. If $M = H$ and if the both left and right module structures are given by multiplication, one obtains the simplicial object in \mathcal{B} equal to the underlying simplicial object of the construction of Akrami and Majid [1], applied to the ribbon automorphism $\sigma = S^2$. When \mathcal{B} is the category of \mathbb{k} -modules, one obtains the simplicial \mathbb{k} -module governing the twisted Hochschild homology in the sense of [15], also with the ribbon automorphism $\sigma = S^2$.

Remark V.2. If $M = H$ and if one applies the above construction to a cocomposite Hopf algebra (see Remark II.2), one gets an object similar to the object $\mathbf{A}_\bullet(H)$ from the Chapter III. In a particular case when H is an involutive Hopf algebra in a ribbon category \mathcal{B} , i.e., when $S^2 = \theta_H$, these two objects are identical.

The main result of the present chapter is the following:

Theorem V.3. *The simplicial object $\text{Hoch}_\bullet(H, M)$ in \mathcal{B} extends to a paracyclic object in \mathcal{B} .*

We prove Theorem V.3 in Section V.2.2. The proof consists in exhibiting a simplicial object isomorphic to $\text{Hoch}_\bullet(H, M)$ on which we explicitly define the paracyclic operators (Lemma V.5).

V.2.2. Proof of Theorem V.3. The idea is to identify this simplicial object to a simplicial object that generalizes the one governing the complex that appeared, among other places, in [12]. To an H -bimodule M , we associate the adjoint H -bimodule ${}^\varepsilon M^{\text{ad}}$. As an object of \mathcal{B} , ${}^\varepsilon M^{\text{ad}} = M$. The left action $H \otimes {}^\varepsilon M^{\text{ad}} \rightarrow {}^\varepsilon M^{\text{ad}}$ of H on ${}^\varepsilon M^{\text{ad}}$ is trivial, or more precisely, it equals to $\varepsilon \otimes \text{id}_M$. The right H action on ${}^\varepsilon M^{\text{ad}}$ equals to right adjoint action of H on M :

$$\begin{array}{c} | \\ \cdot \\ | \\ M \end{array} \quad \begin{array}{c} | \\ \cdot \\ | \\ H \end{array} = \begin{array}{c} | \\ \oplus \\ | \\ M \end{array} \quad \begin{array}{c} | \\ \cdot \\ | \\ H \end{array} .$$

Lemma V.4. *The simplicial objects $\text{Hoch}_\bullet(H, M)$ and $\text{Hoch}_\bullet(H, {}^\varepsilon M^{\text{ad}})$ in \mathcal{B} are isomorphic.*

In Lemma V.4, one obtains a braided generalization of a result from [12] on the simplicial object which governs the Hochschild homology of Hopf algebras. We note that a version of this result appeared (with a different convention though) in [16] in a more general setting of ribbon algebras. Our particular case, where the ribbon automorphism is the square of antipode, is suited for extending the simplicial object $\text{Hoch}_\bullet(H, M)$ in \mathcal{B} to a paracyclic object in \mathcal{B} . See Theorem V.5 and its Corollary V.3. One may recall diagonal (co)actions described in Section II.2.7.

PROOF OF LEMMA V.4. We construct an explicit isomorphism between the simplicial objects $\text{Hoch}_\bullet(H, {}^\varepsilon M^{\text{ad}})$ and $\text{Hoch}_\bullet(H, {}^\varepsilon M^{\text{ad}})$ in \mathcal{B} . It is given by the natural transformation $\{\xi_n : M \otimes H^{\otimes n} \rightarrow M \otimes H^{\otimes n}\}_{n \in \mathbb{N}}$ by setting

$$\xi_n = \begin{array}{c} \oplus \\ | \\ | \\ M \quad H^{\otimes n} \end{array}$$

for any $n \in \mathbb{N}$. The coaction denoted by a triangle is the diagonal action described in Section II.2.7. Let us verify that the inverse ξ_n^{-1} of the map ξ_n is computed by

$$\xi_n^{-1} = \begin{array}{c} \oplus \\ | \\ | \\ M \quad H^{\otimes n} \end{array}$$

for any $n \in \mathbb{N}$. Indeed, by naturality of the braiding, the module axiom, antimultiplicativity, the antipode axiom, the fact that $\varepsilon S = \varepsilon$, and the (co)unitality, we have

$$\begin{array}{c} \oplus \\ | \\ | \\ M \quad H^{\otimes n} \end{array} = \begin{array}{c} \oplus \\ | \\ | \\ M \quad H^{\otimes n} \end{array} = \begin{array}{c} \oplus \\ | \\ | \\ M \quad H^{\otimes n} \end{array} = \begin{array}{c} \oplus \\ | \\ | \\ M \quad H^{\otimes n} \end{array} = \text{id}_{M \otimes H^{\otimes n}} .$$

Similarly,

$$\begin{array}{c} \oplus \\ | \\ | \\ M \quad H^{\otimes n} \end{array} = \begin{array}{c} \oplus \\ | \\ | \\ M \quad H^{\otimes n} \end{array} = \begin{array}{c} \oplus \\ | \\ | \\ M \quad H^{\otimes n} \end{array} = \begin{array}{c} \oplus \\ | \\ | \\ M \quad H^{\otimes n} \end{array} = \text{id}_{M \otimes H^{\otimes n}} .$$

It remains to check that the family $\{\xi_n\}_{n \in \mathbb{N}}$ commutes with faces and degeneracies. To ease the readability, we will denote by $\{\overline{d}_i^n\}_{0 \leq i \leq n, n \geq 1}$ and $\{\overline{s}_j^n\}_{0 \leq j \leq n, n \geq 0}$ the faces and degeneracies of the simplicial object $\text{Hoch}_\bullet(H, {}^\varepsilon M^{\text{ad}})$. Let us first show that $d_i^n \xi_n = \xi_{n-1} \overline{d}_i^n$ for $n \geq 1$ and $0 \leq i \leq n$. Let $i = 0$. By the inductive definition of left diagonal coactions, antimultiplicativity, the module axiom, the bimodule compatibility axiom, naturality of the braiding, and the definition of left adjoint action, we have

$$d_0^n \xi_n = \begin{array}{c} \text{Diagram 1} \\ \text{Diagram 2} \\ \text{Diagram 3} \\ \text{Diagram 4} \\ \text{Diagram 5} \end{array} = \xi_{n-1} \overline{d}_0^n.$$

The diagrams show the transformation of the left diagonal coaction $d_0^n \xi_n$ through several steps using the module axiom, naturality of braiding, and the definition of left adjoint action, resulting in $\xi_{n-1} \overline{d}_0^n$.

Let $1 \leq i \leq n - 1$. By using the definition of a left diagonal coaction, the bialgebra compatibility axiom, associativity, and naturality of the braiding, we have

$$d_i^n \xi_n = \begin{array}{c} \text{Diagram 1} \\ \text{Diagram 2} \\ \text{Diagram 3} \end{array} = \xi_{n-1} \overline{d}_i^n.$$

The diagrams show the transformation of the left diagonal coaction $d_i^n \xi_n$ through several steps using the bialgebra compatibility axiom, associativity, and naturality of braiding, resulting in $\xi_{n-1} \overline{d}_i^n$.

Let $i = n$. By using the inductive definition of left diagonal coactions, naturality of the braiding, the module axiom, antimultiplicativity, associativity, the antipode axiom, and unitality, we have

$$d_n^n \xi_n = \begin{array}{c} \text{Diagram 1} \\ \text{Diagram 2} \\ \text{Diagram 3} \\ \text{Diagram 4} \end{array} = \xi_{n-1} \overline{d}_n^n.$$

The diagrams show the transformation of the left diagonal coaction $d_n^n \xi_n$ through several steps using the module axiom, naturality of braiding, antimultiplicativity, associativity, the antipode axiom, and unitality, resulting in $\xi_{n-1} \overline{d}_n^n$.

Finally, we verify that $s_j^n \xi_n = \xi_{n+1} \overline{s}_j^n$ for all $n \in \mathbb{N}$ and $0 \leq j \leq n$. To show the latter relation, we distinguish the cases $j = 0$, $1 \leq j \leq n - 1$ and $j = n$. In each case, this follows by definition of left diagonal coaction, the fact that unit is a coalgebra morphism, unitality, and naturality of the braiding. Let $j = 0$. We have

$$s_0^n \xi_n = \begin{array}{c} \text{Diagram 1} \\ \text{Diagram 2} \end{array} = \xi_{n+1} \overline{s}_0^n.$$

The diagrams show the transformation of the left diagonal coaction $s_0^n \xi_n$ through two steps using the definition of left diagonal coaction, the fact that unit is a coalgebra morphism, unitality, and naturality of the braiding, resulting in $\xi_{n+1} \overline{s}_0^n$.

$$= \text{diagram} = \text{id}_{M \otimes H^{\otimes n}}.$$

Similarly,

$$t_n \hat{t}_n = \text{diagram} = \text{diagram} = \text{diagram} = \text{diagram} = \text{diagram} = \text{diagram} = \text{id}_{M \otimes H^{\otimes n}}.$$

Let us show the relation $d_0^n t_n = d_n^n$ for $n \geq 1$. By module axioms, the antipode axiom, the fact that $\varepsilon S = \varepsilon$, naturality of the braiding, the fact that ε is an algebra morphism, and the comodule axiom, we have

$$d_0^n t_n = \text{diagram} = \text{diagram} = \text{diagram} = \text{diagram} = \text{diagram} = d_n^n.$$

Let us show $s_0^n t_n = t_{n+1}^2 s_n^n$ for $n \geq 0$. Since the case $n = 0$ is straightforward, we shall focus on the case $n \geq 1$. By the fact that unit is a coalgebra morphism, by (co)unitality, module axioms, inductive definition of right diagonal coaction, (co)associativity, antimultiplicativity of S , naturality of the braiding, the antipode axiom we have

$$\begin{aligned}
 t_{n+1}^{-1} s_0^n t_n &= \text{[Diagram 1]} = \text{[Diagram 2]} = \text{[Diagram 3]} = \text{[Diagram 4]} = \\
 &= \text{[Diagram 5]} = \text{[Diagram 6]} = \text{[Diagram 7]} = \text{[Diagram 8]} = \\
 &= \text{[Diagram 9]} = \text{[Diagram 10]} = \text{[Diagram 11]} = t_{n+1} s_n^n,
 \end{aligned}$$

The diagrams consist of three rows of four diagrams each, connected by equals signs. The first row diagrams are labeled with M and $H^{\otimes n-1} H$. The second row diagrams are labeled with M and $H^{\otimes n-1} H$. The third row diagrams are labeled with M and $H^{\otimes n}$. The final diagram in the third row is labeled $= t_{n+1} s_n^n$.

whence the desired equality. Let us now show the relation $d_i^n t_n = t_{n-1} d_{i-1}^n$ for $n \geq 1$ and $1 \leq i \leq n$. The case $n = i = 1$ follows immediately by counitality. From now on, let $n \geq 2$. We consider three cases:

- (1) Let $i = 1$. By definition of the right diagonal coactions, the bialgebra compatibility axiom, (co)associativity, (co)unitality, the antipode axiom, antimultiplicativity,

naturality of the braiding, and comodule axioms, we have

$$\begin{aligned}
 t_{n-1}^{-1} d_1^n t_n &= \text{[Diagram 1]} = \text{[Diagram 2]} = \text{[Diagram 3]} = \text{[Diagram 4]} \\
 &= \text{[Diagram 5]} = \text{[Diagram 6]} = \text{[Diagram 7]} = \text{[Diagram 8]} \\
 &= \text{[Diagram 9]} = \text{[Diagram 10]} = d_0^n.
 \end{aligned}$$

(2) Let $2 \leq i \leq n - 1$. By definition of the right diagonal coactions, the bialgebra compatibility axiom, naturality of braiding, we have

$$\begin{aligned}
 d_i^n t_n &= \text{[Diagram 1]} = \text{[Diagram 2]} = \text{[Diagram 3]} = \text{[Diagram 4]} = t_{n-1} d_{i-1}^n.
 \end{aligned}$$

The diagrams consist of four stages of a string rewriting process. Each stage shows a vertical line labeled M on the left and several vertical lines representing tensor powers of H . The first stage has lines labeled $1, 2, \dots, i, i+1, \dots, n$ and a box labeled $\text{id}_{H^{\otimes n-1}}$. The second stage has lines labeled $1, 2, \dots, i, i+1, n, n+1$. The third stage has lines labeled $1, i-1, i, n-1, n$. The fourth stage has lines labeled $1, i-1, i, n-1, n$ and a box labeled $\text{id}_{H^{\otimes n-1}}$. The final result is $t_{n-1} d_{i-1}^n$.

(3) Let $i = n$. By the inductive definition of right diagonal coactions, counitality, and associativity, we have

$$\begin{aligned}
 d_n^n t_n &= \text{[Diagram 1]} = \text{[Diagram 2]} = \text{[Diagram 3]} = t_{n-1} d_{n-1}^n.
 \end{aligned}$$

The diagrams consist of three stages of a string rewriting process. Each stage shows a vertical line labeled M on the left and several vertical lines representing tensor powers of H . The first stage has lines labeled $H^{\otimes n-1}, H$ and boxes labeled $\text{id}_{H^{\otimes n-1}}$ and $\text{id}_{H^{\otimes n-1}}$. The second stage has lines labeled $H^{\otimes n-2}, H, H$. The third stage has lines labeled $H^{\otimes n-2}, H, H$ and a box labeled $\text{id}_{H^{\otimes n-1}}$. The final result is $t_{n-1} d_{n-1}^n$.

Let us show that $s_j^n t_n = t_{n+1} s_{j-1}^n$ for all $n \in \mathbb{N}$ and $1 \leq j \leq n$. We will outline the argument for $3 \leq j \leq n - 1$. The cases $j = 1$, $j = 2$, and $j = n$ are similar to verify. By definition of right diagonal coaction, naturality of the braiding, the fact that unit is a

coalgebra morphism, and naturality of the braiding, we have

$$\begin{aligned}
 s_j^n t_n &= \text{Diagram 1} = \text{Diagram 2} \\
 &= \text{Diagram 3} = \text{Diagram 4} = t_{n+1} s_{j-1}^n.
 \end{aligned}$$

□

PROOF OF THE THEOREM V.3. To define paracyclic operators on $\text{Hoch}_\bullet(H, M)$, use Theorem V.5 and the identifications from the proof of Lemma V.4. □

V.3. Braided coHochschild complex

We discuss a braided version of a cosimplicial object giving rise to coHochschild complex adapted to categorical Hopf algebras. We extend this cosimplicial object to a paracyclic object. Since proofs of all the statements in this section are similar to those of Section V.2, we only give a brief sketch of all steps. In this section, N denotes an H -bicomodule.

V.3.1. Braided version of twisted coHochschild complex. There is a cosimplicial object $\text{coHoch}_\bullet(H, N)$ in \mathcal{B} . On objects, it is defined by $\text{coHoch}_n(H, N) = N \otimes H^{\otimes n}$.

For $n \geq 1$, the cofaces $\{\delta_i^n: N \otimes H^{\otimes n-1} \rightarrow N \otimes H^{\otimes n}\}_{0 \leq i \leq n}$ are defined by

$$\delta_i^n = \begin{cases} \begin{array}{c} \text{---} H \text{---} \\ | \\ N \quad H^{\otimes n-1} \end{array} & \text{if } i = 0, \\ \begin{array}{c} | \quad | \quad \cup \quad | \\ N \quad 1 \quad i \quad n-1 \end{array} & \text{if } 1 \leq i \leq n-1 \quad \text{and} \\ \begin{array}{c} \oplus \\ | \\ N \quad H^{\otimes n-1} \end{array} & \text{if } i = n. \end{cases}$$

For $n \geq 0$, the codegeneracies $\{\sigma_j^n: N \otimes H^{\otimes n+1} \rightarrow N \otimes H^{\otimes n}\}_{0 \leq j \leq n}$ are defined by

$$\sigma_j^n = \begin{array}{c} | \quad | \quad \circ \quad | \\ N \quad 1 \quad j+1 \quad n+1 \end{array}$$

An analogue of Theorem V.3 in this setting is the following:

Theorem V.6. *The cosimplicial object $\text{coHoch}_\bullet(H, N)$ in \mathcal{B} extends to a paracocyclic object in \mathcal{B} .*

We prove Theorem V.6 in Section V.3.2. The strategy of the proof is similar to that of Theorem V.3.

V.3.2. Proof of Theorem V.6. To an H -bicomodule N , we associate the coadjoint H -bicomodule ${}^uN^{\text{coad}}$. As an object of \mathcal{B} , ${}^uN^{\text{coad}} = N$. The left coaction ${}^uN^{\text{coad}} \rightarrow H \otimes {}^uN^{\text{coad}}$ of H on ${}^uN^{\text{coad}}$ is trivial, or more precisely, it equals to $u \otimes \text{id}_N$. The right H coaction on ${}^uN^{\text{coad}}$ equals to the right coadjoint action of H on N :

$$\begin{array}{c} \text{---} H \text{---} \\ | \\ N \end{array} = \begin{array}{c} \oplus \\ | \\ N \end{array} \text{---} H \text{---}$$

An analogue of the Lemma V.4 is the following:

Lemma V.7. *The cosimplicial objects $\text{coHoch}_\bullet(H, N)$ and $\text{coHoch}_\bullet(H, {}^uN^{\text{coad}})$ in \mathcal{B} are isomorphic.*

PROOF. As in the proof of Lemma V.4, we construct an explicit isomorphism between the cosimplicial objects $\text{coHoch}_\bullet(H, N)$ and $\text{coHoch}_\bullet(H, {}^uN^{\text{coad}})$ in \mathcal{B} . It is given by the natural transformation $\{\eta_n: N \otimes H^{\otimes n} \rightarrow N \otimes H^{\otimes n}\}_{n \in \mathbb{N}}$, which is defined by setting

$$\eta_n = \begin{array}{c} \oplus \\ | \\ N \quad H^{\otimes n} \end{array}$$

The inverse of the morphism η_n is the map $\eta_n^{-1}: N \otimes H^{\otimes n} \rightarrow N \otimes H^{\otimes n}$ defined by setting

$$\eta_n^{-1} = \begin{array}{c} \oplus \\ | \\ N \quad H^{\otimes n} \end{array}$$

for all $n \in \mathbb{N}$. □

An analogue of Lemma V.5 is the following:

Lemma V.8. *The cosimplicial object $\text{coHoch}_\bullet(H, {}^u N^{\text{coad}})$ in \mathcal{B} extends to a paracyclic object in \mathcal{B} . The paracyclic operator is given by the morphism $\tau_n: N \otimes H^{\otimes n} \rightarrow N \otimes H^{\otimes n}$, defined by*

$$\tau_0 = \text{id}_N \quad \text{and} \quad \tau_n = \text{diagram} \quad \text{for } n \geq 1.$$

Remark V.9. If $N = \mathbb{1}$ is the trivial bicomodule over H , then the paracyclic object $\text{coHoch}_\bullet(H, {}^u \mathbb{1}^{\text{coad}})$ in \mathcal{B} equals to the paracyclic object $\mathbf{CM}_\bullet(H^{\text{op}}, \varepsilon, u)$, which is studied in the Chapter IV. The opposite Hopf algebra H^{op} is recalled in Remark II.2.

PROOF OF LEMMA V.8. The proof of Lemma V.8 is similar to the proof of Lemma V.5. The inverse τ_n^{-1} of the paracyclic operator is given by setting for all $n \geq 0$,

$$\tau_n^{-1} = \text{diagram}$$

□

With the above lemmas, we are ready to prove Theorem V.6:

PROOF OF THEOREM V.6. To define paracyclic operators on $\text{coHoch}_\bullet(H, N)$, use Lemma V.8 and the identifications from the proof of Lemma V.7. □

CHAPTER VI

(Co)cyclic sets from ribbon string links

In this chapter, we construct a cocyclic set \mathcal{SL}_\bullet and a cyclic set $\widetilde{\mathcal{SL}}_\bullet$ from ribbon string links and state some relations with quantum invariants. First, we review string links and their evaluations on ribbon categories (Section VI.1). Section VI.2 is devoted to the construction of \mathcal{SL}_\bullet and $\widetilde{\mathcal{SL}}_\bullet$, respectively. Finally, in Section VI.3, we explicit the duals of \mathcal{SL}_\bullet and $\widetilde{\mathcal{SL}}_\bullet$ with respect to the cyclic dualities L and L^{op} introduced in Chapter I.

VI.1. String links and their evaluations

In this section, we first recall definitions of ribbon string links and ribbon handles. At the end of the section, we outline how to construct a form on a coend from a string link. This is based on [4].

VI.1.1. Ribbon string links. Let $n \in \mathbb{N}^*$. An n -string link is a disjoint union of n smoothly embedded arc components l_1, \dots, l_n in $\mathbb{R}^2 \times [0, 1]$ such that for each $1 \leq i \leq n$, the arc l_i joins $(i, 0, 0)$ to $(i, 0, 1)$. A *ribbon n -string link* is an n -string link equipped with a vector field, which is equal to $(0, -1, 0)$ in the endpoints of arc components. As shown, we number the components from left to the right. A string link is oriented by orienting each of its arc components from top to bottom. Two planar diagrams represent isotopic string links if and only if they are related by a finite sequence of plane isotopies or ribbon Reidemeister moves R1-R3:

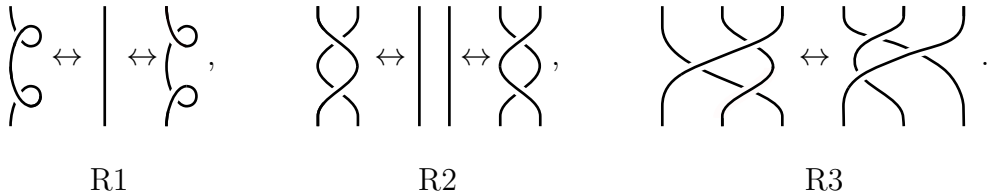

The category **RSL** of ribbon string links has as objects nonnegative integers $n \in \mathbb{N}$. For two nonnegative integers m and n , the set of morphisms from m to n is defined by

$$\text{Hom}_{\mathbf{RSL}}(n, m) = \begin{cases} \text{isotopy classes of ribbon } n\text{-string links} & \text{if } n = m, \\ \emptyset & \text{otherwise.} \end{cases}$$

The composition $T' \circ T$ of two ribbon n -string links is given by stacking T' on the top of T (i.e., with ascending convention) and compressing the result into $\mathbb{R}^2 \times [0, 1]$:

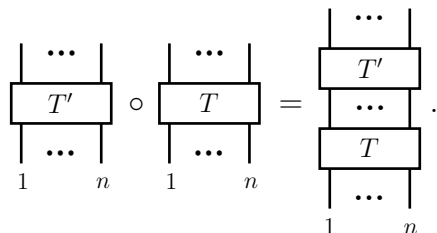

Identities are the trivial string links. The category **RSL** is monoidal: for $m, n \in \mathbb{N}$, set $m \otimes n = m + n$ and let $T \otimes T'$ be a juxtaposition of T' on the right of T .

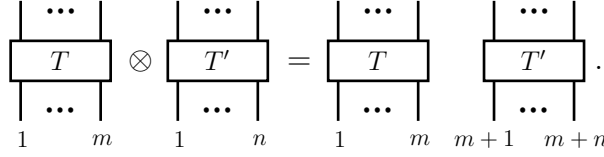

VI.1.2. Ribbon handles. Let $n \in \mathbb{N}^*$. An n -*handle* is a disjoint union of n smoothly embedded arc components h_1, \dots, h_n in $\mathbb{R}^2 \times [0, 1]$ such that for each $1 \leq i \leq n$, the arc h_i joins $(2i - 1, 0, 0)$ to $(2i, 0, 0)$. A ribbon n -handle is an n -handle equipped with a vector field, which is equal to $(0, -1, 0)$ in the endpoints of arc components. One often presents a ribbon n -handle with a planar diagram:

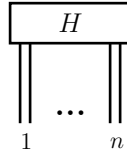

We number its components from left to the right. A ribbon handle is oriented by orienting each component upwards near its left bottom input.

The category **RH** of ribbon handles has as objects nonnegative integers. For two nonnegative integers m and n , the set of morphisms from m to n is defined by

$$\text{Hom}_{\mathbf{RH}}(m, n) = \begin{cases} \text{isotopy classes of ribbon } n\text{-handles} & \text{if } n = m, \\ \emptyset & \text{otherwise.} \end{cases}$$

The composition $H' \circ H$ of two ribbon n -handles H and H' is defined as follows:

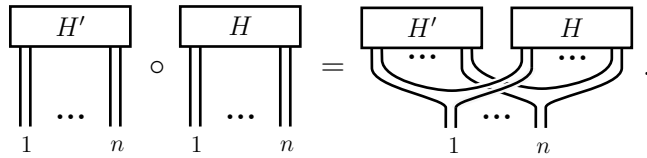

The identity for this composition is a ribbon handle consisting of n caps:



The category **RH** is monoidal: for $m, n \in \mathbb{N}$, set $m \otimes n = m + n$ and $H \otimes H'$ is a juxtaposition of H' on the right of H :

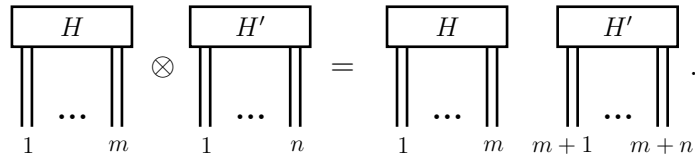

VI.1.3. An isomorphism of categories RSL and RH. We outline a construction of the mutually inverse monoidal functors $\mathfrak{F}: \mathbf{RSL} \rightarrow \mathbf{RH}$ and $\mathfrak{G}: \mathbf{RH} \rightarrow \mathbf{RSL}$, which is done in [4]. For any nonnegative integer n , set $\mathfrak{F}(n) = n$ and $\mathfrak{G}(n) = n$. For an isotopy

class of a ribbon n -string link T , we set

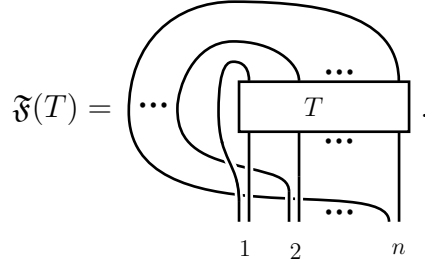

For a nonnegative integer n and an isotopy class of a ribbon n -handle H , we set

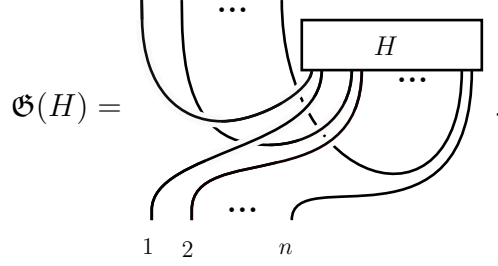

VI.1.4. Convolution category. Consider an algebra $A = (A, \mu, \eta)$ and a coalgebra $C = (C, \Delta, \varepsilon)$ in a braided category \mathcal{B} . The convolution category $\text{Conv}_{\mathcal{B}}(C, A)$ is defined as follows. Its objects are the nonnegative integers. For two nonnegative integers m and n , the set of morphism from m to n is defined by

$$\text{Hom}_{\text{Conv}(C,A)}(n, m) = \begin{cases} \text{Hom}_{\mathcal{B}}(C^{\otimes n}, A) & \text{if } n = m, \\ \emptyset & \text{otherwise.} \end{cases}$$

The composition of morphisms is given by the convolution product $*$, which is defined as follows. For two morphisms $f, g \in \text{Hom}_{\mathcal{B}}(C^{\otimes n}, A)$, we set

$$f * g = \mu(f \otimes g) \Delta_{C^{\otimes n}},$$

where $\Delta_{C^{\otimes n}}$ denotes the coproduct on $\Delta_{C^{\otimes n}}$ (see [4] for details). The identity of an object $n \in \mathbb{N}$ is given by $\text{id}_n = \eta \varepsilon^{\otimes n}$. The category $\text{Conv}_{\mathcal{B}}(C, A)$ is monoidal: the monoidal product of is given by $m \otimes n = m+n$ and the monoidal product of two morphisms $f: m \rightarrow m$ and $g: n \rightarrow n$ is given by $\mu(f \otimes_{\mathcal{B}} g): m+n \rightarrow m+n$.

VI.1.5. Evaluations of ribbon string links. Let \mathcal{B} be a ribbon \mathbb{k} -linear category. In this section we recall the construction of a functor

$$\phi_{\mathcal{B}}: \mathbf{RSL} \rightarrow \text{Conv}_{\mathcal{B}}(C, \mathbb{1})$$

from [4], which will be important in the sequel. For any $n \in \mathbb{N}$, set $\phi_{\mathcal{B}}(n) = n$. For a ribbon n -string link T , the morphism $\phi_{\mathcal{B}}(T): C^{\otimes n} \rightarrow \mathbb{1}$ is defined as follows. First, we orient the ribbon n -handle $\mathfrak{F}(T)$ as described in Section VI.1.2. Further, any choice of objects X_1, X_2, \dots, X_n of \mathcal{B} defines a morphism

$$\mathfrak{F}(T)_{X_1, X_2, \dots, X_n}: X_1^* \otimes X_1 \otimes X_2^* \otimes X_2 \otimes \cdots \otimes X_n^* \otimes X_n \rightarrow \mathbb{1}.$$

Here for all $1 \leq k \leq n$, the k -th component of $\mathfrak{F}(T)$ is decorated by the object X_k . Finally, by the Fubini's Theorem for coends (see Lemma II.3), there exists a unique morphism $\phi_{\mathcal{B}}(T): C^{\otimes n} \rightarrow \mathbb{1}$ such that

$$\mathfrak{F}(T)_{X_1, X_2, \dots, X_n} = \phi_{\mathcal{B}}(T) \circ (i_{X_1} \otimes i_{X_2} \otimes \cdots \otimes i_{X_n})$$

for any objects X_1, X_2, \dots, X_n of \mathcal{B} .

VI.2. (Co)cyclic sets from ribbon string links

In this section, we outline structures of (co)cyclic sets on ribbon string links and relate them with (co)cyclic \mathbb{k} -modules associated to categorical (co)algebras introduced in Chapter III. The main result of the chapter is the following theorem.

Theorem VI.1. *For $n \geq 0$, let \mathcal{SL}_n be the set of isotopy classes of ribbon $(n + 1)$ -string links. Then the family $\{\mathcal{SL}_n\}_{n \geq 0}$ has a structure of a cocyclic set denoted \mathcal{SL}_\bullet and a structure of cyclic set denoted $\widetilde{\mathcal{SL}}_\bullet$. Moreover, if \mathcal{B} is a ribbon \mathbb{k} -category with a coend C , the evaluation functor $\phi_{\mathcal{B}}: \mathbf{RSL} \rightarrow \text{Conv}_{\mathcal{B}}(C, \mathbb{1})$ (see Section VI.1.5) induces a natural transformation of \mathcal{SL}_\bullet to the cocyclic set $\widehat{\mathbf{D}}_\bullet(C)$ (see Section III.1.4.1) and a natural transformation of $\widetilde{\mathcal{SL}}_\bullet$ to the cyclic set $\widehat{\mathbf{B}}_\bullet(C)$ (see Section III.2.4.1).*

We prove Theorem VI.1 in several steps. First, we construct the cocyclic set \mathcal{SL}_\bullet in Section VI.2.1. Second, we construct the cyclic set $\widetilde{\mathcal{SL}}_\bullet$ in Section VI.2.2. In Section VI.2.3, we finish the proof of Theorem VI.1, by relating these (co)cyclic sets to $\widehat{\mathbf{D}}_\bullet(C)$ and $\widehat{\mathbf{B}}_\bullet(C)$.

The cyclic duality $L: \Delta C^{\text{op}} \rightarrow \Delta C$ from Section I.4.2 transforms the cocyclic set \mathcal{SL}_\bullet into the cyclic set $\mathcal{SL}_\bullet^L = \mathcal{SL}_\bullet \circ L$. Similarly, $L^{\text{op}}: \Delta C \rightarrow \Delta C^{\text{op}}$ transforms the cyclic set $\widetilde{\mathcal{SL}}_\bullet$ into the cocyclic set $\widetilde{\mathcal{SL}}_\bullet^{L^{\text{op}}} = \widetilde{\mathcal{SL}}_\bullet \circ L^{\text{op}}$. The cyclic set \mathcal{SL}_\bullet^L is explicated in Section VI.3.1 and that of $\widetilde{\mathcal{SL}}_\bullet^{L^{\text{op}}}$ in Section VI.3.2. An immediate corollary of Theorem VI.1 and the results from Section III.3 is the following:

Corollary VI.2. *Let \mathcal{B} be a ribbon \mathbb{k} -category with a coend C . Then the evaluation functor $\phi_{\mathcal{B}}: \mathbf{RSL} \rightarrow \text{Conv}_{\mathcal{B}}(C, \mathbb{1})$ induces a natural transformation of \mathcal{SL}_\bullet^L to the cyclic set $\mathbf{D}_\bullet(C)$ (see Section III.1.4.2) and a natural transformation of $\widetilde{\mathcal{SL}}_\bullet^{L^{\text{op}}}$ to the cocyclic set $\mathbf{B}_\bullet(C)$ (see Section III.2.4.2).*

VI.2.1. The cocyclic set \mathcal{SL}_\bullet . For $n \geq 0$, define $\mathcal{SL}_n = \text{End}_{\mathbf{RSL}}(n + 1)$, i.e., it is the set of the isotopy classes of ribbon $(n + 1)$ -string links. For $n \geq 1$, we define the cofaces $\{\delta_i^n: \mathcal{SL}_{n-1} \rightarrow \mathcal{SL}_n\}_{0 \leq i \leq n}$ by setting for any $T \in \mathcal{SL}_{n-1}$,

$$\delta_i^n(T) = \begin{cases} \begin{array}{c} \cdots \\ | \\ \boxed{T} \\ | \\ \cdots \\ 1 \quad n \end{array} & \text{if } i = 0, \\ \begin{array}{c} \cdots \quad | \quad | \quad \cdots \\ | \\ \boxed{T} \quad \vdots \\ | \\ \cdots \quad | \quad | \quad \cdots \\ 1 \quad i \quad i+1 \quad n \end{array} & \text{if } 1 \leq i \leq n-1, \\ \begin{array}{c} \cdots \\ | \\ \boxed{T} \\ | \\ \cdots \\ 1 \quad n \end{array} & \text{if } i = n. \end{cases}$$

Next, we show the relation (10). Let $n \in \mathbb{N}$. If $i < j$ and $T \in \mathcal{SL}_{n+1}$, then

$$\begin{aligned} \sigma_j \sigma_i(T) &\stackrel{(a)}{=} \sigma_j \left(\begin{array}{c} \cdots | i \text{ arc} \cdots \\ \hline T \\ \hline \cdots | \cdots | \cdots \\ 0 \qquad i+1 \quad n+1 \end{array} \right) \stackrel{(b)}{=} \begin{array}{c} \cdots | i \text{ arc} \cdots | j+1 \text{ arc} \cdots \\ \hline T \\ \hline \cdots | \cdots | \cdots \\ 0 \qquad i+1 \qquad j+2 \quad n+1 \end{array} \\ &\stackrel{(c)}{=} \sigma_i \left(\begin{array}{c} \cdots | j+1 \text{ arc} \cdots \\ \hline T \\ \hline \cdots | \cdots | \cdots \\ 0 \qquad j+2 \quad n+1 \end{array} \right) \stackrel{(d)}{=} \sigma_i \sigma_{j+1}(T). \end{aligned}$$

Here (a), (c), (d) follow from the definition and (b) follows from the definition and the hypothesis that $i \leq j$. Indeed, since one concatenates the components labelled by i and $i+1$, the j -th component of $\sigma_i(T)$ is the one labelled by $j+1$ on the string link T . The case $i = j$ is trivial to prove.

Let us show Relations (11). Let $T \in \mathcal{SL}_{n-1}$. We consider the four following cases:

- (1) Let $i = j$. In the case when $i \neq 0$, we have

$$\sigma_i \delta_i(T) \stackrel{(a)}{=} \sigma_i \left(\begin{array}{c} \cdots | | \cdots \\ \hline T \\ \hline \cdots | | \cdots \\ 1 \quad i \quad i+1 \quad n \end{array} \right) \stackrel{(b)}{=} \begin{array}{c} \cdots | | \text{arc} | \cdots \\ \hline T \\ \hline \cdots | | \cdots \\ 1 \quad i \quad i+1 \quad n \end{array} \stackrel{(c)}{=} T.$$

Here (a) follows from the definition, (c) follows by the isotopy, and (b) follows from the definition and since the $(i+1)$ -th component of the string link $\delta_i(T)$ is the unlabelled component inserted between the components labelled by i and $i+1$ on the string link T . The case $i = 0$ is trivial to prove.

- (2) Let $i = j+1$. If $i \neq n$, we have

$$\sigma_j \delta_{j+1}(T) \stackrel{(a)}{=} \sigma_j \left(\begin{array}{c} \cdots | | | \cdots \\ \hline T \\ \hline \cdots | | | \cdots \\ 1 \quad j+1 \quad j+2 \quad n \end{array} \right) \stackrel{(b)}{=} \begin{array}{c} \cdots | | \text{arc} | | \cdots \\ \hline T \\ \hline \cdots | | | \cdots \\ 1 \quad j+1 \quad j+2 \quad n \end{array} \stackrel{(c)}{=} T.$$

Here (a) follows from the definition, (c) by the isotopy, and (b) follows from the definition and since the $(j+1)$ -th component of the string link $\delta_{j+1}(T)$ is the component labelled by $j+1$ on the string link T . The case when $i = n$ is proven similarly.

(3) Let $i < j$. In the case when $i \neq 0$, we have

$$\begin{aligned} \sigma_j \delta_i(T) &\stackrel{(a)}{=} \sigma_j \left(\begin{array}{c} \cdots \quad | \quad | \quad \cdots \\ \hline T \\ \hline \cdots \quad | \quad | \quad \cdots \\ 1 \quad \quad i \quad i+1 \quad n \end{array} \right) \stackrel{(b)}{=} \begin{array}{c} \cdots \quad | \quad | \quad \cdots \quad j \\ \hline T \\ \hline \cdots \quad | \quad | \quad \cdots \\ 1 \quad \quad i \quad i+1 \quad \quad j+1 \quad n \end{array} \\ &\stackrel{(c)}{=} \delta_i \left(\begin{array}{c} \cdots \quad | \quad | \quad \cdots \\ \hline T \\ \hline \cdots \quad | \quad | \quad \cdots \\ 1 \quad \quad \quad j+1 \quad n+1 \end{array} \right) \stackrel{(d)}{=} \delta_i \sigma_{j-1}(T). \end{aligned}$$

Here (a), (c), (d) follow from the definition and (b) follows from the definition and the hypothesis that $i < j$. Indeed, since we count the unlabelled trivial component, which is inserted between the components labelled by i and $i + 1$, the $(j + 1)$ -th component of the string link $\delta_i(T)$ is the one labelled by j on the string link T . The case $n = 0$ is proven in a similar way.

(4) Let $i > j + 1$. In the case when $i = n$, we have

$$\begin{aligned} \sigma_j \delta_i(T) &\stackrel{(a)}{=} \sigma_j \left(\begin{array}{c} \cdots \quad | \quad | \quad \cdots \\ \hline T \\ \hline \cdots \quad | \quad | \quad \cdots \\ 1 \quad \quad i \quad i+1 \quad n \end{array} \right) \stackrel{(b)}{=} \begin{array}{c} \cdots \quad | \quad | \quad \cdots \quad j+1 \\ \hline T \\ \hline \cdots \quad | \quad | \quad \cdots \\ 1 \quad \quad \quad j+2 \quad \quad i \quad i+1 \quad n \end{array} \\ &\stackrel{(c)}{=} \delta_{i-1} \left(\begin{array}{c} \cdots \quad | \quad | \quad \cdots \\ \hline T \\ \hline \cdots \quad | \quad | \quad \cdots \\ 1 \quad \quad \quad j+2 \quad n \end{array} \right) \stackrel{(d)}{=} \delta_{i-1} \sigma_j(T). \end{aligned}$$

Here (a), (c), (d) follow from the definition and (b) follows from the definition and the hypothesis that $i > j + 1$. Indeed, in this case the $(j + 1)$ -th component of the string link $\delta_i(T)$ is the one labelled by $j + 1$ on the string link T . The case $i = n$ is proven similarly.

Let us show the relation (25). Let us check the case when $n \geq 3$ and $2 \leq i \leq n - 1$. For $T \in \mathcal{SL}_{n-1}$, we have

$$\tau_n \delta_i(T) \stackrel{(a)}{=} \begin{array}{c} \cdots \\ \hline \hline T \\ \hline \hline \cdots \\ 1 \quad 2 \quad \quad \quad i \quad i+1 \quad n \end{array} \stackrel{(b)}{=} \begin{array}{c} \cdots \\ \hline \hline T \\ \hline \hline \cdots \\ 1 \quad 2 \quad \quad \quad i \quad i+1 \quad n \end{array}$$

$$\stackrel{(c)}{=} \delta_{i-1} \left(\begin{array}{c} \dots \\ \dots \\ \dots \\ \dots \\ \dots \end{array} \right) \stackrel{(d)}{=} \delta_{i-1} \tau_{n-1}(T).$$

Here (a), (c), (d) follow from the definition and (b) follows by isotopy and R3 move. The other cases are shown in the same manner.

Let us show the relation (27). If $1 \leq j \leq n$ and $T \in \mathcal{SL}_{n+1}$, then

$$\tau_n \sigma_j(T) \stackrel{(a)}{=} \begin{array}{c} \dots \\ \dots \\ \dots \\ \dots \\ \dots \end{array} \stackrel{(b)}{=} \begin{array}{c} \dots \\ \dots \\ \dots \\ \dots \\ \dots \end{array} \stackrel{(c)}{=} \begin{array}{c} \dots \\ \dots \\ \dots \\ \dots \\ \dots \end{array} \stackrel{(d)}{=} \sigma_{j-1} \left(\begin{array}{c} \dots \\ \dots \\ \dots \\ \dots \\ \dots \end{array} \right) \stackrel{(e)}{=} \sigma_{j-1} \tau_{n+1}(T).$$

Here (a), (d), (e) follow from the definition, (b) follows by isotopy, and (c) follows by isotopy and R3 move.

By Remark I.2.2, the relation (26) is a consequence of Relations (29) and (25). Similarly, the relation (28) is a consequence of Relations (29) and (27). So it suffices to show that the relation (29) holds. We show it in the case $n = 1$. The general case is treated similarly. If $T \in \mathcal{SL}_1$, then

$$\tau_1^2(T) \stackrel{(a)}{=} \begin{array}{c} \dots \\ \dots \\ \dots \\ \dots \\ \dots \end{array} \stackrel{(b)}{=} \begin{array}{c} \dots \\ \dots \\ \dots \\ \dots \\ \dots \end{array} \stackrel{(c)}{=} \begin{array}{c} \dots \\ \dots \\ \dots \\ \dots \\ \dots \end{array} \stackrel{(d)}{=} \begin{array}{c} \dots \\ \dots \\ \dots \\ \dots \\ \dots \end{array} \stackrel{(e)}{=} T.$$

VI.2.3. Proof of Theorem VI.1. We introduced cocyclic set $\mathcal{S}\mathcal{L}_\bullet$ in Section VI.2.1 and cyclic set $\widetilde{\mathcal{S}}\mathcal{L}_\bullet$ in Section VI.2.2. Let us now show the fact that $\phi_{\mathcal{B}}$ induces a natural transformation of $\mathcal{S}\mathcal{L}_\bullet$ to $\widehat{\mathcal{D}}_\bullet(C)$ and a natural transformation of $\widetilde{\mathcal{S}}\mathcal{L}_\bullet$ to $\widehat{\mathcal{B}}_\bullet(C)$. Since $\phi_{\mathcal{B}}$ is a functor, it induces for any $n \in \mathbb{N}$ the map

$$\phi_{\mathcal{B},n}: \text{End}_{\mathbf{RSL}}(n+1) \rightarrow \text{End}_{\text{Conv}_{\mathcal{B}}(C,\mathbb{1})}(n+1).$$

This defines a family of maps $\phi_{\mathcal{B},\bullet} = \{\phi_{\mathcal{B},n}: \mathcal{S}\mathcal{L}_n \rightarrow \widehat{\mathcal{D}}_n(C)\}_{n \in \mathbb{N}}$. To show that $\phi_{\mathcal{B},\bullet}$ defines a natural transformation between $\mathcal{S}\mathcal{L}_\bullet$ and $\widehat{\mathcal{D}}_\bullet(C)$, we have to show that maps $\phi_{\mathcal{B},\bullet}$ commute with cofaces, codegeneracies, and cocyclic operators. Before checking these facts, we prove two lemmas VI.6 and VI.7.

Lemma VI.6. *Let $n \in \mathbb{N}^*$. For any n -ribbon handle H , the ribbon handles*

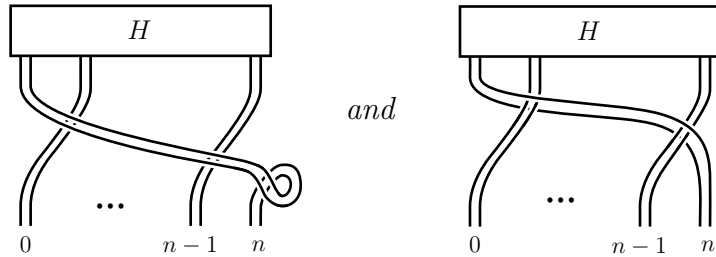

are isotopic.

PROOF. By isotopy and Reidemeister moves, which are explained in Section VI.1.1, we have

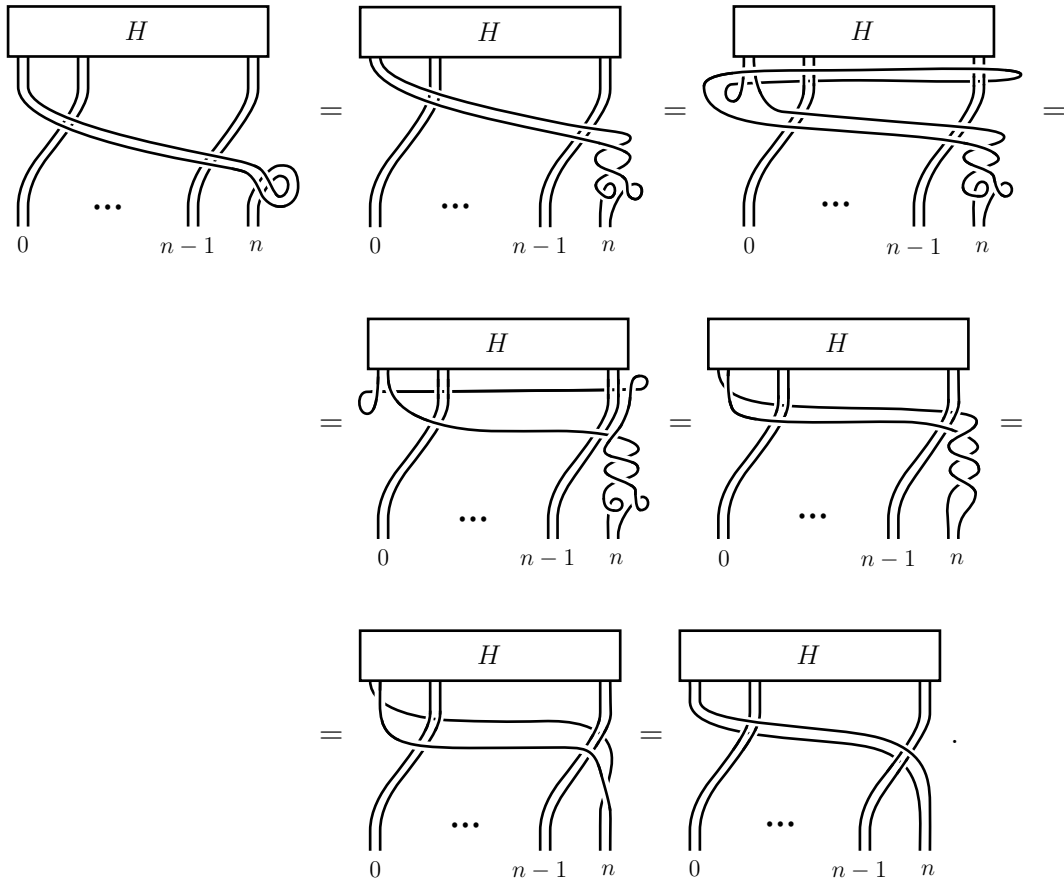

□

Lemma VI.7. *For any $n \geq 1$, the ribbon handle $\mathfrak{F}(\mathcal{SL}_\bullet(\tau_n)(T))$ is isotopic to the ribbon handle*

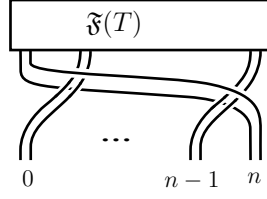

PROOF. We illustrate the proof of this fact in the case $n = 1$. If $T \in \mathcal{SL}_1$, then

$$\mathfrak{F}(\mathcal{SL}_\bullet(\tau_1)(T)) = \begin{array}{c} \text{Diagram 1} \\ \text{Diagram 2} \\ \text{Diagram 3} \\ \text{Diagram 4} \end{array} = \mathfrak{F}(T).$$

The sequence of diagrams shows the isotopy of the ribbon handle for $n=1$. The first diagram shows a box labeled T with two strands labeled 0 and 1. The second diagram shows the box T with a different strand configuration. The third diagram shows the box T with a further strand configuration. The fourth diagram shows the box $\mathfrak{F}(T)$ with two strands labeled 0 and 1.

□

Let us now show that maps $\phi_{\mathcal{B},\bullet}$ commute with cofaces, codegeneracies, and cocyclic operators. Let $n \geq 1, 0 \leq i \leq n$ and $T \in \mathcal{SL}_{n-1}$. We have

$$\phi_{\mathcal{B},n}(\mathcal{SL}_\bullet(\delta_i^n)(T)) = \widehat{\mathbf{D}}_\bullet(C)(\delta_i^n)(\phi_{\mathcal{B},n-1}(T)).$$

(1) Case $i = 0$. Notice that

$$\mathfrak{F}(\mathcal{SL}_\bullet(\delta_0^n)(T)) = \mathfrak{F} \left(\begin{array}{c} \dots \\ | \\ \text{---} \\ | \\ \dots \\ 1 \quad \dots \quad n \end{array} \right) = \mathfrak{F}(T).$$

Consequently,

$$\phi_{\mathcal{B},n}(\mathcal{SL}_\bullet(\delta_0^n)(T)) = \begin{array}{c} \phi_{\mathcal{B},n-1}(T) \\ | \\ \circ \\ | \\ 1 \quad \dots \quad n \end{array} = \widehat{\mathbf{D}}_\bullet(C)(\delta_0^n)(\phi_{\mathcal{B},n-1}(T)).$$

(2) Case $1 \leq i \leq n - 1$. Notice that

$$\mathfrak{F}(\mathcal{SL}_\bullet(\delta_i^n)(T)) = \mathfrak{F} \left(\begin{array}{c} \dots | | \dots \\ | \\ \text{---} \\ | \\ \dots \\ 1 \quad \dots \quad i \quad i+1 \quad \dots \quad n \end{array} \right) = \mathfrak{F}(T).$$

Consequently,

$$\phi_{\mathcal{B},n}(\mathcal{SL}_\bullet(\delta_i^n)(T)) = \begin{array}{c} \phi_{\mathcal{B},n-1}(T) \\ | \\ \circ \\ | \\ \dots \quad \dots \\ 1 \quad \dots \quad i \quad i+1 \quad \dots \quad n \end{array} = \widehat{\mathbf{D}}_\bullet(C)(\delta_i^n)(\phi_{\mathcal{B},n-1}(T)).$$

(3) Case $i = n$. Notice that

$$\mathfrak{F}(\mathcal{SL}_\bullet(\delta_n^n)(T)) = \mathfrak{F}\left(\begin{array}{c} \dots \\ | \\ \boxed{T} \\ | \\ \dots \\ 1 \quad \dots \quad n \end{array}\right) = \begin{array}{c} \boxed{\mathfrak{F}(T)} \\ | \quad \dots \quad | \\ 1 \quad \dots \quad n \end{array}.$$

Consequently,

$$\phi_{\mathcal{B},n}(\mathcal{SL}_\bullet(\delta_n^n)(T)) = \begin{array}{c} \boxed{\phi_{\mathcal{B},n-1}(T)} \\ | \quad \dots \quad | \quad \circ \\ 1 \quad \dots \quad n \end{array} = \widehat{\mathbf{D}}_\bullet(C)(\delta_n^n)(\phi_{\mathcal{B},n-1}(T)).$$

Let $n \geq 0, 0 \leq j \leq n$ and $T \in \mathcal{SL}_{n+1}$. Then

$$\phi_n(\mathcal{SL}_\bullet(\sigma_j^n)(T)) = \widehat{\mathbf{D}}_\bullet(C)(\sigma_j^n)(\phi_{n+1}(T)).$$

To verify this equation, notice that

$$\mathfrak{F}(\mathcal{SL}_\bullet(\sigma_j^n)(T)) = \mathfrak{F}\left(\begin{array}{c} \dots \\ | \\ \boxed{T} \\ | \\ \dots \\ 0 \quad \dots \quad j+1 \quad n+1 \end{array}\right) = \begin{array}{c} \boxed{T} \\ | \quad \dots \quad | \quad \dots \quad | \\ 0 \quad \dots \quad j \quad \dots \quad n+1 \end{array} = \begin{array}{c} \boxed{\mathfrak{F}(T)} \\ | \quad \dots \quad | \\ 0 \quad \dots \quad j \quad \dots \quad n+1 \end{array}.$$

Consequently,

$$\phi_{\mathcal{B},n}(\mathcal{SL}_\bullet(\sigma_j^n)(T)) = \begin{array}{c} \boxed{\phi_{\mathcal{B},n+1}} \\ | \quad \dots \quad | \quad \dots \quad | \\ 0 \quad \dots \quad j \quad \dots \quad n+1 \end{array} = \widehat{\mathbf{D}}_\bullet(C)(\sigma_j^n)(\phi_{\mathcal{B},n+1}(T)).$$

Let $n \geq 0$ and $T \in \mathcal{SL}_n$. We have

$$\phi_{\mathcal{B},n}(\mathcal{SL}_\bullet(\tau_n)(T)) = \widehat{\mathbf{D}}_\bullet(C)(\tau_n)(\phi_{\mathcal{B},n}(T)).$$

To verify the previous equation, we consider two cases.

(1) Let $n = 0$. By definition, we have

$$\phi_{\mathcal{B},0}(\mathcal{SL}_\bullet(\tau_0)(T)) = \phi_{\mathcal{B},0}\left(\begin{array}{c} | \\ \boxed{T} \\ | \end{array}\right) = \begin{array}{c} \boxed{\phi_{\mathcal{B},0}(T)} \\ | \end{array} = \widehat{\mathbf{D}}_\bullet(C)(\tau_0)(\phi_{\mathcal{B},0}(T))$$

(2) Let $n \geq 1$. By Lemma VI.7 and Lemma VI.6, we have

$$\mathfrak{F}(\mathcal{SL}_\bullet(\tau_n)(T)) = \begin{array}{c} \boxed{\mathfrak{F}(T)} \\ | \quad \dots \quad | \quad \dots \quad | \\ 0 \quad \dots \quad n-1 \quad n \end{array} = \begin{array}{c} \boxed{\mathfrak{F}(T)} \\ | \quad \dots \quad | \quad \dots \quad | \\ 0 \quad \dots \quad n-1 \quad n \end{array}.$$

For $n \geq 0$, the degeneracies $\{S_j^n: \mathcal{S}\mathcal{L}_n \rightarrow \mathcal{S}\mathcal{L}_{n+1}\}_{0 \leq j \leq n}$ of the cyclic set $\mathcal{S}\mathcal{L}_\bullet^L$ are computed for any $T \in \mathcal{S}\mathcal{L}_n$ by

$$S_j^n(T) = \begin{cases} \begin{array}{c} \cdots \quad | \quad | \quad | \quad \cdots \\ \hline T \\ \hline \cdots \quad | \quad | \quad | \quad \cdots \\ 0 \quad j+1 \quad j+2 \quad n \end{array} & \text{if } 0 \leq j \leq n-1, \\ \begin{array}{c} \cdots \quad | \\ \hline T \\ \hline \cdots \quad | \\ 0 \quad n \end{array} & \text{if } i = n. \end{cases}$$

For $n \geq 0$, the cyclic operators $T_n: \mathcal{S}\mathcal{L}_n \rightarrow \mathcal{S}\mathcal{L}_n$ of the cyclic set $\mathcal{S}\mathcal{L}_\bullet^L$ are computed for any $T' \in \mathcal{S}\mathcal{L}_n$ by

$$T_n(T') = \begin{cases} \text{id}_{\mathcal{S}\mathcal{L}_0} & \text{if } n \geq 0, \\ \begin{array}{c} \cdots \\ \hline T' \\ \hline \cdots \\ 0 \quad 1 \quad n \end{array} & \text{if } n \geq 1. \end{cases}$$

VI.3.2. The cocyclic dual of $\widetilde{\mathcal{S}\mathcal{L}}_\bullet$ with respect to L^{op} . The cocyclic dual $\widetilde{\mathcal{S}\mathcal{L}}_\bullet^{L^{\text{op}}}$ of $\widetilde{\mathcal{S}\mathcal{L}}_\bullet$ with respect to L^{op} (see Section I.4.3) is the composition $\widetilde{\mathcal{S}\mathcal{L}}_\bullet \circ L^{\text{op}}: \Delta C \rightarrow \mathbf{Sets}$. By definition,

$$\widetilde{\mathcal{S}\mathcal{L}}_\bullet \circ L^{\text{op}}(n) = \widetilde{\mathcal{S}\mathcal{L}}_\bullet(n) = \widetilde{\mathcal{S}\mathcal{L}}_n = \mathcal{S}\mathcal{L}_n$$

holds for any $n \in \mathbb{N}$. For $n \geq 1$, the cofaces $\{\Delta_i^n: \mathcal{S}\mathcal{L}_{n-1} \rightarrow \mathcal{S}\mathcal{L}_n\}_{0 \leq i \leq n}$ of the cocyclic set $\widetilde{\mathcal{S}\mathcal{L}}_\bullet^{L^{\text{op}}}$ are computed by $\Delta_0^n = \Delta_1^n$, which is duplication of the unique component, and for any $T \in \mathcal{S}\mathcal{L}_{n-1}$ with $n \geq 2$ by

$$\Delta_i^n(T) = \begin{cases} \begin{array}{c} \cdots \quad | \quad | \quad | \quad \cdots \\ \hline T \\ \hline \cdots \quad | \quad | \quad | \quad \cdots \\ 1 \quad i+1 \quad n \end{array} & \text{if } 0 \leq i \leq n-1, \\ \begin{array}{c} \cdots \\ \hline T \\ \hline \cdots \\ 1 \quad n-1 \quad n \end{array} & \text{if } i = n. \end{cases}$$

For $n \geq 0$, the codegeneracies $\{\Sigma_j^n: \mathcal{S}\mathcal{L}_{n+1} \rightarrow \mathcal{S}\mathcal{L}_n\}_{0 \leq j \leq n}$ of the cocyclic set $\widetilde{\mathcal{S}\mathcal{L}}_\bullet^{L^{\text{op}}}$ are computed for any $T \in \mathcal{S}\mathcal{L}_{n+1}$ by

$$\Sigma_j^n(T) = \begin{array}{c} \cdots \quad | \quad | \quad | \quad \cdots \\ \hline T \\ \hline \cdots \quad | \quad | \quad | \quad \cdots \\ 0 \quad j+1 \quad n+1 \end{array} .$$

For $n \geq 0$, the cocyclic operators $\hat{T}_n: \mathcal{SL}_n \rightarrow \mathcal{SL}_n$ of the cocyclic set $\widetilde{\mathcal{SL}}_\bullet^{L^{\text{op}}}$ are computed for any $T \in \mathcal{SL}_n$ by

$$\hat{T}_n(T) = \begin{cases} \text{id}_{\mathcal{SL}_0} & \text{if } n = 0, \\ \left(\begin{array}{c} \overbrace{\quad \dots \quad} \\ \boxed{T} \\ \underbrace{\quad \dots \quad} \\ 0 \quad n-1 \quad n \end{array} \right) & \text{if } n \geq 1. \end{cases}$$

CHAPTER VII

Cyclic objects from surfaces and TQFTs

In this chapter, we construct a cocyclic object Σ_\bullet and a cyclic object $\tilde{\Sigma}_\bullet$ in the category \mathbf{Cob}_3 whose objects are closed oriented surfaces and morphisms are 3-dimensional cobordisms. The category \mathbf{Cob}_3 is of a great interest in quantum topology. In particular, a 3-dimensional TQFT (over \mathbb{k}) is a symmetric monoidal functor $Z: \mathbf{Cob}_3 \rightarrow \text{Mod}_{\mathbb{k}}$. The first main result of this chapter is the following:

Theorem VII.1. *For $g \geq 1$, consider a closed oriented surface Σ_g of genus g . Then the family $\{\Sigma_g\}_{g \geq 1}$ has a structure of a cocyclic object in \mathbf{Cob}_3 denoted Σ_\bullet and a structure of a cyclic object in \mathbf{Cob}_3 denoted $\tilde{\Sigma}_\bullet$. Consequently, if Z is a 3-dimensional TQFT, then $Z \circ \Sigma_\bullet$ is a cocyclic \mathbb{k} -module and $Z \circ \tilde{\Sigma}_\bullet$ is a cyclic \mathbb{k} -module.*

We prove Theorem VII.1 in Section VII.3. The existence of (co)cyclic objects in the category \mathbf{Cob}_3 is based on the presentation of connected 3-cobordisms between connected bases via special ribbon graphs, which is recalled in Section VII.1.

A fundamental construction of a 3-dimensional TQFT is the Reshetikhin-Turaev TQFT $\text{RT}_{\mathcal{B}}: \mathbf{Cob}_3 \rightarrow \text{Mod}_{\mathbb{k}}$ associated to an anomaly free modular category \mathcal{B} . Such a category always has a coend C which is a Hopf algebra in \mathcal{B} (see Section II.3.2). In particular, we derive from C a cocyclic \mathbb{k} -module $\widehat{\mathbf{D}}_\bullet(C)$ (see Section III.1.4.1) and a cyclic \mathbb{k} -module $\widehat{\mathbf{B}}_\bullet(C)$ (see Section III.2.4.1). Recall the reindexing involution $\Phi: \Delta C \rightarrow \Delta C$ from Section I.4.4. The second main result of this chapter is the following:

Theorem VII.2. *The cocyclic \mathbb{k} -modules $\text{RT}_{\mathcal{B}} \circ \Sigma_\bullet$ and $\widehat{\mathbf{D}}_\bullet(C) \circ \Phi$ are isomorphic. The cyclic \mathbb{k} -modules $\text{RT}_{\mathcal{B}} \circ \tilde{\Sigma}_\bullet$ and $\widehat{\mathbf{B}}_\bullet(C) \circ \Phi^{\text{op}}$ are isomorphic.*

The proof of Theorem VII.2 is given in Section VII.4. It is based on a computation of the Reshetikhin-Turaev TQFT using the coend C , which is detailed in Section VII.2.

The cyclic duality $L: \Delta C^{\text{op}} \rightarrow \Delta C$ (see Section I.4.2) and reindexing involution automorphism Φ transform the cocyclic object Σ_\bullet in \mathbf{Cob}_3 into a cyclic object $\Sigma_\bullet^{\Phi L} = \Sigma_\bullet \circ \Phi \circ L$ in \mathbf{Cob}_3 . Similarly, the functors $L^{\text{op}}: \Delta C \rightarrow \Delta C^{\text{op}}$ (described in Section I.4.3) and Φ^{op} transform the cyclic object $\tilde{\Sigma}_\bullet$ in \mathbf{Cob}_3 into a cocyclic object $\tilde{\Sigma}_\bullet^{\Phi L} = \tilde{\Sigma}_\bullet \circ \Phi^{\text{op}} \circ L^{\text{op}}$ in \mathbf{Cob}_3 . Recall that to the Hopf algebra C is associated a cyclic \mathbb{k} -module $\mathbf{D}_\bullet(C)$ (see Section III.1.4.2) and a cocyclic \mathbb{k} -module $\mathbf{B}_\bullet(C)$ (see Section III.2.4.2). An immediate corollary of Theorem VII.2 and the results from Section III.3 is the following:

Corollary VII.3. *The cyclic \mathbb{k} -modules $\text{RT}_{\mathcal{B}} \circ \Sigma_\bullet^{\Phi L}$ and $\mathbf{D}_\bullet(C)$ are isomorphic. The cocyclic \mathbb{k} -modules $\text{RT}_{\mathcal{B}} \circ \tilde{\Sigma}_\bullet^{\Phi L}$ and $\mathbf{B}_\bullet(C)$ are isomorphic.*

Another fundamental construction of a 3-dimensional TQFT is the Turaev-Viro TQFT $\text{TV}_{\mathcal{C}}: \mathbf{Cob}_3 \rightarrow \text{Mod}_{\mathbb{k}}$ associated to a spherical fusion \mathbb{k} -category \mathcal{C} with invertible dimension (see [36]). Moreover, in the case when \mathcal{C} is additive and \mathbb{k} an algebraically closed field, the center $\mathcal{Z}(\mathcal{C})$ of \mathcal{C} is an anomaly free modular category (see Theorem II.1). In this case, according to [36, Theorem 17.1.], the TQFTs $\text{TV}_{\mathcal{C}}$ and $\text{RT}_{\mathcal{Z}(\mathcal{C})}$ are isomorphic. Denote by D the coend of $\mathcal{Z}(\mathcal{C})$. These results and Theorem VII.2 imply the following corollary:

Corollary VII.4. *The cocyclic \mathbb{k} -modules $\mathrm{TV}_C \circ \Sigma_\bullet$ and $\widehat{\mathbf{D}}_\bullet(D) \circ \Phi$ are isomorphic. The cyclic \mathbb{k} -modules $\mathrm{TV}_C \circ \widetilde{\Sigma}_\bullet$ and $\widehat{\mathbf{B}}_\bullet(D) \circ \Phi^{\mathrm{op}}$ are isomorphic.*

Similarly as in Corollary VII.3, by using cyclic duality L and reindexing involution Φ , we obtain:

Corollary VII.5. *The cyclic \mathbb{k} -modules $\mathrm{TV}_C \circ \Sigma_\bullet^{\Phi^L}$ and $\mathbf{D}_\bullet(D)$ are isomorphic. The cocyclic \mathbb{k} -modules $\mathrm{TV}_C \circ \widetilde{\Sigma}_\bullet^{\Phi^L}$ and $\mathbf{B}_\bullet(D)$ are isomorphic.*

VII.1. 3-cobordisms and their presentations

In this section we first recall some facts about the category \mathbf{Cob}_3 of 3-cobordisms and combinatorial presentations of 3-cobordisms via ribbon graphs. Then, at the end of the section we recall Kirby calculus.

VII.1.1. 3-cobordisms. A 3-cobordism is a quadruple $(M, h, \Sigma_0, \Sigma_1)$, where M is a compact oriented manifold of dimension 3, Σ_0 and Σ_1 are two closed oriented surfaces, and h is an orientation preserving homeomorphism $h: (-\Sigma_0) \sqcup \Sigma_1 \rightarrow \partial M$. The surface Σ_0 is called the *bottom base* and the surface Σ_1 is called the *top base* of the cobordism M . Two cobordisms $(M, h, \Sigma_0, \Sigma_1)$ and $(M', h', \Sigma_0, \Sigma_1)$ are *homeomorphic*, if there is an orientation preserving homeomorphism $g: M \rightarrow M'$ such that $h = h'g|_{\partial M}$. When clear, we will denote a cobordism $(M, h, \Sigma_0, \Sigma_1)$ only by M .

Given two cobordisms $(M_0, h_0, \Sigma_0, \Sigma_1)$ and $(M_1, h_1, \Sigma_1, \Sigma_2)$, one can form a cobordism $(M, h, \Sigma_0, \Sigma_2)$, where M is obtained by gluing M_0 to M_1 along $h_1 h_0^{-1}: h_0(\Sigma_1) \rightarrow h_1(\Sigma_1)$ and the homeomorphism h is defined by

$$h = h_0|_{\Sigma_0} \sqcup h_1|_{\Sigma_2}: (-\Sigma_0) \sqcup \Sigma_2 \rightarrow \partial M.$$

We say that cobordism M is obtained by gluing cobordisms M_0 and M_1 along Σ_1 .

VII.1.2. The category \mathbf{Cob}_3 . The category \mathbf{Cob}_3 of 3-cobordisms is defined as follows. Objects are closed oriented surfaces. The empty set is also considered as closed oriented surface. A morphism $f: \Sigma_0 \rightarrow \Sigma_1$ in \mathbf{Cob}_3 is determined by the homeomorphism class of cobordisms between Σ_0 and Σ_1 . In \mathbf{Cob}_3 , the identity of a closed oriented surface Σ is represented by *identity cobordism* $(C_\Sigma, e, \Sigma, \Sigma)$, where $C_\Sigma = \Sigma \times [0, 1]$ is a cylinder over Σ , together with product orientation and $e: (-\Sigma) \sqcup \Sigma \rightarrow \partial C_\Sigma$ is the homeomorphism with $e|_{-\Sigma}(x, 0) = (x, 0)$ and $e|_{\Sigma}(x, 1) = (x, 1)$. Composition of morphisms $\Sigma_0 \rightarrow \Sigma_1$ and $\Sigma_1 \rightarrow \Sigma_2$ in \mathbf{Cob}_3 , represented respectively by cobordisms M and N , is represented by cobordism obtained by gluing cobordisms M and N along Σ_1 .

The category \mathbf{Cob}_3 is symmetric monoidal. The monoidal product is given by disjoint union and the monoidal unit is the empty surface. The symmetry $\Sigma \sqcup \Sigma' \rightarrow \Sigma' \sqcup \Sigma$ in \mathbf{Cob}_3 is represented by the cobordism $((\Sigma \sqcup \Sigma') \times [0, 1], f, \Sigma \sqcup \Sigma', \Sigma' \sqcup \Sigma)$, where the homeomorphism $f: -(\Sigma \sqcup \Sigma') \sqcup \Sigma' \sqcup \Sigma \rightarrow \partial((\Sigma \sqcup \Sigma') \times [0, 1])$ is induced by the obvious permutation homeomorphism $\Sigma \sqcup \Sigma' \rightarrow \Sigma' \sqcup \Sigma$.

VII.1.3. Surgery presentation of closed 3-manifolds. Let L be an n -component framed link in 3-sphere \mathbb{S}^3 . Pick a tubular neighbourhood N_L of L . Since N_L is homeomorphic to $\sqcup_{i=1}^n \mathbb{S}^1 \times \mathbb{D}^2$, the boundary of the 3-manifold $\mathbb{S}^3 \setminus \mathrm{Int}(N_L)$ is homeomorphic to the disjoint union of n -tori $\mathbb{S}^1 \times \mathbb{S}^1$. The *Dehn surgery on \mathbb{S}^3 along L* is the closed manifold

$$\mathbb{S}_L^3 = (\mathbb{S}^3 \setminus N_L) \bigcup_{\phi} (\sqcup_{i=1}^n \mathbb{D}^2 \times \mathbb{S}^1),$$

where $\phi: \partial(\mathbb{S}^3 \setminus \text{Int}(N_L)) \rightarrow \sqcup_{i=1}^n \mathbb{S}^1 \times \mathbb{S}^1$ is a homeomorphism exchanging meridians and parallels. The Lickorish's theorem (see [27] for a proof) says that any connected, oriented, closed 3-manifold M is homeomorphic to \mathbb{S}_L^3 for some framed link $L \subset \mathbb{S}^3$.

In Section VII.1.6 we provide a similar presentation for 3-cobordisms using special ribbon graphs.

VII.1.4. Ribbon graphs. A *circle* is a 1-manifold homeomorphic to S^1 . An *arc* is a 1-manifold homeomorphic to the closed interval $[0, 1]$. The boundary points of an arc are called its *endpoints*. A *rectangle* is a 2-manifold with corners homeomorphic to $[0, 1] \times [0, 1]$. The four corner points of a rectangle split its boundary into four arcs called the *sides*. A *coupon* is an oriented rectangle with a distinguished side called the *bottom base*, the opposite side being the *top base*.

A *plexus* is a topological space obtained from a disjoint union of a finite number of oriented circles, oriented arcs, and coupons by gluing some endpoints of the arcs to the bases of the coupons. We require that different endpoints of the arcs are never glued to the same point of a (base of a) coupon. The endpoints of the arcs that are not glued to coupons are called *free ends*. The set of free ends of a plexus γ is denoted by $\partial\gamma$.

Given nonnegative integers g and g' , a *ribbon (g, g') -graph* Γ is a plexus Γ embedded in $\mathbb{R}^2 \times [0, 1]$ and equipped with a framing such that

$$\partial\Gamma = \Gamma \cap \partial(\mathbb{R}^2 \times [0, 1]) = \{(1, 0, 0), \dots, (g, 0, 0)\} \cup \{(1, 0, 1), \dots, (g', 0, 1)\}$$

and the arcs of Γ are transverse to $\partial(\mathbb{R}^2 \times [0, 1])$ at all points of $\partial\Gamma$. The free end $(i, 0, 0)$ is called the *i th-input* and the free end $(j, 0, 1)$ is called the *j th-output* of Γ . For example, ribbon graphs without free ends and without coupons are nothing but framed oriented links in $\mathbb{R}^2 \times (0, 1) \cong \mathbb{R}^3$.

Given a ribbon category \mathcal{B} , a ribbon graph Γ is *\mathcal{B} -colored* if each arc and circle of Γ is endowed with an object of \mathcal{B} and each coupon of Γ is endowed with a morphism in \mathcal{B} from the object determined by its bottom base (as in Section II.1.9) to the object determined by its top base. By [35, Theorem 2.5], any \mathcal{B} -colored ribbon graph determines a morphism in \mathcal{B} .

We represent ribbon graphs by plane diagrams with blackboard framing. We require that for each coupon, its orientation in that of the plane, its bases are horizontal, and its the bottom base is below its top base. By Reidemeister theorem, two diagrams represent isotopic ribbon graphs if and only if they are related by a finite sequence of plane isotopies, ribbon Reidemeister moves R1-R3 (see Section VI.1.1), and the following move:

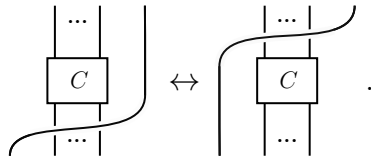

The colors of \mathcal{B} -colored ribbon graphs are shown on their diagrams. For example, given objects $X, Y, Z, T \in \text{Ob}(\mathcal{B})$ and a morphism $f: Y^* \otimes X \rightarrow Z$ in \mathcal{B} , the diagram

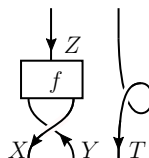

represents a \mathcal{B} -colored ribbon $(2, 1)$ -graph whose associated morphism in \mathcal{B} is

$$(f \circ \tau_{X, Y^*} \otimes \theta_T): X \otimes Y^* \otimes T \rightarrow Z.$$

Here, τ and θ are the braiding and twist of \mathcal{B} .

VII.1.5. Standard ribbon graphs and surfaces. For $g \geq 0$, consider the ribbon graph

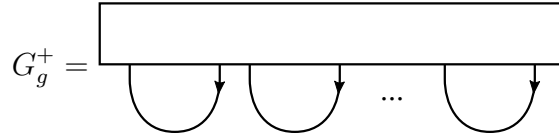

consisting of one coupon and g unknotted untwisted cups oriented from right to left successively attached to the bottom base of the coupon. We fix a closed regular neighbourhood $H_g^+ \subset \mathbb{R}^2 \times [0, 1]$ of G_g^+ . This is a handlebody of genus g and is provided with the right-handed orientation. Consider also the ribbon graph

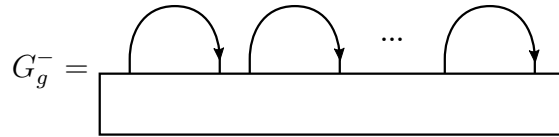

consisting of one coupon and g unknotted untwisted caps oriented from left to right successively attached to the top base of the coupon. We fix a closed regular neighbourhood $H_g^- \subset \mathbb{R}^2 \times [0, 1]$ of G_g^- . This is a handlebody of genus g and is provided with the right-handed orientation. We choose the neighbourhood H_g^+ and H_g^- so that the mirror reflection of \mathbb{R}^3 with respect to the line $\mathbb{R}^2 \times \{\frac{1}{2}\}$ induces an orientation preserving homeomorphism between $-(H_g^-)$ and H_g^+ , where $-(H_g^-)$ is H_g^- with opposite orientation.

The boundary S_g of H_g^+ is a closed connected oriented surface of genus g called the *standard surface of genus g* . The orientation of S_g is induced by that of H_g^+ . (We use the “outward vector first” convention for the induced orientation of the boundary.) The above mirror reflection induces a canonical orientation preserving homeomorphism between $\partial(H_g^-)$ and $-S_g$.

VII.1.6. Special ribbon graphs and 3-cobordisms. Let g and h be nonnegative integers. A *special ribbon (g, h) -graph* is a ribbon $(2g, 2h)$ -graph Γ with no coupons such that:

- for all $1 \leq i \leq g$, the $(2i - 1)$ -th and $2i$ -th inputs of Γ are connected by an arc oriented from the $(2i - 1)$ -th input to the $2i$ -th input,
- for all $1 \leq j \leq h$, the $(2j - 1)$ -th and $2j$ -th outputs of Γ are connected by an arc oriented from the $2j$ -th output to the $(2j - 1)$ -th output.

Any special ribbon (g, h) -graph Γ gives rise to a connected 3-cobordism M_Γ between the standard surfaces S_g and S_h (see Section VII.1.5). It is defined as follows. Attach coupons

$$Q^- = [0, 2g + 1] \times \{0\} \times [-1, 0] \quad \text{and} \quad Q^+ = [0, 2h + 1] \times \{0\} \times [1, 2]$$

to the bottom and the top of Γ , respectively. The result is a ribbon graph $\tilde{\Gamma}$ in \mathbb{R}^3 with no free ends, two coupons Q^\pm , and finite many circle components which form a framed link L in \mathbb{S}^3 . The arcs connecting the inputs Γ become caps attached on the top base of Q^- and so there is an embedding $f^-: G_g^- \rightarrow \tilde{\Gamma}$ mapping the coupon of G_g^- to Q^- and mapping the caps attached to G_g^- to those attached to Q^- . Similarly, the arcs connecting the outputs Γ become cups attached on the bottom base of Q^+ and there is an embedding $f^+: G_h^+ \rightarrow \tilde{\Gamma}$ mapping the coupon of G_h^+ to Q^+ and mapping the cups attached to G_h^+ to those attached to Q^+ . Consider a tubular neighbourhood N_L of L and embeddings $f^-: H_g^- \rightarrow \mathbb{S}^3 \setminus N_L$

and $\tilde{f}^+ : H_h^+ \rightarrow \mathbb{S}^3 \setminus N_L$ respectively extending f^- and f^+ . Let \mathbb{S}_L^3 be the Dehn surgery of \mathbb{S}^3 along L (see Section VII.1.3). The manifold

$$\mathbb{S}_\Gamma^3 = \mathbb{S}_L^3 \setminus \left(\tilde{f}^-(\text{Int}(H_g^-)) \cup \tilde{f}^+(\text{Int}(H_h^+)) \right)$$

is a oriented connected compact 3-manifold. By Section VII.1.5, its boundary $\tilde{f}^-(\partial(H_g^-)) \sqcup \tilde{f}^+(\partial(H_h^+))$ is canonically homeomorphic to $(-S_g) \sqcup S_h$. This gives then rise to a connected 3-cobordism $M_\Gamma : S_g \rightarrow S_h$.

For example, by [35], the identity cobordism of the standard surface S_g (see Section VII.1.2) is represented by the following special ribbon (g, g) -graph

$$I_g = \begin{array}{c} \text{---} \\ \text{---} \\ \text{---} \\ \text{---} \\ \text{---} \end{array} \dots \begin{array}{c} \text{---} \\ \text{---} \\ \text{---} \\ \text{---} \\ \text{---} \end{array} . \tag{66}$$

The following lemma gives a presentation of the composition of 3-cobordisms between (connected) standard surfaces.

Lemma VII.6 ([35, Section IV.2.3]). *Let Γ be a special ribbon (g, h) -graph and Γ' be a special ribbon (h, k) -graph. The the composition of the 3-cobordisms $M_\Gamma : S_g \rightarrow S_h$ and $M_{\Gamma'} : S_h \rightarrow S_k$ is the 3-cobordism $M_{\Gamma' \circ \Gamma} : S_g \rightarrow S_k$, where $\Gamma' \circ \Gamma$ is the special ribbon (g, k) -graph obtained by stacking Γ' over Γ .*

VII.1.7. Linking numbers and linking matrices. The *linking number* $\text{lk}(K_1, K_2)$ of a 2-component oriented link $K_1 \cup K_2$ in \mathbb{S}^3 is probably the oldest invariant of knot theory. It typically distinguishes the trivial link and the Hopf link. The linking number $\text{lk}(K_1, K_2)$ is computed from any plane diagram D of $K_1 \cup K_2$ by the formula:

$$\text{lk}(K_1, K_2) = \frac{p - n}{2}$$

where p is number of positive crossings of D between K_1 and K_2 , and n is the number of negative crossings of D between K_1 and K_2 . Here we use the following standard convention:

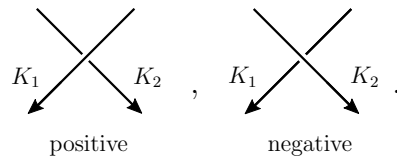

Note that the linking number is symmetric: $\text{lk}(K_1, K_2) = \text{lk}(K_2, K_1)$. For example, the linking number of the following Hopf link is 2:

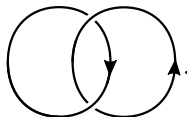

Let $L = L_1 \sqcup \dots \sqcup L_n$ be an oriented n -component framed link in \mathbb{S}^3 . The *linking matrix* of L is the square matrix $A = (a_{i,j})_{1 \leq i,j \leq n}$ defined as follows. For $i \neq j$, the coefficient $a_{i,j}$ is the linking number $\text{lk}(L_i, L_j)$. Otherwise, the coefficient $a_{i,i}$ is the *framing number* of L_i defined to be $\text{lk}(L_i, L'_i)$, where L'_i is a copy of L_i obtained by slightly pushing L_i along its framing. Note that the symmetry of linking numbers implies that linking matrix A is symmetric.

VII.1.8. Kirby calculus special ribbon graphs. Recall from Section VII.1.3 that any closed oriented 3-manifold can be obtained by surgery of \mathbb{S}^3 along a framed link. Kirby proved [22] that two framed links represent the same 3-manifold (up to an orientation preserving homeomorphism) if and only if they are related by a finite sequence of isotopies and of the *Kirby moves* **K1** and **K2**. The move **K1** consists in adding an unknot with framing number 1 or -1 :

$$L \sqcup \bigcirc \longleftrightarrow L \longleftrightarrow L \sqcup \bigcirc.$$

The move **K2** consists in sliding a component over another component. More explicitly, given two distinct components L_i and L_j of a framed link, this move replaces L_i by the connected sum $L_i \# L'_j$ of L_i with a copy L'_j of L_j obtained by slightly pushing L_j along its framing. For example, sliding an unknot with framing number 0 over an unknot with framing number 1 can be depicted as:

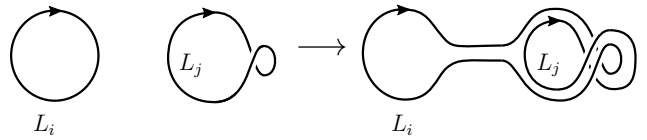

It follows from Reidemeister and Kirby theorems that the Kirby calculus extends to the representation of 3-cobordisms by special ribbon graphs (see for example [23]). More explicitly, special ribbon graphs represent the same 3-cobordism (up to an orientation preserving homeomorphism) if and only if they are related by a finite sequence of isotopies and of the following moves: the move **K1**, the generalized Kirby move **K2'**, the move **OR**, the move **COUPON**, and the move **TWIST**. The move **K2'** consists in sliding an arc or circle component of a special ribbon graph over a distinct circle component. The move **OR** consists in reversing the orientation of a circle component. The **COUPON** move consists in changing the type of a crossing of a component passing over (or under) all its outputs:

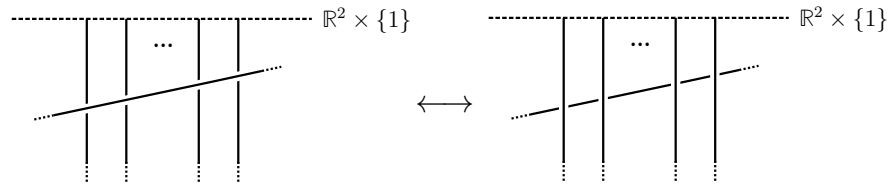

or all its inputs:

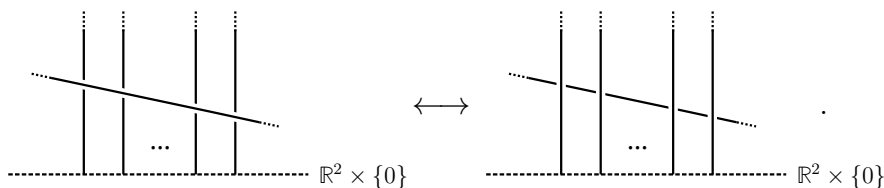

The move **TWIST** consists in simultaneously twisting the output components:

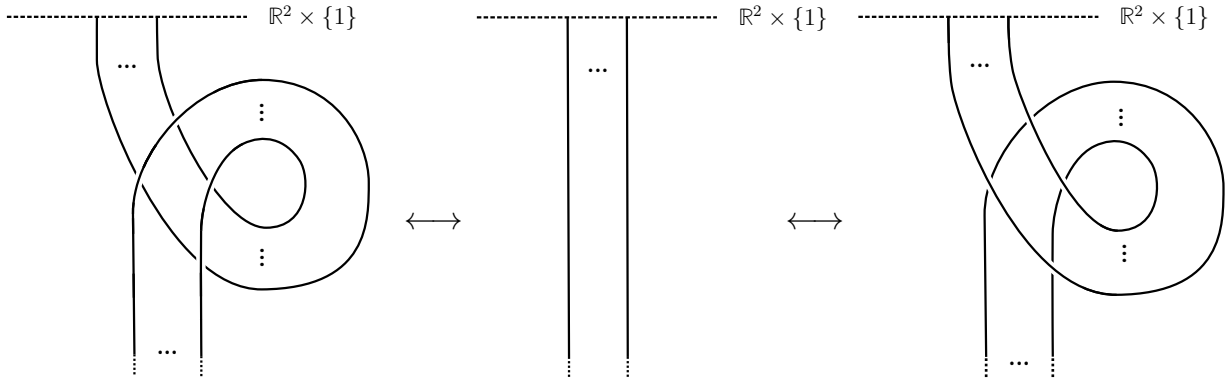

or the input components:

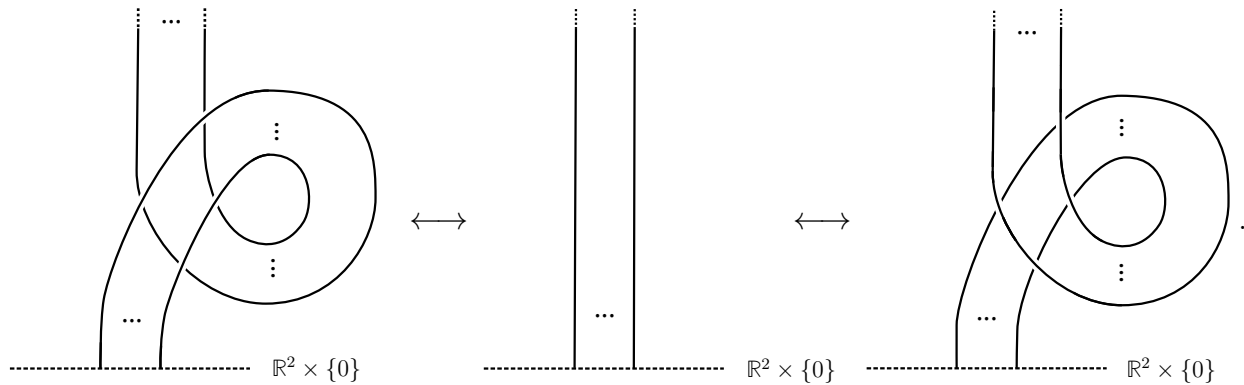

VII.2. The Reshetikhin-Turaev TQFT via coends

In this section we compute the Reshetikhin-Turaev TQFT $\text{RT}_{\mathcal{B}}$ associated with an anomaly free modular category \mathcal{B} . More precisely, given a special ribbon graph Γ , we compute $\text{RT}_{\mathcal{B}}(M_{\Gamma})$ in terms of the coend of \mathcal{B} , where M_{Γ} is the 3-cobordism represented by Γ . This will be used in the proof of Theorem VII.2 (see Section VII.4).

In [35], Turaev associates to any modular category \mathcal{B} a 3-dimensional TQFT $\text{RT}_{\mathcal{B}}$. There, a precise definition of a 3-dimensional TQFT involves Lagrangian spaces in homology of surfaces and p_1 -structures in cobordisms. However, if the modular category \mathcal{B} is anomaly free (see Section II.1.13), then the TQFT $\text{RT}_{\mathcal{B}}$ does not depend on this additional data and is a genuine symmetric monoidal functor $\text{RT}_{\mathcal{B}}: \mathbf{Cob}_3 \rightarrow \text{Mod}_{\mathbb{k}}$.

Let \mathcal{B} be an anomaly free modular \mathbb{k} -category. Recall from Section II.1.13 that the scalar $\Delta = \Delta_+ = \Delta_-$ is invertible and satisfies $\Delta^2 = \dim(\mathcal{B})$. By Section VII.1.6, any special ribbon (g, h) -graph Γ represents a 3-cobordism $M_{\Gamma}: S_g \rightarrow S_h$. Our goal is to compute the \mathbb{k} -linear homomorphism

$$\text{RT}_{\mathcal{B}}(M_{\Gamma}): \text{RT}_{\mathcal{B}}(S_g) \rightarrow \text{RT}_{\mathcal{B}}(S_h)$$

in terms of the coend C of \mathcal{B} (which always exists, see Section II.3.5). First, it follows from the definition of $\text{RT}_{\mathcal{B}}$ and the computation $C = \bigoplus_{i \in I} i^* \otimes i$ of the coend C in terms of a representative set I of simple objects of \mathcal{B} that

$$\text{RT}_{\mathcal{B}}(S_g) = \text{Hom}_{\mathcal{B}}(\mathbb{1}, C^{\otimes g}) \quad \text{and} \quad \text{RT}_{\mathcal{B}}(S_h) = \text{Hom}_{\mathcal{B}}(\mathbb{1}, C^{\otimes h}).$$

Next,

$$\text{RT}_{\mathcal{B}}(M_{\Gamma}) = \Delta^{n+h} \text{Hom}_{\mathcal{B}}(\mathbb{1}, |\Gamma|),$$

where $|\Gamma|: C^{\otimes g} \rightarrow C^{\otimes h}$ is a morphism in \mathcal{B} defined as follows. By pulling down some part of each circle component of Γ and of each arc connecting the outputs of Γ , we obtain that the ribbon graph Γ is isotopic to

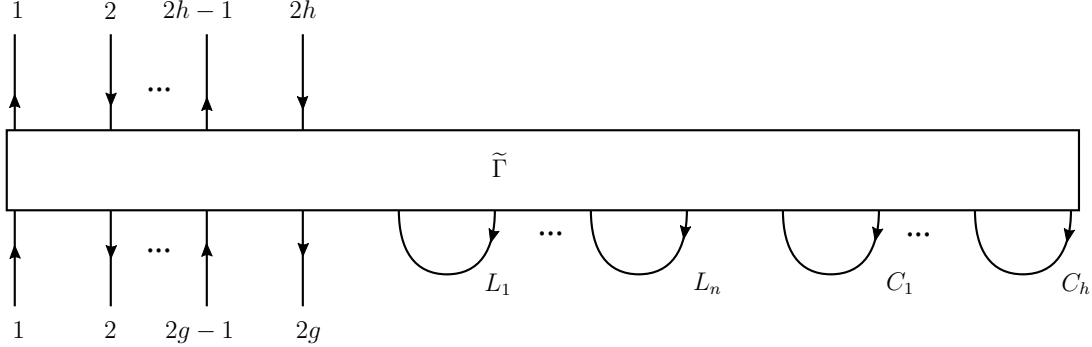

where the cups L_1, \dots, L_n correspond to the circle components of Γ and the cups C_1, \dots, C_h correspond to the upper arcs of Γ . Here, $\tilde{\Gamma}$ is a ribbon graph with $(g+n+2h)$ arcs, $(2g+2n+2h)$ inputs, $2h$ outputs, no coupons, no circle components, and such that:

- for all $1 \leq i \leq g+n$, an arc a_i connects the $(2i-1)$ -th input to the $(2i)$ -th input of $\tilde{\Gamma}$,
- for all $1 \leq j \leq h$, an arc u_j connects the $(2g+2n+2j-1)$ -th input to the $(2j-1)$ -th output of $\tilde{\Gamma}$, and an arc v_j connects the $(2j)$ -th output to the $(2g+2n+2j)$ -th input of $\tilde{\Gamma}$.

Coloring the arc a_i by an object X_i of \mathcal{B} and coloring both the arcs u_j, v_j by an object Y_j of \mathcal{B} , we obtain a \mathcal{B} -colored ribbon graph representing a morphism $\phi_{X_1, \dots, X_{g+n}, Y_1, \dots, Y_h}$. Let $i = \{i_X: X^* \otimes X \rightarrow C\}_{X \in \text{Ob}(\mathcal{B})}$ be the universal dinatural transformation associated to the coend C . Then the family of morphisms

$$(i_{Y_1} \otimes \dots \otimes i_{Y_h}) \circ \phi_{X_1, \dots, X_{g+n}, Y_1, \dots, Y_h}$$

from $X_1^* \otimes X_1 \otimes \dots \otimes X_{g+n}^* \otimes X_{g+n} \otimes Y_1^* \otimes Y_1 \otimes \dots \otimes Y_h^* \otimes Y_h$ to $C^{\otimes h}$ is dinatural in each variable and so, by Lemma II.3, it factorizes as

$$\phi_\Gamma \circ (i_{X_1} \otimes \dots \otimes i_{X_{g+n}} \otimes i_{Y_1} \otimes \dots \otimes i_{Y_h})$$

for a unique morphism $\phi_\Gamma: C^{\otimes g+n+h} \rightarrow C^{\otimes h}$. Then

$$|\Gamma| = \phi_\Gamma \circ (\text{id}_{C^{\otimes g}} \otimes \alpha^{\otimes(n+h)}): C^{\otimes g} \rightarrow C^{\otimes h},$$

where

$$\alpha = \dim(\mathcal{B})^{-1} \sum_{i \in I} \dim(i) \widetilde{\text{coev}}_i: \mathbb{1} \rightarrow C.$$

It follows from the fact that α is a right integral for C (see Section II.3.5) that the morphism $|\Gamma|$ is an isotopy invariant of Γ . This invariant is multiplicative:

$$|\Gamma \sqcup \Gamma'| = |\Gamma| \otimes |\Gamma'|, \quad (67)$$

for all special ribbon graphs, where $\Gamma \sqcup \Gamma'$ is obtained by concatenating Γ' to the right of Γ .

VII.3. Proof of Theorem VII.1

In this section we prove Theorem VII.1. The existence of (co)cyclic objects in \mathbf{Cob}_3 is based on surgery presentation of 3-cobordisms developed in [33, 35] (for a review, see Section VII.1). First, in Section VII.3.1, we construct the functor $S_\bullet: \Delta C \rightarrow \mathbf{Cob}_3$. Then, in Section VII.3.2, we construct the functor $\tilde{S}_\bullet: \Delta C^{\text{op}} \rightarrow \mathbf{Cob}_3$. Cobordisms in both of

these constructions have standard surfaces as bases. In Section VII.3.3, we explain how to pass from S_\bullet and \tilde{S}_\bullet to Σ_\bullet and $\tilde{\Sigma}_\bullet$, as claimed in VII.1.

VII.3.1. The construction S_\bullet . In order to construct the functor $\Sigma_\bullet: \Delta C \rightarrow \mathbf{Cob}_3$ from the Theorem VII.1, we first construct the functor $S_\bullet: \Delta C \rightarrow \mathbf{Cob}_3$, by considering standard surfaces S_g (see Section VII.1.5) of genus g . For general case, see Section VII.3.3.

For any $n \in \mathbb{N}$, set $S_\bullet(n) = S_{n+1}$. For $n \geq 1$ and $0 \leq i \leq n$, the faces $S_\bullet(\delta_i^n): S_n \rightarrow S_{n+1}$ are defined as follows. The morphism $S_\bullet(\delta_0^n): S_n \rightarrow S_{n+1}$ is the cobordism class presented by the special ribbon graph $G_{S_\bullet(\delta_0^n)}$:

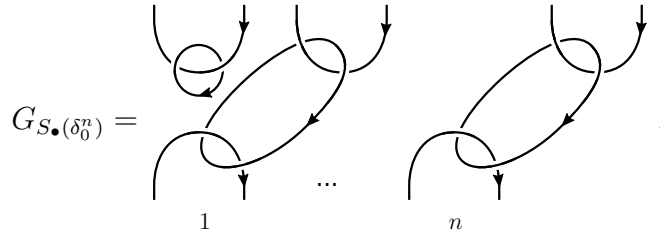

For $1 \leq i \leq n - 1$, the morphism $S_\bullet(\delta_i^n): S_n \rightarrow S_{n+1}$ is defined as the cobordism class presented by the special ribbon graph $G_{S_\bullet(\delta_i^n)}$:

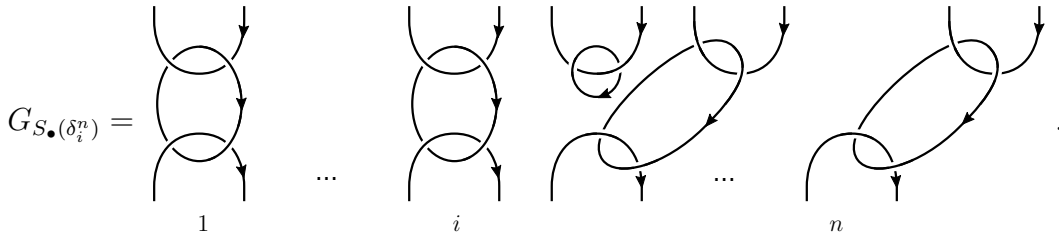

Finally, the morphism $S_\bullet(\delta_n^n): S_n \rightarrow S_{n+1}$ is defined as the cobordism class presented by the special ribbon graph $G_{S_\bullet(\delta_n^n)}$:

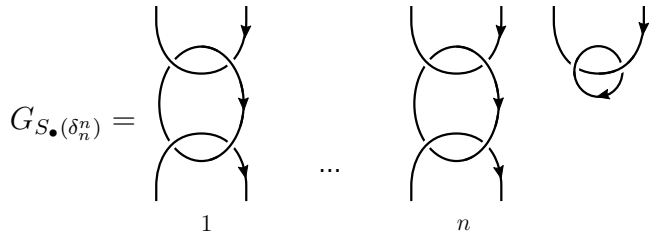

For $n \geq 0$ and $0 \leq j \leq n$, the degeneracy $S_\bullet(\sigma_j^n): S_{n+2} \rightarrow S_{n+1}$ is the cobordism class presented by the special ribbon graph $G_{S_\bullet(\sigma_j^n)}$:

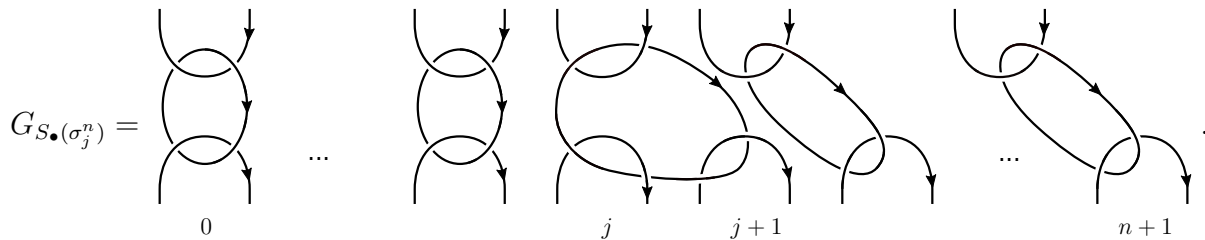

The morphism $S_\bullet(\tau_0): S_1 \rightarrow S_1$ equals the identity map id_{S_1} , which is represented by the special ribbon graph I_1 from Equation (66). For $n \geq 1$, the cocyclic operator $S_\bullet(\tau_n): S_{n+1} \rightarrow$

S_{n+1} is the cobordism class presented by the special ribbon graph $G_{S_\bullet(\tau_n)}$:

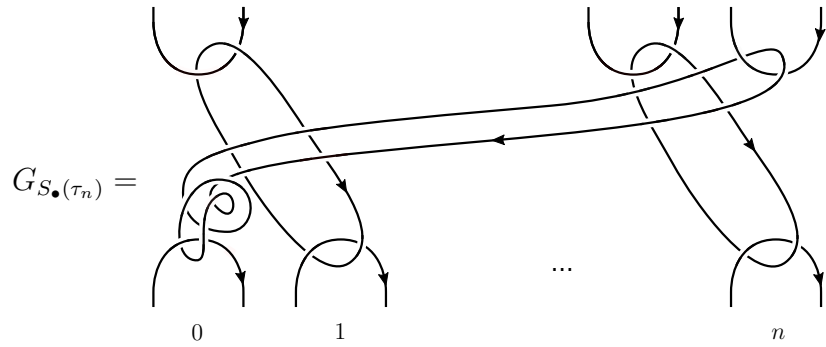

Lemma VII.7. *The family $S_\bullet = \{S_{n+1}\}_{n \geq 0}$, equipped with the cofaces $\{S_\bullet(\delta_i^n)\}_{0 \leq i \leq n, n \geq 1}$, the codegeneracies $\{S_\bullet(\sigma_j^n)\}_{0 \leq j \leq n, n \geq 0}$, and the cocyclic operators $S_\bullet(\tau_n), n \in \mathbb{N}$ is a cocyclic object in \mathbf{Cob}_3 .*

To prove the Lemma VII.7, we will intensively use some consequences of the Kirby calculus (see Section VII.1.8), which we recollect in the following lemma:

Lemma VII.8. *One has the following moves on special ribbon graphs:*

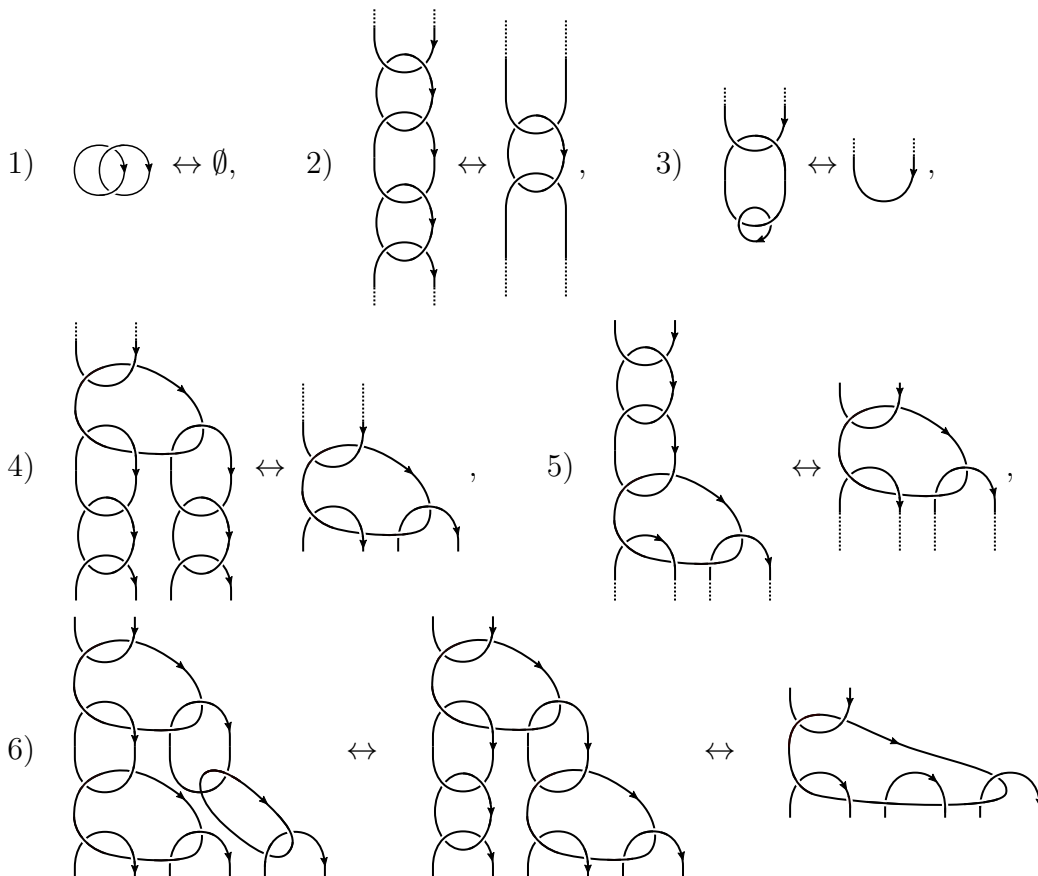

PROOF OF LEMMA VII.7. Let us show Relations (9)-(11).

We first show the relation (9). For $i < j$ we have:

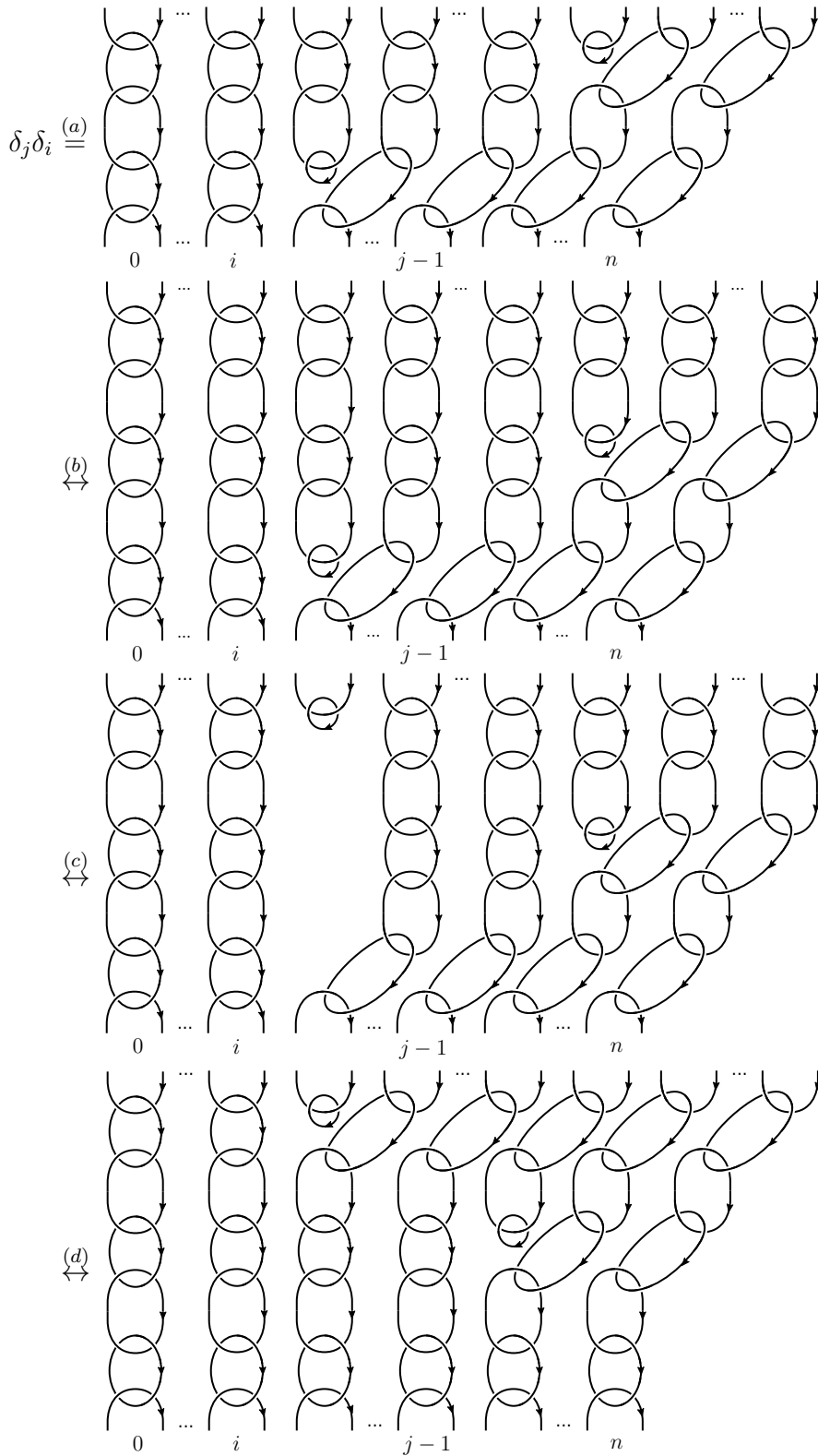

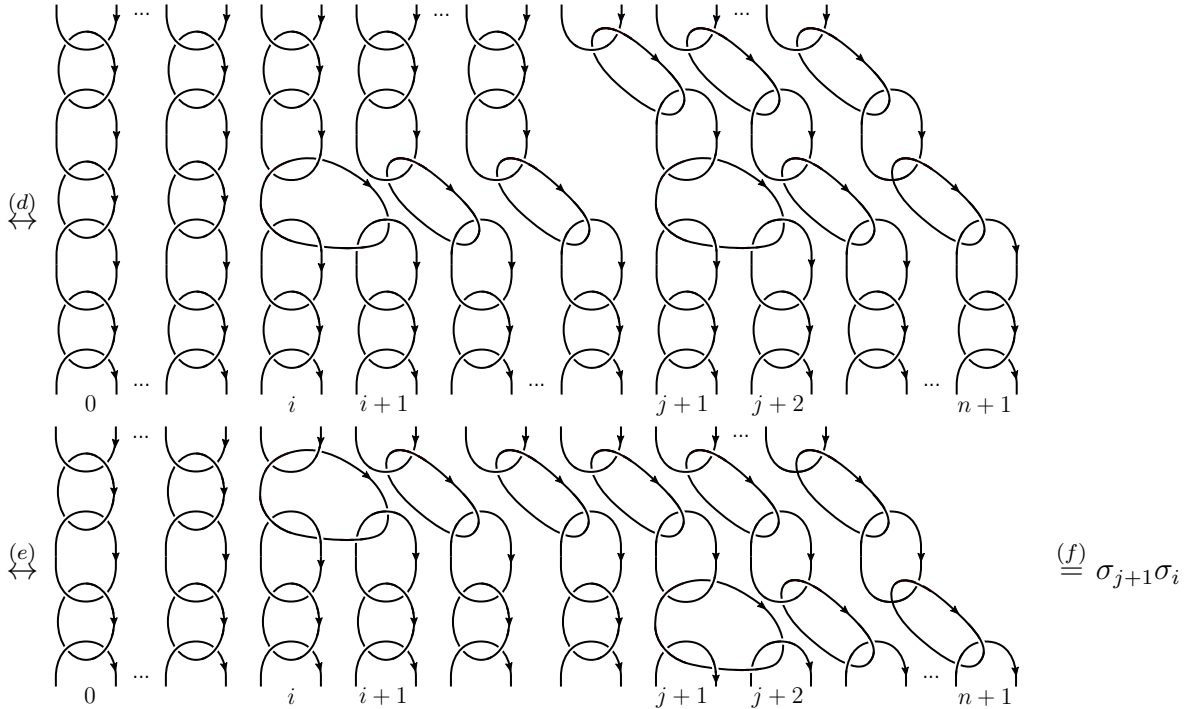

Here (a) and (f) follow from definitions and Lemma VII.6, (b) and (d) follow from Lemma VII.6 and the graph from Equation (66), (c) from Lemma VII.8 part 4) and finally, (e) follows by applying the parts 2), 4) and 5) of Lemma VII.8, and isotopy.

- (2) Suppose that $i = j$. By definition and Lemma VII.6, the composition $\sigma_i\sigma_i$ is presented by

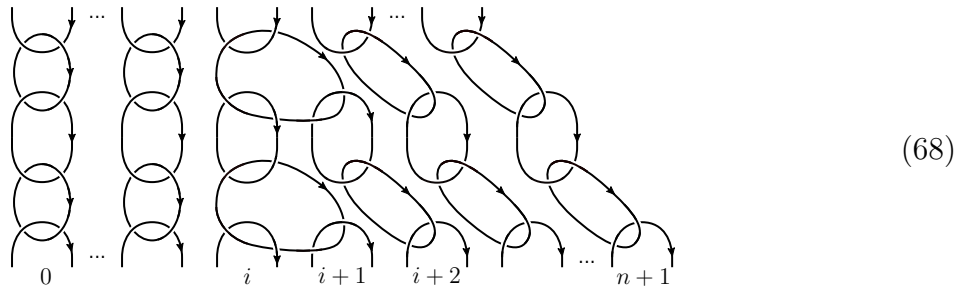

Similarly, the composition $\sigma_i\sigma_{i+1}$ is presented by

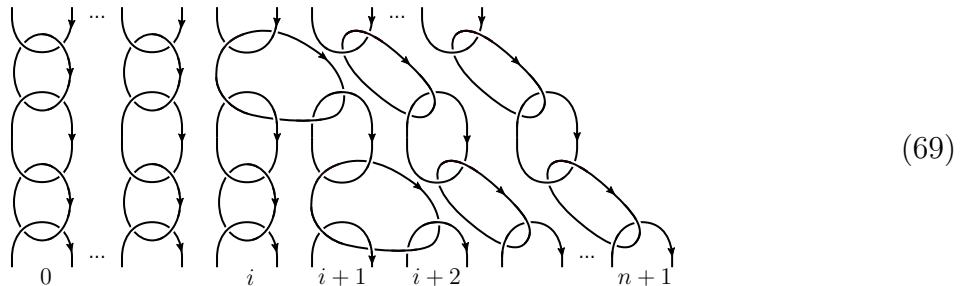

By the part 6) of Lemma VII.8, the both special graphs from (68) and (69) are equivalent to the special graph

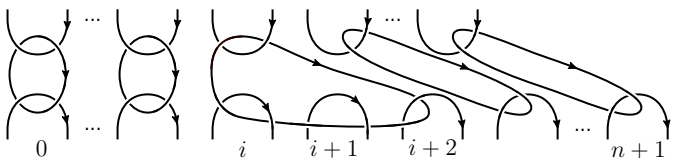

Consequently, the cobordisms $\sigma_i\sigma_i$ and $\sigma_{i+1}\sigma_i$ are in the same class, that is, they are equal in \mathbf{Cob}_3 .

Let us now show the relation (11).

(1) Suppose that $i = j$. For $i \neq 0$, we have

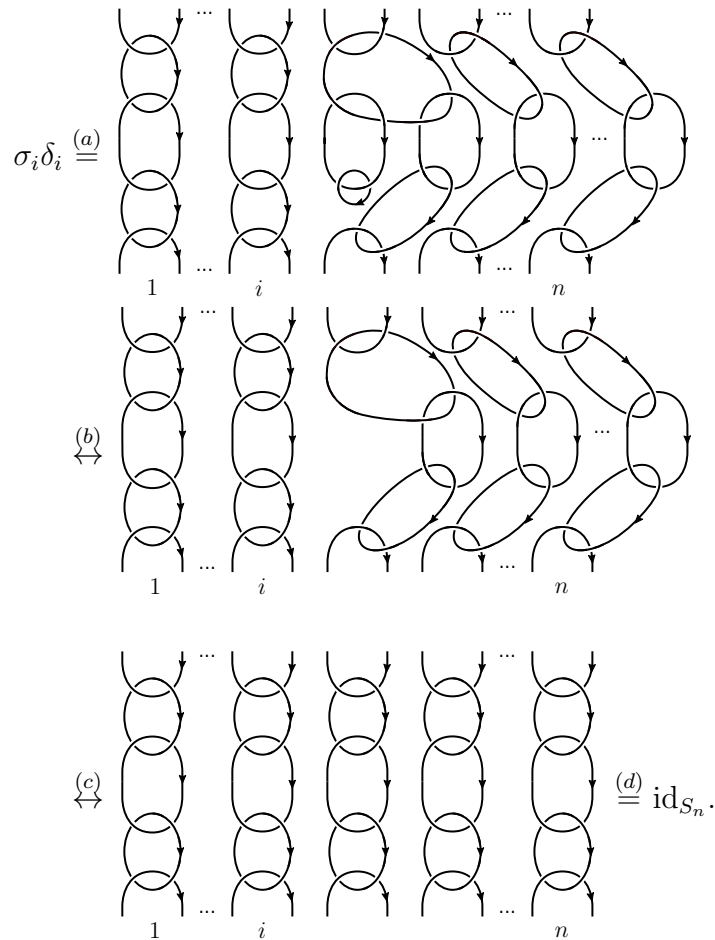

Here (a) follows from definition and Lemma VII.6, (b) from Lemma VII.8 part 3), (c) by isotopy, and (d) follows from Lemma VII.6 and presentation of identity cobordism from Equation (66). The case when $i = 0$ is proven similarly.

(2) Suppose that $i = j + 1$. For $i \neq n$, we have

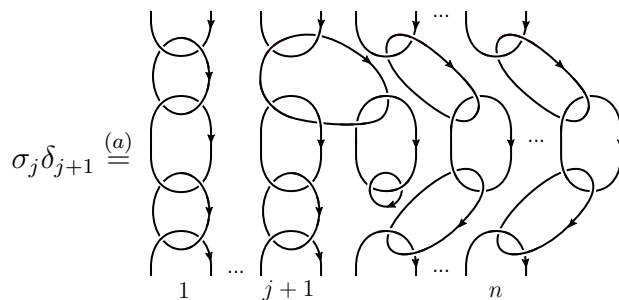

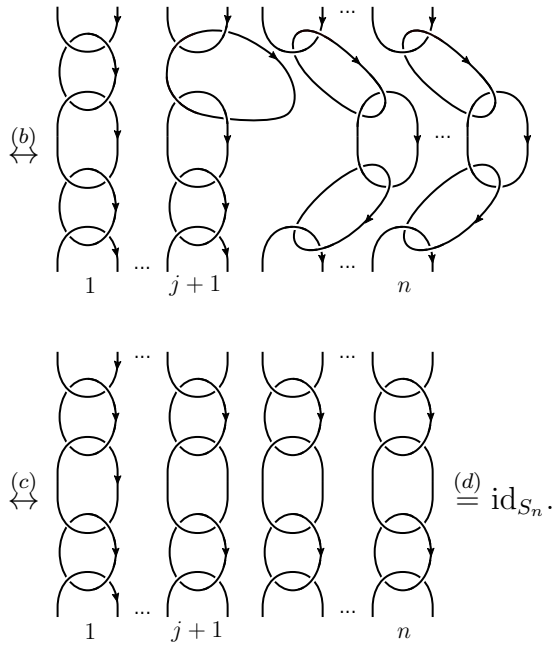

Here (a) follows from definition and Lemma VII.6, (b) from Lemma VII.8 part 3), (c) by isotopy, and (d) follows from Lemma VII.6 and the graph from Equation (66). The case when $i = n$ is proven similarly.

(3) Suppose that $i < j$. For $1 \leq i \leq n$, we have

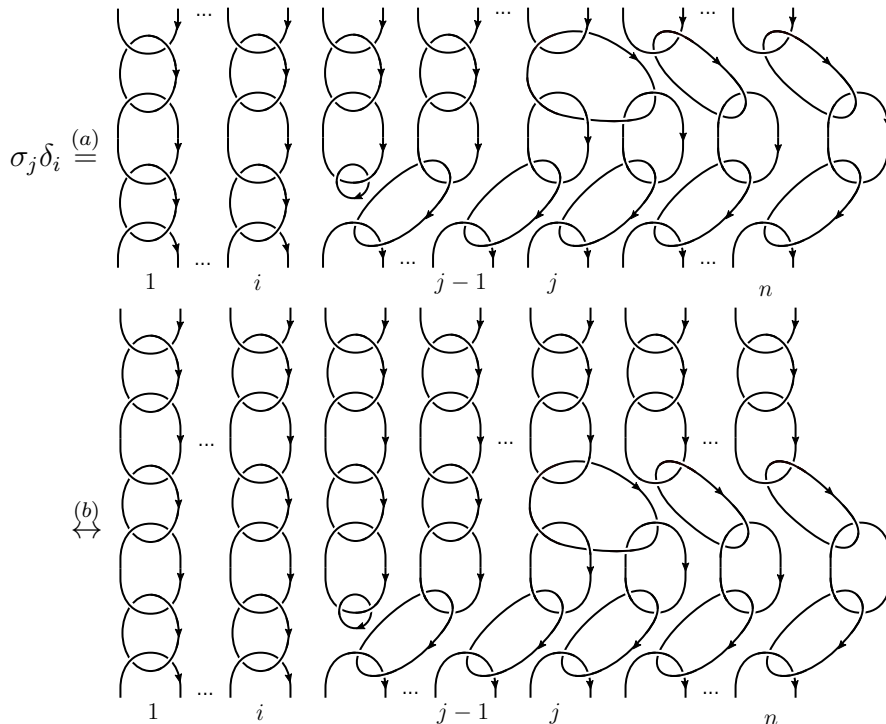

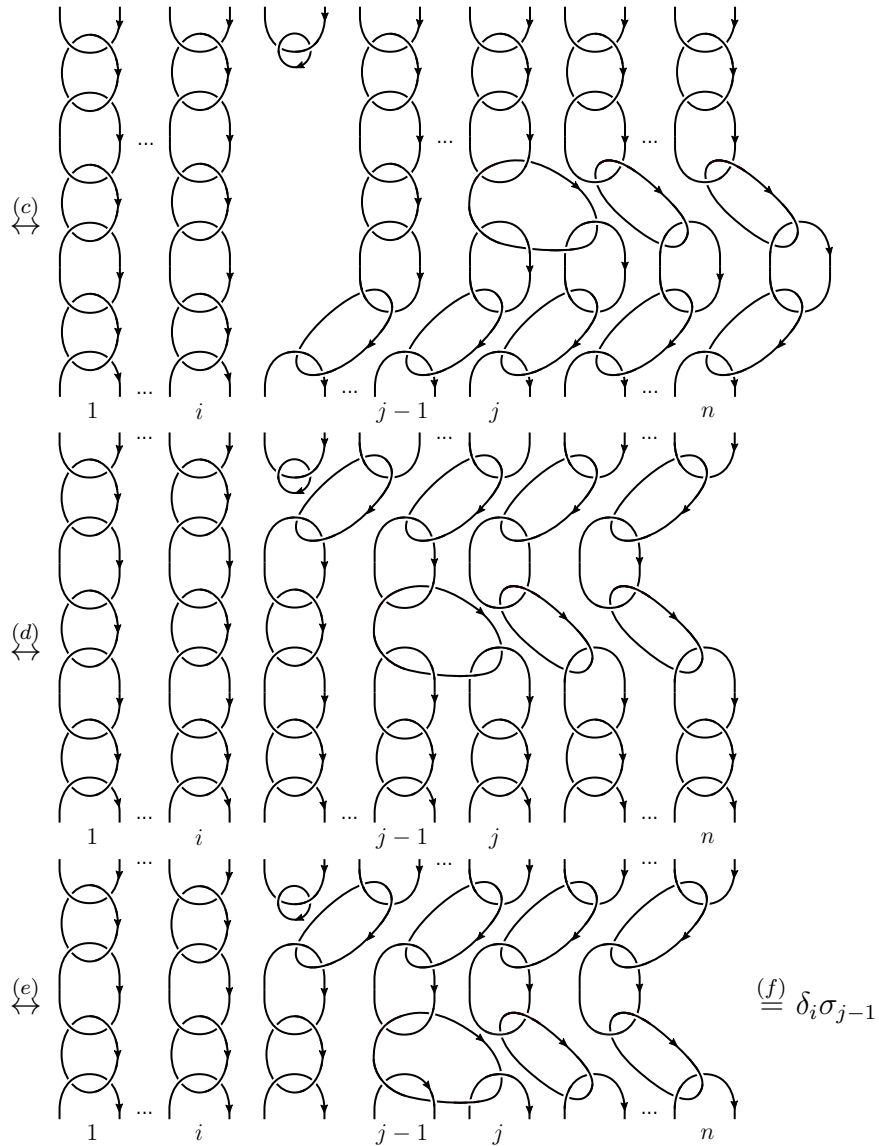

Here (a) and (f) follow from definitions and Lemma VII.6, (b) and (e) follow from Lemma VII.6 and the graph from Equation (66), (c) follows by applying twice the move from Lemma VII.8 part 3), and (d) by isotopy. The case when $i = 0$ is proven similarly.

(4) Suppose that $i > j + 1$. We have:

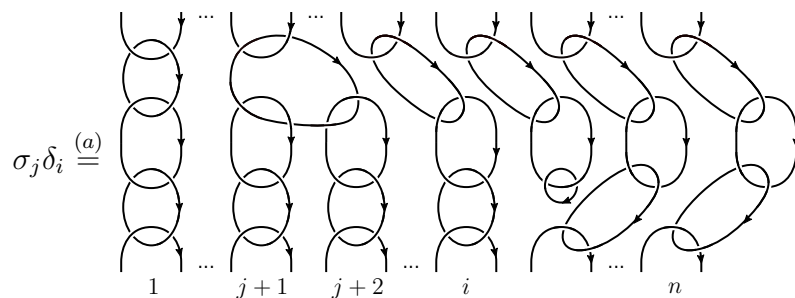

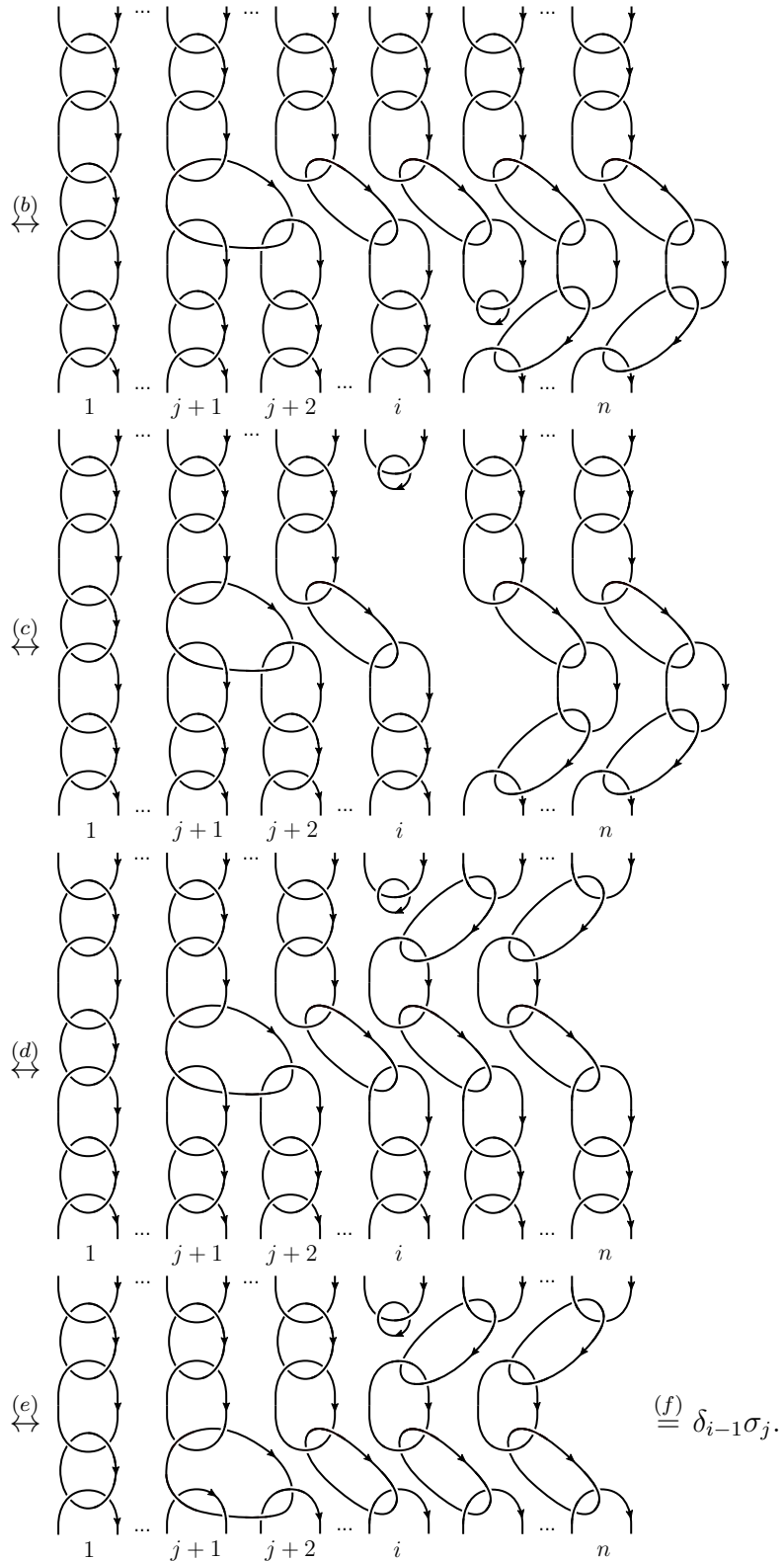

Here (a) and (f) follow from definitions and Lemma VII.6, (b) and (e) follow from Lemma VII.6 and the graph from Equation (66), (c) follows by applying twice the move from Lemma VII.8 part 3), and (d) by isotopy.

Now we prove Relations (25), (27) and (29). If one proves these, then Relations (26) and (28) hold too, according to Remark I.2.2.

Let us show the Relation (25). Let $1 \leq i \leq n$. In the case when $n \geq 3$ and $2 \leq i \leq n-1$, we have

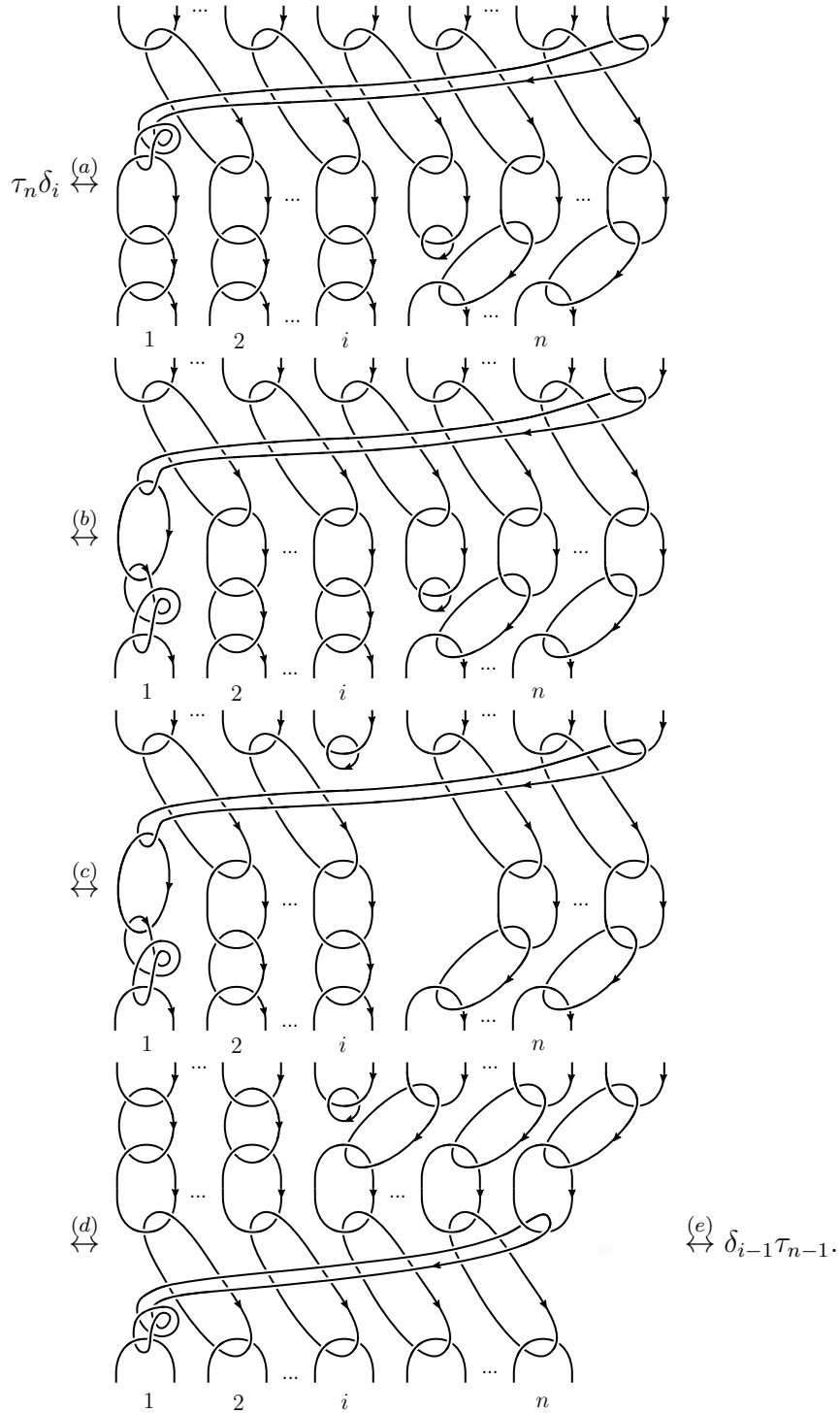

Here (a) and (e) follow from definitions and Lemma VII.6, (b) and (d) by isotopy and finally, (c) follows from Lemma VII.8 part 3). The other cases are proven similarly.

We further show the relation (27). Assume that $1 \leq j \leq n$. We have:

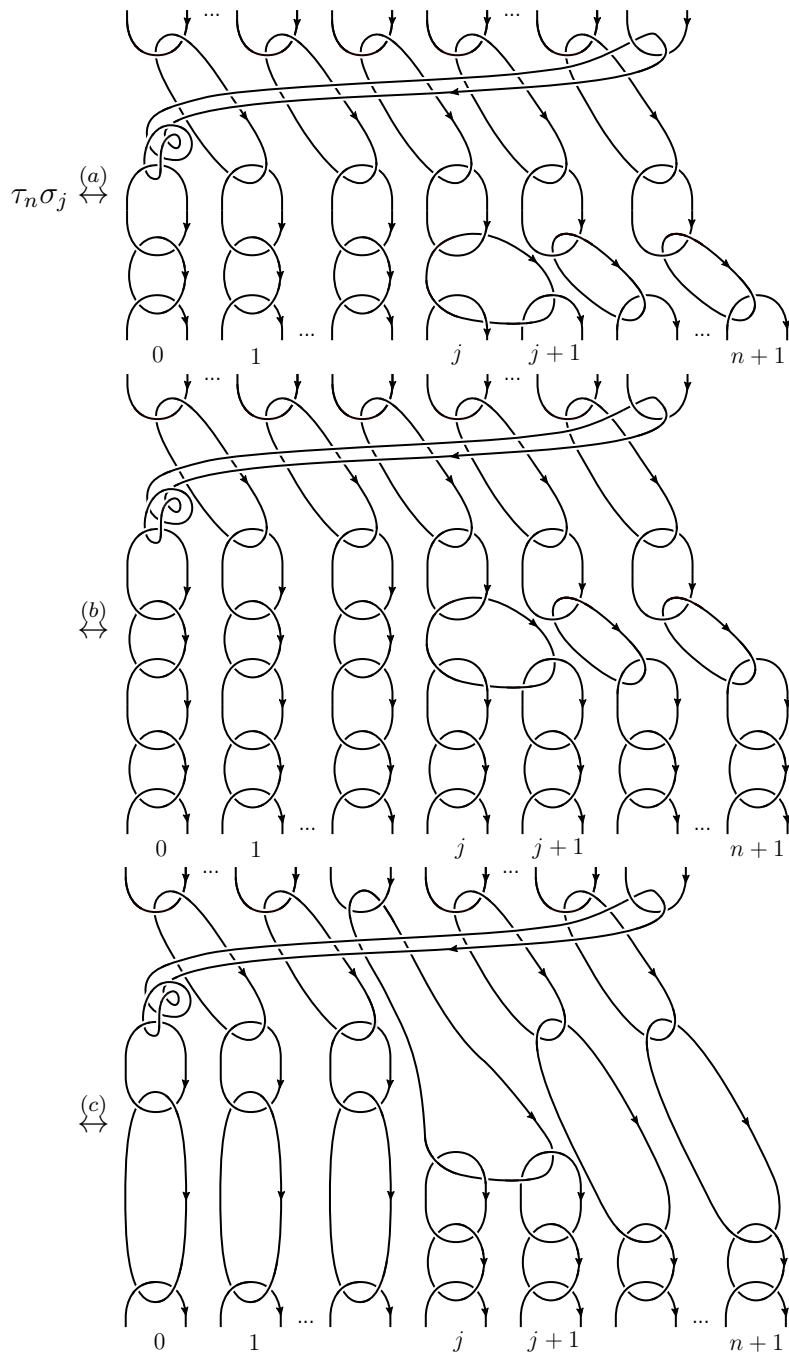

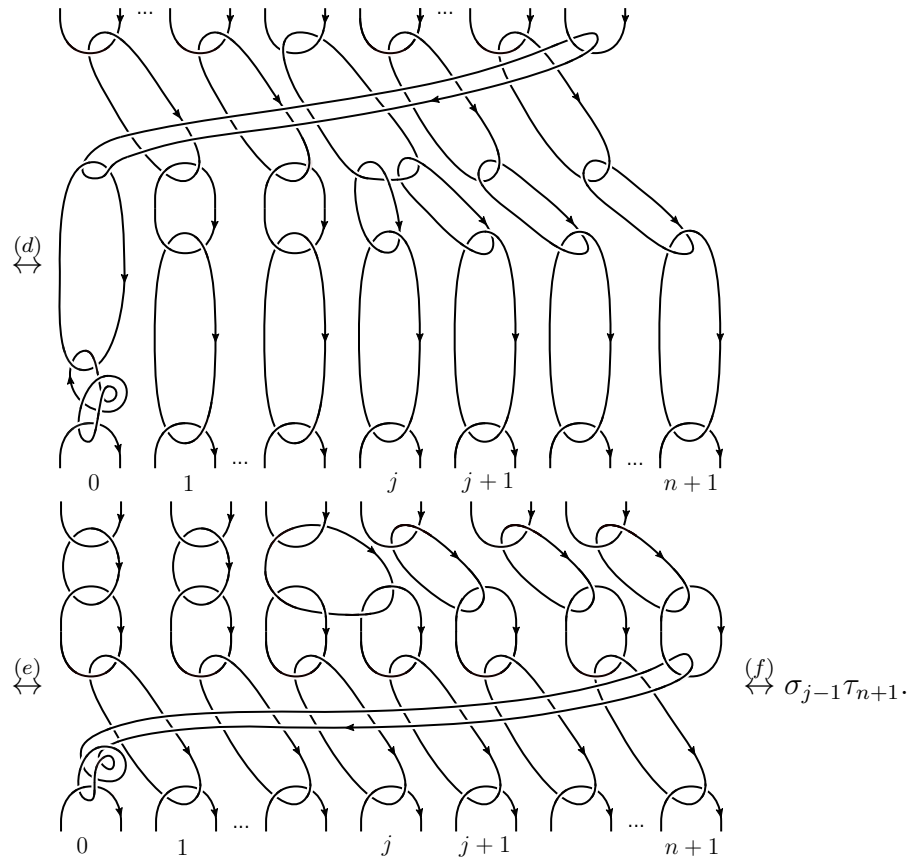

Here (a) and (f) follow from the definition and Lemma VII.6, (b) follows from Lemma VII.6 and the graph from Equation (66), (c) follows by applying the parts 2) and 5) of Lemma VII.8 and isotopy, and finally, (d) and (e) follow by isotopy.

Finally, we check the relation (29) in the case $n = 1$. The general case is proven by the similar reasoning. We have:

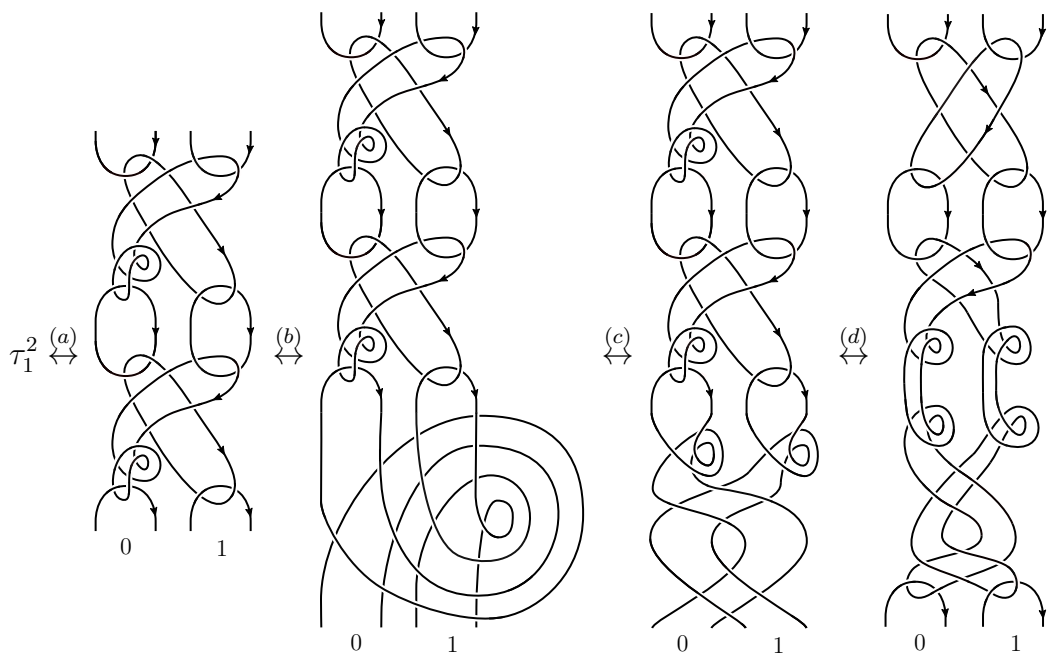

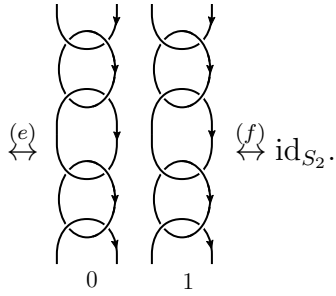

Here (a) follows from definition and Lemma VII.6, (b) follows by the **TWIST** move, (c), (d) and (e) follow by isotopy, and finally, (f) follows from Theorem VII.6 and presentation of the identity cobordism, as given in Equation (66). \square

VII.3.2. The construction \tilde{S}_\bullet . In this section, we sketch the construction of cyclic object $\tilde{\Sigma}_\bullet: \Delta C^{\text{op}} \rightarrow \mathbf{Cob}_3$. We construct the functor $\tilde{S}_\bullet: \Delta C^{\text{op}} \rightarrow \mathbf{Cob}_3$, by considering standard surfaces S_g (see Section VII.1.5) of genus g . For general case, see Section VII.3.3.

For $n \in \mathbb{N}$, set $\tilde{S}_\bullet(n) = S_{n+1}$. For $n \geq 1$ and $0 \leq i \leq n$, the face $\tilde{S}_\bullet(d_i^n): S_{n+1} \rightarrow S_n$ is the cobordism class presented by the special ribbon graph $G_{\tilde{S}_\bullet(d_i^n)}$:

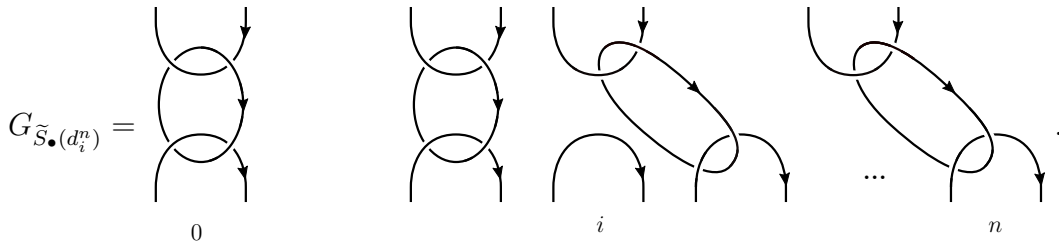

Let $n \geq 0$. For $0 \leq j \leq n$, the morphism $\tilde{S}_\bullet(s_j^n): S_{n+1} \rightarrow S_{n+2}$ is the cobordism class presented by the special ribbon graph $G_{\tilde{S}_\bullet(s_j^n)}$:

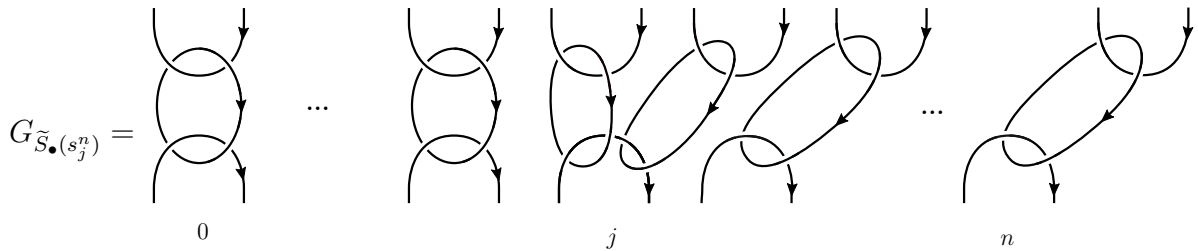

The morphism $\tilde{S}_\bullet(t_0): S_1 \rightarrow S_1$ equals the identity map id_{S_1} , which is represented by the graph I_1 from Equation (66). For $n \geq 1$, the morphism $\tilde{S}_\bullet(t_n): S_{n+1} \rightarrow S_{n+1}$ is the cobordism class presented by the special ribbon graph $G_{\tilde{S}_\bullet(t_n)}$:

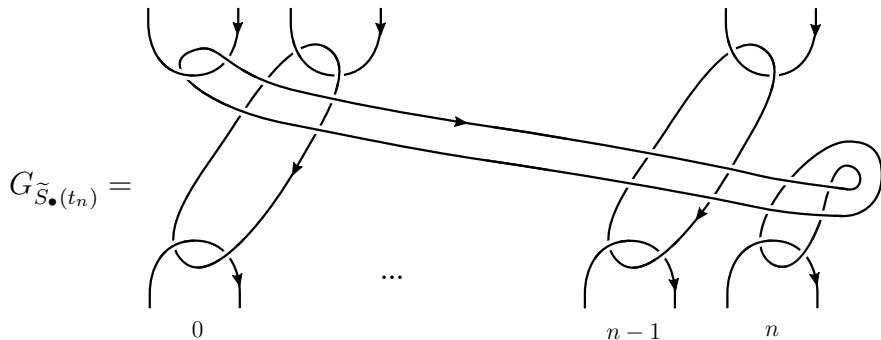

The proof of Theorem VII.1 in this case is similar to the proof of its version with Σ_\bullet , which is detailed in Section VII.3.1. Namely, we have the following lemma:

Lemma VII.9. *The family $\tilde{S}_\bullet = \{S_{n+1}\}_{n \geq 0}$, equipped with the faces $\{\tilde{S}_\bullet(d_i^n)\}_{0 \leq i \leq n, n \geq 1}$, the degeneracies $\{\tilde{S}_\bullet(s_j^n)\}_{0 \leq j \leq n, n \geq 0}$, and the cyclic operators $\tilde{S}_\bullet(t_n), n \in \mathbb{N}$ is a cyclic object in \mathbf{Cob}_3 .*

To prove Lemma VII.9, one uses the following result (similar to Lemma VII.8):

Lemma VII.10. *One has the following moves on special ribbon graphs:*

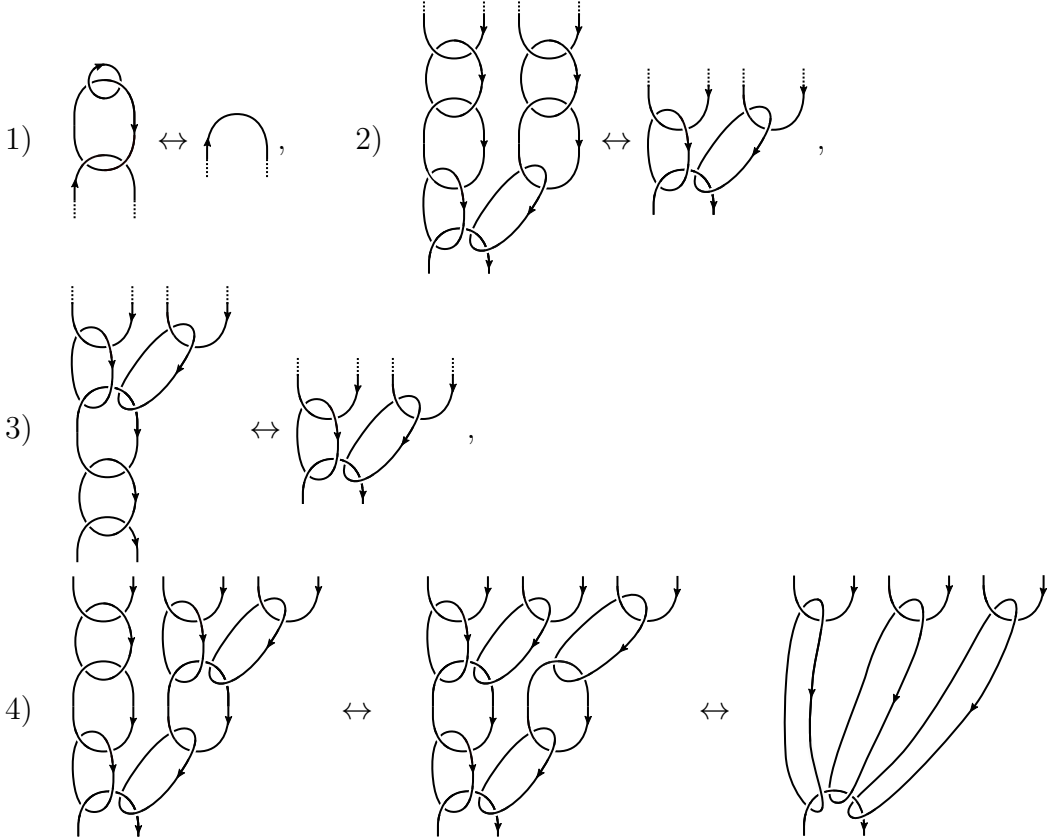

VII.3.3. Passing to Σ_\bullet and $\tilde{\Sigma}_\bullet$. Let $\{\Sigma_{n+1}\}_{n \geq 0}$ be any family of closed oriented surfaces. By the classification theorem, for each n there exist an orientation preserving homeomorphism $f_n^{\Sigma_\bullet}: \Sigma_{n+1} \rightarrow S_{n+1}$. Denote by $\text{Cyl}(f_n^{\Sigma_\bullet}): \Sigma_{n+1} \rightarrow S_{n+1}$ the associated morphism in \mathbf{Cob}_3 , given by the quadruple

$$\text{Cyl}(f_n^{\Sigma_\bullet}) = (C_{S_{n+1}} = S_{n+1} \times [0, 1], h_n: (-\Sigma_{n+1}) \sqcup S_{n+1} \rightarrow \partial(C_{S_{n+1}}), \Sigma_{n+1}, S_{n+1}),$$

where $h_n(x) = (f_n(x), 0)$, if $x \in \Sigma_{n+1}$ and $h_n(x) = (x, 1)$, if $x \in S_{n+1}$. It follows from [35, Section 5.1.], that cobordism $\text{Cyl}(f_n^{\Sigma_\bullet})$ is determined up to isotopy.

We pass from S_\bullet to cocyclic object Σ_\bullet in \mathbf{Cob}_3 as follows. For $n \geq 0$, set $\Sigma_\bullet(n) = \Sigma_{n+1}$. For $n \geq 1$ and $0 \leq i \leq n$, define the morphism $\Sigma_\bullet(\delta_i^n): \Sigma_n \rightarrow \Sigma_{n+1}$ by setting

$$\Sigma_\bullet(\delta_i^n) = (\text{Cyl}(f_n^{\Sigma_\bullet}))^{-1} S_\bullet(\delta_i^n) \text{Cyl}(f_{n-1}^{\Sigma_\bullet}).$$

For $n \geq 0$ and $0 \leq j \leq n$, define the morphism $\Sigma_\bullet(\sigma_j^n): \Sigma_{n+2} \rightarrow \Sigma_{n+1}$ by setting

$$\Sigma_\bullet(\sigma_j^n) = (\text{Cyl}(f_n^{\Sigma_\bullet}))^{-1} S_\bullet(\sigma_j^n) \text{Cyl}(f_{n+1}^{\Sigma_\bullet}).$$

For $n \geq 0$, define the morphisms $\Sigma_\bullet(\tau_n): \Sigma_{n+1} \rightarrow \Sigma_{n+1}$ by setting

$$\Sigma_\bullet(\tau_n) = (\text{Cyl}(f_n^{\Sigma_\bullet}))^{-1} S_\bullet(\tau_n) \text{Cyl}(f_n^{\Sigma_\bullet}).$$

It follows by definition of morphisms $\Sigma_{\bullet}(\delta_i^n)$, $\Sigma_{\bullet}(\sigma_j^n)$, and $\Sigma_{\bullet}(\tau_n)$ that family of cylinders $\{\text{Cyl}(f_n^{\Sigma_{\bullet}}): \Sigma_{n+1} \rightarrow S_{n+1}\}_{n \geq 0}$ is a natural isomorphism between cocyclic objects Σ_{\bullet} and S_{\bullet} in \mathbf{Cob}_3 .

Similarly, we pass from \tilde{S}_{\bullet} to cyclic object $\tilde{\Sigma}_{\bullet}$ in \mathbf{Cob}_3 as follows. For $n \geq 0$, set $\tilde{\Sigma}_{\bullet}(n) = \Sigma_{n+1}$. For $n \geq 1$ and $0 \leq i \leq n$, define the morphism $\tilde{\Sigma}_{\bullet}(d_i^n): \Sigma_{n+1} \rightarrow \Sigma_n$ by setting

$$\tilde{\Sigma}_{\bullet}(d_i^n) = (\text{Cyl}(f_{n-1}^{\Sigma_{\bullet}}))^{-1} \tilde{S}_{\bullet}(d_i^n) \text{Cyl}(f_n^{\Sigma_{\bullet}}).$$

For $n \geq 0$ and $0 \leq j \leq n$, define the morphism $\tilde{\Sigma}_{\bullet}(s_j^n): \Sigma_{n+1} \rightarrow \Sigma_{n+2}$ by setting

$$\tilde{\Sigma}_{\bullet}(s_j^n) = (\text{Cyl}(f_{n+1}^{\Sigma_{\bullet}}))^{-1} \tilde{S}_{\bullet}(s_j^n) \text{Cyl}(f_n^{\Sigma_{\bullet}}).$$

For $n \geq 0$, define the morphisms $\tilde{\Sigma}_{\bullet}(t_n): \Sigma_{n+1} \rightarrow \Sigma_{n+1}$ by setting

$$\tilde{\Sigma}_{\bullet}(t_n) = (\text{Cyl}(f_n^{\Sigma_{\bullet}}))^{-1} \tilde{S}_{\bullet}(t_n) \text{Cyl}(f_n^{\Sigma_{\bullet}}).$$

As above, it follows by definition of morphisms $\tilde{\Sigma}_{\bullet}(d_i^n)$, $\tilde{\Sigma}_{\bullet}(s_j^n)$, and $\tilde{\Sigma}_{\bullet}(t_n)$ that family of cylinders $\{\text{Cyl}(f_n^{\tilde{\Sigma}_{\bullet}}): \Sigma_{n+1} \rightarrow S_{n+1}\}_{n \geq 0}$ is a natural isomorphism between cyclic objects $\tilde{\Sigma}_{\bullet}$ and \tilde{S}_{\bullet} in \mathbf{Cob}_3 .

VII.4. Proof of Theorem VII.2

In this section, \mathcal{B} is a anomaly free modular \mathbb{k} -category. To show the claim from Theorem VII.2, it follows from Section VII.3.3, that it suffices to compute $\text{RT}_{\mathcal{B}} \circ S_{\bullet}$ and $\text{RT}_{\mathcal{B}} \circ \tilde{S}_{\bullet}$. First, in Section VII.4.1, we compute the cocyclic \mathbb{k} -module $\text{RT}_{\mathcal{B}} \circ S_{\bullet}$ using the description of $\text{RT}_{\mathcal{B}}$ via the coend C of \mathcal{B} given in Section VII.2. Next, in Section VII.4.2, we prove that $\text{RT}_{\mathcal{B}} \circ S_{\bullet}$ is isomorphic to $\hat{\mathbf{D}}_{\bullet}(C) \circ \Phi$. Finally, in Section VII.4.3, we sketch the computation of $\text{RT}_{\mathcal{B}} \circ \tilde{S}_{\bullet}$ and the proof of the fact that $\text{RT}_{\mathcal{B}} \circ \tilde{S}_{\bullet}$ is isomorphic to the cyclic \mathbb{k} -module $\hat{\mathbf{B}}_{\bullet}(C) \circ \Phi^{\text{op}}$. Recall that $\Phi: \Delta C \rightarrow \Delta C$ is the reindexing involution automorphism introduced in Section I.4.4.

Recall from Section II.3 that C is a Hopf algebra in \mathcal{B} endowed with a nondegenerate pairing $\omega: C \otimes C \rightarrow \mathbb{1}$. Here, we denote by m_C , u_C , Δ_C , ε_C , and S_C multiplication, unit, comultiplication, counit, and antipode of C , respectively. While using graphical calculus, we drop C from notation. It follows from Remark II.7 that

$$\omega(\alpha \otimes \alpha) = \dim(\mathcal{B})^{-1}.$$

VII.4.1. Computation of $\text{RT}_{\mathcal{B}} \circ S_{\bullet}$. In the following lemma, we calculate the isotopy invariant $|\cdot|$ (see Section VII.2) of particular special graphs:

Lemma VII.11. *If T_i for $i = 1, 2, 3$ are the following special ribbon graphs*

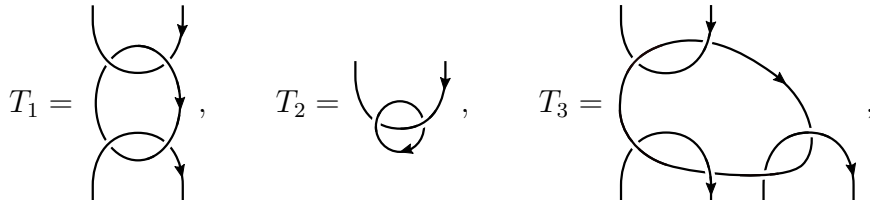

then

- a) $|T_1| = \dim(\mathcal{B})^{-1} \text{id}_C$,
- b) $|T_2| = \dim(\mathcal{B})^{-1} u_C$,
- c) $|T_3| = \dim(\mathcal{B})^{-1} m_C$.

PROOF. a) A ribbon graph whose closure is isotopic to T_1 is

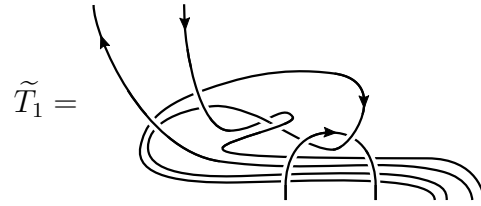

For all objects $X, Y,$ and Z in \mathcal{B} , we have:

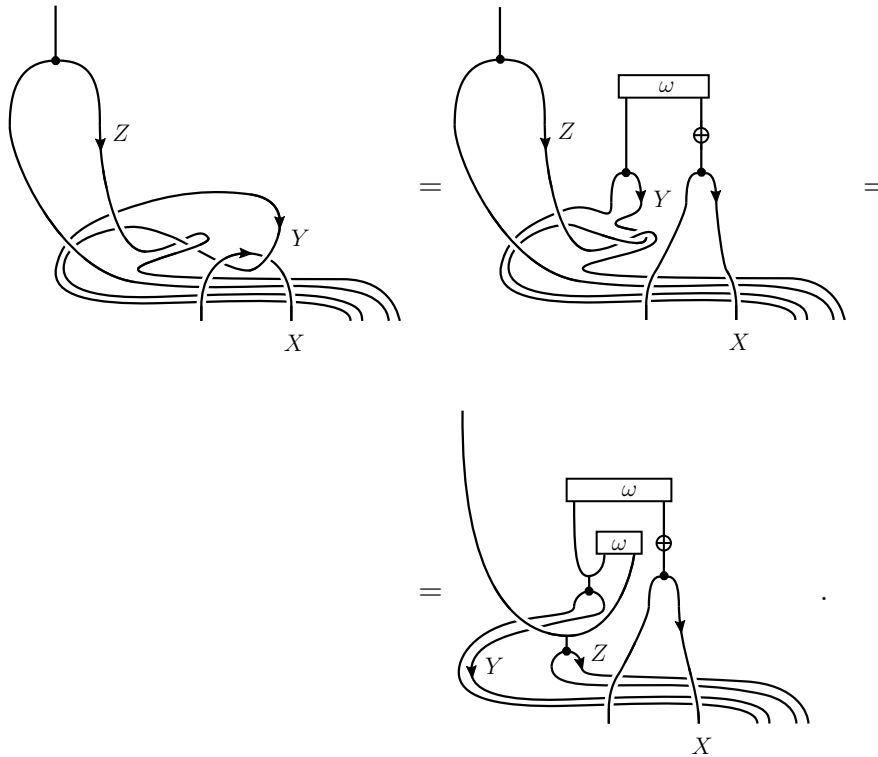

Hence, by definition of $|\cdot|$ given in Section VII.2 and Corollary II.6, we have:

$$|T_1| = \text{Diagram} = \omega(\alpha \otimes \alpha)\text{id}_C = \dim(\mathcal{B})^{-1}\text{id}_C.$$

b) A ribbon graph whose closure is isotopic to T_2 is

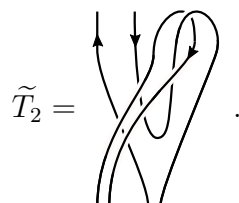

For all objects X, Y in \mathcal{B} , we have:

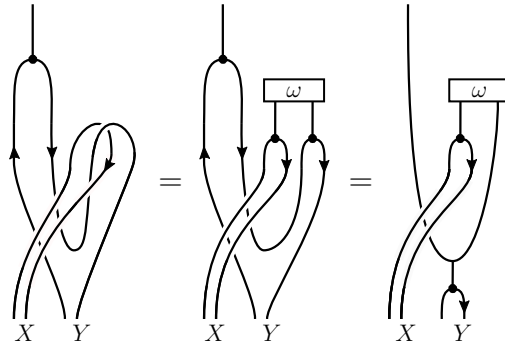

Hence, by definition of $|\cdot|$ given in Section VII.2 and by Lemma II.5 a), we have:

$$|T_2| = \left(\begin{array}{c} \omega \\ \alpha \\ \alpha \end{array} \right) = \omega(\alpha \otimes \alpha)u_C = \dim(\mathcal{B})^{-1}u_C.$$

c) A ribbon graph whose closure is isotopic to T_3 is

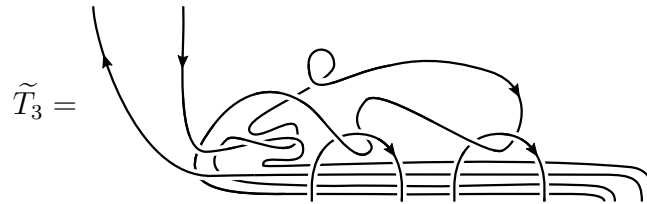

For all objects X, Y , and Z in \mathcal{B} , we have:

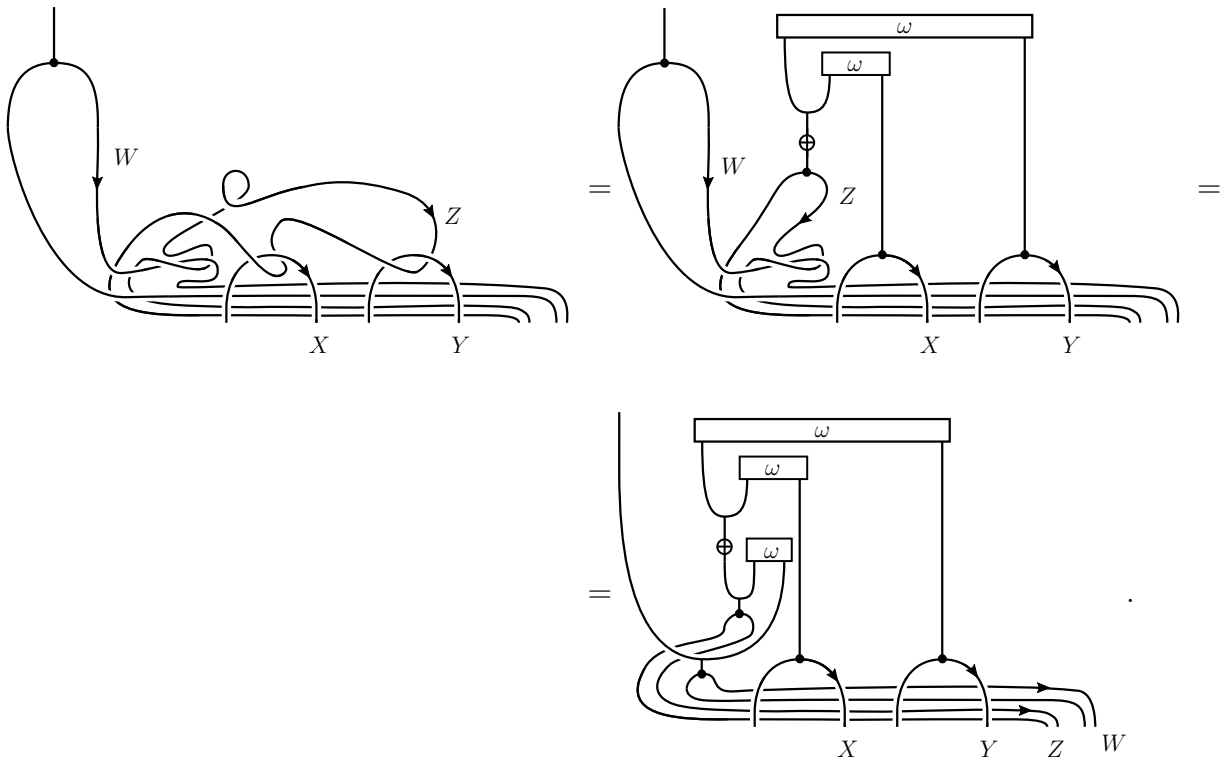

Hence, by definition of $|\cdot|$ given in Section VII.2, the fact that $\omega(S_C \otimes \text{id}_C) = \omega(\text{id}_C \otimes S_C)$, and Corollary II.6, we have

$$|T_3| = \begin{array}{c} \text{Diagram 1: A vertical line with a box } \omega \text{ at the top. A loop goes down from the line, through a box } \omega, \text{ then through a box } \alpha, \text{ and back up to the line. Another loop goes down from the line, through a box } \omega, \text{ then through a box } \alpha, \text{ and back up to the line. A third loop goes down from the line, through a box } \alpha, \text{ and back up to the line.} \end{array} = \begin{array}{c} \text{Diagram 2: A vertical line with a box } \omega \text{ at the top. A loop goes down from the line, through a box } \alpha, \text{ and back up to the line. Another loop goes down from the line, through a box } \alpha, \text{ and back up to the line. A third loop goes down from the line, through a box } \alpha, \text{ and back up to the line.} \end{array} = \omega(\alpha \otimes \alpha)m_C = \dim(\mathcal{B})^{-1}m_C.$$

□

The previously proved Lemma VII.11 implies the following result:

Lemma VII.12. *We have:*

- a) $|G_{S_\bullet(\delta_i^n)}| = \dim(\mathcal{B})^{-n-1} \widehat{\mathbf{A}}_\bullet(C)(\delta_i^n)$,
- b) $|G_{S_\bullet(\sigma_j^n)}| = \dim(\mathcal{B})^{-n-1} \widehat{\mathbf{A}}_\bullet(C)(\sigma_j^n)$,
- c) $|G_{S_\bullet(\tau_n)}| = \begin{cases} \dim(\mathcal{B})^{-1} \text{id}_C, & \text{if } n = 0, \\ \dim(\mathcal{B})^{-n-1} \widehat{\mathbf{A}}_\bullet(C)(\tau_n) & \text{if } n \geq 1, \end{cases}$

where $\widehat{\mathbf{A}}_\bullet(C): \Delta C_\infty \rightarrow \mathcal{B}$ is the paracyclic object in \mathcal{B} (see Section III.2.2) associated to the coend C of \mathcal{B} .

PROOF. a) Recall the special ribbon graphs T_1 and T_2 from Lemma VII.11. Let $n \geq 1$. By Lemma VII.11 and multiplicativity of $|\cdot|$ (see Equation 67), we have:

$$|G_{S_\bullet(\delta_0^n)}| = \dim(\mathcal{B})^{-1}u_C \otimes (\dim(\mathcal{B})^{-1}\text{id}_C)^{\otimes n} = \dim(\mathcal{B})^{-n-1} \widehat{\mathbf{A}}_\bullet(C)(\delta_0^n).$$

Similarly, for $1 \leq i \leq n-1$, we have:

$$\begin{aligned} |G_{S_\bullet(\delta_i^n)}| &= (\dim(\mathcal{B})^{-1}\text{id}_C)^{\otimes i} \otimes \dim(\mathcal{B})^{-1}u_C \otimes (\dim(\mathcal{B})^{-1}\text{id}_C)^{\otimes n-i} = \\ &= \dim(\mathcal{B})^{-n-1} \widehat{\mathbf{A}}_\bullet(C)(\delta_i^n). \end{aligned}$$

Finally,

$$|G_{S_\bullet(\delta_n^n)}| = (\dim(\mathcal{B})^{-1}\text{id}_C)^{\otimes n} \otimes \dim(\mathcal{B})^{-1}u_C = \dim(\mathcal{B})^{-n-1} \widehat{\mathbf{A}}_\bullet(C)(\delta_n^n).$$

b) Recall the special ribbon graphs T_1 and T_3 from Lemma VII.11. Let $n \geq 0$ and $0 \leq j \leq n$. By Lemma VII.11,

$$\begin{aligned} |G_{S_\bullet(\sigma_j^n)}| &= (\dim(\mathcal{B})^{-1}\text{id}_C)^{\otimes j} \otimes (\dim(\mathcal{B})^{-1}m_C) \otimes (\dim(\mathcal{B})^{-1}\text{id}_C)^{\otimes n-j} \\ &= \dim(\mathcal{B})^{-n-1} \widehat{\mathbf{A}}_\bullet(C)(\sigma_j^n). \end{aligned}$$

c) Recall that $S_\bullet(\tau_0)$ is the identity morphism id_{S_1} . Hence

$$|G_{S_\bullet(\tau_0)}| = \dim(\mathcal{B})^{-1}\text{id}_C,$$

by Lemma VII.11 a). Let us show the statement in the case $n = 1$. The statement in the general case $n > 1$ is proved similarly. The special ribbon graph $G_{S_\bullet(\tau_1)}$

depicts as follows:

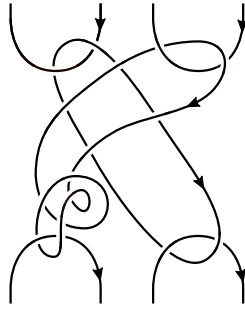

A ribbon graph, whose closure is isotopic to the special ribbon graph $G_{S_\bullet(\tau_1)}$ depicts as follows:

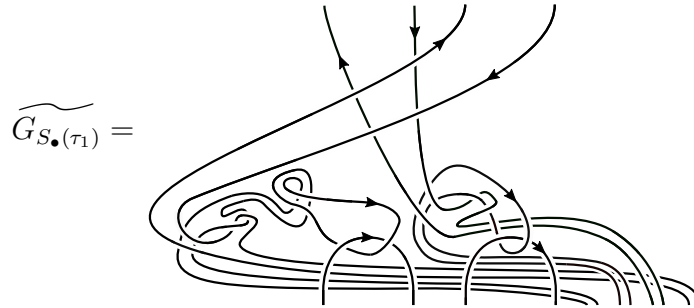

For all objects $X, Y, Z, U, V,$ and W in \mathcal{B} , we have:

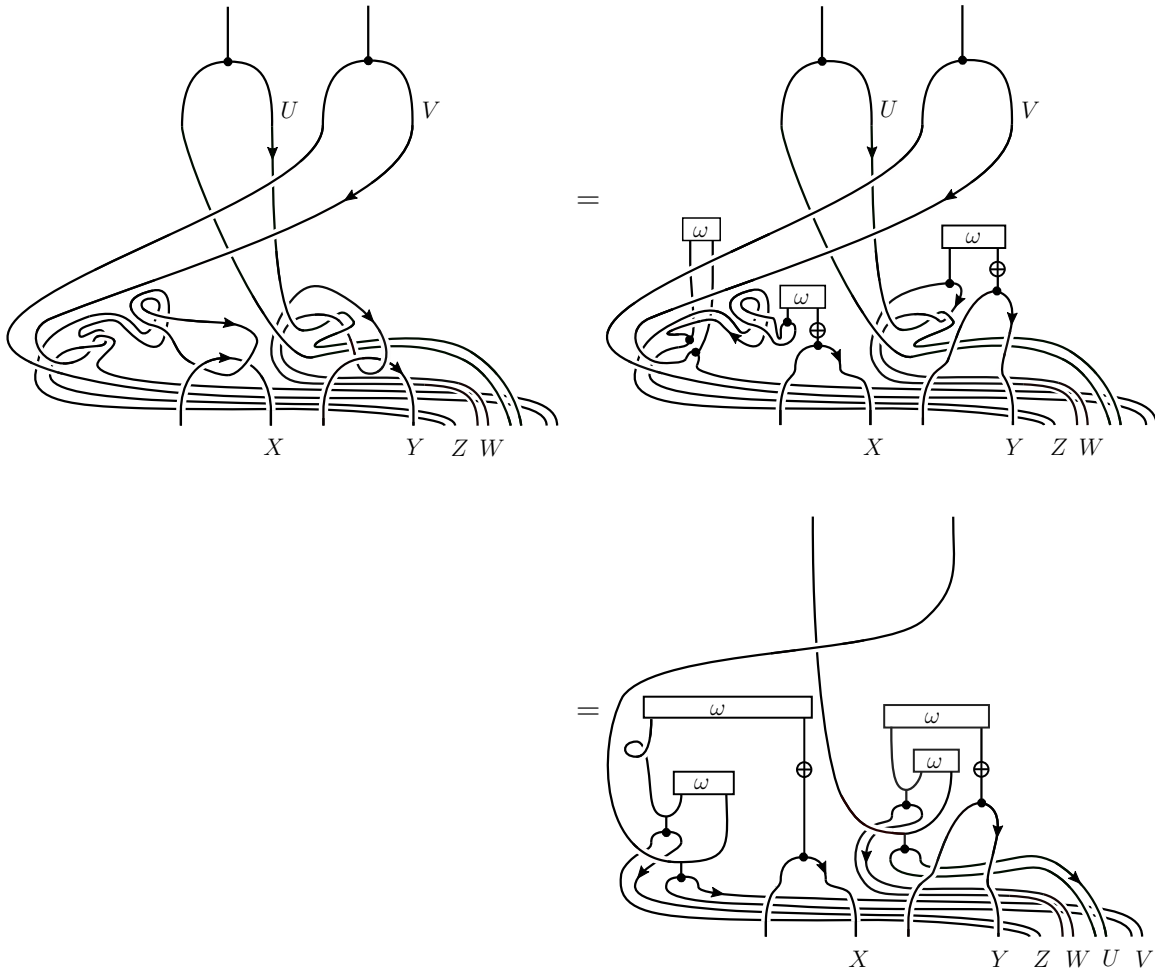

Hence, by definition of $|\cdot|$ given in Section VII.2, the fact that $\omega(S \otimes \text{id}_C) = \omega(\text{id}_C \otimes S)$, the fact that $S^2 = \theta_C$, and Corollary II.6, we have:

$$\begin{aligned}
 |G_{S_\bullet(\tau_1)}| &= \text{Diagram 1} = \text{Diagram 2} \\
 &= (\omega(\alpha \otimes \alpha))^2 \text{Diagram 3} = \dim(\mathcal{B})^{-2} \widehat{\mathbf{A}}_\bullet(C)(\tau_1).
 \end{aligned}$$

□

Recall the construction $\check{\mathbf{B}}_\bullet(C)$ from Section III.2.4.3. The computation of $\text{RT}_{\mathcal{B}} \circ S_\bullet$ follows from Lemma VII.12:

Lemma VII.13. *The cocyclic \mathbb{k} -module $\text{RT}_{\mathcal{B}} \circ S_\bullet$ equals to the cocyclic \mathbb{k} -module $\check{\mathbf{B}}_\bullet(C)$.*

PROOF. Let us calculate $\text{RT}_{\mathcal{B}}(S_\bullet(\delta_i^n))$, $\text{RT}_{\mathcal{B}}(S_\bullet(\sigma_j^n))$, and $\text{RT}_{\mathcal{B}}(S_\bullet(\tau_n))$. For $n \geq 1$ and $0 \leq i \leq n$, we have:

$$\begin{aligned}
 \text{RT}_{\mathcal{B}}(S_\bullet(\delta_i^n)) &= \Delta^{(n+1)+(n+1)} \text{Hom}_{\mathcal{B}}(\mathbb{1}, |G_{S_\bullet(\delta_i^n)}|) = \\
 &= \dim(\mathcal{B})^{n+1} \text{Hom}_{\mathcal{B}}(\mathbb{1}, \dim(\mathcal{B})^{-n-1} \widehat{\mathbf{A}}_\bullet(C)(\delta_i^n)) = \\
 &= \text{Hom}_{\mathcal{B}}(\mathbb{1}, \widehat{\mathbf{A}}_\bullet(C)(\delta_i^n)).
 \end{aligned}$$

Furthermore, for $n \geq 0$ and $0 \leq j \leq n$, we have:

$$\begin{aligned}
 \text{RT}_{\mathcal{B}}(S_\bullet(\sigma_j^n)) &= \Delta^{(n+1)+(n+1)} \text{Hom}_{\mathcal{B}}(\mathbb{1}, |G_{S_\bullet(\sigma_j^n)}|) = \\
 &= \dim(\mathcal{B})^{n+1} \text{Hom}_{\mathcal{B}}(\mathbb{1}, \dim(\mathcal{B})^{-n-1} \widehat{\mathbf{A}}_\bullet(C)(\sigma_j^n)) = \\
 &= \text{Hom}_{\mathcal{B}}(\mathbb{1}, \widehat{\mathbf{A}}_\bullet(C)(\sigma_j^n)).
 \end{aligned}$$

Finally,

$$\begin{aligned}
 \text{RT}_{\mathcal{B}}(S_\bullet(\tau_0)) &= \Delta^{1+1} \text{Hom}_{\mathcal{B}}(\mathbb{1}, |G_{S_\bullet(\tau_0)}|) = \\
 &= \dim(\mathcal{B}) \text{Hom}_{\mathcal{B}}(\mathbb{1}, \dim(\mathcal{B})^{-1} \text{id}_C) = \\
 &= \text{Hom}_{\mathcal{B}}(\mathbb{1}, \widehat{\mathbf{A}}_\bullet(C)(\tau_0)).
 \end{aligned}$$

In the case when $n \geq 1$,

$$\begin{aligned} \mathrm{RT}_{\mathcal{B}}(S_{\bullet}(\tau_n)) &= \Delta^{(n+1)+(n+1)} \mathrm{Hom}_{\mathcal{B}}(\mathbb{1}, |G_{S_{\bullet}(\tau_n)}|) = \\ &= \dim(\mathcal{B})^{n+1} \mathrm{Hom}_{\mathcal{B}}\left(\mathbb{1}, \dim(\mathcal{B})^{-n-1} \widehat{\mathbf{A}}_{\bullet}(C)(\tau_n)\right) = \\ &= \mathrm{Hom}_{\mathcal{B}}\left(\mathbb{1}, \widehat{\mathbf{A}}_{\bullet}(C)(\tau_n)\right). \end{aligned}$$

The claim of Lemma follows since $\check{\mathbf{B}}_{\bullet}(C) = \mathrm{Hom}_{\mathcal{B}}(\mathbb{1}, -) \circ \widehat{\mathbf{A}}_{\bullet}(C)$. \square

VII.4.2. The final step. In Section VII.3.1, we constructed the cocyclic object S_{\bullet} in the category of 3-cobordisms. Next, in Lemma VII.13, we proved that $\mathrm{RT}_{\mathcal{B}} \circ S_{\bullet}$ equals to the cocyclic \mathbb{k} -module $\check{\mathbf{B}}_{\bullet}(C)$, introduced in III.2.4.3. Recall that the coend C is a Hopf algebra in \mathcal{B} , equipped with a nondegenerate pairing. According to Lemma III.17, $\check{\mathbf{B}}_{\bullet}(C)$ is isomorphic to $\widehat{\mathbf{D}}_{\bullet}(C) \circ \Phi$, where $\widehat{\mathbf{D}}_{\bullet}(C)$ is the cocyclic \mathbb{k} -module from Section III.1.4.1 and $\Phi: \Delta C \rightarrow \Delta C$ is the reindexing involution from Section I.4.4. This finishes the proof of the first part of Theorem VII.2. \square

VII.4.3. Computation of $\mathrm{RT}_{\mathcal{B}} \circ \widetilde{S}_{\bullet}$. Let us sketch the computation of $\mathrm{RT}_{\mathcal{B}} \circ \widetilde{S}_{\bullet}$. We use same strategy as in Sections VII.4.1 and VII.4.2. Namely, one has the following lemmas. Similar computations as in Lemma VII.11 give the following result:

Lemma VII.14. *If T_4 and T_5 are the following special ribbon graphs*

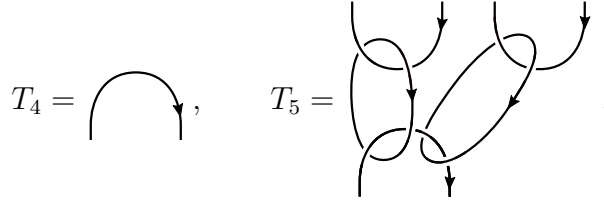

then

- a) $|T_4| = \varepsilon_C$,
- b) $|T_5| = \dim(\mathcal{B})^{-2} \Delta C$.

Next, by using Lemma VII.14, one obtains an analogue of Lemma VII.12:

Lemma VII.15. *We have:*

- a) $|G_{\widetilde{S}_{\bullet}(d_i^n)}| = \dim(\mathcal{B})^{-n} \widehat{\mathbf{C}}_{\bullet}(C)(d_i^n)$,
- b) $|G_{\widetilde{S}_{\bullet}(s_j^n)}| = \dim(\mathcal{B})^{-n-2} \widehat{\mathbf{C}}_{\bullet}(C)(s_j^n)$,
- c) $|G_{\widetilde{S}_{\bullet}(t_n)}| = \begin{cases} \dim(\mathcal{B})^{-1} \mathrm{id}_C, & \text{if } n = 0, \\ \dim(\mathcal{B})^{-n-1} \widehat{\mathbf{C}}_{\bullet}(C)(t_n) & \text{if } n \geq 1. \end{cases}$

where $\widehat{\mathbf{C}}_{\bullet}(C): \Delta C_{\infty}^{\mathrm{op}} \rightarrow \mathcal{B}$ is the paracyclic object in \mathcal{B} (see Section III.1.2) associated to the coend C of \mathcal{B} .

By using Lemma VII.15, one easily computes that $\mathrm{RT}_{\mathcal{B}} \circ \widetilde{S}_{\bullet}$ is equal to the cyclic \mathbb{k} -module $\check{\mathbf{D}}_{\bullet}(C)$. Since C is a Hopf algebra with a nondegenerate pairing, the latter cyclic \mathbb{k} -module is, by applying Lemma III.17, isomorphic to the cyclic \mathbb{k} -module $\widehat{\mathbf{B}}_{\bullet}(C) \circ \Phi^{\mathrm{op}}$, where $\widehat{\mathbf{B}}_{\bullet}(C)$ is the cyclic \mathbb{k} -module from Section III.2.4.2 and Φ is the reindexing involution automorphism from Section I.4.4. This completes our proof of Theorem VII.2. \square

VII.5. Future perspectives

We plan to relate the constructed (co)cyclic objects in \mathbf{Cob}_3 with the cylinder cobordisms associated to Dehn twists on surfaces. The aim is to extend the representations $\text{Mod}(\Sigma_g) \rightarrow \text{Aut}(Z(\Sigma_g))$ of the mapping class groups of the surfaces Σ_g induced by a 3-dimensional TQFT $Z: \mathbf{Cob}_3 \rightarrow \text{Mod}_k$ to $\text{Mod}(\Sigma_\bullet) \rightarrow \text{Aut}(Z \circ \Sigma_\bullet)$, where $\text{Mod}(\Sigma_\bullet)$ is an appropriate subgroup of $\prod_g \text{Mod}(\Sigma_g)$.

Bibliography

- [1] S. E. Akrami and S. Majid. Braided cyclic cocycles and nonassociative geometry. *Journal of Mathematical Physics*, 45(10):3883–3911, 2004.
- [2] G. Böhm and D. Ştefan. A categorical approach to cyclic duality. *Journal of Noncommutative Geometry*, 6(3):481–538, 2012.
- [3] A. M. Bohmann, T. Gerhardt, A. Høgenhaven, B. Shipley, and S. Ziegenhagen. Computational tools for topological coHochschild homology. *Topology and its Applications*, 235:185–213, 2018.
- [4] A. Bruguières and A. Virelizier. Hopf diagrams and quantum invariants. *Algebr. Geom. Topol.*, 5(4):1677–1710, 2005.
- [5] A. Bruguières and A. Virelizier. Categorical centers and Reshetikhin-Turaev invariants. *Acta Mathematica Vietnamica No. 3, Vol. 33 (2008)*, 33(3):255–277, 2008.
- [6] A. Connes. Cohomologie cyclique et foncteurs Ext. 1983.
- [7] A. Connes. Non-commutative differential geometry. *Publications Mathématiques de l’Institut des Hautes Études Scientifiques*, 62(1):41–144, Dec. 1985.
- [8] A. Connes and H. Moscovici. Hopf algebras, cyclic cohomology and the transverse index theorem. *Communications in Mathematical Physics*, 198(1):199–246, 1998.
- [9] A. Connes and H. Moscovici. Cyclic Cohomology and Hopf Algebras. *Letters in Mathematical Physics*, 48(1):97–108, Apr. 1999.
- [10] V. Drinfeld. Quantum groups. *Proc. of ICM Berkeley 1986*, 798, 1986.
- [11] M. Farinati and A. Solotar. Cyclic cohomology of coalgebras, coderivations and De Rham cohomology. In *Hopf algebras and quantum groups*, volume 209 of *Lect. Notes in Pure and Applied Math.*, pages 105–130. Marcel Dekker, 2000.
- [12] P. Feng and B. Tsygan. Hochschild and cyclic homology of quantum groups. *Communications in mathematical physics*, 140(3):481–521, 1991.
- [13] D. Fiorenza and N. Kowalzig. Cyclic Gerstenhaber-Schack cohomology, arxiv.org/abs/1812.10447. 2020.
- [14] K. Habiro. Bottom tangles and universal invariants. *Algebr. Geom. Topol.*, 6:1113–1214, 2006.
- [15] T. Hadfield and U. Krähmer. Twisted homology of quantum $SL(2)$. *K-Theory*, 4(34):327–360, 2005.
- [16] T. Hadfield and U. Krähmer. Braided homology of quantum groups. *Journal of K-Theory*, 4(2):299–332, 2009.
- [17] J. D. Jones. Cyclic homology and equivariant homology. *Inventiones mathematicae*, 87(2):403–423, 1987.
- [18] V. F. Jones. A polynomial invariant for knots via von Neumann algebras. *Bulletin (New Series) of the American Mathematical Society*, 12(1):103–111, 1985.
- [19] M. Karoubi. *Homologie cyclique et K-théorie*, volume 9. Société mathématique de France Paris, 1987.
- [20] M. Khalkhali and A. Pourkia. Hopf cyclic cohomology in braided monoidal categories. *Homology, Homotopy and Applications*, 12(1):111 – 155, 2010.
- [21] M. Khalkhali and B. Rangipour. A note on cyclic duality and Hopf algebras. *Communications in Algebra*, 33(3):763–773, 2005.
- [22] R. Kirby. A calculus for framed links in S^3 . *Inventiones mathematicae*, 45:35–56, 1978.
- [23] M. Lallouche. *Théories des champs quantiques topologiques internes de type Reshetikhin-Turaev*. PhD thesis, Université de Montpellier, 2016.
- [24] S. M. Lane. Natural associativity and commutativity. *Rice Institute Pamphlet-Rice University Studies*, 49(4), 1963.
- [25] S. M. Lane. *Homology*. Springer, 1995.
- [26] S. M. Lane. *Categories for the Working Mathematician*. Springer, 1998.
- [27] W. B. R. Lickorish. *An Introduction to Knot Theory*. Springer, 1997.
- [28] J.-L. Loday. *Cyclic Homology*. Springer, 1998.

- [29] V. Lyubashenko. Invariants of 3-manifolds and projective representations of mapping class groups via quantum groups at roots of unity. *Communications in Mathematical Physics*, 172(3):467–516, 1995.
- [30] V. Lyubashenko. Modular transformations for tensor categories. *Journal of Pure and Applied Algebra*, 98(3):279 – 327, 1995.
- [31] S. Majid. Braided groups. *Journal of Pure and Applied Algebra*, 86(2):187 – 221, 1993.
- [32] D. Quillen. Algebra cochains and cyclic cohomology. *Publications Mathématiques de l’IHÉS*, 68:139–174, 1988.
- [33] N. Reshetikhin and V. G. Turaev. Invariants of 3-manifolds via link polynomials and quantum groups. *Inventiones mathematicae*, 103(1):547–597, 1991.
- [34] B. L. Tsygan. The homology of matrix Lie algebras over rings and the Hochschild homology. *Russian Mathematical Surveys*, 38(2):198, 1983.
- [35] V. Turaev. *Quantum Invariants of Knots and 3-manifolds*. De Gruyter, 2010.
- [36] V. Turaev and A. Virelizier. *Monoidal Categories and Topological Field Theory*. Birkhäuser, 2017.
- [37] A. Virelizier. Kirby elements and quantum invariants. *Proceedings of the London Mathematical Society*, 93(2):474–514, 2006.
- [38] C. A. Weibel. *An introduction to homological algebra*. Number 38. Cambridge university press, 1995.
- [39] E. Witten. Quantum field theory and the Jones polynomial. *Communications in Mathematical Physics*, 121(3):351–399, 1989.

Cyclic bar constructions and low-dimensional topology

Abstract. In this thesis we study cyclic objects and their interplay with quantum invariants and topological field theories. Cyclic cohomology of algebras is introduced independently by Connes and Tsygan in the 1980s. A (co)cyclic object in a category is, roughly speaking, a (co)simplicial object with compatible actions of the cyclic groups. On the other hand, quantum topology is born after the discovery by Jones (1984) of a new polynomial invariant of knots and links, rapidly connected with quantum groups introduced by Drinfeld (1985) and methods of quantum field theory by Witten (1989). A fundamental construction of topological quantum field theory (TQFT) in dimension 3 is given by the Reshetikhin-Turaev construction.

From the algebraic point of view, we study paracyclic and cyclic objects obtained from categorical algebras and coalgebras. In the case of Hopf algebras, building on work from Khalkhali-Pourkia, we study a braided generalization of the Connes-Moscovici construction. In particular, we describe a categorical version of Connes-Moscovici trace. Moreover, we extend the Connes-Moscovici construction to the case of coefficients in bi(co)modules over categorical Hopf algebras.

From the topological point of view, we endow the set of string links with a structure of a (co)cyclic set. This is inspired by braided (co)cyclic bar constructions associated to the coend of a ribbon category, which is a categorical Hopf algebra. Moreover, we show that the family of closed oriented surfaces of genus g has a structure of a (co)cyclic object in the category of 3-dimensional cobordisms. Consequently, any 3-dimensional TQFT gives rise to a (co)cyclic vector space. We compute it algebraically for the Reshetikhin-Turaev TQFT.

Constructions bar cycliques et topologie de basse dimension

Résumé. Dans cette thèse, nous étudions les objets cycliques et leurs interactions avec les invariants quantiques et les théories des champs topologiques. La cohomologie cyclique des algèbres a été introduite dans les années 80, indépendamment par Connes et Tsygan. Un objet (co)cyclique dans une catégorie est un objet (co)simplicial muni d'actions compatibles des groupes cycliques. D'autre part, la topologie quantique est née après la découverte par Jones (1984) d'un nouvel invariant polynomial des nœuds et des entrelacs, qui fut rapidement relié aux groupes quantiques introduits par Drinfeld (1985) et aux méthodes de la théorie quantique des champs par Witten (1989). Une construction fondamentale d'une théorie des champs topologique (TQFT) en dimension 3 est la construction de Reshetikhin-Turaev.

Du point de vue algébrique, nous étudions les objets paracycliques et cycliques associés aux algèbres et cogèbres catégoriques. Dans le cas des algèbres de Hopf, en s'appuyant sur les travaux de Khalkhali-Pourkia, nous étudions une généralisation tressée de la construction de Connes-Moscovici. En particulier, nous décrivons une version catégorique de la trace de Connes-Moscovici. De plus, nous étendons la construction de Connes-Moscovici au cas des coefficients dans les bi(co)modules sur les algèbres de Hopf catégoriques.

Du point de vue topologique, nous munissons les string links d'une structure d'ensemble (co)cyclique. Ceci est inspiré par les constructions bar cycliques tressées associées à la coend d'une catégorie enrubannée, qui est une algèbre de Hopf catégorique. De plus, nous montrons que la famille des surfaces fermées orientées de genre g admet une structure d'objet (co)cyclique dans la catégorie des 3-cobordismes. Par conséquent, toute TQFT de dimension 3 induit un espace vectoriel (co)cyclique. Nous le calculons algébriquement pour la TQFT de Reshetikhin-Turaev.