



HAL
open science

Effect of particulate emissions from road transportation vehicles on health of communities in urban and rural areas, Kano State, Nigeria

Aishatu Abubakar Sadiq

► **To cite this version:**

Aishatu Abubakar Sadiq. Effect of particulate emissions from road transportation vehicles on health of communities in urban and rural areas, Kano State, Nigeria. Environment and Society. Université Claude Bernard - Lyon I, 2022. English. NNT : 2022LYO10007 . tel-03963351

HAL Id: tel-03963351

<https://theses.hal.science/tel-03963351>

Submitted on 30 Jan 2023

HAL is a multi-disciplinary open access archive for the deposit and dissemination of scientific research documents, whether they are published or not. The documents may come from teaching and research institutions in France or abroad, or from public or private research centers.

L'archive ouverte pluridisciplinaire **HAL**, est destinée au dépôt et à la diffusion de documents scientifiques de niveau recherche, publiés ou non, émanant des établissements d'enseignement et de recherche français ou étrangers, des laboratoires publics ou privés.



N°d'ordre NNT: 2022LYO10007

**THESE de DOCTORAT DE
l'Université Claude Bernard Lyon 1**

Ecole Doctorale 162

Mécanique, Energétique, Genie civil, Acoustique

Discipline: Thermique et Energétique

Soutenue publiquement le 26/09/2022, par:

Aishatu Abubakar SADIQ

**Effect of Particulate Emissions from Road
Transportation Vehicles on Health of
Communities in Urban and Rural Areas, Kano
State, Nigeria**

Devant le jury composé de :

Giroir - Fendler, Anne	Professor	Universitè Lyon 1	<i>Présidente</i>
Ali - Khodja, Hocine	Professor	Universitè Frères Mentouri Constantine, Algeria	Rapporteur
Haddou, M	Professor	IRMAR-INSA Rennes	Rapporteur
Mashi, Sani Abubakar	Professor	University of Abuja, Nigeria	Examinateur
Khaldi, Salah	Researcher	Universitè Gustave Eiffel	Directeur de thèse
Trunfio -Sfarghiu,	Researcher	CNRS-INSA Lyon	Co-directrice de thèse
Ana - Maria			
Lazar, Adina- Nicoleta	Researcher	INSA Lyon	Invitee
Magbagbeola, D. Dairo	Assoc. Prof	University of Ibadan, Nigeria	Invité
Vincent, Michel	Professor	Minapath Laboratories	Invité

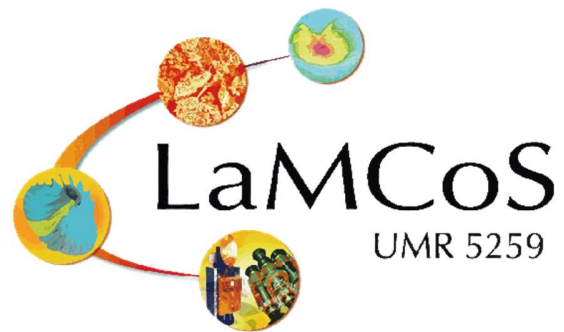

This multi-disciplinary research was conducted in partnership with the Nigerian Institutions (Federal Road safety corps, Kano State Government and Petroleum Technology Development Fund) and French research Laboratories shown above.

This work has been performed in the research institute directed by Than Minh Do:
Environment, transportation and health
Universit  Gustave Eiffel, Bron Campus
25 Avenue Francois Mitterand, Lyon, France

And

IMBL within Contacts and mechanic structures Laboratory (LamCos) directed by Nathalie Bernoud-Hubac
University of Lyon, CNRS, INSA Lyon, LamCos UMR5259, 69621, Villeurbanne,
France.

Universit  Claude Bernard – LYON 1

Pr�sident de l'Universit�	M. Fr�d�ric FLEURY
Pr�sident du Conseil Acad�mique	M. Hamda BEN HADID
Vice-Pr�sident du Conseil d'Administration	M. Didier REVEL
Vice-Pr�sident du Conseil des Etudes et de la Vie Universitaire	M. Philippe CHEVALLIER
Vice-Pr�sident de la Commission de Recherche	M. Petru MIRONESCU
Directeur G�n�ral des Services	M. Pierre ROLLAND

COMPOSANTES SANTE

D�partement de Formation et Centre de Recherche en Biologie Humaine	Directrice : Mme Anne-Marie SCHOTT
Facult� d'Odontologie	Doyenne : Mme Dominique SEUX
Facult� de M�decine et Ma�eutique Lyon Sud - Charles M�rieux	Doyenne : Mme Carole BURILLON
Facult� de M�decine Lyon-Est	Doyen : M. Gilles RODE
Institut des Sciences et Techniques de la R�adaptation (ISTR)	Directeur : M. Xavier PERROT
Institut des Sciences Pharmaceutiques et Biologiques (ISBP)	Directrice : Mme Christine VINCIGUERRA

COMPOSANTES & DEPARTEMENTS DE SCIENCES & TECHNOLOGIE

D�partement G�nie Electrique et des Proc�d�s (GEP)	Directrice : Mme Rosaria FERRIGNO
D�partement Informatique	Directeur : M. Behzad SHARIAT
D�partement M�canique	Directeur M. Marc BUFFAT
Ecole Sup�rieure de Chimie, Physique, Electronique (CPE Lyon)	Directeur : G�rard PIGNAULT
Institut de Science Financ�re et d'Assurances (ISFA)	Directeur : M. Nicolas LEBOISNE
Institut National du Professorat et de l'Education	Administrateur Provisoire : M. Pierre CHAREYRON
Institut Universitaire de Technologie de Lyon 1	Directeur : M. Christophe VITON
Observatoire de Lyon	Directrice : Mme Isabelle DANIEL
Polytechnique Lyon	Directeur : Emmanuel PERRIN

Abstract

Emerging African countries are characterized by explosive population growth and urbanization, which threaten environmental sustainability. This comparative cross sectional study of rural and urban sites/communities investigated the impact of vehicular emissions on air pollution/quality and respiratory health. We characterized ambient aerosols, assessed cytotoxicity, administered structured questionnaires and key informant guides, conducted respiratory assessments and reviewed road transportation data.

Twenty-four air samples were collected at high and low-density traffic sites using polysulfone and stainless steel filters attached to an automated pump. The physico-chemical properties of particulate matter were determined using scanning electron microscopy and energy dispersive X-ray analysis (SEM-EDX). In vitro, toxicity was assessed using macrophages and cell fixation with staining. 150 adult respondents and 30 children comprised the study population. Structured interviewer administered questionnaire were used. Clinical respiratory examination and digital Spirometry were conducted. For the qualitative study, Thirty-five (35) respondents from multidisciplinary agencies were selected using purposive sampling. Informed written consent was obtained from all respondents in the language of choice; Hausa or English. All data were analyzed using thematic areas with Epi info statistical software version 7 (CDC Atlanta).

Results showed 51.7% of particles as PM 2.5, with the highest particle concentration in mixed sites (urban and industrial). Particle classification into four groups by elemental composition and structure showed: sand particles (Si, Al, Fe, Ca, Mg, K, Na, Mo, Sr, Zr) 30–51 %; other fibers 0–3%; other particles (Si, Fe, S, Mo, Zn, and other metals) 22–40%; and silicone-based fibres 23-34%. The abundant elements are: Si, Al, Ca, Ce, Ti, Fe, Cl, Pb, and Mn. The lowest viability on cytotoxicity assessment was recorded in mixed site M2. The majority of households were located within 50 meters of air sampling sites. Proximity to traffic sites worsens health, as evidenced in cytotoxicity findings. The quantitative study showed; Mean age: (36.3± 12.9 years), Linear height: (median 1.65, range: 1.40 – 1.86). Male: female ratio 1:1 among adults. Average Distance of households to roads/highway: 36.03±23.79 meters and prevalent duration of daily transit 2- 5 hours. In urban settlements: distance to highway/road <50 meters (OR 32.4, 95% CI: 8.57-122.3) and Non-use of protective devices (OR: 12.43, 95% CI: 2.60-59.34) showed significant associations. Twenty two (22) Spirometry results were within the obstructive index, with majority of abnormalities as Stage 2. Results for Spirometry in children were normal for age and sex. Respondents reside in close proximity to highways/ roads, Stakeholders indicated a need for improved enforcement of regulations and legislation regarding transportation and health.

We recommended improved public awareness on air pollution and sources, introduction of large capacity public transport vehicles, improved urban planning, intensification of emissions control, use of greener sources of energy and increased focused research to facilitate improving environment and health policy.

KEY WORDS: Emissions, Environment, health, Particles, Pollution, respiratory, transportation, Vehicles

Résumé

Les pays africains émergents sont caractérisés par une croissance démographique et une urbanisation explosives, qui menacent la durabilité environnementale. Cette étude transversale comparative de sites/communautés rurales et urbaines a examiné l'impact des émissions de véhicules sur la pollution/qualité de l'air et la santé respiratoire. Nous avons caractérisé les aérosols ambiants, évalué la cytotoxicité, administré des questionnaires structurés et des guides d'informateurs clés, effectué des évaluations respiratoires et examiné les données relatives au transport routier.

Vingt-quatre échantillons d'air ont été prélevés sur des sites à forte et à faible densité de trafic à l'aide de filtres en polysulfone et en acier inoxydable fixés à une pompe automatisée. Les propriétés physico-chimiques des particules ont été déterminées à l'aide de la microscopie électronique à balayage et de l'analyse par rayons X à dispersion d'énergie (SEM-EDX). In vitro, la toxicité a été évaluée en utilisant des macrophages et la fixation des cellules avec coloration. 150 adultes et 30 enfants ont constitué la population étudiée. Un questionnaire structuré administré par un enquêteur a été utilisé. Un examen clinique respiratoire et une spirométrie numérique ont été réalisés. Pour l'étude qualitative, trente-cinq (35) répondants d'agences multidisciplinaires ont été sélectionnés par échantillonnage raisonné. Un consentement écrit et éclairé a été obtenu de tous les répondants dans la langue de leur choix : haoussa ou anglais. Toutes les données ont été analysées en utilisant des zones thématiques avec le logiciel statistique Epi info version 7 (CDC Atlanta).

Les résultats ont montré que 51,7 % des particules étaient des PM 2,5, la concentration de particules la plus élevée étant observée dans les sites mixtes (urbains et industriels). La classification des particules en quatre groupes selon leur composition élémentaire et leur structure a montré : particules de sable (Si, Al, Fe, Ca, Mg, K, Na, Mo, Sr, Zr) 30-51 % ; autres fibres 0-3 % ; autres particules (Si, Fe, S, Mo, Zn et autres métaux) 22-40 % ; et fibres à base de silicone 23-34 %. Les éléments abondants sont : Si, Al, Ca, Ce, Ti, Fe, Cl, Pb et Mn. La viabilité la plus faible sur l'évaluation de la cytotoxicité a été enregistrée dans le site mixte M2. La majorité des ménages étaient situés à moins de 50 mètres des sites d'échantillonnage de l'air. La proximité des sites de trafic détériore la santé, comme le montrent les résultats de la cytotoxicité. L'étude quantitative a montré que l'âge moyen était de 36,3± 12,9 ans et que la taille linéaire était de 1,65 (médiane, fourchette : 1,40-1,86). Rapport homme/femme 1:1 parmi les adultes. Distance moyenne des ménages par rapport aux routes/autoroutes : 36,03±23,79 mètres et durée prévalente du transit quotidien : 2 à 5 heures. Dans les zones urbaines, la distance aux routes/autoroutes <50 mètres (OR 32,4, IC 95% : 8,57- 122,3) et la non-utilisation de dispositifs de protection (OR : 12,43, IC 95% : 2,60-59,34) ont montré des associations significatives. Vingt-deux (22) résultats de spirométrie se situaient dans l'indice d'obstruction, la majorité des anomalies étant au stade 2. Les résultats de la spirométrie chez les enfants étaient normaux pour l'âge et le sexe. Les intervenants ont indiqué qu'il était nécessaire d'améliorer l'application des règlements et de la législation concernant le transport et la santé.

Nous avons recommandé une meilleure sensibilisation du public à la pollution de l'air et à ses sources, l'introduction de véhicules de transport public de grande capacité, une meilleure planification urbaine, l'intensification du contrôle des émissions, l'utilisation de sources d'énergie plus vertes et une recherche plus ciblée pour faciliter l'amélioration de la politique environnementale et sanitaire.

MOTS CLÉS : Émissions, Environnement, santé, Particules, Pollution, respiratoire, transport, Véhicules

Acknowledgement

I wish to acknowledge my teachers and mentors through the course of my scientific career. My profound gratitude and appreciation is expressed to; Prof. Iliyasu (Consultant Pathologist), Dr. Innocent O. Okpe (Consultant Physician) and Dr. A. O Arenyeka (Public health consultant and Specialist-World Health Organization), Dr. Patrick Nguku (Past resident Advisor-NFELTP/CDC Nigeria), Dr. Shakir Balogun (Resident Advisor-NFELTP/CDC) and Prof. Gabriele Poggensee formerly of the Nigeria Field Epidemiology and Laboratory Training Programme of the US-CDC for their immeasurable guidance and support in my research training.

I appreciate Prof. Aldo Campana, Dr. Venkratamanan Chandra-Mouli, Dr. Raqibat Idris, Fionna Poon and Dr. Karim Abawi of the World Health Organisation Head Office, Geneva-Switzerland for serving as a constant network for perusal of Global health related research. I acknowledge Mylene Noual and Meera Behren of the Global Youth Village, Bedford, Virginia, United States of America and Jennifer Tabola of the United Nations for their Leadership skills and invaluable training in multi-cultural understanding and academic excellence.

My profound gratitude also goes to the Ministry of Health (MoH) - Kano State, Federal Road Safety Corps (FRSC), Nigeria and the People of Kano State for their support and partnership during the field work phase of this International Collaborative research work. I also appreciate the Kaduna State Ministry of health & human services and its leadership for their willingness to support my multi-disciplinary research sojourn, among whom is the current commissioner of health and my senior colleague; Dr. Amina Baloni.

I humbly acknowledge and express my gratitude to my Academic supervisors; Dr. Salah Khardi and Dr. Ana-Maria Trunfio-Sfarghiu, with partial support from Dr. Michel Vincent for accepting my initial proposal and sacrificing their time and expertise to ensure successful completion. I appreciate Adina-Nicoletta Lazar and Nathalie Bernoud-Hubac for their support with experimental work and protocol development for this thesis.

I acknowledge Mrs. Illo & Mrs. Madawaki (Spouses of Nigerian Interpol Officers at Interpol Office, Lyon) for providing a network of compatriots in a foreign Country, also Ibrahim, Isah, Joseph, Idris and Niyi fellow Petroleum Technology Development Fund (PTDF) Scholars who via an informal “support group” have provided a support system to discuss challenges and peculiarities of research work as a foreign student. Your presence and consistency has made this journey possible.

I also acknowledge my Late Grandmother (Hajiya Yarbaba Adamu) a woman who despite being born and living in a conservative, male dominated society chose to be liberated. Her lifelong dedication to ensuring female rights within her family and society has served as a model for us all. She proved a template for strength, nurturing and growth in the midst of any obstacles. I am grateful for her as a mentor, her guidance throughout my life and her Legacy as a family member. I acknowledge my Mother Mrs. Hadiza Mailafia (Past Minister of Environment for Nigeria/ Proprietress Legacy School-Kaduna State, Nigeria) for proving hard work and dedication can surmount multiple challenges and being female is not a handicap.

Above all I wish to appreciate and pay homage to My Father; Dr. Abubakar-Sadiq Adamu (Ciroman Maigana) who turned his natural talent, faith and intelligence despite being orphaned into Global excellence. His inherent determination to ensure his children have access to best of education and Global Knowledge has enabled our achievements. Thank you “Baba” for showing the way and enabling us to follow in your path.

Finally, I acknowledge my siblings who served as my “muses” in all creative and academic endeavours. Your presence and the in-house humor and wit are incomparable.

Table of Contents

Introduction	12
Research Questions.....	16
Study Objectives.....	17
Chapter One: State of the Art.....	18
1.0. Petroleum Production and Utilization in Nigeria	23
1.1. Air Pollution	27
1.1.1. Sulphur oxides and Sulfur dioxide.....	34
1.1.2. Ozone, photochemical oxidants and Carbon monoxide.....	35
1.1.3. Nitrogen oxides	35
1.1.4. Lead and other heavy metals.....	36
1.2. Meteorological effects and greenhouse effect.....	41
1.3. Greenhouse Effect and Climate Change.....	44
1.4. Mineral Dust	47
1.5. Natural dust and its effect in Nigeria.....	51
1.6. Dust resuspension	59
1.7. Health effects of particulate pollution	63
1.8. Human respiratory system: embryology, anatomy and physiology	66
1.8.1. Development of the thoracic cavity and diaphragm	67
1.8.2. Anatomy of the Respiratory system.....	72
1.8.3. Physiology of Respiration.....	73
1.8.3.1. Pulmonary volumes	76
1.8.3.2. Pulmonary capacities	76
1.9. Enrichment Factor Analysis	77
2.0. Scanning Electron Microscopy.....	80
2.1. Spectroscopy.....	82
Chapter Two: Materials and Methods	86
1.0. Study Area	86
1.1. Study Design.....	89
1.2. Air sampling and cytotoxicity studies	90

1.3. Scanning Electron microscopy and energy dispersive X-ray analysis	94
1.4. Particle Extraction for cytotoxicity studies	97
1.5. Cell Culture.....	98
1.6. 3-(4, 5-dimethylthiazol-2-yl)-2, 5-diphenyltetrazolium bromide testing	98
1.7. Cell Fixation and Staining using 4', 6-diamino-2-phenylindole	99
1.8. Fluorescence Microscopy	99
1.9. Structured interviewer administered questionnaire (quantitative) and clinical respiratory assessment	100
1.9.1. Experimental protocol.....	100
1.9.2. Study variables.....	100
1.9.3. Sampling	101
1.9.4. Subject of the study.....	101
1.9.5. Inclusion and exclusion criteria	101
1.9.6. Data collection	102
2.0. Respiratory examination and Spirometry	102
2.0.1. Testing Procedure for Spirometry.....	104
2.0.2. Determination of standard FEV1 and FEV1/FEV6 ratio values.....	105
2.1. Statistical Analysis	105
2.2. Ethical Considerations	106
2.3. Limitations.....	106
2.4. Key Informant Interviews (qualitative component)	106
2.5. Secondary Review and Analysis of Road Transportation Data (2016-2019).....	108
2.6. General Study Limitations.....	108
Chapter Three: Results.....	110
1.0. Scanning Electron Microscopy and EDX Results.....	110
1.1. The Result of the Cytotoxicity Assessment by the MTT Assay.....	123
1.2. Results of Cellular Viability using DAPI Staining.....	123
1.3. Results of Standardized Questionnaires and Clinical Respiratory Assessment	126
1.3.1. Demographic information	126
1.4. Results of Key Informant Interviews.....	135
1.4.1. Vehicular use and safety in relation to emissions	135

1.4.2. Legislation and regulation of vehicular emissions.....	138
1.4.3. Industrial emissions and environment	139
1.4.4. Respiratory diseases, health education and Public health campaigns on non-communicable diseases in Nigeria.....	140
1.4.5. Air quality and its control	141
1.4.6. Role of Stakeholders in Air pollution control in Nigeria and Africa.....	142
1.5. Results of Secondary Data Review and Analysis.....	145
Chapter Four: Discussion	148
Recommendations	166
Conclusion	172
Bibliography	174
Appendices	202

Table of Figures

<i>Figure 1: A multidisciplinary Comparison of projected population sizes 1950-2100 (World Population Prospects, 2019).....</i>	<i>19</i>
<i>Figure 2: Air pollutants by site produced as by-products of combustion from road transportation Vehicles [6].....</i>	<i>20</i>
<i>Figure 3: Diagram of internal combustion which converts liquid fuel to energy (Timothy, 2003)</i>	<i>21</i>
<i>Figure 4: Location of Nigerian Oil and Petrochemical Industries (Odeyemi & Ogunseitan, 1985).....</i>	<i>25</i>
<i>Figure 5: Interplay of pollution and health showing conversion processes of air pollutants (EEA, 2015) 31</i>	
<i>Figure 6: Processes of atmospheric particle evolution: nucleation, condensation, coagulation and deposition (Whitby, Kittleson, Cantrell, Barsic, & Bolan.DF, 1976).</i>	<i>32</i>
<i>Figure 7: Annual average PM 2.5 concentration in cities estimated from surface monitoring and Global burden of disease (GBD2010) model (Krzyzanowski, Bonjour, Brauer, Cohen, & Pruss-Ustin, 2014).....</i>	<i>40</i>
<i>Figure 8: Biofuel production potential (Von Braun, 2007). Sources: data on food insecurity are from FAO (2006). The land availability index is derived by the author based on data from FAO (2007); IEA (2007a, b); and USDA (2006). Data on water availability are from WRI (2007) (Bessou, 2011).....</i>	<i>46</i>
<i>Figure 9: Overview of potential source areas in northern hemispheric Africa (PSANAF), different lines and colors represent analyses outcomes by different authors based on differing data sources and techniques (shown in Legend inset), illustrating the challenge of identifying dust sources with accuracy. 53</i>	
<i>Figure 10: North African Sand storm survey (NASCube) taken respectively (a) and (f) at 9:00 am and 3:00pm on 7th march 2020 are shown, land in brown and surface ocean in black. Spinning Enhanced Visible and Infrared Imager (SEVIRI) images are shown respectively; (b) and (c) Northern Nigeria in February 2020, (d) and (e) West African region in Late February 2020 and (g),(h) and (i) West Africa region in Early March. Dust and cloud features are seen in pink and dark colors.</i>	<i>54</i>
<i>Figure 11: Horizontal visibility over Nigeria on 9th December, 2021(Source: NiMet).</i>	<i>56</i>
<i>Figure 12 a & b: In these figures mean visibility values are shown in meters for (a) February and (b) March 2020, the period of our study in Kano State (Source: NIMET).</i>	<i>57</i>
<i>Figure 13: Linkages between mineral dust aerosol and climate, indicating direct and indirect aerosol effects, and the role of oceanic dust deposition ecosystems (Ajayi, 2021).</i>	<i>58</i>
<i>Figure 14: Key events and cells involved in inflammation and repair (Kumar, Abbass, Fausto, & Mitchell, 2007).....</i>	<i>64</i>
<i>Figure 15: Development of the Lungs and diaphragm: (a) Pleuroperitoneal folds appear at the beginning of the fifth week (b) Pleuroperitoneal folds fuse with the septum transversum and mesentery of the esophagus in the seventh week, which separate the abdominal cavity from the thoracic cavity (c) Transverse section during the fourth month of development, with the body wall forming the periphery of the diaphragm (Sadler, 2012).....</i>	<i>67</i>
<i>Figure 16: Development of the ribs and sternum. A, The costal processes of the vertebrae elongate in the fifth week to form the ribs. Late in the fifth week, the costovertebral joints form and separate the ribs from the vertebrae. B, paired mesenchymal condensations called sternal bars form within the ventral body wall at the end of the sixth week. These bars quickly fuse together at their cranial ends, while their lateral edges connect with the distal ends of the growing ribs. The sternal bars then fuse across the midline in a cranial-to-caudal direction. Ossification centers appear within the sternum as early as sixty days, but the xiphoid process does not ossify until birth (Schoenwolf, Bleyl, Brauer, & Francis-West, 2015).</i>	<i>69</i>
<i>Figure 17: Topography of the Lungs (anterior and posterior views) (Netter, 2019).</i>	<i>72</i>
<i>Figure 18: Progressive cellular transition from the conducting airways to alveoli, epithelial layer transitions also occur from pseudostratified with submucosal glands to cuboidal and then squamous</i>	

<i>epithelium. The underlying mesenchyme tissue and capillaries also undergo changes (Barett, Barman, Brooks, & Yuan, 2019).</i>	74
<i>Figure 19: Changes in lung volume, alveolar pressure, pleural pressure and transpulmonary pressure during normal breathing (Hall, 2016).</i>	75
<i>Figure 20: Diagrammatic representation of respiratory excursions during normal breathing and during maximal inspiration and maximal expiration (Hall, 2016).</i>	77
<i>Figure 21: Map of Africa with Nigeria highlighted in green as a country. The study area; Kano state (North-west) in blue showed the highest number of registered vehicles in; Kano Municipal and Nassarawa LGAs: >1000, Dala/fagge/gwale/tarauni: 500-1000, Other LGAs: 1-500.</i>	87
<i>Figure 22: The Nigerian Map shows Kano State (light blue) and an enlarged map of Kano State showing population density, study areas, and the state capital, Kano Municipal Local Government Area.</i>	89
<i>Figure 23: Schematic showing instruments used during air sample collection.</i>	92
<i>Figure 24: Recorded Temperature and Wind speed at sample collection Sites in Comparism to average values recorded for the sites (2015-2021) by the Nigeria meteorological agency (NIMET).</i>	94
<i>Figure 25: Schematic of the scanning electron microscope (Purdue Univeristy, 2018).</i>	95
<i>Figure 26: Chemical structure of Reduced Nicotinamide adenine dinucleotide phosphate (NADPH).</i>	99
<i>Figure 27: This show the SEM-EDX Imaging: (a) The appearance of the carbon adhesive disc particles is consistent for all collection sites (b) a large sand particle is present in the peripheral zone (c), (g), (i) visualization of central areas, concentrated in particles: (c) mixed site, (g) urban site, (i) rural site; (h) global EDX analysis over the entire area of the image with compound showing in red the Si-based particles and in green the C-based particles. Details of silicone (Si) wicks observed in different sites: (d) urban site (e) mixed site (f) rural site. (j), (k), (l) – EDX spectra associated with images (b), (e) and (h)</i>	111
<i>Figure 28: The number-size distribution of Particles from twelve sampling sites in three local Government Areas.</i>	112
<i>Figure 29: Site specific histograms of particles using equivalent surface ratio (ESR).</i>	113
<i>Figure 30: Site specific histograms showing particle distribution by equivalent circle diameter (ECD).</i>	114
<i>Figure 31: Particle classification from all sites using an Equivalent Surface Ratio (ESR).</i>	115
<i>Figure 32: The classified particles are divided into four groups based on settlement: (a) urban, (b) mixed, and (c) rural. (d) A Comparism diagram of the ratio of Si fibers to sand for all sites.</i>	119
<i>Figure 33: (a) Mineralogy of particles with a size diameter of <2.5 µm from all collection sites; (b) Mineralogy of particles with a size diameter of 2.5 µm – <10 µm from all collection sites.</i>	120
<i>Figure 34: Particle composition within size range < 0.5 µm for (a) rural sites, (b) urban sites and (c) mixed sites, Kano State, Nigeria.</i>	122
<i>Figure 35: The mean and standard errors of MTT tests read at 570 nm absorbance for all sites.</i>	123
<i>Figure 36: Mean viability values and standard errors by DAPI analysis by site.</i>	124
<i>Figure 37: Typical DAPI staining of macrophages in control or particle-exposed conditions in some sites illustrates intense DAPI staining (saturation) due to intense internalization of the dye along with nuclear condensation; note the lower cellular density for the M2 site, corresponding to higher cell death.</i>	124
<i>Figure 38: A comparism of mean viability values for high (blue) and low (red) traffic sites, (a) DAPI, (b) MTT.</i>	125
<i>Figure 39: Results of Spirometry among adult respondents with staging of obstructive index.</i>	130
<i>Figure 40: Distribution of Road Transportation Vehicles in Kano State’s rural and urban settlements.</i>	133
<i>Figure 41: Sex distribution of Stakeholders from inter-disciplinary agencies.</i>	135
<i>Figure 42(a-f): Stakeholders perception on car ownership, emission sources, traffic regulation, transit duration and traffic regulation and stakeholder participation.</i>	137
<i>Figure 43 (a & b): Knowledge among stakeholders on Legislation/regulation of vehicular emissions and Respiratory diseases, health education and campaigns.</i>	139

Figure 44: A distribution by Sex of Registered owners of Road Transportation Vehicles in Kano State, Nigeria (2016-2019)..... 145

Figure 45: Trend of Vehicular registration data in Kano State, Nigeria 2016- 2019. 146

List of Tables

<i>Table 1: Principal pollutants and sources of outdoor and indoor air pollution (WHO, 2000b)</i>	30
<i>Table 2: Common air pollutants and their sources (Fahmy, Y.M.; Fornaseiro, P.; Zinoviev, S.; Miertus, S., 2007)</i>	34
<i>Table 3: Stages of Human Lung Development, adapted from (Schoenwolf, Bleyl, Brauer, & Francis-West, 2015).</i>	71
<i>Table 4: The names, nature, traffic density and pollution sources at air sampling sites in Kano State- Nigeria.</i>	93
<i>Table 5: Distances between households (HH) and air sampling sites in three local government areas in Kano State, Nigeria.</i>	121
<i>Table 6: Respondents' socio-demographic characteristics of respondents in both rural and urban areas of Kano State, Nigeria.</i>	127
<i>Table 7: Height and Ventilatory parameters by sex and settlement type for adults in selected LGAs of Kano State, Nigeria.</i>	129
<i>Table 8: Bivariate analysis of factors associated with respiratory abnormalities due to air pollution in selected rural and urban areas of Kano State, Nigeria.</i>	131
<i>Table 9: Output of Logistic regression for selected variables.</i>	132
<i>Table 10: Parameters obtained on Spirometry in children in Kumbotso (Urban) LGA of Kano State , Nigeria.</i>	134
<i>Table 11: Respondents Knowledge on Air Quality and emissions.</i>	142
<i>Table 12: Quality/adequacy of road Infrastructure on used roads.</i>	144
<i>Table 13: Driving experience and knowledge of fuel sources.</i>	145

List of Appendices

<i>Appendix 1: A1-A3 Site Maps.</i>	202
<i>Appendix 2: Feature measurements and Particle Morphological parameters.</i>	205
<i>Appendix 3: Structured Interviewer administered Questionnaire.</i>	208
<i>Appendix 4: Ethical approval letter</i>	221
<i>Appendix 5: Consent forms for questionnaire and Key Informant guide.</i>	222
<i>Appendix 6: Key Informant Interview (KII) Guide.</i>	224
<i>Appendix 7: Air Sampling and Field work Pictures.</i>	238
<i>Appendix 8: Table A1-A4 on experimentation steps.</i>	240
<i>Appendix 9: Publications, Conferences and Written communications.</i>	245

Abbreviations

Al: Aluminium
AOD: Aerosol Optical depth
AQI: Air Quality Index
BEVs: Battery powered electric Vehicle
BSE: Backscattered electron
Ca: Calcium
CaSO₄: Calcium Sulphate
CCN: Cloud Condensation Nuclei
Cd: Cadmium
CD4: Cluster of Differentiation 4
CDC: Centers for Disease Control
Ce: Cerium
CECs: Combustion Engine Cars
CH₄: Methane
CI: Confidence Interval
Cl: Chloride
CO₂: Carbon dioxide
CO: Carbon Monoxide
CV: Coefficient of Variation
COPD: Chronic Obstructive Pulmonary Disease
Cr: Chromium
Cu: Copper
DAPI: 4, 6 diamino-2-phenylindole
DEP: Diesel Engine Particles
DMEM: Dulbecco's modified Eagles medium
DNA: Deoxyribonucleic Acid
DPBS: Dulbecco's phosphate buffered saline
DPH: Director of Public health
EC: European Commission
ECD: Equivalent circle diameter
EEA: European Environment Agency
EF: Enrichment Factor
EIA: Environmental Impact Assessment
EMV: Electric Motor Vehicle
EPA: Environment Protection Agency
ESR: Equivalent surface ratio
EtOH: Ethanol Alcohol
EU: European Union
FEV₁: Forced vital capacity
FEV_{0.5}: Forced expiratory volume in 0.5 seconds
FEV₆: Forced expiratory volume
FEV₁/FEV₆: Ratio of forced vital capacity to forced expiratory volume
FBS: Fetal bovine serum
Fe: Iron

Fe₂O₃: Hematite Iron
FIA: Flow injection Analysis
FRSC: Federal Road Safety Corps
GBD2010: Global Burden of Disease 2010
GDP: Gross Domestic Product
GHG: Greenhouse Gas
HC: Hydrocarbon
HDEs: Heavy Duty Engine
HFCs: Hydrofluorocarbons
H₂S: Hydrogen sulfide
Hg: Mercury
HH: Household
HM: Heavy Metals
IgA: Immunoglobulin A
ICE: Internal Combustion Engine
ICP: Inductively coupled Plasma
ICP-AES: Inductively coupled Plasma atomic Spectrometry
ICP-OES: Inductively coupled Plasma Optical emission spectroscopy
ICPMS: Inductively coupled Plasma Mass spectroscopy
IFN: Interferon
IL: Interleukin
ILUC: Indirect Land use Charge
IN: Ice Nuclei
ISC: In-service Conformity
ITCZ: Inter-tropical convergence Zone
K: Potassium
KII: Key Informant Interviews
LDVs: Light Duty Vehicles
LGA: Local Government Area
LBW: Low Birth Weight
LEZ: Low emission Zones
LV: Low vacuum
M: meters
ME 2: Multi-linear Engine
MMP: Metallo-matrix Protein
Mg: Magnesium
MgCO₃: Dolomite
Mn: Manganese
Mo: Molybdenum
MoE: Ministry of Environment
MoH: Ministry of health
mRNA: Messenger Ribonucleic Acid
MTT: 3-(4, 5-dimethylthiazol-2-yl)-2, 5-diphenyltetrazolium bromide
Na: Sodium
NP: Nanoparticle
NEE: Non Exhaust Emission
NEDC: New European Driving Cycle

NCD: Non-communicable Disease
NEDC: New European Driving Cycle
NESREA: National Environmental Standards and regulation Agency
NHANES: National health and nutrition examination survey
Ni: Nickel
NIMET: Nigerian Meteorological Agency
NRR: Non-response rate
NSAID: Non-steroidal anti-inflammatory drugs
NURTW: National Union of Road Transportation Workers
NESREA: National Environmental Standards Regulatory Agency
NH3: Ammonia
NO: Nitric Oxide
NOx: Nitrogen oxide
OECD: Organization for Economic cooperation and Development
OPEC: Organization of Petroleum Exporting Countries
OR: Odds Ratio
O2: Oxygen
O3: Ozone
P: Phosphorous
PAN: Peroxyacetyl Nitrate
Pb: Lead
PBS: Phosphate Buffered saline
PM: Particulate Matter
PM10: Particulate Matter less than 10 μ m
PM2.5: Particulate matter less than 2.5 μ m
PAH: Polycyclic Aromatic Hydrocarbons
PAN: Peroxyacetyl Nitrate
Pb: Lead
PEF: Peak expiratory flow
PEMs: Portable emissions monitoring device
PFCs: Polyfluorinated chemicals
PGCs: Primordial Germ Cells
PHEVs: Plug-in hybrid electric Vehicle
PM: Particulate Matter
PMF: Positive Matrix Factorization
PSANAF: Potential Source areas in North Africa
RD: Resuspended Dust Particles
RDE: Real driving emission
REE: Rare Earth element
RH: Relative Humidity
RNA: Ribonucleic Acid
ROS: Reactive Oxygen Species
RR: Relative Risk
RTWUR: Representative of Road Transportation Workers Union
S: Sulfur
SAL: Saharan Air Layer
Sc: Scandium

SD: Standard Deviation
Se: Selenium
SE: Standard Error
SEM-EDX: Scanning electron Microscopy and energy dispersive x-ray analysis
SES: Socioeconomic Status
SEVIRI: Spinning Enhanced Visible and Infra-red Imager
SF6 : Sulphur Hexaflouride
Si: Silicone
SiO2 : Quartz
SOx: Sulfur oxide
SO2: Sulfur dioxide
SP : Surfactant Protein
SP-A : Surfactant protein A
SP-B: Surfactant protein B
SPM: Suspended Particulate matter
Sr: Strontium
STAT 4: Signal transducer and activator of transcription 4
SDS6HCL: Safety data sheet hydrochloric acid
TGF: Transforming Growth Factor
Ti: Titanium
Tio2 : Titanium Oxide
TPH : Total Petroleum Hydrocarbon
UFP: Ultrafine Particles
UN: United Nations
USEPA: United States Environment Protection Agency
VOC: Volatile Organic Compounds
WD: Working distance
WHO: World Health Organization
Zr: Zirconium
Zn: Zinc

Introduction

The twentieth century saw an increase in the human population, due to medical advances and massive increases in agricultural productivity. The United Nations (UN) estimated that the world's population was growing at a rate of 1.14 %, about 75 million people per year in 2012 (Grande, 2012). By 2050, the world population is projected to be 7.4–10.6 billion. Differing environmental standards and costs for remediation have caused the relocation of pollution-intensive industries from strictly controlled countries to those with few or no standards by creating “pollution havens”. Air pollution in the United States has decreased steadily since the 1970s, in contrast to developing countries (Anthony, Anderson, Maginn, & Brennecke, 2005; Bidwe, Mayer, Hawthorne, Charitos, Schuster, & Schenecht, 2011). Despite increasing evidence relating air pollution to climate change and human health, control and regulatory measures have not been effective in all countries. A study showed vehicle emissions as the main source of volatile organic compounds in large cities (Koupal & Palacios, 2019; Shi, Zhang, Yang, Zhang, & Wang, 2019). Point sources of pollution are identified as mainly emissions from industries and vehicles, and they comprise a wide range of air pollutants.

The major pollutants from vehicles are carbon monoxide, nitrogen oxides, volatile organic compounds (VOCs) and particulates, Those from industries include; sulfur dioxide, nitrogen oxides, VOCs and particulates. The negative effects exerted by these pollutants vary from short-term to long-term effects on health and the environment; chronic exposure to sulfur dioxide results in repeated episodes of sinus infections, respiratory diseases, and breathlessness (emphysema). Dry deposition of air pollutants and wet/acid rain damage forests (Qian, 2009). The contribution of poor air quality to premature mortality and cardiovascular/respiratory diseases has been highlighted by several epidemiological studies (Lefranc, Pascal, Larrieu, Blanchard, Wagner, & Declercq, 2009; Sun, Hong, & Wold, 2010; Hoek, et al., 2013; Zivin & Neidell, 2018). Particulate matter is proven to have the most significant health impacts of all the air pollutants studied (Dockery, 2009; Massamba, Coppieters, Mercier, Collart, & Leveque, 2014). Additionally, aerosols play an important role in visibility degradation, cloud formation, scattering and absorption of solar

radiation and human health (Ramanathan, Crutzen, Leliveld, Mitra, & Althausen, 2001; Pope III & Dockery, 2006; Campos-Ramos, Aragon-Pina, Galindo-Estrada, Querol, & Alastuey, 2009).

Particle toxicity is inversely associated with size; deeper penetration into the respiratory tract and more significant health impacts are obtained with smaller particle sizes (Pope & Dockery, 2006; Valavanidis, A, Fiotakis, & Vlachogianni, 2008; Kumar, Pirjola, Ketznel, & Harrison, 2013; Stone, et al., 2017); and with their chemical composition. The ability of heavy metals associated with particulate matter such as cadmium (Cd), lead (Pb) and mercury (Hg) to produce toxicity (WHO, 2007), also transition metals such as iron (Fe), copper (Cu), zinc (Zn) and chromium (Cr), is due to the production of reactive oxygen species which induce oxidative stress in biological tissues (Wei, Wei, Yi, Zhang, & Ding, 2011).

Developed countries have continued to increase their energy demands while developing countries are experiencing greater affluence and progress, resulting in an increased energy demand in the entire world has reached unsustainable levels. At the same time, fossil fuels, which currently provide more than 85% of the total global energy supply, are limited and, in addition, their widespread use has significant adverse environmental consequences. Global population growth and industrialization have resulted in an increased demand for resources and transportation. Increasing urbanization, and industrialization, and the propensity of humans to live in clusters, added to the exponential population growth in the past decades, account for the great concern about air pollution. This is accountable for the emphasis on achieving effective pollution control and mitigating strategies to preserve human health and safety. This urbanization, rapid population growth, and increase in industrial activity will continue to contribute to environmental pollution (Kim, et al., 2015; Squizzato, Cazzaro, Innocente, Visin, Hopke, & Rampazzo, 2017). This growth in urban areas is attributed to easy access to amenities and job opportunities, with increased consumption of resources among the inhabitants of cities (Men, Liu, Wang, Guo, Miao, & Shen, 2019). For transportation, the negative effects it exerts and the consumption of resources are related to its contribution to sustainability (Touzi, Mabrouki, & Farchi, 2015). Developing countries seeking to improve industrialization and commercialization are experiencing a greater need for effective transportation (Schipper, Fabian, & Leather, 2009). The majority of goods and passengers in Africa (80–90%) are transported by road (Gwilliam & Bofinger, 2011). Despite slower industrialization in Africa compared to developed countries, there has been a recorded increase in

emissions (Pirrone, et al., 2010). Metropolitan African cities have grown exponentially (Emmanuel, 2015), with associated technical and data issues affecting transportation and its management (Jayashinge, Sano, & Nishiuchi, 2015). A limitation in the availability of pollution monitoring stations, equipment, funds, and human resources creates difficulty in the impact assessment of air pollution (Ishii, Bell, & Marshall, 2007). Industrial air pollution, in addition to affecting human health, also results in negative impacts on agricultural resources (Vlachokhostas, et al., 2010). Studies show vehicle emissions as the main source of volatile organic compounds (VOCs) in large cities (Koupal & Palacios, 2019). The increase in the number of vehicles in African countries has been linked to an increase in purchasing power and population size (Kingombe, 2014).

For rural communities, emission sources are dependent on the location of the communities, e.g., proximity to highways and biomass burning. Internationally, differing limits are set and enforced to ensure compliance with standards of regulation for air pollutants. Air pollution may still have health effects at levels below current standards (Barnett A. , Williams, Schwartz, Best, & Neller, 2012). Therefore, reductions in exposure to very low levels can still be expected to provide benefits (Crouse, Peters, Van Donkelaar, Goldberg, & Villeneuve, 2012). Within the developing world, motorization is expected to increase at an unprecedented rate (Schipper, Fabian, & Leather, 2009). The existence of this economic need, coupled with persisting infectious disease incidence results in a conflict of priorities, additionally confounded by political instability, dampening efforts at pollution mitigation and control. The contribution of transport to sustainable development depends on the resources it consumes, and the negative side effects it generates (Badr & Mabrouki, 2015). The presence of residential properties proximal to highways has been documented in various developing countries. This leads to increased exposure to consistent levels of pollutants produced by road vehicles. Multiple studies have revealed that the highest exposures normally occur at a distance ranging from 50 to 100 meters from roadways (Rosenlund, Picciotto, Forastiere, Stafoggia, & Perrucci, 2008).

The identified country specific problems which influenced the choice of this research topic include: a reported rapid increase in road transport vehicles; non-use of alternative fuel sources; and a decrease in air quality reported in country-level surveys. A rapid increase in the number of road

vehicles has been recorded between 2010 and 2019 in Nigeria, coupled with population expansion and rapid urbanization ([Federal Road Safety Corps, 2019](#)). Vehicle emissions can be of various types and concentrations, and determining the specific source of emissions is critical for implementing control and preventive measures.

Existing attempts at effective legislation have been largely unproductive, and evidence-based country-specific studies are critical. Research will serve to generate regional (Sub-Saharan and West-African) specific data on vehicular emissions, air pollution and human health. This study will fill the scarcity of published work in developing countries on air quality and health effects that indicate an approach based on curative rather than preventive medicine. It will also provide evidence for use in designing and strengthening preventive measures against the existing major sources of air pollution. Increasing evidence shows important determinants of growth outcomes in children occur in utero and during susceptible periods, including developmental years during their interaction with their immediate environment. Additionally, this study will generate data essential to developmental studies assessing environmental influences on child health.

- The first chapter presents a detailed state of the art on air pollution and factors affecting it such as meteorological conditions and invasion by natural phenomena's like dust storms. It examines the research area vis-à-vis existing/current environmental, scientific, transport and health literature and realities observed by other researchers. It also presents the embryological development, anatomy and physiology of the human respiratory systems which is majorly affected by air pollution.

-The second chapter describes the methodologies utilized in this multi-disciplinary study such as the measurement and sampling techniques used to view the research area in the context of; qualitative, quantitative and analytical research. In addition, it discusses the specifics of the four study components; secondary data analysis, key informant interviews (KII), structured interviewer administered questionnaires, clinical respiratory testing/examination and air sampling with subsequent cytotoxicity studies. It covers a detailed description of the study area/sites, field activities/trainings with a description of the instrumentation and experimental set-ups. The data processing techniques used for each study component are explained in detail and software used.

- The third chapter provides a detailed outline of the results obtained in each study component and illustrates the findings with graphs and charts to ease comprehension. Findings obtained from air sampling are presented in total and based on settlement types, as well as results of cytotoxicity testing. The meteorological findings on air sampling days, such as temperature and wind speed are illustrated. Additionally, comparison is shown for settlement types to highlight the differences and enable a strata wise understanding of the role of variables in each settlement type (rural, urban, and mixed).

-The fourth chapter deals with discussions on the results obtained their significance in relation to the research questions, and their implications in the context of existing global findings in the research area. Additionally, a look at the situation in relation to air pollution from vehicular emissions in developed regions is also taken; in this case, European countries are mainly reviewed. This is to show the impact of alternative regulatory and control measures on air pollution from transport sources based on economic levels and financial capabilities coupled with effective regulation.

- The fifth chapter is devoted to the recommendations based on the study findings to improve environmental and human health by improving preventive and control measures. It attempts to provide a country/region-tailored outline for impacting change while highlighting the success of such methods in other regions. This chapter concludes with a concise section wrapping up our observations as a “conclusion” and presents additional information within the appendices. The appendices contain; study instruments, publications or scientific outputs achieved, and supportive information such as maps.

Research Questions

The research questions for this study are; what are the differential characteristics of particulate emissions from road transportation vehicles in rural and urban communities? What population determinants affect respiratory health? On cytotoxicity assessment *in vitro* is there a differential effect?

Study Objectives

1. To identify and compare the characteristics and mineralo-pathological nature of exhaust and non-exhaust emission substances from road transportation vehicles.
2. To determine stakeholders knowledge and perceptions on road transportation, emissions and health.
3. To assess cytotoxicity of particulate pollutants to macrophages (*in Vitro*).
4. To compare levels of vehicular and industrial air pollutants between communities and assess air quality.
5. To evaluate respiratory function and previous history of acute and chronic respiratory disorders among residents in selected communities.

Chapter One: State of the Art

The global energy demand is variable and dependent on its different forms, commonly gaseous fuels, and electricity, solid and liquid fuels. The increasing demand dates to the industrial revolution with two determining factors: a) global population increase b) rising per capita energy demand as agrarian and impoverished society's transition to industrial and prosperous societies. It is apparent that there exists a direct relationship between the affluence of a nation and the average energy consumption of its citizens. Nations in the Organization for Economic Cooperation and Development group (OECD), which encompasses most of the industrialized and more affluent nations, have significantly higher gross domestic product (GDP) per capita and consume significantly more electricity per capita than developing nations ([International Energy Agency \(IEA\), 2009](#)). A more affluent society demands more goods and services, travels more, and typically has better public or private health care than a poorer society. Hence, citizens of affluent nations consume more energy.

In *figure 1*, shown below, the projected population growth till 2100 is shown for the three presently most populous countries; China, India, and Nigeria, in comparison to that of the United States. As a result, China alone is projected to experience a reduction in its upward growth trend as a result of existing and stringent measures on family size.

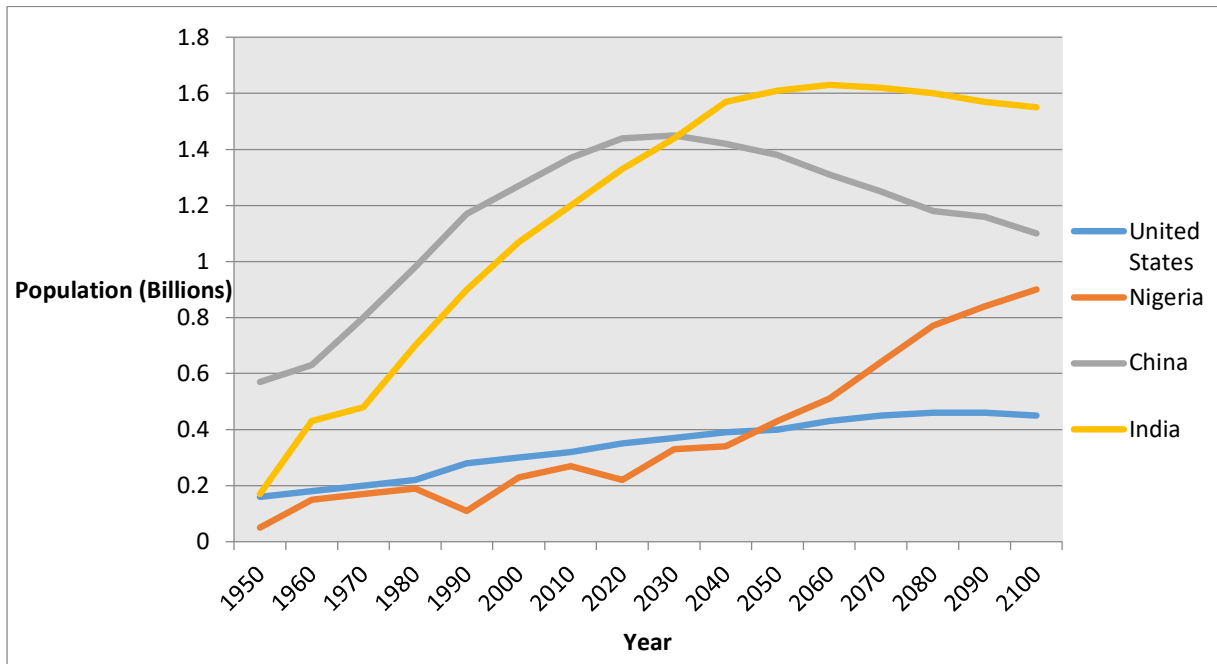

Figure 1: A multidisciplinary Comparison of projected population sizes 1950-2100 (*World Population Prospects, 2019*)

Energy sources exist in the natural environment and include fossil fuels (such as the various forms of coal, crude oil, and natural gas), nuclear fuels (such as uranium and thorium), and renewable energy forms (such as solar, wind, biomass, geothermal, wave, and hydroelectric energy). For example, the internal combustion engine consumes gasoline or diesel and produces work, which is used in propulsion (Efstathios, 2012). Variable concentrations and compositions of exhaust and non-exhaust emissions are produced by road transportation vehicles. The common sources of emissions vary from urban to rural areas; in urban settings, most sources are vehicular or industrial (Adeyanju & Manohar, 2017). Figure 2 below shows the main sites and emission substances from road transportation vehicles.

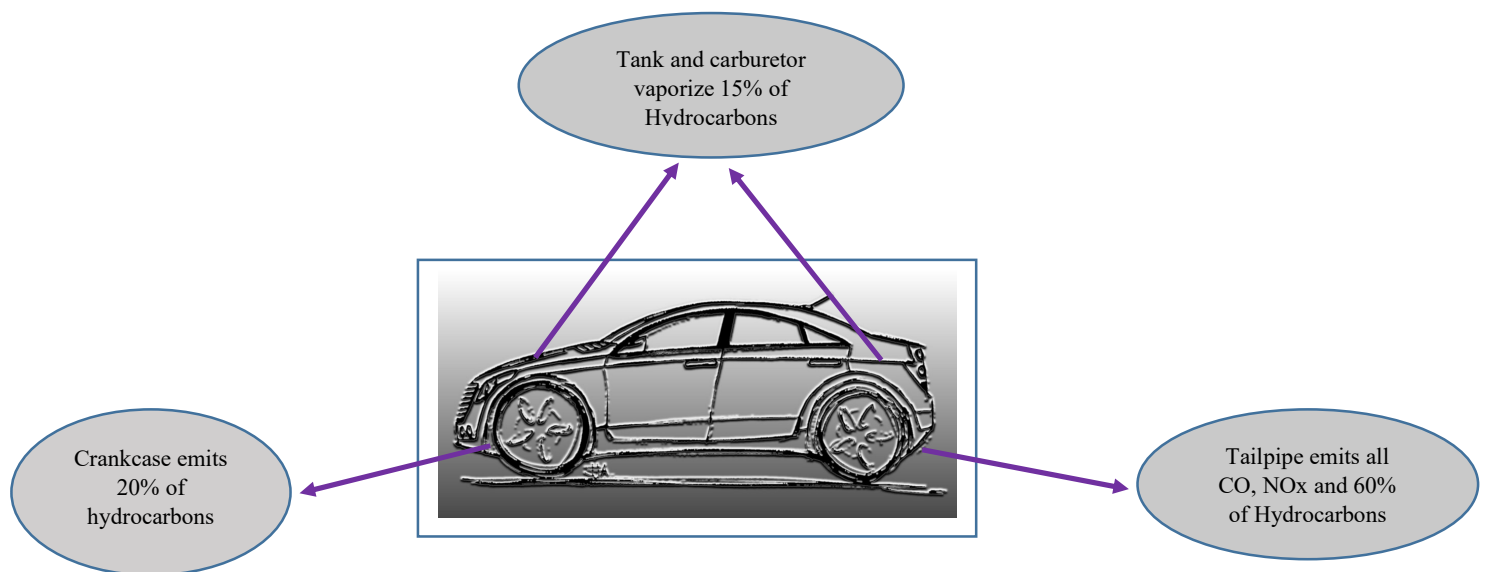

Figure 2: Air pollutants by site produced as by-products of combustion from road transportation Vehicles [6]

Currently, internal combustion engines are commonly used in road transportation vehicles. Improvement in the design of internal combustion engines, especially in such areas as combustion chamber geometry and fuels, has aided in reducing emissions (Olumide & Ademola, 2016; Olumide & Ademola, 2018; Olumide & Ademola AD, 2018). The use of synthetic fuels as a substitute for conventional fuels is expected to prove greener than the use of electric vehicles (Automation, 2017) Figure 3 below shows a labeled diagram of a typical internal combustion engine. A typical internal combustion engine contains two main sections. The largest one is the main piece which is the engine block located in the lower section. It houses the pistons, crankshaft, oil pump, connecting rods, and, if the engine has an “overhead valve”, also a camshaft. On top of the larger engine block is bolted the cylinder head (or heads), which contain exhaust and intake valves, in engines with an “overhead cam” design, the camshafts (Timothy, 2003).

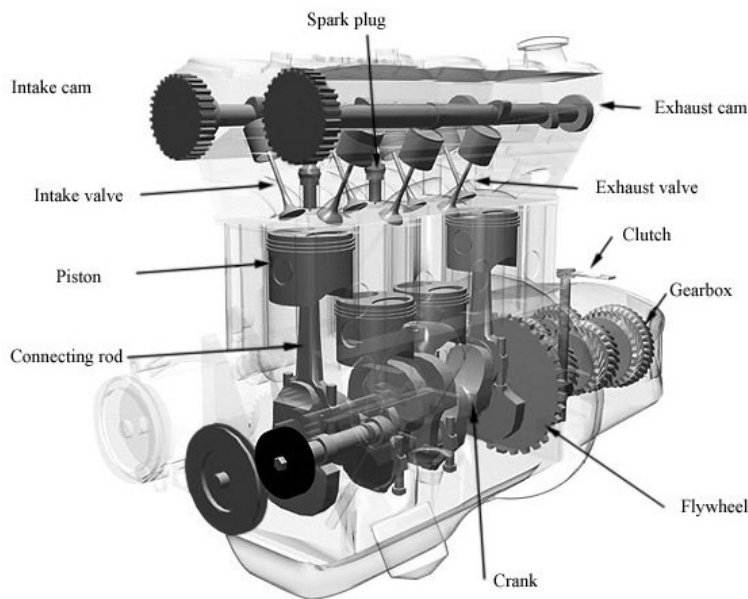

Figure 3: Diagram of internal combustion which converts liquid fuel to energy (Timothy, 2003)

A study which compared internal combustion engine vehicles to electric vehicles concluded that the carbon dioxide (CO₂) emission values of these vehicles are close to those emitted by the internal combustion engine based on a comparison of parameters from multiple countries, including the United Kingdom, Germany, and China (Olumide, Towojua, & Ishola, 2020). Portable emissions monitoring systems (PEMs) for particulate matter are recognized as a cost-effective solution to check in service conformity (ISC) of heavy duty engines (HDEs), which formerly required extracting the engine from the vehicle. The portable devices were proven to exhibit nearly similar performance to laboratory-grade equipment (Bonnel, Kubelt, & Provenza, 2011). Assessments of these PEMs showed high particulate matter (PM) background concentrations that were associated with impurities in the dilution air and/or contamination of the dilution system with exhaust deposits (Anderson, Mamakos, Giechaskiel, Carriero, & Martini, 2010). Thus, highlighting the importance of establishing background PM levels of any PEMs before in-service conformity (ISC) testing via the usage of the same dilution air source that will be employed in the actual tests. The European commission reports that approximately 12% of the total CO₂ emissions are produced by passenger cars, the dominant means of inland transportation, accounting for 83.2% of total passenger-km in Europe for 2013 (European Commission, 2016a). Changes in quality occur during the storage, transportation, pumping, and refueling of machinery, and during physical and chemical

processes of hydrocarbon fuels. Changes in quality occur during the storage, transportation, pumping, and refueling of machinery and during physical and chemical processes of hydrocarbon fuels. The physico-chemical properties as well as the conditions of transportation, manufacturing, storage and use determine the intensity of the quality (Boryayev & Korichev, 2011) . A study on internal combustion engine (ICE) modes in urban conditions during vehicle operations showed ICE modes mainly involve idle running and small loads (Abas & Martinez-Botas, 2015). As such, maximal fuel economy is achieved when using 70-80% of rated capacity. At part loads, ICEs do not reach their full fuel economy potential. Some cylinders are cut-out at part loads and the remaining ones must work harder. To reduce emissions of exhaust gases, various methods can be utilized, e.g. methods of cylinder cut-out in piston engines, cut-off of fuel supply to ICE cylinders and connection of disabled cylinders with the atmosphere or exhaust manifold, cut-off of fuel supply with simultaneous impact on gas distribution components, deactivation of the operating cylinders and stopping the operation of the piston group components (modular CC) (Flierl, Lauer, Breuer, & Hannibal, 2012; Senapati, McDevitt, & Hankinson, 2011; Vinodh, 2005).

In Europe, road transportation has been shown to contribute one-fifth of the European Union's (EU) total emissions of carbon dioxide (CO₂), the main greenhouse gas (GHG), 75% of which originates from passenger cars (European Environmental Agency, 2009; European Commission Report, 2015; European Environmental Agency, 2015) Rising greenhouse gases (GHGs) are recorded solely in the transport sector within the EU (European Commission, 2016). In Europe, CO₂ emissions of passenger cars are measured as part of the vehicle certification (European Energy Commission, 1980) test, which is based on the New European Driving Cycle (NEDC). Though CO₂ emission testing for vehicles is available in some African countries, the volume of second hand vehicles transported over land borders and competing priorities results in a large number of vehicles not being screened. Even in countries with certification testing, tested a disparity in reported CO₂ emissions by manufacturers and independent testing has been reported. Various studies have noted a disparity between reported and test values for CO₂ emissions in vehicles. In France, an official investigation funded by the French ministry of transport (UTACCERAM, 2016) showed most reported CO₂ values (by manufacturers) cannot be reproduced under laboratory conditions, with reproduced certification tests being higher.

Motor vehicles used globally for transportation largely utilize petroleum and its products as a source of energy. Crude oil is a major source of income for oil-producing countries and is still the main source of fuel in use globally. Nigeria is a major oil producing economy, currently ranked sixth in output and sales. This, despite diesel's known reliability, adaptability, handling facilities, and higher combustion efficiency, accounts for its widespread global acceptance (Riberio, et al., 2007). Although diesel is widely used, especially in industrial settings, the recorded rise in emissions from fuel sources is expected to reach 39% by 2030 in the absence of effective legislation, which still entails limitation or substitution of its use (Mofijur, Kalam, Hazrat, Liaquat, Shahabuddin, & Varman, 2012). Traditional fuel sources, including petroleum and diesel, are non-renewable and associated with proven negative effects on the environment and human health. Crude oil was first discovered in the country in commercial quantities within the Niger Delta in 1956 (Omofonmwan & Odia, 2009).

1.0. Petroleum Production and Utilization in Nigeria

Following the discovery of crude oil in multiple states within Nigeria, continued oil exploration and exploitation has led to marked environmental destruction as a result of neglect and limited concern for environmental management by stakeholders (Eregha & Irughe, 2009). Oil is known to form 2-4 km below the earth's surface in the presence of high pressures and temperatures, transforming organic matter into liquid hydrocarbons via thermogenic breakdown (Li, Zhen, Chen, Li, Wang, & Song, 2016). With an estimated 70,000 oil field spread across over 100 countries and production exceeding 1600 billion barrels of known crude oil reservoirs, oil fields potentially affect the environment and health of millions globally (Bentley, 2002; Central Intelligence Agency, 2017; O'Callaghan-Gordo, Orta-Martinez, & Kogevinas, 2016). Petroleum has emerged as a major soil pollutant with negative effects on terrestrial and aquatic ecosystems via the release of toxic hydrocarbons during operation, production, transportation, and use (Liu, et al., 2020b; Benguenab & Chibani, 2021). Most studies have focused on occupational exposure to crude oil's health impacts among exposed residents and clean-up workers of oil spills with regards to psychologic, physical, genotoxic, and endocrine effects (Aguilera, Mendez, Pasaro, & Laffon, 2010). This almost singular focus has neglected the health impacts of crude oil use as a fuel source at the end point.

Some global studies have identified an increase in childhood hematopoietic (blood stem cell) cancer and an elevated relative risk for leukemia (relative risk: RR 3.48, 95% confidence interval: CI 1.25-9.67) linked to the duration of oil extraction (Hurtig & San Sebastian, 2002; Hurtig & San Sebastian, 2004). A similar increased risk, RR 4.3, was obtained in the United States for children aged 5-24 years residing near active oil and gas extraction wells (McKenzie, Allhouse, Byers, Bedrick, Serdar, & Adgate, 2017). Agricultural activities are usually inhibited by the activities of oil companies during drilling and oil exploration (Odeyemi & Ogunseitan, 1985). Environmental impacts of crude oil production have been identified in water bodies contaminated by effluents and chemicals used in the extraction process. The toxic compounds are introduced to the environment through leaks, spills, and volatilization, with their transport and persistence in the environment still being poorly characterized (Strinfellow, Camarillo, Domen, Sandelin, & Varadharajan, 2017).

Petroleum production has been shown to alter the metabolic activities of micro-organisms in multiple studies (Obafemi, Taiwo, Omodara, Dahunsi, & Oranusi, 2018). A study in China on the impact of oil pollution on soil ecological functions, and microbial community compositions via sequencing and molecular bioinformatics identified petroleum concentrations as playing a significant role in shifting soil microbial community structures, ecological functions and alpha diversities. Total petroleum hydrocarbon (TPH) of 4000-20,000 mg kg⁻¹ showed unchanged nitrogen transformation and functional carbon genes, with an associated increase in bacterial community complexity (Gao, Wu, Liu, Xu, & Liu, 2022). A study on African water bodies and fish showed the presence of potential pathogens in wastewater, including bacillus, Escherichia coli, and Staphylococcus, contributes to bacterial diseases affecting aquatic creatures living in water bodies were exposed to wastewater from oil drilling operations, leading to health and economic impacts (Akani & Obire, 2014).

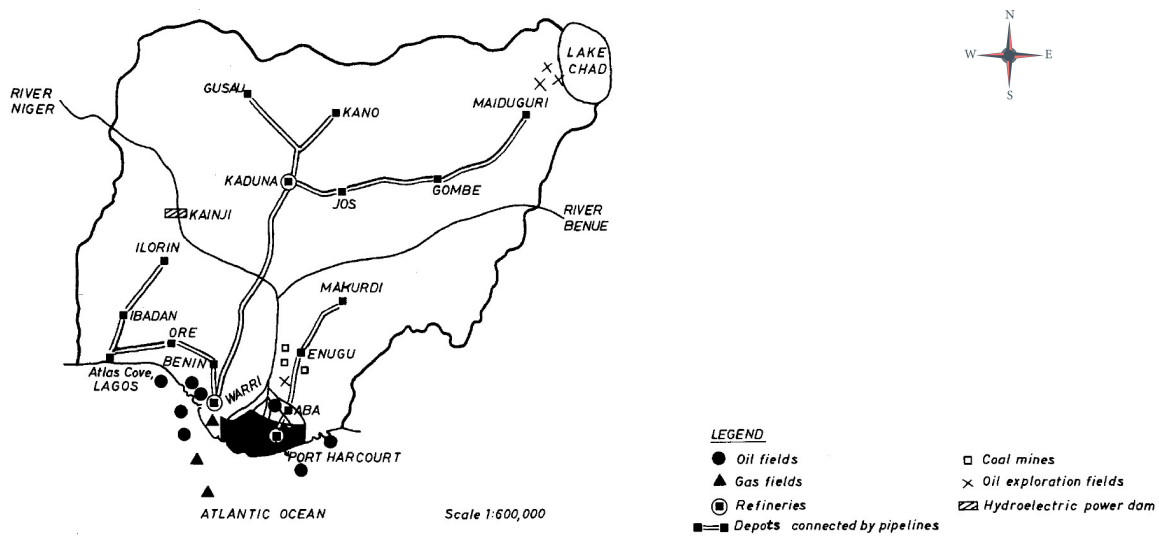

Figure 4: Location of Nigerian Oil and Petrochemical Industries (Odeyemi & Ogunseitan, 1985)

Proven oil reserves within Nigeria are located within the Niger Delta region (eastern Nigeria and a small part of the western region) with a coastline of approximately 450km. The Niger Delta is the largest wetland in Africa with a population of 30 million (Anifowose, 2008). It is made up of the following states: Abia, Akwa Ibom, Bayelsa, Cross River, Delta, Edo, Ondo, Imo, and Rivers shown in figure 4 above. In Nigeria, the scanty land areas that characterize the Niger Delta regions are made unavailable for normal agricultural activities due to oil drilling and exploration. In addition to large spillages, the oil drilling wastes, which include drilling muds and salt water brines pumped out of the wells, usually pollute both aquatic and terrestrial ecosystems (Odeyemi & Ogunseitan, 1985). For Nigeria, as a growing economy, the need for fuel is driven by an increasing population and expanding transportation requirements. Unfortunately, as even in developed countries, the increasing demand for alternative energy driven vehicles, e.g., electric cars, is still largely dependent on fossil fuels. The constant drive to identify new crude oil sources for exploration and processing will not abate soon. In January 2018, the Nigerian National Petroleum Cooperation reported 76.42 billion standard cubic feet of natural gas were flared that quarter, an increase from 62.15 billion and 66.66 billion in the previous first and second quarters (past year).

In an attempt to reduce the impact of air pollution from the petroleum industry, options such as biodynamic cement are being explored. Biodynamic cement is a new type of cement developed by Italcement Company. It is made from titanium dioxide, left over aggregates and marble scraps. It functions by cleaning pollutants from the air automatically, using sunlight via photovoltaic effect to generate a catalytic reaction that modifies them into useful salts (Ekpeyong-Otu & Oloidi, 2018). The salts are washed off the walls during periods of rain, thus effectively neutralizing the contaminant. The availability of natural deposits of titanium (Cross River and Ekiti state) and marble in Abia, Benue and Imo located in the oil producing areas makes it a feasible and potentially cost-effective control option.

A study utilized driving style and road grade on real driving emissions (RDE) compliant test route to depict the correlation to on-road exhaust emissions. Numerous on road tests were conducted with different drivers and two diesel vehicles equipped with portable emissions monitoring systems (PEMS). The use of multiple driving parameters characterized the different driving styles. Results showed a strong correlation for CO₂ and Nitrogen oxides (NO_x) emissions with driving parameters using PEMS. Elevated CO₂ and NO_x emissions were obtained from severe trips characterized by larger driving parameters compared to normal trips. A higher increase was obtained for NO_x emissions 50-255%, while CO₂ increased by 20-40%. Different driving styles did not create a distinct separation for carbon monoxide (CO) and Hydrocarbon (HC) emissions (Gallus, Kirchner, Vogt, & Benter, 2017). Suitable options are aimed at the use of renewable fuel sources such as biodiesel. Biodiesel due to its ability to fulfill the existing energy demand, reduce production of greenhouse gases and impede global warming has become a suitable option (Shahabuddin, Liaquat, Masjuki, Kalam, & Mofijur, 2013). Biodiesel is a non-flammable, biodegradable, non-toxic and renewable fuel source, it's a fatty acid methyl ester produced from vegetable or animal fats through multiple processes. (Singh & Sigh, 2010; Basha & Raja Gopal, 2012; Jayed, Masjuki, Kalam, Mahlia, Husnawan, & Liaquat, 2011). Biodiesel is usable as a bio-diesel-diesel blend in different proportions as vehicular fuel. A comparative experimental study identified the following; at high idling conditions brake specific fuel combustion for jatropha biodiesel blends increased compared to diesel fuels and CO₂ emissions decreased with an increase in blend percentages at all tested conditions, though lower than for diesel fuel. HC emissions decreased with an increase in blend percentages and were lower than for diesel at all tested conditions. For NO_x, an increase in

emissions was associated with increased blend percentages. An increase in idling speed decreased NO_x emissions as a result of reduced residence time/ignition delay available for NO_x formation at higher speeds (Ashrafur Rahman, Masjuki, Kalam, Abedin, & Imtenan, 2014).

1.1. Air Pollution

Air pollution has been defined as by the joint engineer's council as: "the presence in the outdoor atmosphere of one or more contaminants, such as dust, fumes, gas, mist, odor, smoke or vapor in quantities, of characteristics, and of duration, such as to be injurious to human, plant, or property, or which unreasonably interferes with the comfortable enjoyment of life and property" (Pereira & Hung, 2004). Based on their nature, air pollutants are divided into particulates and gases. Both types are emitted by road transportation vehicles during the combustion of fuel and engine processes. As particulates comprise of solids and/or liquid material, air pollutants include all forms of matter. Commonly known air pollutants include gaseous sulfur, nitrogen and nitric oxide (NO). Nitrous oxide is produced during the combustion process. Air pollutants comprise primary and secondary air pollutants. Primary air pollutants are emitted directly from sources. They include, but are not limited to, particulate matter (PM), sulfur dioxide (SO₂), nitric oxides (NO_x), hydrocarbon (HC), volatile organic compounds (VOCs), carbon monoxide (CO), and ammonia (NH₃). Secondary air pollutants are produced by the chemical reactions of two or more primary pollutants or by reactions with normal atmospheric constituents. Secondary air pollutants include formaldehyde, ground level ozone, smog, and acid mist. Particulate matter is a mixture of solid particles and liquid droplets suspended in the air (Tan, 2014). Non particulate air pollutants are primarily gases.

Chemicals that contain carbon and/or hydrogen are known as, Volatile organic compounds (VOCs). VOCs are obtained from construction materials, indoor consumer products, the oil and gas industry, as well as wood and paints. VOCs have been found to be a major contributing factor to ground-level ozone, a common air pollutant, and a proven public health hazard. Sulfur dioxide (SO₂) and nitric oxides (NO_x) are two major gaseous air pollutants generated through combustion processes. Carbon monoxide (CO) and hydrocarbon (HC) are generated from incomplete combustion and are converted into CO₂ through a complete combustion process (Tan Z. , 2014).

CO₂, methane (CH₄), hydrofluorocarbons (HFCs), perfluorinated compounds (PFCs) are the main greenhouse gases. They tend to persist in the atmosphere for long periods and are generally produced by natural processes. Aerosols present in the air have different sources which are divided into natural and anthropogenic (Calvo, Alves, Castro, Pont, & Vivente, 2013). The contribution of anthropogenic GHGs to weather changes and climate change are considered as recent. CO₂ emissions are sometime referred to carbon emissions and are largely due to the combustion of fuels in electric power generation, engines, building heating, and industrial plants. In addition to oil and gas industry, methane (CH₄) emissions can also be produced by the biological degradation of biomass from agricultural activities and landfills. Industrial processes produce hydrofluorocarbons (HFCs) and Polyfluorinated chemicals (PFCs).

Particles or aerosols of natural origin found in Africa are largely desert particles, in North Africa they account for most of the naturally occurring atmospheric aerosols detected. These desert aerosols comprise of a mixture of minerals inclusive of clays and quartz, also calcium-rich minerals; dolomite, gypsum, calcite (Formenti, et al., 2011). The total mass of desert dust contains 1-3% of iron oxides, often as aggregates of clay and iron oxides (Klaver, et al., 2011; Lafon, Sokolik, Rajot, & Gaudichet, 2006). Natural air pollution stems from various biotic and abiotic sources such as plants, radiological decomposition, forest fires, and volcanoes and other geothermal sources and emissions from land and water. These result in a natural background concentration that varies according to local sources or specific weather conditions (WHO, 2001). However, PM₁₀ (thoracic size fractions) and PM_{2.5} (alveolar size fractions) are usually selected as the monitoring parameters for evaluations of air quality (Beslic, Segal, & Klacic, 2004; Gehrig, 2007). The fraction capable of penetrating the tracheobronchial tree and conductive airways is known as PM_{4.0} “finer size fraction, it affects distribution of inhaled air to the pulmonary exchange airways. (Mar, Larson, Stier, Clairborn, & Koenig, 2004), and thus it is called a respirable size fraction.

Desert particles comprise of; Iron (Fe), Calcium (Ca), Aluminium (Al), Silicon (Si) and lower levels of titanium (Ti) and potassium (K). Regular ploughing and de-vegetation of agricultural soils serve as an additional source from the earth’s crust of terrigenous dust, in addition to desert dust. Chemical composition of terrigenous soils is linked to that of the overlying surface soils. Surface

soils are viable for agriculture and usually rich in; clays (phyllosilicates), feldspars (tectosilicates) and quartz (SiO_2). Terrigenous soil is rich in minerals; aluminosilicates (containing Al and Si), oxides (of iron; in its hematite form Fe_2O_3), Titanium as TiO_2 , additionally evaporates such as; dolomite (MgCO_3) and sulphates (gypsum: CaSO_4). However, mainly terrigenous soils contain; potassium (K), calcium (Ca), Aluminium (Al), silicone (Si and sodium (Na). Another source of natural aerosols; marine aerosols result from wind action on the surface of oceans, particularly when wind speeds exceed 7-11m/s (Andreas, Edson, & Smith, 1995). Marine aerosols are largely in the submicron coarse mode group (Cavalli, et al., 2004). The marine particles are rich in; sodium chloride (NaCl), and naturally occurring ions in seawater such as; sulphates, magnesium, calcium and potassium, also organic compounds (Middlebrook, Murphy, & Thomson, 1998; Piazzola, Sellegri, Bourcier, Mallet, Tedeschi, & Missamou, 2012).

The World health Organization (WHO) guidelines in 2000 provided a list of principal pollutants and their sources globally. Anthropogenic activities such as automobile emissions and agriculture are a major source of outdoor air pollution (*Table 1*).

Table 1: Principal pollutants and sources of outdoor and indoor air pollution (WHO, 2000b)

Principal Pollutants	Sources
Sulphur dioxide and particles Ozone Pollens Lead, manganese Lead, cadmium Volatile organic compounds, polycyclic aromatic hydrocarbons	Predominantly outdoor Fuel combustion and smelters Photochemical reactions Trees, grass, weeds, plants Automobiles Industrial emissions Petrochemical solvents, vaporization of aromatic hydrocarbons, unburned fuels
Nitrogen oxides and carbon monoxide Carbon dioxide Fuel burning Particles Water vapor Volatile organic compounds Spores	Both indoor and outdoor Fuel burning Fuel burning and metabolic activity Environmental tobacco smoke, resuspension, condensation of vapors and combustion products Biologic activity, combustion, evaporation Volatilization, fuel burning, paint, metabolic action, pesticides, insecticides, fungicides Fungi, moulds
Radon Formaldehyde Asbestos Ammonia Polycyclic aromatic hydrocarbons, arsenic, nicotine, acrolein Volatile organic compounds Mercury Aerosols Allergens House dust, animal dander Viable organisms	Predominantly Indoor Soil, building construction materials, water Insulation, furnishing, environmental tobacco smoke Fire-retardant, insulation Cleaning products, metabolic activity Environmental tobacco smoke Adhesives, solvents, cooking, cosmetics Fungicides, paints, spills or breakages of mercury-containing products Consumer products, house dust House dust, animal dander Infections

In Figure 5 below the main sources of air pollutants; manmade sources such as vehicles and natural sources such as dust storms are used as a starting point. The produced pollutants which vary in nature and size undergo multiple chemical transformations and reactions before concentrating in the air. Then are distributed largely dependent on the “dispersion hypotheses” affected by such factors as; vegetation, nature of pollution source, topography, wind speed. These determine how far the pollutants travel, their direction and subsequent concentrations. The final stage of the

diagram shows the end point which is that of impact at the human and environment level leading to health effects and changes in the environment and biosphere.

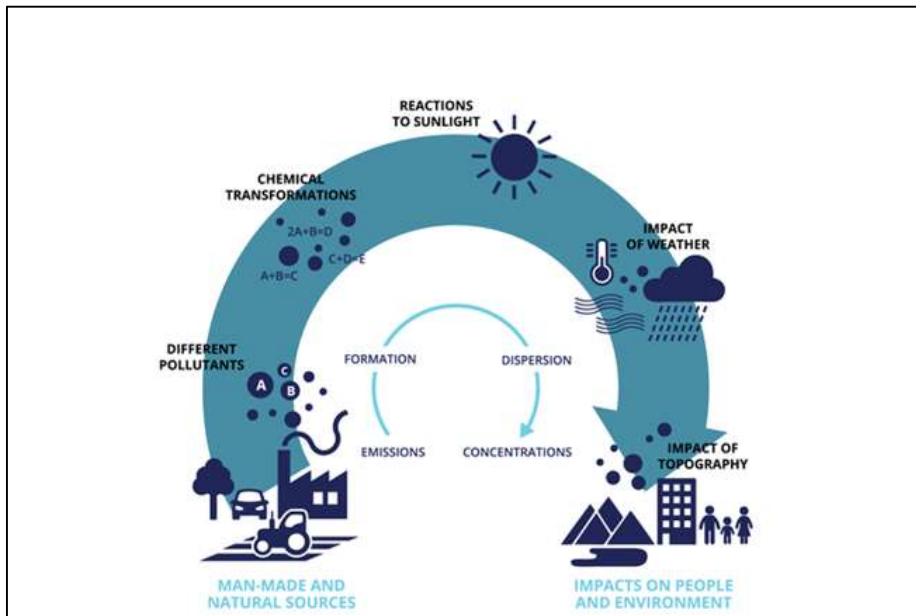

Figure 5: Interplay of pollution and health showing conversion processes of air pollutants (EEA, 2015)

Small solid and liquid particles suspended in the air constitute ambient particulate matter, known as PMs. The sources of air pollutants are varied and dependent on prevalent human activities in any given location. PMs are produced from several sources, including those emitted by traffic, carbon combustion, gas, diesel, and other types of fuel (Riedl & Diaz-Sanchez, 2005). Particulate matter (PM) with a diameter less than $10\ \mu\text{m}$ (PM₁₀), inhalable fine particulates with a diameter of less than $2.5\ \mu\text{m}$ (PM_{2.5}), and ultrafine particles (UFPs) with a diameter of less than $0.1\ \mu\text{m}$ (Gonzalez-Diaz, Arias-Cruz, Macouzet-Sanchez, & Partida-Ortega, 2016). The chemical composition of PM includes substances correlated to toxicity and health; water soluble ions, metallic elements, and organic compounds such as dioxin (USEPA, 2004). Various parameters affect PM concentrations in the air, including local geographic conditions, meteorological conditions, and urbanization (Elminir, 2005; Langner & Endlicher, 2022; Dominici, McDermott, Zeger, & Samet, 2003). A study showed an 18% rise in asthma admissions correlated with a $10\ \mu\text{g}/\text{m}^3$ increase in coarse particles on an admission day (Tecer, Alagha, Karaca, Tuncel, & Eldes, 2008). The World Health Organization (WHO) estimates 3.8 million annual premature deaths are as a consequence of environmental pollution, especially PM pollution (WHO, 2018).

The mechanism of formation and physico-chemical evolution of particles involves multiple processes; nucleation, condensation, coagulation, and deposition. Conversion of particles or gas is key to the evolution of the size and chemical composition of particles. In *Figure 6* below, adapted from Whitby et al 1976, these processes are highlighted.

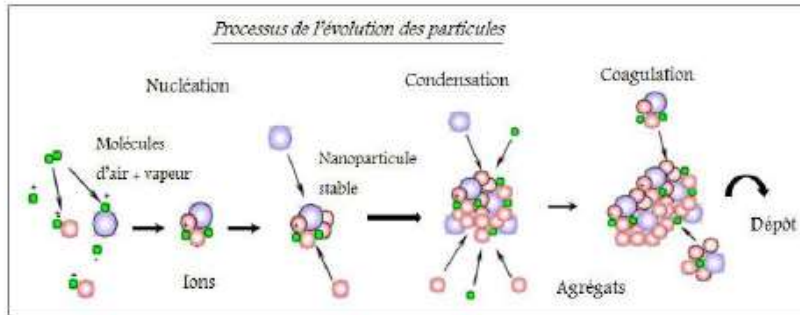

Figure 6: Processes of atmospheric particle evolution: nucleation, condensation, coagulation and deposition (Whitby, Kittleson, Cantrell, Barsic, & Bolan.DF, 1976).

The nucleation process occurs when partial vapour pressure of the gas is higher than saturation pressure. It allows nuclei to be formed that are either made solely of molecules of the vapour mixture (homogenous nucleation), or from a foreign or ionic support (heterogeneous nucleation). In the presence of a higher concentration of gaseous precursors in comparison to particles, homogenous nucleation occurs (Wilmenski, 1984). The process of nucleation produces “embryos” which possess a short life-span, some however become energetically stable after reaching a critical charge. Thus, continuing their evolutionary processes to the next stage which is condensation. Based on theoretical calculations and indirect measurements, a stable embryo is estimated to have a diameter of 1.5nm (Kulmala, et al., 2007; Kulmala, et al., 2013). Additionally, it consists of some molecules held by van der Waals interactions. In urban environments nucleation serves as the main source of ultrafine particles (Brines, Dall'Osto, Beddows, Gomez-Moreno, Nunez, & Querol, 2015). Subsequent, growth occurs by condensation and particle interaction via coagulation and collision, resulting in an increase in size (Madelaine, 1975).

After nucleation growth by condensation is the main mechanism responsible for embryo evolution, although evaporation can occur within the aerosol phase. The concentration gradient of the gaseous species at the gas-particle interface determines the mass transfer between gas and particles. Contact between embryos with pre-existing particles leads to coagulation and associated embryo loss. In

relation to embryo size, coagulation may occur due to turbulence, gravitation, shear or more efficient, Brownian motion (Seinfeld & Pandis, 1998). Coagulation mainly affects pre-existing particles of less than 50nm in diameter and is more important when particle number is high. Dry and wet deposition occurs after emission, with movement of air masses on different temporal and spatial scales (turbulence, wind) causing displacement of aerosol particles and their dilution (horizontal and vertical). Particle removal from the atmosphere occurs via wet and dry deposition. On hitting surface where particles can remain attached such as; soil. Vegetation and walls etc. deposition occurs (dry deposition). This mechanism occurs by gravitational sedimentation for particles with diameters greater than a micrometer (coarse mode) and impaction plus Brownian diffusion for small particles (nucleation mode). Wet deposition on the other hand involves the elimination via integration into water droplets during precipitation (snow, fog, rain etc.). Wet deposition method is frequent with particles from 0.1 μ m to 1.0 μ m (accumulation mode).

Based on composition, two types of pollutants exist; gaseous compounds and particulate matter (PM). The gaseous compounds are ozone, nitrogen oxides (NO_x), carbon monoxide (CO), carbon dioxide (CO₂), VOCs, polyaromatic hydrocarbons (PAH) and heavy metals (Tiotiu, Novakova, Nedeva, Chong-Neto, Steiropoulos, & Kowal, 2020; Bhatia & Dakshinamurti, 2021; Rouadi, et al., 2020). As the presence of these substances in the atmosphere as solid particles, liquid droplets or gaseous compounds are harmful to the biosphere and exists in above normal concentration. Their sources have been identified and studied in order to enable emission source control. *Table 2* below shows these common pollutants and their sources.

Table 2: Common air pollutants and their sources (Fahmy, Y.M.; Fornaseiro, P.; Zinoviev, S.; Miertus, S., 2007)

Pollutants	Main sources
Suspended Particulate matter (SPM)	Automobiles, power plants, boilers, industries requiring crushing and grinding like cement
Sulfur Oxides (SO _x)	Power plants, boilers, sulfuric acid manufacture, protein refining
Lead	Battery manufacturing, automobiles
Nitrogen Oxides (NO _x)	Automobiles, power plants, nitric acid manufacturing
Carbon monoxide (CO)	Automobiles
Hydrogen Sulfide (H ₂ S)	Pulp and paper, petroleum refining
Hydrocarbons (HC)	Automobiles, petroleum refining
Ammonia (NH ₃)	Fertilizer plants

Particulate air pollution refers to the presence in air of small solid and liquid particles of various physical dimensions and chemical properties. Although it may be convenient to group them as particulates, their sources, distribution and effects can be highly variable. Some particles can be of natural origin, such as; biological particles (pollen, fungal spores, etc.), fine soil particles, fine marine salts, wildfire smoke particles and volcanic ash, among other things. Others can originate from a range of sources that include industrial combustion processes, vehicle emissions, domestic heating and cooking, burning of waste crop, Residues, land clearing and fire control activities. Other fine particulates can be produced in air as a result of slow atmospheric reactions among gases (such as some photochemical smog reactions, or the oxidation of Sulphur dioxide and nitrogen dioxide) emitted at distant locations, and transported by atmospheric Processes. Additional information on these common pollutants is shown below:

1.1.1. Sulphur oxides and Sulfur dioxide

The main sources of sulphur dioxide are the combustion of fossil fuels and industrial refining of sulphur-containing ores. Sulphur dioxide is a colorless gas, which can react catalytically or photochemically with other pollutants or natural components of the atmosphere to produce sulphur trioxide, sulphuric acid and sulphates. Sulfur dioxide is an important component of acid deposition and haze. Gaseous sulphur dioxide can remain in dry atmospheres for many days and be subject to

long range transport processes. As a local pollutant, ambient concentrations of sulphur dioxide may show considerable spatial and temporal variations. In many cities in low and middle-income countries ambient concentrations of sulphur dioxide continue to increase, while a decline has been recorded in urban areas within developed countries.

1.1.2. Ozone, photochemical oxidants and Carbon monoxide

Ozone (O_3) and other photochemical oxidants are formed in air by the action of sunlight on mixtures of nitrogen oxides and VOCs. A complex series of photochemical reactions produce various oxidants, the most important being ozone and peroxyacetyl nitrate (PAN). Reactions with nitric oxide remove ozone from the atmosphere. Ozone concentrations vary with factors associated with the processes of formation, dispersion and removal. Concentrations are higher in the suburbs and in rural areas downwind of large cities than in the city center, due to ozone removal from the air by reactions with nitric oxide and other components. Some industrial and natural processes and incomplete combustion of carbon based fuels produce carbon monoxide, with petrol-powered vehicles being its main source. It is always present in the ambient air of cities, but it often reaches maximum concentrations near major highways during peak traffic conditions.

1.1.3. Nitrogen oxides

Although many chemical forms of nitrogen oxides exist, the most significant from a human health perspective is nitrogen dioxide. The main source of nitrogen oxides in cities is the combustion of fuels by motor vehicles and stationary sources such as industrial facilities. Other industrial processes, such as Nitric acid manufacturing facilities, produce nitrogen oxides in air. Urban concentrations tend to be highest near major roads during peak traffic conditions, in the vicinity of major industrial sources and in buildings with unvented sources. Nitrogen oxides are also important indoor air pollutants, as they are produced by domestic and commercial combustion equipment such as stoves, ovens and unflued gas fires. The smoking of cigarettes is an important route of personal exposure.

1.1.4. Lead and other heavy metals

The most important of metals found in the air that are potentially toxic to humans are arsenic, cadmium, chromium, lead, manganese, mercury and nickel. They are chemical elements possessing high densities and exhibiting toxicity at low concentrations and exist as natural constituents of the earth's crust, though the biochemical activities and geochemical cycles are altered by human activities (Giachetti & Sebastiani, 2006). Sources of heavy metals (HMs) in the environment include; industrial, geogenic, agricultural, domestic effluents, industrial, pharmaceutical and atmospheric sources (He, Yang, & Stoffella, 2005). Heavy metals such as; magnesium (Mg), Molybdenum (Mo), Nickel (Ni), selenium (se), zinc (Zn), iron (Fe), manganese (Mn) and chromium (Cr) are essential nutrients for biochemical and physiological functions. Lead is the most prolific based on its distribution and potential for toxicity to humans. Important of these air pollutants on a global basis. When in inadequate supply they have been associated with micro-nutrient deficiency syndromes and diseases (WHO, 1996). The production of reactive oxygen species (ROS) and oxidative stress are key mechanisms in the toxicity and carcinogenicity of metals such as; chromium, lead, mercury, cadmium and arsenic (Yedjou & Tchounwuo, 2007; Yedjou G. , 2006; Patlolla, Barnes, Field, & Hackett, 2009; Sutton & Tchounwuo, 2007). Coarse particles usually contain naturally derived trace metals, while those of anthropogenic origin are distributed in fine particles which carry more toxic chemicals to ecosystems and humans (Stone, Yoon, & Schauer, 2011; Fang, et al., 2000; Fang, Wu, Chang, Huang, & Rau, 2006; Zhao, et al., 2011).

Lead compounds are widely distributed in the atmosphere, mostly due to the combustion of fuels containing alkyl lead additives (Folinsbee, 1992). Arsenic and its compounds are widespread in the environment. Common sources of arsenic include metal smelting, fuel combustion, industrial sources and by the use of some pesticides and, during volcanic eruptions, by wind-blown dusts. Cadmium is emitted to air from steel plants, waste incineration, zinc production and volcanic emissions. Tobacco also contains cadmium; smoking, therefore, can increase uptake of cadmium. Chromium can be introduced into the atmosphere by mining of chromite, production of chromium compounds and wind-blown dusts, though it has a widespread availability in nature. It is a component of tobacco smoke. Manganese is a widely distributed element that occurs entirely as

compounds that may enter the atmosphere due to suspension of road dusts, soils and mineral deposits.

The smelting of ores, combustion of fossil fuels and emissions from other industrial processes also provide local contributions to the manganese content of the atmosphere. Mercury enters the atmosphere through natural processes and industrial activities such as the mining and smelting of ores, burning of fossil fuels, smelting of metals, cement manufacture and waste disposal. Nickel is an element with low natural background concentrations. It enters the atmosphere due to the burning of oils, nickel mining and processing and municipal waste incineration. Most of the work on health responses to exposure to air pollutants has been conducted using single pollutants. Indoor and outdoor air usually contain complex mixtures of air pollutants, and it is practically impossible to examine under controlled conditions all of the combinations of pollutants, exposure Concentrations and exposure patterns. In general, mixtures of air pollutants tend to produce effects that are additive (Folinsbee, 1992).

HMs possess certain characteristics which make them of special interest; they do not decay with time, once the amount of HMs exceeds a specific threshold absorbable by plants (toxicity is exhibited), they are always present in soil from weathering of rocks and pedogenesis (complex phenomenon leading to soil formation from mineral and organic parent rock through multiple processes), and lastly, when present as cations they interact with the soil matrix (Jenny, 1961). Though heavy metals are naturally occurring elements found within the earth's crust, environmental contamination and human exposure result from anthropogenic activities such as; industrial production and use, mining and smelting operations, domestic and agricultural use of metals and metal-containing compounds (Goyer, 2001; Herawati, N, Suzuki, Hayashi, Rivai, & Koyoma, 2000). Heavy metal pollution in the environment is more prominent in point source areas, including mining and metal based industrial operations (He, Yang, & Stoffella, 2005). In busy metropolitan areas, heavy metals have been shown to originate from road vehicles, which release substantial amounts of HMs into soil, water, and air. HMs originating from tire, road, and brake abrasion accumulate in road dust by atmospheric deposition. Via wet and dry deposition processes, some of the road dust ends up in water bodies (Thorpe & Harrison, 2008). Pollutants from traffic origin are shown to include potentially toxic metals like lead, cadmium and zinc (Viard, Pihan,

Promeyrat, & Pihan, 2004; Onder & Dursun, 2006). Some studies have confirmed a reduction in Pb concentration levels by up to 82% after implementation of antipollution policies on automotive emissions (Migon, Robin, Dufour, & Gentili, 2008).

Additional heavy metal contamination occurs via atmospheric deposition, sediment resuspension, soil erosion of metal ions, metal corrosion and evaporation of metals from water resources to ground and soil water (Nriagu, 1989). Lung and cardiopulmonary injuries caused by particulate air pollutant exposure are increased by heavy metal association with respirable particles (Leili, Naddafi, Nabizadeh, & Yunesian, 2008; Cancio, Castellano, Hernandez, Bethencourt, & Ortega, 2008). In cases of contamination by heavy metals, specifications of the sediments can be used to determine the origin of the contaminants. For the aquatic ecosystem sediments can be valuable indicators for monitoring pollutants (Sundararajan & Srinivasalu, 2010; Ajibola & Ladipo, 2011; Suresh, Sutharsan, Ramasamy, & Venkatachalapathy, 2012). Soil sediments serve as a pool of metals potentially released into the water from natural and anthropogenic processes such as dredging and bioturbation which lead to negative health effects (Kim & Kim, 2009). Some heavy metals have a narrow range of concentrations between beneficial and toxic effects (Tchounwuo, Newsome, Williams, & Glass, 2008; Chang, Magos, & Suzuki, 1996). While, others including silver (Ag), Strontium (Sr), titanium (Ti) etc. have no proven biological function and are therefore considered non-essential metals (Chang, Magos, & Suzuki, 1996). Trace element concentrations are affected by meteorological conditions and local sources at any site, with airborne particles serving as important carriers of metals (Tasdemir, Kural, Cindoruk, & Vardar, 2006).

Heavy metal contamination from soil/mine tailings is a widespread problem in many countries, Nigeria inclusive (Makinde, et al., 2018; Makinde O. , et al., 2019; Makinde O. , Oluyemi, Tunbosun, Olabanji, Ogundele, & Fakoya, 2016). Gold extraction produces large amount of tailings that are abandoned after ore retrieval. These tailings contain various contaminants such as; mercury, arsenic, antimony, cyanide and residuals, which are toxic, even at low concentrations (Ogwuegbu & Muhanga, 2005). Artisanal gold mining releases toxic metals such as Cd, As, Cu, Pb, Fe, Cr, Ni, and Zn into the surroundings and constitutes a health hazard. This was experienced in Nigeria in 2010, with greater than 400 deaths reported including children as a consequence of mining activities (WHO, Guidelines for Drinking Water Quality, 2011; Haruna, 2010).

A study in Nigeria on assessment of heavy metal pollution in soil samples from a gold mining area using particle induced X-Ray emissions (PIXE) spectroscopy technique obtained significant variations within samples and between locations. Results showed heavy metal trend as Fe > Ti > Mn > V > Cr > Zn > Pb > Cu, with mean concentrations of heavy metals in the samples excluding Mn found to be in excess of the earth's continental crust (Fagbenro, AA, Yinusa, Ajekiigbe, Oke, & Obiajunwa, 2021). Heavy metals have been found in food crops and have a potential health hazard to humans via dietary pathways in Nigeria (Obiajunwa, Johnson-Fatokun, & Olaniyi, 2001). Extensive soil pollution with heavy metals and elemental components was obtained in a study on heavy metal contamination at a site in eastern Nigeria in the path of dust emissions from a cement factory. Due to the direction of wind flow (southward), high concentrations of the metals were detected in the papalanto site. The mean values from all test sites were higher than average concentrations and normal ranges in soil within control sites (Okoro, Orimolade, Adebayo, AkandeAB, & Ximba, 2017). A study in South Africa identified a large influence of wind-blown dust on trace metal concentrations determined at a site (welgegund) was reflected by 30% or higher trace elements present within the PM_{2.5-10} size fraction (Andrew, et al., 2017).

In spite of all the information available on road transportation vehicles and emissions, there appears to be no reduction in the use of this transport medium. Due to the global dependence on transportation, there is a large number of vehicles in use worldwide. Records show 1.1 billion light-duty vehicles (LDVs) and 380 million trucks in 2015 (San Francisco World Economic Forum, 2016). Approximately 20% of energy use and 23% of global carbon dioxide (CO₂) emissions are attributed to transport (Sims, Schaeffer, Creutzig, Cruz-Nunez, D'Agosto, & Dimitriu, 2014). Internal combustion engines (ICEs) are the main power source for transportation (>99.9%), reciprocating engines are used in land and marine transport and jet engines for aerial transport. Most passenger cars (80%) are powered by spark ignition engines (SI) (OPEC, 2013). For the commercial sector, diesel engines are predominantly used. About 44% of global transport energy is utilized by light-duty vehicles (LDVs) (EIA, 2016). Most of these road transportation vehicles use petroleum-derived liquid fuels, currently accounting for 95% of fuel in use, 60% of which is crude oil (Exxon Mobil Corporation, 2017; World Energy Council, 2011) Presently, there is a marked global demand for fuels used in transport approximately 4.9 billion liters each of gasoline/diesel and over 1 billion liters of jet fuel an expected yearly growth rate of

1% (EIA, 2016; Exxon Mobil Corporation, 2017). The use of ICEs is therefore likely to persist for decades (EIA, 2016; World Energy Council, 2011). The projected oil shortages will not hinder transport sector growth as oil reserves have shown an increase and existing reserves will last decades at current consumption rates (Kalghatgi, 2018).

A comparison of PM levels across global locations demonstrates the presence of air quality and pollutant monitoring stations mainly in large cities. This trend neglects key findings from suburban and rural areas, which can provide ample information on other pollutant sources, for example, agricultural, which is predominant in rural areas of developing countries. *Figure 7* below illustrates monitored and modeled PM_{2.5} levels in major global cities. Monitoring values are generally found to be higher than modeled values, indicating the need for site-based and field evaluation of emission levels as opposed to assessments based on theoretical statistical models.

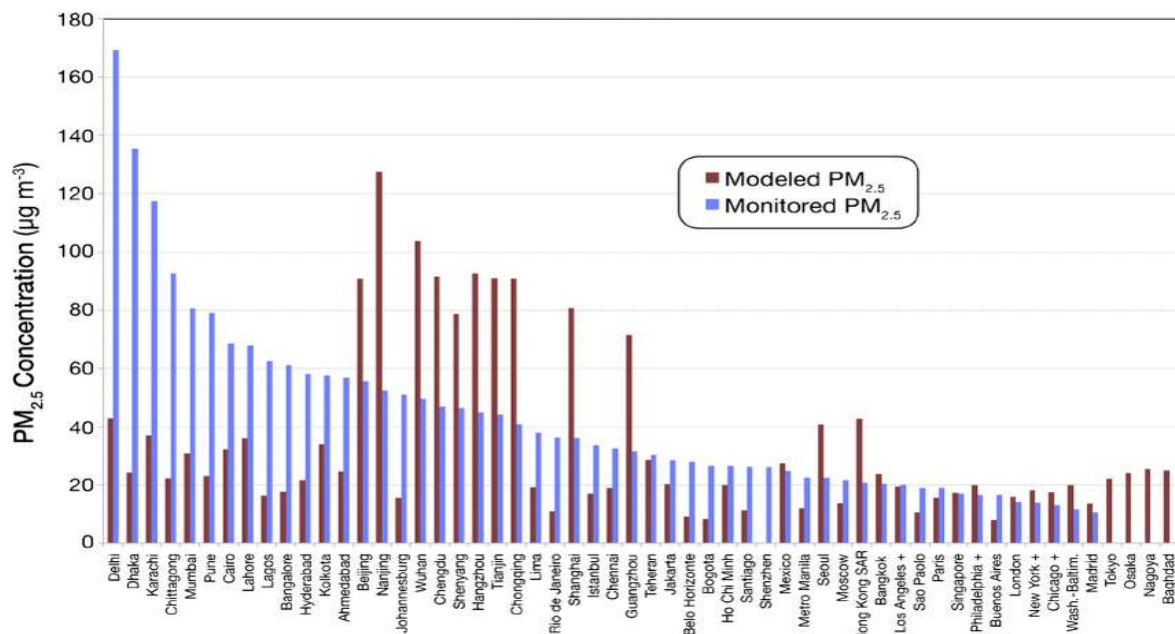

Figure 7: Annual average PM 2.5 concentration in cities estimated from surface monitoring and Global burden of disease (GBD2010) model (Krzyzanowski, Bonjour, Brauer, Cohen, & Pruss-Ustin, 2014)

The Air Quality Index (AQI) is frequently used to express the state of air pollution and is used for assessment and management of air pollution (Sowlat, Gharibi, Yunesian, Mahmoudi, & Lotfi,

2011). An elevated AQI indicates high levels of pollution and the possibility of adverse effects on organisms (USEPA, 1999). Globally, most countries have set up emission standards regulated by national, regional, and state-level coordinating bodies (Sadiq, et al., 2022). Acceptable interim targets for concentrations of PM10 and PM2.5 are provided by the World Health Organization (WHO) in air quality guidelines (WHO, 2018). Elevated exposures occur in the near-field environment and the people most affected are pedestrians, people in nearby buildings, cyclists, and vehicle passengers (Nordling, et al., 2008). Due to conflicting health and economic priorities, developing countries have made insufficient progress in controlling air pollution (Sadiq, et al., 2022). Measurable health effects of unexpectedly low concentrations of particulate air pollution have been reported (Phalen, 2003).

In developed countries, a constant effort to reduce air pollution to acceptable, safe levels is ongoing (Tiotiu, Novakova, Nedeva, Chong-Neto, Steiropoulos, & Kowal, 2020). Internationally, different limits are set and enforced to ensure compliance with set limits of air pollutants (Sadiq, et al., 2022). Even at low levels below current standards, air pollution may still have a negative impact on health (Barnett A. , Williams, Schwartz, Best, & Neller, 2012). Therefore, reductions in exposure to very low levels can still be expected to provide benefits (Crouse, Peters, Van Donkelaar, Goldberg, & Villeneuve, 2012). Long-term studies in large cities have documented the characteristics of aerosols in relation to seasonal changes (Sadiq, et al., 2022). A study in central China on aerosol characteristics and related radiative effects showed high relative humidity (RH), significant optical and microphysical characteristics, tropospheric wind circulation and aerosol radiative effects (ARE) varying between summer and winter and also with different haze conditions (Ma, et al., 2019).

1.2. Meteorological effects and greenhouse effect

Atmospheric aerosols include both natural (i.e. windblown dust, sea salt from the oceans, and volcanic eruptions) and anthropogenic sources (i.e. aerosols from biomass burning, combustion from automobiles, and emissions from power plants) (Kaufman, Tanre, & Boucher, 2002). Aerosol optical depth (AOD) is a dimensionless parameter that characterizes the total absorption and scattering effect of particles in direct or scattered sunlight. However, the relationship between PM

and AOD depends on the season, meteorological variables, and the site location (Pelletier, Santer, & Vidot, 2007). Aerosols have high temporal and spatial variability, which increases the need for and importance of detailed physical and chemical characterization on a regional scale in order to assess the impacts of aerosols (Poschl, 2005). Particulate matter (PM) is classified according to its aerodynamic diameter, as PM₁₀, PM_{2.5}, PM₁, and PM_{0.1}, which relates to aerodynamic diameters being smaller than 10, 2.5, 1, and 0.1 μm , respectively. Larger particulates have shorter lifetimes in the atmosphere than smaller particles, while the impacts of these species are also determined, to a large degree, by their size (Tiwari, Chate, Safai, Srivastava, Bisht, & Padmanabhamurty, 2012; Colbeck, Nasir, Ahmad, & Ali, 2011). Particles can affect global climate by altering the radiative balance of the atmosphere or serving as CCN (cloud condensation nuclei) or IN (ice nuclei), which would alter cloud formation, microphysical properties, and lifetimes (Kim J. , 2006; Rosenfeld, et al., 2008).

Meteorological factors such as; temperature, time of day, wind speed, precipitation, relative humidity, and atmospheric stability, among others, affect particulate matter (Dayan & Levy, 2005; Gietl & Klemm, 2009). The dispersion condition of the atmosphere accounts for the accumulation of PM particles in the air, with relative humidity, precipitation, and temperature affecting variations in PM levels (Islam, Saraor, & Ahmed, 2021). Existing local meteorology has the largest influence on measured particle concentrations, with higher wind speeds leading to greater dilution and therefore smaller measured concentrations. A difference in the dependence of particle concentrations on meteorological conditions with respect to particle class size was identified in some studies (Yao, et al., 2013). Also, a strong positive correlation between new particle formation and solar radiation was observed in some studies, with relative humidity (RH) being anti-correlated with continental new particle formation in others (Birmili & Wiedensohler, 2000; Hamed, et al., 2011).

Studies have shown an increase in particulate matter concentrations during periods of low temperatures, indicating an inverse relationship. However, secondary particle formation is increased in the presence of high temperatures in certain countries such as USA, Germany, and Greece, indicating a positive correlation (Islam, Saraor, & Ahmed, 2021). The most important role of meteorology is the effect on the dispersion, transformation, and removal of atmospheric

pollutants from the atmosphere, which affects the characteristics and pollution levels of PM₁₀ concentrations (Solomon, et al., 2007; Akyuz & Cabuk, 2009). The existence of fine particles with sizes ranging from 0.1- 1.0 μm in diameter in the air dispersed at high concentrations results in haze formation, it reduces vision due to light extinction of particles (Soleiman, Ohtman, Abu Samah, Sulaiman, & Radojevic, 2003). Characteristics of particle size distributions are significantly affected by meteorological processes (Bismarck-Osten, Birmili, Ketzler, Massling, Petaja, & Weber, 2013; El-Metwally & Alfaro, 2013; Hamed, et al., 2011; Lang, Yan, Zhang, & Cao, 2013; Luo, Zhao, Yan, Gong, & Xiong, 2013), mixing layer height (Pandolfini, et al., 2014; Tiwari, et al., 2014), air mass origin (Freutel et al., 2013; Perrone et al., 2014), and precipitation (Chate, Murugavel, Ali, Tiwari, & Beig, 2011; Castro, Alonso-Blanco, Gonzalez-Colino, Calvo, Fernandez-Raga, & Fraile, 2010).

A study found a decrease in solar radiation at high relative humidity (RH) reduced sulfuric acid levels in the air, and therefore high new particle formation rates rarely occurred above 80% RH (Hamed, et al., 2011). Temperature and wind speed also affected particle size distributions, with some studies identifying ambient temperature and local wind conditions as critical factors controlling the number of fine particles (Hussein, et al., 2006; Vakeva, Hameri, Puhakka, Nilsson, Hohti, & Makela, 2000). Furthermore, the dependence of aerosol optical characteristics on dominant winds was identified over the Mediterranean coastal area (Barnaba & Gobbi, 2004).

In urban settings, especially in developing nations such as Nigeria, major sources of PM are combustion of fossil fuels (traffic and heavy-duty power generating sets), household cooking, biomass and refuse burning, industrial activities, smelting, and other energy generation processes (Owoade.OFS, Ogundele, Fawole, & Olaniyi, 2012). Meteorological conditions affect particle transportation, chemical transformation, and removal mechanisms from the atmosphere (Mohan, 2016). Within the lower atmosphere, particularly the boundary layer, the concentration, chemical composition, residence time and removal rate of atmospheric PM are influenced by meteorological factors (Sumesh, Rajeevan, Resmi, & Unnikrishnan, 2017). Studies have been done on the relationship between PM concentration and meteorological variables such as; wind speed, relative humidity, rainfall, air temperature, and wind direction (Owoade.OFS, Ogundele, Fawole, & Olaniyi, 2012; Zu, Huang, Hu, Zhao, Zhang, & Ying, 2017). A study that used linear and non-

linear regression models to focus on the relationship between particle concentration and meteorological variables (Zyromski, Binial-Piero, Burszta-Adamiak, & Zamiar, 2014) focused on the relationship between the concentration of air pollutants and meteorological variables using linear and non-linear regression models. Meteorological factors have been confirmed as major determinants of ambient PM concentrations, as the dispersion process, chemical formation, and removal mechanisms of atmospheric particles are dependent on rainfall, wind speed, and solar radiation (Chakraborty, Fu, Rosenfeld, & Massie, 2018; Haque, Kawamura, & Kim, 2016; Hu, et al., 2018).

A study in western Nigeria (Ile-Ife) on mass concentrations of particulate matter and meteorological parameters (wind speed, wind direction, air temperature, and relative humidity) measured simultaneously at six sampling locations using a network of low-cost air quality sensor units showed results that reinforced meteorological effects. A negative exponential distribution curve was obtained for the relationship between PM and wind speed, with coefficient of determination (R^2) values ranging from 0.06 - 0.18 for PM_{2.5} and 0.03–0.19 for PM₁₀ during daytime and nighttime periods in all the sampling sites. The relationship between PM and temperature gave a decay curve which show that high PM concentrations are associated with lower temperatures while RH had an exponential growth curve with PM concentrations increasing with RH increase (Omokungbe, et al., 2020).

1.3. Greenhouse Effect and Climate Change

The greenhouse effect, driven by increases in carbon-dioxide, exerts a positive feedback on the earth's climate. The warmth on the earth's surface is increased when the atmosphere prevents energy from the sun from leaving the earth after entry. It is defined as; the infrared radiative effect of all infrared-absorbing constituents in the atmosphere. These greenhouse gases (GHGs), some aerosols, and clouds absorb terrestrial radiation emitted by the earth's surface and atmosphere. An increase in the concentration of GHGs increases the magnitude of this effect (enhanced greenhouse effect). The change in GHG concentration because of anthropogenic emissions contributes to an instantaneous radiative forcing. Earth's surface temperature and troposphere warm in response to this forcing, with gradual restoration of the radiative balance at the top of the atmosphere (United

[Nations, 2022](#)). The major greenhouse gases are; water vapour, ozone, methane and carbon dioxide. Other important GHGs include perfluorocarbons (PFCs), chlorofluorocarbons (CFCs), nitrous oxide (N₂O) and sulphur hexafluoride (SF₆) ([United Nations-IPCC Report \(AR6\), 2022](#)).

Interactions occur with water vapour, temperature and infra-red emissions driving the feedback loop. This feedback acts upon an increase in carbon dioxide that induces a warming, a consequent increase in water vapor, and a strengthened greenhouse effect that further warms the climate ([Held & Soden, 2000](#)). This feedback is now proven to be positive by connections between temperature and water vapour through the layers of the earth's lower atmosphere. Additionally, long wave flux emitted to the surface also aids the feedback process ([Stephens & Hu, 2010](#)). Anthropogenic climate change has been attributed with moistening in upper tropospheric and total column water vapor ([Chung, Soden, Sohn, & Shi, 2014](#); [Santer, 2007](#)). Gases like hydrocarbons that are disproportionately strong absorbers of infrared radiation on a molecule-by-molecule basis compared to others e.g. carbon-dioxide are termed "super greenhouse gases" ([United Nations, 2013](#)). Infrared energy is absorbed and emitted by greenhouse gases resulting in increased heat and emission of radiant heat in multiple directions. The earth's natural greenhouse effect maintains the earth's temperature, excessive heating and its consequence arises from the additive effect from released gases. Some measures like the use of alternative fuel sources will reduce the gases released from burning fossil fuels. A global study on biofuel production potential showed the feasibility of utilizing this as a mitigating option in most world regions (*Figure 8* below).

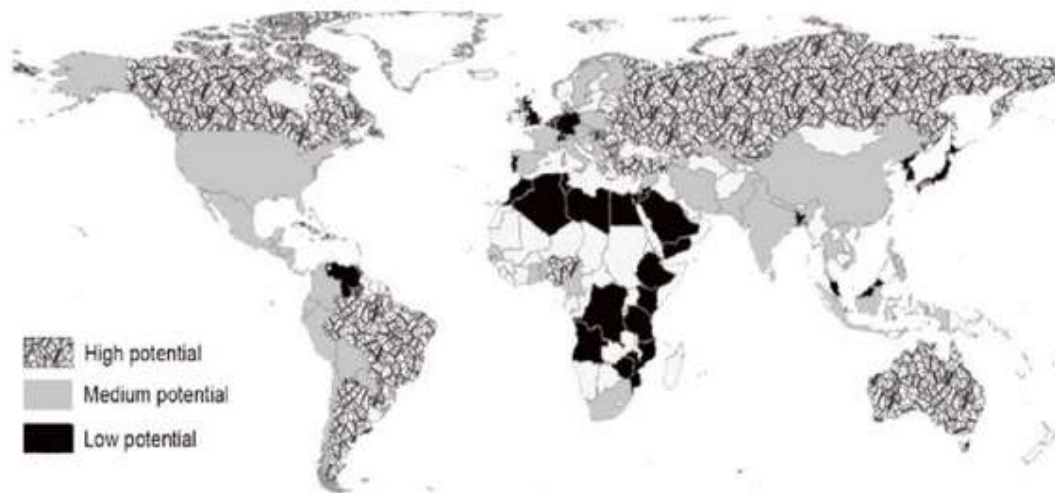

Figure 8: Biofuel production potential (Von Braun, 2007). Sources: data on food insecurity are from FAO (2006). The land availability index is derived by the author based on data from FAO (2007); IEA (2007a, b); and USDA (2006). Data on water availability are from WRI (2007) (Bessou, 2011).

Energy emitted and absorbed by greenhouse gases lies within the thermal infrared range and comprises fluorinated gases, nitrous oxide, CO₂, and methane. Though, fossil fuels account primarily for CO₂ production, the impact of humans on land use and forestry accounts for significant production of nitrous oxides. This, in combination with waste management and combustion of biomass, generates methane (EPA, 2019; Ritchie & Max, 2019; Aizebeokhai, 2009). A study which compared the emissions of carbon dioxide and toxic substances emitted by vehicles with internal combustion engines (ICE) to the equivalent emissions of battery electrical vehicles (BEV) showed emissions depended on a multitude of factors. These include; energy mix, displacement of the internal combustion engine, and type of internal combustion engine (spark-ignition or compression-ignition). It showed the replacement of internal combustion engines with electric engines would not be solely positive for environmental sustainability (Laskowski, Zimakowska-laskowska, & Zasina, 2021).

A study in China on characteristics and recent trends of sulfur dioxide at urban, rural and background sites identified diurnal variations of sulfur dioxide (SO₂). A common feature was seen of a daytime peak higher or equal to nocturnal SO₂ peaks. Stringent control measures like those implemented in preparation for the Beijing Olympics effectively reduced ambient SO₂ by 20%-40% in Beijing and surrounding areas (Weili, Xiaobin, Zhiqiang, Huarong, Xiwen, & Wang, 2012). Reactions in the atmosphere among air pollutants may produce a number of important secondary air pollutants, including those responsible for photochemical smog and haze in ambient air (Mcgranahan & Murray, 2003). The spatial distribution and concentrations of the various air pollutants vary considerably. Most air pollutants are local phenomena, with concentrations at any particular location varying with local site geography, emission rate, and meteorological dispersion factors.

1.4. Mineral Dust

In various countries, including West African countries, natural dust pollution has been identified as an additional factor affecting air quality and impacting health. Dust has been shown to play an indirect role in climate change via modification of cloud properties, thus affecting the hydrological cycle and radiation (Ghan, et al.). It also scatters and absorbs solar radiation and terrestrial radiation, which has been linked to climate. As winds and precipitation result in non-linear changes to dust emission sources and rates, resulting in newly generated dust modulates climate change and feedback processes (Albani & Mahowald, 2019; Hooper & Marx, 2018; Shao, 2011). Deposition of mineral dust into the oceans is shown to increase productivity due to its abundance of iron (Fe) and phosphorous (P). This subsequently affects the climate and the atmosphere-ocean carbon cycle (Ravi, 2011; Jickells & Moore, 2015). Evidence has also emerged regarding the role of African dust as a source of nutrients, particularly phosphorous, and as a fertilizer enriching the Amazon basin (Ben-Ami, Koren, Artaxo, Martin, & Andrea, 2010; Bristow, Hudson-Edwards, & Chappell, 2010). Mineral dust has other effects, including a negative effect on health within the respirable size range and their ability to become coated with carcinogens from the uptake of compounds such as polycyclic aromatic hydrocarbons as they age in the atmosphere (Garcon, et al., 2000; Guthrie Jr & Mossman, 1993).

Following release from the surface, dust particles, are raised to higher levels of the troposphere via convection updrafts and turbulent mixing. The duration of their transportation by wind is dependent on meteorological conditions and size. In combination with turbulent diffusion and impaction, gravitation is the main force pulling dust particles to the surface. This mechanism is known as “dry deposition”. Due to gravitational pull versus size, smaller particles are majorly transported over longer distances. The lifetime of dust particles varies with size; more than 10 days for sub-micrometric particles and few hours for larger ones $>10\mu\text{m}$. Wet deposition also occurs as dust is washed out of the atmosphere through precipitation. In the presence of pollutants, dust particles serve as condensation nuclei for warm cloud formation and as ice nuclei for cold cloud generation. The dust particle characteristics, such as shape, size, and composition, determine their interactions; these characteristics are dependent on emissions, the nature of parent soil, and transport processes. Apart from the direct health effects of dust deposits, indirect impacts include the following; covering of transport routes, filling of irrigation canals, and effects on water quality. Land and air transportation are affected by a reduction in visibility, marked reduction in visibility coupled with dust damaging aircraft surfaces and engines negatively impacts the aviation sector. Solar panels relying directly on solar radiation are damaged by dust, with an output reduction and a marked increase in maintenance costs (Terradellas, Nickovic, & Zhang, 2015).

The North African region, which houses the Sahara desert, is the most persistent and largest dust source globally, estimated to generate 36%-79% of global emissions (Kok, 2021; Wu, Lin, & Liu, 2020). Studies on dust found in other regions and the Atlantic have identified freshwater diatoms, probably from the Bodele depression in northern Chad, where large diatoms have been found till date. White diatom-laden dust plumes up to hundreds of kilometers originating from the Bodele and heading Westward have been identified by satellite imaging (Ben-Ami Y. , Koren, Rudich, Artaxo, Martin, & Andrea, 2010; Armitage, Bristow, & Drake, 2015; Prospero, Ginoux, Torres, & Nicholson, 2002). African dust transport has shown strong seasonal variation in various long term studies, highlighting strong inter-annual variations, with maximal transport periods in summer June-July (Adams, Prospero, & Zhang, 2012; Chin, 2014). Satellite imaging also shows dust transported out of Africa undergoes a seasonal cycle which latitudinally shifts with seasonal changes in the large-scale circulation over the Atlantic, a shift most visible with the seasonal migration of the inter-tropical convergence zone (ITCZ) (Adams, Prospero, & Zhang, 2012; Chin, 2014; Yu, 2020).

Substantial quantities of African dust have also been identified in the United States; southern and eastern United States (US) and Florida, with extensive studies showing its presence in island nations such as Barbados (Prospero, Collard, Molinie, & Jeannot, 2014; Zuidema, 2019; Aldhaif, Lopez, & Sorooshian, 2020; Bozlaker, Prospero, FraserMP, & Chellam, 2013; Hand, White, Gebhart, Hyslop, Gill, & Schichtel, 2016). African dust is documented as strongly layered from findings obtained by aircraft research programs, lidar studies at ground sites and aboard research ships travelling the Atlantic Ocean (Adams, Prospero, & Zhang, 2012; Reid, 2003; Weinzierl, 2017; Bohlmann, Baars, Radenz, Engelmann, & Macke, 2018). There is a decrease in altitude between the top and base layers of the Saharan Air Layer (SAL) as dust moves across the Atlantic, during this transit the dust is transferred from the SAL to the underlying boundary layer. This transfer occurs via convective erosion, some dust is also injected directly into the boundary layer along the African coast (Reid, 2003; Weinzierl, 2017; Bohlmann, Baars, Radenz, Engelmann, & Macke, 2018). The presence of strong dust-related heating within the SAL partially offsets the radiative cooling of the layer and preserves inversion, which functions in extending the lifetime of the SAL (Tao, Braun, Shi, Kim, Matsui, & Peters-Lidard, 2018). The complexity of the processes involved in dust generation and transportation have proved challenging in fully comprehending the sources, emission and transport from Africa and its relationship to easterly waves (Grogan & Thorncroft, 2019; Knippertz & Todd, 2012).

Mineral dust particles with diameters less than microns are made up of a variety of minerals, including calcite, quartz, clay, iron oxides, feldspars, and others, with relative abundances and concentrations varying by region (Caquineau, Gaudichet, Gomes, & Legrand, 2002; Formenti, et al., 2014; Scheuvsens, Schultz, Kandler, Ebert, & Weinbruch, 2013). The ability of these dust particles to serve as cloud condensation nuclei and ice nuclei, retain their iron solubility, maintain their reactivity in the atmosphere, and also control their optical properties is dependent on their mineralogical composition and form (Krueger, Grassian, Cowin, & Laskin, 2004; Engelbrecht, Moosmuller, Pincock, Jayanty, Lersch, & Casuccio, 2016; Moosmuller, Engelbrecht, Skiba, Frey, Chakrabarty, & Arnott, 2012; Schroth, Crusius, Sholkovitz, & Bostick, 2009). Therefore, an understanding of the mineralogical composition of dust and regional variability are essential to understanding its environmental and health impact (Scheuvsens, Schutz, Kandler, Ebert, & Weinbruch, 2013; Schulz, Prospero, & Baker, 2012).

The use of filters to collect aerosol samples provides limited samples (do not exceed a few milligrams). This is inadequate for adequate characterization of particulate mineral composition. Using direct methods that are based on crystallographic properties due to the incompatibility of low sample masses with analytical techniques is more effective. This, results in some cases, in the use of alternative indirect methods based on reconstruction of the mineralogy from radiative properties or elemental composition. Additionally, bulk analysis and individual particle analysis have been utilized to obtain mineralogical compositions (Engelbrecht, McDonald, Gillies, Jayanty, & Gertler, 2009; Engelbrecht, Stenchikov, Prakash, Lersch, Anisimov, & Shevchenko, 2017; Kandler, Schutz, & Deutscher, 2009; Klaver P. , et al., 2011).

Direct measurements of the mineralogical composition of mineral samples can be performed by X-ray diffraction (XRD). However this only provides the relative masses of the mineral phases reported to the crystallized fraction in the sample. Any badly crystallized or amorphous compounds cannot be detected and result in an inability to assess the total mass of the sample. Despite this, XRD analysis, though not absolutely quantitative, is considered semi-quantitative or quantitative depending on the analytic method used (Nowak, Lafon, Caquineau, Journet, & Laurent, 2018). The representation of mineral dust aerosols by climate models and atmospheric chemistry as a size distribution with a single kinetic parameter for reaction with a particular trace gas or a single refractive index to model climate forcing is incorrect due to the varied nature of mineral dust from several regions identified as the "dust belt," which comprises persistent and large sources of dust (Prospero, Ginoux, Torres, Nicholson, & Gill, 2002), the representation by climate models and atmospheric chemistry of mineral dust aerosols as a size distribution with a single kinetic parameter for reaction with a particular trace gas or a single refractive index to model climate forcing is erroneous (Bian & Zender, 2003; Bauer, Balkanski, Schulz, Hauglustaine, & Dentener, 2004). As mineral dust reacts in the atmosphere, the physicochemical properties of the particles change including optical properties, affecting their effectiveness in serving as cloud condensation nuclei (Martin, 2000). A study that studied the heterogeneous chemistry of mineral dust with nitric acid, an important atmospheric gas on particles from four distinct sites; China loess (Asia), Saharan sand (Africa) and coastal and inland sand (Saudi Arabia), identified marked differences. It represented compositions as atomic percent of crustal elements; Si, Mg, Na, Ca, Al, and Fe, which were found in all samples, though varying in proportions. Smaller percentages were also seen of vanadium (V), potassium (K), and Ti. Key differences showed mineral dust from the Sahara desert contained the

highest amount of Si and little Ca, while the China loess had higher Ca and less Si. However, both these sites contained similar amounts of Al. The identified Ca component was attributed to carbonate materials including; calcite and dolomite (Krueger, Grassian, Cowin, & Laskin, 2004; Caquineau, Gaudichet, Gomes, & Legrand, 2002; Formenti, Elbert, Maenhaut, Haywood, & Andreae, 2003). Additionally, the inland dust from Saudi Arabia showed the highest Fe content, with the coastal dust revealing the largest components of Ca, Mg, and Na relative to other sources. The carbonate component obtained in the dust was found to be particularly reactive, most pronounced in China loess and Saudi Arabia, due to the association with carbonate materials. The findings highlight that particle reactivity is dependent on individual particle mineralogy (Krueger, Grassian, Cowin, & Laskin, 2004).

In Europe significant contributions to PM₁₀ levels by desert dust has been recorded especially in the southern and western European countries at levels sufficient to result in an exceedance of the EU air quality PM₁₀ limit values (Basart, et al., 2012; Pey, Querol, Alastuey, Foratiere, & Stafoggia, 2013). The difficulties associated with mitigating this impact on air quality is identified as a major challenge to air pollution chemistry (Gimeno, 2013). Within the Euro-Mediterranean regions, the main natural particles contributing to PM₁₀ (i.e., particles with aerodynamic diameter <10mm) are identified as; desert dust, aerosol from wildfires and sea spray (Viana, Pey, Querol, Alstuey, de Leeuw, & Lukewille, 2014). . Specific guidelines were released by the European Commission (EC) in 2011 and provide member states with common methods to assess the contribution of particles of natural origin to the PM related metrics regulated by the ambient Air Quality Directive 2008/50/EC (European Commission, 2008; EC, 2011).

1.5. Natural dust and its effect in Nigeria

The constant movement of dust from its origin site to countries including Nigeria has resulted in an increased frequency of dust events in those countries. Mineral dust plays a crucial role in modulating and impacting daily weather patterns and climate as well as ecosystems over time. It compounds the negative effects of climate change globally and has been linked with the increasing severity of adverse weather patterns associated with dust emissions and transport. Over the past decade, dust emissions have been observed further downstream from their previously identified

climatologically confined areas. Saharan dust is being observed with increasing frequency and at higher concentrations across the Atlantic and in European countries. The adverse effects of these changes impact the Socio-economic sector, with direct linkages being identified to mineral dust suspension. In figure 2 an identification of potential dust source areas in northern hemispheric Africa based on a synergy analysis identified certain major regions as the main sources of dust to the rest of the continent (Parker & Diop-Kane, 2017). These include most importantly shaded in grey within the figure; PSANAF: Zone of chotts in Tunisia and northern Algeria, PSANAF: Foothills of Atlas Mountains (PSANAF-2a) and western coastal region (PSANAF-2b; Western Sahara, western Mauritania), PSANAF-3: Mali-Algerian border region, PSANAF-4: Central Libya, PSANAF-5: Bodele Depression (western Chad) and PSANAF-6: southern Egypt/northern Sudan. There are other note-worthy regions such as; southern parts of the Azawagh (a dry basin in north-western Niger/north-western Mali shown with the pink stippled line) and the Kaoua region in northern Niger.

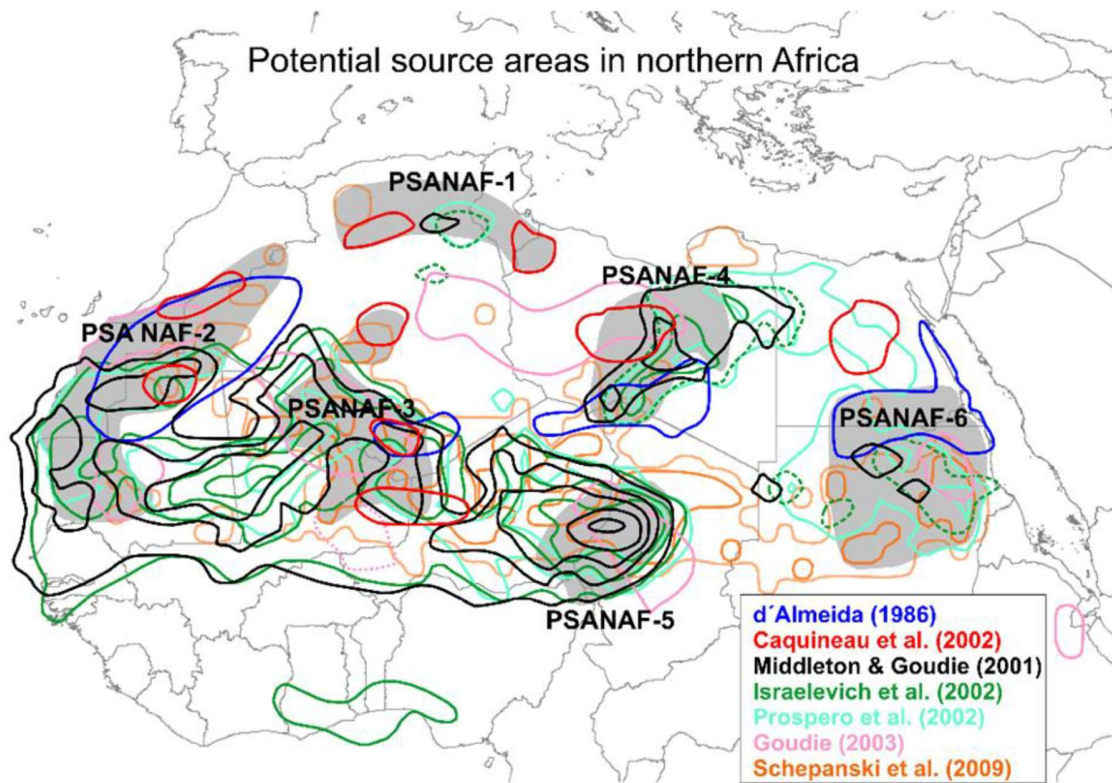

Figure 9: Overview of potential source areas in northern hemispheric Africa (PSANAF), different lines and colors represent analyses outcomes by different authors based on differing data sources and techniques (shown in Legend inset), illustrating the challenge of identifying dust sources with accuracy.

Satellite images shown in Figure 10 below from the Nigerian Meteorological Agency (NIMET) illustrate dust presence/distribution for the period of our study in the year 2020. As, dust winds did not occur daily and at all hours, the images are date and time specific.

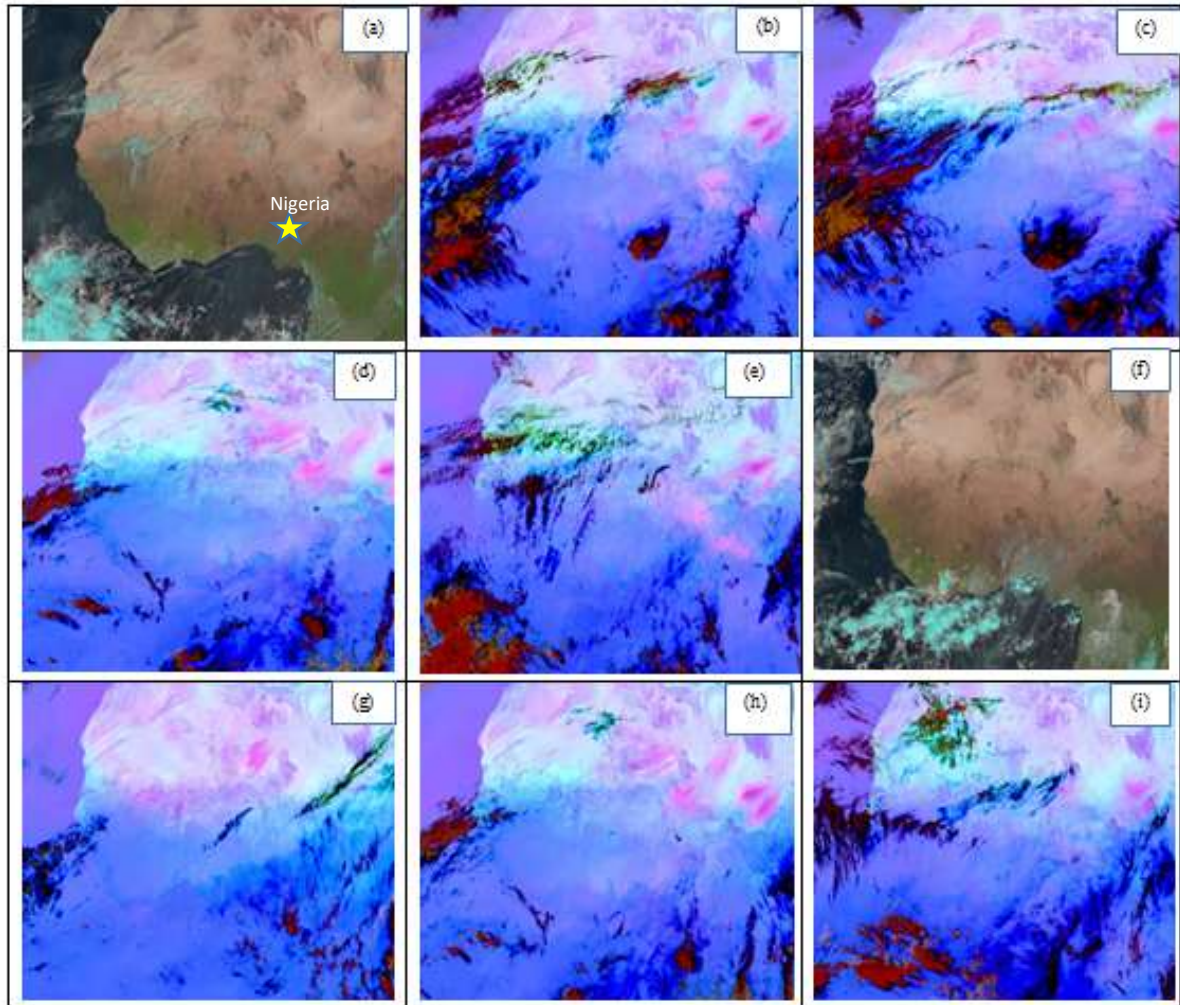

Figure 10: North African Sand storm survey (NASCube) taken respectively (a) and (f) at 9:00 am and 3:00pm on 7th march 2020 are shown, land in brown and surface ocean in black. Spinning Enhanced Visible and Infrared Imager (SEVIRI) images are shown respectively; (b) and (c) Northern Nigeria in February 2020, (d) and (e) West African region in Late February 2020 and (g),(h) and (i) West Africa region in Early March. Dust and cloud features are seen in pink and dark colors.

Based on transport and trajectory, dust originating from the Sahara region of North Africa has been observed not only in countries within Africa but over land and sea in other regions like Europe, the middle East, and across the Atlantic ocean in Mexico City (Prospero & Mayol-Bracero, 2013). Transportation occurs via storm like events, with clouds of desert aerosol particles taking the shape of giant plumes spanning over large regions of West Africa and extending more than 1 kilometer from their source. The dust rises due to occasional shifts in the position of anti-cyclones, resulting

in the periodic incursion of cold polar air into the Sahara region. This subsequently causes a strong tightening of the pressure gradient in the lower layer. Consequently, large amounts of dust produced by weathering of rock and soil at the surface are emitted into the air by strong surface winds resulting from the convergence of air aloft and divergence below, thereby building up a dust reservoir several kilometers thick in the Saharan atmosphere. After, the rising phase, turbulent mixing occurs through the downward transfer of large momentum at the gradient level (925hpa). Horizontal transportation is initiated at this point. This strong horizontal wind is necessary for the transport of dust haze across the West African sub-region in the form of dust plumes (Kalu, 1977).

A partition of the life cycle of Sahara dust into three major phases: The initial phase is the instantaneous rising stage, which involves the rising of the dust in the dust region. This occurs when the dust particles are violently raised from the ground, usually due to strong surface winds in the form of dust storms. Upward diffusion of the dust plume occurs upwards by turbulence and there is pronounced buoyancy, but no horizontal spread occurs in this stage. This is followed by the spreading phase, which follows the rising of the dust from the ground by turbulence to a level where horizontal wind is strong and transportation occurs in a horizontal direction. The dust plume loses vertical momentum due to a weakening of the wind force that raised it. The final phase is the most stable, and is known as the equilibrium stage, and it sets in immediately following the completion of the spreading stage. The plume loses its independence and therefore moves under the influence of prevailing winds. At this final stage, loss of visibility occurs in West Africa. The equilibrium stage characteristically occurs hundreds of kilometers from the point of dust origin.

The impact of dust over West Africa is varied, with some countries experiencing longer exposure durations than others. Nigeria, within West-Africa, characteristically experiences these effects during its dry season and the associated haze and dust events known as “*Harmattan*”. Some of the common effects include; loss or reduction of visibility, affecting aviation and road transportation with flight cancellations and an increase in road traffic accidents as a consequence. In *figure 10* shown below horizontal visibilities over Nigeria on 9th December, 2021. Northern States; Kano, Borno, Adamawa, Yobe, Jigawa and Gombe were under the influence of horizontal visibilities of equal to and less than 1000 meters placing the States on Thick Dust Haze. Over Plateau, Kaduna, Zamfara, Sokoto, Kebbi, FCT, Taraba, Benue, Kwara, Kogi, Ekiti, Edo, Ebonyi, and Rivers,

moderate dust haze ranging from 2000-5000m was observed. Osogbo, Oyo, Ogun, Delta, Bayelsa, Anambra and Enugu are in good visibilities from 5000m and above.

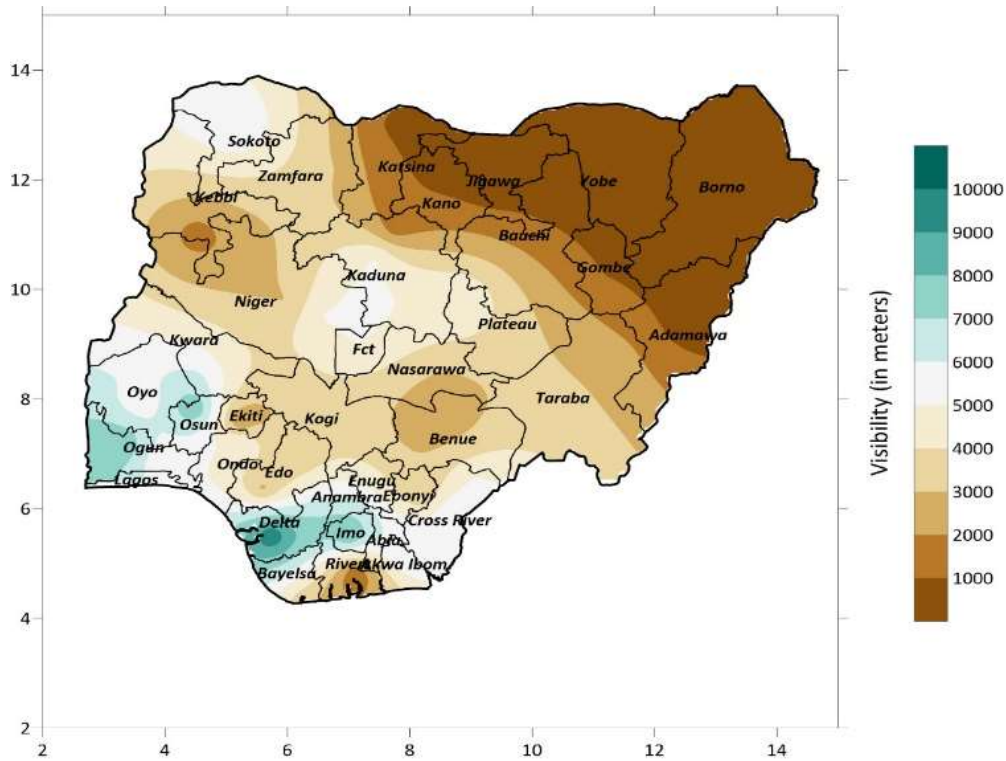

Figure 11: Horizontal visibility over Nigeria on 9th December, 2021 (Source: NiMet).

In Figure 12a and 12b below additional figures show visibility obtained for specific days within our study period, highlighting the presence of variable occurrence of dust invasion.

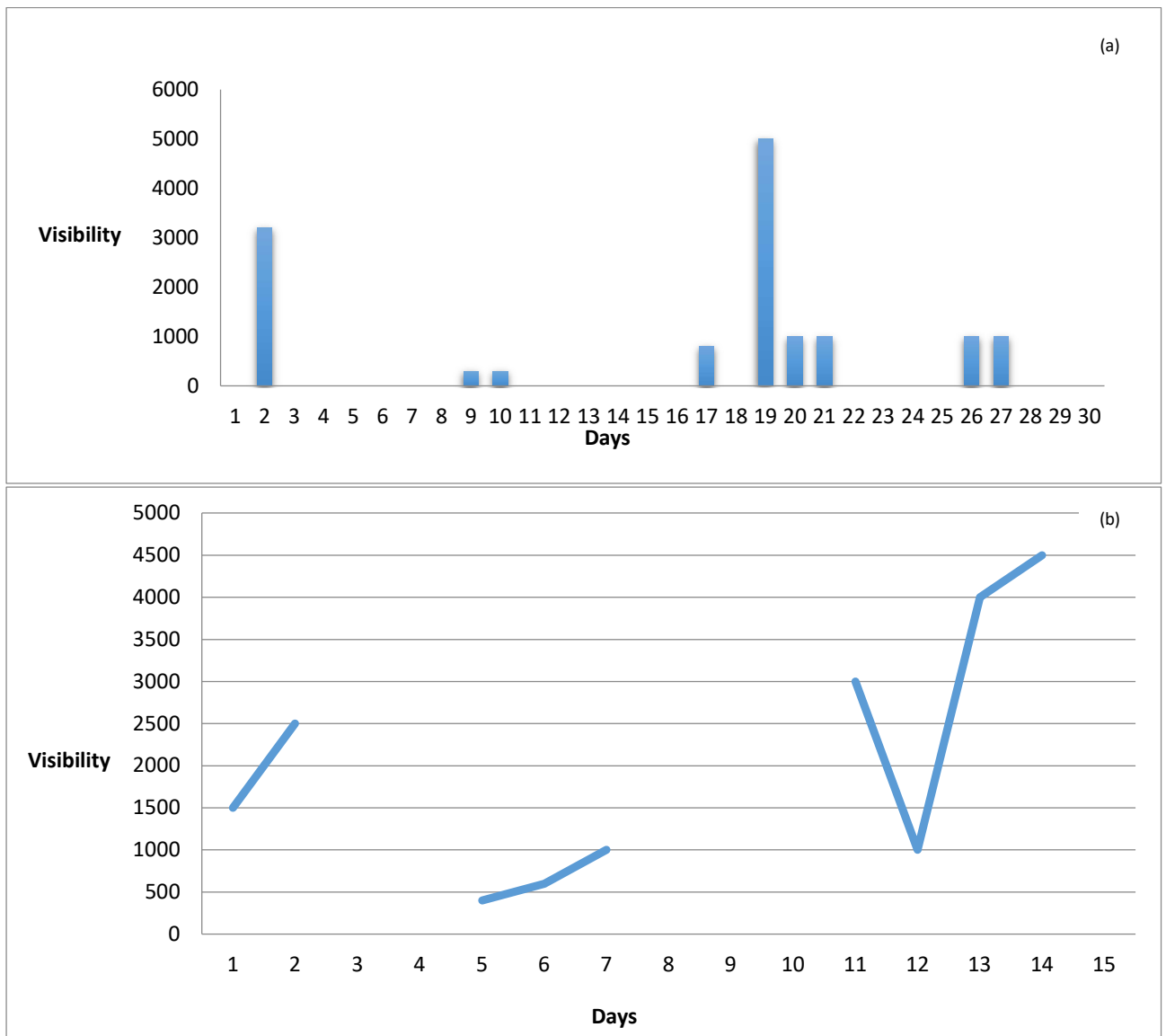

Figure 12 a & b: In these figures mean visibility values are shown in meters for (a) February and (b) March 2020, the period of our study in Kano State (Source: NIMET).

Dust loading in the atmosphere has also been linked to outbreaks of acute respiratory illnesses like pneumonia and bronchitis (Adefolalu, 1984). There are also direct impacts experienced on weather and climate, shown in Figure 13 below. Atmospheric dust affects cloud properties, induces radiative forcing and produces/confounds dust emissions. This subsequently affect wind, precipitation, and temperature, with the emitted dust being deposited on land and water surfaces. Radiative forcing generates a drawdown of CO₂.

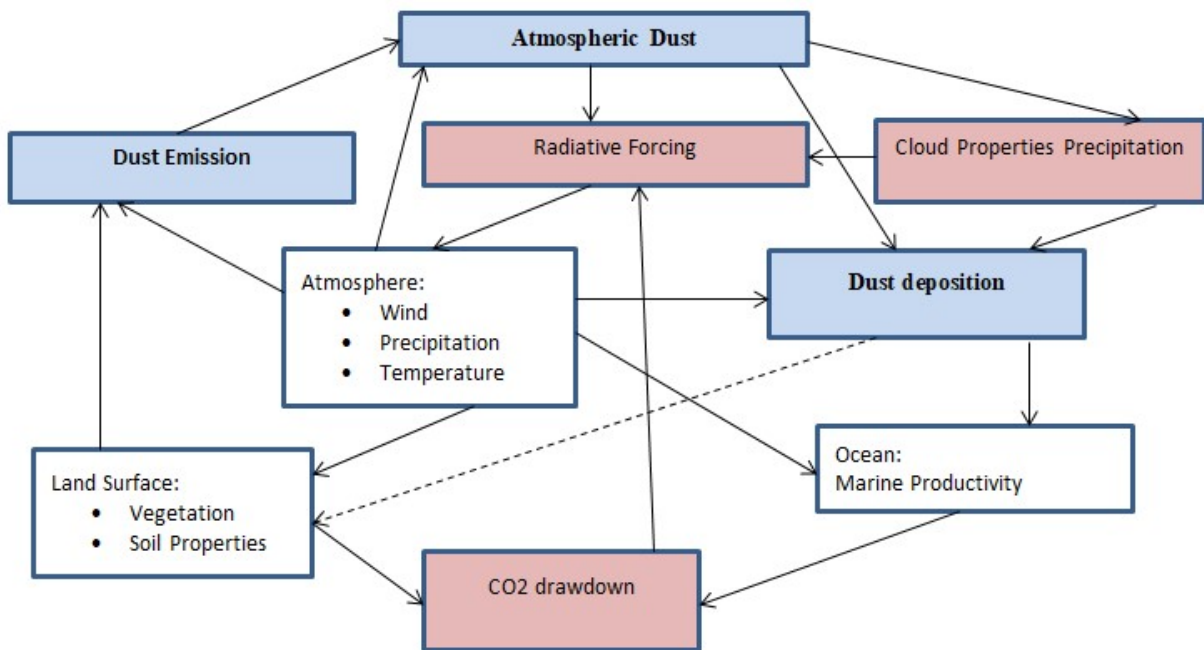

Figure 13: Linkages between mineral dust aerosol and climate, indicating direct and indirect aerosol effects, and the role of oceanic dust deposition ecosystems (Ajayi, 2021).

Other effects include radiative forcing, which influences energy distribution in the atmosphere and impacts atmospheric stability. The changes in energy alter the temperature and wind distribution and ultimately affect the stability of the atmosphere. Despite the negative effects discussed above, soil dust particles are shown to add essential nutrients when deposited into marine and terrestrial ecosystems. Sub-Saharan dust has been shown in some studies to be rich in iron (Adedokun, Emofurieta, & Adedeji, 1989). Enhanced productivity on the introduction of dissolved iron II has been recorded in marine studies, with increased production of oceanic micro-organisms and an increase in CO₂ drawdown in regions rich in micro-nutrients. Transportation of Saharan dust into the Amazon rainforest is associated with vegetation growth (Yu, Chin, Yuan, & Bian, 2015).

Additional pollution from road transportation vehicles arises from sources other than combustion and tail-pipe emissions. These mainly occur from resuspended particles released into the atmosphere.

1.6. Dust resuspension

Particulate emissions from road transport vehicles are often resuspended by vehicular and human traffic. This results in greater exposure and a longer duration of stay in the atmosphere. The lengthened exposure leads to increased exposure of humans to metalloids, mineral matter, and heavy metals (Amato, et al., 2009). In urban environments, dust resuspension by traffic serves as a major source of atmospheric particulate matter. This is further enhanced by the existence of a scarcity of precipitation favoring dust accumulation on the pavement at the site (Thorpe & Harrison, 2008; Johansson, Norman, M, & Gidhagen, 2007). Dry deposition deposits various particle types on the road and adjacent pavement on a regular basis from a variety of sources such as handling of dusty materials, road wear, vehicle-road infrastructure contact, and so on. This results in variability in chemical composition based on particle sizes and site (Amato, et al., 2009; Han, Youn, & Jung, 2011). Dust resuspension occurs by either direct wind action on surfaces or via abrasion as occurs in tyre-road interactions, these processes are dynamic with concurrent flows. The lift-off of soil particles is determined by the balance between aerodynamics, gravity, and cohesive forces. Smaller particles <20 mm. aerodynamic forces play a major role at higher air velocities, causing disintegration and lift-off. At lower velocities, cohesion factors act as a strong limiting factor (Martuzevicius, Kliucininkas, Prasauskas, Krugly, & Kauneliene, 2011).

The various means of estimating windblown and mechanically resuspended road dust have been reviewed by some researchers in relation to their applicability in modeling studies (Denby, Kupiainen, & Gustaffson, 2018; Countess, et al., 2001). Though mineral particles are considered to be the main component of road dust, other contributing sources add other elements and compounds. Brake wear filled with BaSO₄, lubricants containing Sb, Sn, and Mo sulfides, and Cu and Zn (to improve friction) are also released as particles and subsequently resuspended (Lijima, et al., 2007; Thorpe & Harrison, 2008). A study in Spain identified in the Urban atmosphere, Cu, Zn, Sb, Mo, Ba, and Sr in similar and sometimes higher concentrations than in industrial environments (Querol, et al., 2007). The use of enrichment factor analysis for heavy metals as a means of study aids the use of heavy metals as useful markers. Their high content identified in road dust is relevant, due to their potential to catalyze the formation of reactive oxygen species, thus exerting a negative health effects, particularly in urban areas (Kan, London, & Chen, 2007). Coarse particles can elicit inflammatory effects as shown in some studies, adding to the health effects of

resuspended particles (Schwarze, et al., 2010; Morman & Plumlee, 2013). Numerous studies have also implicated; Zn, Cu, Fe, Ni, Mn, and Cr as related to PM toxicity due to their acting as redox compounds (Schlesinger, Kunzli, Hidy, & Gotschi, 2006). A comparative study on six European cities that evaluated the inflammatory and cytotoxic activities of atmospheric PM in different air pollution scenarios discovered that coarse particles were more inflammatory than other PM size fractions (Schwarze, et al., 2007). Despite the availability of receptor modeling for use at urban background sites, various source apportionment studies have identified difficulties in differentiating road dust from other mineral sources or vehicular exhaust. In the presence of pre-existing (Priori) knowledge on source chemical profiles, ratios, etc. for a study area, modelling can be used. Some available modeling software includes the multi-linear engine (ME-2), which is a computer program that solves the positive matrix factorization (PMF). Its ability to function using partial knowledge of sources has made it useful for source apportionment studies (Amato, et al., 2009). However, for our study conducted here, dust resuspension was not studied due to the absence of pre-existing information on particles, fixed air sampling stations, and an existing particle identifier database for the sites.

Additionally, dust resuspension was not within the scope of our study, which is focused on the interphase of particulate pollutants and human health. Due to the improved legislation and regulation of emissions standards on vehicles and the use of diesel particulate filters and catalytic converters, there has been a reduction in exhaust emissions. However, this reduction has not shown a corresponding significant drop in PM₁₀ concentrations. Largely due to an underestimation within existing inventories of a primary pollution source attributed to non-exhaust emissions (NEE) (Amato, et al., 2014b). This represents a portion of particulate matter not originating from the combustion of engines for the propulsion of vehicles. It also includes resuspended particles (RD) previously deposited on the road, pavements, or other infrastructure, as well as abrasion-derived particles from tires, brakes, vehicle materials, and road wear. In European countries, the road traffic sector has been credited with being a major source of particulate matter emissions, with high traffic sites accounting for excessive PM₁₀ values (Pio, et al., 2020; Petit, Pallares, Favez, Alleman, Bonnaire, & Riviere, 2019; EEA, 2020).

A recent study by Amato et al. showed tailpipe emissions from road traffic contributed as much, or in some cases, more than exhaust emissions to PM levels (Monks, et al., 2019; DenierVan der

Gon, et al., 2013; Amato, et al., 2014b). This contrasts with previous studies in the 90s showing 80-90% of road traffic emissions to be attributable to engine exhaust emissions (DenierVan der Gon, et al., 2013). NEE are estimated by some researchers to potentially exceed exhaust emissions by 2020, based on a predicted non-significant reduction in NEE production (Rexeis & Hausberger, 2020). The composition of NEE has been given in three categories by the European Union (EU). These confer percentage PM10 mass concentrations on tyre wear (5-30%), brake wear (16-55% for urban roads and 3% on freeways) and RD resuspension at a range of; 28-59% (EEA, 2019). A source apportionment study of traffic emissions of particulate matter using tunnel measurements was carried out (Lawrence, Sokhi, Ravindra, Mao, Prain, & Bull, 2013). The application of principal component and multiple linear regression analysis enabled the identification of the emission sources for 82% of the total PM10 mass inside the tunnel, from which a fraction of 27% was attributed to resuspension.

Receptor modeling, mentioned earlier in relation to dust resuspension analysis, has been used through PMF to apportion sources of traffic generated PM10 in a canyon in Zurich, Switzerland. The results obtained in the study indicated RD resuspension accounted for 40% (in mixed fleets) and 10% in the case of heavy duty vehicles (Bukowiecki, et al., 2009). In Spain, a study that estimated the impact of road dust emissions on PM10 and PM2.5 using PMF and analytical characterization, though limited by chemical profiles of road dust samples (local), showed a range of values. Road dust contributions to PM2.5 were highest for traffic at 21-31%, then 11%-31% for urban background; urban-industrial showed 6-16% and the lowest was recorded in the rural site at 7%. For PM10, the highest values were obtained in urban areas at 29%-34% and the lowest in rural areas at 9-22% (Amato, et al., 2014b). Within France, a study in Marseille utilizing constrained PMF analysis using ME-2 solver found dust peaks prevailing in fall and summer with concentrations of $4\mu\text{g m}^{-3}$ (10% of PM2.5 levels) and $9\mu\text{g m}^{-3}$ (13% of PM2.5 levels) (Salameh, et al., 2018). An alternative approach by researchers using electron microscopy for PM10 samples in Germany showed 58% of PM10 related to RD suspension with higher values in curbside monitoring stations (Weinbruch, et al., 2014). In urban China, RD was identified as contributing 24.6% of total PM2.5 emissions (Chen, et al., 2019a). Regional variabilities in; composition, meteorology, economic activities, traffic speed, vehicle weight, and maintenance of road infrastructure have resulted in difficulty during estimation of RD as shown in multiple studies (Candeias, Vicente, Tomé, Rocha, Avila, & Alves, 2020; Timmers & Achten, 2016). A study on

traffic hotspots in south western Nigeria identified higher significance ($p < 0.05$) values of Zn at roadsides (paved = 94.1 ± 52.1 mg kg⁻¹, unpaved = 101.5 ± 69 mg kg⁻¹) than control (27.6 ± 16.5 mg kg⁻¹). Pb concentrations of road dust (paved = 31.8 ± 33.6 mg kg⁻¹, unpaved = 50.8 ± 48.9 mg kg⁻¹) were also statistically higher ($p < 0.05$) than those of control samples (6.33 ± 3.36 mg kg⁻¹). The health risk assessment of metals showed values less than 1.0 in adults and greater than 1.0 in children (Taiwo, et al., 2017). Other studies have shown street dust is directly exposed to vehicle exhaust emissions and may absorb polycyclic aromatic hydrocarbons (PAH) and particles. Some studies show street dust-bound PAHs may act as secondary pollutants and as surface water contaminants (Liu, et al., 2007; Boonyatumanond, Murakami, Wattayakorn, Togo, & Takada, 2007; Mai, et al., 2003).

Saharan dust intrusion experienced in African countries and some Mediterranean countries contributes to dust accumulation on road surfaces, thus affecting resuspension (Querol X. , et al., 2008; Artinano, Salvador, Alonso, Querol, & Alastuey, 2003). This may account for the amount of sand particles recorded in our study within Northern Nigeria, a region prone to gusts of silicone laden Saharan dust during the dry season. In Scandinavian countries, PM accumulation on road surfaces during rigid winters is enabled by anti-icing processes (salt and sand application) and the use of studded Tires, thus leading to high pollutant levels in early spring and mid-winter (Kupiainen & Pirjola, 2011; Gustafsson, et al., 2019). For countries which experience rainfall scarcity, there is an associated ease of resuspension of particles previously deposited on road surfaces, leading to an overall increase in total PM levels (Karanasiou, et al., 2011; Amato, et al., 2009). Additionally, a study in Lithuania that investigated resuspension of particulate matter and PAHs from street dust confirmed that street dust is a significant source of urban air pollution. Their results showed that street dust not only emits fugitive dust, but also serves as a substantial source of PAHs bound to particle size fractions; PM_{2.5}, PM₁₀, and PM_{total} (Martuzevicius, Kliucininkas, Prasauskas, Krugly, & Kauneliene, 2011). Therefore, the effects of RD and its resuspension are myriad and warrant intensification of preventive and control measures to safeguard the environment and human health.

1.7. Health effects of particulate pollution

Several negative impacts on humans are associated with use of automobiles including environmental pollution and decreased physical activity. These negative effects arise directly via deterioration in public health and changes in traffic conditions based on natural factor effect on road sections (Pegin & Sitnichuk, 2017; Kapskij, Pegin, & Evtyukov, 2017; Khreis, et al., 2016). There are multiple long-term and short-term effects of exposure to air pollution (Sadiq, et al., 2022). Short-term effects include; decreases in pulmonary function (Lagorio, et al., 2006), increases in inflammatory markers (Zeka, Zanobetti, & Schwartz, 2006) and respiratory symptoms, exacerbations of chronic obstructive pulmonary disease (COPD) and infections (Barnett A. , et al., 2005), and increased respiratory mortality (Ostro, Feng, Broadwin, & Lipsett, 2007). Particulate pollution has been linked to lung and cardiovascular disease, and cognitive dysfunction in the elderly (Saenz, Wong, & Ailshire, 2018; Thompson, 2019). In children, long-term exposure to PM has been linked to low birth weight (LBW), a risk of respiratory infections, and wheezing (Kim E. , et al., 2016; Roy, Hu, Wei, Korn, Chapman, & Zhang, 212).

A study on assessing the impact of automobile use on population morbidity identified statistically significant relationships to morbidity indicators. Significant associations were shown between the number of registered light motor vehicles to malignant neoplasms, stress-related mental disorders and obesity amongst individuals aged 16 years and older (Azemsha, Kapski, & Pegin, 2018). Studies have linked air pollution exposure to systemic oxidative stress, which has an important role in neuronal system development (Franchini & Mannucci, 2011; Nemmar, Hoet, Dinsdale, Vermylen, Hoylaerts, & Nemery, 2003; Maher & Schubert, 2000). Exposure to air pollutants has also been linked to diabetes, cancer, and allergies (Hvidtfeldt, et al., 2019; Ansari & Ehrampoush, 2019; Liu, et al., 2019). Particles with diameters of $<10\ \mu\text{m}$ (PM10) and $<2.5\ \mu\text{m}$ (PM2.5) have been shown to have a negative impact on health (Luo, Zhang, Hu, & Qiu, 2020; Wang, Zhang, Niu, & Liu, 2020). Diesel engine particles (DEP) induce the release of cytokines and chemokines involved in both innate and adaptive immune inflammatory responses (Schwarze, et al., 2010). The acute symptoms arising from air pollution exposure are usually attributable to acute inflammation and long term health effects to chronic inflammation.

Acute inflammation as a response of vascularized tissue is a critical component of regenerative and homeostatic processes such as wound healing. It's a complex defense mechanism in which white blood cells (leucocytes) migrate from the circulation into damaged tissues to destroy the agents the potentially can cause tissue injury. A hallmark of acute inflammation is that initially the leucocyte infiltrate is mostly neutrophilic, but after 24 to 48 hours monocytic cells predominate (Melnicoff, Horan, & Morahan, 1989; Doherty, Downey, Worthen, Haslett, & Henson, 1989). For chronic inflammation macrophages and lymphocytes predominate. In its controlled state it is involved in responses against pathogens and acute phase reactions. Chronic inflammation and cytotoxic storms which are uncontrolled serve as precursors to chronic illnesses. These chronic diseases include; cardiovascular disease, neurodegenerative diseases and cancer (Coussens & Werb, 2002; Campisi, 2005; Murakami, Harada, & Kamimura, 2013). There are multiple players in inflammation including; Lymphocytes, myeloid cells, epithelial cells, endothelial cells, fibroblasts, adipocytes and muscle cells which interact via matrix metallo-proteins (MMP) and molecules. Soluble factors such as; chemokines, cytokines and growth factors are also active participants. *Figure 13* below shows the mediators of inflammation/repair and their roles.

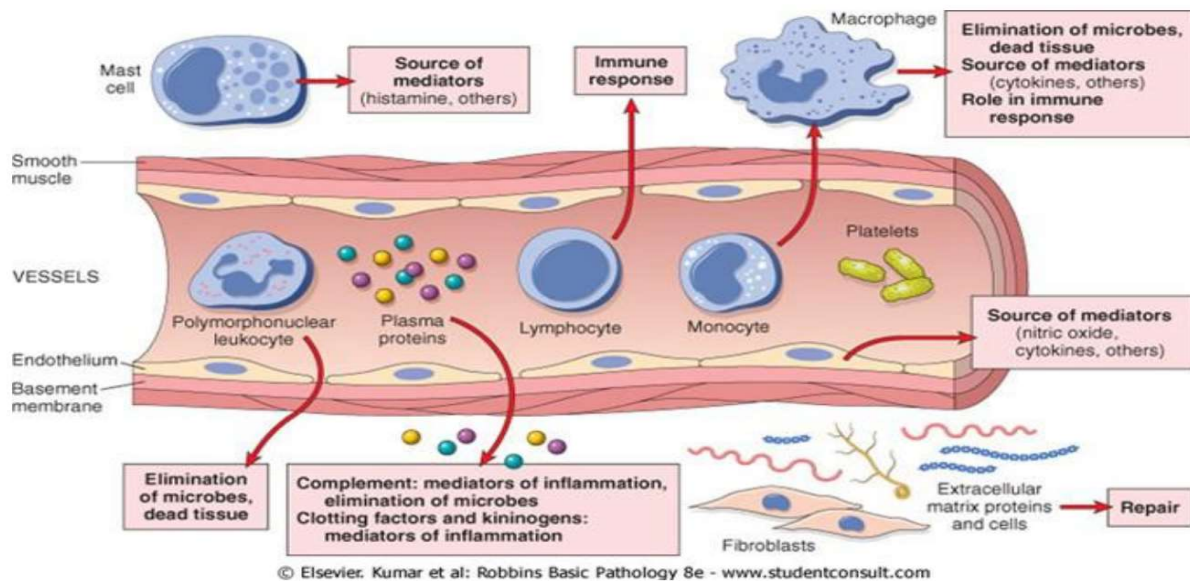

Figure 14: Key events and cells involved in inflammation and repair (Kumar, Abbas, Fausto, & Mitchell, 2007).

There are both pro-inflammatory and anti-inflammatory cytokines, with IL-6 playing a key role in auto-immune diseases, cytokine storm, and chronic inflammatory diseases (Ishihara & Hirano, 2002; Atsumi, Singh, & Sabharwal, 2014; Mahmudpour, Roozbeh, Keshvarz, Farrokhi, & Nabipour, 2020; Grivennikov, Karin, & Terzic, 2009; Hunter & Jones, 2015). Pro-inflammatory cytokines regulate responses to; infection, inflammation, and trauma, a role which worsens diseases in the presence of pathological conditions. Others include; tumor necrosis factor (TNF), interferon (IFN)- γ and interleukin (IL)-1 (Dinarella, 2000; Gao, Tang, Chen, Li, Nie, & Lin, 2015). Interleukin-6 (IL-6) is a known pleiotropic cytokine involved in; bone metabolism, inflammation, embryonic development, immune responses, and other processes (Kamimura, Ishihara, & Hirano, 2003; Van Snick, 1990; Hirano & Kishimoto, 1990). It serves as a key factor in inflammation, auto-immunity, and cancer, mainly via IL-6 signal transduction and activation of transcription 3 (STAT3) pathway (Yu, Pardoll, & Jove, 2009; Bollrath, Pesse, & Von Burstin, 2009; Hunter & Jones, 2015; Masjedi, Hashemi, & Hojjat-Farsangi, 2018). It also promotes antibody production by directly acting on plasma cells and indirectly promoting Bc16-dependent follicular CD4 (+) T (Tfh) cell differentiation along with IL-21 (Jego, Palucka, Blanck, Chalouni, Pascual, & Banchereau, 2003; Cassese, Arce, & Hauser, 2003).

The effectiveness of IL-6 activity inhibition against inflammatory diseases, despite the number of cytokines involved, may be due to IL-6 being a major stimulator of STAT3. STAT3 plays an important role in inflammation and oncogenesis together with nuclear factor Kappa-B (NF-kB), which expresses IL-6 as a target (Hirano, *IL-6 in inflammation, autoimmunity and cancer*, 2020). Interleukin-6 exerts its activity mainly through binding to the cell membrane IL-6 receptor (IL-6R) (Luo Y. , 2016). Cell membrane IL-6R consists of two subunits, IL6R α (gp80 or CD126), a 80-kDa type I transmembrane protein, and IL-6R β (gp130 or CD130), a 130-kDa second signal transmembrane protein. The soluble IL-6R (sIL-6R), which is cleaved from the cell membrane, can still bind its ligand IL-6 (Taga, Hibi, Hirata, Yamasaki, Yasukawa, & Matsuda, 1989; Yamasaki, Taga, Hirata, Yawata, Kawanishi, & Seed, 1988). IL-6 is not expressed in healthy individuals, but is rapidly synthesized with infections and tissue injury. It is critical to the maintenance of host defenses (Hunter & Jones, 2015; Liu, Jones, & Choy, 2016; Garbers, Aparicio-Siegmund, & Rose-John, 2015). It has been shown to exhibit contrasting features in acute and chronic conditions. In models of chronic inflammatory diseases, such as collagen-induced arthritis, murine colitis, or

experimental autoimmune encephalomyelitis, IL-6 is pro-inflammatory (Yamamoto, Yoshizaki, Kishimoto, & Ito, 2000; Alonzi, et al., 1998), whereas in models of acute inflammation, IL-6 exhibits an anti-inflammatory profile (Xing, et al., 1998). Although cytokines such as transforming growth factor (TGF) have anti-inflammatory effects, though despite this, interleukins in particular are potent mediators of the inflammatory response in immune and vascular cells, and play a crucial role in the propagation of atherosclerosis and other vascular inflammatory diseases (Kleeman, Zadelaar, & Kooistra, 2008).

The inflammatory response outlined above occurs in response to air pollutants within the human body. The major system commonly affected is the respiratory system, its development; anatomy and physiology are explained below.

1.8. Human respiratory system: embryology, anatomy and physiology

The human respiratory system commences development in utero through a series of sequential embryological changes, has specialized anatomical structures, and participates in physiological processes to ensure adequate respiration. The health effects of certain substances in the environment have been shown to exert their negative influences even on a growing fetus. The development human organs, known as “organogenesis”, lasts from the 3rd-20th week of intrauterine life and is the period of maximal risk from teratogens. The 3rd to 7th week period is known as the highest risk window (Sadler, 2012). The process of progressing from a single cell through the period of establishing organ primordia (first eight weeks of human development) is known as the period of embryogenesis; the period onwards till birth is known as the period of organogenesis. During the period of organogenesis, fetal growth and weight gain accompany ongoing differentiation. Interactions between cells and tissues form organs, the stages of development are shown in *Table 3*. One group of cells or tissue can make another group of cells or tissues change their direction in a process known as induction. The cell or tissue that produces the signal is known as the inducer, and that which reacts is known as the responder. A competence factor is crucial to activating the ability of a cell or tissue to respond to a given signal. The ability to respond is termed competence. Fertilization marks the beginning of development and is the process where the female gamete, the oocyte, and the male gamete, the sperm, unite to form a zygote.

1.8.1. Development of the thoracic cavity and diaphragm

The thick plate of mesodermal tissue occupying the space between the thoracic cavity and the stalk of the yolk sac is known as the *septum transversum*. It originates from the visceral splanchnic mesoderm surrounding the heart. It takes its position between the abdominal cavity and the primitive thoracic cavity as the cranial end of the embryo grows and curves into the fetal position. The septum leaves a large opening in the thoracic and abdominal cavities on each side of the foregut known as the pericardioperitoneal canals. The growing lung buds expand within the canals. The rapidly growing lungs expand out of the canals into the body wall mesenchyme; laterally, dorsally, and ventrally. Expansion laterally and ventrally occurs posterior to the pleuropericardial folds. Lung expansion splits the mesoderm of the body wall into two components; the pleuropericardial membranes containing the phrenic nerve and common cardinal veins and the definitive wall of the thorax. Cardiac descent and sinus venosus positional changes shift the cardinal veins. Finally, the pleuroperitoneal fusion with the root of the lungs and the thoracic cavity is divided into two pleural cavities and the pericardial cavity in *figure 15* below.

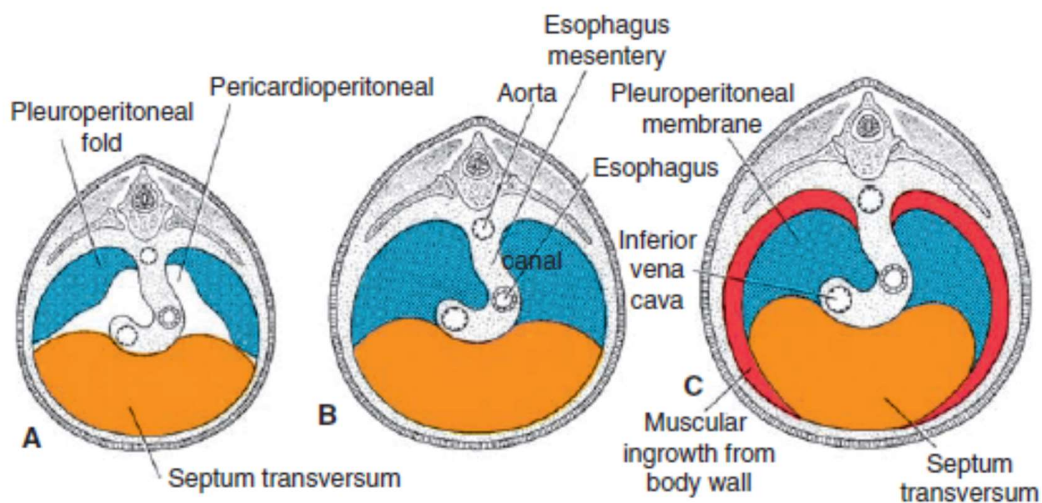

Figure 15: Development of the Lungs and diaphragm: (a) Pleuroperitoneal folds appear at the beginning of the fifth week (b) Pleuroperitoneal folds fuse with the septum transversum and mesentery of the esophagus in the seventh week, which separate the abdominal cavity from the thoracic cavity (c) Transverse section during the fourth month of development, with the body wall forming the periphery of the diaphragm (Sadler, 2012).

The embryo obtains nutrients and eliminates waste by simple diffusion during the first week of development. This additional need arising from rapid growth is filled by the uteroplacental circulation. Formation of the system commences on day nine, as vacuoles called trophoblastic lacunae open within the syncytiotrophoblast. Expansion of maternal capillaries occurs near the syncytiotrophoblast, which then forms maternal sinusoids that rapidly anastomose with the trophoblastic lacunae. Local proliferation of the cytotrophoblast occurs between days 11 and 13, with extensions that grow into the overlying syncytiotrophoblast. The growth of these protrusions is thought to be induced by the underlying newly formed extra-embryonic mesoderm. These extensions of cytotrophoblast grow out into the blood-filled lacunae, carrying with them a covering of syncytiotrophoblast. The resulting outgrowths are called primary chorionic stem villi.

Formation and lengthening of the ribs start on day thirty-five; this is progressively illustrated in *figure 16*. The first seven ribs connect ventrally to the sternum via costal cartilages by day forty-five and are called the true ribs; the lower five are the false ribs. Endochondral ossification occurs later, as initially the ribs develop as cartilaginous precursors. The sternum develops from a pair of longitudinal mesenchymal condensations, the sternal bars (Schoenwolf, Bleyl, Brauer, & Francis-West, 2015). The fusion of the sternal bars occurs along the midline in the seventh week. The fusion commences at the cranial end of the sternal bars and progresses caudally, and ends with formation of the xiphoid process in the ninth week. Ossification of the sternal bars starts at the fifth month and continues until shortly after birth, thus forming the definitive bones of the sternum: xiphoid process, manubrium, and body of the sternum (Schoenwolf, Bleyl, Brauer, & Francis-West, 2015).

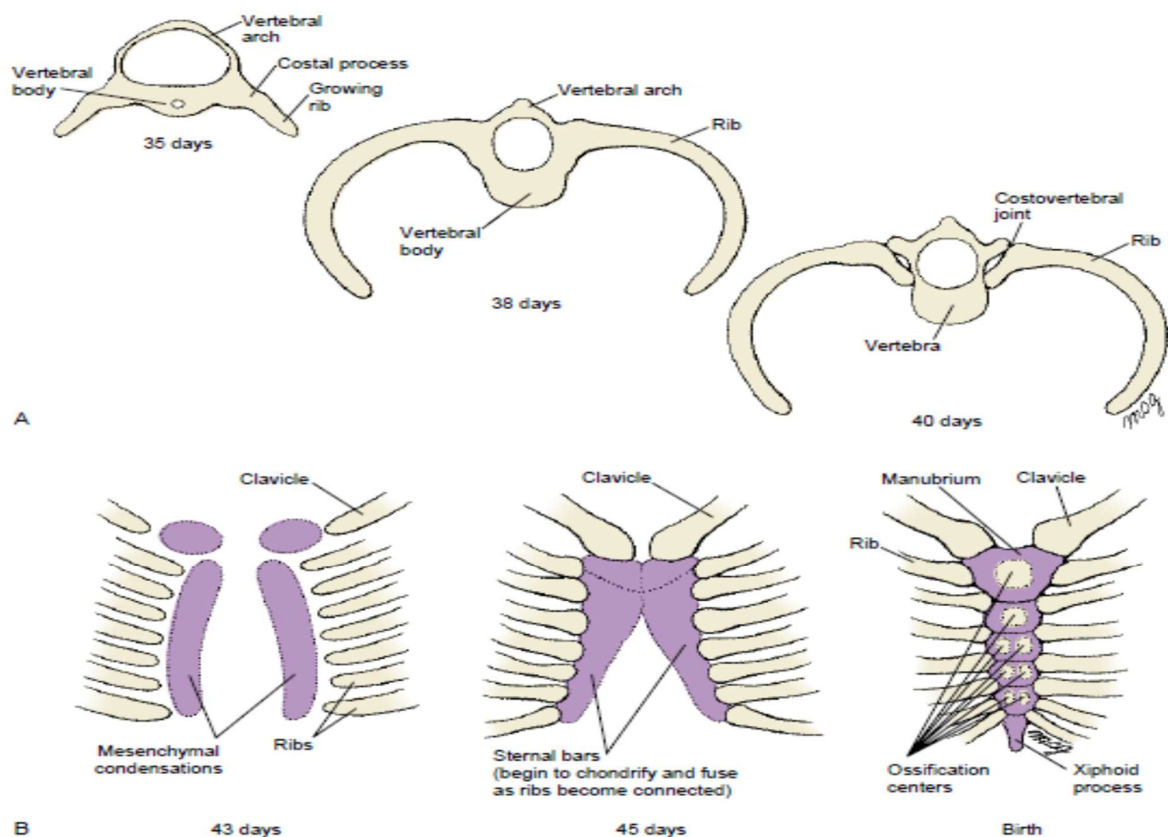

Figure 16: Development of the ribs and sternum. A, The costal processes of the vertebrae elongate in the fifth week to form the ribs. Late in the fifth week, the costovertebral joints form and separate the ribs from the vertebrae. B, paired mesenchymal condensations called sternal bars form within the ventral body wall at the end of the sixth week. These bars quickly fuse together at their cranial ends, while their lateral edges connect with the distal ends of the growing ribs. The sternal bars then fuse across the midline in a cranial-to-caudal direction. Ossification centers appear within the sternum as early as sixty days, but the xiphoid process does not ossify until birth (Schoenwolf, Bleyl, Brauer, & Francis-West, 2015).

The primordium of the lungs: the respiratory diverticulum or lung bud, forms as a ventral evagination of the foregut on day twenty-two. The growing lung bud remains ensheathed in a covering of splanchnopleuric mesoderm, which will give rise to the lung vasculature and to the connective tissue, cartilage, and muscle within the bronchi. The lengthening lung bud bifurcates into left and right primary bronchial buds on days 26-28, which will give rise to the two lungs. During the fifth week, a second generation of branching produces three secondary bronchial buds on the right side and two on the left. These are the primordia of the future lung lobes, these buds continue growing and bifurcate filling the pleural cavities (Schoenwolf, Bleyl, Brauer, & Francis-West, 2015). The terminal bronchioles, which divide into two or more respiratory bronchioles, are

formed by week twenty-eight. These respiratory bronchioles become invested with capillaries by week thirty-six and become terminal sacs or primitive alveoli (Schoenwolf, Bleyl, Brauer, & Francis-West, 2015). The first partition to develop is the septum transversum, a wedge of mesoderm that forms a ventral structure partially dividing the coelom into a thoracic primitive pericardial cavity and an abdominal peritoneal cavity.

Table 3: Stages of Human Lung Development, adapted from (Schoenwolf, Bleyl, Brauer, & Francis-West, 2015)

Stage of Development	Period	Events
Embryonic	Twenty-six days to six weeks	Respiratory diverticulum arises as a ventral outpouching of foregut endoderm and undergoes three initial rounds of branching, producing the primordia successively of the two lung lobes, and the bronchopulmonary segments; the stem of the diverticulum forms the trachea and larynx
Pseudoglandular	Six to sixteen weeks	Respiratory tree undergoes fourteen more generations of branching, resulting in the formation of terminal bronchioles
Canalicular	Sixteen to twenty-eight weeks	Each terminal bronchiole divides into two or more respiratory bronchioles. Respiratory vasculature begins to develop. During this process, blood vessels come into close apposition with the lung epithelium. The lung epithelium also begins to differentiate into specialized cell types (ciliated, secretory, and neuroendocrine cells proximally and precursors of the alveolar type II and I cells distally)
Saccular	Twenty-eight to thirty-six weeks	Respiratory bronchioles subdivide to produce terminal sacs (primitive alveoli). Terminal sacs continue to be produced until well into childhood.
Alveolar	Thirty-six weeks to term	Alveoli mature

1.8.2. Anatomy of the Respiratory system

The lungs are located in the pleural cavity and separated by the heart and great vessels medially, at their base, they lie on the diaphragm. The diaphragm participates in the respiratory process by moving upwards or downwards. The chest cavity is bordered by the sternum anteriorly, the ribs anteriorly, laterally, and posteriorly, the scapula posteriorly, and the clavicles anteriorly and laterally. The process of respiration is a complex interplay between muscular, pleural, skeletal, neural, and vascular components of the thoracic region. The right lung is slightly larger and consists of three lobes, while the left has two lobes and shares space with the heart within the left hemithorax. In *figure 17* below, the anterior and posterior topography of the lungs is illustrated within the thoracic cavity.

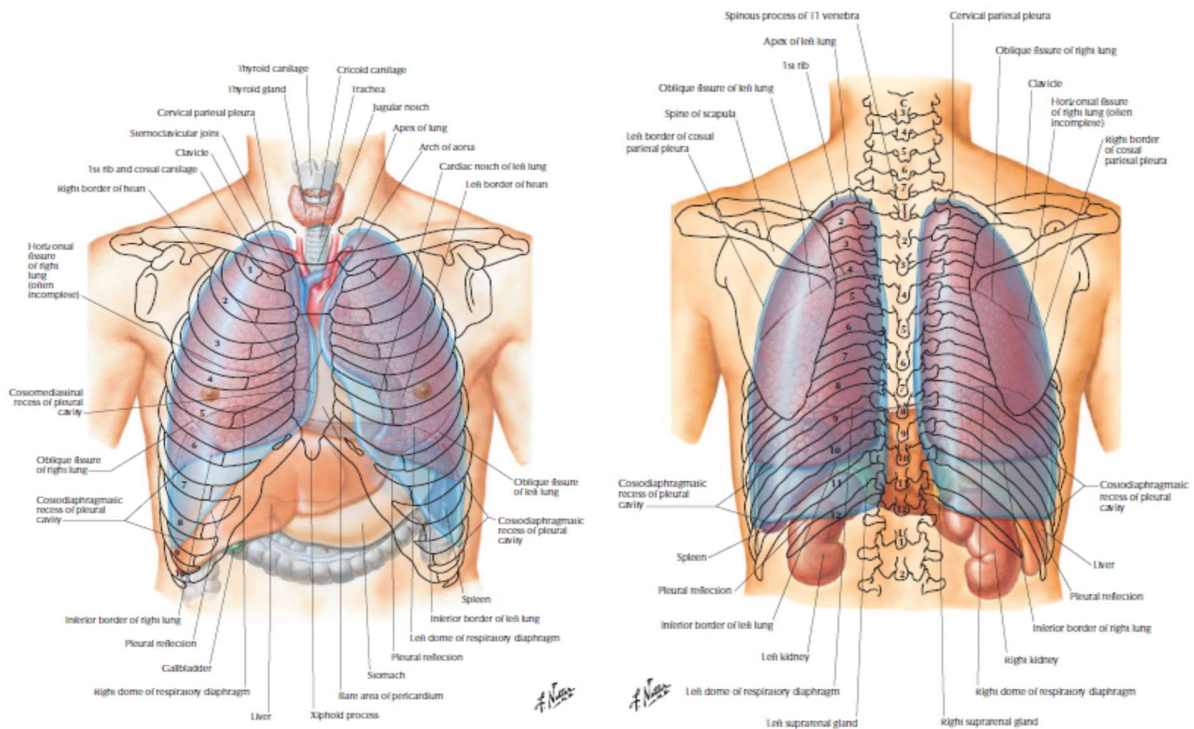

Figure 17: Topography of the Lungs (anterior and posterior views) (Netter, 2019).

1.8.3. Physiology of Respiration

Respiration functions mainly to provide adequate oxygen supply to the body and effectively expel carbon dioxide. It comprises of four main components; pulmonary ventilation, which is the inflow and outflow of air between the lung alveoli and the atmosphere, oxygen (O₂) diffusion and carbon dioxide (CO₂) between the blood and alveoli, transportation of carbon dioxide and oxygen in the blood and body fluids from and to cells, and lastly, regulation of ventilation (Hall, 2016). The airway tree divisions create branches; these are the bronchi, bronchioles, and terminal bronchioles. The conducting contains multiple specialized cells that have additional functions beyond air conduction. The mucosal epithelium is attached to a basement membrane, which is underlined by the lamina propria. They are both referred to as the “airway mucosa”. Portions of the airway with a larger caliber contain smooth muscle cells beneath the epithelium and an enveloping connective tissue that is interspersed with cartilage in larger amounts (Barett, Barman, Brooks, & Yuan, 2019). The airway contains pseudostratified epithelium and several cell types such as; ciliated and secretory cells (e.g. goblet cells and glandular acini), which are components of airway innate immunity, and basal cells that serve as progenitor cells for repair. Approximately 300 million alveoli are found in humans, with a total area of the walls directly in contact with capillaries estimated at 70m².

There are two mechanisms involved in lung expansion and contraction; diaphragmatic movement and elevation and depression of the ribs. Multiple muscles play important roles in moving the rib cage, such as; the external intercostals, internal intercostals, sternocleidomastoid muscles, anterior serrate, and the abdominal recti. The lung is an elastic organ, located in the thoracic cavity and surrounded by pleural fluid which lubricates its surfaces (Hall, 2016). Airflow through the respiratory system can be broken down into three interconnected regions; the upper airway, the conducting airway, and the alveolar airway (also known as the lung parenchyma or acinar tissue). In nose and upper airways, in addition to the role of olfaction, they also filter out large particulates and warm/humidify air as it enters the body (Barett, Barman, Brooks, & Yuan, 2019).

The epithelial cells located in the conducting airway secrete a variety of substances that assist lung defense, such as; secretory immunoglobins (IgA), collectins (including surfactant protein (SP-A and SP-D), defensins, other peptides and proteases, reactive oxygen species (ROS) and reactive nitrogen species are all generated by airway epithelial cells. The alveoli are lined (*figure 18* below)

with two types of cells; type I cells, which are the primary lining cells and cover 95% of the surface, and type II cells (granular pneumocytes), which are thicker and contain lamellar bodies. The type II cells comprise 5% of the total surface area and account for 60% of the epithelial cells. Type II cells produce surfactant and participate in alveolar repair. They also contain lamellar bodies, which contain phospholipids secreted into the alveolar lumen by exocytosis (Barett, Barman, Brooks, & Yuan, 2019). The ultimate importance of pulmonary ventilation is to continually renew the air in gas exchange areas, where air is in proximity to pulmonary blood, such as the alveoli, alveolar sacs, alveolar ducts, and respiratory bronchioles (Hall, 2016).

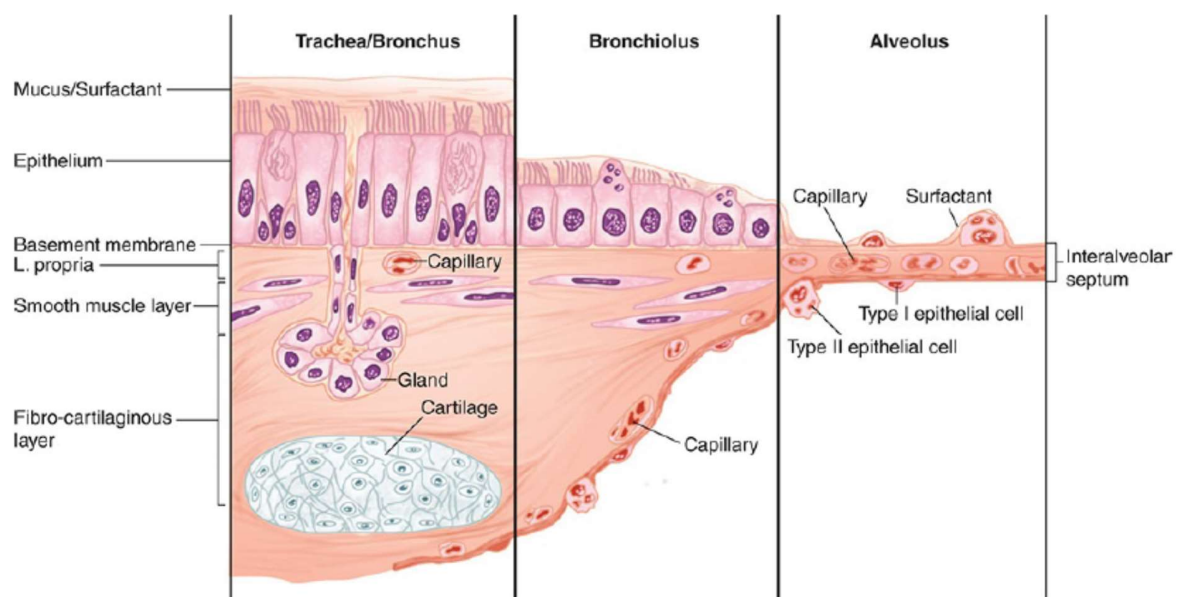

Figure 18: Progressive cellular transition from the conducting airways to alveoli, epithelial layer transitions also occur from pseudostratified with submucosal glands to cuboidal and then squamous epithelium. The underlying mesenchyme tissue and capillaries also undergo changes (Barett, Barman, Brooks, & Yuan, 2019).

Existing pleural pressure is normally a slight negative pressure (slight suction), at the beginning of inspiration has a value of -5cm of water. Expansion of the rib cage during normal inspiration creates more negative pressure to about -7.5cm of water. These changes are reversed during expiration. In the absence of air flow and in the presence of an open glottis, pressure in all parts of the respiratory tree is equal to atmospheric pressure. For air flow to occur, the pressure in the alveoli must fall below atmospheric pressure. The transpulmonary pressure is defined as the difference in pressure

between the surfaces of the lungs and alveoli. Recoil pressure is a measure of elastic forces within the lungs that collapse the lungs during respiration. Lung compliance is the extent of lung expansion for each unit increase in transpulmonary pressure; it has a value of 200 milliliters of air/cm of water for normal adults (Barett, Barman, Brooks, & Yuan, 2019). Surfactant is secreted by type II alveolar epithelial cells and reduces surface tension. The cells are granular and contain lipid inclusions; it's a complex mixture of phospholipids, proteins, and ions. Its most important components are; dipalmitoyl phosphatidylcholine, surfactant apoproteins and calcium ions. Their non-uniform dissolution in fluid lining alveolar surfaces aids in this function. The surface tension of normal fluids lining the alveoli without surfactant is 50 dynes/cm; normal fluids lining alveoli and with normal amounts of surfactant including 5-30 dynes/cm. *Figure 19* below shows changes in lung volume and pressure at different levels during both phases of respiration.

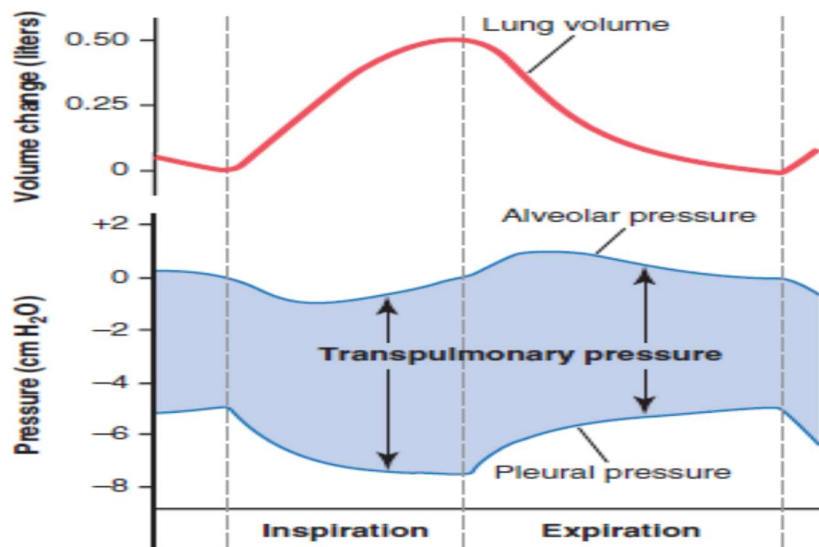

Figure 19: Changes in lung volume, alveolar pressure, pleural pressure and transpulmonary pressure during normal breathing (Hall, 2016).

Spirometry is used to study the volume movement of air in and out of the lungs. A typical spirometer contains an inverted drum counterbalanced by a weight. The drum tends to contain gas, usually air or oxygen, and a tube that connects the mouth to the chamber. Modern spirometers

based on this principle are smaller and more automated making diagnosis and monitoring easier (Barett, Barman, Brooks, & Yuan, 2019). In *figure 20* below, a spirogram shows changes in lung volume under different conditions. The diagram subdivides the findings into four volumes and four capacities:

1.8.3.1. Pulmonary volumes

1. The Tidal Volume: is the volume of air inspired or expired with each normal breath.
2. The inspiratory reserve volume: is the extra volume of air that can be inspired over and above the normal tidal volume when inspiration is done at full force.
3. The expiratory reserve volume: is the maximum extra volume of air that can be expired by forceful expiration at the end of normal tidal expiration.
4. The residual volume: is the volume of air remaining in the lungs after forceful expiration (1.2 liters).

1.8.3.2. Pulmonary capacities

To effectively describe pulmonary events, some lung volumes are combined to obtain pulmonary capacities. These are:

1. Inspiratory capacity: this is the total of the tidal volume plus the inspiratory reserve volume. It's the amount a person can breathe in from the start of normal expiration.
2. Functional residual capacity is the expiratory reserve volume plus the residual volume.
3. Vital capacity equals the inspiratory reserve volume plus the tidal volume plus the expiratory reserve. It is the maximum amount of air a person can expel from the lungs after first filling them to maximal capacity.
4. Total Lung capacity: This is the maximum volume to which the lungs can be expanded with the greatest effort. It's a total of the vital capacity and residual volume.

Values for the pulmonary capacities and volumes are 20-25% less in women, and are higher in athletes compared to those with smaller body sizes.

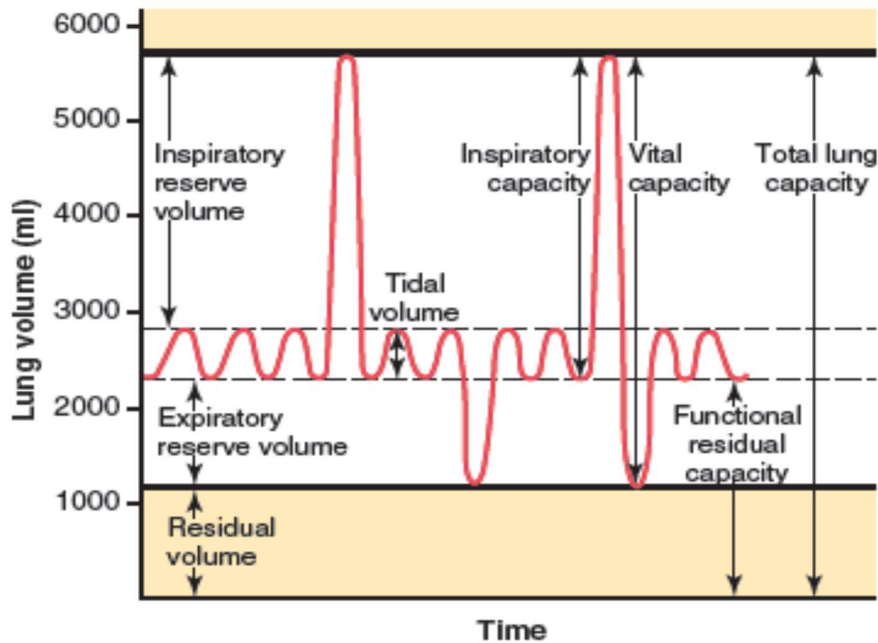

Figure 20: Diagrammatic representation of respiratory excursions during normal breathing and during maximal inspiration and maximal expiration (Hall, 2016).

The ability of particulate pollutants to disperse from their source accounts for the effect they exert on humans and the environment in the near and far field to the source point.

Various analytical methods exist to assess air particles obtained via air sampling. The method selected is dependent on the research questions and objectives for experimentation by the researchers. To obtain an idea of the anthropogenic contribution to metal elements, enrichment factor analysis is done. Scanning electron microscopy with x-ray dispersive analysis is employed to identify the particle morphology, size, composition, and concentration. Spectroscopy, on the other hand, is used to compensate for inadequacies associated with the use of scanning electron microscopy and energy dispersive x-ray analysis (SEM-EDX).

1.9. Enrichment Factor Analysis

Background (natural) levels in relation to the anthropogenic enrichment of heavy metals have been documented in multiple global studies (Blaser, Zimmermann, Luster, & Shoty, 2000; Reimann,

et al., 2007). Various methods, including univariate, multivariate analysis and spatial analysis (frequency space-method), have aided in the separation of anthropogenic and natural sources of elements (Otero, Tolosana-Delgado, Solera, Pawlowsky-Gahn, & Canals, 2005; Zuo, 2011). The enrichment factor (EF) was first introduced to identify the level of mineralization and origin of elements contained in precipitation, the atmosphere, and sea water. These enrichment factors (EFs) or contamination factors (CFs) are used in estimating and identifying anthropogenic interference. The commonly known formula defined by Chester & Stone and Zoller et al (Zoller, Gladney, & Duce, 1974) is shown below:

$$EF_{(El\ crust)} = \frac{[El]_{sample}/[X]_{sample}}{[El]_{crust}/[X]_{crust}}$$

Where [El] is the research element and [X] is the chosen reference element. The values are used based on the concentration represented in the square brackets, e.g. mg kg⁻¹. The quoted “crust” indicates a global average crustal concentration. Certain elements, such as Scandium (Sc), Titanium (Ti), Zirconium (Zr) and Aluminium (Al) are used as reference elements for calculating EFs due to their minimal variability of occurrence and fractionation effects associated with pedogenesis and weathering. The stability of the elements is further demonstrated by their vertical immobility and/or chemical stability or non-degradability (Reimann, Filzmoser, Garrett, & Dutter, 2008). However, studies indicate the method above using an average crustal concentration is unable to distinguish between natural sources and anthropogenic exports due to existing regional variation of research elements (Reimann & de Caritat, 2000; Blaser, Zimmermann, Luster, & Shoty, 2000). They stated the use of site-specific parent material concentration of each individual soil profile under study provided a more realistic objective basis for calculating EFs than the use of the average crust values. Specific conditions have been identified for use in calculating objective EFs. They state specificities for the choice of reference elements, including; geological factor should be the most important control on the distribution of reference element; reference elements used should show the low natural regional variation and in its natural state the ratio of a reference element to a research element should be minimally influenced by natural process such as weathering (Reimann & de Caritat, 2005). To achieve the first condition outlined above, using site-specific background

values such as; deep soil layers not affected by pollution as opposed to the average crust eliminates the natural regional variation (Blaser, Zimmermann, Luster, & Shotyk, 2000; Reimann & de Caritat, 2005). In order to attain the second condition, basic information may be obtained via site-specific geochemical investigations or use of probability and statistics (cumulative distribution function and principal component analysis) (Zhang, Li, Wu, Li, Xu, & Yuan, 2008). The last requirement is that reference elements and research elements, have similar transport characteristics and geochemical Cycles means that in the absence of anthropogenic interference; the ratio of reference to research elements tends to have a constant value. This constant value can be an acceptable means of calculating EFs. The significance of the last condition was highlighted for some elements such as Sc and Ti, which when used as reference elements show a ratio of their concentrations to the study elements leading to a bias in EFs calculated, these results from different geochemical cycles between the research and reference elements (Reimann & de Caritat, 2005). The choice of an appropriate reference element should therefore be made based on similarities in geochemical characteristics during the pedogenic processes to ensure obtainment of a meaningful calculated EF.

Some studies have based the choice of stable elements for use in EF calculation on utilizing statistical estimation such as the coefficient of variation (CV). This has allowed extensive interpretation of the variability of the distribution of the known reference elements Al, Zr, Sc, and Ti using the equation below:

$$CV = \frac{MAD}{MD} \times 100\%$$

In this case, CV shows the variability, MAD represents the median absolute deviation (50th percentile) of the deviations of all concentrations, and MD is the median concentration. This non-parametric estimate is unaffected by outliers (Reimann & de Caritat, 2005). The higher the CV value, the less stable the element.

There is still some confusion regarding the concept of background and/or baseline concentration of elements. It's worthwhile to note that, background values correspond to the range of

concentration of a given element in a specific area, which depends on the mineralogical and compositional characteristics of the parent/source geological material (Reimann & de Caritat, 2005; Albanese, De Vivo, Lima, & Cicchella, 2007). The enrichment factor of metals is therefore calculated as the ratio of the elemental concentration of sediment normalized to a reference selected element from those outlined above. A simpler version of the formula discussed above is used in some studies. Initially developed by Buat-Menard and Chesselet in 1979 (Buat-Menard & Chesselet, 1979), the formula is shown below:

$$EF = \frac{C_x/C_{ref}}{B_x/B_{ref}} \text{ Sample}$$

Where:

C_x is the examined element in the examined environment; C_{ref} represents the content of the examined element in the reference environment. B_x is the content of the reference element in the examined environment, and B_{ref} is the content of the reference element in the reference environment (Mann, E, Varrica, & Dongarra, 2006). The results are subsequently interpreted based on contamination categories. A study outlined five contamination categories, with each based on the anthropogenic origin of the contaminant (Sutherland, 2000). The categories are: $EF < 2$ shows deficiency to minimal enrichment, $EF 2-5$ indicates moderate enrichment, $EF 5-20$ indicates significant enrichment, $EF 20-40$ indicates very high enrichment, and $EF > 40$ indicates extremely high enrichment. In the calculation above, the unpolluted or background point is indicated by the control sampling point.

2.0. Scanning Electron Microscopy

Aerosols vary in their morphology, chemical composition and sizes, these differences including their chemical compositions and myriad mixing states result in impacts on human health and climate (Poschl, 2005; Salma, Maenhaut, Zemplén-Papp, & Zarav, 2001). To obtain an in-depth characterization of atmospheric particles scanning electron microscopy and energy dispersive x-ray analysis (ESM EDX) can be used. It provides information on elemental composition, morphology and particle density, thus providing an understanding of their origins whether natural or anthropogenic (Shi, et al., 2003; Conner & Williams, 2004; Cong, Kang, Dong, Liu, & Qin,

2010). Formally, bulk analysis was performed for atmospheric particles, however due to its limitation of only providing overall information about ions present; it has been replaced by other forms of analysis such as SEM EDX. Elemental composition is considered more useful than bulk analysis as it can be used to determine; particle sources, influence on health and formation (Li, Shao, & Buseck, 2010a). Trajectory cluster analysis can be used to identify the source and transport pathways of airborne particles at sampling sites. This is however dependent on completeness and accuracy of mass back trajectory data from government archives and meteorological agency. This when available can be used to ascertain transport patterns over seasons and time (Pachauri, Singla, Satsangi, Lakhani, & Maharaj Kumari, 2013).

Formerly optical light microscopy (OM) was the predominant imaging technique but its loss of resolution at very high magnifications led to improvements in microscopy (Croft, 2006). Electron microscopy was subsequently developed based on the concept of light radiation having a wavelength of 400-700nm and electrons wavelengths of 0.001 and 0.01 nm. Electron microscopy provides a highly energetic source of illumination which enables a theoretical resolution of around 0.02nm, for 100kV electrons. Due to the existence of some drawbacks such as lens aberration and resolution limits, advances were made on use of enhancing devices such as energy dispersive x-ray spectroscopy (Girao, Caputo, & Ferro, 2017).

Energy dispersive x-ray spectroscopy enables analysis of the elemental composition of a specific sample. Its main operating principle is its capacity of high energy electromagnetic radiation (X-rays) to eject core electrons from an atom. This is based on Moseley's law, which states the direct correlation between the atomic number and frequency of light released by an atom. The removal of electrons from the system creates a vacuum that is fillable by a higher energy electron which releases energy as it relaxes. This relaxation process results in unique energy signatures specific to each element, this on bombardment of the sample with x-rays enables identification using the periodic table (Libretexts.org, 2020). Various detectors can be fitted to SEMs enabling analyses of different aspects of samples. The energy dispersive x-ray detectors commonly used provide information on concentration and chemical composition of elements present in the samples being tested. Energy dispersive X-ray (EDX) microanalysis has shown high sensitivity in detecting elements within tissues, environmental pollution analysis and has proved essential in heavy metal detection (Scimeca, Orlandi, Terrenato, Bischetti, & Bonanno.E, 2014; Scimeca, Bischetti,

[Lamsira, Bonfiglio, & Bonnanno, 2018](#)). The EDS device has three main parts; a collector, an emitter and an analyzer which are usually attached to an electron microscope (SEM), thus enabling analysis of x-rays released and their energies. The output data obtained is in the form of a graph showing peak intensity on the Y-axis and KeV on the x-axis. This method of particle analysis has some disadvantages including; it's not very sensitive in the presence of low element concentration where insufficient energy created will prevent accurate measurement. Additionally, it does not function for low atomic number elements lacking core electrons for displacement. Sample thickness also affects energy levels and creates errors in results, plus x-rays are not particularly effective in penetrating beyond surface nanometers of the sample. Therefore any difference between surface and inner layers results in inaccurate results, also, SEM EDX cannot analyze particles less than 150nm in size. Thus, some results of elemental composition and possible particle sources are lost using this as a sole tool for analysis ([Libretexts.org, 2020](#)).

2.1. Spectroscopy

The existing methods of spectroscopy, available globally, vary in cost, complicity, and availability. One such method, atomic emission spectrometry, is used in elemental qualitative, quantitative, and semi-quantitative analysis. It is based on the characteristic electromagnetic emitted radiation from atoms and ions under electrical excitation and heat. It involves three steps; vaporization of the sample and generation of atoms in the gas phase, dispersion of compound radiation emitted by the optical source forming a spectrum by the monochromatic; and intensity of the spectral lines by the detector ([Daskalova, Velichkov, Krasnobaeva, & Slavova, 1992](#)). Developed in the 1960s inductively coupled plasma (ICP) is a partially ionized gas, formed by the working gas in high frequency electromagnetic fields exposed to high frequency current flows via an induction coil. Inductively coupled plasma atomic spectrometry (ICP-AES) or inductively coupled plasma optical emission spectrometry (ICP-OES) uses ICP as the energy/light source. Its main advantages are; multi-elemental analysis; low chemical interference/matrix effect; wide dynamic linear range, low detection limit; good stability and reproducibility; and varied sample introduction techniques for real sample analysis ([He, Hu, Chen, & Jiang, 2017](#)). It has proven invaluable for rare earth element analysis (REE) due to its possession of low detection limits as low as ng/ml, good reproducibility, low matrix effect, and wide linear range. A less advanced method than that above is the inductively

coupled plasma mass spectrometry (ICPMS), which is one of the most popular elemental and isotopic analysis techniques.

Its basic concepts include plasma production, instrumentation, sample introduction, quantitation, identification of sources of error, and utilization of means of optimization, all of which are essential to ensure qualitative results and effectiveness. There are different types of mass spectrometers, including magnetic sector, ion trap, time of flight, and quadrupole. Sample processing involves multiple techniques, including those for liquid, solid, and gaseous introduction. These techniques range from flow injection, field flow fractionation, and chromatography (Taylor, 2000). For detection, quantification, and characterization of nanoparticles, a method first reported in 1986, single particle inductively coupled plasma mass spectrometry (ICPMS), is used. It provides rapid multi-element analysis and low detection limits for a wide range of samples. It's considered an effective tool in nanoscience due to; its possibility of detecting both the presence of dissolved and particulate forms of an element, ability to detect low number concentrations and its simple instrumental requirements (Laborda, Bolea, & Jimenez-Lamana, 2014). The technique assumes that each recorded pulse represents a single nanoparticle (NP). Therefore, the frequency of pulses is directly related to the concentration of NPs, with the intensity of each pulse proportional to the mass of the element (Degueldre & Favarger, 2006). The relationship between the signal/pulse 'R' (ions counted per time unit) and the mass concentration of a solution of an element 'M' (C_M) nebulized into an ICPPMS is expressed below (Kawaguchi, Fukusawa, & Mizuike, 1986).

$$R = K_{\text{intro}} K_{\text{ICPMS}} K_M C^M$$

Where K_{intro} represents the contribution from the sample introduction system, while K_{ICPMS} is the detection efficiency, which represents the ratio of the number of ions detected versus the number of atoms introduced into the ICP and involves the process of ionization, sampling through the ICPMS interface, as well as the transmission through the mass spectrometer, $K_M (= AN_{\text{Av}}/M_M)$ includes the contribution from the element measured, where A is the atomic abundance of the isotope considered, N_{Av} the Avogadro number, and M_M the atomic mass of M (Laborda, Bolea, & Jimenez-Lamana, 2014).

Some reviews on sample preparation for mass spectroscopy, such as digestion or dissolution (dry or wet) and combustion reactions in closed vessels, which are more advantageous than wet digestion for difficult to dissolve samples, provided additional information. A good alternative to the classical methods of digestion and dissolution was identified as the use of tetramethylammonium hydroxide (TMAH). TMAH is a water soluble tertiary amine and strong alkaline. It's an effective reagent for sample digestion, slurry preparation, and analyte extraction despite occasionally inducing matrix effects (Sneddon, Hardaway, Bobbadi, & Reddy, 2005; Flores, Barin, Mesko, & Knapp, 2007; No'brega, Santos, de Sousa, Cadore, Barnes, & Tatro, 2006). Under enhancing processes for the use of this method include; application of ultrasonic energy to enhance analyte extraction with careful control of experimental methods. Flow injection analysis (FIA) has been effective as a supplementary method of online sample pretreatment (Junior, Krug, Pereira, & Korn, 2006; Priego & Luque de Castro, 2007; Hansen & Miro, 2007).

BLANK PAGE

Chapter Two: Materials and Methods

1.0. Study Area

Nigeria is the most populous country in Africa (Projected population 220 million), it is located between the Gulf of Guinea to the South in the Atlantic Ocean and the Sahel in the North. The country contains a variety of landscapes with tropical rainforests in the south and most of it comprised of Savannah landscapes. The Northern part of the country has sparse vegetation towards its farthest borders and little vegetation. Our study State; Kano State is located in Northern Part of Nigeria (Current Projected Population: 14,311,246) created on May 27th 1967 from the Northern Region. It is located in north-west Nigeria, West Africa and has for centuries served as the seat of a successful Emirate. The Capital and largest city metropolis is Kano Town and serves as the administrative and commercial center of the State. The State covers a total area of 20,131 km² (7,773 square mi), it generates annual revenues upwards of \$12.39 billion US Dollars. Its administrative distributions (*figure 21*) are into Local Government Areas (LGAs) classified mainly as rural or urban, with “mixed” used to describe a mixture of settlement types. It is situated at 484 meters above sea level within the Sahel savannah region and experiences a typical savannah climate with an average of approximately 980 mm (38.6 inches) of precipitation annually. Frequent heat waves with average temperatures of 26.3 degrees centigrade (79.4F) and low humidity occur throughout the year. Variations in wind speed are significant and occur frequently, compounded by frequent sudden gusts of sub-Saharan dust from Northern Africa, known locally as the “*Harmattan*”. Typical average wind speeds are greater than 5.3 miles per hour between November and July each year, with higher values obtained during the dry season. The study LGAs vary in size and distribution of households; urban areas show clustered housing, while rural communities are characterized by widely separated households.

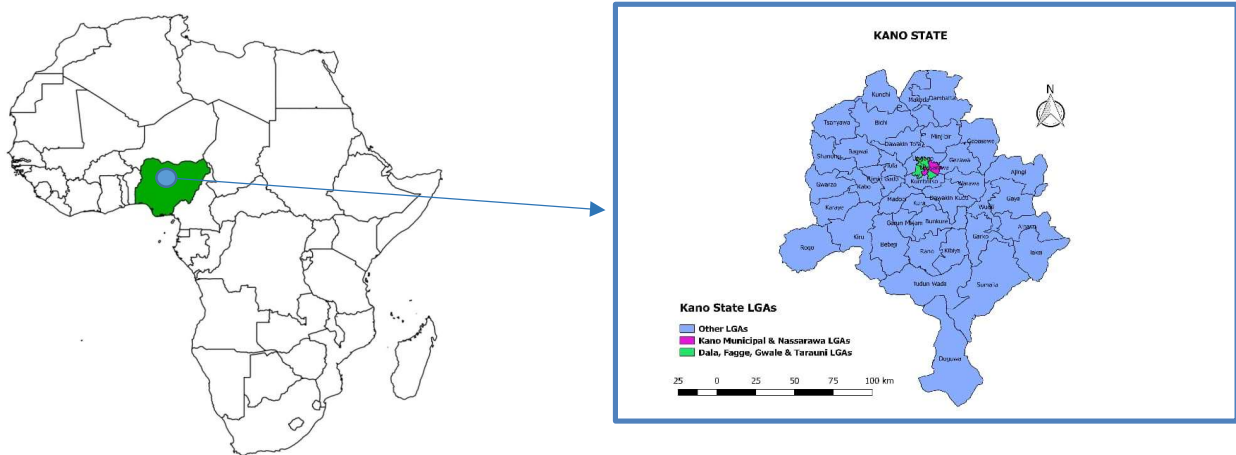

Figure 21: Map of Africa with Nigeria highlighted in green as a country. The study area; Kano state (North-west) in blue showed the highest number of registered vehicles in; Kano Municipal and Nassarawa LGAs: >1000, Dala/fagge/gwale/tarauni: 500-1000, Other LGAs: 1-500

Kano State is the second-largest industrial center after Lagos State in Nigeria and the largest in Northern Nigeria with textile, tanning, footwear, cosmetics, plastics, enamelware, pharmaceuticals, ceramics, furniture and other industries. Others existing industries include agricultural implements, soft drinks, food and beverages, dairy products, vegetable oil, animal feeds etc. Due to the presence of a large number of Academic Institutions, Research Centers, tourism sites, industries, governmental administrative agencies, vast arable Land for Agriculture and a renowned annual Durbar. The State has consistently seen an influx of settlers and visitors. The active Population comprises predominantly civil servants, farmers, traders, manufacturers, students of tertiary institutions and private business owners. Kano Municipal Local Government Area (LGA), which serves as the administrative headquarters, has a projected population of 389,545 and comprises of 13 wards with the LGA headquarters in Tudun Wuzidi. It comprises of multiple large industries and manufacturing companies including; Oil mills, tanneries, plastic companies, pipe manufacturers etc. The predominant language spoken in Kano State is Hausa Language with English commonly understood by most of the populace due to British Colonial Rule. The Study was conducted in selected settlements of Kano Municipal, Nassarawa and Kumbotso Local Government Areas (LGAs) highlighted in *figure 22* below. These LGAs were selected based on population size, recorded vehicular density, strategic location as a center for commercial activities/international trade and presence of manufacturing industries and existence of rural

settlements. Kano Municipal LGA (Current projected population: 389,545) due to its nature as a predominantly urban settlement will serve as a source of high density traffic sites for appropriate air sampling and testing of air pollution levels. Nassarawa LGA has a total (projected population of 909,992) with Hausa language as the predominant language spoken by inhabitants, will serve as a site for testing emissions in a mixed settlement. The LGA comprises of 11 wards with the LGA headquarters located at bompai road, behind the Pilgrims Board. It was selected for fitting the profile of an industrial area with multiple manufacturing and processing activities. The presence of rural communities within Kumbotso LGA with a (projected Population of 409,500) served as a basis for comparing air samples for presence and concentration of air pollutants.

Rural communities tend to have low traffic density and in this case an absence of industrial areas. The sizes of the study LGAs are; Kano Municipal 17km², Nassarawa 5,704km² and Kumbotso 158km². In *Appendix 1 (A1-A3)* satellite images are shown of the study areas depicting typical traffic flow patterns using a scale of 1:40,000 for a 96dpi screen, where 2.5cm equals 1 km on the ground.

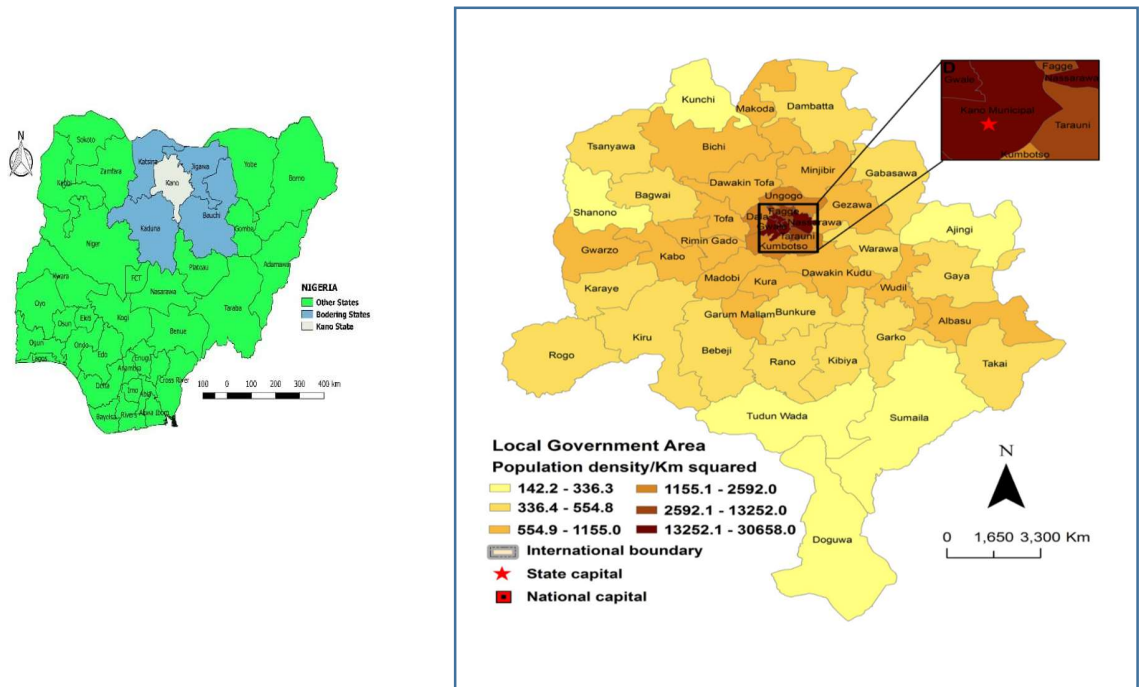

Figure 22: The Nigerian Map shows Kano State (light blue) and an enlarged map of Kano State showing population density, study areas, and the state capital, Kano Municipal Local Government Area.

1.1. Study Design

This is a Multicomponent comparative cross-sectional study across selected Rural and urban settlement/s in Kano Municipal, Nassarawa and Kumbotso LGAs. It comprises of:

- Air sampling at multiple traffic sites, subsequent scanning electron microscopy and energy dispersive analysis (SEM-EDX) and cytotoxicity studies.
- A quantitative component involving administration of a structured pre-tested interviewer administered questionnaire to community members.
- A qualitative component involving administration of structured Key Informant interview (KII) guides to relevant stakeholders.
- A secondary data review, abstraction and analysis of road transportation data for 2016-2019.

1.2. Air sampling and cytotoxicity studies

Twenty-four (24) air samples were collected at 12 sites between February and March 2020, four (4) within each Local Government Area (LGA). The sites were identified using federal road safety corps (FRSC) traffic density records, which were classified as high traffic density (>50 vehicles/km/hr.) and low traffic density (\leq 50 vehicles/km/hr.) within associated residential areas sited close to roads. Sampling sites were selected based on differences in traffic density, nature of settlements, and the presence of emission sources such as road transportation vehicles, which may lead to the exceeding of air quality standards for safety. The location of specific sites, nature of traffic and identified pollution sources are shown in *Table 4* below. Sample collection in all sites occurred during peak road traffic hours; mornings (8:00am-10:00am) and evenings (4:30pm-7:30pm). The nature of the roads ranged from 4-Lane dual carriageways in high traffic density sites such as; the highway near Kumbotso village, Yankaba car park road, Kofar Mata area road, Central Mosque Area road, and Masalacin Alhaji Abba Road. Other sites sampled were characterized by 2-lane dual carriageways. The typology of road transport vehicles present at the sites varied from rural to urban sites. *Figure 40* shows the distribution in the state. The majority of road transportation vehicles in the urban sites were commercial tricycles, followed by commercial buses. In rural communities, however, the predominant type of vehicle in use was motorcycles. The distance from collection points to the homes of residents in the nearby communities was measured in meters (m) for all settlements to ascertain proximity to the point of exposure to road transportation vehicles.

Sampling occurred over a 3 day period in all LGAs. Samples were collected using a self-assembled set-up based on a Peristaltic Electric Volumetric Pump, 3.4L/min, 24 V.c.c (Verderflex AU M380240 15), controlled by a mobile electronic system loaded with Bosch, 18V Li-ion battery carried in a backpack. This pump enables suction of airborne particles through the bifurcated tubing attached to the types of filter holders for syringes from Whatman (stainless steel and poly-sulfone, diameter 30 mm, height 26 mm, CarlRoth CC23.1 and CC19.1). In one of the filter holders, we included carbon adhesive discs (12mm in diameter, Agar AGG3347N) compatible with SEM-EDX analysis for use in microscopy. In the second filter holder we included a Millipore polycarbonate

0.2 μm pore size, hydrophilic polycarbonate membrane, 25 mm diameter (Merck Millipore TETP02500) compatible with culture cells.

The collection device used in this study is shown in *figure 23* below, in the form of a backpack, it was developed in 2018 in the LAMCOS - MINAPATH collaborative contract Nr. **CO0022717** (*Figure 23a*). The device has the following advantages:

- 1) Its fully powered by detachable batteries allowing continuous collection for up to 5 hours (*Figure 23b*)
- 2) It aspirates air via a peristaltic pump with adjustable flow, constantly maintained at 2l/min during sample collection (*Figure 23c*)
- 3) It uses a stainless steel filter port (*Figure 23d*) in direct contact with the outside air (the collection port is located about 10cm higher than the height of the collection bag - equivalent to the nose position when the bag is worn on a person's back).

In addition, the filter port contains a macroscopic stainless steel perforating plate, to prevent the aspiration of large organic contaminants (leaves and small insects), and it allows through circular slits of about 1mm in diameter the direction of particles to impact an adhesive carbon SEM support (*Figure 23e*). This support has a diameter 50% smaller than the internal diameter of the filter port (= 25mm) which allows air to circulate around the SEM support without modifying the flow rate, which is remains constant at 2l/min during the 2h of aspiration (*Figure 23d*).

In this study we added to this system a collection channel (*Figure 23g*) composed of a polysulfone port-filter with a polycarbonate membrane of 0.4 μm porosity. This port-filter allows collection of all particles (even nanometric) by enabling sticking to its internal wall. The filter is weighed before and after sample collection with a precision balance at 0.001 mg. The advantage of this is to enable the recovery of the particles for cell cultures. On the other hand, the disadvantage is that we could not compare the masses of the particles because we recorded a saturation of the filter by the particles which gave the same mass indifferently of the site of collection. The non-contaminating character of our aspiration system was verified by collection in the ISO 5 clean room of LAMCOS where a quantity lower than 100 particles on the whole surface of the carbon disk was collected during 2h of aspiration, while many particles were collected in the air of Nigeria (*Figure 23f*), it

was enough to scan a surface lower than 1mm² in order to be able to make the automatic SEM analysis on 1000 particles. Air samples were collected at a height of 3 meters (due to the average height of the population and the need to avoid contamination by constant dust resuspension from unpaved side-walks) above ground level. These collection parameters were chosen by calibration based on outdoor air sample collection in the city of Lyon, France, where enough particles were obtained with no recorded saturation of filters. An RS-90 anemometer (Manufacturer RS 155-8899) allowed monitoring of temperature and wind speed at the time of collection.

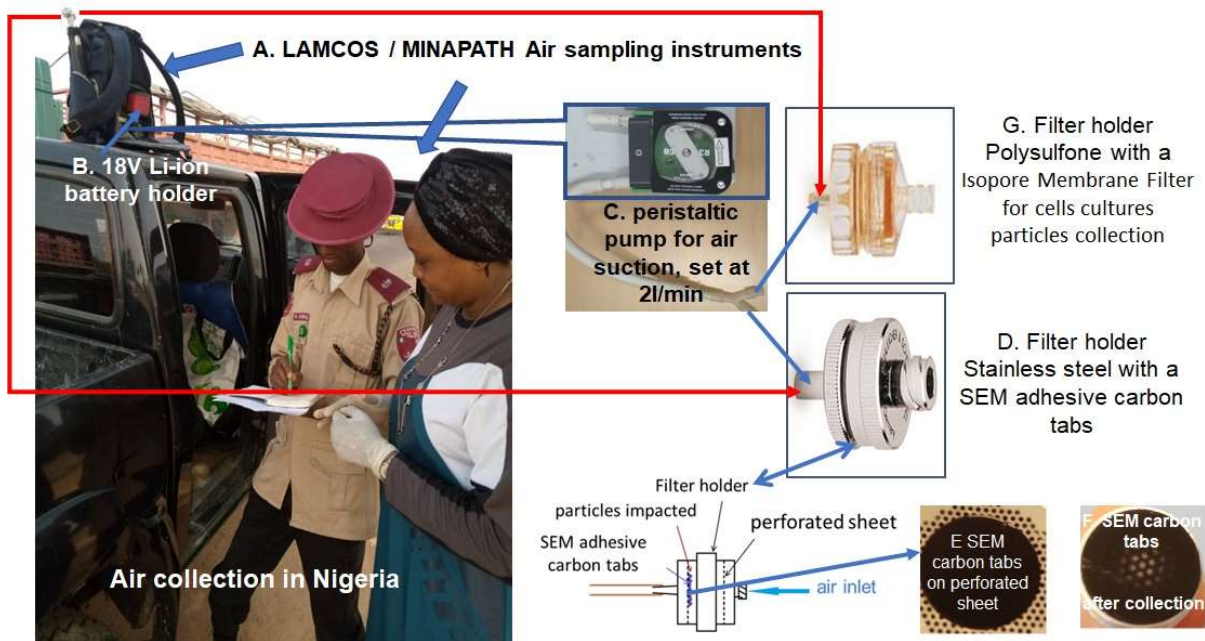

Figure 23: Schematic showing instruments used during air sample collection.

The temperature ranged from 26.2 to 45.3°C (Figure 24a and 24b below) at the time of sample collection and the wind speed was 1.02- 9.40 m/s. For each collection site, we established possible emission sources in the communities, which included: agricultural activities (grain thrashing), plastic and bottling plants (in mixed settlements), cement dust, soil dust, motorcycle exhaust, petroleum exhaust, and vulcanizing stations in all LGA.

Table 4: The names, nature, traffic density and pollution sources at air sampling sites in Kano State-Nigeria.

Site ID	Name	Settlement Type/LGA	Traffic Density	identified pollution sources
R1	Masalacin Alhaji Abba Road	Rural Kumbotso	High	Traffic, grain thrashing, harmattan dust, open burning
R2	Coca-cola Road		Low	Bottling plant, traffic, dust
R3	Turaki Memorial school Highway		Low	Traffic, harmattan dust, open burning
R4	Kumbotso village near highway		High	Traffic, open burning, agriculture
M1	Central Mosque area	Urban-Mixed Nassarawa	High	Traffic, local food industries, dust
M2	Yankaba Car Park (Tashan Yankaba)		High	Traffic, automobile workshops, commercial car park, open burning, factories, dust
M3	Hadeija Road		Low	Traffic, open burning, harmattan dust
M4	Amau Yakubu street, GRA		Low	Traffic, open burning, dust
U1	Municipal Clinic Road	Urban Kano	Low	Traffic, harmattan dust
U2	Kofar Mata Area		High	Traffic, harmattan dust
U3	Near British Council		High	Traffic, harmattan dust
U4	Layin Dantata Koki		Low	Traffic, harmattan dust

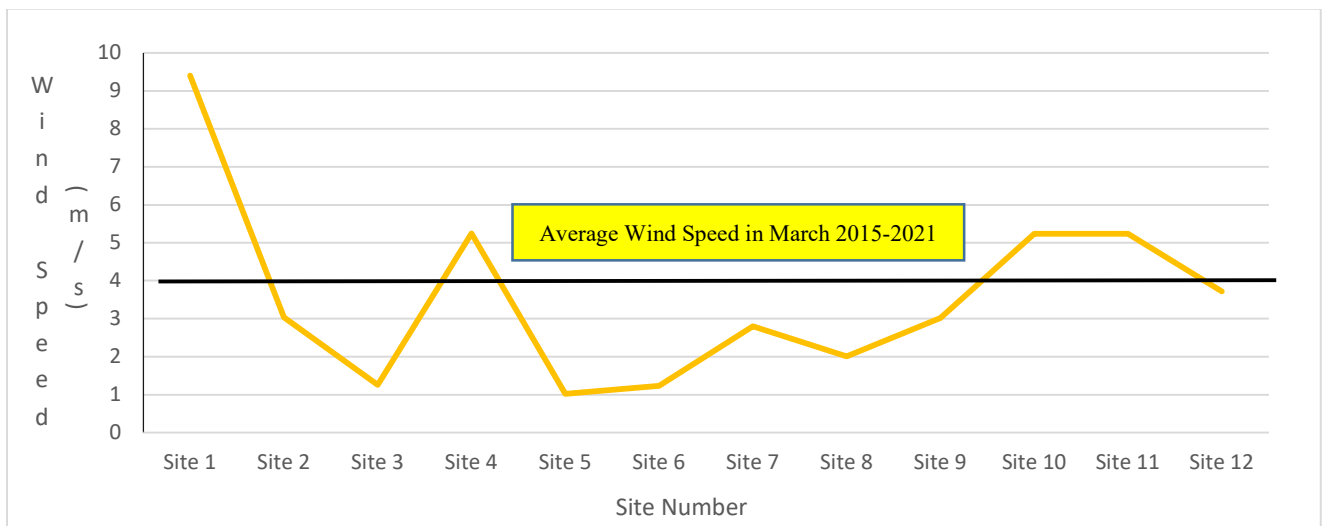
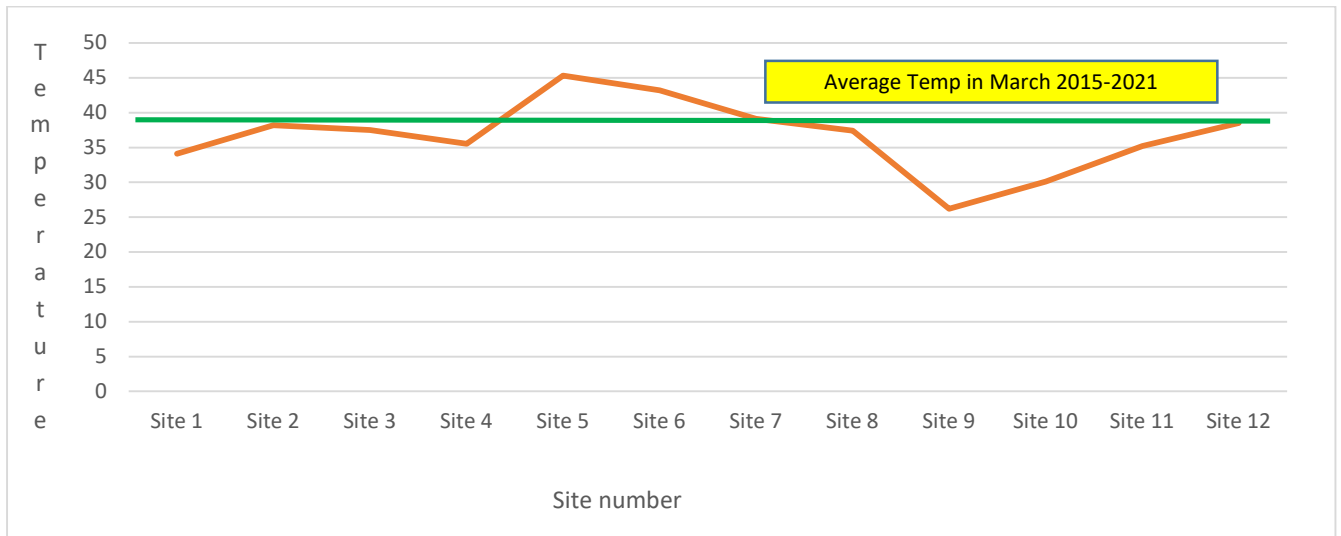

Figure 24: Recorded Temperature and Wind speed at sample collection Sites in Comparism to average values recorded for the sites (2015-2021) by the Nigeria meteorological agency (NIMET).

1.3. Scanning Electron microscopy and energy dispersive X-ray analysis

Scanning electron microscopy and energy dispersive x-ray analysis is used for chemical characterization or elemental analysis of samples. In SEM, a highly energetic and focused electron beam is formed and scans the specimen in a raster scan pattern. The electron gun is usually fitted with a tungsten filament cathode and located at the top of the microscope emits the electron beams. The emitted electrons are focused along a vertical path by an anode. Electromagnetic fields and lenses are set along the vertical path to focus the beam down towards the sample. A variety of

effects result interactions between the electron beam and the electrons in the sample. Part of the electron beam will not be scattered, though most of the electron beam interacts with the specimen and undergoes inelastic and elastic scattering. In the first case, the direction of the primary electrons is changed but their overall energy is kept. Inelastic scattered electrons change their direction and lose part of their energy. Subsequent effects can include emitted secondary electrons, backscattered electrons and characteristic X-rays (Scimeca, Bischetti, Lamsira, Bonfiglio, & Bonnanno, 2018). A key factor in SEM is the interaction volume, the region into which the electron beam penetrates the specimen, i.e., the three-dimensional volume resulting from the interaction of the electron beam with the specimen atoms. The emission depth of the different signals used in SEM is influenced by the electron beam energy, specimen nature, composition and sample preparation (Girao, Caputo, & Ferro, 2017). In figure 25 below a schematic of the scanning electron microscope is shown with its main parts labeled.

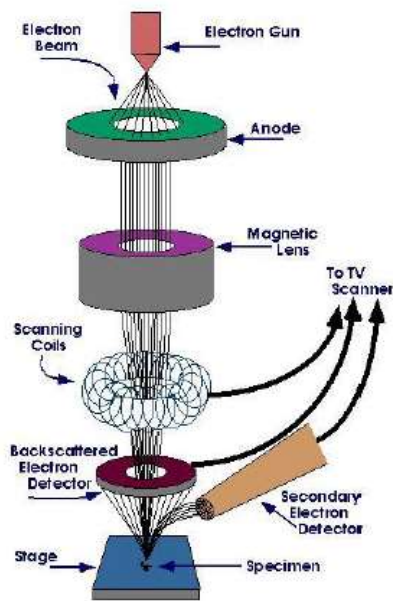

Figure 25: Schematic of the scanning electron microscope (Purdue Univeristy, 2018).

EDX uses the principle of X-rays being highly charged photons resulting from electronic transitions in the atoms of a targeted solid by an incident accelerated electron beam. Typically, the incident electron hits an atom of the specimen and knocks out an electron from the K-shell ($n = 1$ shell) of the metal, and a vacancy or hole is left in that shell. If an electron from another shell fills

in that vacancy (electron transitions), then X-rays are emitted. Electronic transitions to the K-shell ($n = 1$) are named $K_{X\text{-rays}}$, those to the L-shell ($n = 2$) are $L_{X\text{-rays}}$ and to the M-shell ($n = 3$) are the $M_{X\text{-rays}}$. These transitions are characteristic of each chemical element and this is the main reason that led to the development of EDS detection systems in electron microscopy and consequently widening its use in materials and microstructural characterization (Goodhew, Humphreys, & Beanland, 2001; Garratt-Reed & Bell, 2003). Specimen preparation is an added critical factor in EDS because it will determine the depth of the X-rays generation and range. For a correct quantitative X-ray analysis, the sample needs to be polished into a flat surface, minimizing height differences at interfaces and eliminating the geometric effects that arise from the specimen surface. For that, usually the sample is embedded in a resin block and polished with silicon carbide paper with different grids until the surface of the specimen is exposed (Girao, Caputo, & Ferro, 2017).

For this study, scanning electron microscopy and energy dispersive X-ray analysis (SEM-EDX) were performed using environmental scanning and tungsten filament, with EDX coupled analysis (Oxford instrument, INCA software). Two types of images were recorded on each sample “carbon adhesive disc” using low vacuum (LV) mode (30Pa pressure in the SEM chamber), the back scattered electron detector (BSE) set to a Z-contrast mode and the working distance (WD) set at 10mm. A first image was taken at a magnification of x80 to have an overall view of the quantity of particles. A second image was taken at 1200x magnification in the central collection area-the most heavily loaded with particles in order to perform an overall EDX analysis and identify the most prevalent chemical elements in each sample. An individual analysis of 1000 particles was conducted in the peripheral zone. This individual and automatic analysis was developed by Minapath using a microscope JEOL JSM-6010LV plus coupled with EDX spectrometry (EDS Oxford Aztec-DDI detector X MAXN 50). This analysis consisted of a pre-adjustment of the contrast images, so particles appeared clearly on a black background, subsequently followed by several automatic images taken at a magnification of x10000. For each particle, automatic detection of the contours and average automatic EDX analysis over the entire surface of each particle were carried out. The automatic analysis stopped when the particle counter reached 1000 and a table containing morphological and chemical parameters was generated.

An initial comparative analysis of the particles present on the same surface of the ESEM collection support was conducted. As a measure of size, the equivalent circle diameter (ECD), which is the

equivalent diameter of a circle with an equal aggregate sectional area used in the image processor, was obtained. To calculate the equivalent surface ratio (ESR), (Schipper, Haddad, Fullam, Pourzal, & Wimmer, 2018) the following formula was used to analyze particle elongation:

$$w = \frac{(P - [p^2 - 4\pi A]^{1/2})}{\pi}$$

$$l = (P - w\pi)/2 + w$$

$$ESR = l/w$$

Where the following parameters obtained from the output of SEM-EDX represent; P: Perimeter, A: Surface area and calculated values are interpreted as: Elongated particles [$1.5 \leq ESR \leq 3$], round particles [$ESR < 1.5$] and fibrillar particles [$>3 ESR$].

On complete analysis of particles in terms of size (ECD) and morphology (ESR) parameters using the software Kaleidagraph® we obtained specific distributions at each site *figure 29* and *figure 30*. *Appendix 2* shows the specific measurement parameters used for morphology on SEM-EDX analysis.

1.4. Particle Extraction for cytotoxicity studies

The polysulfone filter holders sealed with paraffin tape were opened under sterile conditions and placed entirely into 60 ml of 95% pure ethanol contained in separate labeled containers by site; site 1-12. The sealed containers with the contents were sonicated twice for 15 minutes, partially immersed in a pure rose water bath. The ethanol was further completely evaporated under nitrogen flow. The quantity of particles thus extracted was precisely measured using a precision balance (0.0001 gram). A minimum volume of ethanol (to assure their complete re-solubilization) as well as Dulbecco's Phosphate Buffered Saline (DBPS) containing 1% Penicillin/Streptomycin in order to obtain a final particle percentage concentration of $1\mu\text{g}/\mu\text{l}$ of particles in DPBS containing 1% Ethanol alcohol (EtOH).

1.5. Cell Culture

In order to evaluate the effect of air particles on cellular viability, raw 264 macrophage cell lines (1 mL) from ATCC® were used. The cells were seeded in culture plates with 96 wells (depending on the study) in Dulbecco's modified Eagle's medium (DMEM high Glucose), enriched with 10% of heat inactivated Fetal Bovine Serum (FBS) and 1% Penicillin + Streptomycin. These were then placed in an incubator with controlled temperature and CO₂ (37⁰C, 5% CO₂). On reaching 80% confluence, the cell medium was replaced by a fresh one containing extracted particle pollutants. The final concentration of the particles was 100µg/ml (mass/volume), with appropriate controls (cell media containing 10% DPBS and 0.1% EtOH). Further 3-(4, 5-dimethylthiazol-2-yl)-2, 5-diphenyltetrazolium bromide (MTT) testing and 4', 6-diamino-2-phenylindole (DAPI) staining were used to assess the effect of air particles on cellular viability after 24 hours of incubation.

1.6. 3-(4, 5-dimethylthiazol-2-yl)-2, 5-diphenyltetrazolium bromide testing

ThermoFisher® 3-(4, 5-dimethylthiazol-2-yl)-2, 5-diphenyltetrazolium bromide (MTT) testing (ref V13154) was used to assess cell viability, which is based on the conversion of tetrazolium salt into a purple Formazin product (Mossman, 1983). For this, the cells were seeded into a 96-well plate and allowed to reach 80% confluence. After 24 hours of incubation with 100µg/ml particles, the media was removed from the particle inoculated cultured cells and replaced with 100µl of fresh media. Then 10ml of 12mM MTT stock solution was prepared by adding 1ml of sterile PBS to one 5mg vial of MTT and mixed by vortexing, added to each well. The cells were then incubated at 37⁰C for 4 hours; subsequently, 100µl of the SDS6HCL solution was added to each well, and then mixed thoroughly with a pipette. A humidified chamber was used to incubate the microplate at 37⁰C for 4 hours. The absorbance was recorded in triplicate at 570nm using a **Biotek**® Micro-plate reader after automatic gentle shaking. The experiment was performed in triplicate and site-specific means and confidence intervals were compared at a 95% confidence interval. In *figure 26* below is the chemical structure of Nicotinamide adenine dinucleotide phosphate (NADPH) involved in the reaction at mitochondrial level.

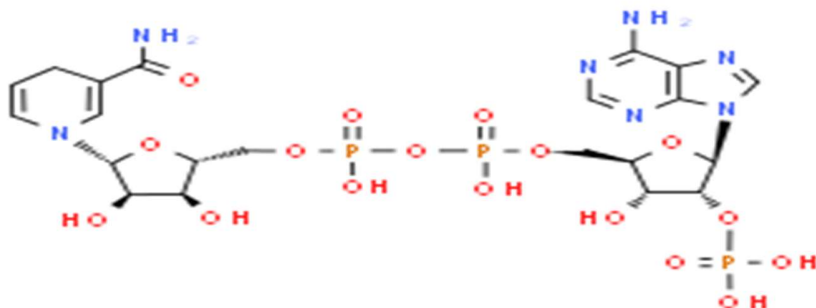

Figure 26: Chemical structure of Reduced Nicotinamide adenine dinucleotide phosphate (NADPH).

1.7. Cell Fixation and Staining using 4', 6-diamino-2-phenylindole

Cellular viability was also estimated by using membrane integrity based on 4',6-diamino-2-phenylindole (DAPI) staining, a cell permeable nucleic acid stain (Kepp, Galluzi, Lipinski, Yuan, & Kroemer, 2011). Cells were seeded into 24 wells as previously described, which ensured adequate sample spreading. After a 24 hour incubation with air particles (a concentration of 100µg/ml), the cells were washed three times with DPBS and fixed with 4% paraformaldehyde in PBS for 10 min, which aided creation of adhesion between protein molecules thereby increasing stability. The cells were further abundantly washed with DPBS and stained using DAPI 1/1000 in PBS for 15 mins; coverslips were then used to seal the slides with flouromount media. Slides were kept in the dark for 30 min before image acquisition using fluorescent microscopy using a Zeiss confocal microscope®.

1.8. Fluorescence Microscopy

A Zeiss microscope equipped with an LSM700 confocal head and a 405nm laser at objective W N-Achroplan 63x/0.9 M27 (df = 2.4mm) was used. Three to five images were recorded for each sample, maintaining the same acquisition settings. The images were further treated using the *Image*

J program®. Approximately 40 cells /image were analyzed for DAPI intensity. The percentage of non-viable cells was determined by the ratio of highly intense DAPI-labeled cells (saturated fluorescence).

1.9. Structured interviewer administered questionnaire (quantitative) and clinical respiratory assessment

1.9.1. Experimental protocol

Three teams, comprising of a team lead (epidemiologist), a nurse, data officer, interviewers, and representatives of the LGA, were trained. Team lead tally sheet, Spirometry results sheets (adult and children), supply monitoring forms, attendance sheets, height measurement guides, and respiratory Spirometry guides were among the data tools used. All Individual subjects had their heights (meters), information on sex, age, and race recorded. A respiratory examination involving inspection, measurement of the respiratory rate (at rest) and auscultation of breath sounds was conducted. This was followed on the same day, after 10 minutes passive rest, by Spirometry measurements using Vitalograph® COPD-6 monitors. Due to possible influences that can induce alterations in biorhythms, Spirometry measurements were always taken in the morning from 10 to 12 a. m. In addition, the distance from the point of road vehicular traffic to each household (HH) was measured in meters (m).

1.9.2. Study variables

Outcome Measure: Abnormal Spirometry Value in the obstructive range in the absence of a history of respiratory disease, clinical evidence of respiratory disease or related co-morbidity, e.g. cardiac disease

Exposure Variables: Perceived exposure to vehicular emissions, Occupational exposure; welding, painting, carpentry, electrical work, agricultural work, dentistry, Non-occupational exposure e.g. smoking, use of clay masks, proximity of residence to road vehicular traffic, transit duration, inhalation of household chemicals, use of protective devices (contained in questionnaire under Appendix 3).

1.9.3. Sampling

The sample size was determined using Epi-info statistical software versions 3.5.3 and 7 (CDC software). In the absence of regional and country specific studies on similar outcomes and exposures, a P-value of 50% was used for prevalence. A 95% confidence level, ratio of exposed to unexposed of 1, power 80%, and a risk ratio of 1.5 were also used. The calculated sample size is 132 respondents, adding a 12 % non-response rate.

[Calculated sample size/ 1- non- response rate (NRR)] = Final Sample size.

The final sample size used was 150 respondents. Thirty minors (<15 years) were selected based on parental/caregiver consent by convenience sampling in Kumbotso LGA (Urban).

1.9.4. Subject of the study

The Local Government areas (LGAs) and communities for the study were selected using multistage sampling. The first stage involved using a simple random sampling technique to select the LGAs. The second stage involved using a purposive sampling technique to select a ward in each LGA based on traffic records available with the Federal Road Safety Corps (FRSC), Kano sector command. In the third stage, communities were selected randomly from the wards obtained in stage two. The subjects were adult participants' recruited via systematic sampling (final stage of multistage sampling) using a calculated sampling interval. The sampling interval was calculated by dividing the total ward estimated population by the calculated sample size (k). Then a random number less than (k) will be used to select the first household and respondent; subsequent respondents will be obtained by drawing every (k) unit from the first unit

1.9.5. Inclusion and exclusion criteria

Included were residents of selected households (15-60 years of age) in the communities who lived for at least one year in the study area prior to data collection. All eligible residents found too sick to be interviewed, unwilling or non-permanent residents, were excluded.

1.9.6. Data collection

An interviewer administered structured questionnaire with sections on socio-demographics, vehicular use, medical history, and exposure in the context of professional and non-professional activities was used to collect data. The questionnaire was comprised of questions in English, subsequently translated into the local "Hausa language" based on respondents' preference. Minors were paired with their parents' and caregivers' questionnaires. The height in meters (m) and age of subjects were recorded. A height measure (standiometer) measuring from zero to > two meters (2.0574m) was used to measure the height of the subjects standing barefoot and upright.

2.0. Respiratory examination and Spirometry

Respiratory examinations were conducted by trained nurses under supervision. Physical examination of the chest for abnormalities, measurement of respiratory rate, and auscultation of breath sounds was performed by each team on the field. using adult and paediatric bells on "Rappaport sphygmomanometers." All study participants underwent a full clinical respiratory examination, which included a detailed history. To ensure accurate history taking, information was obtained on; past medical history of illnesses such as tuberculosis, pneumonia, and heart disease, etc.; family medical history of diseases such as asthma; and personal and occupational history. For personal and occupational history, information was obtained on: occupation, habits, and drug history. Relevant occupational information includes: history of past or present occupations, especially those related to exposure to allergens or chemicals. Some of these questions were also contained in the administered standardized questionnaire under "exposure in the context of professional activities" (*Appendix 3*). Habit associated information was obtained for smoking, use of inhalable substances, and other recreational drugs. A full drug history for prescribed drugs was also reviewed, particularly for penicillin, aspirin, and non-steroidal anti-inflammatory drugs (NSAIDs) with an ability to exacerbate asthma. Also obtained was information on the use of corticosteroids and cytotoxic drugs known to increase predisposition to opportunistic lung infections.

General physical examinations for the presence or absence of anaemia, dehydration, jaundice, fever, or any visible abnormalities were conducted before proceeding to respiratory specific assessment. As these can indicate undiagnosed underlying conditions that may affect respiratory findings or interpretation of obtained results. The general appearance, rate, and nature of breathing were observed. The normal respiratory rate is 14–20 cycles per minute. However, country-specific reference values are used for populations globally. In Nigeria, the normal respiratory rate used and applied for this study is 18 cycles per minute at rest. Observations were made to detect any abnormal breathing patterns such as; wheezing, stridor or associated coughing. Additional examination was done of the eyes due to their implication in certain respiratory disorders, e.g. conjunctival chemosis and kerato-conjunctivitis. The neck was examined for signs of carotid pulsations, distended neck veins in cases of elevated jugular pressure, and cervical lymphadenopathy seen in the presence of infections. The skin was also examined for lesions, discolouration or the presence of nodules, which serve as peripheral stigmata of certain diseases.

A chest specific examination was performed via inspection, palpation, percussion, and auscultation. A detailed inspection was performed to detect the shape of the chest and assess symmetry, antero-posterior diameter, hollowing or flattening, and the position of the shoulders and spine. Observation was also made for any abnormalities in respiratory rate or pattern. We also searched for lesions on the chest wall and movements of the chest. Diminished chest movements can be bilateral or unilateral depending on the cause. Common causes of bilateral reduction in chest expansion include; bronchial asthma, chronic obstructive pulmonary disease (COPD), respiratory muscle paralysis, extrinsic allergic alveolitis etc. In normal individuals, the chest is bilaterally symmetrical and smoothly contoured. This is visible as a slight recession in the infraclavicular regions, with a wider transverse diameter in relation to the antero-posterior diameter (Ratio 7:5). The normal subcostal angle is acute (less than 70 degrees). The trachea was examined for any evidence of deviation and the position of the cardiac apex was ascertained (5th left intercostal space normally).

Palpation was performed to identify any tender areas, further assess chest expansion by measurements, to assess observed abnormalities and to assess tactile vocal fremitus. The maximum inspiratory/expiratory difference is measured in the lower chest at the level of the 4th–5th intercostal space. For manual measurement, we placed our thumbs at the costal margin and our hands along

the chest wall laterally. The respondents were asked to inhale deeply, and observations were made on the degree of thumb divergence. The intercostal spaces were palpated with the fingers to detect widening or narrowing. The tactile vocal fremitus on both sides was checked with the palm of the hand placed flat on the chest. It is vibrations transmitted to the chest wall from the larynx during phonation via the tracheobronchial tree. Percussion of the chest wall was done at multiple sites bilaterally to detect changes or differences in resonance due to underlying lung changes. Dullness on percussion is detected in pleural effusion and hydropneumothorax. Hyper-resonance is associated with pneumothorax and pneumothorax. Lastly, auscultation was performed with the patient in a sitting or supine position. The diaphragm of the stethoscope was placed on the chest after the participant was asked to breathe with their mouths open. The stethoscope was moved from side to side and comparisons were made between the similar positions on each hemithorax. Any abnormal sounds heard resulted in more careful auscultation of surrounding areas. Normal breath sounds were compared for amplitude and vocal resonance. Normal breath sounds are classified as vesicular.

Respiratory Spirometry involves measurement of flow and volume variables (forced vital capacity: FEV1, forced expiratory volume: FEV6, FEV1/FEV6 ratio) using Vitalograph "COPD-Digital spirometers" (Model 4000 Respiratory, Vitalograph, Ennis, Ireland). Pediatric instruments were used for Spirometry assessment of 30 children of consenting adults/caregivers in the urban settlement only. The devices were calibrated before being used daily prior to testing. The participant's height, age, and sex were entered to enable an automated calculation of the predicted expected normal values. The device is programmed to show obtained values in comparison to normal values (National health and nutrition examination survey-NHANES) for each individual tested. Disposable mouthpieces and antibacterial filters/wipes (Vitalograph Ltd., Innis, Ireland) were used to avoid cross contamination. The individual was assessed, while standing or sitting comfortably with their nose pinched and the testing equipment and turbine between their hands.

2.0.1. Testing Procedure for Spirometry

The participant will be seated during the test and a soft clip will be placed on their nose to stop air escaping from it. The tester will explain what you need to do, and you may be asked to have a few practice attempts first. When he/she is ready for the test, they will be asked to:

- Inhale fully so your lungs are completely filled with air.
- Apply a nose clip
- Close your lips tightly around the mouthpiece (single use disposable spirometer tubes).
- Exhale as quickly and forcefully as you can, making sure you empty your lungs fully.

This will normally need to be repeated 2-3 times to ensure a reliable result. Results are given within a short time after testing. All respondents with a positive history of recurrent cough, those with occupational exposure (drivers, factory workers, roadside traders etc.), and those with a family history of cough or allergies will have Spirometry measurements taken. Their results were however interpreted based on the expected impact of identified abnormalities.

2.0.2. Determination of standard FEV1 and FEV1/FEV6 ratio values

The assessed respiratory parameters are defined as forced expiratory volume in 1 s (FEV1), which is the volume exhaled in the first second after deep inspiration and forced expiration. The forced vital capacity (FVC) is the total volume of air that the patient can forcibly exhale in one breath. The ratio of the two, FEV1/FVC, is the ratio of FEV1 to FVC expressed as a percentage of the predicted normal for a person of the same sex, age, and height. The FEV1, FEV6 and FEV1/FEV6 obtained values for adults were subjected to univariate analysis (means and confidence intervals) for the group. A stratification was performed based on type of settlement (rural versus urban), gender, medical history, household distance to nearest road, and exposure in the context of non-professional activities and occupational exposure (with known risk). Each individual's Spirometry value was coded based on calibrated normal for age, sex, and height (NHANES Values). Participants' descriptive statistics are shown in *Table 6*. The Spirometry values for children were evaluated based on normal values for age and sex, with means and standard deviation values presented in *Table 10*.

2.1. Statistical Analysis

The variables were processed using Epi-info statistical software version 3.5.3 and version 7 (CDC software, Atlanta, U.S.A). Descriptive statistics were generated for socio-demographic variables. The FEV1, FEV6 and FEV1/FEV6 values were analyzed for means and standard deviations.

Univariate analysis was performed on the obtained values in each age group and by sex to determine the means as well as the confidence interval. Bivariate analysis for odds ratios and multivariate analysis using logistic regression were also performed. Rejection of the null hypothesis occurred at a probability of $P < 0.05$.

2.2. Ethical Considerations

This study was approved by the Scientific Ethics Research Committee on Health and related research, Kano State Ministry of Health, Nigeria (Ref No: MOH/797/T.1:1700). This is dated September 30th, 2019 (*Appendix 4*) in accordance with the Helsinki Act of 1975. Informed consent (*Appendix 5*) was obtained from participants who signed a consent form which clearly detailed the voluntary nature of participation. Anonymity was maintained.

2.3. Limitations

- Selection bias: This was handled by recruiting participants based solely on the sampling interval from the identified first respondent within the first selected household.
- The primary limitation of cross-sectional study design arising from simultaneous assessment of exposure and outcome and the resultant difficulty in ascertaining temporality is expected. This will be addressed by data obtained on time lines of exposure, pre-existing health conditions, and duration of stay at residence (at risk area in proximity to highways or petrochemical industries).
- Resistance or reluctance to accept Respiratory Spirometry testing: This will be controlled by providing adequate written explanations of the procedure, using trained healthcare workers (nurses) and demonstrating the procedure within households prior to testing.

2.4. Key Informant Interviews (qualitative component)

Using snowball sampling and the Federal Road safety transportation corps (FRSC) as a starting point, a list of thirty-five stakeholders was generated. The stakeholders were from:

- Director of Public health (DPH) Kano State Ministry of health (MoH) Nigeria
- Director of Environment , Ministry of Environment (MoE) Kano State

- Head of Federal Road Safety Corps (FRSC) , Kano State Command
- Automobile and Transportation Engineers from the Federal Road Safety corps
- Representatives of Road Transport Workers Union (RTWUR), Kano State
- Environmental Health Officers in selected Local Government Areas (LGA) and State Levels
- Health Workers at health care facilities in Selected Local Government Areas (LGAs)
- Representative of the National Environmental Standards and Regulation Agency (NESREA), Nigeria
- Lead Epidemiologist, Ministry of Health (MoH), Kano State

A pre-structured key informant guide was used to conduct interviews in English and Hausa language. We assessed responses to the following thematic areas using the Key informant Interview (KII guide) shown in *Appendix 6*. The KII guide contained sections on : Introduction and socio-demographics, Road Vehicular use, Legislation and regulation of vehicular emissions, Industrial emissions and environmental effect, Respiratory diseases, health education and Public health campaigns on Non-communicable diseases (NCD), Air quality/control and Role of stakeholders in Air pollution control. The following measures were upheld during each interview:

1. The respondents received an explanation on the anonymous nature of the interview, and were subsequently asked to read and sign the informed consent form. If the respondent was illiterate, the form was read out and translated for comprehension prior to signing or thumb printing.
2. The interviews were conducted in teams of two. One person asking the questions and the other making written and audio notes for later transcription.
3. After each question specific instructions in BLOCK letters were written, they are NOT to be read to the respondents. They are instructions to aid the interviewer in completing the interview.
4. All relevant answers were ticked in corresponding boxes. For rating scales the complete scale was read out and an answer obtained from the respondent within the same scale.
5. Additional probing questions were asked if needed and indicated on the form.
6. All responses were open ended questions and responses written word for word on the dotted lines, and made clear and understandable for others.

7. No summarization of responses was performed. All answers were written and referral to audio tapes made when necessary.

Thirty five KII each lasting 35-45 minutes were conducted by trained personnel. Informed consent, both verbal and written (*Appendix 5*) was obtained from each participant. Anonymity was maintained using coding of data collection forms. All responses were entered into Epi-info statistical software version 7 (centers for disease control-CDC Atlanta) and analyzed by thematic areas.

2.5. Secondary Review and Analysis of Road Transportation Data (2016-2019)

A review of road transportation data for 2016-2019 was conducted at the record office of the FRSC, Kano Sector command. Records were available in hardcopy (paper) and on the FRSC portal for vehicular records (e-copy). There were limited number of variables available, information on the type of vehicle, address and chassis number were restricted. Access to the restricted variables required a security clearance from the National office which is not granted to researchers within National Laws in the country. Obtained data contained the following variables; date/month of registration, local Government area, type of ownership (Public or private) and sex of owners. The present system utilizes a double entry; manual registration of vehicles, followed by online entry into an e-platform. Due to irregular internet access the hardcopies were used as a reference point, as the e-copies of data sheet were incomplete for all the years reviewed. The obtained data was re-entered into an excel book and cleaned. Subsequent data analysis was performed using Microsoft excel and Epi-Info statistical software version 7.

2.6. General Study Limitations

As this study was funded by a limited research grant, the study scope and analytical methods utilized were based on: availability, accessibility and affordability. The cross-sectional design provided a detailed look at the study variables at a point in time and the study occurred within a defined feasible time-frame. Therefore, temporal deductions and linear trajectories or recto-trajectories were not evaluated.

BLANK PAGE

Chapter Three: Results

1.0. Scanning Electron Microscopy and EDX Results

Figure 27a shows the SEM overall appearance of the carbon adhesive discs. A large particle in the peripheral zone is highlighted in *Figure 27b*. The central areas are seen in *Figures 27c, g, and i* with high particle saturation. *Figure 27d-f* shows multiple views of Si wicks, which are common on construction sites (used for insulation). At urban roadside sampling sites, larger silicone wicks were identified, with a reduction in size (*figure 27f*) seen in rural sites. The images SEM-EDX of the central areas (concentrated with particles) of the carbon collecting discs show similar aspects in urban and rural areas, while mixed areas (*Figure 27h*) show a predominance of Si-based mineral elements (in red) over organic elements (carbon sand). The EDX sum spectrum (*figure 27l*) consists mainly of inorganic particles, particularly silicone (Si), aluminum (Al), and calcium (Ca). These elements can come from sand particles (spectrum 1 – *figure 27j*) or silicon fibers (spectrum 2 – *figure 27k*). Saharan sand particles are known ([Marmureanu, et al., 2019](#)) to consist of calcite, quartz, and iron-rich particles. Therefore, these sand particles can have sizes ranging between a few hundred nanometers and can contain Si, Al, Fe, Ca, Mg, K, Na, Mo, Sr, Zr, and it will therefore be difficult to differentiate them from particles like silicon fiber ([Sadiq, et al., 2022](#)). In order to be able to differentiate these two compounds, we carried out a more complete size and morphology analysis by analyzing 1000 particles on each peripheric zone of each carbon adhesive disc. For this we used the individual SEM-EDX analysis and automatic, which allowed us to go back for each site to the parameters of size (equivalent circle diameter ECD), shape (equivalent surface ratio ESR) and EDX elementary composition for each particle. Due to the automatic recording of the position of each particle, we were also able to obtain the scanned surface in order to obtain 1000 particles. This allowed us to plot *Figure 28*, which gives us, in addition to the particle size distribution, a rough estimate of the particle concentration per mm² for each type of site.

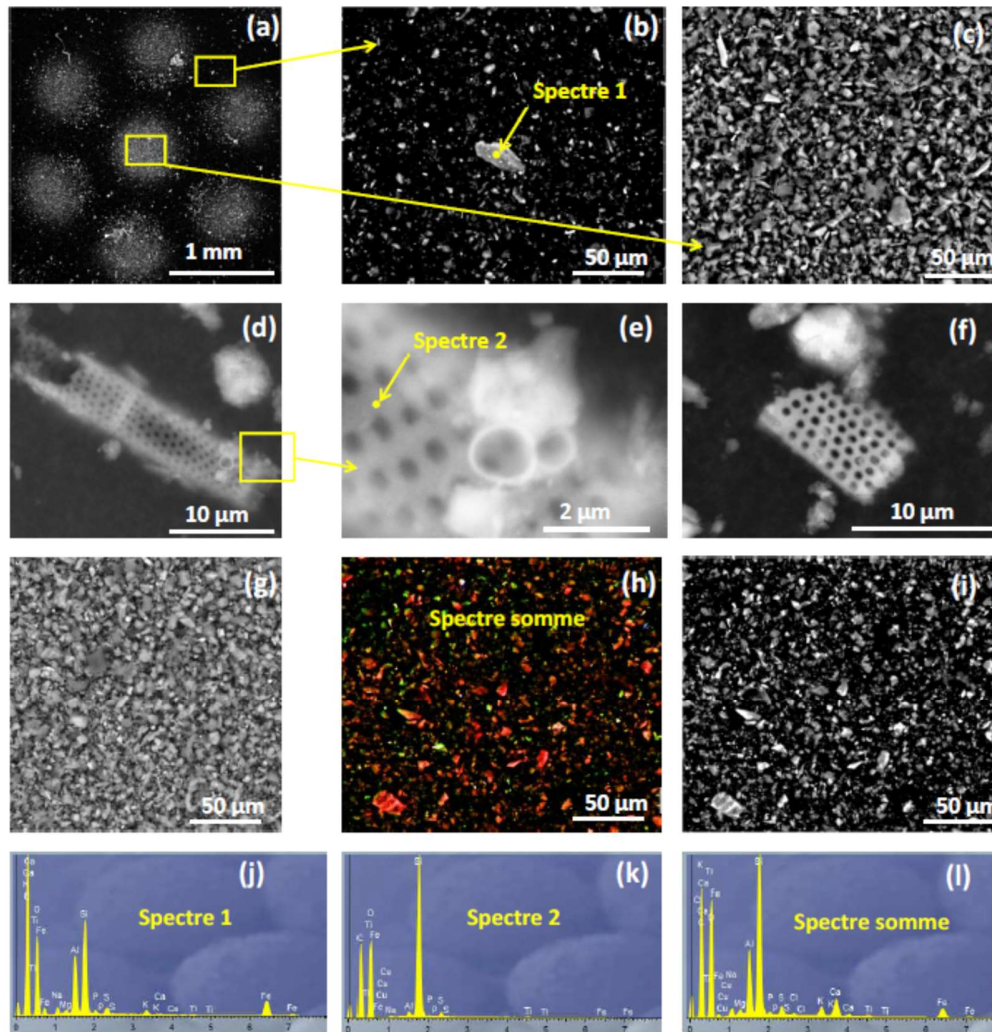

Figure 27: This show the SEM-EDX Imaging: (a) The appearance of the carbon adhesive disc particles is consistent for all collection sites (b) a large sand particle is present in the peripheral zone (c), (g), (i) visualization of central areas, concentrated in particles: (c) mixed site, (g) urban site, (i) rural site; (h) global EDX analysis over the entire area of the image with compound showing in red the Si-based particles and in green the C-based particles. Details of silicone (Si) wicks observed in different sites: (d) urban site (e) mixed site (f) rural site. (j), (k), (l) – EDX spectra associated with images (b), (e) and (h)

A total of 12,313 particles were seen on scanning electron microscopy from all sites, with the highest number of particles, 33.4%, in mixed settlements. Figure 28 below illustrates a Gaussian showing the main size of particles as 0.5 μm to 3.0 μm. Notably, larger-sized particles were scarce in all sites, with a marked reduction in particle number at $\geq 5 \mu\text{m}$.

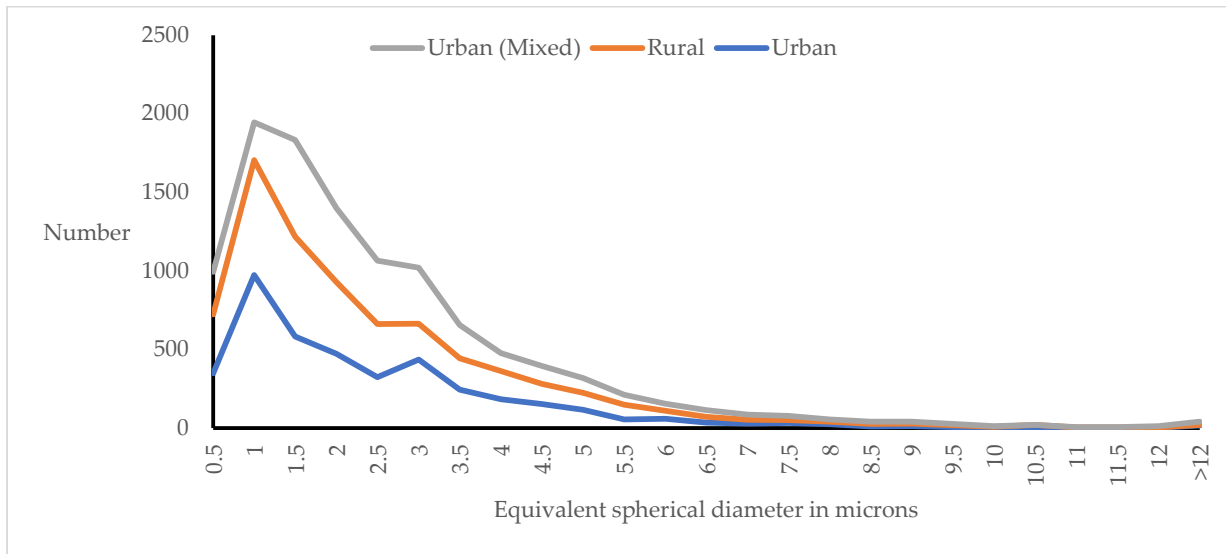

Figure 28: The number-size distribution of Particles from twelve sampling sites in three local Government Areas.

In Figures 29 and 30 below, site-specific histograms are shown, illustrating the size distribution using ECD and morphology using ESR. The distributions show a peak number of particles between 1.5 μm to 2.5 μm (ECD median value of the histogram), with more guaranteed values present more or less often in the sites.

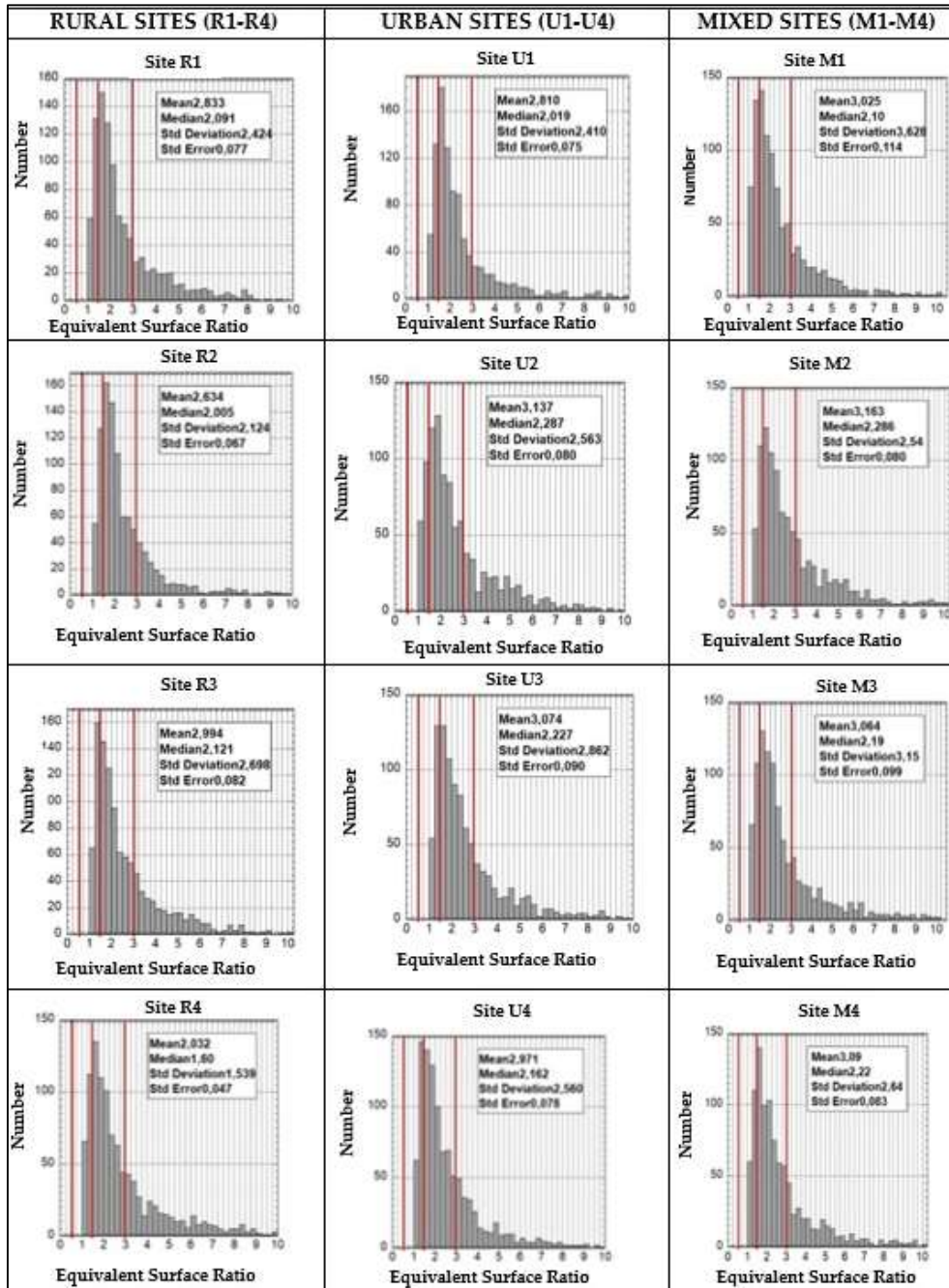

Figure 29: Site specific histograms of particles using equivalent surface ratio (ESR).

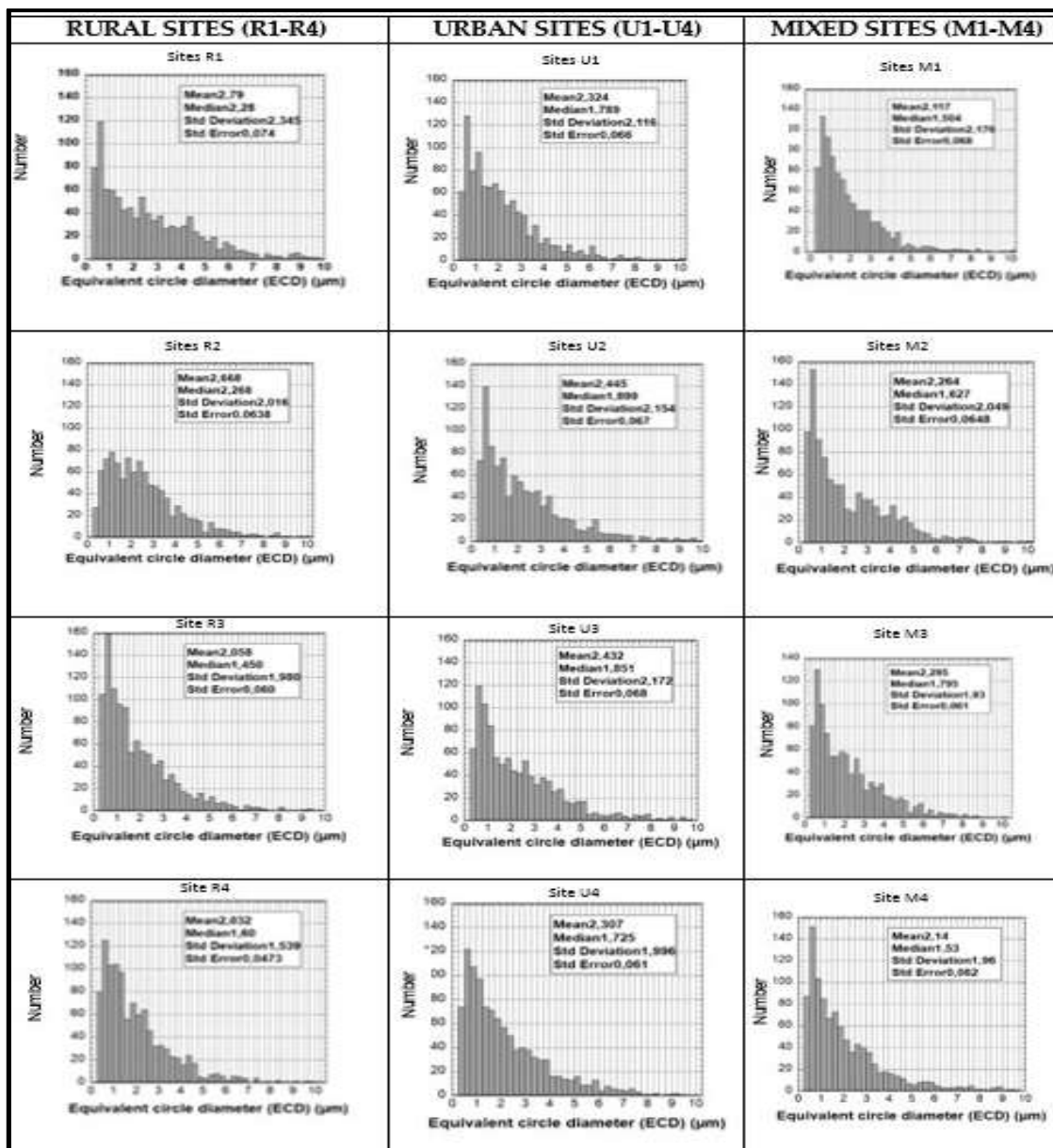

Figure 30: Site specific histograms showing particle distribution by equivalent circle diameter (ECD).

A review of the total particle structure from all sites (rural: sites R1–R4, mixed: sites M1–M4 and urban: sites U1–U4) in *Figure 31* reveals a predominance of non-fibrillar particles of up to 75%, despite the prevalence of a high number of fibrillar particles in all sites.

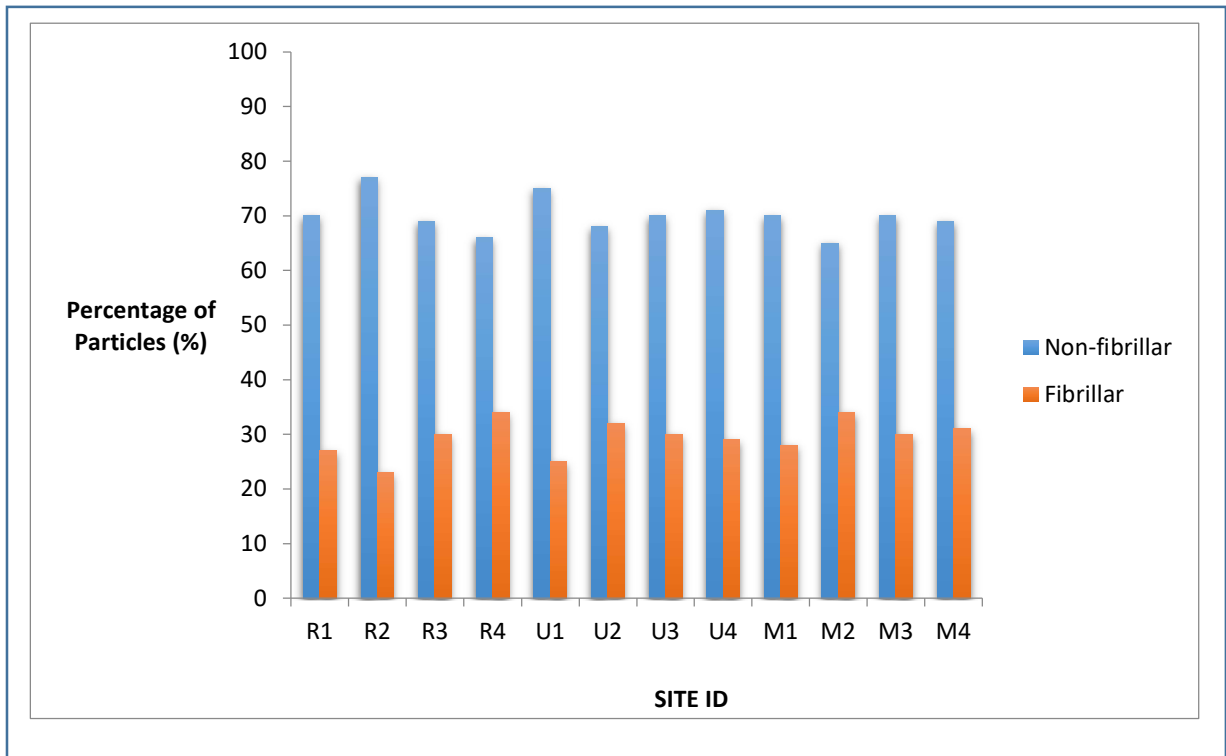

Figure 31: Particle classification from all sites using an Equivalent Surface Ratio (ESR).

In order to precisely classify the particles according to their chemical nature, we have grouped the particles according to their own basic chemical composition into 4 categories: silicon (Si) based fibers (particles with an ESR value greater than 3 and containing Si), other fibers (particles with an ESR value greater than 3 and without Si), sand (particles with an ESR value smaller than 3, ECD greater than 1, and containing Si, Al, Fe, Ca, Mg, K, Na, Mo, Sr, Zr) and lastly, non-sand non-fibers. This enabled the confirmation of strata-specific differences between settlement types. The findings shown in *Figure 32* revealed higher values of non-sand non-fibers. This is why we have looked more closely at the elementary chemical composition of these particles and we have found that the majority contain sulfur, a chemical element which may be linked to the combustion of

transport. This is why we have transformed this class of particles into an applied class of "other particles" (S, Si, Fe, Mo, Zn, and other metals). The values encountered for sand are largely attributable to the north-easterly *Harmattan* winds, characterized by dust storms that occur in the region during the dry season.

High percentages of sand particles were recorded in all sites sampled near roads, in both high and low traffic density locations (see *Figure 32a*). In the urban sites, the bulk of the identified particles have values ranging from 34 to 51%. Mixed sites showed values of 30 – 41% and rural settlements 41–51%. Differing values for this category are attributable to vegetation cover, building heights, and wind speed, which affect particle dispersion over land areas. The major identified source of this particle group is the dust-laden *Harmattan* winds, which characterize the dry season in Northern Nigeria. Re-suspension of road dust has also been linked to calcium (Ca) levels at roadsides (Sadiq, et al., 2022). Additionally, elements in this group have been identified in tyre pavement generated particles and non-exhaust emissions. Non-exhaust emissions originate from abrasion and re-suspension sources. Re-suspension includes corrosion of vehicle components, mechanical processes of driving, brake and tyre wear, and re-suspension of road dust from road wear (Naidja, Ali-Khodja, & Khardi, 2018).

Silicon-based fibers: 23–34 percent of fibrillar particles with a silicone base were identified in samples analyzed by SEM-EDX at all sites. Although silicone particles are usually non-fibrillar, our results indicate the possibility of meteorological conditions prevalent in the study area, including high temperatures and low humidity, resulting in the formation of such secondary particles. An additional source of these particles is industrial emissions. A cement factory, a bottling plant, a plastics factory, and a wood processing plant were located in the mixed settlement. The distance between these industries was greater than 100 meters from the air sampling sites. In the urban site, values ranged from 25–34%, in the mixed site, 23–34%, and in the rural site, 24–31%. Other fiber particles with very low percentages (0–3%) in all sites include iron (Fe), sulfur (S), molybdenum (Mo), and zinc (Zn). grouped here have been linked globally to transportation origins in source apportionment studies.

Non-sand and non-fiber particles: these particles contain S, Si, Fe, Mo, Zn, and Zr with an ECD of $< 1\mu\text{m}$. Heavy minerals like zircon have been identified as sources of aerosolized zirconium particles (Key, et al., 2017), but these particles have an ECD greater than $1\mu\text{m}$ and we have counted them in the sand particle category. High levels are recorded in areas associated with open quarry activities and ongoing construction, which characterize the urban landscape of metropolitan areas in Kano State. The brake parts of old and expended vehicles commonly used for public transportation also release zirconia powder, which is used to modify the friction coefficient and reduce brake pad wear (Ma, Martynkova, Valaskova, Matejka, & Lu, 2012). Particles from road transportation vehicles, exhaust and non-exhaust, are also contained in this category. Values obtained ranged from 22–37% in urban areas, 29-40% in mixed areas, and 22-29% in rural areas.

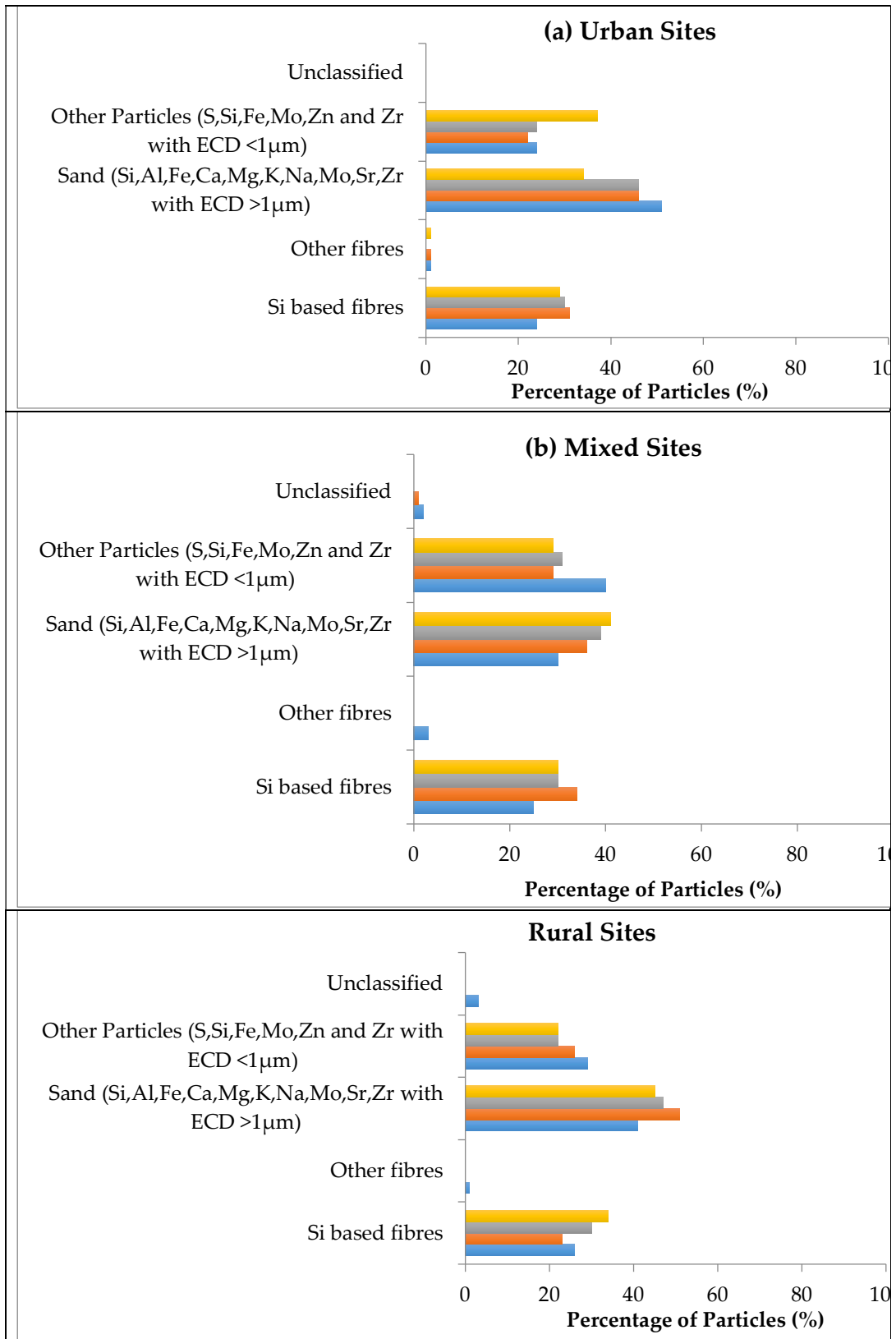

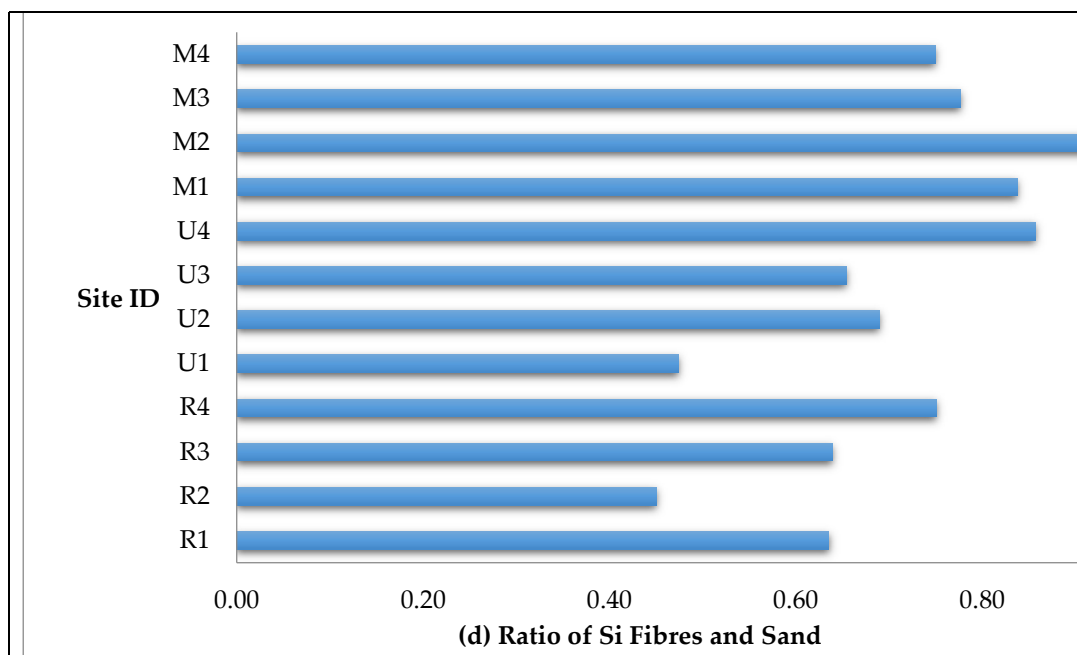
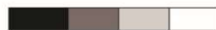

Figure 32: The classified particles are divided into four groups based on settlement: (a) urban, (b) mixed, and (c) rural. (d) A Comparison diagram of the ratio of Si fibers to sand for all sites.

On precise analysis of 1000 particles per collection site for $PM < 2.5 \mu m$ Figure 33a, silicone compounds, predominantly aluminum silicate and zirconium (Zr), are the highest in mixed settlements. Urban settlements revealed a higher abundance of silicone compounds and calcium (Ca). Zirconium was most abundant in $PM 2.5-10 \mu m$ in mixed settlements, while Si and silicon compounds were more abundant in rural and urban areas. Other identified elements, Ca, Ce, Cl, Fe, Mn, and Ti, showed moderate to minimal abundance in all sites. At lower particle sizes of $<2.5 \mu m$ unclassified particles were higher in rural sites, while larger sizes of $2.5 \mu m \leq 10 \mu m$ showed more unclassified particles in urban and mixed sites.

Type of community	Si and Si Cmpds	Ti	Ca	Mn	Fe	S	Zr	Cl	Ce	0<51	Unclassified
Nassarawa (Mixed)	Dark	Light	Dark	Light	Light	Light	Dark	Light	Light	Light	Light
Kumbotso (Rural)	Dark	Light	Light	Light	Light	Light	Dark	Light	Light	Light	Light
Kano Municipal (Urban)	Dark	Light	Dark	Light	Dark	Light	Dark	Light	Light	Light	Light



>Relative abundance<

Si: silica, Si cmpds: silica compounds, Ti: titanium, Ca: calcium, Fe: iron, S: sulfur, Zr: zirconium, Cl: chloride, Ce: cerium, 0<51: oxygen particle.

(a)

Type of Community	Si and Si Cmpds	Ti	Ca	Mn	Fe	S	Zr	Cl	Ce	0<51	Unclassified
Nassarawa (Mixed)	Dark	Light	Light	Light	Dark	Light	Dark	Light	Light	Light	Light
Kumbotso (Rural)	Dark	Light	Dark	Light	Dark	Light	Dark	Light	Light	Light	Light
Kano Municipal (Urban)	Dark	Light	Dark	Light	Dark	Light	Dark	Light	Light	Light	Light



>Relative abundance<

Si: silica, Si cmpds: silica compounds, Ti: titanium, Ca: calcium, Fe: iron, S: sulfur, Zr: zirconium, Cl: chloride, Mn: manganese, Ce: cerium, 0<51: oxygen particle.

(b)

Figure 33: (a) Mineralogy of particles with a size diameter of $<2.5 \mu\text{m}$ from all collection sites; (b) Mineralogy of particles with a size diameter of $2.5 \mu\text{m} - <10 \mu\text{m}$ from all collection sites.

In Table 5 below, the distance from roadside air sampling sites in all settlements showed a mean value of less than 50 meters. The lowest values were recorded in the mixed settlement, where in the commercial car park, residents were living in direct contact with road transportation vehicles.

Table 5: Distances between households (HH) and air sampling sites in three local government areas in Kano State, Nigeria.

S/N	LGA/Site Number	Settlement Type	Distance to Households Mean \pm SD (meters)
1	Kano Municipal Site: U1-U4	Urban	37.2 \pm 27.0
2	Nassarawa Site: M1-M4	Mixed	34.1 \pm 21.7
3	Kumbotso Site: R1-R4	Rural	36.8 \pm 22.7

Appendix 7 shows pictures of air sample collection, field measurements and testing conducted at the study sites. The instruments used to conduct air sampling and their functions are outlined in *Appendix 8*. In *figures 34a, b and c* below, the elemental composition of obtained air particles at low particle sizes was analyzed prior to cell studies. In order to obtain an idea of the predominant elements or compounds present at that size distribution, the results showed that for particle sizes of $< 0.5\mu\text{m}$, silicate compounds (53–75%) were more prevalent in urban and rural sites, while zirconium (57% in mixed sites).

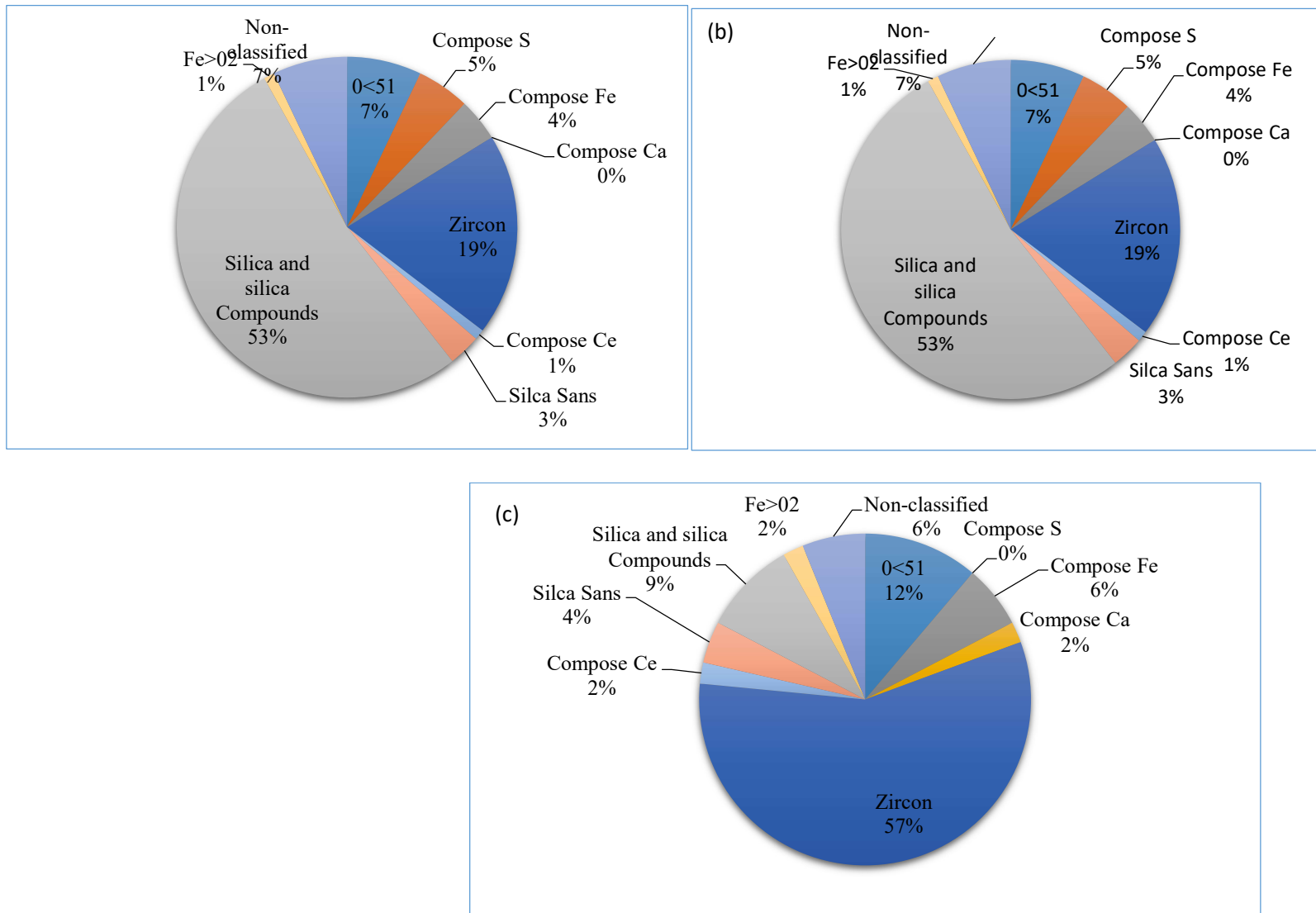

Figure 34: Particle composition within size range <math>< 0.5 \mu\text{m}</math> for (a) rural sites, (b) urban sites and (c) mixed sites, Kano State, Nigeria.

1.1. The Result of the Cytotoxicity Assessment by the MTT Assay

MTT test results *Figure 35* below, conducted in triplicate, showed significant cytotoxicity in mixed settlements M1, M2 and M3, especially site number M2 (commercial motor-park), characterized by the lowest values of absorbance. Other settlements also showed evidence of cytotoxicity as shown by significant *p*-values (<0.05) on Student *t*-tests. These values, though not lower than in mixed sites, were evident in rural site R2 and urban sites, U1 and U2.

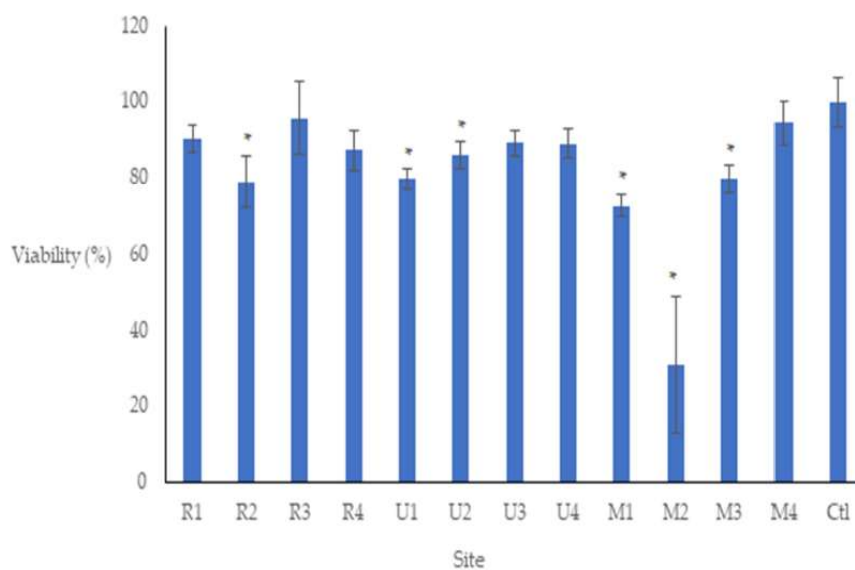

Figure 35: The mean and standard errors of MTT tests read at 570 nm absorbance for all sites.

1.2. Results of Cellular Viability using DAPI Staining

Viability values are presented and calculated in percentage with standard errors shown in *Figure 36*. Evidence of the strongest decrease in cell viability and, therefore, the highest cytotoxic effect was observed in sites M2 (19.6%) and M1 (61.5%), both located in the mixed settlement characterized by high road vehicular traffic density shown in *Table 4*. Other mixed sites, M3 and M4, as well as sites R2, R3, U1, U2 and U4, showed significant but lower reductions in cellular viability. *Figure 37* further provides images of the stained cells, particularly for the sites with the lowest recorded cytotoxicity values.

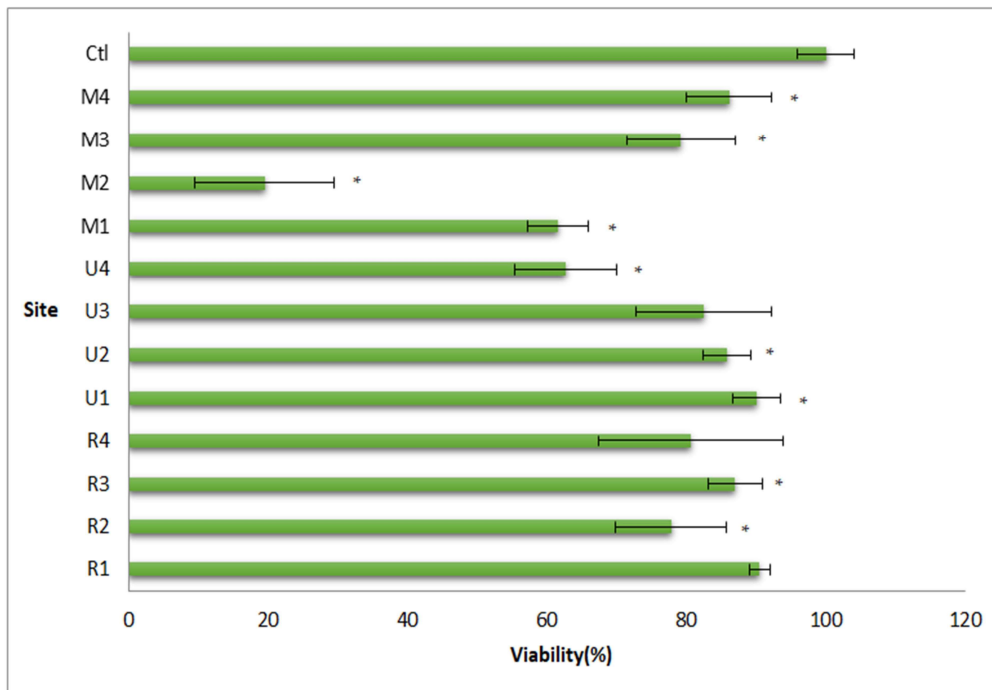

Figure 36: Mean viability values and standard errors by DAPI analysis by site.

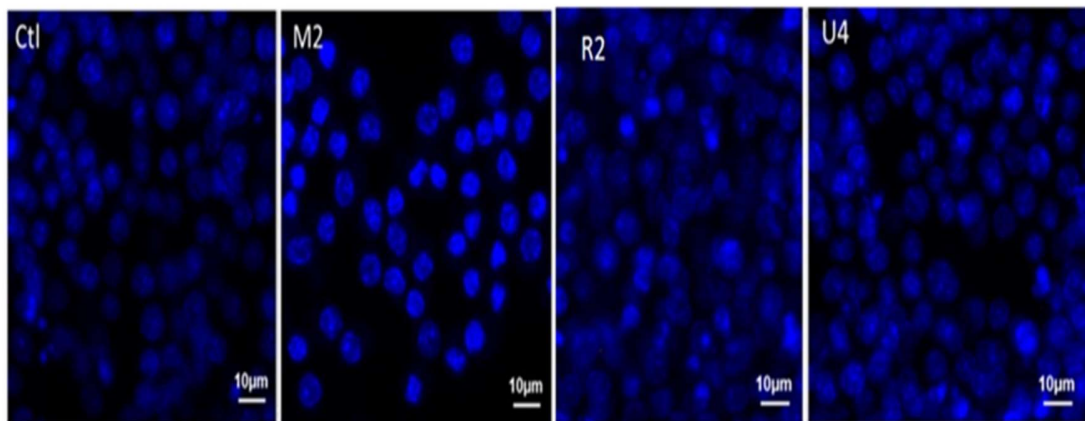

Figure 37: Typical DAPI staining of macrophages in control or particle-exposed conditions in some sites illustrates intense DAPI staining (saturation) due to intense internalization of the dye along with nuclear condensation; note the lower cellular density for the M2 site, corresponding to higher cell death.

A comparison of mean cytotoxicity values (*Figure 38a* below) obtained using DAPI for high and low-density traffic sites showed no significant difference in median toxicity. However, greater variability in mean cytotoxicity was observed among high-traffic sites than those with low traffic density. The lowest mean cytotoxicity value was obtained in a high-density traffic site; the value is attributable to the results shown in *figure 36* above. For MTT testing, median cytotoxicity values (*Figure 39b* below) in low-density traffic sites were found to be lower than in high-density sites, though the difference is statistically insignificant. Also, greater variability was obtained in high traffic density sites. The lowest mean cytotoxicity values were obtained in high traffic density sites, as reflected in *figure 37* above. As a result, traffic density is not directly related to cytotoxicity; other factors, such as existing industrial contamination and geogenic pollutants, may confound the relationship between the exposure and outcome variable.

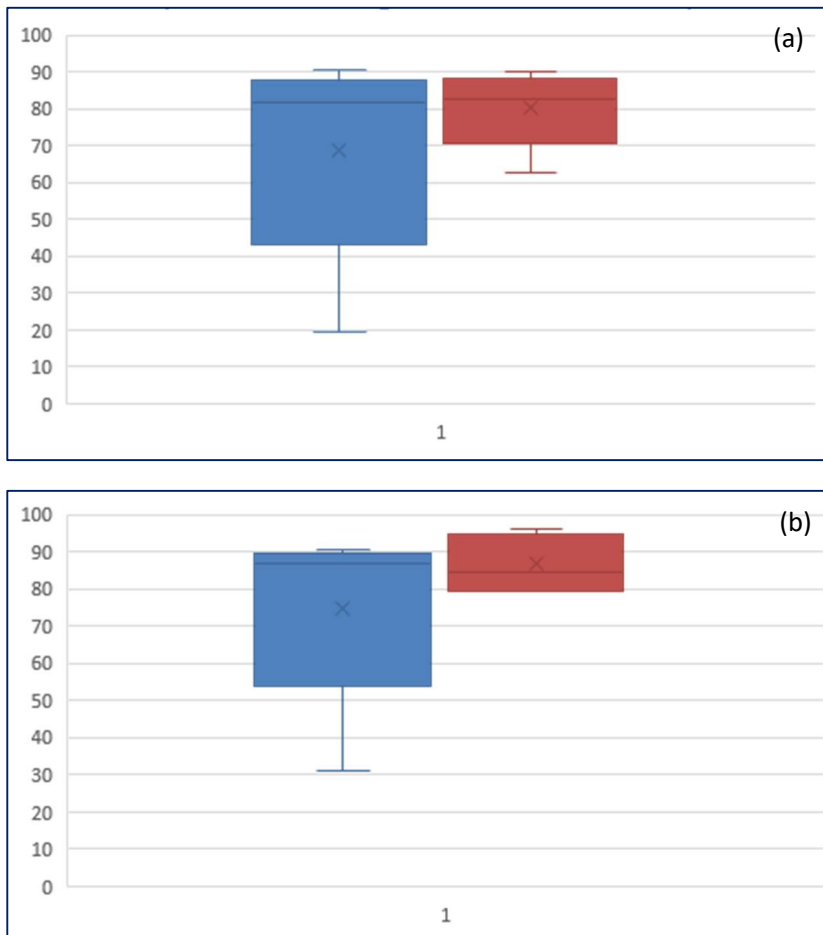

Figure 38: A comparison of mean viability values for high (blue) and low (red) traffic sites, (a) DAPI, (b) MTT.

A table presenting photographs and descriptions of the specific instruments used cell toxicity assessments is shown in *Appendix 8*. Additionally, the calculation of pre and post sampling filter weights are illustrated for each air sampling site.

1.3. Results of Standardized Questionnaires and Clinical Respiratory Assessment

1.3.1. Demographic information

Table 6 shows descriptive statistics derived from the questionnaires; age, sex, marital status, educational level, occupation, and duration of stay in the community; and the distribution of results by settlement type. The majority of adult respondents were married, with a male-to-female ratio that varied between urban and rural areas. Most respondents had a secondary level of education as their highest educational qualification. A long duration of stay ≥ 5 years was prevalent in both rural and urban areas. All households (HH) in both urban and rural settlements were located within a distance of a mean of 36.03 ± 23.79 meters and a range of 2.45–99.0 meters.

Table 6: Respondents' socio-demographic characteristics of respondents in both rural and urban areas of Kano State, Nigeria.

Descriptive Variables	Rural settlement No (%)	Urban settlement No (%)
Sex		
Male	26 (52.0)	47 (47.0)
Female	24 (48.0)	53 (53.0)
Marital Status		
Single	8 (16.0)	30 (30.0)
Married	42 (84.0)	58 (58.0)
Divorced	0 (0.0)	2 (2.0)
Widowed	0 (0.0)	10 (10.0)
Educational Level		
Primary	9 (18.0)	14 (14.0)
Secondary	24 (48.0)	46 (46.0)
Tertiary	12 (24.0)	14 (14.0)
Post-tertiary	2 (4.0)	0 (0.0)
No formal education	3 (6.0)	26 (26.0)
Age		
10-19 years	11 (11.0)	0 (0.0)
20-29 years	26 (26.0)	17 (34.0)
30-39 years	19 (19.0)	14 (28.0)
40-49 years	21 (21.0)	7 (14.0)
≥50 years	23 (23.0)	12 (24.0)
Duration of stay		
<1 year	1 (2.0)	6 (6.0)
3 – 5 years	9 (18.0)	20 (20.0)
≥ 5 years	40 (80.0)	74 (74.0)
Occupation		
Business person	18 (36.0)	50 (50.0)
civil servant	7 (14.0)	6 (6.0)
Agricultural/construction	5(10.0)	1(1.0)
Student	2(4.0)	4 (4.0)
Others	18(36.0)	29(39)

Table 7 presents values for Spirometry by means and standard deviation; the mean height values were higher among males than females in both rural and urban settlements, while the average age of respondents in both settlements was in the 30+ age group. The mean FEV1 and FEV6 values observed were significantly higher in males than in females regardless of age group, with the highest recorded values in males within urban settlements. The mean FEV1/FEV6 ratio and obtained standard deviations (SD) showed values largely distributed at the normal cut-off. *Appendix 7* shows multiple plates of team workers conducting administration of questionnaires, conducting key informant interviews, collecting air samples, and examining respondents on the field at the study sites.

Table 7: Height and Ventilatory parameters by sex and settlement type for adults in selected LGAs of Kano State, Nigeria

Variable	Sex Male (n=73) Female (n= 77)	Rural Male (n=26) Female (n=24)	Urban Male (n=47) Female (n=53)
Age (years)	(Male) (Female)	38.6±14.4 35.7±10.6	34.7±12.0 38.2±13.5
Height (meters)	(Male) (Female)	1.70±0.08 1.58±0.05	1.71±0.07 1.59±0.78
FEV1 (L)	(Male) (Female)	2.13±0.63 1.85±0.50	2.75±0.47 1.75±0.55
**FEV1 Predicted (%)	(Male) (Female)	71.93±9.05 71.74±11.15	73.38±9.74 65.39±13.99
FEV6 (L)	(Male) (Female)	2.96±0.87 2.62±0.69	4.03±0.66 2.54±0.77
FEV1/FEV6 (L)	(Male) (Female)	0.72±0.03 0.71±0.05	0.69±0.06 0.69±0.06

For Table 7: FVC stands for forced vital capacity; FEV1 stands for forced expiratory in one second; FEV1/FEV6 stands for a two-value ratio; and FEV6 stands for forced expiratory in six seconds. The values are mean standard deviations. The predicted normal values are for age, sex, and height based on the CDC reference calculator's generated values for normal Spirometry. The results of Spirometry assessments are shown in Figure 39.

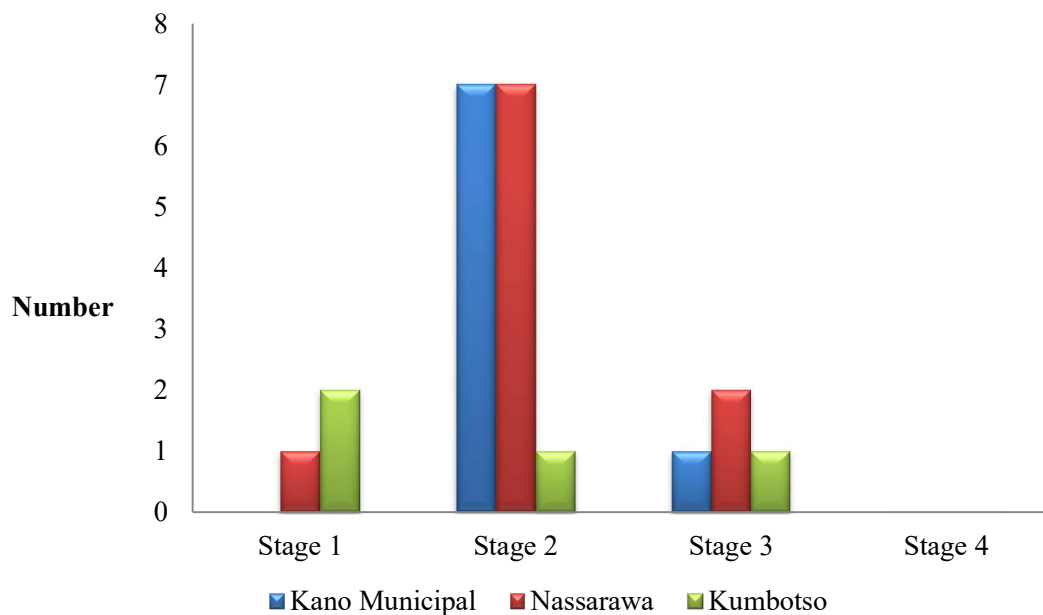

Figure 39: Results of Spirometry among adult respondents with staging of obstructive index.

Only 22 adult participants had values within the obstructive index. For adult participants the standardized reference values used to interpret findings were:

- $FEV1/FEV6 \geq 0.70$ and $FEV1 \geq 80\%$ of predicted: Normal
- $FEV1/FEV6 < 0.70$ and $FEV1 \geq 80\%$ OF Predicted: Stage 1
- $FEV1/FEV6 < 0.70$ and $FEV1 < 80\%$ Predicted: Stage 2
- $FEV1/FEV6 < 0.70$ and $FEV1 < 50\%$ Predicted: Stage 3
- $FEV1/FEV6 < 0.70$ and $FEV1 < 30\%$ Predicted: Stage 4

The Odds ratio (OR) of grouped exposure variables and a 95% confidence interval (*Table 8*) in both rural and urban areas in relation to the outcome of interest were calculated. Confounding variables such as; a history of respiratory illness and abnormalities on clinical examination were controlled for by stratification. Living in a house within 50 meters of a highway or road, as well as not using protective devices such as face masks and shields, was found to increase risk. Findings on multivariate analysis (logistic regression) in *Table 9* showed no significant adjusted odds ratio (aOR).

Table 8: Bivariate analysis of factors associated with respiratory abnormalities due to air pollution in selected rural and urban areas of Kano State, Nigeria.

Exposure Variable	Rural Odds Ratio (OR) Confidence interval (CI)	Urban Odds Ratio (OR) Confidence interval (CI)
Distance to exposure source (Highway/road) <ul style="list-style-type: none"> • <50 meters • ≥50 meters 	2.11 (0.20- 21.9)	32.4 (8.57 – 122.3)
Duration of transit <ul style="list-style-type: none"> • ≥2 Hours • <2 Hours 	3.57 (0.35-36.94)	1.68 (0.60 – 4.69)
Exposure in the context of professional activities <ul style="list-style-type: none"> • Present • Absent 	1.20 (0.11 – 12.83)	0.69 (0.21 – 2.31)
Exposure in the context of non-professional activities <ul style="list-style-type: none"> • Present • Absent 	1.58 (0.14 – 17.25)	1.34 (0.48 – 3.73)
Traffic control on roads <ul style="list-style-type: none"> • Positive • Negative 	2.83 (0.36-22.4)	0.96 (0.34 – 2.72)
Exposure to outdoor air pollution <ul style="list-style-type: none"> • Present • Absent 	0.37 (0.03 – 4.22)	0.71 (0.26 – 1.97)
Use of protection <ul style="list-style-type: none"> • No • Yes 	5.12 (0.49-53.2)	12.43 (2.60 – 59.34)

Table 9: Output of Logistic regression for selected variables.

Exposure Variable	Odds Ratio (aOR)	95% CI	Coefficient	Standard error (SE)	P-Value
Distance to Household ≥50 meters <50 meters	1.23	0.46 – 3.33	0.21	0.51	0.680
Exposure in the context of professional activities Yes No	0.86	0.29 – 2.56	-0.15	0.56	0.788
Duration of Transit ≥2 hours <2 hours	2.33	0.78 – 6.91	0.85	0.56	0.128
Perceived Exposure to vehicular pollution Yes No	0.47	0.18 – 1.22	0.75	0.49	0.123
CONSTANT	*	*	1.49	0.42	0.000

Convergence: Converged

Interactions: 5

Final – 2* Log Likelihood 120.7707

Cases Included: 150

Test	Statistic	D.F	P-Value
Score	4.4551	4	0.3479
Likelihood ratio	4.2943	4	0.3676

Figure 40 shows the frequency of road transportation vehicular use in both urban and rural settlements, with the most commonly used vehicular type as the tricycle in urban areas (commonly known locally as '*Keke Napep*'). In rural settlements, motorcycles were identified as the most common.

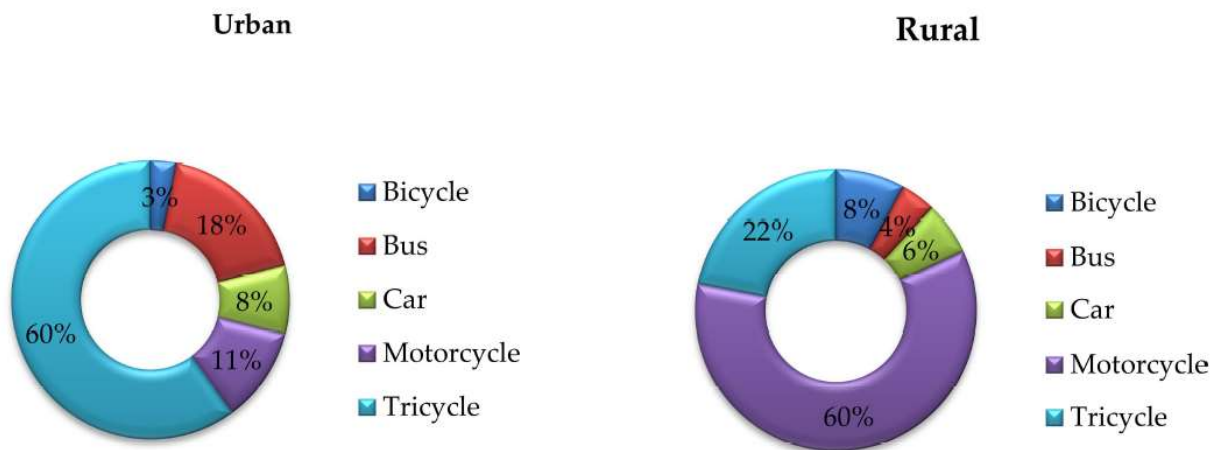

Figure 40: Distribution of Road Transportation Vehicles in Kano State's rural and urban settlements.

Results obtained in children on respiratory Spirometry (Table 10) below were compared to children of similar ages from a regional study on African children (Akhiwu & Aliyu, 2017). Results obtained for children aged 6-13 years showed forced expiratory flow in 0.5 seconds (FEV0.5), FEV1 and peak expiratory flow (PEF) mean values within the normal range. The obtained peak expiratory flow values were lower compared to reference values in the standardized study of African children.

Table 10: Parameters obtained on Spirometry in children in Kumbotso (Urban) LGA of Kano State , Nigeria.

	Age	6 years	7 years	8 years	9 years	10 years	11 years	12 years	13 years
	Male Female	n= 1 n= 0	n = 4 n = 0	n = 3 n = 0	n = 2 n = 3	n = 3 n = 2	n = 1 n = 3	n = 3 n = 0	n = 4 n = 1
Height (meters)	Male Female	1.4±0 0.0±0	1.4±0.1 0.0±0	1.4±0.2 0.0±0.0	1.5±0.1 1.5±0.1	1.5±0.2 1.5±0.3	1.4±0.0 1.5±0.3	1.5±0.1 0.0±0.0	1.5±0.1 1.6±0.0
FEV 0.5 (L)	Male Female	1.4±0 0.0±0	0.9±0.4 0.0±0	.1±0.4 0.0±0.0	0.8±0.0 0.9±0.1	1.3±0.2 1.2±0.4	0.7±0.0 1.1±0.1	1.0±0.0 0.0±0.0	1.2±0.2 0.54±0.0
FEV 0.75 (L)	Male Female	1.4±0 0.0±0	1.0±0.4 0.0±0	1.2±0.5 0.0±0.0	0.8±0.1 0.9±0.1	1.1±0.3 1.2±0.5	0.8±0.0 1.2±0.1	1.1±0.4 0.0±0.0	1.3±0.2 0.66±0.0
FEV 1.0 (L)	Male Female	1.4±0 0.0±0	1.0±0.4 0.0±0	1.2±0.5 0.0±0.0	0.9±0.2 0.9±0.1	1.2±0.3 1.2±0.5	0.8±0.0 1.3±0.1	1.2±0.3 0.0±0.0	1.3±0.2 0.70±0.0
PEF (L/sec)	Male Female	265.0±0 0.0±0	163.8±74.0 0.0±0	197.3±81.7 0.0±0.0	179.5±47.4 195.3±9.1	209.0±19.1 208.5±29.0	166±0.0 214.7±22.6	179.3±46.8 0.0±0.0	242.5±53.2 107.0±0.0

1.4. Results of Key Informant Interviews

Of 35 key respondents, 17 (48.6%) were from the Local Government Area (LGA) and 18 (51.4%) from the State administrative level. In *Figure 41*, the male to female ratio of respondents was 4:1. Fifty-five percent of respondents had completed secondary school, and 45% held graduate or post-graduate degrees.

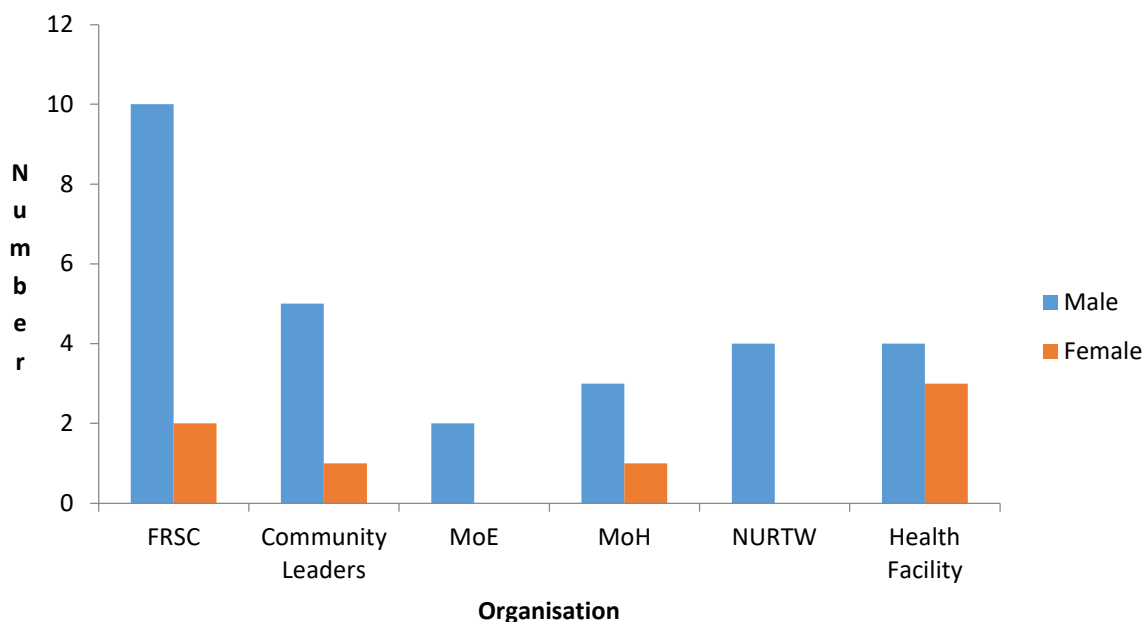

FRSC: Federal Road Safety Corps
MoE: Ministry of Environment
MoH: Ministry of Health
NURTW: National Union of Road Transportation Workers

Figure 41: Sex distribution of Stakeholders from inter-disciplinary agencies.

1.4.1. Vehicular use and safety in relation to emissions

“I believe Rapid Urbanization is the most important factor resulting in increased car ownership. The State is becoming modernized with improved roads and easier access to vehicles for sale.”

Traditional Ruler- Rural Local Government Area

Most respondents (94.3%) believed the highest concentration of vehicles in the state was in urban areas. In response to the distribution of vehicular ownership, 13 (37.1%) of respondents cited private car ownership as more common. On car maintenance practices in their communities, the majority of 24 (68.6%) of respondents classified the maintenance culture as average, 5 (14.3%) as good, and 6 (17.1%) as bad. The age of a vehicle can serve as an index of its functionality, design, and impact on the users and environment. When responding to the perceived age of privately owned vehicles, 27 (77.1%) of respondents mentioned vehicles commonly used were older than 5 years old. According to KII respondents, mixed settlements consisting of residential, commercial, and occasionally industrial areas were most commonly located near highways in the state. While providing their opinions on the quantity of traffic regulators available on roads (*Figure 42a-f*) within their locality, stated that the number of Federal Road Safety Corps members (FRSC) was adequate. Grading non-governmental organizations, respondents believed their availability on roads and car parks was: poor 15 (42.9%), average 11 (31.4%), and good 8 (22.9%).

A large number of respondents (26, or 76.5%) believed automated and intelligent transportation would have a positive effect on green motility. Citing greater traffic control, a reduction in road traffic accidents, reduced emissions and improved health. Only 8 (23.5%) of respondents stated it would have a negative effect on ensuring green mobility, citing possible non-acceptance of new innovations and previous negative experiences with automated transportation devices, e.g. traffic lights, automated speed monitors, and automated emission monitoring devices used by regulatory agencies.

Factors responsible for increased car ownership

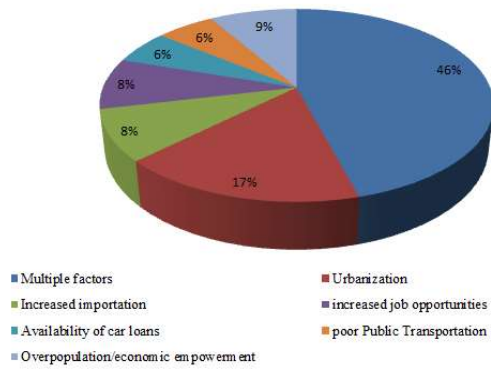

Common types of vehicles in use

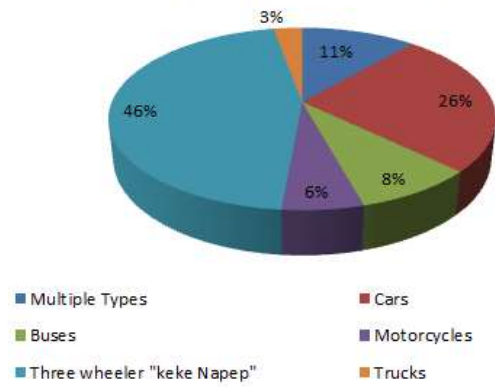

Sources of Vehicular emissions

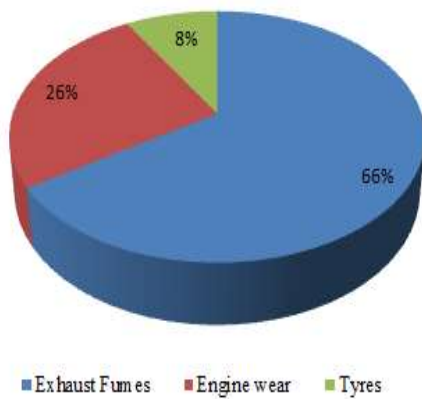

Duration of Transit

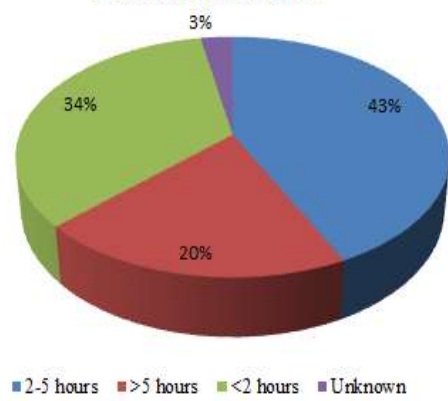

Effective Traffic regulation

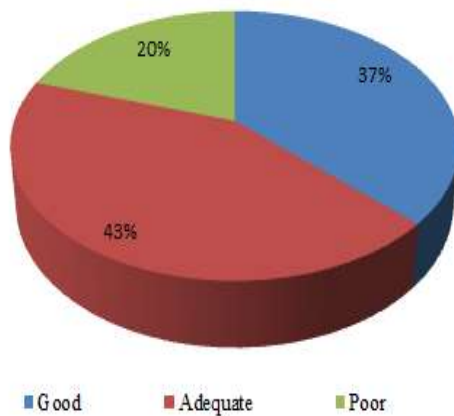

Stakeholder participation in transportation and health

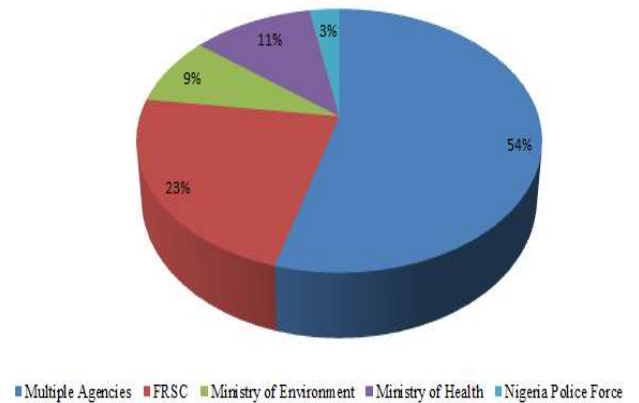

Figure 42(a-f): Stakeholders perception on car ownership, emission sources, traffic regulation, transit duration and traffic regulation and stakeholder participation.

1.4.2. Legislation and regulation of vehicular emissions

Twenty-five (71.4%) of respondents believed road users would abide by legislation/laws (*Figure 43a*); a minority of 10 (28.6%) responded in the negative. In response to the adequacy of existing drivers' education and tests in Nigeria to effectively prepare drivers for safe road use, most respondents (22, 61.8%) responded in the affirmative. Commercial drivers were believed to require additional legislation, as stated by 22 (62.9%) of respondents. A minority of 13 (37.1%) considered separate legislation unnecessary. Commercial drivers' recklessness, disregard for existing laws, the prevalence of drug use among long-haul drivers, and a low educational level were cited as justifications.

“They possess an inherent disregard for established laws and the survival of their passengers, resulting in their involvement in the majority of road accidents. They will definitely benefit from separate rules and regulations.”

Federal Road Safety Corps (FRSC) Road Traffic Officer

For effective implementation of legislation and laws regarding emissions and transportation, a majority of 16 (45.7%) respondents identified the following: regular car inspections at points of entry; monitoring of emission levels; public health education and risk communication, monitoring and inspection of cars on the roads; and issuance of certificates of road worthiness. Some respondents believed solitary measures were adequate; monitoring and inspection of cars on the roads 11 (31.14%), installation of air quality detectors 1 (2.9%), public health education and risk communication 4 (11.4%), regular car inspection at ports of entry 3 (8.6%). Monitoring and supervision of regulations and standards for vehicular emissions was believed to require an interdisciplinary approach involving multiple stakeholders by 34 (97.1%) of KII respondents.

“A multi-disciplinary team can help monitor and regulate vehicular emissions and their prevention and control. This will enable different members to contribute to their specific area of expertise. ”

Public Health Director

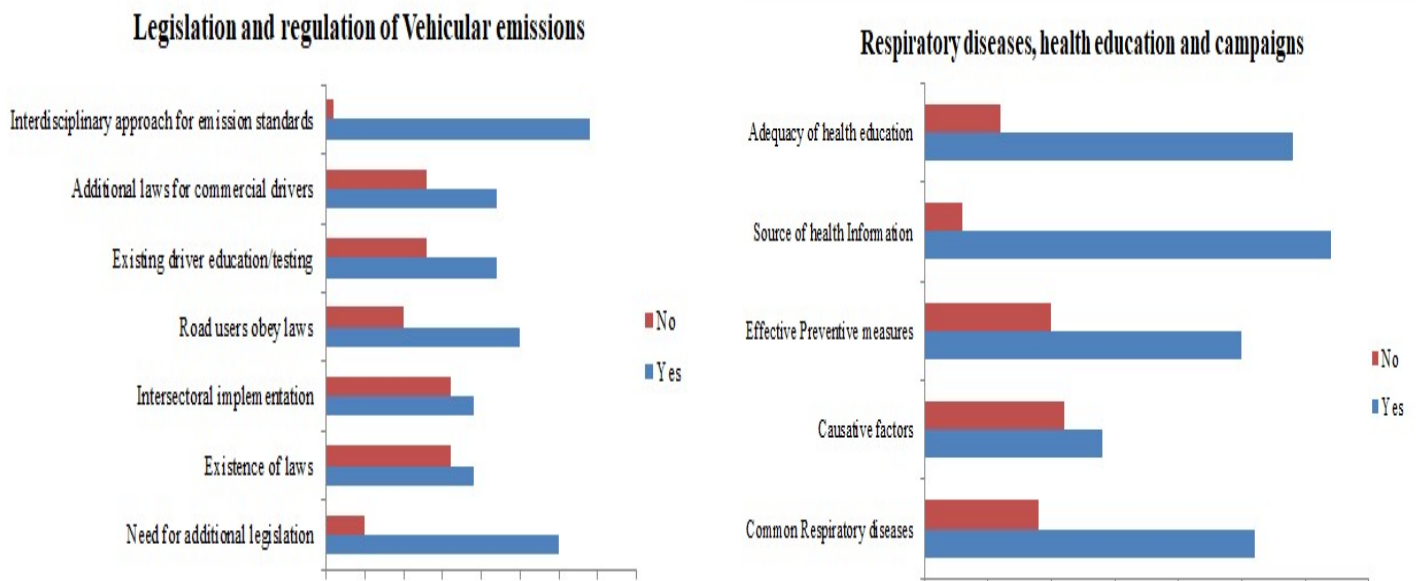

Figure 43 (a & b): Knowledge among stakeholders on Legislation/regulation of vehicular emissions and Respiratory diseases, health education and campaigns.

1.4.3. Industrial emissions and environment

Majority 34 (97.1%) of respondents stated they were aware factories and industries produced emissions, contributing to air pollution. In terms of the safety of emissions to human health, 27 (77.1%) of respondents thought it was harmful. 8 (22.9%) believed industrial emissions from existing factories were safe for humans. To ascertain KI's opinion on the safety of industrial emissions to plants, humans, and animals (Biosphere), they responded thus: 32 (91.4%) were negative and 3 (8.6%) stated it was a positive effect. For the types of diseases related to industrial emissions, multiple diseases such as gastrointestinal, respiratory, cardiac, musculoskeletal, nervous system, and reproductive disorders were cited by the majority of 19 (54.3%). Respiratory diseases only having a causal link to industrial emissions were mentioned by 11 (31.4%), while ≤ 2 (5.7%) stated only cardiac and gastrointestinal diseases. Two (5.7%) of KI declared no knowledge of a linkage between industrial emissions and human diseases.

"Long-lasting illnesses and severe diseases result from us, humans, and our animals inhaling bad substances in the air daily."

Kumbotso-Rural community traditional leader

Participants believed multiple stakeholders (48.7%) were responsible, including the Federal government, State government, local government, factory/industry workers, non-governmental organizations, community members, and international organizations. The Federal Government was cited by 14 (40.0%) as solely responsible for the maintenance of safe emission levels. A small percentage (5.7%) blamed factory/industry workers, state government, and community members. Use of protective clothing was identified as an effective measure for factory/industry workers to protect their health by 16 (45.7%). Some respondents (15, or 42.9%) mentioned multiple protective measures for workers; use of protective clothing, limiting work hours/exposure; monitoring emission levels; and consumption of fruits and vegetables. Monitoring of emission levels as a sole means of protection from industrial emissions was stated by 3 (8.6%) of respondents.

1.4.4. Respiratory diseases, health education and Public health campaigns on non-communicable diseases in Nigeria

To evaluate access and availability of health information on non-communicable diseases (NCDs), KII respondents were asked if they had ever received information on NCDs. Some 29 (82.9%) responded in the affirmative, while a minority, 6 (17.1%) responded in the negative.

"Yes, I have received information on common non-communicable diseases in my workplace and risk factors, such as asthma, those due to environmental or occupational exposure etc."

Health Worker, Primary healthcare facility (PHC)

In response to the adequacy of information being provided at country level on non-communicable diseases (*Figure 43b*), 21 (60.0%) of KI stated available information was adequate. Though 14 (40.0%) believed the information made available was incomplete and inadequate, The responsibility for the provision of adequate and relevant information on NCDs was attributed to the government

by 24 (68.6%) respondents. Multiple stakeholders taking the initiative within an inter-sectoral framework were identified by 8 (2.9%) as the best option. A small percentage of respondents held sole responsibility: nongovernmental organizations (2.9%), traditional rulers (1.9%), and faith-based organizations (2.9%).

1.4.5. Air quality and its control

To assess if key informants were conversant with the concept of air quality, they were asked if they were familiar with the term. The majority of 28 (80.0%) respondents responded positively, while 7 (20.0%) admitted to having no prior knowledge of the term "air quality. Of those who responded positively, when asked to proffer examples of what may affect air quality, 17 (50.0%) cited multiple factors such as open fires/bush burning, factories/industrial emissions, cigarette smoking, waste discharge, exhaust fume from cars, and deforestation. A few respondents cited solitary factors; factories/industrial emissions 9 (26.5%), open fires/bush burning 3 (8.8%) and exhaust from cars 5 (14.7%). Other factors mentioned by respondents included an unclean environment, fumes from generators, Harmattan haze (during the dry season), poor sewage systems, and open dumping. The air quality in their communities was classified as average 19 (54.3%), good 10 (28.6%), and bad 5 (14.3%). Only one respondent (2.9%) classified the air quality as excellent. A large number of KI respondents (88.6%) exhibited an awareness of their role as individuals in contributing to improving air quality in communities. Two (5.7%) answered in the negative and two (5.7%) were unaware.

"Trained personnel should be deployed to conduct health campaigns at public transportation garages for commercial drivers."

Road safety officer- National Union of Road Transport Workers (NURTW)

"The manufacturing companies are located too close to residences and should be relocated to prevent the wind carrying pollutants to people"

Women's Leader (community), rural settlement

Table 11 below shows the respondent's knowledge of air quality and emissions. Adequate knowledge was discerned for interdisciplinary monitoring and regulation of air quality and for the concept of air quality.

Table 11: Respondents Knowledge on Air Quality and emissions.

Criteria	Responses		
	Yes (%)	No (%)	I don't know (%)
Effective Implementation of laws on emissions and transportation:			
-Multiple measures	17(48.6)	7(20)	11 (31.4)
-Monitoring and inspection of cars	11(31.4)	12 (34.3)	12 (34.3)
-Installation of air quality detectors	21 (60)	4 (11.4)	10 (28.6)
-Risk communication	16(45.7)	8 (22.9)	13 (37.1)
-Regular car inspections	27(77.1)	5 (14.3)	3 (8.6)
Inter-disciplinary monitoring and regulation of air quality	34 (97.1)	1 (2.9)	0 (0.0)
Concept of Air quality	28 (80.0)	7 (20)	1 (0.0)
Factors affecting air quality	17 (48.6)	17 (48.6)	1 (2.86)
Classification of air quality in communities (good and excellent)	10 (28.6)	25 (71.4)	0 (0.0)
Awareness of measures to improve air quality	14 (40)	15 (42.9)	6 (17.1)

1.4.6. Role of Stakeholders in Air pollution control in Nigeria and Africa

On responsibility for air quality regulation and control, a majority of 24 (68.6%) cited the government. Responsibility relying on multiple stakeholders through inter-sectoral collaboration was identified by 9 (25.7%). Some KI respondents identified the community 1 (2.9%) and international organizations 1 (2.9%) as solely responsible for regulation and control.

"There must be improvement in social mobilization, increased participation in tree planting, and more health education."

Kano State Ministry of Health Public Health Specialist

"As a citizen to improve air quality and reduce air pollution, I will ensure a reduction of activities which pollute the air." Also, air pollution worsening activities in society are avoided.

FRSC safety/route officer

To ascertain any observed or perceived change in air quality or air pollution levels in communities, respondents were asked if any change was noted. A majority of respondents (10, or 28.6%) stated they had noted a worsening of the situation in the past 5 years. 10 (28.5%) also affirmed the difference in air quality and air pollution that had been observed in the past 4-5 years. A lesser number (9, or 25.7%) cited the change in air pollution and air quality having occurred in the previous year. Only 6 (17.1%) of KI participants cited the changes occurring within a 1–3 year period. The majority of respondents (17, or 48.6%) perceived the observed changes as negative, while 15 (42.9%) considered the change as positive. Three respondents (8.6%) declared an inability to state their opinion on observed changes. Existing measures and regulations in place at the country level to reduce air pollution and improve air quality were considered inadequate by 22 (62.9%). However, some respondents (9, or 25.7%) cited the existing measures as adequate. A few KI participants 4 (11.4%) stated an inability to assess existing measures and regulations. A willingness to adhere to any new legislation or laws regarding the reduction of air pollution or improving air quality was stated by 33 (94.3%). A minority 2 (5.8%) cited an unwillingness to adhere to or uphold new regulations regarding air quality and pollution.

Responses on the quality and adequacy of various components of existing road infrastructure revealed a poor opinion. Less than 50% of respondents graded (*Table 12*) any component as being in good or adequate working condition. Most responses ranged from poor quality to non-availability.

Table 12: Quality/adequacy of road Infrastructure on used roads.

Road Infrastructure	Condition/Quality			
	Good Condition No (%)	Poor Condition No (%)	I don't Know No (%)	Not available No (%)
Road Surface quality	53 (35.3)	90 (60.0)	5 (3.3)	2 (1.7)
Road planning/layout	32 (21.3)	67 (44.7)	29 (19.3)	22 (14.7)
Speed Breakers	24 (16.0)	52 (34.7)	37 (24.7)	37 (24.7)
Pedestrian crossing	11 (7.3)	10 (6.7)	41 (27.3)	88 (58.7)
Road markings	21 (14)	21 (14)	38 (25.3)	70 (46.7)
Lighting	31 (20.7)	37 (24.7)	19 (12.7)	63 (42.0)
Road signs	24 (16.0)	35 (23.3)	14 (9.3)	77 (51.3)
Traffic Lights	49 (32.7)	53 (35.3)	5 (3.3)	43 (28.7)
Emergency services for accidents	19 (12.7)	43 (28.7)	38 (25.3)	50 (33.3)

On driving experience and knowledge of fuel sources (Table 13), a large number had adequate knowledge of traffic control methods and expressed satisfaction with the existing driving experience and public transportation system. However, despite most respondents' willingness to use alternative fuel sources, their knowledge of these alternative sources was low.

Table 13: Driving experience and knowledge of fuel sources.

Driving experience/ knowledge of fuel sources	Yes (%)	No (%)	I don't know (%)
Grading of existing traffic control	97 (66.7)	28 (18.7)	25(16.7)
Knowledge of traffic control methods	91 (60.7)	44 (29.3)	15 (10.0)
Satisfaction with current driving experience	109 (72.7)	16 (10.7)	25 (16.7)
Satisfaction with Public Transportation system	80 (53.3)	55 (36.7)	35 (23.3)
Are you aware of other non-petroleum fuel sources	46 (30.7)	79 (52.7)	25 (16.7)
Knowledge of alternative fuel sources	56 (37.3)	80 (53.3)	14 (9.3)
Willingness to use alternative fuel sources	83 (55.3)	62 (41.3)	5 (3.3)

1.5. Results of Secondary Data Review and Analysis

Of the total entries in the database, only 11,652 were solitary entries and 173 (1.46%) were duplicates. The metropolitan local Government Areas (LGAs) with the most registered vehicles were Kano Municipal and Nassarawa. The highest number of registered vehicles was recorded in 2018; private car ownership was higher by 88% than commercial or public vehicle ownership. More males than females, M: F ratio, 8:1 (*Figure 44*), was registered as owners of road transport vehicles.

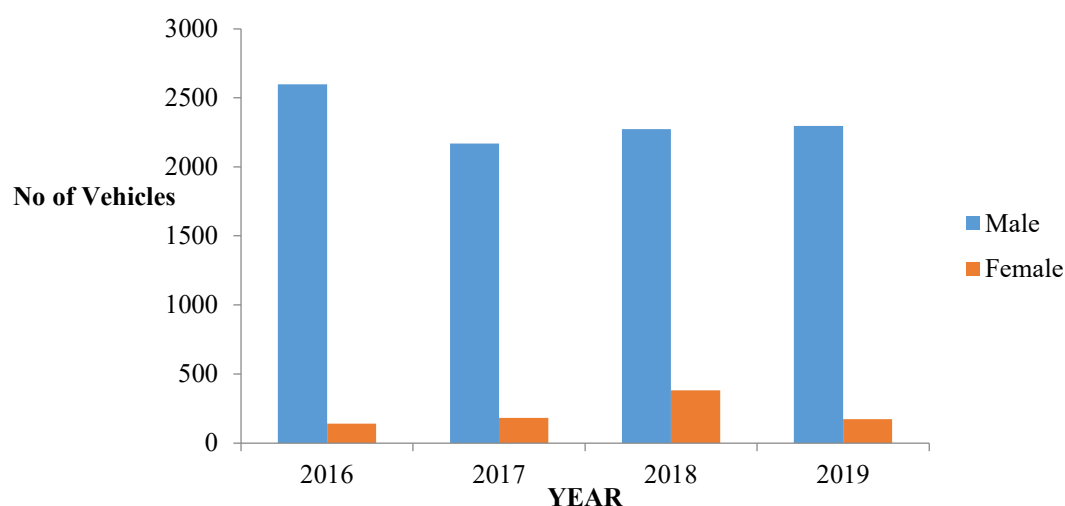

Figure 44: A distribution by Sex of Registered owners of Road Transportation Vehicles in Kano State, Nigeria (2016-2019).

Vehicular registration data showed a constantly irregular pattern (*figure 45*). This indicates multiple factors affect car ownership and registration. The data officers mentioned the existence of large

numbers of unregistered out-of-state vehicles. An influx of three wheeler vehicles, popularly known as *"Keke Napep"*, used widely as public transportation was recorded. These three-wheeled vehicles were identified as the most commonly used road transportation method in urban areas (Figure 40).

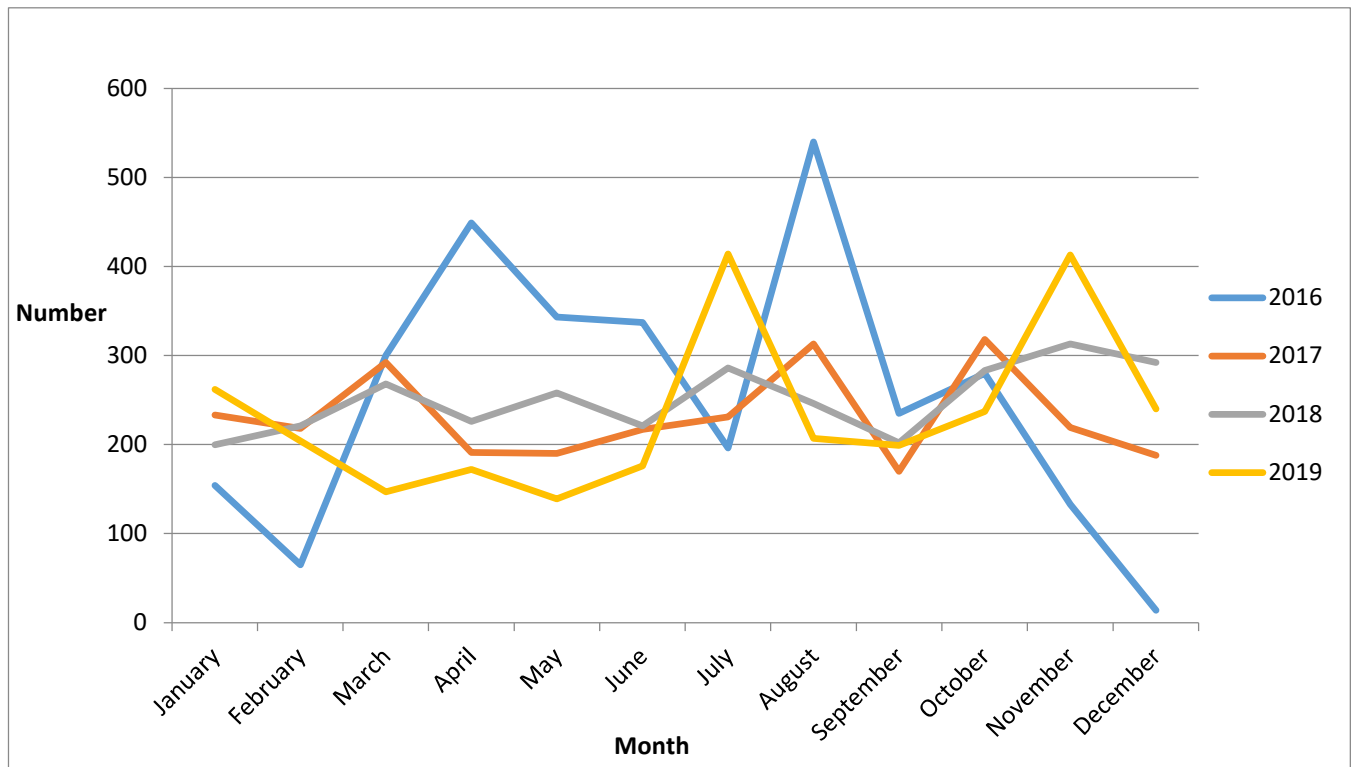

Figure 45: Trend of Vehicular registration data in Kano State, Nigeria 2016- 2019.

BLANK PAGE

Chapter Four: Discussion

Our findings show predominance in all sites of ambient aerosols of a size that significantly affects health, requiring concerted efforts to reduce exposure (Phalen, 2003; Air Quality, 2018). In terms of proximity to sources of air pollution, in this scenario, the health impact of road transportation vehicles varies depending on particle type, distance to source, and duration of exposure (Sadiq, et al., 2022). Long-term air pollutant persistence worsens outcomes by prolonging exposure (Tan Z. , 2014; Annesi-Maesano, et al., 2012). This is further confounded by the location of residential households proximal to the air sampling sites and moving traffic. Our results showed mean distances to sampling sites of <50 m in both rural and urban areas, which is within the radius of maximal risk (near field) to emission sources. The inhabitants of such homes experience chronic exposure to emissions and poor air quality. For PM_{2.5} and ultrafine particles, a 50% decrease within 100–150 m of a road is reported (Hitchins, Morowska, Wolff, & Dale, 2000). A decay to background concentrations within as little as 50 m has been described for PM 2.5 mass concentrations (Tittia, et al., 2000), although PM_{2.5} tends to be more spatially homogenous than ultrafine particles. Exposure occurs on three scales of distance, namely near-field (0 to 0.2 km), the urban scale (0.2 to 20 km), and the regional scale (20 to 2000 km). Elevated exposures occur in the near field environment and the people most affected are pedestrians, people in nearby buildings, cyclists, and vehicle passengers (Nordling, et al., 2008). A variation in emission sources has been reported between rural and urban sites, with most sources in urban settings being vehicular and industrial (Adeyanju & Manohar, 2017). Despite this, and in view of the unprecedented increase in motorization reported in developing countries (Schipper, Fabian, & Leather, 2009) and our study scope, our comparison was based primarily on ambient aerosols at road traffic sites.

Various studies have demonstrated regional and country-specific variability in the chemical composition of particulate matter (PM). These include water-soluble ions, metallic elements, and organic compounds such as sulfates, dioxins, nitrates, and others, such as Ca, Mn, Cl, Al, Cr, Ni, and Pb (USEPA, 2004; Hughes, Cass, Gone, Ames, & Olmez, 1998; Harrison, et al., 2000; Vega, et al., 2011; Mues, Manders, Schaap, Van Ulft, Van Meijgaard, & Builtjes, 2013). Our results showed a predominance of silicon (Si), silicate compounds, predominantly aluminum silicate, calcium (Ca), zinc (Zn), zirconium (Zr), titanium (Ti), manganese (Mn), sulfur (S), iron (Fe), and cerium (Ce) as the elements with the highest relative abundances. Strata-specific differences were observed between rural and urban sites, with Ca, Zr, and Si compounds being the highest in the mixed settlement. Whereas Zr and silicon compounds

had the highest abundance in rural sites, urban areas had higher levels of Fe and Ca. This highlights reported differences in PM sources, components, and concentration differences between urban and rural areas (Langner, Kull, & Endlicher, 2011; Akinlade, et al., 2015). The presence of lower particle sizes of silicone, zirconium, and Ca in high percentages at different settlement types, indicates the presence of elements with proven toxicity to humans. As sizes below $4.0\mu\text{m}$ are within the alveolar fraction, specifically the respirable fraction capable of affecting pulmonary air exchange (Mar, Larson, Stier, Clairborn, & Koenig, 2004), this proves the presence of pollutants directly affecting health at all size ranges. Despite higher particle sizes generally being used to evaluate air quality (Beslic, Segal, & Klaic, 2004), the significance of this finding is more indicative of direct health effects. Higher concentrations of particulate matter have been reported in studies within Africa, one in Nigeria. They showed monthly particulate matter values were higher during dry season usually October- March, than the wet or rainy season April –September. Seasonal pollution sources such as grain thrashing from agriculture and wet deposition due to precipitation are factors causing this observed difference (Islam, Afrin, Ahmed, & Ali, 2015; Okimiji, et al., 2021) .

In the country, studies in a few states also showed variability in elemental compositions. A study to determine the relationship between climate conditions and air quality using X-ray fluorescence spectroscopy to characterize chemical elements showed varying levels of Na, Mg, Al, Si, P, S, Cl, K, Ca, Ti, Mn, Fe, Zn, As, Br, Rb, Sr, and Pb in different sizes (Zircon Occurrence in Nigeria, 2021). The higher relative abundance of zirconium levels in this study could be attributed to the high level of zircon identified in Nigeria, particularly the northern states, as well as excavation activities that result in dust particulate suspension (Key, et al., 2017; Efe, 2008).

Concentrations of titanium and zirconium mineral are majorly found in primary magmatic deposits, or concentrated in sedimentary deposits which may or may not have undergone weathering. Due to their higher density (or specific gravity), these minerals are commonly referred to as valuable heavy minerals (or VHM) (Perks & Mudd, 2019). Zircon is primarily used for its opaqueness, as well as its heat, water chemical and abrasion resistance in applications such as ceramics, refractory, foundry, chemicals, and nuclear reactors. Titanium feedstock primarily find use as TiO_2 pigment, but are also used in metal applications, welding rod coatings, abrasives, metallurgical fluxes and refractory linings. TiO_2 pigments are used to impart whiteness, brightness and opacity in the production of paints, paper, plastic and other products. TiO_2 is also non-toxic, insoluble, has excellent heat stability, weather resistance, hiding power,

easy to disperse in resin systems, and is discoloration resistant (Punis, 1994). Studies that measured concentrations of PM in Nigeria also recorded regional and state variability, with average concentrations of PM₁₀ measured in Abuja and Maiduguri (northern Nigeria) ranging from 118.3 to 132.0 μgm^{-3} and 553 μgm^{-3} in Aba (eastern Nigeria) (Ana, Odeshi, Sridhar, & Ige, 2014). During the dry season an average PM₁₀ daily concentration of $502.3 \pm 39.9 \mu\text{g m}^{-3}$ was obtained in a commercial area within southwestern Nigeria, which exceeded ten-fold the WHO daily guideline value (Geng, Kang, Jung, Choel, Kim, & Ro, 2010). An additional in Nigeria confirmed the impact of meteorological factors on pollutant concentrations and exposure mixture of particles undergoing constant change throughout the year (Okimiji, et al., 2021). These changes related to air pollutant levels and meteorology observed during the year can be influenced by local physiography such as presence of water bodies and mountains (Prabhu, et al., 2020). Specific meteorological parameters such as high humidity lead to ease of absorption of aerosols and semi-volatile species which lead to an increase in PM concentrations at sites (Yang, Ji, Kang, Zhang, Chen, & Lee, 2019). In a study which compared aerosol optical properties and radiative effects during two haze events in China. Findings showed differences in inversion of aerosol properties, an obvious increase in average aerosol optical depth (AOD), and fine mode particles (Shikuan, Yingying, Ming, Wei, Lianfa, & Xin, 2019). Thus, emphasizing the need for studies to span time periods encompassing different weather phenomena and seasonal peculiarities. This highlights the need for constant monitoring of PM values and the use of widely distributed monitoring stations to ensure air quality control (Sadiq, et al., 2022).

An assessment of enrichment factors as a measure of anthropogenic contributions to background values for elements was unattainable during this study. Largely, due to the study design being on the vehicular-human health interface and not the vehicular-environment interface. Also, no database exists within Nigeria for values of reference elements commonly used; Al, Zr, Sc and Ti for the study site. In addition, evidence has shown the use of average crustal concentration in the absence of site specific values is insufficient to distinguish natural and anthropogenic due to regional variation of the elements (Reimann & de Caritat, 2000; Blaser, Zimmermann, Luster, & Shotyk, 2000). Their study affirmed site specific parent material concentration for individual soil profiles were more realistic and objective for calculating EFs. As, background values in EF calculations are the range of concentration of the selected element in a specific area which is dependent on compositional and mineralogical characteristics attributed to source/parent material (Albanese, De Vivo, Lima, & Cicchella, 2007; Reimann & de Caritat, 2005). No

values from another country, region or continent can realistically provide an objective reference value for another country. As an important factor in choosing a reference element for enrichment factor analysis is the distribution of the reference element, our study findings eliminate the use of zirconium for future assessment due to the high abundance obtained in the study site. Studies show reference elements used should have low natural regional variation and be minimally influenced by weathering (Reimann & de Caritat, 2005). Our study did not conduct soil sampling to ascertain background values for metal elements within the study site.

Although other studies have identified typical elemental patterns related to road vehicular emissions such as submicron metal chloride containing particles, which are typically mixed with carbonaceous materials in combustion emissions (USEPA, 2004; Hu, Lin, Zhang, Kong, Fu, & Chen, 2014; Carslaw, Boucher, Spracklen, Mann, Rae, & Woodward, 2010), brake and tire wear particles are classified as traffic/abrasion class, with corrosion products of vehicles as Fe/Cr, elements such as; Cu, Ba, Fe, and Sb used for brake abrasion, and Zn and black carbon for tire abrasion (Furusjo, Sternbeck, & Cousins, 2007; Weckworth, 2001; Marcazzan, Ceriani, Valli, & Vecchi, 2003; Adachi & Tainosho, 2004). Our study identified these elements but with a high relative abundance for only some of these elements. This may be limited by the qualitative nature of our analysis or the short sampling duration within the study area. Longer-term air sampling studies can possibly provide a more detailed elemental profile and clearer wear patterns. The use of simulations and testing in controlled and semi-controlled environments may also account for the elemental patterns reported in referenced studies (Sadiq, et al., 2022). Our study was performed in a purely uncontrolled environment and, therefore, affected by other factors such as: variation in wind speed, temperature changes, and topographic differences.

Fibrillar particles identified primarily in mixed settlements are known to exert cytotoxicity via possible mechanisms such as fragmentation, toxicity from early stages of formation, and acting as seeds for additional fibrils (Glabe, 2008; Aguzzi & O'connor, 2010; Martins, Kuperstein, & Rouseeau, 2008; Xue, Hellewell, & Radford, 2009). These particles have also been shown to possess high elastic moduli stemming from backbone intermolecular hydrogen bonding (Knowles, Fitzpatrick, & Welland, 2007). Low viability values obtained on DAPI staining in sites, particularly M1 and M2, emphasize the cytotoxic effect of particulate pollutants, particularly those of fibrillar nature, which predominate at these sites. The resultant health effects can be short-term, including increases in inflammatory markers (Zeka, Zanobetti,

& Schwartz, 2006), decreases in pulmonary function (Lai, Lin, & Liao, 2017), respiratory symptoms such as exacerbations of chronic obstructive pulmonary disease (COPD) and infections (Barnett A. , et al., 2005), and increases in respiratory mortality (Ostro, Feng, Broadwin, & Lipsett, 2007). Long-term effects can culminate in respiratory and cardiac disease. The evidence of significant reductions in viability in some rural and urban sites, although lower than in mixed sites, shows an adverse effect of pollutants even at reduced values (Sadiq, et al., 2022). Further findings from MTT testing are indicative of marked particle toxicity to normal cell function in the same sites; M1 and M2 highlight the need for identifying particle types, sources, and possibly concentration.

Although this study is limited by its focus on a qualitative comparison of particles only, significant differences in urban and rural settlements provide sufficient information to support policy change. Both zirconium and silica have demonstrated toxicity in previous global studies, with zirconium linked to ocular irritation, skin itching, and respiratory symptoms, while silica has been linked to chronic obstructive pulmonary disease (COPD), silicosis, and lung cancer, via different transforming potencies and varying cytotoxicity (CDC, 2002; Elias, et al., 2000). This occurs through the mechanisms of deoxyribonucleic acid (DNA) cell death, enhancement of *miRNA* expression and apoptosis (Atalay, Celik, & Ayaz, 2018; Cossellu, et al., 2016). The documented peril to communities existing in the absence of regular air quality monitoring and control cannot be overemphasized. Particulate pollution at levels below cut-off values over time shows adverse consequences for exposed individuals (Cossellu, et al., 2016; Brauer, Li, Martin, Meng, & al, 2019). Our findings obtained from air sampling and cytotoxicity tests support the need for long-term studies which will enable effective planning and monitoring of any control measures, such as lowering traffic speeds through the use of speed limits and maintaining constant traffic flow, both of which have been shown to reduce roadside PM₁₀ levels (Kohoutek, Weinbruch, & Boltze, 2012; Gehrig, Hill, Buchanan, Imhof, Weingartner, & Baltensperger, 2004).

The results from key informant interviews show an almost exclusive use of traditional fuel sources in road transportation vehicles within the study area. This is despite, evidence from global studies highlighting the preferential benefits from use of cleaner alternative fuel sources. Policy changes are critical in achieving a greener energy source substitution in countries such as Nigeria. Policies toward decarbonizing road transportation tend to be built around approaches such as a more transport efficient society (incl. transport systems planning), more energy efficient vehicles, larger shares of renewable

fuels and faster introduction of chargeable cars (de Coninck, et al., 2007). Many countries, including Canada, France, Japan, Mexico and the UK, have announced targets or plans for phasing out internal combustion engines (ICEs) (UN, 2019; Wappelhorst, 2020). Such a phase-out would effectively remove direct fossil fuel use from the passenger car system, transferring decarbonization concerns to activities further up fuel and electricity supply chains. The share of the global road transport demand met by biofuels corresponds to 2.8% in 2019 and is projected to increase to 5.4% by 2025 (IEA, 2020b). Fuel cell electric vehicles show very little growth for passenger cars (IEA, 2020a). Biofuels, including synthetic biofuels, can have anywhere from a large beneficial climate change mitigation effect, if a reduction in transport system emissions is combined with land carbon increases and low non-CO₂ emissions, to an undesirable effect, if land carbon losses outweigh any reductions in transport system emissions for a relatively long time period (Jia, et al., 2019; Smith, et al., 2019). There are also many potential co-benefits and adverse side-effects of biofuel systems (Hoegh-Guldberg, et al., 2019). Thus, the implications on mitigation and other sustainability criteria are context dependent and influenced by feedstock, management regime, soil and climate conditions, conversion technology, scale of deployment, among others (Ingrao, Bacenetti, Ioppolo, & Messineo, 2019; Jeswani, Chilvers, & Azapagic, 2020). The potential connection between increasing biofuel production and indirect land use change (ILUC) causing, e.g., biodiversity impacts and GHG emissions, is one concern that have fueled debate as well as policy development the recent decade (Berndes, Ahlgren, Borjesson, & Cowie, 2013; Khanna, Wang, Hudiburg, & Delucia, 2017; Sumfleth, Majer, & Thran, 2020; Santos, 2020).

The assumption that electric vehicles and those using alternative greener sources of fuel are better than fuel powered vehicles is largely based on their production of less waste and pollution. But this would be an incorrect way of thinking, because it would not take impacts such as production and transportation of the fuel into account. While most of the impacts of fossil fuels can be seen directly in their consumption, the majority of the impacts of electricity consumption can be traced back to its production (Rajnoha.R, Jankovsky, & Merkova, 2013). A study which utilized net present value was used to compare electric motor vehicles (EMVs) to combustion engine cars (CECs) based on purchase price, fuel costs, average annual operational costs, and discounted costs. These characteristics were then processed for the use of the vehicles for personal or professional needs. Based on current assessments, EMCs were found to have higher purchase and operational costs than CECs. This highlights how cost and operational implications will limit purchase and use in developing countries with inconsistent electricity supply and low per capita

incomes. Although in developed countries, increased demand may lead to greater production of EMVs and thus lower cost and utilization.

Many nations' governments are formulating policies and offering incentives that favor the uptake of electric vehicles as against the traditional internal combustion engines. Denmark places an 180% tax rate on internal combustion engine powered vehicles (Berman, 2013), This is aside from other incentives like free charging and city parking. There is a general belief that eradicating vehicles powered by internal combustion engines will result in a drastic drop in the emission of CO₂ gas, as the perception of electric vehicles is that they are green and clean (Nie, Ghamami, Zockaie, & Xiao, 2016). However, the contribution to greenhouse gas emissions by economic sector, as at 2010, puts the percentage contribution of the transport sector at about 14%, coming after the electricity and heat generation sectors at about 25%, agriculture, forestry, and other land use at about 24%, and the industrial sector at about 21% for direct emissions. It is, however, imperative to note that not just automobiles make up the transport sector; it also includes planes, ships, trains, and earth moving equipment. However, it is worthy of note that CO₂ emissions related to fossil fuel combustion accounted for about 65% of the global CO₂ emission values in 2010 (IPCC, 2014). In 2015, global energy generation sources showed fossil fuels accounting for about 87% of CO₂ emissions, while renewable sources such as hydropower and nuclear power accounted for about 13% (Wikipedia, 2019). Lithium-ion cells currently populate the batteries of electric vehicles. They are composed of graphite, lithium salts, and other elements (Ning, Linhao, Wenjian, & Jiahua, 2019; Zhang, et al., 2001), used due to their power density and high energy (Messan, et al., 2013).

A major finding in this study is known exposure variables related to emission/air pollution from Vehicular sources showed differing interactions in urban and rural settlements. The abnormalities in a minority of study participants (22) showed predominance in urban areas, with 81.2% of the abnormal results. This may be accounted for by the study ratio of 2:1 in favor of urban communities. Though the presence of longer transit times (with increased duration of exposure) and recorded higher vehicular density are more associated in various global studies with urban settlements. The presence of Poor Urban planning and construction of residential properties in close to roads commonly encountered in developing Sub-Saharan and Asian countries increases health risk. The inhabitants of such homes experience chronic exposure to emissions and poor air quality. Studies show a 50% decrease in PM 2.5

and ultrafine particles within 100-150 meters of a road (Hitchins, Morowska, Wolff, & Dale, 2000). A decay to background concentrations within as little 50 meters has been described for PM 2.5 mass concentrations (Tittia, et al., 2000), although PM2.5 tends to be more spatially homogenous than ultrafine particles. It is imperative to note that in relation to environmental factors discussed above, air pollution is also influenced by land use, traffic patterns and the orientation and type of buildings (Abernethy, Allen, McKendry, & Brauer, 2013). This highlights the need for effective urban planning as an additional control measure.

Various researchers globally have tried to determine reference values for children and healthy adults according to age, sex, height, and even ethnic group. Most of the commonly used reference parameters are for Caucasian (white) populations and most instruments calibrated to suit those references. Most predominantly black populations do not have specific predictive tools to determine normal Spirometry values for their populations. To eliminate significant differences between references equations, study sample sizes should minimally be 100 subjects (Jensen, Crapo, Flint, & Howell, 2002); the calculated sample size of 150 adults used in this study fulfills this requirement. Various studies have clearly shown that Europeans form a compact group that is clearly separated from African populations (Jordan, 2010). These results suggest an explanation for differences in observed FVC and FEV1 values between girls and boys in all age categories independent of sex and the European ERS-93 (Tittia, et al., 2000) standards. The values we obtained in this study are comparable and, in some cases, homogenous to values from previous studies in African Americans and African children. Studies in Nigerian schoolchildren aged 5 to 20 years have demonstrated mean FVC and FEV1 values that are significantly lower than those of their white counterparts (Olanrewaju, 1991). We therefore interpreted normal Spirometry values in this study by comparing values obtained to reference values recorded from a Nigerian study on children of both sexes (Akhiwu & Aliyu, 2017), therefore interpreting pulmonary function with an emphasis on ethnic impact as advocated by some authors. The interpretation of static lung function in children of African descent is limited due to inappropriate reference equations (Messan, et al., 2013). Before Spirometry reference equations were available for use in black individuals, reference values originally derived for white individuals (Quajer, et al., 1995) were used for black individuals by applying an adjustment factor whereby the values for white individuals were reduced by 10-15%. However, the adjustment was found to be inadequate (Scanlon & Shriver, 2010). Spirometry values for adults obtained in this study, though largely within the normal range for adults of African descent, were lower than normal values quoted globally. A large prospective study of adults in Brazil from birth to 30

years involved pulmonary function testing, FVC, and FEV1 (corrected for height and other factors) found values to be lower in males and females with a higher percentage of African ancestry (Menezes, et al., 2015).

Chronic obstructive disease findings are seen in exposure to air pollutants and are present both as short-term and long-term manifestations. The short-term effects include decreases in pulmonary function; increases in inflammatory markers and respiratory symptoms, exacerbations of chronic obstructive pulmonary disease (COPD) and infections; and increases in respiratory mortality (Lagorio, et al., 2006; Zeka, Zanobetti, & Schwartz, 2006; Barnett A. , et al., 2005). Chronic Obstructive Airway Disease (COPD) is poised to become the leading cause of death by 2030. The proximity of residential dwellings to busy roads and levels of chemical compounds known as nitrogen oxide (NO_x) and nitrogen dioxide (NO₂) in the air is related to the number of new cases of COPD and reduced lung function. Although the results were less clear on chronic bronchitis and asthma, this does not imply that poor air quality does not have an impact on these conditions (European Lung Foundation, 2019). The research showed the inhalable particles in the air (PM₁₀) to be of the greatest concern. Prevalent tricycle use and the location of homes in urban areas increase exposure to particulate emissions. A study confirmed elevated lead concentrations along the streets and doubled the lead concentrations in the blood and urine of drivers compared to controls (Tri-Tugaswati, Suzuki, Koyama, & Kawada, 1987). Recurrent motorcycle use seen in rural communities and its health effects are shown in other studies (Jimmy, Solomon, Peter, & Asuquo, 2014; Shrivastava, 2006). As the pollution from motorcycles are at least 15x more pollution per mile than larger capacity vehicles; cars and trucks (Carpenter, 2008). It is imperative that larger capacity and environmental sustainable means of transportation be provided in such communities. In a study on public health and air pollution in Asia (PAPA) stronger associations between pollutants (PM₁₀ <10 micrometers), SO₂, NO₂, ozone (O₃), and daily respiratory mortality among women, elderly and lower socioeconomic status (SES) persons were reported (Kan H. , et al., 2008).

Data accuracy is critical to data management including in effective management of transportation systems. Our results of secondary data review and analysis showed marked data disparity between the FRSC online database and manual entry logbooks was identified. Causative factors cited include; poor internet access and high turnover of data management officers. The prevalence of health effects of air pollution in Nigeria is attributable to multiple factors such as; single engine use, expended vehicles and the Harmattan in the North West (Oluwafemi, Arinola, Huo, & Olopade, 2017). The enactment and

implementation of legal statutes governing transportation and vehicular use is country specific, though with global cross cutting regulatory bodies for international transportation. With the technical problems, data and methodological constraints in developing countries (Jayasinghe, Sano, & Nishiuchi, 2015), these countries are affected with complex traffic problems. Vehicular registration needs to be updated to meet current automated methods available to ensure effectiveness of entries and ease of analysis. Real – time automatic vehicle identification based on Digital Video Recorder (DVR) play a major role in maintaining law enforcement on roads (Kasaei, Kasaei, & Monadjemi, 2009).

In Comparison to our findings obtained in West Africa, air pollution in Europe also shows poor air quality, particularly in megacities such as; Paris and London. Studies show both cities exceed European set limits for nitrogen dioxide (NO₂) with recurrent particulate matter elevations recorded in early spring and winter (Petit, et al., 2017; Macintyre, Heaviside, Neal, Agnew, Thornes, & Vardoulakis, 2016; Rouil, Bessagnet, Favez, & Garzandia, 2015). A study associated long term exposure to poor air quality with approximately 50,000 annual deaths in the United Kingdom and 55,000 annual deaths in France (Gurreiro, Gonzalez-Ortiz, de Leeuw, Viana, & Horalek, 2016). Primary emissions of nitrogen oxides (NO_x) and PM₁₀ are majorly obtained from Road transportation. Recorded inventories show: 42% (PM₁₀) and 73% (NO_x) in Paris, while values obtained for both in Île-de-France; were 28% (PM₁₀) and 61% (NO_x). Lower values of 50% were obtained for both in London (Airparif, 2016; London Atmospheric Emissions Inventory, 2017). Commonly used diesel engines encountered in this region release nitrogen monoxide (NO) and nitrogen dioxide (NO₂). Nitrogen monoxide undergoes oxidation via atmospheric reactions with ozone to form NO₂, concentrations of which are elevated proximal to roads and within urban areas. Other sources of pollutant include incomplete combustion of fuel. This generates particles with diameters <2.5 µm, non-exhaust sources produce coarse PM; which are particles >2.5 µm on roads. The identified major sources of non-exhaust emissions were; tyre wear, brake wear and resuspension (Amato, et al., 2016).

Implementation of targeted policies to reduce/control vehicular emissions has been possible in the European Union (EU), some country specific and others EU wide. European emission standards, which were introduced in 1991, have been updated over time, with changes to emission standards on new vehicles and the strengthening of exhaust emission standards. Despite these measures, a disparity is still noted between expected type-approval tests and real-world emissions. Devices used to reduce PM

emissions have not been completely effective, with after-treatment devices shown to increase NO₂ emissions (Carslaw.DC, Murrells, Anderson, & Keenan, 2016; Weiss, et al., 2012).

Various policies are functional within European countries to reduce air pollution, particularly from transportation. These include the Low Emission Zones (LEZs), which became operational in the United Kingdom in 2008 and have undergone modifications in phases. It incorporated standards for larger vans, minibuses and other specialist vehicles. All buses under transport for London met Euro IV standards in December 2015. In Paris, the introduction of LEZ using the Euro norm classification occurred in September 2015, with the banning of circulation for Euro II heavy vehicles, buses, and coaches in inner Paris. Subsequent modifications were made in 2016 and 2017, with the restrictions lasting between 8am and 8pm on weekdays. Additional pollution-reduction measures include free or reduced-cost public transportation, free residential parking, differentiated circulation based on vehicle classification, and restrictions on wood burning and industrial emissions used as emergency measures during Paris pollution episodes. In Paris, a busy road was converted to a pedestrian street in 2016 (Font, Guiseppin, Blangiardo, Ghersi, & Fuller, 2019).

In the United Kingdom (UK), buses were retrofitted with selective catalytic reduction (SCR), with LEZs introduced in 2017. Various studies have been conducted in Europe to study particulate pollutants, some at roadsides, with significant downward trends recorded in roadside PM_{2.5} in a study conducted in 2010-2014 (Font & Fuller, 2016). Findings from a study that evaluated recent trends in 2005-2016 in traffic related pollutants such as; NO₂, NO_x, PM₁₀ and PM_{2.5} in Paris and London evaluated control/regulatory policies. Results showed differing trends in both cities, with London's roads displaying a mixture of upward and downward trends in NO₂ levels in 2016. The point of introduction of interventions also affected the results, with earlier downward trends in PM₁₀ observed from 2005 (related to the earlier introduction of LEZs). Some findings were constant in both cities, such as the association of light duty vehicles, Euro II and IV heavy vehicles, and motorcycles with an increase in traffic NO₂ concentrations for the period studied (Font, Guiseppin, Blangiardo, Ghersi, & Fuller, 2019). The effectiveness of these policies requires a lower value for real-world emissions from newer vehicles compared to older ones. Motorcycles were implicated in the creation of hotspots for air pollution, probably associated with their increased number. As this type of road transportation vehicle was identified as a predominant mode of transportation in our study within rural areas, there is a need for rapid policy changes. The findings of the European study highlight the need for long term research on

air pollution and the use of serial sampling associated with linear mixed-effect modeling, which can be applied to annual average roadside increments, thus enabling determination of main traffic variables influencing trends. It will ultimately enable the ranking of traffic variables based on their importance as factors affecting pollution concentrations. The utilization of this mixed-effect approach will aid further detailed research and inform successful policy change in African countries.

Additional research in Europe and the United States (US) has identified particulate matter source profiles of fingerprints; these are the mean relative chemical composition of PM derived from a pollution source. Source profiles are usually expressed as a mass ratio between each species and the total PM. The identification of source profiles is essential for source apportionment studies that utilize receptor models (RM) (Hopke & Cohen, 2011; Belis, Karagulian, Larsen, & Hopke, 2013). Numerous developed countries have databases for source profiles of common pollutants, most notably the USA Environmental Protection Agency (EPA) SPECIATE database, which has been in existence since 1988 and now contains 3000 distinct source profiles (Simon, et al., 2010). For Europe, a free repository of source profiles; the SPECIEUROPE (2015), contains relative specie concentrations plus their associated uncertainties reported as ratios of the mass to the PM total mass. Values obtained below the detection limit (BDL) are classified as "not detected". SPECIEUROPE reports fingerprints as; composite (C), original (O), theoretical (T) and derived (D). Identification of source profiles indicative of sources from a study site or area is a critical input value for models such as the chemical balance model (CMB) and validation of attribution factors to sources in multivariate factor analysis (MFA) (Pernigotti, Belis, & Spano, 2016). The generation of a similar database and repository will aid source apportionment studies in other global regions and countries. The absence of this prevented definitive source identification of pollutants identified by our study presented in this work. A study in Europe using cluster analysis identified the heterogeneous nature of industrial source profiles and the difficulty of distinguishing road dust from soil dust. This creates a need for the development of specific markers to provide comprehensible differentiation (Belis, et al., 2015a). As our study site revealed the presence of unpaved roads and side-walks in all settlements sampled, the need to differentiate obtained silicone-containing dust by sources is crucial. However, the confounding effect of dust-laden winds also creates an additional layer of dust sources at the sites. A study which presented an overview of air quality in Europe from 2002–2011 identified the existence of a large proportion of the European population still exposed to air pollution levels in excess of the European Union (EU) standards and the World Health Organization air quality guidelines (WHO, 2001). This is in the presence of a decade's long success in legislation, with

resulting impacts on health and the ecosystem (Guerreiro, Foltescu, & de Leeuw, 2014). Air pollutants from industry, road transportation, agricultural activities, and power plants continue to be significant in Europe. This is in the presence of successful reduction of emissions of carbon monoxide (CO), sulphur dioxide (SO₂), benzene (C₆H₆), and lead (Pb).

Additionally, constant emissions are obtained from household heating demands met by use of solid fuels and biomass which release polycyclic aromatic hydrocarbons (PAHs) and particulate matter (PM). The review of 2002-2011 within EU-27 countries identified a reduction of 14% for primary PM₁₀ and 16% for PM_{2.5} within the 27 EU countries. For EEA-32 countries the reductions were 16% for PM_{2.5} and 9% for PM₁₀. For the same period, EU-countries recorded a fall in NO_x by 27% and Sulphur oxides (SO_x) by 50%. For ammonia the reduction was 7% and NMVOC 28%. Values obtained for the EEA-32 countries were reduction of; NMVOCs by 27%, NH₃ by 5%, SO_x by 34% and NO_x by 23%. As a secondary pollutant ozone is formed in the atmosphere following release of NO_x and NMVOC, while CO and CH₄ play a role in its formation at the continental level (Isaksen, et al., 2014). Ozone leads to global warming, reduction in agricultural yield via damage to plants, causes respiratory problems and leads to early death (WHO, 2013). A reduction in ozone levels was recorded in Europe 2002-2011 with; within EU-27 NMVOCs reduced by 28%, CH₄ by 15% NO_x by 27% and CO by 32%. Reductions were also recorded within EEA-32 countries for the same period. Due to dispersion of air pollutants across long distances and wide areas of land, increasing global emissions such as for CH₄ can lead to a rise in European values. This has been implicated in the increase formation of O₃ from precursors (Guerreiro, Foltescu, & de Leeuw, 2014). Significant reductions were recorded for other major pollutants such as; NO_x, NO₂, BaP, SO₂, CO, benzene and toxic metals. The study however showed not all the countries and economic sectors recorded significant reductions, as values in use are mean values. Ozone and PM still remain significant problematic pollutants within the EU.

The situation of varying socio-economic status affecting health outcomes seen within African countries and other world regions, also exist within Europe. This unequal exposure to health damaging characteristics of the environment is a factor implicated in worsening health outcomes and health inequalities (Pearce, Richardson, Mitchell, & Shortt, 2010). Multiple studies have shown socially disadvantaged groups are at higher risk and experience potentially health damaging exposures to their physical environment (Brulle & Pellow, 2006). This was highlighted in our study findings based on the socio-economic level of majority of the study participants resident in homes proximal to the source of

exposure studied. A study in Europe which investigated the contribution of environmental inequality to health inequalities at population level explored differential exposure and susceptibility to air pollution. Findings obtained from the study showed despite improving air quality in Europe, average PM₁₀ values exceeding WHO recommendations are still obtained in some regions. Prevailing East Europe-West Europe differences prevail, richer western European regions experienced higher pollution levels than lower income regions due to more commerce and wealth generating activities. Stronger relationships of ambient particulate pollution levels to mortality outcomes were recorded in Eastern Europe (Richardson, Pearce, Tunstall, Mitchell, & Shortt, 2013). This disparity between west-east Europe is enhanced by energy poverty, more prevalent in central-eastern and southern regions where combustion of low quality solid fuels such as; coal and wood for heating leads to high exposure of low income populations to PM and PAHs (EEA, 2020).

Identified disparities in Europe are similar to that seen in developing countries, a study that reviewed forty years of improvement in European air quality revealed encouraging findings in the power sector. The manufacturing and power sectors showed increased fuel consumption coupled with a shift towards cleaner energy sources; from coal related to gas. This is also supported by implementation of fuel quality directives which regulate sulfur content and end-of-pipe emissions control. The implementation of abatement measures based on EURO standards for vehicles including use of cleaner fuel sources (with lower S content), shift from petrol to diesel passenger cars (more particles/NO_x and less CO) has reduced transport sector emissions despite recorded increase in traffic volumes (Crippa, et al., 2016). This success in attaining reduction in values is largely attributable to designation of air pollution by the European commission (EC) as the most important environmental risk to human health, and the second significant environmental issue behind climate change (European Commission, 2017). Another review of particulate matter air pollution across Europe for 2006-2019 also showed reduction in particulate pollution over the time period. Recorded PM₁₀ and PM_{2.5} concentrations in Europe declined by 36.5 and 39.1% for the time period. A decrease in the number of people exposed to PM_{2.5} varied from 91.0% in 2006 to 53.6% in 2019. For PM₁₀ the exposure to levels exceeding the stipulated WHO thresholds fell from 78.3% in 2006 to 28.4% in 2019 (Beloconi & Vounatsou, 2021). However, it's worthy to note that the accuracy of analysis output is dependent on input values for PM obtained from monitoring stations. As, any change in the number or sites of the stations will introduce variability. The absence of widespread monitoring stations/sites in all localities, particularly within our study area in West Africa prevented a trend analysis based on regularly obtained PM values.

Within European countries with widespread availability of regular monitoring data on pollutants, the impact of legislation on the abatement of particular pollutants can be analyzed. To achieve this various methods are utilized including changes in overall pollutant output over time. It involves a comparison of values from a baseline year (with the earliest data) followed over time and its subsequent relation to existing abatement efforts. To achieve a “level assessment” the total output obtained can be divided or stratified into sector specific values and analyzed thus. This enables an identification of sectors contributing the highest to the pollutant and a sector specific evaluation of abatement efforts. Those contributing >80% in any year are the usual focus of additional abatement measures. A second approach has also proven effective in assessment within Europe; the “trend assessment” weighs the trend of a specific sector contributing pollutants versus the trend of the total inventory. It is useful in situations where there is a disparity between average pollutant output and direction of production obtained from a specific sector (EMEP/EEA, 2016). Both these approaches if implemented in our study site in the presence of adequate input values can aid in monitoring placed abatement methods and tracking sector specific contributions to overall pollutant values obtained. Various control measures in the EU are targeted at ambient concentrations of air pollutants and modification of ceilings and threshold values. Tools in use within Europe to prevent and mitigate air pollution include; the national emission ceilings directive (NECD) and the air quality directives (AQD). Other used agreements include; the Gothenburg Protocol which has ceilings for NO_x, NMVOCs, NH₃ and SO₂ for up to 2020 and beyond (European Parliament and the Council, 2001; European Parliament and the Council, 2001; UNECE, 2020). The European Union’s new clean Air Policy Package (CAPP) established in 2013 outlined legislation till 2020 with the aim of strengthening cutbacks on emissions to improve air quality till 2030 (European Commission, 2013). To ensure continuous selection and implementation of effective control measures, cost benefit and cost effectiveness analysis are performed within developing countries. Cost effectiveness analysis aim to identify pollution strategies that are most effective in delivering a given benefit (in this case reduction of any specific outcome of exposure to the air pollutants). The cost-benefit analysis compares the benefits of actions to reduce environmental burdens against their costs. It involves a complete assessment of all possible impacts to prevent underestimation. The use of both these methods enables the keeping of concentration-response functions (CRF) to a minimum to ensure attainment and effective resource distribution for mitigation strategies (WHO Regional Office for Europe, 2013). The availability of modelling studies in Europe like the integrated assessment model has aided the calculation

of PM concentrations and estimation of their compliance with international limits. Due to changing meteorological conditions and dust episodes PM concentrations are prone to annual and inter-annual variability (Kiese Wetter, et al., 2014). This variability also varies with seasons, as our study in Northern Nigeria shows, the dust during the dry season compounds values and characteristics of PM obtained at the sites sampled.

Recorded roadside concentrations of PM are typically a few $\mu\text{g m}^{-3}$ greater than concentrations seen in the ambient urban air (Stedman, Kent, Grice, Bush, & Derwent, 2007). Measures to reduce emissions from road transportation are ongoing daily in France, as within an estimated 71% of the health burden related to transportation is attributed to on-road vehicles transportation (Anenberg, Miller, Henze, & Minjares, 2019). Various cities around the world and in Europe have implemented urban vehicle access regulations aimed at reducing congestion and traffic-related pollution. The city of London operates a citywide LEZ for Lorries and other vehicles over 3.5 tons and a separate Ultra Low Emission Zone (ULEZ) in the city center for all vehicles. For driver or vehicle to access the ULEZ, they must meet the minimum Euro 4 standard for petrol and Euro 6 for diesel vehicles. In the case of non-compliance a daily fee of £12.50 must be paid (Wappelhorst & Muncrief, 2019). LEZs is a form of urban vehicle access regulation, it limits vehicle access to a defined geographic area e.g., a city center or metropolitan area based on certification level or vehicle emissions performance. LEZs aim to reduce traffic related air pollution exposure, particularly from fine particles PM_{2.5}, NO₂ and precursors to secondary ozone and PM_{2.5}. The design of an effective LEZ includes; affected vehicle types, geographic boundary, an implementation schedule, minimum certification criteria and emissions performance, operating times, exempted vehicle categories, enforcement methods and terms of access such as; usage charges for non-compliant vehicles or bans and penalties (Bernard, Miller, Wappelhorst, & Braun, 2020). Within France LEZs came into effect in September 2015 and use the national Air quality certificate (CRIT 'Air) applied to all on-road vehicles.

Our findings of a significant association between exposure to air pollutants and human health, as shown in cytotoxicity assessment results and quantitative studies, are mirrored in other cities. A pioneering European study explored premature mortality in adults ≥ 20 years due to air pollution in European cities as a means of health impact assessment (HIA). The study used an estimate of the annual premature mortality burden that could be avoided if the WHO recommended values (i.e., 10 $\mu\text{g m}^{-3}$ for PM_{2.5} and 40 $\mu\text{g m}^{-3}$ for NO₂) were met in the presence of air pollution concentrations that were at their lowest in

European cities in 2015. The results showed a considerable proportion of premature deaths were avoidable by lowering air pollution levels below WHO guidelines. Variability in mortality burdens was also identified between European cities, up to 15% for PM 2.5 and 7% for NO_x in the cities with the highest recorded pollution values. The estimated average preventable mortality for PM 2.5 in the cities was higher than in the EU region. The highest preventable mortality was noted in cities with the highest pollution levels, consistent with the highest positive correlation between air pollution concentrations and estimated preventable mortality for PM_{2.5} and NO_x (Khomenko, et al., 2021). There is a need for further city-level studies in Nigeria to obtain an impact assessment of air pollutants on morbidity and mortality, to enable the design and implementation of control measures for preventable morbidity and mortality. The EU identifies seven main air pollutants; ammonia (NH₃), nitrogen oxides (NO_x), carbon monoxide (CO), particulate matter with a diameter of less than 2.5mm and 10µm (PM 2.5 and PM₁₀), sulfur oxides (SO_x), tropospheric ozone (O₃) and non-methane volatile organic compounds (NMVOCs) (Koolen & Rothenberg, 2019).

Within cities where 74% of the EU population resides (EU, 2016), PM_{2.5} and ground level O₃ potentially exert the most significant effects on human health seen as respiratory, cardiovascular diseases and mortality (Pascal, et al., 2013; WHO, 2013). The official national values of the main air pollutants are obtained in Europe through the Center on Emission Inventories and Projections (CEIP) under the European Monitoring and Evaluation Program (EMEP) (Amoatey, Sicard, De Marco, & Khaniabadi, 2019a). A study on decades of urban population exposure to air pollution for 2000 and 2017, recorded within the EU-28, found a fall for SO_x by 80%, NMVOCs: 44%, NH₃: 10%, NO_x: 46%, CO: 49%, PM₁₀: 29% and PM_{2.5} by 31%. The recorded reduction confirms the effectiveness of existing control strategies for air pollutants, despite the levels of air pollutants in some cities still exceeding EU standards and WHO AQG for human health (EEA, 2018a; Guerreiro, Foltescu, & de Leeuw, 2014; Sicard, Khaniabadi, Perez, Gualtieri.M, & De Marco, 2019).

Strengthening of legislation and utilization of newer cleaner technologies are shown to improve air quality. Legislative and technological measures have therefore led to a reduction of aerosol mass in Europe, which is beneficial for the climate and human health. A comparison of changes in aerosol concentrations obtained due to specific air quality mitigation measures against aerosol concentrations that occurred from 1970–2009 using a model simulated by Turnock et al. (2015) showed mitigation measures accounting for 29% of PM_{2.5} reductions (Turnock & al, 2015). A study estimated that the

improvement in health from implementing air pollution mitigation measures in Europe resulted in a perceived economic benefit to society of US \$232 billion across the EU (Turnock, et al., 2016), thus highlighting the cost-benefit of mitigation as a preventive measure for air pollution. The application of similar mitigation strategies within Nigeria and its regions will therefore free resources for use in addressing conflicting health priorities in human health and protecting the environment. The economic gain will exceed the amount in Europe and, cumulated over time, can serve to improve the economic status of the populace.

The persistence of urgent conflicting priorities in the developing country's landscape has continually limited the restrictions or upgrades of pollution sources and control. A study showed that these upgrades can be strenuous to enforce as they are not in line with the state's paradigms (Aliyu & Botai, 2018). Due to these limitations, the use of pollution hotspot-based spatial monitoring systems (Liang, et al., 2014) can limit cost and provide further information on the mechanisms involved in the relationship between particle pollution and health in resource constrained countries. Nigeria's upwardly mobile and productive sub-set of the population (youth) has existing transportation needs that are largely unfulfilled by the existing transport structure. This is due to unmatched growth in transport facilities (Ogunbodede, 2008). Despite adequate knowledge of air pollution sources, regulatory agencies were perceived as not fully implementing Acceptable Standards on Vehicular Emission Levels.

Recommendations

Our recommendations are targeted to address, mitigate, and improve specific consequences of the results obtained in this study. Effective and sustainable transportation is related to multiple sustainable development goals within the 2030 agenda for sustainable development adopted in 2015 by all United Nations member states. The goals directly related to transportation include: good health and well-being (Goal 3), affordable and clean energy (Goal 7), industry, innovation and infrastructure (Goal 9), sustainable cities and communities (Goal 11), climate action (Goal 13) and partnerships to achieve the goals (Goal 17).

Our recommendations aim to: improve energy efficiency and reduce vehicular emissions; improve accessibility and sustainable road infrastructure; reduce environmental damage; and ensure road safety and human health. To achieve a reduction in emissions from road transportation vehicles, we recommend setting up vehicle emission standards and suitable inspection and testing of all vehicles. Vehicular testing can occur at the point of sale, point of entry into the country, or in-service testing to ensure conformity to safe emissions values. Strengthening of partnerships between regulatory agencies such as the FRSC and national and international organizations will enable us to achieve this, as critical materials and supplies will be obtained. Additionally, collaboration provides access to training in the use of devices such as PEMs that can be used directly on the field or roads and are easy to operate by regulatory officers. Vehicle emission standards should be set based on the maximum level of exposure at which the great majority of people, even in sensitive groups, would not be expected to experience any adverse effects. Many users simply interpreted these guidelines' values as if they were recommended standards, which pollution levels should not be allowed to exceed. If there is no such threshold, no single guideline value can be provided by WHO. However, guideline values are not meant to be converted into standards without giving any consideration to prevailing exposure levels or the economic and social context. If applied correctly, the new guidelines should help provide the basis for more appropriate and locally grounded standards for the specific country concerned. It should, however, be accepted that most guidelines currently in existence are based on studies and testing done in developed countries and may not directly translate to the development country landscape. As Nigeria is a middle-income country as classified by the World Bank, certain factors must be considered when developing emission standards and guidelines for use.

These factors include the different chemical composition of the particles. The mixture of particles in the communities studied is dominated by emissions from motor vehicles, mesh fibres from construction sites, and a large volume of natural pollutants from the prevailing "harmattan dust". Therefore, reduction/control measures should aim to reduce open quarry activities accountable for zirconium values seen, use of trees to provide cover against the dust and interrupt particulate pollutant dispersion, and utilization of cleaner sources of energy as opposed to the prevailing use of petroleum products.

Additionally, the concentration range may be substantially different. The WHO response–concentration relationships for particulate matter are based on a linear model of response within the range of particulate concentrations typically found in the studies used by WHO and obtained from western countries. There is no basis for simple extrapolation of the concentration–exposure relationship to high levels of particulate pollution. The slope of the regression line is reduced when the concentration of particulates is at high concentration levels. These levels may be observed in urban areas in some highly polluted cities in middle-income countries such as Nigeria. Therefore, site-specific studies to obtain the actual concentration of specific pollutants are necessary. Our study focused on a qualitative assessment only. This we recommend be used as a guide to plan future studies and time series assessment of concentration values in the study area and other parts of the country to enable the development of fact-based and country-applicable standards. Population responsiveness also differs as, in contrast to developed countries, the populations exposed to higher concentrations of particles in less affluent countries may have a lower level of quality in both nutrition and healthcare. The identified dust storms in the area studied are a major confounding factor and must be considered when setting up standards. A review of the meteorological conditions and seasonal trends will ensure adequate planning and necessary modifications are utilized when implementing and monitoring standards. National air pollution standards should be developed to support local air pollution management and resolve inter-jurisdictional air pollution problems. Fuel taxes and subsidies must be designed to reflect air pollution contributions. The federal government should also provide expertise and guidance not available locally, especially in smaller urban centers and rural communities. They should also provide local authorities with the fiscal, legal, and institutional basis for taking action on air pollution locally.

The development of vehicle import regulations at both regional and national levels based on vehicle age, mileage, or emissions is also recommended. Our results identified a high average age of vehicles in use in the study area, largely attributable to the high influx of second-hand vehicles into the country. These used vehicles come with high mileage and usually do not undergo effective emissions testing before being used. This, combined with the findings of the current vehicle maintenance culture, necessitates the development and implementation of newer, more targeted, and more effective regulations. The adoption of cleaner fuels as an energy source is a key recommendation made, especially low-sulphur fuels. The reduction of sulphur and organic toxic content and the elimination of lead from the relevant petroleum products, taxes on high polluting fuels (e.g. coal), the introduction of low polluting fuels (e.g. liquefied petroleum gas and compressed natural gas) and increased use of locally applicable renewable energy can reduce emissions. Alternative fuel sources such as biofuels are a feasible alternative and, coupled with the abundance of natural sunlight (solar energy), can be gradually introduced as cleaner alternatives. Though a large number of our study respondents indicated a willingness to utilize alternative energy sources, the financial cost and existence of competing priorities warrant a phased introduction, starting with affordable sources of clean energy. In order to enable the development of a state and national level policy to improve fuel economy, we recommend the following measures in addition to the measures above. Also recommended is the designing and conduct of a state and country level fuel economy analysis to generate evidence-based data for action.

The achievement of sustainable transportation requires the development of an effective and feasible national policy. To achieve this, there is a need to review and, in some instances, modify the existing predominant means of transportation. Our findings highlighted the practice of using three-wheeled petroleum-fuelled vehicles as the commonest means of transportation in urban areas and motorcycles in rural areas. These means of road transportation, coupled with the population size in the state and country, result in a large and ever increasing vehicle fleet. Our recommendations to address this include increasing investments in mass transport systems and making provision for pedestrian and bicycle travel to reduce the use of polluting vehicles. As large capacity vehicles carry more people, they decongest traffic and, in cases where they are powered by alternative fuel sources, directly decrease point source pollution. Additionally, further traffic demand management can reduce congestion in city centres, thereby reducing emissions. More recommendations are to ensure

mandatory vehicle inspection and maintenance, retrofits, programs to remove the most polluting vehicles and emissions standards for new vehicles.

The predilection to using cars as a favoured transport option partly results from a lack of adequate road infrastructure for use of other options, such as bicycles. However, inadequate knowledge of the health effects of cycling is also a factor. The development of integrated transport plans that focus on multi-modal transportation will tackle this problem. as it will provide options such as bicycle loan schemes, waivers on parking charges and other incentives to attract users to other less polluting transportation modes. State and national assessments will aid in the creation and implementation of national policies on mass transportation. The establishment of connecting train, tram, and bus networks with effective data harmonization and clear schedules will be an effective means of emissions control. Urbanization and its associated increased demand for housing has resulted in an encroachment of residential buildings into previously designated industrial areas. To address this a range of tools can be applied to limit urban sprawl and promote mixed land uses, while also ensuring that polluting activities are located in areas least likely to result in human exposure. These tools include land use zoning as well as public infrastructure investment. As land use planning is typically dominated by other concerns, this requires working closely with government departments for whom public health and environmental protection are not principal responsibilities. Our recommendation is therefore increased inter-agency collaboration to ensure effective urban planning and location of residences at a safe distance from emission sources (Vehicular and industrial). Our results also revealed a location of residences in all communities less than the recommended safe distance of 100-150 meters from points of vehicular emission.

Dedicated institutions for road safety are an integral part of traffic management. The existing FRSC in Nigeria has a national span, with offices in every state and LGA in the country. However, it is plagued by resource inadequacies and supply shortages, which justify our next recommendation. We recommend the allocation by the government of adequate funding to ensure effective operation and management of the dedicated institution for road transport and safety management. In addition, there should be increased training of personnel on developments and advances in traffic management, regulation, and control to ensure efficacy. An identified outcome of the secondary data review of road transportation data is data management issues ranging from entry to analysis. Ensuring a comprehensive data collection and reporting mechanism on road safety incidents and trends, traffic

volume, traffic flow, and use of satellite imaging for forecasting are essential recommendations to improve the current situation. To achieve this, the regulatory agency should collect information to create baselines, monitor progress (including in priority action areas) and share best practices with relevant partner agencies. Such best practices include, but are not limited to; road fatalities and injuries; air quality; health impacts of poor air quality; and motorized and non-motorized transport infrastructure. Improvement for all stakeholders and continually generating awareness is also essential and should be ensured. Some proponents of source elimination recommend adoption of a non-motorized transport policy, especially in middle and low-income countries with large and expanding mobile youth populations. This recommendation will remove a large volume of motorized vehicles from the roads at a point or period in time, as pedestrians will access locations on foot or in water-bordered or traversed areas by boats or canoes. To achieve this, there is a need to develop and design a non-motorized transport policy, ensure its implementation, and also monitor its effect on emission levels.

There are existing guidelines developed in regions and globally to ensure road safety, such as the African Plan for the Decade of Action for Road Safety and those by the Partnership for Clean Fuels and Vehicles (PCFV), which are targeted at middle and low income countries. Continued participation and conformity to these globally developed and tested guidelines will aid in the achievement of emission control targets. It is imperative to acknowledge that vehicular emission control measures and air pollution standards require constant enforcement and not solely monitoring, as difficulty may be encountered in identifying major pollution sources and devising measures to reduce them at the source. A key recommendation is for comprehensive action utilizing a systemic approach, with clear policy objectives and regional and other comprehensive plans, including clear allocation of responsibilities, targets, milestones, reviews and continuous improvement initiatives.

To ensure a reduction/mitigation of the health effects identified via clinical respiratory examination and in vitro testing in our study. Recommendations are made to intensify public information and health warnings regarding emissions and pollution. In cities where air pollution is severe, public information systems can be used to warn local residents of severe pollution episodes, trigger pollution control measures, and, perhaps most importantly in the long run, increase public awareness of air pollution problems. Compulsory public disclosure aims to inform the community about the activities, emissions, discharges, and policies of organizations. The generalized dissemination of this

study's findings will aid in behaviour change modification and strengthen use of personal protective equipment, particularly in communities and during periods of dust storms and high force winds. Successful achievement of public information and health warnings relies on the recognition of good performers and the public shaming of poor performers as drivers that improve environmental performance. Examples of the effectiveness of ensuring accountability via public declarations have been seen in the United States, where the Emergency Planning and Community Right to Know Act is in use. The US Environmental Protection Agency (EPA)'s toxic release inventory is regarded as one of its most efficient and effective instruments.

Increased focused research involving prospective cohort studies will produce additional findings on the long-term health consequences of recurrent near-field exposure to traffic-related emissions. There need to be additional studies, preferably time series and mapping studies, to study these emissions. This requires the setting up of emission monitoring stations, sites for assessment and the use of weather research forecasting as a predictive tool. Additional studies should seek to obtain both qualitative and quantitative values for specific emission substances at multiple sites and during different traffic flow rates to facilitate targeted control strategies and effective monitoring. The role of effective stakeholder collaboration in health, the environment, transportation, and other related fields is essential to evidence-based research.

Although this study focused on emissions from road transportation vehicles, the incidental identification of mixed settlements consisting of both residential and industrial components necessitates addressing possible recommendations to reduce industrial emissions. Industrial pollution should be addressed directly through emissions standards and obligatory environmental and health impact statements. These should be backed up by inspections and appropriate enforcement procedures. In some settings, emissions trading systems can be put in place to help ensure that the least costly measures are selected. Where this is not feasible, co-regulation and other means of negotiating cost-effective improvements are likely to be needed. The promotion of clean technologies and special programmes for small and medium-sized enterprises can help reduce the cost of reducing emissions.

Conclusion

Our study identified a predominance of PM_{2.5} particles in all sampled sites, indicating the presence of persisting significant exposure to adverse health effects from the dominant pollution sources, e.g., road vehicles. Mixed settlements, with a combination of vehicular and industrial sources of pollution, revealed the largest proportion of PM_{2.5} particles. This, coupled with the proximity of residences and households to road traffic sites, indicates a lack of adequate zoning and planning of residential areas. PM₁₀ values, although lower than recorded PM_{2.5}, are indicative of the dual risk to humans from various particle sizes. Despite lower cytotoxicity values being obtained in non-mixed settlements (urban and rural), this evidence shows that all settlements experience unwanted particulate pollution. Existing silica and aluminum silicone laden dust pollution, though limited by season, serves as a confounding factor and worsens air quality. The presence of a significant proportion of morphological fibrillar particles with known toxicity, also proven by our findings, here highlights a neglect of mitigating strategies for long-term respiratory and other chronic diseases. Non-communicable diseases from environmental exposure contribute to the burden of diseases in developing countries undergoing epidemiological transitions and changes in disease prevalence.

The presence of minimal elemental variability, except for some elements such as zirconium, emphasizes a possible similarity of pollution sources. This study provides a preliminary characterization of PM pollution and the role of natural pollution sources in Kano State, representative of expanding urban areas in Nigeria. The results support the need for improvement in traffic monitoring at multiple sites; further testing to identify emission profiles by point of origin, e.g., exhaust or non-exhaust; and the setting up of air quality monitoring stations to assess and manage safe levels. A further assessment of the concentration of these particles, possibly in a long-term study, will provide sufficient data to generate a trend analysis of particulate pollution in these sites. However, an identified limitation to our study is the absence of existing monitoring data to enable a comparison of particle profiles and constituents for similar periods in the year and peak traffic flow times similar to those utilized for this study. Recommendations made to stakeholders based on the results obtained will highlight the importance and effectiveness of future modelling on the impact of different particle types. Based on the findings obtained here, this can occur as a follow-up study or via implementation strategies and pathways aimed at tackling pollution through inter-sectoral collaboration. Stakeholder agencies such as

health, transportation, and the environment can expand on this to provide a wider vision and strengthen future research partnerships and mitigation strategies. Proven cytotoxicity using different assessment methods in vitro will prove critical to informing behavioural change regarding the location of residences and residential planning protocols. Use of alternative fuel sources, i.e., greener sources of energy, will reduce emissions from the predominant use of petroleum products as a source of fuel. This will ultimately reduce particulate pollution, improving air quality and thus protecting human health and safety.

Increasing urbanization and vehicular ownership in emerging global economies and sub-Saharan African nations has yielded a low air quality index. This, coupled with a reliance on petroleum products as a major source of fuel, has maintained exposure, especially of the lower classes, to negative health effects. Various studies have shown the disproportionate effect of environmental exposure across income levels on health. Though this study did not investigate income levels, the present average per capita income in Nigeria and the occupational spectra of the respondents indicate their possible income strata. The location of residential houses proximal to highways and roads has been proven by studies to worsen respiratory health at distances ≤ 50 meters, with effects seen up to 100-150 meters from exposure points. This study showed all households are located within a hazardous distance. This study highlights the need for further investigation into the mineralo-pathology and cellular cytotoxicity of the particulate air pollutants residents are exposed to daily. There is also a need for increased health education, the implementation of standardized sustainable urban planning, and further evidenced based research.

Bibliography

- Abas, M., & Martinez-Botas, R. (2015). *Engine operational benefits with cylinder deactivation in Malaysian urban driving conditions*. SAE Technical Paper 2015-01-0983.
- Abernethy, R., Allen, R., McKendry, I., & Brauer, M. (2013). A Land use regression model for ultrafine particles in Vancouver, Canada. *Environ. Sci. Technol*(47), 5217-5225.
- Adachi, K., & Tainosho, Y. (2004). Characterization of heavy metal particles embedded in tire dust. *Environ.Int*(30), 1009-1017.
- Adams, A., Prospero, J., & Zhang, C. (2012). CALIPSO-derived three-dimensional structure of aerosol over the Atlantic basin and adjacent continents. *J.Climate*, 6862-6879.
- Adedokun, J., Emofurieta, W., & Adedeji, O. (1989). Physical mineralogical and chemical properties of harmattan dust in Ile-Ife, Nigeria. *Theor Appl Climatol*(40), 161-169.
- Adefolalu, D. (1984). On bio-climatological aspects of Hramattan dust haze in Nigeria. *Archives of Metereology, geophysics and bioclimatology, Series B*, 33, 387-404.
- Adeyanju, A., & Manohar, K. (2017). Effects of Vehicular Emissions on Environmental Pollution in Lagos. *Science Afric Journal of Scientific Issues, Research and Essays*(5), 34-51.
- Aguilera, F., Mendez, J., Pasaro, E., & Laffon, B. (2010). Review on the effects of exposure to spilled oil on human health. *J. Appl. Toxicol*(30), 291-301.
- Aguzzi, A., & O'connor, T. (2010). Protein aggregation diseases: Pathogenicity and therapeutic perspective. *Nat.Rev.Drug Discov*(9), 237-248.
- (2018). *Air Quality*. Health and environmental alliance HEAL. Consulté le November 15, 2020, sur Health and Environment Alliance (HEAL): <https://www.env-health.org/issues/air-quality>
- Airparif. (2016). *Inventaire regional des emissions en ile-de-France Annee de reference 2012-elements synthetiques*. Paris: AIRPARIF, 7 rue Crillon 75004.
- Aizebeokhai, A. (2009). Global warming and climate change: Realities, uncertainties and measures. *Int J Phys Sci*, 4(13), 868-879.
- Ajayi, V. (2021). Dust over West Africa. *Seminar, Federal Univeristy of Technology, Nigeria*. Abuja, Nigeria: Nigerian Meteorological Agency (NIMET).
- Ajibola, V., & Ladipo, M. (2011). Sediment quality of effluent discharge channels from six industrial sites in Lagos, Nigeria. *Int.J.Environ.Res*(5), 901-908.
- Akani, N., & Obire, O. (2014). Bacterial populations of *Clarias garipinus* (Burchell 1822) exposed to an oil field wastewater in Rivers State, Nigeria. *Asian J.Biol.Sci*(7), 208-216.
- Akhiwu, O., & Aliyu, I. (2017). Spirometric values in healthy Nigerian School Children Aged 6-11. *Journal of Advances in Medicine and Medical Research. Previously known as British Journal of Medicine and Medical Research*, 22(9), 1-8.
- Akinlade, G., Olaniyi, H., Olise, F., Owoade, O., Almeida, S., Almeida-Silva, M., & Hopke, P. (2015). Spatial and temporal variations of the particulate size distribution and chemical composition over Ibadan, Nigeria. *Environ.Monit.Assess.*(187), 544.
- Akyuz, & Cabuk. (2009). Meteorological variations of PM_{2.5}/PM₁₀ concentrations and particle-associated polycyclic aromatic hydrocarbons in the atmospheric environment of Zonguldak, Turkey. *Journal of Hazard Material*, 170(1), 13-21.
- Albanese, S., De Vivo, S., Lima, A., & Cicchella, D. (2007). Geochemical background and baseline values of toxic elements in stream sediments of Campania region (Italy). *J.Geochem.Explor*(93), 21-34.
- Albani, S., & Mahowald, N. (2019). Paleodust insights into dust impacts on climate. *J.Climate*(32), 7897-7913.
- Aldhaif, A., Lopez, D., & Sorooshian, A. (2020). Sources, frequency, and chemical nature of dust events impacting the United States East Coast. *Atmos.Environ*(231), 117456.
- Aliyu, Y., & Botai, J. (2018). An Exposure Appraisal of Outdoor Air Pollution on the Respiratory Well-being of a Developing City Population. *J.Epidemiolo Glob Health*, 8(1-2), 91-100.

- Alonzi, T., Lazzaro, D., Costa, P., Probert, L., Kollias, G., De Benedetti, F., . . . Ciliberto, G. (1998). Interleukin-6 is required for the development of collagen-induced arthritis. *J Exp Med*(187), 461-468.
- Amato, F., Cassee, F. d., Gehrig, H., Gustaffson, M., Hafner, W., Harrison, R., . . . Querol, X. (2014b). Urban Air Quality: The challenge of traffic non-exhaust emissions. *J.Hazard Mater*(275), 31-36.
- Amato, F., Favez, O., Pandolfi, M., Alastuey, A., Querol, X., Moukhtar, S., & Sciare, J. (2016). Traffic induced particle resuspension in Paris: Emissions and source contributions. *Atmos.Environ*, 114-124.
- Amato, F., Pandolfi, M., Escrig, X., Querol, A., Alastuey, A., Perez, N., & Hopke, P. (2009). Quantifying road dust resuspension in urban environment by Multilinear Engine: A comparison with PMF2. *Atmospheric Environment*(43), 2770-2780.
- Amoatey, P., Sicard, P., De Marco, A., & Khaniabadi, Y. (2019a). Human health risk assessment of long-term exposures to PM2.5 in Rome, Italy. *Clin. Epidemiol Glob Health*(7), 222-227.
- Ana, G., Odeshi, T., Sridhar, M., & Ige, M. (2014). Outdoor respirable particulate matter and the lung function status of residents of selected communities in Ibadan, Nigeria. *Perspect.Public Health*(134), 169-175.
- Anderson, J., Mamakos, A., Giechaskiel, B., Carriero, M., & Martini, G. (2010). Particle measurement programme (PMP) heavy-duty inter-laboratory correlation exercise (ILCE_HD). Final Report. *JRC Scientific and Technical Report*, EUR 24561.
- Andreas, E., Edson, J., & Smith, S. (1995). The spray contribution to net evaporation from the sea: A review of recent progress. *BoLMe*(72), 3-52.
- Andrew, D., Peter, G., Beukes, J., Josipovic, M., Hendriks, J., Vakkari, V., & Laakso, L. (2017). Atmospheric trace metals measured at a regional background site (Welgegund) in South Africa. *Atmos.Chem.Phys*(17), 4251-4263.
- Anenberg, S., Miller, J., Henze, D., & Minjares, R. (2019). *Health impacts of air pollution from transportation sources in Paris (2019), Fact Sheet: Europe*. Paris: theicct.
- Anifowose, B. (2008). Assessing the impact of Oil and Gas Transport on Nigeria's Environment. *U21 Postgraduate Research Conference Proceedings 1*. Birmingham United Kingdom: University of Birmingham.
- Annesi-Maesano, I., Forastiere, F., Balmes, J., Garcia, E., Harkema, J., Holgate, S., . . . al, e. (2012). The clear and persistent impact of air pollution on chronic respiratory diseases: A call for interventions. *Eur.Respir.J*(18), 2002981.
- Ansari, M., & Ehrampoush, M. (2019). Meteorological correlates and AirQ+health risk assessment of ambient fine particulate matter in Tehran, Iran. *Environ.Res*(170), 141-150.
- Anthony, J., Anderson, J., Maginn, E., & Brennecke, J. (2005). Anion effects of gas solubility in ionic liquids. *Journal of Physics Chemistry Biology*(109), 6366-6374.
- Armitage, S., Bristow, C., & Drake, N. (2015). West African monsoon dynamics inferred from abrupt fluctuations of Lake Mega-Chad. *Proc.Natl.Acad.Sci*(112), 8543-8548.
- Artinano, B., Salvador, P., Alonso, D., Querol, X., & Alastuey, A. (2003). Anthropogenic and natural influence on the PM10 and PM2.5 aerosol in Madrid (Spain). Analysis of high concentration episodes. *Environ Pollution*(125), 453-465.
- Ashrafur Rahman, S., Masjuki, H., Kalam, M., Abedin, A., & Imtenan, S. (2014). Effect of idling on fuel consumption and emissions of a diesel fueled by jatropha biodiesel blends. *Journal of Cleaner Production*(69), 208-215.
- Atalay, H., Celik, A., & Ayaz, F. (2018). Investigation of genotoxic and apoptotic effects of zirconium oxide nanoparticles (20nm) on L929 mouse fibroblast cell line. *Chem.Biol.Interact*(296), 98-104.
- Atsumi, T., Singh, R., & Sabharwal, L. a. (2014). Inflammation amplifier, a new paradigm in cancer biology. *Cancer Res*(74), 8.
- Automation. (2017). Combustion engines with CO2-avoiding fuel. (2).

- Azemsha, S., Kapski, D., & Pegin, P. (2018). A method for assessing the automobilization impact on population morbidity. *Thirteenth International Conference on organization and Traffic safety Mangament in Large cities (SPboTSIC 2018)*. 36, pp. 18-24. St.Petersburg: Transportation Research Procedia.
- Badr, T., & Mabrouki, A. F. (2015). Sustainable Road Transport in Developed and Developing Countries: Framework and Future Research. *International Journal of Engineering Research and Technology (IJERT)*(4), 08.
- Barett, K., Barman, S., Brooks, H., & Yuan, J. (2019). *Ganong's Review of Medical Physiology* (éd. 26th Edition). London, London, United Kingdom: McGraw-Hill Education, 338 Euston Road.
- Barnaba, F., & Gobbi, G. (2004). Aerosol seasonal variability over the mediterranean region and realtive impact of maritime, continental and Saharan dust particiles over the basin from MODIS data in the year 2001. *Atmos.Chem.Phys*(4), 2367-2391.
- Barnett, A., Williams, G., Schwartz, J., Best, T., & Neller, A. (2012). The effects of air pollution on hospitalizations for cardiovascular disease in elderly people in Australian and New Zealand cities. *Environmental Health Perspectives*, 120(5), 1018-1023.
- Barnett, A., Williams, G., Schwartz, j., Neller, A., Best, T., Petroeschevsky, A., & Simpson, R. (2005). Air pollution and child respiratory health: A case crossover study in Australia and New Zealand. *Am.J.Respir.Crit.Care.Med*(171), 1272-1278.
- Basart, S., Pay, M., Jorba, O., Perez, C., Jimenez-Guerrero, P., Schulz, M., & Baldasano, J. (2012). Aerosols in the CALIOPE air quality modelling system: evaluation and analysis of PM levels, optical depths and chemical composition over Europe. *Atmos.Chem,Phys*(12), 3363-3392.
- Basha, S., & Raja Gopal, K. (2012). A review of the effects of catalyst and additives on biodiesel production, performance, combustion and emission characteristics. *Renew.Sustain.Energy.Rev*(16), 711-717.
- Bauer, S., Balkanski, Y., Schulz, M., Hauglustaine, D., & Dentener, F. (2004). Global modeling of heterogenous chemistry on mineral aerosol surfaces: influence on tropospheric ozone chemistry and comparism to observations. *Journal of Geophysical Research*(109), D02304.
- Belis, C., Karagulian, F., Amato, F., Almeida, M., Artaxo, P., Beddows, D., . . . al, e. (2015a). A new methodology to assess the performance and uncertainty of source apportionement methods II: The results of two European intercomparism exerciscs. *Atmos.Environ*(123), 240-250.
- Belis, C., Karagulian, F., Larsen, B., & Hopke, P. (2013). Critical review and meta-analysis of ambient particulate matter source apportionement using receptor models in Europe. *Atmos. Environ*(69), 94-108.
- Beloconi, A., & Vounatsou. (2021). Substantial Reduction in Particulate Matter Air Pollution across Europe during 2006-2019: A Spatiotemporal Modeling Analysis. *Environ.Sci.Technol*(55), 15505-15518.
- Ben-Ami, Y., Koren, I., Artaxo, P., Martin, S., & Andrea, M. (2010). Transport of North African dust from the Bodele depression to the Amazon basin: A case study. *Atmos.Chem.Phys*(10), 7533-7544.
- Ben-Ami, Y., Koren, I., Rudich, Y., Artaxo, P., Martin, S., & Andrea, M. (2010). Transport of North African dust from the Bodele depression to the Amazon basin: A case study. *Atmos.Chem.Phys*(10), 7533-7544.
- Benguenab, A., & Chibani, A. (2021). Biodegradation of petroleum hydrocarbons by filamentous fungi (*Aspergillus ustus* and *Purpureocillium lilacinum*) isolated from used engine oil contaminated soil. *Acta Ecol.Sin*(41), 416-423.
- Bentley, R. (2002). Global oil and gas depletion: an overview. *Energy Policy*(30), 189-205.
- Berman, B. (2013, December). *Better place pulled down Isreal and Denmark electric car markets, say local drivers*. Consulté le October 7, 2021, sur Plugincars: <https://www.pluginCars.com/better-place-pulled-down-isreal-and-denmark-electric-car-market-say-local-drivers-129094.html>
- Bernard, Y., Miller, J., Wappelhorst, S., & Braun, C. (2020). *Impacts of Paris low-emission zone and implications for other cities*. London, United Kingdom: True-the real urban initiative, FIA Foundation, 60 Trafalgar Square, London, WC2N 5DS.

- Berndes, G., Ahlgren, S., Borjesson, P., & Cowie, A. (2013). Bioenergy and land use change-state of the art. *Wiley Interdiscip.Rev.Energy Environ*(2), 282-303.
- Beslic, I., Sega, K., & Klacic, Z. (2004). *PM10 and PM2.5 Levels in Urban Part of Zagreb, Croatia: Self-constructed vs Reference Samplers*. <https://eurasap.gfz.hr/53/paper2.html>: EURASAP Newsletter.
- Bessou, C. e. (2011). Biofuels, Greenhouse Gases and Climate Change. Dans E. Lichfouse, M. Hamelin, M. Navarette, & P. Debaeke, *Sustainable Agriculture Volume 2*. Dordrecht: Springer, Dordrecht.
- Bhatia, V., & Dakshinamurti, S. (2021). Tracing the path of Inhaled Nitric Oxide: Biological Consequences of Protein Nitrilation. *Pediatric Pulmonol*(56), 525-538.
- Bian, H., & Zender, C. (2003). Mineral dust and global tropospheric chemistry: relative roles of photolysis and heterogenous uptake. *Journal of Geophysical Research*(108), 4672.
- Bidwe, A., Mayer, O., Hawthorne, C., Charitos, A., Schuster, A., & Schenecht, G. (2011). Use of ilmenite as an oxygen carrier in chemical looping combustion-batch and continuous dual fluidized bed investigation. *Energy Procedia*(4), 433-440.
- Birmili, W., & Wiedensohler, A. (2000). New Particle formation in the continental boundary layer: meteorological and gas phase parameter influence. *Geophys.Res. Lett*, 27(20), 3325-3328.
- Bismarck-Osten, C., Birmili, W., Ketzler, M., Massling, A., Petaja, T., & Weber, S. (2013). Characterization of parameters influencing the spatio-temporal variability of urban particle number size distributions in four European cities. *Atmos. Environ*(77), 415-429.
- Blaser, P., Zimmermann, S., Luster, J., & Shotyk, W. (2000). Critical examination of trace element enrichments and depletions in soils: As, Cr, Ni, Pb, and Zn in Swiss forest soils. *Sci. Total Environ*(249), 257-280.
- Bohlmann, S., Baars, H., Radenz, M., Engelmann, R., & Macke, A. (2018). Ship-borne aerosol profiling with lidar over the Atlantic Ocean: From pure marine conditions to complex dust-smoke mixtures. *Atmos.Chem.Phys*(18), 9661-9679.
- Bollrath, J., Phesse, T., & Von Burstin, V. a. (2009). Gp 130-mediated stat3 activation in enterocytes regulates cell survival and cell-cycle progression during colitis-associated tumorigenesis. *Cancer Cell*(15), 91.
- Bonnel, P., Kubelt, J., & Provenza, A. (2011). Heavy-Duty engines conformity testing based on pems-lessons learned from the European Pilot program. *JRC Scientific and Technical Report EUR 24921*.
- Boonyatumanond, R., Murakami, M., Wattayakorn, G., Togo, A., & Takada, H. (2007). Sources of polycyclic aromatic hydrocarbons (PAHs) in street dust in a tropical Asian mega-city, Bangkok, Thailand. *Science of the Total Environment*(384), 520-432.
- Boryayev, A., & Korichev, A. (2011). *Operational materials for road vehicles-A practical guide*. St Petersburg, Russia: SPbGUSE Publishers.
- Bozlaker, A., Prospero, J., FraserMP, & Chellam, S. (2013). Quantifying the contribution of long-range Saharan dust transport on particulate matter concentrations in Houston, Texas, using detailed elemental analysis. *Environ.Sci.Technol*(47), 10179-10187.
- Brauer, M., Li, C., Martin, R., Meng, J., & al, e. (2019). Mortality air pollution associations in low-exposure environments (MAPLE): Ohase 1. *Res.Rep.Health Eff. Inst*(203), 1-87.
- Brines, M., Dall'Osto, M., Beddows, D., Gomez-Moreno, F., Nunez, & Querol, X. e. (2015). Traffic and nucleation events as main sources of ultrafine particles in high insolation developed world cities. *Atmospheric Chem.Phys*(15), 5929-5945.
- Bristow, C., Hudson-Edwards, K., & Chappell, A. (2010). Fertilizing the Amazon and equatorial Atlantic with West African dust. *Geophys.Res.Lett*, L14807.
- Bulle, R., & Pellow, D. (2006). Environmental justice: human health and environmental inequalities. *Annu Rev Public Health*(27), 103-124.
- Buat-Menard, R., & Chesset, R. (1979). Variable influence of the atmospheric flux on the trace metal chemistry of oceanic suspended matter. *J Earth Planet Sci Lett*(42), 398-411.

- Bukowiecki, N., Lienemann, P., Hill, M., Figi, R., Richard, A., Furger, M., . . . Gehrig, R. (2009). Real-world emission factors for antimony and brake wear related trace elements: size-segregated values for light and heavy duty vehicles. *Environ Sci Technol*(43), 8072-8078.
- Calvo, A., Alves, C., Castro, A., Pont, V., & Vivente, A. (2013). Research on aerosol sources and chemical composition: Past, current and emerging issues. *Atmospheric Res*, 1(28), 120-121.
- Campisi, J. (2005). Senescent cells, tumour suppression, and organismal aging: good citizens, bad neighbors. *Cell*(120), 513.
- Campos-Ramos, A., Aragon-Pina, A., Galindo-Estrada, I., Querol, X., & Alastuey, A. (2009). Characterization of Atmospheric Aerosols by SEM in a Rural Area in the Western Part of Mexico and its Relation with Different Pollution sources. *Atmos. Environ*(43), 6159-6167.
- Cancio, J., Castellano, A., Hernandez, M., Bethencourt, R., & Ortega, E. (2008). Metallic Species in Atmospheric Particulate Matter in Las Palmas de Gran Canaria. *J. Hazard. Mater*(160), 521-528.
- Candeias, C., Vicente, E., Tomé, M., Rocha, F., Avila, P., & Alves, C. (2020). Geochemical, mineralogical and morphological characterization of road dust and associated health risks. *Int. J. Environ. Res. Public Health*, 17.
- Caquineau, S., Gaudichet, A., Gomes, L., & Legrand, M. (2002). Mineralogy of Saharan dust transported over northwestern tropical Atlantic Ocean in relation to source regions. *Journal of Geophysical Research*(107), JD000247.
- Caquineau, S., Gaudichet, A., Gomes, L., & Legrand, M. (2002). Mineralogy of Sharan dust transported over northwestern tropical Atlantic Ocean in relation to source regions. *J. Geophys. Res*, 107(D15), 4251.
- Carpenter, S. (2008). *Inconvenient truth motorcycles and smog*. Consulté le November 19th, 2020, sur [htt-articles by throttle](#).
- Carslaw, K., Boucher, O., Spracklen, D., Mann, G., Rae, J., & Woodward, S. (2010). A review of natural aerosol interactions and feedbacks within the earth system. *Atmos. Chem. Phys*(10), 1701-1737.
- Carslaw, DC, Murrells, T., Anderson, J., & Keenan, M. (2016). Have vehicle emissions of primary NO₂ peaked? *Faraday Discuss*(00), 1-16.
- Cassese, G., Arce, S., & Hauser, A. a. (2003). Plasma cell survival is mediated by synergistic effects of cytokines and adhesion-dependent signals. *J. Immunol*(171), 1684.
- Castro, A., Alonso-Blanco, E., Gonzalez-Colino, M., Calvo, A., Fernandez-Raga, M., & Fraile, R. (2010). Aerosol size distribution in precipitation events in Leon, Spain. *Atmos. Res*(96), 421-435.
- Cavalli, F., Facchini, M., Descesari, S., Mircea, M., Emblico, L., Fuzzi, S., . . . Dell'Acqua, A. (2004). Advances in characterization of size-resolved organic matter in marine aerosol over the North Atlantic. *J. Geophys. Res. Atmospheres*, 109.
- CDC. (2002). *Health effects of occupational exposure to respirable Crystalline Silica. DHHS (NIOSH)*. Atlanta: CDC publication Number 2002-129.
- Central Intelligence Agency. (2017). *The World Factbook-Crude Oil-provide reserves*. Washington DC, United States of America: Central Intelligence Agency -CIA.
- Chakraborty, S., Fu, R., Rosenfeld, D., & Massie, S. (2018). The influence of aerosols and meteorological conditions on the total rain volume of the mesoscale convective systems over tropical continents. *Geophys. Res. Lett*, 23(13), 099-13,106.
- Chang, L., Magos, L., & Suzuki, T. (1996). *Toxicology of Metals*. Florida, USA: CRC Press-Boca Raton.
- Chate, D., Murugavel, P., Ali, K., Tiwari, S., & Beig, G. (2011). Below-cloud rain scavenging of atmospheric aerosols for aerosol deposition models. *Atmos. Res*(99), 528-536.
- Chen, S., Zhang, X., Lin, J., Huang, J., Zhao, D., Yuan, T., . . . Xie, L. (2019a). Fugitive road Dust PM_{2.5} emissions and their potential health impacts. *Environ Sci Technol*(53), 8455-8465.
- Chin, M. e. (2014). Multi-decadal aerosol variations from 1980-2009: A perspective from observations and a global model. *Atmos. Chem. Phys*(14), 3657-3690.

- Chung, E., Soden, B., Sohn, B., & Shi, L. (2014). Upper Tropospheric moistening in response to anthropogenic warming. *Proc. Natl. Acad. Sci.*, 111(11), 636-641.
- Colbeck, I., Nasir, Z., Ahmad, S., & Ali, Z. (2011). Exposure to PM₁₀, PM_{2.5}, PM₁ and Carbon Monoxide on Roads in Lahore, Pakistan. *Aerosol Air Qual. Res*(11), 689-695.
- Cong, Z., Kang, S., Dong, S., Liu, X., & Qin, D. (2010). Elemental and Individual Particle Analysis of Atmospheric Aerosols from High Himalayas. *Environ. Monit. Assess*(160), 323-335.
- Conner, T., & Williams, R. (2004). Identification of Possible Sources of Particulate Matter in the Personal Cloud Using SEM/EDX. *Atmos. Environ*(38), 5305-5310.
- Cossellu, G., Motta, V., Dioni, L., Angelici, L., Vigna, L., Farronto, G., . . . Bollati, V. (2016). Titanium and zirconium levels associated with changes in microRNAs expression: Results from a Human Cross-sectional Study on Obese Population. *PLoS ONE*, 11,e016191.
- Countess, R., Barnard, W., Claiborn, C., Gillette, D., Latimer, D., Pace, T., & Watson, J. (2001). *Methodologies for estimating fugitive windblown and mechanically resuspended road dust emissions applicable for regional scale air quality modelling. In Finl Report for WGA contract No.30203-9.* West Lake, California, USA: Countess Environmental.
- Coussens, L., & Werb, Z. (2002). Inflammation and cancer. *Nature*(420), 860.
- Crippa, M., Janssens-Maenhout, G., Dentner, F., Guizzardi, D., Sindelarova, K., Muntean, M., . . . Granier, C. (2016). Forty years of improvements in European air quality: regional policy-industry interactions with global impacts. *Atmos. Chem. Phys*(16), 3825-3841.
- Croft, W. (2006). *Under the microscope: A Brief history of Microscopy.* Singapore: World Scientific Publishing Co. Pte. Ltd.
- Crouse, D., Peters, P., Van Donkelaar, A., Goldberg, M., & Villeneuve, P. a. (2012). Risk of non-accidental and cardiovascular mortality in relation to long-term exposure to low concentrations of fine particulate matter: a Canadian national-level cohort study. *Environ Health Perspective*, 120(5), 708-714.
- Daskalova, N., Velichkov, S., Krasnobaeva, N., & Slavova, P. (1992). Spectral interferences in the determination of traces of scandium, yttrium and rare-earth elements in pure earth rare-earth matrices by inductively coupled plasma atomic spectrometry i. cerium, neodymium and lanthanum matrices. *Spectrochim Acta Part B-A Spectrosc*(47), E1595-E620.
- Dayan, U., & Levy, I. (2005). The influence of Meteorological Conditions and Atmospheric Circulation Types on PM₁₀ and Visibility in Tel Aviv. *J Appl Meteorol*, 44(5), 606-619.
- de Coninck, H., Aromar, R., Mustafa, B., Buckeridge, B., Cartwright, M., Maldives, A., . . . al, e. (2007). *Global Warming of 1.5 degrees centigrade. An IPCC Special Report on the impacts of Global Warming of 1.5 degrees above Pre-industrial Levels and Related Global Response to the threat of CLIMATE CHANGE.* Geneva, Switzerland: IPCC .
- Degueldre, C., & Favarger, W. (2006). Mass Spectroscopy. *Anal. Chim. Acta Part B*(68), 263-268.
- Denby, B., Kupiainen, L., & Gustaffson, M. (2018). Review of Road Dust Emissions. Dans A. (Ed), *Non-Exhaust Emissions* (pp. 183-203). London, United Kingdom: Academic Press.
- Denier Van der Gon, H., Gerlofs-Nijland, M., Gehrig, R., Gustaffson, M., Janssen, N., Harrison, R., . . . Cassee, F. (2013). The policy relevance of wear emissions from road transport, now and in the future-An international workshop report and consensus statement. *J. Air Waste Management Association*(63), 136-149.
- Dinarella, C. (2000). Pro-inflammatory cytokines. *Chest*(118), 503-508.
- Dockery, D. (2009). Health effects of Particulate Air Pollution. *Ann. Epidemiol.*(19), 257-263.
- Doherty, D., Downey, G., Worthen, G., Haslett, C., & Henson, P. (1989). Monocyte retention and migration in pulmonary inflammation. Requirement for neutrophils. *Lab Invest*(59), 200-213.
- Dominici, F., McDermott, A., Zeger, S., & Samet, J. (2003). National maps of the effects of particulate matter on mortality: Exploring geographical variation. *Environ. Health. Perspect*(111), 39-44.

- EC. (2011). *Establishing Guidelines for Demonstration and subtraction of Exceedances Attributable to Natural sources under the Directive 2008/50EC on ambient Air quality and cleaner air for Europe.*, Febraury 2011.
- EEA. (2015). *Total Greenhouse gas (GHG) emissions trends and projections and emission of air pollutants from transport*. Brussels: European Environment Agency.
- EEA. (2018a). *Air Quality in Europe-2018 report*. EEA Technical Report No 12/2018. Copenhagen: European Environment Agency (EEA).
- EEA. (2019). *Air Quality in Europe*, EEA Report No: 10/2019. Luxembourg: Office of the European Union.
- EEA. (2020). *Air Quality in Europe-2020 report*. Luxembourg: Publications Office of the European Union.
- EEA. (2020). *EEA Report No:09/2020*. Copenhagen,Denmark: European Environment Agency, Publications office of the European Union,European Environment Agency Kongens Nytorv 6,1050.
- Efe, S. (2008). Spatial distributions of particulate air pollution in Nigerian cities: Implications for human health. *J.Environ.Health Res*(7), 107-116.
- Efstathios, E. (2012). Alternative Energy Sources. Dans *Green Technology* (pp. 20951-20952). Verlag Berlin Heidelberg: Springer Heidelberg Germany.
- EIA. (2016). *International Energy Outlook*. Washington DC: US Energy Information Administration.
- Ekpeyong-Otu, E., & Oloidi, W. (2018). Pollution resulting from oil exploration and Plastic disposal in Niger-Delta, Nigeria: biodynamics and artist's recycling methods as control measures. *Global Journal of social sciences*, 17, 31-40.
- Elias, Z., Poirot, O., Daniere, C., Terzetti, F., Marande, M., Dzwigaj, S., . . . Fubini, B. (2000). Cytotoxic and transforming effects of silica particiles with different surface properties in Syrian hamster embryos (SHE) cells. *Toxicol.Vitr.*(14), 409-422.
- El-Metwally, M., & Alfaro, S. (2013). Correlation between metereological conditions and aerosol characteristics at an East-Mediterranean coastal site. *Atmos,Res*, 132-133,76-90.
- Elminir, H. (2005). Dependance of urban air pollutants on metereology. *Sci, Total Environ*(350), 225-237.
- EMEP/EEA. (2016). *Air Pollutant Emission Inventroy Guidebook*. Copenhagen: European Environment Agency.
- Emmanuel, A. (2015). The impact of road development and expansion on urban cities "A case study of Akure metropolis". *Worldwide Journal of Multidisciplinary Research and Development*, 2(6), 46-48.
- Engelbrecht, J., McDonald, E., Gillies, J., Jayanty, R., & Gertler, A. (2009). Characterizing mineral dusts and other aerosols from the Middle East-Part 1: ambient sampling. *Inhal.Toxicol*, 21(4), 297-326.
- Engelbrecht, J., Moosmuller, H., Pincock, S., Jayanty, R., Lersch, T., & Casuccio, G. (2016). Mineralogical, chemical,morphological, and optical inter-relationships of mineral dust resuspensions. *Atmos.Chem.Phys*(16), 10809-10830.
- Engelbrecht, J., Stenchikov, G., Prakash, P., Lersch, T., Anisimov, A., & Shevchenko, I. (2017). Physical and chemical properties of deposited airborne particulates over the Arabian Red Sea coastal plain. *Atmos.Chem.Phys*(17), 11467-11490.
- EPA. (2019). *Greenhouse Gas Emission*. Consulté le April 15, 2019, sur Environmental Protection Agency: <https://www.epa.gov/ghgemissions/global-greenhouse-gas-emissions-data>
- Eregha, P., & Irughe, R. (2009). Oil induced environmental degradation in the Nigeria's Niger Delta: the multiplier effects. *Journ.Sust.Dev.Africa*, 11(4), 160-175.
- EU. (2016). *Urban Europe Statistics on cities,towns and suburbs*. Eurostat Statistical Book. Brussels: European Union.
- European Commission. (2008). *Directive 2008/50/EC of the European Parliament and of the council of 21 May 2008 on Ambient Air Quality and cleaner Air in Europe*. OJ 152, 11.6.2008. Brussels: European Commission (EC).
- European Commission. (2013). *Press Release-Environment: New Policy Package To Clean up Europe's Air*. Brussels: European Commission.

- European Commission. (2016). *Road Transport reducing CO2 emissions from vehicles*. Directorate General Climate Action. Brussels: European Commission .
- European Commission. (2017). *Special Eurobarometer 468: Attitudes of European citizens towards the environment*. Luxembourg: European Commission.
- European Commission Report. (2015). *Reducing emissions from transport*. Brussels: European Commission.
- European Energy Commission. (1980). *On the approximation of the law of member states relating to the fuel consumption of motor vehicles*. Directive80/1268/EEC.Councildirective80/1268/EEC. European Energy Commission (EEC).
- European Environmental Agency. (2009). *Total greenhouse gas emissions by sector(%) in EU-27,2009.2012*. Brussels: European Union.
- European Environmental Agency. (2015). *Final energy consumption by sector and fuel*. Brussels: European Environmental Agency.
- European Lung Foundation. (2019). *Health effects of outdoor air pollution*. Consulté le February 20, 2021, sur European Lung foundation: <https://www.european-lung-foundation.org/16539-health-effects-of-outdoor-airpollution>
- European Parliament and the Council. (2001). *Directive 2001/81/EC*. Brussels: European Commission.
- European Parliament and the Council. (2001). *National Emission Ceilings for Certain Atmospheric Pollutants (Directive 2001/81/EC)*. Brussels: European Commission.
- European Commission. (2016a). *Statistical Pocketbook-Transport in Figures*. Luxembourg: European Union (EU).
- Exxon Mobil Corporation. (2017). *Outlook for Energy: A view to 2040*. Irving: Exxon Mobile Corporation.
- Fagbenro, AA, Yinusa, T., Ajekiiigbe, K., Oke, A., & Obiajunwa, E. (2021). Assessment of heavy metal pollution in soil samples from a gold mining area in Ogun State, Nigeria using proton-induced X-ray emission. *Scientific African*(1), e01047.
- Fahmy, YM;Fornaseiro,P;Zinoviev,S;Miertus,S. (2007). *Air Pollution Control Technologies Compendium. International Center for science and high Technology*. Geneva, Switzerland: United Nations Industrial Development Organization.
- Fang, G., Chnag, C., Wu, Y., Wang, V., Fu, P. D., Chen, S., & Chu, C. (2000). The study of fine and coarse particles, and metallic elements for the daytime and night-time in a suburban area of Central Taiwan,Taichung. *Chemosphere*(41), 639-644.
- Fang, G., Wu, Y., Chang, S., Huang, S., & Rau, J. (2006). Size distributions of ambient Air Particles and Enrichment Factor Analyses of Metallic Elements at Taichung Harbor near the Taiwan Strait. *Atmos, Res*(81), 320-333.
- Federal Road Safety Corps. (2019). *2019, FRSC Corporate strategic goals*. Abuja: Federal Road Safety Corps (FRSC).
- Flierl, R., Lauer, F., Breuer, M., & Hannibal, W. (2012). Cylinder deactivation with mechanically fully variable valve train. *SAE Int.J. Engines*, 5(2), 207-215.
- Flores, E., Barin, J., Mesko, M., & Knapp, G. (2007). *Spectrochim Acta,Part B*(62), 1051-1064.
- Folinsbee, L. (1992). Human health effects of air pollution. *Environmental Health Perspectives*, 100, 45-56.
- Font, A., & Fuller, G. (2016). Did policies to abate atmospheric emissions from traffic have a positive effect in London? *Environ.Pollut*, 1-12.
- Font, A., Guiseppin, L., Blangiardo, M., Ghersi, V., & Fuller, G. (2019). A tale of two cities: is air pollution improving in Paris and London? *Environmental Pollution*, 1-12.
- Formenti, P., Caquineau, S., Chevallier, S., Klaver, A., Desboeufs, K., Rajot, J., . . . Briois, V. (2014). Dominance of goethite over hematite in iron oxides of mineral dust from Western Africa: quantitative partitioning by X-ray absorption spectroscopy. *J.Geophys.Res*(119), 12740-12750.
- Formenti, P., Elbert, W., Maenhaut, W., Haywood, J., & Andreae, M. (2003). Inorganic and carbonaceous aerosols during the southern African Regional Science Initiative (SAFARI 2000) experiment: chemical

- characteristics, physical properties, and emission data for smoke from African biomass burning. *Journal of Geophysical Research*(108), 8576.
- Formenti, P., Schultz, L., Balkanski, Y., Desboeufs, K., Ebert, M., Kandler, K., . . . Zhnag, D. (2011). Recent Progress in understanding physical and chemical properties of African and Asian mineral dust. *Atmospheric Chem.Phys*(11), 8231-8256.
- Franchini, M., & Mannucci, P. (2011). Thrombogenicity and cardiovascular effects of ambient air pollution. *Blood*(118), 2405-2412.
- Furusjo, E., Sternbeck, J., & Cousins, A. (2007). PM10 source characterization at urban and highway roadside locations. *Sci.Total Environ*(35), 5525-5536.
- Gallus, J., Kirchner, U., Vogt, R., & Benter, T. (2017). Impact of driving style and road grade on gaseous exhaust emissions of passenger vehicles measured by a Portable Emission Measurement System (PEMS). *Transportation Research Part D*(52), 215-226.
- Gao, H., Wu, M., Liu, H., Xu, Y., & Liu, Z. (2022). Effect of petroleum hydrocarbon pollution levels on the soil micro-ecosystem and ecological function. *Environmental Pollution*, 293, 118511.
- Gao, Y., Tang, J., Chen, W., Li, Q., Nie, J., & Lin, F. a. (2015). Inflammation negatively regulates FOXP3 and regulatory T-cell function via DBC1. *Proc.Natl Acad Sci U S A*(112), 3246-3254.
- Garbers, C., Aparicio-Siegmund, S., & Rose-John, S. (2015). The IL-6/gp130/STAT3 signaling axis: recent advances towards specific inhibition. *Curr Opin Immunol*(34), 75-82.
- Garcon, G., Shirali, P., Sebastien, G., Fontaine, M., Zerimech, M., Martin, A., & Hannotiaux, M. (2000). Polycyclic aromatic hydrocarbon coated onto Fe2O3 particles: assessment of cellular membrane damage and antioxidant system disruption in human epithelial lung cells (L132) in culture. *Toxicology Letters*(117), 25-35.
- Garratt-Reed, A., & Bell, D. (2003). *Energy Dispersive X-ray Analysis in the Electron Microscope*. Oxford: BIOS Scientific Publishers Limited.
- Gehrig, R. (2007). Mass and Number Concentrations of Fine Particles in Switzerland: Annual and Seasonal Trends, Spatial Variability and Chemical Composition. *Particles and Photooxidants in Europe*, 25-26.
- Gehrig, R., Hill, M., Buchanan, B., Imhof, D., Weingartner, E., & Baltensperger, U. (2004). Separate determination of PM10 emission factors of road traffic for tailpipe emissions and emissions from abrasion and resuspension processes. *Int.J.Environ.Pollut*(22), 312-325.
- Geng, H., Kang, S., Jung, H., Choel, M., Kim, H., & Ro, C. (2010). Characterization of individual sub-micrometer aerosol particles collected in Incheon, Korea, by quantitative transmission electron microscopy energy dispersive X-ray spectrometry. *J.Geophys.Res*(115), 15306.
- Ghan, S., Liu, X., Easter, R., Zaveri, R., Rasch, P., Yoon, J., & Eaton, B. (s.d.). Toward a minimal representation of aerosols in climate models: Comparative decomposition of aerosol direct, semidirect and indirect radiative forcing. *J.Climate*, 25, 6461-6476.
- Giachetti, G., & Sebastiani, L. (2006). Metal accumulation in poplar plant grown with industrial waste. *Chemosphere*(64), 446-454.
- Gietl, J., & Klemm, O. (2009). Analysis of traffic and meteorology on airborne particulate matter in Munster, Northwest Germany. *J. Air Waste Manage*, 59(7), 809-818.
- Gimeno, L. (2013). Grand challenges in atmospheric science. *Front.Earth.Sci*, 1.
- Girao, A., Caputo, G., & Ferro, M. (2017, June). *Application of scanning Electron Microscopy and Energy Dispersive X-ray Spectroscopy (SEM-EDS)*. Consulté le April 12, 2012, sur Comprehensive Analytical Chemistry.
- Glabe, C. (2008). Structural classification of toxic amyloid oligomers. *J.Biol.Chem*(283), 29639-29643.
- Gonzalez-Diaz, S., Arias-Cruz, A., Macouzet-Sanchez, C., & Partida-Ortega, B. (2016). Impact of air pollution in respiratory allergic diseases. *Med, Univ*(18), 212-215.
- Goodhew, P., Humphreys, R., & Beanland, R. (2001). *Electron Microscopy and Analysis* (éd. Third Edition). New York: Taylor & Francis.

- Goyer, R. (2001). *Toxic effects of metals in: Klaassen CD.* (C. a. Poisons, Éd.) New York, New York, United State of America: McGraw-Hill Publisher.
- Grande, C. (2012). Advances in pressure swing adsorption for gas separation. *International Scholarly Research Notices (ISRN) Chemical Engineering*(9).
- Grivennikov, S., Karin, E., & Terzic, J. a. (2009). IL-6 and Stat3 are required for survival of intestinal epithelial cells and development of colitis-associated cancer. *Cancer Cell*(15), 103.
- Grogan, D., & Thorncroft, C. (2019). The characteristics of African easterly waves coupled to Saharan mineral dust aerosols. *Quart.J.Roy.Meteor.Soc*(145), 1130-1146.
- Guerreiro, C., Foltescu, V., & de Leeuw, F. (2014). Air quality status and trends in Europe. *Atmos.Environ*(98), 376-384.
- Guerreiro, C., Foltescu, V., & de Leeuw, F. (2014). Air quality status and trends in Europe. *Atmospheric Environment*(98), 376-384.
- Gurreiro, C., Gonzalez-Ortiz, A., de Leeuw, F., Viana, M., & Horalek, J. (2016). *Air quality in Europe.* Copenhagen: European Environmental Agency (EEA).
- Gustafsson, M., Blomqvist, G., Jarlskog, I., Lundberg, J., Janhall, S., Elmgren, M., . . . Silvergren, S. (2019). Road dust load dynamics and influencing factors for six winter seasons in Stockholm, Sweden. *Atmos.Environ*(X2), 100014.
- Guthrie Jr, G., & Mossman, B. (1993). Merging the geological and biological sciences; an integrated approach to the study of mineral-induced pulmonary diseases. Dans *Health effects of mineral dust* (Vol. 28, pp. 1-5). Washington DC, United States of America: Mineralogical Society of America.
- Gwilliam, K., & Bofinger, H. (2011). *Africa's transport infrastructure: mainstreaming, maintenance and management.* Washington DC: World Bank Publications.
- Hall, J. (2016). *Guyton and Hall Textbook of Medical Physiology* (éd. Thirteenth Edition). Philadelphia: Elsevier Inc. Elsevier, 160 John F. Kennedy Boulevard, Ste 1800, PA 19103-2899.
- Hamed, A., Korhonen, H., Sihto, S., Joutsensaari, J., Jarvinen, H., Petaja, T., . . . al, S. e. (2011). The role of relative humidity in continental new particle formation. *J.Geophys.Res.*, D03202.
- Han, S., Youn, J., & Jung, Y. (2011). Characterization of PM10 and PM2.5 source profiles for resuspended road dust collected using mobile sampling methodology. *Atmospheric Environment*, 45(20), 3343-3351.
- Hand, J., White, W., Gebhart, K., Hyslop, N., Gill, T., & Schichtel, B. (2016). Earlier onset of the spring fine dust season in the southwestern United States. *Geophys.Res.Lett*(43), 4001-4009.
- Hansen, E., & Miro, M. (2007). *Trends Anal Chem*(26), 18-26.
- Haque, M., Kawamura, K., & Kim, Y. (2016). Seasonal variations of biogenic secondary aerosol tracers in ambient aerosols from Alaska. *Atmos, Environ*(130), 95-104.
- Harrison, R., Shi, J., Xi, S., Khan, A., Mark, D., Kinnersley, R., & Yin, J. (2000). Measurement of number mass and size distribution of particles in the atmosphere. *Philos.Trans.R.Soc.Lond.Ser.A Math.Phys.Eng.Sci*(358), 2567-2580.
- Haruna, Y. (2010). *An independent Report of Physical and Process Audit of Nigeira's Solid Minerals Industry (2007-2010).* Abuja, Nigeria: Nigeria Extractive Industries Transparency Initiative (NEITI).
- He, M., Hu, B., Chen, B., & Jiang, Z. (2017). Inductively Coupled Plasma Optical Emission Spectrometry for Rare Earth Elements Analysis. *Physical Sciences Reviews*, 20160059.
- He, Z., Yang, X., & Stoffella, P. (2005). Trace elements in agro-ecosystems and impacts on the environment. *J.Trace Elem Med Biol*, 19((2-3)), 125-140.
- Held, I., & Soden, B. (2000). Water vapour feedback and global warming. *Annu.Rev.Energy.Environ*(25), 441-475.
- Herawati, a., N, Suzuki, S., Hayashi, K., Rivai, I., & Koyoma, H. (2000). Cadmium, copper and zinc levels in rice and soil of Japan, Indonesia and China by soil type. *Bull Env.Contam Toxicol*(64), 33-39.
- Hirano, T. (2020). IL-6 in inflammation, autoimmunity and cancer. *International Immunology*, 33(3), 127-148.

- Hirano, T., & Kishimoto, T. (1990). Interleukin-6. Dans M. Sporn, & A. Roberts, *Peptide growth factors and their receptors* (p. 633). Berlin, Germany: Springer.
- Hitchins, J., Morowska, L., Wolff, R., & Dale, G. (2000). Concentrations of sub-micrometer particles from vehicle emissions near a major road. *Atmos. Environ*(34), 51-59.
- Hoegh-Guldberg, O., Jacob, D., Taylor, M., Bindi, M., Brown, S., Camilloni, I., . . . al, e. (2019). *Global warming of 1.5 degrees centigrade. An IPCC special Report on the impacts of Global Warming of 1.5 degrees above pre-industrial levels and related Global Greenhouse Gas Emission Pathways, in the context of strengthening the Global Response ...* Geneva: IPCC, Switzerland.
- Hoek, G., Krishnan, R., Beelen, R., Peters, A., Ostro, B., Brunkeef, B., & Kaufman, J. (2013). Long-term air pollution exposure and cardio-respiratory mortality: a review. *Environ. Health*(12), 43.
- Hooper, J., & Marx, S. (2018). A Global doubling of dust emissions during the Anthropocene. *Global Planet Change*(169), 70-91.
- Hopke, P., & Cohen, D. (2011). Application of receptor modeling methods. *Atmos. Pollut. Res*(2), 122-125.
- Hu, R., Wang, H., Yin, Y., Zhu, B., Xia, L., Zhang, Z., & Chen, K. (2018). Measurement of ambient aerosols by single particle mass spectroscopy in the Yangtze River Delta, China: seasonal variations, mixing state and meteorological effects. *Atmos. Res*(213), 562-575.
- Hu, Y., Lin, J., Zhang, S., Kong, L., Fu, H., & Chen, J. (2014). Identification of the typical metal particles among haze, fog and clear episodes in the Beijing atmosphere. *Sci. Total. Environ*(1), 369-380.
- Hughes, L., Cass, G., Gone, J., Ames, M., & Olmez, I. (1998). Physical and chemical characterization of atmospheric ultrafine particles in the Los Angeles area. *Environ. Sci. Technol*(32), 1153-1161.
- Hunter, C., & Jones, S. (2015). IL-6 as a keystone cytokine in health and disease. *Nat. Immunol*(16), 448.
- Hunter, C., & Jones, S. (2015). IL-6 as a keystone cytokine in health and disease. *Nat. Immunol*(16), 448.
- Hurtig, A., & San Sebastian, M. (2002). Geographical differences in cancer incidence in the Amazon basin of Ecuador in relation to residence near oil fields. *Int. J. Epidemiol*(31), 1021-1027.
- Hurtig, A., & San Sebastian, M. (2004). Incidence of childhood leukemia and oil exploitation in the Amazon basin of Ecuador. *Int. J. Occup. Environ. Health*(10), 245-250.
- Hussein, T., Karpinen, A., Kukkonen, J., Harkonen, J., Aalto, P., Hameri, K., . . . Kulmala, M. (2006). Meteorological dependence of size-fractionated number concentrations of urban aerosol particles. *Atmospheric Environment*(40), 1427-1440.
- Hvidtfeldt, U., Sorensen, M., Geels, C., Ketzel, M., Khan, J., Tjonneland, A., . . . Raaschou-Nielsen, O. (2019). Long-term residential exposure to PM2.5, PM10, black carbon, NO2, and ozone and mortality in a Danish cohort. *Environ. Int*(123), 265-272.
- IEA. (2020a). *In Global EV Outlook 2020-Entering the decade of electric drive?* Paris, France: OECD/IEA.
- IEA. (2020b). *Renewables 2020-Analysis and forecast to 2025.* Paris, France: OECD/IEA.
- Ingrao, C., Bacenetti, J., Ioppolo, G., & Messineo, A. (2019). *Energy and Environmental Assessments of Agro-biogas Supply Chains for Energy Generation: A Comprehensive Review In: Basosi, R; et al (EDs). Life cycle assessment of energy systems and sustainable energy technologies, Green Energy and Technology.* New York: Springer.
- International Energy Agency (IEA). (2009). Relationship between electric energy demand and GDP adjusted according to purchasing power. *About OECD-Data from Key World Energy Statistics.*
- IPCC. (2014). *Summary for policymakers: mitigation of climate change In Edenhofer, O; et al Contribution of working group III to the fifth assessment report of the intergovernmental panel on climate change, Cambridge, United Kingdom and New York, NY, USA.* Cambridge, United Kingdom: Cambridge University Press.
- Isaksen, I., Berntsen, T., Dalsoren, S., Eleftheratos, Y., Orsolini, Y., Rognerud, B., . . . Holmes, C. (2014, July 13). Atmospheric Ozone and Methane in a Changing Climate. *Atmosphere*, 518-535. doi:10.3390/atmos5030518
- Ishihara, K., & Hirano, T. (2002). IL-6 in autoimmune disease and chronic inflammatory proliferative disease. *Cytokine Growth Factor Rev*(13), 357.

- Ishii, S., Bell, J., & Marshall, F. (2007). Phytotoxic risk assessment of ambient air pollution on agricultural crops in Selangor State, Malaysia. *Environ.Pollut*, 150(2), 267-279.
- Islam, M., Afrin, S., Ahmed, T., & Ali, M. (2015). Meteorological and seasonal influences in ambient air quality parameters of Dhaka City. *J.Civil.Eng*(43), 67-77.
- Islam, N., Saraor, M., & Ahmed, T. (2021). Meteorological influences on urban air quality parameters in dhaka city. *Journal of Engineering Science*, 12(1), 1-8.
- Jayashinge, A., Sano, K., & Nishiuchi, H. (2015). Network Centrality Assessment (NCA) as an alternative approach to predict vehicular traffic volume: A case of Colombo, Sri Lanka. *Advances in Transportation Studies*(11), 834-853.
- Jayasinghe, A., Sano, K., & Nishiuchi, H. (2015). Network Centrality Assessment (NCA) as an alternative approach to predict vehicular traffic volume: A case of Colombo, Sri Lanka. *Journal of Eastern Asia Society for Transportation Studies*(11), 834-853.
- Jayed, M., Masjuki, H., Kalam, M., Mahlia, T., Husnawan, M., & Liaquat, A. (2011). Prospects of dedicated biodiesel engine vehicles in Malaysia and Indonesia. *Renew.Sustain.Energy Rev*(15), 220-235.
- Jego, G., Palucka, A., Blanck, J., Chalouni, C., Pascual, V., & Banchereau, J. (2003). Plasmacytoid dendritic cells induce plasma cell differentiation through type 1 interferon and interleukin-6. *Immunity*(19), 225.
- Jenny, H. (1961). Heavy metals in soil. *Soil Sci.Soc.Am.Proc*(25), 385-388.
- Jensen, R., Crapo, R., Flint, A., & Howell, H. (2002). Problems in selecting representative reference values and interpretive strategies. *American Journal of Respiratory and Critical Care Medicine*, 165, A200.
- Jeswani, H., Chilvers, A., & Azapagic, A. (2020). Environmental sustainability of biofuels: a review. *Proc.R.Soc.A Math.Phys.Eng.Sci*(476), 20200351.
- Jia, G., Shevliakova, E., Artaxo, P., Noblet-Ducoudre, N., Hoghton, R., House, J., . . . al, e. (2019). *Land climate interactions. In Climate change and Land: An IPCC Special Report on Climate Change.Desertification, Land Degradation,sustainable Land Mangament,Food security and Greenhouse Fluxes in Terrestrial ecosystems.* Geneva, Switzerland: IPCC.
- Jickells, T., & Moore, C. (2015). The importance of atmospheric deposition for ocean productivity. *Annu.Rev.Evol.Syst*(46), 481-501.
- Jimmy, E., Solomon, M., Peter, A., & Asuquo, C. (2014). Environmental implications of motorcycles emitted Gases in a metropolitan Nigeria. *American Journal of Environmental Protection*, 2(1), 7-10.
- Johansson, N., Norman, M, & Gidhagen, L. (2007). Spatial and temporal variations of PM10 and particle number concentrations in urban air. *Environemental monitoring and assessment*(127), 477-487.
- Jordan, B. (2010). DNA Genetic superiority and social, "race": the contribution of SNPs. *Medicine and Science*, 26(2), 215-218.
- Junior, D., Krug, F., Pereira, M., & Korn, M. (2006). *Appl.Spectrosc.Rev*(41), 305-321.
- Kalghatgi, G. (2018). Is it really the end of the internal combustion engines and petroleum in transport? *Appl Energy*(225), 965-974.
- Kalu, A. (1977). The Africa dust Plume: Its characteristics and propagation across West Africa in winter. Dans *Sahara Dust* (pp. 95-118). New York: Wiley and Sons.
- Kamimura, D., Ishihara, K., & Hirano, T. (2003). IL-6 signal transduction and its physiological roles: the signal orchestration model. *Rev. Physiol.Biochem.Pharmacol*(149), 1.
- Kan, H., London, S., & Chen, B. (2007). Differentiating the effects of fine and coarse particles on daily mortality in Shanghai,China. *Environmental International*, 33(3), 376-384.
- Kan, H., London, S., Chen, G., Zhang, Y., Song, G., Zhao, N., & al, e. (2008). Season,sex,age and education as modifiers of the effects of outdoor air pollution on daily monitoring in Shanghai, China.Public Health and Air Pollution in Asia (PAPA) study. *Environmental Health Perspectives*(116), 1183-1188.

- Kandler, K., Schutz, L., & Deutscher, C. e. (2009). Size distribution, mass concentration, chemical and mineralogical composition and derived optical parameters of the boundary layer aerosol at Tinfou, Morocco during SAMUM2006. *Tellus*(61B), 32-50.
- Kapskij, D., Pegin, P., & Evtyukov, S. (2017). Definition of ecological losses in the city from the movement of vehicles. *Water and Ecology*(3), 146-157.
- Karanasiou, A., Moreno, T., Amato, F., Lumberras, J., Narros, A., Borge, R., . . . Querol, X. (2011). Road Dust contribution to PM levels-Evaluation of the effectiveness of street washing activities by means of Positive Matrix Factorization. *Atmos. Environ*(45), 2193-2201.
- Kasaei, S., Kasaei, S., & Monadjemi, S. (2009). A Novel Morphological Method for Detection and Recognition of Vehicle License Plates. *American Journal of Applied Sciences*, 6(12), 2066-2070.
- Kaufman, Y., Tanre, D., & Boucher, O. (2002). A Satelliteview of increase of aerosols in climate systems. *Nature*(419), 215-223.
- Kawaguchi, H., Fukusawa, N., & Mizuike, A. (1986). *Spectrochim Acta Part B*(41), 1277-1286.
- Kepp, O., Galluzi, L., Lipinski, M., Yuan, J., & Kroemer, G. (2011). Cell death assays for drug discovery. *Nat.Rev.Drug Discov*(10), 221-237.
- Key, M., Johnson, C., Horstwood, A., Lapworth, J., Knights, K., Kemp, . . . Adekanmi, M. (2017). Investigating high Zircon concentration in the fine fraction of stream sediment draining the Pan-African Dahomeyan Terrane in Nigeria. *Appl.Geochem*(27), 1525-1539.
- Khanna, M., Wang, W., Hudiburg, T., & Delucia, E. (2017). The social inefficiency of regulating indirect land use change due to biofuels. *Nat.commun*(8), 1-9.
- Khomenko, S., Cirach, M., Pereira-Barboza, E., Mueller, N., Barrera-Gomez, J., Rojas-Rueda, D., . . . Nieuwenhuijsen, M. (2021). Premature mortality due to air pollution in European Cities: a health impact assessment. *Lancet PPlanet Health*(5), 121-134.
- Khreis, H., Warsow, K., Verlinghier, E., Guzman, A., Pellecuer, L., Ferrereira, A., & Nieuwenhuijsen. (2016). The health impacts of traffic-related exposures in urban areas: Understanding real effects, underlying driving forces and co-producing future directions. *Journal of Transport and Health*, 3(3), 249-267.
- Kiesewetter, G., Borcken-Kleefeld, J., Schopp, C., Heyes, P., Thunis, B., Bessagnet, E., . . . Amann, M. (2014). Modelling of street level PM10 concentrations across Europe: source apportionment and possible futures. *Atmos.Chem.Phys.Discuss*(14), 18315-18354.
- Kim, B., Park, J., Kim, S., Kim, H., Jeon, H., Cho, C., . . . Panday, A. e. (2015). Source apportionment of PM10 mass and particulate carbon in the Kathmandu Valley, Nepal. *Atmos. Environ.*(123), 190-199.
- Kim, E., Park, H., Park, E., Hong, Y., Ha, M., Kim, H., & Ha, E. (2016). Particulate matter and early childhood body weight. *Environ.Int*(94), 591-599.
- Kim, J. (2006). *Hygroscopic Properties of Asian Aerosols: Their Effects on Direct Aerosol Radiative Forcing*. Seoul: Seoul University, Korea.
- Kim, Y., & Kim, B. (2009). Distribution and speciation of heavy metals and their sources in Kumbo River sediment, Korea. *Environ Earth Sci*, 60(5), 943-952.
- Kingombe, C. (2014). *Africa's rising middle class amid plenty and extreme poverty*. Brussels: European Center for Development and Policy Mangement (ECDPM).
- Klaver, A., Formenti, P., Caquineau, S., Chevaillier, S., Ausset, P., Osborne, S., . . . Dubovik, O. (2011). Physico-chemical and optical properties of Sahelian and Saharan mineral dust: in situ measurements during GERBILS campaign. *Q.J.R Meteorol.Soc*(137), 1193-1210.
- Klaver, P., Formenti, S., Caquineaau, S., Chevaillier, P., Ausset, G., Calzolari, S., . . . Harrison, O. (2011). Physico-chemical and optical properties of Sahelian and Saharan mineral dust: in situ measurements during the GERBILLS campaign. *QJR Meteorol.Soc*, 889.
- Kleeman, R., Zadelaar, S., & Kooistra, T. (2008). Cytokines and atherosclerosis: a comprehensive review of studies in mice. *Cardiovasc Res*(79), 360-376.

- Knippertz, P., & Todd, M. (2012). Mineral dust aerosols over the Sahara: Meteorological controls on emission and transport and implications for modelling. *Rev. Geophys*, RG1007.
- Knowles, T., Fitzpatrick, A., & Welland, M. (2007). Role of intermolecular forces in defining properties of protein nanofibrils. *Science*(318), 1900-1903.
- Kohoutek, S., Weinbruch, S., & Boltze, M. (2012). Reduction potential of environment responsive traffic control on roadside particulate matter and nitrogen oxide concentrations. *Transp. Res. Rec. J. Transp. Res. Board*(2270), 162-170.
- Kok, J. e. (2021). Contribution of the World's main dust source regions to the global cycle of desert dust. *Atmos. Chem. Phys*(21), 8169-8193.
- Koolen, C., & Rothenberg, G. (2019). Air Pollution in Europe. *Chemosuschem*(39), 164-172.
- Koupal, J., & Palacios, C. (2019). Impact of new fuel specifications on vehicle emissions in Mexico. *Atmospheric Environment*(201), 41-49.
- Koupal, J., & Palacios, C. e. (2019). Impact of new fuel specifications on vehicle emissions in Mexico. *Atmos. Environment*(201), 41-49.
- Krueger, B., Grassian, V., Cowin, J., & Laskin, A. (2004). Heterogeneous chemistry of individual mineral dust particles from different dust source regions: the importance of particle mineralogy. *Atmos. Environ*(38), 6253-6261.
- Krueger, B., Grassian, V., Cowin, J., & Laskin, A. (2004). Heterogeneous Chemistry of Individual Mineral Dust Particles from Different Dust Source Regions: The importance of Particle Mineralogy. *Atmospheric Environment*(38), 6253-6261.
- Krzyzanowski, M., Bonjour, J., Brauer, S., Cohen, A., & Pruss-Ustin, A. (2014). Air Pollution in the Mega-Cities. *Current Environmental Health Reports*(1), 185-191.
- Kulmala, M., Kontkanen, J., Junninen, H., Lehtipalo, K., Manninen, H., Nieminen, T., . . . Jokinen, T. e. (2013). Direct Observation of Atmospheric Aerosol Nucleation. *Science*(339), 943-946.
- Kulmala, M., Riipinen, I., Sipila, M., Manninen, H., Petaja, T., Junninen, H., . . . Harrison, R. e. (2007). Toward Direct Measurement of Atmospheric Nucleation. *Science*(318), 89-92.
- Kumar, P., Pirjola, L., Ketzler, M., & Harrison, R. (2013). Nanoparticle emissions from 11 non-vehicle exhaust sources-A review. *Atmos. Environ*, 252-277.
- Kumar, V., Abbass, A., Fausto, N., & Mitchell, R. (2007). *Robbins Basic Pathology* (éd. 8th). Philadelphia, PA 19103, United States: Saunders Elsevier, 1600 John F Kennedy Blvd #1800.
- Kupiainen, K., & Pirjola, L. (2011). Vehicle non-exhaust emissions from the tyre-road interface-effect of stud properties, traction sanding and resuspension. *Atmos Environ*(45), 4141-4146.
- Laborda, F., Bolea, E., & Jimenez-Lamana, J. (2014). Single Particle Inductively Coupled Plasma Mass Spectrometry: A Powerful Tool for Nanoanalysis. *Anal. Chem*, 86(5), 2270-2278.
- Lafon, S., Sokolik, I., Rajot, J., & Gaudichet, A. (2006). Characterization of iron oxides in mineral dust aerosols: Implication for light absorption. *J. Geophys. Res. Atmospheres*, 111.
- Lagorio, S., Forastiere, F., Pistelli, R., Lavorone, I., Michelozzi, P., Fano, V., . . . Ostro, D. (2006). Air Pollution and lung function among susceptible adult subjects: A panel study. *Environ. Health*(5), 11.
- Lai, C., Lin, C., & Liao, C. (2017). Respiratory deposition and health risk of inhalation of particle bound heavy metals in the carbon black feeding area of a tire manufacturer. *Air. Qual. Atmos. Health*(10), 1281-1289.
- Lang, F., Yan, W., Zhang, Q., & Cao, J. (2013). Size distribution of atmospheric particle number in Beijing and association with meteorological conditions. *China Environ. Sci*, 33(7), 1153-1159.
- Langner, M., & Endlicher, W. (2022). Shrinking Cities: Effects on urban Ecology and Challenges for Urban Development. *Atmosphere*, 17-35.
- Langner, M., Kull, M., & Endlicher, W. (2011). Determination of PM10 deposition based on antimony flux to selected urban surfaces. *Environ. Pollut*(159), 2028-2034.

- Laskowski, P., Zimakowska-laskowska, M., & Zasina, D. e. (2021). Comparative analysis of the emissions of carbon dioxide and toxic substances emitted by vehicles with ICE compared to the equivalent emissions of BEV. *Combustion Engines*, 187(4), 102-105.
- Lawrence, S., Sokhi, R., Ravindra, K., Mao, H., Prain, H., & Bull, I. (2013). Source apportionment of traffic emissions of particulate matter using tunnel measurements. *Atmos. Environ*(77), 548-557.
- Lefranc, A., Pascal, L., Larrieu, S., Blanchard, M., Wagner, V., & Declercq, C. (2009). Pollution atmospherique et maladies cardiovasculaires: elements apportés par le programme de surveillance air et sante. *Arch.Mal.Prof.Environ*(70), 339-345.
- Leili, M., Naddafi, K., Nabizadeh, R., & Yunesian, M. (2008). The study of TSP and PM10 concentration and their heavy Metal content in Central Area of Tehran, Iran. *Air Qual. Atmos, health*(1), 159-166.
- Li, J., Zhen, M., Chen, X., Li, D., Wang, S., & Song, T. (2016). Connotation analysis, source reservoir assemblage types and developmenet potential of unconventional hydrocarbons in China. *Pet.Res*(1), 135-148.
- Li, W., Shao, L., & Buseck, P. (2010a). Haze Types in Beijing and the influence of Agricultural Biomass Burning. *Atmos.Chem.Phys*(10), 8119-8130.
- Liang, Y., Fang, L., Pan, H., Zhang, K., Kan, H., Brook, J., & Sun, Q. (2014). PM 2.5 in Beijing- Temporal pattern and its association with influenza. *Environ.Health*(13), 102.
- Libretexts.org. (2020, May 6th). *Energy Dispersive X-ray Spectroscopy (EDS)*. Consulté le April 12th, 2022, sur Chemistry Libretexts: <https://chem.libretexts.org/@go/page/148440>
- Lijima, A., Sato, K., Yano, K., Tago, H., Kato, M., Kimura, H., & Furuta, N. (2007). Particle size and composition distribution analysis of automative brake abrasion dustsfor the evaluation of antimony sources of airborne particulate matter. *Atmospheric Environment*, 4908-4919.
- Liu, F., Chen, G., Huo, W., Wang, C., Liu, S., Li, N., . . . Xiang, H. (2019). Associations between long-term exposure to ambient air pollution and risk of type 2 diabetes mellitus: A systemic review and meta-analysis. *Environ. Pollut*(252), 1235-1245.
- Liu, J., Wei, K., Xu, S., Cui, J., Ma, J., Xiao, X., . . . He, X. (2020b). Surfeviewactant-enhanced remediation of oil-contaminated soil and groundwater: a review. *Sci.Total Environ*(756), 144142.
- Liu, M., Cheng, S., Ou, D., Hou, L., Gao, L., Wang, L., . . . Xu, S. (2007). Characterization, identification of road dust PAHs in central Shanghai areas,China. *Atmospheric Environment*(41), 8785-8795.
- Liu, X., Jones, G., & Choy, E. a. (2016). The biology behind interleukin-6 targeted interventions. *Curr Opin Rheumatol*(28), 152-160.
- London Atmospheric Emissions Inventory. (2017). *GLA (Greater London Authority)*. London, United Kingdom: London Atmospheric Emissions Inventory.
- Luo, G., Zhang, L., Hu, X., & Qiu, R. (2020). Quantifying public health benefits of PM2.5 reduction and spatial distribution analysis in China. *Sci.Total.Environ*(719), 137445.
- Luo, N., Zhao, W., Yan, X., Gong, Z., & Xiong, Q. (2013). Study on influence of traffic and metereological factors on inhalable particle matters of different size. *Environ.Sci*, 33(7), 3741-3748.
- Luo, Y. (2016). Hall of fame among pro-inflammatory cytokines-Interleukin-6 Gene and its Transcriptional Regulation mechanism. *Front Immunol*(7), 604. doi:10.3389/fimmu.2016.00604
- Ma, Y., Martynkova, S., Valaskova, M., Matejka, V., & Lu, Y. (2012). Effects of ZrSiO4 in non-metallic brake friction materials on friction performance. *Tribol.Int*(41), 166-174.
- Ma, Y., Zhang, M., Jin, S., Gong, W., Chen, Z., Jin, Y., & Shi, Y. (2019). Long term onvestigation of Aerosol optical and Radiative Characteristics in a Typical Megacity of Central China during Winter Haze Periods. *J.Geophys. Res*(124), 12093-12106.
- Macintyre, H., Heaviside, C., Neal, L., Agnew, P., Thornes, J., & Vardoulakis, S. (2016). Mortality and emergency hospitalizations associated with particulate matter episodes across the UK in spring 2014. *Environ.Int*(97), 108-116.
- Madelaine, G. (1975). Formation and evolution of atmospheric aerosols. *Journal de Physique Colloques*, 43.

- Maher, P., & Schubert, D. (2000). Signaling by reactive oxygen species in the nervous system. *Cell.Mol.Life Sci*(57), 1287-1305.
- Mahmudpour, M., Roozbeh, J., Keshvarz, M., Farrokhi, S., & Nabipour, I. (2020). COVID-19 cytokine storm: the anger of inflammation. *Cytokine*(131), 155151.
- Mai, B., Qi, S., Zeng, E., Yang, Q., Zhang, G., Fu, J., . . . Wang, Z. (2003). Distribution of polycyclic aromatic hydrocarbons in the coastal region off Macao,China: assessment of input sources and transport pathways using compositional analysis. *Environmental Science and Technology*(37), 4855-4863.
- Makinde, O., Olutemi, E., Adesiyani, A., Eludoyin, K., Ogundele, I., Olabanji, I., & Tubosun, A. (2018). A study of heavy metal loading of sediments in a mining environment using nuclear analytical technique. *Open Sci,J,Anal,Chem*, 3(1), 11-16.
- Makinde, O., Oluyemi, E., Olabanji, I., Adesiyani, A., Eludoyin, K., Ogundele, S., . . . Tubosun, A. (2019). A particule induced X-ray emission (PIXE) analysis of heavy metals in soil and plantain (*Musa paradisiaca*) leaves at an artisinal gold mining settlement in Southwestern, Nigeria. *Open J.Ecol*(9), 200-208.
- Makinde, O., Oluyemi, I., Tunbosun, I., Olabanji, K., Ogundele, K., & Fakoya, O. (2016). Heavy Metal contamination in stream water and sediments of gold mining areas of Southwestern Nigeria. *Afr.J. Environ.Sci.Technol*, 10(5), 150-161.
- Mann, E, Varrica, D., & Dongarra, G. (2006). Metal distribution in road dust sample collected in an Urban area close to a Petrochemical plant at Gela, Sicily. *Atmos Environ*(40), 5929-5941.
- Mar, T., Larson, T., Stier, R., Clairborn, C., & Koenig, J. (2004). An Analysis of the Association Between Respiratory Symptoms in Subjects with Asthma and Daily Air Pollution in Spokane, Washington. *Inhal.Toxicol*(16), 809-815.
- Marcazzan, G., Ceriani, M., Valli, G., & Vecchi, R. (2003). Source apportionment of PM10 and PM2.5 in Milan (Italy) using receptoe modelling. *Sci.Total Environ*(317), 137-147.
- Marmureanu, L., Marin, C., Andrei, S., Antonescu, B., Ene, D., Boldeanu, M., . . . Levei, E. (2019). Orange snow-A saharan Dust intrusion over Romania during Winter conditions. *Remote Sensing*, 11(21), 2466.
- Martin, S. (2000). Phas transitions of acqueous atmospheric particles. *Chemical Reviews*(100), 3403-3453.
- Martins, I., Kuperstein, I., & Rouseeau, F. (2008). Lipids revert inert Ab amyloid fibrils to neurotoxic profibrils that affect learning in mice. *EMBO J*(27), 224-233.
- Martuzevicius, D., Kliucininkas, L., Prasauskas, T., Krugly, E., & Kauneliene, B. (2011). Resuspension of particulate matter and PAHs from street dust. *Atmospheric Environment*(14), 310-317.
- Masjedi, A., Hashemi, V., & Hojjat-Farsangi, M. e. (2018). The significant role of interleukin-6 and its signaling pathway in the immunopathogenesis and treatment of breast cancer. *Biomed Pharmacocother*(108), 1415.
- Massamba, V., Coppieters, Y., Mercier, G., Collart, P., & Leveque, A. (2014). Effets de la pollution particulaire sur le risque de maladies cardiovasculaires. *Ann.Cardiol.Angeiologie*(63), 40-47.
- Mcgranahan, G., & Murray, F. (2003). *Air Pollution and health in rapidly developing countries*. London, London, United Kingdom: Earthscan Publications Limited, 120 Pentoville Road,N1 9jN .
- McKenzie, L., Allhouse, W., Byers, T., Bedrick, E., Serdar, B., & Adgate, J. (2017). Childhood hematologic cancer and residential proximity to oil and gas development. *PLoS One* 12.
- Melnicoff, M., Horan, P., & Morahan, P. (1989). Kinetics of changes in peritoneal cell populations following acute inflammation. *Cell Immunol*(118), 178-191.
- Men, C., Liu, R., Wang, Q., Guo, L., Miao, Y., & Shen, Z. (2019). Uncertainty in source apportionment of heavy metals in road dust on positive matrix factorization model and geographic information system. *Sci. Total Environ*, 652, 27-39.
- Menezes, A., Wehrmeister, F., Hartwig, F., Perez-Padilla, R., Gigante, D., Barros, F., & al, e. (2015). African ancestry,lung function and the effect of genetics. *European Respiratory Journal*, 45(6), 1582.

- Messan, F., Dansou, P., Marqueste, T., Decherchi, P., Tossou, R., Amoussou, T., & al, e. (2013). "First report of FVC and FEV1 Reference Values for Beninese Children Aged 11-16 Years". *ISRN Pulomnology*, 2013(2), 284386.
- Middlebrook, A., Murphy, D., & Thomson, D. (1998). Observations of organic material in individual marine particulates at Cape Grim during the First Aerosol characterization experiment (ACE 1). *J.Geophys.Res.Atmospheres*(103), 16475-16483.
- Migon, C., Robin, T., Dufour, A., & Gentili, B. (2008). Decrease of Lead Concentrations in the Western Mediterranean atmosphere during the Last 20 Years. *Atmos Environ*(42), 815-821.
- Mofijur, M., Kalam, M., Hazrat, M., Liaquat, A., Shahabuddin, M., & Varman, M. (2012). Prospects of biodiesel from *Jatropha* in Malaysia. *Renew.Sustain.Energy Rev*(16), 5007-5020.
- Mohan, S. (2016). An overview of particulate dry deposition: measuring methods, deposition velocity and controlling factors. *Int.J.Environ.Sci.Technol*, 13(1), 387-402.
- Monks, P., Allan, J., Carruthers, D., Carslaw, D., Fuller, G., Heal, M., . . . Reeves, C. (2019). *Non-exhaust Emissions from Road Traffic*. London: Expert Group to the Department for Environment, Food and Rural Affairs; Scottish Government; Welsh Government and Department of the Environment in Northern Ireland.
- Moosmuller, H., Engelbrecht, J., Skiba, M., Frey, G., Chakrabarty, R., & Arnott, W. (2012). Single scattering albedo of fine mineral dust aerosols controlled by iron concentration. *J.Geophys.Res*(117), D11210.
- Morman, S., & Plumlee, G. (2013). The role of airborne mineral dusts in human disease. *Aeolian Research*, 203-212.
- Mossman, T. (1983). Rapid colorimetric assay for cellular growth and survival: Application to proliferation and cytotoxicity assays. *J.Immunol.Methods*(65), 55-63.
- Mues, A., Manders, A., Schaap, M., Van Ulft, L., Van Meijgaard, E., & Builtjes, P. (2013). Differences in particulate matter concentrations between urban and rural regions under current and changing climate conditions. *Atmos.Environ*(80), 232-247.
- Murakami, M., Harada, M., & Kamimura, D. a. (2013). Disease association analysis of an inflammation-related feedback loop. *Cell Rep*(3), 946.
- Naidja, L., Ali-Khodja, H., & Khardi, S. (2018). Sources and Levels of particulate matter in North African and Sub-saharan cities: A literature review. *Environ.Sci.Pollut.Res*(25), 12303-12328.
- Nemmar, A., Hoet, P., Dinsdale, D., Vermeylen, J., Hoylaerts, M., & Nemery, B. (2003). Diesel exhaust particles in lung acutely enhance experimental peripheral thrombosis. *Circulation*(107), 1202-1208.
- Netter, F. (2019). *Atlas of Human Anatomy* (éd. 7th Edition). Philadelphia, Philadelphia (PA), United State of America (USA): Elsevier Inc., 1600 John F.Kennedy Boulevard, Ste 1800, PhA 19103-2899.
- Nie, Y., Ghamami, M., Zockaie, A., & Xiao, F. (2016). Optimization of incentive policies for plug-in electric vehicles. *Transp.Res B Methodol*(84), 10-23.
- Ning, W., Linhao, T., Wenjian, Z., & Jiahua, G. (2019). How to face the challenges caused by the abolishment of subsidies for electric vehicles in China? *Energy*(166), 359-372.
- No'brega, J., Santos, M., de Sousa, R., Cadore, S., Barnes, R., & Tatro, M. (2006). *Spectrochim Acta Part B*(61), 465-495.
- Nordling, E., Berglind, N., Mele, E., Emenius, G., Hallberg, J., Nyberg, F., . . . Bellander, T. (2008). Traffic-Related Air Pollution and Childhood Respiratory Symptoms, Function and Allergies. *Epidemiology*(19), 401-408.
- Nowak, S., Lafon, S., Caquineau, S., Journet, E., & Laurent, B. (2018). Quantitative study of the mineralogical composition of mineral dust aerosols by X-ray diffraction volume. *Talanta Journal*(15), 133-139.
- Nriagu, J. (1989). A global assessment of natural sources of atmospheric trace metals. *Nature*(338), 47-49.

- Obafemi, Y., Taiwo, O., Omodara, O., Dahunsi, O., & Oranusi, S. (2018). Biodegradation of crude petroleum by bacterial consortia from oil-contaminated soils in Ots, Ogun State, Soth-Western,Nigeria. *Environ.Technol.Innov*(12), 230-242.
- Obiajunwa, E., Johnson-Fatokun, F., & Olaniyi, H. a. (2001). Analysis of some Nigerian solid mineral ores by energy-dispersive X-ray flourescence spectroscopy. *Nucl. Instr.Meth.Phys.Res*, 437-440.
- O'Callaghan-Gordo, Orta-Martinez, M., & Kogevinas, M. (2016). Health effects of non-occupational exposure to spilled oils on human health. *Environ.Health*(15), 56.
- Odeyemi, O., & Ogunseitan, O. (1985). Petroleum Industry and its pollution Potential in Nigeria. *Oil and Petrochemical Pollution*(2), 223-229.
- Ogunbodede, E. (2008). Urban Road Transportation in Nigeria 1960-2006: Problems,Prospects and Challenges. *Ethiopian Journal of Environmental Studies and Management*, 1(1), 7-18.
- Ogwuegbu, M., & Muhanga, W. (2005). Investigation of lead concentration in the blood of people in the copper belt province of Zambia. *J.Environ*(1), 66-75.
- Okimiji, O., Techato, K., Simon, J., Tope-Ajayi, O., Okafor, A., Aborisade, M., & Phoungthong, K. (2021). Spatial Pattern of Air Pollutant Concentrations and Their Relationship with Metereological Parametrs in Coastal Slum Settlements of Lagos, Southwestern Nigeria. *Atmospher*(12), 1426.
- Okoro, H., Orimolade, B., Adebayo, B., AkandeAB, & Ximba, J. C. (2017). An assessment of Heavy Metals Contents in the soil around a Cement Factory in Ewekoro, Nigeria using Pollution Indices. *Pol.J.Environ.Stud*, 26(1), 221-228.
- Olanrewaju, D. (1991). Spirometric standards for healthy Nigerian childen and adolescents. *East African Medical Journal*, 68(10), 812-819.
- Olumide, A., & Ademola AD, F. (2018). Experimental investigation of the performance and emission characteristics of a CI engine equipped with a modified truncated cone piston crown operated on diesel and shea-butter biodiesel. *Eur J Eng Res Sci*, 3(10), 126-131.
- Olumide, A., & Ademola, A. (2018). Impact of conical piston crown equipped compression ignition engine on performance. *Eur J Eng Technol*(6), 13-25.
- Olumide, A., & Ademola, D. (2016). Di-methyl ether (DME) as a substitute for diesel fuel in compression ignition engines. *Int J Adv Res Eng Manage*(2), 39-47.
- Olumide, A., Towojua, & Ishola, A. (2020). A case for the internal combustion engine powered vehicle. *The 6th International Conference on Powerand Energy Systems Engineering (CPESE 2019)* (pp. 315-321). Okinawa Japan: Energy Reports 6.
- Oluwafemi, O., Arinola, G., Huo, D., & Olopade, C. (2017). Household biomass fuel use,astham symptoms severity and asthma underdiagnosis in rural school children in Nigeria: a cross-sectional observational study. *BMC Pulmonary Medicine*(17), 3.
- Omofonmwan, S., & Odia, L. (2009). Oil exploration and conflict in the Niger-Delta Region of Nigeria. *Kamla-Raj.Journ.Human Ecol*, 26(1), 25-30.
- Omokungbe, R., Fawole, G., Owoade, K., Olalekan, A., Jones, R., Olise, F., . . . Sunmonu, A. e. (2020). Analysis of the variability of airborne particulate matter with prevailing metereological conditions across a semi-urban environement using a network of low-cost air quality sensors. *Heliyon* 6, e04207.
- Onder, S., & Dursun, S. (2006). Air orne heavy metal pollution of cedrus libani (A.Rich) in the city centr of Konya (Turkey). *Atmos Environ*(4), 1122- 1133.
- OPEC. (2013). *World Oil Outlook Report*. Vienna, Austria: Organization of petroleum exporsting countries.
- Ostro, B., Feng, W., Broadwin, R., & Lipsett, M. (2007). The effects of component of fine particulate air pollution on mortality in Carlifornia: Results from CALFINE. *Environ.Health Perspect*(115), 13-19.
- Otero, N., Tolosana-Delgado, R., Solera, A., Pawlowsky-Gahn, V., & Canals, A. (2005). Relative vs absolute statistical analysis of compositions : A comparative study of surface waters of a Mediterreanean river. *Water Res*(39), 1404-1414.

- Owoade.OFS, Ogundele, L., Fawole, O., & Olaniyi, H. (2012). Correlation between particulate matter concentration and meteorological parameter at a site in Ile-Ife, Nigeria. *J.Sci*, 14(1), 83-93.
- Pachauri, T., Singla, V., Satsangi, A., Lakhani, A., & Maharaj Kumari, K. (2013). SEM-EDX Characterization of Individual Coarse Particles in Agra, India. *Aerosol and Air Quality Research*(13), 523-536.
- Pandolfini, M., Querol, X., Alstuey, A., Jimenez, J., Jorba, O., Day, D., . . . Sicard, M. e. (2014). Effects of sources and meteorology on particulate matter in the Western Mediterranean Basin: an overview of the DAURE campaign. *J.Geophys.Res*(119), 4978-5010.
- Parker, J., & Diop-Kane, M. (2017). *Meteorology of Tropical West Africa: The forecaster's Handbook, First Edition*. Sussex, United Kingdom: John Wiley and Sons Limited.
- Pascal, M., Corso, M., Chanel, O., Declercq, C., Badaloni, C., Cesaroni, G., & al, e. (2013). Assessing the public health impacts of urban air pollution in 25 European cities: results of the Aphekom Project. *Sci.Total Environ*(449), 390-400.
- Patlolla, A., Barnes, C., Field, J., & Hackett, D. T. (2009). Potassium dichromate induced cytotoxicity, genotoxicity and oxidative stress in human liver carcinoma (HepG2) cells. *Int. J Environ Res Public Health*(6), 643-653.
- Pearce, J., Richardson, E., Mitchell, R., & Shortt, N. (2010). Environmental justice and health: the implications of the socio-spatial distribution of multiple environmental deprivation for health inequalities in the United Kingdom. *Trans Inst Br Geogr*, 35(4), 522-539.
- Pegin, P., & Sitnichuk, E. (2017). The effect of sun glare: concept, characteristics, classification. *Transportation Research Procedia*(20), 474-479.
- Pelletier, B., Santer, R., & Vidot, J. (2007). Retrieving of Particulate matter from optical measurements: a semi-parametric approach. *Journal of Geophysical Research*(112), 18.
- Pereira, C., & Hung, Y.-T. (2004). *Air Pollution Control Engineering: A handbook of Environmental Engineering* (Vol. 1). (L. k, & Wang, Éd.s.) Totowa, New Jersey, United States: Human Press Inc. 999 Riverview Drive, Suite 208.
- Perks, C., & Mudd, G. (2019). Titanium, Zirconium resources and production: A state of the art literature review. *Ore Geology Reviews*(107), 629-646.
- Pernigotti, D., Belis, C., & Spano, L. (2016). SPECIEUROPE: The European database for PM source profiles. *Atmospheric Pollution Research*(2), 307-314.
- Petit, J., Amodeo, T., Meleux, F., Bessagnet, B., Menut, L., Grenier, D., & Favez, O. (2017). Characterising an intense PM pollution episode in March 2015 in France from multi-site approach and near real time data: Climatology, variabilities, geographical origins and model evaluation. *Atmos.Environ*, 68-84.
- Petit, J., Pallares, C., Favez, O., Alleman, L., Bonnaire, N., & Riviere, E. (2019). Sources and Geographical origins of PM10 in Metz (France) using oxalate as a marker of secondary organic aerosols by positive matrix factorization analysis. *Atmosphere*, 10070370.
- Pey, J., Querol, X., Alastuey, A., Foratiere, F., & Stafoggia, M. (2013). African dust outbreaks over the Mediterranean Basin during 2001-2011: PM10 concentrations, phenomenology and trends, and its relation with synoptic and mesoscale meteorology. *Atmos.Chem.Phys*, 1395-1410.
- Phalen, F. (2003). The particulate air pollution controversy. *Atmosphere*(19), 401-408.
- Piazzola, J., Sellegri, K., Bourcier, L., Mallet, M., Tedeschi, G., & Missamou, T. (2012). Physicochemical characteristics of aerosols measured in the spring time in the Mediterranean coastal zone. *Atmos.Environ*(54), 545-556.
- Pio, C., Alves, C., Nunes, T., Cerqueira, M., Lucarelli, F., Nava, S., . . . Karanasiou, A. (2020). Source apportionment of PM2.5 and PM10 by ionic and mass Balance (IMB) in a traffic influenced urban atmosphere, in Portugal. *Atmos, Environment*(223), 117217.

- Pirrone, N., Cinrella, S., Feng, X., Finkelman, B., Friendl, R., Leanre, J., . . . Streets, G. e. (2010). Global mercury emissions into the atmosphere from anthropogenic and natural sources. *Atmos.Chem Phys*, 10(13), 5951-5964.
- Pope & Dockery, D. (2006). Health effects of fine particulate air pollution: Lines that connect. *Journal Air Waste Management Association*(56), 709-742.
- Pope III, A., & Dockery, D. (2006). Critical Review: Health Effects of fine particulate Air Pollution: Lines that connect. *J.Air Waste Manage.Assoc*(56), 709-742.
- Poschl, U. (2005). Atmospheric Aerosols: composition, Transformation, Climate and Health Effects. *Angew.Chem.Int*(44), 7520-7540.
- Poschl, U. (2005). Atmospheric aerosols: Composition, transformation, climate and health effects. *Angew.Chem.Int.Edit*(44), 7520-7540.
- Prabhu, V., Soni, A., Madhval, S., Gupta, A., Sundriyal, S., Shridhar, V., . . . Mahapatra, P. (2020). Black carbon and biomass burning associated high pollution episodes observed at Doon valley in the foothills of the Himalayas. *Atmos.Res.*(243), 105001.
- Priego, C., & Luque de Castro, M. (2007). *Anal. Bioanal.Chem*(387), 249-257.
- Prospero, J., & Mayol-Bracero, O. (2013). Understanding the Transport and Impact of African Dust on the Caribbean Basin. *Bulletin of American Meteorological Society*, 94(9), 1329-1337.
- Prospero, J., Collard, J., Molinie, J., & Jeannot, A. (2014). Characterizing the annual cycle of African dust transport to the Caribbean Basin and South America and its impact on the environment and air quality. *Global Biogeochem Cycles*(28), 757-773.
- Prospero, J., Ginoux, P., Torres, O., & Nicholson, S. (2002). Environmental characterization of global sources of atmospheric soil dust identified with the Nimbus 7 Total Ozone Mapping Spectrometer (TOMS) absorbing aerosol product. *Rev.Geophys*(40), 1002.
- Prospero, J., Ginoux, P., Torres, O., Nicholson, S., & Gill, T. (2002). Environmental characterization of global sources of atmospheric soil dust identified with the Nimbus 7 Total Ozone Mapping Spectrometer (TOMS) absorbing aerosol production. *Reviews of Geophysics*, 40(1), 1002.
- Punis, K. (1994). Color control improves pigment quality. *Quality*, 33.
- Purdue University. (2018, May). *Scanning Electron Microscope*. Consulté le February 5th, 2022, sur [purdue.edu: https://www.purdue.edu/ehps/rem/rs/sem.htm](https://www.purdue.edu/ehps/rem/rs/sem.htm)
- Qian, Y. (2009). Point sources of Pollution: Local effects and their control. Dans *Encyclopaedia of Life Support Systems*. St. Aldate's, Oxford OX1 1BN, United Kingdom: EOLSS Publishers Co.Ltd/UNESCO.
- Quajer, P., Borsboom, G., Brunekreef, B., Zach, M., Forche, G., Cotes, J., & al, e. (1995). Spirometric reference values for white European Children and adolescents: Polgar revisited. *Pediatric Pulmonology*, 19(2), 135-142.
- Querol, X., Alastuey, A., Amato, F., Moreno, T., Castillo, S., Pey, J., . . . Zabalza, J. (2007). Source origin of trace elements in PM from regional background, urban and industrial sites of Spain. *Atmospheric Environment*, 7219-7231.
- Querol, X., Alastuey, A., Moreno, T., Viana, M., Castillo, S., Pey, J., . . . Cuevas, E. (2008). Spatial and temporal variations in airborne particulate matter (PM10 and PM2.5) across Spain 1999-2005. *Atmos.Environ*(42), 3964-3979.
- Rajnoha, R., Jankovsky, M., & Merkova, M. (2013). Economic comparison of automobiles with electric and with combustion engines; An analytical study. *2nd World Conference on Business, Economic and Management-WCBEM* (pp. 225-230). Budapest: Procedia-Social and Behavioral Sciences 109 (2014), WCBEM.
- Ramanathan, V., Crutzen, P., Leliveld, J., Mitra, A., & Althausen, D. a. (2001). Indian Ocean Experiment: An integrated Analysis of the Climate Forcing and Effects of the Great Indo-Asian Haze. *J.Geophys. Res*(106), 28371-28399.
- Ravi, S. e. (2011). Aeolian processes and the biosphere. *Rev.Geophys*, 49, RG3001.

- Reid, J. e. (2003). Analysis of measurements of Saharan dust by airborne and ground-based remote sensing methods during the Puerto Rico Dust Experiment (PRIDE). *J.Geophys.Res*(108), 8586.
- Reimann, C., & de Caritat, P. (2000). Intrinsic flaws of element enrichment factors (EFs) in environmental geochemistry. *Environ.Sci.Technol*(34), 5084-5091.
- Reimann, C., & de Caritat, P. (2005). Distinguishing between natural and anthropogenic sources for elements in the environment: regional geochemical surveys versus enrichment factors. *Sci.Total.Environ*(337), 91-107.
- Reimann, C., Arnoldussen, A., Englmaier, P., Filmoser, P., Finne, T., Garrett, R., . . . Nordgulen, O. (2007). Element concentrations and variations along a 120-km transect in southern Norway-Anthropogenic vs geogenic vs biogenic element sources and cycles. *Appl.Geochem*(22), 851-871.
- Reimann, C., Filzmoser, P., Garrett, R., & Dutter, R. (2008). Statistical data analysis explained. Dans R. Chichester, *Applied Environmental Statistics* (p. 362). New Jersey: Wiley Publishing.
- Rexeis, M., & Hausberger, S. (2020). Trend of vehicle emission levels until 2020-Prognosis based on current vehicle measurements and future emission legislation. *Atmos.Environ*(43), 4689-4698.
- Riberio, N., Pinto, A., Quintella, C., da Rocha, G., Teixeira, L., Guariero,LL, d. C., . . . Serpa da Cruz, R. (2007). The role of additives for diesel and diesel blended (ethanol or biodiesel) fuels: a review. *Energy Fuels*(21), 2433-2445.
- Richardson, E., Pearce, J., Tunstall, H., Mitchell, R., & Shortt, N. (2013). Particulate air pollution and health inequalities: a Europe-wide ecological analysis. *International Journal of Health Geographics*(12), 34.
- Riedl, M., & Diaz-Sanchez, D. (2005). Biology of diesel exhaust effects on respiratory function. *J.Allergy Clin. Immunol*(115), 221-228.
- Ritchie, H., & Max, R. (2019). *CO2 and other greenhouse gas emissions* . Consulté le April 15, 2019, sur <https://ourworldindata.org/Co2-and-other-greenhouse-gas-emissions>
- Rosenfeld, D., Lohmann, U., Raga, G., O'Dowd, C., Kulmala, M., Fuzzi, S., . . . Andreae, M. (2008). Flood or drought: how do aerosols affect precipitation? *Science*, 321(5894), 1309-1313.
- Rosenlund, M., Picciotto, S., Forastiere, M., Stafoggia, M., & Perrucci, C. (2008). Traffic-related Air Pollution in Relation to Incidence and Prognosis of Coronary Heart Disease. *Epidemiology*, 19(1), 121-128.
- Rouadi, P., Idriss, S., Naclerio, R., Peden, D., Ansotegui, I., Canonica, G., . . . Hellings, P. e. (2020). Immunological Features of Air Pollution and Its impact on Inflammatory Airway Diseases (IAD). *World Allergy Organ. J*(13), 100467.
- Rouil, L., Bessagnet, B., Favez, O., & Garzandia, E. (2015). Episodes de pollution particulaire en France: quel enseignements tirer des recents episodes? Particulate Air pollution in France: lessons learnt from recent episodes. *Poll.Atmos*, 101-114.
- Roy, A., Hu, W., Wei, F., Korn, L., Chapman, R., & Zhang, J. (2012). Ambient particulate matter and lung function growth in Chinese children. *Epidemiology*(23), 464-472.
- Sadiq, A., Khardi, S., Lazar, A., Bello, I., Salam, S., Faruk, A., . . . Sfarghiu, A. (2022). A characterization and cell toxicity assessment of Particulate pollutants from Road traffic sites, Kano State,Nigeria. *Atmosphere*, 13(1), 80. doi:Doi.org110.3390/atmos13010080
- Sadler, T. (2012). *Langman's Medical Embryology* (éd. Twelfth Edition). Baltimore, Maryland, United States of America: Williams and Wilkins, a Wolters Kluwer Health Business,351 West Camden Street.
- Saenz, J., Wong, R., & Ailshire, J. (2018). Indoor air pollution and cognitive function among older Mexican adults. *J.Epidemiol.Commun.Health*(72), 21-26.
- Salameh, D., Pey, J., Bozzetti, C., El Haddad, I., Detornay, A., Sylvestre, A., . . . mARCHAND, n. (2018). Sources of PM2.5 at an urban-industrial Mediterranean city.Marseille (France): Application of the ME-2 solver to inorganic and organic markers. *Atmos.Res*(214), 263-274.

- Salma, I., Maenhaut, W., Zemplén-Papp, E., & Zarav, G. (2001). Comprehensive Characterization of Atmospheric Aerosols in Budapest, Hungary: Physicochemical Properties of Inorganic Species. *Atmos. Environ.*(35), 4367-4378.
- San Francisco World Economic Forum. (2016, April 22). *The number of cars worldwide is set to double by 2040*. Consulté le June 12, 2019, sur weforum: <https://www.weforum.org/agenda/2016/04/the-number-of-cars-worldwide-is-set-to-double-by-2040>
- Santer, B. (2007). Identification of human-induced changes in atmospheric moisture content. *Proc. Natl. Acad. Sci. USA*(104), 248-15 253.
- Santos, T. (2020). Confronting governance challenges of the resource nexus through reflexivity: A cross-case comparison of biofuel policies in Germany and Brazil. *Energy Res. Soc. Sci.*(65), 101464.
- Scanlon, D., & Shriver, D. (2010). "Race correction" in pulmonary-function testing. *New England Journal of Medicine*, 363(4), 385.
- Scheuvens, D., Schultz, L., Kandler, K., Ebert, M., & Weinbruch, S. (2013). Bulk composition of northern African dust and its source sediments—a compilation. *Earth Sci. Rev.*(116), 170-194.
- Scheuvens, D., Schutz, K., Kandler, K., Ebert, M., & Weinbruch, S. (2013). Bulk composition of northern African dust and its source sediments—a compilation. *Earth Sci Rev.*(116), 170-194.
- Schipper, L., Fabian, H., & Leather, J. (2009). *Transport and Carbon dioxide Emissions: Forecasts, Options Analysis and Evaluation*. ADB sustainable Development working Paper Series. Mandaluyong: ADB: Philippines.
- Schipper, O., Haddad, S., Fullam, S., Pourzal, R., & Wimmer, M. (2018). Wear characteristics of conventional ultrahigh Molecular Weight Polyethylene versus highly cross-linked Polyethylene in Total Ankle Arthroplasty. *Foot and Ankle International*, 39(11), 1335-1344.
- Schlesinger, R., Kunzli, N., Hidy, G., & Gotschi, T. (2006). The health relevance of ambient particulate matter characteristics: coherence of toxicological and epidemiological inferences. *Inhalation Toxicology*, 95-125.
- Schoenwolf, G., Bleyl, S., Brauer, P., & Francis-West, P. (2015). *Larson's Human Embryology* (éd. Fifth Edition). Philadelphia, Philadelphia, PA 19103-2899, United States of America: Churchill Livingstone an imprint of Elsevier Inc. Elsevier Saunders, 1600 John F. Kennedy Blvd, Ste 1800.
- Schroth, A., Crusius, J., Sholkovitz, E., & Bostick, B. (2009). Iron solubility driven by speciation in dust sources to the ocean. *Nat. Geosci.*, 2(5), 337-340.
- Schulz, M., Prospero, J., & Baker. (2012). Atmospheric transport and deposition of mineral dust to the ocean: implications for research needs. *Environ. Sci. Technol.*, 49(19), 10390-10404.
- Schwarze, P., Ovrevik, J., Hetland, R., Becher, R., Cassee, F., Lag, M., . . . Refsnes, M. (2007). Importance of size and composition of particles for effects on cells in vitro. *Inhal Toxicol.*, 19(Suppl 1), 17-22.
- Schwarze, P., Totlandsdal, A., Herseth, I., Holme, A., Lag, M., Refsnes, M., . . . Bolling, K. (2010). Importance of sources and components of particulate air pollution for cardio-pulmonary inflammatory responses. *In Air Pollution; Rijeka, V.V., Ed.; Sciyo: Oslo, Norway*, 47-54.
- Schwarze, P., Totlandsdal, A., Herseth, J., Holme, J., Lag, M., Refsnes, M., . . . Boling, A. (2010). Importance of components and sources for health effects of Particulate Air Pollution. *Air Pollution*, 83947.
- Scimeca, M., Bischetti, S., Lamsira, H., Bonfiglio, R., & Bonnanno, E. (2018). Energy Dispersive X-ray (EDX) microanalysis: A powerful tool in biomedical research and diagnosis. *European Journal of Histochemistry*, 62, 2841.
- Scimeca, M., Orlandi, A., Terrenato, I., Bischetti, S., & Bonanno, E. (2014). Assessment of metal contaminants in non-small cell lung cancer by EDX microanalysis. *Eur J Histochem.*(58), 2403.
- Seinfeld, J., & Pandis, S. (1998). From Air Pollution to Climate Change. *Atmospheric Chemistry and Physics*.
- Senapati, U., McDevitt, I., & Hankinson, A. (2011). Vehicle refinement challenges for a large displacement engine with cylinder deactivation capability. *SAE Technical Paper 2011-01-1678*.
- Shahabuddin, M., Liaquat, A., Masjuki, H., Kalam, M., & Mofijur, M. (2013). Ignition delay, combustion and emission characteristics of diesel engine fueled with biodiesel. *Renew. Sustain. Energy Rev.*(21), 623-632.

- Shao, Y. e. (2011). Dust cycle: An emerging core theme in Earth system science. *Aeolian Res*(2), 181-204.
- Shi, S., Zhang, H., Yang, W., Zhang, Q., & Wang, X. (2019). A life cycle assessment of battery electric and internal combustion engines: A case in hebei province, China. *Journal of Clean Production*, 228, 606-618.
- Shi, Z., Shao, L., Jones, T., Whittaker, A., Lu, S., Berube, K., . . . Richards, R. (2003). Characyerization of Airborne Individual Particles collected in an Urban Area, a satellite city and a clean Air Area in Beijing,2001. *Atmos. Environ*(37), 4097-4108.
- Shikuan, J., Yingying, M., Ming, Z., Wei, G., Lianfa, L., & Xin, M. (2019). Comparism of Aerosol optical properties and associated radiative effects of Air pollution events between summer and winter: A case study in January and July 2014 over Wuhan, Central China. *Atmos. Environ*(218), 117004.
- Shrivastava, I. (2006). *Environmental education principles, concepts and management* (éd. 1st Edition). New Delhi, India: Karishika Publishers.
- Sicard, P., Khaniabadi, Y., Perez, S., Gualtieri, M, & De Marco, A. (2019). Effect of O3, PM10 and PM2.5 on cardiovascular and respiratory diseases in cities of France, Iran and Italy. *Environ Sci Pollut Res*(26), 32645-32665.
- Simon, H., Beck, L., Bhave, P., Divita, F., Hsu, Y., Luecken, D., . . . Strum, M. (2010). The development and uses of EPA's SPECIATE database. *Atmos. Pollut. Res*, 196-206.
- Sims, R., Schaeffer, R., Creutzig, F., Cruz-Nunez, X., D'Agosto, M., & Dimitriu, D. (2014). Climate Change 2014: mitigation of climate change. Contribution of Working Group III to the fifth assessment report. Dans *The fifth Assessment Report of the intergovernmental Panel on Climate Change*. New York: Cambridge Univeristy Press.
- Singh, S., & Sigh, D. (2010). Biodiesel production through the use of different sources and characterization of oils and their esters as the substitute of diesel: a review. *Renew. Sustain. Energy Rev*(14), 200-216.
- Smith, P., Nkem, J., Calvin, K., Campbell, D., Cherubini, F., Grassi, G., . . . McElwee, P. a. (2019). *Interlinkages between desertification, land degradation, food security and greenhouse gas fluxes: Synergies, trade offs and integrated response options in Climate climate change and land: An IPCC Special Report on climate change, desertification etc*. Geneva: IPCC, Switzerland.
- Sneddon, J., Hardaway, C., Bobbadi, K., & Reddy, A. (2005). *Appl. Spectroscop Rev*(41), 1-14.
- Soleiman, A., Ohtman, M., Abu Samah, A., Sulaiman, N., & Radojevic, M. (2003). The occurrence of haze in Malaysia: A case study in an urban industrial area. *Pure Applied Geophysics*, 160, 221-238.
- Solomon, S., Qin, D., Manning, M., Chen, Z., Marquis, M., Averyt, K., . . . Miller, H. (2007). *Climate change 2007: the physical science basis. In: Contribution of Working Group I to the Fourth Assessment Report of the intergovernmental Panel on Climate Change*. Cambridge, United Kingdom: Cambridge Univeristy, UK and New York, NY, USA.
- Sowlat, M., Gharibi, H., Yunesian, M., Mahmoudi, M., & Lotfi, S. (2011). A novel, Fuzzy-based air quality index (FAQI) for air quality assessment. *Atmos. Environ*(45), 2050-2059.
- Squizzato, S., Cazzaro, M., Innocente, E., Visin, F., Hopke, P., & Rampazzo, G. e. (2017). Urban air quality in a mid-size city-PM2.5 composition, sources and identification of impact areas: From local to long range contributions. *Atmos. Res*(186), 51-62.
- Stedman, J., Kent, A., Grice, S., Bush, T., & Derwent, R. (2007). A consistent method for modeling PM10 and PM2.5 concentrations across the United Kingdom in 2004 for air quality. *Atmos. Environ*(41), 161-172.
- Stephens, G., & Hu, Y. (2010). Are climate-related changes to the character of global precipitation predictable? *Environ. Res. Lett*(5), 025209.
- Stone, E., Yoon, S., & Schauer, J. (2011). Chemical characterization of fine and coarse particles in Gosan, Korea during Springtime Dust events. *Aerosol Air Quality Res*(11), 31-43.

- Stone, V., Miller, M., Clift, M., Elder, A., Mills, N., Moller, P., . . . Cassee, F. (2017). Nanomaterials versus Ambient Ultrafine Particles: An Opportunity to Exchange Toxicology Knowledge. *Environ. Health Perspect*(125), 106002.
- Strinfellow, W., Camarillo, M., Domen, J., Sandelin, W., & Varadharajan, C. e. (2017). Identifying chemicals of concern in hydraulic fracturing fluids used for oil production. *Environ.Pollut*(220), 413-420.
- Sumesh, R., Rajeevan, K., Resmi, E., & Unnikrishnan, C. (2017). Particulate matter concentrations in the southern tip of India: temporal variation, meteorological influences, and source identification. *Earth System.Environment*, 1(2), 13.
- Sumfleth, B., Majer, S., & Thran, D. (2020). Recent developments in low iluc policies and certification in the EU biobased economy. *Sustain*(12), 1-34.
- Sun, Q., Hong, X., & Wold, L. (2010). Cardiovascular effects of ambient particulate air pollution exposure. *Circulation*, 2755-2765.
- Sundararajan, M., & Srinivasalu, S. (2010). Geochemistry of core sediments from Gulf of Mannar, India. *Int.J.Environ.Res*(4), 861-876.
- Suresh, G., Sutharsan, P., Ramasamy, V., & Venkatachalapathy, R. (2012). Assessment of spatial distribution and potential ecological risk of the heavy metals in relation to granulometric contents of Veeranam lake sediments, India. *Ecotoxicol.Environ,Saff*(84), 117-124.
- Sutherland, R. (2000). Bed sediment-associated trace metals in an urban stream, Oahu, Hawaii. *Environ.Geol*(39), 611-637.
- Sutton, D., & Tchounwuo, P. (2007). Mercury induces the externalization of phosphatidylserine in human proximal tubule (HK-2) cells. *Intl J Environ Res Public Health*(4), 138-144.
- Taga, T., Hibi, M., Hirata, Y., Yamasaki, K., Yasukawa, K., & Matsuda, T. a. (1989). Interle, gp130 ukin-6 triggers the association of its receptor with a possible signal transducer. *Cell*(58), 573-581.
- Taiwo, A., Awomeso, J., Taiwo, O., Oremodu, B., Akintunde, O., Ojo, N., . . . Arowolo, T. (2017). Assessment of health risks associated with road susts in major traffic hotspots in Abeokuta metropolis, Ogun State, Southwestern Nigeria. *Stoch.Environ.Res.Risk Assessment*(31), 431-447.
- Tan, Z. (2014). Air Pollution and Greenhouse Gases. Dans *Basic concepts to Engineering Applications for Air Emission Control* (éd. <https://doi.org/10.1007/978-981-287-212-8>, ISSN 978-981-287-212-8 (E-book)). Singapore: Springer Science+Business Media.
- Tao, Z., Braun, S., Shi, J., Kim, D., Matsui, T., & Peters-Lidard, C. (2018). Microphysics and radiation effect of dust on Saharan air layer: An HS3 case study. *Mon.Wea.Rev*(146), 1813-1835.
- Tasdemir, Y., Kural, C., Cindoruk, S., & Vardar, N. (2006). Assessment of trace element concentrations and their estimated dry deposition fluxes in an urban atmosphere. *Atmos.Res*(81), 17-5.
- Taylor, H. (2000). *Inductively coupled mass spectroscopy: Practices and Techniques*. San Diego, USA: Academic Press .
- Tchounwuo, P., Newsome, C., Williams, J., & Glass, K. (2008). Copper-induced cytotoxicity and transcriptional activation of stress genes in human liver carcinoma cells. *Metal Ions Biol, Med*(10), 285-290.
- Tecer, L., Alagha, O., Karaca, F., Tuncel, G., & Eldes, N. (2008). Particulate matter (PM2.5, PM10-2.5 and PM10) nad children's hospital admissions for astham amd respiratory diseases: A bidirectional cas-crossover study. *J.Toxicol. Environ.Health Part A*(71), 512-520.
- Terradellas, E., Nickovic, S., & Zhang, X. (2015). Airborne Dust: A hazard to Human Health. *Environment and Society*, 64(2), 1.
- Thompson, L. (2019). Household Air pollution from cooking Fires is a Global Problem. *Am.J.Nurs*(119), 61-64.
- Thorpe, A., & Harrison, R. (2008). Sources and properties of non-exhaust particulate matter from road traffic: A review. *Science of the Total Environment*, 270-282.

- Timmers, V., & Achten, P. (2016). Non-exhaust PM emissions from electric vehicles. *Atmos. Environ*(134), 10-17.
- Timothy, Z. (2003). *How does an internal combustion Engine Work?* Consulté le November 27, 2021, sur [www.carid.com](https://www.carid.com/articles/how-does-internal-combustion-engine-work.html): <https://www.carid.com/articles/how-does-internal-combustion-engine-work.html>
- Tiotiu, A., Novakova, P., Nedeva, D., Chong-Neto, H., Steiropoulos, P., & Kowal, K. (2020). Impact of Air Pollution on Asthama Outcomes. *Int.J. Environ. Res. Public Health*(17), 6212.
- Tittia, P., Raunemaa, P., Tissari, J., Yli-Tuomi, T., Leskinen, A., Kukkonen, J., . . . Karpinnen, A. (2000). Measurements and modeling of PM_{2.5} concentrations near a major road in Kuopio, Finland. *Atmos. Environ*(36), 4057-4068.
- Tiwari, S., Bisht, D., Srivastava, A., Pipal, A., Taneja, A., Srivastava, M., & Attiri, S. (2014). Variability in atmospheric particulates and meteorological effects on their mass concentrations over Delhi, India. *Atmos. Res*, 145-146, 45-56.
- Tiwari, S., Chate, D., Safai, P., Srivastava, A., Bisht, D., & Padmanabhamurty, B. (2012). Statistical evaluation of PM₁₀ and distribution of PM₁, PM_{2.5} and PM₁₀ in ambient air due to extreme fireworks episodes (Deepawali festivals) in megacity Delhi. *Nat. Hazards*(61), 521-531.
- Touzi, B., Mabrouki, C., & Farchi, A. (2015). Sustainable Road Transportation in developed and developing countries. *Framework and future research*, 4(8).
- Tri-Tugaswati, A., Suzuki, S., Koyama, H., & Kawada, T. (1987). Health effects of air pollution due to automotive lead in Jakarta. *Asia Pac J Public Health*, 23-7.
- Turnock, S., & al, e. (2015). Modelled and observed changes in aerosols and surface solar radiation over Europe between 1960 and 2009. *Atmos. Chem. Phys*(15), 9477-9500.
- Turnock, S., Butt, E., Richardson, T., Mann, G., Reddington, C., Forster, P., . . . al, e. (2016). The impact of European legislative and technology measures to reduce air pollutants on air quality, human health and climate. *Environ. Res. Lett*(11), 024010.
- UN. (2019). *Emissions Gap Report*. Nairobi, Kenya: United Nations Environment Programme.
- UNECE. (2020). *Gothenberg Protocol-Air Pollution-Environmental Policy, Press Release*. Geneva: United Nations Economic Commission for Europe.
- United Nations. (2013). *Climate Change: The Physical Science Basis*. Cambridge: Cambridge University Press.
- United Nations. (2022). *Intergovernmental Panel on Climate Change (IPCC), Sixth assessment report (AR6), Annex VII-Glossary-WG-1*. Geneva, Switzerland: United Nations.
- United Nations-IPCC Report (AR6). (2022). *Intergovernmental Panel on Climate Change (IPCC), Sixth assessment (AR6) of the United Nations, Annex VII-Glossary*. Geneva, Switzerland: United Nations.
- USEPA. (1999). *Guideline for Developing an Ozone Forecasting Program*. Washington DC, United States of America.
- USEPA. (2004). Exposure and human health reassessment of 2,3,7,8-Tetrachlorodibenzo-p-Dioxin (TCDD) and related compounds. National Academy of sciences external review draft. *United States Environmental Protection Agency*.
- UTACCERAM. (2016). *Dossier depresser resultants des controles des emissions depollutants atmosphere risques et de CO₂ mesurés 52 premiers véhicules*. Paris: Union Technique de l'automobile du motocycle et du cycle union de syndicats.
- Vakeva, M., Hameri, K., Puhakka, T., Nilsson, E., Hohti, H., & Makela, J. (2000). Effects of meteorological processes on aerosol particle size distribution in an urban background area. *Journal of Geophysical Research*, 105(D8), 9807-9821.
- Valavanidis, A., Fiotakis, K., & Vlachogianni, T. (2008). Airborne particulate matter and human health: toxicological assessment and importance of size and composition of particles for oxidative damage and carcinogenic mechanisms. *J. Environ. Sci. Health Part C Environ. Carcinog. Ecotoxicol. Rev*(26), 339-362.

- Van Snick, J. (1990). Interleukin-6: an overview. *Annu.Rev.Immunol*(8), 253.
- Vega, E., Ruiz, H., Escalona, S., Cervantes, A., Lopez-Veneroni, D., Gonzalez-Avalos, E., & Sanchez-Reyna, G. (2011). Chemical composition of fine particles in Mexico City during 2003-2004. *Atmos.Pollut.Res*(2), 477-483.
- Viana, M., Pey, J., Querol, X., Alstuey, A., de Leeuw, F., & Lukewille, A. (2014). Natural sources of atmospheric aerosols influencing air quality across Europe. *Science of the Total Environment*(472), 825-833.
- Viard, B., Pihan, F., Promeyrat, S., & Pihan, J. (2004). Integrated assessment of heavy metals (Pb,Zn.Cd) highway Pollution: Bioaccumulation in soil, graminaceae and land snails. *Chemosphere*(55), 1349-59.
- Vinodh, B. (2005). Technology for cylinder deactivation. *SAE Technical Paper 2005-01-0077*.
- Vlachokhostas, C., Nastis, S., Achillas, C., Kalogeropoulos, K., Karmiris, I., Moussiopoulos, N., . . . Limperi, N. e. (2010). Economic damages of ozone air pollution to crops using combined air quality and GIS modeling. *Atmos.Environ*, 44(28), 3352-3361.
- Wang, J., Zhang, L., Niu, X., & Liu, Z. (2020). Effects of Pm2.5 on health and economic loss: Evidence from Beijing-Tianjin-Hebei region of China. *J.Clean.Prod*(257), 120605.
- Wappelhorst, S. (2020). *The end of the road? An overview of combustion engine car phase out announcements across Europe*. Récupéré sur International Council on Clean Transportation, Berlin, Germany: <https://theicct.org/publications/combustion-engine-car-phase-out-EU>
- Wappelhorst, S., & Muncrief, R. (2019). *How can real-world vehicle emissions data help cities to become zero-emission: some evidence from Europe, Policy Dialogue 1*. Paris: The Real Urban Emissions Initiative.
- Weckworth, G. (2001). Verification of traffic emitted aerosol components in the ambient air of Cologne (Germany). *Atmos.Environ*(35), 5525-5536.
- Wei, H., Wei, D., Yi, S., Zhang, F., & Ding, W. (2011). Oxidative stress induced by urban fine particles in cultured EA.hy926 cells. *Hum.Exp.Toxicol*(30), 579-590.
- Weili, L., Xiaobin, X., Zhiqiang, M., Huarong, Z., Xiwen, L., & Wang, Y. (2012). Characteristics and recent trends of sulfur dioxide at urban,rural and background sites in North China: Effectiveness of control measures. *Journal of Environmental Sciences*, 24(1), 34-49.
- Weinbruch, S., Worringen, A., Ebert, M., Scheuven, D., Kandler, K., Pfeffer, U., & Bruckmann, P. (2014). A Quantitative estimation of the exhaust,abrasion and resuspension components of particulate traffic emissions using electron microscopy. *Atmos. Environ*(99), 175-182.
- Weinzierl, B. (2017). The Saharan Aerosol Long-range Transport and Aerosol Cloud Interaction Experiment: Overview and selected highlights. *Bull.Amer.Meteor.Soc*(98), 1427-1451.
- Weiss, M., Bonnel, P., Kuhlwein, J., Provenza, A., Lambrecht, U., Alessandrini, S., . . . al, e. (2012). Will Euro 6 reduce the NOx emissions of new diesel cars: Insights from on-road tests with Portable Emissions Measurement Systems (PEMS). *Atmos.Environ*(62), 657-665.
- Whitby, K., Kittleson, D., Cantrell, B., Barsic, N., & Bolan,DF. (1976). Aerosol size distributions and concentrations measured during the General Motors proving grounds sulfate study. Washington DC,USA: American Chemical Society (CHEM SOC).
- WHO. (1996). *Trace elements in human health and nutrition*. Geneva, Switzerland: World Health Organisation.
- WHO. (2000b). *Guidelines for Air Quality*. Consulté le February 15, 2019, sur World Health Organisation, Geneva: <https://www.who.int/peh>
- WHO. (2001). *Air Quality Guidelines for Europe, Second edition*. Geneva, Switzerland: World Health Organization (WHO) Regional Publications, European Series.
- WHO. (2007). *Health Risks of heavy metals from long-range transboundary air pollution*. Geneva: World Health Organisation,Switzerland.
- WHO. (2011). *Guidelines for Drinking Water Quality. First addendum to the third Edition Volume 1. Recommendation*(4), 449-491.

- WHO. (2013). *Review of evidence on Health Aspects of Air Pollution eREVIHAAP Project Technical Report*. Copenhagen, Denmark: World Health Organization, Regional Office for Europe.
- WHO. (2018). *Household Air Pollution and Health*. Consulté le March 11, 2019, sur World Health Organisation: <https://www.who.int/newsroom/fact-sheets/details/household-air-pollution=and-health>
- WHO Regional Office for Europe. (2013). *Health risks of air pollution in Europe (HRAPIE): Recommendations for concentration-response functions for cost-benefit analysis of particulate matter, ozone and nitrogen*. Copenhagen: WHO Regional office for Europe, UN City, Marmorvej, DK-2100.
- Wikipedia. (2019). *World Energy Consumption*. Consulté le April 17, 2019, sur Wikepeadia.org: https://en.wikipedia.org/World_energy_consumption
- Wilmenski, G. (1984). Composition of the critical nucleus in multicomponent vapor nucleation. *J.Chem.Phys*(80), 1370-1372.
- World Energy Council. (2011). *Global Transport Scenarios 2050*. London: World Energy Council.
- World Population Prospects. (2019). *Department of economic and social affairs, population dynamics*. Geneva: United Nations.
- World Population Prospects. (2019). *Department of economic and social, population dynamics*. Geneva: United Nations.
- Wu, C., Lin, Z., & Liu, X. (2020). The global dust cycle and uncertainty in CMIP5 (Coupled Model Intercomparison Project Phase 5) models. *Atmos. Chem.Phys*(20), 10401-10425.
- Xing, Z., Gaultie, J., Cox, G., Baumann, H., Jordana, M., Lei, X., & Achong, M. (1998). Il-6 is an anti-inflammatory cytokine required for controlling local or systemic acute inflammatory responses. *J Clin Invest*(101), 311-320.
- Xue, W., Hellewell, A., & Radford, S. (2009). Fibril fragmentation enhances amyloid cytotoxicity. *J.Biol.Chem*(284), 34272-34282.
- Yamamoto, M., Yoshizaki, K., Kishimoto, T., & Ito, H. (2000). Il-6 is required for the development of Th-1 cell-mediated murine colitis. *J Immunol*(164), 4878-4882.
- Yamasaki, K., Taga, T., Hirata, Y., Yawata, H., Kawanishi, Y., & Seed, B. a. (1988). Cloning and exoression of the human interleukin-6 (BSF-2/IFN beta 2) receptor. *Science*(241), 825-828.
- Yang, J., Ji, Z., Kang, S., Zhang, Q., Chen, X., & Lee, . (2019). Spatiotemporal varaiations of air pollutants in western China and their relationship to metereological factors and emission sources. *Environ.Pollut*(254), 112952.
- Yao, J., Liu, W., Chen, W., Wang, G., Zeng, Y., Huang, Y., & Lin, J. (2013). Effect of atmospheric parameters on fine particulate concentration in suburban. *Particuology*(11), 48-54.
- Yedjou, G. (2006). Oxidative stress in human leukemia cells (HL-60), human liver carcinoma cells (HepG2) and human Jerkat-T cells exposed to arsenic trioxide. *Metal Ions Biol Med*(9), 298-303.
- Yedjou, G., & Tchounwuo, P. (2007). In Vitro cytotoxic and genotoxic effects of arsenic trioxide on human leukemia cells using the MTT and lakaline single cell gel electrophoresis (comet) assays. *Mol. Cell. Biochem*(301), 123-130.
- Yu, H., Chin, M., Yuan, T., & Bian, H. (2015). The fertilizing role of African dust in the Amazon rainforest: A first multiyear Assessment based on CALIPSO Lidar observation. *Geophysical Research Letters*, 42(6), GL063040.
- Yu, H., Pardoll, D., & Jove, R. (2009). STATS in cancer inflammation and immunity; a leading role for STAT3. *Nat.Rev.Cancer*(9), 798.
- Yu, Y. e. (2020). Disproving the Bodele depression as the primary source of dust fertilizing the Amazon rainforest. *Geophys.Res.Lett*(47), e2020GL088020.
- Zeka, A., Zanobetti, A., & Schwartz, J. (2006). Individual-level modifiers of the effects of particulate matter on daily mortality. *Am.J.Epidemiol*(163), 849-859.

- Zhang, H., Li, F., Wu, Z., Li, D., Xu, D., & Yuan, H. (2008). Baseline concentrations and spatial distribution of Trace Metals in surface soils of Guangdong Province, China. *J. Environ. Qual*(37), 1752-1756.
- Zhang, X., Ross Philip, N., Kostecki, R., Kong, F., Sloop, S., Kerr, J., & al, e. (2001). Diagnostic characterization of high power lithium-ion batteries for use in hybrid electric vehicles. *J. Electrochem Soc*, 148(5), A463-70.
- Zhao, J., Zhang, F., Xu, Y., Chen, J., Yin, L., Shang, X., & Xu, L. (2011). Chemical characteristics of Particulate matter during a heavy dust episode in a coastal city. Xiamen. *Aerosol Air Qual*(11), 299-308.
- Zircon Occurrence in Nigeria. (2021, January). Consulté le May 10, 2021, sur Ministry of Mines and Steel developmen, Federal Republic of Nigeria: <https://portal.minesandsteel.gov.ng/Marketplace/Mineral/occurrence/141>
- Zivin, J., & Neidell, M. (2018). Air Pollution's hidden impacts. *Science*(359), 39-40.
- Zoller, W., Gladney, E., & Duce, R. (1974). Atmospheric concentrations and sources of trace metals at the South Pole. *Science*(183), 199-201.
- Zu, Y., Huang, L., Hu, J., Zhao, Z., Zhang, H., & Ying, Q. (2017). Investigation of relationships between meteorological conditions and high PM10 pollution in a megacity in the western Yangtze River Delta, China. *Air. Qual. Atmos. Health*, 10(6), 713-724.
- Zuidema, P. e. (2019). Is summer African dust arriving earlier to Barbados? The updated long-term in situ dust mass concentration time series from Ragged Point, Barbados, and Miami, Florida. *Bull. Amer. Meteor. Soc*(100), 1981-1986.
- Zuo, R. (2011). Decomposing of mixed pattern of arsenic using fractal model in Gangdese belt, Tibet, China. *Appl. Geochem*(26), S271-S273.
- Zyromski, A., Binial-Piero, G., Burszta-Adamiak, E., & Zamiar, Z. (2014). Evaluation of relationship between air pollutant concentration and meteorological elements in winter months. *J. Water Land Dev*, 22(1), 25-32.

Appendices

Appendix 1: A1-A3 Site Maps.



Figure A-1: Map of Nigeria highlighting Kano State and Satellite image of Kano Municipal Local Government Areas showing typical week day traffic (Source: Google maps®)



Figure A-2: Map of Nigeria highlighting Kano State and Satellite image of Kumbotso Local Government Areas showing typical week day traffic (Source: Google maps®)

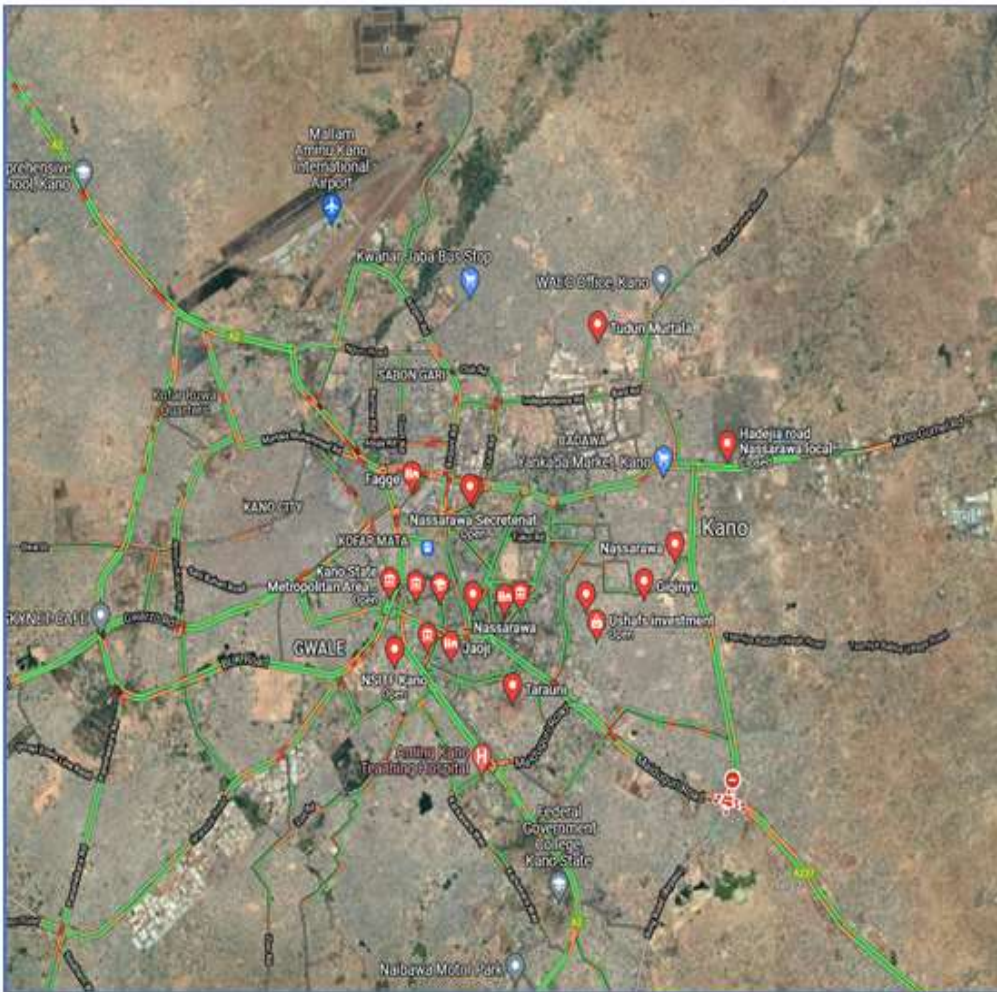

Figure A-3: Map of Nigeria highlighting Kano State and Satellite image of Nassarawa Local Government Areas showing typical week day traffic (Source: Google maps®)

Appendix 2: Feature measurements and Particle Morphological parameters.





- Shape - $\text{sq}(\text{Perimeter})/4\text{Pi} * \text{Area}$
- Beam X - Of longest chord
- Beam Y - Of longest chord
- ECD - Square root of $(4 \times \text{Area})/\text{Pi}$
- Spectrum area - Number of counts in the whole spectrum (except the noise peak) for an individual feature.
- Mean grey level - Mean image grey level over an individual feature.
- Stage X - Calculated stage position of the centre of the longest chord.
- Stage Y - Calculated stage position of the centre of the longest chord.
- Stage Z - Calculated stage position of the centre of the longest chord.
- % - Element % (wt %)

The measurements made during a run are detailed below:

- Area - Area of whole feature in square microns
- Length - Max Feret
- Breadth - Min Feret
- Perimeter - Perimeter of whole feature in microns
- Aspect Ratio - Length/Breadth
- Direction - Of maximum Feret. Angle is from the horizontal in degrees.

MORPHOLOGIE DES PARTICULES (Particle Morphology)

La morphologie (taille et forme) d'une particule est importante pour le classement par type. Par exemple, les fibres d'amiante sont longues et fines. Les mesures suivantes permettent de définir la morphologie d'une particule.

Mesure	Description
Surface	Zone à l'intérieur de la particule, en microns carrés.
Rapport largeur-hauteur	Longueur divisée par largeur, produisant une valeur de 1 ou plus. Les particules symétriques, telles que les sphères ou les cubes, ont un rapport largeur/hauteur de 1 environ. Les particules de forme ovale ou étirée ont un rapport largeur/hauteur très supérieur à 1.
Largeur, longueur	Diamètres maximum et minimum de la particule. Par exemple : 
Direction	Angle d'inclinaison entre l'axe horizontal et la valeur de longueur de la particule. Par exemple, les particules suivantes ont une direction de 60 degrés : 
Diamètre de cercle équivalent (ECD)	Diamètre d'une particule circulaire ayant la même aire que la particule.  Par exemple, les deux particules suivantes ont le même diamètre de cercle équivalent, bien qu'elles aient une forme différente.  Le diamètre de cercle équivalent se définit ainsi : $\sqrt{(4A/\pi)}$, où A correspond à l'aire.

Mesure	Description
Périmètre	Distance totale le long du bord extérieur de la particule. Une particule présentant un bord rugueux a un périmètre plus long et une aire peu importante. 
Forme	Nombre indiquant la forme de la particule. Un cercle a une valeur de 1. Les particules allongées et irrégulières ont des valeurs supérieures. La forme se définit ainsi : $P^2/4\pi A$, où P correspond au périmètre et A, à l'aire.
X Platine Y Platine	Emplacement de la particule. Ces valeurs sont disponibles après une exécution automatisée.

Particle Form:

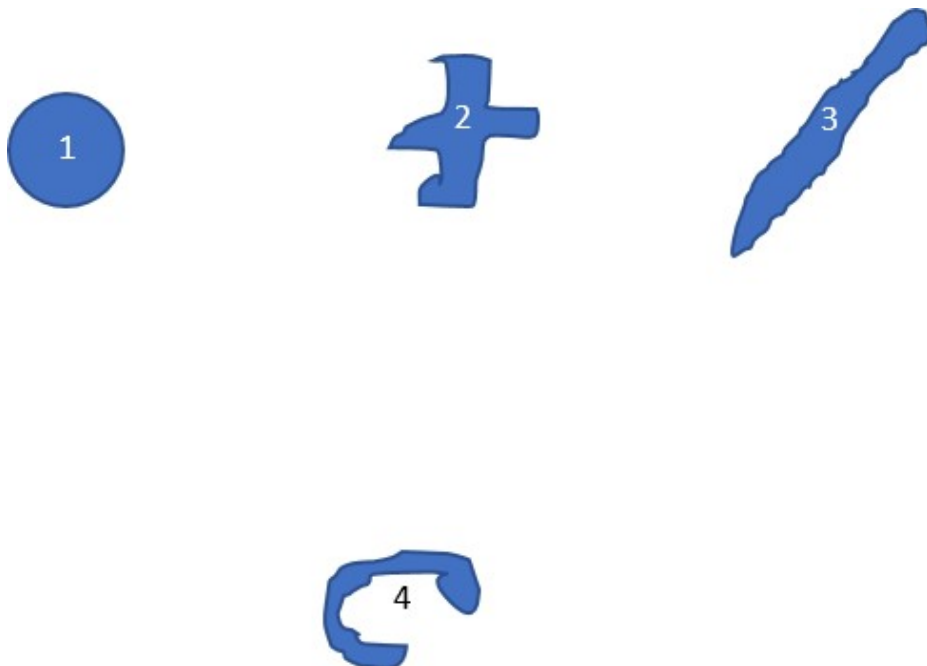

QUESTIONNAIRE ON EFFECT OF EMISSIONS FROM ROAD TRANSPORT VEHICLES ON RESPIRATORY HEALTH IN RURAL AND URBAN COMMUNITIES, KANO STATE, NIGERIA 2019- 2022: COMPARATIVE CROSS SECTIONAL STUDY

This Study tool (questionnaire) has been designed by Dr. Aishatu Abubakar-Sadiq (University of Lyon-INSa Lyon/UGE-Bron, Campus) for use in her PhD research; it is the intellectual property of the author. The section on occupational exposure is adapted from a questionnaire on mineralo-pathology (donated by Minapath/EASE Laboratories, UGE-Bron Campus, Lyon, France). Any interested parties **MUST** seek the written consent of the primary author and supervising body to adapt or use this study tool.

SADIQ Aishatu-Abubakar

University of Lyon, France

Résumé

For use during the implementation phase of Research work in Kano State, Nigeria under Scholarship from Petroleum Technology Development Fund (PTDF), Abuja, Nigeria

SECTION A: Socio-demographic Information

Q1. Sex: Male [] Female []

Q1a. Identification (ID) Number _____

Q1b. Height (M): _____

Q2. Age: <10 years [] 11-19yrs [] 20-29years []
30-39 years [] 40-49years [] >50years []

Q3. Date of Birth: [][][]

Q4. Place of Birth (In Nigeria), if other country
indicate: _____

Within Nigeria: _____

Outside Nigeria: _____

Q5. Occupation (Specify): _____

Q6. Do you live in: Urban [] Rural [] Close to a
highway [] Close to an industrial Area []

Q7. What is your duration of stay in this community?

<1 year [] 1-5 years [] >5 years []

Q8. Educational Level: No Formal Education []
Primary [] Secondary [] Tertiary [] Post-
Tertiary []

Q9. Marital Status: Single [] Married []

Divorced [] Widowed []

SECTION B: Vehicular use

Q10. What is your commonest mean of transportation? Private Cars []
Commercial Public transportation vehicles [] motorcycles [] bicycle []
Horses/donkeys/camels []

Q11. If automotive vehicles are used, specify what type?
Car [] Bus [] Truck [] motorcycle [] bicycle []

Q12. If private vehicle, what is the age of the vehicle?
< 1 year [] 1- 3 years [] 3- 5 years [] >5 years []

Q13. What is your average duration of daily transit by road?
<2hours [] 2-5 hours [] >5 hours []

Q14. In general, do you think you have been exposed to mineral particles or outdoor air pollutants?
Yes [] No []

Q15. In general, do you think you have been exposed to Outdoor Air pollutants/emissions from industries or vehicles?
Yes [] No []

Q16. If you were exposed, did you use any means of protection? Always | _ |
Sometimes | _ | Never | _ |

Q17. What jobs did you do and for how long? List_____

Q18. How often do you use Public Transportation?
Daily [] Weekly [] Monthly [] Yearly []

Q19. Why do you use Public transportation?

I don't have a private vehicle it's convenient it saves money/cost it's safer
Reduces effect on the environment other reason (specify)

Q20. What type of Public Transportation do you use?

Cars Buses Motor-cycles 3 wheelers/Tuk- Tuk Bicycle

Q21. Are you satisfied with the services of the public transport system you utilize? Extremely satisfied satisfied somewhat satisfied Not satisfied

Q22. If not satisfied, explain why? **(WRITE CLEARLY)**

.....

Q23. Are you aware there are other types of road transport vehicles which don't use petroleum products?

Yes No

Q24. If yes, which type of vehicles do you know?

Coal Electricity Solar Nuclear Others

Q25. Would you be willing to use these vehicles with newer sources of energy? Yes
No

Q26. Do you think Road transport vehicles using newer sources of energy are better than the old petroleum products fueled ones?

Yes No

Q27. How would you grade traffic control in your community/city/locality? Excellent
Good Average Bad

Q28. How do you think traffic control and management can be improved in your locality/community/state?

Increased legislation Improved enforcement increase in traffic workforce
Community involvement Introduction of safety trainings on road usage in schools
 others

Q29. If others selected in question 28 above **[SPECIFY]**

.....

Q30. Are you satisfied with the driving experience in your locality or community?

Yes [] No []

Q31. How would you rate the quality or adequacy of the following on roads or areas you drive on or travel in via public transportation?

Road Infrastructure	Condition/Quality			
	I don't know	Not available	Poor Condition	Good Condition
Road Surface Quality				
Road Planning/layout				
Speed Breakers				
Road Markings				
Lighting				
Road Signs				
Traffic Lights				
Emergency Services for accidents				

SECTION C: Medical History

Q32. Do you have a Family history of Respiratory disease or allergies?

Yes [] No []

Q33. Do you have a history of chronic disease (s)? Yes []

No []

Q34. Which ones?

Respiratory [] Cardiac [] Other []

Q35. Do you have allergic terrain or have you ever been diagnosed or experienced allergies?

Yes [] No []

Q36. If yes, for which allergens? _____

Q37. Have you ever been diagnosed as hypersensitive to certain metals (skin reaction to jewels, bracelets ...)? Yes [] No []

Q38. Have you ever experienced productive cough of greater than 2 weeks?

Yes [] No []

Q39. Did you seek medical care?

Yes [] No []

Q40. If yes, what was the diagnosis?

Q41. Do you currently suffer from productive or not?

Yes [] No []

Q42. Do you smoke:

Yes [] No []

Q43. Number of packages smoked-Years: | _____

Q44. During your lifetime, have you ever taken any drugs by injection (e.g., cocaine, heroin, morphine, crack or other)?

Yes [] No []

Q45. Have you ever used sniffing drugs (e.g., tobacco snuff, cocaine or other drugs)? Yes []

No []

Q46. And have you ever sniffed powdered household products? Yes []

No []

SECTION D: *Exposure in the Context of Professional Activities*

Q47. Do you in Agriculture?

<1 year [] 1-5 years [] >5 years [] No []

Specify type of work?: harvests, handling hay or plants, outdoors, in a location confined, handling of rice husks, bedding, use of insecticides (name?)?

Q48. Are you in or did you have a career in MINES or the DRILLING of tunnels?

<1 year [] 1-5 years [] > 5 years [] No []

Q49. In building and public works sector

<1 year [] 1-5 years [] > 5 years [] No []

If yes, specify: demolition, sandblasting, cutting of cement or concrete, use of stones, restoration, masonry activity, plasterer painter, roofer, electrician, carpentry, Works site maintenance: sweeping, cleaning?

Q50. Did you have a career or do you work in the manufacture or sizing of glass, crystal, fiber glass or other artificial mineral fibers?

<1 year [] 1-5 years [] > 5 years [] No []

If yes, which ones: raw materials (sands, quartz), refractory materials, glasses, fibers synthetic? Specify which, Grinding or sizing of glass or crystal?

Q51. Do you or did you work in the manufacture of cement?

<1 year [] 1-5 years [] > 5 years [] No []

If yes, specify handling of raw materials: clay, limestone, sand, diatomaceous earth?

Q52. Do you or did you work in the manufacture of abrasive materials?

<1 year [] 1-5 years [] > 5 years [] No []

If yes, how: manufacture and / or use of silicon carbide, powder manufacture scouring, abrasive papers, detergents, corundum for emery paper, grinding wheels?

Q53. In the manufacture of ceramics: bricks, pipes, installations, sanitary, porcelain, pottery, refractory materials, and emaux.

<1 year [] 1-5 years [] > 5 years [] No []

If yes, in what way, specify: mixtures, casts, frosting, finishes with glaze enamel?

Q54. Did you or do you work in In metallurgy, electro metallurgy or steelwork?

<1 year [] 1-5 years [] > 5 years [] No []

Q55. Did you or do you work in in the production of silicon or ferrosilicium?

<1 year [] 1-5 years [] > 5 years [] No []

Q56. In a foundry (cast iron and non-ferrous metals such as copper, aluminum, etc.)?

<1 year [] 1-5 years [] > 5 years [] No []

If yes, in what way: by doing casting operations, abrasive blasting

(Blasting, sanding ...) or deburring, breaking and shaking the molds to get out the products in the installation or repair of furnaces or furnaces, by handling sand or materials

Q57. In the manufacture of metallic products, including manufacture of metal frameworks, machines or transport equipment?

<1 year [] 1-5 years [] > 5 years [] No []

Q58. In the rubber or manufacturing sector plastics, paint or paint use?

<1 year [] 1-5 years [] > 5 years [] No []

If yes, including: handling raw materials such as Tripoli or ground

for the manufacture of putty, by handling raw materials such as tripoli, ground, diatoms, talc or silica flour, as for the manufacture of putty? Including: by doing painting work on plaster or making sanding paints?

Q59. Did you or do you work in the manufacture of soaps, cosmetics, medicines?

<1 year [] 1-5 years [] > 5 years [] No []

Q60. Did you or do you work in the manufacture or use of asphalt or felt bituminous?

<1 year [] 1-5 years [] > 5 years [] No []

Q61. Did you or do you work in the manufacture of chemicals for agriculture or of dental equipment?

<1 year [] 1-5 years [] > 5 years [] No []

If yes, how: in sanding or polishing, using sand, abrasive materials (e.g., abrasive powders) or cutting or abrasive equipment (e.g., file, saw, sander, brush or metal sponge)?

Q62. In the automotive manufacture or repair?

<1 year [] 1-5 years [] > 5 years [] No []

Q63. In the ebenisterie, carpentry, work of wood, sawmilling

<1 year [] 1-5 years [] > 5 years [] No []

If yes, for example: by sawing, sanding, polishing, carving soft wood or essences exotic wood, using abrasive materials or equipment (eg sandpaper, sponge or wire brush)?

Q64. In plumbing, heating installation or repair, boiler?

<1 year [] 1-5 years [] > 5 years [] No []

If yes specify for example: by performing welding, drilling, descaling boiler, on coal boilers, by handling ashes or concretions?

Q65. Did you or do you work in the printing or reprography sector?

<1 year [] 1-5 years [] > 5 years [] No []

Q66. Did you or do you have work with asbestos or have used asbestos in your work?

<1 year [] 1-5 years [] > 5 years [] No []

Q67. Have you been exposed to asbestos in a passive way, for example if a building in which you worked contained asbestos?

<1 year [] 1-5 years [] > 5 years [] No []

Q68. Have you regularly used fungicides, pesticides, Herbicides or insecticides in powder, solid or in pellets,

Mix in water or dilute in water? Where have you worked regularly in places where someone had just used it?

<1 year [] 1-5 years [] > 5 years [] No []

Q69. Have you happened, to make you care of maintenance (dusting, washing, ironing ...) of Empoussier work clothes by: mineral dust (sand, clay, plaster, asbestos ...),metal dust ...or wood

<1 year [] 1-5 years [] > 5 years [] No []

Q70. Apart from all the answers you have given so far, do you think that you have been exposed, during professional activities?

Yes [] No []

Q71. Apart from all the answers you have given so far, do you think that you have been exposed, during Non- professional activities?

Yes []

No []

SECTION E: Exposure in the context of nonprofessional activities

Q72. Have you ever done DIY ACTIVITIES? Such as plastering, welding, flooring, carpentry

Yes []

No []

If yes specify, especially: in cutting, polishing, sanding, filing, welding, use of abrasive products (sanding, abrasive papers ...), etc. ... with exposure to particles, Mineral, wood, metal or artificial particles (resins, polymers) respirable?

Q73. Do you practice CLEANING OR CLEANING ACTIVITIES regularly using abrasive products (e.g., powdered detergents, scouring powder)? :

Yes []

No []

Apart from all the answers you have given so far, do you think that you have been exposed, during professional activities?

Q74. Have you ever used TALC?

Apart from all the answers you have given so far, do you think that you have been exposed, during professional activities?

Yes []

No []

Q75. For beauty treatments or to heal your skin, have you ever PRACTICED MUD BATHS, APPLIES CLAY MASKS?

Apart from all the answers you have given so far, do you think that you have been exposed, during professional activities?

Yes []

No []

Q76. Do you use a lot of makeup powders, lipsticks? Yes []

No []

Q77. Do you practice outdoor domestic gardening or farming?

Yes []

No []

Q78. HAVE YOU LIVED OR HAVE YOU BEEN IN CONTACT REPEAT with a person whose work clothes were sturdy? For example, your father used bruises for his work or tinkering and reported them to the house containing dust

Yes []

No []

Q79. Do you have traditional tribal marks or tattoos? Yes []

No []

Q80. Do you have dental implants? Yes []

No []

Q81. Do you have articular prostheses?

Yes []

No []

If yes, A. What is the date of lying?_B. What type?_____

Q82. Do you have other implantable devices? Yes []

No []

If yes: specify Injectable silicone, Breast prosthesis, Silicone prosthesis, Silicone ring in case of bariatric surgery, Cochlear implant

Q83. Do you take regular medications?

Yes []

No []

If yes, specify

- Based on powders?
- Of tablet or capsule type?
- Injectable?

Q84. Regarding your eating habits, how much portion/fraction do you eat per week from?

-Meat:

-Fish:

-Vegetables:

-Starches:

Q85. What oil do you usually use to cook?_____

Q86. Do you use margarines enriched in ω -3?_____

Thank you for your participation.

All responses you have given will be kept anonymous and answers coded for analysis.

This Structured Questionnaire is designed by Dr. Aishatu Abubakar Sadiq (Petroleum Technology Development (PTDF) Scholar for use in her research under supervision at EAS/LaMCos Laboratories, University of Lyon, France. It is the intellectual property of the author and is protected by copyright. Any unauthorized copying or use of all or part of this study tool without the express written permission of the author is prohibited.

Appendix 4: Ethical approval letter



KANO STATE OF NIGERIA
MINISTRY OF HEALTH
2nd & 3rd Floor, Post Office Road,
P.M.B. 3066, Kano.

Commissioner: 08023337427
Permanent Secretary: 09096639985
website: www.kanostateminiistryofhealth.gov.ng

MOH/DRP/97T/3/1700

30th September 2019

Ref: _____

Date: _____

Dr Aisha Abubakar Sadiq,
PTDF PhD Scholar,
MEGA Doctoral School,
University of Lyon,
France.

RE: APPLICATION FOR ETHICAL APPROVAL

Reference to your letter dated 20th September, 2019 on the above request addressed to the Chairman Health Research Ethics Committee of the Ministry requesting for ethical approval to conduct a Research work in Municipal, Nassarawa and Kumbotso Local Government Areas, Kano State.

2. The research entitled "*Effect of Particulate and Non Particulate Emissions from Road Transport Vehicles on Air Quality and Health of Communities within Industrial and Commercial; Urban and Rural Areas of Kano State, Nigeria 2019-2022*" is for the Award of Doctor of Philosophy Degree in Environment, Mechanics and Health.

3. In view of the foregoing, I wish to convey the Ministry's approval for you to conduct the research at the above mentioned LGAs.

4. You are also requested to share your findings with the Ministry of Health, Kano State.

5. Best Regards

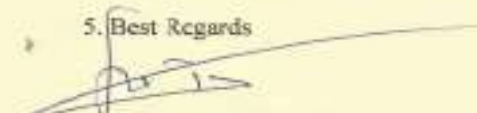
Liti Gwarzo, Abdullahi
DPRS
Secretary (HREC)
For: Honourable Commissioner

CONSENT FORM FOR KEY INFORMANT INTERVIEWS

My name is _____ (ADD YOUR NAME) a _____ (ADD TITLE OR ROLE) here with partners/colleagues from Ministry of health, Kano State. I am a Consultant Medical Epidemiologist/Researcher with the Government; we are conducting a study in partnership with the University of Lyon and Research institutions in France. The title of the study is: ***“Effect of Particulate emissions from Road Transport Vehicles on health of communities in Urban and Rural Areas, Kano State, Nigeria”***. You have been selected as a key stakeholder in the field of Road transportation/health/environment to participate. I will be grateful if you can participate as a respondent.

All that is required of you as a participant is to answer some select questions. Your responses will be written down and audio tapes made. Everything you say will be confidential and anonymous-no one will know what you personally said, and we will only share the summary of your combined responses.

If you agree to participate, kindly sign in the space below, participation is entirely **voluntary**. Refusal to participate will not affect you in any way. You should be willing to provide us with all the necessary information needed from you during the course of the study.

The outcome of the study will be used to improve environmental management, road transportation and health policy in your community and State.

Thank you

Name of participant:

Sign/ Thumbprint: _____

Date: _____

Name of researcher

Sign/ Thumbprint _____

Date _____

CONSENT FORM FOR STRUCTURED QUESTIONNAIRE

My name is _____ (ADD YOUR NAME) a _____ (ADD TITLE OR ROLE) here with partners/colleagues from Ministry of health, Kano State. I am a Consultant Medical Epidemiologist/Researcher with the Government; we are conducting a study in partnership with the University of Lyon and Research institutions in France. The title of the study is: *“Effect of Particulate emissions from Road Transport Vehicles on health of communities in Urban and Rural Areas, Kano State, Nigeria”*. You have been selected as a **RESPONDENT** in based on sampling of households to participate. I will be grateful if you can participate as a respondent.

All that is required of you as a participant is to answer some select questions. Your responses will be written down and audio tapes made. Everything you say will be confidential and anonymous-no one will know what you personally said, and we will only share the summary of your combined responses.

If you agree to participate, kindly sign in the space below, participation is entirely **voluntary**. Refusal to participate will not affect you in any way. You should be willing to provide us with all the necessary information needed from you during the course of the study.

The outcome of the study will be used to improve environmental management, road transportation and health policy in your community and State.

Thank you

Name of participant:

Sign/ Thumbprint: _____

Date: _____

Name of researcher

Sign/ Thumbprint _____

Date _____

PTDF, NIGERIA/UNIVERSITY OF
LYON/EASE/LAMCOS LABORATORIES, FRANCE

**KEY INFORMANT
GUIDE FOR
COMPARATIVE STUDY
ON PARTICULATE
POLLUTANTS,
TRANSPORTATION AND
HEALTH, STATE, 2019-
2022**

*For administration to keystakeholders in health,
transportation and environment*

This Key informant Interview (KII) guide is designed by Dr. Aishatu Abubakar Sadiq (Petroleum Technology Development (PTDF) Scholar for use in her research under supervision at EAS/LaMCos Laboratories, University of Lyon, France. It is the intellectual property of the author and is protected by copyright. Any unauthorized copying or use of all or part of this study tool without the express written permission of the author is prohibited.

LIST OF IDENTIFIED KEY STAKEHOLDERS:

1. Director of Public health (DPH), Kano state Ministry of Health (MoH), Nigeria
2. Director of Environment, Ministry of Environment (MoE), Kano State, Nigeria
3. Head of Federal Road Safety Corps (FRSC), Kano Sector Command, Nigeria
4. Representative of Road Transport Workers Union (RTWUR), Kano State, Nigeria
5. Environmental Health Officers in selected Local Government Areas (LGAs)
6. Health Workers at health facilities in selected LGAs, Kano State, Nigeria
7. Lead Epidemiologists, Ministry of Health (MoH), Kano State, Nigeria

ASSESSMENT AREAS:

1. Introduction and Socio-demographics
2. Road Vehicular Use
3. Legislation and regulation of Vehicular Emissions
4. Industrial emissions and environmental health
5. Respiratory diseases, health education and Public health campaigns on non-communicable diseases (NCDs)
6. Air quality and its control
7. Role of stakeholders in Air pollution control

NUMBER OF RESPONDENTS:

Thirty-five respondents (35) were selected using convenience sampling from the categories stated above. As the information obtained in this KII is for use in triangulation, not as a separate study, adequate information can be obtained by ensuring representativeness from each category.

PROGRAM AREAS:

This is a Key informant interview guide (KII) for use by _____ (PhD Student name) as part of a thesis titled “Effect of Particulate pollutants from Road transportation vehicles on health of communities in urban and rural areas, Kano State, Nigeria”. This study is being conducted under sponsorship by the Petroleum Technology Development Fund (PTDF), Nigeria in partnership with research institutions in France. This is a part of fulfillment for a PhD from the University of Lyon, France. The study will assess emissions, air quality and respiratory health within selected urban

and rural areas of Kano state, Nigeria.

All participants will be introduced briefly to the scope and nature of the study, subsequently informed consent (verbal or written) will be obtained.

MODE OF ADMINISTRATION:

When conducting the interview the following measures will be implemented:

- The respondents will receive an explanation on the anonymous nature of the interview, and subsequently asked to read and sign the informed consent form. If the respondents are illiterate, the form will be read out and translated for comprehension prior to signing.
- The interviews will be conducted in teams of two. One person asking the questions, with the other making written and audio notes for later transcription.
- After each question specific instructions in BLOCK letters will be written, they are NOT to be read to the respondents. They are instructions to aid the interviewer in completing the interview.
- All relevant answers should be ticked in corresponding boxes.
- For rating scales the complete scale must be read and an answer obtained from the respondent within the same scale.
- Additional probing questions can be asked if needed and where indicated.
- All responses for open ended questions should be written word for word on the dotted lines, and made clear and understandable for others.
- No summarization of responses should occur. All answers must be written and referral to audio tapes made if necessary.

LGA (Urban/Rural)	Type of settlement	Date (dd/mm/yyyy)	Interview Number

INTRODUCTION:

This interview aims to identify the role of emissions (particulate and non-particulate) in air pollution within Kano state. The effect of industrial emissions in relation to vehicular emissions in different locations will also be assessed. It will focus on the effect of both on human health specifically respiratory health in urban and rural areas. Focus will be on thematic areas that affect all the study components; vehicular emissions, industrial emissions, legislation/traffic control, air quality and health.

READ THE INFORMED CONSENT FORM TO THE RESPONDENTS AND MAKE THEM SIGN IT.

1.1 What is your current position? (WRITE THE RESPONSE BELOW)

1.2 What is your current place of work or institution? (WRITE THE RESPONSE BELOW)

1.3 Are you a representative of _____ (READ RESPONSES BELOW) . TICK ALL THAT APPLY

/ / The Federal Road safety Corps (FRSC)

/ / The Federal Ministry of Health (FMoH)

/ / The State Ministry of Health (SMoH)

/ / Ministry of Environment (MoE)

/ / Union of Road transport workers (URTW)

/ / Local Government health union (LGAHU)

/ / Health Facility

/ / National Environmental standards and Regulatory Agency (NESREA)

Others

(SPECIFY) _____

SECTION 2.0 VEHICULAR USE AND SAFETY IN RELATION TO EMISSIONS

2.1 in your opinion what is responsible for the increased car ownership in Nigeria (CHECK ALL THAT APPLY)

- / / increased importation of Road vehicles
- / / Rapid Urbanization
- / / Breakdown of Public transportation
- / / Increased Job opportunities in the cities
- / / Availability of car loan from banks
- / / Improved Road infrastructure and expanded road networks
- / / Economic empowerment/increased job opportunities
- / / Overpopulation and need for faster transportation

Others (SPECIFY) _____

2.2 In relation to your previous response, what is the single most important factor that is responsible for increased car ownership in Nigeria?

2.3 In your opinion where is the highest concentration of Road vehicles?

- / / Urban
- / / Rural
- / / I don't know

2.3.1 Why? Explain answer

2.4. In your opinion which is higher in (State or LGA)?

- / / Private car ownership
- / / Public car ownership (commercial vehicles)
- / / I don't know

2.5. What in your opinion are the most commonly used Road transport vehicles in your locality or settlement?

/ / Car

/ / Bus

/ / Truck

/ / Motorcycle

/ / Bicycle

/ / I don't know

2.6. How would you classify the car maintenance culture or practice in your area (community/locality)?

/ / Good

/ / Average

/ / Bad

/ / I don't know

2.7. Do you believe the age of most (>50%) of privately owned Road vehicle in the country are generally from:

/ / <1 year

/ / 1-3 years

/ / 3.5 years

/ / >5 years

2.8. In your opinion what is the average duration of transit spent daily by road vehicle users within your state?

/ / < 2 hours

/ / 2-5 hours

/ / > 5 hours

2.9. What type of settlements do you believe are most frequently located near highways and road junctions?

/ / Residential

- / / Commercial
- / / Industrial
- / / Administrative
- / / Mixed Type
- / / I don't know

2.10. In your opinion what are the commonest sources of emissions from Road transport vehicles in your area or locality?

- / / Exhaust Fumes
- / / Tyres
- / / Brakes
- / / Engine wear
- / / I don't know

2.11. What in your opinion of the QUANTITY of Road traffic regulators available on the roads in your area or locality? (CHECK ONE BOX FOR EACH ITEM)

Category of Road traffic regulators	Poor 1	Adequate 2	Good 3	I don't know 0
1 Federal Road safety corps members, traffic controllers, other governmental agencies e.g. civil Defence, police force				
2 Non — governmental agencies e.g. URTWR, volunteers				

2.12. In your opinion what is the role of automated vehicles and use of intelligent transportation in ensuring green motility?

Positive [] Negative []

2.12A. Explain your answer in 2.12 above (WRITE THE ANSWER CLEARLY)

SECTION 3.0: LEGISLATION AND REGULATION OF VEHICULAR EMISSION

3.1. In your opinion does vehicular emission in Nigeria require legislation?

/ / Yes

/ / No

/ / I don't know

3.2. Are you aware of any existing laws and regulation on emissions from vehicles in Nigeria?

/ / Yes

/ / No

/ / I don't know

3.3. In your opinion which organization should implement laws and regulations on vehicular emissions (CHECK ALL THAT APPLY)?

/ / Federal Road Safety Corps (FRSC)

/ / National environment standards and regulatory Agency (NESREA)

/ / Nigeria Police Force (NPF)

/ / Civil Defence corps

/ / Ministry of Defence (MoD)

/ / Ministry of Environment (MoE)

/ / Ministry of Health (MoH)

Others (SPECIFY) _____

3.4. In your opinion would Road Users adhere to the legislation/laws?

/ / Yes

/ / No

/ / I don't know

3.5. In your opinion do existing driver education and driving tests in the country effectively prepare road users for safe road use?

/ / Yes

/ / No

/ / I don't know

3.6. In your opinion do commercial drivers require separate legislation from private drivers?

/ / Yes

/ / No

/ / I don't know

3.7. Can you explain your answer in question 3.6 above (WRITE YOUR COMPLETE RESPONSE?)

3.8. In your opinion how can any legislation and laws be implemented affectively?

/ / Regular Car inspections at point of entry

/ / monitoring of Emission levels

/ / Installation of Air quality detectors

/ / Public health education & risk communication

/ / monitoring and inspection of cars on the roads

/ / Issuance of certificates of road worthiness

3.9. In your opinion should an interdisciplinary team be set up to monitor and supervise regulations and standards of vehicular emissions?

/ / Yes

/ / No

/ / I don't know

3.10. Explain your answer in 3.9 above (WRITE YOUR RESPONSE CLEARLY)

SECTION 4.0 INDUSTRIAL EMISSIONS AND THE ENVIRONMENT

4.1. In your opinion do factories and industries produce emissions into the Air?

/ / Yes

/ / No

/ / I don't know

4.2 Do you believe the level of emissions from factories and industries in your locality or community are safe for Humans?

/ / Yes

/ / No

/ / I don't know

4.3. In your opinion what type of effect can industrial emissions have on humans, plants and animals?

/ / Positive

/ / Negative

/ / I don't know

4.4. In your opinion what type of diseases in humans can be related to emissions into the Air from industries? (CHECK ALL THAT APPLY)

/ / Gastrointestinal diseases

/ / Respiratory diseases

/ / Cardiac diseases

/ / Musculoskeletal diseases

/ / Nervous system disorders

/ / Reproductive Diseases/disorders

/ / I don't know

4.4a. Can you explain your answer if multiple responses are chosen in 4.4 above.

4.5. In your opinion who should ensure the maintainance of safe emission levels into the air from industries/factories?

/ / Government

/ / State Government

/ / Local Government

/ / Factory/industry owners

/ / Non-governmental organizations

/ / Community members

/ / International / global community and organizations

4.6. In your opinion how can factory workers and owners protect themselves and their staff from high emission levels while at work?

/ / Protective clothing

/ / limiting work hours

/ / monitoring emission levels

- / / Taking medication
- / / Taking traditional herbs
- / / eating fruits and vegetables
- / / I don't know

4.7. Explain your answer in 4.6 above (WRITE YOUR RESPONSE CLEARLY)

SECTION 5.0: RESPIRATORY DISEASES, HEALTH EDUCATION AND PUBLIC HEALTH CAMPAIGNS ON NON-COMMUNICABLE DISEASES IN NIGERIA.

5.1 What do you think is the commonest respiratory disease in Nigeria?

- / / Tuberculosis / / Pneumonia / / Asthma / / Pertussis
- / / Others

5.2. If you selected "others" as your response in 5.1 above (WRITE THEM OUT CLEARLY HERE)

5.3. What do you think causes respiratory disease in Nigeria?

- ./ / Infection / / Hereditary / / Cold weather / / Allergies / / Cigarette smoking
- / / others

5.4. If others selected in 5.3 above, please specify (WRITE ANSWER CLEARLY}

5.5. How can you protect yourself from respiratory diseases?

- / / wear warm clothing / / Practice effective hygiene/cough etiquette
- / / Vaccination / / Use of traditional herbs / / Taking drugs (antibiotics) / / others

5.6. If you selected "others" as your response in 5.1 above (WRITE THEM OUT CLEARLY HERE)

5.7. What is your source of information on respiratory diseases?

- / / Media: TV, Radio, newspapers, flyers
- / / Health facility
- / / Schools
- / / Community outreaches
- / / work place
- / / Others

5.8. Do you believe you have adequate information on how to protect yourself against ALL respiratory diseases?

- / / Yes / / No / / I don't know

5.9. Have you ever received information on non-communicable/non-infective respiratory diseases?

- / / Yes / / No / / I don't know

5.10. If yes, which ones, specify (WRITE YOUR ANSWER CLEARLY IN FULL)

5.11. Do you think adequate information is being provided on non-communicable diseases in Nigeria?

- / / Yes / / No

5.12. Who do you think should provide your community with information on non-communicable respiratory diseases?

- / / Government / / Non-governmental organizations
- / / Faithbased organizations / / International organizations
- / / Traditional rulers / / others

SECTION 6.0 AIR QUALITY AND CONTROL

6.1 Have you ever heard of air quality? / / Yes / / No

6.2 If yes, what do you know that can affect Air quality?

- / / Open Fires/bush burning / / Factories and industrial emissions
- / / Cigarette smoking / / Waste discharge into water bodies
- / / Exhaust fumes from Cars / / Deforestation / / Others

6.2 If others selected in 6.2 above, specify (WRITE ANSWER CLEARLY}

6.3 How would you classify the Air quality in your community/locality/state?

/ /Excellent / / Good / / Average / / Bad

6.3 Explain your answer in 6.3 above (WRITE FULL ANSWER CLEARLY)?

6.4 Do you think you can contribute to improving Air quality?

Yes/ /No/ / / /I don't know

6.6. If yes indicated in 6.5 above, describe how you can do this (WRITE ANSWER CLEARLY AND FULLY)?

6.7. Do you know of any measures in place in your community/locality/state set up to Improve Air quality?

/ / Yes / / No / / I don't know

SECTION 7.0 ROLE OF STAKEHOLDERS IN AIR POLLUTION CONTROL IN NIGERIA AND AFRICA

7.1 Who do you believe is responsible for regulating Air quality and Air pollution control in your locality/community/state?

/ / Government / / Non-governmental organization

/ / Community members / / International organizations / / Faith

Based organization / / others

7.2 What can you as a citizen do to improve Air quality and reduce Air pollution in Nigeria?

7.3 Would you say there has been a change in Air quality and Air pollution levels in the past:

/ / < 1 year / / 1-3 years / / 3- 5 years / / > 5 years

7.4 Would you classify this change as?

/ / Positive / / Negative / / I don't know

7.4 Do you believe enough measures or regulations are in place to control Air pollution?

/ / Yes / / No / / I don't know

7.5 Would you uphold to adhere to any new regulations or laws regarding

regulation of air pollution or improvement of Air quality?
/ / Yes / / No / / I don't know

All your responses will be kept anonymous and only a cumulative summary shared.

Thank you for your co-operation and Participation.

This Key informant Interview (KII) guide is designed by Dr. Aishatu Abubakar Sadiq (Petroleum Technology Development (PTDF) Scholar for use in her research under supervision at EAS/LaMCos Laboratories, University of Lyon, France. It is the intellectual property of the author and is protected by copyright. Any unauthorized copying or use of all or part of this study tool without the express written permission of the author is prohibited.

Appendix 7: Air Sampling and Field work Pictures.



Plate 1: Working in partnership with a representative of the Federal Road Safety Corps (FRSC) to measure Wind speed and ambient temperature before collection of air samples at Nassarawa and Kumbotso LGAs, Kano State, Nigeria.



Plate 2: Portable digital spirometer, disposable mouthpieces and batteries used to conduct Spirometry assessment in communities, Kano State, Nigeria.



Plate 3: Pictures showing participants from multi-disciplinary agencies (Transportation, health and environment) during the training of field workers. Additional images show field workers administering the questionnaires, performing chest auscultation and conducting respiratory Spirometry.

Appendix 8: Table A1–A4 on experimentation steps.

Table A1: Weight Difference in Grams (Pre and Post sample collection) of Poly-Sulfone Filters used for Air sampling in Nigeria

Filter No	Pre-collection Weight (Grams)	Post-collection Weight (Grams)	Weight difference (Sample weight Grams)
01	8.3738	8.3794	0.0056
02	8.3622	8.3634	0.0012
03	8.3885	8.3956	0.0071
04	8.3037	8.3050	0.0013
05	8.3706	8.3757	0.0051
06	8.2345	8.2409	0.0064
07	8.4124	8.4162	0.0038
08	8.4909	8.4968	0.0059
09	8.3421	8.3459	0.0038
10	8.3397	8.4156	0.0759
11	8.2201	8.2256	0.0055
12	8.3365	8.3430	0.0065

Table A2: Instruments used for air sampling, Kano State, Nigeria













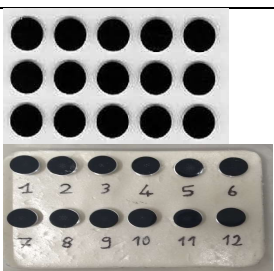

S/N	Image	Name	Description
		Automated Fixed flow rate Verderflex Pump © mounted on a portable motor board	Fixed flow rate pump (V=2l/min) attached to tubing bifurcated at the end to fit filters
2		Polysulfone air filters	Contains silicone O-ring used for sterile filtration to collect air samples for cell culture. Height of 80mm and maximal application temperature 180°C. Hose connectors (external 11mm)
3		Stainless steel filters	Contains silicone O-ring used for sterile filtration to collect air samples for cell culture. Height of 80mm and maximal application temperature 180°C. Hose connectors (external 11mm). Used to collect samples for SEM-EDX
4		SEM Specimen Stubs	Aluminium SEM specimen stubs 12.5mm diameter, 3.2 x 6mm pin. Used to mount polyurethane filters after air sampling in preparation for use with SEM-EDX microscope.
5		Polyurethane membrane	Used to trap air particles on entry into filters using suction provided by the pump.
6		Back up Battery	Inserted into motor board to power Verderflex pump due to blackouts experienced in rural sites.
7		Digital anemometer	Used to measure and record; temperature and wind speed prior to air sampling at all sites.



Table A3: Comparison of elemental prevalence by settlement type for particle sizes <math><5.0\mu\text{m}</math>

S/N	Settlement	<math><0.5\mu\text{m}</math>
1	Urban (Kano Municipal)	<ul style="list-style-type: none">▪ Silicate Compounds 73%▪ Compose Ca: 6%▪ Non-classified: 5%
2	Rural (Kumbotso)	<ul style="list-style-type: none">▪ Silicate compounds: 53%▪ Zircon: 19%▪ O<math><51</math> and Non classified 7%
3	Urban/mixed Nassarawa	<ul style="list-style-type: none">▪ Zircon: 57%▪ O<math><51</math>: 12%▪ Silicate Compounds: 9%

** Silicate Compounds identified were predominantly Aluminium Silicate (AlSi) containing mainly Aluminium, others: Silicate Aluminium containing mainly silicates, Silicate Titanium (SiTi), Silicate Sodium Aluminium Potassium (SiNaAlK) and silicate Sodium Aluminium (SiNaAl).

Table A4: Instruments used in Cell cytotoxicity Testing

S/N	Image	Name	Description
1		Polysulfone filters, sonicator and 96% ethanol	Used to ensure sterility and complete removal of particles from filters.
3		Evaporation of ethanol from particle solution using Nitrogen chamber	Used to obtain particles in solid form by complete fluid evaporation in preparation for cytotoxicity studies.
4		PBS, DMEM and Trypsin for cell culture	Media, nutrient source and enzyme used in cell culture.
5		Prepared Cells	Cells during cell culture prepared prior to particle introduction to assess cytotoxicity.
6		Culture Flasks	Used to hold, store and mix cells during cell culture.
7		Centrifuge	Used for separation into sediment and supernatant.
		High resolution microscope	Used to visualize cells and capture images.
		MTT Test Kit	Used to assess cellular viability based on physiological function within the mitochondria.

		Vortex	For adequate mixing.
		Introduction of test components to wells	Pipette holders used to introduce test components into wells within the test tray.
		Micro-Plate reader	Used to read absorbance at specific wavelengths depending on test being undertaken.

Appendix 9: Publications, Conferences and Written communications.

This work has been performed in the research institute directed by Than Minh Do:

Environment, transportation and health
Universit e Gustave Eiffel, Bron Campus
25 Avenue Francois Mitterrand, Lyon, France

And

IMBL within Contacts and mechanic structures Laboratory (LamCos) directed by Nathalie Bernoud-Hubac

University of Lyon, CNRS, INSA Lyon, LamCos UMR5259, 69621, Villeurbanne,
France

It has given rise to the following articles:

1. Sadiq, A.A.; Khardi, S.; Lazar, A.-N.; Bello, I.W.; Salam, S.P.; Faruk, A.; Alao, M.A.; Catinon, M.; Vincent, M.; Trunfio-Sfarghiu, A.-M. A Characterization and Cell Toxicity Assessment of Particulate Pollutants from Road Traffic Sites in Kano State, Nigeria. *Atmosphere* **2022**, *13*, 80. <https://doi.org/10.3390/atmos13010080>
2. Sadiq AA, Khardi S, et al. *Emissions from road transport vehicles and respiratory health in rural and urban communities, Kano State, Nigeria: A comparative cross sectional study*. Accepted full paper at combined International conference on environment and biotechnology (ICESB 2021) and 12th International Conference on Future Environment and Energy (ICFEE 2022), January 2022, Osaka, Japan. Published under licence by IOP Publishing Ltd [IOP Conference Series: Earth and Environmental Science, Volume 1046, 12th International Conference on Future Environment and Energy \(ICFEE 2022\) 20/01/2022 - 22/01/2022 Online Citation](#) Aishatu A Sadiq *et al* 2022 *IOP Conf. Ser.: Earth Environ. Sci.* **1046** 012001. <https://iopscience.iop.org/article/10.1088/1755-1315/1046/1/012001>. ISSN ~1755 ~1315 indexed in El Compendex, Scopus, Inspec et al.
3. Sadiq AA, Khardi S, Trunfio Sfarghiu AM, Wada Bello I. *A Review or road transportation, air pollution and the vehicular registration system (2016 ~ 2019) in Rural and Urban communities, Kano State, Nigeria*. Published in Worldwide journal of multidisciplinary research and development (WWJMRD) 2021, 7 (3), 00 ~ 00. E ISSN 2454 6615.

And to the presentation of the following communications:

Oral Presentations:

-Key stakeholders on transportation, emissions and health, Kano State, Nigeria presented at 8th International conference on Environment and Pollution Prevention (ICEPP), 3RD-5TH December 2021, Sydney, Australia.

- Vehicular emissions and respiratory health in rural and urban communities, Kano State (*Awarded best overall presentation*) presented at 15TH International Conference on environment, health and safety (ICEHS), March 2021, Rio De Janeiro, Brazil.

- Emissions from road transport vehicles and respiratory health in rural and urban communities, Kano State, Nigeria: A comparative cross sectional study (*Awarded best overall presentation*). Abstract and published full paper/abstract published in **International Conference Proceedings** at combined International conference on environment and biotechnology (ICESB 2021) and 12th International Conference on Future Environment and Energy (ICFEE 2022), Osaka, Japan.

Poster presentations:

- Effect of particulate emission from Road transportation Vehicles on health of communities in rural and urban areas of Kano State, Nigeria (Accepted for presentation at scientific meeting in LamCos).
**The meeting was cancelled due to the Covid-19 Pandemic.

Also presented the following communications:

-A review of collaborative research paper on characterization and toxicity assessment of particulate emissions from multiple road transportation sites in Nigeria. Presented at LamCos/IMBL seminar, January-February 2022

-A Theses Update and Manuscript presentation on; a characterization and cell toxicity assessment of particulate pollutants from road traffic sites in Kano State, Nigeria. Presented at LamCos, Seminar, 15th February 2022

Oral:

-Kano state Government: An introduction to collaborative research on exploring the link between air pollution and human health, Presented at Kano State Ministry of health to Key stakeholders pre-implementation of field work, February 2020, Kano State, Nigeria and UGE-Bron Campus, Lyon.

- Training sessions Lectures to field personnel on: Research methodology, Data tools, field work organogram, qualitative study methods, non-communicable diseases, environmental health, clinical approaches to comprehensive respiratory examination, air pollution and its control, February-March 2019, Royal Tropicana Hotel, Kano State, Nigeria.

-Internal meetings and presentations: Theses updates on effect of particulate emissions from road transportation vehicles and health in communities, research protocol development and field work methodology and progress, September 2019, UGE-Bron Campus, Lyon.

Written:

-Full report of field work findings on interdisciplinary study conducted on particulate emissions and health submitted to Federal Road safety Corps (FRSC), Nigeria Field Epidemiology and Laboratory

training Programme (NFELTP), Nigeria and Ministry of Health and Human Services, Kano State, Nigeria, April 2019.

- Full paper on baseline qualitative study; a review of road transportation, air pollution and the vehicular registration system (2016-2019) in rural and urban communities, Kano State, Nigeria published in worldwide journal of multi-disciplinary research and development (WWJMDRD), April 2021.

