



HAL
open science

Development of laterality : asymmetrical human behaviors and perceptual biases

Jad Hamaoui

► **To cite this version:**

Jad Hamaoui. Development of laterality : asymmetrical human behaviors and perceptual biases. Psychology. Université de Strasbourg, 2022. English. NNT : 2022STRAG024 . tel-03964755

HAL Id: tel-03964755

<https://theses.hal.science/tel-03964755v1>

Submitted on 31 Jan 2023

HAL is a multi-disciplinary open access archive for the deposit and dissemination of scientific research documents, whether they are published or not. The documents may come from teaching and research institutions in France or abroad, or from public or private research centers.

L'archive ouverte pluridisciplinaire **HAL**, est destinée au dépôt et à la diffusion de documents scientifiques de niveau recherche, publiés ou non, émanant des établissements d'enseignement et de recherche français ou étrangers, des laboratoires publics ou privés.

ÉCOLE DOCTORALE 519

Sciences humaines et sociales, perspectives européennes

Laboratoire de Psychologie des Cognitions (UR 4440)

THÈSE présentée par :

Jad Hamaoui

soutenue le : **29 septembre 2022**

pour obtenir le grade de : **Docteur de l'université de Strasbourg**

Discipline/ Spécialité : Psychologie

Développement de la latéralité :

Comportements humains asymétriques et biais perceptuels

Development of laterality:

Asymmetrical human behaviors and perceptual biases

THÈSE dirigée par :

SEGOND Hervé

Maître de conférences HDR, université de Strasbourg

RAPPORTEURS :

JOVER Marianne

Professeur des Universités, université Aix Marseille

MCMANUS Chris

Professeur des Universités, University College de Londres

AUTRES MEMBRES DU JURY :

WEINER Luisa

Professeur des Universités, université de Strasbourg

PAPADATOU-PASTOU Marietta

Maître de conférences, université d'Athènes

STEFANIAK Nicolas

Maître de Conférences, université de Reims Champagne-Ardenne

Remerciements (Acknowledgments)

I would like to thank my jury committee, Marianne Jover, Luisa Weiner, Chris McManus, Marietta Papadatou-Pastou, and Nicolas Stefaniak for agreeing to devote their precious time to reading and assessing this Ph.D. dissertation. Throughout my research project, you were an example for me to follow.

Thanks to Wilf Gardner, Justin Silver, and Laurence de Lussy-Kubisa for proofreading my manuscript.

"Les hommes se trompent en ce qu'ils se croient libres et cette opinion consiste en cela seul qu'ils sont conscients de leurs actions, et ignorants des causes qui les déterminent" Baruch Spinoza

Si on donne raison à l'école philosophique du déterminisme, il y aurait alors des facteurs externes qui ont déterminés mon choix à entamer une thèse de doctorat. Il n'y a aucun doute que mes expériences professionnelles et personnelles, dont font partie les personnes que j'ai côtoyées durant ma vie, ont joué un rôle important dans le chemin que j'ai emprunté. Dans ce qui suit, je tiens à mentionner et remercier toutes les personnes qui m'ont marqué dans mon parcours personnel et professionnel.

Tout d'abord, aucun remerciement ne peut être suffisant pour remercier mes parents : Edmond et Ghada. Cela n'est pas si évident durant notre jeunesse, mais avec l'âge, on se rend compte que nos parents ont fait de leur mieux pour créer le meilleur environnement possible et pour offrir à leurs enfants les opportunités nécessaires afin qu'ils puissent poursuivre leurs rêves. J'ai eu la chance d'avoir ce type de parents et je leur en suis reconnaissant. Chacun de nous a besoin d'une personne qui l'encourage à se surpasser sans relâche. Dans mon cas, c'est sans aucun doute mon frère. Tu as passé des années à m'aider, à m'apprendre, à m'offrir ton temps, ta patience et ta sagesse. C'est en grande partie grâce à toi que je suis arrivé en France. Je tiens alors à te remercier du fond du cœur, Georges. Je te pardonne officiellement d'avoir oublié de mentionner mon prénom dans tes propres remerciements de thèse. Merci à la femme de ta vie, Carmen, de t'avoir rendu le plus heureux des hommes mais aussi de m'avoir encouragé durant ces dernières années. Merci à vous deux pour votre générosité et amour.

J'aimerais à présent remercier les personnes qui ont joué un rôle fondamental lors de mon arrivée en France, et qui sont Chrystel Besche-Richard et Isabella Morrone. Merci pour votre bienveillance envers moi,

merci de m'avoir donné la chance d'intégrer votre master, de m'avoir transmis votre passion pour la psychologie, de m'avoir inspiré à faire de la recherche et surtout, d'avoir cru en moi.

Mes meilleurs souvenirs ont vu le jour à Reims, et cela, c'est grâce à trois personnes. Je dois remercier mes très, très chers amis, Luc, Alban, et Sylvain. Vous avez cru en moi, sacrifié des heures, des jours, et même des semaines à m'apprendre la neuropsychologie, les statistiques et l'écriture d'un mémoire de recherche. C'est grâce à vous que j'ai pu acquérir mon diplôme et l'envie de rester en France. En effet, rester car votre amitié m'était trop chère à mon cœur. Je serai à jamais reconnaissant envers vous. Cette thèse est l'aboutissement des efforts que vous avez consacrés pour moi. Luc et Alban, c'est qu'avec vous que je peux parler de philosophie et intelligence artificielle le matin et penser au paradis rose le soir. J'ai passé deux 14 Juillet que je n'oublierai pas, et l'un d'eux c'était avec vous. C'est ce jour là où on a vu deux portes de l'enfer, celle de Rodin le midi et celle de Paris la nuit. Teddy Picolo, Jean Baptiste Hugo Mitchell, et tant d'autres personnes et situations qu'on a vécues ensemble resterons à jamais dans ma mémoire. Merci Alban pour tes messages de soutien quotidien lors de ma rédaction du manuscrit. Luc, merci sincèrement pour tout le temps que tu as consacré à relire une partie de ma thèse et pour tes retours toujours pertinents. Vous êtes les pédalos de mon bateau. Enfin, Sylvain, je tiens à te remercier pour les discussions sur la vie, l'amour, l'amitié et la politique qu'on a eues toute au long de ces années, les moments inoubliables qu'on a passé ensemble, et merci pour toutes les vacances en Bretagne qu'on a fait.

Je tiens à remercier également une autre personne à qui je dois ma première réelle expérience dans le monde de la recherche, et c'est Jérémie Lafraire. Je tiens à te remercier de m'avoir accepté dans ton équipe de recherche à Lyon. Merci pour toutes les discussions passionnantes sur les sciences cognitives, la philosophie et la psychologie. J'ai tellement appris de toi, et je t'en remercie.

"What would you think if I sang out of tune? Would you stand up and walk out on me? ... Oh, I get by with a little help from my friends" The Beatles

Qu'est-ce que j'aurai pu faire sans mes amis à Strasbourg. Marine, je te remercie pour ton amitié. Tu étais présente tout au long de cette aventure. On s'est vu quasiment chaque jour, du matin jusqu'au soir. Il y a tellement de choses qu'on a partagé ensemble qu'il serait bien trop long de les énumérer ici. C'est pourquoi je résume en te disant ceci : merci d'avoir été à mes côtés, que ce soit dans les moments joyeux

ou difficiles. Merci de m'avoir supporté même dans les périodes où j'étais en mode « grognon ». Sans toi, je n'ose même pas imaginer comment aurai été ma vie à Strasbourg (il ne faut pas exagérer, elle aurait été bien, mais sans saveur). Tu le sais déjà, j'ai attaché mon vélo au tien tout au long de cette aventure et j'espère que cela continuera. Aussi, merci d'avoir relu une partie de ma thèse.

Mon aventure à Strasbourg a été encore plus excitante et formidable grâce à vous, Mylène et Guillaume. Merci pour votre gentillesse, amour, générosité et compagnie ainsi que les moments forts en émotion, comme votre mariage. Mimi et Guigui, j'ai beaucoup appris de vous, dont comment aimer le moment présent, et surtout apprécier le bon vin. Guigui, je n'oublierai jamais les soirées que l'on a passé ensemble et où je cédaï à toi quand tu me disais « allez Jad, encore un seul verre » (pour info, ces moment-là se passent généralement vers 3h-4h le matin).

Merci du fond du cœur à vous, Gaëlle, Lolo, Matthieu, Samy, Szandra, Wilfy et Zizou pour votre amitié, votre gentillesse, votre amour, ainsi que toutes les soirées que l'on a passées ensemble et les discussions qu'on a partagées. Votre compagnie m'a été indispensable. Merci aussi à Livia, pour ta bonne humeur et les meilleures leçons de vie, tu es mon gourou. Merci à vous Luc et Ianis, pour les discussions et les fous rires qu'on a eu durant le travail. Sans vous, la vie au laboratoire aurait été différente. Je remercie également Laura et Romain, sans qui les pauses clopes n'auraient pas été les mêmes.

Merci à Sandrine et aux chercheurs du laboratoire LPC, dont Elisabeth et Bruno. Merci Valérian et Camille pour toutes les discussions ainsi que les rires que l'on a partagés ensemble. Aussi, merci Camille d'avoir relu une partie de ma thèse. Je remercie également tout particulièrement Odile et Jean. Merci à vous deux pour votre écoute constante que vous m'avez accordé durant ces dernières années et pour toute l'aide que vous m'avez apporté. Odile, merci pour ta disponibilité, ta gentillesse, ta bonne humeur ainsi que le temps que tu as consacré afin de m'aider et à m'aiguiller quand je faisais face à mes incertitudes. J'ai été chanceux de t'avoir à mes côtés durant ma thèse. Je le dis encore une fois, un grand merci pour tout.

Je tiens également à remercier toutes les personnes qui, de près ou de loin, ont partagé mon quotidien durant mon parcours. Je remercie mes amis au Liban, surtout Joy, Jad, Jean-Paul, Michel, Marie Joe, Yara Rana, Simona, et Rita. Je remercie aussi mes camarades en France que j'ai rencontré à Reims, Lyon, et Strasbourg : Camille, Solène, Morgane, Dominique, Jeremy, Marie, Arthur, Kenza, Lola, Elise, Erika,

Mechthild, Tatiana, Mika, Théo, Justin, Gary, Marina, Marie-Ange, Thibaut, Marie, Thomas, Claire, Jessie et Cécile. Et aussi, merci à la Lolita, surtout l'équipe des Cash à l'eau (on avait la classe en finale), et mes meilleures voisines de la résidence Soleure. Merci à Leïa Cazanova pour le dessin qui symbolise le sujet de ma thèse.

Je tiens aussi à remercier mes collaborateurs. Tout d'abord, merci sincèrement Nicolas pour tout le temps que tu as consacré à m'aider. Tu as également joué un rôle important dans ma manière d'aborder et de raisonner sur les sujets scientifiques. Ton écoute, tes conseils, et ta rigueur dans le travail m'ont conduit à me surpasser et à acquérir de nouvelles compétences. Tu as cru en moi, et j'espère avoir été à la hauteur de tes attentes. Myriam, merci pour le temps que tu as consacré pour m'accompagner dans mes réflexions statistiques. Je remercie également Jean Luc Velay, Jeremie Danna, Nicolas Sananes, et Chris Minella pour tout le temps que vous m'avez consacré. Merci également aux étudiants de master 1, Chloé Neumann, Elodie Ernst, Arthur Servage, Marine Kessler, Sarah Codello, Sarah Fischer et Valéria Nassar, qui ont eu un rôle très important dans la récolte des données. Aussi, merci à tous les participants qui ont accepté de participer à nos études.

Il reste la personne qui a joué le rôle le plus important dans le chemin qui m'a amené à réaliser ce travail, et c'est bien évidemment mon directeur de thèse. Hervé, sachant que j'avais un parcours atypique issu d'un mélange entre psychanalyse, neuropsychologie, et psychologie cognitive, tu m'as choisi pour conduire ce projet de recherche qui est en psychologie du développement. Tu as cru en moi, et je t'en remercie sincèrement. Merci également pour ta confiance, ton écoute, ta disponibilité et pour les nombreux encouragements que tu m'as prodigués tout au long de ces années.

Pour clôturer ces longs remerciements, je tiens à exprimer toute ma gratitude aux personnes qui ont partagé mon quotidien et mon intimité durant ces dernières années. Merci aux Ogres de Barback, Jacques Brel, Georges Brassens, Jean Ferrat, Bob Dylan, Dire Straits, The Velvet Underground, David Bowie, Frank Sinatra, et tant d'autres artistes encore. Vous êtes ma zone de réconfort et ma source d'inspiration dans, comme disait Aragon, cet enfer moderne.

Georges Brassens a chanté "*Heureux qui, comme Ulysse, a fait un beau voyage*". Le mien a commencé en 2016, et comme Ulysse, je suis heureux de l'avoir fait.

Table of contents

General introduction	1
Part I - Theoretical overview	6
Chapter 1. Asymmetries in humans: Laterality and neurodevelopment	7
1.1 Handedness and cerebral lateralization	7
1.2 Measuring laterality: challenges and progress	11
1.3 Developmental trends of laterality.....	16
1.4 (Dis)Advantages of laterality.....	19
1.5 Conclusion	23
Chapter 2. Perceptual biases: Show me your drawings and I will tell you your laterality	24
2.1 Graphomotor asymmetries	24
2.1.1 The laterality influence	25
2.1.2 The biomechanical influence.....	28
2.1.3 The cultural influence	28
2.2 Measurements.....	30
2.3 Conclusion	33
Chapter 3. The development of laterality: A multifactorial origin.....	34
3.1 Evolution	34
3.2 Genetics	35
3.3 Steroid hormones	38
3.3.1 Sex hormones: Androgens, estrogens, and progestogens.....	38
3.3.2 Stress hormones: Cortisol.....	39
3.4 Prenatal environment.....	40
3.4.1 Prenatal adversities	40
3.4.2 Developmental cascades	43

3.5	Sociocultural factors.....	46
3.6	Conclusion.....	49
Part II – Thesis Objectives		50
Chapter 4. Research queries and aim of the thesis		51
Part III – Empirical contribution		52
Chapter 5. Identifying graphomotor asymmetrical patterns		53
5.1	Article 1.....	55
5.2	Complementary study 1.....	100
Chapter 6. The role of the prenatal environment in the development of handedness		113
6.1	Article 2.....	116
6.2	Complementary study 2.....	147
Part IV - General discussion		152
Chapter 7. Thesis’ objectives, results, and conclusion.....		153
7.1	Developmental patterns of graphomotor asymmetries.....	155
7.2	Perinatal adversities, laterality, and neurodevelopmental disorders	161
7.3	Thesis conclusion.....	174
References		178
Appendix		213
Article 1.....		213
Complementary study 1.....		224
Article 2.....		234
Complementary study 2.....		240
Résumé en français (<i>French summary</i>)		244

General introduction

Why are we, and how do we become right or left-handed? Why are the majority right-handed, and Ziggy Stardust left-handed? Everyone has asked at least once some of these intriguing questions related to handedness, the most common lateralized behavior in humans. Laterality, which is the focus of this research project, refers to the preference for one side of the body over the other. It reflects the asymmetries that can manifest at a behavioral level (e.g., handedness), and a functional level (Scharoun & Bryden, 2014).

Laterality influences our perception, cognition, and behavior (Manns, 2021a). Furthermore, there is a large body of evidence that behavioral and functional asymmetries are not a unique characteristic of humans, and can be observed also in the animal kingdom (Corballis, 2019; Rogers, 2021). Thus, understanding laterality can be considered of major biological importance, where answering the four questions (i.e., phylogeny, function, ontogeny, mechanism) of Tinbergen (1963) becomes essential. The present dissertation does not extend to studies on the phylogeny (i.e., evolution) and function (i.e., adaptation) of laterality, which reflect an evolutionary view (i.e., answering the question “why”). Instead, the focus of this thesis is on the mechanisms (i.e., causation) and the ontogeny (i.e., development) of laterality, therefore answering the question “how”.

Understanding the developmental mechanisms underlying laterality may shed a light on the etiology of cognitive and motor impairments. Atypical laterality (e.g., non-right-handedness) is frequently mentioned in the scientific literature as belonging to the clinical picture of several neurodevelopmental and psychiatric disorders (Berretz, Wolf et al., 2020). More precisely, a higher prevalence of atypical laterality has been associated with neurodevelopmental disorders such as Developmental Dyslexia (Abbondanza et al., 2022), Developmental Coordination Disorder (Darvik et al., 2018), Intellectual Deficiency (Papadatou-Pastou & Tomprou, 2015), Autism Spectrum Disorders (Markou et al., 2017), Attention Deficit Hyperactivity Disorder (Nastou et al., 2022), psychiatric disorders such as schizotypy personality disorder (Somers et al., 2009) or even schizophrenia (Hirnstein & Hugdahl, 2014) and neurodegenerative diseases (Lubben et al., 2021).

Since the last century, after the discovery of the localization of language in the left cerebral hemisphere by Marc Dax in 1836 and Paul Broca in 1861 and 1863, numerous studies have been conducted to understand laterality. The scientific literature witnessed the birth of several theories that propose an explanation of the relationship between atypical laterality and an atypical development (Annett, 2002; Bakan et al., 1973; Berretz, Wolf et al., 2020; Bishop, 1990a, 2013; Corballis, 1997; Geschwind & Galaburda, 1985; McManus, 2002; Michel, 2021; Previc, 1991; Satz, 1972). Some of these theories stood the test of time, whereas others appeared to be false leads (McManus, 2019). Partly due to the conflicting empirical evidence frequently found in the literature, elucidating the mysteries of laterality has appeared so far to be a challenging job for scientists (Porac, 2016).

Different hypotheses have been proposed to explain the development of laterality and can be summarized into two perspectives, which are not necessarily mutually exclusive. According to the first view, genetics and randomness, which is an important source of variation in human development, are considered as being the major factors underlying human functional and behavioral asymmetries such as handedness (McManus, 2021; Mitchell, 2018). Recent studies have identified multiple gene loci that are associated with mixed- and left-handedness (Cuellar-Partida et al., 2020). While genetic influence accounts for approximately one-quarter of the variance in human handedness, randomness is considered the factor underlying the remaining variance (McManus, 2021). Even if genetics are undoubtedly implicated in the development of laterality (Medland et al., 2009; Medland et al., 2006; Schmitz et al., 2022), it does not explain all the phenotypic variance of laterality, and other factors, such as epigenetic and environmental aspects, could also be involved in its ontogenesis (Michel, 2021; Schmitz et al., 2017). This observation led to an alternative perspective, where genetics plays a limited and indirect role in the ontogenesis of handedness, while environmental influences such as prenatal environment and sociocultural factors are considered to play an important role in its development (Michel, 2021; Previc, 1991). However, there is no clear consensus in the scientific literature regarding the environmental influence on the development of laterality (Porac, 2016). In the light of this theoretical disagreement, the initial motivation for the present research project was to offer new evidence to support or refute the role of the prenatal environment in the development of laterality, while addressing some methodological limitations identified in the past studies.

In the beginning, the aim of this Ph.D. project, which is affiliated with the Laboratory of Psychology of Cognitions (*Laboratoire de Psychologie des Cognitions*; LPC, UR 4440,) and funded by the Grand-Est region (Alsace, France), was to test a theoretical causal cascade based on the Left-Otolithic Dominance Theory (Previc, 1991, 1996), adopting a developmental approach. Our objective was to test the supposed link between the vestibular system and intrauterine fetal presentation, and its influence on the development of laterality, cognitive and motoric functions. This could partly explain the etiology of neurodevelopmental disorders such as language and motor impairments (i.e., developmental dyslexia and developmental coordination disorders, respectively) since they share common traits including atypical laterality and postural impairments, which are related to a dysfunctional vestibular system (Abbondanza et al., 2022; Darvik et al., 2018; Blythe, 2017, p. 14 to 18). To achieve our main goal, we aimed to conduct a cross-sectional study over three years, with two groups of children: the first consisting of children observed from birth to 3 years old, and the second consisting of children observed from 3 to 6 years old. A collaboration was made with the Medical-Surgical and Obstetrical Center – Strasbourg Hospital Center (CMCO, *Centre Medico-Chirurgical et Obstetrical – Hôpitaux Universitaires de Strasbourg*) in order to acquire data on the intrauterine fetal presentation of children that were born in Strasbourg from 2012 and 2018. All measurements were to be collected via laboratory assessments during this thesis, where we planned to assess children's handedness and functional lateralization. For the former, we intended to use the questionnaire of De Agostini and Dellatolas (1988) and the tapping test, and for the latter, we programmed the Poffenberger paradigm test (Poffenberger, 1912), the Navon hierarchical figures task (Navon, 1977) and the tapping test with dual-task interference on E-prime 3 software (Psychology Software Tools, 2016; Hiscock & Kinsbourne, 1980). As for the cognitive, motor, and vestibular functions, we planned to use the Kaufman Assessment Battery for Children 2 (K-ABC 2, Kaufman & Kaufman, 2004), the Movement Assessment Battery for Children 2 (M-ABC 2, Henderson et al., 2007), and a posturography test that includes the Romberg test (Llorens et al., 2016).

However, due to the pandemic of COVID-19, conducting the above study became rapidly more challenging, and the collaboration with the CMCO was postponed. Some changes in the initial plan regarding the empirical aspect of this research project thus had to be made to cope with the new situation. A glimmer of hope was established after a solution was found in the article "Half a century of handedness research:

Myths, truths; fictions, facts; backward, but mostly forwards” (McManus, 2019). In the last chapter, entitled “The next half-century”, the author mentioned the importance of using large databases in investigating laterality. Therefore, a research project was submitted to the Avon Longitudinal Study of Parents and Children (ALSPAC, Boyd et al., 2012; Fraser et al., 2012) in order to obtain access to this dataset, which offers several benefits. Firstly, ALSPAC includes several of our variables of interest, which allowed us to test most of the causal cascade mentioned earlier. Secondly, access to ALSPAC offered us an opportunity to go beyond the sole investigation of the influence of fetal presentation on handedness and allowed us to additionally test the influence of prenatal factors, such as prematurity, birthweight, and neonatal health. Thirdly, the use of a large cohort such as ALSPAC allowed us to access a large sample of rare populations (e.g., breech fetal presentation, preterm births), which is essential to deal with the lack of statistical power, which is related to the replicability crisis (Mundorf & Ocklenburg, 2021, p. 112).

Furthermore, a new objective was added during the progression of this Ph.D. project. We aimed to study the implication of cerebral lateralization in perceptual biases, which can in turn influence graphomotor productions. More specifically, past research found that children’s and adults’ drawings are asymmetric, and can be explained by visuospatial biases related to cerebral functional lateralization (Vaid, 2011). Nonetheless, these biases are assessed with different tasks, which makes it difficult to measure the interaction between them. Therefore, we introduced in this thesis a novel drawing task, the 3D-2D transcription task, which can assess in a comprehensive way the asymmetries identified in human drawings that are partly underpinned by cerebral lateralization. This novel drawing task aimed to identify global asymmetrical graphomotor patterns of young children. The 3D-2D transcription task could be a promising tool for future studies to explore graphomotor patterns of children with atypical cerebral lateralization (Friedrich et al., 2018). This could bring up opportunities for early detection of atypical laterality patterns underpinned by children with visuospatial difficulties.

In the first part of this dissertation, we will present an overview of some of the asymmetries observed in humans, their measurements, their developmental trends, and the possible mechanisms underlying their manifestation. In chapter 1, we will discuss the research on handedness and its relation with cerebral asymmetries and child development. In chapter 2, we will discuss the graphomotor asymmetries by presenting the literature on attentional and directional biases implicated in visuospatial attention, their

measurements, and their underlying mechanisms. In chapter 3, we will present the major theoretical theories suggested for explaining the ontogenesis of laterality. This will be followed by chapter 4 in the second part of this thesis, where we will present the objectives and the rationale of the studies conducted in this Ph.D. thesis.

The third part of this dissertation will be devoted to our empirical work. Chapter 5 includes one main study and another complementary study aimed to identify global asymmetrical graphomotor patterns that are partly related to cerebral lateralization. In this chapter, Article 1 introduces a novel drawing task aiming to assess in a comprehensive way children's attentional and directional biases, followed by Complementary study 1, aiming to extend the previous findings by including adult participants. Similarly to Chapter 5, Chapter 6 includes one main study and a complementary study where the implication of the prenatal environment in the development of handedness and neurodevelopmental disorders was tested. In this chapter, Article 2 tested the influence of the fetal presentation and the vestibular system on handedness, cognitive, and motor impairments, whereas Complementary study 2 tested the influence of prenatal adversities. The fourth and final part of this dissertation will end with Chapter 7, consisting of a general discussion that summarizes this research project's contributions and its implication for the scientific literature.

PART I - THEORETICAL OVERVIEW

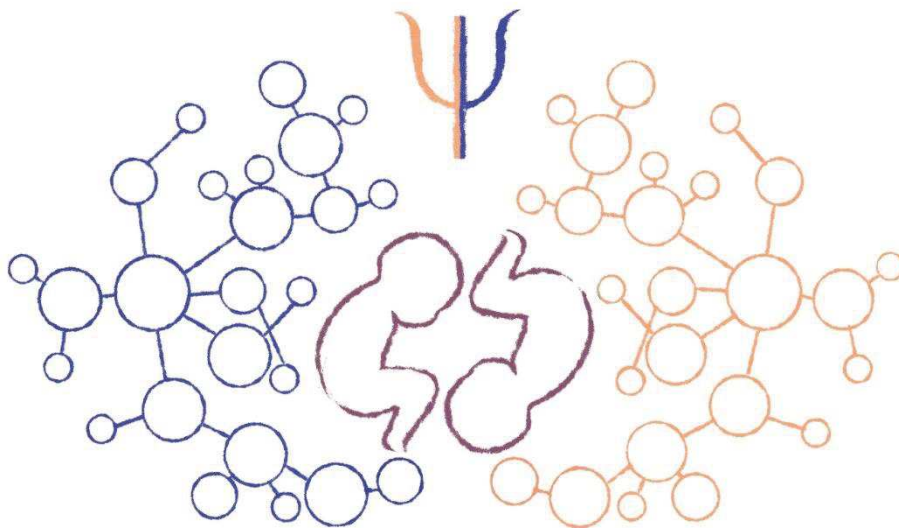

Chapter 1. Asymmetries in humans: Laterality and neurodevelopment

In this chapter, a general overview of laterality research will be presented. We will begin by addressing the literature on the asymmetries observed in humans, focusing on handedness and its association with cerebral lateralization. Afterward, different measurements and dimensions of handedness will be described, which can give us important information on both a methodological and theoretical level. This will be followed by a presentation of the developmental trends of handedness and functional lateralization, which are observed across the lifespan from intrauterine life to adulthood. In the final part of the chapter, we will discuss the nature of the possible relation between atypical laterality, neurodevelopmental and psychiatric disorders.

1.1 Handedness and cerebral lateralization

In most humans, a lateral preference for one side of the body concerning limbs, eyes, and ears is observed (Tran et al., 2014). Among these preferences, one can mention footedness, which refers to the preferred foot when performing an action (e.g., kicking a ball or standing on one foot). There exists also eyedness and eardness, which refer respectively to the preference of one eye for monocular activities (e.g., looking through a telescope) and the preference of one ear for monaural activities (e.g., placing an ear against a closed door). Finally, the most obvious and studied lateral preference is handedness, which is the preference to use one hand more than the other for common tasks (e.g., writing, drawing).

On a population level, about 90% of individuals prefer to use their right hand, while approximately 10% have a preference to use their left hand and around 1% have no preference for either hand (Vingerhoets, 2019). In a recent meta-analysis based on 2,396,170 individuals, Papadatou-Pastou et al. (2020) found that the best estimate for left-handedness in the general population is 10.6%, but can vary between 9.3% and 18.1% depending on how handedness is measured. For other lateral preferences, around 78.6% are right-footed (see Packheiser et al., 2020 for a recent meta-analysis), about 71% are right-eyed, and around 60% are right-eared (Porac & Coren, 1981, p. 36). There is a correlation between these lateral preferences, but the strongest one is between handedness and footedness (Tran et al., 2014). In a large sample (n = 7364) consisting of 7-year-old children, 70.5% of the right-handers presented a

preference for the right foot, whereas 58.0% showed a preference for the right eye, and about 40% reported a consistent right preference for handedness, footedness, and eyedness (Nachshon et al., 1983). Recently, it has been suggested that all lateral preferences share a common genetic origin (Schmitz et al., 2022). It is noteworthy to mention that lateral preferences can vary according to sex. A higher percentage of left-handedness is generally observed among males (11.62%) in opposition to females (9.53%; Papadatou-Pastou et al., 2020) and a similar trend is observed for footedness (Packheiser et al., 2020).

To better understand handedness, it is helpful to have some information from comparative research, where the prevalence of right and left-handedness is studied on historical and phylogenic levels. From a historical point of view, some theories suggest that the survival of our species, the *Homo sapiens*, may be due partly to lateralization. A functionally lateralized brain may improve the ability to perform tasks involving both hemispheres, and a stable hand preference may facilitate the acquisition of complex bimanual skills (Uomini & Ruck, 2018). Handedness in prehistory was studied by analyzing archeological samples obtained from fossil skeletons, human paintings, art, stone tools, endocast asymmetries (i.e., imprints left by the brain inside fossilized skulls), and other artifacts (see for a review Steele & Uomini, 2005). It has been found that more than 75% of Neanderthals, *Homo heidelbergensis*, *Homo erectus*, and *Australopithecus africanus* were right-handed (Faurie et al., 2016). Thus, right-handedness has been present since the prehistoric period, at least 500 000 years ago, and the evolution of a bias toward right-handedness may have preceded the evolution of the modern capacity and complexity of the human brain (Steele & Uomini, 2005). It is plausible that our ancestors also had cerebral asymmetries and preexisting lateral biases for vision, praxis, and communication (Uomini & Ruck, 2018). Cerebral asymmetries and right-hand preference may have strengthened over the eras due to the increasing complexity of manual motor actions and social learnings (Faurie et al., 2016; Uomini & Ruck, 2018). Since the majority of humans exhibit this preference, one can suggest that there are some advantages to being right-handed. Some authors proposed that the left-handed minority survived as they have maintained selective advantages related to fighting or aggressive interactions (Uomini & Ruck, 2018) and the performance of unexpected and unpredictable actions, which is beneficial in fights and survival (Faurie et al., 2016).

From a phylogenic point of view, contrary to the idea that handedness is one of the hallmarks of human evolution, the scientific literature shows evidence of limb and cerebral asymmetries in vertebrates.

Limb preferences for motor actions were observed in animals such as fish, amphibians, reptiles, birds, and mammals (Esteves, Lopes et al., 2020; Güntürkün et al., 2020; Meguerditchian et al., 2013; Ströckens et al., 2013; Vallortigara & Rogers, 2005). Among these animals, investigating handedness in nonhuman primates such as monkeys and great apes is important due to their phylogenetic proximity to humans (Meguerditchian et al., 2013). A meta-analysis of hand preference from 96 studies on great apes found a population-level bias for right-handedness in some chimpanzees and bonobos, where the right-handedness proportion was elevated to 54% (Hopkins, 2006; see also Hopkins et al., 2011). Nonetheless, this proportion is considerably lower than what is observed in humans, showing that the right-hand bias has evolved along the human lineage (Willems et al., 2014; see Chapter 3 for further details on evolution and handedness).

Handedness is a behavioral manifestation of laterality, and most of the sensory and motor innervation of the hands and fingers is controlled by the contralateral hemisphere (Michel, 2021). Moreover, it seems to be related to functional lateralization (Zago et al., 2016) and it can be a reflection to some extent of hemispherical dominance (Dassonville et al., 1998; Esteves, Lopes et al., 2020; Prichard et al., 2013; Willems et al., 2014). Hemispherical dominance refers to the idea that a hemisphere is typically faster or more accurate in the processing of a specific cognitive function (i.e., dominant), while the non-dominant hemisphere is active to a lesser extent (Mundorf & Ocklenburg, 2021, p.2). At a population level, language is predominantly processed in the left hemisphere in most right- and left-handers (86% and 66% respectively, Vingerhoets, 2019). The right hemisphere is dominant in the processing of spatial attention for both right and left-handers (87% and 76% respectively; Vingerhoets, 2019). During the last decade, some studies provided evidence that functional lateralization can vary for different aspects of the same cognitive function (Bradshaw et al., 2020; Van der Haegen et al., 2012; Woodhead et al., 2019). For example, language is multidimensional, and the strength of cerebral lateralization differs according to the different tasks used to assess it (e.g., phonological decision, sentence generation, syntactic decision tasks; Woodhead et al., 2019). Therefore, one should be cautious when studying functional lateralization since it appears to be task-dependent (Parker et al., 2022; Planton et al., 2022). Another difference between the left and right hemispheres is that the former processes information locally and analytically, whereas the latter processes information globally and holistically (Brederoo et al., 2017; Corballis, 2012).

Functional lateralization can vary depending on the degree and the direction of handedness (Johnstone et al., 2021; Parker et al., 2022). Right-handers are generally strongly lateralized, whereas left-handers exhibit a bilateral hemispheric representation or even a right hemisphere dominance (Carey & Johnstone, 2014; Isaacs et al., 2006; Pujol et al., 1999; Willems et al., 2014). The latter show weaker hemispheric lateralization and might have a larger corpus callosum (Johnstone et al., 2021; Ocklenburg & Güntürkün, 2017, p.77). Functional lateralization seems also to differ according to sex (Hirnstein et al., 2019; Voyer, 1996). Males are generally more lateralized than females for language processing, face processing, and spatial attention (Bourne & Maxwell, 2010; Hausmann, 2017; Hirnstein et al., 2019; Vogel et al., 2003). It is also shown that female fetuses have a thicker corpus callosum compared to males (Achiron et al., 2001). On a side note, there are structural brain asymmetries at a micro and macro level (Esteves, Lopes et al., 2020; Guadalupe et al., 2016). However, they are not found to be associated with handedness (Kong et al., 2018), and it is likely that they are not related to functional lateralization (Papadatou-Pastou, 2018; Tzourio-Mazoyer et al., 2018).

It is hypothesized that brain functional segregation, which refers to the lateralization of some functions in one hemisphere and some other functions in the opposite hemisphere, confers a selective advantage (Poeppel et al., 2022; Rogers, 2021). This could be by avoiding redundancy, preventing duplication of control systems which enhance the use of both hemispheres, increasing the brain's ability to perform multiple tasks simultaneously, maximizing available space, and allowing higher processing speed (Esteves, Lopes et al., 2020; Gerrits et al., 2020b; Güntürkün et al., 2020). Some authors took interest in investigating the nature of the relationship between the different lateralized cognitive functions. Some of them suggest that the lateralization of one function is not related to lateralization of other functions (i.e., the statistical hypothesis), whereas others suggest the causal hypothesis, where it is proposed that the lateralization of one function can predict the lateralization of another (Badzakova-Trajkov et al., 2016; Cai et al., 2013). Using fMRI to observe the lateralization of five different functions, Gerrits et al. (2020b) found that language dominance predicted the lateralization of other functional lateralization (i.e., praxis, spatial attention, face recognition, emotional prosody), where a right language lateralization increases the probability of having atypical lateralization of the other functions. However, an absence of related lateralization between these functions was also observed (Gerrits et al., 2020b). Similarly, Parker et al.

(2020) found that the lateralization of verbal and nonverbal tasks are independent while testing the validity and reliability of online assessments in four laterality tasks (i.e., rhyme decision visual half-field task, dichotic listening task, chimeric faces task, finger tapping task; see also Bryden et al., 1983). Thus, lateralized functions are not wholly dependent nor wholly independent, contrary to both the statistical and causal hypotheses (Gerrits et al., 2020b; Parker et al., 2020). It is likely that the lateralization of cognitive functions is to some degree related to a blueprint determined early in ontogenesis, but can be influenced later by independent mechanisms which hinder this interdependency between the different lateralized functions (Gerrits et al., 2020b).

1.2 Measuring laterality: challenges and progress

Assessing laterality, especially handedness, can be to some extent challenging. Handedness is a multidimensional trait and at least two dimensions underlie it, which are hand preference and hand performance. The former refers to the preferred hand for completing common manual tasks (Scharoun & Bryden, 2014), and it is the most studied in the literature. It can be generally assessed by the writing hand, which is an activity where most individuals cannot perform equally well with either hand (Perelle & Ehrman, 2005). However, measuring hand preference by a single activity is insufficient, and can also be misleading (Johnstone et al., 1979; Roszkowski et al., 1981). Instead, self-reported questionnaires are the most used for assessing hand preference, such as the Edinburgh Handedness Inventory (EHI; Oldfield, 1971), Annett's hand preference questionnaire (Annett, 1970), and the Waterloo Handedness Questionnaire (Steenhuis & Bryden, 1989). More recently, Fagard et al. (2015) developed a 15-item questionnaire where standard items such as the hand used for writing and brushing teeth are present, but also novel items related to new habits, such as the hand used for using a computer mouse and pressing the buttons of a TV remote control (Fagard et al., 2015).

This kind of tool provides two pieces of information: directionality and consistency. The directionality indicates if a person prefers the use of the left or right hand, which can categorize an individual as being left- or right-handed. Regarding consistency, it refers to how strongly a person prefers to use the same hand for doing different kinds of tasks. When the non-preferred hand is used for at least one task, the person is considered as having inconsistent handedness. A highly inconsistent handedness is the most

common definition of weak-handedness and is also called “mixed-handedness” (Fagard et al., 2015). Mixed-handedness is the use of the right hand for some activities and the left for others. The literature offers a second definition of mixed-handedness, which is generally called “ambidexterity”, and which refers to the ability to use either hand at will to perform a single task (Fagard et al., 2015). According to this second definition, ambidexterity can be measured by quantifying the degree of either hand usage based on the number of items for which an individual declared a preference for either hand (e.g., Glover et al., 2004; Shaw et al., 2001). It should be noted that true ambidextrous individuals are very rare, with the prevalence estimated at 0.9% in the general population (Perelle & Ehrman, 1994).

Three characteristics of a hand preference questionnaire are important to take into account. The first is the length of the questionnaire, as longer questionnaires (i.e., 10 items and more) supposedly cover a greater range of manual activities, which leads to better sensitivity (Peters, 1998). Porac (2016) suggests the use of a hand preference questionnaire containing between 10 and 25 items since it is easily administered and provides an adequate range of hand preference behaviors. Nonetheless, several studies have tested the psychometric properties of short questionnaires among adults (e.g., Bryden, 1977; Dragovic, 2004; Mcfarland & Anderson, 1980; Veale, 2014), and children (Brito et al., 1992). From these studies, it appears that the shortened versions can present good psychometric properties, similar to the longer ones. The second characteristic is related to the available response choices of each item. Some questionnaires use a forced-choice (i.e., answering “left” or “right”), some others include an “either” response, while others require the respondent to specify the degree of hand preference through a 5-point Likert scale (Peters, 1998; Porac, 2016). Graded answer options are to be privileged since gradations of hand preference strength can better correlate with hand performance (Peters, 1998). The third characteristic that should be taken into account for hand preference questionnaires is the type of activities reflected by the questionnaire’s items. Skilled activities, such as writing, can better discriminate between the right and left-hand preference than unskilled activities, such as picking up an object (Steenhuis & Bryden, 1989). However, Peters (1998) suggests that hand preference questionnaires should ideally include both skilled and unskilled activities since the latter can improve the assessment of hand preference strength.

The scoring procedure of hand preference questionnaires varies across studies. For questionnaires with three response choices (i.e., left, either, right), a Laterality Index (LI) can be calculated by the following procedure: A score of 1 is attributed each time the participant answers “left” or “right”, and a score of 0 for the “either” response. Then, the LI is calculated using the formula $LI = [(nR - nL) / (\text{total number of responses})] * 100$, where nR and nL correspond to the number of right- and left-hand use, respectively. Then, the researcher must choose the cut-offs that allow distinguishing between right-handers, mixed-handers, and left-handers. Some authors classify strong right- and left-handers as having an LI greater than 75 and lower than -75 respectively, and all those in between are considered mixed-handers. Others delimit mixed-handers as having an LI between +50 and -50, between +40 and -40, between +20 and -20 or between +15 and -15 (Fagard et al., 2015). One of the limitations of this heterogeneity in choosing cut-offs is the risk of non-replicability due to methodological inconsistencies. Laterality Index must categorize the hand preference, whether it is right-, mixed, or left-handedness, based on a statistically defensible and not arbitrary classification (Michel, Babik et al., 2013). Fagard et al. (2015) conducted a study that allows a good operational distinction between mixed-handers/ambidextrous individuals from right- and left-handers. The authors found that a cut-off of -30 and +30 could successfully identify weak hand preference (i.e., mixed-handedness and ambidexterity).

Measuring hand preference is insufficient to obtain a global overview of handedness since the preference for one hand for manual tasks does not necessarily reflect its ability to perform these tasks efficiently. This performance on manual tasks is referred to as hand performance, and it differentiates skills (e.g., strength, speed, accuracy, precision) of both hands (Scharoun & Bryden, 2014). It can be assessed using behavioral tasks such as Annett’s Peg-Placing task (Annett, 1992), Tapley-Bryden’s dot-filling task (Tapley & Bryden, 1985), Square Marking task (Annett, 1992), Match-Sorting task (Bishop, 1984), Finger Tapping task (Peters & Durdin, 1978), and the Grip Strength task (Clerke & Clerke, 2001). Generally, individuals show poorer performances and greater intra-individual variability with their non-dominant hand compared to the dominant one (Mickevičienė et al., 2015; Porac, 2016). It should be noted that all these hand performance tasks are only weakly related to each other (Porac, 2016). In a recent large-scale study, Buenaventura Castillo et al. (2020) assessed the correlation between the pegboard task, marking squares task, sorting matches task, and grip strength. The authors found that these tasks are weakly

correlated between each other. The difference between these tasks can be explained on a functional and behavioral level. For the former, each hand performance task may reflect different dimensions of motor lateralization (Buenaventura Castillo et al., 2020; Steenhuis & Bryden, 1999). For the latter, fine differences in motor lateralization tend to be hidden when using motor tasks, such as dot-filling tasks, that share similarity with daily activities like writing (Peters, 1998). Since the use of a pen is needed, the preferred hand's strong specialization due to experience may influence performance on such tasks (Buenaventura Castillo et al., 2020; Peters, 1998).

Hand performance tasks can be scored by computing an index (Porac, 2016). For example, the Pegboard task consists of placing, one at a time and as quickly as possible, 12 pegs into a pegboard, with the task carried out with each hand consecutively. The time needed for each hand to complete this task is recorded. Afterward, one can calculate the PegQ index using the formula $\text{PegQ} = [(L-R)/(L+R)] * 100$, with L referring to the time in seconds to perform the task with the left hand and R referring to the time in seconds to perform the task with the right hand. A negative index refers to a better performance of the left hand, a positive index is interpreted as a better performance of the right hand, and an index of zero reflects an equal performance of both hands. The same procedure can be applied to other assessments, such as the Sorting Match task, where participants are asked to move one match at a time using one hand at a time from a full box to an empty one. The time required to transfer all the matches is recorded. As with the pegboard task and using the same formula, one can compute the SortQ index.

Distributions of hand preference and hand performance indexes are different. For the former, the data present a J-shaped bimodal distribution (see Figure 1.1), where most scores on hand preference questionnaires are shifted toward the extreme right, with very few individuals showing an equal preference, and slightly more individuals showing extreme left-handedness (Annett, 2002, p. 65; Porac, 2016, p. 12; Porac & Coren, 1981, p. 17). For hand performance, the data have a bell-shaped distribution (see Figure 1.2), where the mean of the distribution is slightly shifted to the right (Annett, 2002, p. 64).

Figure 1.1. J-shaped density plot of the hand preference

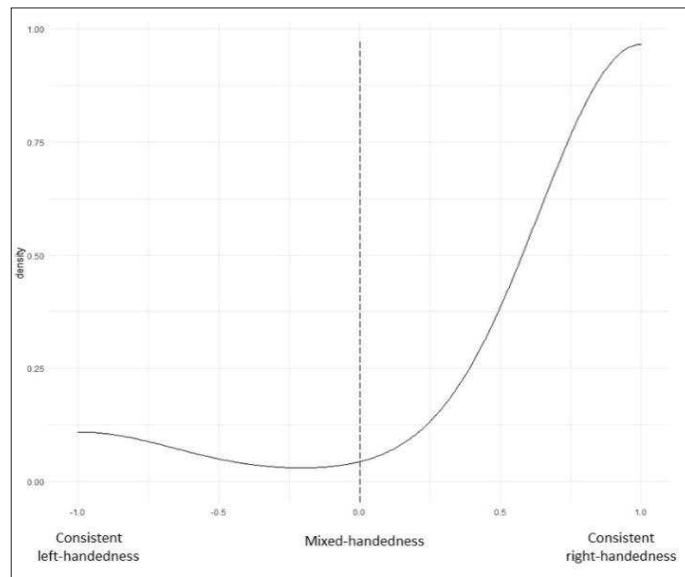

Note. This plot is based on a sample of 7676 children according to a 6-items hand preference questionnaire from the ALSPAC database (see Article 2 for more details)

Figure 1.2. Bell-shaped density plot of the hand performance

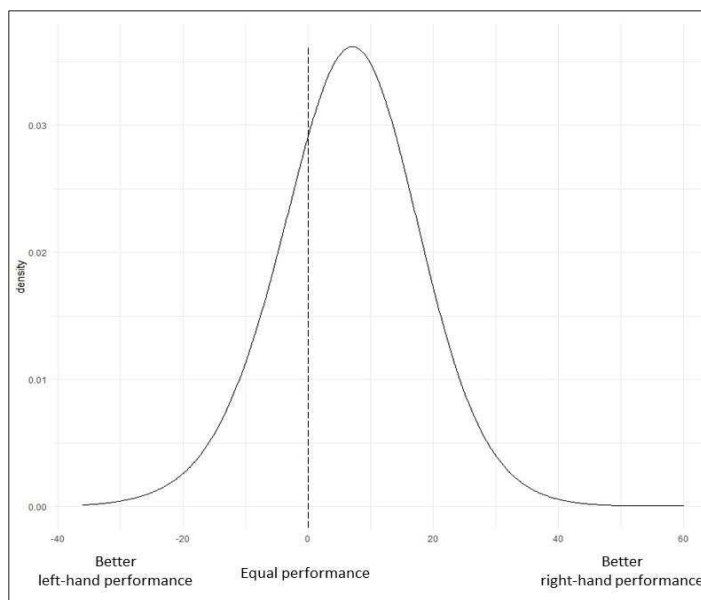

Note. This plot is based on a sample of 7310 children according to a Pegboard task from the ALSPAC database (see Article 2 for more details)

Hand preference and hand performance could be related to each other to some extent (Bryden, 2016; McManus et al., 2016; Triggs et al., 2000), and an asymmetry in hand performance could be a consequence of a pre-established hand preference (McManus et al., 1992). Nonetheless, it is noteworthy that recent studies are showing that they are most likely to represent different phenotypes affected by distinct genetic factors and molecular pathways (Schmitz et al., 2019).

Lastly, several measures are proposed to assess other asymmetries beside handedness. One can measure lateral preferences (i.e., footedness, eyedness, and eardness) with the Lateral Preference Inventory (Coren, 1993; see also Kalaycıoğlu et al., 2008 for additional items for measuring footedness). There are also behavioral tasks such as the Foot Tapping task that can assess foot performance (Musálek et al., 2020), and monocular deprivation tasks such as the Miles test (i.e., looking through a small hole with one eye open and the other closed) that can assess eyedness (Min et al., 2021). Regarding functional lateralization, it should be tested ideally with neuro-imagery techniques. Nonetheless, behavioral tasks can be used to infer to some extent cerebral lateralization. There is, for example, the Navon hierarchical task for local/global processing (Hausinger & Pletzer, 2021; Navon, 1977), the Poffenberger paradigm test for interhemispheric connection (Berretz et al., 2022b; Poffenberger, 1912; see for a recent meta-analysis Westerhausen, 2022), the Dichotic listening task for language lateralization (Hirnstein et al., 2013; see for a review Westerhausen & Kompus, 2018), the visual half-field task for vision (Van der Haegen & Brysbaert, 2018), and the Chimeric faces task for facial processing lateralization (Burt & Perrett, 1997; Karlsson et al., 2019). Some of these tasks have shown to be relevant as an online evaluation of cerebral lateralization (Parker et al., 2020). On a side note, it is noteworthy to mention the study by Sørensen and Westerhausen (2020) where the authors proposed a general Bayesian framework for inferring cerebral lateralization based on scores obtained on behavioral assessments such as the Dichotic listening task.

1.3 Developmental trends of laterality

For most individuals, the left hemisphere is dominant for speech production and the control of the right hand, therefore understanding the development of handedness may shed light on the development of cerebral lateralization (Michel, Nelson et al., 2013). Although the direction of handedness is suggested to be fixed around the age of 4 (Scharoun & Bryden, 2014), hand preference can manifest during infancy,

even it can become apparent as early as fetal life (Cochet, 2016; Ferre et al., 2020; Hepper, 2013; Michel, 2021). At 10 weeks of gestation, most fetuses present a right-hand preference for arm movement (Hepper et al., 1998), and they suck their right thumb at 15 weeks of gestation, whereas the minority suck their left thumb (Hepper et al., 1991). This prenatal thumb sucking can predict postnatal behavioral asymmetries. In their study, Hepper et al. (2005) showed that all the fetuses who sucked their right thumb during gestation became right-handed at the age of 12, in contrast to fetuses who sucked their left thumb. It should be noted that de Vries et al. (2001) did not find a preference for right thumb sucking in fetuses studied longitudinally from 12 to 38 weeks of gestation. Nonetheless, as the authors mentioned, this divergent result from the one found by Hepper et al. (1991) may be due to methodological differences (i.e., small vs. large sample size, longitudinal vs. cross-sectional study design, respectively).

Postnatal preferences are also observed very early after birth (Butterworth & Hopkins, 1993), where more neonates show a right-hand preference for grasping reflex (Tan & Tan, 1999) and a preference to turn their head to the right (Michel & Goodwin, 1979; Rönqvist & Hopkins, 1998). Compared to adults, children present weaker degree of hand preference and higher prevalence of left-handedness (Nelson et al., 2013; see also Fagard et al., 2020). Nelson et al. (2013) conducted a longitudinal study on toddlers from 6 to 24 months of age, and found that the prevalence of right-handedness reached 76% by age two. Another longitudinal study showed that children at the age of 5 months who preferred reaching for objects with the right hand showed a higher probability of becoming right-handers five years later, whereas children who preferred the left hand presented a weaker handedness (Marschik et al., 2008). Thus, similar to fetal thumb sucking, an early postnatal hand preference can predict later handedness (Gonzalez et al., 2014). Hand preference consistency also increases with age. Children aged between 3 and 5 years use their preferred hand around half of the time in a Reaching task, while older children between 6 and 10 years use their preferred hand most of the time (Bryden et al., 2011). Thus, it is postulated that the use of a hand is associated with object proximity in young children, whereas older children will select their preferred hand for most of their activities (Williams et al., 2019).

Porac et al. (1980) conducted a study on 1964 participants aged 8 to 100 years old to investigate the development of lateral preferences (i.e., hand, eye, foot, and ear). The authors found that the bias toward right-handedness increased with age (but see Kilshaw & Annett, 1983). In line with Porac et al. (1980)

findings, a series of studies on children aged between 4 to 7 years (Brito et al., 1992), 8 to 15 years (Brito & Santos-Morales, 1999), and adults between 20 to 72 years (Brito et al., 1989) found that the prevalence of right-handedness is lesser in children compared to adults. These findings may reflect an underlying developmental maturational process that continues during the third decade of life (Porac et al., 1980). An increase in right-handedness through age could be a consequence of a motor learning capacity related to continued experience with the right hand (Brito & Santos-Morales, 1999). In a recent meta-analysis, Packheiser et al. (2020) found that footedness increases in either direction according to age and not necessarily only towards the right side. Therefore, it is suggested that the degree of motor asymmetries (e.g., handedness, footedness), whether towards the right or left side, will continue to strengthen in parallel with cerebral asymmetries with the increase of age (McManus et al., 1988; Packheiser et al., 2020; Scharoun & Bryden, 2014).

Hand performance asymmetry is also influenced by age. It has been found that the grip strength increases with age, and right-handers are usually stronger with their preferred hand (i.e., right hand) than left-handers (Daniels & Backman, 1993). Carlier, Duyme et al. (1993) conducted a study using the dot-filling task (Tapley & Bryden, 1985) on children aged between 7 and 14 years old and found that laterality degree increased with age (see also Roy et al., 2003 for similar results using the pegboard task on participants between 5 and 24 years old). Thus, hand skills such as speed, strength, and dexterity seem to increase with age, but only to some extent (Williams et al., 2019). Indeed, a decline in hand performance is observed among elderly participants, where a loss in the right- or left-hand performance are observed with advancing age (Francis & Spirduso, 2000; Kalisch et al., 2006; Scharoun Benson et al., 2021; Sebastjan et al., 2017). However, other studies did not find a relationship between the degree of handedness and age (e.g., Carlier, Dumont et al., 1993; Dellatolas et al., 2003; Kilshaw & Annett, 1983). These discrepancies could be explained by the use of different hand performance tasks, which are supposed to assess different dimensions of handedness (Buenaventura Castillo et al., 2020; Carlier, Dumont et al., 1993; Scharoun & Bryden, 2014).

Similarly to behavioral lateralization, functional asymmetries can be observed before the first year of life (Streri & de Hevia, 2014). Using Magnetoencephalography, Imada et al. (2006) found that lateralization in the left hemisphere of both phonetic perception and motor system is present as early as 6 months of

age. After the first year of life, it is shown that children between 1 and 5 years present leftward lateralization of language, but not as prominent and stable as in older children and adults (Kohler et al., 2015). Szaflarski et al. (2012) conducted an fMRI study on participants aged between 5 and 18 years old to investigate the development of language lateralization in right- and left-handers. While the typical left-hemisphere lateralization of language is more commonly observed among right-handers, the authors found that the degree of this leftward lateralization increases with age for both right- and left-handers. A reversed developmental trend is observed for visuospatial attention, where a rightward lateralization is increased with age (Everts et al., 2008). Nonetheless, older adults and elderly individuals seem to present weaker functional lateralization than younger ones. Several studies showed reduced lateralization and bilateral brain activation in old adults (Kalisch et al., 2006; see Cabeza, 2001 for review). These observations led Cabeza (2001) to propose a model known as the Hemispheric Asymmetry Reduction in Old Adults (HAROLD). It suggests that a lateralization reduction in the elderly may be explained by a compensation mechanism, where older adults activate both hemispheres as a coping mechanism for neuro-cognitive deficits (Cabeza, 2001). Another theoretical model, the Right Hemi-Aging Model (RHAM), which is not mutually exclusive with the HAROLD model, postulates that the right hemisphere declines faster than the left hemisphere during the lifespan, leading to weak lateralization (Dolcos et al., 2002). It should be noted that several studies did not find support for either model (Hausmann, Güntürkün & Corballis, 2003; Yamashita, 2021; see for further details Esteves, Ganz et al., 2020 and Ocklenburg & Güntürkün, 2017, p.282).

1.4 (Dis)Advantages of laterality

At one point, there were two opposed theoretical perspectives on the advantages and disadvantages of laterality on a cognitive level. The first perspective considered that cognitive deficits are observed in weakly lateralized individuals. Crow et al. (1998) found that among 12,770 individuals, children close to an equal hand performance presented the most substantial deficits on verbal, non-verbal, and reading comprehension tasks (see also Corballis et al., 2008; Nettle, 2003). These results led to the “hemispheric indecision” hypothesis, which suggests that a failure to establish a cerebral asymmetry is associated with a delay in development, and can lead to an atypical developmental trajectory (Crow, 2000; Crow et al., 1996; Leask & Crow, 2001). This is in line with Orton’s (1937) model, which postulates that weak handedness,

reflecting weak cerebral lateralization, leads to learning difficulties. In contrast, the second perspective considered that weak-handedness is an advantage on a cognitive level. Annett (1996) found that individuals with strong left-hand performance were associated with phonological difficulties, whereas the ones with strong right-hand performance were associated with visuospatial difficulties (Annett, 2002; see also Kempe et al., 2009). The author concluded that the non-dominant hemisphere of the strongly lateralized individuals would exhibit lesser performances than the one of the weakly lateralized individuals (Annett, 1996).

Some authors suggested that the low prevalence of left-handedness at a population level might reflect some disadvantages of being left-handed (Coren & Halpern, 1991; Halpern & Coren, 1988). Several meta-analyses were conducted to investigate the cognitive differences between right- and left-handers. Somers et al. (2015) showed a slight benefit for right-handedness for verbal (only observed among children) and spatial abilities. Nonetheless, the size of these differences is so small that left-handedness cannot be considered a real disadvantage on a cognitive level (Somers et al., 2015). By examining full-scale IQ scores, Ntolka and Papadatou-Pastou's (2018) meta-analysis replicated these results by reporting negligible differences between right- and left-handedness (see also Papadatou-Pastou et al., 2021 for meta-analysis on mathematical learning). Similar findings are also obtained in individuals reporting a crossed laterality (e.g., the same individual presenting right-handedness and left-footedness; see for meta-analysis Ferrero et al., 2017). These meta-analyses show the absence of a relationship between handedness and cognitive performance. Nonetheless, it should be highlighted that they are based on studies that have mostly assessed the directionality of hand preference (i.e., right- vs. left-hand preference) but not the degree assessed by hand performance (Papadatou-Pastou, 2018). Therefore, the possible relationship between hand performance and cognitive performances was not directly tested.

The interest in studying the development of laterality has increased considerably over the past decades. This has been driven by findings showing a higher prevalence of Non-Right Handedness (NRH, left- and mixed-handedness) among individuals with neurodevelopmental and psychiatric disorders. Atypical handedness has been associated with neurodevelopmental disorders such as Developmental Dyslexia (DD, for meta-analyses see Abbondanza et al., 2022 and Eglinton & Annett, 1994, but see the meta-analysis of Bishop, 1990a for opposite evidence), Developmental Coordination Disorder (DCD, see for meta-

analysis Darvik et al., 2018), Intellectual Deficiency (ID; see for meta-analysis Papadatou-Pastou & Tomprou, 2015), Autism Spectrum Disorders (ASD, see for meta-analysis Markou et al., 2017), and Attention Deficit Hyperactivity Disorder (ADHD, see for meta-analysis Nastou et al., 2022). It can also be observed among psychiatric disorders such as schizotypy personality disorder (for meta-analysis see Somers et al., 2009), or even schizophrenia (for meta-analyses see Dragovic & Hammond, 2005; Hirnstein & Hugdahl, 2014; Sommer et al., 2001), and neurodegenerative diseases (see for a review Lubben et al., 2021). There is also evidence of atypical functional and structural lateralization among these populations. Children with DD show weak lateralization, reduced leftward asymmetry of the planum temporale, and an under-activation of the left hemisphere for language processing (Berretz, Wolf et al., 2020; Bishop, 2013; Penolazzi et al., 2006; Weiss et al., 2022). Children with DCD tend to present reduced interhemispheric connectivity and atypical lateralization of executive functions in the left hemisphere, compared to the right lateralization found in typically developing children (Biotteau et al., 2016; Querne et al., 2008). Children with ASD show a lesser involvement of their left hemisphere in motor functions and a rightward asymmetry of the planum temporale, which may contribute to motor and language impairments (Berretz, Wolf et al., 2020). Individuals with schizophrenia present a reduction in planum temporale asymmetry, and a decreased functional language lateralization, which may be related to the origin of auditory verbal hallucinations (Berretz, Wolf et al., 2020).

Considering the assumption that there is a genuine relationship between atypical laterality, neurodevelopmental and psychiatric disorders, there is no clear consensus on how they are related (Mundorf & Ocklenburg, 2021, p.3). Bishop (2013) proposed different theoretical models to explain the possible relationship between neurodevelopmental disorders and laterality, more precisely between language impairments and weak lateralization. There may be a causal relation, where weak cerebral lateralization is supposed to exert a causal influence on language impairments. Nonetheless, cerebral lateralization and language impairments may share the same genes (i.e., endophenotype model) or not (i.e., additive/interactive risks model). In contrast, it could be assumed that language impairments, which have a genetic basis, favor the development of atypical weak lateralization (i.e., neuroplasticity model). The final model suggests that language impairments and atypical lateralization are not linked, but share the same origin, which is likely to be genetics (i.e., the pleiotropy model). Bishop (2013) suggests that

neuroplasticity might be the best model to explain this relationship, where it is more likely that language impairments lead to atypical development of lateralization. However, recent studies have shown that there is a moderate but not strong genetic overlap between lateralization and disorders (Cuellar-Partida et al., 2020; Kong et al., 2020), which makes the neuroplasticity model less likely (Mundorf & Ocklenburg, 2021, p.107). Rather, there is some evidence supporting the pleiotropy model, which suggests a partial genetic overlap, but also independent ontogenetic influences for each laterality and neurodevelopmental, and psychiatric disorders (Mundorf & Ocklenburg, 2021, p.107).

While the relationship between atypical laterality and disorders cannot be considered absolute, atypical asymmetries are a characteristic shared by several disorders (Mundorf et al., 2021). Mundorf et al. (2021) postulated, on a theoretical level, three different types of associations between structural asymmetries, neurodevelopmental, and psychiatric disorders. The first is where several factors, such as genetics, increase the general risk of developing atypical asymmetries and non-specific disorders (i.e., non-specific association). The second is where it is postulated that specific factors increase the risk of atypical asymmetries related to a specific disorder, such as neural language networks in individuals with DD (i.e., diagnosis-specific association). The third, which falls under a transdiagnostic perspective, proposes that specific factors are implicated in the development of atypical structural asymmetries and specific symptoms, independently of the diagnosis (i.e., symptom-specific association). In line with the third type of association, alterations in structural asymmetries among patients with schizophrenia who exhibit auditory verbal hallucinations are different from those in patients with no auditory hallucinations, but similar to those found in individuals with other disorders such as DD. Furthermore, on a functional level, it has been found that children with severe symptoms of DD do not show a right ear advantage on a dichotic listening task unlike children with less severe symptoms (Helland et al., 2008). These findings suggest that a better approach to understanding the relation between atypical laterality, neurodevelopmental, and psychiatric disorders is a symptom-specific approach, where the severity of the symptoms should be taken into consideration (Mundorf & Ocklenburg, 2021, p. 111; Mundorf et al., 2021).

1.5 Conclusion

In summary, laterality, which is suggested to give an advantage for survival, appears to be the norm and not the exception that rules our world. It can be found among human and nonhuman populations. It is likely that the strong bias toward right-handedness among humans increased in our current era.

Behavioral and functional lateralization appear very early in human development, and their degree increases during childhood until adulthood. When studying laterality, the assessments must be chosen carefully. Cognitive functions and handedness are multidimensional, and different tasks assess different dimensions. Directionality, consistency, and degree of handedness, reflected by hand preference and hand performance, should be assessed.

An important aspect of investigating the mechanisms underlying the development of laterality is that a higher prevalence of atypical lateralization is found among individuals with neurodevelopmental and psychiatric disorders. However, the nature of this relation is still subject of debate.

Before discussing the major theories that have been proposed to explain the factors implicated in the development of laterality, we will present in the next chapter another asymmetrical behavior that is well documented in the scientific literature. Graphomotor productions, which are asymmetrical, seem to be related to handedness and functional lateralization.

Chapter 2. Perceptual biases: Show me your drawings and I will tell you your laterality

In addition to the lateral preferences mentioned in the first chapter, other lateralized behaviors can be observed. For example, preferring an arm for cradling a baby (Vauclair, 2022; see Packheiser, Schmitz, Berretz et al., 2019 for a meta-analysis and see Boulinguez-Ambroise et al., 2022 for a recent study on baboons), for initiating an embrace (Packheiser, Schmitz, Metzen et al., 2019), as well as head orientation when kissing (Ocklenburg et al., 2018; Packheiser, Schmitz, Metzen et al., 2019). In this thesis, we will focus on another asymmetrical behavior frequently observed in humans: drawing. This complex behavior reflects various aspects of a child's cognitive functioning such as verbal abilities, working memory, cognitive flexibility, divergent thinking, and visual attention (Ebersbach & Hagedorn, 2011; Morra & Panesi, 2017; Sutton & Rose, 1998; Toomela, 2002). This graphomotor activity also requires visuospatial and motor skills (Toomela, 2002). Drawing can thus be considered an interesting tool for assessing children's cognitive and motor development (Schepers et al., 2012). In this chapter, we will begin by presenting an overview of drawing asymmetries and their underlying mechanisms, while describing the developmental trends observed from childhood to adulthood. This will be followed by a presentation of some tasks that can measure the asymmetries related to perceptual and motor biases.

2.1 Graphomotor asymmetries

Humans' drawings exhibit distinct asymmetric features and directional patterns that are most likely influenced by perceptual and motor biases (see Vaid, 2011 for a review on the subject). A large body of literature generally reports two biases which are each related to specific mechanisms underlying them. Firstly, there is the attentional bias, where one of the visual fields (i.e., right or left) is favored while completing a visuospatial task. Secondly, there is the directional bias, which is the orientation given to a depicted asymmetrical object (i.e., right, left). These biases seem to differ in terms of degree and direction according to handedness, sex, and age.

Each of the factors that lead to drawing asymmetries will now be discussed while taking into consideration inter-individual differences, which are related to the moderators mentioned above (i.e., handedness, sex, and age).

2.1.1 The laterality influence

Functional lateralization constitutes an important determinant in the development of children since it is associated with executive functions, as well as cognitive and visuospatial abilities (Ocklenburg et al., 2014). Drawing, which is a bimanual graphomotor activity, is shown to be an efficient tool reflecting laterality. Indeed, part of the asymmetries observed in drawings is suggested to be related to the cerebral lateralization of attentional functions (Picard & Zarhbouch, 2014).

A deviation toward the left visual field compared to the right is generally observed in neurologically healthy individuals on tasks requiring visuospatial attention (Friedrich et al., 2018; for a meta-analysis see Jewell & McCourt, 2000). This phenomenon is referred to as “pseudoneglect” (Bowers & Heilman, 1980). Vertical pseudoneglect can also exist, where an upward spatial bias is observed when a vertical line is in the left visual field as opposed to the right (Suavansri et al., 2012). This attentional bias in favor of the left visual field on tasks with a spatial component is interpreted as the consequence of the right hemisphere’s dominance in processing spatial information (Kinsbourne, 1970; Vogel et al., 2003; Zago et al., 2017). There is another hypothesis that may explain the relation between pseudoneglect and cerebral lateralization which is not mutually exclusive with right hemisphere dominance for visuospatial attention. It has been shown that emotion has an impact on attention and consequently on spatial biases. Therefore, the relation between pseudoneglect and the right hemisphere may be a consequence of an interaction between attentional and emotion lateralization (see the review of Strappini et al., 2021). However, there is no clear evidence on the direction of the effects produced by these interactions (Strappini et al., 2021).

Handedness, which can be considered to some extent as a moderator of cerebral lateralization (e.g., Johnstone et al., 2021) has been found to influence the pseudoneglect. With a draw-a-tree task (see “2.2. Measurements” for further details) proposed to participants aged from 5 to 15 years old, Picard and Zarhbouch (2014) found a leftward bias among the right-handers concerning the location of the figure on the graphical space (i.e., depiction of the figure more to the left of the graphical space). This bias was not found among the left-handed participants. Jewell and McCourt (2000) also found a stronger bias toward the left exhibited by right-handers using the line bisection task (see “2.2. Measurements” further details

on this task). The weaker bias present among left-handed individuals can be a consequence of their weaker functional lateralization (Johnstone et al., 2021; Ocklenburg & Güntürkün, 2017, p.77).

In addition to handedness, previous studies have shown that spatial attention could be modulated by sex (for a meta-analysis see Vogel et al., 2003). A modest influence of sex was reported in Jewell and McCourt's (2000) meta-analysis. There is a slightly greater leftward bias for males than for females. These findings can be explained by the laterality account, where at a functional level, males are more strongly lateralized than females (Amunts et al., 2007; Friedrich et al., 2014). The line bisection visuospatial task requires a connection between spatial information and motor response, and it is reasonable to assume that handedness may interact with sex during this task (Hausmann et al., 2002). To investigate the interaction between sex and the hand used, Hausmann et al. (2002) conducted a study on 38 right-handed students (equally distributed between women and men) using a line bisection task. Contrary to what was shown in Jewell and McCourt (2000)'s study, female participants were significantly more prone to a leftward bias with either their right or left hand, whereas males showed a significant leftward bias only with their left hand. The authors interpreted the pseudoneglect found in the female participants as a consequence of their greater interhemispheric connection, modulating motor areas of both hemispheres, and resulting in a leftward bias for both hands (Hausmann et al., 2002).

Age has also been reported as a moderator of the pseudoneglect phenomenon alongside handedness and sex (Hausmann, Waldie & Corballis, 2003; for a review see Friedrich et al., 2018). Failla et al. (2003) conducted a study using a line bisection task on right-handed individuals aged between 5 to 70 years old. They found a "symmetrical neglect" among 5 to 7 year olds, where a left bias was observed when using the left hand and a right bias when using the right hand. Older children (10 to 12 years old) exhibited a weaker bias to the left, whereas young adults (20 to 30 years old) reported a consistent left bias. Finally, older adults (60 to 70 years old) displayed a symmetrical neglect (i.e., ipsilateral bias according to the hand used). The authors attributed their results to the maturation of the corpus callosum. The symmetrical neglect among young children may be the consequence of callosal immaturity, where incomplete myelination leads to an insufficient interhemispheric transfer of perceptual information. This can cause difficulty in crossing the midline during visuospatial activities. The shift toward the left will gradually develop following the maturation of the corpus callosum, lasting until early adulthood. Regarding the absence of a leftward bias

among older adults, it can be explained by the possibility of degeneration of the myelinated corpus callosal fibers (Failla et al., 2003). Another study replicated to some degree these results, showing a symmetrical neglect in children from the age of 3 and a pseudoneglect among 5 year olds (Girelli et al., 2017). These findings may reflect an increase in motor and callosal maturity allowing the emergence of the behavioral manifestation of attentional biases. Five-year-old right-handed children also showed a leftward attentional bias on a 3D spatial line bisection task (Patro et al., 2018). With regards to the elderly, due to the strong heterogeneity of the past studies, it is still difficult to draw any conclusion concerning the suggested weaker leftward bias (Friedrich et al., 2018). What is most likely to be certain is that pseudoneglect exists since childhood (see for a recent meta-analysis Kaul et al., 2021) and seems to remain present throughout an individual's lifespan (see for a recent meta-analysis Learmonth & Papadatou-Pastou, 2022).

It is suggested that attentional bias may lead to another perceptual bias: aesthetic preference. A leftward attentional bias may explain the generally reported aesthetic preference for images with more elements and details on the right visual field. It is postulated that this preference may restore the imbalance created by the leftward attentional bias (Ishii et al., 2011; Levy, 1976; for a review see Page et al., 2017). It has been found that this bias is stronger among right-handers than left-handers, which may be a consequence of their different cerebral lateralization (De Agostini et al., 2011; Levy, 1976). Aesthetic preferences are also moderated by sex, where males show a lateralized activity to the right hemisphere when judging a visual stimulus as beautiful, whereas females show bilateral brain activity (Cela-Conde et al., 2009).

Gerrits et al. (2020a) recently conducted a study by directly testing the hypothesis that a leftward attentional bias is a consequence of the right hemispheric dominance. Using fMRI on 40 left-handers with a right hemispheric dominance for visuospatial attention and 23 left-handers with a left hemispherical dominance, the authors found that the magnitude of the pseudoneglect was slightly less among participants in the latter category. Nonetheless, the theorized complete reverse pseudoneglect among the left-lateralized participants was not observed. Therefore, it is most likely that cerebral dominance constitutes one of several factors which underlie perceptual biases (Gerrits et al., 2020a).

2.1.2 The biomechanical influence

Drawing asymmetries are not only a consequence of laterality, reflected by attentional bias and its related aesthetical preference; motor development can also have an impact. More precisely, graphomotor productions are influenced by the hand-movement-related asymmetries arising from a biomechanical factor, which depends on whether the right or left hand is used to draw. It is easier to perform outward-directed movements (i.e., extension) than inward-directed movements (i.e., flexion). Thus, the stroke's starting point and orientation are directly related to the hand used to execute the movement (van Sommers, 1984). Right-handers generally follow a left-to-right stroke direction, beginning their drawing from the left side, while the opposite pattern is found among left-handers (van Sommers, 1984, 1989). It is suggested that the preference for extensor movement leads to a directional bias, which reflects the orientation of which an asymmetrical object is depicted. Right-handed adults predominately orient their drawings to the left when they are asked to draw familiar objects, whereas left-handers present an absence of preference or orient their drawing to the right (Alter, 1989; Karev, 1999; Picard, 2011; Shanon, 1979). These findings are in line with the biomechanical influence. Given that the front of an object tends to be drawn first, the profile will end up facing leftward or rightward depending on whether one is using the right or the left hand to draw. Tosun and Vaid (2014) conducted two meta-analyses revealing the importance of the hand used in the direction of the drawing's final orientation. The authors argued that the directionality bias is strongly determined by the biomechanical principle.

2.1.3 The cultural influence

Directional tendencies have been found in the motor and perceptual behaviors of humans. The motor directional tendencies can be related to the biomechanical factors discussed earlier. For the perceptual directional tendencies, when an individual horizontally scans a stimulus, two options are possible: left to right or right to left (Dreman, 1974). It has been reported that cultural factors, which are related to the direction of reading and writing (i.e., script directionality), influence visual fixation and scanning habits. Eye-tracking experiments demonstrated visual saccades on the left side of the visual field during exploration tasks in Left to Right readers (LR script), while Right to Left readers (RL script) did not show any bias (Ossandón et al., 2014). Thus, script directionality is found to modify the scanning habits and the visual

orientation, which consequently influences the attentional bias (Abed, 1991; Hoyos et al., 2021; Rinaldi et al., 2014). The effect culture has on visuospatial tasks is found in cross-cultural studies and in different populations (Chokron & De Agostini, 2000; Dobel et al., 2007; Ishii et al., 2011; Kazandjian et al., 2010; Rinaldi et al., 2020; Rinaldi et al., 2016; Tversky et al., 1991; Vaid et al., 2011; for reviews see Page et al., 2017 and Vaid, 2011).

Classically, research that studies culture's influence on perceptual biases compares several age groups. Researchers can assess preschoolers (3 to 5 years old), older children (5 years old and up) who acquired some reading and writing experience, and adults. For example, Fagard and Dahmen (2003) compared the performance on the line bisection task between two groups composed of right-handed French (LR script) and Tunisian (RL script) children. These participants are aged 5, 7, and 9 years old (i.e., before and after learning how to read and write). With the youngest children, the leftward attentional bias is observed for the two groups. The bias is even more important as the task is performed with the left hand, which is under the control of the right hemisphere. However, with the development of the practice of reading and writing, the leftward attentional bias increased among French children (LR script) while it decreased among Tunisian children (RL script), disappearing completely by age 9. Supporting these results, Faghihi et al. (2019) investigated the effect of script directionality and handedness in a draw-a-tree task. Participants were divided into English (LR script) and Urdu, Arabic, and Farsi (RL script) adult readers. The authors found an overall attentional bias to the left and it was significantly stronger for the right-handers. However, leftward attentional bias was significantly stronger for LR adult readers than for RL readers. This is in contrast with Picard and Zarhbouch's (2014) study, where the authors did not find any influence of script directionality using the same drawing task among younger participants from 5 to 15 years old. Faghihi et al. (2019) suggested that a significant amount of experience with reading and writing is required to result in noticeable drawing asymmetries.

There is also an impact of the script directionality on aesthetic preferences (Chokron & De Agostini, 2000). De Agostini et al. (2011) compared children aged from 7 to 10 years old and adults. All the right-handers preferred a rightward directionality. However, for left-handers, male adults preferred rightward-oriented images, whereas an absence of directionality preference was found among female adults. In contrast, the left-handed children (males and females) preferred leftward-oriented images. The authors

suggested that the shift to a rightward preference among left-handed males could be the consequence of the exposure to the LR script directionality. In contrast, left-handed females may be less sensitive to this cultural factor, which may explain the absence of directional preferences. This sex difference may also be explained by the stronger cerebral lateralization generally found among males compared to females (see also Friedrich et al., 2014 for similar results regarding the interaction between sex, script directionality, and aesthetic preference). The link between script directionality and aesthetic preference can be explained by the fluency theory; when an image is more easily and fluently processed, it is more positively and aesthetically evaluated (see for review Page et al., 2017).

Finally, it has been shown that the biomechanical factors (i.e., the ease of execution of certain movements) can also be moderated by cultural factors (Kebbe & Vinter, 2013). Among readers, a LR script directionality enhances the LR stroke orientation for right-handers (congruent directionality), whereas the same script directionality weakens the RL stroke orientation of the left-handers (Vaid et al., 2002). This work agrees with other studies showing script directionality influence on directional biases. Kebbe and Vinter (2013) found that right-handed French participants (LR script) exhibit a leftward directional bias when drawing side-view objects, whereas right-handed Syrian participants (RL script) are more prone to draw objects oriented toward the right.

2.2 Measurements

Several tasks have been created to assess visuospatial attention. Different types of tasks can be used to measure various forms of visuospatial processing (Ocklenburg & Güntürkün, 2017, p.179). Some examples are: spatial visualization tasks (e.g., mental rotation of objects), spatial orientation tasks (e.g., localization of dots on a spatial map), and manual manipulation tasks based on haptic modality (Vogel et al., 2003). In this chapter, we will present a brief overview of the different measures that can identify the attentional and directional biases mentioned earlier.

The most popular assessment for measuring attentional bias is the line bisection task. The participant is asked to mark with a pencil or cursor the middle of a horizontal line. Healthy children and adults are generally more biased to the left (see Figure 2.1).

Figure 2.1. Example of a leftward bias on a line bisection task

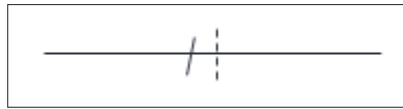

Common variants to the line bisection task exist (Friedrich et al., 2018; Strappini et al., 2021). One example is the tactile rod bisection task where participants explore, with their eyes closed, the entire length of a rod. They are then asked to place their index finger at the rod's center. Another is the landmark task, a non-manual assessment where the participant makes a forced-choice decision concerning the length of two halves of a pre-bisected line. Finally, the grayscales task, which requires a judgment in luminance, consists of asking a participant to choose which of two mirrored stimuli is darker. Generally, healthy individuals will exhibit a leftward bias on all these tasks (Brooks et al., 2016; Seydell-Greenwald et al., 2019; Yamashita, 2021). It is noteworthy that the extent of attentional bias (i.e., pseudoneglect) depends on the nature of the presented stimuli and varies across the visuospatial tasks (Girelli et al., 2017; Mitchell et al., 2020; for meta-analyses see Jewell & McCourt, 2000 and Vogel et al., 2003). The attentional bias can also be assessed by drawing, such as in the draw-a-tree task, where participants are asked to draw a tree on a piece of paper (Picard & Zarhbouch, 2014). Similarly to the line bisection task, healthy individuals more often depict the tree on the left visual field (see Figure 2.2).

Figure 2.2. Example inspired by Faghihi et al. (2019) of a leftward tree depiction, reflecting an attentional bias to the left

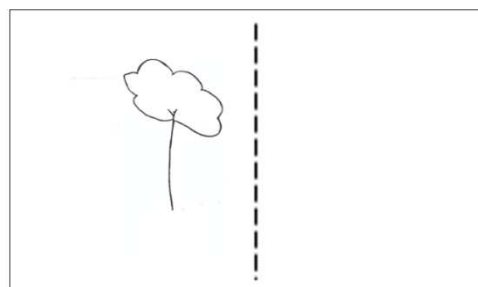

For the aesthetic preference, one can use an aesthetic judgment task where participants are asked to compare mirror-image stimuli. These stimuli are usually asymmetrical images or drawings, where more elements are presented on either the left or the right (see Figure 2.3). It is found that more individuals prefer the image with a greater weight on the right side, which may be a consequence of the imbalance created by the leftward attentional bias (De Agostini et al., 2011). Similar to the pseudoneglect, it has been

found that aesthetic preference depends on the type of stimuli. Comparing moving images, static images, and landscape images, Ishii et al. (2011) only found a correlation between the landscape stimuli and the line bisection task. Contrary to moving and static images, landscape images share similarities with the line bisection task since they require an evaluation of spatial information spread across a horizontal line. This may explain the association between these two tasks (Ishii et al., 2011).

Figure 2.3. Example inspired by Chokron and De Agostini (2000) of a mirror-image stimulus of an aesthetic preference task

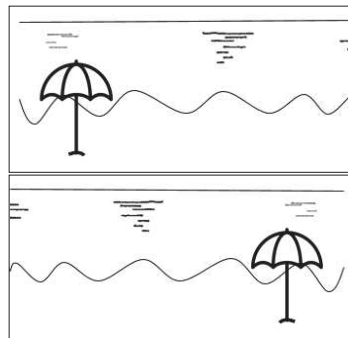

For the directional bias, the directionality task by Alter (1989) or its variants (e.g., Picard, 2011) can be used. In these assessments, participants are invited to draw a set of common asymmetrical objects (e.g., facial profile, bicycle, truck, and cup). Due to co-interaction between biomechanical and cultural factors, right-handers and LR readers depict objects with a leftward orientation. Left-handers and RL readers depict objects with a rightward orientation (Kebbe & Vinter, 2013; see Figure 2.4).

Figure 2.4. Example of drawing directionality, reflecting a directional bias

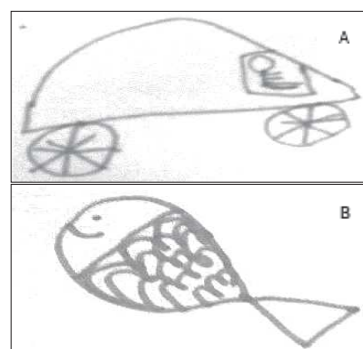

Note. A: Rightward orientation; B: Leftward orientation

2.3 Conclusion

The literature suggests that drawing asymmetries, which can be a manifestation of attentional and directional biases, are a consequence of a complex interaction between biological, motoric, and cultural factors (DiNuzzo et al., 2022; Rinaldi et al., 2020). The asymmetries observed in graphomotor productions such as drawing may reflect the implication of cerebral lateralization (i.e., right hemisphere dominance for visuospatial attention), biomechanical (i.e., the ease for outward oriented motor movements) and cultural factors (i.e., script directionality). Furthermore, the attentional and directional biases may vary among individuals with regards to their handedness, sex, and age.

In chapters 1 and 2, we presented a global overview on handedness and drawing asymmetries. In the subsequent and final chapter of this introduction, we will present several theories which attempt to explain the manifestation of laterality.

Chapter 3. The development of laterality: A multifactorial origin

The ontogenetic mechanisms of laterality, which are the processes involved in its origin and development, are complex. With initial research starting a few decades ago, experts are still identifying genetic and environmental factors that could play a role in the ontogenesis of laterality. The different hypotheses can be summarized into two perspectives that are not mutually exclusive (Marcori & Okazaki, 2020). The first view postulates that genetics and randomness are the major factors underlying functional and behavioral asymmetries in humans (McManus, 2021). The second suggests that environmental factors such as prenatal environment, early sensorimotor experiences, and sociocultural factors play an important role in the development of handedness (Michel, 2021).

In this chapter, we will explore several of the proposed theories which attempt to explain the development of human asymmetries.

3.1 Evolution

Evolution theories have been proposed to explain the strong right-hand bias among humans. Based on monogenetic models (see 3.2. Genetics), Corballis (1997) suggested that during hominid evolution a mutation caused the appearance of an allele. Its presence leads to right-handedness and a left cerebral dominance for language (i.e., the D allele). The chance allele (i.e., C allele), which leads to a random development of lateralization, is also integrated into this model. It is postulated that the stability of the proportion of right- and left-handedness across time is due to a heterozygote advantage among individuals with a DC allele combination. These advantages can lead to greater fitness (McManus et al., 2013) and better cognitive performance among individuals (Annett, 2002, p. 203-216). This view supports monogenetic models since the observed handedness phenotype is explained by a single genetic factor. It is possible, however, that the evolutionary hypothesis could still be applied under a polygenetic model of handedness (Corballis, 2019).

It has also been suggested that the strong right-hand bias in humans may be related to the evolution of bipedal locomotion (Papademetriou et al., 2005). A preference may have risen with bipedalism since the forelimbs are no longer involved in bilateral acts of locomotion. This could have led to a development of

greater motor efficiency and asymmetries (Corballis, 2019). Over time, these asymmetries may have been accelerated in humans due to the use of hands for more complex actions. Examples include the manufacture and use of tools, as well as the development of more expressive communication (Corballis, 2015).

With one hemisphere controlling both praxis and language, these two phenotypes could be related on an evolutionary level (Corballis, 1997). This hypothesis was supported by Becker et al. (2022) who showed that handedness in gestural communication, but not object manipulation, was associated with the asymmetry of the Inferior Arcuate sulcus (i.e., Broca's area homolog) in baboons. In the same vein, a longitudinal study reported that infants from 8 to 20 months show a higher tendency to use the right hand for gestural communication (i.e., declarative pointing) than for grasping task (Jacquet et al., 2012). Becker et al. (2022) suggested that gestural communication might be one of the multimodal evolutionary roots of language's lateralization (Badzakova-Trajkov et al., 2010; Corballis, 2012, 2019). Furthermore, Sha, Pepe et al. (2021) found genetic components for handedness which are associated with brain asymmetries in the language-related regions. These findings support the evolutionary theory postulating a relation between handedness and language (Sha, Pepe et al., 2021).

3.2 Genetics

Given that right-handedness is predominant in the human population, was present among the homo-sapiens ancestors, and can be observed as early as the prenatal life (see Chapter 1), the existence of a genetic component that shifted the distribution of handedness toward the right can be assumed. Two influential monogenetic models were proposed to explain the development of cerebral dominance and handedness (Corballis, 1997; McManus & Bryden, 1992), with both considering a genetic component and an element of chance (i.e., fluctuating asymmetry).

The first model was introduced by Annett (1972, for further details see Annett, 2002) and is entitled the "Right Shift Theory". Supposedly, a single gene caused the bias toward right-handedness resulting in a phenomenon called the "right shift". The author proclaims that this gene (i.e., Right Shift gene; RS gene) would lead to a left hemisphere dominance, which will consequently lead to a rightward bias for hand performance (Annett, 2000). For individuals lacking this gene, the cerebral dominance for language and

handedness comes down to chance. Therefore, the presence of the RS gene increase the probability of right-handedness, but it is not a necessary condition, since someone lacking this gene can still have 50% of being a right-hander. In this theory, the RS gene works in an additive manner, contrary to a classical dominant-recessive model (Annett, 2002, p. 122). Individuals with two copies of the RS gene (RS++) will be more strongly shifted (approximately two standard deviations) to the right on their hand performance scores. Those with one copy (RS+-) will be moderately shifted (about one standard deviation) to the right (Annett, 2002, p. 123). An equal distribution of right- and left-hand performance will be observed among those lacking this gene (RS --) due to chance. This model thus implies that left- and right-handedness are randomly determined, while the latter is also genetically influenced (Porac, 2016, p. 23).

The “DC model”, proposed by McManus (1985; for further details see McManus, 2002, 2022), is another monogenetic theory. Similar to Annett’s theory, McManus postulates that handedness is related to a single gene locus working in an additive manner. He suggests that the Dextral allele (i.e., D allele) leads to a rightward bias, whereas the Chance allele (i.e., C allele) is related to randomness. Contrary to the Right Shift Theory, it appears that hand preference is the heritable phenotype rather than hand performance, and that the single gene directly affects handedness over cerebral dominance. In this two allele Mendelian model, a CC genotype will lead to equal distribution of handedness (50% each), a heterozygous DC genotype will lead to 75% of right-handers and 25% of left-handers, and the homozygous DD genotype will lead to 100% of right-handers (McManus, 2002, p. 177).

These monogenetic theories were mostly constructed based on data from family and twin studies (McManus & Bryden, 1992). However, no indication was found that a single gene was responsible for both cerebral dominance and handedness (Goble & Brown, 2008; Ocklenburg et al., 2013). In contrast to monogenetic views, recent studies suggest that handedness could have a polygenetic origin (Ocklenburg et al., 2013). It is suggested that multiple genes, each with a small effect, might additively contribute to the development of body asymmetries (Francks et al., 2007; Guadalupe et al., 2016).

Over the last decade, researchers have conducted Genome-Wide Association Studies (GWAS) to investigate this hypothesis. GWAS allows rapid scanning of complete sets of DNA among large samples, aiming to find gene locations related to specific phenotypes such as handedness (Porac, 2016, p. 27). With

this approach, McManus et al. (2013) found no support for monogenetic models, and estimated that a minimum of 40 loci may be involved in handedness (for a GWAS on twins, see Armour et al., 2014). These results led to a reconceptualization of the DC model, suggesting the existence of multiple loci, each with a D and C allele (McManus et al., 2013). Supporting this polygenetic view, a recent GWAS meta-analysis conducted on a sample of 1,766,671 individuals found that 41 loci were associated with left-handedness, and 7 with ambidexterity (Cuellar-Partida et al., 2020; see also Ocklenburg et al., 2021). The authors also discovered a low genetic correlation between the two traits, implying that they could be influenced by different genetic mechanisms.

Despite the importance of genetics in handedness, several studies have found its influence to be limited. A study on 25,732 twin families has shown that genetic effects account for around 24% of the variance in handedness data (Medland et al., 2009; see also Medland et al., 2006 and Schmitz et al., 2022). Further evidence for a limited influence of genes is brought by family studies. The majority of children are right-handed, even if the biological left-handed parents increase the probability of having left-handed offspring (Porac, 2016, p.18). Statistically, the chance of having left-handed children is 37% with both parents left-handed, 22% when only one is, and finally 11% in families with exclusively right-handed parents (Porac, 2016, p. 18). Carter-Saltzman (1980) found that the concordance of left-handedness is higher between adopted left-handed children and their biological left-handed parents (27%) than their adopted left-handed parents (5%). Based on these family studies, we can observe a genuine but limited influence of genetics. This conclusion is also supported with studies on twins. According to the genetic perspective, monozygotic twins (genetically identical) should exhibit the same handedness, while dizygotic twins (50% genetically similar) should exhibit more discordant handedness. A recent meta-analysis reported only a 10% higher chance of handedness concordance among monozygotic twins compared to dizygotic ones (Pfeifer et al., 2022; for another meta-analysis see Sicotte et al., 1999).

Although these studies illustrate a genetic influence for handedness, but the variances found at the population level are not fully explained. This implies that handedness may have a multifactorial origin, with genetics accounting for only one of the factors.

3.3 Steroid hormones

In the last decade, several studies have brought forth genetic evidence supporting the implication of steroid hormones on the development of cerebral lateralization. It was shown that the length of androgen receptors located on the X chromosome varies according to handedness (Arning et al., 2015). Furthermore, the asymmetry of the planum temporale, which is stronger in males compared to females, was found to be linked to genes involved in the steroid hormone receptor activity and steroid metabolic processes (Guadalupe et al., 2015; Hirnstein et al., 2019).

Steroid hormones, which are chemical substances related to the endocrine system, have varied functions such as maintaining metabolism and promoting growth (Erlanger et al., 1999). By acting on the central nervous system, they can affect mental functions, influencing social behavior and cognition (Erlanger et al., 1999). These chemicals can furthermore be classified into two main groups: sex, or stress hormones.

The development of laterality may be influenced by both categories of hormones (Hausinger & Pletzer, 2021; Ocklenburg et al., 2016; Richards, Beking et al., 2021). This is deduced from two main observations: first, sex differences are generally found on a functional and behavioral level (for a review see Hirnstein et al., 2019), which suggests an implication of sex hormones. The second one which indicates an effect of stress hormones is the higher proportion of atypical handedness among neurodevelopmental and psychiatric disorders (Berretz, Wolf et al., 2020).

3.3.1 Sex hormones: Androgens, estrogens, and progestogens

The most notable theoretical model concerned with the influence of sex hormones on laterality is Geschwind, Behan, and Galaburda's GBG hypothesis (Geschwind & Galaburda, 1985). It is stipulated that there is a link between cerebral lateralization and prenatal testosterone exposure. More precisely, the GBG hypothesis suggests that elevated levels of testosterone during pregnancy will hinder the development of the left hemisphere. This will consequently lead to an atypical cerebral dominance and disruption of early language development (Cohen-Bendahan et al., 2004; Geschwind & Galaburda, 1985; Kalmady et al., 2013). The delay in the development of the left hemisphere will result in a compensatory growth of the right

hemisphere's homolog regions, increasing the incidence of left-handedness (Beking et al., 2018; Geschwind & Galaburda, 1985). Although this theory has been challenged (e.g., Bryden et al., 1994; Richards, Medland et al., 2021; Richardson, 2022), there is some evidence supporting testosterone's influence on lateralization. For example, Lust et al. (2011) found that a high level of prenatal testosterone is related to a weaker handedness and stronger cerebral dominance for language among 6-year-old children. Additionally, Beking et al. (2018) noticed that testosterone exposure could be related to cerebral lateralization in males aged 15 years old, where the higher levels of testosterone were positively correlated with a stronger left hemisphere lateralization. The authors do mention, however, that both prenatal and pubertal levels of testosterone should be taken into account, and that the effects are task-dependent.

Besides testosterone, there is a suggested link between cerebral dominance, estradiol, and progesterone, with some studies finding a negative correlation between their levels in the organism and functional lateralization (Hausmann, 2017). Although it remains unclear how sex hormones can be involved in functional lateralization, it is hypothesized that they may influence interhemispheric connection affecting the interaction/inhibition between the two hemispheres (for review see Hausmann, 2017). It is noteworthy that recent evidence showed an absence of an association between female sex hormones and hand preference (Richardson, 2022).

3.3.2 Stress hormones: Cortisol

Despite different etiologies in neurodevelopmental and psychiatric disorders, an atypical functional and behavioral lateralization is shared (See Chapter 1). Some genes are found to be associated with laterality and involved in the development of certain neurodevelopmental and psychiatric disorders like Developmental Dyslexia, Autism Spectrum Disorders, and Schizophrenia (Berretz, Wolf et al., 2020, p. 221, Table 1; Sha, Schijven, Carrion-Castillo et al., 2021; Sha, Schijven & Francks, 2021; Wiberg et al., 2019). Nonetheless, the genetic influence fails to completely explain the atypical lateralization found among several of these disorders (Berretz, Wolf et al., 2020). Based on that, Ocklenburg et al. (2016) proposed two non-genetic models that may explain the association between atypical laterality and disorders. In both, it is suggested that stress can modulate cerebral lateralization. In the first model (i.e., the hormonal model), cortisol has a possibility of altering the interhemispheric connection, which increases cerebral

lateralization. In the second (i.e., the cognitive emotionality model), stressful situations might be associated with a greater right hemisphere response, via an interaction between stress and emotion lateralization.

In the same vein, Berretz, Wolf et al. (2020) considered that alterations in the Hypothalamic-Pituitary Adrenocortical axis (HPA axis) might lead to the manifestation of atypical cerebral lateralization. The mechanism underlying this theoretical model is a disturbance in the typical levels of cortisol in the organism. It is stipulated that early life stress (e.g., intrauterine and birth stress) and chronic stress are risk factors for a reduction of cerebral lateralization, neurodevelopmental and psychiatric disorders. Even if the relations between stress, cortisol, and cerebral lateralization appeared to be complex, results from recent studies showed that acute and chronic stress could indeed influence hemispheric asymmetries on a behavioral and neural level (Berretz et al., 2022a, 2022b; Berretz, Packheiser et al., 2020; Mundorf et al., 2020).

3.4 Prenatal environment

Beyond the genetic and hormonal theoretical frameworks, theories on prenatal environmental factors have been proposed to explain the mechanisms underlying the development of functional and behavioral lateralization. The intrauterine environment is of utmost importance for the fetus and it is strongly implicated in the fetal development. Prenatal events, changes, or even adversities can constitute a protective or risk factors for fetal neurodevelopment (Connors et al., 2008; Gliga & Alderdice, 2015).

3.4.1 Prenatal adversities

The early emergence of Non-Right-Handedness (NRH; i.e., left- and mixed-handedness combined) could be a consequence of pathological events occurring between the prenatal period and birth, which are usually regrouped under the PCBS label (for Pregnancy Complications and Birth Stressors). Firstly, a co-occurrence has been discovered between hypoxia (i.e., oxygen deprivation), neurodevelopmental, and psychiatric disorders such as autism spectrum disorder, intellectual disability, epilepsy, and schizophrenia (Giannopoulou et al., 2018). Secondly, there is an elevated prevalence of NRH among individuals suffering from these disorders (Hirnstein & Hugdahl, 2014; Markou et al., 2017; Papadatou-Pastou & Tomprou, 2015;

Slezicki et al., 2009). These observations have paved the way for theories explaining the link between brain damage and handedness.

The first proposed theory was called: “Early brain insult”, where NRH is considered a result of neurological impairment during pregnancy (Bakan, 1971, 1977; Bakan et al., 1973). The higher occurrence of NRH is indirectly explained by a larger vulnerability of the left over the right hemisphere. The former is supposed to have a greater need for oxygen due to a more active metabolism (Bakan et al., 1973). Also, the late development of the left hemisphere over the right suggests it to be more vulnerable to external influences (Bisiacchi & Cainelli, 2022; Manns, 2021a; Njiokiktjien, 2006; Sanches et al., 2013). Such influences, like hypoxia, could lead to NRH. Because handedness is associated with motor lateralization in early neonatal life (Bisiacchi & Cainelli, 2022; Cioni & Pellegrinetti, 1982), minor PCBS coupled with hypoxia could lead to a unilateral brain insult localized in the left hemisphere. This may then alter the functioning of the contralateral hand resulting in a shift from right-handedness to left-handedness (Bakan, 1971; Bakan et al., 1973; Bishop, 1990a, p. 90; Porac, 2016, p. 40). It should be noted that Bakan suggested that all left-handers suffered from early brain damage. This can be considered an extreme hypothesis since, on average, left-handers do not show cognitive deficits or motor impairment related to early brain insult (Bishop, 1990a, p. 90-92; for further discussion see McManus, 1983).

Satz (1972, 1973) diverges from Bakan by proposing the “pathological left-handedness” theory. It can be considered less extreme as it does not postulate that all left-handers suffered from PCBS. Based on the hypothesis that brain damage may determine the development of handedness in some individuals, Satz stipulated that there would be two types of pathological handedness: the pathological left-handers and the pathological right-handers. While the former reflects left-brain damage among natural right-handers, the latter consists of natural left-handers with right-brain damage (Satz, 1973). Contrary to Bakan’s theory, there is no need to consider the left hemisphere as more vulnerable to brain insults to explain the higher prevalence of pathological left-handedness over right-handedness. To give an illustration of what these two pathological pathways are, we will use the fictive example given by Bishop (1990a, p. 92). Let’s suppose two groups of individuals: the first consists of 50 individuals who suffered from unilateral early brain damage, resulting in an impairment of the contralateral side of the body. The other group consists of 50 healthy individuals. For the former group, pathological left- and right-handers will be equally distributed,

leaving us with 25 left-handers and 25 right-handers. As for the latter group, since nearly 10% of the general population are left-handers, we will observe 5 left-handers and 45 right-handers. If we combine these two groups, we will obtain, out of the 100 individuals, 30 left-handers including 25 pathological left-handers (83% of the total left-handed individuals), and 70 right-handers including 25 pathological right-handers (36% of the total right-handed individuals). This will lead to a majority of pathological left-handers that should have been natural right-handers, and a minority of pathological right-handers that should have been natural left-handers (see Figure 3.1; for another example, see Ocklenburg & Güntürkün, 2017, p.142). While these two possible pathways propose an underlying mechanism for NRH, it cannot explain the higher prevalence of NRH among individuals with neurodevelopmental and psychiatric disorders. This is due to these disorders not necessarily being related to unilateral or bilateral brain insult (Previc, 1996).

Figure 3.1. Example inspired by Bishop (1990a) explaining Satz's theory (1972, 1973)

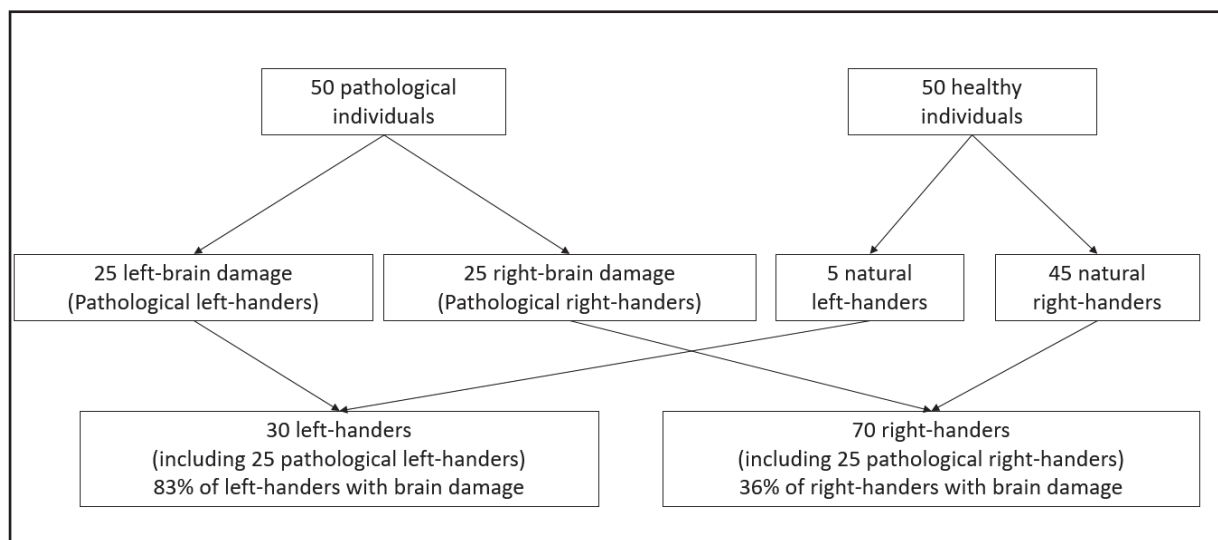

Batheja and McManus (1985) offered an alternative mechanism to the pathological left-handedness theory. They suggested that early brain insults result in an increase of biological noise. This thus leads to a higher fluctuating asymmetry, which in turn increases the likelihood of chance playing a role in the development of handedness (Batheja & McManus, 1985).

Concerning direct measurements of early brain insults, Vargha-khadem et al. (1985) found that all patients with prenatal and early postnatal left-hemisphere lesions developed a left-handedness, regardless of the lesion's severity. For this reason, the data supports the concept of "pathological left-handedness"

(for similar results see Orsini & Satz, 1986). More recently, an excess of mixed-handedness and left-handedness was found among premature children with brain injuries compared to those with no injuries (Marlow et al., 2019). These findings could also support Batheja's and McManus's (1985) explanation that early brain damage may increase the implication of randomness in the development of handedness. However, another recent study failed to find an association between brain injury and atypical handedness (van Heerwaarde et al., 2020). While it may be due to low statistical power as the authors suggested, these results indicate that handedness has different origins, resulting from genetic and environmental pathological factors (van Heerwaarde et al., 2020).

3.4.2 Developmental cascades

Other theories have been offered to explain how the intrauterine environment, without any pathological event, can be a major contributor in the typical development of laterality (Turkewitz, 2007). Michel (1983, 2021) postulated that the early and typical development of handedness is a consequence of a complex cascade of events involving pre and postnatal postural asymmetries, which contribute to the growth of early sensorimotor asymmetries of the arm and hand. These early asymmetries will consequently favor the use of a preferred hand for simple unimanual and later complex bimanual motor activities.

These developmental cascades are suggested to start with the fetal posture, seen as one of the first plausible causes of handedness. After the 16th week of gestation, factors such as gravity and the uterus's shape restrict the fetus's position and movement (Ververs et al., 1994b). Due to this restriction, the fetus adopts a cephalic (i.e., vertex) presentation, where the head is down and fixed in the mother's pelvis. While adopting this presentation, most fetuses turn to the left (i.e., Left Occiput Anterior or Transverse uterine position; LOA/LOT), which will constrain the left arm movement and the leftward head turns (Previc, 1991). In contrast, fetuses that turn to the right (ROA/ROT) will have their right arm movement constrained and the head turns oriented to the right (see Figure 3.2).

These fetal presentations will likely lead to lateral asymmetries in the organization of spinal synergies, which are related to the functional coordination between different muscles that produce a specific movement. In addition, it is suggested that the cephalic presentation, whether it is oriented to the left or right, will contribute to the lateralization of the vestibular system. This hypothesis is derived from

the Left-Otolithic Dominance Theory (LODT) of Previc (1991). The vestibular system, which is located in the inner ear, is involved in the sensory inputs implicated in the balance control and in cognitive functions that include spatial memory, orientation, and navigation (Dieterich & Brandt, 2015).

Figure 3.2. Right- and left-oriented cephalic presentation

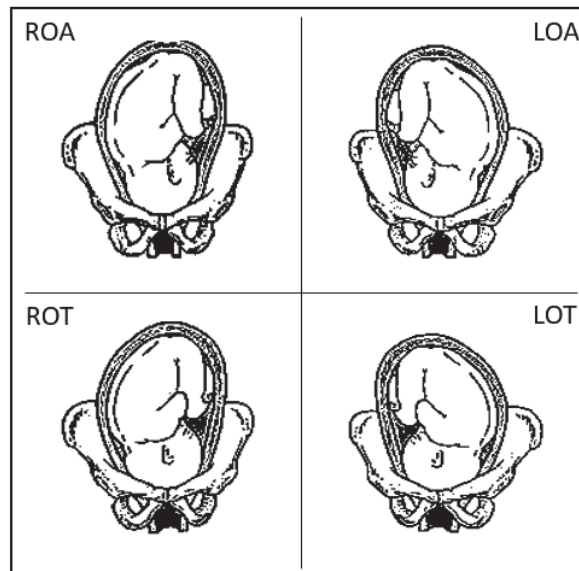

The asymmetric stimulation of the vestibular system and the asymmetrically lateralized activation of neuromotor mechanisms will produce a directional prenatal and postnatal head-turn (Fong et al., 2005; Rönnqvist & Hopkins, 1998; Rönnqvist et al., 1998). Newborn infants with a leftward cephalic presentation will exhibit a rightward head orientation preference in the supine position after birth, whereas newborns with a rightward cephalic presentation will exhibit a leftward head orientation preference in the postnatal supine position (Michel & Goodwin, 1979). The postnatal head orientation has been shown to predict later handedness. A rightward head orientation preference is associated with right-handedness, whereas a leftward head orientation is related to left-handedness (Goodwin & Michel, 1981; Michel & Harkins, 1986). It is stipulated that the asymmetrical proprioceptive and visual experience of the hand are the mechanisms underlying the association between the early head orientation preference and the later handedness (Goble & Brown, 2008; Michel, 2021; Ocklenburg et al., 2010). During the first year of life, the hand that was on the visual field during the early head orientation preference will be preferred by infants for reaching and

afterward for acquiring objects (Michel, Nelson et al., 2013). Ultimately, these asymmetrical experiences will contribute to the development of handedness (Michel, 2021; Michel, Nelson et al., 2013).

A notable remark is that in this “cascade theory of handedness” (see Figure 3.3), asymmetries caused by the fetal presentation are the main contributors to the development of postnatal functional and behavioral lateralization, rather than an already established cerebral lateralization (Michel, 2021; Previc, 1991). This theoretical approach is linked with the Embodied cognition theory (for a brief review of Embodied cognition and handedness see Willems et al., 2014, p. 195), where it is suggested that the early asymmetric sensorimotor activities during the development of handedness will lead to hemispheric variations in the neurophysiology of cognitive and emotional functions (Michel, Nelson et al., 2013). For example, infants are more motivated in using their preferred hand for reaching objects that generally provide positive feedback (e.g., sweet, round) rather than negative ones (e.g., bitter, spikey). The association between the preferred hand and the positive behaviors will likely lead to a functional lateralization for affective processing (Michel, Nelson et al., 2013). From the same perspective, Michel, Babik et al. (2013) suggested that language programming is influenced by the manual programming. Thus, early sensorimotor experiences, which are associated with hand preference, will shape later language abilities (see also Gonzalez et al., 2018; Gonzalez et al., 2020; Nelson et al., 2017). According to this view, the early development of handedness is mainly a result of an interaction between the individual and the environment (Ferre et al., 2020; Nelson et al., 2017).

Figure 3.3. The cascade theory of handedness as suggested by Michel (2021)

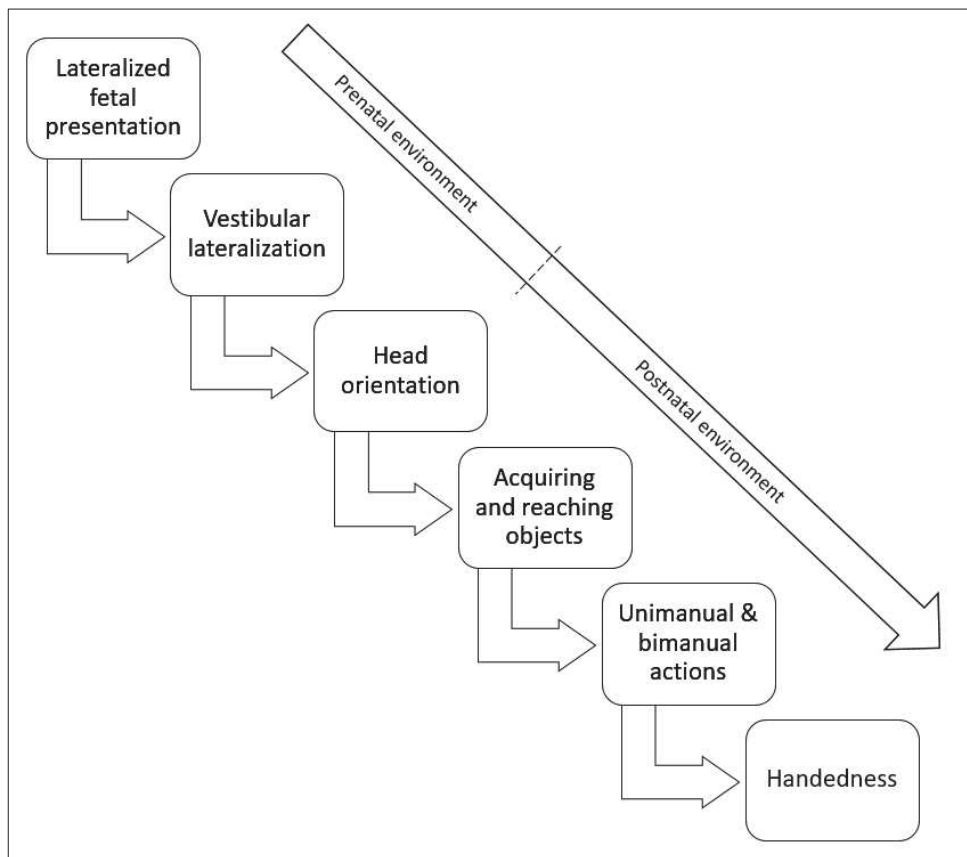

Note. This figure schematizes the developmental cascades that lead to handedness. A lateralized fetal presentation will lead to vestibular lateralization. In turn, it will result in a head orientation preference. Since most fetuses adopt a leftward cephalic presentation, the over-stimulation of the vestibular system will be asymmetric, leading to pre and postnatal rightward head orientation bias. Afterward, this head orientation preference will lead to a right-hand use for acquiring and reaching objects. Throughout the first years after birth, motor actions using the right hand will become more complex with the appearance of unimanual and then bimanual actions. The accumulation of sensorimotor experiences with the right hand will ultimately lead to the development of a right-handedness.

As a final note, the asymmetric sensorimotor experiences that the infant will acquire are supposed to interact with the caregiver's handedness within a cultural context (Michel, 2021).

3.5 Sociocultural factors

« *On ne choisit pas son enfance, on m'a pas laissé être droitier* » (You do not choose your childhood, they did not let me be right-handed). In this French Fatalis Picards song, the singer shares a story about a

father who is politically left-wing affiliated, refusing everything related to the word “right”. An interesting question can be inferred from this song, namely the implication of sociocultural factors in the development of laterality. Piaget and Vygotsky are two important pioneers in the field of developmental psychology, who disagreed on the role sociocultural influences have on a child’s development. While Piaget considered that the early development of children is the result of their actions in their environment, Vygotsky put much more weight on the influence of social factors (Cole & Wertsch, 1996). Nowadays, it has been shown that both early sensorimotor experiences and sociocultural factors contribute to child’s development (Catmur et al., 2007).

The prevalence of right- and left-handedness vary across different countries (Perelle & Ehrman, 1994, 2005; Raymond & Pontier, 2004). For example, on a sample of 255,100, Peters et al. (2006) found that left-handedness varies between 7% and 11.8% while comparing seven ethnic groups. These differences could highlight an influence of social pressures (Papadatou-Pastou et al., 2020). These pressures may be explained by social influences like symbolism. In many cultures, the right (*dextrae* in Latin) is generally associated with dexterity and positive attributes (e.g., power, authority), whereas the left (*sinistrae* in Latin) is generally associated with clumsiness and negative attributes such as evil and treachery (Hertz, 2013). Indeed, “left” and “left-handedness” are negatively connoted in our language (Schiefenhövel, 2013). Historically, and in certain contemporary societies, this particularity may have led to culturally accepted practices where left-handers are forced to use their right hand (Perelle & Ehrman, 2005; Zverev, 2006). Porac et al. (1986) conducted a study on 650 psychology students and found that 8% of them have undergone pressure to switch their hand preference to the right. About half of these students reported a success rate in switching hand preferences. Handedness switching seems to have an impact on the brain on a macroscopic level but also on the functional activity such as the cerebral motor control of writing (Klöppel et al., 2010). Furthermore, left-handers could be subject to cultural pressures, such as discrimination, prejudice, and stigmatization, which might impact their social responses and self-image (Coren, 1994). Compared to right-handers, left-handers are socially perceived as less warm and competent on the warmth and competence dimensions (for more details on this theoretical model of social cognition see Fiske et al., 2002), which suggests a persistent stereotype toward left-handedness (Dragović, Badcock et al., 2013).

Parental influence is another social factor that can contribute to the development of handedness. Left-arm cradling, for example, can induce sensory input asymmetries of the head movement, resulting in an easier right-side head orientation (Michel, Nelson et al., 2013). Moreover, children have a strong tendency to imitate adults by encoding most of their actions as causally meaningful (Lyons et al., 2011). Imitation could be a factor underlying the right-hand preference, especially from mother-child interaction (Laland, 2008). Right-handed mothers strongly use both their and their child's right hand when playing contrary to left-handed mothers (Michel, Nelson et al., 2013). Since the majority of mothers are right-handed, children will therefore imitate mostly right-handed adults (Marcori & Okazaki, 2020).

Apart from peer pressure, there exists the "right-side world hypothesis", where left-handers must deal daily with social behaviors and tools designed for right-handers (Coren, 1994). Social behaviors such as the right-handed handshake, script directionality from left to right (easier for right-handers), and tools such as cars and scissors are all factors that can increase the tendency of right-hand use (Marcori & Okazaki, 2020). This hypothesis can be supported by two different observations. Firstly, data on footedness generally point to a higher prevalence of non-right footedness compared to non-right-handedness, which may be the consequence of a lesser influence from social training and pressure (Chapman et al., 1987; Marcori & Okazaki, 2020; Packheiser et al., 2020). The social influence exerted on handedness can also partly explain the higher prevalence of left-handedness in young children compared to adults (see Chapter 1). Secondly, there are animal studies showing that lateral preferences could be influenced by the environment. Data from mice implied a world bias on the paw preference. In a particular study by Collins (1975), a food-reaching task was employed. When the feeding tube was placed in the center between two walls on the right and left side (i.e., unbiased world), the author observed that half of the mice reached the food with their left paw and the other half with the right one. However, when the feeding tube is placed on the right wall (i.e., right biased world), about 90% of the mice preferred the right paw for reaching the food. This result is in line with the hypothesis that a right-sided world can increase a rightward hand-use bias.

3.6 Conclusion

Despite the undoubted implication of genetic factors in the development of handedness, early environmental experience seems to also contribute to its development (Ocklenburg & Güntürkün, 2017). Evidence from numerous studies during the last decades suggests that functional and behavioral lateralization are the consequence of complex interactions between genetic, environmental, and epigenetic factors (Güntürkün et al., 2020; Schmitz et al., 2017).

A multifactorial model is possible, where selection pressure throughout human evolution has favored right-handedness and evolutionary advantages. This thus increased the number of right-handed individuals and children raised by right-handed parents. Early imitation and sociocultural influences will also enhance the preference for right-hand usage (Laland, 2008). Schmitz et al. (2017) proposed that instead of focusing on the long-lasting debate of “nature or nurture”, studies on handedness’ ontogenesis should adopt an epigenetic perspective. The authors proposed to evaluate the influence of environmental factors on gene expression via DNA methylation, which is the biological process that can change the DNA activity without changing the sequence.

In the next section, we will present the rationale and the objectives of this thesis (Part 2), followed by the empirical work performed (Part 3).

PART II – THESIS OBJECTIVES

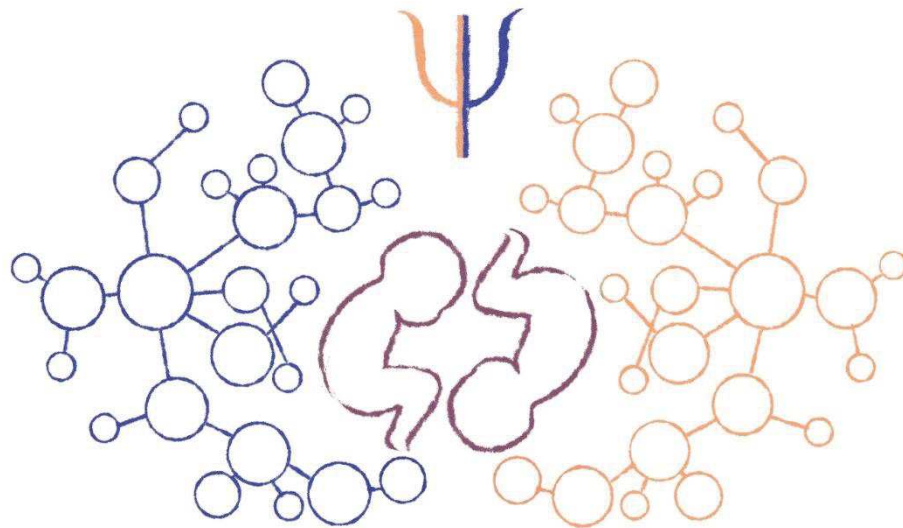

Chapter 4. Research queries and aim of the thesis

The aim of the present thesis is twofold. The first objective, which will be referred to as the applied objective, was to study in an exhaustive way the perceptual and motor biases that are implicated in the graphomotor asymmetries (see Chapter 2). Studying simultaneously the different perceptual biases implicated in asymmetrical graphical productions can allow us to investigate the interactions between the biological and cultural mechanisms underlying visuospatial attention. Based on this rationale, we aimed to identify in a comprehensive way the graphomotor asymmetries of healthy individuals from whom we can infer prototypical asymmetrical patterns. These patterns can be considered a foundation when investigating atypical asymmetrical patterns associated with neurodevelopmental disorders. Indeed, understanding the typical interindividual variability of visuospatial attention would help researchers and clinicians interpret findings from clinical populations (Friedrich et al., 2018). Previous studies found atypical visuospatial attention among individuals with neurodevelopmental disorders. Compared to neurologically healthy children who exhibit a leftward bias, those with Developmental Dyslexia or with Attention Deficit Hyperactivity Disorders show a rightward spatial bias (Sheppard et al., 1999; Sireteanu et al., 2005; Waldie & Hausmann, 2010). These results may reflect a right hemisphere dysfunction and a disturbance of interhemispheric connection in those clinical groups (Waldie & Hausmann, 2010).

The second aim of this thesis, which will be referred to as the theoretical objective, was to study the influence of non-genetic factors on the development of handedness. Understanding the developmental mechanisms of laterality may shed light on the complex etiology of neurodevelopmental and psychiatric disorders (see Chapter 1). However, it is still not clear whether this association is a reflection of causal relation or a consequence of common mechanisms underlying their ontogenesis (Bishop, 2013). Therefore, we aimed to investigate different prenatal and perinatal factors that may explain the higher prevalence of atypical laterality in individuals with neurodevelopmental disorders.

The empirical part of this research revolves around two scientific articles and two complementary studies. Article 1 and Complementary study 1 are related to the applied objective and are presented in Chapter 5. Article 2 and Complementary study 2 focus on the theoretical objective in Chapter 6.

PART III – EMPIRICAL CONTRIBUTION

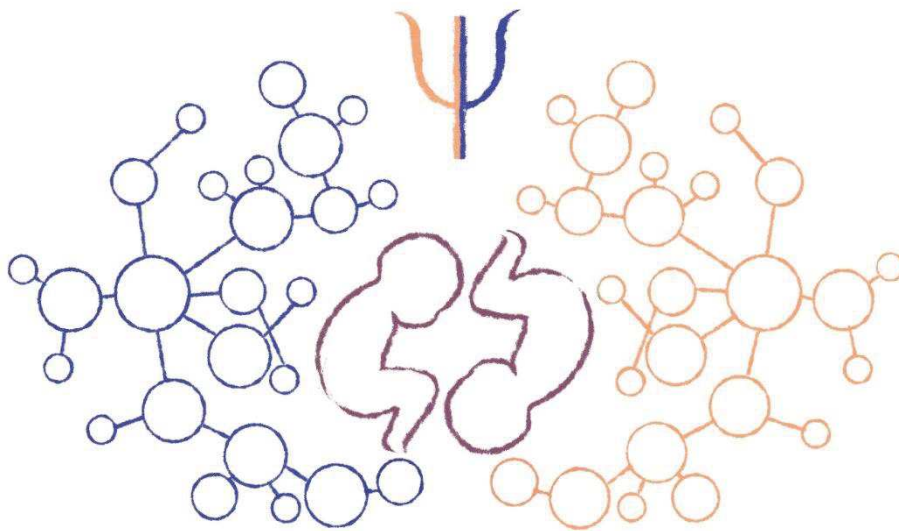

Chapter 5. Identifying graphomotor asymmetrical patterns

Children and adults exhibit asymmetries in their drawings due to several perceptual and motor biases. Originating from laterality, biomechanical, and cultural effects, the individual biases are usually assessed through different techniques (see Chapter 2). For example, the attentional bias is measured by the line bisection or draw-a-tree tasks, the aesthetic preference by aesthetic judgment tasks, and the directional biases by directionality tasks. However, few studies evaluate all three simultaneously. Therefore, behavioral and ecological tasks that can assess comprehensively these perceptual and motor biases could allow us to study their co-interactions. This could bring a deeper understanding of the mechanisms underlying visuospatial attention. Within a research and clinical context, tasks requiring fewer resources than neuroimaging experiments can help in screening individuals with atypical cerebral lateralization (Van der Haegen & Brysbaert, 2018).

Drawing is a strong candidate to reach this objective. It seems to be a reliable and useful measurement tool for assessing cerebral lateralization (e.g., Faghihi et al., 2019; Picard, 2011). Its usage is applicable to young children, enabling the investigation of visuospatial attention from a developmental perspective. It is also a graphomotor activity that is correlated with writing (Bonoti et al., 2005), and evidence on children with neurodevelopmental disorders such as Developmental Dyslexia and Developmental Coordination Disorder showed graphomotor dysfunctions reflected by handwriting difficulties (Gosse et al., 2022; Huau et al., 2015). Drawing was therefore used in this thesis as a tool to simultaneously investigate the perceptual biases implicated in visuospatial attention.

Article 1 introduces a novel ecological tool which aims to detect global graphomotor asymmetrical patterns. It is called the 3D-2D transcription graphic task, and was developed to help identify comprehensively the asymmetries resulting from perceptual and motor biases. This tool could potentially assess the extent to which cerebral lateralization, modulated by handedness and sex, can influence an individual's drawing. It can also provide information on the interaction between the attentional and directional biases, reflected by pseudoneglect and biomechanical factors, respectively.

Complementary study 1 is an attempt to extend the findings of Article 1, albeit with a different approach. In this study, the Rey-Osterrieth Complex Figure was used as the graphomotor task. It was chosen

due to its standardization and extensive usage in literature, contrary to the 3D-2D transcription task. A computerized Rey-Osterrieth Complex Figure was employed (Wallon, 2016), which provides a more accurate assessment of our variables of interest. For handedness, we used the 15 items hand preference questionnaire proposed by Fagard et al. (2015). This questionnaire investigates modern behaviors, such as which hand is used while manipulating a computer mouse. Another added test not performed in Article 1 was the Finger Tapping task, which measures hand performance. Its inclusion permits the analysis of another dimension of handedness. Lastly, contrary to the previous study, adult participants were recruited. The consequence of cultural factors (i.e., script directionality) on drawing asymmetries is the strongest within this age group (Faghihi et al., 2019). We therefore aimed to compare the graphical patterns observed from children in Article 1, with our results using older participants.

5.1 Article 1

Laterality and visuospatial strategies among young children: A novel 3D-2D transcription task

Jad Hamaoui¹, Myriam Maumy-Bertrand², Hervé Segond¹

¹Laboratoire de Psychologie des Cognitions (UR 4440), Université de Strasbourg, France

²Institut Charles Delaunay, Université de Technologie de Troyes, France

Reference

Hamaoui, J., Maumy-Bertrand, M., & Segond, H. (2021). Laterality and visuospatial strategies among young children: A novel 3D-2D transcription task. *Laterality*, 1-35.

DOI: 10.1080/1357650X.2021.1892715

Supplemental data for this article can be accessed at DOI: 10.1080/1357650X.2021.1892715.

Corresponding author

Jad Hamaoui

Laboratoire de Psychologie des Cognitions (UR 4440), Université de Strasbourg, France

jhamaoui@unistra.fr

ORCID: 0000-0003-2935-813X

Abstract

Recent findings showed that children, like adults, exhibit directional biases leading to asymmetrical drawings. This appears to be the result of a complex interaction between several biological, motoric, and cultural factors. We created a drawing task designed to investigate the influence of laterality (i.e., hemispherical functional specialization and handedness) and sex on children's graphical asymmetries. This task consists of transcribing a symmetrical three-dimensional landscape model to a two-dimensional representation. Sixty-six French pre-school children, aged between 5 and 6 years, were asked to undertake the 3D-2D transcription task, as well as the classical Alter's directionality task. The novel task exhibited higher sensitivity than the Alter's directionality test when examining the spatial biases resulting from handedness, and sex. Specific drawing patterns related to these variables were identified. These results suggest that, in addition to the influence of biomechanical factors and handedness, sex plays a role in children's early graphomotor development. They also support the influence of laterality as a key factor underlying early directional biases.

Keywords

Lateralization; hemispherical functional specialization; handedness; sex; visuospatial patterns

1. Introduction

The human brain is asymmetrically organized showing complementary specialization of the two cerebral hemispheres. This Hemispherical Functional Specialization (HFS) refers to the nature of the information that each hemisphere controls as well as the way each hemisphere processes it (Corballis, 2012). Thus, for most of the population, the left hemisphere is dominant for language, praxis, local and sequential processing, while the right hemisphere is dominant for spatial attention, face recognition, visuospatial activities, and global processing (Evans, Shedden, Hevenor, & Hahn, 2000; Tzourio-Mazoyer & Seghier, 2016; Vingerhoets, 2019).

The influence of HFS on individuals' drawings is well documented. Drawings are characterized by directional patterns and distinct asymmetric features that are referred to as directional biases (Picard, 2013). One interpretation of these directional biases is based on cognitive, attentional, representational asymmetries underpinned by HFS. An attentional bias, known as "pseudoneglect", is frequently reported in the literature among neurotypical individuals (Bowers & Heilman, 1980) who manifest a leftward deviation when executing line bisection tasks (Jewell & McCourt, 2000). This phenomenon reflects the influence of HFS on visuospatial attention and, more precisely, the dominance of the right hemisphere in the treatment of spatial information and in the processing of tasks with a spatial component which results in an attentional bias in favour of the left visual field (Kinsbourne, 1970). This leftward attentional bias appears to be associated with a general aesthetic preference for images with more elements and details on the right hemisphere. This aesthetic preference appears to restore the imbalance created by the leftward attentional bias caused by the dominance of the right hemisphere (Levy, 1976). Interindividual differences are observed concerning attentional biases in terms of importance and direction as a function of biological maturity (cerebral asymmetries, corpus callosum and sensorimotor development), reading experience (exposure to visuomotor explorations according to the script directionality), and the nature of the visual stimuli. However, it is still unclear to what extent each of these factors influence these attentional biases.

1.1. Handedness

At 3 years of age, the attentional bias in favour of the left visual field is only slight. The direction of attentional bias depends on the hand used in a line bisection task: rightward when the right hand is used and vice versa for the left hand (e.g., Failla, Sheppard, & Bradshaw, 2003; Girelli, Marinelli, Grossi, & Arduino,

2017). This ipsilateral bias for the used hand, called “symmetrical neglect”, reflects incomplete psychomotor development and insufficient interhemispheric transfer of perceptual information, causing a difficulty in crossing the midline during motor activities. From 5 years of age, increased motor maturity allows for the emergence of attentional biases. However, there are variations depending on the nature of the presented stimuli and implied information processing. Indeed, Girelli et al. (2017) found that 5-year-old right-handed (RH) children presented a leftward attention bias for the line bisection task, but rightward bias for the bisection of words and figure strings. This difference suggests a differential treatment of visual stimuli according to their continuous or discontinuous nature: discontinuous stimuli (e.g., series of letters) preferentially activates local processing of information for which the left hemisphere is dominant, causing attentional bias to the right. In line with this result, 5-year-old RH children also show attentional biases on a 3D spatial line bisection task (in which they had to point to the middle of lines oriented horizontally, vertically, and radially), where leftward and upward biases are more apparent for the younger children (Patro, Nuerk, & Brugger, 2018). Picard and Zarhbouch (2014) examined the influence of age, handedness, and script directionality (i.e., reading and writing’s directionality) on the attentional bias. With a draw-a-tree task proposed to right and left-handed French (5–15 years old) and Moroccan (7–11 years old) children, the authors failed to observe any influence of age and script directionality. However, they found a leftward bias concerning the location of the figure on the graphical space (i.e., depiction of the figure more to the left of the graphic space), for the right-handers. The absence of bias in left-handed children is commonly related to a weaker lateralization generally observed in comparison with their right-handed peers (de Schotten et al., 2011; Willems, Haegen, Van, Fisher, & Francks, 2014). Indeed, right-handers are strongly lateralized, while left-handers present lesser hemispheric lateralization, fewer cerebral asymmetries, and a larger corpus callosum (Li et al., 2014; Ocklenburg & Güntürkün, 2018a).

Differences according to handedness are also found in directionality preferences. Adult right-handers predominately orient their drawings to the left when they are asked to draw familiar objects (Alter, 1989; Karev, 1999; Shanon, 1979). However, this directionality bias is less clear among the left-handers. While a weaker directionality bias is observed among the lefthanders (Karev, 1999; Shanon, 1979), Alter (1989) found the inverse effect where the left-handers favoured right directionality. This directionality difference between right- and left-handers is assumed to reflect the degree of lateralization, which is stronger in rights-handers and more heterogeneous among left-handers. Therefore, there is a disparity in the results

concerning left-handers, though this may simply be due to the relative underrepresentation of left-handed (LH) participants in many handedness studies. Drawing directionality can also be influenced by the hand-movement-related asymmetries arising from a biomechanical factor associated with whether the right or left hand is used to draw. It is easier to perform outward-directed movements than inward directed movements. Thus, the handedness of a person creates a difference in the stroke's starting point and orientation (van Sommers, 1984). Right-handers generally follow a left-to-right stroke direction, beginning their drawing from the left side, while the opposite pattern is found among the left-handers (van Sommers, 1984, 1989). Tosun and Vaid (2014) conducted two meta-analyses that revealed the importance of the hand used in influencing the direction in which the object faces. They argue that figure drawing direction is determined largely by biomechanical principle. They found a significant influence of handedness irrespective of the script directionality. Consequently, handedness appears to determine how one orients the drawing of a face. Given that the front of an object tends to be drawn first, depending on whether one is using the right or the left hand to draw, the profile will end up facing leftward or rightward, respectively. However, the authors emphasize that a large unexplained variance remained even after correcting for uneven sample size and sampling error of left and right-handers. Consequently, the authors suggest that there may be other factors, such as aesthetic judgments, that may influence drawing directionality. One important factor that can affect aesthetic judgments, and which the authors could not include in their study, is sex.

1.2. Sex

Different brain activity is reported between males and females during an aesthetic judgment task. Cela-Conde et al. (2009) asked their participants to rate unfamiliar artistic and natural visual stimuli as beautiful or not during magnetoencephalography. For the stimuli rated as beautiful, a bilateral activity in the parietal regions was found in females, while males showed lateralized activity to the right hemisphere. These findings may reflect different spatial strategies in assessing aesthetic preferences. Indeed, due to their lateralized activity to the right hemisphere, males are more prone to use coordinate-based strategies (i.e., relying on precise metrics), whereas females, due to their bilateral activity, will tend to use categorical spatial strategies (Kosslyn, 1987). An alternative interpretation was also given by the authors based on spatial exploration strategies. Since the right hemisphere is associated with a global and the left

hemisphere with a local visual processing, males may rely more on the global features of a visual stimulus to make a judgment, whereas females will rely on both global and local features.

This interpretation appears supported in the literature given that, at a functional level, boys are more strongly lateralized than girls for language processing, facial processing and spatial attention (Bourne & Maxwell, 2010; Ocklenburg & Güntürkün, 2018b). Furthermore, girls are found to perform better than boys in spatial tasks requiring a categorical process such as recalling spatial configuration (Silverman & Eals, 1992), and also in spatial accuracy and visuomotor skills as early as five years of age (Barral & Debû, 2002; O’Gorman, 1999; Karapetsas & Vlachos, 1997). These findings are associated with a more efficient interhemispheric connection among girls. In agreement with this, females have a denser interhemispheric connection and larger corpus callosum. The latter can be detected as soon as the foetal life, where girls present a thicker corpus callosum than boys (Achiron, Lipitz, & Achiron, 2001; Ocklenburg & Güntürkün, 2018c; for a review on sex differences, see Hirnstein, Hugdahl, & Hausmann, 2019).

Consistent with the previous observations, the stronger lateralization of visuospatial attention in males was associated with a greater aesthetic preference for a left-to-right directionality than females (Friedrich, Harms, & Elias, 2014), and a slightly greater leftward bias in line bisection tasks (Jewell & McCourt, 2000). Similarly, De Agostini, Kazandjian, Cavézian, Lellouch, and Chokron (2011) reported a sex difference with visual aesthetic preferences by comparing French children (aged from 7 to 10 years) and adults. They presented static images (e.g., lamp), moving images (e.g., duck), and landscapes (e.g., an umbrella in front of a beach) oriented either from left to right or from right to left. They asked their participants to indicate which of the stimuli were more aesthetically pleasing. Similar results were found for the static and moving objects. For left-handers, adult men preferred rightward oriented images, whereas adult women did not show any directionality preference. In contrast, the LH children (boys and girls) preferred leftward oriented images. All the right-handers preferred a rightward directionality. These findings reflect the contribution of biological factors, such as handedness and sex, in visuospatial organization. The authors suggested that the shift to a rightward preference among LH males could be the consequence of the exposure to the left to- right script directionality. However, LH females appear to be less sensitive to this cultural factor, explaining the absence of directional preferences. The landscape stimuli resulted in a significant preference for a rightward directionality which increased with age for

males, compared to females who showed no significant difference. Indeed, RH or LH girls and females did not have any directional preferences.

Overall, the results suggest that aesthetic preference for moving and static images may be more sensitive to cultural factors (i.e., script directionality), whereas the aesthetic preference for landscape images may be more influenced by HFS (see also Chokron & De Agostini, 2000). However, Kebbe and Vinter (2013) failed to replicate the significant sex difference found by De Agostini et al. (2011). They asked children (aged 6–10 years) and adults to draw a side view of different objects (e.g., vehicles, faces, animals, tools). They found a significant difference according to the script directionality for the older children and adults only. The absence of a sex difference can be explained by two reasons. Firstly, as the authors noted, it may be a consequence of the low number of males and females per group in their study. Secondly, both static and moving objects were used in this study which appear to be more influenced by the script directionality, whilst the landscape objects appear to be more influenced by HFS (Chokron & De Agostini, 2000; De Agostini et al., 2011).

Ishii, Okubo, Nicholls, and Imai (2011) investigated the difference between moving/statics and landscape images further. They conducted a study on adults using a line bisection task and a similar aesthetic preference task as the one used by De Agostini et al. (2011). Interestingly, they found a correlation between landscape stimuli and the line bisection task. The authors suggested that landscape images and the line bisection task share common features since they require an evaluation of spatial information spread across a horizontal line. Based on the pseudoneglect literature, they argued that the degree of the attentional bias is stronger for stimuli with long horizontal and short vertical axes, thus the correlation between the two tasks. However, this is not the case for moving and static images, which due to their form, are less influenced by attentional biases and more sensitive to external factors, such as script directionality (Ishii et al., 2011).

Together, the literature suggests that visuospatial attentional bias and positioning asymmetries in drawing activities mainly reflect HFS and specifically the right hemisphere dominance of visual attention. These biases are more pronounced among individuals with a higher degree of lateralization and can be modulated by biological factors such as handedness and sex. We should note that the script directionality also plays an important role in the graphomotor asymmetries (Abed, 1991; Chokron & De Agostini, 2000; Ishii et al., 2011; Kebbe & Vinter, 2013; Ossandón, Onat, & König, 2014; Picard & Zarhbouch, 2014; Rinaldi,

Gallucci, & Girelli, 2016; Rinaldi, Di Luca, Toneatto, & Girelli, 2020; Tversky, Kugelmass, & Winter, 1991; for reviews see Page, McManus, González, & Chahboun, 2017; Vaid, 2011).

A complex interaction of several biological, motoric, and cultural factors leads to the directional biases observed in children and adults (Rinaldi et al., 2020). Whilst these studies investigated the perceptual biases, they scarcely considered the interaction between all these factors, and the degree of the influence of each mechanism underlying them (Tosun & Vaid, 2014). Therefore investigating these factors simultaneously is important for understanding how biological and cultural factors interact at a perceptual and representational level (De Agostini et al., 2011).

1.3. Proposed study

The aim of this study is to investigate the extent to which the HFS, modulated by the handedness and sex, can influence graphical productions in children. Based on the previous findings, we created a new drawing task which is both fun for the child and can probe the following underlying graphic asymmetries in children: (1) attentional biases related to HFS, through graphic density and drawing directionality; (2) biomechanical preferences related to handedness; (3) aesthetic preferences that develops with age. From this, we will identify specific graphical patterns, allowing us to investigate, in a comprehensive way, the interaction between the key contributing factors.

In our task, pre-schoolers are asked to transcribe a symmetrical three dimensional (3D) landscape model, into a two-dimensional (2D) representation on an A4 landscape-oriented sheet. These conditions were chosen for several reasons. Firstly, it is necessary to try to distinguish between biological and cultural factors. For this purpose, we focused on a population of pre-schoolers with a typical development (mean age 5 years and 6 months). Children at this age are less exposed to literacy than the older ones, which limits the potential influence of script directionality. Indeed, past studies on French children did not find any influence of script directionality among children of 6 years of age (Fagard & Dahmen, 2003; Kebbe & Vinter, 2013; Picard & Zarhbouch, 2014). However, categorial and coordinate spatial relations are present at this age, so our participants will know how to establish spatial relationships of up/down and left/right (Koenig, Reiss, & Kosslyn, 1990).

Secondly, at an intra-representational level, children generally depict their internal model of reality around 5 years of age (Barrett & Light, 1976; Piaget & Inhelder, 1948; Luquet, 1927). Hence, we suppose

that our participants' drawings will be the product of their mental representations and not an imitation of the outside world. Thus, their graphical transcription of a realistic 3D model should be a good indicator of HFS influence on spatial attention and the processing of visuo-spatial information.

Thirdly, we chose a landscape as our 3D model since landscape objects seem to be a better reflection of HFS than other objects. Thus, we suppose that the graphical patterns, identified by the 3D-2D task, will be influenced mostly by handedness and sex. Therefore, the detection of specific graphical patterns is needed in order to consider this novel drawing task as a valid assessment. We should observe the following patterns:

(1) Biomechanically, we expect that RH children will tend to draw from left to right, whilst LH children will tend to draw from right to left. Furthermore, the RH are expected to begin their drawing from the left (left point of origin) and the LH from the right (right point of origin).

(2) According to handedness, we expect more drawings to be oriented to the left among our RH participants, while an opposite pattern will be expected among the LH. Furthermore, we expect that the RH children will draw a more asymmetrical 2D representation of the 3D symmetrical model, reflecting their stronger HFS. We expect LH children will draw more balanced graphical production due to their lesser lateralization.

(3) We expect that girls will produce a better quality of drawing which is more balanced and symmetrical, since they present a lesser degree of HFS and greater interhemispheric connection than boys.

2. Methods

2.1. Participants

Sixty-six children participated (mean age = 67.9 months, sd = 3.78 months). The children's handedness was assessed using the Auzias laterality test (see Table 1 for descriptive statistics).

The participants were pre-reader children and from nursery classes located in the Paris region (Aulnay-Sous-Bois), and from three kindergartens in Alsace, France. Ethical approval for the study was obtained from the Research Ethics Committee of the University of Strasbourg (see <https://cil.unistra.fr/registre.html#proc-374>). Preliminary academic authorization and parental authorization were obtained before the beginning of the study. Only volunteer participants contributed to this study. None of the children suffered from any psychomotor difficulties that could hinder their writing or drawing performance.

Table 1. Distribution of our nominal variables

Variables	Categories	n (%)	Variables	Categories	n (%)
Sex & Handedness	Boys	Left	17 (25.8%)		
		Right	17 (25.8%)		
	Girls	Left	14 (21.2%)		
		Right	18 (27.3%)		
Alter's directionality	Balanced	9 (13.60%)	Progression Axe	Left to Right	35 (53.00%)
	Left	24 (36.40%)		Right to Left	24 (36.40%)
	Right	33 (50.00%)		Vertical	7 (10.60%)
	Total	66 (100%)		Total	66 (100%)
Complementarity	Balanced	41 (62.10%)	Density	Balanced	29 (43.94%)
	Left	14 (21.20%)		Left	22 (33.33%)
	Right	10 (15.20%)		Right	15 (22.73%)
	NA	1 (1.50%)			
	Total	66 (100%)		Total	66 (100%)
Placement order	ABC	13 (19.70%)		Centre	4 (6.06%)

	BAC	25 (37.90%)	Origin point	Left	37 (56.06%)
	BCA	22 (33.30%)		Right	25 (37.88%)
	Other	6 (9.10%)			
	Total	66 (100%)		Total	66 (100%)
Representation	Correct	25 (37.90%)	Spatial arrangement	A (Left)	10 (15.20%)
	Incorrect	40 (60.60%)		B (Balanced)	39 (59.10%)
	NA	1 (1.50%)		C (Right)	16 (24.20%)
				NA	1 (1.50%)
	Total	66 (100%)		Total	66 (100%)

Note. n(%): Sample Size.

2.2. Materials

Auzias laterality test (Auzias, 1975): This test measures manual preference. Ten items are presented in order to calculate a Laterality Index (LI). The experimenter asks the participants to manipulate different familiar objects and perform different actions (striking a match, erasing, ringing a small bell, eating with a spoon, shining a shoe, combing hair, transferring water from one container to another, brush teeth). Each object is placed in front of the participants in turn. The experimenter observes the manipulation and notes “L” if the participants use their left hand and “R” for the right one. Then, the LI is calculated by the following equation: $LI = [(nR - nL) / (nR + nL)] \times 100$ where nR and nL correspond respectively to the number of right- and left-hand uses. LI scores must be between -100 and -50 to be identified as a LH, or between +50 and +100 to be RH.

Alter directionality test (Alter, 1989): The children are verbally asked to draw six different items: fish, airplane, spoon, boat, bus, and car. The orientation of the drawing is noted as either left (L), right (R), or front (=), making it possible to calculate a Directionality Index (DI) = $(nR - nL) / 6$ where nL is equivalent to the number of drawings oriented to the left, nR to the number of drawings oriented to the right and 6 is the total number of drawings. The individual DI is distributed between -1 and +1.

Two-dimensional (2D) transcription of the three-dimensional (3D) model: This task consisted of the presentation of a 3D model with 3 different planes (see Figure 1a). This model had to be reproduced on an

A4 sheet by memory. Different coloured pencils are left at the disposal of the child. At the same time as the child draws, the experimenter transcribes the child's actions on an evaluation sheet (see Figure 1b).

Figure 1a. 3D model

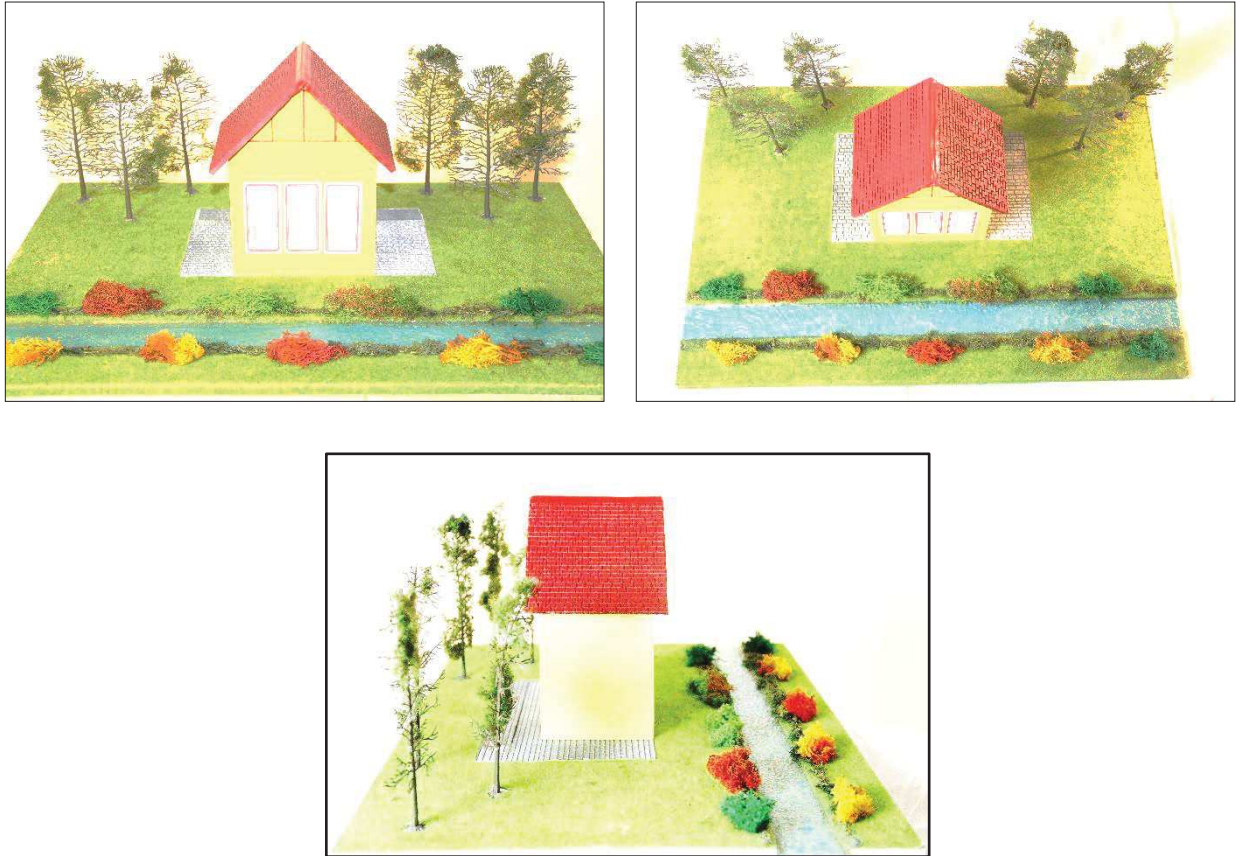
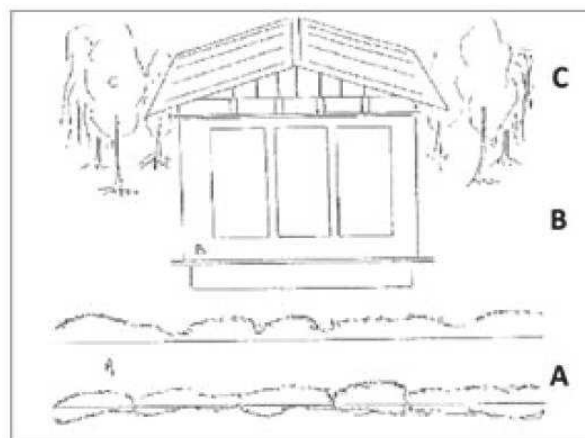

Figure 2b. Scoring sheet with the 3 planes (A, B, C)



The three planes of the model are consisted of: the foreground (plane A), representing a long horizontal river surrounded by lichens; the middle ground (plane B), representing a symmetrical house with three windows; the background (plane C), representing three trees on either side of the house.

This task allows us to observe the characteristics and variations of the graphical strategies employed by the children reflecting motor dominance, attentional biases, and mental representations. Together these can be used as a proxy for the degree of HFS (see “Experimental Design and Scoring” for a detailed explanation of all the variables). The reproduction on paper encourages the child to create an orientation. For example, the top of the paper will be the distal part and the bottom is the proximal part (Davis, 1985). Thus, a conversion of the vertical plane into a horizontal one is needed to be able to code the elements perceived in 3D into 2D.

2.3. Procedure

Three trained experimenters each separately assessed a different set of children. Afterwards, the lead experimenter carried out the scoring. The assessments were conducted in an isolated room to avoid any alteration of the child’s concentration. Each experimenter, alone with the participant in the evaluation room, is first seated on the child’s side during the handedness and directionality assessments. These tests are presented in the form of small games to promote the motivation of the child. After determining the manual preference and drawing directionality, the experimenter shows the 3D model and retreats slightly behind the child. The table and chairs are child-sized, and thus do not interfere with the motor tasks. At the end of the transcription task, the experimenter accompanies the child into his class while giving some compliments on the achieved work.

2.4. Instructions

The examiner stands beside the child and says (for the original instructions in French, please see online Appendix 1):

Well, I see that you draw very well. I really like your drawings. Now look, I am going to show you something and then I would like you to draw it for me. Be careful, look carefully as you are going to make a drawing that looks as close as possible to the model you are going to see.

Showing the model: *Do you see the house and the landscape? So, tell me what you see.* Then he follows the enumeration made by the child, repeating after him to encourage him. This helps the child to pay attention on all the present elements (avoiding an exclusive focus on the main and attractive element of the model, which is the house—i.e., plane B). In addition, the examiner specifies the relations between the elements located on the foreground and background compared to the middle: *In the centre, we see a symmetrical house, just in front is a river surrounded by bushes, and behind the house we see six trees.* After the transcription tools are placed in front of the child, the examiner states the following instruction after hiding the model: *You are now going to draw everything you saw.* The examiner then steps back and closely follows the evolution of the graphical production.

2.5. Experimental design and scoring

The aim of this study is to investigate the influence of handedness and sex on drawing directionality (underpinned by visuo-motor coordination) and spatial strategies underlying the 2D reproduction of a 3D model (underpinned by visuo-spatial perception such as depth, perspective, relative size). Thus, our independent variables are sex and handedness. Eight dependent variables are measured in our experiment:

(1) The dominant drawing directionality (cf. Alter's test): A negative value on the ID was quoted as left directionality preference and a positive value was considered as a right preference. A score of 0 was quoted as a balanced directionality (i.e., 3 drawings oriented to the left, 3 to the right).

The following variables are only assessed by the 3D-2D transcription task (see Figure 2 for a sample of the children's 2D transcriptions):

(1) Origin point: This variable reflects the point at which the child begins his drawing. It can be situated either to the left, the centre, or the right. Usually, the point of origin is a good indicator of the progression axis.

(2) Progression axis: this is the dominant line's direction—vertically or horizontally oriented. We scored lines from left to right and from right to left in two separate categories, while vertical strokes (down-up or up-down) are scored in a single category.

(3) Density of the elements: The density is relative to the area where the different elements of the drawing are located. It is evaluated from the number of occupied squares across the whole surface of the page (divided into 1 cm squares of each side). Thus, the density is determined relative to the middle of the

vertical and horizontal axes of the graphical support. We can observe a right, left or balanced density. We assume that the density of the elements reflects the attentional bias underpinned by the dominance of the right hemisphere.

(4) Complementarity of the main graphical elements: The level of detail represented by more drawing and colouring on each side of the house is evaluated. The evaluation of the degree of complexity on one side or the other of the house determines a left, right or a balanced complementarity. Since the attentional bias is associated with an aesthetic preference for images with more elements on one side, we believe that the complementarity of the graphical elements will reflect the aesthetic preferences of the participants.

(5) Correct or incorrect representation: The quality of the graphical production depends on the depicted and omitted elements as well as the spatial relations between the three planes characterizing the 3D model. A correct representation is identified by the offset between each of the three levels along a vertical axis, which is key to the translation from the 3D spatial “front-behind” relation to a 2D “bottom up relation” (Ingram & Butterworth, 1989). Thus, a drawing where the river is depicted on the bottom, the house in the middle and the trees on both sides of the house was considered a correct representation. Other representations were therefore considered incorrect.

(6) Placement order: The depiction order of the three planes (A, B and C) represents the transcription strategy. This variable will show us the different graphic strategies adopted by the children. For example, a BAC strategy will represent a drawing where the child starts to draw the house (i.e., the main element), followed by the river and finishes by drawing the trees (i.e., the background). However, due to the diversity of the strategies encountered during the assessment, we chose to combine all the results with a low frequency into one category. This category was named “other” and included the following strategies: ACB, B, CAB, CBA (see Table 1 for all the indicators used in the MCA analysis with their respective categories and frequencies).

(7) Spatial arrangement: This characterizes the orientation of the drawing based on all the elements. We divided this variable into three categories: A, B and C. Category A was defined as when the river is depicted on the left side of the house and/or the trees are on the right side (a leftward orientation). Category B was defined as a symmetrical drawing where the house and river are in the middle of the picture and the trees are present on both sides of the house. Category C was defined as when the river is depicted on the right side of the house and/or the trees are on the left side (a rightward orientation of the drawing).

Figure 2. Examples of the 2D transcription

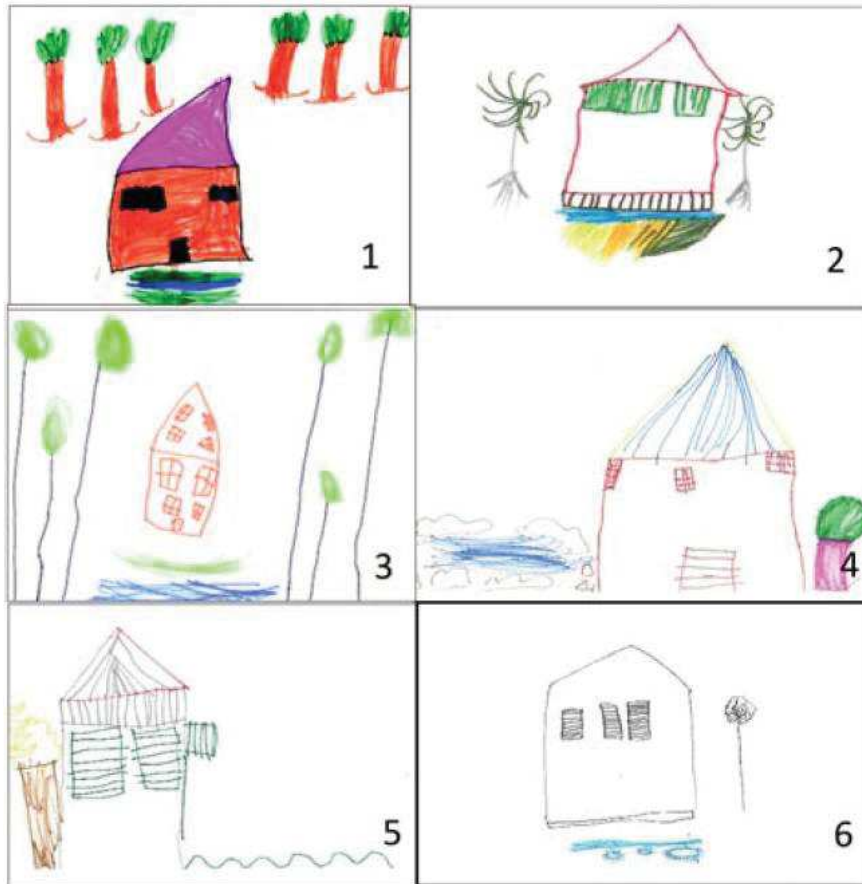

Example 1: Correct representation and symmetrical drawing. Left density and balanced complementarity.

Example 2: Incorrect representation and symmetrical drawing. Balanced density and complementarity.

Example 3: Incorrect representation and symmetrical drawing. Balanced density and complementarity.

Example 4: Incorrect representation and asymmetrical drawing, leftward orientation. Right density and balanced complementarity.

Example 5: Incorrect representation and asymmetrical drawing, rightward orientation. Left density and complementarity.

Example 6: Incorrect representation and asymmetrical drawing, leftward orientation. Left density and right complementarity.

2.6. Statistical analysis

Our statistical analysis was divided into two parts. The first one consisted of conducting an exploratory analysis allowing us to investigate the children's graphical patterns. We conducted a cluster analysis to classify our participants into different groups. Each of these groups represent participants with common graphical characteristics. These common characteristics allowed us to uncover specific graphical patterns. However, since we have a large number of variables, it is better to perform a dimensional reduction of variables before the clustering (Mitsuhiro & Yadohisa, 2015). Therefore, the exploratory analysis consisted of two parts.

The first part of the analysis was conducting a Multiple Correspondence Analysis (MCA) to perform the dimensional reduction, and to examine the relationship between our several nominal variables (i.e., sex, handedness, and the graphical variables). The MCA is a multivariate exploratory analysis that does not need any distributional assumptions and is used to investigate the relation between the variable response categories (Greenacre, 1984; Sourial et al., 2010). It allows us to map our data as points in a low-dimensional space, enabling us to examine underlying structures (i.e., dimensions) best suited to uncover the correlations between our variables (Mitsuhiro & Yadohisa, 2015)

The second part of the exploratory analysis consisted of conducting a Hierarchical Clustering (HC) to group our participants according to their similarities along the relevant dimensions obtained by the MCA. The statistical analyses were done using R 4.0.3 (R Core Team, 2020). All the study's variables are nominal. The MCA and HCPC functions of the FactoMineR package were used to conduct the MCA and the clustering analyses (Lê, Josse, & Husson, 2008). In addition, we used the factoextra, FactoInvestigate, and ade4 packages to optimize our interpretations and graphical representations of the MCA (Dray & Dufour, 2007; Kassambara & Mundt, 2017; Lê et al., 2008; Thureau & Husson, 2017).

The final part of our statistical analysis consisted in conducting Generalized Linear Models (GLM) to examine if our independent variables (i.e., sex and handedness) can predict the graphical variables. These GLM with logistic or multinomial dependent variables were computed in Jamovi 1.1.9 (Gallucci, 2019; Jamovi project, 2019) and in R 4.0.3. (R Core Team, 2020) using the multinom function of the nnet and ggeffect packages (Lüdecke, 2018; Venables & Ripley, 2002).

3. Results

To investigate the relationship between our nominal variables, we conducted an MCA combined with an HC. This method was designed to identify the relationship between our variables and to discern any specific patterns across our participants in a multidimensional space. This allowed us to create specific categories for the children's graphical productions.

For this analysis, we should note that participants 52 and 54 were deleted due to missing data in the complementarity, representation, and spatial arrangement variables due to a poor graphical production. The maximum number of dimensions are determined by subtracting total number of variables (J) from total number of categories (K): Number of dimensions = $K - J$.

From the 18 initially obtained dimensions, dimensions 1, 2 and 3 presented a greater inertia than those obtained by the 0.95-quantile of random distribution. Thus, we consider that the explained variance of the first three dimensions (40.16%) is adequate to show any real correlations between the variables (see Figure 3 for the Scree plot of the first 10 dimensions and Table I in online Appendix 2 for the cumulative variance percentage).

Figure 3. Percentage of the explained variance of the first 10 dimensions

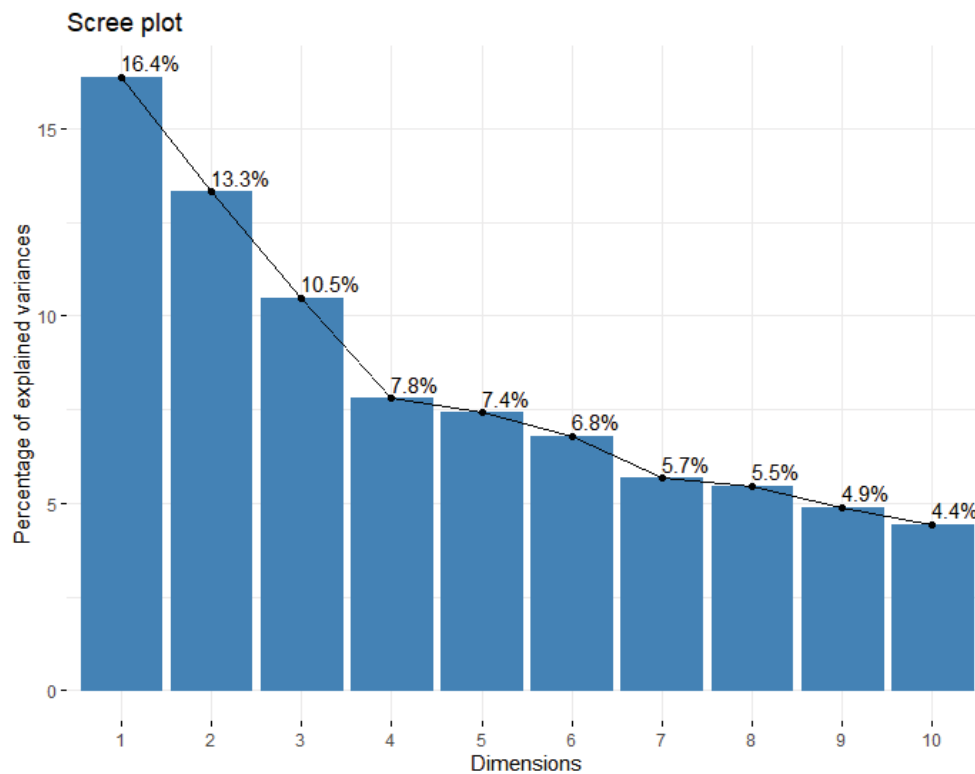
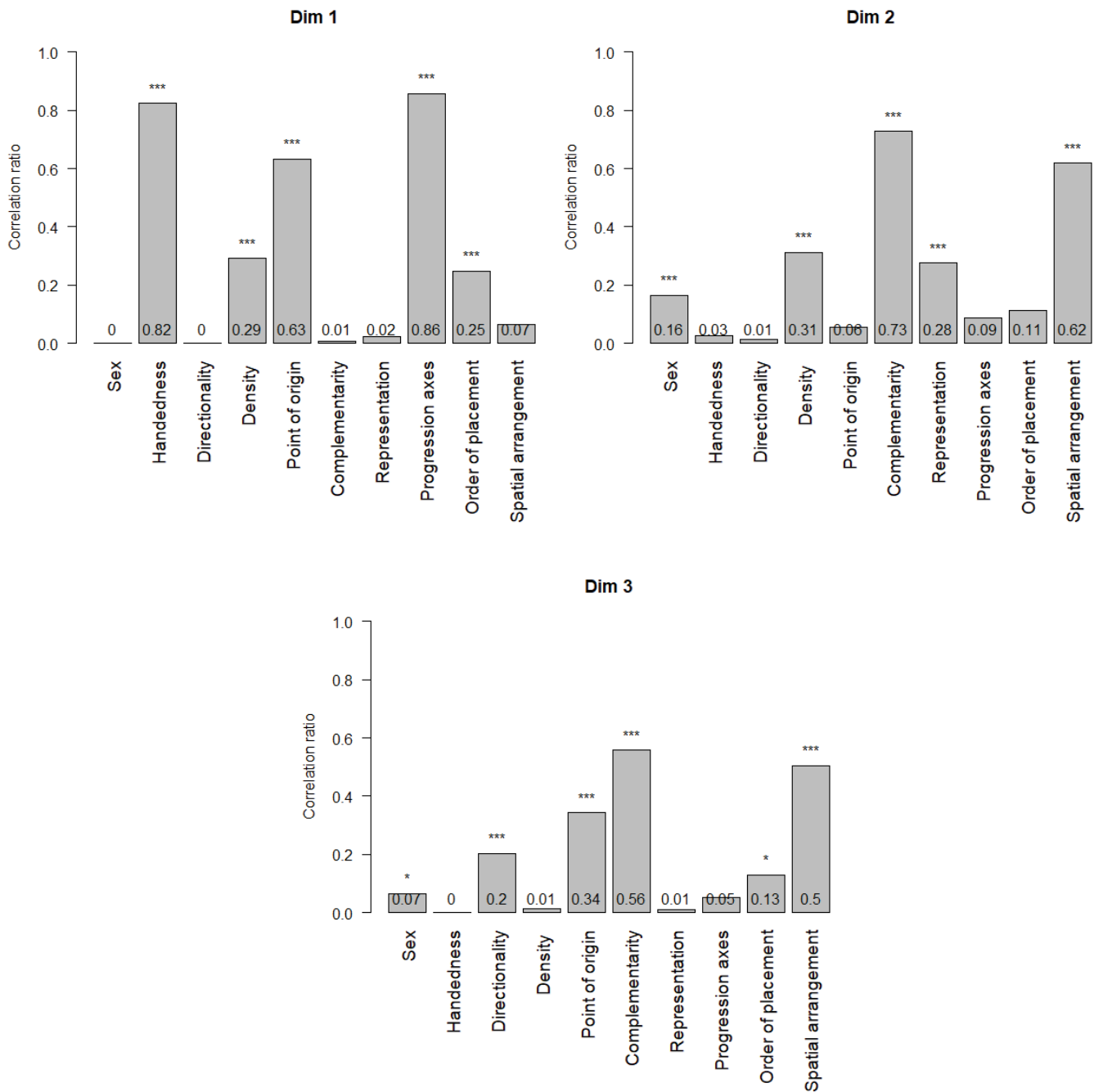

Figure 4. Bar plots presenting the association between the variables and the three dimensions



Note. *: $p < .05$; ***: $p < .001$

To understand the characteristics of each of our three dimensions, we must identify the variables that contribute the most to each of them. Therefore, we conducted correlation plots to identify the contribution of the variables on the three dimensions (see Figures 4 and 5 for the confidence ellipses of the significant

variables). Higher correlations represent higher contributions of the variables on each dimension. The first dimension is strongly characterized by handedness, biomechanical factors (progression axes and the origin point), and, to a lesser degree, by density and placement order. The second dimension is strongly characterized by complementarity and spatial arrangement variables, followed by density, representation, and sex variables. Similar to dimension 2, dimension 3 is strongly influenced by complementarity and spatial arrangement. However, we observe a significant influence of the origin point, the directionality, and the placement order (see Table II in online Appendix 3 for the effect size and p value of all the variables on these three dimensions).

Figure 5. Confidence ellipses for each significant categorical variable for the MCA analysis

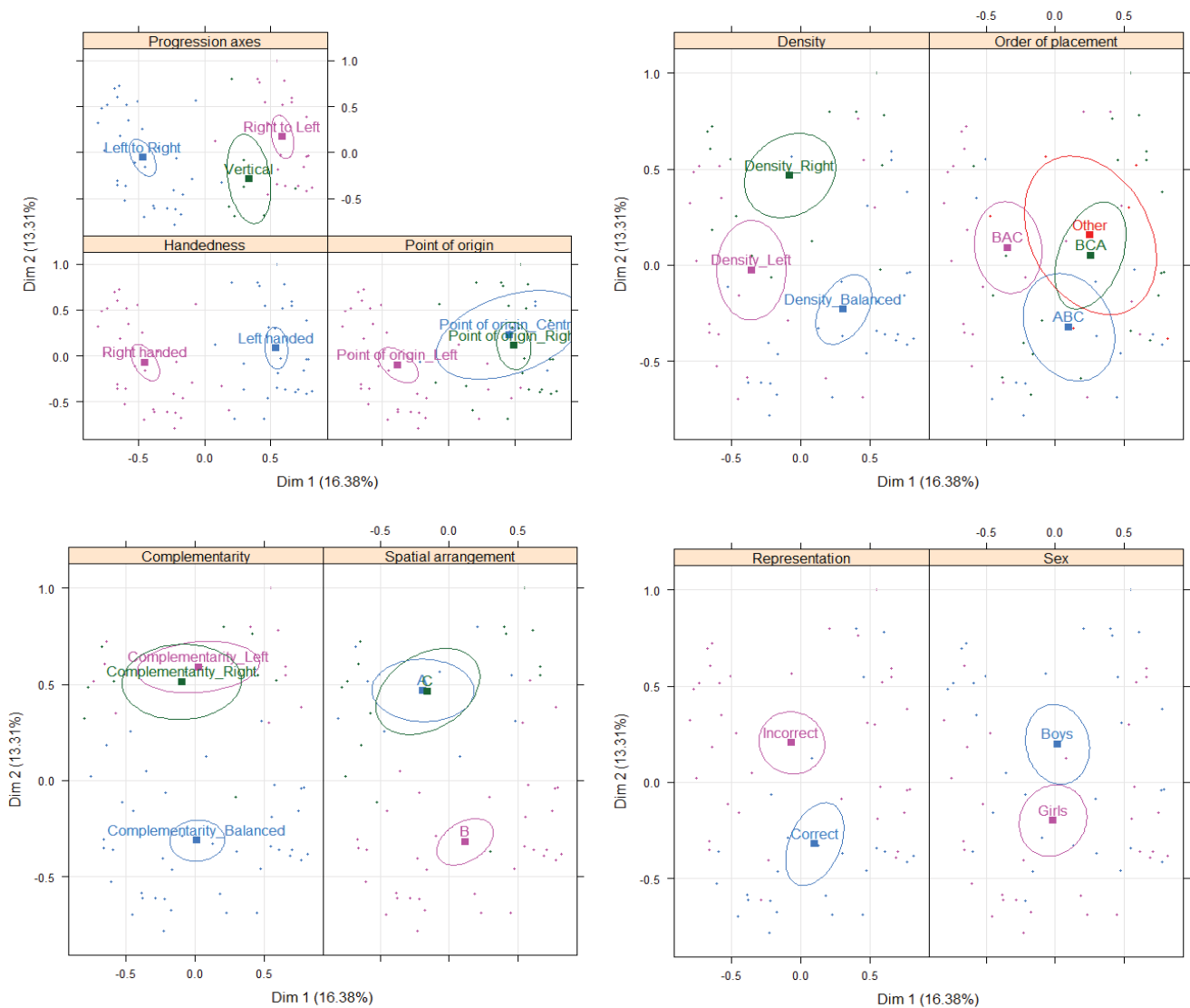

After identifying the main variables contributing to each of the three dimensions, we ran a bidimensional plot to observe the distribution and the correlation of the categories among these dimensions (see Figure 6 for the bidimensional plot).

Figure 6. Two-dimensional factor maps presenting all the categories of the three dimensions

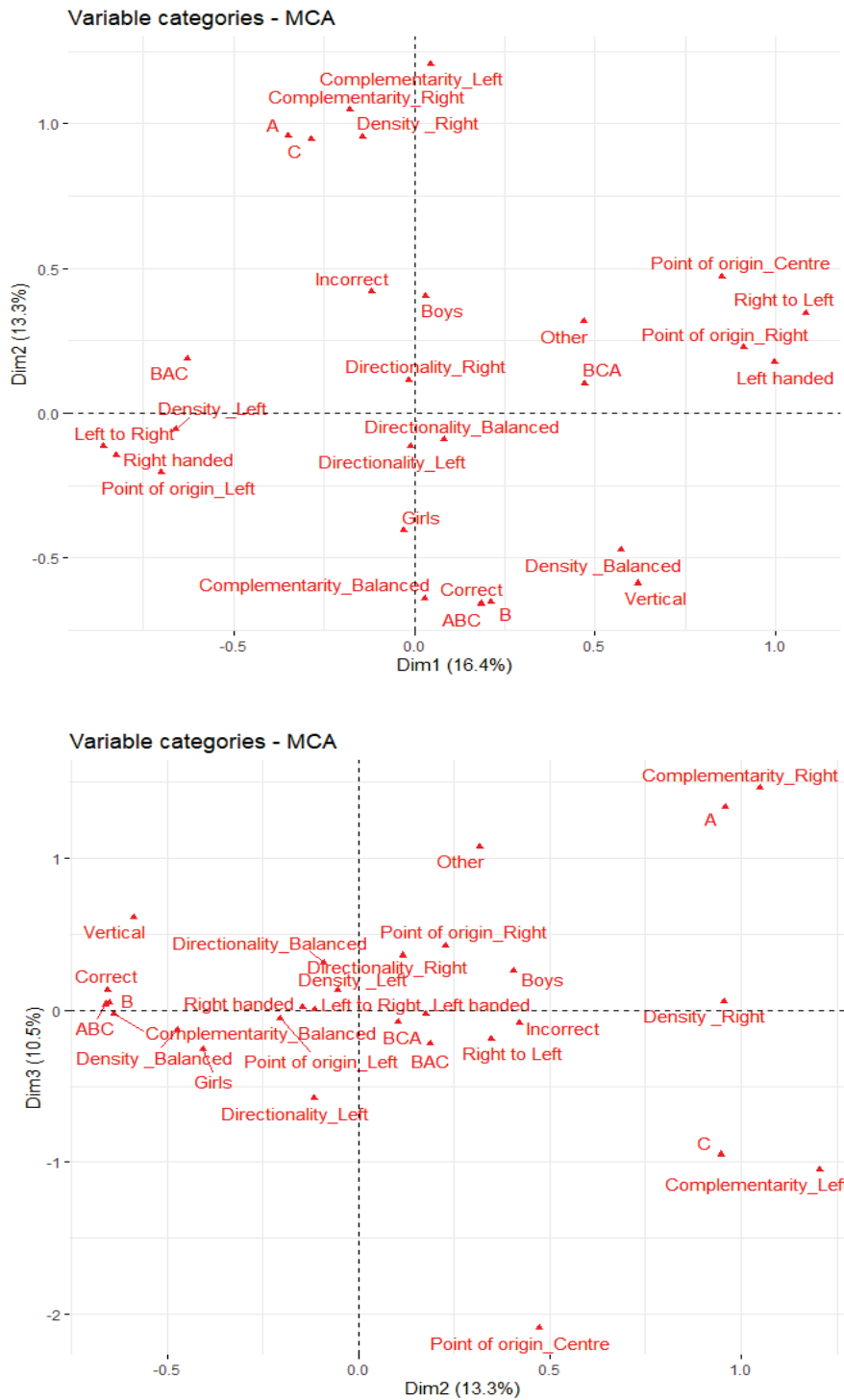

This bidimensional plot gives us a global pattern of the relationships between our variable categories. Each variable category is represented by a red triangle. The distance between the red triangles gives us a measure of their similarity or their dissimilarity. Thus, correlated variable categories will be close to each other, whilst negatively correlated categories will be on opposite sides of a dimension. We should note also that farther the variable category is away from the origin of the factor map (i.e., Figure 6), the better it is represented (see Table III in online Appendix 4 for the estimates and p values of all the categories characterizing the three dimensions).

In dimension 1, the results show that right-handedness is strongly correlated to a left point of origin, a left-to-right progression axis, and to a left density. We also observe that the right-handers have a strong correlation with the BAC order of placement (i.e., drawing firstly the house, followed by the river and lastly the trees). Conversely, left-handedness is strongly correlated with a right-to-left progression axis, a right and central origin point. It is less strongly but still significantly correlated with a balanced density, vertical progression axes and diverse order of placement strategies (e.g., BCA, ACB).

In dimension 2, the results show that girls are significantly correlated with a balanced density and complementarity, a B spatial arrangement (i.e., symmetrical drawing), correct representation (i.e., the river is drawn at the bottom, the house in the centre and the trees in the background), and with an order of placement ABC (i.e., beginning with the foreground, followed by the midground, and ending with the background,). However, boys, are loosely correlated with a right density, a right or left complementarity, spatial arrangements A and C (i.e., asymmetrical drawings orientated to the left or right) and incorrect representations.

Dimension 3 shows that right and balanced directionality are associated mainly with a right origin point, a right complementarity, and an A spatial arrangement (leftward orientation of the 3D/2D task). However, left directionality is associated with a centred point of origin, a C spatial arrangement (rightward orientation of the 3D/2D task) and left complementarity.

The MCA presented a general view of the relationship between our variables and categories. The second step is to perform a cluster analysis to investigate any specific patterns explained by inter-individual differences between our participants.

Five clusters were identified using Ward's method. This distance measure, which can be applied to a correspondence analysis, is an agglomerative clustering method based on the sum-of-square criterion and

generates clusters in a multivariate space (Husson, Lê, & Pagès, 2017; Murtagh, 2005; Murtagh & Legendre, 2014). Each cluster includes participants with similar characteristics (see Figure 7 for the visualization of the individuals' clusters).

Our classification analysis is in line with the MCA results, but allows us to make more accurate observations. RH and LH children were clustered into two separate groups: clusters 1 and 2 represented the right-handers, whilst clusters 4 and 5 represented the left-handers (see Table 2 for the characteristics of the five clusters; for all the results with their coefficients values, see Tables IV and V in online Appendix 5).

The right-handers were distributed nearly equally between the two clusters regrouping respectively 40.00% and 45.70% of the total number of right-handers. A left point of origin and left-to-right strokes were found in common between these two clusters. However, the first group were characterized by a left density and complementarity, a rightward asymmetrical drawing (spatial arrangement C), a BAC order of placement, and a left directionality preference. The second group was characterized by balanced transcription and the correct representation of the 3D model, symmetrical drawing, and Alter's test drawings that were oriented rightward (see cluster 2). Conversely, LH participants were unevenly distributed between their two respective clusters where cluster 4 contained 58.62% of the LH children, and cluster 5 contained 31.03%. The cluster 4 was characterized by vertical and right-to-left lines, a right origin point, balanced density and complementarity, symmetrical drawing and an ABC placement order. In cluster 5, participants showed a right-to-left axis of progression, a left complementarity, a centre point of origin, a rightward asymmetrical graphical production and a BCA order of placement. Cluster 3 was characterized by 7 children presenting no specific laterality or biomechanical features. These children had a rightward complementarity, a leftward asymmetrical drawing, a variable order of placement, and a rightward drawing on Alter's test.

Overall, the five obtained clusters corresponded to five groups of participants characterized by both the direction and the degree of their handedness. For the right-handers, cluster 1 represents the strong right-handers and cluster 2 represents the weak right-handers. For the left-handers, cluster 4 represents the weak left-handers and cluster 5 represents the strong left-handers.

Figure 7. Factor maps representing the different clusters among the three dimensions

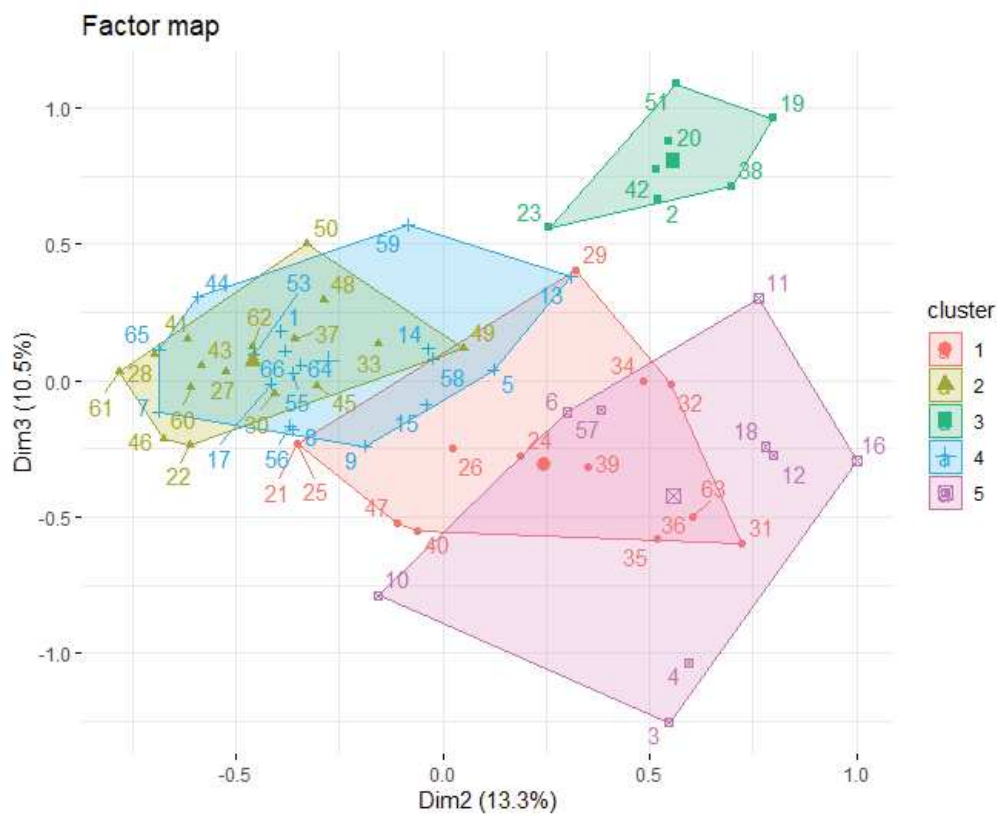
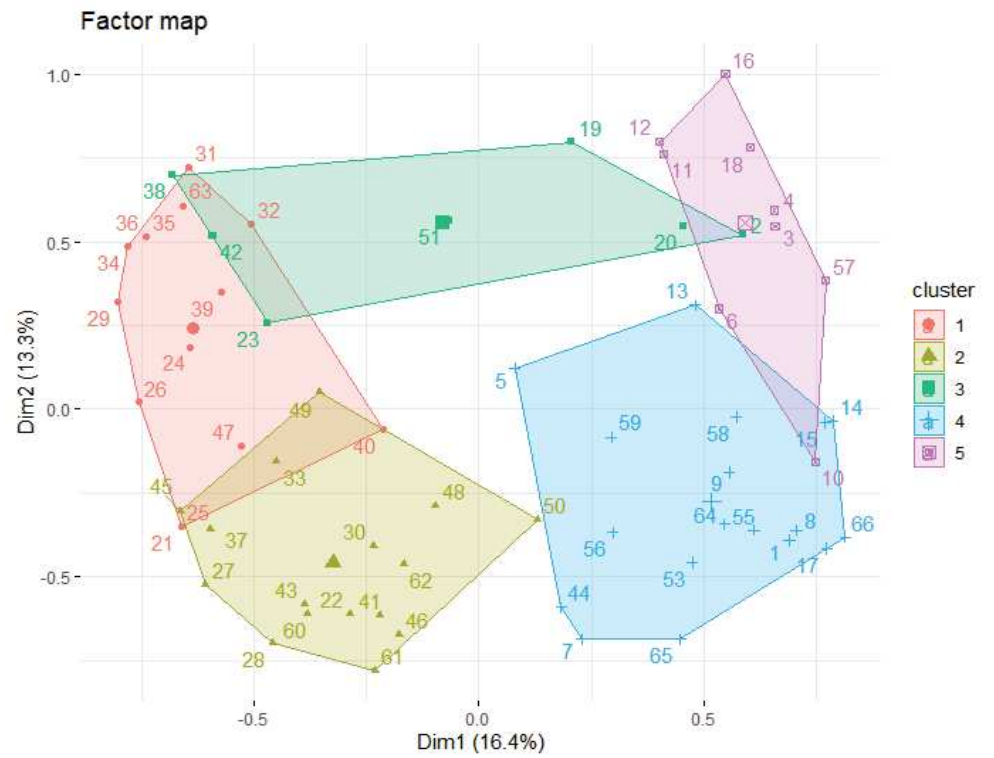

Note. Each number represents one participant

Table 2. Characteristics of each cluster

Clusters	Cluster 1	Cluster 2	Cluster 3	Cluster 4	Cluster 5
n	14	16	7	18	9
Handedness	Right	Right	-	Left	Left
Progression axes	Left to Right	Left to Right	-	Other/ Right to Left	Right to Left
Point of origin	Left	Left	-	Right	Centre
Density	Left	-	-	Balanced	-
Spatial arrangement	C	B	A	B	C
Complementarity	Left	Balanced	Right	Balanced	Left
Order placement	BAC	-	Other	ABC	BCA
Representation	Incorrect	Correct	-	-	-
Directionality	Left	Right	Right	-	-

The overall exploratory results show that the 3D/2D depiction task successfully categorized participants according to handedness and sex. The second part of our statistical analysis is testing these findings with GLM in which handedness and sex are the predictors. A significance threshold of 0.05 was adopted for all statistical analyses. For post-hoc tests, the p values are adjusted using Holm's correction. In the following section, we will present only the significant models and their follow-up post-hoc tests (see Table 3 for the model coefficients, and Table 4 for the predicted probabilities).

3.1. Complementarity

A significant difference is found between boys and girls in the drawings' complementarity ($\chi^2(2, N = 65) = 9.55, p = .01, R^2 = .08$). Girls favoured significantly more balanced complementarity compared to boys ($z = 3.11, p = .01$).

3.2. Density

The results revealed a significant difference between right- and left-handers in the drawings' density ($\chi^2(2, N = 66) = 9.78, p = .01, R^2 = .07$). Left-handers are significantly more likely to draw a balanced density

compared to the right-handers ($z = 2.86, p = .02$), while the right-handers favoured significant left density ($z = 3.04, p = .02$).

3.3. Origin point

The results revealed a significant interaction between sex and handedness ($\chi^2(2, N = 66) = 6.78, p = .03, R^2 = .33$). The origin point of the drawing was significantly different among right- and left-handers. RH boys generally began their drawing from the left compared to the LH boys and girls ($z = 3.18, p = .04, z = 4.47, p < .01$ respectively), whilst LH boys often started their drawing from the right more than the RH boys and girls ($z = 3.67, p = .02, z = 5.29, p < .01$, respectively). Similar results are obtained for girls. Indeed, RH girls were more prone to begin their drawing from the left compared to the LH boys and girls ($z = 5.29, p < .01, z = 7.42, p < .001$ respectively), while LH girls preferred to start their drawing from the right significantly more than the RH girls ($z = 4.23, p = .01$) and near significance compared to RH boys ($z = 2.95, p = .06$).

However, after a post-hoc test (with Holm correction), neither RH boys differentiate significantly from RH girls nor LH boys differentiate significantly from LH girls. The fact that we do not observe any sex difference in the post-hoc results while the main effect of the interaction is significant may be due to a lack of statistical power. However, we notice that without any p correction, the results show that LH girls tend to begin their drawing from the centre more often than LH boys ($z = 1.95, p = .09$). This tendency, combined with the strong influence of handedness, may have contributed to the significance of the interaction's main effect model.

3.4. Progression axis

A significant difference is observed between handedness and the axes of progression ($\chi^2(2, N = 66) = 78.68, p < .001, R^2 = .62$). The right-handers typically oriented their strokes from left to right ($z = 22.13, p < .001$), while the lefthanders typically oriented their stroke from right to left ($z = 10.31, p < .001$). Moreover, we should note too that left-handers showed a tendency to draw more vertical lines than the right-handers ($z = 2.16, p = .09$).

Neither sex nor handedness predicted the following variables: directionality, order of placement, representation, and partial arrangement (see Table VI in online Appendix 6 for the Goodness of fit of the GLM of all the variables).

Table 3. Estimates and Odds Ratio of the multinomial regressions

	<i>B (SE)</i>	95% CI for odds ratio		
		Lower	Odds Ratios	Upper
Complementarity and Sex				
Balanced vs. Left complementarity				
Intercept	0.41 (0.41)			
Girls	1.47 (0.67)*	1.15	4.33	16.26
Right vs. Left complementarity				
Intercept	-0.22 (0.47)			
Girls	-0.47 (0.99)	0.09	0.63	4.32
Density and Handedness				
Balanced vs. Right density				
Intercept	0.22 (0.47)			
Left-handedness	0.76 (0.43)	0.61	2.17	7.74
Left vs. Right density				
Intercept	0.76 (0.65)			
Left-handedness	-1.09 (0.73)	0.08	0.34	1.39
Point of origin and Handedness				
Left vs. Centre				
Intercept	3.40 (1.02)***			
Left-handedness	-2.55 (1.23)*	0.01	0.08	0.86
Right vs. Centre				
Intercept	1.39 (1.12)			
Left-handedness	0.56 (1.28)	0.14	1.75	21.38

Point of origin and Sex					
Left vs. Centre					
	Intercept	2.89 (1.03)**			
	Girls	-1.05 (1.20)	0.03	0.35	0.70
Right vs. Centre					
	Intercept	2.71 (1.03)**			
	Girls	-1.50 (1.22)	0.02	0.22	2.45
Axes of progression and Handedness					
Left to right vs. Vertical					
	Intercept	3.53 (1.01)***			
	Left-handedness	-5.32 (1.48)***	0.01	4.90e-03	0.09
Right to left vs. Vertical					
	Intercept	-15.50 (2324.44)			
	Left-handedness	16.88 (2324.44)	0.00	2.16e+07	Inf

Note. * $p < .05$; ** $p < .01$; *** $p < .001$

Table 4. Predicted probabilities obtained by the GLM

			Predicted probability (95% CI)
Complementarity and Sex			
Balanced complementarity	Girls		0.83 (0.64 – 0.93)
	Boys		0.46 (0.30 – 0.62)
Left complementarity	Girls		0.11 (0.03 – 0.29)
	Boys		0.30 (0.17 – 0.48)
Right complementarity	Girls		0.06 (0.02 – 0.22)
	Boys		0.24 (0.13 – 0.42)

Density and Handedness

Balanced density	Left-handedness	0.61 (0.43 – 0.77)
	Right-handedness	0.29 (0.16 – 0.45)
Left density	Left-handedness	0.16 (0.07 – 0.33)
	Right-handedness	0.49 (0.33 – 0.65)
Right density	Left-handedness	0.23 (0.11 – 0.40)
	Right-handedness	0.23 (0.12 – 0.39)
<hr/>		
Point of origin and Handedness		
Centre point of origin	Left-handedness	0 (0.00 – 1.00)
	Right-handedness	0 (0.00 – 1.00)
Left point of origin	Left-handedness	0.23 (0.11 – 0.44)
	Right-handedness	0.89 (0.69 – 0.97)
Right point of origin	Left-handedness	0.76 (0.54 – 0.90)
	Right-handedness	0.11 (0.04 – 0.28)
<hr/>		
Point of origin and Sex		
Centre point of origin	Girls	0 (0.00 – 1.00)
	Boys	0 (0.00 – 1.00)
Left point of origin	Girls	0.69 (0.36 – 0.90)
	Boys	0.59 (0.38 – 0.77)
Right point of origin	Girls	0.31 (0.11 – 0.62)
	Boys	0.41 (0.23 – 0.61)
<hr/>		
Axes of progression and Handedness		
Left to right	Left-handedness	0.03 (0.00 – 0.20)
	Right-handedness	0.97 (0.82 – 1.00)
Right to left	Left-handedness	0.77 (0.60 – 0.89)
	Right-handedness	0.00 (0.00 – 1.00)

Vertical	Left-handedness	0.19 (0.09 – 0.37)
	Right-handedness	0.03 (0.00 – 0.18)

4. Discussion

The study's aim was to identify typical graphical characteristics according to individual differences prior to the acquisition of literacy. We investigated children's depiction patterns using a novel 3D/2D transcription task. We were able to report several results reflecting the influence of handedness and sex on children's graphical productions. We should note that even though the exploratory analysis showed strong relationship between our variables, we demonstrated a statistical significance through our models only for some of them. Nonetheless, we decided to interpret all our findings from the perspective of future studies to further investigate these observations.

4.1. Sex

Our results showed a significant influence of sex on the graphical complementarity. A balanced complementarity was presented by girls, while boys presented a lateralized one. Furthermore, girls appeared to find it easier to make drawings characterized by a balanced density and a symmetrical graphical production. They were also associated with the spatial arrangement B, while boys showed asymmetrical and lateralized drawings (spatial arrangements A and C). This is in line with previous studies where males are shown to exhibit more aesthetic preferences to asymmetrical drawings (notably a rightward directional preference), contrary to females who exhibit a weaker, or even an absence of aesthetic preferences for asymmetrical drawings (De Agostini et al., 2011; Friedrich et al., 2014). These findings may be explained by a lesser HFS in girls allowing them greater gestural flexibility and weaker spatial bias. The boys drew more asymmetrical drawings displaying stronger spatial bias that may be related to a stronger degree of HFS (Bourne, 2008; De Agostini et al., 2011; Ocklenburg & Güntürkün, 2018c; Segond, 2015).

Furthermore, girls were more likely to create correct graphical productions than boys. Indeed, their drawings tended not only to include all the perceived elements, but also to correctly transcribe their respective positions into the 2D space based on their relative positions in the 3D space. The boys were more prone to omit elements in addition to incorrect representation characterized by a negligence of spatial relationship between the 3D model elements (e.g., the river and the house were depicted on the same level). This observation may be the reflection of a developmental phenomenon. Drawing requires a visual perception and visual imagery for encoding spatial relations between objects (Guérin, Ska, & Belleville,

1999). Vinter and colleagues showed that five-year-old children generally depict isolated and independent elements with an occasional juxtaposition of these elements (Vinter, Picard, & Fernandes, 2008). These findings were only spotted in the graphical productions of boys. This observation may reflect the difference in maturation trajectories between boys and girls. Indeed, until ~7 years of age, girls present an earlier cognitive and psychomotor development (Flatters, Hill, Williams, Barber, & Mon-Williams, 2014; Peyre et al., 2019). It is only later, around the seventh and eighth year, that children will be able to integrate the totality of the perceived object and take into consideration spatial characteristics, in addition to creating graphical productions identical to what is perceived (Barrett & Light, 1976; Luquet, 1927; Piaget & Inhelder, 1969). Thus, the sex difference found in our study may illustrate the better graphical productions associated with girls' earlier maturation. Our work corresponds with studies that showed that males do not outperform females on all the visuo-spatial tasks, and is in line with the authors who argued that girls may be better than boys on spatial tasks requiring the recall of the spatial configuration of objects (Rybash & Hoyer, 1992; see for a review Jager & Postma, 2003).

4.2. Handedness

Handedness did significantly influence the starting point of graphical production and the strokes' orientation. Most right-handers showed a strong preference for a left origin point and left-to-right progression axis, whereas left-handers preferred a right origin point and right-to-left progression axis. These results highlights the influence of biomechanical factors, particularly the preference for performing extension movements with outward motions of the body (Picard, 2011; van Sommers, 1984; Vaid, 2011). Furthermore, the LH children showed heterogeneity in their results, tending to draw more vertical strokes, and beginning their depictions from the centre. This finding may reflect the weaker lateralization generally associated with left-handedness (Christman, 2001; Hellige, 1993; Luders et al., 2010).

Also, the right-handers showed a strong leftward density, while the left-handers presented a balanced graphical density. It is in line with existence of a leftward attentional bias in right-handers due to the right hemisphere specializing in visuospatial processing (Jewell & McCourt, 2000; Picard & Zarhbouch, 2014). As for the left-handers, a weaker lateralization, and a greater interaction between the two hemispheres (Karev, 1999) may lead them to a more balanced graphical production.

We did not observe a significant relationship between directionality and handedness in the Alter's directionality test. This is consistent with past studies in which no difference in directionality preference among five year old children was found (Kebbe & Vinter, 2013; Picard, 2011). Furthermore, in line with previous findings, landscape objects, represented in our study by the 3D-2D task, may be more sensitive to the HFS than static/moving objects, represented here by the Alter's directionality test (Chokron & De Agostini, 2000; De Agostini et al., 2011; Ishii et al., 2011). However, we should note that the cluster analysis showed that the two RH groups (i.e., cluster 1 and 2, see Table 2) were characterized by opposite directionality preferences, whereas the LH did not have any directionality preference. This supports previous results where left-handers present a greater variability in directionality compared to right-handers (De Agostini & Chokron, 2002; Railo, Tallus, & Hämäläinen, 2011). This also supports Kerev (1999) who argues that left-handedness may reduce the emergence of a preferred directionality since a weaker functional asymmetry is found among them. As for the difference between the two RH clusters, a leftward directionality was observed by the children of the cluster 1. This cluster is characterized also by a preference for a left origin point, density, and complementarity. Rightward directionality preference characterized cluster 2, which include children who also showed balanced complementarity and symmetrical drawing. Although it is not frequently observed, a rightward directionality preference among the right-handers was found in a previous study on children aged 7–10 years (De Agostini & Chokron, 2002). The HFS may have played a role in the difference among our RH children. Equally, it is possible that the level of development of five-year-old children may not be sufficient to consider the directionality of the drawing as a relevant characteristic or be sufficiently sensitive to individual traits. With the acquisition of literacy and the influence of culture, we expect that this diversity in directionality preferences found in our study will decrease, while a stronger preferences, or even new preferences, will emerge later for the left-handers (Alter, 1989; Faghihi, Garcia, & Vaid, 2019; Kebbe & Vinter, 2013; Picard, 2011; Portex, Foulon, & Troade, 2017; Vaid, 2011).

Regarding the graphical strategies, most of the children began by drawing the house (approximately 71%, see Table 1). This corroborates the general observation that young children tend to start their drawing with the main component of a figure (Vinter et al., 2008). This observation shows a good ability to distinguish the essential elements from the less essential, something that is not observed in younger children. The latter pay equal attention to all the details of a visual scene (local processing of information)

without emphasizing the main theme (global processing of information). The global and simultaneous processing of information characterizing spontaneous visual perception develops gradually. The observer only uses more local processing of visual information when required by the task for example when looking to discriminate the fine details and differences (e.g., recognition of a face within a group of individuals).

Our results showed that three graphical strategies were adopted by nearly all the children. A difference was found between the RH and LH children, in contrast to Braine, Schauble, Kugelmass, and Winter (1993). In the present study, the right-handers frequently adopted the BAC strategy to transcribe the 3D model. Meanwhile, left-handers adopted two different strategies (BCA and ABC). The more lateralized left-handers, who drew asymmetrical drawing (i.e., cluster 5), favoured a BCA strategy. Interestingly, the less lateralized left-handers, who drew symmetrical drawings with a balanced density and complementarity (i.e., cluster 4), favoured the best strategy to account for the spatial relationships between the 3 planes, which is the ABC order. Indeed, the graphical representation of perspective and depth requires drawing the closest elements first to account for interposition—the reproduction of objects partially hidden by others in front of them. Since left-handers exhibit a more diffuse inter-hemispheric connection and a lesser lateralization, they will present greater global processing and spatial scanning that may lead to a balanced symmetrical drawing, and a more flexible transcription strategy conform to the 3D model: The near element is drawn first, followed by the farther elements (Braine et al., 1993). Thus, left-handers appear more capable, depending on the task, of drawing the various elements in the appropriate order with a view to their correct representation as opposed to focusing on the main theme. This leads them to start their drawing with an accessory and not the main element. However, Vaid, Rhodes, Tosun, and Eslami (2011) found a strong influence of script directionality on spatial strategies for older participants. Adults with a script directionality from left-to-right represented “near objects” on the left and “far objects” on the upper right hemispace, contrary to adults with a right-to-left directionality. We argue that a prolonged exposure to a specific reading and writing orientation is needed to observe any effect of script directionality on spatial biases in visual attention and depiction tasks (Fagard & Dahmen, 2003; Faghihi et al., 2019).

4.3. Limitations and perspectives

The complexity and diversity of the collected results invite us to consider some future improvements to our experiment. Firstly, it is necessary to confirm our results through a new study with a larger sample size. Such a study would allow us to include the rare mixed-handed children. Secondly, we should consider assessing handedness along a continuum based on the manual performance, and not limit our assessments to manual preference as this can be a better indicator for handedness (Bryden, Pryde, & Roy, 2000; Nicholls, Chapman, Loetscher, & Grimshaw, 2010). This measure will allow us to assess the degree of handedness as well as the direction. Thirdly, we must be cautious in our interpretations since our results supporting the laterality account are based on inductive inferences from a behavioural task. Brain imaging is needed to complement the laterality patterns found in the present behavioural study with cerebral activity measurement. Furthermore, we did not find any specific interpretation for our cluster 3. This cluster is constituted of 7 children with no unique drawing pattern (see Table VII in online Appendix 7). They may be an indicator that there were other factors/variables that influenced the children's graphical productions that were not captured by our test. Thus, we intend to replicate this study by assessing children's manual performance and the hemispherical lateralization (i.e., language dominance, type of information processing and the interhemispheric connection). We could also consider using line bisection and aesthetic preference tasks alongside our graphical task. They would allow us to collect more data on the children's cognitive development in parallel with data on the development of the sensorimotor system. Furthermore, our assessments were conducted using a manual scoring sheet. Electronic graphical tablets would enable more precise assessment. Finally, a longitudinal study would allow us to follow the evolution of the graphical productions developed within each specific cluster. For example, by comparing the results obtained before and after the acquisition of literacy we would be investigating the social and cultural influence on our task.

Conclusion

This research proposed a 3D/2D task capable of distinguishing specific patterns of drawing at a young age, improving our understanding of the neurotypical development of laterality. Indeed, the present 3D/2D depiction task has successfully identified graphical patterns according to handedness and sex and provided us with a rich dataset for examining the behavioural manifestation of hemispherical lateralization. It was more sensitive than the Alter's directionality test for understanding the spatial biases resulting from handedness and HFS among young children. This is in line with previous findings that landscape stimuli could be more influenced by HFS than static or moving objects. Furthermore, this 3D/2D task appears promising to explore specific laterality patterns identifiable in participants with atypical development, particularly those with neurodevelopmental disorders. Such studies could bring up opportunities for an early detection of atypical laterality patterns, underpinned by spatial difficulties. These are found in many neurodevelopmental and learning disorders such as dyslexia, dyspraxia, and autism spectrum disorder (Penolazzi, Spironelli, Vio, & Angrilli, 2006; Postema, Carrion-Castillo, Fisher, Vingerhoets, & Francks, 2020; Querne et al., 2008; Xu, Yang, Siok, & Tan, 2015) as well as in certain psychiatric disorders such as schizophrenia (Wiberg et al., 2019).

Acknowledgments

The present work was financially supported by the Grand-Est Region (Alsace, France) via the LATERALCOG project. The authors wish to gratefully thank Elodie Ernst and Chloé Neumann for their help in collecting the data, and Laurence de Lussy-Kubisa for his assistance. We would like also to thank Dr. Nic Badcock and an anonymous reviewer for their valuable comments on the manuscript.

Disclosure statement

No potential conflict of interest was reported by the author(s).

Funding

This work was supported by Grand-Est Region (Alsace, France) [18P07546 – 18_GE4_066 – LATERALCOG].

Data Sharing and Data Accessibility

The data that support the findings of this study and the scoring walkthrough of the 3D/2D task are openly available in OSF at <https://doi.org/10.17605/OSF.IO/2TQXH>.

References

- Abed, F. (1991). Cultural Influences on Visual Scanning Patterns. *Journal of Cross-Cultural Psychology*, 22(4), 525–534. <https://doi.org/10.1177/0022022191224006>
- Achiron, R., Lipitz, S., & Achiron, A. (2001). Sex-related differences in the development of the human fetal corpus callosum: in utero ultrasonographic study. *Prenatal Diagnosis: Published in Affiliation With the International Society for Prenatal Diagnosis*, 21(2), 116–120. [https://doi.org/10.1002/1097-0223\(200102\)21:2](https://doi.org/10.1002/1097-0223(200102)21:2)
- Alter, I. (1989). A cerebral origin for “Directionality.” *Neuropsychologia*, 27(4), 563–573. [https://doi.org/10.1016/0028-3932\(89\)90060-2](https://doi.org/10.1016/0028-3932(89)90060-2)
- Auzias, M. (1975). *Enfants gauchers, enfants droitiers: une épreuve de latéralité usuelle: rapports entre latéralité usuelle et latéralité graphique* (Vol. 1). Delachaux et Niestlé.
- Barral, J., & Debû, B. (2002). Hand and gender differences in the organization of aiming in 5-year-old children. *Neuropsychologia*, 40(2), 152–161. [https://doi.org/10.1016/S0028-3932\(01\)00080-X](https://doi.org/10.1016/S0028-3932(01)00080-X)
- Barrett, M. D., & Light, P. H. (1976). Symbolism and intellectual realism in children’s drawings. *British Journal of Educational Psychology*, 46(2), 198–202. <https://doi.org/10.1111/j.2044-8279.1976.tb02312.x>
- Bourne, V. J. (2008). Examining the Relationship Between Degree of Handedness and Degree of Cerebral Lateralization for Processing Facial Emotion. *Neuropsychology*, 22(3), 350–356. <https://doi.org/10.1037/0894-4105.22.3.350>
- Bourne, V. J., & Maxwell, A. M. (2010). Examining the sex difference in lateralisation for processing facial emotion: Does biological sex or psychological gender identity matter? *Neuropsychologia*, 48(5), 1289–1294. <https://doi.org/10.1016/j.neuropsychologia.2009.12.032>
- Bowers, D., & Heilman, K. M. (1980). Pseudoneglect: Effects of hemispace on a tactile line bisection task. *Neuropsychologia*, 18(4-5), 491–498. [https://doi.org/10.1016/0028-3932\(80\)90151-7](https://doi.org/10.1016/0028-3932(80)90151-7)
- Braine, L. G., Schauble, L., Kugelmass, S., & Winter, A. (1993). Representation of depth by children: Spatial strategies and lateral biases. *Developmental Psychology*, 29(3), 466. <https://doi.org/10.1037/0012-1649.29.3.466>
- Bryden, P. J., Pryde, K. M., & Roy, E. A. (2000). A performance measure of the degree of hand preference. *Brain and Cognition*, 44(3), 402–414. <https://doi.org/10.1006/brcg.1999.1201>
- Cela-Conde, C. J., Ayala, F. J., Munar, E., Maestú, F., Nadal, M., Capó, M. A., ... & Marty, G. (2009). Sex-related similarities and differences in the neural correlates of beauty. *Proceedings of the National Academy of Sciences*, 106(10), 3847–3852. <https://doi.org/10.1073/pnas.0900304106>
- Chokron, S., & De Agostini, M. (2000). Reading habits influence aesthetic preference. *Cognitive Brain*

- Research*, 10(1-2), 45-49. [https://doi.org/10.1016/S0926-6410\(00\)00021-5](https://doi.org/10.1016/S0926-6410(00)00021-5)
- Christman, S. D. (2001). Individual differences in stroop and local-global processing: A possible role of interhemispheric interaction. *Brain and Cognition*, 45(1), 97-118. <https://doi.org/10.1006/brcg.2000.1259>
- Corballis, M. C. (2012). Lateralization of the human brain. *Progress in Brain Research*, 195, 103-121. <https://doi.org/10.1016/B978-0-444-53860-4.00006-4>
- Davis, A. (1985). Conflict between canonicity and array-specificity in young children's drawings. *British Journal of Developmental Psychology*, 3(4), 363-372. <https://doi.org/10.1111/j.2044-835X.1985.tb00988.x>
- De Agostini, M., & Chokron, S. (2002). The influence of handedness on profile and line drawing directionality in children, young, and older normal adults. *Brain and Cognition*, 48(2-3), 333-336. <https://doi.org/10.1006/brcg.2001.1372>
- De Agostini, M., Kazandjian, S., Cavézian, C., Lellouch, J., & Chokron, S. (2011). Visual aesthetic preference: Effects of handedness, sex, and age-related reading/writing directional scanning experience. *Writing Systems Research*, 2(2), 77-85. <https://doi.org/10.1093/wsr/wsq006>
- Dray, S., & Dufour, A. B. (2007). The ade4 package: implementing the duality diagram for ecologists. *Journal of statistical software*, 22(4), 1-20.
- Evans, M. ., Shedden, J. ., Hevenor, S. ., & Hahn, M. . (2000). The effect of variability of unattended information on global and local processing: evidence for lateralization at early stages of processing. *Neuropsychologia*, 38(3), 225-239. [https://doi.org/10.1016/S0028-3932\(99\)00080-9](https://doi.org/10.1016/S0028-3932(99)00080-9)
- Fagard, J., & Dahmen, R. (2003). The effects of reading-writing direction on the asymmetry of space perception and directional tendencies: A comparison between French and Tunisian children. *Laterality*, 8(1), 39-52. <https://doi.org/10.1080/713754473>
- Faghihi, N., Garcia, O., & Vaid, J. (2019). Spatial bias in figure placement in representational drawing: Associations with handedness and script directionality. *Laterality*, 24(5), 614-630. <https://doi.org/10.1080/1357650X.2018.1561708>
- Failla, C. V., Sheppard, D. M., & Bradshaw, J. L. (2003). Age and responding-hand related changes in performance of neurologically normal subjects on the line-bisection and chimeric-faces tasks. *Brain and Cognition*, 52(3), 353-363. [https://doi.org/10.1016/S0278-2626\(03\)00181-7](https://doi.org/10.1016/S0278-2626(03)00181-7)
- Flatters, I., Hill, L. J. B., Williams, J. H. G., Barber, S. E., & Mon-Williams, M. (2014). Manual control age and sex differences in 4 to 11 year old children. *PLoS ONE*, 9(2). <https://doi.org/10.1371/journal.pone.0088692>

- Friedrich, T. E., Harms, V. L., & Elias, L. J. (2014). Dynamic stimuli: Accentuating aesthetic preference biases. *Laterality: Asymmetries of Body, Brain and Cognition*, 19(5), 549-559. <https://doi.org/10.1080/1357650X.2014.886585>
- Gallucci, M. (2019). *GAMLj: General analyses for linear models*. [jamovi module]. Retrieved from <https://gamlj.github.io/>.
- Girelli, L., Marinelli, C. V., Grossi, G., & Arduino, L. S. (2017). Cultural and biological factors modulate spatial biases over development. *Laterality*, 22(6), 725-739. <https://doi.org/10.1080/1357650X.2017.1279623>
- O’Gorman, R. (1999). Sex differences in spatial abilities: An evolutionary explanation. *The Irish Journal of Psychology*, 20(2-4), 95-106. <https://doi.org/10.1080/03033910.1999.10558227>
- Greenacre M. J. (1984) Theory and applications of correspondence analysis. London: Academic Press.
- Guérin, F., Ska, B., & Belleville, S. (1999). Cognitive processing of drawing abilities. *Brain and Cognition*, 40(3), 464-478. <https://doi.org/10.1006/brcg.1999.1079>
- Hamaoui, J., & Segond, H. (2020). Open data from “Laterality and visuospatial strategies among young children: A novel 3D-2D transcription task.” <https://doi.org/10.17605/OSF.IO/2TQXH>
- Hellige, J. B. (1993). Unity of Thought and Action: Varieties of Interaction Between the Left and Right Cerebral Hemispheres. *Current Directions in Psychological Science*, 2(1), 21-26. <https://doi.org/10.1111/1467-8721.ep10770559>
- Hirnstain, M., Hugdahl, K., & Hausmann, M. (2019). Cognitive sex differences and hemispheric asymmetry: A critical review of 40 years of research. *Laterality: Asymmetries of Body, Brain and Cognition*, 24(2), 204-252.
- Husson, F., Lê, S., & Pagès, J. (2017). *Exploratory multivariate analysis by example using R*. CRC press.
- Ingram, N., & Butterworth, G. (1989). The young child’s representation of depth in drawing: Process and product. *Journal of Experimental Child Psychology*, 47(3), 356-369. [https://doi.org/10.1016/0022-0965\(89\)90019-2](https://doi.org/10.1016/0022-0965(89)90019-2)
- Ishii, Y., Okubo, M., Nicholls, M. E. R., & Imai, H. (2011). Lateral biases and reading direction: A dissociation between aesthetic preference and line bisection. *Brain and Cognition*, 75(3), 242-247. <https://doi.org/10.1016/j.bandc.2010.12.005>
- Jager, G., & Postma, A. (2003). On the hemispheric specialization for categorical and coordinate spatial relations: A review of the current evidence. *Neuropsychologia*, 41(4), 504-515. [https://doi.org/10.1016/S0028-3932\(02\)00086-6](https://doi.org/10.1016/S0028-3932(02)00086-6)
- Jewell, G., & McCourt, M. E. (2000). Pseudoneglect: A review and meta-analysis of performance factors in line bisection tasks. *Neuropsychologia*, 38(1), 93-110. <https://doi.org/10.1016/S0028->

3932(99)00045-7

- Karapetsas, A. B., & Vlachos, F. M. (1997). Sex and handedness in development of visuomotor skills. *Perceptual and Motor Skills*, *85*(1), 131-140. <https://doi.org/10.2466/pms.1997.85.1.131>
- Karev, G. B. (1999). Directionality in right, mixed and left handers. *Cortex*, *35*(3), 423-431. [https://doi.org/10.1016/S0010-9452\(08\)70810-4](https://doi.org/10.1016/S0010-9452(08)70810-4)
- Kassambara, A., & Mundt, F. (2017). Factoextra: extract and visualize the results of multivariate data analyses. *R package version*, *1*(4), 2017.
- Kebbe, H., & Vinter, A. (2013). How Culture, Age, and Manual Dominance Affect Directionality in Drawing Side View Objects. *Journal of Cross-Cultural Psychology*, *44*(1), 160-172. <https://doi.org/10.1177/0022022111435098>
- Kinsbourne, M. (1970). The cerebral basis of lateral asymmetries in attention. *Acta Psychologica*, *33*(C), 193-201. [https://doi.org/10.1016/0001-6918\(70\)90132-0](https://doi.org/10.1016/0001-6918(70)90132-0)
- Koenig, O., Reiss, L. P., & Kosslyn, S. M. (1990). The development of spatial relation representations: Evidence from studies of cerebral lateralization. *Journal of Experimental Child Psychology*, *50*(1), 119-130. [https://doi.org/10.1016/0022-0965\(90\)90035-7](https://doi.org/10.1016/0022-0965(90)90035-7)
- Kosslyn, S. M. (1987). Seeing and imagining in the cerebral hemispheres: A computational approach. *Psychological Review*, *94*, 148-175. <https://doi.org/10.1037/0033-295X.94.2.148>
- Lê, S., Josse, J., & Husson, F. (2008). FactoMineR: an R package for multivariate analysis. *Journal of statistical software*, *25*(1), 1-18.
- Levy, J. (1976). Lateral dominance and aesthetic preference. *Neuropsychologia*, *14*(4), 431-445. [https://doi.org/10.1016/0028-3932\(76\)90072-5](https://doi.org/10.1016/0028-3932(76)90072-5)
- Li, M., Chen, H., Wang, J., Liu, F., Long, Z., Wang, Y., Iturria-Medina, Y., Zhang, J., Yu, C., & Chen, H. (2014). Handedness- and hemisphere-related differences in small-world brain networks: A diffusion tensor imaging tractography study. *Brain Connectivity*, *4*(2), 145-156. <https://doi.org/10.1089/brain.2013.0211>
- Lüdtke, D. (2018). ggeffects: Tidy data frames of marginal effects from regression models. *Journal of Open Source Software*, *3*(26), 772. <https://doi.org/10.21105/joss.00772>
- Luders, E., Cherbuin, N., Thompson, P. M., Gutman, B., Anstey, K. J., Sachdev, P., & Toga, A. W. (2010). When more is less: Associations between corpus callosum size and handedness lateralization. *NeuroImage*, *52*(1), 43-49. <https://doi.org/10.1016/j.neuroimage.2010.04.016>
- Luquet, G. H. (1927). (*Children's drawing*) Le Dessin Enfantin. Neuchâtel-Paris, Switzerland: Delachaux & Niestlé.

- Mitsuhiro, M., & Yadohisa, H. (2015). Reduced k-means clustering with MCA in a low-dimensional space. *Computational Statistics*, 30(2), 463–475. <https://doi.org/10.1007/s00180-014-0544-8>
- Murtagh, F. (2005). *Correspondence analysis and data coding with Java and R*. CRC Press.
- Murtagh, F., & Legendre, P. (2014). Ward's hierarchical agglomerative clustering method: which algorithms implement Ward's criterion?. *Journal of classification*, 31(3), 274–295. <https://doi.org/10.1007/s00357-014-9161-z>
- Nicholls, M. E. R., Chapman, H. L., Loetscher, T., & Grimshaw, G. M. (2010). The relationship between hand preference, hand performance, and general cognitive ability. *Journal of the International Neuropsychological Society*, 16(4), 585–592. <https://doi.org/10.1017/S1355617710000184>
- Ocklenburg, S., & Güntürkün, O. (2018a). Handedness and Other Behavioral Asymmetries. *The Lateralized Brain* (pp. 123–158). Elsevier. <https://doi.org/10.1016/b978-0-12-803452-1.00005-9>
- Ocklenburg, S., & Güntürkün, O. (2018b). Sex Differences in Hemispheric Asymmetries. *The Lateralized Brain* (pp. 289–311). Elsevier. <https://doi.org/10.1016/b978-0-12-803452-1.00011-4>
- Ocklenburg, S., & Güntürkün, O. (2018c). The Connected Hemispheres—The Role of the Corpus Callosum for Hemispheric Asymmetries. *The Lateralized Brain* (pp. 57–85). Elsevier. <https://doi.org/10.1016/b978-0-12-803452-1.00003-5>
- Ossandón, J. P., Onat, S., & König, P. (2014). Spatial biases in viewing behavior. *Journal of Vision*, 14(2), 1–26. <https://doi.org/10.1167/14.2.20>
- Page, A. G., McManus, C., González, C. P., & Chahboun, S. (2017). Is beauty in the hand of the writer? Influences of aesthetic preferences through script directions, cultural, and neurological factors: a literature review. *Frontiers in psychology*, 8, 1325. <https://doi.org/10.3389/fpsyg.2017.01325>
- Patro, K., Nuerk, H. C., & Brugger, P. (2018). Visuospatial biases in preschool children: Evidence from line bisection in three-dimensional space. *Journal of Experimental Child Psychology*, 173, 16–27. <https://doi.org/10.1016/j.jecp.2018.03.002>
- Penolazzi, B., Spironelli, C., Vio, C., & Angrilli, A. (2006). Altered hemispheric asymmetry during word processing in dyslexic children: an event-related potential study. *NeuroReport*, 17(4), 429–433. <https://doi.org/10.1097/01.wnr.0000203350.99256.7d>
- Peyre, H., Hoertel, N., Bernard, J. Y., Rouffignac, C., Forhan, A., Taine, M., Heude, B., & Ramus, F. (2019). Sex differences in psychomotor development during the preschool period: A longitudinal study of the effects of environmental factors and of emotional, behavioral, and social functioning. *Journal of Experimental Child Psychology*, 178, 369–384. <https://doi.org/10.1016/j.jecp.2018.09.002>
- Piaget, J. & Inhelder, B. (1948). *La représentation de l'espace chez l'enfant*. Paris, France : Presses Universitaires de France.

- Piaget, J. & Inhelder, B. (1969). *The Psychology of the Child*. London, Routledge.
- Picard, D. (2011). Impact of manual preference on directionality in children's drawings. *Laterality*, *16*(1), 24–34. <https://doi.org/10.1080/13576500903140610>
- Picard, D. (2013). La recherche sur le dessin : quelles questions se pose-t-on actuellement en psychologie ? *Développements*, *16–17*(3), 83. <https://doi.org/10.3917/devel.016.0083>
- Picard, D., & Zarhbouch, B. (2014). Leftward spatial bias in children's drawing placement: Hemispheric activation versus directional hypotheses. *Laterality*, *19*(1), 96–112. <https://doi.org/10.1080/1357650X.2013.777072>
- Portex, M., Foulon, J. N., & Troadec, B. (2017). Cultural influence on directional tendencies in children's drawing. *Laterality*, *22*(5), 621–640. <https://doi.org/10.1080/1357650X.2016.1266363>
- Postema, M. C., Carrion-Castillo, A., Fisher, S. E., Vingerhoets, G., & Francks, C. (2020). The genetics of situs inversus without primary ciliary dyskinesia. *Scientific Reports*, *10*(1), 1–11. <https://doi.org/10.1038/s41598-020-60589-z>
- Querne, L., Berquin, P., Vernier-Hauvette, M. P., Fall, S., Deltour, L., Meyer, M. E., & de Marco, G. (2008). Dysfunction of the attentional brain network in children with Developmental Coordination Disorder: A fMRI study. *Brain Research*, *1244*, 89–102. <https://doi.org/10.1016/j.brainres.2008.07.066>
- Railo, H., Tallus, J., & Hämäläinen, H. (2011). Right visual field advantage for perceived contrast: Correlation with an auditory bias and handedness. *Brain and Cognition*, *77*(3), 391–400. <https://doi.org/10.1016/j.bandc.2011.08.019>
- Rinaldi, L., Di Luca, S., Toneatto, C., & Girelli, L. (2020). The effects of hemispheric dominance, literacy acquisition, and handedness on the development of visuospatial attention: A study in preschoolers and second graders. *Journal of Experimental Child Psychology*, *195*, 104830. <https://doi.org/10.1016/j.jecp.2020.104830>
- Rinaldi, L., Gallucci, M., & Girelli, L. (2016). Spatial-numerical consistency impacts on preschoolers' numerical representation: Children can count on both peripersonal and personal space. *Cognitive Development*, *37*, 9–17. <https://doi.org/10.1016/j.cogdev.2015.10.006>
- Rybash, J. M., & Hoyer, W. J. (1992). Hemispheric specialization for categorical and coordinate spatial representations: A reappraisal. *Memory & Cognition*, *20*(3), 271–276. <https://doi.org/10.3758/BF03199664>
- Segond, H. (2015). *Le Toucher en Développement : Latéralité, Cécité, Autisme. Des activités perceptives au soin*. Sarrebruck : Editions Universitaires Européennes.
- Shanon, B. (1979). Graphological patterns as a function of handedness and culture. *Neuropsychologia*, *17*(5), 457–465. [https://doi.org/10.1016/0028-3932\(79\)90052-6](https://doi.org/10.1016/0028-3932(79)90052-6)

- Silverman, I., & Eals, M. (1992). *Sex differences in spatial abilities: Evolutionary theory and data*. In J. H. Barkow, L. Cosmides, & J. Tooby (Eds.), *The adapted mind: Evolutionary psychology and the generation of culture* (p. 533–549). Oxford University Press.
- van Sommers, P. (1984). *Drawing and Cognition*. Cambridge University Press. <https://doi.org/10.1017/CBO9780511897672>
- van Sommers, P. (1989). A System for Drawing and Drawing-Related Neuropsychology. *Cognitive Neuropsychology*, 6(2), 117–164. <https://doi.org/10.1080/02643298908253416>
- Sourial, N., Wolfson, C., Zhu, B., Quail, J., Fletcher, J., Karunanathan, S., Bandeen-Roche, K., Béland, F., & Bergman, H. (2010). Correspondence analysis is a useful tool to uncover the relationships among categorical variables. *Journal of Clinical Epidemiology*, 63(6), 638–646. <https://doi.org/10.1016/j.jclinepi.2009.08.008>
- de Schotten, M. T., Dell’Acqua, F., Forkel, S., Simmons, A., Vergani, F., Murphy, D. G., & Catani, M. (2011). A Lateralized Brain Network for Visuo-Spatial Attention. *Nature Precedings*. <https://doi.org/10.1038/npre.2011.5549.1>
- R Core Team (2020). R: A language and environment for statistical computing. R Foundation for Statistical Computing, Vienna, Austria. URL <https://www.R-project.org/>.
- The jamovi project (2019). jamovi. (Version 1.1) [Computer Software]. Retrieved from <https://www.jamovi.org>.
- Thuleau, S. H. F., & Husson, F. (2017). FactoInvestigate: automatic description of factorial analysis. *R package version, 1*.
- Tosun, S., & Vaid, J. (2014). What affects facing direction in human facial profile drawing? A meta-analytic inquiry. *Perception*, 43(12), 1377–1392. <https://doi.org/10.1068/p7805>
- Tversky, B., Kugelmass, S., & Winter, A. (1991). Cross-cultural and developmental trends in graphic productions. *Cognitive psychology*, 23(4), 515–557. [https://doi.org/10.1016/0010-0285\(91\)90005-9](https://doi.org/10.1016/0010-0285(91)90005-9)
- Tzourio-Mazoyer, N., & Seghier, M. L. (2016). The neural bases of hemispheric specialization [Editorial]. *Neuropsychologia*, 93(Part B), 319–324. <https://doi.org/10.1016/j.neuropsychologia.2016.10.010>
- Vaid, J. (2011). Asymmetries in representational drawing: Alternatives to a laterality account. In *Spatial Dimensions of Social Thought*. <https://doi.org/10.1515/9783110254310.231>
- Vaid, J., Rhodes, R., Tosun, S., & Eslami, Z. (2011). Script directionality affects depiction of depth in representational drawings. *Social Psychology*. <https://doi.org/10.1027/1864-9335/a000068>
- Venables W.N., Ripley B.D. (2002) *Random and Mixed Effects*. In: *Modern Applied Statistics with S*. Statistics and Computing. Springer, New York, NY. https://doi.org/10.1007/978-0-387-21706-2_10

- Vingerhoets, G. (2019). Phenotypes in hemispheric functional segregation? Perspectives and challenges. *Physics of Life Reviews*, 30, 1–18. <https://doi.org/10.1016/j.plrev.2019.06.002>
- Vinter, A., Picard, D., & Fernandes, V. (2008). Graphic syntax and representational development. *Drawing and the Non-Verbal Mind: A Life-Span Perspective*, 139–158. <https://doi.org/10.1017/CBO9780511489730.008>
- Wiberg, A., Ng, M., Omran, Y. Al, Alfaro-Almagro, F., McCarthy, P., Marchini, J., Bennett, D. L., Smith, S., Douaud, G., & Furniss, D. (2019). Handedness, language areas and neuropsychiatric diseases: Insights from brain imaging and genetics. *Brain*, 142(10), 2938–2947. <https://doi.org/10.1093/brain/awz257>
- Willems, R. M., Der Haegen, L. Van, Fisher, S. E., & Francks, C. (2014). On the other hand: Including left-handers in cognitive neuroscience and neurogenetics. *Nature Reviews Neuroscience*, 15(3), 193–201. <https://doi.org/10.1038/nrn3679>
- Xu, M., Yang, J., Siok, W. T., & Tan, L. H. (2015). Atypical lateralization of phonological working memory in developmental dyslexia. *Journal of Neurolinguistics*, 33, 67–77. <https://doi.org/10.1016/j.jneuroling.2014.07.004>

5.2 Complementary study 1

Drawing asymmetries in adults

Data are available on OSF: <https://osf.io/269a4>

1. Objective

The 3D–2D graphic transcription task proposed in Article 1 succeeded in identifying different categories of graphomotor patterns among children aged five to six years old. The present study aimed to extend these findings by administering another graphical task, the Rey–Osterrieth Complex Figure (ROCF), to adults. We expected cerebral lateralization and biomechanical factors, moderated by handedness, sex, and cultural factors to be implicated in drawing asymmetries.

Our hypotheses were:

- A. The attentional bias will differ according to handedness and sex. It is expected to be stronger among right-handers and males since it is assumed that they present stronger cerebral lateralization (see Chapter 2 and Article 1). In contrast, left-handers and females are expected to show a reduced attentional bias due to their weaker cerebral lateralization.
- B. Regarding the point of origin, sociocultural influences (i.e., script directionality) were assumed to enhance the preference toward the left visual field. Considering their long experience with Left to Right (LR) script directionality, right- and left-handed adults will exhibit a left point of origin.
- C. Right-handers will draw from left to right, whilst left-handers will draw from Right to Left (RL).

2. Method

2.1. Participants

Fifty-eight adults participated in our study. Two participants had to be excluded due to missing data. Therefore, our final sample consisted of 56 adults (mean age = 29.1 years; sd = 13.60; see Table 5.1 for the descriptive statistics). The participants were students from the Faculty of Psychology at the University of Strasbourg or were recruited from the experimenters' surroundings. The information and consent letter was read and signed before each assessment. The exclusion criteria were cognitive or motor impairments. The inclusion criteria were a script directionality from left to right and an age over 18 years old.

2.2. Measures

Rey-Osterrieth Complex Figure (ROCF; Rey, 1959): The ROCF is a neuropsychological test that assesses visuo-constructional abilities and non-verbal memory. This test consists of a complex geometrical figure divided into 18 sub-figures, one nested inside the other. Usually, this test is administered in two trials. The first one is the copying trial where the participant is asked to copy the figure. The second is a delayed recall trial in which the participant is asked to draw the figure from memory after an amount of time.

Eliau software and the Anoto DP-201 digital pen (Wallon, 2016): The Anoto digital pen is a ballpoint pen with an embedded infrared camera that works on large, augmented surfaces (Haller et al., 2007; see Figure 5.1). The paper's dimensions are 210 mm on the X-axis and 275 mm on the Y-axis. The movement of the pen is tracked with a precision of up to tenths of a millimeter and tenths of a second (Wallon, 2016). The pen can collect numerical data from any graphomotor activity (e.g., duration, length, speed, pressure) and can record the movements, which allows for the construction of the drawing to be replayed step by step. The elements recorded are then extracted and analyzed by the ELIAN software (Expert Line Information Analysis; Wallon, 2016). As part of this study, this software was used to analyze the ROCF (Figure 5.1).

Hand preference questionnaire (Fagard et al., 2015): In this 15-items questionnaire, the participants are asked about their preferred hand to carry out various daily tasks. The 15 items consisted of the hand used for: writing, brushing teeth, throwing a ball, using a hammer, holding a racket, holding a hairbrush, holding a spoon to eat, using a tissue to wipe the face, playing marbles, holding the scissors to cut, holding the stapler to staple, opening a drink can (hand that pulls the opening), holding a vegetable peeler, using the computer mouse, and pressing the buttons of the TV remote control. Participants had to choose between three answers: the right hand, the left hand, or no preference. Afterward, a Laterality Index was calculated with the following equation: $LI = (n(R) - n(L)) / (\text{total number of responses}) * 100$, where nR and nL correspond to the number of right- and left-hand use, respectively. Following Fagard et al. (2015) recommendation, participants with a LI between 100 and 30 were categorized as right-handers, between 30 and -30 as mixed-handers/ambidextrous, and between -30 and -100 as left-handers (see Table 5.1 for descriptive statistics).

Figure 5.1. (1) Anoto digital pen; (2) Augmented papers adapted to the Anoto pen; (3) ROCF example with a copy and delayed recall drawings; (4) ELIAN software

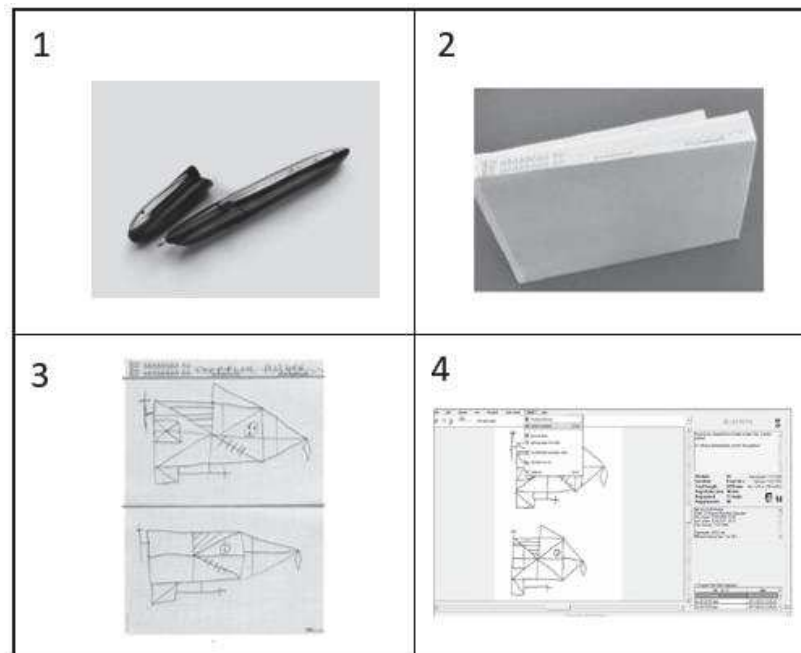

Note. These photos are retrieved from Wallon, P. (2008). *Elian et stylo numérique : une approche psychopathologique des tests « papier-crayon » par la dynamique du trait (version 4.2 de 2019)*. Crédag-seldage; and on the ELIAN site: <http://eliansoftware.com/web/US/PageProduits.php>

Tapping test with E-prime 3 software (Psychology Software Tools, 2016): A Tapping test was programmed in E-prime 3 software to determine hand performance. This task consists of four blocks: the first two blocks contain training, during which the participants must tap, as fast as possible, for 30 seconds, on a key of a computer keyboard with the index finger. Following this training session, the participants were invited to complete two test blocks following the same instructions. Between each block, the participant had a 10 s break. Right and left hands were counterbalanced for each blocks. The number of taps with the right and left hand for each block was recorded. Afterward, a Tapping Index (TI) was calculated with the equation: $TI = (n(R) - n(L)) / (n(R) + n(L)) * 100$, where nR and nL correspond to the number of right- and left-hand use, respectively. A positive score reflects a hand performance in favor of the right hand and a negative score reflects a hand performance in favor of the left hand.

2.3. Instructions and procedure

All the instructions given to participants are listed in Appendix 1. The experiment started with the copy trial of the ROCF, followed by the assessment of the hand preference and hand performance. Afterward, the participants were asked to draw from memory the ROCF (for further details on the procedure, see Appendix 2).

2.4. Scoring

Center of gravity: ELIAN software can report the center of gravity of the ROCF. In the present study, this variable was considered to reflect the attentional bias. For example, if the overall figure is drawn more to the left, the center of gravity will be shifted to the same side, which will be interpreted as an attentional bias toward the left visual field. This variable is based on the precise coordinates of the X-axis. The farthest point to the left is scored as 0 mm, and this score will get higher as the center of gravity nears the right side of the paper (210 mm maximum). Therefore, a center of gravity lower than 105 mm on the X-axis (i.e., the middle of the drawing paper) is considered a leftward attentional bias.

Point of origin: This variable is based on the coordinates of the X-axis. Participants that start their drawing from the left are those who exhibit a point of origin less than 105 mm on the X-axis.

Stroke orientation: The number of strokes was counted according to three orientations: LR, RL, and vertically. Then, a Stroke Orientation Index (SOI) was calculated using the following equation: $SOI = (n(LR) - n(RL) / (\text{total strokes})) * 100$. A positive score would reflect a preference for LR orientation, whereas a negative score reflects a RL orientation.

2.5. Statistical analysis

As with Article 1, our statistical analyses were divided into two parts.

The first part consisted of conducting a cluster analysis to classify our participants into different groups. We conducted a Multiple Correspondence Analysis (MCA) to perform the dimensional reduction and to examine the relationship between our nominal variables (i.e., sex, hand preference) and our numerical variables (i.e., hand performance, the center of gravity, point of origin, stroke orientation). Secondly, we conducted a Hierarchical Clustering (HC) to group our participants according to their similarities along the relevant dimensions obtained by the MCA. The statistical analyses were done using R 4.1.0 (R Core Team,

2022). The MCA and HCPC functions of the FactoMineR package were used to conduct the MCA and the clustering analyses (Lê et al., 2008; see Results in Article 1 for a detailed description of these analyses).

The second part consisted of conducting inferential statistical tests to examine if our independent variables (i.e., sex and handedness) can predict the center of gravity, point of origin, and stroke orientation. The analyses were computed in Jamovi 1.2.27 (Jamovi project, 2022).

The normality assumption has been checked for our numerical variables. The Tapping scores and the center of gravity variables are normally distributed, whereas the point of origin and stroke orientation variables do not follow a normal distribution (see Figure A to Figure G in Appendix 3 for the QQ plots).

3. Results

3.1. Preliminary analysis

We conducted a Fisher Exact test (three cell counts under 5) to assess the association between sex and hand preference. There is no significant difference between females and males in our sample (see Table 5.1). Nonetheless, descriptively, we can observe a higher prevalence of left-handedness among males (31.6%) than females (10.8%). For hand performance, a t-test (Levene's test $p = .676$) showed that males presented significantly lower scores than females on the Tapping test (see Table 5.1).

Table 5.1. Sex differences according to handedness

	Sex		<i>p</i>			
	Females	Males				
Hand preference	n (%)	n (%)				
Total	37 (66.07%)	19 (33.93%)				
Left-handed	4 (10.8%)	6 (31.6%)				
Mixed-handed	3 (8.1%)	2 (10.5%)	.112			
Right-handed	30 (81.1%)	11 (57.9%)				
Hand performance	Mean (sd)	Mean (sd)	<i>df</i>	<i>t</i>	<i>p</i>	Cohen's <i>d</i>
Tapping Index (LI)	4.24 (4.71)	1.23 (5.30)	54	2.17	.035	0.611

An ANOVA (Levene's test $p = .939$) showed a significant association between hand preference and hand performance ($F(2, 53) = 17.4, p < .001, \eta^2 = .397$). Pairwise Holm post-hoc comparisons showed no difference between left ($M = -2.71$) and mixed handed adults ($M = -0.40; t = -1.05, p = .299$) on the Tapping Index (TI), whereas they both were significantly lower than the right-handers ($M = 5.10; t = -5.51, p < .001; t = -2.89, p = .011$, respectively).

3.2. Exploratory statistics

In the following analysis, the first two dimensions obtained from the MCA were interpreted. These dimensions account for 75.6% of the explained variances (see Figure H in Appendix 4 for the Scree plot of all the dimensions).

As shown in Figure 5.2 and Figure 5.3, Dimension 1 was significantly associated with the nominal variables sex and hand preference, and the continuous variables hand performance and stroke orientation. Dimension 2 was only significantly associated with hand preference (see Table A in Appendix 4 for the correlation estimates of the association between the variables and the dimensions). The center of gravity and the point of origin were not significantly correlated to either dimension.

Figure 5.2. Two-dimensional factor map presenting the categories of the nominal variables of the two dimensions

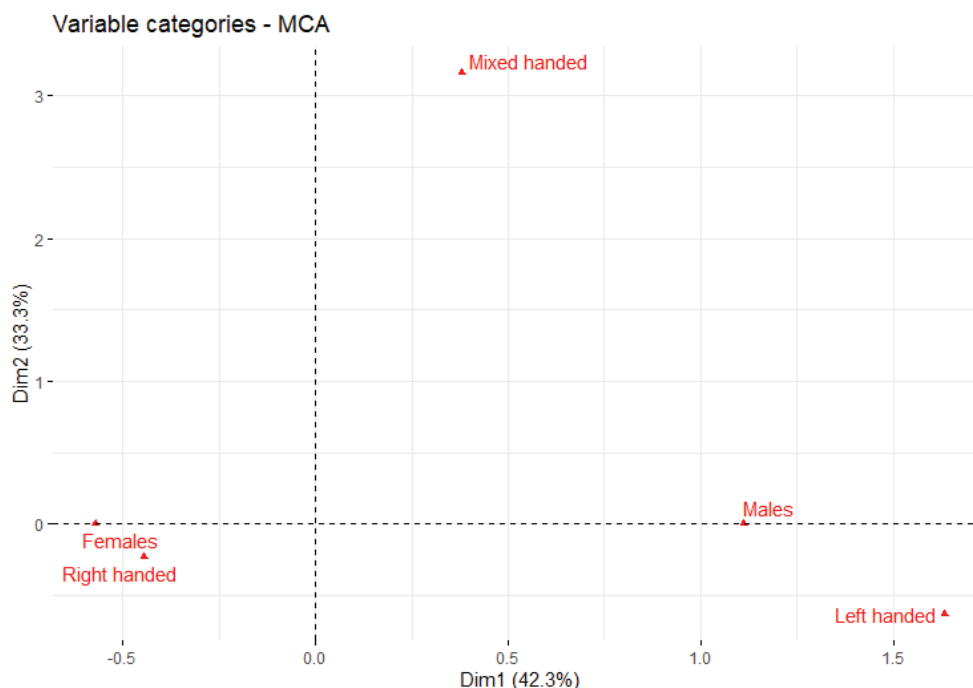
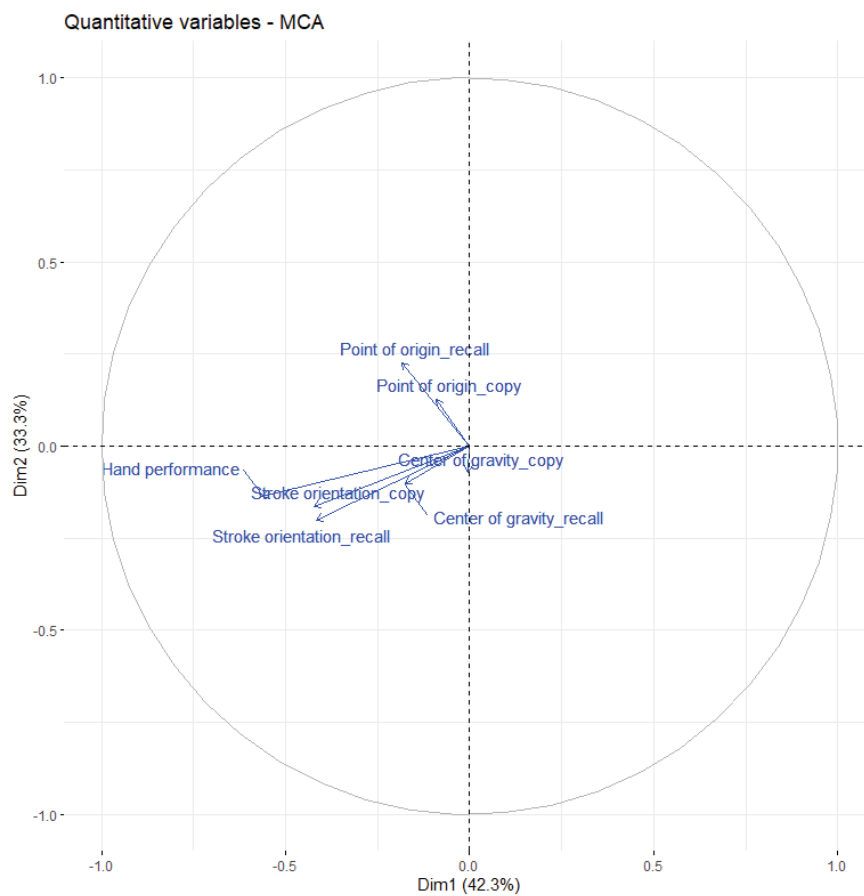

Figure 5.3. Two-dimensional factor map presenting the continuous variables of the two dimensions



In Dimension 1, right-handedness is positively correlated with females, hand performance, and stroke orientation indexes (for copy and recall trials). In contrast, left-handedness is correlated with males and negatively correlated with hand performance and stroke orientation indexes (see Figure 5.2, Figure 5.3, and Table A in Appendix 4). In Dimension 2, mixed-handedness is the only category that is significantly differentiated.

We conducted a cluster analysis to investigate global patterns that could be identified according to our participants (see Table B in Appendix 4 for further details of the variables characterizing each of the clusters). Using Ward's method, five clusters were identified. Each of these clusters included participants with similar characteristics (Figure 5.4). As shown in Table 5.2, the right-handers were distributed between cluster 1 and cluster 3 (both clusters represent together 73.21% of the total sample). The former is characterized by female participants, and positive scores on the hand performance and stroke orientation

indexes. In contrast, the latter cluster is characterized by male participants, which are only associated with positive scores on the stroke orientation of the copy trial. Cluster 4 and cluster 5 are characterized by the left-handers. Participants in both these clusters present negative scores on the hand performance and stroke orientation indexes. Nonetheless, cluster 4 is also characterized by the center of gravity of the ROCF (copy trial), whereas cluster 5 includes more male participants. Lastly, cluster 2 is characterized by mixed-handed participants that exhibit a negative score on the stroke orientation index of the recall trial.

Figure 5.4. Factor maps representing different clusters according to the two dimensions.

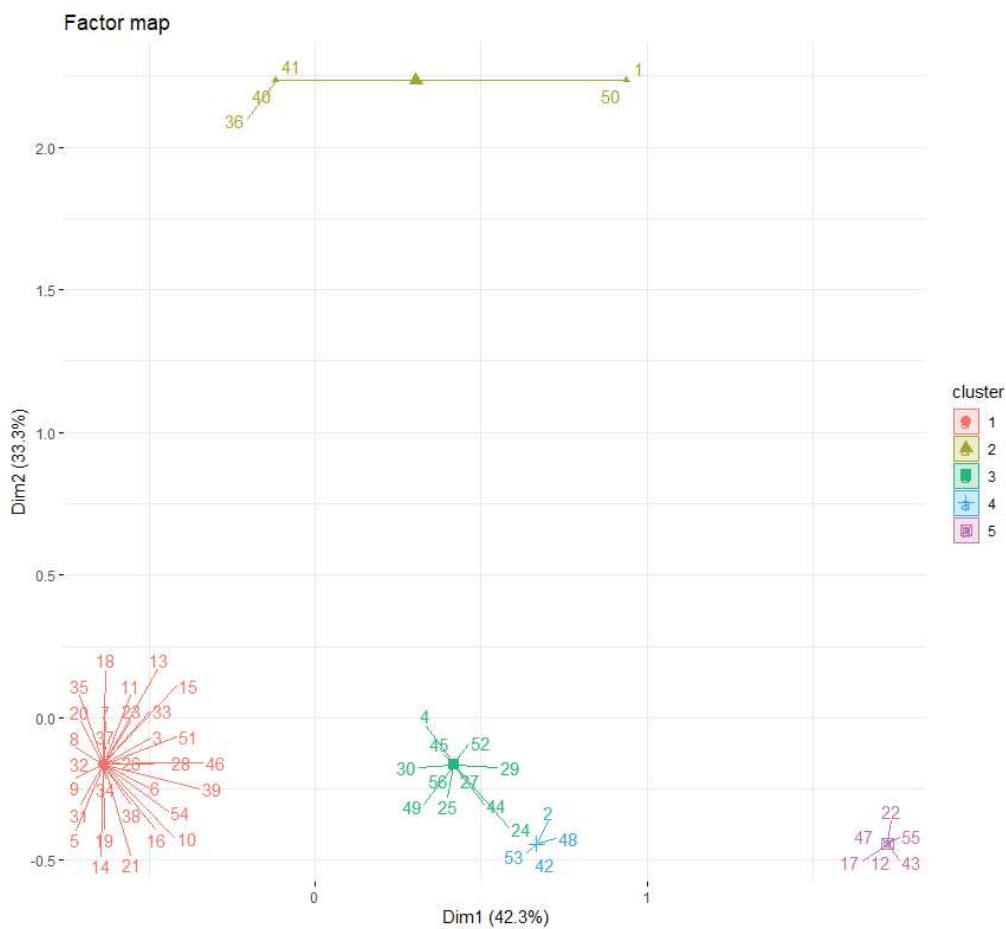

Note. Each number represents one participant.

Overall, the five obtained clusters differentiated the participants according to their handedness, sex, and stroke orientation. For right-handers, cluster 1 represents female participants which are faster with their right hand on the tapping test and a Left-to-Right (LR) stroke preference on both the copy and

recall trials. Cluster 3 represents the male right-handers with LR strokes on the copy trial, but they are not associated with the hand performance index. Cluster 4 and cluster 5 include the left-handed participants, which exhibit a better performance with the left hand on the tapping test and Right-to-Left (RL) stroke preference. In addition, the participants in cluster 4 are characterized by their center of gravity in the ROCF copy trial, whereas cluster 5 is characterized by male participants. The remaining cluster (i.e., cluster 2) is characterized by mixed-handers who exhibit a preference for RL stroke orientation only during the recall trial.

Table 5.2. Characteristics of each cluster

Clusters	Cluster 1	Cluster 2	Cluster 3	Cluster 4	Cluster 5
n	30	5	11	4	6
Qualitative variables					
Sex	Females	-	Males	-	Males
Hand preference	Right-handed	Mixed-handed	Right-handed	Left-handed	Left-handed
Quantitative variables (mean)					
Hand performance	5.49	-	-	-2.62	-2.77
Center of gravity (copy)	-	-	-	97.00	-
Stroke orientation (copy)	37.73	-	47.66	-6.58	-4.89
Stroke orientation (recall)	42.69	-2.47	-	-11.64	-3.30

3.3. Inferential statistics

We conducted Generalized Linear Models (GLM) to test handedness and sex as predictors of the center of gravity and point of origin. For the stroke orientation indexes, non-parametrical ANOVA and correlation tests were used to assess their association with hand preference and hand performance.

In the following section, we will present only the significant models and their follow-up post-hoc tests (see Table C in Appendix 4 for all the GLM results). For all the post-hoc tests, the p values are adjusted using Holm's correction.

3.3.1. Center of gravity

For both ROCF copy and recall trials, the results revealed a significant difference between males and females in their drawings' center of gravity ($\chi^2(1) = 6.69, p = .010, R^2 = .153$; $\chi^2(1) = 6.49, p = .011, R^2 = .132$;

respectively). For the copy trial, males are significantly more likely to draw the ROCF toward the left ($M=82.8$) compared to females ($M=92.1$; $z = -2.59$, $p = .010$). Similar results are found for the recall trial, where males ($M=77.2$) are more leftward biased than females ($M=90.7$; $z = -2.55$, $p = .011$). It should be noted that, in this trial, the interaction between sex and hand preference tended to be significant ($\chi^2(2) = 5.62$, $p = .060$, $R^2 = .153$, see Figure 5.5). Nonetheless, the post-hoc analysis with Holm's correction did not show any significant differences.

Figure 5.5. Interaction between hand preference and sex according to the center of gravity (copy trial)

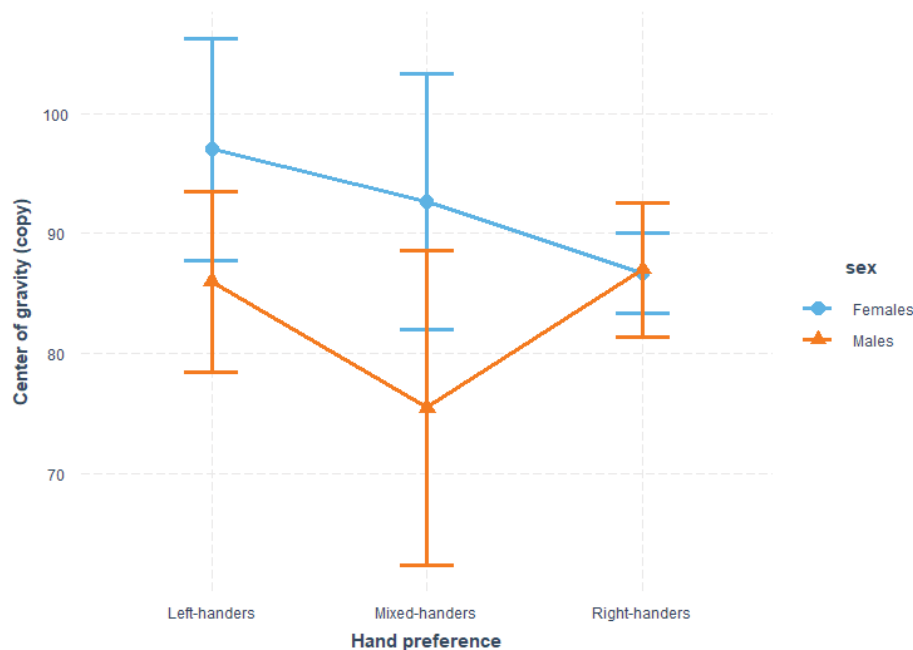

3.3.2. Point of origin

A GLM showed a difference between sexes for the point of origin in the ROCF copy trial ($\chi^2(1) = 4.65$, $p = .031$, $R^2 = .133$). Males began their drawing more to the left ($M=32.4$) than females ($M=49.1$; $z = -2.16$, $p = .031$). Furthermore, there is a statistical tendency regarding the interaction between sex and hand preference ($\chi^2(2) = 5.85$, $p = .054$, $R^2 = .133$). The post-hoc analyses did not reveal any significant differences between the variables' categories.

For the ROCF delayed recall trial, a GLM showed a significant interaction between hand preference and sex ($\chi^2(2) = 7.79$, $p = .020$, $R^2 = .225$). As seen in Figure 5.6, female mixed-handers presented the weakest

bias toward the left ($M= 88.0$). A post-hoc analysis showed that they are significantly different from male left-handers ($M= 29.8$; $z=3.34$, $p =.013$), male mixed handers ($M= 16.0$; $z=3.20$, $p =.019$), male right-handers ($M= 37.0$; $z=3.18$, $p =.019$), and female right-handers ($M= 41.8$; $z=3.09$, $p =.024$). In contrast, they did not differ significantly from the female left-handers ($M= 39.8$; $z=2.56$, $p =.114$).

Figure 5.6. Interaction between hand preference and sex according to the point of origin (recall trial)

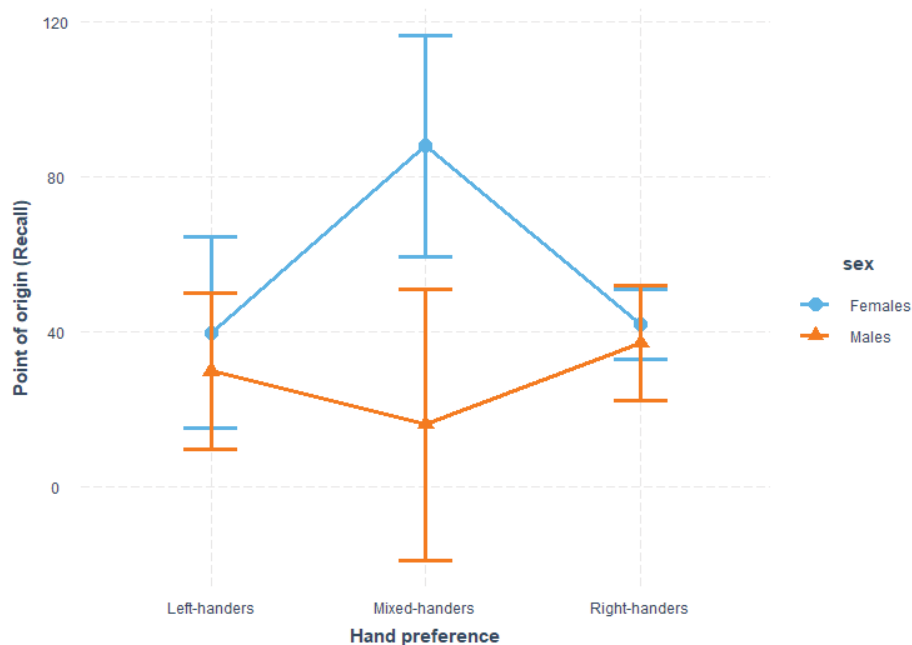

3.3.3. Stroke orientation

For both the copy and delayed recall trials, a Kruskal-Wallis ANOVA showed that the stroke orientation differs significantly according to hand preference ($\chi^2(2) = 17.3$, $p <.001$, $\varepsilon^2 = .315$; $\chi^2(2) = 16.3$, $p <.001$, $\varepsilon^2 = .296$; respectively). In the copy trial, Dwass-Steem-Critchlow-Flinger (DSCF) pairwise comparison showed that right-handers significantly oriented their strokes from left-to-right (LR; mean= 40.39) compared to left-handers which preferred a right-to-left (RL) stroke orientation (mean = -5.57; $W = 5.50$, $p <.001$). No significant difference was found between mixed-handers (mean= 4.31) and right-handers ($W = 2.87$, $p =.105$) nor between mixed-handers and left-handers ($W = 0.86$, $p =.814$). Similarly, for the delayed recall trial, the right-handers (mean = 42.87) showed a LR stroke orientation, differ significantly from left-handers (mean= -6.64; $W = 5.60$, $p <.001$) who exhibited a LR stroke orientation. Mixed-handers (mean= -2.47) were not found to differ from left-handers ($W = -0.35$, $p = .968$) and right-handers ($W = 2.37$, $p = .214$).

Pearson's correlations were performed to test the association between hand performance and stroke orientation. For both the copy and recall trial, the stroke orientation was positively correlated with the Tapping Index ($r=0.46$, $p<.001$; $r=43$, $p<.001$; respectively).

4. Conclusion

To extend the findings of Article 1, the objective of this complementary study was to investigate the graphomotor patterns of adults using the same statistical procedure that was adopted in Article 1. This consisted of exploratory and inferential analyses aimed at finding different categories of graphomotor patterns. In this study, the drawing task was computerized, and an additional variable for handedness, hand performance, was added. The cluster analysis detected different groups according to hand preference, hand performance, sex, the center of gravity, and stroke orientation. Right-handedness was predominant among female participants, whereas left-handedness was more associated with males. A positive correlation was found between right-handedness and a LR stroke orientation preference. In contrast, a negative correlation was found for left-handedness, which similarly to the mixed-handers, preferred a RL stroke orientation. In addition, left-handers had a center of gravity mean score ($M=97.00$), which is higher than the one of the overall sample ($M=87.34$; see cluster 4 in Table B Appendix 4). This is in line with the hypothesis in which left-handers were expected to exhibit a weaker attentional bias due to their weaker lateralization. The inferential statistics showed that the center of gravity of both the ROCF copy and recall trials differ according to sex, indicating differences in attentional bias. Males drew their figures more to the left compared to females. This reflects the stronger leftward attentional bias exhibited by males, which is in line with previous findings that showing that males are strongly lateralized on a functional level compared to females (see Article 1). Nonetheless, it should be noted that, even when female participants exhibited a weaker bias, they still showed a leftward bias. Indeed, the mean of their centers of gravity were 92.1 and 90.7 on the ROCF copy and recall trials respectively, which is to the left of the middle of the x-axis at 105 mm. Therefore, even if the degree of the attentional bias varied according to handedness and sex, all the participants presented a leftward bias. This can be explained by the fact that the ROCF is not a symmetrical figure. It has a rightward shape and is visually scanned from left to right, which is congruent with the LR writing direction (Portex et al., 2017). Therefore, it is likely that a prolonged experience with the LR script directionality combined with the rightward shape of the ROCF may have enhanced the

attentional bias toward the left visual field. This supports previous studies that showed that attentional bias is task-dependent (Mitchell et al., 2020).

All the participants started to draw the figure from the left. These biomechanical findings can be related to the influence of script directionality. It may be considered more natural for them to start their drawing from the left since it is congruent with their LR script directionality. Nonetheless, an interaction between hand preference and sex was found regarding the point of origin. Mixed-handed female participants exhibited the weakest bias toward the left compared to the right-handed females and to male participants, whatever their hand preference. This result is in line with other studies that found that females seem to be less influenced by reading direction when compared to males (De Agostini et al., 2011). Moreover, this sex difference can be explained by cerebral lateralization. Mixed-handed and female participants are assumed to have weak lateralization. This may have decreased the bias toward the left visual field when they start a drawing (Friedrich et al., 2014). It should be noted that this result was found only for the recall trial of the ROCF. Therefore, one can assume that the processes involved in the copy and recall trials are different. When copying, an individual reproduces a real object that can be seen. In contrast, it is the mental representation of this object which is drawn from memory. Therefore, it is likely that functional lateralization exhibits a stronger influence on graphomotor asymmetries when it is produced from memory. We found stroke orientation to be significantly associated with handedness (Table C in Appendix 4). Right-handed adults, as determined by both hand preference and hand performance, produced LR strokes contrary to the left-handers, which were more prone to orient their stroke from RL. It would seem that the point of origin is influenced by both script directionality and cerebral lateralization, whereas the stroke orientation remains the result of the biomechanical factors, i.e., the motor constraints on hand used while drawing. It should be noted that descriptively, mixed handers exhibited differing stroke orientation between the copy trial (LR, mean=4.31) and the delayed recall trial (RL, mean=-2.47). This observation can be related to the rightward shape of the ROCF, which may enhance the LR stroke orientation in the copy trial.

We can conclude from this study that cerebral lateralization, biomechanical, and cultural factors are all implicated in the graphomotor asymmetries of adults. These factors seem to be moderated by handedness, sex, the graphical task (i.e., shape of the model), and the depiction procedure (i.e., copy vs. memory).

Chapter 6. The role of the prenatal environment in the development of handedness

In the cascade theory of handedness (Michel, 2021), a cephalic fetal presentation is presumed to asymmetrically stimulate the vestibular system (see Chapter 3). This vestibular lateralization will lead to a head orientation bias, which heavily contributes to handedness development. To explain the relation between fetal presentation, vestibular system, and the head orientation bias, Michel (2021) referred to the Left-Otolithic Dominance Theory (LODT) of Previc (1991, 1996). According to the LODT, vestibular lateralization that results from an asymmetrical fetal presentation will lead to functional visuospatial and motor lateralization, as well as a head orientation bias. The theory goes on to provide an explanation of the association between atypical lateralization and neurodevelopmental disorders such as Developmental Dyslexia (DD). It is suggested that vestibular impairment is expected to alter the otolithic asymmetry, leading to lesser lateralization, and increasing the probability of atypical development associated with neurodevelopmental disorders (Previc, 1991, 1996). Although the LODT explains the link between fetal presentation, handedness, and neurodevelopmental disorders, studies that tested this theoretical framework are scarce.

Article 2 aimed to test a hypothetical developmental pattern based on several predictions derived from the LODT. It was postulated that a breech presentation, which is assumed to be related to a dysfunctional and weakly lateralized vestibular system, can lead to weak-handedness and can be a risk factor for neurodevelopmental disorders (i.e., DD and Developmental Coordination Disorder; DCD). As a supplementary analysis, the influence of prematurity on handedness DD, and DCD was tested.

Complementary study 2 further explored the role perinatal adversities have on the development of laterality. Early complications and stressors such as prematurity, low birthweight, and deteriorated neonatal health may disrupt a typical developmental trajectory of the fetus and the neonate, and are considered to be risk factors for neurodevelopmental disorders (Cha et al., 2022; Modabbernia et al., 2016). Under this perspective, we investigated the implication of Pregnancy Complications and Birth Stressors (PCBS) on handedness. We tested the association between handedness and birthweight, which is usually correlated with gestational age, and neonatal health, assessed with the Apgar test. These variables were selected due to several findings showing that gestational age and birthweight are related to handedness

(for meta-analyses see Domellöf et al., 2011; Searleman et al., 1989). A higher prevalence of Non-Right Handedness (NRH) is found among premature children (e.g., Burnett et al., 2018; Marlow et al., 2019; van Heerwaarde et al., 2020) and children with low birthweight (James & Orlebeke, 2002; O’Callaghan et al., 1987; O’Callaghan et al., 1993; Powls et al., 1996). Furthermore, deteriorated neonatal health reflected by a low Apgar score is shown to increase the prevalence of left-handedness (Dragović, Milenković et al., 2013; Schwartz, 1988). Many studies failed, however, to find an association between PCBS and handedness (e.g., Annett & Ockwell, 1980; Dellatolas et al., 1991; Ehrlichman et al., 1982; Levander et al., 1989; McManus, 1981; Nicholls et al., 2012; Tan & Nettleton, 1980; Van Der Elst et al., 2011). These conflicting results may be in part due to the different methodologies applied for assessing handedness and PCBS (Coren et al., 1982; Elliott, 1992; Levander et al., 1989; Marcori & Okazaki, 2020; Porac, 2016, p. 40; Searleman et al., 1989). Firstly, some studies used non-validated handedness measurements such as parental reporting, or the sole assessment of the writing hand. Secondly, PCBS were either self-reported or indicated by the parents, which are both less accurate than hospital records. Thirdly, several studies grouped all forms of PCBS under a single category. This approach is not ideal since each PCBS may uniquely affect handedness. Fourthly, some studies conducted their investigation on small sample sizes, resulting in low statistical power. Lastly, the operationalization of some of the PCBS can vary across the studies.

In addition to these methodological limitations, we can offer two theoretical ones. The first is that most studies only compared the prevalence of right- vs. left-handedness, or right- vs. NRH. However, this dichotomized classification, especially grouping left- and mixed handedness, must be treated with caution. Some authors suggest that PCBS might not lead to a complete shift from right- to left-handedness. Instead, PCBS might only reduce the bias towards the right-hand preference, leading to mixed handedness (Coren et al., 1982; Domellöf et al., 2011; Hicks et al., 1980; Searleman et al., 1989). On top of that, it has been shown that among extremely preterm children assessed at 10 years of age, mixed-handed individuals were associated with an increased risk of cognitive and motor difficulties (Burnett et al., 2018). These results suggest that mixed-handed children who experienced PCBS may have different developmental trajectories than their left- and right-handed peers. As a result, mixed handedness should be assessed on its own (Domellöf et al., 2011; Marcori & Okazaki, 2020; Van Der Elst et al., 2011).

The second theoretical limitation is the prevailing measurement of only one dimension of handedness: hand preference; hand performance was largely neglected. Measuring the latter along a continuum may be a more sensitive approach when studying the influence of PCBS (Bishop, 1984). It is suggested that PCBS may reduce right-hand ease of use, but not necessarily cause a hand preference switch from right to left (Bishop, 1990a, p. 96; Domellöf et al., 2011; Ross et al., 1992; Van Der Elst et al., 2011).

Complementary study 2 aimed to investigate the relation between PCBS and handedness, while taking into consideration the above limitations.

6.1 Article 2

The influence of vestibular system and fetal presentation on handedness, cognitive and motor development: A comparison between cephalic and breech presentation

Jad Hamaoui¹, Nicolas Stefaniak², Hervé Segond¹

¹Laboratoire de Psychologie des Cognitions (UR 4440), Université de Strasbourg, France

²Laboratoire Cognition Santé Société (UR 6291), Université de Reims Champagne-Ardenne, France

Reference

Hamaoui, J., Stefaniak, N., & Segond, H. (2022). The influence of vestibular system and fetal presentation on handedness, cognitive and motor development: A comparison between cephalic and breech presentation. *Developmental Science*, e13317. <https://doi.org/10.1111/desc.13317>

Corresponding author

Jad Hamaoui

Laboratoire de Psychologie des Cognitions (UR 4440), Université de Strasbourg, France

jhamaoui@unistra.fr

ORCID: 0000-0003-2935-813X

Research highlight

- The vestibular system is not related to the fetal presentation, and children with breech presentation were not associated with a dysfunctional vestibular system.
- Handedness and neurodevelopmental disorders were not associated with the fetal presentation in utero.
- Whilst genetics and randomness are implicated in the development of handedness, non-genetic factors such as prematurity may exhibit genuine association with handedness.
- Higher prevalence of left-handers and motor difficulties were found among premature children.

Abstract

Genetics are undoubtedly implicated in the ontogenesis of laterality. Nonetheless, environmental factors, such as the intrauterine environment, may also play a role in the development of functional and behavioral lateralization. The aim of this study was to test the Left-Otolithic Dominance Theory (LODT; Previc, 1991) by investigating a hypothetical developmental pattern where it is assumed that a breech presentation, which is putatively associated with a dysfunctional and weakly lateralized vestibular system, can lead to weak handedness and atypical development associated with language and motor difficulties. We used the ALSPAC cohort of children from 7 to 10 years of age to conduct our investigation. Our results failed to show an association between the vestibular system and fetal presentation, nor any influence of the latter on hand preference, hand performance, or language and motor development. Bayesian statistical analyses supported these findings. Contrary to our LODT-derived hypotheses, this study offers evidence that fetal presentation does not influence the vestibular system's lateralization and seems to be a poor indicator for handedness. Nonetheless, we found that another non-genetic factor, prematurity, could lead to atypical development of handedness.

Keywords

Left Otolithic Dominance Theory, Vestibular system, Breech presentation, Handedness, Language and motor development, ALSPAC.

1. Introduction

Although the ontogenesis of handedness remains unclear (Ocklenburg et al., 2021), the interest in studying the development of laterality increased considerably over the past decades. This has been driven by findings showing that non-right-handers are more frequently associated with neurodevelopmental and psychiatric disorders (e.g., autism, developmental dyslexia, developmental coordination disorder, schizophrenia; Berretz et al., 2020; Darvik et al., 2018; Eglinton & Annett, 1994). Several theoretical frameworks have been proposed in order to explain this relationship (e.g., Annett, 2002; Berretz et al., 2020; Bishop, 2013; McManus, 2002).

Behavioral lateralization, which includes handedness, appears to manifest very early in life (Hepper, 2013; Reissland et al., 2015). A lateralized behavior can be identified before birth, where most fetuses suck their right thumb early in gestation and exhibit a rightward head orientation during the last weeks of gestation (Hepper et al., 1991; Ververs et al., 1994a). These lateralized patterns can predict early, but also later, post-natal lateralized behavior, such as handedness (Hepper et al., 2005). Genetics are undoubtedly involved in handedness (Cuellar-Partida et al., 2021; McManus, 2021; Medland et al., 2006; Medland et al., 2009). Recently, using the Avon Longitudinal Study of Parents and Children (ALSPAC) cohort, Schmitz et al. (2022) conducted a large study investigating the heritability of lateral preferences (i.e., handedness, footedness, eyedness). The authors found that individuals with parental left-sidedness are more likely to present the same trait. In addition, they suggested that all these phenotypes share a common genetic factor. Nonetheless, the influence of other factors (i.e., environmental and epigenetic factors) could also be involved in its ontogenesis (Bishop, 2013; Michel, 2021; Schmitz et al., 2017). Among these factors, it has been proposed in the Left-Otolithic Dominance Theory (LODT) that the intrauterine environment could influence the development of handedness (Previc, 1991).

More specifically, according to LODT (Previc, 1991), cerebral lateralization is influenced by fetal presentation in the last trimester of gestation. Most cephalic fetuses lie head-down with their back turned to the mother's left side, and their right ear facing outward (Previc, 1991). This leftward turning preference in the cephalic presentation may be a result of the uterus torsion on the right due to the maternal bladder and rectum positioned on the same side (Ververs et al. 1994b). This uterus asymmetry will allow more space for the fetus' head and body to turn on the left side (Ververs et al. 1994b). Another explanation can be given for the predominance of the fetal left occiput positioning and it is linked to the maternal positioning

during pregnancy. Pregnant women prefer the left lateral position in the third trimester of pregnancy since a supine or right lateral position leads to a compression of the right inferior vena cava by the weighted uterus, which results in a hypotension syndrome (Matsuo et al., 2007). Thus, a left occiput position will allow more stability for the fetus in mothers adopting a left lateral position, whereas a right occiput position will lead to instability since the fetus's center of gravity will be higher than that of the mother (for further details see Matsuo et al., 2007, p. 282). It is noteworthy that it is central to Previc's theory that the ratio between leftward and rightward cephalic positions is 2:1. However, a study conducted on 1250 women using transabdominal ultrasound examinations, a superior method to abdominal palpation (Webb et al., 2011), showed that the ratio is closer to 1.53:1 in favor of the leftward cephalic orientation (Ahmad et al., 2014).

According to the LODT, the left occiput presentation will contribute to the lateralization of the vestibular system. During mother's locomotion, the acceleration of the mother during locomotion would influence the asymmetric development of the otolithic pathways. Specifically, the left utricle would more benefit from stimulations of the inertial force (for more details, see Previc, 1991, p. 318). Thus, in most cases, the head position in the bony maternal pelvis at the end of gestation will lead to an over-excitation of the left otoliths. This will result in an early stimulation of the right hemisphere's vestibular cortex, leading to early specialization in information processing of body positioning in space and visuo-spatial processing. Consequently, this will allow the left hemisphere to specialize in motoric performance, increasing the ability of the right side of the body for voluntary motor movements. Furthermore, during maternal walking, the left otolith stimulation will result in more impulses of the brain stem terminating on the vestibulospinal tract that innervates the ipsilateral control of the extensor muscles. This left-sided bias in activating the sternocleidomastoid muscle will lead to a rightward turning of the head (Ververs et al., 1994b), which was found to be associated with later right-handedness (Ferre et al., 2020; Goodwin & Michel, 1981; Ocklenburg et al., 2010). Therefore, a reversed lateralization should be observed among the cephalic fetuses with a rightward orientation and the left-ear facing outward. Thus, one can directly test the LODT by comparing leftward and rightward cephalic presentations. Some evidence supports this hypothesis showing that newborn infants with a leftward intrauterine orientation exhibit a rightward head orientation preference in supine position after birth and a later right-handedness, whereas newborns with a rightward intrauterine orientation were more prone to a leftward head orientation preference and a later left-

handedness (Churchill et al., 1962; Goodwin & Michel, 1981; Michel & Goodwin, 1979). In addition, prenatal vestibular asymmetries resulting from a lateralized fetal presentation can be related to behaviors other than handedness, such as postural biases and lateralized reflexes (e.g., Asymmetric Tonic Neck Reflex, grasping reflex), which are generally greater on the right side of the body (Previc, 1991, p. 317).

Importantly, given that children with neurodevelopmental disorders such as Developmental Dyslexia (DD) are generally poorly lateralized, the LODT provides an explanation for the link between lateralization and neurodevelopmental disorders. Previc (1991) has suggested that a vestibular hypoactivity and an otolithic impairment, which may alter the otolithic asymmetry (Previc, 1996, p. 453), could explain higher incidence of neurodevelopmental disorders (Previc, 1991, 1996). Thus, minor vestibulo-cerebellar symptoms (e.g., postural control deficit), that presumably reflect otolithic impairments, could represent a risk factor for neurodevelopmental disorders. In line with this assumption, it has been reported that children with DD and Developmental Coordination Disorder (DCD) exhibit atypical lateralization (Berretz et al., 2020; Biotteau et al., 2016; Darvik et al., 2018, Eglinton & Annett, 1994), and spatial, postural and proprioceptive impairments, which are clinical symptoms observed when the vestibular system is dysfunctional (Blythe, 2017, p. 14 to 18).

Although the LODT provides an explanation for the link between fetal presentation, handedness, and neurodevelopmental disorders, studies that tested this theoretical framework are surprisingly scarce. To the best of our knowledge, Fong et al.'s (2005) is the most recent study that empirically tested this model. The authors investigated the head orientation of cephalic and breech presentations after 36 weeks of gestation. They found that cephalic fetuses exhibited a lateralized head position, mostly to the right, whereas breech fetuses showed no preference to either side. These results were interpreted using the LODT, where it was postulated that breech fetuses have a less asymmetrical stimulation of their otoliths since their position allows for more freedom in head movements. This would lead to lesser vestibular lateralization, which, consequently, would result in a weaker manifestation of lateralized head orientation. Also, this lesser vestibular lateralization among breech children can be explained by intrinsic factors to the development of the vestibular system (Fong et al., 2005). It is postulated that a mature vestibular system in the last trimester is required for adopting a typical position (head down), whereas fetuses in a breech presentation are presumed to have a dysfunctional vestibular system (Eliot, 2000, p. 143; Blythe, 2017, p. 184, 185). Thus, since the vestibular dysfunction may alter the otolithic asymmetry (Previc, 1996, p. 453),

it may explain why breech children are lesser lateralized. To our knowledge, only one empirical study tested the relationship between fetal presentation and the vestibular system, and found that school age children born in breech (n=42) showed significantly weaker vestibular reactions after thermic and rotational balance tests than those born in cephalic presentation (n= 30; Tymnik et al., 1981; cited by Fong et al., 2005). Nonetheless, due to the lack of other empirical support for this view, replications are required to test this hypothesis.

Our first aim was to test whether breech fetal presentation is associated to vestibular dysfunctions. If so, we should observe that children born in breech presentation present more difficulties in performing tasks involving the vestibular system. More specifically, the saccule and the utricle, which constitute the otolith organs, respond to gravity, which suggest that they contribute to maintaining postural stability (McCaslin et al., 2011). Thus, to test the hypothesis that breech children present an atypical vestibular functioning, one can assess the link between breech presentation and children's scores on clinical balance tests. Basta et al. (2005) found that patients diagnosed with otolith disorder demonstrate poor postural performance on the Standard-Balance-Deficit-Test (SBDT) which evaluates the ability to use somatosensory, visual, and vestibular information to maintain postural control. Specifically, two subtests from the SBDT obtained the greatest diagnostic power to indicate a utricular or sacculo-utricular disorder (i.e., "standing on two legs with eyes closed", which reduces the visual input, and "standing with two legs on a foam with eyes closed", which reduces visual and somatosensory inputs).

The second aim of this study was to test indirectly the LODT by investigating, through handedness, the influence of fetal presentation on postnatal lateralized behaviors. Since breech fetuses showed weaker lateralization than cephalic fetuses (Fong et al., 2005) and fetal presentation has been associated with handedness (Churchill et al., 1962; Ehrlichman et al., 1982; Ferre et al., 2020; Michel, 2021; Michel & Goodwin, 1979), we expected an association between breech presentation and weaker handedness. Among the few studies that investigated the association between breech presentation and handedness, some authors found that breech presentation tends to be associated with non-right handedness (Smart et al., 1980), whereas others failed to find any association (Levander et al., 1989; McManus, 1981; Tan & Nettleton, 1980).

There are several reasons that could account for this lack of association. Since the prevalence of breech presentation is only around 4.51% (Fruscalzo et al., 2014) a lack of statistical power may be

responsible. Large samples are required to examine this link which has often not been the case (e.g., 8 breech presentations in Levander et al., 1989; 51 breech and other abnormal presentations in Tan & Nettleton, 1980; 32 breech presentations in Smart et al., 1980). McManus (1981) was the only study to analyze a large sample of 203 breech births derived from the National Child Development Study (NCDS). However, the author only examined the prevalence of right- and left-handedness, whilst breech presentation may not be associated with right- or left-handedness per se, but rather with weak handedness. Furthermore, handedness can be understood in several complementary ways that should be taken into account. Indeed, handedness is a multidimensional trait that encompasses both hand preference and hand performance (Buenaventura Castillo et al., 2020). McManus (1981) only tested the hand preference, even though the NCDS includes both hand preference and hand performance measures.

Hand preference is the preferred hand for completing common manual tasks (Scharoun & Bryden, 2014), and it can be generally assessed by questionnaires, such as the Edinburgh Handedness Inventory (Oldfield, 1971). This kind of tool provides two pieces of information: directionality and consistency. The directionality indicates if a person prefers the use of the left, right, or both hands, while consistency refers to how strongly a person prefers to use the same hand for doing different kind of tasks. When the non-preferred hand is used for at least one task, the person is considered as having inconsistent handedness. A highly inconsistent handedness is the most common definition of weak handedness, and is also called “mixed handedness” (Fagard et al., 2015). Thus, mixed handedness is the use of the right hand for some activities and the left for others. Nonetheless, knowing the preferred hand is insufficient to obtain a global overview on handedness since the preference for one hand for manual tasks does not necessarily reflect its ability to perform these tasks efficiently. This performance on manual tasks is referred to as the hand performance, and it differentiates the abilities of both hands to conduct tasks requiring speed and dexterity (Scharoun & Bryden, 2014). Thus, when one is interested in assessing handedness, the performance on manual tasks must be taken into account, and an asymmetry in the hand performance reflects a lateralized handedness. In summary, it is necessary to investigate directionality, consistency, and degree of handedness. It should be noted that the LODT does not state which dimension of handedness the fetal presentation should influence. Thus, this study included both hand preference and hand performance in order to determine how fetal presentation impact handedness. We can predict from the LODT that

children born in breech presentation should exhibit weaker handedness than children born in cephalic presentation.

The LODT suggests that vestibular impairment is expected to alter the otolithic asymmetry, leading to a lesser lateralization, and increasing the probability of atypical development associated with neurodevelopmental disorders. Thus, the third aim of this study is to test the prediction that, if breech presentation reflects vestibular dysfunctions and lesser lateralization as has been suggested, children born in breech presentation should be more often associated with neurodevelopmental disorders (i.e., language and motor impairments). To our knowledge, no studies investigated the developmental pattern that include breech presentation, atypical lateralization, and an atypical development that may be associated with neurodevelopmental disorders.

Beyond the hypotheses related to fetal presentation, several predictions need to be also tested. First, since vestibular impairments should alter the otolithic asymmetry, which may lead to weak lateralization (Previc, 1996), we can expect that mixed handers will be more associated with balance difficulties than right- and left-handers. Second, children with neurodevelopmental disorders should present non-right handedness at a higher rate (see Darvik et al., 2018 and Eglinton & Annett, 1994 for meta-analyses). Third, children with neurodevelopmental disorders should present with more difficulties in performing tasks involving the vestibular system (see Rochelle & Talcott, 2006 and Verbecque et al., 2021 for meta-analyses).

2. Methods

2.1. Participants

The data analyzed for the current study come from the Avon Longitudinal Study of Parents and Children (ALSPAC). The objective of this large cohort is to understand the influence and the interaction between physical and social environmental factors and genetic inheritance on mental and physical health from infancy to adulthood. Pregnant women in south-west England with an expected delivery date between 1st April 1991 and 31st December 1992 were recruited. The total sample size for analyses is 15,454 pregnancies, resulting in 15,589 fetuses (Boyd et al., 2013; Fraser et al., 2013). The exclusion criteria were non-singleton birth, premature birth (before 37 weeks of gestation), and low birthweight (below 2500 g). According to the LODT, the differential stimulation of the otolith organs due to the fetal presentation will occur in the 3rd trimester of pregnancy (i.e., after the 28th week of gestation). Therefore, the fetal presentation data used in this study were collected at onset of labor. The total sample size after exclusion and missing data is 7047. Figure 1 summarizes the flowchart of the sample size according to the exclusion criteria. Among the 7047 births, 95.53% of the participants were born in a cephalic presentation (n=6732 including 3279 females) and 4.47% were born in breech presentation (n=315 including 175 females) during the 3rd trimester (see Figure 1).

Ethical approval for the study was obtained from the Research Ethics Committee of the University of Strasbourg (see <https://cil.unistra.fr/registre.html#proc-374>), from the ALSPAC Ethics and Law Committee, and the Local Research Ethics Committees. Informed consent for the use of data collected via questionnaires and clinics was obtained from participants following the recommendations of the ALSPAC Ethics and Law Committee at the time.

2.2. Measures

The data collected in this study are from obstetric medical records, psychological and clinical examinations undertaken by the participants until they reached the age of 10. The details of all the data are available through a fully searchable data dictionary with a variable search tool on the following webpage: <http://www.bristol.ac.uk/alspac/researchers/our-data/>. See Appendix 1 for the ALSPAC variable codes for all the measures used.

Figure 1. Flowchart of the sample size according to the exclusion criteria

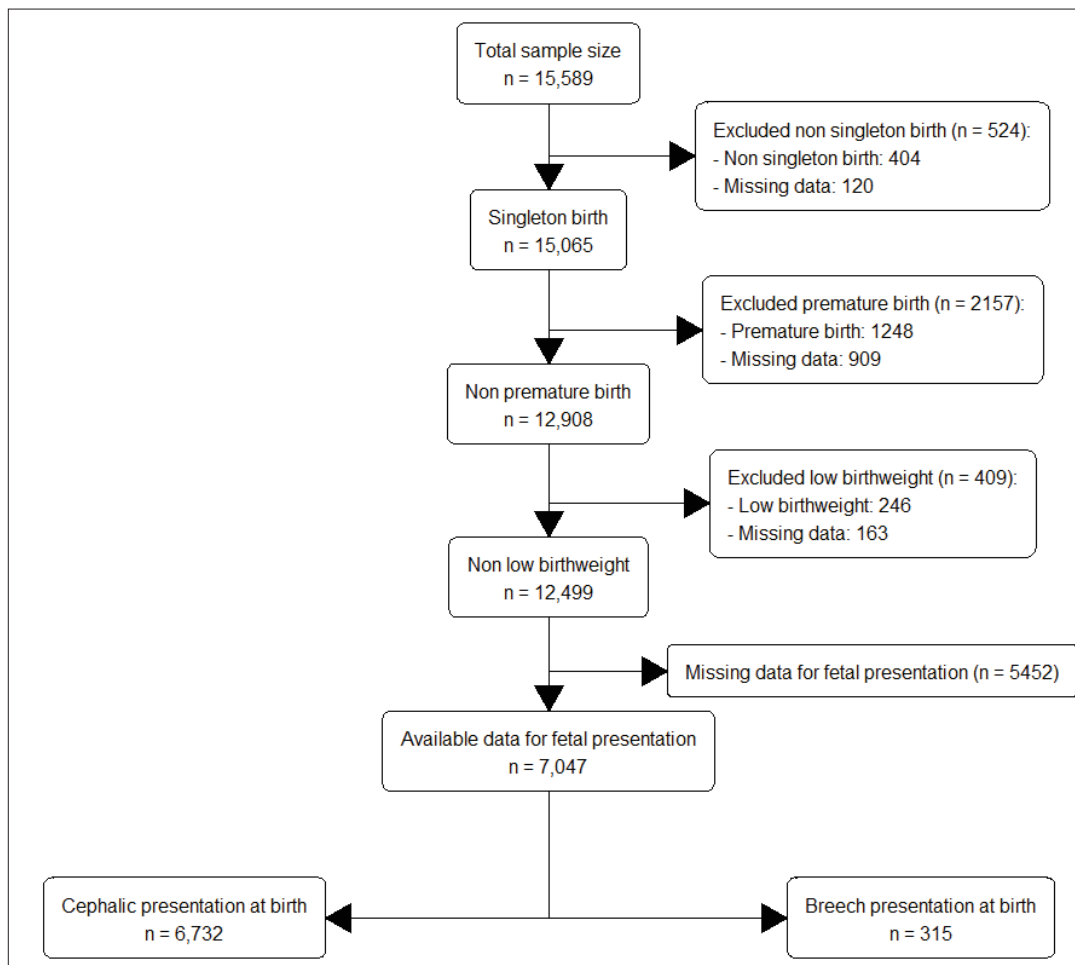

2.2.1. Assessment of the vestibular system

Following Basta et al.'s (2005) results, the closest measure of the static balance in ALSPAC database is the "heel-to-toe balance on a beam, eyes closed" subtest, which is a part of clinical tests assessing balance and administered at the age of 10. This test should be the most sensitive to vestibular dysfunctions. In the "heel-to-toe balance on a beam, eyes closed" subtest, the tester gave a demonstration followed by a short practice session. In this test, the duration of balance was recorded based on two trials, one for the right foot forwards and the other for the left foot forwards, and the test was stopped after 20 seconds. For every child, a second attempt was given if the maximum score of 20 on the first attempt was not achieved. Children who reached the maximum score on the first attempt were considered to have reached 20 seconds on the second attempt without being asked to perform it. It meant that they were given a final score of 40

(20 from the first and 20 from the second attempt). For the other children, the sum of the scores (i.e., number of seconds) from both attempts was calculated (see Humphriss et al., 2011 for more details about this variable).

2.2.2. Assessment of handedness

2.2.2.1. Hand preference

Participants' hand preference was assessed at 9 years of age with a six-item questionnaire consisting of whether the child uses the "left", "right" or "either" hand for drawing, throwing a ball, coloring, holding a toothbrush, cutting, and hitting things.

This questionnaire allows us to assess both mixed handedness (i.e., inconsistent hand preference between different tasks) and ambidexterity (i.e., consistent use of either hand for the same tasks).

A score of 1 was attributed each time the child answers "left" or "right", and a score of 0 for the "either" response. We calculated a Laterality Index (LI) with the formula:

$$LI = \frac{(nR - nL)}{\text{Total number of responses}} \times 100,$$

where nR and nL correspond to the number of right- and left-hand use, respectively. Then, we used the cut-offs proposed by Fagard et al. (2015) to distinguish weak from lateralized children. In their study, Fagard and colleagues (2015) searched for the best criterion to evaluate weak handedness (i.e., both mixed handedness and ambidexterity). They suggested that a cut-off of -30 to +30 of the LI is able to efficiently distinguish between mixed and ambidextrous children from right- and left-handers. Based on this criterion, we created a nominal variable with three categories: children with a LI between -100 and -30 were considered left-handers, -30 to +30 were considered mixed-handers, from +30 to +100 were considered right-handers. In the present paper, mixed handedness will be used to refer to both mixed handed and ambidextrous children. The proportion of mixed handed individuals identified in Fagard et al. (2015) was 3.3%, whereas in the present study it was 4.7%.

2.2.2.2. Hand performance

It has been suggested that fine differences of motor lateralization tend to be hidden when using motor tasks, such as dot-filling, that share similarities with daily activities like writing (Peters, 1998). Since the use of a pen is needed, the preferred hand's strong specialization due to experience may influence the

performances on such tasks (Buenaventura Castillo et al., 2020; Peters, 1998). In contrast, other hand performance tasks may appear more sensitive in identifying lateral specialization in motor control (Peters, 1998). Motor tasks such as pegboard task do not require the use of a writing utensil, resulting in the reduced influence of experience. Thus, such tasks are more relevant for the assessment of hand performance.

The pegboard test was conducted at 7 years of age as a subtest of the Movement Assessment Battery for Children (M-ABC; Henderson & Sugden, 1992). It consisted of placing, one at a time and as quickly as possible, 12 pegs into a pegboard. The board was held with one hand and the pegs inserted with the other. The task was carried out with both hands, after it had been described and demonstrated by the tester, and after a practice session with each hand. The time needed for each hand to complete this task was recorded. We computed the PegQ index using the formula:

$$PegQ = \frac{(L-R)}{(L+R)} \times 100,$$

with L referring to the time in seconds to perform the task with the left hand and R referring to the time in seconds to perform the task with the right hand. A negative index refers to a better performance of the left hand, a positive index is interpreted as a better performance of the right hand, and an index of 0 reflect an equal performance of both hands.

2.2.3. Neurodevelopmental disorders

2.2.3.1. Language impairment

Literacy was assessed at the age of 9. The difference between reading age based on the Neale Analysis of Reading Ability (NARA-II, Neale, 1997) and the chronological age was calculated. When the assessed reading age is more than 30 months behind the chronological age, and the child's IQ is greater than or equal to 85, the child is diagnosed with Developmental Dyslexia (DD). The ALSPAC dataset provides one binary variable consisting of children without DD and children with DD.

2.2.3.2. Motor impairments

Motor coordination was assessed at the age of 7 using the M-ABC (Henderson & Sugden, 1992). The subtests administered to the children were the pegboard task and threading lace task (for manual dexterity), bean bags task (for ball skills), and heel-to-toe walking task (for balance). The ALSPAC dataset

provides a binary variable consisting of children without motor impairments, and children with motor impairments (i.e., scores below the 5th percentile on the M-ABC), reflecting a Developmental Coordination Disorder (DCD).

2.2.4. Statistical analysis

Our statistical analyses were computed in R 4.1.0 (R Core Team, 2021). Tests of assumptions are presented in Appendix 2 and Appendix 3. When non-parametrical tests were used, it is recommended to use more robust measures of central tendency and dispersion such as median (med) and median absolute deviation (mad), respectively (Wilcox, 2011).

Although the database is large enough to maintain high statistical power even when missing data are handled using listwise deletion, this procedure can bias estimates (Little & Rubin, 2019), especially when the percentage of missing data is large. Thus, we performed our analyses using both listwise deletion and Multiple Imputation (MI). Using the *naniar* package (Tierny & Cook, 2018), Little's test suggests that the missing values of the total sample are Missing Completely At Random ($\chi^2(100) = 92.9, p = .679$). For the MI, we used the *mice* and *miceadds* packages (van Buuren & Groothuis-Oudshoorn, 2011; Robitzsch, Grund & Henke, 2021). To find the minimal number of imputed datasets required, we used the *howManyImputations* package (von Hippel, 2020). For a coefficient of variation of .01, i.e., coefficient that summarizes the imputation variation in the standard error estimate, and for an alpha of .01, we needed 4946 imputed datasets. Therefore, we chose to impute 5000 datasets in total to pool the results and conduct the statistical analyses.

Concerning the dataset after a listwise deletion procedure, we computed a sensitivity power analysis for each hypothesis (Perugini et al., 2018) in order to determine the minimal statistically detectable effect given the sample size of the ALSPAC database. These sensitivity analyses were computed in G*Power 3.1 (Faul et al., 2007) with an α -level of .05, and a power of 0.80. In addition, Bayesian analyses were conducted to determine if non-significant results could be interpreted as evidence in favor of the null. A Bayes Factor (BF) below 0.33 indicates evidence in favor of the null model, whereas BF greater than 3 is interpreted as evidence in favour of the alternative model (Wetzels et al. 2011). The BF was calculated with the *BayesFactor* package (Morey & Rouder, 2015). If non-parametric analyses were required, a rank transformation was applied on the variables before conducting the analyses.

3. Results

3.1. Preliminary analysis: Testing the hand preference's cut-offs (n=2771)

Data for hand preference were available for 2393 right-handers, 133 mixed handers, and 245 left-handers. In order to determine whether the cut-offs chosen for the hand preference appropriately distinguished weak from strong lateralized children, we performed an ANOVA with Welch's correction on the hand performance task's scores (i.e., PegQ) as dependent variable and the hand preference categories (i.e., right, left, and mixed handers) as independent variable.

There was a significant effect of hand preference on the PegQ scores, $F(2, 253.22) = 263.81, p < .001$, $est.\omega^2 = .160$. Pairwise Games-Howell post-hoc comparisons (for unequal variances) showed that all the hand preference categories are well distinguished from each other. Right-handed children scored higher values on the PegQ than mixed-handed children ($t = 9.68, p < .001$; right-handers' mean = 8.27 and mixed handers' mean = -0.31), and mixed handed children scored higher values on the PegQ than left-handers ($t=4.45, p < .001$; left-handers' mean = -4.99). Interestingly, mixed handed children had a mean of -0.31 on the PegQ, showing that these children present nearly an equal performance of both hands, which support the choice of the cut-off chosen to classify children with weak handedness (see Figure 2).

Figure 2. Hand performance scores according to children's hand preference

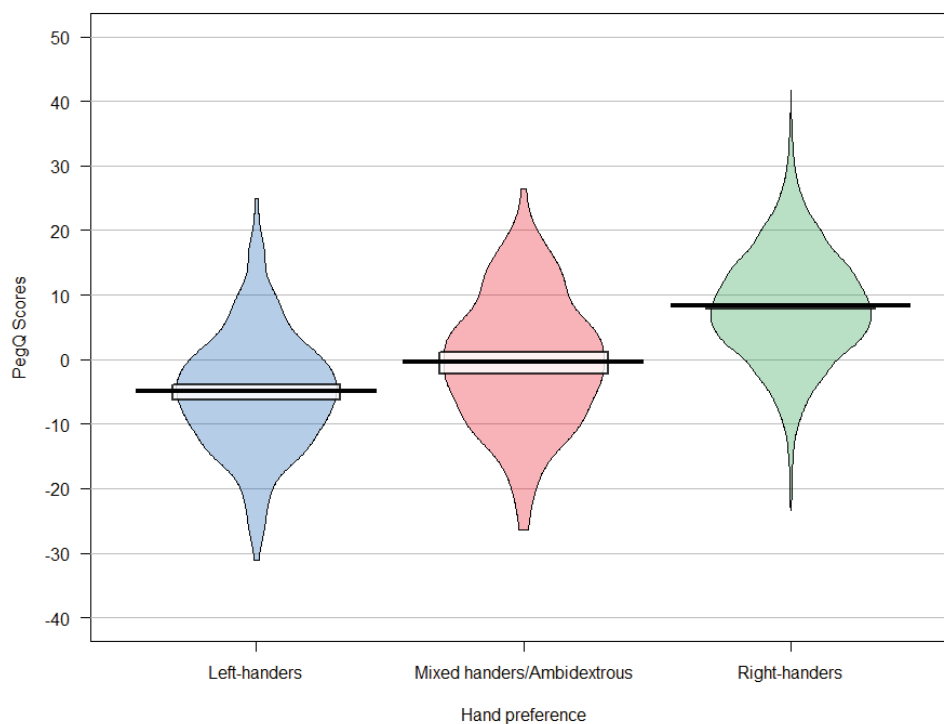

3.2. Testing the hypotheses

To examine the hypothesis that breech children present more difficulties in their balance control, reflecting an otolith impairment, we compared breech and cephalic children's scores on the static balance task using Mann-Whitney U test. This analysis showed no significant differences between breech (med = 18.5, mad = 11.49) and cephalic (med = 17.5, mad = 11.12) children (see Table 1 for a summary of the results).

We conducted a chi-square test to examine if breech children are more associated with a weak hand preference than cephalic children. No difference was found between breech and cephalic children (see Table 1, see Table A in Appendix 4 for descriptive statistics). Similarly, a t-test showed no significant differences in PegQ between breech presentation (M = 6.56, SD = 9.72) and cephalic presentation (M = 6.59, SD = 9.88).

Fisher's exact tests were performed due to small cell counts to examine whether breech presentation shows a greater association with neurodevelopmental disorders. These analyses were not significant for either for DD or for DCD (see Table 1, see Table B and Table C in Appendix 4 for descriptive statistics).

To examine whether mixed handers exhibited more difficulties on balance tasks than right- or left-handers, we conducted a Kruskal-Wallis test with the static balance scores as dependent variable and the hand preference categories (i.e., right, left, and mixed handers) as the independent variable. Results suggest that hand preference is unrelated to static balance scores (see Table 1). Spearman's correlation showed an absence of an association between hand performance and static balance (see Table 1).

Fisher's exact test was conducted to examine the association between hand preference and neurodevelopmental disorders. No association was found, either between hand preference and DD or between hand preference and DCD (see Table 1, see Table D and Table E in Appendix 4 for descriptive statistics). A t-test analyzing hand performance showed that there is no significant difference between children with DD (M = 7.58, SD = 9.67) and children without DD (M = 6.56, SD = 9.83). Similarly, a Welch's t-test showed no significant difference between children with DCD (M = 6.23, SD = 13.0) and children without DCD (M = 6.59, SD = 9.80). See Table 1 for the summary of the results.

To examine the hypothesis of an association between neurodevelopmental disorders and balance difficulties, we conducted Mann-Whitney tests to compare children's scores on the static balance task. As shown in Table 1, no significant difference was found between children with DD (med = 15.8, mad = 10.01)

and without DD (med = 18.0, mad = 11.86). In contrast, significant difference was found between children with DCD (med = 11.8, mad = 6.67) and without DCD (med = 18.0, mad = 11.86).

Table 1. Summary of the statistical analyses and results.

Statistical test	n after listwise deletion	Sensitivity analysis	Results	Bayes Factor ₁₀
H1: Association between the vestibular system and fetal presentation				
Mann-Whitney U test	3669	0.221	U=281738, $p=.357$, RBC = 0.042	0.07
MI's p -value from the pooled data			$p=.484$	
H2a: Association between fetal presentation and hand preference				
Chi-squared	3852	0.050	$\chi^2(2) = 1.44, p = .931$, Cramer's $V = .0006$.001
MI's p -value from the pooled data			$p=.851$	
H2b: Association between fetal presentation and hand performance				
t-test	3639	0.224	$t(3637) = -0.04, p = .970$, Cohen's $d = -0.003$	0.09
MI's p -value from the pooled data			$p=.827$	
H3a: Association between fetal presentation and language impairments				
Fisher's exact test	3875	0.045	$p = .268$	0.07
MI's p -value from the pooled data			$p=.207$	
H3b: Association between fetal presentation and motor impairments				
Fisher's exact test	3511	0.047	$p > .99$	0.02
MI's p -value from the pooled data			$p=.917$	
H4a: Association between hand preference and static balance				
Kruskal-Wallis test	2975	0.057	$\chi^2(2) = 0.77, p=.681, \epsilon^2 = <.001$	0.02
MI's p -value from the pooled data			$p=.455$	

H4b: Association between hand performance and static balance

Spearman's correlation	2915	0.073	$r=0.02, p=.174$	0.11
MI's p -value from the pooled data			$p=.599$	

H5a: Association between language impairments and hand preference

Fisher's exact test	3129	0.055	$p = .401$	0.003
MI's p -value from the pooled data			LH $p=.636$; RH $p=.284^*$	

H5b: Association between language impairments and hand performance

t -test	3062	0.349	$t(3060) = -0.84, p = .402,$ Cohen's $d = -0.104$	0.19
MI's p -value from the pooled data			$p=.520$	

H5c: Association between motor impairments and hand preference

Fisher's exact test	2681	0.060	$p = .500,$	0.001
MI's p -value from the pooled data			LH $p=.289$; RH $p=.760^*$	

H5d: Association between motor impairments and hand performance

Welch's t -test	3478	0.403	Welch's $t(48.8) = -0.19, p = .848,$ Cohen's $d = -0.031$	0.16
MI's p -value from the pooled data			$p=.780$	

H6a: Association between the vestibular system and language impairments

Mann-Whitney U test	3407	0.334	$U=111288, p = .288,$ $RBC = 0.073$	0.22
MI's p -value from the pooled data			$p=.303$	

H6b: Association between the vestibular system and motor impairments

Mann-Whitney U test	2834	0.470	$U=30825, p <.001,$ $RBC = 0.388$	317.54
MI's p -value from the pooled data			$p=.0004$	

*: LH: Left-handedness category; RH: Right-handedness category; Logistic regressions were conducted on the pooled data

4. Discussion

Whilst genetic factors clearly play an important role in the ontogenesis of laterality (Cuellar-Partida et al., 2021; McManus, 2021; Medland et al., 2006; Medland et al., 2009), non-genetic prenatal factors may also influence the development of behavioral and functional lateralization (Bishop, 2013; Michel, 2021). Previc (1991) proposed a theoretical framework to explain the link between the intrauterine environment, and children's laterality, language and motor development. However, although this model could at least partly explain the etiology of developmental disorders, few studies had tested it. Thus, our objective was to test Previc's Left Otolithic Dominance Theory (1991) by exploring the associations between early vestibular lateralization, fetal presentation, and handedness. Moreover, we wanted to know how these factors could be involved in the etiology of neurodevelopmental disorders. Our hypothesis inferred from the LODT is that a higher prevalence of neurodevelopmental disorders should be observed among children with breech presentation since they supposedly present a dysfunctional vestibular system and atypical lateralization (Fong et al., 2005). Both these characteristics are found among individuals with DCD and DD (Berretz et al., 2020; Darvik et al., 2018; Eglinton & Annett, 1994; Blythe, 2017).

To our knowledge, Tymnik et al.'s (1981; cited by Fong et al., 2005) study is the sole study to empirically support the view that a breech presentation is a consequence of a vestibular dysfunction. Thus, we first aimed to bring new empirical evidence of Tymnik et al.'s (1981) findings, and we hypothesized that breech born children should present more difficulties than cephalic children on a static balance task, reflecting otolith dysfunctions. We did not find any difference between breech and cephalic children. Our results suggest that a failure to adopt a cephalic presentation is not explained by a vestibular system dysfunction. Other factors, such as genetics, birth stress and pregnancy complications (e.g., uterine malformations, low volume of amniotic fluid) may explain why fetuses stay in breech presentation during gestation (Nordtveit et al., 2008).

According to our second hypothesis, breech position should allow the head to move more freely, leading to a lesser asymmetrical stimulation of the otoliths, and thus to a weak cerebral lateralization. Based on this theoretical framework, we predicted that children born in breech presentation should be less lateralized (i.e., more mixed handedness) than children with cephalic presentation. This prediction was refuted by our results. Fetal presentation failed to predict children's handedness, regardless of hand preference or hand performance (for similar results, see Rönnqvist & Hopkins, 2000). It is possible that the

absence of significant results between handedness and fetal presentation can be attributed to the measures used in this study. For hand preference, the 6-items questionnaire may presents some limitations (e.g., Edlin et al., 2015). Nonetheless, this assessment appeared to provide useful information about handedness. For instance, Schmitz et al. (2022) successfully identified a heritability estimate of handedness using the same 6-item questionnaire of ALSPAC, finding a similar heritability estimate to what was previously reported in twin studies (Medland et al., 2006; Medland et al., 2009). Thus, we believe that the questionnaire has scientific validity and can inform the relationship between hand preference and fetal presentation. For hand performance, the PegQ of the pegboard task was based only on the scores of one trial. This is suboptimal since intra-individual variability is important, and one should ideally calculate an average time for each hand derived from several trials (e.g., Annett, 1970). Nonetheless, there is some indication in the present study that our measure is valid even if the reliability could have been improved with greater control of intra-variability. The trial of the pegboard task used in this study was preceded by a demonstration of the experimenter, a practice session with each hand, and the PegQ do match the categories derived from the hand preference questionnaire.

Therefore, the role of the fetal presentation on newborns' lateralization may have been overstated in the LODT due to the fact that, contrary to the LODT which supposes a fixed head position in the last weeks of gestation (Previc, 1991), fetus' heads can move freely even in the cephalic presentation (Rönnqvist & Hopkins, 1998), and some fetuses continue to switch their positions from cephalic to breech presentations and vice-versa until the end of the pregnancy (Ververs et al., 1994a).

If our results challenge the link suggested by the LODT between fetal presentation and handedness, it remains possible that fetal presentation may only have an influence on early-lateralized behavior, whereas later lateralization will be affected by other factors, such as social (e.g., caregiver's handedness) and cultural factors (Michel, 2021; Previc, 1991). In addition, postnatal visual stimulation can possibly lead to a readjustment of the asymmetrical vestibular system, which may reduce the effect of the early fetal presentation on later behaviors. In line with this assumption, an association was found between fetal presentation and early behavioral asymmetries (Fong et al., 2005; Goodwin & Michel, 1981; Michel & Goodwin, 1979), and handedness at the age of 2 (Churchill et al., 1962), but disappeared when handedness was assessed at the age of 7 (Vles et al., 1989). To determine the likelihood of this assumption, and to directly test the LODT, one could conduct a longitudinal study starting from gestation, where it would be

possible to assess only the fetuses who adopted the same presentation during the last trimester while comparing fetuses with a rightward and leftward orientation. Afterward, one can measure early and later handedness, i.e., before and after the potential influence of social and cultural factors.

We predicted that the prevalence of neurodevelopmental disorders would be higher among children born in breech presentation, but our results did not corroborate our hypothesis, neither for DD nor for DCD (for similar results see Bartlett et al., 2000; Eide et al., 2005). These results support our previous findings where we failed to show a significant relation between breech presentation, dysfunctional vestibular system, and weak handedness, which were supposed to be related to neurodevelopmental disorders (Darvik et al., 2018; Eglinton & Annett, 1994; Blythe, 2017).

Based on our results, fetal presentation seems to be a poor indicator of vestibular dysfunction. Nonetheless, it is possible that handedness is directly related to early vestibular asymmetries, as suggested by Previc (1991). According to Previc (1991, 1996), a dysfunctional vestibular system may lead to a reduced otolithic asymmetry, resulting in a lesser cerebral lateralization. Thus, we tested this relation by predicting that mixed handed children would present more difficulties on a static balance task, which is supposed to reflect otoliths impairments. However, our results did not support this prediction. This is in line with Previc and Saucedo's (1992) study, which did not find a correlation between handedness and a task that measured vestibular asymmetry in high school students. It is possible that the absence of association reflects sociocultural influence and/or weak reliability of the vestibular asymmetry measures, as suggested by Previc and Saucedo (1992). However, another explanation is that handedness is not associated with the vestibular lateralization, and a weak handedness does not reflect a vestibular dysfunction. Nevertheless, these results neither exclude the relationships between neurodevelopmental disorders and handedness, nor refute the role of the vestibular system on neurodevelopmental disorders.

We predicted that a higher prevalence of language and motor impairments would be found among children with an atypical handedness, which was not corroborated by our results. These results differ from previous studies which showed that non-right handedness was associated with DD (Peters et al., 2006; for a meta-analysis see Eglinton & Annett, 1994), and with DCD (Cairney et al., 2008; see for a meta-analysis Darvik et al., 2018). It has also been shown that children with these disorders exhibit atypical functional lateralization (see for reviews Berretz et al., 2020 and Biotteau et al., 2016). One explanation for our results could be that our analysis is underpowered. Indeed, several studies highlighted that the influence of

atypical lateralization is small and large sample size is required to detect this weak but genuine association between language impairments and atypical lateralization (Eglinton & Annett, 1994; Porac, 2016; for a power analysis see Bishop, 2013). Nonetheless, in the present study, the sensitivity power analyses showed that we should be able to detect very small effect sizes, which makes this explanation less likely. Alternatively, it may be that atypical lateralization is not one of the factors causing neurodevelopmental disorders (Berretz et al., 2020). More specifically, it has been proposed that the association between atypical lateralization and neurodevelopmental disorders is due to a common mechanism underlying their ontogenesis, which is stress. Indeed, through an alteration in the hypothalamic-pituitary-adrenal axis, early life or chronic stress may lead to atypical cerebral lateralization and to neurodevelopmental or psychiatric disorders (Berretz et al., 2020). Following this view, Davis et al. (2022) showed that prematurity, which is related to early life stress (Field & Diego, 2008), exhibits atypical functional lateralization. As a non-planned complementary analysis (see Appendix 5), we tested the relation between prematurity, handedness, and neurodevelopmental disorders. Among preterm (<37 weeks gestation), very preterm (<32 weeks gestation), and extremely preterm children (<28 weeks gestation), we found a higher prevalence of left-hand preference and DCD compared to children born at term (>37 weeks gestation), and this all the more so when the prematurity is great (see Appendix 5). These results replicate previous studies that have found a link between prematurity and atypical handedness (e.g., de Kovel et al., 2019; see Domellöf et al. 2011 for a meta-analysis). This analysis suggests that the higher prevalence of neurodevelopmental disorders in non-right handedness is not a direct relationship but could be mediated by intrauterine stress. In other words, these results support that the development of laterality is not entirely due to genetic factors, and intrauterine factors such as early stress, could play a role in the ontogenesis of laterality, but also neurodevelopmental disorders (Berretz et al., 2020).

Finally, we expected that individuals with neurodevelopmental disorders such as DD and DCD will present more difficulties on static balance performance, which reflect otolith impairments. In line with previous studies (Fong et al., 2012; Verbecque et al., 2021), we showed that children with DCD exhibited significantly lower scores on the static balance task, supported by the Bayesian statistics. Contrary to our hypothesis, no difference on static balance was found between children with and without DD. Previous studies led to mixed results with some showing a postural instability in dyslexia (e.g., Pozzo et al., 2006), whilst others suggested that balance impairments are not related to reading skills (Rochelle & Talcott,

2006). Indeed, the association between vestibular impairments and dyslexia seems to be moderated by other factors and may be found only among children with dyslexia exhibiting visuospatial difficulties (Bemporad & Kinsbourne, 1983; Previc, 1991), or among children with dyslexia who present comorbidities, such as DCD (Rochelle & Talcott, 2006) and Attention-Deficit/Hyperactivity Disorder (Rochelle & Talcott, 2006; Wimmer et al., 1999). This may explain the absence of difference between the children with and without DD.

Because our study relied on a large-scale archival database, we were limited to the variables present in ALSPAC which were not made to specifically answer our hypotheses and for which errors and inaccuracies are possible due to the influence of multiple experimenters in the acquisition of the data. Nonetheless, using such data from a large-scale study allows for the analysis of a large sample of rare populations (i.e., breech fetal presentation). This is essential to deal with the lack of statistical power inherent in rare phenomena and therefore represents an important tool in tackling the replicability crisis. Furthermore, although the sample size is large, most of our results are statistically non-significant. Thus, whilst the data has some limitations, it was still able to probe the theoretical model that we are testing and tends to refute it. Therefore, our results can be considered valid and raise the important question of the relevance of designing a longitudinal study (which would be expensive in time, human resources, and participants) to specifically test this model if there is nothing in an existing large-scale database to support it.

Conclusion

Our study aimed to test the LODT. We found no evidence to support the hypothesis that breech presentation at birth is linked to children's vestibular system functioning, handedness, language and motor abilities. Our findings are in line with the perspective that handedness is mainly dependent on genetic factors and randomness (McManus, 2021), but also support previous findings in which nongenetic factors, such as stress, may exhibit a genuine but weak influence on handedness (de Kovel et al., 2019). Thus, if handedness is influenced at least partially by environmental factors as well as through epigenetics regulation (Berretz et al., 2020; Schmitz et al., 2017), the influence of stress and, as yet unidentified additional non-genetic factors deserves further investigation.

Data Sharing and Data Accessibility

The informed consent obtained from ALSPAC participants does not allow the data to be made freely available through any third party maintained public repository. However, data used for this submission can be made available on request to the ALSPAC Executive. The ALSPAC data management plan describes in detail the policy regarding data sharing, which is through a system of managed open access. Full instructions for applying for data access can be found here:

<http://www.bristol.ac.uk/alspac/researchers/access/>. The ALSPAC study website contains details of all the data that are available (<http://www.bristol.ac.uk/alspac/researchers/our-data/>).

Funding

The Grand-Est Region (Alsace, France) financially supported the present work [18P07546 – 18_GE4_066 – LATERALCOG]. The UK Medical Research Council and Wellcome (Grant ref: 217065/Z/19/Z) and the University of Bristol provide core support for ALSPAC. This publication is the work of the authors and J.H. will serve as guarantor for the contents of this paper.

Disclosure statement

No potential conflict of interest was reported by the author(s).

Ethics approval statement

Ethical approval for the study was obtained from the Research Ethics Committee of the University of Strasbourg (see <https://cil.unistra.fr/registre.html#proc-374>), from the ALSPAC Ethics and Law Committee, and the Local Research Ethics Committees. Informed consent for the use of data collected via questionnaires and clinics was obtained from participants following the recommendations of the ALSPAC Ethics and Law Committee at the time.

Acknowledgments

We would like to thank the LPC (UR 4440) for their support, Laurence de Lussy-Kubisa and Andrea Phelps for their assistance. We wish to gratefully thank Pr. Chris McManus and the anonymous reviewers for their valuable comments on the manuscript. Furthermore, we are extremely grateful to all the families who took part in this study, the midwives for their help in recruiting them, and the whole ALSPAC team, which includes interviewers, computer and laboratory technicians, clerical workers, research scientists, volunteers, managers, receptionists, and nurses.

Author contributions

JH and HS conceived the paper. JH and NS wrote the paper with inputs from HS. All authors contributed to the review and approval of the final version of the article.

References

- Ahmad, A., Webb, S. S. E., B., Sitch, A., Khan, K., & Macarthur, C. (2014). Association between fetal position at onset of labor and mode of delivery: a prospective cohort study. *Ultrasound Obstet Gynecol*, *43*, 176-182. <https://doi.org/10.1002/uog.13189>
- Annett, M. (1970). The growth of manual preference and speed. *British Journal of Psychology*, *61*(4), 545-558. <https://doi.org/10.1111/j.2044-8295.1970.tb01274.x>
- Annett, M. (2002). *Handedness and brain asymmetry: The right shift theory*. Psychology Press.
- Bartlett, D. J., Okun, N. B., Byrne, P. J., Watt, J. M., & Piper, M. C. (2000). Early motor development of breech- and cephalic-presenting infants. *Obstetrics & Gynecology*, *95*(3), 425-432. [https://doi.org/10.1016/S0029-7844\(99\)00556-6](https://doi.org/10.1016/S0029-7844(99)00556-6)
- Basta, D., Todt, I., Scherer, H., Clarke, A., & Ernst, A. (2005). Postural control in otolith disorders. *Human Movement Science*, *24*(2), 268-279. <https://doi.org/10.1016/j.humov.2005.04.002>
- Bemporad, B., & Kinsbourne, M. (1983). Sinistrality and dyslexia: A possible relationship between subtypes. *Topics in Learning & Learning Disabilities*.
- Berretz, G., Wolf, O. T., Güntürkün, O., & Ocklenburg, S. (2020). Atypical lateralization in neurodevelopmental and psychiatric disorders: What is the role of stress? *Cortex*, *125*, 215-232. <https://doi.org/10.1016/j.cortex.2019.12.019>
- Biotteau, M., Chaix, Y., Blais, M., Tallet, J., Péran, P., & Albaret, J.-M. (2016). Neural Signature of DCD: A Critical Review of MRI Neuroimaging Studies. *Frontiers in Neurology*, *7*, 227. <https://doi.org/10.3389/fneur.2016.00227>
- Bishop, D. V. M. (2013). Cerebral Asymmetry and Language Development: Cause, Correlate, or Consequence? *Science*, *340*(6138), 1230531. <https://doi.org/10.1126/science.1230531>
- Blythe, S. G. (2017). *Attention, balance and coordination: The ABC of learning success*. John Wiley & Sons.
- Boyd, A., Golding, J., Macleod, J., Lawlor, D. A., Fraser, A., Henderson, J., Molloy, L., Ness, A., Ring, S., & Davey Smith, G. (2013). Cohort Profile: The 'Children of the 90s'—the index offspring of the Avon Longitudinal Study of Parents and Children. *International Journal of Epidemiology*, *42*(1), 111-127. <https://doi.org/10.1093/ije/dys064>
- Buenaventura Castillo, C., Lynch, A. G., & Paracchini, S. (2020). Different laterality indexes are poorly correlated with one another but consistently show the tendency of males and females to be more left- and right-lateralized, respectively. *Royal Society Open Science*, *7*(4), 191700. <https://doi.org/10.1098/rsos.191700>
- Cairney, J., Schmidt, L. A., Veldhuizen, S., Kurdyak, P., Hay, J., & Fought, B. E. (2008). Left-Handedness and Developmental Coordination Disorder. *The Canadian Journal of Psychiatry*, *53*(10), 696-699. <https://doi.org/10.1177/070674370805301009>
- Churchill, J. A., Igna, E., & Senf, R. (1962). The association of position at birth and handedness. *Pediatrics*, *29*, 307-309.

- Cuellar-Partida, G., Tung, J. Y., Eriksson, N., Albrecht, E., Aliev, F., Andreassen, O. A., Barroso, I., Beckmann, J. S., Boks, M. P., Boomsma, D. I., Boyd, H. A., Breteler, M. M. B., Campbell, H., Chasman, D. I., Cherkas, L. F., Davies, G., de Geus, E. J. C., Deary, I. J., Deloukas, P., ... Medland, S. E. (2021). Genome-wide association study identifies 48 common genetic variants associated with handedness. *Nature Human Behaviour*, *5*(1), 59–70. <https://doi.org/10.1038/s41562-020-00956-y>
- Darvik, M., Lorås, H., & Pedersen, A. V. (2018). The Prevalence of Left-Handedness Is Higher Among Individuals With Developmental Coordination Disorder Than in the General Population. *Frontiers in Psychology*, *9*, 1948. <https://doi.org/10.3389/fpsyg.2018.01948>
- Davis, R., Donati, G., Finnegan, K., Boardman, J. P., Dean, B., Fletcher-Watson, S., & Forrester, G. S. (2022). Social gaze in preterm infants may act as an early indicator of atypical lateralization. *Child Development*, *93*(4), 869–880. <https://doi.org/10.1111/cdev.13734>
- de Kovel, C. G. F., Carrión-Castillo, A., & Francks, C. (2019). A large-scale population study of early life factors influencing left-handedness. *Scientific Reports*, *9*(1), 584. <https://doi.org/10.1038/s41598-018-37423-8>
- Domellöf, E., Johansson, A.-M., & Rönqvist, L. (2011). Handedness in preterm born children: A systematic review and a meta-analysis. *Neuropsychologia*, *49*(9), 2299–2310. <https://doi.org/10.1016/j.neuropsychologia.2011.04.033>
- Edlin, J. M., Leppanen, M. L., Fain, R. J., Hackländer, R. P., Hanaver-Torrez, S. D., & Lyle, K. B. (2015). On the use (and misuse?) of the Edinburgh Handedness Inventory. *Brain and cognition*, *94*, 44–51. <https://doi.org/10.1016/j.bandc.2015.01.003>
- Eglinton, E., & Annett, M. (1994). Handedness and Dyslexia: A Meta-Analysis. *Perceptual and Motor Skills*, *79*(3_suppl), 1611–1616. <https://doi.org/10.2466/pms.1994.79.3f.1611>
- Ehrlichman, H., Zoccolotti, P., & Owen, D. (1982). Perinatal factors in hand and eye preference: Data from the collaborative perinatal project. *International Journal of Neuroscience*, *17*(1), 17–22. <https://doi.org/10.3109/00207458208985084>
- Eide, M. G., Øyen, N., Skjærven, R., Irgens, L. M., Bjerkedal, T., & Nilsen, S. T. (2005). Breech Delivery and Intelligence: A Population-Based Study of 8,738 Breech Infants: *Obstetrics & Gynecology*, *105*(1), 4–11. <https://doi.org/10.1097/01.AOG.0000149743.80837.d3>
- Eliot, L. (2000). *What's going on in there? How the brain and mind develop in the first five years of life* (Bantam trade paperback ed). Bantam Books.
- Fagard, J., Chapelain, A., & Bonnet, P. (2015). How should “ambidexterity” be estimated? *Laterality: Asymmetries of Body, Brain and Cognition*, *20*(5), 543–570. <https://doi.org/10.1080/1357650X.2015.1009089>
- Faul, F., Erdfelder, E., Lang, A.-G., & Buchner, A. (2007). G*Power 3: A flexible statistical power analysis program for the social, behavioral, and biomedical sciences. *Behavior Research Methods*, *39*, 175–191. <https://doi.org/10.3758/BF03193146>
- Ferre, C. L., Babik, I., & Michel, G. F. (2020). A perspective on the development of hemispheric specialization,

- infant handedness, and cerebral palsy. *Cortex*, 127, 208–220. <https://doi.org/10.1016/j.cortex.2020.02.017>
- Field, T., & Diego, M. (2008). Cortisol: the culprit prenatal stress variable. *International Journal of Neuroscience*, 118(8), 1181–1205. <https://doi.org/10.1080/00207450701820944>
- Fong, B. F., Savelsbergh, G. J. P., Van Geijn, H. P., & De Vries, J. I. P. (2005). Does intra-uterine environment influence fetal head-position preference? A comparison between breech and cephalic presentation. *Early Human Development*, 81(6), 507–517. <https://doi.org/10.1016/j.earlhumdev.2004.11.002>
- Fong, S. S. M., Tsang, W. W. N., & Ng, G. Y. F. (2012). Altered postural control strategies and sensory organization in children with developmental coordination disorder. *Human Movement Science*, 31(5), 1317–1327. <https://doi.org/10.1016/j.humov.2011.11.003>
- Fraser, A., Macdonald-Wallis, C., Tilling, K., Boyd, A., Golding, J., Davey Smith, G., Henderson, J., Macleod, J., Molloy, L., Ness, A., Ring, S., Nelson, S. M., & Lawlor, D. A. (2013). Cohort Profile: The Avon Longitudinal Study of Parents and Children: ALSPAC mothers cohort. *International Journal of Epidemiology*, 42(1), 97–110. <https://doi.org/10.1093/ije/dys066>
- Fruscalzo, A., Londero, A. P., Salvador, S., Bertozzi, S., Biasioli, A., Della Martina, M., Driul, L., & Marchesoni, D. (2014). New and old predictive factors for breech presentation: Our experience in 14 433 singleton pregnancies and a literature review. *The Journal of Maternal-Fetal & Neonatal Medicine*, 27(2), 167–172. <https://doi.org/10.3109/14767058.2013.806891>
- Goodwin, R. S., & Michel, G. F. (1981). Head Orientation Position during Birth and in Infant Neonatal Period, and Hand Preference at Nineteen Weeks. *Child Development*, 52(3), 819. <https://doi.org/10.2307/1129082>
- Henderson, S. E. & Sugden, D. (1992). *The Movement Assessment Battery for Children*. The Psychological Corporation, Kent, UK
- Hepper, P. G. (2013). The developmental origins of laterality: Fetal handedness: Fetal Handedness. *Developmental Psychobiology*, 55(6), 588–595. <https://doi.org/10.1002/dev.21119>
- Hepper, P. G., Shahidullah, S., & White, R. (1991). Handedness in the human fetus. *Neuropsychologia*, 29(11), 1107–1111. [https://doi.org/10.1016/0028-3932\(91\)90080-R](https://doi.org/10.1016/0028-3932(91)90080-R)
- Hepper, P. G., Wells, D. L., & Lynch, C. (2005). Prenatal thumb sucking is related to postnatal handedness. *Neuropsychologia*, 43(3), 313–315. <https://doi.org/10.1016/j.neuropsychologia.2004.08.009>
- Humphriss, R., Hall, A., May, M., & Macleod, J. (2011). Balance ability of 7 and 10 year old children in the population: results from a large UK birth cohort study. *International journal of pediatric otorhinolaryngology*, 75(1), 106–113. <https://doi.org/10.1016/j.ijporl.2010.10.019>
- Levander, M., Schalling, D., & Levander, S. E. (1989). Birth Stress, Handedness and Cognitive Performance. *Cortex*, 25(4), 673–681. [https://doi.org/10.1016/S0010-9452\(89\)80027-9](https://doi.org/10.1016/S0010-9452(89)80027-9)
- Little, R. J., & Rubin, D. B. (2019). *Statistical analysis with missing data* (Vol. 793). John Wiley & Sons.
- Matsuo, K., Shimoya, K., Ushioda, N., & Kimura, T. (2007). Maternal positioning and fetal positioning in utero.

- Journal of Obstetrics and Gynaecology Research*, 33(3), 279-282. <https://doi.org/10.1111/j.1447-0756.2007.00524.x>
- McCaslin, D. L., Jacobson, G. P., Grantham, S. L., Piker, E. G., & Vergheze, S. (2011). The Influence of Unilateral Saccular Impairment on Functional Balance Performance and Self-Report Dizziness. *Journal of the American Academy of Audiology*, 22(08), 542–549. <https://doi.org/10.3766/jaaa.22.8.6>
- McManus, I. C. (1981). Handedness and birth stress. *Psychological Medicine*, 11(3), 485–496. <https://doi.org/10.1017/S0033291700052806>
- McManus, I. C. (2002). *Right hand, left hand: The origins of asymmetry in brains, bodies, atoms, and cultures* (1. publ). Harvard Univ. Press.
- McManus, I. C. (2021). Is any but a tiny fraction of handedness variance likely to be due to the external environment? *Laterality*, 26(3), 310–314. <https://doi.org/10.1080/1357650X.2021.1892126>
- Medland, S. E., Duffy, D. L., Wright, M. J., Geffen, G. M., Hay, D. A., Levy, F., van-Beijsterveldt, C. E. M., Willemsen, G., Townsend, G. C., White, V., Hewitt, A. W., Mackey, D. A., Bailey, J. M., Slutske, W. S., Nyholt, D. R., Treloar, S. A., Martin, N. G., & Boomsma, D. I. (2009). Genetic influences on handedness: Data from 25,732 Australian and Dutch twin families. *Neuropsychologia*, 47(2), 330–337. <https://doi.org/10.1016/j.neuropsychologia.2008.09.005>
- Medland, S. E., Duffy, D. L., Wright, M. J., Geffen, G. M., & Martin, N. G. (2006). Handedness in Twins: Joint Analysis of Data From 35 Samples. *Twin Research and Human Genetics*, 9(1), 46–53. <https://doi.org/10.1375/twin.9.1.46>
- Michel, G. F. (2021). Handedness Development: A Model for Investigating the Development of Hemispheric Specialization and Interhemispheric Coordination. *Symmetry*, 13(6), 992. <https://doi.org/10.3390/sym13060992>
- Michel, G. F., & Goodwin, R. (1979). Intrauterine birth position predicts newborn supine head position preferences. *Infant Behavior and Development*, 2, 29–38. [https://doi.org/10.1016/S0163-6383\(79\)80005-3](https://doi.org/10.1016/S0163-6383(79)80005-3)
- Morey, R. D., & Rouder, J. N. (2015). Bayesfactor: Computation of bayes factors for common designs [Computer software manual]. Retrieved from <https://CRAN.R-project.org/package=BayesFactor> (R package version 0.9.12-2)
- Neale, M. D. (1997). *Neale Analysis of Reading Ability – Revised*. Windsor: NFER-Nelson.
- Nordtveit, T. I., Melve, K. K., Albrechtsen, S., & Skjaerven, R. (2008). Maternal and paternal contribution to intergenerational recurrence of breech delivery: population based cohort study. *BMJ*, 336(7649), 872–876. <https://doi.org/10.1136/bmj.39505.436539.BE>
- Ocklenburg, S., Berretz, G., Packheiser, J., & Friedrich, P. (2021). Laterality 2020: Entering the next decade. *Laterality*, 26(3), 265–297. <https://doi.org/10.1080/1357650X.2020.1804396>
- Ocklenburg, S., Bürger, C., Westermann, C., Schneider, D., Biedermann, H., & Güntürkün, O. (2010). Visual experience affects handedness. *Behavioural Brain Research*, 207(2), 447–451.

<https://doi.org/10.1016/j.bbr.2009.10.036>

- Oldfield, R. C. (1971). The assessment and analysis of handedness: The Edinburgh inventory. *Neuropsychologia*, 9(1), 97–113. [https://doi.org/10.1016/0028-3932\(71\)90067-4](https://doi.org/10.1016/0028-3932(71)90067-4)
- Perugini, M., Gallucci, M., & Costantini, G. (2018). A Practical Primer To Power Analysis for Simple Experimental Designs. *International Review of Social Psychology*, 31(1), 20. <https://doi.org/10.5334/irsp.181>
- Peters, M. (1998). Description and Validation of a Flexible and Broadly Usable Handedness Questionnaire. *Laterality: Asymmetries of Body, Brain and Cognition*, 3(1), 77–96. <https://doi.org/10.1080/713754291>
- Peters, M., Reimers, S., & Manning, J. T. (2006). Hand preference for writing and associations with selected demographic and behavioral variables in 255,100 subjects: The BBC internet study. *Brain and Cognition*, 62(2), 177–189. <https://doi.org/10.1016/j.bandc.2006.04.005>
- Porac, C. (2016). *Laterality: Exploring the enigma of left -handedness*. Elsevier/AP, Academic Press is an imprint of Elsevier.
- Pozzo, T., Vernet, P., Creuzot-Garcher, C., Robichon, F., Bron, A., & Quercia, P. (2006). Static postural control in children with developmental dyslexia. *Neuroscience Letters*, 403(3), 211–215. <https://doi.org/10.1016/j.neulet.2006.03.049>
- Previc, F. H. (1991). A general theory concerning the prenatal origins of cerebral lateralization in humans. *Psychological Review*, 98(3), 299–334. <https://doi.org/10.1037/0033-295X.98.3.299>
- Previc, F. H. (1996). Nonright-handedness, central nervous system and related pathology, and its lateralization: A reformulation and synthesis. *Developmental Neuropsychology*, 12(4), 443–515. <https://doi.org/10.1080/87565649609540663>
- Previc, F. H., & Saucedo, J. C. (1992). The Relationship between Turning Behavior and Motoric Dominance in Humans. *Perceptual and Motor Skills*, 75(3), 935–944. <https://doi.org/10.2466/pms.1992.75.3.935>
- R Core Team. (2021). *R: A language and environment for statistical computing*. Vienna, Austria: R Foundation for Statistical Computing. URL <https://www.R-project.org/>
- Reissland, N., Aydin, E., Francis, B., & Exley, K. (2015). Laterality of foetal self-touch in relation to maternal stress. *Laterality: Asymmetries of Body, Brain and Cognition*, 20(1), 82–94. <https://doi.org/10.1080/1357650X.2014.920339>
- Rochelle, K. S. H., & Talcott, J. B. (2006). Impaired balance in developmental dyslexia? A meta-analysis of the contending evidence. *Journal of Child Psychology and Psychiatry*, 47(11), 1159–1166. <https://doi.org/10.1111/j.1469-7610.2006.01641.x>
- Robitzsch, A., Grund, S., & Henke, T. (2021). miceadds: Some additional multiple imputation functions, especially for mice (Version 3.12-16). <https://CRAN.R-project.org/package=miceadds>
- Rönnqvist, L., & Hopkins, B. (1998). Head Position Preference in the Human Newborn: A New Look. *Child Development*, 69(1), 13–23. <https://doi.org/10.1111/j.1467-8624.1998.tb06129.x>

- Rönnqvist, L., & Hopkins, B. (2000). Motor asymmetries in the human newborn are state dependent, but independent of position in space. *Experimental Brain Research*, 134(3), 378–384. <https://doi.org/10.1007/s002210000467>
- Scharoun, S. M., & Bryden, P. J. (2014). Hand preference, performance abilities, and hand selection in children. *Frontiers in Psychology*, 5. <https://doi.org/10.3389/fpsyg.2014.00082>
- Schmitz, J., Metz, G. A. S., Güntürkün, O., & Ocklenburg, S. (2017). Beyond the genome—Towards an epigenetic understanding of handedness ontogenesis. *Progress in Neurobiology*, 159, 69–89. <https://doi.org/10.1016/j.pneurobio.2017.10.005>
- Schmitz, J., Zheng, M., Lui, K. F., McBride, C., Ho, C. S.-H., & Paracchini, S. (2022). Quantitative multidimensional phenotypes improve genetic analysis of laterality traits. *Translational Psychiatry*, 12(1), 1-8. <https://doi.org/doi.org/10.1038/s41398-022-01834-z>
- Smart, J. L., Jeffery, C., & Richards, B. (1980). A retrospective study of the relationship between birth history and handedness at six years. *Early Human Development*, 4(1), 79–88. [https://doi.org/10.1016/0378-3782\(80\)90011-0](https://doi.org/10.1016/0378-3782(80)90011-0)
- Tan, L. E., & Nettleton, N. C. (1980). Left Handedness, Birth Order and Birth Stress. *Cortex*, 16(3), 363–373. [https://doi.org/10.1016/S0010-9452\(80\)80038-4](https://doi.org/10.1016/S0010-9452(80)80038-4)
- Tierney, N. J., & Cook, D. H. (2018). Expanding tidy data principles to facilitate missing data exploration, visualization and assessment of imputations. *arXiv preprint arXiv:1809.02264*
- Tymnik, G., Donat, H., & Fischer, B. (1981). [Abnormal obstetric presentation—Consequence of defective vestibular function (author's transl)]. *Zentralblatt Fur Gynakologie*, 103(16), 952–956.
- van Buuren, S., & Groothuis-Oudshoorn, K. (2011). mice: Multivariate imputation by chained equations in R. *Journal of statistical software*, 45, 1-67.
- Verbecque, E., Johnson, C., Rameckers, E., Thijs, A., van der Veer, I., Meyns, P., Smits-Engelsman, B., & Klingels, K. (2021). Balance control in individuals with developmental coordination disorder: A systematic review and meta-analysis. *Gait & Posture*, 83, 268–279. <https://doi.org/10.1016/j.gaitpost.2020.10.009>
- Ververs, I. A. P., de Vries, J. I. P., van Geijn, H. P., & Hopkins, B. (1994a). Prenatal head position from 12–38 weeks. I. Developmental aspects. *Early Human Development*, 39(2), 83–91. [https://doi.org/10.1016/0378-3782\(94\)90157-0](https://doi.org/10.1016/0378-3782(94)90157-0)
- Ververs, I. A. P., de Vries, J. I. P., van Geijn, H. P., & Hopkins, B. (1994b). Prenatal head position from 12–38 weeks. II. The effects of fetal orientation and placental localization. *Early Human Development*, 39(2), 93–100. [https://doi.org/10.1016/0378-3782\(94\)90158-9](https://doi.org/10.1016/0378-3782(94)90158-9)
- Vles, J. S. H., Grubben, C. P. M., & Hoogland, H. J. (1989). Handedness not related to foetal position. *Neuropsychologia*, 27(7), 1017–1018. [https://doi.org/10.1016/0028-3932\(89\)90077-8](https://doi.org/10.1016/0028-3932(89)90077-8)
- von Hippel, P. T. (2020). How many imputations do you need? A two-stage calculation using a quadratic rule. *Sociological Methods & Research*, 49(3), 699–718. <https://doi.org/10.1177/0049124117747303>

- Webb, S. S., Plana, M. N., Zamora, J., Ahmad, A., Earley, B., Macarthur, C., & Khan, K. S. (2011). Abdominal palpation to determine fetal position at labor onset: a test accuracy study. *Acta obstetrica et gynecologica Scandinavica*, *90*(11), 1259-1266. <https://doi.org/10.1111/j.1600-0412.2011.01226.x>
- Wetzels, R., Matzke, D., Lee, M. D., Rouder, J. N., Iverson, G. J., and Wagenmakers, E.-J. (2011). Statistical Evidence in Experimental Psychology: An Empirical Comparison Using 855 t Tests. *Perspectives on Psychological Science*, *6*(3), 291–298. <https://doi.org/10.1177/1745691611406923>
- Wilcox, R. R. (2011). Introduction to robust estimation and hypothesis testing. Academic press.
- Wimmer, H., Mayringer, H., & Raberger, T. (1999). Reading and Dual-Task Balancing: Evidence Against the Automatization Deficit Explanation of Developmental Dyslexia. *Journal of Learning Disabilities*, *32*(5), 473–478. <https://doi.org/10.1177/002221949903200513>

6.2 Complementary study 2

Influence of perinatal adversities on handedness and neurodevelopmental disorders

1. Objective

This complementary study is based on the findings of Article 2 where prematurity was significantly associated with an atypical hand preference and motor impairments. The aim of this study was to conduct further analyses on other Pregnancy Complications and Birth Stressors (PCBS) that may be implicated in the development of atypical handedness and neurodevelopmental disorders. The studied PCBS are birthweight and neonatal health assessed by the Apgar test at 1 and 5 minutes after birth. We hypothesized that, compared to healthy newborns, children born with a low birthweight (<2500 g) and that presented poor neonatal health (Apgar score <7) would be more associated with atypical handedness, cognitive, and motor impairments.

2. Method

2.1. Participants

Our sample in the present study is from ALSPAC (for further details on our sample see Methods in Article 2). The exclusion criterion was the non-singleton birth (n=524).

2.2. Measures

The data are from ALSPAC and were collected from obstetric medical records and clinical examinations. See Appendix 1 for the ALSPAC variable codes for all the measures used.

Birthweight: This variable was divided into four categories (for the cut-offs see Cutland et al., 2017): Typical birthweight (higher than 2500 g); Low birthweight (between 1500 and 2500 g); Very low birthweight (between 1000 and 1500 g); Extremely low birthweight (lesser than 1000 g).

Apgar test: As a neonatal evaluation, the Apgar test provides a measure of neonatal health and can give some indications of the baby's health condition after the birthing process. This test assesses the baby's

breathing effort, skin color, reflexes, heart rate, and muscle tone (Apgar, 1952). Generally, it is administered at 1 and 5 minutes after birth. The scores on this test can vary between 0 and 10. This variable was divided into three categories (for the cut-offs see Watterberg et al., 2015): Typical neonatal health (scores higher than 7); Poor neonatal health (i.e., low Apgar scores; between 4 and 7); Very poor neonatal health (i.e., very low Apgar scores; lesser than 4).

Handedness: Hand preference is based on a 6-item questionnaire administered at the age of nine, and hand performance is based on the pegboard test conducted at the age of seven (for further details on these measures, see Methods in Article 2).

3. Results

3.1. PCBS and handedness

3.1.1. Hand preference

We conducted a Fisher Exact test (three cell counts were less than 5) to examine if low birthweight is more associated with atypical hand preference. The probability of being left-handed was significantly higher among children with low birthweight ($N= 7074$; $p = .023$). Compared to the children born with a typical birthweight, the prevalence of left-handers was higher among children born with very (between 1000g and 1500g) and extremely (lesser than 1000g) low birthweight (see Table A in Appendix 2 for descriptive statistics).

A Chi-square test was conducted to test the association between the Apgar scores at 1 minute and the hand preference, where no significant difference was found ($\chi^2(4, N = 4261) = 3.54, p = .472$, Cramer's $V = 0.020$; see Table B in Appendix 2 for descriptive statistics). In contrast, Apgar scores at 5 minutes were significantly associated with atypical hand preference. The Fisher's exact test (four cell counts were less than 5) showed a higher prevalence of left-handedness among children with a very low score on the Apgar test at 5 minutes ($N= 4258$; $p=.045$; See Table C in Appendix 2 for descriptive statistics).

3.1.2. Hand performance

An ANOVA was conducted to examine whether children born with a low, very low, or extremely low birthweight differ from the children with typical birthweight on the hand performance scores (the homogeneity of variances assumption is met, Levene's $F(3, 6627) = 0.677, p = .566$). No significant difference was found ($N=6631; F(3, 6627) = 1.40, p = .242, \eta^2 = .001$).

We performed an ANOVA with Welch's correction (Levene's $F(2, 4018) = 4.78, p = .008$) with the hand performance task (i.e., PegQ) as the dependent variable and the Apgar test at 1 minute (i.e., typical, low, very low) as the independent variable. There was no significant effect of the Apgar test at 1 minute on the PegQ scores ($N=4021; F(2, 417.51) = 0.507, p = .603, \text{est.}\omega^2 < .001$). In contrast, an ANOVA (Levene's $F(2, 4017) = 0.533, p = .587$) showed that the Apgar test at 5 minutes tended to be associated with the PegQ scores ($N=4020; F(2, 4017) = 2.81, p = .061, \eta^2 = .001$). Pairwise Holm post-hoc comparisons showed that children with very low scores on the Apgar test at 5 minutes tended to have a lower mean ($M=0.33$) on the PegQ than children with typical scores ($M=6.63; t=2.29, p = .066$, see Figure 6.1). No differences were found between children with very low scores and those with low scores ($M=5.94; t=1.90, p = .115$).

Figure 6.1. Association between the Apgar test at 5 minutes and the PegQ scores

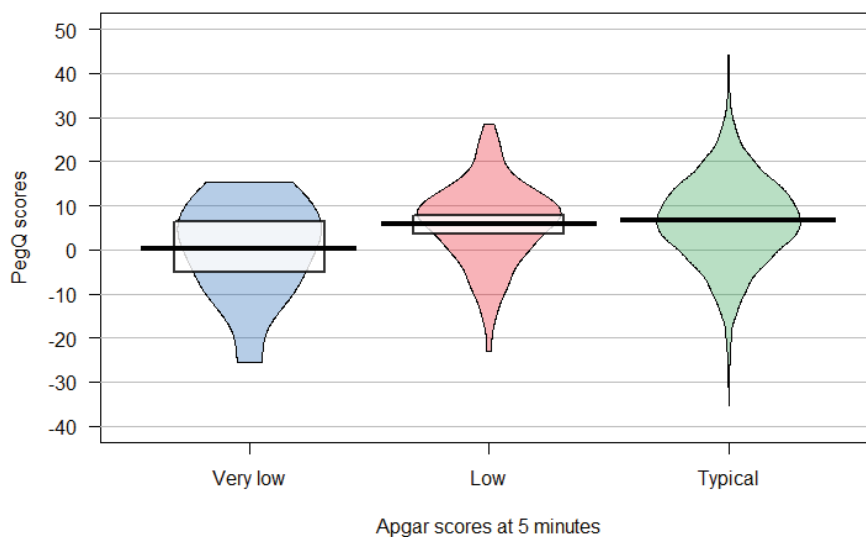

Descriptively, children with a very low Apgar score at 5 minutes had a near equal performance between the right and left hand on the pegboard task ($M=0.33$). To understand the origin of this result, a mixed ANOVA was performed with Apgar scores as the in-between variable, the hand used to execute the

pegboard task as the within variable, and the time taken to achieve the task as the outcome. The interaction between Apgar scores and hand used was not significant ($F(2, 4021) = 1.53$; $p = .216$; partial $\eta^2 = .001$). Nonetheless, descriptively, while the right hand was faster among the children with typical and low Apgar scores, its speed decreases in those with very low scores (see Figure 6.2). An exploratory analysis using pairwise comparison with Holm's correction showed that the performances with the right hand of children born with typical Apgar scores ($M=22.9$) were significantly faster than the children with very low scores on the Apgar test ($M= 26.1, p=.014$).

Figure 6.2. Interaction between Apgar scores at 5 minutes and the hand used during the pegboard task

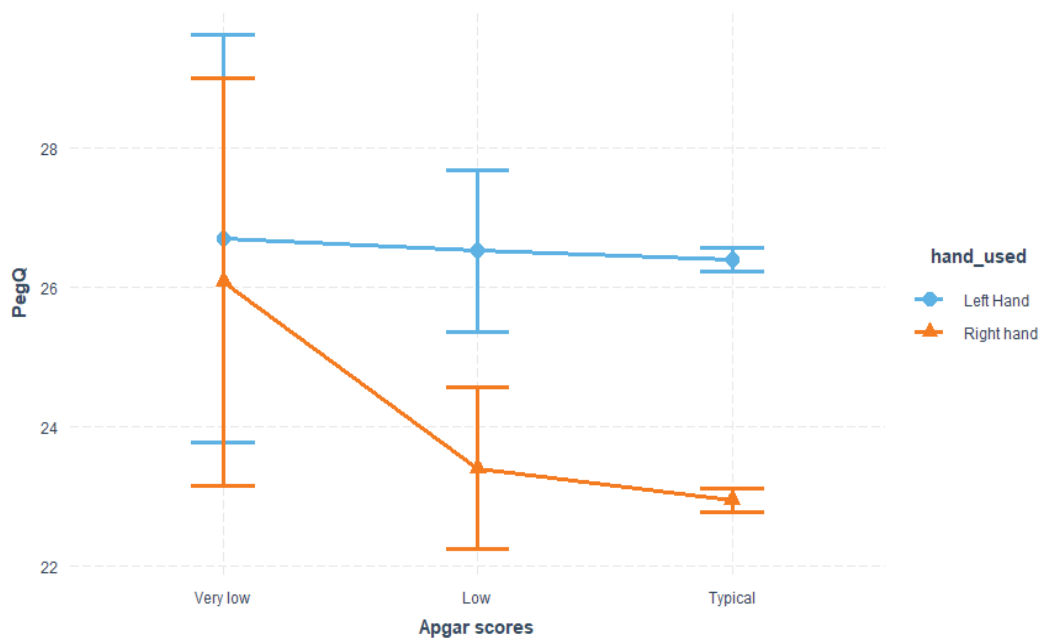

3.2. PCBS and neurodevelopmental disorders

We conducted a Fisher Exact test (three cell counts were less than 5) to examine if birthweight is associated with Developmental Dyslexia (DD). No significant difference was found ($N = 7016$; $p = .917$, see Table D in Appendix 2). In contrast, a Fisher Exact test (two cell counts were less than 5) showed a significant association between birthweight and Developmental Coordination Disorder (DCD; $N = 6389$; $p < .001$). As shown in Table E in the Appendix 2, a higher prevalence of DCD was found among children with low birthweight compared with children with typical birthweight, and this even more so when the birthweight

was very low or extremely low. We performed a series of Chi-square tests to evaluate the association between the Apgar test and neurodevelopmental disorders. For the assessment at 1 minute, no significant association was found with DD ($\chi^2(2, N = 4318) = 1.44, p = .486, \text{Cramer's } V = 0.018$), nor with DCD ($\chi^2(2, N = 3879) = 0.574, p = .750, \text{Cramer's } V = 0.012$). See Table F and Table G in Appendix 2 respectively for descriptive statistics. Similarly, a series of Fischer Exact tests did not show any significant association between the Apgar test at 5 minutes and DD ($N = 4318; p = .779$, see Table H in Appendix 2) or with DCD ($N = 3878; p = .704$, see Table I in Appendix 2).

4. Conclusion

The aim of this complementary study was to test if birthweight and neonatal health are associated with handedness and neurodevelopmental disorders. Our hypotheses were partly corroborated. Firstly, birthweight and neonatal health assessed at 5 minutes after birth showed a significant association with handedness. Low birthweights (i.e., <2500g) and very low scores on the Apgar test (i.e., <4) were associated with a higher prevalence of left-handedness. Secondly, hand performance tended to be associated with neonatal health at 5 minutes after birth, where children with very low scores on the Apgar test exhibited a near equal performance with both hands on the pegboard task compared to their healthier peers who presented a better right-hand performance. Lastly, concerning the association between these PCBS and neurodevelopmental disorders, only the birthweight was associated with the DCD, where low birthweights (i.e., <2500g) were associated with motor impairments contrary to children born with typical birthweight (i.e., >2500g).

We can conclude that prenatal adversities such as low birthweight and poor neonatal health are factors associated with atypical handedness. Nonetheless, the mechanisms underlying these associations may not be the same. Indeed, contrary to neonatal health, low birthweight is also associated with motor impairments, which suggest that birthweight may be one factor among others that explain the association between atypical handedness and neurodevelopmental disorders. Finally, a decrease in right hand performance is observed in children with very low neonatal health compared to their healthier peers. This result suggests that it is the right hand performance which is most likely to be impaired among these children. An interpretation of these results will be presented in the general discussion (Chapter 7).

PART IV - GENERAL DISCUSSION

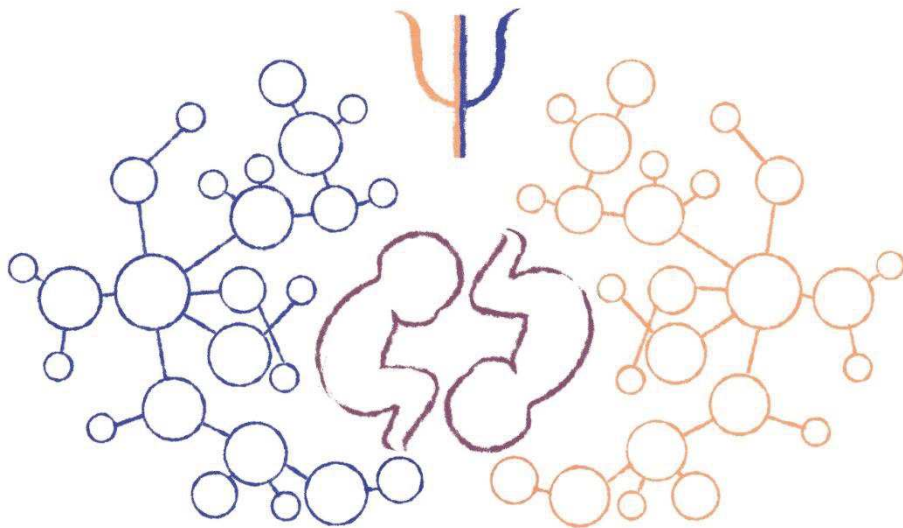

Chapter 7. Thesis' objectives, results, and conclusion

This thesis aimed to contribute to the scientific research on laterality with a developmental perspective. We investigated the development of two asymmetric behaviors present in humans: drawing and handedness.

Our first objective was to comprehensively observe asymmetric patterns exhibited by neurologically healthy individuals. We assessed the implication of cerebral lateralization, biomechanical constraints, and sociocultural influences in drawing asymmetries for both children and adults while considering their handedness and sex. This empirical work intended to identify different categories of prototypical graphomotor patterns. Our research hypotheses were based on studies that measured perceptual and motor biases through different tasks (Alter, 1989; Chokron & De Agostini, 2000; De Agostini et al., 2011; Faghihi et al., 2019; Ishii et al., 2011; Picard, 2011; Picard & Zarhbouch, 2014; Tosun & Vaid, 2014). We started our investigation on child participants (Article 1) since they are less subject to sociocultural influences (Faghihi et al., 2019; Picard & Zarhbouch, 2014). We expected that they would exhibit perceptual and motor biases more strongly than adults. This allowed us to observe the extent to which cerebral lateralization and motor constraints, in concert with handedness and sex, can influence graphomotor asymmetries in Article 1. A complementary study was conducted to extend the first study while taking into consideration some of its limitations. In Complementary study 1, we included mixed-handedness and assessed handedness along a continuum based on the hand performance. Contrary to Article 1, where a manual scoring procedure was used, the graphical variables were scored electronically. Lastly, adult participants were assessed. Our main hypothesis was that, considering their long experience with script directionality, adults would exhibit different perceptual biases than children. Sociocultural influences (i.e., Left to Right script directionality) were assumed to enhance the preference toward the left visual field.

The second objective was to test theoretical models that postulate that the intrauterine environment is implicated in the typical or atypical developmental trajectory of handedness. The first theoretical framework suggests that handedness is a manifestation of early asymmetries related to fetal presentation (Michel, 2021). Previc (1991) proposed in his Left-Otolithic Dominance Theory (LODT) that cephalic fetal presentation stimulates asymmetrically the vestibular system, leading to its lateralization. In turn, this leads

to later motor lateralization. Additionally, it was suggested that a dysfunctional vestibular system will disturb the lateralization process which can increase the risk of developing neurodevelopmental disorders. Based on this theoretical model (Previc, 1991, 1996), a link is inferred between the vestibular system, fetal presentation, laterality, and disorders. To our knowledge, since Previc (1991) proposed this model, no studies have investigated this developmental pattern. The LODT inspired the work in Article 2, where we hypothesized that an atypical fetal presentation (i.e., breech presentation), assumed to reflect a dysfunctional and weakly lateralized vestibular system, will lead to weak hemispherical and behavioral asymmetries and later cognitive and motor impairments. Related to our work testing the LODT, we took an interest in studying prenatal stressors and complications. Among children with Pregnancy Complications and Birth Stressors (PCBS), there is a higher prevalence of both atypical handedness (e.g., Domellöf et al., 2011) and atypical structural and functional lateralization (Davis et al., 2022; Kwon et al., 2015; Lee et al., 2021). Nonetheless, there are inconsistent results in the literature concerning the role of PCBS in the development of atypical laterality (Porac, 2016), which may be due to methodological limitations (see Chapter 6). We tested the association between some PCBS indicators (i.e., prematurity, low birthweight, and poor neonatal health), handedness, and neurodevelopmental disorders while taking into consideration these limitations (i.e., Article 2, Complementary study 2). Our hypotheses were that PCBS would lead to a higher prevalence of atypical handedness, cognitive and motor impairments. If these hypotheses are corroborated, then PCBS may be one of the shared factors between atypical laterality and neurodevelopmental disorders.

This general discussion has been divided into two main parts: the first focusing on the development of drawing asymmetries, and the second on the development of handedness. In the following sections, we will present the main results obtained through the articles and complementary studies. Furthermore, limitations and future perspectives for each objective will be presented, as well as an overall conclusion. Several fundamental aspects of our research on behavioral asymmetries will be discussed:

1. The interaction between biological and sociocultural factors in graphomotor asymmetries and the extent to which visuospatial biases can be modulated by handedness, sex, age, and other variables.
2. The link between atypical laterality and neurodevelopmental disorders that may be partly explained by perinatal stress events.

7.1 Developmental patterns of graphomotor asymmetries

The first part of this thesis consisted of studying the perceptual and motor biases that manifest through drawing asymmetries. These biases can be both of biological and sociocultural origin (Rinaldi et al., 2020). Drawing an object is usually skewed to the left of the paper. The preference for the left visual field is related to the lateralized visuospatial attention in the right hemisphere (Picard & Zarhbouch, 2014). A graphical production is also characterized by its orientation, and depends on whether the right or the left hand is used. This, in turn, is associated with the motor constraints related to biomechanical factors. It is easier to execute an extensor movement and, therefore, right-handers execute strokes from left to right. In addition, depiction generally starts with the main element of a stimulus (e.g., head of a fish, front of a car). Consequently, right-handers' drawings are generally oriented to the left, and vice versa for left-handers (Tosun & Vaid, 2014). These attentional and directional biases can interact with sociocultural influences. Exposure to script directionality (i.e., writing and reading orientation) can enhance or hinder these biases (Friedrich et al., 2014; Tosun & Vaid, 2014; Vaid et al., 2002). While a Left to Right (LR) script directionality tends to increase the left visual field bias and a LR stroke orientation, a Right to Left (RL) script could decrease them (Picard, 2011). These biases are shown to be moderated by handedness and sex. Left-handers and females exhibit a weaker bias than right-handers and males, which can be putatively related to their weaker lateralization (De Agostini et al., 2011; Friedrich et al., 2014; Jewell & McCourt, 2000; Karev, 1999; Shanon, 1979). Based on these findings, two key questions arise. Do perceptual and motor biases interact with each other in the same way in all individuals? Are there specific patterns that reflect prototypical profiles regarding drawing asymmetries? Untangling these asymmetries' underlying mechanisms and their variability in healthy individuals can help researchers and clinicians understand findings observed in clinical populations (Friedrich et al., 2018) where individuals with neurodevelopmental disorders exhibit different visuospatial biases than their peers (Waldie & Hausmann, 2010).

Article 1 showed that children exhibit different drawing asymmetries dependent on their handedness and sex. These findings were detected through the administration of a 3D-2D graphic transcription task. The participants were asked to reproduce a 3D symmetrical model, consisting of a river (foreground), house (center) and trees (background) by a 2D drawing. Complementary Study 1 extended these findings using the Rey-Osterrieth Complex Figure to measure these asymmetries in adults, where the influence

sociocultural influences could be observed. In both studies, we conducted cluster analyses to identify different categories of graphomotor asymmetrical patterns.

Based on our results, we suggest a first simplified version of the developmental trend of global asymmetrical graphical patterns observed in neurologically healthy individuals (see Figure 7.1).

Figure 7.1. Summary of the different mechanisms and moderators implicated in graphomotor asymmetries

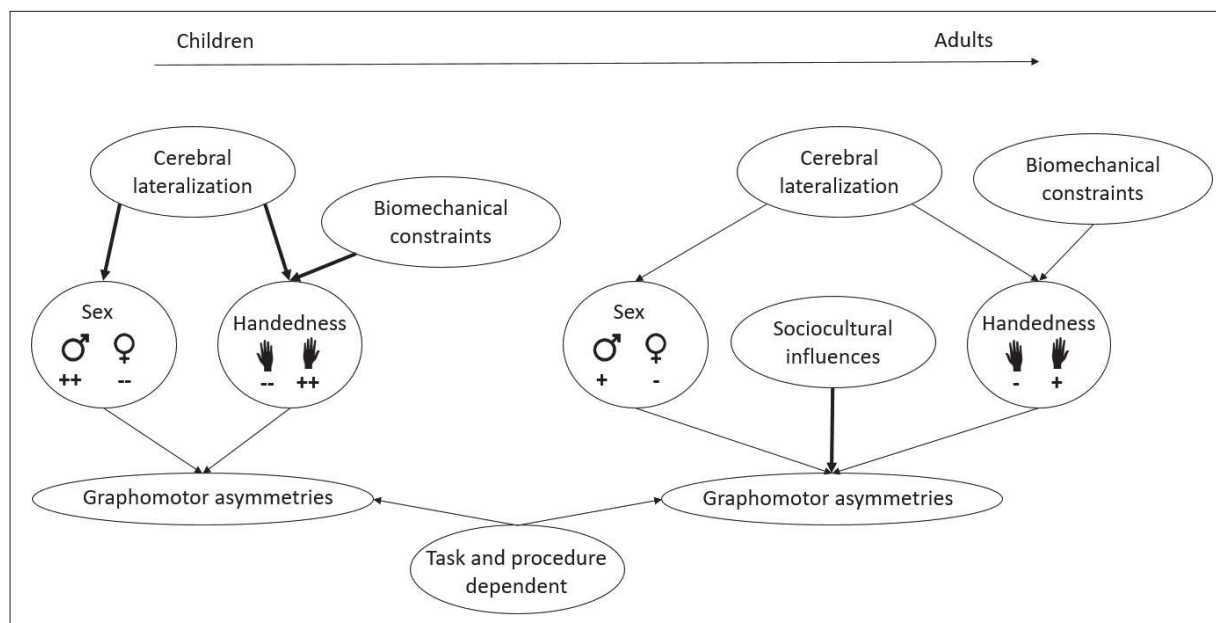

Note. In children, the influence of cerebral lateralization and biomechanical factors, modulated by handedness and sex, are suggested to be the strongest (bold arrows). Being a male and a right-hander enhances the perceptual biases (++), contrary to left-handers and females (--). In adults, script directionality is a strong influence (bold arrow), moderating the influence of cerebral lateralization and biomechanical constraints. Handedness and sex will still influence the graphomotor asymmetries but to a smaller degree (+, -) compared to children (++, --). Finally, drawing asymmetries are suggested to be task and procedure dependent in both children and adults.

Mechanisms underlying drawing asymmetries

In Article 1, children were categorized into five groups characterized by their handedness and degree of lateralization. The latter was inferred from different graphical variables such as density, complementarity of the graphical elements, spatial arrangement, and the progression axis. Girls were more prone to depict balanced drawings and symmetrical graphic productions. Similarly, left-handers were more associated to balanced drawings. These findings may be explained by a weaker functional lateralization in girls and left-handers that leads to weaker spatial bias. In contrast, boys and right-handers drew more asymmetrical drawings, displaying stronger spatial biases (see Figure 7.1). This result may be related to their stronger degree of functional lateralization (De Agostini et al., 2011; Jewell & McCourt, 2000; Karev, 1999; Picard & Zarhbouch, 2014).

Children appeared to be strongly impacted by the biomechanical constraints (see Figure 7.1). Most right-handers started their drawings from the left, whereas left-handers started from the right. In addition, right-handers adopted a Left-to-Right (LR) stroke orientation contrary to left-handers who tended to draw from Right-to-Left (RL). Nevertheless, it is noteworthy that some left-handed children exhibited a point of origin located in the center of the drawing paper. Thus, biomechanical factors seem to be influenced by cerebral lateralization, whereby weaker lateralization among left-handers may explain the heterogeneity in their point of origin.

In Complementary study 1, similarly to children, adults were categorized into five groups according to their handedness, sex, and degree of lateralization. The latter was reflected by the center of gravity and point of origin. All the participants depicted the Rey-Osterrieth Complex Figure (ROCF) on the left side of the paper and started to draw from the left. These results contrast with those found among children, where a leftward density and a left point of origin was observed among right-handers, whereas left-handers exhibited a balanced density and a right or center point of origin. Children are less subject to the sociocultural influences (i.e., script directionality; Fagard & Dahmen, 2003). With the absence of a confounding variable, cerebral lateralization may be strongly influencing drawing asymmetries in children. In contrast, our adult participants have a prolonged experience with a LR writing and reading, which may enhance the leftward attentional bias of both right- and left-handers (see Figure 7.1). One should note that

left-handers and females exhibited a weaker attentional bias toward the left. Similarly, mixed-handed female participants started their drawings near the center of the paper, whereas the remaining participants tended to start more from the left. These results can be explained by findings showing that left-handers and females exhibit a weaker attentional bias due to a weaker functional lateralization compared to right-handers and males. Therefore, cerebral lateralization seems to exert an influence on graphomotor asymmetries in both children and adults. However, it is weaker among the adults, likely due to the sociocultural influences (see Figure 7.1).

Task and procedure dependency

The perceptual and motor biases were found to be task dependent, in line with previous studies reporting that pseudoneglect varies according to different visuospatial tasks (Mitchell et al., 2020). In Article 1, the 3D-2D graphic transcription task was compared to the Alter's directionality test. The former succeeded in detecting directional biases in young children, unlike the latter. One difference between the two measurements is that the 3D-2D task represents a 3D landscape figure, whereas Alter's test consists in static and moving objects (e.g., spoon, airplane). Previous studies showed that landscape images are correlated with the line bisection task, and share common characteristics, such as a horizontal evaluation of spatial information (Ishii et al., 2011). Therefore, the landscape model in the 3D-2D task may have been more sensitive to the cerebral lateralization than the static/moving objects of the Alter's directionality test (Chokron & De Agostini, 2000; De Agostini et al., 2011; Ishii et al., 2011). For the Complementary study 1, the ROCF is an asymmetrical figure with a rightward oriented shape, contrary to the symmetrical 3D-2D transcription task. This shape can increase the LR visual scanning, which is congruent with the LR script directionality (Portex et al., 2017). Therefore, in addition to the sociocultural influences, the leftward bias exhibited by all the adults can be explained by a factor intrinsic to the ROCF, which is its asymmetrical shape.

There is an additional explanation for the differences seen between the two graphical tasks used in these studies, their association to a semantic effect. Past studies showed that giving a meaning to a stimulus may change the way it is depicted (Portex et al., 2017). van Sommers (1984) reported that when adult right-handers are asked to draw a line, their strokes follow a left-to-right orientation. Interestingly, when they are asked to draw an arrow pointing to the left, the strokes are reversed and a right-to-left

orientation is observed. The author interpreted this result by suggesting that drawing is dependent on semantic constraints. In an absence of meaning, a stroke's orientation will only be a consequence of biomechanical and cultural influences. These results were supported by Vinter (1999) who found that the same ambiguous shape, depending on how it is labelled (e.g., pipe vs. house with shadows), will be depicted by children differently (LR orientation vs RL orientation, respectively). Therefore, it was suggested that the influence of culture decreases when one is depicting an object with a specific meaning (Portex et al., 2017). In our studies, the 3D-2D task is a representation of a figurative model (i.e., house, river, trees), which is associated with semantics. Before the depiction of the 3D model, children were invited to verbalize what they were seeing. In contrast, the ROCF is an abstract geometrical figure that does not imply any semantic coding. Therefore, children may have exhibited different perceptual biases due to the semantic-related drawing task, whereas adults were more impacted by their script directionality and shape of the ROCF, which can both have a priming effect on the LR orientation.

Another factor influencing the perceptual and motor biases is whether the drawing is produced from copy or memory. The graphomotor processes involved in the copy and recall trials differ. In Article 1, children were only asked to reproduce the 3D model from memory. In contrast, adults in Complementary study 1 drew the ROCF during both a copy and a recall trial. For both trials, the right-handed adults preferred a LR stroke orientation and the left-handers preferred a RL one (similar to the children). Nonetheless, mixed handed adults preferred LR strokes in the copy ROCF, whereas they exhibited a preference for RL strokes in the recall ROCF. For the point of origin, whilst no significant differences were found in the copy trial, mixed handed females in the recall trial started their drawing nearer of the center of the drawing paper compared to right-handed females and all the male participants who started significantly more to the left. These results suggest that the copy trial may be context sensitive, where the salient LR orientation of the ROCF guided the stroke orientation and the point of origin. In contrast, when drawing from memory, what is depicted is the mental representation of the ROCF. In this case, the stroke orientation and the point of origin will no longer follow the specific orientation that characterizes the stimulus, leaving the interaction between cerebral lateralization and biomechanical constraints as the main contributor.

Drake and Winner (2013) found that the imaginative act of generating a mental image and then drawing it influences emotional regulation, whereas the simple task of copying an image does not. Emotion has been shown to modulate the attentional bias, but this interaction appears to be complex (Strappini et al., 2021). There is no consensus of whether it enhances the leftward or rightward bias, and if it is valence dependent. For further reading, see the review of Strappini et al. (2021) on the interaction between emotion, attentional bias, and the related theoretical framework. It is possible that in, Complementary study 1, the recall trial of the ROCF was associated with a specific emotion. This could have facilitated the influence of functional lateralization on the attentional bias, which appeared among the weakly lateralized participants. However, we did not measure any variables associated with the participants' emotions.

Limitations and perspectives

The two studies presented earlier have some limitations. The most straightforward one is our small sample sizes of 66 and 56 participants in Article 1 and Complementary study 1 respectively. Moreover, the latter consisted of an unbalanced sample with 37 females/19 males, and 10 left-/5 mixed-/41 right-handers. For future studies, it is important to have larger and more balanced sample sizes. We reported effect sizes regarding every graphical variable of interest, for both children and adults, and therefore power analyses can be performed to estimate future sample sizes.

Two different graphical tasks were used in our studies. The first one was a symmetrical figurative drawing, whereas the second one was an asymmetrical geometrical figure. In addition, manual scoring was adopted for the 3D-2D task and the graphical variables were categorical. In contrast, the ROCF scoring was digital and the graphical variables were numerical. Thus, caution should be taken when comparing the results obtained from these two tasks. For future studies, we would recommend using the 3D-2D transcription task with adults. We can thus more appropriately compare the graphomotor patterns of children and adults. Another advantage to the use of the 3D-2D with adults is to observe the inter-individual differences obtained from the ROCF and the 3D-2D transcription task. This could test the task dependency hypothesis (rightward shape vs. balanced shape). Furthermore, we could add a copy trial for the 3D-2D transcription task in order to test if the differences between the copy and recall trials are procedure dependent.

In addition to the graphic production tasks, it would be interesting to administer questionnaires that can assess emotions. This would allow us to investigate any potential interactions between emotion and graphic asymmetries. Instead of using a manual scoring sheet as in Article 1, we suggest using the electronic scoring procedure used in Complementary study 1 when administering the 3D-2D task. This is a more objective methodology that can detect precise numerical measures. This method will allow researchers to accurately study the extent to which biological and sociocultural factors interact with each other during graphomotor productions. Lastly, an important perspective is to use the 3D-2D graphic task in individuals with neurodevelopmental disorders in order to observe if they would exhibit different graphomotor asymmetrical patterns than those obtained in our present studies.

7.2 Perinatal adversities, laterality, and neurodevelopmental disorders

The second part of this research project consisted of the investigation of possible non-genetic factors related to the prenatal life that could be implicated in the development of both atypical laterality and neurodevelopmental disorders. Several scientific reviews and meta-analyses have shown a higher prevalence of an atypical lateralization among individuals with neurodevelopmental and psychiatric disorders (Abbondanza et al., 2022; Darvik et al., 2018; Hirnstein & Hugdahl, 2014; Markou et al., 2017; Nastou et al., 2022; Papadatou-Pastou & Tomprou, 2015; Somers et al., 2009). Different hypotheses have been suggested to describe the nature of this association (Bishop, 2013). It may be a reflection of a causal relation (i.e., atypical laterality leads to disorders), a consequence (i.e., atypical laterality is a result of disorders), or a correlation due to common underlying factors (i.e., atypical laterality and disorders share common factors). Recent evidence tends to support the latter association (Mundorf & Ocklenburg, 2021, p. 107). A question can nonetheless arise: what are the common factors that increase the probability of developing atypical laterality, neurodevelopmental and psychiatric disorders?

These phenotypes have genetic roots (Cuellar-Partida et al., 2020; Mitchell, 2011; Paracchini et al., 2016), and a growing number of studies found common polygenic factors between them (e.g., Brandler & Paracchini, 2014; Sha, Schijven & Francks, 2021; Wiberg et al., 2019). However, non-genetic factors have also been shown to be implicated in the development of laterality and disorders (Connors et al., 2008; Gliga & Alderdice, 2015; Michel, 2021; Rentería, 2012; Schmitt et al., 2014). Therefore, it is possible to suggest

that common non-genetic factors may lead to both atypical laterality and mental disorders (Berretz, Wolf et al., 2020; Ocklenburg et al., 2016). In line with this perspective, some experts have recently been working on stress (i.e., via stress induction paradigms and cortisol administration) as a non-genetic factor that may be involved in the ontogenesis of different disorders and hemispheric asymmetries (Berretz et al., 2022a, 2022b; Berretz, Packheiser et al., 2020; Mundorf et al., 2020). In this research project, other non-genetic factors were studied, which are the fetal presentation and Pregnancy Complications and Birth Stressors (PCBS).

Based on a large sample from the ALSPAC database (Boyd et al., 2012; Fraser et al., 2012), we started by hypothesizing that a dysfunctional vestibular system leads to a breech presentation and weak lateralization. Consequently, we tested if breech presentation increases the risk of neurodevelopment disorders in Article 2. No difference was found between children with cephalic and breech presentations on the static balance test, which was supposed to reflect the vestibular system functioning. Moreover, fetal presentation was not associated with either handedness or neurodevelopmental disorders. These results do not corroborate our assumptions derived from the Left-Otolithic Dominance Theory (LODT) of Previc (1991, 1996). In contrast, a higher prevalence of left-hand preference and Developmental Coordination Disorder (DCD) was found among preterm children (Article 2). Furthermore, low birthweight was associated with a left-hand preference and DCD, whereas a very poor neonatal health assessed at 5 minutes was only related to a left-hand preference and a weak hand performance (Complementary study 2). These results support previous studies that reported a higher rate of atypical handedness and motor impairments among individuals with PCBS (de Kovel et al., 2019; Domellöf et al., 2011; Dragović, Milenković et al., 2013; Zwicker et al., 2013).

Article 2 and Complementary study 2 showed that PCBS are related to handedness and neurodevelopmental disorders, but that fetal presentation had no influence on either. This suggests that the PCBS (i.e., gestational age, birthweight, neonatal health) could be common factors that lead to both atypical laterality and neurodevelopmental disorders.

Before offering explanations as to the relation between prenatal and perinatal adversities, handedness, and neurodevelopmental disorders, we will first address some puzzling findings and observations found in our studies.

Not all things are equal

I. Differences in outcomes between different types of PCBS

Low Gestational Age and Low Birthweight (LGA and LB) led to different outcomes when compared to poor neonatal health reflected by low Apgar scores. The LGA and LB were associated with a higher prevalence of left-hand preference and DCD, whereas the latter PCBS was related to hand preference and hand performance but not DCD. The fact that LGA and LB were associated with the same phenotypes is not surprising since low birthweight has a strong preterm birth component in its etiology (e.g., Goldenberg & Culhane, 2007; Iliodromiti et al., 2014). The association between LGA/LB and DCD, in contrast to poor neonatal health assessed by the Apgar test, is supported by previous studies (Zwicker et al., 2013).

It should be noted that contrary to the scores obtained at 1 minute after birth, it is the Apgar scores assessed at 5 minutes which were related to atypical handedness. The difference between these two scores was previously documented. While both reflect antepartum complications associated with infant development, the 1-minute Apgar score is considered to be an indicator of the short-term development, whereas the 5-minutes Apgar score, regardless of gestational age at birth, is an indicator of long-term outcomes (Wainstock & Sheiner, 2022). Low scores on the Apgar test at 5 minutes may indicate an intrapartum hypoxic-ischemic event, and it is associated with risk outcomes such as cerebral palsy and neurological disability, unlike the 1-minute Apgar scores (Modabbernia et al., 2016; Wainstock & Sheiner, 2022; Watterberg et al., 2015).

LGA, LB and Apgar scores reflect different etiologies and are not necessarily related (Behnke et al., 1987; Tiemeier & McCormick, 2019; Wainstock & Sheiner, 2022). One finding from our studies suggests at the underlying differences between these PCBS. LGA, LB and the very low Apgar scores were significantly associated with hand preference, but only the latter tended to also be associated with hand performance. Handedness is multidimensional, where hand preference and hand performance are weakly correlated

between each other (Buenaventura Castillo et al., 2020). Furthermore, the direction and strength of asymmetry are two different phenotypes affected by different biochemical pathways and genetic factors (Schmitz et al., 2019). LGA and LB may affect mechanisms that are solely implicated in the development of hand preference, whereas low Apgar scores may reflect other mechanisms related to both hand preference and hand performance. It was stipulated that an atypical hand performance, manifested in poor right hand functioning, could be related to early brain damage (Domellöf et al., 2011; Satz, 1972, 1973). In Complementary Study 2 we found that, whilst the left-hand performance was stable across the different categories, children with very low Apgar score (i.e., <4) had a significant reduction in their right hand performance. Very low Apgar scores are highly associated with anoxia (Iliodromiti et al., 2014). Furthermore, for both at term and preterm gestations, a higher mortality rate attributed to anoxia is shown among children with low Apgar score at 5 minutes (Iliodromiti et al., 2014). Therefore, a potential anoxia among our participants with very low Apgar scores could explain why atypical hand performance was associated with the Apgar scores but not with LGA or LB.

Whilst we did make some distinctions between these PCBS events depending of their outcomes, it is difficult to draw strong conclusions from our results. The different outcomes obtained according to each of these PCBS may be due to the multifactorial origins of PCBS, which could be genetic, medical, environmental and socioeconomic factors (Di Renzo et al., 2018; Wadon et al., 2020; Watterberg et al., 2015). Furthermore, Apgar score is a composite measure of birth stress events and is a substitute for a range of isolated factors (Dragović, Milenković et al., 2013), which naturally increases the difficulty of identifying precisely what it is being measured (Tiemeier & McCormick, 2019). Thus, it would be inappropriate to try and uncover the exact underlying mechanisms that associate each of the PCBS with their outcomes. Nonetheless, these findings show the importance of testing each PCBS individually and raise the question of the classification of PCBS and their respective consequences.

II. Differences between the direction, consistency, and strength of handedness

In both our studies, it was a higher prevalence of left- but not mixed-handedness that was associated with all the PCBS. It does not support the assumption that prenatal adversities lead to an inconsistent hand preference rather than left-handedness (Chapter 6). One explanation for this finding is that mixed

handedness is a function of age (Gutteling et al., 2007; Ross et al., 1987). Marlow et al. (2019) showed that mixed handedness prevalence among preterm children is high at 2.5 years old (58.5%) but decreases over the years (30.1% at 6 years, 17.1% at 11 years, and 13.0% at 19 years). Since our hand preference assessment was performed at 9 years old, it may explain why we did not observe a higher prevalence of mixed handedness among children with PCBS. Nonetheless, children with very low Apgar scores at 5 minutes tended to have reduced differences between the performances of their two hands on the Pegboard task, showing a near equal hand performance. This result supports the assumption that PCBS could be associated with hand performance (Bishop, 1984; Ross, et al., 1992; Van Der Elst et al., 2011), whereby they lead to weak handedness reflected by the hand performance rather than the hand preference.

III. Differences between the neurodevelopmental disorders

LGA and LB were associated with DCD but not with Developmental Dyslexia (DD). This is supported by previous studies (Bos & Tijms, 2012; Zwicker et al., 2013). Some authors speculated that language impairments that could be found among children with LGA and/or LB do not reflect DD, but rather might be a consequence of more diffuse neurodevelopmental disorders (Bos & Tijms, 2012). DCD could be considered as a candidate disorder since it is associated with learning disability and deficits in speech, language, arithmetic, attention, postural control, motor, and visuospatial skills (Jover et al., 2010; Wocadlo & Rieger, 2008). Interestingly, very preterm children with motor impairments show poorer literacy and numeracy performances than those without motor impairments (Wocadlo & Rieger, 2008). The relationship between motor and language development among children with PCBS can be looked at through an embodied cognition perspective. A disruption of cognitive development in children may not be related directly to LGA and/or LB, but rather might reflect the consequence of the motor impairments, where early sensorimotor interactions with the physical world are reduced (Oudgenoeg-Paz et al., 2017). Therefore, LGA and LB could be more strongly related to motor rather than language development, and could explain why these variables were significantly associated with DCD but not DD in our studies.

As mentioned earlier, we found that LGA and LB were associated with atypical hand preference. These results suggest that atypical handedness and motor impairments, but not language impairments, are

related to the same predictors (i.e., LGA/LB). These findings raise the question of a potential link between atypical laterality and DCD but not DD. Whilst it is not consistent in the literature, a higher prevalence of atypical handedness was observed among individuals with language-impaired disorders associated with articulation problems and motor impairments than those without motor-related difficulties (Bishop, 1990b). Furthermore, there is a higher prevalence of left-handedness among children with DCD than those with DD (Darvik et al., 2018). These findings led us to reconsider a hypothesis proposed by Bishop (1990a, p. 138-139) in which it is the motor functioning, rather than language, which may be linked with handedness. A result that appears to contradict this assumption is that a recent meta-analysis conducted by Abbondanza et al. (2022) found a higher prevalence of non-right handedness among individuals with reading and/or language impairment compared to the control group (OR=1.21). Nonetheless, this finding may be a reflection of the association between atypical handedness and motor instead of language impairments. Indeed, due to the fact that the authors had a large sample consisting of 2528 individuals with DD, and since between 40% and 57% (depending on the severity) of individuals with DD present motor impairments (Chaix et al., 2007), this could explain why a significant association between atypical handedness and DD was found in this meta-analysis.

Altogether, it is likely that hand preference is dependent on the maturation of skilled motor functioning, hence the atypical handedness observed among children with motor immaturity (Bishop, 1990a, p. 139), which could be a consequence of LGA and/or LB (Wallois et al., 2020). It is noteworthy that this assumption is in line with Mundorf et al. (2021) suggestion that the association between atypical laterality and neurodevelopmental disorders is more likely to be symptom-specific (e.g., motor impairments) rather than diagnosis-specific (e.g., DCD or DD; see Chapter 1).

Prenatal and perinatal events as common factors between atypical laterality and disorders

In the following, some general theoretical frameworks, which are not necessarily mutually exclusive, will be suggested to describe the possible links between PCBS, atypical laterality and neurodevelopmental disorders.

In the pathological left-handedness theory, Satz (1972, 1973) proposed a natural and a pathological origin for left-handedness. For the latter, it is suggested that a left-hemisphere damage leads to left-

handedness (see Chapter 3). As shown in Complementary Study 2, children with very low Apgar scores (i.e., <4) showed a decreased right-hand performance on the Pegboard task. As mentioned earlier, a higher prevalence of anoxia is found among children with very low Apgar scores (Iliodromiti et al., 2014). Considering that the left-hemisphere is more vulnerable to external influences (Bisiacchi & Cainelli, 2022; Dubois et al., 2007; Manns, 2021a; Njiokiktjien, 2006; Sanches et al., 2013), the reduced skill of the right-hand among children with very low Apgar score could be explained by a left-hemisphere impairment due to anoxia. This might explain one of our results where children with very low Apgar scores had a significantly reduced right-hand performance compared to their peers. This is similar to a study conducted by Ross et al. (1992) where the authors found poorer right-hand performance on the Pegboard task when compared to the left-hand among premature children. However, in our studies, hand performances differences were not found among children with LGA and/or LB, and thus the assumption of a left-hemisphere impairment cannot be generalized to all the PCBS. Furthermore, Apgar scores were not associated with DCD, in contrast to LGA and LB. Since not all individuals with non-right handedness and neurodevelopmental disorders suffer from an early brain insult, a left-hemisphere impairment is unlikely to be the common factor that could explain the relation between PCBS, atypical laterality and motor impairments.

Stress, which is mediated by the Hypothalamic-Pituitary-Adrenal (HPA) axis, might be a possible factor underlying the relationship between prenatal adversities, atypical laterality, and neurodevelopmental disorders. More precisely, it was suggested that early life stress, altering HPA axis function, will lead to atypical cerebral lateralization, neurodevelopmental and psychiatric disorders (Berretz, Wolf et al., 2020). Elevated levels of cortisol predict delayed fetal growth, fetal activity, and importantly LGA and LB (Field et al., 2006; Field & Diego, 2008). Cortisol can directly cross the placenta and therefore mothers' prenatal cortisol levels are associated with their fetus' cortisol levels, and consequently with their newborns' levels (Field & Diego, 2008). It was found that prenatal adversities lead to a permanent modification of the HPA-axis (Kapoor et al., 2006). Very preterm school-age children were found to have an altered HPA axis functioning (Brummelte et al., 2015). The right hemisphere is linked to the HPA axis, and cortisol secretion is mainly under the excitatory control of this hemisphere (Hecht, 2010). For example, when exposed to stressful stimuli, 8-9 year-old children with low birthweight show greater blood flow to the right

hemisphere than to the left one (Jones et al., 2011). Mundorf et al. (2020) found that early life stress induced atypical asymmetries in turning behaviors favoring the left side, suggesting that stress exposure leads to greater activation of the right-hemisphere. In line with these results, maternal prenatal stress is found to be positively related to fetal left-handed self-touch (Reissland et al., 2015). Furthermore, it is known that the PCBS increases the risk of neurodevelopmental disorders (Cha et al., 2022; Edwards et al., 2011; Modabbernia et al., 2016; Wallois et al., 2020), which are generally associated with the dysregulation of the HPA axis (Cartier et al., 2016; Theodoridou et al., 2021). Therefore, it can be stipulated that PCBS, via the disruption of both the HPA axis (Kapoor et al., 2006) and typical neurodevelopment (Wallois et al., 2020), could lead to atypical laterality and neurodevelopmental disorders.

A third theoretical model could also be proposed and it concerns the role of the vestibular system. Newborns aged from one to five days show a Moro reflex asymmetry, where the right arm starts to move before the left (Rönqvist, 1995). These results suggest that there is an early spinal asymmetry related to the vestibulospinal system. Since the Moro reflex is connected to the vestibular system, it can be assumed that vestibular lateralization during gestation leads to newborn movement and posture asymmetries (Rönqvist, 1995). On a functional level, some evidence shows that the vestibular and the motor lateralization are related. Among adults, using caloric irrigation in Positron Emission Tomography (Dieterich et al., 2003) and auditory evoked vestibular otolith stimulation in fMRI (Janzen et al., 2008), it was found that there is a right-hemisphere dominance for the vestibular system in right-handers, and a left hemisphere dominance in left-handers (see Zu Eulenburg et al., 2012 for a meta-analysis of vestibular lateralization). Thus, the vestibular dominance seems to be ipsilateral to handedness, and therefore contralateral to the motor hemispherical dominance (i.e., the left hemisphere controls the right hand and vice versa for the left hand). These findings raised a question about a possible relation between vestibular and motor lateralization. Since the vestibular system matures early during gestation, before the development of the hand preference, Brandt and Dieterich (2015) proposed a hypothesis that early vestibular system lateralization determines later sensorimotor lateralization. The authors suggested that each of the higher vestibular functions (e.g., spatial memory, orientation, navigation) and handedness require their own coordinate system. The former is allocentric and responsible for self-localization in the environment, whereas the latter is egocentric and responsible for object manipulation. Their functional

lateralization in opposite hemispheres enables them to operate independently from one another, allowing for an optimization of both functions during development (Dieterich & Brandt, 2018a). Thus, an early vestibular lateralization will lead to a well-established perceptive and motor functional asymmetry (Brandt & Dieterich, 2015; Dieterich et al., 2003). This hypothesized relationship between the vestibular and motor lateralization could explain how PCBS is connected to atypical handedness.

An activation of the HPA axis has been shown to be connected to the vestibular system, where an excessive or inappropriate stress can have deleterious impact on the latter (Saman et al., 2020). Therefore, prenatal stress events could disturb vestibular lateralization. This hypothesis can be supported by the evidence that premature children are found to exhibit a weaker visuospatial attentional bias compared to their peers, reflecting an atypical functional lateralization of the right hemisphere (Davis et al., 2022). Interestingly, visuospatial attention and vestibular processing are partly related to each other and are both lateralized in the right hemisphere (Karnath & Dieterich, 2006). Thus, PCBS may disrupt early vestibular lateralization, which could alter the hemispherical asymmetries of other functions. Furthermore, vestibular cortical areas are linked to the motor and pre-motor cortex used for balance and voluntary movement coordination (Carmona et al., 2009). PCBS are also shown to impact the maturation of the motor system (Wallois et al., 2020). It is possible, therefore, to explain how PCBS can be related to both atypical functional lateralization via vestibular lateralization and motor impairments via the alteration of motor and vestibular development.

Additional findings also support the link between atypical vestibular lateralization and other atypical asymmetries. It was shown that atypical functional lateralization is found among individuals with DD characterized by visuospatial deficits, spatial dysgraphia, dyscalculia and finger agnosia but not with dysfunctional language (Pirozzolo, 1979, as cited in Bemporad & Kinsbourne, 1983). Furthermore, visual motion sensitivity, which is related to the vestibular system (Dieterich & Brandt, 2018b), is found to be more impaired in non-right-handers with DD compared to the control group (Richardson, 1995). Therefore, as mentioned by Previc (1991, p. 321), atypical cerebral lateralization and non-right handedness are likely to be present only in specific subtypes of disorders associated with atypical vestibular lateralization, e.g., the visuospatial deficit subtype of DD. On a side note, these results give further support to the symptom-

specific rather than diagnosis-specific type of association between atypical laterality and neurodevelopmental disorders (Mundorf et al., 2021).

On a behavioral level, Moro reflex asymmetry is associated with head orientation preference (Rönqvist, 1995; Rönqvist et al., 1998). Both, in turn, are suggested to be related to vestibular lateralization. Interestingly, newborns with LGA and/or LB are found to exhibit a reduced head turning orientation compared to full term babies (Fox & Lewis, 1982; Gardner et al., 1977; Geerdink et al., 1994; Kurtzberg et al., 1979). Therefore, it is possible that PCBS such as prematurity might prevent the development of vestibular asymmetries in the last trimester, which in turn will disturb the development of other related behavioral lateralization (Previc, 1991, 1996). However, it should be noted that previous studies showed that the head orientation preference might only be partly related to the vestibular system, and other factors intrinsic to the developing fetus could be involved in the early postural asymmetries (Gardner et al., 1977; Geerdink et al., 1994). Postural and head asymmetries could also be a consequence of early gene expression (Fagard, 2013a, 2013b). Adopting the perspective that genetics is also a factor underlying the development of early asymmetries, PCBS may result in an increase of biological noise, which will reinforce the implication of chance in the development of lateralized behaviors such as the head orientation (Batheja & McManus, 1985).

Independent of its origins, one can suggest that reduced head orientation among children with PCBS could lead, based on the cascade theory of handedness (Michel, 1983), to different trajectories of the development of handedness. Under a “development from” approach, where developmental traits emerge from an interaction between physiological processes and environmental experiences (Michel, 2021), weak postural asymmetries reduce the right-hand use that is generally observed in most newborns, consequently reducing the proprioceptive and visual experience related to this hand during development. This could then lead to higher probability of developing non-right handedness.

It is noteworthy that in Article 2 we tested the LODT (Previc, 1991) hypothesizing that a breech presentation is related to a weakly lateralized and dysfunctional vestibular system, which results in weak motor lateralization. We did not corroborate this hypothesis. Nonetheless, our findings do not refute the potential link between vestibular and motor lateralization as aforementioned. Indeed, fetal presentation

may not reflect the vestibular lateralization. Even in the third trimester, fetuses continue to switch their positions from cephalic to breech presentations and vice-versa (Ververs et al., 1994a) and fetus' heads can move freely even in cephalic presentation (Rönnqvist & Hopkins, 1998). These findings contradict the LODT (Previc, 1991), where it supposed that cephalic fetal presentation would be fixed in the third trimester, stimulating asymmetrically the vestibular system. Furthermore, the vestibular organs begin to develop as early as the 8 week of gestation and asymmetrical behaviors such as thumb sucking appear from 15 weeks of gestation, many weeks before a lateralized fetal presentation (Rönnqvist, 1995). Therefore, the lateralization of vestibular system is likely to precede the asymmetrical fetal presentation generally observed in the third trimester.

To conclude, it is most likely that laterality is a consequence of an interaction between genetics and environmental factors (Schaafsma et al., 2009), and some of these factors are shared with neurodevelopmental and psychiatric disorders (Berretz, Wolf et al., 2020). In critical periods during development, prenatal and perinatal adversities could disrupt the development of lateralization through epigenetic mechanisms (Kwon et al., 2015). Under this perspective, environmental factors (e.g., maternal stress, birth complications) might induce epigenetic modifications, which will affect in turn the ontogenesis of brain asymmetries, including handedness (Schmitz et al., 2017).

Limitations and perspectives

Several limitations in our two studies can be reported. The first one is the psychometric properties of our measures. The 6-item questionnaire might not present a highly reliable test for hand preference. Longer questionnaires with 10 items or more can cover a greater range of manual activities increasing the questionnaire sensitivity (Peters, 1998; Porac, 2016). The measure used to infer vestibular function in Article 2 (i.e., static balance) may be unreliable. It has been shown that dysfunctional otolith organs can be compensated for by an increase in the activity of the somatosensory and visual system (Zu Eulenburg et al., 2010). To be able to detect otolith dysfunction, a complete clinical vestibular and caloric examination is required (Wiener-Vacher, 2001). Another limitation was our reliance on an archival database (ALSPAC) to test our hypotheses. The data analyzed could include errors and inaccuracies that might have biased our results. For future work, it would be better to conduct longitudinal studies specifically made for further

examining the theories tested in the present research project. Another concern is that, even if our sample size is relatively large, it may still be underpowered (Bishop, 2013). All the variables of interest are rare events which reduce the sensitivity of tests based on frequency data (Searleman et al., 1989). Indeed, the prevalence of children with breech presentation or PCBS combined with specific characteristics such as left- or mixed handedness is very low in the population. An example of this limitation is the analysis of the relationship between hand preference and DD. Our results did not find any association between these two variables. In contrast, a recent meta-analysis, which include the ALSPAC data, found a higher prevalence of non-right handedness on a sample consisting of 2528 cases with reading/language impairments (Abbondanza et al., 2022)¹. Therefore, very large samples are needed to detect small but genuine association between these rare events.

Despite these limitations, Article 2 showed no relationship between fetal presentation and handedness. Therefore, fetal presentation might not reflect motor lateralization and may just be a poor indicator of behavioral asymmetries, including handedness. Several studies support this conclusion. Firstly, no differences were found between cephalic and breech presentations regarding their head orientation preferences (Rönnqvist & Hopkins, 2000) and handedness (McManus, 1981). Secondly, the conclusions of an influential study showing a relationship between fetal presentation and handedness are limited. Churchill et al. (1962) conducted a study on a large sample of children at two years of age (n=1102) and found a higher prevalence of left-handers among children with rightward cephalic orientation, and vice versa for the right-handers. The authors suggested that handedness is predicted by the orientation of cephalic presentation (e.g., leftward cephalic orientation leads to right-handedness). However, as mentioned in Annett and Ockwell (1980), even if it was statistically significant, the differences in proportion of rightward cephalic presentation between left-, mixed, and right-handers was relatively low (62.4%, 49.1%, 42.7%, respectively). Thirdly, in the LODT, the ratio of left compared to right cephalic presentation is of 2:1, which partly explains the higher prevalence of right-handedness in the population. However, recent evidence showed that the ratio is closer to 1.53:1 in favor of the leftward cephalic orientation (Ahmad et al., 2014). Thus, considering these findings and in addition to our study, it is difficult to argue

¹ Assessments of hand preference and DD were different between our studies and that of Abbondanza et al. (2022).

that fetal presentation (i.e., cephalic vs. breech) or the orientation of cephalic presentation (i.e., right vs. left) is a major influence on handedness (e.g., Annett & Ockwell, 1980).

Article 2 and Complementary Study 2 allowed us to propose several theoretical frameworks that could explain the mechanisms underlying the association of atypical laterality and neurodevelopmental disorders. Our current data do not provide us with the necessary tools to test the previously mentioned hypotheses (i.e., HPA alteration, vestibular lateralization). Nonetheless, our findings can pave the way for several future perspectives.

Firstly, preterm birth is usually considered as a single category on a clinical and research level (Frey & Klebanoff, 2016). However, prematurity is multifactorial and could be a consequence of genetics and/or environmental factors (Wadon et al., 2020). Furthermore, several risk factors leading to prematurity are well identified, which are related to maternal characteristics, reproductive history, and pregnancy characteristics (Frey & Klebanoff, 2016). Thus, differentiating between preterm births according to their etiologies become essential. Some authors suggested that new classifications of prematurity are required to replace the classical dichotomous one i.e., spontaneous or indicated (Frey & Klebanoff, 2016). Consequently, a question arises: is it prematurity, whatever its origin, which leads to atypical laterality? Or is it specific factors that lead to both prematurity and atypical laterality? In a future study, it might be interesting to separate preterm children into different categories according to the causes that led to the early birth. One could suppose that, if there is a difference between these categories, it might indicate the potential mechanisms underlying their association with atypical laterality. Secondly, since LGA/LB increase the risk of brain damage and cerebral palsy (Goldenberg & Culhane, 2007), it is important to take this variable into consideration. Indeed, controlling for this variable will allow for the testing of the previous theoretical frameworks (i.e., alteration of HPA axis and atypical vestibular lateralization) without having a confounding variable that could bias the results (i.e., early brain insult). Thirdly, we found an association between the Apgar score and atypical handedness, but it is difficult to infer what the Apgar test measures precisely (Tiemeier & McCormick, 2019). It could be interesting to administer another neonatal test that could be more informative on the newborn deficits. The Neonatal Behavioral Assessment Scale (Brazelton, 1973) presents itself as it aims to comprehensively assess the neonatal function over a full range of

behaviors such as habituation, orientation, motoric processes, reflexes, and physiological response to stress (Costa et al., 2010).

Another perspective is that to test the implication of the vestibular system in the development of behavioral and functional lateralization, future studies should target a direct measure of vestibular asymmetries, such as caloric irrigation combined with brain imaging (e.g., Dieterich et al., 2003; Janzen et al., 2008). Assessing vestibular lateralization could be done on children with PCBS and on children with neurodevelopmental disorders. Such studies would allow us to observe if a higher prevalence of atypical vestibular lateralization is present among children with PCBS, and if it is related with other atypical functional asymmetries generally found in individuals with neurodevelopmental disorders.

Lastly, it is important for future studies interested in investigating the relationship between laterality, neurodevelopmental and psychiatric disorders to identify their subtypes. As aforementioned (Mundorf et al., 2021), it is most likely that atypical laterality is associated with specific symptoms (e.g., motor and visuospatial impairments) rather than with a diagnosis (e.g., DD, DCD, schizophrenia).

7.3 Thesis conclusion

Asymmetries can be found everywhere, from the molecular to the behavioral level. The present thesis aimed to investigate the development of two asymmetrical behaviors that humans exhibit from early childhood until late adulthood, drawing and handedness.

For the former, we studied the interaction between the mechanisms underlying graphomotor asymmetries. Cerebral lateralization and biomechanical constraints exert a stronger influence in children and the effects of this influence decreases with age due to growing sociocultural influences. For both children and adults, sex and handedness moderate these asymmetries. Our work presented a developmental pattern of drawing asymmetries, related to the visuospatial biases. It will be relevant to conduct further studies on pathological populations in order to observe potential atypical visuospatial specificities.

For the latter, we investigated the implication of prenatal life on the development of handedness. In the literature, fetal presentation is considered as an important determinant of the early manifestation of

postural asymmetries. We showed this not to be the case. In contrast, perinatal stress events were associated with handedness, which corroborates numerous previous works. It was suggested that these events could be potential candidates for explaining the higher prevalence of atypical laterality in neurodevelopmental disorders. The mechanisms underlying this association remain to be clarified but are likely either stress (i.e., via the alteration of the HPA axis) and/or disrupted vestibular lateralization.

In this conclusion, I will go beyond the aim of this research project and take a larger perspective regarding the ontogenesis of handedness. Similarly to Satz (1972, 1973) and based on our results, I find it reasonable to suggest a non-pathological and pathological origin for left-handedness (Schaafsma et al., 2009). For the former, it is likely that it is determined by rare intrinsic factors (e.g., genetics, McManus et al., 2013) favoring the motoric left side, where environmental influences are not be strong enough to shift the preference to the right side (Fagard, 2013b). For the latter, perinatal adversities could play a significant role by disrupting early fetal growth, affecting both the development of atypical laterality, and cognitive and motor systems (Davis et al., 2022; Domellöf et al., 2011; Wallois et al., 2020).

Nonetheless, the question remains as to the extent to which each of the genetic and environmental factors could be implicated in the development of laterality. Genetic factors reflect the genetic variation among individuals in a population, whereas non-genetic factors include environmental variations such as maternal effects, ontogenetic variation, and randomness (Graham, 2021). In their meta-analysis, Searleman et al. (1989) found that birth stressors and handedness are very weakly associated and accounted for less than 1% of the variances. Similar results were once again found by de Kovel et al. (2019) who studied the role of early life factors on handedness on a very large sample ($n = 500,000$ approximately). The influence of intrauterine environment seems to be genuine, but appears to be very small. McManus (2021) suggests that environmental factors could explain, at best, 1-2% of the variance in handedness, while genetics factors are most likely to be the strongest contributor (McManus, 2009, 2021). However, genetic factors are limited in explaining most of the variances in the population, and the heritability of handedness is around 24% (Chapter 3, Medland et al., 2009; Schmitz et al., 2022). Therefore, the majority of the variance in handedness is unaccounted for.

McManus (2002, 2021, 2022) emphasizes the role of randomness (i.e., fluctuating asymmetry) in the development of handedness. In genetics, most of the environmental component of the total phenotypic variance can be attributed to random developmental and stochastic variations, which involve the random behavior of molecules and cells in a developing organism (Graham, 2021). This can explain the differences between genetically identical individuals raised in the same environment. In the case of handedness, developmental noise and randomness are suggested to play a major role in its ontogenesis, and are supposed to be under the control of the C allele in the DC model (McManus, 2022). Stochastic variations are also discussed in Bishop and Bates (2020) regarding language lateralization. Mitchell (2018) provides an overview of the influence of randomness on handedness, but also on other phenotypes like intelligence, personality, and neurodevelopmental disorders. Therefore, the nonlinear developmental processes of handedness could be partly deterministic but modified by true random variation (Graham, 2021). To complete this picture, it is possible that, while genetics and randomness constrain the developmental trajectories of handedness, individual-environment coaction (e.g., early sensorimotor experience, sociocultural influences) might modify to some extent the degree and strength of handedness (Michel, 2021).

The final question that will be addressed in this thesis concerns the future of laterality research. Interestingly, several authors have suggested recently what may happen in the next decade (Ocklenburg et al., 2020), or even in the next half century (McManus, 2019). Briefly, several trends are anticipated. On a methodological level, the next decades might witness an increase in studies using large databases. These allow for the analysis of very large samples with brain imaging and genetic data (McManus, 2019). These large databases could be combined with the recent meta-analyses which will rigorously test the validity of the theories proposed to explain the ontogenesis of laterality (Ocklenburg et al., 2020). Based on such reliable studies, more attention will be paid to size effects and the issue of replicability (Nicholls, 2021; Ocklenburg et al., 2020). Laterality should be treated as a continuum rather than dichotomous, and the strength of handedness should be prioritized (Beaton & Richards, 2021; Nicholls, 2021). Similarly, more focus will be given to the reliability and validity of the measurements of laterality in human and animal experiments (Frasnelli, 2021; Voyer, 2021).

On a theoretical level, more studies will investigate the genetic relationship between handedness and cerebral asymmetries, while measuring the hand performance, allowing for a better understanding of the link between handedness and functional lateralization (Beaton & Richards, 2021; McManus, 2019). More studies will focus on the factors (e.g., environmental factors) underlying atypical laterality, neurodevelopmental, and psychiatric disorders (Ocklenburg et al., 2020). Researchers will have greater interest in transdiagnostic approaches (Ocklenburg et al., 2020), and will focus on linking atypical handedness with symptoms rather than diagnoses. This can be already seen in the literature where some experts are planning to assess cerebral lateralization of written language in children with developmental dyslexia instead of the more common assessment of oral language comprehension and production (Papadopoulou et al., 2022). Undoubtedly, future studies on epigenetics will be conducted in order to understand the interaction between genetics and the environment (Marcori & Okazaki, 2020; Schmitz et al., 2019). Lastly, more studies on a phylogenetic level are likely to be conducted to understand the evolutionary reasons underlying laterality while investigating its costs and benefits (Donati & Forrester, 2021; Groothuis et al., 2021; Manns, 2021b).

In light of these promising research trends, I hope that this thesis has contributed to laterality research and to advancement of the understanding of the development of graphomotor asymmetries, handedness, and cerebral lateralization.

References

- Abbondanza, F., Dale, P., Wang, C., Hayiou-Thomas, M. E., Toseeb, U., koomar, T., ... Paracchini, S. (2022, March 7). Non-right handedness is associated with language and reading impairments. <https://doi.org/10.31234/osf.io/74jsd>
- Abed, F. (1991). Cultural Influences on Visual Scanning Patterns. *Journal of Cross-Cultural Psychology*, 22(4), 525–534. <http://doi.org/10.1177/0022022191224006>
- Achiron, R., Lipitz, S., & Achiron, A. (2001). Sex-related differences in the development of the human fetal corpus callosum: in utero ultrasonographic study. *Prenatal Diagnosis: Published in Affiliation With the International Society for Prenatal Diagnosis*, 21(2), 116–120. [https://doi.org/10.1002/1097-0223\(200102\)21:2<116::AID-PD19>3.0.CO;2-M](https://doi.org/10.1002/1097-0223(200102)21:2<116::AID-PD19>3.0.CO;2-M)
- Ahmad, A., Webb, S. S., Early, B., Sitch, A., Khan, K., & Macarthur, C. (2014). Association between fetal position at onset of labor and mode of delivery: A prospective cohort study. *Ultrasound in Obstetrics and Gynecology*, 43(2), 176–182. <http://doi.org/10.1002/uog.13189>
- Alter, I. (1989). A cerebral origin for “Directionality.” *Neuropsychologia*, 27(4), 563–573. [http://doi.org/10.1016/0028-3932\(89\)90060-2](http://doi.org/10.1016/0028-3932(89)90060-2)
- Amunts, K., Armstrong, E., Malikovic, A., Hömke, L., Mohlberg, H., Schleicher, A., & Zilles, K. (2007). Gender-specific left-right asymmetries in human visual cortex. *Journal of Neuroscience*, 27(6), 1356–1364. <http://doi.org/10.1523/JNEUROSCI.4753-06.2007>
- Annett, M. (1970). A classification of hand preference by association analysis. *British Journal of Psychology*, 61(3), 303–321. <http://doi.org/10.1111/j.2044-8295.1970.tb01248.x>
- Annett, M. (1972). The distribution of manual asymmetry. *British Journal of Psychology*, 63(3), 343–358. <http://doi.org/10.1111/j.2044-8295.1972.tb01282.x>
- Annett, M. (1992). Five Tests of Hand Skill. *Cortex*, 28(4), 583–600. [http://doi.org/10.1016/S0010-9452\(13\)80229-8](http://doi.org/10.1016/S0010-9452(13)80229-8)
- Annett, M. (1996). Laterality and Types of Dyslexia. *Neuroscience & Biobehavioral Reviews*, 20(4), 631–636. [http://doi.org/10.1016/0149-7634\(95\)00076-3](http://doi.org/10.1016/0149-7634(95)00076-3)
- Annett, M. (2000). Predicting combinations of left and right asymmetries. *Cortex*, 36(4), 485–505. [http://doi.org/10.1016/S0010-9452\(08\)70534-3](http://doi.org/10.1016/S0010-9452(08)70534-3)
- Annett, M. (2002). *Handedness and brain asymmetry: The right shift theory*. Psychology Press.
- Annett, M., & Ockwell, A. (1980). Birth Order, Birth Stress and Handedness. *Cortex*, 16(1), 181–187. [http://doi.org/10.1016/S0010-9452\(80\)80033-5](http://doi.org/10.1016/S0010-9452(80)80033-5)
- Apgar, V. (1952). A proposal for a new method of evaluation of the newborn. *Classic Papers in Critical Care*, 32(449), 97.

- Armour, J. A. L., Davison, A., & McManus, I. C. (2014). Genome-wide association study of handedness excludes simple genetic models. *Heredity*, *112*(3), 221–225. <http://doi.org/10.1038/hdy.2013.93>
- Arning, L., Ocklenburg, S., Schulz, S., Ness, V., Gerding, W. M., Hengstler, J. G., Falkenstein, M., Epplen, J. T., Güntürkün, O., & Beste, C. (2015). Handedness and the X chromosome : The role of androgen receptor CAG-repeat length. *Scientific Reports*, *5*(1). <https://doi.org/10.1038/srep08325>
- Badzakova-Trajkov, G., Corballis, M. C., & Häberling, I. S. (2016). Complementarity or independence of hemispheric specializations? A brief review. *Neuropsychologia*, *93*, 386–393. <http://doi.org/10.1016/j.neuropsychologia.2015.12.018>
- Badzakova-Trajkov, G., Häberling, I. S., Roberts, R. P., & Corballis, M. C. (2010). Cerebral asymmetries: Complementary and independent processes. *PLoS ONE*, *5*(3). <http://doi.org/10.1371/journal.pone.0009682>
- Bakan, P. (1971). Handedness and Birth Order. *Nature*, *229*(5281), 195–195. <http://doi.org/10.1038/229195a0>
- Bakan, P. (1977). Left handedness and birth order revisited. *Neuropsychologia*, *15*(6), 837–839. [http://doi.org/10.1016/0028-3932\(77\)90018-5](http://doi.org/10.1016/0028-3932(77)90018-5)
- Bakan, P., Dibb, G., & Reed, P. (1973). Handedness and birth stress. *Neuropsychologia*, *11*(3), 363–366. [http://doi.org/10.1016/0028-3932\(73\)90050-X](http://doi.org/10.1016/0028-3932(73)90050-X)
- Batheja, M., & McManus, I. C. (1985). Handedness in the mentally handicapped. *Developmental Medicine & Child Neurology*, *27*(1), 63–68. <http://doi.org/10.1111/j.1469-8749.1985.tb04526.x>
- Beaton, A. A., & Richards, G. (2021). Where next for laterality research? Looking back and looking forward. *Laterality*, *26*(3), 336–341. <http://doi.org/10.1080/1357650X.2021.1895189>
- Becker, Y., Claidière, N., Margiotoudi, K., Marie, D., Roth, M., Nazarian, B., Anton, J. L., Coulon, O., & Meguerditchian, A. (2022). Broca's cerebral asymmetry reflects gestural communication's lateralisation in monkeys (*Papio anubis*). *eLife*, *11*. <https://doi.org/10.7554/elife.70521>
- Behnke, M., Carter, R. L., Hardt, N. S., Eyler, F. D., Cruz, A. C., & Resnick, M. B. (1987). The Relationship of Apgar Scores, Gestational Age, and Birthweight to Survival of Low-Birthweight Infants. *American Journal of Perinatology*, *4*(2), 121–124. <http://doi.org/10.1055/s-2007-999752>
- Beking, T., Geuze, R. H., van Faassen, M., Kema, I. P., Kreukels, B. P. C., & Groothuis, T. G. G. (2018). Prenatal and pubertal testosterone affect brain lateralization. *Psychoneuroendocrinology*, *88*, 78–91. <http://doi.org/10.1016/j.psyneuen.2017.10.027>
- Bemporad, B., & Kinsbourne, M. (1983). Sinistrality and dyslexia: A possible relationship between subtypes. *Topics in Learning & Learning Disabilities*, *3*(1), 48–65.
- Berretz, G., Packheiser, J., Wolf, O. T., & Ocklenburg, S. (2020). Dichotic listening performance and interhemispheric integration after stress exposure. *Scientific Reports*, *10*(1), 1–13. <http://doi.org/10.1038/s41598-020-77708-5>
- Berretz, G., Packheiser, J., Wolf, O. T., & Ocklenburg, S. (2022a). Acute stress increases left hemispheric

- activity measured via changes in frontal alpha asymmetries. *iScience*, 25(2), 103841. <http://doi.org/10.1016/j.isci.2022.103841>
- Berretz, G., Packheiser, J., Wolf, O. T., & Ocklenburg, S. (2022b). Improved interhemispheric connectivity after stress during lexical decision making. *Behavioural Brain Research*, 418, 113648. <http://doi.org/10.1016/j.bbr.2021.113648>
- Berretz, G., Wolf, O. T., Güntürkün, O., & Ocklenburg, S. (2020). Atypical lateralization in neurodevelopmental and psychiatric disorders: What is the role of stress? *Cortex*, 125, 215–232. <http://doi.org/10.1016/j.cortex.2019.12.019>
- Biotteau, M., Chaix, Y., Blais, M., Tallet, J., Péran, P., & Albaret, J.-M. (2016). Neural Signature of DCD: A Critical Review of MRI Neuroimaging Studies. *Frontiers in Neurology*, 7, 227. <https://doi.org/10.3389/fneur.2016.00227>
- Bishop, D. V. M. (1984). Using Non-Preferred Hand Skill To Investigate Pathological Left-Handedness in an Unselected Population. *Developmental Medicine & Child Neurology*, 26(2), 214–226. <http://doi.org/10.1111/j.1469-8749.1984.tb04434.x>
- Bishop, D. V. M. (1990a). *Handedness and developmental disorder* (Vol. 110). Cambridge University Press.
- Bishop, D. V. M. (1990b). Handedness, clumsiness and developmental language disorders. *Neuropsychologia*, 28(7), 681–690. [https://doi.org/10.1016/0028-3932\(90\)90123-6](https://doi.org/10.1016/0028-3932(90)90123-6)
- Bishop, D. V. M. (2013). Cerebral asymmetry and language development: Cause, correlate, or consequence? *Science*, 340(6138). <http://doi.org/10.1126/science.1230531>
- Bishop, D. V. M., & Bates, T. C. (2020). Heritability of language laterality assessed by functional transcranial Doppler ultrasound: a twin study. *Wellcome Open Research*, 4, 161. <http://doi.org/10.12688/wellcomeopenres.15524.2>
- Bisiacchi, P., & Cainelli, E. (2022). Structural and functional brain asymmetries in the early phases of life: a scoping review. *Brain Structure and Function*, 227(2), 479–496. <http://doi.org/10.1007/s00429-021-02256-1>
- Blythe, S. G. (2017). *Attention, balance and coordination: The ABC of learning success*. John Wiley & Sons.
- Bonoti, F., Vlachos, F., & Metallidou, P. (2005). Writing and drawing performance of school age children : Is there any relationship? *School Psychology International*, 26(2), 243–255. <http://doi.org/10.1177/0143034305052916>
- Bos, L. T., & Tijms, J. (2012). The incidence of prematurity or low birth weight for gestational age among children with dyslexia. *Acta Paediatrica*, 101(11), e526. <https://doi.org/10.1111/j.1651-2227.2012.02806.x>
- Boulinguez-Ambroise, G., Pouydebat, E., Disarbois, É., & Meguerditchian, A. (2022). Maternal cradling bias in baboons: the first environmental factor affecting early infant handedness development?. *Developmental Science*, 25(1), e13179. <https://doi.org/10.1111/desc.13179>
- Bourne, V. J., & Maxwell, A. M. (2010). Examining the sex difference in lateralisation for processing facial

- emotion: Does biological sex or psychological gender identity matter? *Neuropsychologia*, 48(5), 1289–1294. <http://doi.org/10.1016/j.neuropsychologia.2009.12.032>
- Bowers, D., & Heilman, K. M. (1980). Pseudoneglect: Effects of hemispace on a tactile line bisection task. *Neuropsychologia*, 18(4–5), 491–498. [http://doi.org/10.1016/0028-3932\(80\)90151-7](http://doi.org/10.1016/0028-3932(80)90151-7)
- Boyd, A., Golding, J., Macleod, J., Lawlor, D. A., Fraser, A., Henderson, J., Molloy, L., Ness, A., Ring, S., & Davey Smith, G. (2012). Cohort Profile : The 'Children of the 90s'—the index offspring of the Avon Longitudinal Study of Parents and Children. *International Journal of Epidemiology*, 42(1), 111–127. <https://doi.org/10.1093/ije/dys064>
- Bradshaw, A. R., Woodhead, Z. V. J., Thompson, P. A., & Bishop, D. V. M. (2020). Investigation into inconsistent lateralisation of language functions as a potential risk factor for language impairment. *European Journal of Neuroscience*, 51(4), 1106–1121. <http://doi.org/10.1111/ejn.14623>
- Brandler, W. M., & Paracchini, S. (2014). The genetic relationship between handedness and neurodevelopmental disorders. *Trends in Molecular Medicine*. <http://doi.org/10.1016/j.molmed.2013.10.008>
- Brandt, T., & Dieterich, M. (2015). Does the vestibular system determine the lateralization of brain functions? *Journal of Neurology*, 262(1), 214–215. <http://doi.org/10.1007/s00415-014-7548-8>
- Brazelton, T. B. (1973). *Neonatal Behavioral Assessment Scale*. Clinics in Developmental Medicine, No.50. London: Wm. Heinemann Medical Books; Philadelphia: J. P. Lippincott. (Second edition, 1984).
- Brederoo, S. G., Nieuwenstein, M. R., Lorist, M. M., & Cornelissen, F. W. (2017). Hemispheric specialization for global and local processing: A direct comparison of linguistic and non-linguistic stimuli. *Brain and Cognition*, 119, 10–16. <http://doi.org/10.1016/j.bandc.2017.09.005>
- Brito, G. N. O., Brito, L. S. O., Paumgarten, F. J. R., & Lins, M. F. C. (1989). Lateral Preferences in Brazilian Adults: An Analysis with the Edinburgh Inventory. *Cortex*, 25(3), 403–415. [http://doi.org/10.1016/S0010-9452\(89\)80054-1](http://doi.org/10.1016/S0010-9452(89)80054-1)
- Brito, G. N. O., Lins, M. F. C., Paumgarten, F. J. R., & Brito, L. S. O. (1992). Hand Preference in 4- to 7-Year-Old Children: An Analysis with the Edinburgh Inventory in Brazil. *Developmental Neuropsychology*, 8(1), 59–68. <http://doi.org/10.1080/87565649209540515>
- Brito, G. N. O., & Santos-Morales, T. R. (1999). Lateral preferences in 8- to 15-year-old Brazilian children assessed with the Edinburgh Inventory: Different measures of handedness and comparison with younger children and adults. *Developmental Neuropsychology*, 16(3), 433–453. http://doi.org/10.1207/S15326942DN1603_25
- Brooks, J. L., Darling, S., Malvaso, C., & Della Sala, S. (2016). Adult developmental trajectories of pseudoneglect in the tactile, visual and auditory modalities and the influence of starting position and stimulus length. *Brain and Cognition*, 103, 12–22. <http://doi.org/10.1016/j.bandc.2015.12.001>
- Brummelte, S., Chau, C. M. Y., Cepeda, I. L., Degenhardt, A., Weinberg, J., Synnes, A. R., & Grunau, R. E. (2015). Cortisol levels in former preterm children at school age are predicted by neonatal procedural pain-related stress. *Psychoneuroendocrinology*, 51, 151–163.

- <http://doi.org/10.1016/j.psyneuen.2014.09.018>
- Bryden, M. P. (1977). Measuring handedness with questionnaires. *Neuropsychologia*, *15*(4–5), 617–624. [http://doi.org/10.1016/0028-3932\(77\)90067-7](http://doi.org/10.1016/0028-3932(77)90067-7)
- Bryden, M. P., Hécaen, H., & DeAgostini, M. (1983). Patterns of cerebral organization. *Brain and Language*, *20*(2), 249–262. [http://doi.org/10.1016/0093-934X\(83\)90044-5](http://doi.org/10.1016/0093-934X(83)90044-5)
- Bryden, M. P., Mcmanus, I. C., & Bulmanfleming, M. B. (1994). Evaluating the Empirical Support for the Geschwind–Behan–Galaburda Model of Cerebral Lateralization. *Brain and Cognition*, *26*(2), 103–167. <http://doi.org/10.1006/brcg.1994.1045>
- Bryden, P. J. (2016). The influence of M. P. Bryden’s work on lateralization of motor skill: Is the preferred hand selected for and better at tasks requiring a high degree of skill? *Laterality*, *21*(4–6), 312–328. <http://doi.org/10.1080/1357650X.2015.1099661>
- Bryden, P. J., Mayer, M., & Roy, E. A. (2011). Influences of task complexity, object location, and object type on hand selection in reaching in left and right-handed children and adults. *Developmental Psychobiology*, *53*(1), 47–58. <http://doi.org/10.1002/dev.20486>
- Burnett, A. C., Anderson, P. J., Joseph, R. M., Allred, E. N., O’Shea, T. M., Kuban, K. C., Leviton, A., Shah, B., Singh, R., Smith, A., Klein, D., McQuiston, S., Rollins, J., Douglass, L., Ware, J., Coster, T., Henson, B., Wilson, R., McGhee, K., . . . Vogt, K. (2018). Hand Preference and Cognitive, Motor, and Behavioral Functioning in 10-Year-Old Extremely Preterm Children. *The Journal of Pediatrics*, *195*, 279–282.e3. <https://doi.org/10.1016/j.jpeds.2017.11.056>
- Burt, D. M., & Perrett, D. I. (1997). Perceptual asymmetries in judgements of facial attractiveness, age, gender, speech and expression. *Neuropsychologia*, *35*(5), 685–693. [http://doi.org/10.1016/S0028-3932\(96\)00111-X](http://doi.org/10.1016/S0028-3932(96)00111-X)
- Butterworth, G., & Hopkins, B. (1993). Origins of Handedness in Human Infants. *Developmental Medicine & Child Neurology*, *35*(2), 177–184. <http://doi.org/10.1111/j.1469-8749.1993.tb11620.x>
- Cabeza, R. (2001). Cognitive neuroscience of aging: Contributions of functional neuroimaging. *Scandinavian Journal of Psychology*, *42*(3), 277–286. <http://doi.org/10.1111/1467-9450.00237>
- Cai, Q., Van Der Haegen, L., & Brysbaert, M. (2013). Complementary hemispheric specialization for language production and visuospatial attention. *Proceedings of the National Academy of Sciences of the United States of America*, *110*(4). <http://doi.org/10.1073/pnas.1212956110>
- Carey, D. P., & Johnstone, L. T. (2014). Quantifying cerebral asymmetries for language in dextrals and adextrals with random-effects meta analysis. *Frontiers in Psychology*, *5*(NOV), 1–23. <http://doi.org/10.3389/fpsyg.2014.01128>
- Carlier, M., Dumont, A. M., & Beau, J. (1993). Finger-Tapping Test in Relation To, 931–940.
- Carlier, M., Duyme, M., Capron, C., Dumont, A. M., & Perez-Diaz, F. (1993). Is a dot-filling group test a good tool for assessing manual performance in children? *Neuropsychologia*, *31*(3), 233–240. [http://doi.org/10.1016/0028-3932\(93\)90087-G](http://doi.org/10.1016/0028-3932(93)90087-G)

- Carmona, J. E., Holland, A. K., & Harrison, D. W. (2009). Extending the Functional Cerebral Systems Theory of Emotion to the Vestibular Modality: A Systematic and Integrative Approach. *Psychological Bulletin*, *135*(2), 286–302. <http://doi.org/10.1037/a0014825>
- Carter-Saltzman, L. (1980). Biological and sociocultural effects on handedness: Comparison between biological and adoptive families. *Science*, *209*(4462), 1263–1265. <http://doi.org/10.1126/science.7403887>
- Cartier, J., Zeng, Y., & Drake, A. J. (2016). Glucocorticoids and the prenatal programming of neurodevelopmental disorders. *Current Opinion in Behavioral Sciences*, *7*, 1–7. <http://doi.org/10.1016/j.cobeha.2015.08.001>
- Castillo, C. B., Lynch, A. G., & Paracchini, S. (2020). Different laterality indexes are poorly correlated with one another but consistently show the tendency of males and females to be more left- And rightlateralized, respectively. *Royal Society Open Science*, *7*(4). <http://doi.org/10.1098/rsos.191700>
- Catmur, C., Walsh, V., & Heyes, C. (2007). Sensorimotor Learning Configures the Human Mirror System. *Current Biology*, *17*(17), 1527–1531. <http://doi.org/10.1016/j.cub.2007.08.006>
- Cela-Conde, C. J., Ayala, F. J., Munar, E., Maestú, F., Nadal, M., Capó, M. A., del Río, D., López-Ibor, J. J., Ortiz, T., Mirasso, C., & Marty, G. (2009). Sex-related similarities and differences in the neural correlates of beauty. *Proceedings of the National Academy of Sciences*, *106*(10), 3847–3852. <https://doi.org/10.1073/pnas.0900304106>
- Cha, J. H., Ahn, J. H., Kim, Y. J., Lee, B. G., Kim, J. I., Park, H. K., Kim, B. N., & Lee, H. J. (2022). Impact of Preterm Birth on Neurodevelopmental Disorders in South Korea : A Nationwide Population-Based Study. *Journal of Clinical Medicine*, *11*(9), 2476. <https://doi.org/10.3390/jcm11092476>
- Chaix, Y., Albaret, J. M., Brassard, C., Cheuret, E., de Castelnau, P., Benesteau, J., Karsenty, C., & Démonet, J. F. (2007). Motor impairment in dyslexia : The influence of attention disorders. *European Journal of Paediatric Neurology*, *11*(6), 368–374. <https://doi.org/10.1016/j.ejpn.2007.03.006>
- Chapman, J. P., Chapman, L. J., & Allen, J. J. (1987). The measurement of foot preference. *Neuropsychologia*, *25*(3), 579–584. [http://doi.org/10.1016/0028-3932\(87\)90082-0](http://doi.org/10.1016/0028-3932(87)90082-0)
- Chokron, S., & De Agostini, M. (2000). Reading habits influence aesthetic preference. *Cognitive Brain Research*, *10*(1–2), 45–49. [http://doi.org/10.1016/S0926-6410\(00\)00021-5](http://doi.org/10.1016/S0926-6410(00)00021-5)
- Churchill, J. A., Igna, E., & Senf, R. (1962). The association of position at birth and handedness. *Pediatrics*, *29*, 307–309.
- Cioni, G., & Pellegrinetti, G. (1982). Lateralization of sensory and motor functions in human neonates. *Perceptual and Motor Skills*, *54*(3 Pt 2), 1151–1158. <http://doi.org/10.2466/pms.1982.54.3c.1151>
- Clerke, A., & Clerke, J. (2001). A literature review of the effect of handedness on isometric grip strength differences of the left and right hands. *American Journal of Occupational Therapy*, *55*(2), 206–211. <http://doi.org/10.5014/ajot.55.2.206>
- Cochet, H. (2016). Manual asymmetries and hemispheric specialization: Insight from developmental studies.

- Neuropsychologia*, 93, 335–341. <http://doi.org/10.1016/j.neuropsychologia.2015.12.019>
- Cohen-Bendahan, C. C. C., Buitelaar, J. K., Van Goozen, S. H. M., & Cohen-Kettenis, P. T. (2004). Prenatal exposure to testosterone and functional cerebral lateralization: A study in same-sex and opposite-sex twin girls. *Psychoneuroendocrinology*, 29(7), 911–916. <http://doi.org/10.1016/j.psyneuen.2003.07.001>
- Cole, M., & Wertsch, J. V. (1996). Beyond the Individual-Social Antinomy in Discussions of Piaget and Vygotsky. *Human Development*, 39(5), 250–256. <http://doi.org/10.1159/000278475>
- Collins, R. L. (1975). When left-handed mice live in right-handed worlds. *Science*, 187(4172), 181–184. <http://doi.org/10.1126/science.1111097>
- Connors, S. L., Levitt, P., Matthews, S. G., Slotkin, T. A., Johnston, M. V., Kinney, H. C., Johnson, W. G., Dailey, R. M., & Zimmerman, A. W. (2008). *Fetal Mechanisms in Neurodevelopmental Disorders*. *Pediatric Neurology*, 38(3), 163–176. <https://doi.org/10.1016/j.pediatrneurol.2007.10.009>
- Corballis, M. C. (1997). The Genetics and Evolution of Handedness. *Psychological Review*, 104(4), 714–727. <http://doi.org/10.1037/0033-295X.104.4.714>
- Corballis, M. C. (2012). Lateralization of the human brain. In *Progress in Brain Research* (Vol. 195, pp. 103–121). Elsevier B.V. <http://doi.org/10.1016/B978-0-444-53860-4.00006-4>
- Corballis, M. C. (2015). What's left in language? Beyond the classical model. *Annals of the New York Academy of Sciences*, 1359(1), 14–29. <http://doi.org/10.1111/nyas.12761>
- Corballis, M. C. (2019). Evolution of cerebral asymmetry. In *Progress in Brain Research* (Vol. 250, pp. 153–178). Elsevier B.V. <http://doi.org/10.1016/bs.pbr.2019.04.041>
- Corballis, M. C., Hattie, J., & Fletcher, R. (2008). Handedness and intellectual achievement: An even-handed look. *Neuropsychologia*, 46(1), 374–378. <http://doi.org/10.1016/j.neuropsychologia.2007.09.009>
- Coren, S. (1993). The lateral preference inventory for measurement of handedness, footedness, eyedness, and earedness: Norms for young adults. *Bulletin of the Psychonomic Society*, 31(1), 1–3. <http://doi.org/10.3758/BF03334122>
- Coren, S. (1994). Personality Differences between Left- and Right-Handers: An Overlooked Minority Group? *Journal of Research in Personality*, 28(2), 214–229. <http://doi.org/10.1006/jrpe.1994.1016>
- Coren, S., & Halpern, D. F. (1991). Left-handedness: A marker for decreased survival fitness. *Psychological Bulletin*, 109(1), 90–106. <http://doi.org/10.1037/0033-2909.109.1.90>
- Coren, S., Searleman, A., & Porac, C. (1982). The effects of specific birth stressors on four indexes of lateral preference. *Canadian Journal of Psychology*, 36(3), 478–487. <http://doi.org/10.1037/h0080657>
- Costa, R., Figueiredo, B., Tendais, I., Conde, A., Pacheco, A., & Teixeira, C. (2010). Brazelton Neonatal Behavioral Assessment Scale: A psychometric study in a Portuguese sample. *Infant Behavior and Development*, 33(4), 510–517. <http://doi.org/10.1016/j.infbeh.2010.07.003>
- Crow, T. J. (2000). Schizophrenia as the price that Homo sapiens pays for language: a resolution of the

- central paradox in the origin of the species. *Brain Research Reviews*, 31(2-3), 118-129. [http://doi.org/10.1016/S0165-0173\(99\)00029-6](http://doi.org/10.1016/S0165-0173(99)00029-6)
- Crow, T. J., Crow, L. R., Done, D. J., & Leask, S. (1998). Relative hand skill predicts academic ability: Global deficits at the point of hemispheric indecision. *Neuropsychologia*, 36(12), 1275-1282. [http://doi.org/10.1016/S0028-3932\(98\)00039-6](http://doi.org/10.1016/S0028-3932(98)00039-6)
- Crow, T. J., Done, D. J., & Sacker, A. (1996). Cerebral lateralization is delayed in children who later develop schizophrenia. *Schizophrenia Research*, 22(3), 181-185. [http://doi.org/10.1016/S0920-9964\(96\)00068-0](http://doi.org/10.1016/S0920-9964(96)00068-0)
- Cuellar-Partida, G., Tung, J. Y., Eriksson, N., Albrecht, E., Aliev, F., Andreassen, O. A., Barroso, I., Beckmann, J. S., Boks, M. P., Boomsma, D. I., Boyd, H. A., Breteler, M. M. B., Campbell, H., Chasman, D. I., Cherkas, L. F., Davies, G., de Geus, E. J. C., Deary, I. J., Deloukas, P., . . . Medland, S. E. (2020). Genome-wide association study identifies 48 common genetic variants associated with handedness. *Nature Human Behaviour*, 5(1), 59-70. <https://doi.org/10.1038/s41562-020-00956-y>
- Cutland, C. L., Lackritz, E. M., Mallett-Moore, T., Bardají, A., Chandrasekaran, R., Lahariya, C., Nisar, M. I., Tapia, M. D., Pathirana, J., Kochhar, S., & Muñoz, F. M. (2017). Low birth weight : Case definition & ; guidelines for data collection, analysis, and presentation of maternal immunization safety data. *Vaccine*, 35(48), 6492-6500. <https://doi.org/10.1016/j.vaccine.2017.01.049>
- Daniels, L., & Backman, C. (1993). Grip and pinch strength norms for children. *Physical and Occupational Therapy in Pediatrics*, 13(1), 81-90. http://doi.org/10.1080/J006v13n01_05
- Darvik, M., Lorås, H., & Pedersen, A. V. (2018). The prevalence of left-handedness is higher among individuals with developmental coordination disorder than in the general population. *Frontiers in Psychology*. Frontiers Media S.A. <http://doi.org/10.3389/fpsyg.2018.01948>
- Dassonville, P., Zhu, X.-H., Ugurbil, K., Kim, S.-G., & Ashe, J. (1998). Functional activation in motor cortex reflects the direction and. *Proceedings of the National Academy of Sciences of the United States of America*, 94(13), 14015-14018.
- Davis, R., Donati, G., Finnegan, K., Boardman, J. P., Dean, B., Fletcher-Watson, S., & Forrester, G. S. (2022). Social gaze in preterm infants may act as an early indicator of atypical lateralization. *Child Development*, 93(4), 869-880. <https://doi.org/10.1111/cdev.13734>
- De Agostini, M., & Dellatolas, G. (1988). Une épreuve simple pour évaluer la préférence manuelle chez l'enfant à partir de 3 ans. *Enfance*, 41(3), 139-147.
- De Agostini, M., Kazandjian, S., Cavézian, C., Lellouch, J., & Chokron, S. (2011). Visual aesthetic preference: Effects of handedness, sex, and age-related reading/writing directional scanning experience. *Writing Systems Research*, 2(2), 77-85. <http://doi.org/10.1093/wsr/wsq006>
- de Kovel, C. G. F., Carrión-Castillo, A., & Francks, C. (2019). A large-scale population study of early life factors influencing left-handedness. *Scientific Reports*, 9(1). <http://doi.org/10.1038/s41598-018-37423-8>
- Dellatolas, G., Curt, F., & Lellouch, J. (1991). Birth Order and Month of Birth Are Not Related with Handedness in a Sample of 9370 Young Men. *Cortex*, 27(1), 137-140. [185](http://doi.org/10.1016/S0010-</p>
</div>
<div data-bbox=)

9452(13)80277-8

- Dellatolas, G., De Agostini, M., Curt, F., Kremin, H., Letierce, A., Maccario, J., & Lellouch, J. (2003). Manual skill, hand skill asymmetry, and cognitive performance in young children. *Laterality*, *8*(4), 317–338. <http://doi.org/10.1080/13576500342000121>
- de Vries, J. I. P., Wimmers, R. H., Ververs, I. A. P., Hopkins, B., Savelsbergh, G. J. P., & van Geijn, H. P. (2001). Fetal handedness and head position preference: A developmental study. *Developmental Psychobiology*, *39*(3), 171–178. <http://doi.org/10.1002/dev.1042>
- Dieterich, M., Bense, S., Lutz, S., Drzezga, A., Stephan, T., Bartenstein, P., & Brandt, T. (2003). Dominance for vestibular cortical function in the non-dominant hemisphere. *Cerebral Cortex*, *13*(9), 994–1007. <http://doi.org/10.1093/cercor/13.9.994>
- Dieterich, M., & Brandt, T. (2015). The bilateral central vestibular system: Its pathways, functions, and disorders. *Annals of the New York Academy of Sciences*, *1343*(1), 10–26. <http://doi.org/10.1111/nyas.12585>
- Dieterich, M., & Brandt, T. (2018a). Global orientation in space and the lateralization of brain functions. *Current Opinion in Neurology*, *31*(1), 96–104. <http://doi.org/10.1097/WCO.0000000000000516>
- Dieterich, M., & Brandt, T. (2018b). *The parietal lobe and the vestibular system. Handbook of Clinical Neurology* (1st ed., Vol. 151). Elsevier B.V. <http://doi.org/10.1016/B978-0-444-63622-5.00006-1>
- DiNuzzo, M., Mascali, D., Bussu, G., Moraschi, M., Guidi, M., Macaluso, E., Mangia, S., & Giove, F. (2022). Hemispheric functional segregation facilitates target detection during sustained visuospatial attention. *Human Brain Mapping*. <https://doi.org/10.1002/hbm.25970>
- Di Renzo, G. C., Tosto, V., & Giardina, I. (2018). The biological basis and prevention of preterm birth. *Best Practice and Research: Clinical Obstetrics and Gynaecology*, *52*, 13–22. <http://doi.org/10.1016/j.bpobgyn.2018.01.022>
- Dobel, C., Diesendruck, G., & Bölte, J. (2007). How writing system and age influence spatial representations of actions: A developmental, cross-linguistic study: Research report. *Psychological Science*, *18*(6), 487–491. <http://doi.org/10.1111/j.1467-9280.2007.01926.x>
- Dolcos, F., Rice, H. J., & Cabeza, R. (2002). Hemispheric asymmetry and aging: right hemisphere decline or asymmetry reduction. *Neuroscience & Biobehavioral Reviews*, *26*(7), 819–825. [http://doi.org/10.1016/S0149-7634\(02\)00068-4](http://doi.org/10.1016/S0149-7634(02)00068-4)
- Domellöf, E., Johansson, A. M., & Rönqvist, L. (2011). Handedness in preterm born children: A systematic review and a meta-analysis. *Neuropsychologia*, *49*(9), 2299–2310. <http://doi.org/10.1016/j.neuropsychologia.2011.04.033>
- Donati, G., & Forrester, G. S. (2021). Hindsight 20/20: The future of laterality research. *Laterality*, *0*(0), 1–6. <http://doi.org/10.1080/1357650X.2021.1876720>
- Dragovic, M. (2004). Categorization and validation of handedness using latent class analysis. *Acta Neuropsychiatrica*, *16*(4), 212–218. <http://doi.org/10.1111/j.0924-2708.2004.00087.x>

- Dragović, M., Badcock, J. C., Sanja, M., Gregurović, M., & Šram, Z. (2013). Social stereotyping of left-handers in Serbia. *Laterality*, *18*(6), 719–729. <http://doi.org/10.1080/1357650X.2012.755993>
- Dragovic, M., & Hammond, G. (2005). Handedness in schizophrenia: A quantitative review of evidence. *Acta Psychiatrica Scandinavica*, *111*(6), 410–419. <http://doi.org/10.1111/j.1600-0447.2005.00519.x>
- Dragović, M., Milenković, S., Kocijančić, D., & Šram, Z. (2013). Etiological aspect of left-handedness in adolescents. *Srpski Arhiv Za Celokupno Lekarstvo*, *141*(5–6), 354–358. <http://doi.org/10.2298/SARH1306354D>
- Drake, J. E., & Winner, E. (2013). How children use drawing to regulate their emotions. *Cognition and Emotion*, *27*(3), 512–520. <http://doi.org/10.1080/02699931.2012.720567>
- Dreman, S. B. (1974). Directionality Trends as a Function of Handedness and of Reading and Writing Habits. *The American Journal of Psychology*, *87*(1/2), 247. <http://doi.org/10.2307/1422018>
- Dubois, J., Benders, M., Cachia, A., Lazeyras, F., Ha-Vinh Leuchter, R., Sizonenko, S. V., Borradori-Tolsa, C., Mangin, J. F., & Huppi, P. S. (2007). Mapping the Early Cortical Folding Process in the Preterm Newborn Brain. *Cerebral Cortex*, *18*(6), 1444–1454. <https://doi.org/10.1093/cercor/bhm180>
- Ebersbach, M., & Hagedorn, H. (2011). The role of cognitive flexibility in the spatial representation of children's drawings. *Journal of Cognition and Development*, *12*(1), 32–55. <http://doi.org/10.1080/15248372.2011.539526>
- Edwards, J., Berube, M., Erlandson, K., Haug, S., Johnstone, H., Meagher, M., Sarkodee-Adoo, S., & Zwicker, J. G. (2011). Developmental Coordination Disorder in School-Aged Children Born Very Preterm and/or at Very Low Birth Weight : A Systematic Review. *Journal of Developmental & Behavioral Pediatrics*, *32*(9), 678–687. <https://doi.org/10.1097/dbp.0b013e31822a396a>
- Eglinton, E., & Annett, M. (1994). Handedness and dyslexia: a meta-analysis. *Perceptual and Motor Skills*, *79*(3 Pt 2), 1611–1616. <http://doi.org/10.2466/pms.1994.79.3f.1611>
- Ehrlichman, H., Zoccolotti, P., & Owen, D. (1982). Perinatal factors in hand and Eye preference: Data from the collaborative perinatal project. *International Journal of Neuroscience*, *17*(1), 17–22. <http://doi.org/10.3109/00207458208985084>
- Elliott, B. A. (1992). Birth order and health: Major issues. *Social Science & Medicine*, *35*(4), 443–452. [https://doi.org/10.1016/0277-9536\(92\)90337-p](https://doi.org/10.1016/0277-9536(92)90337-p)
- Erlanger, D. M., Kutner, K. C., & Jacobs, A. R. (1999). Hormones and cognition: Current concepts and issues in neuropsychology. *Neuropsychology Review*, *9*(4), 175–207. <http://doi.org/10.1023/A:1021634622577>
- Esteves, M., Ganz, E., Sousa, N., & Leite-Almeida, H. (2020). Asymmetrical Brain Plasticity: Physiology and Pathology. *Neuroscience*. <http://doi.org/10.1016/j.neuroscience.2020.01.022>
- Esteves, M., Lopes, S. S., Almeida, A., Sousa, N., & Leite-Almeida, H. (2020). Unmasking the relevance of hemispheric asymmetries—Break on through (to the other side). *Progress in Neurobiology*, *192*, 101823. <http://doi.org/10.1016/j.pneurobio.2020.101823>

- Everts, R., Lidzba, K., Wilke, M., Kiefer, C., Mordasini, M., Schroth, G., Perrig, W., & Steinlin, M. (2008). Strengthening of laterality of verbal and visuospatial functions during childhood and adolescence. *Human Brain Mapping, 30*(2), 473–483. <https://doi.org/10.1002/hbm.20523>
- Fagard, J. (2013a). Early development of hand preference and language lateralization: Are they linked, and if so, how? *Developmental Psychobiology, 55*(6), 596–607. <http://doi.org/10.1002/dev.21131>
- Fagard, J. (2013b). The nature and nurture of human infant hand preference. *Annals of the New York Academy of Sciences, 1288*(1), 114–123. <http://doi.org/10.1111/nyas.12051>
- Fagard, J., Chapelain, A., & Bonnet, P. (2015). How should “ambidexterity” be estimated? *Laterality, 20*(5), 543–570. <http://doi.org/10.1080/1357650X.2015.1009089>
- Fagard, J., Corbetta, D., Somogyi, E., Safar, A., & Bernard, C. (2020). Right-handed one day, right-handed the next day?: Short-term test-retest reliability of infant handedness. *Laterality, 0*(0), 1–14. <http://doi.org/10.1080/1357650X.2020.1729171>
- Fagard, J., & Dahmen, R. (2003). The effects of reading-writing direction on the asymmetry of space perception and directional tendencies: A comparison between French and Tunisian children. *Laterality, 8*(1), 39–52. <http://doi.org/10.1080/713754473>
- Faghihi, N., Garcia, O., & Vaid, J. (2019). Spatial bias in figure placement in representational drawing: Associations with handedness and script directionality. *Laterality, 24*(5), 614–630. <http://doi.org/10.1080/1357650X.2018.1561708>
- Failla, C. V., Sheppard, D. M., & Bradshaw, J. L. (2003). Age and responding-hand related changes in performance of neurologically normal subjects on the line-bisection and chimeric-faces tasks. *Brain and Cognition, 52*(3), 353–363. [http://doi.org/10.1016/S0278-2626\(03\)00181-7](http://doi.org/10.1016/S0278-2626(03)00181-7)
- Faurie, C., Raymond, M., & Uomini, N. (2016). Origins, Development, and Persistence of Laterality in Humans. In *Laterality in Sports: Theories and Applications* (pp. 11–30). Elsevier. <http://doi.org/10.1016/B978-0-12-801426-4.00002-X>
- Ferre, C. L., Babik, I., & Michel, G. F. (2020). A perspective on the development of hemispheric specialization, infant handedness, and cerebral palsy. *Cortex, 127*, 208–220. <http://doi.org/10.1016/j.cortex.2020.02.017>
- Ferrero, M., West, G., & Vadillo, M. A. (2017). Is crossed laterality associated with academic achievement and intelligence? A systematic review and meta-analysis. *PLoS ONE*. Public Library of Science. <http://doi.org/10.1371/journal.pone.0183618>
- Field, T., & Diego, M. (2008). Cortisol: the culprit prenatal stress variable. *The International Journal of Neuroscience, 118*(8), 1181. <http://doi.org/10.1080/00207450701820944>
- Field, T., Hernandez-Reif, M., Diego, M., Figueiredo, B., Schanberg, S., & Kuhn, C. (2006). Prenatal cortisol, prematurity and low birthweight. *Infant Behavior and Development, 29*(2), 268–275. <http://doi.org/10.1016/j.infbeh.2005.12.010>
- Fiske, T. S., Cuddy, J. C. A., Glick, P., & Xu, J. (2002). A model of (often mixed) stereotype content:

- Competence and warmth respectively follow from perceived status and competition. *Journal of Personality and Social Psychology*, 82.
- Fong, B. F., Savelsbergh, G. J. P., Van Geijn, H. P., & De Vries, J. I. P. (2005). Does intra-uterine environment influence fetal head-position preference? A comparison between breech and cephalic presentation. *Early Human Development*, 81(6), 507–517. <http://doi.org/10.1016/j.earlhumdev.2004.11.002>
- Fox, N., & Lewis, M. (1982). Motor asymmetries in preterm infants: Effects of prematurity and illness. *Developmental Psychobiology*, 15(1), 19–23. <http://doi.org/10.1002/dev.420150105>
- Francis, K. L., & Spirduso, W. W. (2000). Age differences in the expression of manual asymmetry. *Experimental Aging Research*, 26(2), 169–180. <http://doi.org/10.1080/036107300243632>
- Francks, C., Maegawa, S., Laurén, J., Abrahams, B. S., Velayos-Baeza, A., Medland, S. E., Colella, S., Groszer, M., McAuley, E. Z., Caffrey, T. M., Timmusk, T., Pruunsild, P., Koppel, I., Lind, P. A., Matsumoto-Itaba, N., Nicod, J., Xiong, L., Joober, R., Enard, W., . . . Monaco, A. P. (2007). LRRTM1 on chromosome 2p12 is a maternally suppressed gene that is associated paternally with handedness and schizophrenia. *Molecular Psychiatry*, 12(12), 1129–1139. <https://doi.org/10.1038/sj.mp.4002053>
- Fraser, A., Macdonald-Wallis, C., Tilling, K., Boyd, A., Golding, J., Davey Smith, G., Henderson, J., Macleod, J., Molloy, L., Ness, A., Ring, S., Nelson, S. M., & Lawlor, D. A. (2012). Cohort Profile : The Avon Longitudinal Study of Parents and Children : ALSPAC mothers cohort. *International Journal of Epidemiology*, 42(1), 97–110. <https://doi.org/10.1093/ije/dys066>
- Frasnelli, E. (2021). Looking at lateralization as a dynamic and plastic feature of nervous systems. *Laterality*, 26(3), 323–326. <http://doi.org/10.1080/1357650X.2021.1876083>
- Frey, H. A., & Klebanoff, M. A. (2016). The epidemiology, etiology, and costs of preterm birth. In *Seminars in Fetal and Neonatal Medicine* (Vol. 21, No. 2, pp. 68–73). WB Saunders. <https://doi.org/10.1016/j.siny.2015.12.011>
- Friedrich, T. E., Harms, V. L., & Elias, L. J. (2014). Dynamic stimuli: Accentuating aesthetic preference biases. *Laterality*, 19(5), 549–559. <http://doi.org/10.1080/1357650X.2014.886585>
- Friedrich, T. E., Hunter, P. V., & Elias, L. J. (2018). The Trajectory of Pseudoneglect in Adults: A Systematic Review. *Neuropsychology Review*, 28(4), 436–452. <http://doi.org/10.1007/s11065-018-9392-6>
- Gardner, J., Lewkowicz, D., & Turkewitz, G. (1977). Development of postural asymmetry in premature human infants. *Developmental Psychobiology*, 10(5), 471–480. <http://doi.org/10.1002/dev.420100507>
- Geerdink, J. J., Hopkins, B., & Hoeksma, J. B. (1994). The development of head position preference in preterm infants beyond term age. *Developmental Psychobiology*, 27(3), 153–168. <http://doi.org/10.1002/dev.420270303>
- Gerrits, R., Verhelst, H., & Vingerhoets, G. (2020a). Hemispheric dominance for visuospatial attention does not predict the direction of pseudoneglect. *Neuropsychologia*, 148, 107634. <http://doi.org/10.1016/j.neuropsychologia.2020.107634>

- Gerrits, R., Verhelst, H., & Vingerhoets, G. (2020b). Mirrored brain organization: Statistical anomaly or reversal of hemispheric functional segregation bias? *Proceedings of the National Academy of Sciences of the United States of America*, *117*(25), 14057–14065. <http://doi.org/10.1073/pnas.2002981117>
- Geschwind, N., & Galaburda, A. M. (1985). Cerebral lateralization: Biological mechanisms, associations, and pathology: I. A hypothesis and a program for research. *Archives of neurology*, *42*(5), 428–459. <https://doi.org/10.1001/archneur.1985.04060050026008>
- Giannopoulou, I., Pagida, M. A., Briana, D. D., & Panayotacopoulou, M. T. (2018). Perinatal hypoxia as a risk factor for psychopathology later in life: the role of dopamine and neurotrophins. *Hormones*, *17*(1), 25–32. <http://doi.org/10.1007/s42000-018-0007-7>
- Girelli, L., Marinelli, C. V., Grossi, G., & Arduino, L. S. (2017). Cultural and biological factors modulate spatial biases over development. *Laterality*, *22*(6), 725–739. <http://doi.org/10.1080/1357650X.2017.1279623>
- Gliga, T., & Alderdice, F. (2015). New frontiers in fetal and infant psychology. *Journal of Reproductive and Infant Psychology*, *33*(5), 445–447. <http://doi.org/10.1080/02646838.2015.1086070>
- Glover, V., O'Connor, T. G., Heron, J., & Golding, J. (2004). Antenatal maternal anxiety is linked with atypical handedness in the child. *Early Human Development*, *79*(2), 107–118. <http://doi.org/10.1016/j.earlhumdev.2004.04.012>
- Goble, D. J., & Brown, S. H. (2008). The biological and behavioral basis of upper limb asymmetries in sensorimotor performance. *Neuroscience and Biobehavioral Reviews*, *32*(3), 598–610. <http://doi.org/10.1016/j.neubiorev.2007.10.006>
- Goldenberg, R. L., & Culhane, J. F. (2007). Low birth weight in the United States. *American Journal of Clinical Nutrition*, *85*(2), 584–590. <http://doi.org/10.1093/ajcn/85.2.584s>
- Gonzalez, C. L. R., Flindall, J. W., & Stone, K. D. (2014). Hand preference across the lifespan: Effects of end-goal, task nature, and object location. *Frontiers in Psychology*, *5*(OCT), 1–9. <http://doi.org/10.3389/fpsyg.2014.01579>
- Gonzalez, C. L. R., van Rootselaar, N. A., & Gibb, R. L. (2018). *Sensorimotor lateralization scaffolds cognitive specialization*. *Progress in Brain Research* (1st ed., Vol. 238). Elsevier B.V. <http://doi.org/10.1016/bs.pbr.2018.06.011>
- Gonzalez, S. L., Campbell, J. M., Marcinowski, E. C., Michel, G. F., Coxe, S., & Nelson, E. L. (2020). Preschool language ability is predicted by toddler hand preference trajectories. *Developmental Psychology*, *56*(4), 699–709. <http://doi.org/10.1037/dev0000900>
- Goodwin, R. S., & Michel, G. F. (1981). Head Orientation position during birth and in infant neonatal period, and hand preference at nineteen weeks. *Child Development*, *52*(3), 819–826. <http://doi.org/10.1111/j.1467-8624.1981.tb03119.x>
- Gosse, C., Dricot, L., & Van Reybroeck, M. (2022). Evidence of graphomotor dysfunction in children with dyslexia: A combined behavioural and fMRI experiment. *Cortex*, *148*, 68–88.

- <http://doi.org/10.1016/j.cortex.2021.11.021>
- Graham, J. H. (2021). Nature, nurture, and noise: Developmental instability, fluctuating asymmetry, and the causes of phenotypic variation. *Symmetry*, *13*(7). <http://doi.org/10.3390/sym13071204>
- Groothuis, T. G. G., Zickert, N., Riedstra, B., & Geuze, R. (2021). The importance of understanding function and evolution. *Laterality*, *26*(3), 342–347. <http://doi.org/10.1080/1357650X.2021.1909610>
- Guadalupe, T., Mathias, S. R., vanErp, T. G. M., Whelan, C. D., Zwiers, M. P., Abe, Y., Abramovic, L., Agartz, I., Andreassen, O. A., Arias-Vásquez, A., Aribisala, B. S., Armstrong, N. J., Arolt, V., Artiges, E., Ayesa-Arriola, R., Baboyan, V. G., Banaschewski, T., Barker, G., Bastin, M. E., . . . Francks, C. (2016). Human subcortical brain asymmetries in 15,847 people worldwide reveal effects of age and sex. *Brain Imaging and Behavior*, *11*(5), 1497–1514. <https://doi.org/10.1007/s11682-016-9629-z>
- Guadalupe, T., Zwiers, M. P., Wittfeld, K., Teumer, A., Vasquez, A. A., Hoogman, M., Hagoort, P., Fernandez, G., Buitelaar, J., van Bokhoven, H., Hegenscheid, K., Völzke, H., Franke, B., Fisher, S. E., Grabe, H. J., & Francks, C. (2015). Asymmetry within and around the human planum temporale is sexually dimorphic and influenced by genes involved in steroid hormone receptor activity. *Cortex*, *62*, 41–55. <https://doi.org/10.1016/j.cortex.2014.07.015>
- Güntürkün, O., Ströckens, F., & Ocklenburg, S. (2020). Brain lateralization: A comparative perspective. *Physiological Reviews*, *100*(3), 1019–1063. <http://doi.org/10.1152/physrev.00006.2019>
- Gutteling, B. M., De Weerth, C., & Buitelaar, J. K. (2007). Prenatal stress and mixed-handedness. *Pediatric Research*, *62*(5), 586–590. <http://doi.org/10.1203/PDR.0b013e3181558678>
- Haller, M., Brandl, P., Leithinger, D., Leitner, J., & Seifried, T. (2007). Large interactive surfaces based on digital pens. In *10th International Conference on Humans and Computers* (pp. 172–177).
- Halpern, D. F., & Coren, S. (1988). Do right-handers live longer? *Nature*, *333*(6170), 213–213. <http://doi.org/10.1038/333213b0>
- Hausinger, T., & Pletzer, B. (2021). Sex hormones modulate sex differences and relate to hemispheric asymmetries in a divided visual field Navon task. *Behavioural Brain Research*, *408*, 113281. <http://doi.org/10.1016/j.bbr.2021.113281>
- Hausmann, M. (2017). Why sex hormones matter for neuroscience: A very short review on sex, sex hormones, and functional brain asymmetries. *Journal of Neuroscience Research*. John Wiley and Sons Inc. <http://doi.org/10.1002/jnr.23857>
- Hausmann, M., Ergun, G., Yazgan, Y., & Güntürkün, O. (2002). Sex differences in line bisection as a function of hand. *Neuropsychologia*, *40*(3), 235–240. [http://doi.org/10.1016/S0028-3932\(01\)00112-9](http://doi.org/10.1016/S0028-3932(01)00112-9)
- Hausmann, M., Güntürkün, O., & Corballis, M. C. (2003). Age-related changes in hemispheric asymmetry depend on sex. *Laterality*, *8*(3), 277–290. <http://doi.org/10.1080/13576500244000201>
- Hausmann, M., Waldie, K. E., & Corballis, M. C. (2003). Developmental changes in line bisection: A result of callosal maturation? *Neuropsychology*, *17*(1), 155–160. <http://doi.org/10.1037/0894-4105.17.1.155>
- Hecht, D. (2010). Depression and the hyperactive right-hemisphere. *Neuroscience Research*, *68*(2), 77–87.

- <http://doi.org/10.1016/j.neures.2010.06.013>
- Helland, T., Asbjørnsen, A. E., Hushovd, A. E., & Hugdahl, K. (2008). Dichotic listening and school performance in dyslexia. *Dyslexia*, *14*(1), 42–53. <http://doi.org/10.1002/dys.343>
- Henderson, S. E., Sugden, D. A., & Barnett, A. (2007). Movement Assessment Battery for Children – Second edition (Movement ABC-2). The Psychological Corporation, London.
- Hepper, P. G. (2013). The developmental origins of laterality: Fetal handedness. *Developmental Psychobiology*, *55*(6), 588–595. <http://doi.org/10.1002/dev.21119>
- Hepper, P. G., McCartney, G. R., & Shannon, E. A. (1998). Lateralised behaviour in first trimester human fetuses. *Neuropsychologia*, *36*(6), 531–534. [http://doi.org/10.1016/S0028-3932\(97\)00156-5](http://doi.org/10.1016/S0028-3932(97)00156-5)
- Hepper, P. G., Shahidullah, S., & White, R. (1991). *HANDEDNESS IN THE HUMAN FETUS* (Vol. 29).
- Hepper, P. G., Wells, D. L., & Lynch, C. (2005). Prenatal thumb sucking is related to postnatal handedness. *Neuropsychologia*, *43*(3), 313–315. <http://doi.org/10.1016/j.neuropsychologia.2004.08.009>
- Hertz, R. (2013). The pre-eminence of the right hand. *HAU: Journal of Ethnographic Theory*, *3*(2), 335–357. <http://doi.org/10.14318/hau3.2.024>
- Hicks, R. A., Dusek, C., Larsen, F., Williams, S., & Pellegrini, R. J. (1980). Birth Complications and the Distribution of Handedness. *Cortex*, *16*(3), 483–486. [http://doi.org/10.1016/S0010-9452\(80\)80049-9](http://doi.org/10.1016/S0010-9452(80)80049-9)
- Hirnstain, M., & Hugdahl, K. (2014). Excess of non-right-handedness in schizophrenia: Meta-analysis of gender effects and potential biases in handedness assessment. *British Journal of Psychiatry*, *205*(4), 260–267. <http://doi.org/10.1192/bjp.bp.113.137349>
- Hirnstain, M., Hugdahl, K., & Hausmann, M. (2019). Cognitive sex differences and hemispheric asymmetry: A critical review of 40 years of research. *Laterality*, *24*(2), 204–252. <http://doi.org/10.1080/1357650X.2018.1497044>
- Hirnstain, M., Westerhausen, R., Korsnes, M. S., & Hugdahl, K. (2013). Sex differences in language asymmetry are age-dependent and small: A large-scale, consonant-vowel dichotic listening study with behavioral and fMRI data. *Cortex*, *49*(7), 1910–1921. <http://doi.org/10.1016/j.cortex.2012.08.002>
- Hiscock, M., & Kinsbourne, M. (1980). Asymmetry of verbal-manual time sharing in children: A follow-up study. *Neuropsychologia*, *18*(2), 151–162. [https://doi.org/10.1016/0028-3932\(80\)90061-5](https://doi.org/10.1016/0028-3932(80)90061-5)
- Hopkins, W. D. (2006). Comparative and familial analysis of handedness in great apes. *Psychological Bulletin*, *132*(4), 538–559. <http://doi.org/10.1037/0033-2909.132.4.538>
- Hopkins, W. D., Phillips, K. A., Bania, A., Calcutt, S. E., Gardner, M., Russell, J., Schaeffer, J., Lonsdorf, E. V., Ross, S. R., & Schapiro, S. J. (2011). Hand preferences for coordinated bimanual actions in 777 great apes : Implications for the evolution of handedness in Hominins. *Journal of Human Evolution*, *60*(5), 605–611. <https://doi.org/10.1016/j.jhevol.2010.12.008>
- Hoyos, P. M., Kim, N. Y., Cheng, D., Finkelston, A., & Kastner, S. (2021). Development of spatial biases in school-aged children. *Developmental Science*, *24*(3). <http://doi.org/10.1111/desc.13053>

- Huau, A., Velay, J. L., & Jover, M. (2015). Graphomotor skills in children with developmental coordination disorder (DCD): Handwriting and learning a new letter. *Human movement science, 42*, 318-332. <https://doi.org/10.1016/j.humov.2015.03.008>
- Iliodromiti, S., MacKay, D. F., Smith, G. C. S., Pell, J. P., & Nelson, S. M. (2014). Apgar score and the risk of cause-specific infant mortality: A population-based cohort study. *The Lancet, 384*(9956), 1749-1755. [http://doi.org/10.1016/S0140-6736\(14\)61135-1](http://doi.org/10.1016/S0140-6736(14)61135-1)
- Imada, T., Zhang, Y., Cheour, M., Taulu, S., Ahonen, A., & Kuhl, P. K. (2006). Infant speech perception activates Broca's area: A developmental magnetoencephalography study. *NeuroReport, 17*(10), 957-962. <http://doi.org/10.1097/01.wnr.0000223387.51704.89>
- Isaacs, K. L., Barr, W. B., Peter, A., Nelson, K., & Devinsky, O. (2006). *Degree of handedness and cerebral dominance*. Retrieved from www.neurology.org
- Ishii, Y., Okubo, M., Nicholls, M. E. R., & Imai, H. (2011). Lateral biases and reading direction: A dissociation between aesthetic preference and line bisection. *Brain and Cognition, 75*(3), 242-247. <http://doi.org/10.1016/j.bandc.2010.12.005>
- Jacquet, A. Y., Esseily, R., Rider, D., & Fagard, J. (2012). Handedness for grasping objects and declarative pointing: A longitudinal study. *Developmental Psychobiology, 54*(1), 36-46. <http://doi.org/10.1002/dev.20572>
- James, W. H., & Orlebeke, J. F. (2002). Determinants of handedness in twins. *Laterality, 7*(4), 301-307. <http://doi.org/10.1080/13576500143000320>
- Janzen, J., Schlindwein, P., Bense, S., Bauermann, T., Vucurevic, G., Stoeter, P., & Dieterich, M. (2008). Neural correlates of hemispheric dominance and ipsilaterality within the vestibular system. *NeuroImage, 42*(4), 1508-1518. <http://doi.org/10.1016/j.neuroimage.2008.06.026>
- Jewell, G., & McCourt, M. E. (2000). Pseudoneglect: A review and meta-analysis of performance factors in line bisection tasks. *Neuropsychologia, 38*(1), 93-110. [http://doi.org/10.1016/S0028-3932\(99\)00045-7](http://doi.org/10.1016/S0028-3932(99)00045-7)
- Johnstone, J., Galin, D., & Herron, J. (1979). Choice of handedness measures in studies of hemispheric specialization. *International Journal of Neuroscience, 9*(2), 71-80. <http://doi.org/10.3109/00207457909147222>
- Johnstone, L. T., Karlsson, E. M., & Carey, D. P. (2021). Left-Handers Are Less Lateralized Than Right-Handers for Both Left and Right Hemispheric Functions. *Cerebral Cortex, 31*(8), 3780-3787. <http://doi.org/10.1093/cercor/bhab048>
- Jones, A., Osmond, C., Godfrey, K. M., & Phillips, D. I. W. (2011). Evidence for developmental programming of cerebral laterality in humans. *PLoS ONE, 6*(2), 2-7. <http://doi.org/10.1371/journal.pone.0017071>
- Jover, M., Schmitz, C., Centelles, L., Chabrol, B., & Assaiante, C. (2010). Anticipatory postural adjustments in a bimanual load-lifting task in children with developmental coordination disorder. *Developmental Medicine & Child Neurology, 52*(9), 850-855. <https://doi.org/10.1111/j.1469-8749.2009.03611.x>

- Kalaycıoğlu, C., Kara, C., Atbasoğflu, C., & Nalçacı, E. (2008). Aspects of foot preference: Differential relationships of skilled and unskilled foot movements with motor asymmetry. *Laterality*, *13*(2), 124–142. <http://doi.org/10.1080/13576500701701704>
- Kalisch, T., Willimzig, C., Kleibel, N., Tegenthoff, M., & Dinse, H. R. (2006). Age-related attenuation of dominant hand superiority. *PLoS ONE*, *1*(1). <http://doi.org/10.1371/journal.pone.0000090>
- Kalmady, S. V., Agarwal, S. M., Shivakumar, V., Jose, D., Venkatasubramanian, G., & Janardhan Reddy, Y. C. (2013). Revisiting geschwind's hypothesis on brain lateralisation: A functional MRI study of digit ratio (2D:4D) and sex interaction effects on spatial working memory. *Laterality*, *18*(5), 625–640. <http://doi.org/10.1080/1357650X.2012.744414>
- Kapoor, A., Dunn, E., Kostaki, A., Andrews, M. H., & Matthews, S. G. (2006). Fetal programming of hypothalamo-pituitary-adrenal function: prenatal stress and glucocorticoids. *The Journal of Physiology*, *572*(1), 31–44. <http://doi.org/10.1113/jphysiol.2006.105254>
- Karev, G. B. (1999). Directionality in right, mixed and left handers. *Cortex*, *35*(3), 423–431. [http://doi.org/10.1016/S0010-9452\(08\)70810-4](http://doi.org/10.1016/S0010-9452(08)70810-4)
- Karlsson, E. M., Johnstone, L. T., & Carey, D. P. (2019). The depth and breadth of multiple perceptual asymmetries in right handers and non-right handers. *Laterality*, *24*(6), 707–739. <http://doi.org/10.1080/1357650X.2019.1652308>
- Karnath, H. O., & Dieterich, M. (2006). Spatial neglect - A vestibular disorder? *Brain*, *129*(2), 293–305. <http://doi.org/10.1093/brain/awh698>
- Kaufman, A. S., & Kaufman, N. L. (2004). Kaufman Brief Intelligence Test, Second Edition. Bloomington, MN: Pearson, Inc.
- Kaul, D., Papadatou-Pastou, M., & Learmonth, G. (2021, May 27). A meta-analysis of line bisection and landmark task performance in children. <https://doi.org/10.31234/osf.io/n26fx>
- Kazandjian, S., Cavézian, C., Zivotofsky, A. Z., & Chokron, S. (2010). Bisections in two languages: When number processing, spatial representation, and habitual reading direction interact. *Neuropsychologia*, *48*(14), 4031–4037. <http://doi.org/10.1016/j.neuropsychologia.2010.10.020>
- Kebbe, H., & Vinter, A. (2013). How Culture, Age, and Manual Dominance Affect Directionality in Drawing Side View Objects. *Journal of Cross-Cultural Psychology*, *44*(1), 160–172. <http://doi.org/10.1177/0022022111435098>
- Kempe, V., Brooks, P. J., & Christman, S. D. (2009). Inconsistent handedness is linked to more successful foreign language vocabulary learning. *Psychonomic Bulletin and Review*, *16*(3), 480–485. <http://doi.org/10.3758/PBR.16.3.480>
- Kilshaw, D., & Annett, M. (1983). Right- and left-hand skill I: Effects of age, sex and hand preference showing superior skill in left-handers. *British Journal of Psychology*, *74*(2), 253–268. <http://doi.org/10.1111/j.2044-8295.1983.tb01861.x>
- Kinsbourne, M. (1970). The cerebral basis of lateral asymmetries in attention. *Acta Psychologica*, *33*(C),

- 193–201. [http://doi.org/10.1016/0001-6918\(70\)90132-0](http://doi.org/10.1016/0001-6918(70)90132-0)
- Klöppel, S., Mangin, J. F., Vongerichten, A., Frackowiak, R. S. J., & Siebner, H. R. (2010). Nurture versus nature: Long-term impact of forced right-handedness on structure of pericentral cortex and basal ganglia. *Journal of Neuroscience*, *30*(9), 3271–3275. <http://doi.org/10.1523/JNEUROSCI.4394-09.2010>
- Kohler, M., Keage, H., Spooner, R., Flitton, A., Hofmann, J., Churches, O., Elliott, S., & Badcock, N. (2015). Variability in lateralised blood flow response to language is associated with language development in children aged 1–5 years. *Brain and Language*, *145–146*, 34–41. <https://doi.org/10.1016/j.bandl.2015.04.004>
- Kong, X., Postema, M. C., Guadalupe, T., Kovel, C., Boedhoe, P. S. W., Hoogman, M., Mathias, S. R., Rooij, D., Schijven, D., Glahn, D. C., Medland, S. E., Jahanshad, N., Thomopoulos, S. I., Turner, J. A., Buitelaar, J., Erp, T. G. M., Franke, B., Fisher, S. E., Heuvel, O. A., . . . Francks, C. (2020). Mapping brain asymmetry in health and disease through the ENIGMA consortium. *Human Brain Mapping*, *43*(1), 167–181. <https://doi.org/10.1002/hbm.25033>
- Kong, X. Z., Mathias, S. R., Guadalupe, T., Glahn, D. C., Franke, B., Crivello, F., Tzourio-Mazoyer, N., Fisher, S. E., Thompson, P. M., Francks, C., Kong, X. Z., Mathias, S. R., Guadalupe, T., Abé, C., Agartz, I., Akudjedu, T. N., Aleman, A., Alhusaini, S., Allen, N. B., . . . Orhan, F. (2018). Mapping cortical brain asymmetry in 17,141 healthy individuals worldwide via the ENIGMA Consortium. *Proceedings of the National Academy of Sciences*, *115*(22). <https://doi.org/10.1073/pnas.1718418115>
- Kurtzberg, D., Vaughan, H. G., A. Bruce, C. D., Albin, G. S., & Rotkin, L. (1979). Neurobehavioral Performance of Lowbirthweight Infants at 40 Weeks Conceptional Age: Comparison with Normal Full term Infants. *Developmental Medicine & Child Neurology*, *21*(5), 590–607. <http://doi.org/10.1111/j.1469-8749.1979.tb01674.x>
- Kwon, S. H., Scheinost, D., Lacadie, C., Sze, G., Schneider, K. C., Dai, F., Constable, R. T., & Ment, L. R. (2015). Adaptive mechanisms of developing brain : Cerebral lateralization in the prematurely-born. *NeuroImage*, *108*, 144–150. <https://doi.org/10.1016/j.neuroimage.2014.12.032>
- Laland, K. N. (2008). Exploring gene–culture interactions: Insights from handedness, sexual selection and niche–construction case studies. *Philosophical Transactions of the Royal Society B: Biological Sciences*, *363*(1509), 3577–3589. <http://doi.org/10.1098/rstb.2008.0132>
- Lê, S., Josse, J., & Husson, F. (2008). FactoMineR: an R package for multivariate analysis. *Journal of statistical software*, *25*(1), 1–18.
- Learmonth, G., & Papadatou-Pastou, M. (2022). A Meta-Analysis of Line Bisection and Landmark Task Performance in Older Adults. *Neuropsychology Review*, *32*(2), 438–457. <http://doi.org/10.1007/s11065-021-09505-4>
- Leask, S. J., & Crow, T. J. (2001). Word acquisition reflects lateralization of hand skill. *Trends in Cognitive Sciences*, *5*(12), 513–516. [http://doi.org/10.1016/S1364-6613\(00\)01795-2](http://doi.org/10.1016/S1364-6613(00)01795-2)
- Lee, J. Y., Choi, Y. H., Cha, J. H., Lee, J. Y., Lee, Y. J., Kim, B. H., Kim, I. K., Lee, J. M., & Lee, H. J. (2021). Altered asymmetries of the structural networks comprising the fronto–limbic brain circuitry of preterm

- infants. *Scientific Reports*, 11(1). <https://doi.org/10.1038/s41598-020-79446-0>
- Levander, M., Schalling, D., & Levander, S. E. (1989). Birth Stress, Handedness and Cognitive Performance. *Cortex*, 25(4), 673–681. [http://doi.org/10.1016/S0010-9452\(89\)80027-9](http://doi.org/10.1016/S0010-9452(89)80027-9)
- Levy, J. (1976). Lateral dominance and aesthetic preference. *Neuropsychologia*, 14(4), 431–445. [http://doi.org/10.1016/0028-3932\(76\)90072-5](http://doi.org/10.1016/0028-3932(76)90072-5)
- Llorens, R., Latorre, J., Noé, E., & Keshner, E. A. (2016). Posturography using the Wii Balance Board™: a feasibility study with healthy adults and adults post-stroke. *Gait & posture*, 43, 228–232. <https://doi.org/10.1016/j.gaitpost.2015.10.002>
- Lubben, N., Ensink, E., Coetzee, G. A., & Labrie, V. (2021). The enigma and implications of brain hemispheric asymmetry in neurodegenerative diseases. *Brain Communications*, 3(3). <http://doi.org/10.1093/braincomms/fcab211>
- Lust, J. M., Geuze, R. H., Van de Beek, C., Cohen-Kettenis, P. T., Bouma, A., & Groothuis, T. G. G. (2011). Differential Effects of Prenatal Testosterone on Lateralization of Handedness and Language. *Neuropsychology*, 25(5), 581–589. <http://doi.org/10.1037/a0023293>
- Lyons, D. E., Damrosch, D. H., Lin, J. K., Macris, D. M., & Keil, F. C. (2011). The scope and limits of overimitation in the transmission of artefact culture. *Philosophical Transactions of the Royal Society B: Biological Sciences*, 366(1567), 1158–1167. <http://doi.org/10.1098/rstb.2010.0335>
- Manns, M. (2021a). It is not just in the genes. *Symmetry*, 13(10). <http://doi.org/10.3390/sym13101815>
- Manns, M. (2021b). Laterality for the next decade: Costs and benefits of neuronal asymmetries—putting lateralization in an evolutionary context. *Laterality*, 26(3), 315–318. <http://doi.org/10.1080/1357650X.2021.1886110>
- Marcori, A. J., & Okazaki, V. H. A. (2020). A historical, systematic review of handedness origins. *Laterality*, 25(1), 87–108. <http://doi.org/10.1080/1357650X.2019.1614597>
- Markou, P., Ahtam, B., & Papadatou-Pastou, M. (2017). Elevated Levels of Atypical Handedness in Autism: Meta-Analyses. *Neuropsychology Review*. Springer New York LLC. <http://doi.org/10.1007/s11065-017-9354-4>
- Marlow, N., Ni, Y., Beckmann, J., O'Reilly, H., Johnson, S., Wolke, D., & Morris, J. K. (2019). Hand Preference Develops Across Childhood and Adolescence in Extremely Preterm Children: The EPICure Study. *Pediatric Neurology*, 99, 40–46. <http://doi.org/10.1016/j.pediatrneurol.2019.04.007>
- Marschik, P. B., Einspieler, C., Strohmeier, A., Plienegger, J., Garzarolli, B., & Prechtel, H. F. R. (2008). From the reaching behavior at 5 months of age to hand preference at preschool age. *Developmental Psychobiology*, 50(5), 511–518. <http://doi.org/10.1002/dev.20307>
- Mcfarland, K., & Anderson, J. (1980). Test-Retest Performance , Age and Sex, 5.
- McManus, I. C. (1981). Handedness and birth stress. *Psychological Medicine*, 11(3), 485–496. <http://doi.org/10.1017/S0033291700052806>

- McManus, I. C. (1983). Pathologic left-handedness: Does it exist? *Journal of Communication Disorders*, 16(5), 315–344. [http://doi.org/10.1016/0021-9924\(83\)90016-3](http://doi.org/10.1016/0021-9924(83)90016-3)
- McManus, I. C. (1985). Handedness, language dominance and aphasia: a genetic model. *Psychological Medicine. Monograph Supplement*, 8, 3–40. <http://doi.org/10.1017/S0264180100001879>
- McManus, I. C. (2002). *Right hand, left hand: The origins of asymmetry in brains, bodies, atoms, and cultures* (1. publ). Harvard Univ. Press.
- McManus, I. C. (2009). The history and geography of human handedness. *Language Lateralization and Psychosis*, 37–58. <http://doi.org/10.1017/CBO9780511576744.004>
- McManus, I. C. (2019). Half a century of handedness research: Myths, truths; fictions, facts; backwards, but mostly forwards. *Brain and Neuroscience Advances*, 3, 239821281882051. <http://doi.org/10.1177/2398212818820513>
- McManus, I. C. (2021). Is any but a tiny fraction of handedness variance likely to be due to the external environment? *Laterality*, 26(3), 310–314. <http://doi.org/10.1080/1357650X.2021.1892126>
- McManus, I. C. (2022). Cerebral Polymorphisms for Lateralisation: Modelling the Genetic and Phenotypic Architectures of Multiple Functional Modules. *Symmetry*, 14(4). <http://doi.org/10.3390/sym14040814>
- McManus, I. C., & Bryden, M. P. (1992). The genetics of handedness, cerebral dominance, and lateralization. *Handbook of Neuropsychology*, 6, 115–144.
- McManus, I. C., & Davison, A., & Armour, J. A. L. (2013). Multilocus genetic models of handedness closely resemble single-locus models in explaining family data and are compatible with genome-wide association studies. *Annals of the New York Academy of Sciences*, 1288(1), 48–58. <http://doi.org/10.1111/nyas.12102>
- McManus, I. C., Murray, B., Doyle, K., & Baron-Cohen, S. (1992). Handedness in Childhood Autism Shows a Dissociation of Skill and Preference. *Cortex*, 28(3), 373–381. [http://doi.org/10.1016/S0010-9452\(13\)80147-5](http://doi.org/10.1016/S0010-9452(13)80147-5)
- McManus, I. C., Sik, G., Cole, D. R., Mellon, A. F., Wong, J., & Kloss, J. (1988). The development of handedness in children. *British Journal of Developmental Psychology*, 6(3), 257–273. <http://doi.org/10.1111/j.2044-835x.1988.tb01099.x>
- McManus, I. C., Van Horn, J. D., & Bryden, P. J. (2016). The Tapley and Bryden test of performance differences between the hands: The original data, newer data, and the relation to pegboard and other tasks. *Laterality*, 21(4–6), 371–396. <http://doi.org/10.1080/1357650X.2016.1141916>
- Medland, S. E., Duffy, D. L., Wright, M. J., Geffen, G. M., Hay, D. A., Levy, F., van-Beijsterveldt, C. E., Willemsen, G., Townsend, G. C., White, V., Hewitt, A. W., Mackey, D. A., Bailey, J. M., Slutske, W. S., Nyholt, D. R., Treloar, S. A., Martin, N. G., & Boomsma, D. I. (2009). Genetic influences on handedness : Data from 25,732 Australian and Dutch twin families. *Neuropsychologia*, 47(2), 330–337. <https://doi.org/10.1016/j.neuropsychologia.2008.09.005>
- Medland, S. E., Duffy, D. L., Wright, M. J., Geffen, G. M., & Martin, N. G. (2006). Handedness in twins: Joint

- analysis of data from 35 samples. *Twin Research and Human Genetics*, 9(1), 46–53. <http://doi.org/10.1375/183242706776402885>
- Meguerditchian, A., Vauclair, J., & Hopkins, W. D. (2013). On the origins of human handedness and language: A comparative review of hand preferences for bimanual coordinated actions and gestural communication in nonhuman primates. *Developmental Psychobiology*, 55(6), 637–650. <http://doi.org/10.1002/dev.21150>
- Michel, G. F. (1983). Development of hand-use preference during infancy. In: Young G, Segalowitz S, Corter C, Trehub S, editors. *Manual specialization and the developing brain*. New York: Academic Press; pp. 33–70.
- Michel, G. F. (2021). Handedness Development: A Model for Investigating the Development of Hemispheric Specialization and Interhemispheric Coordination. *Symmetry*, 13(6), 992. <http://doi.org/10.3390/sym13060992>
- Michel, G. F., Babik, I., Nelson, E. L., Campbell, J. M., & Marcinowski, E. C. (2013). How the development of handedness could contribute to the development of language. *Developmental Psychobiology*, 55(6), 608–620. <http://doi.org/10.1002/dev.21121>
- Michel, G. F., & Goodwin, R. (1979). Intrauterine birth position predicts newborn supine head position preferences. *Infant Behavior and Development*, 2(1), 29–38. [http://doi.org/10.1016/S0163-6383\(79\)80005-3](http://doi.org/10.1016/S0163-6383(79)80005-3)
- Michel, G. F., & Harkins, D. A. (1986). Postural and lateral asymmetries in the ontogeny of handedness during infancy. *Developmental Psychobiology*, 19(3), 247–258. <http://doi.org/10.1002/dev.420190310>
- Michel, G. F., Nelson, E. L., Babik, I., Campbell, J. M., & Marcinowski, E. C. (2013). Multiple Trajectories in the developmental psychobiology of human handedness. In *Advances in Child Development and Behavior* (Vol. 45, pp. 227–260). Academic Press Inc. <http://doi.org/10.1016/B978-0-12-397946-9.00009-9>
- Mickevičienė, D., Skurvydas, A., & Karanauskienė, D. (2015). Is Intraindividual Variability Different between Unimanual and Bimanual Speed-Accuracy Movements? *Perceptual and Motor Skills*, 120(1), 125–138. <http://doi.org/10.2466/25.PMS.120v14x3>
- Min, S. H., Gong, L., Baldwin, A. S., Reynaud, A., He, Z., Zhou, J., & Hess, R. F. (2021). Some psychophysical tasks measure ocular dominance plasticity more reliably than others. *Journal of Vision*, 21(8), 20. <http://doi.org/10.1167/jov.21.8.20>
- Mitchell, A. G., Harris, J. M., Benstock, S. E., & Ales, J. M. (2020). The reliability of pseudoneglect is task dependent. *Neuropsychologia*, 148, 107618. <http://doi.org/10.1016/j.neuropsychologia.2020.107618>
- Mitchell, K. J. (2011). The genetics of neurodevelopmental disease. *Current Opinion in Neurobiology*, 21(1), 197–203. <http://doi.org/10.1016/j.conb.2010.08.009>
- Mitchell, K. J. (2018). *Innate: How the wiring of our brains shapes who we are*. Princeton, NJ: Princeton University Press.
- Modabbernia, A., Mollon, J., Boffetta, P., & Reichenberg, A. (2016). Impaired Gas Exchange at Birth and Risk

- of Intellectual Disability and Autism: A Meta-analysis. *Journal of Autism and Developmental Disorders*, 46(5), 1847–1859. <http://doi.org/10.1007/s10803-016-2717-5>
- Morra, S., & Panesi, S. (2017). From scribbling to drawing: the role of working memory. *Cognitive Development*, 43, 142–158. <http://doi.org/10.1016/j.cogdev.2017.03.001>
- Mundorf, A., Matsui, H., Ocklenburg, S., & Freund, N. (2020). Asymmetry of turning behavior in rats is modulated by early life stress. *Behavioural Brain Research*, 393, 112807. <http://doi.org/10.1016/j.bbr.2020.112807>
- Mundorf, A., & Ocklenburg, S. (2021). *The clinical neuroscience of lateralization*. Routledge.
- Mundorf, A., Peterburs, J., & Ocklenburg, S. (2021). Asymmetry in the Central Nervous System: A Clinical Neuroscience Perspective. *Frontiers in Systems Neuroscience*, 15. <http://doi.org/10.3389/fnsys.2021.733898>
- Musálek, M., Scharoun Benson, S. M., Lejcarova, A., & Bryden, P. J. (2020). Cross-lateralisation in children with attention-deficit/hyperactivity disorder and motor skill performance. *International Journal of Psychology*. <http://doi.org/10.1002/ijop.12658>
- Nachshon, I., Denno, D., & Aurand, S. (1983). Lateral preferences of hand, Eye and foot: Relation to cerebral dominance. *International Journal of Neuroscience*, 18(1–2), 1–9. <http://doi.org/10.3109/00207458308985872>
- Nastou, E., Ocklenburg, S., Hoogman, M., & Papadatou-Pastou, M. (2022). Handedness in ADHD: Meta-Analyses. *Neuropsychology Review*. <http://doi.org/10.1007/s11065-021-09530-3>
- Navon, D. (1977). Forest before trees: The precedence of global features in visual perception. *Cognitive psychology*, 9(3), 353–383. [https://doi.org/10.1016/0010-0285\(77\)90012-3](https://doi.org/10.1016/0010-0285(77)90012-3)
- Nelson, E. L., Campbell, J. M., & Michel, G. F. (2013). Unimanual to bimanual: Tracking the development of handedness from 6 to 24 months. *Infant Behavior and Development*, 36(2), 181–188. <http://doi.org/10.1016/j.infbeh.2013.01.009>
- Nelson, E. L., Gonzalez, S. L., Coxe, S., Campbell, J. M., Marcinowski, E. C., & Michel, G. F. (2017). Toddler hand preference trajectories predict 3-year language outcome. *Developmental Psychobiology*, 59(7), 876–887. <http://doi.org/10.1002/dev.21560>
- Nettle, D. (2003). Hand laterality and cognitive ability: A multiple regression approach. *Brain and Cognition*, 52(3), 390–398. [http://doi.org/10.1016/S0278-2626\(03\)00187-8](http://doi.org/10.1016/S0278-2626(03)00187-8)
- Nicholls, M. E. R. (2021). To the next decade and beyond. *Laterality*, 26(3), 327–329. <http://doi.org/10.1080/1357650X.2021.1893329>
- Nicholls, M. E. R., Johnston, D. W., & Shields, M. A. (2012). Adverse birth factors predict cognitive ability, but not hand preference. *Neuropsychology*, 26(5), 578–587. <http://doi.org/10.1037/a0029151>
- Njiokiktjien, C. (2006). Differences in vulnerability between the hemispheres in early childhood and adulthood. *Human Physiology*, 32(1), 37–42. <http://doi.org/10.1134/S0362119706010051>

- Ntolka, E., & Papadatou-Pastou, M. (2018). Right-handers have negligibly higher IQ scores than left-handers: Systematic review and meta-analyses. *Neuroscience and Biobehavioral Reviews*. Elsevier Ltd. <http://doi.org/10.1016/j.neubiorev.2017.08.007>
- O'Callaghan, M. J., Burnt, Y. R., Mohay, H. A., Rogers, Y., & Tudehope, D. I. (1993). Handedness in Extremely Low Birth Weight Infants: Aetiology and Relationship to Intellectual Abilities, Motor Performance and Behaviour at Four and Six Years. *Cortex*, 29(4), 629–637. [http://doi.org/10.1016/S0010-9452\(13\)80286-9](http://doi.org/10.1016/S0010-9452(13)80286-9)
- O'Callaghan, M. J., Tudehope, D. I., Dugdale, A. E., Mohay, H., Burns, Y., & Cook, F. (1987). Handedness in children with birthweights below 1000 g. *The Lancet*, 329(8542), 1155. [http://doi.org/10.1016/S0140-6736\(87\)91719-3](http://doi.org/10.1016/S0140-6736(87)91719-3)
- Ocklenburg, S., Berretz, G., Packheiser, J., & Friedrich, P. (2020). Laterality 2020: entering the next decade. *Laterality*, 0(0), 1–33. <http://doi.org/10.1080/1357650X.2020.1804396>
- Ocklenburg, S., Beste, C., & Güntürkün, O. (2013). Handedness: A neurogenetic shift of perspective. *Neuroscience and Biobehavioral Reviews*. <http://doi.org/10.1016/j.neubiorev.2013.09.014>
- Ocklenburg, S., Bürger, C., Westermann, C., Schneider, D., Biedermann, H., & Güntürkün, O. (2010). Visual experience affects handedness. *Behavioural Brain Research*, 207(2), 447–451. <http://doi.org/10.1016/j.bbr.2009.10.036>
- Ocklenburg, S., & Güntürkün, O. (2017). *The lateralized brain: The neuroscience and evolution of hemispheric asymmetries*. Academic Press.
- Ocklenburg, S., Hirnstein, M., Beste, C., & Güntürkün, O. (2014). Lateralization and cognitive systems. *Frontiers in Psychology*, 5(SEP). <http://doi.org/10.3389/fpsyg.2014.01143>
- Ocklenburg, S., Korte, S. M., Peterburs, J., Wolf, O. T., & Güntürkün, O. (2016). Stress and laterality - The comparative perspective. *Physiology and Behavior*. Elsevier Inc. <http://doi.org/10.1016/j.physbeh.2016.06.020>
- Ocklenburg, S., Metzen, D., Schlüter, C., Fraenz, C., Arning, L., Streit, F., Güntürkün, O., Kumsta, R., & Genç, E. (2021). Polygenic scores for handedness and their association with asymmetries in brain structure. *Brain Structure and Function*, 227(2), 515–527. <https://doi.org/10.1007/s00429-021-02335-3>
- Ocklenburg, S., Packheiser, J., Schmitz, J., Rook, N., Güntürkün, O., Peterburs, J., & Grimshaw, G. M. (2018). Hugs and kisses – The role of motor preferences and emotional lateralization for hemispheric asymmetries in human social touch. *Neuroscience and Biobehavioral Reviews*. Elsevier Ltd. <http://doi.org/10.1016/j.neubiorev.2018.10.007>
- Oldfield, R. C. (1971). The assessment and analysis of handedness: The Edinburgh inventory. *Neuropsychologia*, 9(1), 97–113. [http://doi.org/10.1016/0028-3932\(71\)90067-4](http://doi.org/10.1016/0028-3932(71)90067-4)
- Orsini, D. L., & Satz, P. (1986). A Syndrome of Pathological Left-handedness: Correlates of Early Left Hemisphere Injury. *Archives of Neurology*, 43(4), 333–337. <http://doi.org/10.1001/archneur.1986.00520040021012>

- Orton, S. T. (1937). *Reading, writing and speech problems in children*. W W Norton & Co.
- Ossandón, J. P., Onat, S., & König, P. (2014). Spatial biases in viewing behavior. *Journal of Vision*, *14*(2), 1–26. <http://doi.org/10.1167/14.2.20>
- Oudgenoeg-Paz, O., Mulder, H., Jongmans, M. J., van der Ham, I. J., & Van der Stigchel, S. (2017). The link between motor and cognitive development in children born preterm and/or with low birth weight: A review of current evidence. *Neuroscience & Biobehavioral Reviews*, *80*, 382–393. <https://doi.org/10.1016/j.neubiorev.2017.06.009>
- Packheiser, J., Schmitz, J., Berretz, G., Carey, D. P., Paracchini, S., Papadatou-Pastou, M., & Ocklenburg, S. (2020). Four meta-analyses across 164 studies on atypical footedness prevalence and its relation to handedness. *Scientific Reports*, *10*(1), 1–21. <http://doi.org/10.1038/s41598-020-71478-w>
- Packheiser, J., Schmitz, J., Berretz, G., Papadatou-Pastou, M., & Ocklenburg, S. (2019). Handedness and sex effects on lateral biases in human cradling: Three meta-analyses. *Neuroscience and Biobehavioral Reviews*, *104*, 30–42. <http://doi.org/10.1016/j.neubiorev.2019.06.035>
- Packheiser, J., Schmitz, J., Metzen, D., Reinke, P., Radtke, F., Friedrich, P., Güntürkün, O., Peterburs, J., & Ocklenburg, S. (2019). Asymmetries in social touch—motor and emotional biases on lateral preferences in embracing, cradling and kissing. *Laterality*, *25*(3), 325–348. <https://doi.org/10.1080/1357650x.2019.1690496>
- Page, A. G., McManus, C., González, C. P., & Chahboun, S. (2017). Is beauty in the hand of the writer? Influences of aesthetic preferences through script directions, cultural, and neurological factors: A literature review. *Frontiers in Psychology*, *8*(AUG), 1–10. <http://doi.org/10.3389/fpsyg.2017.01325>
- Papadatou-Pastou, M. (2018). *Handedness and cognitive ability: Using meta-analysis to make sense of the data*. *Progress in Brain Research* (1st ed., Vol. 238). Elsevier B.V. <http://doi.org/10.1016/bs.pbr.2018.06.008>
- Papadatou-Pastou, M., Ntolka, E., Schmitz, J., Martin, M., Munafò, M. R., Ocklenburg, S., & Paracchini, S. (2020). Human handedness: A meta-analysis. *Psychological Bulletin*, *146*(6), 481–524. <http://doi.org/10.1037/bul0000229>
- Papadatou-Pastou, M., Panagiotidou, D. A., Abbondanza, F., Fischer, U., Paracchini, S., & Karagiannakis, G. (2021). Hand preference and Mathematical Learning Difficulties: New data from Greece, the United Kingdom, and Germany and two meta-analyses of the literature. *Laterality*, *0*(0), 1–54. <http://doi.org/10.1080/1357650X.2021.1906693>
- Papadatou-Pastou, M., & Tomprou, D. M. (2015). Intelligence and handedness: Meta-analyses of studies on intellectually disabled, typically developing, and gifted individuals. *Neuroscience and Biobehavioral Reviews*. Elsevier Ltd. <http://doi.org/10.1016/j.neubiorev.2015.06.017>
- Papademetriou, E., Sheu, C. F., & Michel, G. F. (2005). A meta-analysis of primate hand preferences, particularly for reaching. *Journal of Comparative Psychology*, *119*(1), 33–48. <http://doi.org/10.1037/0735-7036.119.1.33>
- Papadopoulou, A., Vlachos, F., & Papadatou-pastou, M. (2022). Cerebral lateralization of language in

- children at risk for dyslexia : A review of neuroscientific evidence. *Dialogues in Clinical Neuroscience & Mental Health*, 5(2), 89–97. <http://doi.org/https://doi.org/10.26386/obrela.v5i2.228>
- Paracchini, S., Diaz, R., & Stein, J. (2016). Advances in Dyslexia Genetics—New Insights Into the Role of Brain Asymmetries. *Advances in Genetics*, 96, 53–97. <http://doi.org/10.1016/bs.adgen.2016.08.003>
- Parker, A. J., Woodhead, Z. V., Carey, D. P., Groen, M. A., Gutierrez-Sigut, E., Hodgson, J., Hudson, J., Karlsson, E. M., MacSweeney, M., Payne, H., Simpson, N., Thompson, P. A., Watkins, K. E., Egan, C., Grant, J. H., Harte, S., Hudson, B. T., Sablik, M., Badcock, N. A., & Bishop, D. V. (2022). Inconsistent language lateralisation – Testing the dissociable language laterality hypothesis using behaviour and lateralised cerebral blood flow. *Cortex*, 154, 105–134. <https://doi.org/10.1016/j.cortex.2022.05.013>
- Parker, A. J., Woodhead, Z. V. J., Thompson, P. A., & Bishop, D. V. M. (2020). Assessing the reliability of an online behavioural laterality battery: A pre-registered study. *Laterality*, 0(0), 1–39. <http://doi.org/10.1080/1357650X.2020.1859526>
- Patro, K., Nuerk, H. C., & Brugger, P. (2018). Visuospatial biases in preschool children: Evidence from line bisection in three-dimensional space. *Journal of Experimental Child Psychology*, 173, 16–27. <http://doi.org/10.1016/j.jecp.2018.03.002>
- Penolazzi, B., Spironelli, C., Vio, C., & Angrilli, A. (2006). Altered hemispheric asymmetry during word processing in dyslexic children: an event-related potential study. *NeuroReport*, 17(4), 429–433. <http://doi.org/10.1097/01.wnr.0000203350.99256.7d>
- Perelle, I. B., & Ehrman, L. (1994). An international study of human handedness: The data. *Behavior Genetics*, 24(3), 217–227. <http://doi.org/10.1007/BF01067189>
- Perelle, I. B., & Ehrman, L. (2005). On the other hand. *Behavior Genetics*. <http://doi.org/10.1007/s10519-005-3226-z>
- Peters, M. (1998). Description and validation of a flexible and broadly usable handedness questionnaire. *Laterality*, 3(1), 77–96. <http://doi.org/10.1080/713754291>
- Peters, M., & Durdling, B. M. (1978). Handedness measured by finger tapping: a continuous variable. *Canadian Journal of Psychology*, 32(4), 257–261. <http://doi.org/10.1037/h0081694>
- Peters, M., Reimers, S., & Manning, J. T. (2006). Hand preference for writing and associations with selected demographic and behavioral variables in 255,100 subjects: The BBC internet study. *Brain and Cognition*, 62(2), 177–189. <http://doi.org/10.1016/j.bandc.2006.04.005>
- Pfeifer, L. S., Schmitz, J., Papadatou-Pastou, M., Peterburs, J., Paracchini, S., & Ocklenburg, S. (2022). Handedness in twins: meta-analyses. *BMC Psychology*, 10(1), 1–19. <http://doi.org/10.1186/s40359-021-00695-3>
- Picard, D. (2011). Impact of manual preference on directionality in children’s drawings. *Laterality*, 16(1), 24–34. <http://doi.org/10.1080/13576500903140610>
- Picard, D., & Zarhbouch, B. (2014). Leftward spatial bias in children’s drawing placement: Hemispheric activation versus directional hypotheses. *Laterality*, 19(1), 96–112.

- <http://doi.org/10.1080/1357650X.2013.777072>
- Planton, S., Wang, S., Bolger, D., Bonnard, M., & Pattamadilok, C. (2022). Effective connectivity of the left-ventral occipito-temporal cortex during visual word processing: Direct causal evidence from TMS-EEG co-registration. *Cortex*, *154*(Umr 7309), 167–183. <http://doi.org/10.1016/j.cortex.2022.06.004>
- Poeppel, T. B., Dimas, E., Sakreida, K., Kernbach, J. M., Markello, R. D., Schöffski, O., Dagher, A., Koellinger, P., Nave, G., Farah, M. J., Mišić, B., & Bzdok, D. (2022). Pattern learning reveals brain asymmetry to be linked to socioeconomic status. *Cerebral Cortex Communications*, *3*(2). <https://doi.org/10.1093/texcom/tgac020>
- Poffenberger, A. T. (1912). *Reaction Time to Retinal Stimulation: With Special Reference to the Time Lost in Conduction through Nerve Centers* (No.23). Science Press.
- Porac, C. (2016). *Laterality: Exploring the enigma of left -handedness*. Elsevier/AP, Academic Press is an imprint of Elsevier.
- Porac, C., & Coren, S. (1981). *Lateral preferences and human behavior*. New York: Springer-Verlag. <https://doi.org/10.1007/978-1-4613-8139-6>
- Porac, C., Coren, S., & Duncan, P. (1980). Life-span age trends in laterality. *Journals of Gerontology*, *35*(5), 715–721. <http://doi.org/10.1093/geronj/35.5.715>
- Porac, C., Coren, S., & Searleman, A. (1986). Environmental factors in hand preference formation: Evidence from attempts to switch the preferred hand. *Behavior Genetics*, *16*(2), 251–261. <http://doi.org/10.1007/BF01070800>
- Portex, M., Foulon, J. N., & Troadec, B. (2017). Cultural influence on directional tendencies in children's drawing. *Laterality*, *22*(5), 621–640. <http://doi.org/10.1080/1357650X.2016.1266363>
- Powls, A., Botting, N., Cooke, R. W., & Marlow, N. (1996). Handedness in very-low-birthweight (VLBW) children at 12 years of age: Relation to perinatal and outcome variables. *Developmental Medicine & Child Neurology*, *38*(7), 594–602. <http://doi.org/10.1111/j.1469-8749.1996.tb12124.x>
- Previc, F. H. (1991). A general theory concerning the prenatal origins of cerebral lateralization in humans. *Psychological Review*, *98*(3), 299–334. <http://doi.org/10.1037/0033-295X.98.3.299>
- Previc, F. H. (1996). *Nonright-handedness, central nervous system and related pathology, and its lateralization: A reformulation and synthesis*. *Developmental Neuropsychology* (Vol. 12). <http://doi.org/10.1080/87565649609540663>
- Prichard, E., Propper, R. E., & Christman, S. D. (2013). Degree of handedness, but not direction, is a systematic predictor of cognitive performance. *Frontiers in Psychology*. <http://doi.org/10.3389/fpsyg.2013.00009>
- Pujol, J., Deus, J., Losilla, J. M., & Capdevila, A. (1999). Cerebral lateralization of language in normal left-handed people studied by functional MRI. *Neurology*, *52*(5), 1038–1038. <https://doi.org/10.1212/WNL.52.5.1038>
- Querne, L., Berquin, P., Vernier-Hauvette, M. P., Fall, S., Deltour, L., Meyer, M. E., & de Marco, G. (2008).

- Dysfunction of the attentional brain network in children with Developmental Coordination Disorder: A fMRI study. *Brain Research*, 1244, 89–102. <http://doi.org/10.1016/j.brainres.2008.07.066>
- Raymond, M., & Pontier, D. (2004). Is there geographical variation in human handedness? *Laterality*, 9(1), 35–51. <http://doi.org/10.1080/13576500244000274>
- Reissland, N., Aydin, E., Francis, B., & Exley, K. (2015). Laterality of foetal self-touch in relation to maternal stress. *Laterality*, 20(1), 82–94. <http://doi.org/10.1080/1357650X.2014.920339>
- Rentería, M. E. (2012). Cerebral asymmetry: A quantitative, multifactorial, and plastic brain phenotype. *Twin Research and Human Genetics*, 15(3), 401–413. <http://doi.org/10.1017/thg.2012.13>
- Rey, A. (1959). *Manuel test de copie d'une figure complexe [Manual of complex Rey's figure]*. Paris, France: Editions du Centre de Psychologie Appliquée.
- Richards, G., Beking, T., Kreukels, B. P. C., Geuze, R. H., Beaton, A. A., & Groothuis, T. (2021). An examination of the influence of prenatal sex hormones on handedness: Literature review and amniotic fluid data. *Hormones and Behavior*, 129, 1–41. <http://doi.org/10.1016/j.yhbeh.2021.104929>
- Richards, G., Medland, S. E., & Beaton, A. A. (2021). Digit ratio (2D:4D) and handedness: A meta-analysis of the available literature. *Laterality*, 26(4), 421–484. <http://doi.org/10.1080/1357650X.2020.1862141>
- Richardson, A. J. (1995). Handedness and visual motion sensitivity in adult dyslexics. *The Irish Journal of Psychology*, 16(3), 229–247. <http://doi.org/10.1080/03033910.1995.10558059>
- Richardson, T. (2022). No association between adult sex steroids and hand preference in humans. *American Journal of Human Biology*, 34(2), 1–7. <http://doi.org/10.1002/ajhb.23605>
- Rinaldi, L., Di Luca, S., Henik, A., & Girelli, L. (2014). Reading direction shifts visuospatial attention: An Interactive Account of attentional biases. *Acta Psychologica*, 151, 98–105. <http://doi.org/10.1016/j.actpsy.2014.05.018>
- Rinaldi, L., Di Luca, S., Toneatto, C., & Girelli, L. (2020). The effects of hemispheric dominance, literacy acquisition, and handedness on the development of visuospatial attention: A study in preschoolers and second graders. *Journal of Experimental Child Psychology*, 195, 104830. <http://doi.org/10.1016/j.jecp.2020.104830>
- Rinaldi, L., Gallucci, M., & Girelli, L. (2016). Spatial-numerical consistency impacts on preschoolers' numerical representation: Children can count on both peripersonal and personal space. *Cognitive Development*, 37, 9–17. <http://doi.org/10.1016/j.cogdev.2015.10.006>
- Rogers, L. J. (2021). Brain lateralization and cognitive capacity. *Animals*, 11(7), 1–15. <http://doi.org/10.3390/ani11071996>
- Rönnqvist, L. (1995). A critical examination of the Moro response in newborn infants—Symmetry, state relation, underlying mechanisms. *Neuropsychologia*, 33(6), 713–726. [http://doi.org/10.1016/0028-3932\(95\)00006-0](http://doi.org/10.1016/0028-3932(95)00006-0)
- Rönnqvist, L., & Hopkins, B. (1998). Head Position Preference in the Human Newborn: A New Look. *Child Development*, 69(1), 13–23. <http://doi.org/10.1111/j.1467-8624.1998.tb06129.x>

- Rönnqvist, L., & Hopkins, B. (2000). Motor asymmetries in the human newborn are state dependent, but independent of position in space. *Experimental Brain Research*, *134*(3), 378–384. <http://doi.org/10.1007/s002210000467>
- Rönnqvist, L., Hopkins, B., Van Emmerik, R., & De Groot, L. (1998). Lateral biases in head turning and the Moro response in the human newborn: Are they both vestibular in origin? *Developmental Psychobiology*, *33*(4), 339–349. [http://doi.org/10.1002/\(SICI\)1098-2302\(199812\)33:4<339::AID-DEV5>3.0.CO;2-R](http://doi.org/10.1002/(SICI)1098-2302(199812)33:4<339::AID-DEV5>3.0.CO;2-R)
- Ross, G., Lipper, E., & Auld, P. A. M. (1992). Hand preference, prematurity and developmental outcome at school age. *Neuropsychologia*, *30*(5), 483–494. [http://doi.org/10.1016/0028-3932\(92\)90095-4](http://doi.org/10.1016/0028-3932(92)90095-4)
- Ross, G., Lipper, E. G., & Auld, P. A. M. (1987). Hand Preference Of Four-Year-Old Children: Its Relationship To Premature Birth And Neurodevelopmental Outcome. *Developmental Medicine & Child Neurology*, *29*(5), 615–622. <http://doi.org/10.1111/j.1469-8749.1987.tb08503.x>
- Roszkowski, M. J., Snelbecker, G. E., & Sacks, R. (1981). Children's, Adolescents', and Adults' Reports of Hand Preference: Homogeneity and Discriminating Power of Selected Tasks. *Journal of Clinical Neuropsychology*, *3*(3), 199–213. <http://doi.org/10.1080/01688638108403126>
- Roy, E. A., Bryden, P., & Cavill, S. (2003). Hand differences in pegboard performance through development. *Brain and Cognition*, *53*(2), 315–317. [http://doi.org/10.1016/S0278-2626\(03\)00133-7](http://doi.org/10.1016/S0278-2626(03)00133-7)
- Saman, Y., Arshad, Q., Dutia, M., & Rea, P. (2020). *Stress and the vestibular system*. *International Review of Neurobiology* (1st ed., Vol. 152). Elsevier Inc. <http://doi.org/10.1016/bs.irn.2020.03.013>
- Sanches, E. F., Arteni, N. S., Nicola, F., Boisserand, L., Willborn, S., & Netto, C. A. (2013). Early hypoxia-ischemia causes hemisphere and sex-dependent cognitive impairment and histological damage. *Neuroscience*, *237*, 208–215. <http://doi.org/10.1016/j.neuroscience.2013.01.066>
- Satz, P. (1972). Pathological Left-Handedness: An Explanaory Model. *Cortex*, *8*(2), 121–135. [http://doi.org/10.1016/S0010-9452\(72\)80013-3](http://doi.org/10.1016/S0010-9452(72)80013-3)
- Satz, P. (1973). Left-handedness and early brain insult: An explanation. *Neuropsychologia*, *11*(1), 115–117. [http://doi.org/10.1016/0028-3932\(73\)90071-7](http://doi.org/10.1016/0028-3932(73)90071-7)
- Schaafsma, S. M., Riedstra, B. J., Pfannkuche, K. A., Bouma, A., & Groothuis, T. G. G. (2009). Epigenesis of behavioural lateralization in humans and other animals. *Philosophical Transactions of the Royal Society B: Biological Sciences*. Royal Society. <http://doi.org/10.1098/rstb.2008.0244>
- Scharoun, S. M., & Bryden, P. J. (2014). Hand preference, performance abilities, and hand selection in children. *Frontiers in Psychology*. <http://doi.org/10.3389/fpsyg.2014.00082>
- Scharoun Benson, S. M., Williams, N., Tucker, J., & Bryden, P. J. (2021). How far will you go before switching hands? Handedness on the long pegboard across the lifespan. *Developmental Psychobiology*, *63*(5), 1109–1119. <http://doi.org/10.1002/dev.22112>
- Schepers, S., Deković, M., Feltzer, M., De Kleine, M., & Van Baar, A. (2012). Drawings of very preterm-born children at 5 years of age: A first impression of cognitive and motor development? *European Journal*

- of Pediatrics*, 171(1), 43–50. <http://doi.org/10.1007/s00431-011-1476-8>
- Schiefenhövel, W. (2013). Biased semantics for right and left in 50 Indo-European and non-Indo-European languages. *Annals of the New York Academy of Sciences*, 1288(1), 135–152. <http://doi.org/10.1111/nyas.12124>
- Schmitt, A., Malchow, B., Hasan, A., & Falkai, P. (2014). The impact of environmental factors in severe psychiatric disorders. *Frontiers in Neuroscience*, 8(8 FEB), 1–10. <http://doi.org/10.3389/fnins.2014.00019>
- Schmitz, J., Güntürkün, O., & Ocklenburg, S. (2019). Building an asymmetrical brain: The molecular perspective. *Frontiers in Psychology*. Frontiers Media S.A. <http://doi.org/10.3389/fpsyg.2019.00982>
- Schmitz, J., Metz, G. A. S., Güntürkün, O., & Ocklenburg, S. (2017). Beyond the genome—Towards an epigenetic understanding of handedness ontogenesis. *Progress in Neurobiology*, 159, 69–89. <http://doi.org/10.1016/j.pneurobio.2017.10.005>
- Schmitz, J., Zheng, M., Lui, K. F. H., McBride, C., Ho, C. S. H., & Paracchini, S. (2022). Quantitative multidimensional phenotypes improve genetic analysis of laterality traits. *Translational Psychiatry*, 12(1), 1–8. <http://doi.org/10.1038/s41398-022-01834-z>
- Schwartz, M. (1988). Handedness, prenatal stress and pregnancy complications. *Neuropsychologia*, 26(6), 925–929. [http://doi.org/10.1016/0028-3932\(88\)90060-7](http://doi.org/10.1016/0028-3932(88)90060-7)
- Searleman, A., Porac, C., & Coren, S. (1989). Relationship Between Birth Order, Birth Stress, and Lateral Preferences: A Critical Review. *Psychological Bulletin*, 105(3), 397–408. <http://doi.org/10.1037/0033-2909.105.3.397>
- Sebastjan, A., Skrzek, A., Ignasiak, Z., & Slawinska, T. (2017). Age-related changes in hand dominance and functional asymmetry in older adults. *PLoS ONE*, 12(5). <http://doi.org/10.1371/journal.pone.0177845>
- Seydell-Greenwald, A., Pu, S. F., Ferrara, K., Chambers, C. E., Newport, E. L., & Landau, B. (2019). Revisiting the Landmark Task as a tool for studying hemispheric specialization: What's really right? *Neuropsychologia*, 127, 57–65. <http://doi.org/10.1016/j.neuropsychologia.2019.01.022>
- Sha, Z., Pepe, A., Schijven, D., Carrión-Castillo, A., Roe, J. M., Westerhausen, R., Joliot, M., Fisher, S. E., Crivello, F., & Francks, C. (2021). Handedness and its genetic influences are associated with structural asymmetries of the cerebral cortex in 31,864 individuals. *Proceedings of the National Academy of Sciences*, 118(47). <https://doi.org/10.1073/pnas.2113095118>
- Sha, Z., Schijven, D., Carrion-Castillo, A., Joliot, M., Mazoyer, B., Fisher, S. E., Crivello, F., & Francks, C. (2021). The genetic architecture of structural left–right asymmetry of the human brain. *Nature Human Behaviour*, 5(9), 1226–1239. <https://doi.org/10.1038/s41562-021-01069-w>
- Sha, Z., Schijven, D., & Francks, C. (2021). Patterns of brain asymmetry associated with polygenic risks for autism and schizophrenia implicate language and executive functions but not brain masculinization. *Molecular Psychiatry*, 26(12), 7652–7660. <http://doi.org/10.1038/s41380-021-01204-z>
- Shanon, B. (1979). Graphological patterns as a function of handedness and culture. *Neuropsychologia*,

- 17(5), 457–465. [http://doi.org/10.1016/0028-3932\(79\)90052-6](http://doi.org/10.1016/0028-3932(79)90052-6)
- Shaw, J., Claridge, G., & Clark, K. (2001). Schizotypy and the shift from dextrality: A study of handedness in a large non-clinical sample. *Schizophrenia Research*, 50(3), 181–189. [http://doi.org/10.1016/S0920-9964\(00\)00167-5](http://doi.org/10.1016/S0920-9964(00)00167-5)
- Sheppard, D. M., Bradshaw, J. L., Mattingley, J. B., & Lee, P. (1999). Effects of stimulant medication on the lateralisation of line bisection judgements of children with attention deficit hyperactivity disorder. *Journal of Neurology Neurosurgery and Psychiatry*, 66(1), 57–63. <http://doi.org/10.1136/jnnp.66.1.57>
- Sicotte, N. L., Woods, R. P., & Mazziotta, J. C. (1999). Handedness in Twins: A Meta-analysis. *Laterality*, 4(3), 265–286. <http://doi.org/10.1080/713754339>
- Sireteanu, R., Goertz, R., Bachert, I., & Wandert, T. (2005). Children with developmental dyslexia show a left visual “minineglect.” *Vision Research*, 45(25–26), 3075–3082. <http://doi.org/10.1016/j.visres.2005.07.030>
- Slezicki, K. I., Cho, Y. W., Yi, S. D., Brock, M. S., Pfeiffer, M. H., McVearry, K. M., Tractenberg, R. E., & Motamedi, G. K. (2009). Incidence of atypical handedness in epilepsy and its association with clinical factors. *Epilepsy & Behavior*, 16(2), 330–334. <https://doi.org/10.1016/j.yebeh.2009.08.006>
- Somers, M., Shields, L. S., Boks, M. P., Kahn, R. S., & Sommer, I. E. (2015). Cognitive benefits of right-handedness: A meta-analysis. *Neuroscience and Biobehavioral Reviews*, 51, 48–63. <http://doi.org/10.1016/j.neubiorev.2015.01.003>
- Somers, M., Sommer, I. E., Boks, M. P., & Kahn, R. S. (2009). Hand-preference and population schizotypy: A meta-analysis. *Schizophrenia Research*, 108(1–3), 25–32. <http://doi.org/10.1016/j.schres.2008.11.010>
- Sommer, I., Aleman, A., Ramsey, N., Bouma, A., & Kahn, R. (2001). Handedness, language lateralisation and anatomical asymmetry in schizophrenia: Meta-analysis. *British Journal of Psychiatry*, 178(APR.), 344–351. <http://doi.org/10.1192/bjp.178.4.344>
- Sørensen, Ø., & Westerhausen, R. (2020). From observed laterality to latent hemispheric differences: Revisiting the inference problem. *Laterality*, 25(5), 560–582. <http://doi.org/10.1080/1357650X.2020.1769124>
- Steele, J., & Uomini, N. (2005). Humans, tools and handedness. *Stone Knapping: The Necessary Conditions for a Uniquely Hominin Behavior*, 217–239. Retrieved from <http://discovery.ucl.ac.uk/2345/>
- Steenhuis, R. E., & Bryden, M. P. (1989). Different Dimensions of Hand Preference That Relate to Skilled and Unskilled Activities. *Cortex*, 25(2), 289–304. [http://doi.org/10.1016/S0010-9452\(89\)80044-9](http://doi.org/10.1016/S0010-9452(89)80044-9)
- Steenhuis, R. E., & Bryden, M. P. (1999). The Relation between Hand Preference and Hand Performance: What You Get Depends on What You Measure. *Laterality*, 4(1), 3–26. <http://doi.org/10.1080/713754324>
- Strappini, F., Galati, G., & Pecchinenda, A. (2021). A Systematic Review on the Interaction between Emotion and Pseudoneglect. *Symmetry*, 13(8), 1531. <http://doi.org/10.3390/sym13081531>

- Streri, A., & de Hevia, M. D. (2014). Manual lateralization in infancy. *Frontiers in Psychology*. Frontiers Media S.A. <http://doi.org/10.3389/fpsyg.2014.01575>
- Ströckens, F., Güntürkün, O., & Ocklenburg, S. (2013). Limb preferences in non-human vertebrates. *Laterality*, *18*(5), 536–575. <http://doi.org/10.1080/1357650X.2012.723008>
- Suavansri, K., Falchok, A. D., Williamson, J. B., & Heilman, K. M. (2012). Right up there: Hemispatial and hand asymmetries of altitudinal pseudoneglect. *Brain and Cognition*, *79*(3), 216–220. <http://doi.org/10.1016/j.bandc.2012.03.003>
- Sutton, P. J., & Rose, D. H. (1998). *The Role of Strategic Visual Attention in Children's Drawing Development*. *JOURNAL OF EXPERIMENTAL CHILD PSYCHOLOGY* (Vol. 68).
- Szaflarski, J. P., Rajagopal, A., Altaye, M., Byars, A. W., Jacola, L., Schmithorst, V. J., Schapiro, M. B., Plante, E., & Holland, S. K. (2012). Left-handedness and language lateralization in children. *Brain Research*, *1433*, 85–97. <https://doi.org/10.1016/j.brainres.2011.11.026>
- Tan, L. E., & Nettleton, N. C. (1980). Left Handedness, Birth Order and Birth Stress. *Cortex*, *16*(3), 363–373. [http://doi.org/10.1016/S0010-9452\(80\)80038-4](http://doi.org/10.1016/S0010-9452(80)80038-4)
- Tan, U., & Tan, M. (1999). Incidences of asymmetries for the palmar grasp reflex in neonates and hand preference in adults. *NeuroReport*, *10*(16), 3253–3256. <http://doi.org/10.1097/00001756-199911080-00001>
- Tapley, S. M., & Bryden, M. P. (1985). A group test for the assessment of performance between the hands. *Neuropsychologia*, *23*(2), 215–221. [http://doi.org/10.1016/0028-3932\(85\)90105-8](http://doi.org/10.1016/0028-3932(85)90105-8)
- Theodoridou, D., Christodoulides, P., Zakopoulou, V., & Syrrou, M. (2021). Developmental dyslexia: Environment matters. *Brain Sciences*, *11*(6), 1–8. <http://doi.org/10.3390/brainsci11060782>
- Tiemeier, H., & McCormick, M. C. (2019). The Apgar paradox. *European Journal of Epidemiology*, *34*(2), 103–104. <http://doi.org/10.1007/s10654-018-0466-9>
- Tinbergen, N. (1963). On aims and methods of ethology. *Zeitschrift für tierpsychologie*, *20*(4), 410–433. <https://doi.org/10.1111/j.1439-0310.1963.tb01161.x>
- Toomela, A. (2002). Drawing as a verbally mediated activity: A study of relationships between verbal, motor, and visuospatial skills and drawing in children. *International Journal of Behavioral Development*, *26*(3), 234–247. <http://doi.org/10.1080/01650250143000021>
- Tosun, S., & Vaid, J. (2014). What affects facing direction in human facial profile drawing? A meta-analytic inquiry. *Perception*, *43*(12), 1377–1392. <http://doi.org/10.1068/p7805>
- Tran, U. S., Stieger, S., & Voracek, M. (2014). Evidence for general right-, mixed-, and left-sidedness in self-reported handedness, footedness, eyedness, and earedness, and a primacy of footedness in a large-sample latent variable analysis. *Neuropsychologia*, *62*(1), 220–232. <http://doi.org/10.1016/j.neuropsychologia.2014.07.027>
- Triggs, W. J., Calvanio, R., Levine, M., Heaton, R. K., & Heilman, K. M. (2000). Predicting Hand Preference with Performance on Motor Tasks. *Cortex*, *36*(5), 679–689. <http://doi.org/10.1016/S0010->

9452(08)70545-8

- Turkewitz, G. (2007). The relevance of the fetal and neonatal period for the development of novelty preferences, learning, habituation and hemispheric specialization. *Developmental Psychobiology*, 49(8), 780–787. <http://doi.org/10.1002/dev.20275>
- Tversky, B., Kugelmass, S., & Winter, A. (1991). Cross-cultural and developmental trends in graphic productions. *Cognitive Psychology*, 23(4), 515–557. [http://doi.org/10.1016/0010-0285\(91\)90005-9](http://doi.org/10.1016/0010-0285(91)90005-9)
- Tzourio-Mazoyer, N., Crivello, F., & Mazoyer, B. (2018). Is the planum temporale surface area a marker of hemispheric or regional language lateralization? *Brain Structure and Function*, 223(3), 1217–1228. <http://doi.org/10.1007/s00429-017-1551-7>
- Uomini, N. T., & Ruck, L. (2018). Manual laterality and cognition through evolution: An archeological perspective. In *Progress in Brain Research* (Vol. 238, pp. 295–323). Elsevier B.V. <http://doi.org/10.1016/bs.pbr.2018.06.015>
- Vaid, J. (2011). Asymmetries in representational drawing: Alternatives to a laterality account. *Spatial Dimensions of Social Thought*, 231–256. <http://doi.org/10.1515/9783110254310.231>
- Vaid, J., Rhodes, R., Tosun, S., & Eslami, Z. (2011). Script directionality affects depiction of depth in representational drawings. *Social Psychology*, 42(3), 241–248. <http://doi.org/10.1027/1864-9335/a000068>
- Vaid, J., Singh, M., Sakhuja, T., & Gupta, G. C. (2002). Stroke Direction Asymmetry in Figure Drawing: Influence of Handedness and Reading/Writing Habits. *Brain and Cognition*, 48(2–3), 597–602. <http://doi.org/10.1006/brcg.2001.1424>
- Vallortigara, G., & Rogers, L. (2005). Survival with an asymmetrical brain: advantages and disadvantages of cerebral lateralization. *Behavioral and brain sciences*. <https://doi.org/10.1017/S0140525X05270103>
- Van Der Elst, W., Hurks, P. P. M., Wassenberg, R., Meijs, C. J. C., Van Boxtel, M. P. J., & Jolles, J. (2011). On the association between lateral preferences and pregnancy/birth stress events in a nonclinical sample of school-aged children. *Journal of Clinical and Experimental Neuropsychology*, 33(1), 1–8. <http://doi.org/10.1080/13803391003757825>
- Van der Haegen, L., & Brysbaert, M. (2018). The relationship between behavioral language laterality, face laterality and language performance in left-handers. *PLoS ONE*, 13(12), 1–22. <http://doi.org/10.1371/journal.pone.0208696>
- Van der Haegen, L., Cai, Q., & Brysbaert, M. (2012). Colateralization of Broca's area and the visual word form area in left-handers: FMRI evidence. *Brain and Language*, 122(3), 171–178. <http://doi.org/10.1016/j.bandl.2011.11.004>
- van Heerwaarde, A. A., van der Kamp, L. T., van der Aa, N. E., de Vries, L. S., Groenendaal, F., Jongmans, M. J., Eijssermans, R. J. C., Koopman-Esseboom, C., van Haastert, I. L. C., Benders, M. J. N. L., & Dudink, J. (2020). Non-right-handedness in children born extremely preterm : Relation to early neuroimaging and long-term neurodevelopment. *PLOS ONE*, 15(7), e0235311. <https://doi.org/10.1371/journal.pone.0235311>

- van Sommers, P. (1984). *Drawing and Cognition*. Cambridge University Press. <https://doi.org/10.1017/CBO9780511897672>
- van Sommers, P. (1989). A System for Drawing and Drawing-Related Neuropsychology. *Cognitive Neuropsychology*, 6(2), 117–164. <https://doi.org/10.1080/02643298908253416>
- Vargha-khadem, F., O'gorman, A. M., & Watters, G. V. (1985). Aphasia and handedness in relation to hemispheric side, age at injury and severity of cerebral lesion during childhood. *Brain*, 108(3), 677–696. <http://doi.org/10.1093/brain/108.3.677>
- Vauclair, J. (2022). Maternal cradling bias: A marker of the nature of the mother–infant relationship. *Infant Behavior and Development*, 66, 101680. <http://doi.org/10.1016/j.infbeh.2021.101680>
- Veale, J. F. (2014). Edinburgh Handedness Inventory – Short Form: A revised version based on confirmatory factor analysis. *Laterality*, 19(2), 164–177. <http://doi.org/10.1080/1357650X.2013.783045>
- Ververs, I. A. P., de Vries, J. I. P., van Geijn, H. P., & Hopkins, B. (1994a). Prenatal head position from 12–38 weeks. I. Developmental aspects. *Early Human Development*, 39(2), 83–91. [http://doi.org/10.1016/0378-3782\(94\)90157-0](http://doi.org/10.1016/0378-3782(94)90157-0)
- Ververs, I. A. P., de Vries, J. I. P., van Geijn, H. P., & Hopkins, B. (1994b). Prenatal head position from 12–38 weeks. II. The effects of fetal orientation and placental localization. *Early Human Development*, 39(2), 93–100. [http://doi.org/10.1016/0378-3782\(94\)90158-9](http://doi.org/10.1016/0378-3782(94)90158-9)
- Vingerhoets, G. (2019). Phenotypes in hemispheric functional segregation? Perspectives and challenges. *Physics of Life Reviews*. Elsevier B.V. <http://doi.org/10.1016/j.plrev.2019.06.002>
- Vinter, A. (1999). How meaning modifies drawing behavior in children. *Child Development*, 70(1), 33–49. <http://doi.org/10.1111/1467-8624.00004>
- Vogel, J. J., Bowers, C. A., & Vogel, D. S. (2003). Cerebral lateralization of spatial abilities: A meta-analysis. *Brain and Cognition*, 52(2), 197–204. [http://doi.org/10.1016/S0278-2626\(03\)00056-3](http://doi.org/10.1016/S0278-2626(03)00056-3)
- Voyer, D. (1996). On the magnitude of laterality effects and sex differences in functional lateralities. *Laterality*, 1(1), 51–84. <http://doi.org/10.1080/713754209>
- Voyer, D. (2021). Look to the future but remember the past: A commentary on Ocklenburg, Berretz, Packheiser, and Friedrich (2020). *Laterality*, 0(0), 1–5. <http://doi.org/10.1080/1357650X.2020.1866595>
- Wadon, M., Modi, N., Wong, H. S., Thapar, A., & O'Donovan, M. C. (2020). Recent advances in the genetics of preterm birth. *Annals of Human Genetics*, 84(3), 205–213. <http://doi.org/10.1111/ahg.12373>
- Wainstock, T., & Sheiner, E. (2022). Low Five-Minute Apgar Score and Neurological Morbidities: Does Prematurity Modify the Association? *Journal of Clinical Medicine*, 11(7). <http://doi.org/10.3390/jcm11071922>
- Waldie, K. E., & Hausmann, M. (2010). Right fronto-parietal dysfunction in children with ADHD and developmental dyslexia as determined by line bisection judgements. *Neuropsychologia*, 48(12), 3650–3656. <http://doi.org/10.1016/j.neuropsychologia.2010.08.023>

- Wallois, F., Routier, L., & Bourel-Ponchel, E. (2020). *Impact of prematurity on neurodevelopment. Handbook of Clinical Neurology* (1st ed., Vol. 173). Elsevier B.V. <http://doi.org/10.1016/B978-0-444-64150-2.00026-5>
- Wallon, P. (2016). Intérêt des mesures objectives en psychologie. *Le Journal Des Psychologues*, *n° 340*(8), 58–63. <http://doi.org/10.3917/jdp.340.0058>
- Watterberg, K. L., Aucott, S., Benitz, W. E., Cummings, J. J., Eichenwald, E. C., Goldsmith, J., Poindexter, B. B., Puopolo, K., Stewart, D. L., Wang, K. S., Ecker, J. L., Wax, J. R., Borders, A. E. B., El-Sayed, Y. Y., Heine, R. P., Jamieson, D. J., Mascola, M. A., Minkoff, H. L., Stuebe, A. M., . . . Wharton, K. R. (2015). The Apgar Score. *Pediatrics*, *136*(4), 819–822. <https://doi.org/10.1542/peds.2015-2651>
- Weiss, B., Nárai, Á., & Vidnyánszky, Z. (2022). Lateralization of early orthographic processing during natural reading is impaired in developmental dyslexia. *NeuroImage*, *258*, 119383. <http://doi.org/10.1016/j.neuroimage.2022.119383>
- Westerhausen, R. (2022, July 4). Interhemispheric integration in the split-brain: a meta-analysis of Poffenberger and redundant-target paradigms after callosotomy. <https://doi.org/10.31234/osf.io/ptbkg>
- Westerhausen, R., & Kompus, K. (2018). How to get a left-ear advantage: A technical review of assessing brain asymmetry with dichotic listening. *Scandinavian Journal of Psychology*, *59*(1), 66–73. <http://doi.org/10.1111/sjop.12408>
- Wiberg, A., Ng, M., al Omran, Y., Alfaro-Almagro, F., McCarthy, P., Marchini, J., Bennett, D. L., Smith, S., Douaud, G., & Furniss, D. (2019). Handedness, language areas and neuropsychiatric diseases : insights from brain imaging and genetics. *Brain*, *142*(10), 2938–2947. <https://doi.org/10.1093/brain/awz257>
- Wiener-Vacher, S. (2001). What is useful in vestibular testing? *Oto-Rhino-Laryngologia Nova*, *11*(2), 95–98. <http://doi.org/10.1159/000048746>
- Willems, R. M., der Haegen, L. V., Fisher, S. E., & Francks, C. (2014). On the other hand: Including left-handers in cognitive neuroscience and neurogenetics. *Nature Reviews Neuroscience*. Nature Publishing Group. <http://doi.org/10.1038/nrn3679>
- Williams, N., Scharoun Benson, S. M., & Bryden, P. J. (2019). Investigating the efficacy of the hand selection complexity task across the lifespan. *Frontiers in Psychology*, *10*(JUN). <http://doi.org/10.3389/fpsyg.2019.01130>
- Wocadlo, C., & Rieger, I. (2008). Motor impairment and low achievement in very preterm children at eight years of age. *Early human development*, *84*(11), 769–776. <https://doi.org/10.1016/j.earlhumdev.2008.06.001>
- Woodhead, Z. V. J., Bradshaw, A. R., Wilson, A. C., Thompson, P. A., & Bishop, D. V. M. (2019). Testing the unitary theory of language lateralization using functional transcranial Doppler sonography in adults. *Royal Society Open Science*, *6*(3). <http://doi.org/10.1098/rsos.181801>
- Yamashita, H. (2021). Impact of aging on perceptual asymmetries for horizontal and vertical stimuli in the greyscales task. *Applied Neuropsychology:Adult*, *0*(0), 1–10.

<http://doi.org/10.1080/23279095.2021.1917577>

- Zago, L., Petit, L., Jobard, G., Hay, J., Mazoyer, B., Tzourio-Mazoyer, N., Karnath, H. O., & Mellet, E. (2017). Pseudoneglect in line bisection judgement is associated with a modulation of right hemispheric spatial attention dominance in right-handers. *Neuropsychologia*, *94*, 75-83. <https://doi.org/10.1016/j.neuropsychologia.2016.11.024>
- Zago, L., Petit, L., Mellet, E., Jobard, G., Crivello, F., Joliot, M., Mazoyer, B., & Tzourio-Mazoyer, N. (2016). The association between hemispheric specialization for language production and for spatial attention depends on left-hand preference strength. *Neuropsychologia*, *93*, 394-406. <https://doi.org/10.1016/j.neuropsychologia.2015.11.018>
- Zu Eulenburg, P., Caspers, S., Roski, C., & Eickhoff, S. B. (2012). Meta-analytical definition and functional connectivity of the human vestibular cortex. *NeuroImage*, *60*(1), 162-169. <http://doi.org/10.1016/j.neuroimage.2011.12.032>
- Zu Eulenburg, P., Stoeter, P., & Dieterich, M. (2010). Voxel-based morphometry depicts central compensation after vestibular neuritis. *Annals of Neurology*, *68*(2), 241-249. <http://doi.org/10.1002/ana.22063>
- Zverev, Y. P. (2006). Cultural and environmental pressure against left-hand preference in urban and semi-urban Malawi. *Brain and Cognition*, *60*(3), 295-303. <http://doi.org/10.1016/j.bandc.2005.07.008>
- Zwicker, J. G., Yoon, S. W., MacKay, M., Petrie-Thomas, J., Rogers, M., & Synnes, A. R. (2013). Perinatal and neonatal predictors of developmental coordination disorder in very low birthweight children. *Archives of Disease in Childhood*, *98*(2), 118-122. <http://doi.org/10.1136/archdischild-2012-302268>

Appendix

Article 1

Appendix 1

French original instructions:

"Well, I see that you draw very well. I really like your drawings. Now look, I am going to show you something and then I would like you to draw it for me. Be careful, look carefully as you are going to make a drawing that looks as close as possible to the model you are going to see":

"Bien, je vois que tu dessines très bien. J'aime beaucoup tes dessins. Maintenant regarde, je vais te montrer quelque chose et j'aimerais que tu me le dessines. Fait attention, regarde-là attentivement car après tu devras dessiner uniquement ce que tu vas voir de la maquette".

"Do you see the house and the landscape? So, tell me what you see":

"Tu vois la maison et le paysage ? Alors, raconte-moi ce que tu vois".

"In the centre, we see a symmetrical house, just in front is a river surrounded by bushes, and behind the house we see six trees":

"Au centre, nous voyons une maison symétrique, juste devant se trouve une rivière avec autour des buissons, et derrière la maison se trouve six arbres".

"You are now going to draw everything you saw".

"Tu vas dessiner maintenant tout ce que tu vois".

Appendix 2

Table I. Eigen values and the variance percentage of the 18 dimensions

Dimensions	Eigen value	Variance %	Cumulative variance %
1	0.29	16.38	16.38
2	0.24	13.32	29.70
3	0.19	10.46	40.16
4	0.14	7.80	47.96
5	0.13	7.42	55.38
6	0.12	6.79	62.17
7	0.10	5.67	67.84
8	0.01	5.47	73.31
9	0.09	4.88	78.19
10	0.08	4.43	82.62
11	0.07	3.85	86.47
12	0.06	3.45	89.92
13	0.05	2.88	92.80
14	0.04	2.39	95.19
15	0.03	1.92	97.11
16	0.03	1.52	98.63
17	0.02	1.26	99.89
18	0.002	0.11	100.00

Appendix 3

Table II. Significant factor sets of the three main dimensions presented in a descendent order

Variables	Dimension 1	
	R ²	<i>p</i>
Progression axes	0.86	<.001

Handedness	0.82	<.001
Point of origin	0.63	<.001
Density	0.29	<.001
Order of placement	0.25	<.001
Dimension 2		
Variables	R ²	<i>p</i>
Complementarity	0.73	<.001
Spatial arrangement	0.62	<.001
Density	0.31	<.001
Representation	0.28	<.001
Sex	0.16	<.001
Dimension 3		
Variables	R ²	<i>p</i>
Complementarity	0.56	<.001
Spatial arrangement	0.50	<.001
Point of origin	0.34	<.001
Directionality	0.20	<.001
Order placement	0.13	<.05
Sex	0.07	<.05

Note. R²: effect size of each category

Appendix 4

Table III. Association between our variables' categories on the MCA's two dimensions

Dimension 1		
Categories	Estimate	<i>p</i>
Handedness: Left	0.50	<.001
Progression axes: Right to left	0.44	<.001
Point of origin: Right	0.30	<.001

Density: Balanced	0.35	<.001
Order of placement: BCA	0.19	<.01
Spatial arrangement: B	0.19	<.05
Density: Left	-0.32	<.001
Order of placement: BAC	-0.41	<.001
Point of origin: Left	-0.57	<.001
Handedness: Right	-0.50	<.001
Progression axes: Left to right	-0.62	<.001

Dimension 2

Categories	Estimate	<i>p</i>
Complementarity: Left	0.33	<.001
Spatial arrangement: C	0.26	<.001
Density: Right	0.40	<.001
Representation: Incorrect	0.26	<.001
Complementarity: Right	0.25	<.001
Spatial arrangement: A	0.26	<.001
Sex: Boys	0.20	<.001
Progression axes: Right to left	0.23	<.05
Order placement: ABC	-0.32	<.01
Sex: Girls	-0.20	<.001
Density: Balanced	-0.30	<.001
Representation: Correct	-0.26	<.001
Spatial arrangement: B	-0.52	<.001
Complementarity: Balanced	-0.58	<.001

Dimension 3

Categories	Estimate	<i>p</i>
Complementarity: Right	0.60	<.001
Spatial arrangement: A	0.52	<.001

Directionality: Right	0.14	<.01
Order of placement: Other	0.38	<.01
Point of origin: Right	0.43	<.01
Sex: Boys	0.11	<.05
Sex: Girls	-0.11	<.05
Directionality: Left	-0.27	<.001
Complementarity: Left	-0.51	<.001
Point of origin: Centre	-0.66	<.001
Spatial arrangement: C	-0.47	<.001

Appendix 5

Table IV. All the significant variables describing the five clusters

Variables	<i>df</i>	<i>p</i>
Complementarity	8	<.001
Progression axes	8	<.001
Handedness	4	<.001
Spatial arrangement	8	<.001
Point of origin	8	<.001
Order of placement	12	<.001
Directionality	8	<.001
Density	8	<.01
Representation	4	<.01

Table V. Results for all the significant categories characterizing each cluster

Cluster 1					
	Cla/Mod	Mod/Cla	Global	v.test	<i>p</i>
Progression axes: Left to right	41.18	100.00	53.13	4.18	<.001
Order of placement: BAC	50.00	85.71	37.50	4.06	<.001
Handedness: Right	40.00	100.00	54.69	4.06	<.001
Spatial arrangement: C	56.25	64.29	25.00	3.49	<.001
Point of origin: Left	36.11	92.86	56.25	3.17	<.01
Directionality: Left	41.67	71.43	37.50	2.82	<.01
Representation: Incorrect	33.33	92.86	60.94	2.82	<.01
Complementarity: Left	46.15	42.86	20.31	2.14	<.05
Density: Left	38.10	57.14	32.81	2.06	<.05
Cluster 2					
	Cla/Mod	Mod/Cla	Global	v.test	<i>p</i>
Progression axes: Left to right	47.06	100.00	53.12	4.59	<.001
Handedness: Right	45.71	100.00	54.69	4.46	<.001
Spatial arrangement: B	42.11	100.00	59.38	4.08	<.001
Complementarity: Balanced	39.02	100.00	64.06	3.71	<.001
Directionality: Right	41.94	81.25	48.44	2.98	<.01
Point of origin: Left	38.89	87.50	56.25	2.91	<.01
Representation: Correct	44.00	68.75	39.06	2.69	<.01
Cluster 3					
	Cla/Mod	Mod/Cla	Global	v.test	<i>p</i>
Spatial arrangement: A	60.00	85.71	15.63	4.28	<.001
Complementarity: Right	60.00	85.71	15.63	4.28	<.001
Order of placement: Other	50.00	42.86	9.38	2.43	<.05
Directionality: Right	19.35	85.71	48.44	1.98	<.05

Cluster 4

	Cla/Mod	Mod/Cla	Global	v.test	<i>p</i>
Handedness: Left	58.62	94.44	45.31	5.02	<.001
Density: Balanced	50.00	77.78	43.75	3.35	<.001
Complementarity: Balanced	41.47	94.44	64.06	3.27	<.01
Progression axes: Other	85.71	33.33	10.94	3.18	<.01
Progression axes: Right to left	52.17	66.67	35.94	3.06	<.01
Point of origin: Right	50.00	66.67	37.50	2.89	<.01
Spatial arrangement: B	39.47	83.33	59.38	2.42	<.05
Order placement: ABC	53.85	38.89	20.31	2.13	<.05
Cluster 5					
	Cla/Mod	Mod/Cla	Global	v.test	<i>p</i>
Progression axes: Right to left	39.13	100	35.94	4.18	<.001
Complementarity: Left	53.85	77.78	20.31	3.93	<.001
Handedness: Left	31.03	100.00	45.31	3.57	<.001
Order of placement: BCA	33.33	77.78	32.81	2.84	<.01
Spatial arrangement: C	37.50	66.67	25.00	2.75	<.01
Point of origin: Centre	75.00	33.33	6.25	2.67	<.01

Note. Cla/Mod: % of individuals belonging to the cluster

Global: % of the individual among our sample

Appendix 6

Table VI. Goodness of fit of the General Linear Models

Variable	n	df	AIC	χ^2	Model R^2	<i>p</i>
Complementarity	65	2				
handedness			125.11	1.47	.01	.48
sex			116.73	9.55*	.08	.01
handedness*sex			122.75	1.02	.10	.60
Density	66	2				

handedness			138.90	9.78*	.07	.01
sex			147.90	0.73	.01	.70
handedness*sex			145.86	0.36	.08	.83
Directionality	66	2				
handedness			138.02	0.10	.01	.95
sex			135.11	3.60	.02	.16
handedness*sex			138.56	4.30	.06	.12
Order of placement	66	3				
handedness			176.01	3.89	.02	.27
sex			177.18	3.09	.02	.38
handedness*sex			181.07	4.43	.06	.22
Point of origin	66	2				
handedness			92.91	28.40***	.25	<.001
sex			119.77	0.23	.02	.90
handedness*sex			92.36	6.78*	.33	.03
Progression axes	66	2				
handedness			55.94	78.68***	.62	<.001
sex			132.09	2.59	.01	.27
handedness*sex			61.32	0.001	.64	.99
Representation	65	1				
handedness			90.60	0.04	.00	.83
sex			90.60	0.03	.00	.86
handedness*sex			94.31	0.23	.01	.63
Spatial arrangement	65	2				
handedness			129.85	0.46	.01	.80
sex			126.23	4.14	.03	.13
handedness*sex			133.56	0.25	.04	.88

Note. * $p < .05$; ** $p < .01$; *** $p < .001$

Appendix 7

Table VII. Description of the participants constituting cluster 3

Variables	Participants						
	2	19	20	23	38	42	51
Sex	Girl	Boy	Boy	Girl	Boy	Boy	Boy
Handedness	Left	Left	Left	Right	Right	Right	Right
Directionality	Right	Right	Right	Right	Balanced	Right	Right
Density	Right	Right	Left	Right	Right	Left	balanced
Point of origin	Right	Right	Right	Left	Left	Left	Right
Complementarity	Right	Right	Right	balanced	Right	Right	Right
Representation	Incorrect	Incorrect	Correct	Incorrect	Incorrect	Incorrect	Incorrect
Progression axes	RL	Vertical	RL	LR	LR	LR	LR
Order of placement	Other	BAC	BCA	Other	BAC	BCA	Other
Spatial arrangement	B	A	A	A	A	A	A

Note: RL: Right to left; LR: Left to right

Appendix 8

Figure 1. Correlations between all the categories on the three dimensions obtained by the MCA

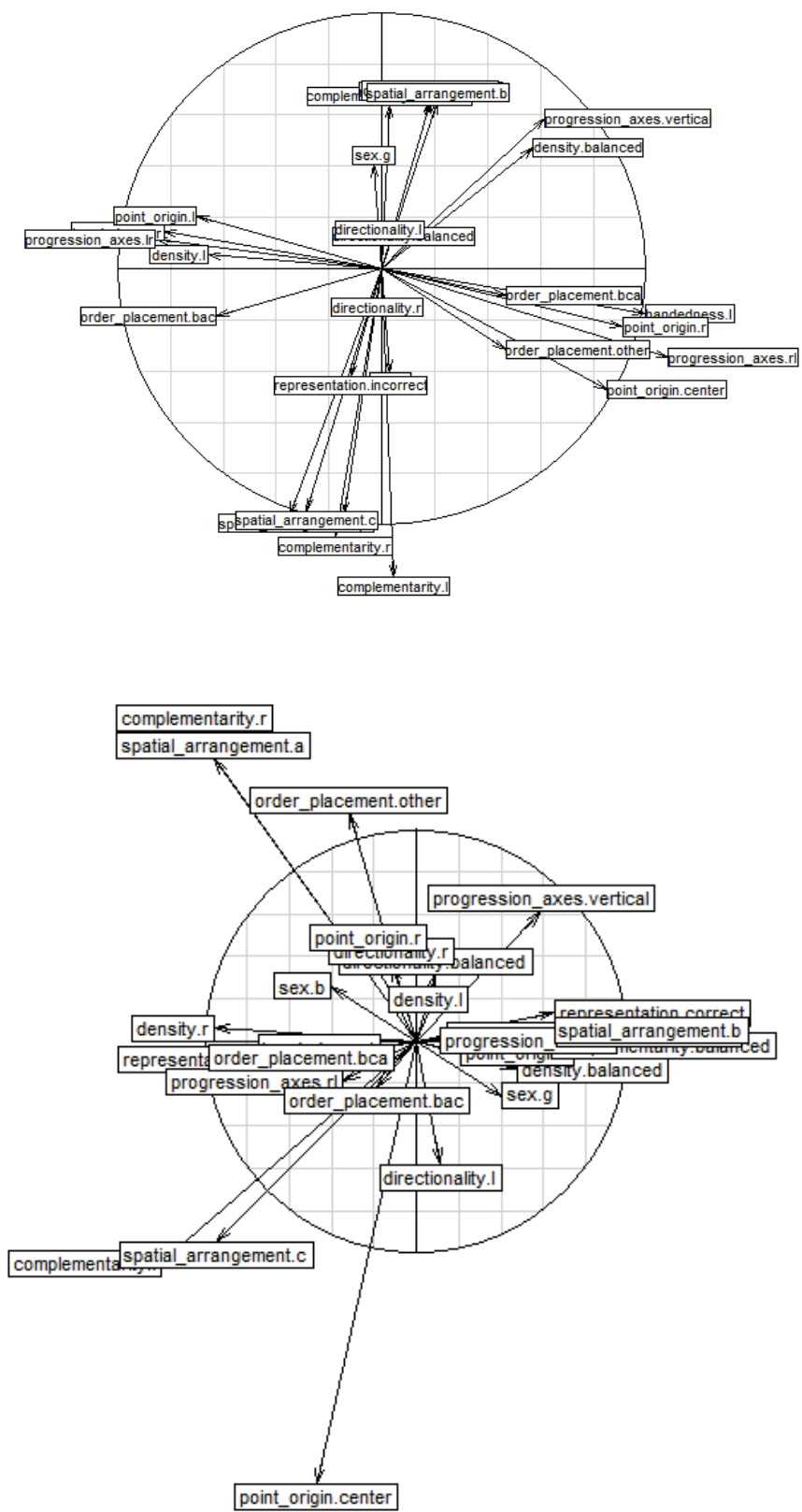

Appendix 9

Figure II. Dendrogram representing the optimal number of clusters

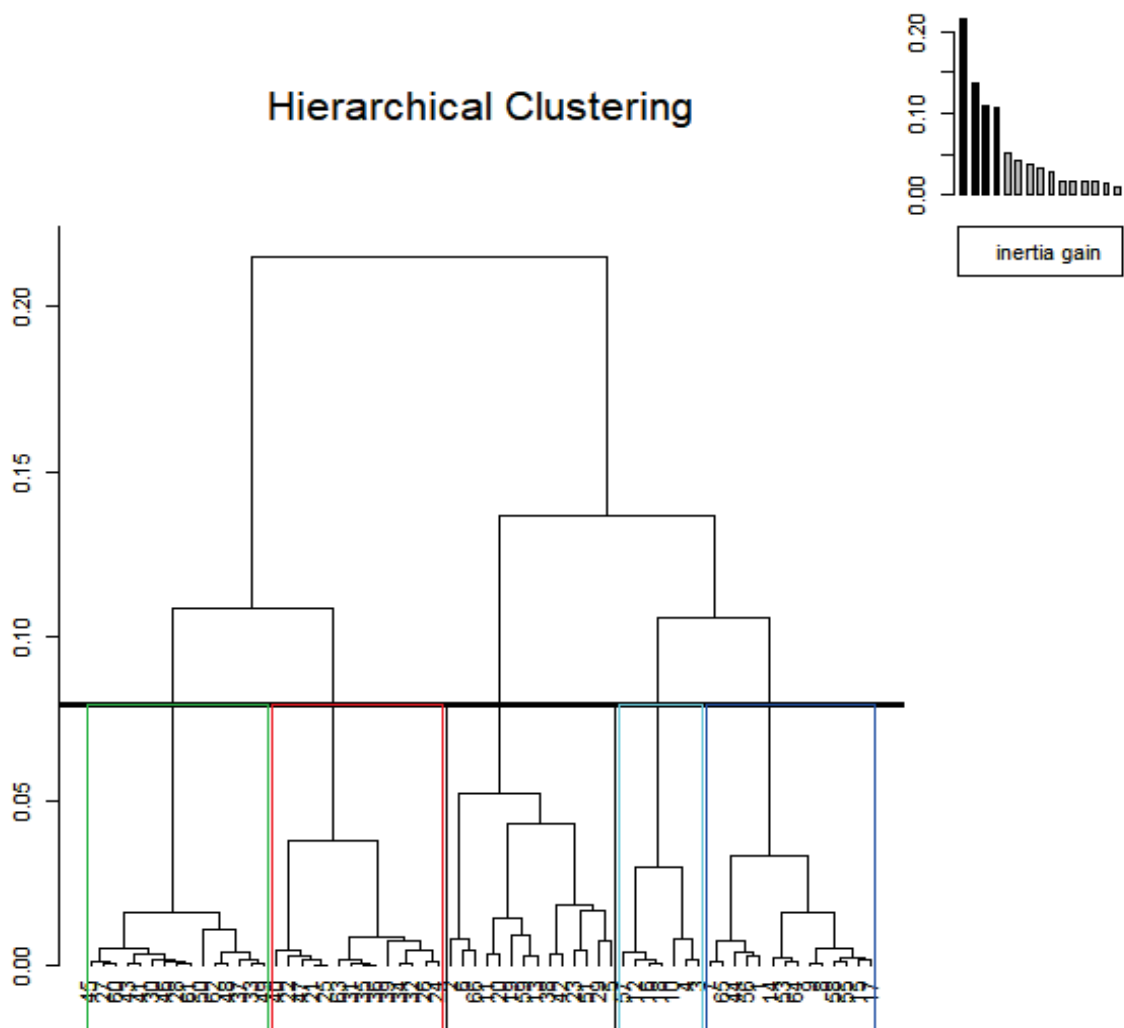

Note. Vertical line: the tree is automatically cut at the suggested level following Ward's method

Complementary study 1

Appendix 1. Instructions

ROCF copy trial: *"I am going to ask you to copy the figure in front of you with this pen on the sheet I gave you. You have all the time you need and you can let me know when you are done so that we can move to the next step. It is possible that the pen might vibrate sometimes, but do not worry about it and continue your drawing, it will not influence your drawing. But, I will just ask you not to move your drawing sheet, nor the model of the figure as much as possible".*

Hand preference questionnaire: *"I am going to ask you 15 questions about your preferences for one hand or the other in everyday tasks, and each time you can answer that you prefer to use your right hand, your left hand or that you don't have a preference".*

Tapping test: *"I am going to ask you to position yourself in front of the computer screen and to place your left index finger on the S key of the keyboard and your right index finger on the L key of the keyboard. I will first ask you to tap as fast as possible with your right/left index finger for 30 seconds, then you will have a 10 seconds pause, and afterward, you will have to tap with the other index finger for another 30 seconds".*

Delayed recall of the ROCF: *"I am going to ask you to redraw on this sheet and with this pen the figure that I presented to you at the beginning of the study. Again, you have all the time you need and you can let me know when you think you're done".*

Appendix 2. Experiment's procedure

Five master's students conducted the assessments in the *Laboratoire de Psychologie des Cognitions* (LPC, UR 4440) of the Faculty of Psychology of the University of Strasbourg. Each participant was assessed individually, and the experiment took approximately 15 minutes.

Upon their arrival, the participants sat down at a desk on which a screen, a keyboard, and the information/consent letter are placed in front of them. The first step was the ROCF copy trial. This geometrical figure was placed in front of each participant, who were provided with a blank augmented

paper adapted to the Anoto digital pen. This paper was folded in half, so that one side was dedicated to copying, and the other to the delayed recall trial of the ROCF. Folding the paper is a requirement for the Elian software to be able to separate the copy from the delayed recall drawing (Wallon, 2008). After finishing copying the figure, the ROCF is removed as well as their drawing. It should be noted that the participants were unaware of the upcoming recall trial.

The second step consisted of the hand preference assessment followed by the third step where the participants are asked to complete the Tapping test.

The final step was the ROCF delayed recall trial. The participants were given back the paper on which they had already copied the ROCF on one side. Nonetheless, the copy drawing was hidden behind an opaque paper. The participants were asked to reproduce from memory the ROCF on the second half of the augmented paper.

Appendix 3. Normality check

The Tapping test scores can be considered normally distributed according to the Shapiro-Wilk test ($p=.912$) and the QQ-plot (Figure A).

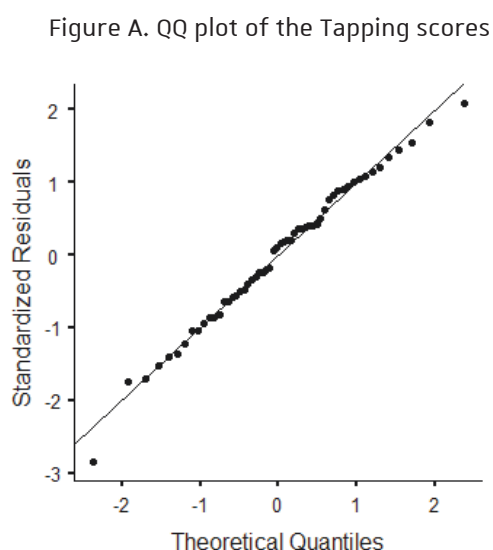

The center of gravity variables are normally distributed (Figure B and Figure C).

Figure B. QQ plot of the center of gravity variable in the copy trial

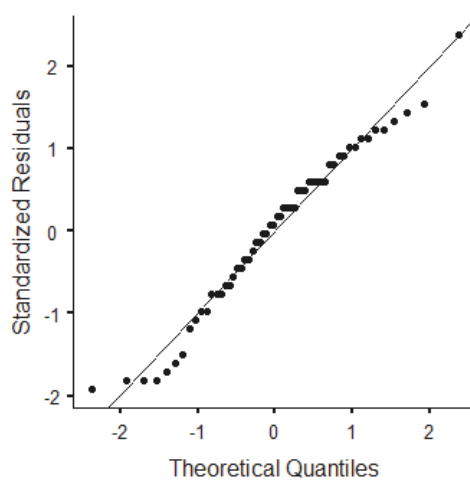

Shapiro-Wilk test ($p=.287$)

Figure C. QQ plot of the center of gravity variable in delayed recall trial

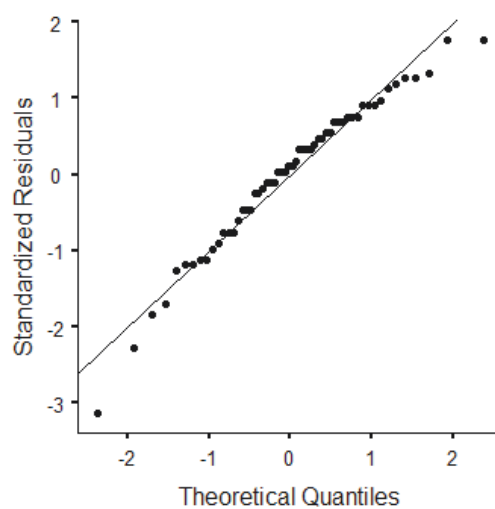

Shapiro-Wilk test ($p=.117$)

The point of origin and stroke orientation variables of both the ROCF copy and delayed recall trials do not follow a normal distribution (Figure D to Figure G).

Figure D. QQ plot of the point of origin variable in the copy trial

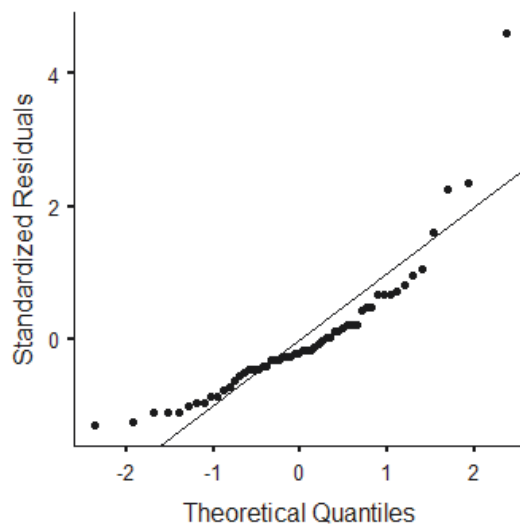

Shapiro-Wilk test ($p < .001$)

Figure E. QQ plot of the point of origin variable in the delayed recall trial

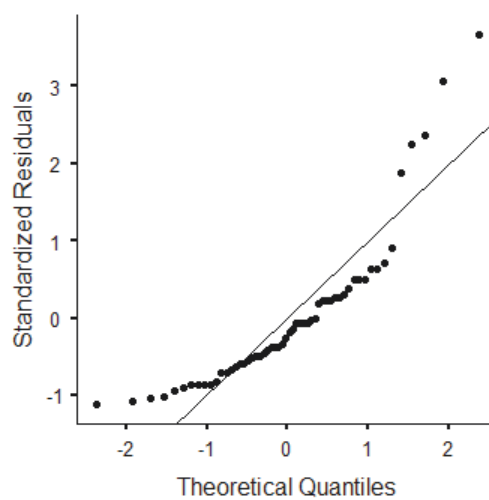

Shapiro-Wilk test ($p < .001$)

Figure F. QQ plot of the stroke orientation variable in the copy trial

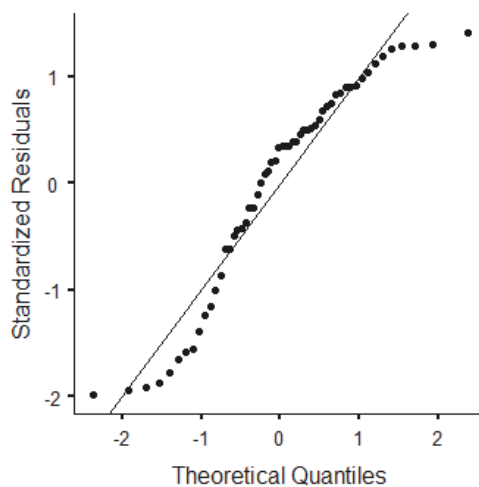

Shapiro-Wilk test ($p=.001$)

Figure G. QQ plot of the stroke orientation variable in the delayed recall trial

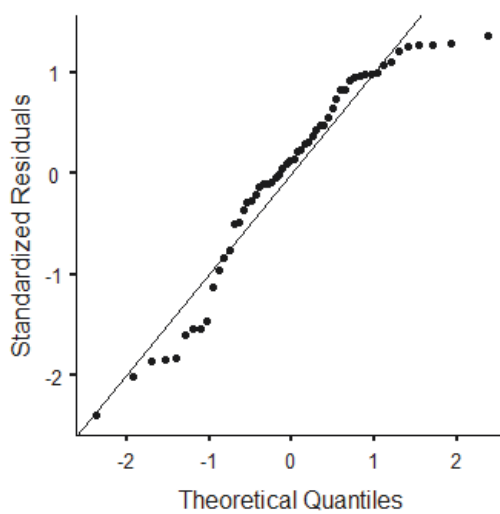

Shapiro-Wilk test ($p=.003$)

Appendix 4. Supplementary data for Multiple Correspondence Analysis , Clustering Analysis, and GLM

Figure H. Scree plot of the percentage of the explained variance of all the dimensions

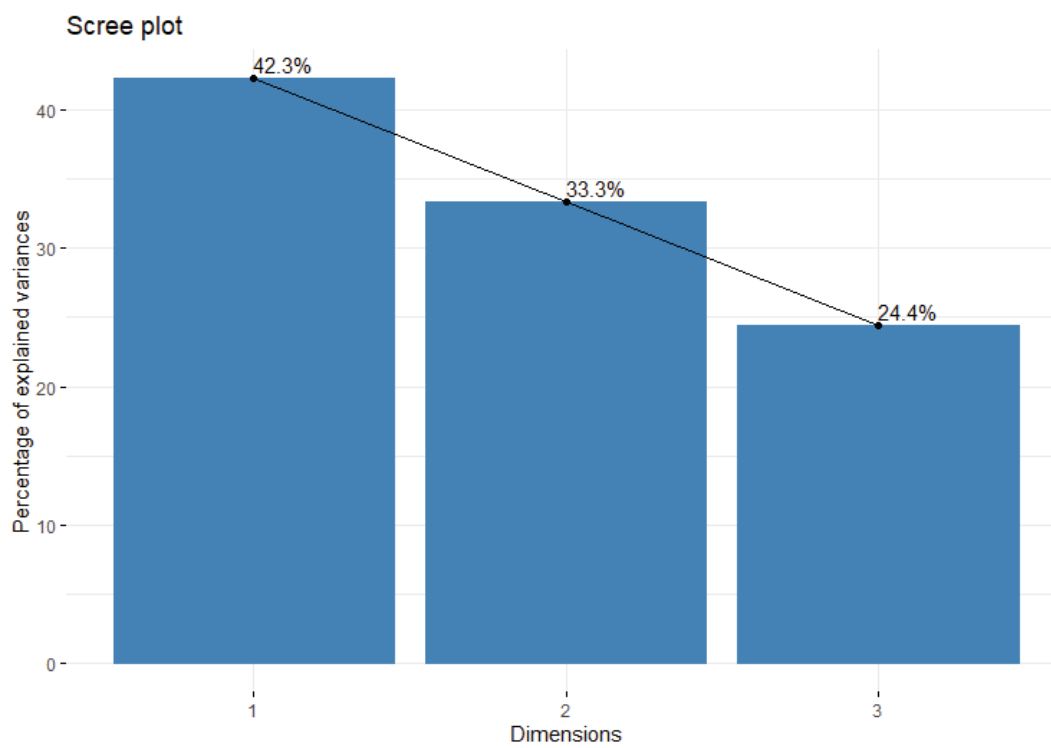

Table A. Correlations between the variables and the two dimensions obtained by the MCA

Dimension 1			
Variable		Estimates	<i>p</i>
Quantitative variables			
Stroke orientation (recall)		-0.417	.001
Stroke orientation (copy)		-0.424	.001
Hand performance		-0.564	<.001
Qualitative variables			
	Categories		
Sex		0.634	<.001
	Males	0.670	<.001
	Females	-0.670	<.001
Hand preference		0.634	<.001
	Left-handed	0.884	<.001

		Right-handed	-0.770	<.001
Dimension 2				
Variable		Estimates		<i>p</i>
Qualitative variables	Categories			
Hand preference		1		.000
	Mixed-handed	1.691		<.001
	Left-handed	-0.985		.029
	Right-handed	-0.706		.003

Table B. Results for all the significant categories characterizing each cluster

Cluster 1					
Qualitative variables					
	Cla/Mod (%)	Mod/Cla (%)	Global (%)	v.test	<i>p</i>
Females	81.08	100	66.07	6.04	<.001
Right-handed	73.17	100	73.21	5.04	<.001
Quantitative variables					
	Mean (sd) in category	Overall Mean (sd)		v.test	<i>p</i>
Hand performance	5.49 (4.06)	3.22 (5.04)		3.60	<.001
Stroke orientation (copy)	37.73 (23.87)	28.96 (30.75)		2.27	.023
Stroke orientation (recall)	42.69 (26.29)	29.98 (35.79)		2.83	.005
Cluster 2					
Qualitative variables					
	Cla/Mod (%)	Mod/Cla (%)	Global (%)	v.test	<i>p</i>
Mixed-handed	100	100	8.93	5.15	<.001
Quantitative variables					
	Mean (sd) in category	Overall Mean (sd)		v.test	<i>p</i>
Stroke orientation (recall)	-2.47 (50.66)	29.98 (35.79)		-2.11	.035
Cluster 3					
Qualitative variables					
	Cla/Mod (%)	Mod/Cla (%)	Global (%)	v.test	<i>p</i>
Males	57.89	100	33.93	5.02	<.001
Right-handed	26.83	100	73.21	2.30	.021
Quantitative variables					
	Mean (sd) in category	Overall Mean (sd)		v.test	<i>p</i>
Stroke orientation (copy)	47.66 (14.60)	28.96 (30.75)		2.23	.026
Cluster 4					

Qualitative variables					
	Cla/Mod (%)	Mod/Cla (%)	Global (%)	v.test	<i>p</i>
Left-handed	40	100	17.86	3.44	<.001
Quantitative variables					
	Mean (sd) in category		Overall Mean (sd)	v.test	<i>p</i>
Hand performance	-2.62 (1.75)		3.22 (5.04)	-2.38	.017
Center of gravity (copy)	97.00 (10.51)		87.34 (9.43)	2.11	.035
Stroke orientation (copy)	-6.58 (14.70)		28.96 (30.75)	-2.37	.017
Stroke orientation (recall)	-11.64 (19.85)		29.98 (35.79)	-2.39	.017
Cluster 5					
Qualitative variables					
	Cla/Mod (%)	Mod/Cla (%)	Global (%)	v.test	<i>p</i>
Left-handed	60	100	17.86	4.51	<.001
Males	31.58	100	33.93	3.34	<.001
Quantitative variables					
	Mean (sd) in category		Overall Mean (sd)	v.test	<i>p</i>
Hand performance	-2.77 (5.49)		3.22 (5.04)	-3.05	.002
Stroke orientation (copy)	-4.89 (30.17)		28.96 (30.75)	-2.83	.005
Stroke orientation (recall)	-3.30 (28.47)		29.98 (35.79)	-2.39	.017

Note. Cla/Mod: Percentages of individuals belonging to the cluster
Global: Percentages of the individual among our sample

Table C. Goodness of fit of the General Linear Models

Variable	<i>df</i>	AIC	χ^2	Model R^2	<i>p</i>
Center of gravity (copy)		414.99		.153	
Hand preference	2		2.64		.267
Sex	1		6.69		.010*
Hand preference*sex	2		5.62		.060
Center of gravity (recall)		458.45		.132	
Hand preference	2		1.35		.509
Sex	1		6.49		.011*
Hand preference*sex	2		2.33		.312
Center of gravity (copy)		418.80		.026	
Hand performance	1		0.03		.862

Sex	1	0.97	.324
Hand performance*sex	1	0.25	.620
Center of gravity (recall)		456.33	.102
Hand performance	1	0.47	.493
Sex	1	2.82	.093
Hand performance*sex	1	1.33	.249
Point of origin (copy)		500.85	.133
Hand preference	2	0.24	.889
Sex	1	4.65	.031*
Hand preference*sex	2	5.85	.054
Point of origin (recall)		525.54	.225
Hand preference	2	1.58	.454
Sex	1	9.01	.003*
Hand preference*sex	2	7.79	.020*
Point of origin (copy)		503.10	.031
Hand performance	1	0.03	.852
Sex	1	0.52	.471
Hand performance*sex	1	0.84	.360
Point of origin (recall)		529.10	.113
Hand performance	1	0.02	.903
Sex	1	2.13	.145
Hand performance*sex	1	3.45	.063
Stroke orientation (copy)		527.73	.403
Hand preference		33.03	<.001*
Sex		0.01	.933
Hand preference*sex		1.03	.597
Stroke orientation (recall)		548.48	.362
Hand preference		25.52	<.001*

Sex		0.48	.489
Hand preference*sex		0.32	.852
<hr/>			
Stroke orientation (copy)	538.69		.220
Hand performance		12.54	<.001*
Sex		0.13	.715
Hand performance*sex		0.25	.619
<hr/>			
Stroke orientation (recall)	557.12		.200
Hand performance		9.78	.002*
Sex		<.001	.981
Hand performance*sex		0.72	.397
<hr/>			

Note. *: $p < .05$

Article 2

Appendix 1. ALSPAC variable codes for all the measures

Sex	kz021
Multiple birth	MZ010a
Birthweight	kz030
Gestational age	bestgest
Fetal presentation at onset of labor	DEL_P1200
Static balance	fdba113; fdba115; fdba117; fdba119
Hand preference	ccf200; ccf201; ccf202; ccf203; ccf204; ccf205; ccf205
Pegboard task	f7cr106b; f7cr116b
Developmental dyslexia	f9sn800
Developmental coordination disorder	f7cr500

Appendix 2. Assumption check for the PegQ scores

Normality was checked visually with the Density plot, which provides a visual judgment about whether the distribution is bell shaped, and the Q-Q plot, which shows the correlation between our sample and the normal distribution. These plots show that the normality assumption is not violated (see Figure A).

Figure A. Density plot (right) and Q-Q plot (left) of the PegQ scores.

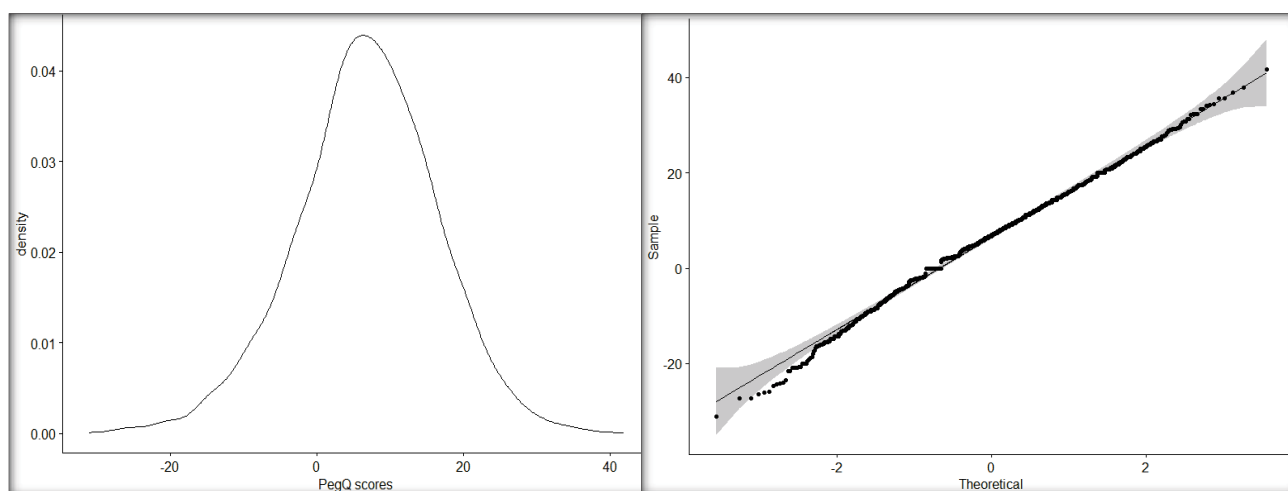

However, the Levene's test shows that the equality of variances assumption is violated for preliminary analyses, $F(2,2768) = 4.12$, $p = .016$, and hypothesis 5d, $F(1, 3476)=6.94$, $p=.008$), but not for hypothesis 2b, $F(1,3637) = 0.45$, $p = .500$), or for hypothesis 5b, $F(1, 3060)=0.45$, $p=0.504$.

Appendix 3. Assumption check for the static balance scores

Levene's test shows that the homogeneity of variances assumption is met ($F(2,2972)=1.32$, $p=.268$) for the hypothesis 4a, whereas the normal distribution assumption of the static balance scores is violated. Indeed, the density and Q-Q plots showed the non-normality of the distribution for static balance (see Figure B) and therefore non-parametric analyses are required.

Figure B. Density plot (right) and Q-Q plot (left) of the static balance task scores.

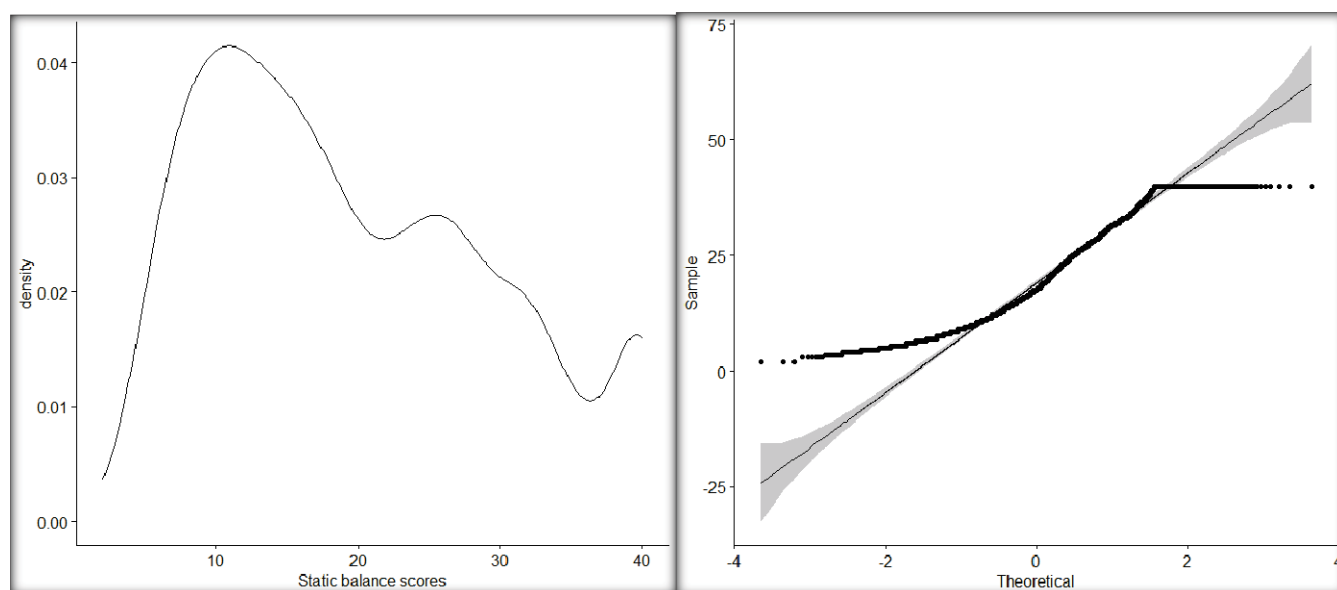

Appendix 4. Descriptive statistics²

Table A. Cell counts of hand preference according to fetal presentation.

	Fetal presentation	
	Cephalic	Breech
	n	n
Left-handers	320	15
Mixed handers	171	9
Right-handers	3190	147

Table B. Cell counts of language impairments according to fetal presentation.

	Fetal presentation	
	Cephalic	Breech
	n	n
No language impairments	3621	173
Developmental Dyslexia (DD)	80	<5

² Due to small cell counts in some of the variables' categories, and following ALSPAC's policy, the exact number of small cell counts (<5) and the cell percentages cannot be given in order to minimise the risks of potential disclosure.

Table C. Cell counts of motor impairments according to fetal presentation.

	Fetal presentation	
	Cephalic	Breech
	n	n
No motor impairments	3310	152
Motor impairments (DCD)	47	<5

Table D. Cell counts of hand preference according to language impairments.

	Language impairments	
	Without DD	With DD
	n	n
Left-handedness	268	<5
Mixed handedness	146	<5
Right-handedness	2654	57

Table E. Cell counts of hand preference according to motor impairments.

	Motor impairments	
	Without DCD	With DCD
	n	n
Left-handedness	235	<5
Mixed handedness	122	<5
Right-handedness	2292	29

Appendix 5. Testing the influence of preterm birth on handedness, language and motor impairments³

We conducted a Fisher Exact test (three cell counts were less than 5) to examine if prematurity, reflected by preterm (<37 weeks gestation), very preterm (<32 weeks gestation), and extremely preterm children (<28 weeks gestation) is more associated with atypical hand preference than children born at term (>37 weeks of gestation). The probability of being left-handed was significantly higher among preterm ($p = .035$). As shown in Table F, compared to the children born at term, the prevalence of left-handers was higher among preterm, very preterm, and extremely preterm children.

Table F. Cell counts of hand preference according to the gestational age.

	Gestational age			
	Extremely preterm	Very preterm	Preterm	Born at term
	n	n	n	n
Left-handers	5	<5	30	586
Mixed handers	<5	<5	12	313
Right-handers	9	21	229	5953

Note. One cell includes zero counts

An ANOVA was conducted to examine whether preterm children present atypical hand performance when compared to children born at term (the homogeneity of variances assumption is met, Levene's $F(3, 6706) = 1.57, p=.194$). No significant difference was found ($F(3, 6706) = 0.59, p=.618, \eta^2 < .001$).

Similarly, we performed a Fisher's exact test (two cell counts were less than 5) to assess the association between preterm and Developmental Dyslexia (DD). No significant association between gestational age and DD was found ($p=.580$). See Table G for descriptive statistics.

Table G. Cell counts of language impairments according to the gestational age.

³ Due to small cell counts in some of the variables' categories, and following ALSPAC's policy, the exact number of small cell counts (<5) and the cell percentages cannot be given in order to minimise the risks of potential disclosure.

	Gestational age			
	Extremely preterm	Very preterm	Preterm	Born at term
	n	n	n	n
No language impairments	10	29	295	6618
Language impairments (DD)	<5	<5	9	144

Note. Two cells includes zero counts

Since two of the cell counts were less than 5, we performed Fisher's exact test to examine if preterm children are more associated with motor impairments than children born at term. There was a significant association between the gestational age and Developmental Coordination Disorder (DCD), where a higher prevalence of children with DCD are among preterm children ($p = .006$). Compared to the children born at term, the prevalence of DCD was higher among preterm, very preterm, and extremely preterm children. See Table H for descriptive statistics.

Table H. Cell counts of motor impairments according to the gestational age.

	Gestational age			
	Extremely preterm	Very preterm	Preterm	Born at term
	n	n	n	n
No motor impairments	6	28	249	6068
Motor impairments (DCD)	<5	<5	6	100

Complementary study 2

Appendix 1. ALSPAC variable codes for all the measures

Multiple birth	MZ010a
Birthweight	kz030
Apgar at 1 minute	DEL_B4003
Apgar at 5 minutes	DEL_B4004
Hand preference	ccf200; ccf201; ccf202; ccf203; ccf204; ccf205; ccf205
Pegboard task	f7cr106b; f7cr116b

Appendix 2. Descriptive statistics⁴

Table A. Cell counts of hand preference according to birthweight.

	Birthweight			
	Extremely low	Very low	Low	Typical
	n	n	n	n
Left-handers	<5	7	16	590
Mixed handers	<5	<5	11	310
Right-handers	7	19	203	5908

Note. Two cells include zero counts

⁴ Due to small cell counts in some of the variables' categories, and following ALSPAC's policy, the exact number of small cell counts (<5) and the cell percentages cannot be given in order to minimise the risks of potential disclosure.

Table B. Cell counts of hand preference according to Apgar test at 1 minute.

	Apgar at 1 minute		
	Very low	Low	Typical
	n	n	n
Left-handers	18	63	298
Mixed handers	7	32	159
Right-handers	159	507	3018

Table C. Cell counts of hand preference according to Apgar test at 5 minutes.

	Apgar at 5 minutes		
	Very low	Low	Typical
	n	n	n
Left-handers	<5	<5	372
Mixed handers	<5	<5	198
Right-handers	9	72	3600

Note. Two cells include zero counts

Table D. Cell counts of children with Developmental Dyslexia according to birthweight.

	Birthweight			
	Extremely low	Very low	Low	Typical
	n	n	n	n
Without DD	11	25	239	6592
With DD	<5	<5	<5	145

Note. Two cells include zero counts

Table E. Cell counts of children with Developmental Coordination Disorder according to birthweight.

	Birthweight			
	Extremely low	Very low	Low	Typical
	n	n	n	n
Without DCD	6	25	205	6045
With DCD	<5	<5	8	97

Table F. Cell counts of Developmental Dyslexia according to Apgar test at 1 minute.

	Apgar at 1 minute		
	Very low	Low	Typical
	n	n	n
Without DD	186	621	3419
With DD	<5	10	79

Table G. Cell counts of Developmental Coordination Disorder according to Apgar test at 1 minute.

	Apgar at 1 minute		
	Very low	Low	Typical
	n	n	n
Without DCD	167	564	3085
With DCD	<5	9	50

Table H. Cell counts of Developmental Dyslexia according to Apgar test at 5 minutes.

	Apgar at 5 minutes		
	Very low	Low	Typical
	n	n	n
Without DD	14	82	4130
With DD	<5	<5	90

Note. One cell includes zero counts

Table I. Cell counts of Developmental Coordination Disorder according to Apgar test at 5 minutes.

	Apgar at 5 minutes		
	Very low	Low	Typical
	n	n	n
Without DCD	<5	<5	63
With DCD	12	79	3724

Note. Two cells includes zero counts

Résumé en français (*French summary*)

Introduction générale

La latéralité, qui fait l'objet de cette thèse, désigne la préférence pour un côté du corps par rapport à l'autre. Elle se caractérise par des asymétries qui peuvent se manifester au niveau comportemental (e.g., la latéralité manuelle) et au niveau fonctionnel (Scharoun & Bryden, 2014). La latéralité influence notre perception, notre cognition et notre comportement (Manns, 2021a). En outre, de nombreuses preuves montrent que les asymétries comportementales et fonctionnelles ne sont pas une caractéristique propre à l'homme et peuvent être observées également dans le règne animal (Corballis, 2019 ; Rogers, 2021). La compréhension des mécanismes développementaux sous-jacents à la latéralité peut éclairer l'étiologie des difficultés cognitives et motrices. En effet, la latéralité atypique (e.g., gaucherie et ambidextrie) est fréquemment mentionnée dans la littérature scientifique comme faisant partie du tableau clinique de plusieurs troubles neuro-développementaux et psychiatriques (Berretz, Wolf et al., 2020). Une prévalence plus élevée de latéralité atypique a été associée à des troubles neuro-développementaux tels que la dyslexie développementale (Abbondanza et al., 2022), le trouble du développement des coordinations (Darvik et al., 2018), la déficience intellectuelle (Papadatou-Pastou & Tomprou, 2015), les troubles du spectre autistique (Markou et al., 2017), le trouble déficitaire de l'attention/hyperactivité (Nastou et al., 2022), les troubles psychiatriques tels que le trouble de la personnalité schizotypique (Somers et al., 2009) ou encore la schizophrénie (Hirnsstein & Hugdahl, 2014), et les maladies neurodégénératives (Lubben et al., 2021).

Même si la génétique est indubitablement impliquée dans le développement de la latéralité (Medland et al., 2009 ; Medland et al., 2006 ; Schmitz et al., 2022), elle n'explique pas toute la variance phénotypique de la latéralité, et d'autres facteurs, de nature épigénétique et environnementale, pourraient également être impliqués dans son ontogenèse (Michel, 2021 ; Schmitz et al., 2017). Cette observation a conduit à une perspective théorique où la génétique joue un rôle limité et indirect dans l'ontogenèse de la latéralité, tandis que les influences environnementales, telles que l'environnement prénatal et les facteurs sociaux, sont considérées comme jouant un rôle important dans son développement (Michel, 2021; Previc, 1991). Cependant, il n'existe pas de consensus clair dans la littérature scientifique concernant l'influence de

l'environnement sur le développement de la latéralité (Porac, 2016). Ainsi, l'objectif du présent projet de recherche était d'offrir de nouvelles preuves pour soutenir ou réfuter le rôle de l'environnement prénatal dans le développement de la latéralité, tout en abordant certaines limites méthodologiques identifiées à partir des études antérieures.

Un autre objectif a également fait l'objet de ce projet de doctorat. Nous avons voulu étudier l'implication de la latéralisation cérébrale dans les biais perceptifs, qui peuvent à leur tour influencer les productions graphomotrices. Des recherches ont montré que les dessins des enfants et des adultes sont asymétriques, et peuvent être expliqués par des biais perceptifs liés à la latéralisation fonctionnelle hémisphérique (Vaid, 2011). Néanmoins, ces biais sont évalués avec des tâches différentes, ce qui rend difficile la mesure de leur interaction. Par conséquent, nous avons introduit dans cette thèse une nouvelle tâche de dessin, la tâche de transcription graphique 3D-2D, qui permet d'évaluer de manière globale les asymétries identifiées dans les dessins et qui sont en partie sous-tendues par la latéralisation cérébrale. Cette nouvelle tâche de dessin visait à identifier des patterns graphomoteurs asymétriques globaux des jeunes enfants. La tâche de transcription 3D-2D pourrait être un outil prometteur pour de futures études visant à explorer les asymétries graphomotrices des enfants présentant une latéralisation cérébrale atypique (Friedrich et al., 2018). Cela pourrait faire apparaître des opportunités de détection précoce de patterns de latéralité atypiques sous-tendus par des difficultés visuo-spatiales chez certains enfants.

Objectifs de la thèse

L'objectif de la présente thèse est double. Le premier objectif, qui sera désigné comme l'objectif appliqué, était d'étudier de manière exhaustive les biais perceptifs qui sont impliqués dans les asymétries graphomotrices. Comprendre la variabilité interindividuelle typique de l'attention visuo-spatiale aiderait les chercheurs et les cliniciens à interpréter les résultats obtenus auprès de populations cliniques (Friedrich et al., 2018). Des études antérieures ont révélé l'existence d'une attention visuo-spatiale atypique chez les personnes atteintes de troubles neuro-développementaux. Par rapport aux enfants sains, qui présentent un biais attentionnel vers la gauche, ceux atteints de dyslexie développementale ou de troubles déficitaires de l'attention/hyperactivité présentent un biais vers la droite (Sheppard et al., 1999 ; Sireteanu et al., 2005 ; Waldie & Hausmann, 2010). Ces résultats peuvent refléter un dysfonctionnement de l'hémisphère droit et

une perturbation de la connexion inter-hémisphérique dans ces groupes cliniques (Waldie & Hausmann, 2010). Par conséquent, l'étude simultanée des différents biais perceptifs impliqués dans les productions graphiques asymétriques peut nous permettre d'étudier les interactions entre les mécanismes biologiques et culturels qui sous-tendent l'attention visuo-spatiale. Sur la base de ce raisonnement, nous avons cherché à identifier de manière exhaustive les asymétries graphomotrices d'individus sains à partir desquelles nous pouvons déduire des patterns asymétriques prototypiques. Ces derniers peuvent être considérés comme une base pour l'étude des productions graphomotrices asymétriques atypiques associés aux troubles neuro-développementaux.

Le deuxième objectif de cette thèse, que nous appellerons l'objectif théorique, était d'investiguer l'influence des facteurs non génétiques sur le développement de la latéralité. La compréhension des mécanismes développementaux de la latéralité peut éclairer l'étiologie complexe des troubles neuro-développementaux et psychiatriques. En effet, la littérature scientifique mentionne fréquemment la latéralité atypique comme faisant partie du tableau clinique de plusieurs de ces troubles. Cependant, que cette association soit le reflet d'une relation causale ou la conséquence de mécanismes communs qui sous-tendent leur ontogenèse (Bishop, 2013) n'apparaît toujours pas clairement défini. Par conséquent, nous avons cherché à étudier différents facteurs liés à l'environnement prénatal qui pourraient expliquer la prévalence plus élevée de la latéralité atypique chez les personnes atteintes de troubles neuro-développementaux.

La partie empirique de la thèse s'articule autour de deux articles scientifiques et de deux études complémentaires. L'Article 1 et l'étude complémentaire 1 sont liés à l'objectif appliqué. L'Article 2 et l'étude complémentaire 2 se concentrent sur l'objectif théorique.

Objectif appliqué

Contexte théorique

Le cerveau humain est organisé de manière asymétrique montrant une spécialisation complémentaire des deux hémisphères cérébraux. Cette Spécialisation Fonctionnelle Hémisphérique (SFH) fait référence à la nature des informations que chaque hémisphère contrôle, ainsi qu'à la manière dont chaque hémisphère

les traite (Corballis, 2012). Ainsi, pour la majorité de la population, l'hémisphère gauche est dominant pour le langage, la praxis, le traitement local et séquentiel de l'information, tandis que l'hémisphère droit est dominant pour l'attention spatiale, la reconnaissance des visages, les activités visuo-spatiales et le traitement global des informations (Brederoo et al., 2017; Corballis, 2012; Vingerhoets, 2019). L'influence de la SFH sur les dessins des individus est bien documentée. Les dessins sont caractérisés par des patterns directionnels et des caractéristiques asymétriques distinctes, que l'on appelle des biais directionnels. Une interprétation de ces biais est basée sur les asymétries cognitives, attentionnelles et représentationnelles sous-tendues par la SFH. Un biais attentionnel, connu sous le nom de « pseudo-négligence », est fréquemment rapporté dans la littérature chez des individus neurotypiques (Bowers & Heilman, 1980) ; il se manifeste par une déviation vers la gauche lors de l'exécution de tâches de bissection de lignes (Jewell & McCourt, 2000). Ce phénomène reflète l'influence de la SFH sur l'attention visuo-spatiale et, plus précisément, la dominance de l'hémisphère droit dans le traitement de l'information spatiale. Ce biais attentionnel se traduit par une préférence en faveur du champ visuel gauche (Kinsbourne, 1970). Ce biais attentionnel vers la gauche semble être associé à une préférence esthétique générale pour les images comportant plus d'éléments et de détails dans l'hémichamp droit. Cette préférence esthétique semble rétablir le déséquilibre créé par le biais attentionnel vers la gauche occasionné par la dominance de l'hémisphère droit (Levy, 1976). Des différences interindividuelles sont observées concernant les biais attentionnels en termes de degré et de direction en fonction de la maturité biologique (asymétries cérébrales et sensorimotrices), de l'expérience en lecture (exposition à des explorations visuelles selon la directionnalité du script). Cependant, on ne sait toujours pas dans quelle mesure chacun de ces facteurs influence ces biais attentionnels.

À l'âge de 3 ans, le biais attentionnel en faveur du champ visuel gauche est faible. La direction du biais attentionnel dépend de la main utilisée dans une tâche de bissection de ligne : vers la droite lorsque la main droite est utilisée et vice versa pour la main gauche (Failla et al., 2003 ; Girelli et al., 2017). Ce biais ipsilatéral pour la main utilisée, appelé " négligence symétrique ", reflète un développement psychomoteur incomplet et un transfert inter-hémisphérique insuffisant des informations perceptives, entraînant une difficulté à franchir la ligne médiane lors des activités motrices. A partir de 5 ans, l'augmentation de la maturité motrice permet l'émergence de biais attentionnels. Picard et Zarhouch (2014) ont examiné l'influence de l'âge, de

la main et de la directionnalité du script (c'est-à-dire la directionnalité de la lecture et de l'écriture) sur le biais attentionnel. Avec une tâche de dessin d'arbre proposée à des enfants français (5-15 ans) et marocains (7-11 ans) droitiers et gauchers, les auteurs n'ont pas observé d'influence de l'âge et de la directionnalité du script. Cependant, ils ont constaté un biais vers la gauche concernant l'emplacement de la figure sur l'espace graphique (c'est-à-dire une représentation de la figure plus à gauche dans l'espace graphique), pour les droitiers. L'absence de biais chez les enfants gauchers est communément liée à une latéralisation plus faible généralement observée par rapport à leurs pairs (Carey & Johnstone, 2014; Isaacs et al., 2006; Pujol et al., 1999; Willems et al., 2014). En effet, les droitiers sont fortement latéralisés, tandis que les gauchers présentent une latéralisation hémisphérique moindre et un corps calleux plus large (Johnstone et al., 2021; Ocklenburg & Güntürkün, 2017, p.77).

Les différences selon la latéralité manuelle se retrouvent également dans les préférences directionnelles. Les droitiers adultes orientent majoritairement leurs dessins vers la gauche lorsqu'on leur demande de dessiner des objets familiers (Alter, 1989 ; Karev, 1999 ; Shanon, 1979). Cependant, ce biais de directionnalité est moins clair chez les gauchers. Alors qu'il est plus faible chez les gauchers (Karev, 1999 ; Shanon, 1979), Alter (1989) a trouvé l'effet inverse où les gauchers favorisaient la directionnalité à droite. Cette différence de directionnalité entre droitiers et gauchers est supposée refléter le degré de latéralisation, qui est plus fort chez les droitiers et plus hétérogène chez les gauchers. La directionnalité du dessin peut également être influencée par les asymétries liées au mouvement de la main qui découlent d'un facteur biomécanique. Des contraintes biomécaniques sont associées à l'utilisation de la main droite ou de la main gauche pour dessiner. Il est plus facile d'effectuer des mouvements dirigés vers l'extérieur que des mouvements dirigés vers l'intérieur. Ainsi, le fait qu'une personne soit droitière crée une différence dans le point d'origine et l'orientation du trait (van Sommers, 1984). Les droitiers suivent généralement une direction de trait de gauche à droite (i.e., orientation du trait), en commençant leur dessin par le côté gauche (i.e., point d'origine gauche), tandis que le pattern inverse se retrouve chez les gauchers (van Sommers, 1984, 1989). Tosun et Vaid (2014) ont réalisé deux méta-analyses qui ont révélé l'importance de la main utilisée dans l'influence de la direction vers laquelle l'objet est orienté et qui est expliqué par le principe biomécanique. Plus précisément, la main semble déterminer la façon dont on oriente le dessin d'un visage. Étant donné que la partie la plus informative du thème d'un dessin a tendance

à être représentée en premier (e.g. le visage d'un personnage), selon que l'on utilise la main droite ou la main gauche, un profil sera orienté respectivement vers la gauche ou vers la droite. Cependant, les auteurs soulignent qu'une grande variance inexplicée subsiste même après avoir corrigé la taille inégale de l'échantillon et l'erreur d'échantillonnage des gauchers et des droitiers. Par conséquent, ils suggèrent que d'autres facteurs, tels que la préférence esthétique, peuvent influencer la directionnalité des dessins. Un facteur important qui peut influencer la préférence esthétique, et que les auteurs n'ont pas pu inclure dans leur étude, est le sexe.

Une activité cérébrale différente est signalée entre les hommes et les femmes pendant une tâche de jugement esthétique. Cela-Conde et al. (2009) ont demandé à leurs participants d'évaluer des stimuli visuels artistiques et naturels non familiers comme étant beaux ou non pendant une magnétoencéphalographie. Pour les stimuli jugés beaux, une activité bilatérale dans les régions pariétales a été observée chez les femmes, tandis que les hommes ont montré une activité latéralisée vers l'hémisphère droit. Ces résultats peuvent refléter des stratégies spatiales différentes dans l'évaluation des préférences esthétiques. Puisque l'hémisphère droit est associé à un traitement visuel global et l'hémisphère gauche à un traitement local, les hommes pourraient se fier davantage aux caractéristiques globales d'un stimulus visuel pour porter un jugement, alors que les femmes se fieront à la fois aux caractéristiques globales et locales. Cette interprétation semble être soutenue dans la littérature étant donné qu'au niveau fonctionnel, les garçons sont plus fortement latéralisés que les filles pour le traitement du langage, le traitement facial et l'attention spatiale (Bourne & Maxwell, 2010 ; Ocklenburg & Güntürkün, 2017). De plus, la connexion inter-hémisphérique est plus efficace chez les filles. Ces dernières ont une connexion inter-hémisphérique plus dense et un corps calleux plus large (Achiron et al., 2001 ; Ocklenburg & Güntürkün, 2017 ; pour une revue de littérature des différences entre les sexes, voir Hirnstein et al., 2019).

En accord avec les observations précédentes, la plus forte latéralisation de l'attention visuo-spatiale chez les garçons a été associée à une plus forte préférence esthétique pour une directionnalité de gauche à droite que chez les filles (Friedrich et al., 2014), et à un biais vers la gauche légèrement plus important dans les tâches de bissection de lignes (Jewell & McCourt, 2000). De même, De Agostini et al. (2011) ont observé une différence de sexe dans les préférences esthétiques visuelles en comparant des enfants (âgés de 7 à 10 ans) et des adultes. Ils ont présenté des images statiques (e.g., une lampe), des images en

mouvement (e.g., un canard) et des paysages (e.g., un parasol devant une plage) orientés soit de gauche à droite, soit de droite à gauche. Ils ont demandé à leurs participants d'indiquer lequel des stimuli était le plus agréable sur le plan esthétique. Chez les gauchers, les hommes adultes ont préféré les images orientées vers la droite, tandis que les femmes adultes n'ont montré aucune préférence en matière de directionnalité. En revanche, les enfants gauchers (garçons et filles) ont préféré les images orientées vers la gauche. Tous les droitiers préféraient une directionnalité vers la droite. Ces résultats reflètent la contribution de facteurs biologiques, tels que la latéralité manuelle et le sexe, dans l'organisation visuo-spatiale. Les auteurs ont suggéré que le passage à une préférence vers la droite chez les garçons gauchers pourrait être la conséquence de l'exposition à la directionnalité de script gauche-droite. Cependant, les femmes gauchères semblent être moins sensibles à ce facteur culturel, ce qui explique l'absence de préférences directionnelles.

L'ensemble de la littérature suggère que les biais perceptifs et les asymétries graphomotrices reflètent principalement la SFH et plus particulièrement la dominance de l'hémisphère droit sur l'attention visuelle. Ces biais sont plus prononcés chez les individus présentant un degré de latéralisation plus élevé (e.g., droitiers, hommes) et peuvent être modulés par des facteurs tels que la latéralité manuelle et le sexe. Notons que la directionnalité du script joue également un rôle important dans les asymétries graphomotrices. Fagard et Dahmen (2003) ont comparé les performances à la tâche de bissection de lignes entre deux groupes composés d'enfants droitiers français (script Gauche à Droite ; GD) et tunisiens (script Droite à Gauche ; DG). Ces participants sont âgés de 5, 7 et 9 ans (c'est-à-dire avant et après l'apprentissage de la lecture et de l'écriture). Chez les enfants les plus jeunes, le biais attentionnel vers la gauche est observé pour les deux groupes. Ce biais est d'autant plus important que la tâche est réalisée avec la main gauche, qui est sous le contrôle de l'hémisphère droit. Cependant, avec le développement de la pratique de la lecture et de l'écriture, le biais attentionnel vers la gauche augmente chez les enfants français (script GD) alors qu'il diminue chez les enfants tunisiens (script DG), disparaissant complètement à l'âge de 9 ans. Faghihi et al. (2019) ont étudié l'effet de la directionnalité du script et de la latéralité manuelle dans une tâche de dessin d'arbre. Les participants étaient divisés en lecteurs adultes d'anglais (script GD) et d'ourdou, d'arabe et de farsi (script DG). Les auteurs ont constaté un biais attentionnel global vers la gauche et il était significativement plus fort pour les droitiers. Cependant, le biais attentionnel vers la gauche était

significativement plus fort pour les adultes lecteurs de GD que pour les lecteurs de DG. Ceci est en contraste avec l'étude de Picard et Zarhbouch (2014), où les auteurs n'ont pas trouvé d'influence de la directionnalité du script en utilisant la même tâche de dessin chez des participants plus jeunes de 5 à 15 ans. Faghihi et al. (2019) ont suggéré qu'une expérience longue en lecture et en écriture est nécessaire pour entraîner des asymétries de dessin.

En conclusion, une interaction de plusieurs facteurs biologiques, moteurs et culturels conduit aux biais attentionnels et directionnels observés chez les enfants et les adultes (Rinaldi et al., 2020). Si ces études se sont intéressées aux biais perceptifs, rare sont celles qui ont étudié l'interaction entre tous ces facteurs et le degré d'influence de chaque mécanisme qui les sous-tend (Tosun & Vaid, 2014). Il est donc important d'étudier ces facteurs simultanément pour comprendre comment les facteurs biologiques et culturels interagissent au niveau de la perception et de la représentation du dessin (De Agostini et al., 2011).

Article 1

Hamaoui, J., Maumy-Bertrand, M., & Segond, H. (2021). Laterality and visuospatial strategies among young children: A novel 3D-2D transcription task. *Laterality*, 1-35.

DOI: 10.1080/1357650X.2021.1892715

L'objectif de cette étude était d'examiner dans quelle mesure la SFH, modulée par la latéralité manuelle et le sexe, peut influencer les productions graphiques chez les enfants. Sur la base des résultats précédents, nous avons créé une nouvelle tâche de dessin qui, à la fois, est amusante pour l'enfant et peut permettre d'identifier les asymétries graphiques suivantes : (1) les biais attentionnels liés à la SFH, à travers la densité graphique et la directionnalité du dessin ; (2) les contraintes biomécaniques liées à la main ; (3) les préférences esthétiques qui se développent avec l'âge. À partir de là, nous identifierons des patterns graphiques spécifiques ; ce qui nous permettra d'étudier, de manière exhaustive, l'interaction entre les principaux facteurs contributifs.

Dans notre tâche, les enfants d'âge préscolaire sont invités à transcrire un modèle de paysage tridimensionnel (3D) symétrique en une représentation bidimensionnelle (2D) sur une feuille A4 orientée paysage. Ces conditions ont été choisies pour plusieurs raisons. Tout d'abord, il est nécessaire d'essayer de distinguer les facteurs biologiques et culturels. À cette fin, nous nous sommes concentrés sur une

population d'enfants d'âge préscolaire au développement typique (âge moyen de 5 ans et 6 mois). Les enfants de cet âge sont moins exposés à la directionnalité du script que les plus âgés, ce qui limite l'influence potentielle des facteurs socio-culturels. En effet, des études antérieures sur des enfants français n'ont pas trouvé d'influence de la directionnalité du script chez les enfants de 6 ans (Fagard & Dahmen, 2003 ; Kebbe & Vinter, 2013 ; Picard & Zarhbouch, 2014). Cependant, les relations spatiales catégorielles et de coordonnées sont présentes à cet âge ; nos participants sauront donc établir des relations spatiales de type haut/bas et gauche/droite (Koenig et al., 1990). Deuxièmement, au niveau intra-représentationnel, les enfants dessinent généralement leur modèle interne de la réalité vers l'âge de 5 ans (Barrett & Light, 1976 ; Piaget & Inhelder, 1948 ; Luquet, 1927). Nous supposons donc que les dessins de nos participants seront le produit de leurs représentations mentales et non une imitation du monde extérieur. Ainsi, leur transcription graphique d'un modèle 3D devrait être un bon indicateur de l'influence de la SFH sur l'attention spatiale et le traitement des informations visuo-spatiales. Troisièmement, nous avons choisi un paysage comme modèle 3D car ce type de stimuli semble mieux refléter la SFH que les stimuli statiques ou en mouvement (Ishii et al., 2011). Ainsi, nous supposons que les patterns graphiques de nos participants, identifiés par la tâche 3D-2D, seront principalement influencés par la latéralité manuelle et le sexe, soutenu par la SFH.

Afin de considérer cette nouvelle tâche de dessin comme permettant une évaluation valide, la détection de patterns graphiques asymétriques est nécessaire. Nous devrions observer les patterns suivants :

(1) Nous nous attendons à ce que les enfants droitiers aient tendance à dessiner de GD, tandis que les enfants gauchers auront tendance à dessiner de DG. De plus, on s'attend à ce que les enfants droitiers commencent à dessiner depuis la gauche (point d'origine gauche) et les enfants gauchers depuis la droite (point d'origine droit). Ces tendances graphiques sont liées aux facteurs biomécaniques ; (2) Selon la latéralité manuelle, nous nous attendons à ce que les dessins des enfants droitiers soient plus souvent orientés vers la gauche, tandis que les enfants gauchers auront tendance à faire le contraire. En outre, nous nous attendons à ce que les enfants droitiers dessinent une représentation 2D plus asymétrique du modèle 3D symétrique, reflétant leur plus forte SFH. Parallèlement, nous nous attendons à ce que les enfants gauchers présentent une production graphique plus équilibrée en raison de leur moindre latéralisation ; (3) Nous nous attendons à ce que les filles produisent une meilleure qualité de dessin, plus

équilibrée et symétrique, puisqu'elles présentent un degré moindre de SFH et une plus grande connexion inter-hémisphérique que les garçons.

Soixante-six enfants ont participé (âge moyen = 67,9 mois, ET = 3,78 mois). Le matériel utilisé était : (1) Test de latéralité d'Auzias (Auzias, 1975) ; (2) Test de directionnalité d'Alter (Alter, 1989) ; (3) Tâche de transcription graphique 3D-2D.

Etude complémentaire 1

L'étude complémentaire 1 est une tentative d'étendre les résultats de l'Article 1, bien qu'avec une approche différente. Dans cette étude, la Figure Complexe de Rey-Osterrieth (FCRO) a été utilisée comme tâche graphomotrice. Elle a été choisie en raison de sa standardisation et de son utilisation extensive dans la littérature, contrairement à la tâche de transcription graphique 3D-2D. Nous avons utilisé une FCRO informatisée (Wallon, 2016), qui permet une évaluation plus précise de nos variables d'intérêt. Aussi, contrairement à l'étude précédente, des participants adultes ont été recrutés. La conséquence des facteurs culturels (i.e., la directionnalité du script) sur les asymétries de dessin est la plus forte dans ce groupe d'âge (Faghihi et al., 2019). Nous avons donc cherché à comparer les patterns graphiques observés chez les enfants dans l'Article 1 avec nos résultats utilisant des participants plus âgés. Nous nous attendions à ce que la latéralisation cérébrale et les facteurs biomécaniques, modulés par la latéralité manuelle et le sexe, soient impliqués dans les asymétries de dessin. Nos hypothèses étaient les suivantes :

(1) Le biais attentionnel sera différent selon la latéralité manuelle et le sexe. On s'attend à ce qu'il soit plus fort chez les droitiers et les hommes, car on suppose qu'ils présentent une latéralisation cérébrale plus forte. En revanche, les gauchers et les femmes devraient présenter un biais attentionnel réduit en raison de leur latéralisation cérébrale plus faible ; (2) En ce qui concerne le point d'origine, on suppose que les influences socioculturelles (i.e., la directionnalité du script) renforcent la préférence vers le champ visuel gauche. Compte tenu de leur longue expérience de la directionnalité du script de GD, les adultes droitiers et gauchers présenteront un point d'origine gauche ; (3) L'orientation des traits sera de GD pour les droitiers, tandis que les gauchers auront tendance à dessiner de DG.

Cinquante-six adultes ont participé (âge moyen = 29,1 ans ; ET = 13). Le matériel utilisé était : Figure complexe de Rey-Osterrieth (ROCF ; Rey, 1959) ; Logiciel Elian et stylo numérique Anoto DP-201 (Wallon, 2016) ; Questionnaire de préférence manuelle (Fagard et al., 2015) ; Test de Tapping avec le logiciel E-prime 3 (Psychology Software Tools, 2016).

Résultats et discussion

Dans l'Article 1, les enfants ont été répartis en cinq groupes caractérisés par leur latéralité manuelle et leur degré de latéralisation. Ce dernier a été déduit de différentes variables graphiques telles que la densité (i.e., la zone où se trouvent les différents éléments du dessin), la complémentarité des éléments graphiques (i.e., le degré de complexité du côté droit ou gauche de la feuille), la disposition spatiale (i.e., l'orientation du dessin en fonction de tous les éléments) et l'axe de progression (i.e., l'orientation des traits). Les filles étaient plus enclines à représenter des dessins équilibrés (i.e., densité et complémentarité équilibrées) et des productions graphiques symétriques. De même, les gauchers étaient plus associés aux dessins équilibrés (i.e., densité équilibrée). Ces résultats peuvent s'expliquer par une latéralisation fonctionnelle plus faible chez les filles et les gauchers, qui entraîne un biais visuo-spatial plus faible. En revanche, les garçons et les droitiers ont dessiné davantage de dessins asymétriques, affichant des biais visuo-spatiaux plus forts. Ce résultat pourrait être lié à leur plus fort degré de latéralisation fonctionnelle (De Agostini et al., 2011 ; Jewell & McCourt, 2000 ; Karev, 1999 ; Picard & Zarhbouch, 2014). Les enfants semblaient être fortement impactés par les contraintes biomécaniques. La plupart des droitiers ont commencé leurs dessins par la gauche, alors que les gauchers ont commencé par la droite. En outre, les droitiers ont adopté une orientation du trait de GD, contrairement aux gauchers qui avaient tendance à dessiner de DG. Néanmoins, il convient de noter que certains enfants gauchers présentaient un point d'origine situé au centre de la feuille de dessin. Ainsi, les facteurs biomécaniques semblent être influencés par la latéralisation cérébrale, la latéralisation plus faible chez les gauchers pouvant expliquer l'hétérogénéité de leur point d'origine.

Dans l'étude complémentaire 1, comme pour les enfants, les adultes ont été répartis en cinq groupes en fonction de leur latéralité manuelle, de leur sexe et de leur degré de latéralisation. Ce dernier était reflété par le centre de gravité (i.e., le placement de la figure entière sur le papier à dessin) et le point

d'origine. Tous les participants ont dessiné la FCRO sur le côté gauche de la feuille (centre de gravité à gauche) et ont commencé à dessiner à partir de la gauche (point d'origine gauche). Ces résultats s'opposent à ceux trouvés chez les enfants, où une densité et un point d'origine à gauche ont été observés chez les droitiers, alors que les gauchers présentaient une densité équilibrée et un point d'origine à droite ou au centre. Les enfants sont moins soumis aux influences socioculturelles (i.e., directionnalité du script). En l'absence de ces influences, la latéralisation cérébrale peut avoir été fortement impliquée dans les asymétries de dessin des enfants. En revanche, nos participants adultes ont une expérience prolongée de l'écriture/lecture de GD, ce qui pourrait avoir renforcé le biais attentionnel vers la gauche chez les droitiers comme chez les gauchers. Il convient de noter que les gauchers et les femmes présentaient un biais attentionnel vers la gauche plus faible (i.e., le centre de gravité de la FCRO était plus proche du centre du papier à dessin). De même, les femmes avec une latéralité manuelle mixte commençaient leurs dessins près du centre de la feuille, tandis que les autres participants avaient tendance à commencer plus à gauche. Ces résultats peuvent être interprétés sur la base des observations montrant que les gauchers et les femmes présentent un biais attentionnel plus faible en raison d'une SFH plus faible par rapport aux droitiers et aux hommes. Par conséquent, la latéralisation cérébrale semble exercer une influence sur les asymétries graphomotrices tant chez les enfants que chez les adultes. Cependant, elle est plus faible chez les adultes ; ce qui pourrait être dû à des influences socioculturelles.

Objectif théorique

Contexte théorique

Bien que l'ontogenèse de la latéralité manuelle reste peu claire (Ocklenburg et al., 2021), l'intérêt pour l'étude du développement de la latéralité a considérablement augmenté au cours des dernières décennies. Ceci a été motivé par des résultats montrant que les non-droitiers sont plus fréquemment associés à des troubles neuro-développementaux et psychiatriques tels que l'autisme, la Dyslexie Développementale (DD), le Trouble Développemental de la Coordination (TDC) et la schizophrénie (Berretz, Wolf et al., 2020 ; Darvik et al., 2018 ; Eglinton & Annett, 1994). Différentes directions ont été suggérées pour décrire la nature de cette association (Bishop, 2013). Elle peut être le reflet d'une relation causale (i.e., la latéralité atypique entraîne des troubles), d'une conséquence (i.e., la latéralité atypique est un résultat des troubles), ou d'une

corrélation due à des facteurs sous-jacents communs (i.e., la latéralité atypique et les troubles partagent des facteurs communs). Les données récentes tendent à soutenir le troisième type d'association (Mundorf & Ocklenburg, 2021, p. 107). Une question peut néanmoins se poser sur la nature des facteurs communs qui augmentent la probabilité de développer une latéralité atypique, des troubles neuro-développementaux et psychiatriques. D'une part, la génétique est sans aucun doute impliquée dans la latéralité manuelle (Cuellar-Partida et al., 2020 ; McManus, 2021 ; Medland et al., 2006 ; Medland et al., 2009 ; Schmitz et al., 2022). De même, les troubles neuro-développementaux et psychiatriques ont des origines génétiques (Mitchell, 2011 ; Paracchini et al., 2016). Récemment, un nombre croissant d'études ont trouvé des facteurs polygéniques communs entre la latéralité et les troubles neuro-développementaux (Brandler & Paracchini, 2014 ; Sha, Schijven, Carrion-Castillo et al., 2021 ; Sha, Schijven & Francks, 2021 ; Wiberg et al., 2019). D'autre part, il est démontré que des facteurs non génétiques sont également impliqués dans le développement de la latéralité et des troubles mentaux (Connors et al., 2008 ; Gliga & Alderdice, 2015 ; Michel, 2021 ; Rentería, 2012 ; Schmitt et al., 2014). Par conséquent, il est pertinent de suggérer que des facteurs non génétiques communs peuvent entraîner un développement atypique de la latéralité et des troubles neuro-développementaux (Berretz, Wolf et al., 2020 ; Ocklenburg et al., 2016). Dans cette optique, nous avons testé plusieurs modèles théoriques qui suggèrent que l'environnement prénatal est impliqué dans la trajectoire développementale typique ou atypique de la latéralité manuelle et dans le développement cognitif et moteur.

Le premier cadre théorique étudié postule que la latéralité manuelle est une manifestation des asymétries précoces liées à la position fœtale (Michel, 2021). Selon la Théorie de la Dominance Otolithique Gauche (TDOG ; Previc, 1991), la latéralisation cérébrale est influencée par la position fœtale au cours du dernier trimestre de gestation. La plupart des fœtus se retournent dans le ventre de la mère et adoptent la position céphalique du premier vertex (i.e., position occipito-iliaque gauche). En d'autres termes, ils sont couchés tête en bas, le dos tourné vers le côté gauche de la mère et l'oreille droite tournée vers l'extérieur (Previc, 1991). Dans ce qui suit, on va se référer à cette position par « position céphalique gauche », et vice versa pour la position orientée vers la droite. Selon la TDOG, la position céphalique gauche contribuera à la latéralisation du système vestibulaire. L'accélération de la mère lors de la locomotion influencerait le développement asymétrique des voies otolithiques. Plus précisément, l'utricule gauche bénéficierait

davantage des stimulations de la force d'inertie (pour plus de détails, voir Previc, 1991, p. 318). Ainsi, dans la plupart des cas, la position de la tête dans le bassin osseux maternel en fin de gestation va conduire à une surexcitation des otolithes gauches. Il en résultera une stimulation précoce du cortex vestibulaire de l'hémisphère droit, entraînant une spécialisation précoce dans le traitement de l'information du positionnement du corps dans l'espace et le traitement visuo-spatial. Par conséquent, cela permettra à l'hémisphère gauche de se spécialiser dans la performance motrice, augmentant la capacité du côté droit du corps pour les mouvements moteurs volontaires. En outre, pendant la marche maternelle, la stimulation des otolithes gauches entraînera un plus grand nombre d'impulsions du tronc cérébral se terminant sur le tractus vestibulospinal qui innerve le contrôle ipsilatéral des muscles extenseurs. Ce biais à gauche dans l'activation du muscle sternocléidomastoïdien entraînera une rotation de la tête vers la droite (Ververs et al., 1994b), qui s'est avérée être associée à la droiterie (Ferre et al., 2020 ; Goodwin & Michel, 1981 ; Ocklenburg et al., 2010). Il est important de noter que, étant donné que les enfants souffrant de troubles neuro-développementaux tels que la DD sont généralement faiblement latéralisés, la TDOG fournit une explication du lien entre la latéralisation atypique et les troubles neuro-développementaux. Previc (1991, 1996) a suggéré qu'une hypoactivité vestibulaire et un dysfonctionnement otolithique, qui peuvent altérer la latéralisation vestibulaire (Previc, 1996, p. 453), pourraient expliquer l'incidence plus élevée des troubles neuro-développementaux (Previc, 1991, 1996). Ainsi, des symptômes vestibulo-cérébelleux mineurs (e.g., déficit du contrôle postural), qui reflètent vraisemblablement un dysfonctionnement otolithique, pourraient représenter un facteur de risque de troubles neuro-développementaux. Conformément à cette hypothèse, il a été rapporté que les enfants atteints de DD et de TCD présentent une latéralisation atypique (Berretz, Wolf et al., 2020 ; Biotteau et al., 2016 ; Darvik et al., 2018, Eglinton & Annett, 1994), ainsi que des déficiences spatiales, posturales et proprioceptives, qui sont des symptômes cliniques observés lorsque le système vestibulaire est dysfonctionnel (Blythe, 2017, p. 14 à 18). Alors que la TDOG (Previc, 1991) pourrait expliquer l'association entre une latéralité atypique et les troubles neuro-développementaux, aucune étude à notre connaissance n'a testé un pattern développemental incluant la position fœtale, le système vestibulaire, la latéralité, et les troubles neuro-développementaux.

Le deuxième cadre théorique étudié dans cette thèse postule l'existence d'une origine pathologique et non-pathologique pour la non-droiterie (i.e., gaucherie et ambidextrie). En ce qui concerne l'origine

pathologique, l'émergence précoce de la non-droiterie pourrait être une conséquence de facteurs de risques survenant entre la période prénatale et la naissance (Bakan, 1971 ; Bakan et al., 1973 ; Satz, 1972). Le raisonnement sous-jacent à cette théorie est que la prévalence élevée de la non-droiterie est indirectement expliquée par une plus grande vulnérabilité de l'hémisphère gauche par rapport à l'hémisphère droit à des événements pathologiques externes. En effet, l'hémisphère gauche est censé avoir un plus grand besoin d'oxygène en raison d'un métabolisme plus actif (Bakan et al., 1973). De telles influences, comme l'hypoxie, pourraient conduire à une latéralité atypique. Étant donné que la latéralité manuelle est associée à la latéralisation motrice au début de la vie néonatale (Bisiacchi & Cainelli, 2022 ; Cioni & Pellegrinetti, 1982), des Complications durant la Grossesse et des facteurs de Stress à la Naissance (CGSN) mineures, couplée à une hypoxie, pourraient entraîner une altération cérébrale unilatérale localisée dans l'hémisphère gauche. Cela pourrait alors endommager le fonctionnement de la main controlatérale, en l'occurrence la main droite (Bakan, 1971 ; Bakan et al., 1973 ; Bishop, 1990a, p. 90 ; Porac, 2016, p. 40). Alors que quelques études ont obtenu des résultats allant dans le sens de cette théorie, d'autres n'ont cependant pas réussi à trouver une association entre les CGSN et la non-droiterie (Annett & Ockwell, 1980 ; Dellatolas et al., 1991 ; Ehrlichman et al., 1982 ; Levander et al., 1989 ; McManus, 1981 ; Nicholls et al., 2012 ; Tan & Nettleton, 1980 ; Van Der Elst et al., 2011). Ces résultats contradictoires peuvent être en partie dus aux différentes méthodologies appliquées pour évaluer la latéralité manuelle et les CGSN (Coren et al., 1982 ; Elliott, 1992 ; Levander et al., 1989 ; Marcori & Okazaki, 2020 ; Porac, 2016, p. 40 ; Searleman et al., 1989). Premièrement, certaines études ont utilisé des mesures de la latéralité manuelle non validées, comme, par exemple, la seule mesure de la main utilisée pour écrire. Deuxièmement, les CGSN étaient soit auto-déclarés, soit indiqués par les parents. Ces deux moyens sont moins précis que des données issues de dossiers médicaux. Troisièmement, plusieurs études ont regroupé toutes les formes de CGSN sous une seule catégorie. Cette approche n'est pas idéale puisque chaque CGSN peut affecter d'une manière différente la latéralité manuelle. Quatrièmement, l'opérationnalisation de certains des CGSN peut varier d'une étude à l'autre. En plus de ces limites méthodologiques, nous pouvons en proposer deux de nature théorique. La première est que la plupart des études n'ont comparé que la prévalence de droitiers par rapport aux gauchers, ou des droitiers par rapport aux non-droitiers. Cependant, cette classification dichotomique, avec regroupement des gauchers et ambidextres, n'est pas souhaitable. Certains auteurs suggèrent que les CGSN pourraient ne pas conduire à un changement de la dextralité à la gaucherie, mais seulement réduire

le biais en faveur de la préférence pour la main droite, conduisant à une ambidextrie (Coren et al., 1982 ; Domellöf et al., 2011 ; Hicks et al., 1980 ; Searleman et al., 1989). Par conséquent, l'ambidextrie devrait être évaluée séparément (Burnett et al., 2018 ; Domellöf et al., 2011 ; Marcori & Okazaki, 2020 ; Van Der Elst et al., 2011). La deuxième limite théorique est la mesure d'une seule dimension de la latéralité manuelle, en l'occurrence la préférence manuelle. La performance manuelle a été largement négligée dans la littérature. Mesurer cette dernière le long d'un continuum pourrait être une approche plus sensible lors de l'étude de l'influence des CGSN (Bishop, 1984). En effet, il a été suggéré que les CGSN peuvent réduire les performances de la main droite et non pas la préférence manuelle (Bishop, 1990a, p. 96 ; Domellöf et al., 2011 ; Ross et al., 1992 ; Van Der Elst et al., 2011).

Article 2

Hamaoui, J., Stefaniak, N., & Segond, H. (accepted). The influence of vestibular system and fetal presentation on handedness, cognitive and motor development: A comparison between cephalic and breech presentation. *Developmental Science*.

Bien que la TDOG (Previc, 1991) fournisse une explication du lien entre la position fœtale, la latéralité manuelle et les troubles neuro-développementaux, les études qui ont testé ce cadre théorique sont rares. À notre connaissance, l'étude de Fong et al. (2005) est la plus récente à avoir testé empiriquement ce modèle. Les auteurs ont étudié l'orientation de la tête en comparant les fœtus ayant une position céphalique et ceux ayant une position siège (i.e., position où la tête reste en haut). Ils ont constaté l'existence d'une latéralisation progressive de l'orientation de la tête, principalement en faveur du côté droit, chez les fœtus en position céphalique à partir de la 36ème semaine de gestation, alors que les fœtus en siège ne présentaient aucune préférence pour l'un ou l'autre côté. Ces résultats ont été interprétés en se référant à la TDOG, où il a été postulé que les fœtus en siège ont une stimulation moins asymétrique de leurs otolithes puisque leur position permet une plus grande liberté dans les mouvements de la tête. Cela conduirait à une moindre latéralisation vestibulaire, ce qui, par conséquent, se traduirait par une manifestation plus faible de l'orientation latéralisée de la tête. De plus, cette moindre latéralisation vestibulaire chez les enfants en siège peut s'expliquer par des facteurs intrinsèques au développement du système vestibulaire (Fong et al., 2005). Il est postulé qu'un système vestibulaire mature au cours du dernier trimestre est nécessaire pour adopter une position typique (i.e., position céphalique), alors que les

fœtus en position siège sont présumés avoir un système vestibulaire dysfonctionnel (Eliot, 2000, p. 143 ; Blythe, 2017, p. 184, 185). Ainsi, puisque le dysfonctionnement vestibulaire peut modifier l'asymétrie otolithique (Previc, 1996, p. 453), il peut expliquer pourquoi les enfants en siège sont moins latéralisés.

Le premier objectif de cette étude était de vérifier si la position fœtale en siège est associée à des dysfonctionnements vestibulaires. Si c'est le cas, nous devrions observer que les enfants nés en position siège présentent plus de difficultés à effectuer des tâches impliquant le système vestibulaire. Plus spécifiquement, le saccule et l'utricule, qui constituent les organes otolithiques, répondent à la gravité ; ce qui suggère qu'ils contribuent au maintien de la stabilité posturale (McCaslin et al., 2011). Basta et al. (2005) ont constaté que les patients diagnostiqués avec un trouble otolithique présentent de mauvaises performances posturales. Ainsi, pour tester l'hypothèse selon laquelle les enfants en siège présentent un fonctionnement vestibulaire atypique, on peut évaluer le lien entre la position siège et les scores des enfants aux tests cliniques d'équilibre. Le second objectif de cette étude était de tester indirectement la TDOG en étudiant, par le biais de la latéralité manuelle, l'influence de la position fœtale sur les comportements latéralisés postnataux. Étant donné que les fœtus en position siège ont montré une latéralisation plus faible que les fœtus en position céphalique (Fong et al., 2005) et que la position fœtale a été associée à la latéralité manuelle (Churchill et al., 1962 ; Ehrlichman et al., 1982 ; Ferre et al., 2020 ; Michel, 2021 ; Michel & Goodwin, 1979), nous nous attendions à une association entre la position siège et une moindre latéralité manuelle. La TDOG suggère qu'un dysfonctionnement vestibulaire devrait modifier l'asymétrie otolithique, conduisant à une moindre latéralisation, et augmentant la probabilité d'un développement atypique associé à des troubles neuro-développementaux. Ainsi, si la position par le siège reflète bien des dysfonctionnements vestibulaires et une moindre latéralisation comme cela a été suggéré, le troisième objectif de cette étude était alors de tester la prédiction selon laquelle les enfants nés en position siège devraient être plus souvent associés à des troubles neuro-développementaux. En conséquence, et en se basant sur la TDOG (Previc, 1991), nous avons testé un modèle développemental hypothétique selon lequel une présentation par le siège (qui serait associée à un système vestibulaire dysfonctionnel et une faible latéralisation) peut conduire à une faible latéralité manuelle et à un développement atypique associé à des difficultés langagière et motrice. Également, dans le cadre d'une

analyse complémentaire non planifiée, nous avons testé la relation entre la prématurité, la latéralité manuelle et les troubles neuro-développementaux.

Les données analysées pour l'Article 2 et l'étude complémentaire 2 proviennent de l'Avon Longitudinal Study of Parents and Children (ALSPAC). L'objectif de cette grande cohorte est de comprendre l'influence et l'interaction entre les facteurs environnementaux physiques et sociaux et l'héritage génétique sur la santé mentale et physique de la petite enfance à l'âge adulte. Des femmes enceintes du sud-ouest de l'Angleterre, dont la date d'accouchement était prévue entre le 1er avril 1991 et le 31 décembre 1992, ont été recrutées. La taille totale de l'échantillon de la cohorte était de 15 454 grossesses, donnant lieu à 15 589 fœtus (Boyd et al., 2012 ; Fraser et al., 2012). La taille totale de l'échantillon pour notre étude, après avoir appliqué nos critères d'exclusion et retirer les sujets présentant des données manquantes, était de 7047 (dont 315 enfants avec position siège).

Etude complémentaire 2

L'étude complémentaire 2 a exploré davantage le rôle des CGSN dans le développement de la latéralité. Les complications et les facteurs de stress précoces, tels que la prématurité, le faible poids de naissance et une santé néonatale à risque, peuvent perturber la trajectoire développementale typique du fœtus et du nouveau-né, et sont considérés comme des facteurs de risque de troubles du neuro-développementaux (Cha et al., 2022 ; Modabbernia et al., 2016). Dans cette perspective, nous avons étudié l'implication des CGSN sur la latéralité manuelle. Nous avons testé l'association entre la latéralité manuelle atypique, le poids néonatal (habituellement corrélé à l'âge gestationnel), et la santé néonatale évaluée à l'aide du score d'Apgar. Ces variables ont été sélectionnées en raison de plusieurs résultats montrant que l'âge gestationnel et le poids à la naissance sont liés à la latéralité manuelle (Domellöf et al., 2011 ; Searleman et al., 1989). Une prévalence plus élevée de non-droiterie est constatée chez les enfants prématurés (Burnett et al., 2018 ; Marlow et al., 2019 ; van Heerwaarde et al., 2020) et les enfants ayant un faible poids néonatal (James & Orlebeke, 2002 ; O'Callaghan et al., 1987 ; O'Callaghan et al., 1993 ; Powls et al., 1996). En outre, il est démontré qu'une santé néonatale à risque, reflétée par un faible score d'Apgar, augmente la prévalence de la gaucherie (Dragović, Milenković et al., 2013 ; Schwartz, 1988). L'étude complémentaire 2 avait donc pour but d'étudier la relation entre les CGSN et la latéralité manuelle, tout en prenant en compte les limites

mentionnées précédemment. Nos hypothèses étaient que les CGSN (i.e., la prématurité, le faible poids néonatal et une santé néonatale à risque) conduiraient à une latéralité manuelle atypique et à des troubles neuro-développementaux. Si ces hypothèses étaient corroborées, alors le CGSN pourrait faire partie des facteurs communs entre la latéralité atypique et les troubles neuro-développementaux.

Résultats et discussion

Dans l'article 2, nous avons émis l'hypothèse qu'un dysfonctionnement du système vestibulaire ne permettrait pas à l'enfant de se retourner au troisième trimestre de gestation, entraînant ainsi une position siège et une faible latéralisation vestibulaire. Par conséquent, nous avons testé si la position siège augmentait le risque de troubles neuro-développementaux. Aucune différence n'a été trouvée entre les enfants ayant eu une position fœtale céphalique et ceux ayant eu une position en siège sur le test d'équilibre statique, qui était censé refléter le fonctionnement du système vestibulaire. De plus, la position fœtale n'était associée ni à la latéralité manuelle ni aux troubles neuro-développementaux. Ces résultats ne corroboraient pas nos hypothèses issues de la Théorie de la Dominance Otolithique Gauche (TDOG) de Previc (1991, 1996). En revanche, une prévalence plus élevée de la préférence manuelle gauche et du Trouble Développementale de la Coordination du (TDC) a été constatée chez les enfants prématurés. Dans l'étude complémentaire 2, un faible poids à la naissance était associé à une préférence manuelle gauche et au TDC, alors qu'une très mauvaise santé néonatale évaluée à 5 minutes avec le test d'Apgar n'était liée qu'à une préférence manuelle gauche et à une faible performance manuelle de la main droite. Ces résultats soutiennent les études précédentes qui ont constaté que les Complications de la Grossesse et les facteurs de Stress à la Naissance (CGSN) augmentent la probabilité d'avoir une latéralité atypique (de Kovel et al., 2019 ; Domellöf et al., 2011 ; Dragović, Milenković et al., 2013). Différentes théories peuvent être proposées pour tenter d'expliquer le lien entre CGSN, latéralité atypique et troubles neuro-développementaux.

Dans la théorie de la gaucherie pathologique, Satz (1972, 1973) a proposé une origine naturelle et une origine pathologique pour la gaucherie. Pour cette dernière, il est suggéré qu'une lésion de l'hémisphère gauche entraîne une gaucherie. L'étude complémentaire 2 montre que les enfants ayant un score d'Apgar très bas (c'est-à-dire <4) ont montré une diminution de la performance de la main droite. De plus, une prévalence plus élevée d'anoxie est observée chez les enfants ayant un score d'Apgar très bas (Iliodromiti

et al., 2014). Étant donné que l'hémisphère gauche est plus vulnérable aux influences externes (Bisiacchi & Cainelli, 2022 ; Manns, 2021a ; Njiokiktjien, 2006), la performance réduite de la main droite chez les enfants ayant un score d'Apgar très bas pourrait s'expliquer par une altération de l'hémisphère gauche consécutive à l'anoxie. Cependant, une différence entre les mains n'a pas été trouvée chez les enfants prématurés et/ou avec un faible poids néonatal, et donc l'hypothèse d'une altération de l'hémisphère gauche ne peut pas être généralisée à tous les CGSN. De plus, dans notre étude, les scores d'Apgar n'étaient pas associés au TDC. Étant donné que les personnes non droitères et atteintes de troubles du développement ne présentent pas toutes des altérations hémisphériques, il est peu probable qu'une altération de l'hémisphère gauche soit le facteur commun qui pourrait expliquer la relation entre le CGSN, la latéralité atypique et les déficiences motrices. D'autres théories peuvent être avancées.

Le stress, qui est lié à l'axe Hypothalamo-Hypophyso-Surrénalien (HHS), pourrait être un facteur possible sous-tendant la relation entre les adversités prénatales, la latéralité atypique et les troubles neuro-développementaux. Plus précisément, il a été suggéré que le stress précoce, altérant le fonctionnement de l'axe HHS, conduirait à une latéralisation cérébrale atypique et à des troubles neuro-développementaux et psychiatriques (Berretz, Wolf et al., 2020). Des niveaux élevés de cortisol permettent de prédire un retard de croissance du fœtus et surtout une prématurité et un faible poids néonatal (Field et al., 2006 ; Field & Diego, 2008). En traversant directement le placenta, le niveau de cortisol prénatal de la mère est associé au niveau de cortisol du fœtus et, par conséquent, du nouveau-né (Field & Diego, 2008). Il a été constaté que les adversités prénatales entraînent une modification permanente de l'axe HHS (Kapoor et al., 2006). On constate que les enfants d'âge scolaire nés très prématurément ont un fonctionnement altéré de l'axe HHS (Brummelte et al., 2015). L'hémisphère droit est lié à l'axe HHS, et la sécrétion de cortisol est principalement sous le contrôle excitateur de cet hémisphère (Hecht, 2010). Lorsqu'ils sont exposés à des stimuli stressants, les enfants de huit à neuf ans, ayant eu un faible poids de naissance, présentent un débit sanguin plus important dans l'hémisphère droit que dans l'hémisphère gauche (Jones et al., 2011). Mundorf et al. (2020) ont constaté que le stress précoce induisait des asymétries comportementales atypiques favorisant le côté gauche, ce qui suggère que l'exposition au stress entraîne une plus grande activation de l'hémisphère droit. Il a également été montré que le stress maternel prénatal est positivement lié à l'exploration tactile du corps avec la main gauche (Reissland et al., 2015). En outre, les PCBS augmentent le

risque de troubles neuro-développementaux (Cha et al., 2022 ; Edwards et al., 2011 ; Modabbernia et al., 2016 ; Wallois et al., 2020), généralement associé à un dérèglement de l'axe HHS (Cartier et al., 2016 ; Theodoridou et al., 2021). Par conséquent, on peut stipuler que les CGSN, par le biais de la perturbation de l'axe HHS (Kapoor et al., 2006) et du développement typique de l'enfant (Wallois et al., 2020), pourraient entraîner une latéralité atypique associée à des troubles neuro-développementaux (Berretz, Wolf et al., 2020 ; Mundorf et al., 2020).

Un troisième modèle théorique pourrait également être exposé, en liaison avec le système vestibulaire. Les nouveau-nés âgés d'un à cinq jours présentent une asymétrie du réflexe de Moro, où le bras droit commence à bouger avant le gauche (Rönnqvist, 1995). Comme le réflexe de Moro est lié au système vestibulaire, on peut supposer qu'une latéralisation vestibulaire pendant la gestation entraîne des asymétries de mouvements et de postures chez les nouveau-nés (Rönnqvist, 1995). Au niveau fonctionnel, certaines études ont montré que les latéralisations vestibulaire et motrice sont liées. Il a été constaté que le contrôle du système vestibulaire est dominant dans l'hémisphère droit chez les droitiers et dans l'hémisphère gauche chez les gauchers (Dieterich et al., 2003 ; Zu Eulenburg et al., 2012 ; Janzen et al., 2008). Ainsi, la dominance vestibulaire semble être ipsilatérale à la latéralité manuelle, et donc controlatérale à la dominance hémisphérique motrice (i.e., l'hémisphère gauche contrôle la main droite et vice versa pour la main gauche). Ces résultats ont soulevé la question d'une relation possible entre la latéralisation vestibulaire et motrice. Étant donné que le système vestibulaire devient mature tôt au cours de la gestation, avant le développement de la latéralité manuelle, Brandt et Dieterich (2015) ont proposé l'hypothèse selon laquelle la latéralisation précoce du système vestibulaire détermine la latéralisation sensorimotrice ultérieure. Les auteurs ont suggéré que chacune des fonctions vestibulaires supérieures (e.g., la mémoire spatiale, l'orientation, la navigation) et la latéralité manuelle nécessitent leur propre système de coordonnées. Le premier est allocentrique et responsable de la localisation de soi dans l'environnement, tandis que le second est égocentrique et responsable de la manipulation des objets. Ainsi, leur latéralisation fonctionnelle dans des hémisphères opposés va leur permettre de fonctionner indépendamment l'un de l'autre, permettant une optimisation des deux fonctions au cours du développement de l'enfant (Dieterich & Brandt, 2018a). Ainsi, une latéralisation vestibulaire précoce conduira à une asymétrie fonctionnelle perceptive et motrice bien établie (Brandt & Dieterich, 2015 ;

Dieterich et al., 2003). Sur la base de la relation suggérée entre les latéralisations vestibulaire et motrice, nous pourrions expliquer comment les CGSN pourraient être liées à une latéralité manuelle atypique. Il a été démontré qu'une activation de l'axe HHS est liée au système vestibulaire, un stress excessif ou inapproprié pouvant avoir un impact délétère sur celui-ci (Saman et al., 2020). Par conséquent, les événements de stress prénatal pourraient perturber la latéralisation vestibulaire. Cette hypothèse peut être étayée par le fait que les enfants prématurés présentent un biais attentionnel visuo-spatial plus faible que leurs pairs nés à terme, reflétant ainsi une latéralisation fonctionnelle atypique de l'hémisphère droit (Davis et al., 2022). Il est intéressant de noter que l'attention visuo-spatiale et le traitement vestibulaire sont partiellement liés l'un à l'autre et sont tous deux latéralisés dans l'hémisphère droit (Karnath & Dieterich, 2006). Ainsi, les CGSN peuvent perturber la latéralisation vestibulaire précoce, ce qui pourrait modifier les asymétries hémisphériques pour d'autres fonctions. De plus, les aires corticales vestibulaires sont liées au cortex moteur et prémoteur dans le maintien de l'équilibre et la coordination des mouvements volontaires (Carmona et al., 2009), et il est démontré que les CGSN ont un impact sur la maturation du système moteur (Wallois et al., 2020). Cela pourrait donc expliquer comment les CGSN peuvent être liés à la fois à une latéralisation fonctionnelle atypique (via la latéralisation vestibulaire) et à des déficiences motrices (en altérant le développement moteur et vestibulaire).

Au niveau comportemental, l'asymétrie du réflexe de Moro est associée à la préférence pour l'orientation de la tête (Rönnqvist, 1995 ; Rönnqvist et al., 1998), ce qui suggère que ces deux phénomènes sont liés à la latéralisation vestibulaire. Il est intéressant de noter que les nouveau-nés prématurés et avec faible poids néonatal présentent une orientation latérale réduite de la tête par rapport aux bébés nés à terme (Fox & Lewis, 1982 ; Gardner et al., 1977 ; Geerdink et al., 1994 ; Kurtzberg et al., 1979). Par conséquent, on pourrait suggérer que les CGSN tels que la prématurité pourraient empêcher le développement des asymétries vestibulaires au cours du dernier trimestre, ce qui à son tour perturberait le développement d'autres latéralisations comportementales (Previc, 1991, 1996). Suite à un tel événement, on peut suggérer que l'orientation réduite de la tête chez les enfants ayant connu des CGSN pourrait conduire, en se référant à la "théorie en cascade de la latéralité manuelle" (Michel, 1983), à différentes trajectoires développementales. En effet, de faibles asymétries posturales réduiront l'utilisation de la main droite qui est généralement observée chez la plupart des nouveau-nés, réduisant

l'expérience proprioceptive et visuelle qui y est associée au cours du développement. Cela pourrait donc conduire à une probabilité plus élevée de développer une non-droiterie.

Pour conclure, en se référant à Satz (1972, 1973) et sur la base de nos résultats, on pourrait suggérer une origine soit non pathologique, soit pathologique pour la gaucherie (Schaafsma et al., 2009). Dans le premier cas, il est probable que la gaucherie soit déterminée par de rares facteurs intrinsèques (e.g., la génétique, McManus et al., 2013) favorisant le côté gauche, où les influences environnementales ne pourraient pas être assez fortes pour favoriser la préférence vers le côté droit (Fagard, 2013b). Quant à la gaucherie d'origine pathologique, les adversités prénatales pourraient jouer un rôle important en perturbant la croissance fœtale précoce, affectant à la fois le développement de la latéralité atypique et les systèmes cognitifs et moteurs (Davis et al., 2022 ; Domellöf et al., 2011 ; Wallois et al., 2020).

Jad Hamaoui

Développement de la latéralité : Comportements humains asymétriques et biais perceptuels

Résumé

De nombreuses asymétries caractérisent le fonctionnement humain au niveau comportemental, telles que la latéralité manuelle (droiterie, gaucherie, ambidextrie), mais également au niveau cérébral. Une latéralité atypique est fréquemment mentionnée dans la littérature scientifique comme faisant partie du tableau clinique de plusieurs troubles neuro-développementaux et psychiatriques. Ainsi, la compréhension des mécanismes neuro-développementaux sous-jacents à la latéralité pourrait éclairer une partie de l'étiologie des difficultés cognitives et motrices. L'objectif de cette thèse est double. Le premier, de nature théorique, est de tester l'implication de l'environnement prénatal dans le développement de la latéralité manuelle. L'influence du système vestibulaire, de la position fœtale et d'autres facteurs périnataux relevant des complications de la grossesse et facteurs de stress à la naissance ont été testés. Nos résultats montrent une absence d'influence de la position fœtale sur le développement ultérieur de la latéralité manuelle. Cependant, des événements périnataux comme la prématurité, le faible poids de naissance, et une santé néonatale à risque reflétée par un très faible score d'Apgar se révèlent être des facteurs pouvant augmenter la prévalence d'un développement atypique de l'enfant au niveau de la latéralité manuelle et moteur. Le deuxième objectif de cette thèse, de nature appliquée, est de détecter, de manière exhaustive, les différents biais perceptuels qui peuvent se manifester lors d'une production graphomotrice. Ainsi, une tâche graphique de transcription 3D-2D a été proposée afin d'identifier des patterns globaux des asymétries du dessin, sous-tendues par la latéralisation cérébrale et comportementale, les contraintes biomécaniques, et les influences socioculturelles. Nos résultats montrent que la latéralisation cérébrale, modulée par la latéralité manuelle et le sexe, semble exercer une influence sur les asymétries graphomotrices tant chez les enfants que chez les adultes. Cependant, elle est plus faible chez les adultes, ce qui pourrait être dû aux influences socioculturelles.

Mots-clés : Latéralité, Environnement prénatal, Développement cognitif et moteur, Biais perceptuels, Asymétries graphomotrices

Jad Hamaoui

Development of laterality: Asymmetrical human behaviors and perceptual biases

Abstract

Many asymmetries characterize human functioning at the behavioral level, such as handedness (right-handedness, left-handedness, mixed-handedness) and the cerebral level. Atypical laterality is frequently mentioned in scientific literature as part of the clinical picture of several neurodevelopmental and psychiatric disorders. Thus, understanding the neurodevelopmental mechanisms underlying laterality could shed light on the etiology of cognitive and motor difficulties. The goal of this thesis is twofold. Firstly, the theoretical objective was to investigate the involvement of the prenatal environment in the development of handedness. The influence of the vestibular system, fetal presentation, and other perinatal factors related to pregnancy complications and birth stressors were tested. Our results show no influence of the fetal presentation on the subsequent development of handedness. Perinatal adversities such as prematurity, low birthweight, and poor neonatal health reflected by very low Apgar scores however, appear to be risk factors which increase the prevalence of atypical handedness and motor impairments. Secondly, the applied objective was to simultaneously detect the different perceptual biases implicated in graphomotor productions. A 3D-2D transcription graphic task was proposed for identifying global patterns of drawing asymmetries, underpinned by cerebral lateralization, biomechanical constraints, and sociocultural influences. Our results suggest that cerebral lateralization, modulated by handedness and sex, influence graphomotor asymmetries in both children and adults. However, this influence is weaker in adults, which could be due to sociocultural influences.

Keywords: Laterality, Prenatal environment, Cognitive and motor development, Perceptual biases, Graphomotor asymmetries