



**HAL**  
open science

# Systèmes Dynamiques en Réseau : Nouvelles Approches Entrée-Sortie pour l'analyse de la Stabilité et de la Synchronisation

Jijju Thomas

► **To cite this version:**

Jijju Thomas. Systèmes Dynamiques en Réseau : Nouvelles Approches Entrée-Sortie pour l'analyse de la Stabilité et de la Synchronisation. Automatic. Centrale Lille Institut; Technische hogeschool (Eindhoven, Pays-Bas), 2021. English. NNT : 2021CLIL0008 . tel-04007723

**HAL Id: tel-04007723**

**<https://theses.hal.science/tel-04007723v1>**

Submitted on 28 Feb 2023

**HAL** is a multi-disciplinary open access archive for the deposit and dissemination of scientific research documents, whether they are published or not. The documents may come from teaching and research institutions in France or abroad, or from public or private research centers.

L'archive ouverte pluridisciplinaire **HAL**, est destinée au dépôt et à la diffusion de documents scientifiques de niveau recherche, publiés ou non, émanant des établissements d'enseignement et de recherche français ou étrangers, des laboratoires publics ou privés.

**CENTRALE LILLE**

THÈSE

Présentée en vue  
d'obtenir le grade de

**DOCTEUR**

En

**Spécialité : Automatique, Génie Informatique,  
Traitement du Signal et des Images**

Par

**Jijju THOMAS**

**DOCTORAT DELIVRÉ CONJOINTEMENT PAR CENTRALE LILLE ET  
TECHNISCHE UNIVERSTEIT EINDHOVEN**

Titre de la thèse :

**Systèmes Dynamiques en Réseau: Nouvelles Approches  
Entrée-Sortie pour l'analyse de la Stabilité et de la Synchronisation**

Soutenue le 4 mai, 2021 devant le jury d'examen :

<b>Président</b>	Philip DE GOEY, <i>Professeur, TU Eindhoven, Pays-Bas</i>
<b>Directeur</b>	Jean-Pierre RICHARD, <i>Professeur, Centrale Lille, France</i>
<b>Co-Directeur</b>	Nathan VAN DE WOUW, <i>Professeur, TU Eindhoven, Pays-Bas</i>
<b>Rapporteur</b>	Michael CANTONI, <i>Professeur, University of Melbourne, Australie</i>
<b>Rapporteure</b>	Sophie TARBOURIECH, <i>Directrice de Recherche, LAAS-CNRS, France</i>
<b>Examinateur</b>	Henk NIJMEIJER, <i>Professeur, TU Eindhoven, Pays-Bas</i>
<b>Examinateur</b>	Laurentiu HETEL, <i>Chargé de Recherche, CRISTAL-CNRS, France</i>
<b>Examinatrice</b>	Elena PANTELEY, <i>Directrice de Recherche, L2S-CNRS, France</i>

Thèse préparée dans le Laboratoire CRISTAL  
Ecole Doctorale SPI 072



# Networked Dynamical Systems

An Input-Output Approach towards Stability and  
Synchronization Analysis

Jijju Thomas



The work described in this thesis was carried out at Centrale Lille, UMR 9189 - CRIStAL - Centre de Recherche en Informatique Signal et Automatique de Lille, F-59000 Lille, France, and Eindhoven University of Technology, Netherlands. The research is part of the project “UCoCoS” funded by the European Union’s EU Framework Programme for Research and Innovation, Horizon H2020, Grant Agreement No: 675080.

A catalogue record is available from the Eindhoven University of Technology Library.  
ISBN: 978-90-386-5260-3

Typeset using L<sup>A</sup>T<sub>E</sub>X.

Reproduction: ProefschriftMaken, the Netherlands

Cover design: Jijju Thomas and ProefschriftMaken, the Netherlands

© 2021 by J. Thomas. All rights reserved.

# Networked Dynamical Systems

## An Input-Output Approach towards Stability and Synchronization Analysis

PROEFSCHRIFT

ter verkrijging van de graad van doctor aan de Technische Universiteit Eindhoven, op gezag van de rector magnificus prof.dr.ir. F.P.T. Baaijens, voor een commissie aangewezen door het College voor Promoties, in het openbaar te verdedigen op dinsdag 4 mei 2021 om 13:30 uur

door

Jijju Thomas

geboren te Ernakulam, India

Dit proefschrift is goedgekeurd door de promotoren en de samenstelling van de promotiecommissie is als volgt:

voorzitter: prof.dr. L. P. H. de Goey  
1<sup>e</sup> promotor: prof.dr.ir. N. van de Wouw  
2<sup>e</sup> promotor: prof.dr. J.-P. Richard (Centrale Lille, France)  
co-promotor: dr. L. Hetel (CRIS<sup>t</sup>AL-CNRS, Lille, France)  
leden: prof.dr. H. Nijmeijer (Technische Universiteit Eindhoven, Netherlands)  
dr. S. Tarbouriech (LAAS-CNRS, Toulouse, France)  
prof.dr. M. Cantoni (University of Melbourne, Australia)  
dr. E. Panteley (L2S-CNRS, Gif-sur-Yvette, France)

Het onderzoek dat in dit proefschrift wordt beschreven is uitgevoerd in overeenstemming met de TU/e Gedragscode Wetenschapsbeoefening.

*To my beloved Meryl,  
in whom my strength lies.*

*To Achacha, Amma and Sajju,  
for supporting the philomath in me.*





---

# Summary

---

## **Networked Dynamical Systems** An Input-Output Approach towards Stability and Synchronization Analysis

This thesis describes novel tools for the analysis of stability and synchronization in networked dynamical systems. Recent advances in communication technology have given rise to a wide range of applications involving networked engineering systems such as, e.g., transportation systems, power grids, cooperative robotics, etc., in which systems, sensors, actuators and controllers are linked over a (wireless) communication network. A well-known challenge in this context is that sampling and delay effects induced by the communication network can render systems unstable and destroy synchronization properties in multi-agent networked systems. The main goal of this research is to develop modelling and analysis tools for stability and synchronization analysis in complex networked systems, while considering asynchronous, aperiodic sampling and delay effects. From a network perspective, this objective can be divided into the following two problems. First, how can we guarantee system stability and performance when information transmission over the communication network is sampled and delayed? This problem applies to both single-loop networked control systems wherein information is transmitted via a network between a plant and a controller, and to large-scale multi-agent systems that have aperiodic, asynchronous sensing and actuation. Second, can important global properties of the networked system such as synchronization be guaranteed in the presence of these network-induced effects? These questions are answered by addressing the following three major challenges.

The first challenge is to develop modelling and stability analysis tools for networked linear dynamical control systems subject to asynchronous, aperiodic sampling and delay. Existing results considering this problem setting provide tools based on time-domain methods. In contrast, we provide frequency-domain based tools with favorable applicability properties from an engineering perspective. Additionally, for a similar problem setting, the few frequency-domain based

results available in literature consider less generic scenarios with synchronous sampling. We provide a novel modelling framework and a stability analysis tool based on Integral Quadratic Constraints (IQC), which considers sampling and delay bounds introduced by individual sensors and actuators.

In order to consider generic networked systems, which can have nonlinear dynamics, the next challenge is to develop modelling and analysis tools for nonlinear networked control systems subject to aperiodic sampling and delay. Existing analysis methods considering this problem setting use system-dependent functions, for example, Lyapunov functions, that need to be redefined when the system is subjected to additional/other perturbations. Consequently, analysis will have to be redone using new functions that may be challenging to obtain. In contrast, in our novel approach based on Input-Output modelling, we decouple the effects of sampling and delay as perturbations to a nominal continuous-time system, and any additional perturbation can be easily accommodated as an external input, without changing the general analysis framework. Using the Input-Output framework, we provide a novel modelling and stability analysis tool based on the notion of ‘Dissipativity Theory’. We propose novel conditions for stability analysis in terms of dissipativity type properties of the associated continuous-time system (without sampling and delay effects), for which many results for classes of nonlinear systems exist in literature.

Finally, we consider generic multi-agent networked systems wherein individual agents are nonlinear. The challenge taken on is to extend the above modelling and analysis tools to analyze synchronization properties of generic nonlinear networked systems with directed, weighted, coupling gains and asynchronous information transmission (sampling). In literature, existing results only considered a two-agent system with synchronous sampling. By the grace of the advantages offered by the framework we previously used for single-loop networked nonlinear systems, here, we use a similar Input-Output modelling approach, in conjunction with Dissipativity Theory.

The main contributions of this thesis can be summarized as the development of:

1. A novel modelling and frequency-domain based analysis tool, using Integral Quadratic Constraints, for stability analysis of linear networked control systems with asynchronous, aperiodic sampling and delay.
2. A novel modelling and analysis tool based on Dissipativity Theory, for stability analysis of nonlinear networked control systems subject to asynchronous, aperiodic sampling and delay.
3. A novel modelling and analysis tool for synchronization analysis of generic multi-agent networked systems with directed, weighted, coupling gains and asynchronous information transmission.

---

This thesis provides novel modelling and analysis tools for stability and synchronization analysis of networked systems. The analysis tools provided in this thesis aid in obtaining a trade-off between, on the one hand, system performance requirements (guaranteeing system stability and synchronization properties), and, on the other hand, sampling period bounds and delay bounds imposed by network requirements. The introduced framework has laid the foundation for future research considering additional network effects such as quantization, complex data scheduling protocols, etc.



### **Systèmes Dynamiques en Réseau**

#### Nouvelles Approches Entrée-Sortie pour l'analyse de la Stabilité et de la Synchronisation

Ce travail présente de nouveaux outils pour gérer les questions de stabilité et de synchronisation dans les systèmes dynamiques interconnectés en réseau. La révolution des technologies de communication a généré de nombreuses opportunités applicatives mettant en oeuvre une ingénierie de réseaux et systèmes : systèmes de transport, réseaux de distribution électrique, robotique coopérative, etc. Dans chacun de ces domaines, des processus, des capteurs, des actionneurs et des contrôleurs sont connectés à travers un réseau de communication – le plus souvent sans fil. Dans ce contexte de multi-agents connectés, les effets d'échantillonnage (digitalisation) et de retards (qualité de service du réseau) ont été clairement identifiés comme des dynamiques additionnelles sources d'instabilité ou de désynchronisation du réseau. Savoir maîtriser les conséquences de ces phénomènes (échantillonnage asynchrone, retards) dès la phase de conception représente donc un enjeu important.

Le but principal de cette recherche est de développer des outils de modélisation et d'analyse permettant de garantir la stabilité ou la synchronisation de systèmes en réseau, en tenant compte des effets complexes d'asynchronisme des échantillonneurs (non périodiques) et de retard dans le réseau. Lorsque ces phénomènes sont considérés dans une perspective d'interconnexions en réseau, cet objectif peut être séparé en deux questions : (1) Comment garantir la stabilité et les performances d'un système dans lequel la transmission des informations (échantillonnées) est à la fois asynchrone et retardée ? Ce problème se pose aussi bien dans le cas d'une unique boucle de contrôle (rétroaction) réalisée par un réseau de communication entre le processus et son contrôleur, que dans le cas d'un système multi-agents de grande dimension où les multiples actionneurs et capteurs n'ont ni périodicité ni synchronisme. (2) Le système interconnecté peut-il conserver au global des propriétés importantes, telle que la synchronisation, malgré les perturbations générées par les

dynamiques inhérentes au réseau? Nous apportons notre contribution sur ces deux questions en nous confrontant aux trois défis suivants.

Notre premier défi était de développer des outils pour la modélisation et l'analyse des systèmes dynamiques linéaires soumis à un échantillonnage asynchrone/apériodique et à des retards. Alors que les résultats existants abordaient cette question par des méthodes du domaine temporel, nous la déplaçons dans un contexte de type fréquentiel, moins exploré, qui présente de meilleures capacités d'utilisation dans une perspective d'ingénierie. De plus, les quelques approches de la littérature qui se situaient dans ce contexte fréquentiel considéraient des scénarii moins génériques que celui que nous mettons en place : une adaptation originale de l'outil IQC (contrainte intégrale quadratique), nous permet d'exprimer nos résultats à partir des bornes des intervalles de variation des échantillonnages et des retards.

- Pour pouvoir considérer des systèmes plus généraux, pour lesquels le principe de superposition ne s'applique pas, notre deuxième défi a été de généraliser nos outils à des systèmes non linéaires. Les méthodes existantes pour le cas non linéaire mettent en jeu des quantités fonctionnelles liées au modèle du système (le plus souvent des fonctions de Lyapunov) qui peuvent être difficiles à construire. Lorsque le modèle du système se complexifie par d'intégration des phénomènes de type retard ou échantillonnage, la synthèse doit être à nouveau menée : par exemple, l'analyse doit être recommencée avec de nouvelles fonctions (de Lyapunov) ou fonctionnelles (de Lyapunov-Krassovskii). De façon différente, le caractère entrée-sortie de notre modélisation permet de conserver un système nominal en temps continu et de représenter les effets d'échantillonnage et de retards sous la forme d'un bloc de perturbation découplé : ces effets étant traduits en une perturbation externe, les acquis d'une analyse du système non linéaire de départ peuvent être conservés : nous montrons qu'il est possible d'adapter simplement le contexte nominal, en utilisant par exemple les fonctions de Lyapunov déjà construites pour le cas sans réseau. Ainsi, en se plaçant dans un contexte entrée-sortie, nous proposons une nouvelle approche de modélisation et d'analyse de stabilité basée sur la théorie de la dissipativité, plus général que l'outil IQC car applicable au cas non linéaire. Ceci conduit à de nouvelles conditions de stabilité du système échantillonné exprimées comme des propriétés de dissipativité du système non linéaire de départ (en temps continu et sans retards). Il est alors possible d'exploiter les nombreux résultats de la théorie de la dissipativité disponibles selon le type de système non linéaire.

Enfin, notre troisième défi a été de généraliser ces approches par dissipativité en considérant la synchronisation de systèmes multi-agents génériques, où chaque agent connecté peut être non-linéaire. Chaque interconnexion est ici orientée, pondérée par un gain de couplage, via une ligne de communication (échantillonnée) asynchrone. Notre étude de stabilité dans le contexte entrée-sortie de la théorie de la dissipativité se limitait à une boucle non linéaire unique, nous montrons comment élargir cet outil à un contexte de synchronisa-

tion d'agents multiples. Notons que la littérature relative à ce contexte n'avait considéré que des liaisons synchrones, et se limitait à un faible nombre d'agents (deux).

Les contributions de cette thèse peuvent donc être résumées comme suit :

1. une nouvelle modélisation fréquentielle de type IQC (contraintes intégrale quadratique) des effets de retards et d'échantillonnage non synchrone, conduisant à un outil d'analyse de stabilité des systèmes linéaires en réseau;
2. une autre modélisation entrée-sortie de ces phénomènes, basée sur la théorie de la dissipativité et valable en non-linéaire, conduisant à un outil d'analyse de stabilité des systèmes non linéaires en réseau, avec retards et échantillonnage non synchrone;
3. une troisième modélisation originale s'appuyant elle aussi sur la théorie de la dissipativité, conduisant à un outil d'analyse pour la synchronisation de réseau multi-agent générique: agents non linéaires, interconnexions orientées sous la forme de gains de couplage, ligne de communication (échantillonnée) asynchrone.

Les outils ainsi définis sont une aide pour obtenir un compromis entre, d'une part, les performances requises pour la dynamique du système contrôlé (stabilité, convergence exponentielle/rapidité, synchronisation) et, d'autre part, des caractéristiques temporelles du réseau (bornes des intervalles de variation des échantillonnages et des retards) liées à sa qualité de service. Le contexte que nous avons défini constitue par ailleurs une base ouverte vers une recherche incluant d'autres effets du réseau, comme la perte de paquets ou la quantification.





---

# Contents

---

Summary	i
Résumé	v
<b>I Opening</b>	<b>1</b>
<b>1 Introduction</b>	<b>3</b>
1.1 Networked Systems . . . . .	3
1.2 Stability and Synchronization . . . . .	5
1.3 Existing Results: A brief overview . . . . .	9
1.4 Research goals . . . . .	13
1.5 Contributions and Approaches . . . . .	13
1.6 Publications . . . . .	15
1.7 Thesis outline . . . . .	16
<b>II Networked Systems: Stability Analysis</b>	<b>17</b>
<b>2 Frequency-Domain Stability Conditions for Asynchronously Sampled Decentralized LTI Systems</b>	<b>19</b>
2.1 Introduction . . . . .	20
2.2 Preliminary Result . . . . .	24
2.3 Stability Analysis of Decentralized LTI System: Large-delay Case	29
2.4 Small Delay Case: Separation of $\Delta$ operator . . . . .	44
2.5 Numerical Example . . . . .	51
2.6 Conclusion . . . . .	52
2.7 Appendix . . . . .	53

<b>3</b>	<b>Dissipativity-based Framework for Stability Analysis of Aperiodically Sampled Nonlinear Systems with Time-varying Delay</b>	<b>57</b>
3.1	Introduction . . . . .	58
3.2	Problem Statement . . . . .	60
3.3	Preliminary Generic Stability Result . . . . .	61
3.4	Stability Analysis for the Large Delay Case . . . . .	63
3.5	Stability Analysis for the Small Delay Case . . . . .	67
3.6	Illustrative Examples . . . . .	71
3.7	Conclusion . . . . .	75
3.8	Appendix . . . . .	77
<b>III</b>	<b>Networked Systems: Synchronization Analysis</b>	<b>99</b>
<b>4</b>	<b>Exponential Synchronization of Networked Systems Under Asynchronous Sampled-Data Coupling</b>	<b>101</b>
4.1	Introduction . . . . .	101
4.2	Problem Statement . . . . .	104
4.3	Preliminary Results on Boundedness and Synchronization . . . . .	106
4.4	Synchronization Error Dynamics . . . . .	115
4.5	Synchronization Criterion . . . . .	124
4.6	Numerical Example . . . . .	128
4.7	Conclusion . . . . .	131
<b>IV</b>	<b>Closing</b>	<b>133</b>
<b>5</b>	<b>Conclusions and Recommendations</b>	<b>135</b>
5.1	General conclusions on the results . . . . .	135
5.2	Recommendations . . . . .	137
	<b>Bibliography</b>	<b>141</b>
	<b>Acknowledgement</b>	<b>155</b>
	<b>About the author</b>	<b>159</b>

**Part I**

**Opening**



# Chapter 1

---

## Introduction

---

*This chapter presents a high-level introduction of this thesis. First, in Section 1.1, a generic description of large-scale networked systems is provided, followed by its significance in scientific and technological aspects. Then, in Section 1.2, the relevance and motivation is provided for analysing stability and synchronization properties of large-scale networked systems subjected to asynchrony induced by the communication network. The section concludes with a presentation of the overall objective of this thesis. Section 1.3 provides a high-level literature review of existing results in stability and synchronization of systems subjected to communication network induced asynchrony. The in-depth literature reviews are provided in individual chapters. The research goals and contributions of this thesis are provided in Section 1.4 and Section 1.5, respectively. In Section 1.6, a list of the peer-reviewed publications attached to this Ph.D. work is provided. The chapter concludes with Section 1.7, wherein an outline of this thesis is given.*

### 1.1 Networked Systems

The world as we know it is becoming more complex with every passing day. Just like human beings work together towards achieving various goals, technology and automation has evolved to a level wherein systems, with or without human interaction, can collaborate to achieve specific goals. Technological advances in this direction have in fact drawn inspiration from nature. Naturally occurring interconnected systems, such as neuron networks, biological networks, social networks, etc., involve constant communication between entities forming the network. Such communication results in some form of benefit for the network at the sub-system and global level [35]. In such settings, be it natural or artificial, individual systems communicate with each other via system-specific

communication channels, in turn forming an intricate web of interconnected systems with numerous links. The overall system encompassing such a web is commonly defined as a *networked system*.

In engineering and scientific applications, such networked control systems are occurring increasingly frequently. Networked systems are preferred for many tasks due to advantages such as efficient utilisation of global resources, higher flexibility and reliability, easier maintenance, etc., in comparison to conventional point-to-point control systems [54], [111], [133], [144]. Consequently, they are used in many different applications ranging from critical infrastructures such as water distribution, transportation, smart grids and smart electricity networks, to technological applications such as swarm robotics, mobile sensor networks, co-operative control of multi-agent systems, supervisory control, etc., [35], [55], [111]. For example, in smart grids, many electrical components such as transformers, generators, etc., interact through physical (electrical) networks and digital communication networks so that power supply is provided to consumers in a sustainable and economic fashion [120], [146]. In swarm robotics, the individual sub-systems that form the networked systems are robots, which communicate with each other in applications such as surveying, tracking, transportation, etc. [23]. Another example is intelligent transportation networks used in regulating traffic flow, which are composed of heterogeneous sub-systems such as vehicles and humans interacting within the network, distributed controllers, etc., [4]. In cyber-physical systems, which are defined as joining physical and informational (cyber) worlds, a wide variety of “smart devices”, wherein objects can be quite reduced in size but involve numerous processors, sensors, actuators, etc., form a network. For instance, a modern-day car includes more than 40 embedded microprocessors that take into account not only local information, but also information about other vehicles and traffic events in the transportation network [73]. Recently, strides have been made in implementing networked systems in the “Internet of Things” (IoT), health care, etc., [69], [127]. Research is also being carried out in exploring novel network topologies for different applications such as resilient systems, heating and cooling systems, etc., see for example, [60], [122] and the references therein. These and many other applications that are supported by large-scale networked systems, have raised interest from the scientific community since the inception of this concept.

This thesis considers two important aspects of networked systems, namely *stability* and *synchronization*. From a high-level perspective, these properties aid in understanding the performance of networked systems in terms of attaining global objectives. The significance of these properties is elaborated on in the following section.

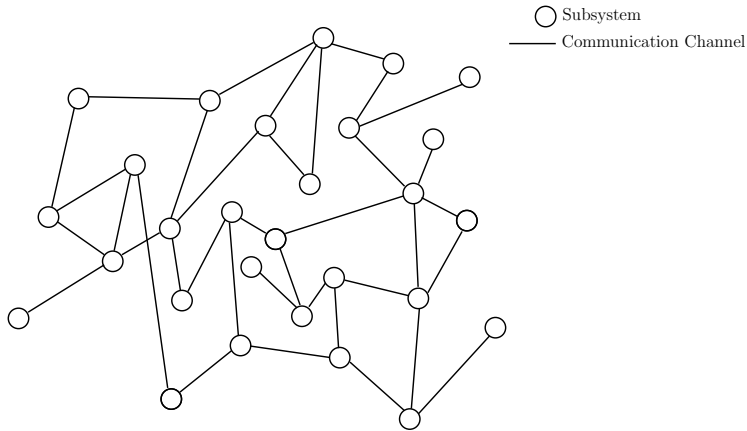

Figure 1.1: A generic representation of large-scale networked dynamical systems. The individual sub-systems, indicated by the nodes, communicate with other sub-systems via communication channels, which can be dedicated or shared, and wired or wireless.

## 1.2 Stability and Synchronization

A generic representation of large-scale networked dynamical systems is given in Figure 1.1. In such systems, individual sub-systems are usually dynamic in nature, and the dynamics at a sub-system level can affect the dynamics of the overall networked system [35], [133]. Consequently, the “task” assigned to the networked system needs to be executed while ensuring that individual sub-system dynamics and the overall networked system dynamics are *stable*<sup>1</sup> in some sense. A few examples wherein such a requirement is needed are:

1. In the scope of electrical grids, for example, instability in even a single sub-system can lead to cascading failures [113], which are known to result in economic losses [14].
2. Similarly, in the case of water distribution networks, failure/instability at an individual sub-system level can have dire consequences [119].

Many additional examples are available in literature pointing to the fact that system stability, both at individual sub-system and global levels, needs to be guaranteed depending on the task for which the network is designed [133], [134]. In many scenarios, in addition to stability, important network properties need to be

<sup>1</sup>At this level of the presentation, we use the term “stable” in the sense of a desirable convergence and boundedness of the dynamics at the sub-system and global levels. The formal definition of stability will be given in later chapters.



guaranteed. One such complex networked systems property that is widely studied in neuroscience, systems biology, electro-chemistry, swarm robotics, sensor-networks, controlled communication, etc., is *synchronization*, wherein as the name suggests, individual sub-systems behave in a synchronous manner<sup>2</sup> [7], [101], [103], [109]. A few examples in which the synchronization property is desired are:

1. In swarm robotics for instance, the synchronous behaviour in terms of coordination in space and/or time is desirable in applications such as precision agriculture, surveying, etc., [10].
2. In many networks of technological systems with communication protocols between sub-systems, synchronized clocks are often used to coordinate and control communication [61], [78], [109].
3. Cooperative behaviour among multi-agent dynamical systems, for example in formation flights, robot cooperation in production lines, etc., depends on exploitation of the synchronization property in networked systems [74].

While stability and synchronization can be viewed as distinct properties, in many scenarios, it is important to ensure that both properties are preserved. A few scenarios wherein both properties are important are:

1. A prime example of this can be found in the healthcare sector, wherein networked systems are being used to perform remote physiological measurements, and procedures [49], [85]. In such scenarios, the patient's safety relies on ensuring stability of every sub-system involved and having synchronized systems for proper measurement of physiological data.
2. In coupled semiconductor laser arrays, which are widely used in many photonics applications, it is required to maintain that each laser in the array is stable and synchronized with each other [141].

Numerous similar examples can be found in [13], [100], [101] and the references therein. The preservation of stable dynamics and synchronization properties in networks of dynamical systems is a challenging topic that has attracted scientific attention, with particular interest in various complexities arising in the networked system at local and global levels. Among the different sources of complexities, a peripheral view on some sources which are of interest in the scope of this Ph.D. (related to stability and synchronization analysis) is listed as follows.

### Generality of network topology

All the networked system examples mentioned previously can be related to the generic topology shown in Figure 1.1. Moreover, each of the individual sub-systems in such a generic topology could have its own complexity, with multiple

<sup>2</sup>Synchronization will be defined more precisely in Chapter 4.

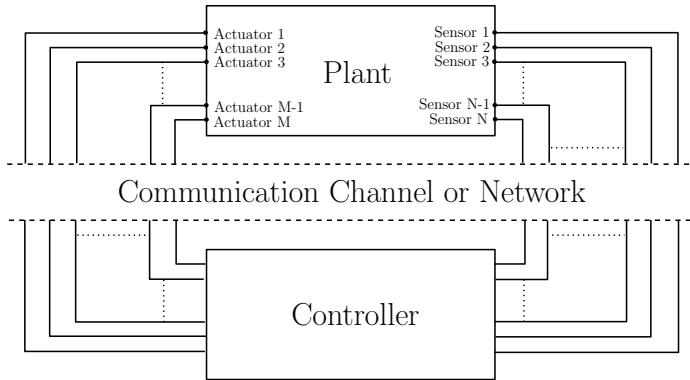

Figure 1.2: A generic representation of networked sensing and actuation in single plant-controller setup with  $N$  sensors and  $M$  actuators. The plant-controller, and controller-plant information transmission is via a communication channel. In the scope of Figure 1.1, the individual sub-systems could have such a configuration and the communication channel could be shared with other subsystems with similar configuration.

sensors and actuators leading to another sub-graph. In some cases, more specific topologies can also be used in subsystems, such as the one depicted in Figure 1.2. These complexities in the network topology are known to have a correlation with properties of the overall networked system dynamics, such as stability and synchronization [32], [106]. It is therefore important that the theory that will be developed, should be able to deal with generic network topologies, which makes the stability and synchronization analysis challenging for such systems.

### Variety in communication protocols and Quality-of-Service (QoS)

Communication-induced complexities also contribute towards the challenges in analysing stability and synchronization properties. The sub-systems in Figure 1.1 are often connected via some form of dedicated or shared, and wired or wireless, communication channels/networks through which information needs to be shared. Different types of communication channels and protocols, such as Try-Once-Discard (TOD), Carrier Sense Multiple Access (CSMA), Time Division Multiple Access (TDMA), IEEE Standard 802.5, etc., are employed depending upon the task, see for example, [61], [133], [134] and the references therein. The *quality of service* in such communication channels is viewed in terms of (1) the maximum allowable transmission interval, i.e., the maximum time-interval between information transmission instants such that system properties (stability and synchronization, for example) are still guaranteed, (2) the maximum al-

lowable delay, which specifies the maximum delay in transmitted information to reach its destination (controller, actuator, etc.) such that system properties are still guaranteed, and (3) other constraints such as complex data scheduling protocols, quantization, etc. While the use of communication networks help in achieving global objectives, irrespective of the type of communication protocol that is employed, the restrictions in terms of the *quality of service* are known to impact stability and synchronization properties of the networked system [15], [38], [53], [54], [123]. The impact also occurs due to asynchrony that is induced in the networked system, which is detailed as the next source of complexity. The challenge in this domain is to extend the theory of dynamical systems so as to take into account the dynamics induced by communication networks due to restrictions in quality of service.

### Asynchronous Sensing and Actuation

Communication networks that are employed in large-scale networked systems often have inherent effects such as sampling, delay, data-packet drop-outs, etc., which are known to affect information transmission, see for example, [54], [55], [57] and the references therein. A simple method to handle these effects is to consider them as asynchronous sensing and actuation in the networked system, at the sub-system and global levels. The scientific community has focussed on the impact of such asynchrony on the performance and stability of networked systems. It has been established that asynchrony at the sub-system level between sensors and actuators, for example, can scale to a global level [53], [55], [134]. A very common communication network induced effect, i.e., sampling, is known to cause asynchrony between sensors and actuators even in the case of a single-system within which the sensed information is transmitted via a communication network, see [57] and the references therein. In the scope of large-scale networked systems, such asynchrony occurs at the local sub-system level, which can lead to asynchrony at a global system level. [42], [54], [55], [57], [128], [140].

The asynchrony induced by communication networks can lead to performance loss in terms of stability, and destroy properties such as synchronization within large-scale networked systems. Even in a single plant-controller setup, with multiple sensors and actuators as shown in Figure 1.2, the effects of asynchronous information transmission on system stability have been evidenced in a multitude of examples, see for example, [6], [53], [90], [107]. In the case of large-scale networked systems, asynchrony caused by communication effects such as sampling and delay are known to destroy synchronization properties in addition to system stability. Sampling- and delay-induced asynchrony, for example, can render networks of neuron models asynchronous and unstable [110], [123], [129], [140]. Motivated by such examples, it is important to study the degree of tolerance of large-scale networked systems to communication network induced asynchrony, such that stability and synchronization properties are preserved. From a scien-

tific and engineering perspective, it is important to have tools that can be used to guarantee that stability and synchronization properties are preserved, while tolerating asynchrony in local and global levels of the networked system, arising due to the communication network used within the system.

### **Nonlinearity**

It is a known fact that most systems are nonlinear in nature, and their dynamics can only be approximated by linear dynamics under stringent conditions [70]. In some cases, the approximation may simply not be possible. Nonlinear systems can exhibit complex behaviours such as multiple equilibria, oscillatory behaviour, etc. [70]. In a networked setting, individual node dynamics could exhibit such behaviour, which makes it challenging to analyse properties such as stability and synchronization [82], [95], [104], [125], [134]. Consequently, in order to consider global behaviour in the tools that are used to analyse networked system properties, nonlinear models need to be taken into account, even at the sub-system level.

As a consequence of the variety in the sources of complexity in the analysis of stability and synchronization properties in networked systems, the tools to be developed have to be as versatile as possible, i.e., it should be able to deal with the most generic classes of effects that can come from the networked situation of Figure 1.1. This leads to the high-level objective of this thesis.

### **High-level goal:**

The main goal of this thesis is to provide versatile modelling and analysis tools for stability and synchronization analysis in complex nonlinear networked dynamical systems, while considering asynchronous communication within the network.

## **1.3 Existing Results: A brief overview**

In this section, a high-level literature survey on stability and synchronization analysis of networked dynamical systems is provided. Detailed literature surveys on the individual topics are provided in the introductions of Chapter 2 and Chapter 3 (for stability analysis), and Chapter 4 (for synchronization analysis).

For a few decades now, researchers have been interested in studying communication network effects and its impact in the scope of networked control systems [22], [43], [58], [88], [121], [134]. Asynchrony induced by sampling and delay effects have previously been studied from centralized control system perspectives [17], [46], [65], [84]. In stability analysis of systems subject to communication network effects, the approaches available in literature that consider sampling-and/or delay-induced asynchrony, are classified under the following four categories (see a detailed review in [57]):

1. *Time-delay approach*: This approach, which was first introduced in [1], [83], and popularized in [43], relies on modelling communication network effects such as sampling as a time-varying delay (in addition to delay effects induced by the communication network), see also [43], [116], [137].
2. *Discrete-time approach*: As the name suggests, this approach captures the behaviour of the system at sampling instants, without considering the inter-sample behaviour [56]. However, in the case of linear time-invariant systems, it has been shown that asymptotic stability in continuous-time is equivalent to asymptotic stability in discrete-time [45]. The approach has been used for LTI systems [25], [26], [33], [137] and in some cases, for nonlinear systems [99], [138].
3. *Hybrid-systems approach*: In this approach, the effects of communication networks and related asynchrony are modelled using hybrid dynamical models that include both continuous-time and discrete dynamics [19], [47], [53], [89].
4. *Input-Output approach*: Classical robust control techniques inspired researchers to model systems under communication network effects using input-output models [46], [65], [81], [84]. The main idea of this approach is to consider the effects of communication network as perturbations to a nominal system.

In comparison to the first three approaches (see more details on them in [54], [57] and the references therein), the input-output approach offers certain advantages that makes it more appealing from an engineering perspective. For instance, this approach helps in clearly separating the continuous-time dynamics of the system and the communication network effects such as sampling- and delay-induced asynchrony [46], [65], [84]. Such a separation is interesting due to the fact that numerous analysis results are available in literature for continuous-time systems. The input-output framework also helps to easily include additional nonlinearities, by treating them as operators represented by perturbations [51]. Additionally, this approach provides conditions for desired system properties in the robust control framework, which is often preferred for engineering applications [2], [142]. Motivated by these advantages, in the scope of this thesis, we will progress further in the direction of the input-output approach.

For generic closed-loop control systems that use robust and optimal control methods, the input-output approach, which was first proposed in [112], [143], is widely popular since it allows engineers to guarantee properties of the input-output behaviour [145].

In the scope of systems subjected to communication network induced effects, this approach was first used in the analysis of time-delay systems [63], [81] and later adapted towards considering sampling induced asynchrony [37], [64], [93]. As mentioned previously, the main idea behind the input-output approach is to

decouple the effects of communication network induced asynchrony into exogenous perturbations acting upon the system under consideration, in the absence of asynchrony [46], [65], [84].

For single-loop linear time-invariant (LTI) systems, in [46], [81], [84], the exogenous perturbations that capture the effects of non-uniform sampling or delay in the communication network are characterized using an operator. The properties of the operator are then studied to provide a frequency-domain criterion that guarantees stability of the single-loop system. However, in the case of LTI systems, this approach has been used only in a few scenarios considering both sampling- and delay-induced asynchrony.

For LTI systems with multiple sensors and actuators, in [39], the input-output approach has been used to analyse stability, with each sensor-actuator pair experiencing asynchrony induced by non-uniform sampling. In [17], [18], the  $\mathcal{L}_2$ -stability<sup>3</sup> of LTI systems with asynchronous sensors and actuators in distributed control settings is considered. Note that the result in [17], [18] only provides boundedness of system solutions. In realistic scenarios, it is often desirable to have additional performance guarantees on system dynamics. The input-output approach has been used in [18], by considering a purely operator based representation towards input-output analysis of large-scale systems with sampling- and delay-induced asynchrony. However, in the scope of such systems with asynchronous sensing and actuation, there are no state-space based frameworks that exploit the input-output approach. This is an interesting open problem particularly due to the fact that in many engineering applications and scientific studies, state-space formulations are used to model dynamical systems. This problem is considered in this thesis.

Contrary to linear systems, input-output approaches for nonlinear systems subject to communication network induced asynchrony have not received much attention. In [93], [94], this framework was used to analyse the stability of nonlinear systems subject to aperiodic sampling in the communication network. By combining the input-output framework with the notion of *Dissipativity Theory* [50], [135], sufficient stability conditions that guarantee system stability in the presence of aperiodic sampling were provided. Adapting this framework towards considering both sampling- and delay-induced asynchrony, even in the scope of single-loop nonlinear systems, is another open problem that is considered in this thesis.

Analysis of network properties such as synchronization, in the presence of asynchronous communication, has received considerably less attention. For networked systems without any communication network effects, results guaranteeing synchronization properties are available in literature. The relation between the underlying network topology and synchronization properties has been established for large-scale networked systems with linear subsystems [139], and nonlinear subsystems [12], [103]. In [103], large-scale networks of nonlinear systems

<sup>3</sup>Details on  $\mathcal{L}_2$ -stability are given in later chapters and [131].

that are diffusively coupled<sup>4</sup> are considered, and the authors provide analysis methods to study the synchronization or non-synchronization of the network in terms of the underlying topology. Similar results that provide algebraic conditions used to predict synchronization are also available in literature for linear systems [20], [86], and nonlinear systems [82], [92], wherein only delay-induced asynchrony is considered in the communication links. For large-scale networked systems with linear coupling, researchers have shown that if two sub-systems within the networked system synchronize for certain coupling gains, conditions can be provided on the network topology such that the overall synchronization property is guaranteed [11], [139]. In [5], conditions that govern the existence of a synchronizer (coupling law) based on infinitesimal stabilizability of individual sub-systems is provided. These conditions in turn guarantee the exponential synchronization of the networked system. Results guaranteeing synchronization in large-scale networked systems with heterogeneous sub-systems and linear coupling have also been studied recently [3], [95]. Scenarios wherein the interaction between sub-systems is governed by nonlinear coupling laws in the absence of asynchronous information transmission, have also been considered in recent literature [97].

Synchronization analysis in large-scale nonlinear networked systems wherein communication between subsystems is subject to channel-dependent delay, i.e., with each channel having a unique latency, has previously been considered in [123]. In this reference, the authors analyse synchronization properties of large-scale networks of semi-passive systems<sup>5</sup> with diffusive coupling, and constant delay-induced asynchrony between individual sub-systems. It is shown that for identical sub-systems that are strictly semi-passive, sufficiently strong coupling gains guarantee that synchronization property is preserved even in the presence of constant delay-induced asynchrony. The approach in [123] was later extended towards considering sampling-induced asynchrony in networked systems [110], wherein the authors consider two strictly semi-passive systems that are diffusively coupled and are subject to sampling induced asynchrony. However, the sampling periods of the sensors in both sub-systems were considered to be same. A similar setting with different, time-varying sampling intervals was considered in [130], and conditions guaranteeing exponential synchronization, based on dissipativity properties of the networked system, were provided. The synchronization analysis of large-scale networked systems with asynchrony induced by different, time-varying sampling intervals is a challenging problem that has not been studied.

---

<sup>4</sup>The definition of diffusive coupling is given in Chapter 4.

<sup>5</sup>The semi-passivity property is discussed in Chapter 4.

**Open Challenges:**

Let us now summarize several open challenges that arise from the above literature survey, and form the basis for the research in this thesis. In the scope of large-scale networked systems subject to communication network induced asynchrony, the following open challenges are identified:

1. Using the input-output analysis framework, how can we guarantee system stability and (transient) performance when information transmission, i.e., sensing and actuation are asynchronous over the communication network? This problem is to be addressed for both single-loop and large-scale networked systems.
2. How can important global properties of the networked system such as synchronization be guaranteed in the presence of sampling- and delay-induced asynchrony over the communication network?

In the context of the aforementioned open challenges, there are other challenges that we do not focus on. For instance, asynchrony over the communication network can also be due to phenomena such as event-triggered communications, complex data-scheduling protocols, etc.

**1.4 Research goals**

Motivated by the open challenges formulated above, the main research goal of this thesis is to develop an input-output modelling and analysis framework for stability and synchronization analysis of large-scale networked systems subjected to communication network induced asynchrony. To that end, the following research (sub-)goals are recognized. Using the input-output framework, we aim to:

1. Develop modelling and stability analysis tools for large-scale networked linear dynamical control systems subjected to asynchrony induced by sampling and delay, at local and global levels.
2. Develop modelling and analysis tools for single-loop nonlinear networked control systems subjected to asynchronous sensing and actuation.
3. Develop modelling and analysis tools that guarantee stability and synchronization properties within large-scale nonlinear networked control systems subjected to asynchronous communication.

**1.5 Contributions and Approaches**

The aforementioned research goals have been accomplished in this thesis via the following research contributions:



1. A new modelling and frequency-domain based analysis approach, using Integral Quadratic Constraints<sup>6</sup>, for stability analysis of large-scale decentralized linear networked control systems with asynchronous, aperiodic sampling and delay.

The asynchronous networked system is represented by a feedback interconnection between a nominal continuous-time system representing the dynamics of the networked linear system in the absence of any communication network induced effects, and an operator characterizing the effects of asynchrony as perturbations (to the continuous-time system). The properties of the operator characterizing the perturbations are studied using Integral Quadratic Constraints (IQCs) and frequency domain-based tools are developed to guarantee stability of the asynchronous networked system.

2. A novel modelling and analysis approach based on dissipativity theory, for stability analysis of single-loop nonlinear networked control systems subject to asynchronous, aperiodic sampling and delay.

Similar to the approach used in solving research goal 1, as explained briefly in research contribution 1, the nonlinear system is modelled as a feedback interconnection between a system operator representing the nonlinear system in the absence of any communication network induced asynchrony, and an operator that captures the effects of communication network as perturbations. Theoretical stability analysis techniques based on the notion of dissipativity theory are developed. In particular, novel conditions are provided for stability analysis in terms of dissipativity type properties of the associated continuous-time system, i.e., in the absence of any communication network induced asynchrony, for which many results for classes of nonlinear systems exist in literature. The developed conditions aid in making trade-offs between control performance and the bounds on sampling interval and delay.

3. A novel modelling and analysis approach for synchronization analysis of generic multi-agent networked systems with directed, weighted, diffusive coupling laws and asynchronous information transmission.

This contribution builds upon the dissipativity-based framework developed for solving research goal 2, as mentioned in research contribution 2. Novel conditions guaranteeing exponential synchronization of the networked system are proposed in terms of dissipativity-type properties of the associated synchronization problem in continuous-time, i.e., in the absence of any communication network induced asynchrony, for which many results exist in literature. The developed condition aids in making trade-offs between the coupling (gain) between sub-systems, and the bounds on sampling intervals for each communication channel.

---

<sup>6</sup>Details given in Chapter 2.

In the aforementioned contributions, state-space models have been used, and the main source of novelty is the blending of techniques more typically seen in purely input-output settings with a focus on exponential stability analysis.

## 1.6 Publications

The research contributions of this thesis have been published in the following peer-reviewed journals and conference proceedings.

### 1.6.1 Peer-reviewed journal articles

#### Articles in preparation

- **J. Thomas**, E. Steur, C. Fiter, L. Hetel, and N. van de Wouw. “Exponential Synchronization of Networked Systems Under Asynchronous Sampled-Data Coupling”, in preparation, 2021.

#### Published/Accepted articles

- **J. Thomas**, C. Fiter, L. Hetel, N. van de Wouw, and J. P. Richard. “Frequency-Domain Stability Conditions for Asynchronously Sampled Decentralized LTI Systems”, *Automatica*, in press, 2021.
- **J. Thomas**, C. Fiter, L. Hetel, N. van de Wouw, and J. P. Richard. “Dissipativity-based Framework for Stability Analysis of Aperiodically Sampled Nonlinear Systems with Time-varying Delay”, *Automatica*, in press, 2021.
- D. Dileep, **J. Thomas**, L. Hetel, N. van de Wouw, J. P. Richard, and W. Michiels. “Design of  $\mathcal{L}_2$  stable fixed-order decentralised controllers in a network of sampled-data systems with time-delays”, *European Journal of Control*, Volume 56, Pages 73-85, November 2020.

### 1.6.2 Peer-reviewed articles in conferences and colloquia

- **J. Thomas**, E. Steur, C. Fiter, L. Hetel, N. Van De Wouw. “Exponential Synchronization of Nonlinear Oscillators Under Sampled-Data Coupling”. In *proceedings of the 59<sup>th</sup> IEEE Conference on Decision and Control*, Jeju Island, Republic of Korea, December 2020.
- **J. Thomas**, E. Steur, L. Hetel, C. Fiter, J. P. Richard and N. van de Wouw. “An Input-Output Approach Towards Synchronization Under Communication Constraints”. *10th European Nonlinear Dynamics Conference (ENOC 2020)*, Lyon, France, July 2020 (postponed to 2021).

- **J. Thomas**, L. Hetel, C. Fiter, N. van de Wouw, and J. P. Richard. “ $\mathcal{L}_2$ -Stability Criterion for Systems with Decentralized Asynchronous Controllers”. In *proceedings of the 57<sup>th</sup> IEEE Conference on Decision and Control*, Miami Beach, Florida, USA, December 2018.
- **J. Thomas**, C. Fiter, L. Hetel, N. van de Wouw, and J. P. Richard. “Dissipativity Based Stability Criterion for Aperiodic Sampled-data Systems subject to Time-delay”. *5th IFAC Conference on Analysis and Control of Chaotic Systems*, Netherlands, October 2018.

### 1.6.3 Peer-reviewed workshop articles

- **J. Thomas**, L. Hetel, C. Fiter, N. van de Wouw, J. P. Richard. “Frequency Domain Stability Criteria for Decentralized Systems with Asynchronous Controllers”. *38th Benelux Meeting on Systems and Control*, Lommel, Belgium, March 2019.
- **J. Thomas**, L. Hetel, C. Fiter, N. van de Wouw, J. P. Richard. “Input-Output Stability Analysis of Decentralized Systems with Asynchronous Controllers”. *JD/JN/Ecole MACS 2019 - Journées Nationales, Journées Doctorales et Ecole du GdR MACS*, Bordeaux, France, June 2019.

## 1.7 Thesis outline

The rest of this thesis is comprised of three parts and four chapters. Excluding the last chapter, every chapter is a reprint of the published or submitted papers mentioned in Section 1.6. All the chapters provide tools based on the input-output analysis framework. Part II concerns the stability analysis and consists of Chapters 2 and 3. Chapter 2 presents modelling and stability analysis tools for decentralized linear time invariant systems, with aperiodic sampling and delay induced asynchrony at local and global levels. In Chapter 3, modelling and stability analysis tools are provided for single-loop nonlinear systems with sensors and actuators subjected to sampling and delay induced asynchrony. Part III concerns synchronization analysis, and is composed of Chapter 4, which provides modelling and analysis tools for synchronization analysis of large-scale nonlinear systems interconnected via a generic network topology and diffusively coupled via asynchronous sampled-data coupling laws. Every chapter provides a detailed outline of the chapter contents. Finally, in Part IV, Chapter 5, conclusions and recommendations for future research are provided.

## **Part II**

# **Networked Systems: Stability Analysis**



## Chapter 2

---

# Frequency-Domain Stability Conditions for Asynchronously Sampled Decentralized LTI Systems

---

*This chapter deals with the exponential stability analysis of decentralized, sampled-data, Linear Time Invariant (LTI) control systems with asynchronous sensors and actuators. We consider the case where each controller in the decentralized setting has its own sampling and actuation frequency, which translates to asynchrony between sensors and actuators. Additionally, asynchrony may be induced by delays between the sampling instants and actuation update instants as relevant in a networked context. The decentralized, asynchronous LTI system is represented as the feedback interconnection of a continuous-time LTI system operator and an operator that captures the effects of asynchrony induced by sampling and delay. By characterizing the properties of the operators using small-gain type Integral Quadratic Constraints (IQC), we provide criteria for exponential stability of the asynchronous, decentralized LTI state-space models. The approach provided in this chapter considers two scenarios, namely the ‘large-delay’ case and the ‘small-delay’ case where the delays are larger and smaller than the sampling interval, respectively. The effectiveness of the proposed results is corroborated by a numerical example.*

---

This chapter is based on J. Thomas, C. Fiter, L. Hetel, N. van de Wouw, and J. P. Richard. “Frequency-Domain Stability Conditions for Asynchronously Sampled Decentralized LTI Systems”, *Automatica*, in press, 2021

## 2.1 Introduction

Modern-day complex systems are hyper-connected with several wireless and wired components that interact with controllers and actuators. In such systems, due to the large number of distributed sensors and actuators, implementing a centralized control strategy is often not possible [9]. Decentralized control, wherein controllers are assigned to individual sub-systems, is often employed in such cases [8], [9]. Typical examples include Swarm Robotics, Vehicle Platooning, etc., [9], [102].

Implementing a decentralized control architecture provides certain advantages. Large-scale systems, the complexity of which prohibits a centralized controller design, are usually decoupled into subsystems. Consequently, the control design problem becomes a local problem, in the sense that global performance is achieved via local performance. Moreover, since the controllers are decoupled, diagnostics and maintenance tasks are easier. This results in overall lower running costs [8], [9].

Sensors and actuators in a decentralized scheme are typically deployed over aperiodic communication channels. However, local controllers are usually designed using classical sampled-data techniques [9]. This fact, in turn, poses a challenge in synchronization of different control system elements due to two main reasons. First, at an implementation level, individual controllers are usually algorithms programmed on embedded processors which work at different frequencies. Secondly, individual communication channels over which the sensor-actuator nodes are distributed, have unique network characteristics such as communication delay, sampling and actuation frequencies, etc. The resulting asynchrony may in turn affect the overall performance of the system and even its stability. In this chapter, this particular problem within the sampled-data implementation of decentralized controls is considered. In other words, we study the effect of asynchrony between local, possibly aperiodic, sampled-data controllers, on the overall stability of the system. The significance of such an analysis is corroborated using the following example studied in [129]. Consider the decentralized LTI system defined by

$$\begin{aligned} \Sigma_1: \quad \dot{x}_1(t) &= -2x_1(t) - x_2(t) + u_1(t) \\ \Sigma_2: \quad \dot{x}_2(t) &= 4x_2(t) - 2.8x_1(t) + u_2(t), \end{aligned} \tag{2.1}$$

where  $u_1(t) = -\hat{x}_1(t)$ ,  $u_2(t) = -4.6\hat{x}_2(t)$  are the decentralized control inputs to systems  $\Sigma_1$  and  $\Sigma_2$ , respectively, and  $\hat{x}_1(t)$ ,  $\hat{x}_2(t)$  are the state values obtained through sampling and hold. In the event that both systems  $\Sigma_1$  and  $\Sigma_2$  are sampled periodically as well as synchronously with a sampling period  $T = 0.59$  (i.e.,  $\hat{x}_i(t) = x_i(kT), \forall t \in [kT, (k+1)T), i = \{1, 2\}$ ), the overall system is asymptotically stable as illustrated in Figure 2.1a. However, as can be observed from Figure 2.1b, the stability is compromised when the sampling is periodic but control loops are asynchronous. Figure 2.1b presents the case when

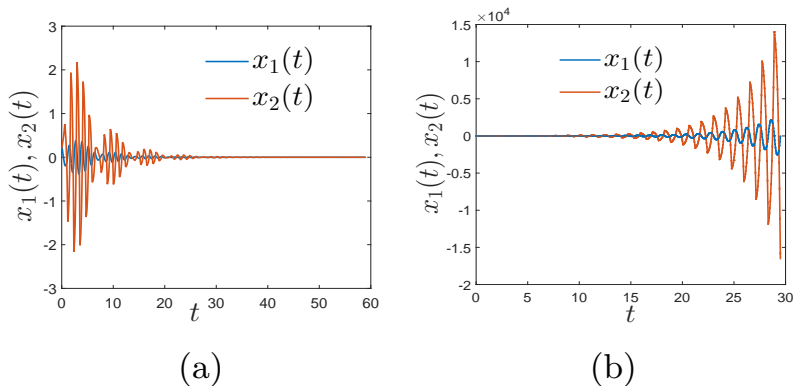

Figure 2.1: (a) The decentralized LTI system (2.1) is stable for synchronous sampling with  $T = 0.59$ . (b) Stability is lost when  $x_2(t)$  is sampled asynchronously with respect to  $x_1(t)$  with a shift of  $\delta = 0.2$ .

a shift  $\delta = 0.2$  is introduced in the sampling of the second state, i.e., when  $\hat{x}_2(t) = x_2(kT + \delta), \forall t \in [kT + \delta, (k + 1)T + \delta)$ .

The stability problem can become even more complex when both the sensors and actuators involved within individual control loops are asynchronous. In this chapter, we provide novel methods for the stability analysis of LTI systems with decentralized sampled-data linear controllers subject to asynchrony. The asynchrony in question is attributed to the separate sampling and actuation frequencies of each sensor and actuator node, as well as the delay induced in the control loop by control computation and communication latencies.

Mathematical problem settings that are closely related to the one considered in this chapter, have previously been studied [17], [30], [41], [132]. For example, in the case of centralized controllers with aperiodic sampling and asynchrony between sensors and actuators, stability analysis methods have been proposed in [132]. However, the sampling and actuation frequencies were considered to be constant, and same for all sub-systems. In [17],  $\mathcal{L}_2$ -stability was analyzed for a distributed control system in which a single sensor transmits information to two distributed controllers with asynchronous actuation. The sampling and actuation scheme considered in [17] allows multiple samples to be overwritten before a hold update occurs. In comparison, we assume that actuation events are ordered. In [30], the asynchrony between sensors and actuators is controlled to attain desired levels of system performance, via decentralized event-triggered control. In this chapter, we check the robustness of a decentralized system setting with respect to arbitrary asynchrony periods, implying that the time elapsed between sampling and actuation instants is arbitrary.

In literature, stability analysis of sampled-data systems are broadly classi-



fied into four approaches, namely the *Time-delay*, *Discrete-time*, *Hybrid systems*, and *Input-output* approaches. An overview of these approaches can be found in [57]. In this chapter, we focus on the input-output approach [81], which was initially employed in the stability analysis of time-delay systems [44], [63], [65], [66]. The general idea of the approach, in the context of sampled-data systems, is to take into account the effects of sampling as perturbations and model it using operators. By studying these operators, powerful optimization-based stability conditions can be derived using Integral Quadratic Constraints (IQC) [81]. IQCs are inequalities that are used to exploit structural information about perturbations, characterize properties of external signals, etc. They offer a general framework for abstracting complex elements of dynamical system models (nonlinearities, delay, time-varying elements, etc.) to rigorously analyse robustness and performance using basic LTI models commonly employed in control engineering applications. The main advantage of an IQC-type formulation is its flexibility. Sampling is just one perturbation among others; the approach can be easily extended to take into account other performance and robustness specifications. In the case of LTI systems subject to aperiodic sampling or delay, the input-output approach leads to simple frequency-domain characterisations, which sometimes are model-free (measured frequency response functions) [65], [84].

The stability analysis of sampled-data systems using the input-output approach relies on two distinct formulations. In the first one, a purely operator-based formulation is considered, wherein the system is represented by operators with zero initial conditions [17], [65], [84]. This formulation leads to  $\mathcal{L}_2$ -stability conditions with respect to exogenous perturbations. Additionally, in this formulation, non-linearities can be treated as operators represented by perturbations. In the second type of formulation, state-space model representations with non-zero initial conditions are considered [39], [93]. The robustness with respect to asynchrony is then given in terms of exponential stability property. Contrary to the first formulation, in this case, non-linear systems are handled by providing dissipativity type conditions on state-space models, using supply function characterisation of operators [93], [128]. Both formulations mentioned here may lead to similar stability conditions. Specifically, in the case of LTI systems, both formulations lead to characterisation in terms of IQC. More closely related to our problem formulation, IQC has previously been used in the  $\mathcal{L}_2$ -stability analysis of a single sensor-actuator system with aperiodic sampling [46], [84]. In [44], it has been shown that  $\mathcal{L}_2$ -stability of a sampled-data system with respect to exogenous perturbations also implies asymptotic stability of the equilibrium of the state-space model. In [17], the  $\mathcal{L}_2$ -stability of a system in a distributed control setting, with asynchrony between sensors and actuators, is addressed. The result provided in [17], and earlier closely related works [37], [64], provide IQCs along with gain bound characterizations of the kind considered in this chapter. Additionally, in [17], only boundedness of the system solutions with

respect to exogenous perturbations was established. However, in [17], [18], [37], [64], richer characterizations that account for bounded gain, as well as passivity properties of the operator characterizing network effects, have been provided. The benefit of accounting for both gain bound and passivity properties has been illustrated in [18]. In the general case, there are no results in literature that provide relations between IQC formulations and exponential stability of asynchronous sampled-data control systems. In this chapter, we bridge this gap in the case of LTI systems with decentralized controllers, by providing general exponential stability results based on bounded gain type IQC formulations.

The main contributions of this chapter are as follows. The major result is an IQC-based framework for the exponential stability analysis of LTI state-space models of decentralized sampled-data (networked) systems with asynchrony. Novel aspects of this approach are detailed next. First, we propose a preliminary result introducing a novel and general framework for representing LTI state-space models of single-loop sampled-data systems with asynchronous sensors and actuators, in the robust control framework, as an interconnection between a continuous-time LTI system operator and an operator that captures the effects of asynchrony. Second, we apply this result to a generic class of LTI state-space models of aperiodically sampled asynchronous decentralized systems, and formulate small-gain type IQC conditions not only for  $\mathcal{L}_2$ -stability, but also for exponential stability. For the sake of generality, we consider the sampling and actuation intervals to be time-varying and possibly unknown (but bounded). Third, we consider two relevant scenarios, namely the large-delay and small-delay cases. As the name suggests, in the large-delay case, for individual control loops in the decentralized setting, the actuation corresponding to a measured (sampled) state could occur after the next sampling instant or instants. The only restriction is that the actuation instants for each control loop occurs in an order corresponding to the sampling instants. In this scenario, a single operator is used to capture the effects of asynchrony induced by sampling and delay. The second scenario, namely the small-delay case, implies that the actuation corresponding to a sampled state occurs before the next sampling instant. This scenario has been studied in numerous theoretical as well as practical settings (see [107], [134], [140]). For example, in [107], it was shown that in the case of a single sensor sampling periodically, when the sampled data experienced delays smaller than sampling-interval, the system was rendered unstable. The problem becomes much more complex when multiple systems are involved, with individual sensors and actuators having aperiodic, asynchronous sampling and actuation. For such scenarios, we provide a less conservative criterion in comparison to the criterion provided for the large-delay case, applied to the small-delay case. This is achieved by capturing the effects of sampling-induced asynchrony and delay-induced asynchrony, using two separate operators.

In [129], the *Input-output* approach has been used to provide easy-to-check  $\mathcal{L}_2$ -stability conditions for a setting similar to the one considered in this chapter.

However, the results in [129] only established boundedness and did not take into account individual bounds on sampling and actuation frequencies, thereby leading to considerably more conservative results. Here, in this chapter, we propose a novel approach that guarantees exponential stability of the state-space model by taking into account individual bounds on sampling and actuation frequencies, which ensures that the results in this chapter are less conservative and more generic in comparison to the results in [129].

The remainder of this chapter has been structured as follows. In Section 2.2, we provide a preliminary result that provides a general framework for representing LTI systems with asynchronous sensors and actuators, as an interconnection between a system operator and an operator capturing the effects of asynchrony. In Sections 2.3 and 2.4, we provide small-gain IQC-type stability conditions guaranteeing exponential stability of aperiodically sampled, decentralized, asynchronous LTI systems. In Section 2.3, the criterion is provided for the large-delay case, i.e., the transmission delay is larger than the sampling interval. In Section 2.4, a less conservative criterion is provided for the small-delay case, i.e., the transmission delay is smaller than the sampling interval. Section 2.5 provides a numerical example corroborating the results introduced in Sections 2.3 and 2.4.

**Notations:**

$\mathbb{R}$  is the set of all real numbers, implying  $\mathbb{R}^n$  is the set of all  $n$ -dimensional real vectors.  $\mathbb{N}$  denotes the set of all natural numbers i.e.,  $\{0, 1, 2, \dots, \infty\}$ . The notation  $\mathbb{N}^*$  is used to denote the set  $\{\mathbb{N} \setminus \{0\}\}$ .  $Diag(M_1, M_2, \dots, M_n)$  is the block-diagonal matrix with elements  $M_i, i \in \{1, 2, \dots, n\}$ , of appropriate dimensions.  $\mathcal{L}_2[a, b]$  is the  $\mathcal{L}_2$ -space of all square integrable and Lebesgue measurable functions defined on the interval  $[a, b]$ , with the  $\mathcal{L}_2$ -norm defined as  $\|q\|_{\mathcal{L}_2}^2 = \langle q, q \rangle$ , and the inner product  $\langle p, q \rangle = \int_a^b p(s)^T q(s) ds$ .  $\mathcal{L}_{2e}[0, \infty)$  is the extended  $\mathcal{L}_2$ -space of all square integrable and Lebesgue measurable functions defined on the interval  $[0, \infty)$ .

**2.2 Preliminary Result**

In this section, we provide a preliminary result on the remodelling of a generic single-loop, LTI system with asynchronous sensors and actuators, as the feedback interconnection of a continuous-time system operator and an operator that captures the effects of asynchrony. This result by itself bears significance in the robust control framework, wherein feedback interconnections of system operators are often considered. Consider the sampled-data LTI system defined by

$$\begin{aligned} \dot{x}(t) &= Ax(t) + BK\hat{x}(t) + w(t), \\ x(0) &= x_0, \end{aligned} \tag{2.2}$$

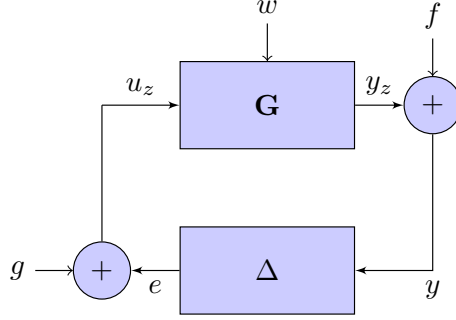
Figure 2.2: The feedback interconnection of  $\mathbf{G}$  and  $\Delta$ 

where  $x \in \mathbb{R}^n$ ,  $w \in \mathcal{L}_{2e}^n[0, \infty)$  and

$$\hat{x}(t) = \begin{cases} x_{init}, \forall t \in [0, a_0) \\ x(s_k), \forall t \in [a_k, a_{k+1}), k \in \mathbb{N}, \end{cases} \quad (2.3)$$

with  $x_{init} \in \mathbb{R}^n$  being some constant initial value applied at the actuator level.  $A, B$  and  $K$  are matrices of appropriate dimensions. The system under consideration follows from an LTI system controlled by state feedback over a sampled-data network with delay. The sampling sequence  $\{s_k\}_{k \in \mathbb{N}}$  satisfying

$$s_{k+1} = s_k + h_k, \forall k \in \mathbb{N}, \quad (2.4)$$

where the time-varying sampling interval  $h_k$  satisfies  $0 < \underline{h} \leq h_k \leq \bar{h}$ ,  $\forall k \in \mathbb{N}$ . Similarly, the actuation sequence  $\{a_k\}_{k \in \mathbb{N}}$  satisfies

$$a_k = s_k + \tau_k, \forall k \in \mathbb{N}, \quad (2.5)$$

where  $\tau_k$  represents the asynchrony (delay) between sampling and actuation instants and satisfies  $0 \leq \underline{\tau} \leq \tau_k \leq \bar{\tau}$ ,  $\forall k \in \mathbb{N}$ . In addition, the actuation instants satisfy

$$a_k \leq a_{k+1}, \forall k \in \mathbb{N}. \quad (2.6)$$

Now consider the feedback interconnection of the form shown in Figure 2.2, where the dynamics of  $\mathbf{G}$  are given by

$$\mathbf{G}: \begin{cases} \dot{z}(t) = A_{cl}z(t) + B_{cl}u_z(t) + w(t) \\ y_z(t) = \dot{z}(t), z(0) = 0, w(t) \in \mathcal{L}_{2e}[0, \infty), \end{cases} \quad (2.7)$$

where  $A_{cl} = A + BK$ ,  $B_{cl} = BK$ ,  $z \in \mathbb{R}^n$ , and

$$u_z(t) = e(t) + g(t), \quad (2.8)$$

with  $g \in \mathcal{L}_{2e}^n[0, \infty)$ . The signal  $e(t)$  is given by

$$e(t) = (\Delta y)(t) := \begin{cases} 0, \forall t \in [0, a_0) \\ -\int_{s_k}^t y(s) ds, \forall t \in [a_k, a_{k+1}), k \in \mathbb{N}, \end{cases} \quad (2.9)$$

where

$$y = y_z + f, \quad (2.10)$$

with  $f \in \mathcal{L}_{2e}[0, \infty)$ . In the following theorem, we provide conditions under which the single-loop sampled-data LTI system (2.2)-(2.3) can be represented using the feedback-interconnection of operators  $G$  and  $\Delta$ , given by (2.7) and (2.9), respectively. This theorem builds upon similar transformations given in [17], [37], [46], [64]–[66], [84].

**Theorem 2.1.** *Consider system (2.2),(2.3), the feedback-interconnection (2.7)-(2.10), and sampling and actuation sequences satisfying (2.4) and (2.5), respectively. Consider*

$$\eta(t) = z(t) + e^{A_{cl}t}x_0, \quad (2.11)$$

where  $z(t)$  follows the dynamics given by the interconnection (2.7)-(2.10), in which  $f(t) = A_{cl}e^{A_{cl}t}x_0$  and

$$g(t) = \begin{cases} x_{init} - \mu(t), \forall t \in [0, a_0) \\ 0, \forall t \geq a_0, \end{cases} \quad (2.12)$$

with  $\mu(t) : [0, a_0) \mapsto \mathbb{R}^n$  given by

$$\mu(t) = e^{At}x_0 + \int_0^t e^{A(t-\tau)}(BKx_{init} + w(\tau))d\tau. \quad (2.13)$$

Then, for  $x(t)$  given in (2.2), (2.3), we have

$$x(t) = \eta(t) = z(t) + e^{A_{cl}t}x_0, \quad (2.14)$$

for all  $t \geq 0$ .

*Proof.* From the definition of  $\eta(t)$  in (2.11), we have

$$\dot{\eta}(t) = \dot{z}(t) + A_{cl}e^{A_{cl}t}x_0. \quad (2.15)$$

Substituting  $\dot{z}(t)$  from (2.7),

$$\begin{aligned} \dot{\eta}(t) &= A_{cl}z(t) + B_{cl}u_z(t) + w(t) + A_{cl}e^{A_{cl}t}x_0, \\ &= A_{cl}(z(t) + e^{A_{cl}t}x_0) + B_{cl}u_z(t) + w(t). \end{aligned} \quad (2.16)$$

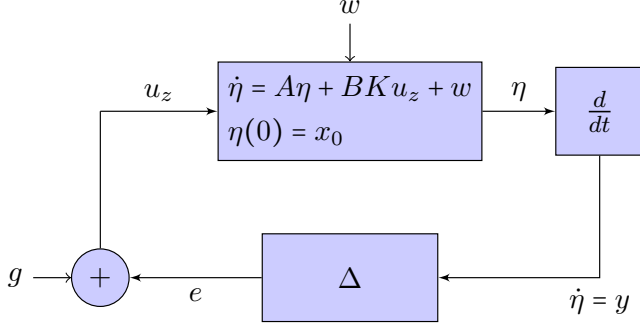

Figure 2.3: The feedback-interconnection used as an intermediate while transitioning from system (2.2),(2.3) to system (2.7)-(2.10), as shown in proof of Theorem 2.1.

Substituting  $\eta$  as defined in (2.11), we have

$$\dot{\eta}(t) = A_{cl}\eta(t) + B_{cl}u_z(t) + w(t), \quad (2.17)$$

with  $\eta(0) = x_0$ , and  $u_z(t)$  as given in (2.8). The system (2.17) has been shown in Figure 2.3.

1) For  $t \in [0, a_0]$ : As per definition (2.9), we have  $e(t) = 0$ . Consequently, using the definition of  $g(t)$  in (2.12),

$$u_z(t) = g(t) = x_{init} - \mu(t), \forall t \in [0, a_0]. \quad (2.18)$$

Hence, we have from (2.17)

$$\dot{\eta}(t) = A_{cl}\eta(t) + B_{cl}(x_{init} - \mu(t)) + w(t). \quad (2.19)$$

Note that the signal  $\mu$  in (2.12), satisfies

$$\dot{\mu}(t) = A\mu(t) + B_{cl}x_{init} + w(t), \quad (2.20)$$

where  $B_{cl} = BK$  and  $\mu(0) = x_0$ . Therefore

$$\begin{aligned} \dot{\mu}(t) &= A\mu(t) + B_{cl}\mu(t) - B_{cl}\mu(t) + B_{cl}x_{init} + w(t), \\ &= A_{cl}\mu(t) + B_{cl}(x_{init} - \mu(t)) + w(t). \end{aligned} \quad (2.21)$$

Comparing (2.19) and (2.21), since  $\mu(0) = \eta(0) = x(0) = x_0$ , and

$$\dot{x}(t) = Ax(t) + BKx_{init} + w(t), \forall t \in [0, a_0], \quad (2.22)$$

we have,

$$\eta(t) = \mu(t) = x(t), \forall t \in [0, a_0]. \quad (2.23)$$

2) For  $t \geq a_0$ : From (2.12), we have  $g(t) = 0$ , for all  $t \geq a_0$ . Therefore, from the definition of  $u_z(t)$  in (2.8) and  $e(t)$  in (2.9), we have

$$u_z(t) = e(t) = (\Delta y)(t), \forall t \geq a_0. \quad (2.24)$$

From the interconnection (2.7)-(2.10), we have

$$\begin{aligned} y(t) &= y_z(t) + f(t), \\ &= A_{cl}z(t) + B_{cl}u_z(t) + w(t) + A_{cl}e^{A_{cl}t}x_0, \\ &= A_{cl}(z(t) + e^{A_{cl}t}x_0) + B_{cl}u_z(t) + w(t), \\ &= A_{cl}\eta(t) + B_{cl}u_z(t) + w(t). \end{aligned} \quad (2.25)$$

Therefore, from (2.17), we can conclude  $y(t) = \dot{\eta}(t)$  for all  $t \geq 0$ . Consequentially, we have from (2.24),

$$u_z(t) = e(t) = (\Delta \dot{\eta})(t) = \eta(s_k) - \eta(t), \forall t \in [a_k, a_{k+1}). \quad (2.26)$$

This transformation of capturing the sampling- and asynchrony-induced effects using an operator is based on similar works given in [17], [37], [46], [64]–[66], [84]. By substituting (2.26) in (2.17), we have for all  $t \in [a_k, a_{k+1})$ ,

$$\begin{aligned} \dot{\eta}(t) &= A_{cl}\eta(t) + B_{cl}(\eta(s_k) - \eta(t)) + w(t), \\ &= A\eta(t) + BK\eta(t) + BK\eta(s_k) - BK\eta(t) + w(t), \\ &= A\eta(t) + BK\eta(s_k) + w(t). \end{aligned} \quad (2.27)$$

Comparing (2.27) with (2.2) and (2.3), and since  $\eta(a_0) = x(a_0)$  from (2.23), we can conclude that

$$\eta(t) = x(t), \forall t \geq a_0. \quad (2.28)$$

Therefore, from (2.11), (2.23) and (2.28), we have

$$x(t) = \eta(t) = z(t) + e^{A_{cl}t}x_0, \forall t \geq 0. \quad (2.29)$$

□

*Remark:* The goal of Theorem 2.1 is to show that system (2.2), (2.3) (with non-zero initial conditions) can be represented in the form of system (2.7)-(2.10) (with zero initial conditions) for particular signals  $f$  and  $g$ . To this end, we use an intermediate feedback-interconnection model given in Figure 2.3, in which system (2.2), (2.3) is represented as an interconnection between a nominal LTI system (with state variable  $\eta$ ) with non-zero initial conditions, and an operator  $\Delta$ . This transformation is based on arguments previously used in [17], [37], [46],

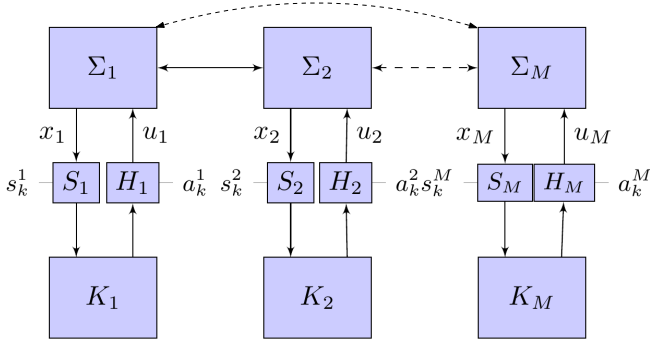

Figure 2.4: A decentralized controller setup example.  $S_i$  and  $H_i$ , for all  $i \in \{1, 2, \dots, M\}$ , denotes the sample and hold components, respectively, for the  $i^{\text{th}}$  closed-loop.

[64]–[66], [84]. Next, an additional transformation is used to relate the model in Figure 2.3 with the model (2.7)–(2.10), by deriving the appropriate signals  $f$  and  $g$  that represent the initial conditions.

Based on Theorem 2.1, in the following section, we will remodel a generic asynchronous, decentralized LTI system of the form shown in Figure 2.4, as a feedback interconnection of the form shown in Figure 2.2.

## 2.3 Stability Analysis of Decentralized LTI System: Large-delay Case

In this section, we deal with the decentralized problem setting shown in Figure 2.4, in the large-delay case. First, we introduce the mathematical description of the problem setting. Constructive conditions are then given to analyse the stability of the decentralized setting.

### 2.3.1 System description

Consider the decentralized system configuration shown in Figure 2.4, wherein the dynamics of system  $\Sigma_i$  is given by

$$\dot{x}_i(t) = A_i x_i(t) + B_i u_i(t) + \sum_{j=1, j \neq i}^M A_{ij} x_j(t), \forall t \geq 0, \quad (2.30)$$

with  $i \in \{1, 2, \dots, M\}$ ,  $x_i(t) \in \mathbb{R}^{n_i}$ ,  $x_i(0) = x_0^i$  and  $u_i(t) \in \mathbb{R}^{m_i}$ . The matrices  $A_i$ ,  $B_i$  and  $A_{ij}$  are of appropriate dimensions. The term  $A_{ij} x_j(t)$  denotes the influence of the states of the  $j^{\text{th}}$  system  $\Sigma_j$  on the dynamics of system  $\Sigma_i$ . Here, we



consider the case where the control of the global system is linear. Furthermore, we assume that it is decentralized in the sense that the control input  $u_i(t)$  only depends on the local state variables  $x_i(t)$ .

**Assumption 2.2.** *The decentralized system (2.30) with  $u_i(t) = u_i^*(t) = K_i x_i(t)$ , is exponentially stable.*

In the aforementioned assumption,  $K_i$  is a feedback matrix of appropriate dimension. In this chapter, we consider that the control inputs are asynchronous. The system states  $x_i(t)$  are sampled according to a sampling sequence  $\{s_k^i\}_{k \in \mathbb{N}}$  defined by

$$\{s_k^i : s_{k+1}^i - s_k^i = h_k^i, k \in \mathbb{N}, i \in \{1, 2, \dots, M\}\}. \quad (2.31)$$

The sequence of sampling intervals  $\{h_k^i\}_{k \in \mathbb{N}}$  satisfying  $h_k^i \in [\underline{h}_i, \bar{h}_i]$  takes into account imperfection in sampling caused by, e.g., jitter, data packet dropouts, etc. Note that the sampling instants of different systems are not necessarily synchronous (hence the index  $i$  in  $s_k^i$ ). The control input  $u_i(t)$  based on  $x_i(s_k^i)$  will be implemented at a time instant  $a_k^i$  at the level of the actuator of system  $\Sigma_i$ . We consider that the sequence of actuation times  $\{a_k^i\}_{k \in \mathbb{N}}$  satisfies

$$\{a_k^i : a_k^i = s_k^i + \eta_k^i, a_k^i \leq a_{k+1}^i, k \in \mathbb{N}, i \in \{1, 2, \dots, M\}\}, \quad (2.32)$$

where  $\eta_k^i \in [\underline{\eta}_i, \bar{\eta}_i]$  denotes the asynchrony between sensors and actuators. Such an asynchrony may be due to network delays, control computational delay, etc. Note that the constraint  $a_k^i \leq a_{k+1}^i$  represents the large-delay case, wherein the network delay  $\eta_k^i$  on the sampled state  $x(s_k^i)$  can be greater than  $h_k^i$ , but the actuation instants stay ordered with respect to the sampling sequence. Without loss of generality, we consider  $\bar{h}_i + \bar{\eta}_i \leq a_0^i \leq a_0^*$ , where  $a_0^* = \max_{i=1}^M (\bar{h}_i + \bar{\eta}_i)$ . Note that in this chapter, the lower bounds on sampling and asynchrony, i.e.,  $\underline{h}_i$  and  $\underline{\eta}_i$ , respectively, are used only to indicate that there are no accumulation points (of transmitted information). However, as shown possible in other approaches such as the *Discrete-time* approach or the *Hybrid Systems* approach, it could be interesting to take into account the lower bounds in the stability analysis as well. Based on this consideration, the control input to the system  $\Sigma_i$  is given by the sampled-data decentralized static state-feedback law

$$u_i(t) = \begin{cases} K_i x_{init}^i, \forall t \in [0, a_0^i), \\ K_i x_i(s_k^i), \forall t \in [a_k^i, a_{k+1}^i), k \in \mathbb{N}, \end{cases} \quad (2.33)$$

with some constant value  $x_{init}^i \in \mathbb{R}^{n_i}$ . The main goal of this chapter is to provide exponential stability criteria for the decentralized LTI system (2.30)-(2.33), uniformly with respect to the set of actuation and sampling instants.

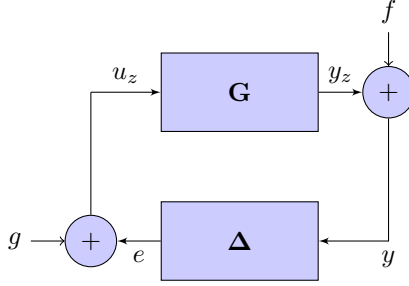

Figure 2.5: Standard feedback interconnection of two exemplary operators  $\mathbf{G}$  and  $\mathbf{\Delta}$ , which will be used to represent the decentralized system (2.30)-(2.33).

### 2.3.2 System reformulation

Using the result in Theorem 2.1 as a stepping stone, we illustrate in this section how the decentralized system (2.30)-(2.33) can be represented by a feedback interconnection of the form given in Figure 2.5. This representation is useful in providing easy-to-check IQC-type stability criteria. The system (2.30)-(2.33) can also be given by

$$\dot{x}(t) = Ax(t) + Bu(t), \forall t \geq 0, \quad (2.34)$$

where

$$A = \begin{bmatrix} A_1 & A_{12} & \dots & A_{1M} \\ A_{21} & A_2 & \dots & A_{2M} \\ \vdots & \vdots & \ddots & \vdots \\ A_{M1} & A_{M2} & \dots & A_M \end{bmatrix}, \quad (2.35)$$

$$B = \text{diag}(B_1, B_2, \dots, B_M),$$

and

$$u(t) = [u_1^T(t) \quad u_2^T(t) \quad \dots \quad u_M^T(t)]^T, \quad (2.36)$$

with  $u_i(t)$  given by (2.33), for all  $i \in \{1, 2, \dots, M\}$ . Now consider a feedback interconnection  $\mathbf{G} - \mathbf{\Delta}$  of the form given in Figure 2.5, where the operator  $\mathbf{G}$  is defined by the dynamics

$$\mathbf{G}: \begin{cases} \dot{z}(t) = \tilde{A}_{cl}z(t) + B_{cl}u_z(t), \forall t \geq 0, \\ y_z(t) = \dot{z}(t), \end{cases} \quad (2.37)$$

with  $z(t) = [z_1^T(t), z_2^T(t), \dots, z_M^T(t)]^T$ ,  $z(0) = 0$ ,

$$\tilde{A}_{cl} = \begin{bmatrix} A_{cl}^1 & A_{12} & \dots & A_{1M} \\ A_{21} & A_{cl}^2 & \dots & A_{2M} \\ \vdots & \vdots & \ddots & \vdots \\ A_{M1} & A_{M2} & \dots & A_{cl}^M \end{bmatrix}, \quad (2.38)$$

and

$$B_{cl} = \text{diag}(B_1K_1, B_2K_2, \dots, B_MK_M), \quad (2.39)$$

with

$$A_{cl}^i = A_i + B_iK_i, \forall i \in \{1, 2, \dots, M\}, \quad (2.40)$$

and  $A_{ij}$ ,  $A_i$ ,  $B_i$ ,  $K_i$  for all  $j \in \{1, 2, \dots, M\}, j \neq i$  given by (2.30). Let the input  $u_z$  be given by

$$u_z(t) = e(t) + g(t), \quad (2.41)$$

with  $g \in \mathcal{L}_{2e}^n[0, \infty)$ , and the signal  $e = \Delta y$  such that

$$\Delta y = \begin{pmatrix} \Delta_1 y_1 \\ \Delta_2 y_2 \\ \vdots \\ \Delta_M y_M \end{pmatrix}, \quad (2.42)$$

with  $\Delta_i$  analogous to (2.9), for all  $i \in \{1, 2, \dots, M\}$ , and

$$y = y_z + f, \quad (2.43)$$

where  $f \in \mathcal{L}_{2e}^n[0, \infty)$ . In the following theorem, we show how the system given by (2.30)-(2.33), can be remodelled as the feedback interconnection of  $\mathbf{G}$  and  $\Delta$  given by (2.37)-(2.43), i.e.,

$$\begin{aligned} y &= \mathbf{G}u_z + f \\ u_z &= g + e, \\ e &= \Delta y, \end{aligned} \quad (2.44)$$

by appropriately introducing the signals  $f$  and  $g$ .

**Theorem 2.3.** *Consider system (2.34), (2.33), the feedback-interconnection (2.37)-(2.43), and the sampling and actuation sequences satisfying (2.31) and (2.32), respectively. Consider  $\mu(t) = [\mu_1(t), \mu_2(t), \dots, \mu_M(t)]$ , where  $\mu_i(t) : [0, a_0^*] \mapsto \mathbb{R}^n$  satisfies*

$$\dot{\mu}_i(t) = A_i\mu_i(t) + B_iu_\mu^i(t) + \sum_{j=1, j \neq i}^M A_{ij}\mu_j(t), \forall t \in [0, a_0^*], \quad (2.45)$$

for all  $i \in \{1, 2, \dots, M\}$ , with  $\mu_i(0) = x_0^i$ ,  $a_0^* = \max_{i=1}^M(a_0^i)$ , and

$$u_\mu^i(t) = \begin{cases} K_i x_{init}^i, \forall t \in [0, a_0^i), \\ K_i \mu_i(s_k^i), \forall t \in [a_k^i, a_{k+1}^i) \cap [0, a_0^*), k \in \mathbb{N}, \end{cases} \quad (2.46)$$

with  $x_{init}^i \in \mathbb{R}^{n_i}$ , and

$$\eta(t) = z(t) + \int_0^t e^{\tilde{A}_{cl}(t-\tau)} \tilde{A} e^{\hat{A}\tau} x_0 d\tau + e^{\hat{A}t} x_0, \quad (2.47)$$

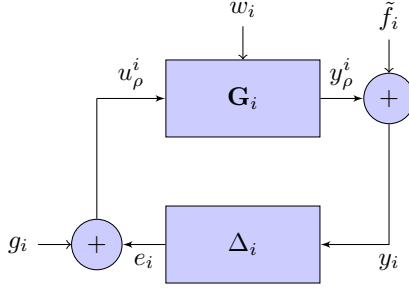

Figure 2.6: The feedback interconnection of  $\mathbf{G}_i$  and  $\Delta_i$ , representing the  $i^{th}$  closed-loop  $\Sigma_i - K_i$ .

for all  $t \geq 0$ , where  $z(t)$  is given by the dynamics (2.37)-(2.43),  $\tilde{A}_{cl}$  is given by (2.38),

$$\hat{A} = \begin{bmatrix} A_{cl}^1 & 0 & \dots & 0 \\ 0 & A_{cl}^2 & \dots & 0 \\ \vdots & \vdots & \ddots & \vdots \\ 0 & 0 & \dots & A_{cl}^M \end{bmatrix}, \quad (2.48)$$

and  $\tilde{A} = \tilde{A}_{cl} - \hat{A}$ . Then, for

$$f(t) = \tilde{A}_{cl} e^{\hat{A}t} x_0, \quad (2.49)$$

and  $g(t) = [g_1^T(t) \quad g_2^T(t) \quad \dots \quad g_M^T(t)]^T$ , defined by

$$g_i(t) = \begin{cases} x_{init}^i - \mu_i(t), \forall t \in [0, a_0^i) \\ 0, \forall t \geq a_0^i, \end{cases} \quad (2.50)$$

we have that  $x(t) = \eta(t)$  for all  $t \geq 0$ , where  $x(t)$  is given by (2.34),(2.33).

*Proof.* Consider the  $i^{th}$  closed-loop  $\Sigma_i - K_i$  in Figure 2.4, given by (2.30)-(2.33). We have

$$\dot{x}_i(t) = A_i x_i(t) + B_i u_i(t) + w_i(t), \forall t \geq 0, \quad (2.51)$$

for all  $i \in \{1, 2, \dots, M\}$ , where

$$w_i(t) = \sum_{j=1, i \neq j}^M A_{ij} x_j(t). \quad (2.52)$$

By applying Theorem 2.1, the  $i^{th}$  closed-loop  $\Sigma_i - K_i$  can be remodelled as the feedback interconnection  $\mathbf{G}_i - \Delta_i$  shown in Figure 2.6, where the operator  $\Delta_i$  is

given in a similar manner as defined in (2.9). The dynamics of system operator  $\mathbf{G}_i$  will be given by

$$\begin{aligned}\dot{\rho}_i(t) &= A_{cl}^i \rho_i(t) + B_{cl}^i u_\rho^i(t) + w_i(t), \forall t \geq 0, \\ y_\rho^i(t) &= \dot{\rho}_i(t), \rho_i(0) = 0, i \in \{1, 2, \dots, M\} \\ A_{cl}^i &= A_i + B_i K_i, B_{cl}^i = B_i K_i.\end{aligned}\tag{2.53}$$

Also, the signals

$$\tilde{f}_i(t) = A_{cl}^i e^{A_{cl}^i t} x_0^i,\tag{2.54}$$

and

$$g_i(t) = \begin{cases} x_{init}^i - \mu_i(t), \forall t \in [0, a_0^i), \\ 0, \forall t \geq a_0^i, \end{cases}\tag{2.55}$$

where  $\mu_i(t)$  is generated by (2.45),(2.46). Then, as a direct application of Theorem 2.1, for all  $i \in \{1, 2, \dots, M\}$ , the dynamics of the  $i^{th}$  closed-loop  $\Sigma_i - K_i$  is given by

$$x_i(t) = \eta_i(t) = \rho_i(t) + e^{A_{cl}^i t} x_0^i, \forall t \geq 0,\tag{2.56}$$

and consequentially, from (2.52), we have

$$w_i(t) = \sum_{j=1, i \neq j}^M A_{ij} (\rho_j(t) + e^{A_{cl}^j t} x_0^j).\tag{2.57}$$

Therefore, (2.53) gives

$$\dot{\rho}_i(t) = A_{cl}^i \rho_i(t) + \sum_{j=1, i \neq j}^M A_{ij} \rho_j(t) + B_{cl}^i u_\rho^i(t) + \sum_{j=1, i \neq j}^M A_{ij} e^{A_{cl}^j t} x_0^j,\tag{2.58}$$

for all  $i \in \{1, 2, \dots, M\}$ . From Figure 2.6, for the  $i^{th}$  feedback interconnection  $\mathbf{G}_i - \Delta_i$ , we have  $u_\rho^i(t) = e_i(t) + g_i(t)$ , where  $g_i(t)$  is given by (2.50) and  $e_i(t)$  is given using the operator  $\Delta_i$ , defined similarly as in (2.9), i.e.,

$$e_i(t) = (\Delta_i y_i)(t) := \begin{cases} 0, \forall t \in [0, a_0^i) \\ -\int_{s_k^i}^t y_i(s) ds, \forall t \in [a_k^i, a_{k+1}^i), k \in \mathbb{N}. \end{cases}\tag{2.59}$$

for all  $i \in \{1, 2, \dots, M\}$ . Additionally, for the  $i^{th}$  feedback interconnection  $\mathbf{G}_i - \Delta_i$  shown in Figure 2.6, we have

$$y_i(t) = y_\rho^i(t) + \tilde{f}_i(t),\tag{2.60}$$

where  $y_\rho^i(t) = \dot{\rho}_i(t)$ , and  $\tilde{f}_i(t)$  is given by (2.54).

Now, considering (2.56) for all  $i \in \{1, 2, \dots, M\}$ , we have

$$\eta(t) = \rho(t) + e^{\hat{A}t} x_0,\tag{2.61}$$

where  $\eta(t) = [\eta_1^T(t) \ \eta_2^T(t) \ \dots \ \eta_M^T(t)]^T$ , and  $\hat{A}$  is given by (2.48). From (2.58), for all  $i \in \{1, 2, \dots, M\}$ ,  $\rho(t)$  is given by the dynamics of the system

$$\begin{aligned} \dot{\rho}(t) &= \tilde{A}_{cl}\rho(t) + B_{cl}u_\rho(t) + \tilde{A}e^{\hat{A}t}x_0, \\ y_\rho(t) &= \dot{\rho}(t), \rho(0) = 0, \end{aligned} \quad (2.62)$$

where

$$\tilde{A} = \begin{bmatrix} 0 & A_{12} & \dots & A_{1M} \\ A_{21} & 0 & \dots & A_{2M} \\ \vdots & \vdots & \ddots & \vdots \\ A_{M1} & A_{M2} & \dots & 0 \end{bmatrix}, \quad (2.63)$$

and

$$\begin{aligned} \rho(t) &= [\rho_1^T(t) \ \rho_2^T(t) \ \dots \ \rho_M^T(t)]^T, \\ y_\rho(t) &= [(y_\rho^1)^T(t) \ (y_\rho^2)^T(t) \ \dots \ (y_\rho^M)^T(t)]^T, \\ u_\rho(t) &= [(u_\rho^1)^T(t) \ (u_\rho^2)^T(t) \ \dots \ (u_\rho^M)^T(t)]^T, \\ x_0 &= [(x_0^1)^T \ (x_0^2)^T \ \dots \ (x_0^M)^T]^T. \end{aligned} \quad (2.64)$$

In (2.62), the matrices  $\tilde{A}_{cl}$ ,  $B_{cl}$  and  $\hat{A}$  are given by (2.38), (2.39), and (2.48), respectively. Moreover, from (2.56) and (2.61), the state evolution of the dynamics of the decentralized system (2.30)-(2.33) is given by

$$x(t) = \eta(t), \forall t \geq 0. \quad (2.65)$$

Additionally,

$$u_\rho(t) = e(t) + g(t), \quad (2.66)$$

where  $g(t) = [g_1^T(t) \ g_2^T(t) \ \dots \ g_M^T(t)]^T$  and

$$\begin{aligned} e(t) &= [e_1^T(t) \ e_2^T(t) \ \dots \ e_M^T(t)]^T \\ &= (\Delta y)(t), \end{aligned} \quad (2.67)$$

with  $\Delta$  given by (2.42),  $y(t) = [y_1^T(t) \ y_2^T(t) \ \dots \ y_M^T(t)]^T$ . From (2.60), we have

$$y(t) = y_\rho(t) + \tilde{f}(t), \quad (2.68)$$

where  $y_\rho(t)$  is given by (2.64), and from (2.54),

$$\tilde{f}(t) = [\tilde{f}_1^T(t) \ \tilde{f}_2^T(t) \ \dots \ \tilde{f}_M^T(t)]^T = \hat{A}e^{\hat{A}t}x_0. \quad (2.69)$$

Therefore, the decentralized system given by (2.30)-(2.33), can be represented by the feedback interconnection (2.62), (2.66), (2.67), and (2.68), as shown in

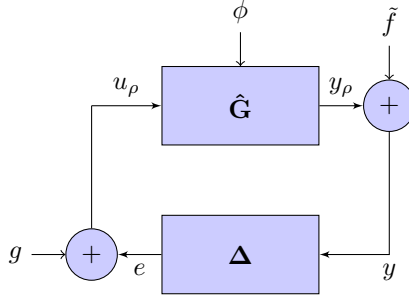

Figure 2.7: The feedback interconnection of  $\hat{\mathbf{G}}$  and  $\Delta$ , representing the decentralized system (2.30)-(2.33).

Figure 2.7, where  $\hat{\mathbf{G}}$  describes the dynamics given by (2.62) and  $\phi(t) = \tilde{A}e^{\hat{A}t}x_0$ . Now, consider the system defined by

$$\begin{aligned} \dot{z}(t) &= \tilde{A}_{cl}z(t) + B_{cl}u_z(t), \\ y_z(t) &= \dot{z}(t), z(0) = 0, \end{aligned} \quad (2.70)$$

with  $u_z(t) = u_\rho(t)$ . Then, we have

$$z(t) = \int_0^t e^{\tilde{A}_{cl}(t-\tau)} B_{cl}u_z(\tau) d\tau, \forall t \geq 0. \quad (2.71)$$

Similarly, from (2.62), we have

$$\rho(t) = \int_0^t e^{\tilde{A}_{cl}(t-\tau)} B_{cl}u_\rho(\tau) d\tau + \int_0^t e^{\tilde{A}_{cl}(t-\tau)} \phi(\tau) d\tau. \quad (2.72)$$

Since  $u_z(t) = u_\rho(t)$ , using (2.71) and (2.72), we have

$$\rho(t) = z(t) + \int_0^t e^{\tilde{A}_{cl}(t-\tau)} \phi(\tau) d\tau. \quad (2.73)$$

Consequently, we have

$$\dot{\rho}(t) = \dot{z}(t) + \phi(t) + \tilde{A}_{cl} \int_0^t e^{\tilde{A}_{cl}(t-\tau)} \phi(\tau) d\tau. \quad (2.74)$$

Therefore, we have

$$y_\rho(t) = y_z(t) + \hat{f}(t), \quad (2.75)$$

where

$$\hat{f}(t) = \tilde{A}e^{\hat{A}t}x_0 + \tilde{A}_{cl} \int_0^t e^{\tilde{A}_{cl}(t-\tau)} \tilde{A}e^{\hat{A}\tau}x_0 d\tau. \quad (2.76)$$

Consequently, from (2.68), we have

$$y(t) = y_z(t) + \hat{f}(t) + \tilde{f}(t) = y_z(t) + f(t), \quad (2.77)$$

where

$$\begin{aligned} f(t) &= \hat{f}(t) + \tilde{f}(t) \\ &= (\tilde{A} + \hat{A})e^{\hat{A}t}x_0 + \tilde{A}_{cl} \int_0^t e^{\tilde{A}_{cl}(t-\tau)} \tilde{A}e^{\hat{A}\tau}x_0 d\tau \\ &= \tilde{A}_{cl}e^{\hat{A}t}x_0 + \tilde{A}_{cl} \int_0^t e^{\tilde{A}_{cl}(t-\tau)} \tilde{A}e^{\hat{A}\tau}x_0 d\tau. \end{aligned} \quad (2.78)$$

Therefore, the feedback interconnection in Figure 2.7, can also be expressed as the feedback interconnection shown in Figure 2.5, given by

$$\begin{aligned} y &= \mathbf{G}u_z + f, \\ u_z &= g + e, \\ e &= \mathbf{\Delta}y, \end{aligned} \quad (2.79)$$

where the system operator  $\mathbf{G}$  is defined by the transfer function of the system given by (2.70), i.e.,

$$\mathbf{G}(s) = \tilde{A}_{cl}(sI - \tilde{A}_{cl})^{-1}B_{cl} + B_{cl}. \quad (2.80)$$

Also, from (2.65) and (2.61), we obtain

$$x(t) = \eta(t) = \rho(t) + e^{\hat{A}t}x_0 = z(t) + \int_0^t e^{\tilde{A}_{cl}(t-\tau)} \tilde{A}e^{\hat{A}\tau}x_0 d\tau + e^{\hat{A}t}x_0. \quad (2.81)$$

Differentiating both sides of (2.65), and recalling that  $\tilde{A}_{cl} = \tilde{A} + \hat{A}$ , we have

$$\begin{aligned} \dot{x}(t) &= \dot{z}(t) + \frac{d}{dt} \left( e^{\tilde{A}_{cl}t} \int_0^t e^{-\tilde{A}_{cl}\tau} \tilde{A}e^{\hat{A}\tau}x_0 d\tau \right) + \hat{A}e^{\hat{A}t}x_0 \\ &= y_z(t) + \tilde{A}_{cl}e^{\hat{A}t}x_0 + \tilde{A}_{cl} \int_0^t e^{\tilde{A}_{cl}(t-\tau)} \tilde{A}e^{\hat{A}\tau}x_0 d\tau. \end{aligned} \quad (2.82)$$

Therefore, from the definition of  $f(t)$  in (2.78), and (2.77), we have

$$\dot{x}(t) = y_z(t) + f(t) = y(t). \quad (2.83)$$

□

*Remark:* In the aforementioned theorem, it has to be noted that the operator  $\mathbf{G}$  is based on a system with zero initial condition. The signals  $\mu_i(t)$ ,  $f(t)$  and  $g(t)$  are merely used for replicating the evolution of the decentralized LTI system with respect to the initial condition. This in turn leads to the construction of the signal  $g_i(t)$  that serves as an input to the feedback interconnection of  $\mathbf{G}$  and  $\mathbf{\Delta}$  given in Figure 2.5.



We have illustrated how the decentralized LTI system can be represented by the feedback interconnection of a system operator  $\mathbf{G}$ , and an operator  $\Delta$  that captures the effects of asynchrony. Feedback interconnections of this form, shown in Figure 2.5, are often studied in the robust control framework. This representation aids in providing simple  $\mathcal{L}_2$ -stability criteria as shown in [129]. See Appendix 2.7.1 for a definition of  $\mathcal{L}_2$  stability for the feedback interconnection  $\mathbf{G} - \Delta$ . In the next section, we illustrate the implication of such  $\mathcal{L}_2$ -stability properties on the exponential stability of the decentralized LTI system (2.30)-(2.33).

### 2.3.3 Exponential stability criteria

Typically, by obtaining bounds on the operator  $\Delta$ , results that establish  $\mathcal{L}_2$ -stability properties of the feedback-interconnection  $\mathbf{G} - \Delta$  are obtained [129]. However, in the following theorem, we provide a result that establishes exponential stability of the system (2.30)-(2.33), based on boundedness properties of the feedback interconnection  $\mathbf{G} - \Delta$  shown in Figure 2.5.

**Theorem 2.4.** *Suppose that  $\tilde{A}_{cl}$ ,  $\hat{A}$  given by (2.38), (2.48), respectively, are Hurwitz. Then, the decentralized system (2.30)-(2.33) is globally exponentially stable if the feedback interconnection  $\mathbf{G} - \Delta$  defined by (2.44) is  $\mathcal{L}_2$ -stable.*

*Proof.* The main idea of this proof is to use the particular signals  $f$  and  $g$  that established the equivalence, as proven in Theorem 2.3, between the decentralized LTI system (2.34), (2.33) and the feedback interconnection  $\mathbf{G} - \Delta$  given by (2.44), to prove exponential stability. First, we shall compute bounds on  $f$  and  $g$  to show that  $f, g \in \mathcal{L}_2^n$ .

**Boundedness of  $x(t)$  :** Recalling the definition of  $f(t)$  in (2.49), we have,

$$f(t) = \tilde{A}_{cl} e^{\hat{A}t} x_0 + \tilde{A}_{cl} \int_0^t e^{\tilde{A}_{cl}(t-\tau)} \tilde{A} e^{\hat{A}\tau} x_0 d\tau. \quad (2.84)$$

Therefore,

$$\|f(t)\| \leq \left( \|\tilde{A}_{cl} e^{\hat{A}t}\| + \|\tilde{A}_{cl}\| \int_0^t e^{\tilde{A}_{cl}(t-\tau)} \|\tilde{A} e^{\hat{A}\tau}\| d\tau \right) \|x_0\|, \quad (2.85)$$

where  $\|\cdot\|$  denotes the *Euclidean norm*, and is given by  $\|f(t)\| = \sqrt{f^T(t)f(t)}$ . Since  $\hat{A}$  and  $\tilde{A}_{cl}$  are Hurwitz, there exist constants  $c_1, c_2, \alpha_1 < 0$  and  $\alpha_2 < 0$  such that

$$\|e^{\hat{A}t}\| \leq c_1 e^{\alpha_1 t}, \|e^{\tilde{A}_{cl}t}\| \leq c_2 e^{\alpha_2 t}, \forall t \geq 0. \quad (2.86)$$

Consequently,

$$\begin{aligned} \|f(t)\| &\leq \left( \|\tilde{A}_{cl}\| c_1 e^{\alpha_1 t} + \|\tilde{A}\| \|\tilde{A}_{cl}\| c_1 c_2 \int_0^t e^{\alpha_2(t-\tau)} e^{\alpha_1 \tau} d\tau \right) \|x_0\| \\ &= \left( \|\tilde{A}_{cl}\| c_1 e^{\alpha_1 t} + \|\tilde{A}\| \|\tilde{A}_{cl}\| c_1 c_2 e^{\alpha_2 t} \int_0^t e^{(\alpha_1 - \alpha_2)\tau} d\tau \right) \|x_0\|. \end{aligned} \quad (2.87)$$

Since

$$\int_0^t e^{(\alpha_1 - \alpha_2)t} d\tau = \begin{cases} \frac{1}{\alpha_1 - \alpha_2} (e^{(\alpha_1 - \alpha_2)t} - 1), & \text{if } \alpha_1 \neq \alpha_2, \\ t, & \text{if } \alpha_1 = \alpha_2, \end{cases} \quad (2.88)$$

we can state that

$$\|f(t)\| \leq (c_3 e^{\alpha_1 t} + c_4 \zeta(t)) \|x_0\|, \quad (2.89)$$

where  $c_3 = \|\tilde{A}_{cl}\| c_1$ ,  $c_4 = \|\tilde{A}\| \|\tilde{A}_{cl}\| c_1 c_2$ , and

$$\zeta(t) = \begin{cases} \frac{1}{\alpha_1 - \alpha_2} (e^{\alpha_1 t} - e^{\alpha_2 t}), & \text{if } \alpha_1 \neq \alpha_2, \\ t e^{\alpha_2 t}, & \text{if } \alpha_1 = \alpha_2. \end{cases} \quad (2.90)$$

This implies that  $\|f(t)\|$  can be upper-bounded by an exponentially decaying signal, i.e.,  $f \in \mathcal{L}_2^n[0, \infty)$ . Additionally  $\lim_{t \rightarrow \infty} f(t) \rightarrow 0$  and  $f \in \mathcal{L}_{2e}^n[0, \infty)$ . For the remainder of the proof,  $\mathcal{L}_2^n[0, \infty)$  and  $\mathcal{L}_{2e}^n[0, \infty)$  will be denoted by  $\mathcal{L}_2^n$  and  $\mathcal{L}_{2e}^n$ , respectively. Now, recalling the definition of  $g(t)$  in (2.50), and from (2.45), since  $\mu(t)$  is bounded for all  $t \in [0, a_0^*)$  owing to its linearity, we have that  $g(t)$  is bounded for all  $t \in [0, a_0^*)$  and  $g(t) = 0, \forall t \geq a_0^*$ , with  $a_0^* = \max_{i=1}^M a_0^i$ . Consequentially,

$$\int_0^\infty g^T(t)g(t)dt = \mathcal{C}_2 < \infty, \quad (2.91)$$

implying that  $g \in \mathcal{L}_2^n$ . Since the feedback interconnection (2.44) is  $\mathcal{L}_2$ -stable, i.e., the mapping  $\begin{bmatrix} f \\ g \end{bmatrix} \mapsto \begin{bmatrix} y \\ u_z \end{bmatrix}$  is  $\mathcal{L}_2$ -stable, we have

$$\int_0^\infty (y^T(\theta)y(\theta) + u_z^T(\theta)u_z(\theta)) d\theta \leq \mathcal{C} \int_0^\infty (f^T(\theta)f(\theta) + g^T(\theta)g(\theta)) d\theta < \infty, \quad (2.92)$$

where the constant  $\mathcal{C} > 0$ , implying that  $y, u_z \in \mathcal{L}_2^n$ . We know from the definition of the feedback interconnection (2.44), that  $y_z = y - f$ , implying that since  $y, f \in \mathcal{L}_2^n$ , we have  $y_z \in \mathcal{L}_2^n$ . As per definition of system operator  $\mathbf{G}$  in (2.37), we have

$$y_z(t) = \dot{z}(t) = \tilde{A}_{cl}z(t) + B_{cl}u_z(t), \forall t \geq 0. \quad (2.93)$$

Therefore,  $\tilde{A}_{cl}z(t) = y_z(t) - B_{cl}u_z(t)$ , and since  $\tilde{A}_{cl}$  is invertible, we have  $z \in \mathcal{L}_2^n$ . Recalling Theorem 2.3, from (2.47), we have

$$x(t) = z(t) + \int_0^t e^{\tilde{A}_{cl}(t-\tau)} \tilde{A} e^{\hat{A}\tau} x_0 d\tau + e^{\hat{A}t} x_0. \quad (2.94)$$

We know that  $\hat{A}$  is Hurwitz implying  $\lim_{t \rightarrow \infty} e^{\hat{A}t} x_0 \rightarrow 0$ . Additionally, the signal  $\int_0^t e^{\tilde{A}_{cl}(t-\tau)} \tilde{A} e^{\hat{A}\tau} x_0 d\tau \in \mathcal{L}_2^n$ , since it is the response of a stable LTI system to the input  $\tilde{A} e^{\hat{A}\tau} x_0 \in \mathcal{L}_2^n$ . Finally, since we have shown that  $z \in \mathcal{L}_2^n$ , from (2.94), we have  $x \in \mathcal{L}_2^n$ .

**Exponential stability of  $x(t)$  :** From Theorem 2.3, we know that the feedback interconnection  $\mathbf{G} - \mathbf{\Delta}$  defined by (2.44) represents the decentralized system (2.30)-(2.33), given by the homogenous state-space equation

$$\dot{x}(t) = Ax(t) + BK\hat{x}(t), x(0) = x_0, \quad (2.95)$$

with  $\hat{x}(t) = [\hat{x}_1^T(t) \quad \hat{x}_2^T(t) \quad \dots \quad \hat{x}_M^T(t)]^T$ , where

$$\hat{x}_i(t) = \begin{cases} x_{init}^i, \forall t \in [0, a_0^i), \\ x_i(t - \tau_i(t)), \forall t \in [a_k^i, a_{k+1}^i), k \in \mathbb{N}, \end{cases} \quad (2.96)$$

for all  $i \in \{1, 2, \dots, M\}$ , and

$$\tau_i(t) = t - s_k^i, \forall t \in [a_k^i, a_{k+1}^i), k \in \mathbb{N}. \quad (2.97)$$

Based on the  $\mathcal{L}_2$ -stability of the feedback interconnection  $\mathbf{G} - \mathbf{\Delta}$ , we have proved above that the solution  $x(t)$  of the homogeneous system (2.95)-(2.97) belongs to  $\mathcal{L}_2^n$ . In order to prove exponential stability of the equilibrium point  $x = 0$ , we shall invoke the *Bohl-Perron Principle* given in [42], recalled in Appendix 2.7.2. In accordance with the *Bohl-Perron Principle*, we shall prove that in the presence of an additional disturbance belonging to  $\mathcal{L}_2^n$ , the solution of the decentralized system (2.95)-(2.97) belongs to  $\mathcal{L}_2^n$ . To this end, consider the system

$$y_*(t) = \dot{x}_*(t) = Ax_*(t) + BK\hat{x}_*(t) + w_*(t), x_*(0) = x_0, \quad (2.98)$$

with

$$x_*(t) = [x_{1*}^T(t) \quad x_{2*}^T(t) \quad \dots \quad x_{M*}^T(t)]^T \quad (2.99)$$

and

$$\hat{x}_*(t) = [\hat{x}_{1*}^T(t) \quad \hat{x}_{2*}^T(t) \quad \dots \quad \hat{x}_{M*}^T(t)]^T, \quad (2.100)$$

where

$$\hat{x}_{i_*}(t) = \begin{cases} x_{init}^i, \forall t \in [0, a_0^i), \\ x_{i_*}(t - \tau_i(t)), \forall t \in [a_k^i, a_{k+1}^i), k \in \mathbb{N}, \end{cases} \quad (2.101)$$

for all  $i \in \{1, 2, \dots, M\}$ , and the disturbance  $w_* \in \mathcal{L}_2^n$ . In a similar manner as given in the proof of Theorem 2.3, the system (2.98), (2.101) can be shown to be equivalent to the feedback interconnection given by

$$\begin{aligned} y_{z_*} &= \mathbf{G}u_{z_*}, u_{z_*} = g_* + e_*, \\ e_* &= \mathbf{\Delta}y_*, y_* = y_{z_*} + (f_* + w_*) \end{aligned} \quad (2.102)$$

where  $g_*$  is given in a similar manner as shown in (2.50), i.e.,

$$g_{i_*}(t) = \begin{cases} x_{init}^i - \mu_{i_*}(t), \forall t \in [0, a_0^i), \\ 0, \forall t \geq a_0^i, \end{cases} \quad (2.103)$$

for all  $i \in \{1, 2, \dots, M\}$ , with  $\mu_{i_*}(t)$  defined by a duplicate system with dynamics similar to that of (2.98), for all  $t \in [0, a_0^*]$ , and

$$\begin{aligned} f_*(t) &= \tilde{A}_{cl} e^{\hat{A}t} x_0 + \tilde{A}_{cl} \int_0^t e^{\tilde{A}_{cl}(t-\tau)} \tilde{A} e^{\hat{A}\tau} x_0 d\tau \\ &\quad + w_*(t) + \tilde{A}_{cl} \int_0^t e^{\tilde{A}_{cl}(t-\tau)} w_*(\tau) d\tau, \\ &= f(t) + w_*(t) + \tilde{A}_{cl} \int_0^t e^{\tilde{A}_{cl}(t-\tau)} w_*(\tau) d\tau. \end{aligned} \quad (2.104)$$

where  $f(t) \in \mathcal{L}_{2e}^n$  is given by (2.84), and the disturbance  $w_* \in \mathcal{L}_2^n$ . Note that  $f(t)$  also belongs to  $\mathcal{L}_2^n$ . The term  $\int_0^t e^{\tilde{A}_{cl}(t-\tau)} w_*(\tau) d\tau$  is the response of a stable LTI system to the input  $w_* \in \mathcal{L}_2^n$ , which belongs to  $\mathcal{L}_2^n$ . Consequently, we have that  $f_* \in \mathcal{L}_2^n$ . Additionally, the solution of the non-homogeneous decentralized system (2.98), (2.101) will be given by

$$x_*(t) = z_*(t) + \int_0^t e^{\tilde{A}_{cl}(t-\tau)} \tilde{A} e^{\hat{A}\tau} x_0 d\tau + \int_0^t e^{\tilde{A}_{cl}(t-\tau)} w_*(\tau) d\tau + e^{\hat{A}t} x_0, \quad (2.105)$$

with  $z_*$  given by a system similar to (2.70), with the variables  $z_*$ ,  $y_{z_*}$  and  $u_{z_*}$  instead of  $z$ ,  $y$  and  $u_z$ , respectively. The aforementioned equivalence between feedback interconnection (2.102) and system (2.98), (2.101) can be easily verified by replacing  $w_i(t)$  in (2.51) with  $w_i(t) + w_{i_*}(t)$ , and following the proof of Theorem 2.3. Therefore, the  $i^{th}$  closed-loop in the decentralized setting (with the variable  $x_{i_*}$ ) can be remodelled as the feedback interconnection given in Figure 2.6, but with the disturbance  $w_i + w_{i_*}$  on the operator  $\mathbf{G}_i$ . Consequently, the decentralized system can be remodelled in the form shown in Figure 2.7, but with the disturbance  $\phi + w_*$  on the operator  $\tilde{\mathbf{G}}$ . Finally, by considering a system similar to (2.70), with the variables  $z_*$ ,  $y_{z_*}$  and  $u_{z_*}$  instead of  $z$ ,  $y$  and  $u_z$ , respectively, the equivalence between  $x_*$  and  $z_*$  given by (2.105), can be proved.

Since  $g_* \in \mathcal{L}_2^n$  and the feedback-interconnection  $\mathbf{G} - \mathbf{\Delta}$  is  $\mathcal{L}_2$ -stable, we have that  $y_{z_*}, u_{z_*} \in \mathcal{L}_2^n$ . Therefore, we have proved that  $z_* \in \mathcal{L}_2^n$  and consequently, from (2.105), we have  $x_* \in \mathcal{L}_2^n$ . Now, since the solution of the non-homogeneous decentralized system (2.98), (2.101), i.e.,  $x_* \in \mathcal{L}_2^n$ , by virtue of *Bohl-Perron Principle*, we can conclude that the equilibrium solution  $x = 0$  of the homogeneous decentralized system (2.95), (2.96), is globally exponentially stable.  $\square$

*Remark:* In Theorem 2.4, the condition that both  $\tilde{A}_{cl}$  and  $\hat{A}$  need to be Hurwitz, imposes an easy-to-satisfy constraint that in the absence of sampling and delay, the decentralized system (2.30)-(2.33) is asymptotically stable. However, there are systems of the form (2.30) that cannot be stabilized by decentralized state feedback, see [8].

Theorem 2.4 shows that in order to prove that the decentralized system (2.30)-(2.33) is exponentially stable, it is enough to prove that the feedback-interconnection  $\mathbf{G} - \mathbf{\Delta}$  given by (2.44), is  $\mathcal{L}_2$ -stable. In the following section, we

will provide tractable numerical stability criteria that guarantees  $\mathcal{L}_2$ -stability of the interconnection  $\mathbf{G} - \mathbf{\Delta}$ , by characterizing the properties of the operator  $\mathbf{\Delta}$  given in (2.42) using an IQC. As such, these conditions also guarantee exponential stability of the decentralized system (2.30)-(2.33).

### 2.3.4 Bounded-gain IQC Characterization of Asynchrony Effect

In this section, we study the properties of the operator  $\mathbf{\Delta}$  in (2.42), with  $\Delta_i$  defined analogous to (2.9), and characterize its gain properties using an IQC. The following lemma extends the result given in [65], to include an arbitrary number of sensors and actuators. We provide the proof for the sake of completeness.

**Lemma 2.5.** *Consider  $R = \text{diag}(R_1, R_2, \dots, R_M)$ , with  $R_i \in \mathbb{R}^{n_i \times n_i}$ ,  $R_i = R_i^T > 0$ , for all  $i \in \{1, 2, \dots, M\}$ . Then, the operator  $\mathbf{\Delta}$  defined by (2.42), with  $\Delta_i$  defined analogous to (2.9), satisfies the IQC given by*

$$\int_0^\infty \begin{bmatrix} y(t) \\ e(t) \end{bmatrix}^T \begin{bmatrix} S & 0 \\ 0 & -R \end{bmatrix} \begin{bmatrix} y(t) \\ e(t) \end{bmatrix} dt \geq 0, \quad (2.106)$$

where  $e = \mathbf{\Delta}y$  with  $y(t)$  given by (2.83), and

$$S = \text{diag}(\gamma_1^2 R_1, \gamma_2^2 R_2, \dots, \gamma_M^2 R_M), \quad (2.107)$$

with  $\gamma_i = \bar{h}_i + \bar{\eta}_i$ , for all  $i = \{1, 2, \dots, M\}$ .

*Proof.* The proof is given in Appendix 2.7.3. □

The bounded gain type IQC characterizing the properties of operator  $\mathbf{\Delta}$  can now be used to establish  $\mathcal{L}_2$ -stability of the feedback interconnection  $\mathbf{G} - \mathbf{\Delta}$  defined by (2.44), as given in the following theorem. Consequently, as a result of Theorem 2.4, the exponential stability of the decentralized system (2.30)-(2.33) is then also guaranteed.

**Theorem 2.6.** *Consider the decentralized system defined by (2.30)-(2.33), and the transfer function*

$$\mathbf{G}(s) = \tilde{A}_{cl}(sI - \tilde{A}_{cl})^{-1}B_{cl} + B_{cl}, \quad (2.108)$$

where  $B_{cl}$  is given by (2.39). Suppose that  $\tilde{A}_{cl}$ ,  $\hat{A}$  given by (2.38), (2.48), respectively, are Hurwitz. If there exists  $\epsilon > 0$  such that

$$\begin{bmatrix} \mathbf{G}(j\omega) \\ I \end{bmatrix}^T \Pi \begin{bmatrix} \mathbf{G}(j\omega) \\ I \end{bmatrix} \leq -\epsilon I, \quad (2.109)$$

is satisfied for all  $\omega \in \mathbb{R}$ , and

$$\Pi = \begin{bmatrix} S & 0 \\ 0 & -R \end{bmatrix}, \quad (2.110)$$

where

$$R = \text{diag}(R_1, R_2, \dots, R_M), R_i = R_i^T > 0, \quad (2.111)$$

and

$$S = \text{diag}(\gamma_1^2 R_1, \gamma_2^2 R_2, \dots, \gamma_M^2 R_M) \quad (2.112)$$

with  $\gamma_i = \bar{h}_i + \bar{\eta}_i$  for all  $i \in \{1, 2, \dots, M\}$ , then, the origin is a globally exponentially stable solution of the decentralized system (2.30)-(2.33).

*Proof.* From Lemma 2.5, we have that the operator  $\Delta$  satisfies the IQC defined by  $\Pi$ . Consequently, by invoking the standard IQC Theorem [81], we have that the mapping  $\begin{bmatrix} f \\ g \end{bmatrix} \mapsto \begin{bmatrix} y \\ u_z \end{bmatrix}$  defined by the feedback interconnection  $\mathbf{G} - \Delta$  in (2.44) is  $\mathcal{L}_2$ -stable if the condition (2.109) is satisfied. Then, as a direct application of Theorem 2.4, since the feedback interconnection of  $\mathbf{G}$  and  $(\Delta)$  is  $\mathcal{L}_2$ -stable, the decentralized system (2.30)-(2.33) is exponentially stable.  $\square$

*Remark:* By applying the *Kalman-Yakubovich-Popov Lemma*, we can infer that the frequency-domain criterion given by (2.109) is equivalent to the existence of matrices  $P = P^T > 0$  and  $R_i = R_i^T > 0$ , such that the Linear Matrix Inequality (LMI)

$$\begin{bmatrix} \tilde{A}_{cl}^T P + P \tilde{A}_{cl} & P B_{cl} \\ B_{cl}^T P & 0 \end{bmatrix} + \begin{bmatrix} \tilde{A}_{cl} & B_{cl} \\ 0 & I \end{bmatrix}^T \Pi \begin{bmatrix} \tilde{A}_{cl} & B_{cl} \\ 0 & I \end{bmatrix} < 0, \quad (2.113)$$

where  $\Pi$  is given by (2.110), and where  $\tilde{A}_{cl}$ ,  $B_{cl}$  are given by (2.38), (2.39), respectively, is satisfied. This condition can easily be checked using existing LMI solvers. Algorithm 1 gives a peripheral idea on how this check can be done. For a set of asynchronous sampling intervals and delays, the condition allows

---

**Algorithm 1** Solving LMI (2.113)

---

- 1: Initialize matrices  $\tilde{A}_{cl}$ ,  $B_{cl}$
  - 2: Grid  $\bar{h}_i$ ,  $\bar{\eta}_i$  over fixed limits with desired gridding interval.
  - 3: **for** every  $(\bar{h}_i, \bar{\eta}_i)$  **do**
  - 4:     Solve (2.113) using LMI solvers for  $P$ ,  $R_i$ .
  - 5:     **if** the obtained  $P > 0$ , and  $R_i > 0$  **then**
  - 6:          $(\bar{h}_i, \bar{\eta}_i)$  ensures exponential stability.
  - 7:     **else** discard the pair  $(\bar{h}_i, \bar{\eta}_i)$
- 

to validate system stability. This is shown via a numerical example in Section

2.5. For a single system setting, when  $\bar{h}_1 = 0$ , the condition (2.113) recovers the result given in [66]. Similarly, when  $\bar{\eta}_1 = 0$ , we recover the condition given in [84]. Richer IQC characterizations that account for passivity properties of operators similar to  $\Delta$ , in addition to the bounded gain properties, can be found in [17], [18], [37], [64]. These characterizations could be useful in future work to derive less conservative stability criteria.

## 2.4 Small Delay Case: Separation of $\Delta$ operator

The large-delay case considered in Section 2.3 delineates scenarios commonly arising in data transmission over shared networks, where delays can be considerably longer than the sampling intervals. However, in a relevant subset of practical scenarios, the delays can be guaranteed to be smaller than the sampling interval. Such scenarios and its impact on the stability of systems has previously been illustrated in [107]. It was shown that for an exemplary LTI system, a specific sequence of alternating time delays, with the delay being less than the sampling interval, induced instability in the system. In such scenarios, the result presented in Theorem 2.6, i.e., for the large-delay case, can be applied. However, since asynchrony effects are analysed in between actuation instants, using a global operator, which does not distinguish between asynchrony induced by sampling, and delay, the obtained results are conservative when adapted to the small-delay case. In this section, we show how in the small-delay case, a distinction can be made between asynchrony induced by sampling and asynchrony induced by delay, by considering two operators. This distinction also aids in obtaining less conservative results, when compared to the results obtained in the large-delay case, adapted to the small-delay case. We proceed to provide a mathematical description of the decentralized setting (2.30)-(2.33), in the small-delay case.

### 2.4.1 System description

In this section, we recall the decentralized sampled-data system (2.30)-(2.33). In the small-delay case, it holds for the  $i^{th}$ -loop in the decentralized setting that the  $k^{th}$  actuation instant occurs before the  $(k+1)^{th}$  sampling instant, i.e.,

$$\eta_k^i \leq h_k^i, \forall k \in \mathbb{N}, i \in \{1, 2, \dots, M\}. \quad (2.114)$$

Exploiting this more stringent requirement on the network, we proceed to provide a criterion that is less conservative in comparison to the more generic criteria given in Theorem 2.6, when applied to this small-delay case. As a stepping stone, we consider two operators to characterize the effects of sampling and delay separately, by adapting a similar formulation we have provided in [129]. The error due to sampling is given by

$$e_s(t) = [e_1^s{}^T(t) \quad e_2^s{}^T(t) \quad \dots \quad e_M^s{}^T(t)]^T, \quad (2.115)$$

where

$$e_i^s(t) = (\Delta_i^s y_i)(t) = \begin{cases} 0, \forall t \in [0, a_0^i), \\ -\int_{s_0^i}^t y_i(\theta) d\theta, \forall t \in [a_0^i, s_1^i), \\ -\int_{s_k^i}^t y_i(\theta) d\theta, \forall t \in [s_k^i, s_{k+1}^i), k \in \mathbb{N}^*, \end{cases} \quad (2.116)$$

for all  $i \in \{1, 2, \dots, M\}$ . In a similar manner, the error induced on a sampled signal due to delay, is given by

$$e_d(t) = \begin{bmatrix} e_1^{dT}(t) & e_2^{dT}(t) & \dots & e_M^{dT}(t) \end{bmatrix}^T, \quad (2.117)$$

where for all  $i \in \{1, 2, \dots, M\}$ ,

$$e_i^d(t) = (\Delta_i^d y_i)(t) = \begin{cases} 0, \forall t \in [0, s_1^i), \\ -\int_{s_{k-1}^i}^{s_k^i} y_i(\theta) d\theta, \forall t \in [s_k^i, a_k^i), k \in \mathbb{N}^*, \\ 0, \forall t \in [a_k^i, s_{k+1}^i), k \in \mathbb{N}^*. \end{cases} \quad (2.118)$$

## 2.4.2 Operator decomposition

In the following lemma, for the decentralized system (2.30)-(2.33) under the constraint (2.114), we demonstrate the equivalence between the error captured using a single operator, i.e., (2.59), and the error captured using two separate operators, i.e., (2.116) and (2.118).

**Lemma 2.7.** Consider the operator  $\Delta^s$  given by

$$\Delta^s y = \begin{pmatrix} \Delta_1^s y_1 & \Delta_2^s y_2 & \dots & \Delta_M^s y_M \end{pmatrix}^T, \quad (2.119)$$

where, for all  $i \in \{1, 2, \dots, M\}$ , the operator  $\Delta_i^s$  is defined by (2.116). Consider the operator  $\Delta^d$  given by

$$\Delta^d y = \begin{pmatrix} \Delta_1^d y_1 & \Delta_2^d y_2 & \dots & \Delta_M^d y_M \end{pmatrix}^T, \quad (2.120)$$

where, for all  $i \in \{1, 2, \dots, M\}$ , the operator  $\Delta_i^d$  is defined by (2.118). Then, for the decentralized sampled-data system (2.30)-(2.33) under constraint (2.114),

$$(\Delta y)(t) = (\Delta^s y)(t) + (\Delta^d y)(t), \forall t \geq 0, \quad (2.121)$$

where the operator  $\Delta = \text{diag}(\Delta_1, \Delta_2, \dots, \Delta_M)$ , so that for all  $i \in \{1, 2, \dots, M\}$ ,  $\Delta_i$  is defined by (2.59).

*Proof.* Based on the structure of the operators  $\Delta$ ,  $\Delta^s$ , and  $\Delta^d$ , in order to prove (2.121), it is sufficient to show that

$$(\Delta_i y_i)(t) = (\Delta_i^s y_i)(t) + (\Delta_i^d y_i)(t), \forall t \geq 0, \quad (2.122)$$



where  $\Delta_i$  is defined by (2.59).

For all  $t \in [0, a_0^i]$ : From (2.116), (2.118), and (2.59), we have  $(\Delta_i^s y_i)(t) = (\Delta_i^d y_i)(t) = (\Delta_i y_i)(t) = 0$ , implying

$$(\Delta_i^s y_i)(t) + (\Delta_i^d y_i)(t) = (\Delta_i y_i)(t), \forall t \in [0, a_0^i]. \quad (2.123)$$

For all  $t \in [a_0^i, s_1^i]$ : From the definition of  $\Delta_i$  in (2.59), we have

$$(\Delta_i y_i)(t) = - \int_{s_0^i}^t y_i(\theta) d\theta, \forall t \in [a_0^i, a_1^i] \supset [a_0^i, s_1^i]. \quad (2.124)$$

From (2.118), since  $(\Delta_i^d y_i)(t) = 0$ , for all  $t \in [a_0^i, s_1^i]$ , using the definition of  $\Delta_i^s$  in (2.116), (2.124) can be expressed as

$$(\Delta_i y_i)(t) = (\Delta_i^s y_i)(t) + (\Delta_i^d y_i)(t), \forall t \in [a_0^i, s_1^i]. \quad (2.125)$$

For all  $t \in [s_k^i, a_k^i], k \in \mathbb{N}^*$ : From (2.116) and (2.118), we have

$$\begin{aligned} (\Delta_i^s y_i)(t) + (\Delta_i^d y_i)(t) &= - \int_{s_k^i}^t y_i(\theta) d\theta - \int_{s_{k-1}^i}^{s_k^i} y_i(\theta) d\theta, \forall t \in [s_k^i, a_k^i], k \in \mathbb{N}^* \\ &= - \int_{s_{k-1}^i}^t y_i(\theta) d\theta, \forall t \in [s_k^i, a_k^i], k \in \mathbb{N}^* \end{aligned} \quad (2.126)$$

From (2.59), under the condition (2.114), we have

$$\begin{aligned} (\Delta_i y_i)(t) &= - \int_{s_k^i}^t y_i(\theta) d\theta, \forall t \in [a_k^i, a_{k+1}^i] \supset [s_{k+1}^i, a_{k+1}^i], k \in \mathbb{N}, \\ &= - \int_{s_{p-1}^i}^t y_i(\theta) d\theta, \forall t \in [a_{p-1}^i, a_p^i] \supset [s_p^i, a_p^i], p \in \mathbb{N}^*. \end{aligned} \quad (2.127)$$

Therefore, (2.126) gives

$$(\Delta_i^s y_i)(t) + (\Delta_i^d y_i)(t) = (\Delta_i y_i)(t), \forall t \in [s_k^i, a_k^i], k \in \mathbb{N}^*. \quad (2.128)$$

For all  $t \in [a_k^i, s_{k+1}^i], k \in \mathbb{N}^*$ : Using (2.116) and (2.118), we have,

$$(\Delta_i^s y_i)(t) + (\Delta_i^d y_i)(t) = - \int_{s_k^i}^t y_i(\theta) d\theta, \forall t \in [a_k^i, s_{k+1}^i], k \in \mathbb{N}^*. \quad (2.129)$$

Now, from the definition of  $\Delta_i$  in (2.59), under constraint (2.114), we can state

$$\begin{aligned} (\Delta_i y_i)(t) &= - \int_{s_{k+1}^i}^t y_i(\theta) d\theta, \forall t \in [a_{k+1}^i, a_{k+2}^i] \supset [a_{k+1}^i, s_{k+2}^i], k \in \mathbb{N}, \\ &= - \int_{s_p^i}^t y_i(\theta) d\theta, \forall t \in [a_p^i, a_{p+1}^i] \supset [a_p^i, s_{p+1}^i], p \in \mathbb{N}^*. \end{aligned} \quad (2.130)$$

Therefore (2.130) and (2.129) gives

$$(\Delta_i^s y_i)(t) + (\Delta_i^d y_i)(t) = (\Delta_i y_i)(t), \forall t \in [a_k^i, s_{k+1}^i), k \in \mathbb{N}^*. \quad (2.131)$$

Hence, from (2.122), (2.125), (2.128) and (2.131), we have

$$(\Delta_i^s y_i)(t) + (\Delta_i^d y_i)(t) = (\Delta_i y_i)(t), \forall t \geq 0. \quad (2.132)$$

□

In a similar fashion as demonstrated in the large-delay case, we proceed to characterize the properties of the operators  $\Delta^s$  and  $\Delta^d$ , given by (2.119) and (2.120), respectively, using IQCs. By doing so, we can provide IQC conditions that guarantee  $\mathcal{L}_2$ -stability of the feedback interconnection  $\mathbf{G}$ - $\Delta$ , with  $\Delta$  satisfying the decomposition (2.121).

### 2.4.3 Bounded-gain IQC Characterization

In this section, we characterize the properties of the operators  $\Delta^s$  and  $\Delta^d$  using bounded gain type IQCs. The following lemma provides IQC conditions on the operator  $\Delta^s$ , that characterizes the effects of asynchrony induced by sampling and hold. The result given in this lemma is an extension of the results provided in [76], [84], wherein a single-loop LTI system with aperiodic sampling was considered.

**Lemma 2.8.** *Consider  $R_s = \text{diag}(R_1^s, R_2^s, \dots, R_M^s)$ , with  $R_i^s \in \mathbb{R}^{n_i \times n_i}$ ,  $R_i^s = (R_i^s)^T > 0$ , for all  $i \in \{1, 2, \dots, M\}$ . The operator  $\Delta^s$  defined by (2.119) satisfies the Integral Quadratic Constraint (IQC) given by*

$$\int_0^\infty \begin{bmatrix} y(t) \\ e_s(t) \end{bmatrix}^T \begin{bmatrix} S_s & 0 \\ 0 & -R_s \end{bmatrix} \begin{bmatrix} y(t) \\ e_s(t) \end{bmatrix} dt \geq 0, \quad (2.133)$$

where  $y$  is given by (2.83),  $e_s = \Delta^s y$ , and

$$S_s = \text{diag}((\gamma_1^s)^2 R_1^s, (\gamma_2^s)^2 R_2^s, \dots, (\gamma_M^s)^2 R_M^s), \quad (2.134)$$

with  $\gamma_i^s = \frac{2\bar{h}_i}{\pi}$ , for all  $i = \{1, 2, \dots, M\}$ .

*Proof.* The proof is given in Appendix 2.7.4. □

In a similar manner as shown in Lemma 2.8, in the following lemma, we characterize the properties of the operator  $\Delta^d$ , that characterizes the effects of asynchrony induced by delay, using an IQC.

**Lemma 2.9.** Consider  $R_d = \text{diag}(R_1^d, R_2^d, \dots, R_M^d)$ , with  $R_i^d \in \mathbb{R}^{n_i \times n_i}$ ,  $R_i^d = (R_i^d)^T > 0$ , for all  $i \in \{1, 2, \dots, M\}$ . The operator (2.120) satisfies the Integral Quadratic Constraint (IQC) given by

$$\int_0^\infty \begin{bmatrix} y(t) \\ e_d(t) \end{bmatrix}^T \begin{bmatrix} S_d & 0 \\ 0 & -R_d \end{bmatrix} \begin{bmatrix} y(t) \\ e_d(t) \end{bmatrix} dt \geq 0, \quad (2.135)$$

where  $y(t)$  is given by (2.83),  $e_d = \mathbf{\Delta}^d y$ , and

$$S_d = \text{diag}((\gamma_1^d)^2 R_1^d, (\gamma_2^d)^2 R_2^d, \dots, (\gamma_M^d)^2 R_M^d), \quad (2.136)$$

with  $\gamma_i^d = \sqrt{\bar{h}_i \bar{\eta}_i}$ , for all  $i \in \{1, 2, \dots, M\}$ .

*Proof.* Consider the delay-induced error given by (2.118). We have,

$$\begin{aligned} \int_{s_1^i}^\infty e_i^d(t)^T R_i^d e_i^d(t) dt &= \sum_{k=1}^\infty \int_{s_k^i}^{s_{k+1}^i} e_i^d(t)^T R_i^d e_i^d(t) dt \\ &= \sum_{k=1}^\infty \int_{s_k^i}^{a_k^i} e_i^d(t)^T R_i^d e_i^d(t) dt, \end{aligned} \quad (2.137)$$

since  $e_i^d(t) = 0$  for all  $t \in [a_k^i, s_{k+1}^i)$ ,  $k \in \mathbb{N}^*$ . Since

$$e_i^d(t) := - \int_{s_{k-1}^i}^{s_k^i} y_i(\theta) d\theta, \forall t \in [s_k^i, a_k^i), k \in \mathbb{N}^*, \quad (2.138)$$

by employing Jensen's inequality, we obtain

$$e_i^d(t)^T R_i^d e_i^d(t) \leq \bar{h}_i \int_{s_{k-1}^i}^{s_k^i} y_i(\theta)^T R_i^d y_i(\theta) d\theta, k \in \mathbb{N}^*. \quad (2.139)$$

Using the bound (2.139), we have from (2.137) that

$$\begin{aligned} \int_{s_1^i}^\infty e_i^d(t)^T R_i^d e_i^d(t) dt &\leq \bar{h}_i \sum_{k=1}^\infty \int_{s_k^i}^{a_k^i} \left( \int_{s_{k-1}^i}^{s_k^i} y_i(\theta)^T R_i^d y_i(\theta) d\theta \right) dt \\ &= \bar{h}_i \bar{\eta}_i \sum_{k=1}^\infty \int_{s_{k-1}^i}^{s_k^i} y_i(\theta)^T R_i^d y_i(\theta) d\theta \\ &\leq \bar{h}_i \bar{\eta}_i \int_0^\infty y_i(t)^T R_i^d y_i(t) dt. \end{aligned} \quad (2.140)$$

Since  $e_i^d(t) = 0$  for all  $t \leq s_1^i$ , we have

$$\int_0^\infty e_i^d(t)^T R_i^d e_i^d(t) dt = \int_{s_1^i}^\infty e_i^d(t)^T R_i^d e_i^d(t) dt \leq \bar{h}_i \bar{\eta}_i \int_0^\infty y_i(t)^T R_i^d y_i(t) dt. \quad (2.141)$$

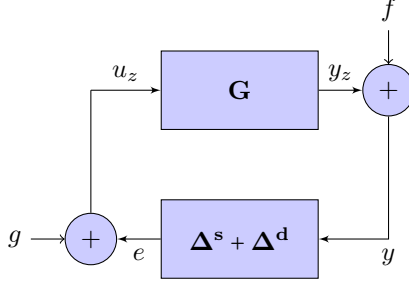

Figure 2.8: The feedback interconnection of  $\mathbf{G}$  and  $\Delta^s + \Delta^d$ , representing the decentralized system (2.30)-(2.33).

Consequently, for all  $i = \{1, 2, \dots, M\}$ , we have

$$\int_0^\infty \begin{bmatrix} y_i(t) \\ e_i^d(t) \end{bmatrix}^T \begin{bmatrix} (\gamma_i^d)^2 R_i^d & 0 \\ 0 & -R_i^d \end{bmatrix} \begin{bmatrix} y(t) \\ e_i^d(t) \end{bmatrix} dt \geq 0, \quad (2.142)$$

where  $\gamma_i^d = \sqrt{\bar{h}_i \bar{\eta}_i}$ . Considering the integral quadratic constraint (2.142) for all  $i \in \{1, 2, \dots, M\}$ , i.e., for the operator  $\Delta^s$ , we have

$$\int_0^\infty \begin{bmatrix} y(t) \\ e_d(t) \end{bmatrix}^T \begin{bmatrix} S_d & 0 \\ 0 & -R_d \end{bmatrix} \begin{bmatrix} y(t) \\ e_d(t) \end{bmatrix} dt \geq 0, \quad (2.143)$$

where

$$\begin{aligned} e_d(t) &= [e_1^{dT}(t), e_2^{dT}(t), \dots, e_M^{dT}(t)]^T, \\ y(t) &= [y_1^T(t), y_2^T(t), \dots, y_M^T(t)]^T, \\ S_d &= \text{diag}((\gamma_1^d)^2 R_1^d, (\gamma_2^d)^2 R_2^d, \dots, (\gamma_M^d)^2 R_M^d). \end{aligned} \quad (2.144)$$

□

We have now characterized the properties of operators  $\Delta^s$  and  $\Delta^d$  using IQCs. In a similar manner as shown in the large-delay case, this will be used to provide tractable numerical conditions that guarantee  $\mathcal{L}_2$ -stability of the feedback interconnection  $\mathbf{G}-\Delta$ , where  $\Delta$  satisfies the decomposition (2.121), and ultimately global exponential stability of the decentralized system (2.30)-(2.33).

#### 2.4.4 Exponential Stability Criterion

In this section, based on the IQCs characterizing operators  $\Delta^s$  and  $\Delta^d$ , we establish the  $\mathcal{L}_2$ -stability of the feedback interconnection  $\mathbf{G}-\Delta$ . By doing so, in conjunction with Theorem 2.4, we are able to guarantee the exponential stability of decentralized system (2.30)-(2.33).

**Theorem 2.10.** Consider the decentralized system defined by (2.30)-(2.33), and the transfer function

$$\mathbf{G}(s) = \tilde{A}_{cl}(sI - \tilde{A}_{cl})^{-1}B_{cl} + B_{cl}, \quad (2.145)$$

where  $B_{cl}$  is given by (2.39). Suppose that  $\tilde{A}_{cl}$ ,  $\hat{A}$  given by (2.38), (2.48), respectively, are Hurwitz. If there exists  $\epsilon > 0$  such that

$$\begin{bmatrix} \mathbf{G}(j\omega) \\ I \end{bmatrix}^T \tilde{\Pi} \begin{bmatrix} \mathbf{G}(j\omega) \\ I \end{bmatrix} \leq -\epsilon I, \quad (2.146)$$

is satisfied for all  $\omega \in \mathbb{R}$ , and

$$\tilde{\Pi} = \begin{bmatrix} S_s + S_d & 0 & 0 \\ 0 & -R_s & 0 \\ 0 & 0 & -R_d \end{bmatrix}, \quad (2.147)$$

with  $S_s$ ,  $S_d$  given by (2.134), (2.136), respectively,  $R_s = \text{diag}(R_1^s, R_2^s, \dots, R_M^s)$ ,  $R_d = \text{diag}(R_1^d, R_2^d, \dots, R_M^d)$ , so that  $R_i^s = (R_i^s)^T > 0$ , and  $R_i^d = (R_i^d)^T > 0$  for all  $i \in \{1, 2, \dots, M\}$ , then, the decentralized system (2.30)-(2.33) is globally exponentially stable.

*Proof.* Based on Lemma 2.7, since  $(\Delta y)(t) = (\Delta^s y)(t) + (\Delta^d y)(t)$ ,  $\forall t \geq 0$ , we have that  $e(t) = e_s(t) + e_d(t)$ ,  $\forall t \geq 0$ , where  $e_s(t)$  and  $e_d(t)$  are given by (2.171) and (2.144), respectively. Consequently, using the feedback interconnection  $\mathbf{G} - \Delta$  given by Figure 2.5, we can represent the decentralized system (2.30)-(2.33) by the feedback interconnection given in Figure 2.8. Additionally, using Lemmas 2.8 and 2.9, we have that  $\Delta^s + \Delta^d$  satisfies the IQC given by

$$\int_0^\infty \begin{bmatrix} y(t) \\ e_s(t) \\ e_d(t) \end{bmatrix}^T \tilde{\Pi} \begin{bmatrix} y(t) \\ e_s(t) \\ e_d(t) \end{bmatrix} dt \geq 0, \quad (2.148)$$

where  $\tilde{\Pi}$  is given by (2.147). Therefore by invoking the IQC Theorem [81], we can state that the feedback-interconnection of the operators  $\mathbf{G}$  and  $(\Delta^s + \Delta^d)$  is  $\mathcal{L}_2$ -stable if the IQC condition (2.146) is satisfied. Then, as a direct application of Theorem 2.4, since the feedback interconnection of  $\mathbf{G}$  and  $(\Delta^s + \Delta^d)$  is  $\mathcal{L}_2$ -stable, the decentralized system (2.30)-(2.33) is exponentially stable.  $\square$

*Remark:* By applying the *Kalman-Yakubovich-Popov Lemma*, we can infer that the frequency-domain criterion given by (2.146) is equivalent to the existence of  $P = P^T > 0$ ,  $R_i^s = (R_i^s)^T > 0$ ,  $R_i^d = (R_i^d)^T > 0$ , such that the LMI given by

$$\begin{bmatrix} \tilde{A}_{cl}^T P + P \tilde{A}_{cl} & P \tilde{B} \\ \tilde{B}^T P & 0 \end{bmatrix} + \begin{bmatrix} \tilde{A}_{cl} & \tilde{B} \\ 0 & I \end{bmatrix}^T \tilde{\Pi} \begin{bmatrix} \tilde{A}_{cl} & \tilde{B} \\ 0 & I \end{bmatrix} < 0, \quad (2.149)$$

where  $\tilde{\Pi}$  is given by (2.147), and  $\tilde{B} = \begin{bmatrix} B_{cl} & B_{cl} \end{bmatrix}$ , is satisfied. The matrices  $\tilde{A}_{cl}$  and  $B_{cl}$  are given by (2.38) and (2.39), respectively. The LMI (2.149) can be solved in a similar manner as given in Algorithm 1.

## 2.5 Numerical Example

In this section, we consider again the motivating example given in the introduction, also studied in [129], and given by the matrices

$$A = \begin{bmatrix} -2 & -1 \\ 2.8 & 4 \end{bmatrix}, B = \begin{bmatrix} 1 & 0 \\ 0 & 1 \end{bmatrix}, K = \begin{bmatrix} -1 & 0 \\ 0 & -4.6 \end{bmatrix}. \quad (2.150)$$

One of the prime advantages of the results obtained in this chapter, compared to the results in [129], is that the stability conditions introduced in this chapter can be checked for any sampling and delay upper-bounds, for each sensor, individually. In this example, we can therefore check the system's stability for any quadruplet  $(\bar{h}_1, \bar{h}_2, \bar{\eta}_1, \bar{\eta}_2)$ . We will now illustrate as follows, how the results proposed in this chapter aid in computing the feasible values of individual sampling interval bounds, i.e.,  $\bar{h}_1$  and  $\bar{h}_2$ , separately, for fixed delays. In Figure 2.9, we show for instance, the stability domain obtained with fixed delay upper-bounds  $\bar{\eta}_1 = \bar{\eta}_2 = 0.075$ .

The feasible values of  $\bar{h}_1$  and  $\bar{h}_2$  are computed for  $\bar{\eta}_1 = \bar{\eta}_2 = 0.075$ , in the large-delay case (in blue) and the small-delay case (in red), and are shown in Figure 2.9. It is evident from the figure that the criterion proposed for the small-delay case provides less conservative results, in comparison to the criterion introduced for the large-delay case, but adapted to the small-delay scenario. The advantage of the large-delay case, as mentioned previously, is that it allows for the delay  $\eta_i^k, i \in \{1, 2\}, k \in \mathbb{N}$ , to be greater than the sampling interval  $h_i^k, i \in \{1, 2\}, k \in \mathbb{N}$ , for any feasible point  $(\bar{h}_1, \bar{h}_2)$  chosen in the blue feasibility region, as long as the sampling and actuation instants satisfy the large-delay constraint given in (2.32). On the contrary, for a feasible point  $(\bar{h}_1, \bar{h}_2)$  in the red feasibility region,  $h_i^k, i \in \{1, 2\}, k \in \mathbb{N}$  and  $\eta_i^k, i \in \{1, 2\}, k \in \mathbb{N}$  need to satisfy the more restrictive small-delay constraint given by (2.114). A plot providing the feasible values of  $\bar{h}_1$  and  $\bar{h}_2$ , can also be obtained for fixed delay bounds with  $\bar{\eta}_1 \neq \bar{\eta}_2$ .

In order to illustrate that the stability criteria proposed in this chapter are less conservative compared to the criteria provided in [129], we study the maximum bound on sampling interval, so that  $\bar{h}_1 = \bar{h}_2$ , when delay bounds are set to zero, i.e.,  $\bar{\eta}_1 = \bar{\eta}_2 = 0$ . For the large-delay case, by virtue of Theorem 2.6, by solving the LMI (2.113), we obtain  $\bar{h}_1 = \bar{h}_2 = 0.19$ , in comparison to a bound of 0.18 obtained in [129]. Similarly, for the small-delay case, applying Theorem 2.10 by virtue of LMI (2.149), we obtain  $\bar{h}_1 = \bar{h}_2 = 0.31$ , whereas a bound of 0.27 was obtained in [129].

The example shown in this section gives an insight into how the tools proposed in this chapter can be used to decide the trade-off between sampling-

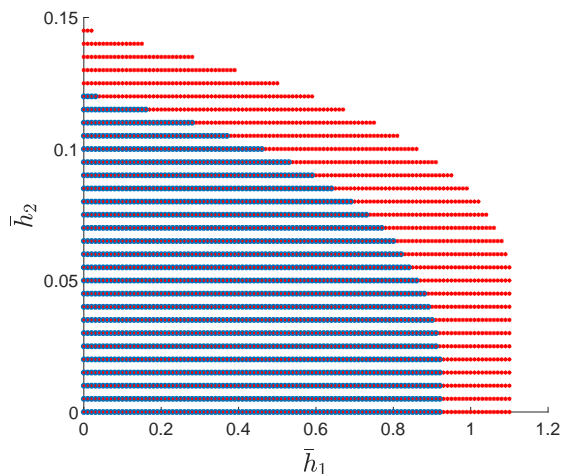

Figure 2.9: Feasible values of  $\bar{h}_1$  and  $\bar{h}_2$ , when  $\bar{\eta}_1 = \bar{\eta}_2 = 0.075$ , for the large-delay case (in blue) and the small-delay case (in red). For the small-delay case, the bounds  $\bar{h}_1 < 0.075$  and  $\bar{h}_2 < 0.075$  are applicable only if the condition (2.114) is satisfied.

interval bounds and delays, depending upon the system under consideration, and the constraints imposed by the networked communication channel. As a result, separate, effective sampling and actuation strategies can be employed on individual sensors and actuators, respectively.

## 2.6 Conclusion

In this chapter, a novel, IQC based framework towards exponential stability analysis of state-space models of decentralized, sampled-data LTI control systems with asynchronous sensors and actuators, is provided. As a preliminary result, an approach is introduced to represent the state-space model of a single-loop LTI system with asynchronous sensors and actuators, as an interconnection between a continuous time system operator and an operator that captures the effects of asynchrony. Consequently, by scaling this preliminary result, the decentralized, sampled-data, asynchronous LTI state-space model under consideration, is reformulated as a feedback interconnection. By characterizing the properties of the operator that captures asynchrony effects, using an IQC, stability results on the feedback-interconnection, which imply global exponential stability of the decentralized system, are provided. Two scenarios, namely the large-delay case and the small-delay case, are considered. In the large-delay case, the effects of

asynchrony induced by sampling and delay, are captured using a single operator. In contrast, these effects are captured using two separate operators in the small-delay case. This leads to less conservative results, in comparison to the result obtained in the large-delay case, when adapted to the small-delay case. The effectiveness of the proposed results have been illustrated using a numerical example. Although only bounded gain type IQCs have been considered in this chapter, there are several richer characterizations such as anti-passivity properties, etc. of the operator capturing sampling and asynchrony effects that can be considered [18], [46]. This can be useful in deriving less conservative results.

## 2.7 Appendix

### 2.7.1 $\mathcal{L}_2$ Stability of $\mathbf{G} - \Delta$

The feedback interconnection  $\mathbf{G} - \Delta$  defined by (2.44) is said to be  $\mathcal{L}_2$  stable if the mappings  $\begin{bmatrix} f \\ g \end{bmatrix} \mapsto \begin{bmatrix} y \\ u_z \end{bmatrix}$  and  $\begin{bmatrix} f \\ g \end{bmatrix} \mapsto \begin{bmatrix} e \\ y_z \end{bmatrix}$  have a finite  $\mathcal{L}_2$  gain [131].

### 2.7.2 Bohl-Perron Principle

If for  $p \geq 1$  and any  $f \in \mathcal{L}_p[0, \infty)$ , the non-homogeneous system  $\dot{x}(t) = \sum_{k=1}^m A_k(t)x(t - \tau_k(t)) + \int_0^h A_d(t, \theta)x(t - \theta)d\theta + f(t)$ ,  $x(s) = 0, s \in [-h, 0], 0 \leq \tau_k(t) \leq \bar{\tau}$ , with piecewise continuous delay  $\tau_k$  has a solution  $x \in \mathcal{L}_p[0, \infty)$ , and the condition

$$\sup_{t \geq 0} \left[ |A_k(t)| + \int_0^{\bar{\tau}} |A_d(t, \theta)| d\theta \right] < \infty,$$

holds, then the homogeneous system

$$\begin{aligned} \dot{x}(t) &= \sum_{k=1}^m A_k(t)x(t - \tau_k(t)) + \int_0^h A_d(t, \theta)x(t - \theta)d\theta, \\ x(s) &= \phi(s), s \in [-h, 0], \phi \in C[-\bar{\tau}, 0], \end{aligned}$$

is exponentially stable.

### 2.7.3 Proof of Lemma 2.5

Consider  $e_i(t)$  defined using the operator  $\Delta_i$  given in (2.59). We have,

$$e_i(t) = - \int_{s_k^i}^t y_i(\theta) d\theta, \forall t \in [a_k^i, a_{k+1}^i), k \in \mathbb{N}. \quad (2.151)$$



By virtue of Jensen's inequality, we can state

$$\begin{aligned} e_i(t)^T R_i e_i(t) &= \left( \int_{s_k^i}^t y_i(\theta) d\theta \right)^T R_i \left( \int_{s_k^i}^t y_i(\theta) d\theta \right) \\ &\leq (t - s_k^i) \int_{s_k^i}^t y_i^T(\theta) R_i y_i(\theta) d\theta, \end{aligned} \quad (2.152)$$

and since  $t \in [a_k^i, a_{k+1}^i)$ , from (2.31), (2.32), we obtain

$$t - s_k^i \leq a_{k+1}^i - s_k^i = s_{k+1}^i + \eta_{k+1}^i - s_k^i = h_k^i + \eta_{k+1}^i \leq \bar{h}_i + \bar{\eta}_i. \quad (2.153)$$

Therefore,

$$e_i(t)^T R_i e_i(t) \leq (\bar{h}_i + \bar{\eta}_i) \int_{s_k^i}^t y_i^T(\theta) R_i y_i(\theta) d\theta. \quad (2.154)$$

Substituting  $\theta = t + p$  and once again using the fact that  $t \in [a_k^i, a_{k+1}^i)$ , we have

$$e_i(t)^T R_i e_i(t) \leq (\bar{h}_i + \bar{\eta}_i) \int_{-(\bar{h}_i + \bar{\eta}_i)}^0 y_i^T(t+p) R_i y_i(t+p) dp. \quad (2.155)$$

Hence,

$$\begin{aligned} \int_{a_0^i}^{\infty} e_i(t)^T R_i e_i(t) dt &\leq (\bar{h}_i + \bar{\eta}_i) \int_{a_0^i}^{\infty} \left( \int_{-(\bar{h}_i + \bar{\eta}_i)}^0 y_i^T(t+p) R_i y_i(t+p) dp \right) dt \\ &\leq (\bar{h}_i + \bar{\eta}_i) \int_{-(\bar{h}_i + \bar{\eta}_i)}^0 \left( \int_{a_0^i}^{\infty} y_i^T(t+p) R_i y_i(t+p) dt \right) dp, \end{aligned} \quad (2.156)$$

where  $\theta = t + p$ , implying  $\theta \rightarrow \infty$  as  $t \rightarrow \infty$  and  $\theta \rightarrow a_0^i + p$  as  $t \rightarrow a_0^i$ . Since  $a_0^i \geq \bar{h}_i + \bar{\eta}_i$ ,  $p \in [-(\bar{h}_i + \bar{\eta}_i), 0]$  and the integrand of the inner integral is the positive term  $y_i^T(t+p) R_i y_i(t+p) = y_i^T(\theta) R_i y_i(\theta)$ , we can upper bound the aforementioned inequality by

$$\int_{a_0^i}^{\infty} e_i(t)^T R_i e_i(t) dt \leq (\bar{h}_i + \bar{\eta}_i) \int_{-(\bar{h}_i + \bar{\eta}_i)}^0 \left( \int_0^{\infty} y_i^T(\theta) R_i y_i(\theta) d\theta \right) dp. \quad (2.157)$$

As per the definition of  $e_i(t)$  in (2.59), since  $e_i(t) = 0, \forall t \in [0, a_0^i)$ , we have

$$\int_0^{\infty} e_i(t)^T R_i e_i(t) dt = \int_{a_0^i}^{\infty} e_i(t)^T R_i e_i(t) dt \leq \gamma_i^2 \int_0^{\infty} y_i^T(t) R_i y_i(t) dt, \quad (2.158)$$

with  $\gamma_i = \bar{h}_i + \bar{\eta}_i$ . Consequently, we have

$$\int_0^{\infty} \begin{bmatrix} y_i(t) \\ e_i(t) \end{bmatrix}^T \begin{bmatrix} \gamma_i^2 R_i & 0 \\ 0 & -R_i \end{bmatrix} \begin{bmatrix} y_i(t) \\ e_i(t) \end{bmatrix} dt \geq 0. \quad (2.159)$$

Note that  $\gamma_i$  is essentially the upper bound on the  $\mathcal{L}_2$  induced norm of the operator  $\Delta_i$ . Considering the integral quadratic constraint (2.159) for all  $i \in \{1, 2, \dots, M\}$ , i.e., for the operator  $\Delta$ , we have

$$\int_0^\infty \begin{bmatrix} y(t) \\ e(t) \end{bmatrix}^T \begin{bmatrix} S & 0 \\ 0 & -R \end{bmatrix} \begin{bmatrix} y(t) \\ e(t) \end{bmatrix} dt \geq 0, \quad (2.160)$$

where

$$\begin{aligned} e(t) &= [e_1^T(t), e_2^T(t), \dots, e_M^T(t)]^T, \\ y(t) &= [y_1^T(t), y_2^T(t), \dots, y_M^T(t)]^T, \end{aligned} \quad (2.161)$$

and  $S = \text{diag}(\gamma_1^2 R_1, \gamma_2^2 R_2, \dots, \gamma_M^2 R_M)$ .

### 2.7.4 Proof of Lemma 2.8

Consider the term

$$e_i^{s^*}(t) = (\Delta_i^{s^*} y_i)(t), \forall t \geq 0, \quad (2.162)$$

where

$$(\Delta_i^{s^*} y_i)(t) = \begin{cases} 0, & \forall t \in [0, s_0^i], \\ -\int_{s_k^i}^t y_i(\theta) d\theta, & \forall t \in [s_k^i, s_{k+1}^i], k \in \mathbb{N}, \end{cases} \quad (2.163)$$

with  $y_i(t) = \dot{x}_i(t)$ ,  $\forall t \geq 0$ . Therefore, we have

$$e_i^{s^*}(t) = \begin{cases} 0, & \forall t \in [0, s_0^i], \\ x_i(s_k^i) - x_i(t), & \forall t \in [s_k^i, s_{k+1}^i], k \in \mathbb{N}. \end{cases} \quad (2.164)$$

Consider the expression  $\sum_{k=0}^\infty \int_{s_k^i}^{s_{k+1}^i} e_i^{s^*T}(t) R_i^s e_i^{s^*}(t) dt$ , where  $R_i^s > 0$  is a scaling matrix. By virtue of the Wirtinger inequality [76], we can state

$$\begin{aligned} & \sum_{k=0}^\infty \int_{s_k^i}^{s_{k+1}^i} e_i^{s^*T}(t) R_i^s e_i^{s^*}(t) dt \\ & \leq \sum_{k=0}^\infty \frac{4(s_{k+1}^i - s_k^i)^2}{\pi^2} \int_{s_k^i}^{s_{k+1}^i} \frac{d}{dt} (e_i^{s^*T}(t)) R_i^s \frac{d}{dt} (e_i^{s^*}(t)) dt. \end{aligned} \quad (2.165)$$

Since  $s_{k+1}^i - s_k^i \leq \bar{h}_i$ ,  $\forall k \in \mathbb{N}$ , from (2.163), we have

$$\begin{aligned} & \sum_{k=0}^\infty \int_{s_k^i}^{s_{k+1}^i} e_i^{s^*T}(t) R_i^s e_i^{s^*}(t) dt \leq \frac{4\bar{h}_i^2}{\pi^2} \int_{s_k^i}^{s_{k+1}^i} \frac{d}{dt} (e_i^{s^*T}(t)) R_i^s \frac{d}{dt} (e_i^{s^*}(t)) dt \\ & = \frac{4\bar{h}_i^2}{\pi^2} \sum_{k=0}^\infty \int_{s_k^i}^{s_{k+1}^i} \frac{d}{dt} (\Delta_i^{s^*} y_i)^T(t) R_i^s \frac{d}{dt} (\Delta_i^{s^*} y_i)(t) dt \\ & = \frac{4\bar{h}_i^2}{\pi^2} \sum_{k=0}^\infty \int_{s_k^i}^{s_{k+1}^i} y_i(t)^T R_i^s y_i(t) dt \\ & \leq \frac{4\bar{h}_i^2}{\pi^2} \int_0^\infty y_i(t)^T R_i^s y_i(t) dt. \end{aligned} \quad (2.166)$$

We have from (2.162) that  $e_i^{s^*}(t) = 0$  for all  $t \leq s_0^i$ , implying

$$\int_0^\infty e_i^{s^*T}(t) R_i^s e_i^{s^*}(t) dt = \int_{s_0^i}^\infty e_i^{s^*T}(t) R_i^s e_i^{s^*}(t) dt \leq \frac{4\bar{h}_i^2}{\pi^2} \int_0^\infty y_i(t)^T R_i^s y_i(t) dt. \quad (2.167)$$

From (2.116) and (2.162), we have that  $e_i^s(t) = e_i^{s^*}(t)$  for all  $t \geq a_0^i$ , and  $e_i^s(t) = 0$  for all  $t \leq a_0^i$ , thereby implying

$$\int_0^\infty e_i^{sT}(t) R_i^s e_i^s(t) dt \leq \int_0^\infty e_i^{s^*T}(t) R_i^s e_i^{s^*}(t) dt \leq \frac{4\bar{h}_i^2}{\pi^2} \int_0^\infty y_i(t)^T R_i^s y_i(t) dt. \quad (2.168)$$

Consequently, for all  $i = \{1, 2, \dots, M\}$ , we have

$$\int_0^\infty \begin{bmatrix} y_i(t) \\ e_i^s(t) \end{bmatrix}^T \begin{bmatrix} \gamma_i^{s^2} R_i^s & 0 \\ 0 & -R_i^s \end{bmatrix} \begin{bmatrix} y_i(t) \\ e_i^s(t) \end{bmatrix} dt \geq 0, \quad (2.169)$$

where  $\gamma_i^s = \frac{2\bar{h}_i}{\pi}$ . Considering the integral quadratic constraint (2.169) for all  $i \in \{1, 2, \dots, M\}$ , i.e., for the operator  $\mathbf{\Delta}^s$ , we have

$$\int_0^\infty \begin{bmatrix} y(t) \\ e_s(t) \end{bmatrix}^T \begin{bmatrix} S_s & 0 \\ 0 & -R_s \end{bmatrix} \begin{bmatrix} y(t) \\ e_s(t) \end{bmatrix} dt \geq 0, \quad (2.170)$$

where

$$\begin{aligned} e_s(t) &= [e_1^{sT}(t), e_2^{sT}(t), \dots, e_M^{sT}(t)]^T, \\ y(t) &= [y_1^T(t), y_2^T(t), \dots, y_M^T(t)]^T, \\ S_s &= \text{diag}((\gamma_1^s)^2 R_1^s, (\gamma_2^s)^2 R_2^s, \dots, (\gamma_M^s)^2 R_M^s). \end{aligned} \quad (2.171)$$

## Chapter 3

---

# Dissipativity-based Framework for Stability Analysis of Aperiodically Sampled Nonlinear Systems with Time-varying Delay

---

*In this chapter, we provide novel conditions for stability analysis of aperiodically sampled nonlinear control systems subjected to time-varying delay. The proposed approach provides an estimate of the system decay rate and can deal with cases in which delay is larger than the sampling interval. It is applicable to a general class of nonlinear systems and provides sufficient criteria for stability that aid in making trade-offs between control performance and the bounds on sampling interval and delay. As a stepping stone, a preliminary and generic result based on dissipativity, is introduced to analyse the exponential stability of a class of feedback-interconnected systems. The nonlinear sampled-data system is remodelled to consider the effects of sampling and delay in the dissipativity framework, as perturbations to the nominal closed-loop system. This leads to constructive stability conditions for a continuous time closed-loop system given by the feedback interconnection of the nominal closed-loop system and an operator(s) that captures the effects of sampling and delay. For Linear Time-Invariant (LTI) systems, we recover simple Linear Matrix Inequality (LMI) and frequency domain conditions previously proposed in the robust control framework.*

---

This chapter is based on J. Thomas, C. Fiter, L. Hetel, N. van de Wouw, and J. P. Richard. “Dissipativity-based Framework for Stability Analysis of Aperiodically Sampled Nonlinear Systems with Time-varying Delay”, *Automatica*, in press, 2021.

### 3.1 Introduction

Currently, almost all sampled-data control systems are implemented numerically, and embedded in a networked environment where data is exchanged between sensors, controllers and actuators through digital communication channels [55], [134]. Typical examples include mobile sensor networks, smart grids, automated highway systems, etc., see [55].

However, in such control configurations, perturbing effects such as sampling jitter, data-packet dropouts, delays, etc., are often introduced in the network and this impacts the overall stability of the system [1], [46], [55], [57], [71], [134]. From the point of view of control theory, such phenomena are considered as sampled-data systems with aperiodic sampling and/or time-varying delay, or more generally, as Networked Control Systems (NCS) [134]. In this chapter, we focus on the stability analysis problem for aperiodically sampled nonlinear systems subjected to time-varying delay.

Existing literature provides various methods that deal with the stability analysis of sampled-data systems, with or without delay. An overview of different approaches in the case of aperiodic sampled-data systems can be found in [57]. These approaches are broadly classified into four categories, i.e., the *Time-delay* approach, the *Discrete-time* approach, the *Hybrid systems* approach, and the *Input-output* approach. The *Time-delay* approach, has been largely used in the context of Linear Time Invariant (LTI) systems [116]. One of the advantages of this approach is that it can easily handle situations in which delay is greater than sampling period [137]. However, it is usually difficult to make a differentiation between sampling induced delay and actuation induced delay. The approach has also been extended to nonlinear systems [68], [80]. The *Discrete-time* approach, has been used for stability analysis of LTI systems [26], [45], [137] and in some cases, nonlinear systems [99], [138]. Since it is based on the exact system discretization, it leads to very accurate numerical tools for stability analysis. Additionally, inter-sampling behaviour has been taken into account only in the case of LTI systems, see for example, [24]. Additionally, the application of such discretization-based approach is challenging for general nonlinear systems and for the large-delay case, see [79], [105]. The *Hybrid system* approach, was developed based on the fact that systems with sampling-and-hold in control and sensor signals can be modelled using impulsive systems [53]. In the LTI systems case, by using Impulsive Delay Differential Equations, situations when delay is greater than the sampling interval was also studied [75]. However, for nonlinear systems, the analysis has only been done for cases in which delay is less than the sampling interval [15], [108].

The *Input-output* approach treats the error induced by sampling and/or delay as a perturbation to the continuous-time control system and captures its effects using an operator [65], [129]. This approach is intuitively simple to develop and the stability analysis problem is related to the classical robust control framework

[46], [84]. A primary advantage of this approach is that it can easily include perturbations as well as nonlinearities. However, in the case of LTI systems, this approach has been used for stability analysis in the presence of sampling, and delay, only separately. The existing results only provide  $\mathcal{L}_2$ -stability criteria for LTI systems. Generally, it can be shown that this implies asymptotic stability of the LTI sampled-data system. However, in such cases, it is difficult to describe the system performance, even in terms of the transient decay-rate. In the case of nonlinear systems, this approach has been employed to analyse stability only in the case of aperiodic sampling in the absence of delay [93]. Providing constructive conditions for stability of nonlinear systems with aperiodic sampling and time-varying delay is largely an open problem.

In this chapter, we provide a novel framework to analyse the stability of aperiodically sampled nonlinear systems subjected to time-varying delay, using an approach inspired from the notion of dissipativity [136]. We will extend some arguments developed in Chapter 2. More specifically, instead of using an IQC characterization, we will develop a supply function (in the context of dissipativity theory) that satisfies an IQC property. The main contributions of this chapter are as follows. We introduce a constructive approach that is applicable to a general class of aperiodically sampled nonlinear systems with time-varying delays, even in the scenario when delay is greater than the sampling interval. We provide two tractable exponential stability conditions by taking into account the specific discontinuities in delay, as well as inter-sampling and inter-actuation behaviour. The dissipativity-based approach proposed in this chapter leads to conditions in terms of dissipativity type properties of the associated continuous-time system, for which many results for classes of nonlinear systems exist in literature. Additionally, the approach provides bounds on operator(s) characterizing sampling, hold and delay effects. The proposed results provide an estimate of the system decay-rate, and also aid in deciding the trade-off between system decay-rate, and the bounds on sampling interval and delay. As a stepping stone, we introduce a primary result that provides exponential stability conditions for a class of feedback interconnected systems, which bear relevance to a range of problems in the robust control framework. The first criterion caters to the so-called ‘large delay case’, which delineates the situation arising often in information transmission over shared networks, where the delay introduced to the data packet exceeds the sampling interval of the sensors. The second criterion, a less conservative one, deals with the ‘small delay case’ where delay is less than the sampling period. This scenario has been studied in numerous theoretical as well as practical settings (see [24], [134], [140]). For example, in [24], it was shown that in the case of a single sensor sampling periodically, when the sampled-data experienced delays less than sampling-interval, the system was rendered unstable. The problem becomes much more complex when the sensors and actuators involved have aperiodic sampling and actuation frequencies. In our analysis for the small-delay case, two separate operators are used to capture

the effects of sampling and delay. In the case of LTI systems, we recover simple LMI and frequency domain conditions previously proposed in the robust control framework [65], [84].

The outline of this chapter is as follows. In Section 3.2, we introduce the problem setting which comprises of a generic aperiodically sampled nonlinear system subjected to time-delay. In Section 3.3, a preliminary stability result in the exponential dissipativity framework is provided, for a class of feedback interconnected systems. Section 3.4 deals with the stability analysis of the nonlinear sampled-data system under the large-delay case. It begins with a model reformulation of the problem setting in terms of the feedback interconnection introduced in Section 3.3. Next, the remodelled system properties are exploited to formulate a required supply function that will be used to provide a stability criterion by employing the result introduced in Section 3.3. Section 3.5 introduces the stability analysis of the nonlinear sampled-data system in the small-delay case, and follows a similar outline as Section 3.4. In Section 3.6, examples are provided to corroborate the effectiveness of the proposed results in the nonlinear as well as linear case. Finally, conclusions and an insight into possible future work are given in Section 3.7. The proofs of the results introduced in this chapter, if not given in the main body of the chapter, are given in the appendices.

## Notations

Throughout the chapter, we denote  $\mathbb{R}^+ = \{x \in \mathbb{R} : x \geq 0\}$ . The Euclidean norm of a vector  $x \in \mathbb{R}^n$  is denoted by  $\|x\|$ . The derivative of a time-varying vector  $z(t) \in \mathbb{R}^n$  is given by the Dini derivative or upper right-hand derivative, i.e.,  $\dot{z}(t) \triangleq \lim_{h \rightarrow 0^+} \sup \frac{z(t+h) - z(t)}{h}$ . We denote  $\mathcal{W}^n$  as the set of all piecewise continuous  $n$ -dimensional functions over  $\mathbb{R}^+$ . The notation  $\mathbb{N}^*$  is used to denote the set  $\{\mathbb{N} \setminus \{0\}\}$ . The set of all continuously differentiable functions is denoted by  $\mathcal{C}^1$ , and the set of all continuous functions are denoted by  $\mathcal{C}^0$ . The maximum and minimum eigen values of a matrix  $M \in \mathbb{R}^{n \times n}$  are denoted by  $\delta_{max}$  and  $\delta_{min}$ , respectively. The Euclidean norm of a matrix  $M$  is given by  $\|M\|_2 = \sqrt{\delta_{max}(M^T M)}$ .

## 3.2 Problem Statement

Consider the nonlinear system

$$\dot{x}_p(t) = f(x_p(t)) + g(x_p(t))u(t), \forall t \geq 0, \quad (3.1)$$

with the nonlinear sampled-data control

$$u(t) = \begin{cases} 0, & \forall t \in [0, a_0), \\ \kappa(x_p(s_k)), & \forall t \in [a_k, a_{k+1}), k \in \mathbb{N}, \end{cases} \quad (3.2)$$

where  $x_p(t) \in \mathbb{R}^{n_p}$  is the system state vector,  $x_p(0) = x_0^*$  and  $u(t) \in \mathbb{R}^{m_p}$  is the control input based on the continuous time signal

$$u_c(t) = \kappa(x_p(t)), \forall t \geq 0, \quad (3.3)$$

subjected to sampling and delay. It is assumed that in the absence of sampling and delay, the origin of system (3.1) with  $u(t) = u_c(t)$ , is exponentially stable. The functions  $f : \mathbb{R}^{n_p} \mapsto \mathbb{R}^{n_p}$  with  $f(0) = 0$ ,  $g : \mathbb{R}^{n_p} \mapsto \mathbb{R}^{n_p \times m_p}$  are globally Lipschitz, and the function  $\kappa : \mathbb{R}^{n_p} \mapsto \mathbb{R}^{m_p}$  belongs to  $\mathcal{C}^1$ . The time instants  $s_k$  and  $a_k$  specify the sampling instants (when sensors send the measured state value to the controller) and actuation instants (when the control input is updated at the actuator level) respectively. We consider a sampling sequence  $\{s_k\}_{k \in \mathbb{N}}$  satisfying

$$s_{k+1} = s_k + h_k, \forall k \in \mathbb{N}, \quad (3.4)$$

where the time-varying sampling interval  $h_k$  satisfies

$$0 < \underline{h} \leq h_k \leq \bar{h}, \forall k \in \mathbb{N}. \quad (3.5)$$

Similarly, we consider the actuation sequence  $\{a_k\}_{k \in \mathbb{N}}$  such that

$$a_k = s_k + \tau_k, \forall k \in \mathbb{N}, \quad (3.6)$$

where  $\tau_k$  is the time-varying delay between sampling and actuation instants and satisfies

$$0 \leq \underline{\tau} \leq \tau_k \leq \bar{\tau}, \forall k \in \mathbb{N}. \quad (3.7)$$

**Hypothesis 1:** The actuation instants satisfy

$$a_k < a_{k+1}, \forall k \in \mathbb{N}. \quad (3.8)$$

This assumption allows the bound on delay,  $\bar{\tau}$ , to be greater than the bound on sampling interval,  $\bar{h}$ , but under the constraint that the actuation instants occur in an order corresponding to the sampling instants. Without loss of generality, we consider that the first actuation occurs at time  $a_0 = \bar{\tau} + \bar{h}$ , while the first sampling instant is  $s_0 = a_0 - \tau_0$ . This assumption can also be ensured with a time-scale shift. Throughout the chapter,  $\mathcal{P}$  denotes the nonlinear closed-loop sampled-data system defined by (3.1), (3.2), (3.4)-(3.8). The objective of this chapter is to analyse the exponential stability of the system  $\mathcal{P}$ .

### 3.3 Preliminary Generic Stability Result

In this chapter, we will use the fact that system  $\mathcal{P}$  can be remodelled as the feedback-interconnection given by

$$\Sigma : \begin{cases} \dot{x}(t) = \bar{f}_0(x(t)) \\ y(t) = \bar{h}_0(x(t)) \end{cases} \forall t \in [0, a_0), \quad (3.9)$$

$$\begin{cases} \dot{x}(t) = \bar{f}(x(t)) + \bar{g}(x(t))\omega(t) \\ y(t) = \bar{h}(x(t)) + \bar{l}(x(t))\omega(t) \end{cases} \forall t \geq a_0,$$



with  $x(t) \in \mathbb{R}^n$ ,  $\omega(t) \in \mathbb{R}^m$ ,  $y(t) \in \mathbb{R}^p$ ,  $x(0) = x_0$ , and the operator  $\Delta : \mathcal{W}^p \mapsto \mathcal{W}^m$  such that

$$\omega = \Delta y. \quad (3.10)$$

The function  $\bar{f}_0$  in (3.9) is considered to be globally Lipschitz, with a Lipschitz constant  $k_0$  and  $\bar{f}_0(0) = 0$ . Additionally, we consider that the functions  $\bar{f}$ ,  $\bar{g}$ ,  $\bar{h}$  and  $\bar{l}$  are sufficiently smooth. We assume that solutions exist for the feedback interconnection  $\Sigma - \Delta$ . We shall denote the feedback interconnection (3.9)-(3.10) by  $\Sigma - \Delta$ . Such interconnection models will be introduced in Sections 3.4 and 3.5, wherein the functions introduced in (3.9) will also be detected. This will also establish the relation between the dimensions  $n$  introduced in (3.9) and  $n_p$  introduced in (3.1). Prior to presenting such models, we will formulate, a technical result concerning exponential stability of  $\Sigma - \Delta$ . This result will serve as a stepping stone for the stability analysis of systems of the form (3.1), (3.2), (3.4)-(3.8).

**Theorem 3.1.** *Consider the feedback interconnection  $\Sigma - \Delta$  and the following assumptions:*

Assumption 1: *There exists a supply function  $\mathcal{S} : \mathbb{R}^+ \times \mathbb{R}^p \times \mathbb{R}^m \mapsto \mathbb{R}$  continuous in all parameters satisfying the integral constraint*

$$\int_0^t \mathcal{S}(\theta, \phi(\theta), (\Delta\phi)(\theta)) d\theta \leq 0, \forall t \geq 0, \phi \in \mathcal{W}^p. \quad (3.11)$$

Assumption 2: *There exists a continuously differentiable storage function  $V : \mathbb{R}^n \mapsto \mathbb{R}^+$  and scalars  $0 < c_1 < c_2$ , and  $q > 0$  such that*

$$c_1 \|x\|^q \leq V(x) \leq c_2 \|x\|^q. \quad (3.12)$$

Assumption 3: *There exist scalars  $\lambda \in \mathbb{R}$  and  $\rho > 0$  such that the inequalities*

$$-\mathcal{S}(t, y(t), \omega(t)) \leq \rho V(x(t)), \forall t \in [0, a_0), \quad (3.13)$$

$$\dot{V}(x(t)) \geq \lambda V(x(t)), t \in [0, a_0), \quad (3.14)$$

and

$$\dot{V}(x(t)) + \alpha V(x(t)) \leq e^{-\alpha(t-a_0)} \mathcal{S}(t, y(t), \omega(t)), \forall t \geq a_0, \quad (3.15)$$

are satisfied for some  $\alpha > 0$ , along the solutions of the system  $\Sigma - \Delta$ .

Then  $\Sigma - \Delta$  is exponentially stable with a decay-rate of at least  $\alpha/q$ , i.e.,

$$\exists \delta > 0 : \forall t \geq 0, \|x(t)\| \leq \delta e^{\frac{-\alpha}{q}t} \|x(0)\|. \quad (3.16)$$

*Proof.* The proof is given in Appendix 3.8.1. □

Inequality (3.15) is motivated from the notion of exponential dissipativity introduced in [21], wherein exponentially weighted storage and supply functions were used to establish exponential stability conditions for nonlinear dynamical

systems. The aforementioned theorem is a general result for stability analysis of feedback interconnected systems of the form  $\Sigma - \Delta$ . However, it also applies to the robustness analysis of systems subjected to various perturbations that can be modelled by an operator of the form (3.10).

*Remark:* If the assumptions in Theorem 3.1 only hold locally, the results can be extended easily in a manner similar to the one shown in [93], so that the conditions hold in a compact set containing the origin. Note that the result provided in [93] holds only for scenarios with aperiodic sampling alone. Theorem 3.1 generalizes the result in [93] by taking into account a general class of perturbation characterizing the effects of sampling and delay.

In order to make Theorem 3.1 constructive, a manner to construct the supply function  $\mathcal{S}$  needs to be provided. This can be done in part by analytical study of the operator  $\Delta$ . In Sections 3.4.2 and 3.5.2, we show how this supply function can be characterized for the case where the operator  $\Delta$  characterizes sampling and delay effects. The following sections explain how Theorem 3.1 allows for building robust stability criteria for the nonlinear sampled-data system  $\mathcal{P}$ . In Section 3.4, we consider the large delay case given by Hypothesis 1, i.e. (3.8). Similarly, in Section 3.5, we provide stability conditions for the small delay case, given by  $\tau_k < h_k, \forall k \in \mathbb{N}$ .

### 3.4 Stability Analysis for the Large Delay Case

In this section, we provide a constructive approach for applying Theorem 3.1 to analyse the stability of system  $\mathcal{P}$  introduced in Section 3.2. The term ‘large delay’ signifies Hypothesis 1, which implies that the delay  $\tau_k$  can indeed be greater than the sampling interval  $h_k$ , under the constraint that the actuation instants occur in order. Theorem 3.1 can be used in this scenario by reformulating the system  $\mathcal{P}$  as an interconnection of the form  $\Sigma - \Delta$  given by (3.9)-(3.10), so that the effects of sampling and delay are included as a perturbation. In order to do so, we define the perturbation induced by sampling and delay as

$$e(t) = \begin{cases} 0, \forall t \in [0, a_0), \\ \kappa(x_p(s_k)) - \kappa(x_p(t)), \forall t \in [a_k, a_{k+1}), k \in \mathbb{N}. \end{cases} \quad (3.17)$$

For all  $t \geq a_0$ ,  $e(t)$  can be interpreted as the ‘error’ on the control action when compared to a continuous time controller as given in (3.3). We will introduce an operator  $\Delta$  that helps in expressing the error  $e(t)$  in an alternate manner. Additionally, we provide the functions introduced in (3.9), so that the dynamics of the interconnection  $\Sigma - \Delta$  and the sampled-data system  $\mathcal{P}$  are equivalent.

#### 3.4.1 System Model Reformulation

In this section, we introduce a particular case of operator  $\Delta$  in (3.10), with  $m = p = m_p$ , that captures the perturbation (3.17). Subsequently, the system  $\mathcal{P}$  given

by (3.1), (3.2), (3.4)-(3.8) is reformulated in terms of a feedback interconnection of the form  $\Sigma - \Delta$  in (3.9), (3.10).

**Lemma 3.2.** *Consider the operator  $\Delta : \mathcal{W}^{m_p} \mapsto \mathcal{W}^{m_p}$  defined for any signal  $z \in \mathcal{W}^{m_p}$  as*

$$(\Delta z)(t) = \begin{cases} 0, \forall t \in [0, a_0), \\ -\int_{s_k}^t z(s) ds, \forall t \in [a_k, a_{k+1}), k \in \mathbb{N}, \end{cases} \quad (3.18)$$

and the derivative of the continuous control in (3.3),

$$\dot{u}_c(t) = \frac{d}{dt} \kappa(x_p(t)). \quad (3.19)$$

Then, the sampling and delay induced error  $e$  defined in (3.17) can be expressed as  $e = \Delta \dot{u}_c$ .

*Proof.* The proof is given in Appendix 3.8.2. □

We show next how the sampled-data system  $\mathcal{P}$  can be remodelled in the format  $\Sigma - \Delta$  given by (3.9), (3.10). This formulation in conjunction with Lemma 3.2 is used to prove the equivalence between the sampled-data system  $\mathcal{P}$  and the interconnection  $\Sigma - \Delta$ .

**Lemma 3.3.** *Consider the system  $\Sigma$  in (3.9), with*

$$\begin{aligned} \bar{f}_0(x) &= f(x), \bar{h}_0(x) = \frac{\partial \kappa(x)}{\partial x} \bar{f}_0(x), \\ \bar{f}(x) &= f(x) + g(x) \kappa(x), \bar{g}(x) = g(x), \\ \bar{h}(x) &= \frac{\partial \kappa(x)}{\partial x} \bar{f}(x), \bar{l}(x) = \frac{\partial \kappa(x)}{\partial x} \bar{g}(x), \end{aligned} \quad (3.20)$$

$n = n_p$ ,  $m = p = m_p$ ,  $x_0 = x_0^*$  and the operator  $\Delta$  in (3.10), defined by (3.18). Then, system  $\mathcal{P}$  can be expressed as the feedback interconnection  $\Sigma - \Delta$  in (3.9), (3.10), with  $x = x_p$ .

*Proof.* The proof is given in Appendix 3.8.3. □

*Remark:* Modelling system (3.1), (3.2) in the form of (3.9), (3.10) implies adding an artificial output  $y$ , that will correspond to the derivative of the continuous-time control input, as given in (3.19).

Lemmas 3.2 and 3.3 will be used to provide constructive stability conditions for the system  $\mathcal{P}$ . In the following section, as a prerequisite for this development, the properties of  $\Delta$  in (3.18) are exploited to provide a supply function  $\mathcal{S}$  that satisfies the assumptions in Theorem 3.1.

### 3.4.2 Stability Analysis

In this section, we characterize the properties of  $\Delta$  by a supply function  $\mathcal{S}$  satisfying assumption (3.11).

**Lemma 3.4.** *Consider  $\Delta$  defined in (3.18),  $\alpha \in \mathbb{R}^+$  and  $R \in \mathbb{R}^{m_p \times m_p}$  with  $R = R^T > 0$ . Then, for all  $z \in \mathcal{W}^{m_p}$ ,*

$$\int_0^t \mathcal{S}(\theta, z(\theta), (\Delta z)(\theta)) d\theta \leq 0, \quad \forall t \geq 0, \quad (3.21)$$

where the function  $\mathcal{S} : \mathbb{R}^+ \times \mathbb{R}^{m_p} \times \mathbb{R}^{m_p} \mapsto \mathbb{R}$  is defined by

$$\mathcal{S} : (\theta, v, w) \mapsto e^{\alpha(\theta - a_0)} (w^T R w - \gamma^2 v^T R v), \quad (3.22)$$

with  $\gamma^2 = (\bar{h} + \bar{\tau})^2 e^{\alpha(\bar{h} + \bar{\tau})}$ .

*Proof.* The proof is given in Appendix 3.8.4. □

The result presented in Lemma 3.4 holds for any symmetric positive definite matrix  $R$  characterizing the supply function. Note that when  $\alpha = 0$ , the condition (3.21) can be related to the IQC introduced in Lemma 2.5. This relates to the so-called hard and soft IQC factorizations, see [114]. For the function  $\mathcal{S}$  in (3.22), we can see that the condition (IQC) (3.21) is not only a soft IQC factorization but also a hard IQC factorization in the sense that it holds for the interval  $[0, t)$  and also for the interval  $[0, \infty)$ . The following Theorems 3.5 and 3.6, provide tools to tune the matrix  $R$ . The supply function given by (3.22), together with Lemmas 3.2 and 3.3, can now be used to provide stability conditions for the sampled-data system  $\mathcal{P}$ .

**Theorem 3.5.** *Consider system  $\mathcal{P}$  in (3.1), (3.2), (3.4)-(3.8), the interconnection  $\Sigma - \Delta$  given by (3.9), (3.10), (3.18) and (3.20). If there exists a supply function  $\mathcal{S}$  of the form (3.22) and a storage function  $V : \mathbb{R}^n \mapsto \mathbb{R}^+$  that satisfy assumptions (3.12), (3.13), (3.14) and (3.15), then system  $\mathcal{P}$  is exponentially stable with a decay-rate  $\alpha/q$ .*

*Proof.* First, we exploit Lemma 3.3 to show the equivalence between  $\mathcal{P}$  in (3.1), (3.2), (3.4)-(3.8) and  $\Sigma - \Delta$  in (3.9), (3.10). Then, by Lemma 3.4, Assumption 1 in Theorem 3.1 is satisfied for the operator  $\Delta$  defined by (3.18). Under the conditions of the theorem, Assumptions 2 and 3 of Theorem 3.1 are satisfied. Applying Theorem 3.1,  $\Sigma - \Delta$  is proved to be exponentially stable and therefore, so is system  $\mathcal{P}$ . □

*Remark:* The aforementioned theorem provides (only) sufficient stability conditions based on the existence of a storage function. In the following sections, we will present how this can be used in a constructive manner based on LMI

and Sum of Squares (SOS) criteria. In Section 3.6, we will illustrate with examples, how Theorem 3.5 can be used to provide stability conditions for nonlinear sampled-data systems of the form given by  $\mathcal{P}$ . In Section 3.6.1, for an exemplary nonlinear system, we will show how the matrix  $R$  characterizing the supply function, can be tuned using standard MATLAB routines.

### 3.4.3 Stability Criterion for Linear Systems

In this section, we will consider a linear sampled-data system  $\mathcal{P}_L$  of the form

$$\dot{x}(t) = Ax(t) + Bu(t), \forall t \geq 0, \quad (3.23)$$

with  $x(0) = x_0$ ,

$$u(t) = \begin{cases} 0, & \forall t \in [0, a_0), \\ Kx(s_k), & \forall t \in [a_k, a_{k+1}), k \in \mathbb{N}, \end{cases} \quad (3.24)$$

where  $x(t) \in \mathbb{R}^n$ ,  $A \in \mathbb{R}^{n \times n}$ ,  $B \in \mathbb{R}^{n \times m}$ , and  $K \in \mathbb{R}^{m \times n}$ . Now, we provide a stability criterion for the linear sampled-data system  $\mathcal{P}_L$  in the form of tractable LMI.

**Theorem 3.6.** *Consider  $\alpha \in \mathbb{R}^+$ . The linear sampled-data system  $\mathcal{P}_L$  is exponentially stable with a decay-rate  $\alpha/2$  if there exists  $P = P^T > 0$  and  $R = R^T > 0$  such that*

$$\begin{bmatrix} \bar{A}^T P + P \bar{A} + \alpha P & PB \\ B^T P & 0 \end{bmatrix} + \begin{bmatrix} K \bar{A} & KB \\ 0 & I \end{bmatrix}^T \begin{bmatrix} \gamma^2 R & 0 \\ 0 & -R \end{bmatrix} \begin{bmatrix} K \bar{A} & KB \\ 0 & I \end{bmatrix} < 0, \quad (3.25)$$

with  $\bar{A} = A + BK$ , and  $\gamma^2 = (\bar{h} + \bar{\tau})^2 e^{\alpha(\bar{h} + \bar{\tau})}$ .

*Proof.* The proof is given in Appendix 3.8.5. □

*Remark:* Applying the *Kalman-Yakubovich-Popov Lemma*, we can infer that the LMI given by (3.25) is equivalent to the frequency domain criterion  $\|\tilde{G}\|_\infty < 1/\gamma$ , where  $\tilde{G}$  is the operator defined by the transfer function  $\tilde{G}(s) = K \bar{A}(sI - \bar{A} - \frac{\alpha}{2}I)^{-1}B + KB$ . This result is in fact a generalization of the results provided in [65] and [84]. We have extended the results in [65], [84] by providing stability conditions for non-linear sampled-data systems while guaranteeing an exponential decay-rate. If  $\alpha = 0$ , and  $\bar{h} = 0$ , we recover the result in [65]. Similarly, if  $\alpha = 0$ , and  $\bar{\tau} = 0$ , we recover the result provided in [84].

In Section 3.6.2, we will demonstrate how matrices  $P$  and  $R$  can be tuned numerically using standard LMI solvers. Using a similar gridding approach as given in Algorithm 1 in Chapter 2, the LMI (3.25) can be used to obtain the set of sampling and delay bounds for which the system is stable.

### 3.5 Stability Analysis for the Small Delay Case

The large-delay case studied in Section 3.4 is more generic to processes communicating via a shared network, where traffic flow can increase considerably. However, in some cases, it has been shown that it is desirable to have delay less than sampling interval since sampled data arriving in a non-chronological order at the actuator can be hazardous from a control point of view [1]. Consequentially, this would make the implementations of algorithms and analysis much more complex. In this section, we will demonstrate how considering sampling and delay separately in the small-delay case, gives a less conservative stability criterion. The following assumption is considered throughout the section.

**Hypothesis 2:** The actuation based on the sampled state  $x(s_k)$  is implemented before the next sampling instant  $s_{k+1}$ , i.e.,

$$\tau_k < h_k, \forall k \in \mathbb{N}. \quad (3.26)$$

Next, we re-formulate the sampled-data model for system  $\mathcal{P}$  in order to include the effects of sampling and delay using two separate errors, denoted by  $e_s(t)$  and  $e_d(t)$ , respectively. Consider an exemplary continuous-time control signal  $u_c(t) = \kappa(x_p(t))$ . The sampled version of this signal is denoted by

$$u_s(t) = \kappa(x_p(s_k)), \forall t \in [s_k, s_{k+1}), k \in \mathbb{N}. \quad (3.27)$$

The sampling-induced error  $e_s(t)$  is given by  $u_s(t) - u_c(t)$ . Without loss of generality, we consider that  $e_s(t) = 0, \forall t < s_0$ . Formally,  $e_s(t)$  is therefore defined as

$$e_s(t) = \begin{cases} 0, \forall t \in [0, s_0), \\ \kappa(x_p(s_k)) - \kappa(x_p(t)), \forall t \in [s_k, s_{k+1}), k \in \mathbb{N}. \end{cases} \quad (3.28)$$

The delayed version of  $u_s(t)$  is the control signal  $u(t)$  applied at the level of the actuator. We introduce another error  $e_d(t)$ , which can be given by  $u(t) - u_s(t)$ . Note that we can define the error  $e_d(t) = 0, \forall t < a_0$ , since it bears no relevance. Formally,  $e_d(t)$  is given by

$$e_d(t) = \begin{cases} 0, \forall t \in [0, a_0), \\ 0, \forall t \in [a_{k-1}, s_k), k \in \mathbb{N}^*, \\ \kappa(x_p(s_{k-1})) - \kappa(x_p(s_k)), \forall t \in [s_k, a_k), k \in \mathbb{N}^*. \end{cases} \quad (3.29)$$

Using this formulation for  $e_s(t)$  and  $e_d(t)$ , given by (3.28) and (3.29), respectively, we proceed to reformulate the sampled-data system  $\mathcal{P}$  in the form of  $\Sigma - \Delta$ .

### 3.5.1 System Model Reformulation

In this section, we introduce two different operators  $\Delta_s$  and  $\Delta_d$ , which capture the errors induced by sampling and delay given in (3.28) and (3.29), respectively. In an approach similar to the one used in Section 3.4.1, system  $\mathcal{P}$  under Hypothesis 2, i.e. (3.26), can be represented as a feedback interconnection of the form  $\Sigma - \Delta$ .

**Lemma 3.7.** *Consider the operator  $\Delta : \mathcal{W}^{2m_p} \mapsto \mathcal{W}^{2m_p}$*

$$\Delta : \phi = \begin{pmatrix} v \\ w \end{pmatrix} \rightarrow (\Delta\phi) = \begin{pmatrix} \Delta_s v \\ \Delta_d w \end{pmatrix}, \forall v \in \mathcal{W}^{m_p}, w \in \mathcal{W}^{m_p}, \quad (3.30)$$

under Hypothesis 2, i.e. (3.26), where

$$(\Delta_s v)(t) = \begin{cases} 0, \forall t \in [0, s_0), \\ -\int_{s_k}^t v(\theta) d\theta, \forall t \in [s_k, s_{k+1}), k \in \mathbb{N}, \end{cases} \quad (3.31)$$

and

$$(\Delta_d w)(t) = \begin{cases} 0, \forall t \in [0, a_0), \\ 0, \forall t \in [a_{k-1}, s_k), k \in \mathbb{N}^*, \\ -\int_{s_{k-1}}^{s_k} w(\theta) d\theta, \forall t \in [s_k, a_k), k \in \mathbb{N}^*. \end{cases} \quad (3.32)$$

Then, the sampling and delay induced errors defined in (3.28) and (3.29), respectively, can be expressed as

$$\begin{pmatrix} e_s \\ e_d \end{pmatrix} = \begin{pmatrix} \Delta_s \dot{u}_c \\ \Delta_d \dot{u}_c \end{pmatrix}, \quad (3.33)$$

with  $\dot{u}_c$  given by (3.19).

*Proof.* The proof is given in Appendix 3.8.6. □

Analogous to the approach used in Section 3.4, we now proceed to reformulate the sampled-data system  $\mathcal{P}$  under Hypothesis 2, i.e. (3.26), in the format  $\Sigma - \Delta$  given by (3.9), (3.10). In the following lemma, by using such a model reformulation along with Lemma 3.7, we provide the equivalence between the sampled-data system  $\mathcal{P}$  under Hypothesis 2, and the feedback interconnection  $\Sigma - \Delta$ .

**Lemma 3.8.** *Consider the system  $\Sigma$  in (3.9), with*

$$\begin{aligned} \bar{f}_0(x) &= f(x), \bar{h}_0(x) = \begin{bmatrix} \frac{\partial \kappa(x)}{\partial x} \bar{f}_0(x) \\ \frac{\partial \kappa(x)}{\partial x} \bar{f}_0(x) \end{bmatrix}, \\ \bar{f}(x) &= f(x) + g(x)\kappa(x), \bar{g}(x) = \begin{bmatrix} g(x) & g(x) \end{bmatrix}, \\ \bar{h}(x) &= \begin{bmatrix} \frac{\partial \kappa(x)}{\partial x} \bar{f}(x) \\ \frac{\partial \kappa(x)}{\partial x} \bar{f}(x) \end{bmatrix}, \bar{l}(x) = \begin{bmatrix} \frac{\partial \kappa(x)}{\partial x} \bar{g}(x) \\ \frac{\partial \kappa(x)}{\partial x} \bar{g}(x) \end{bmatrix}, \end{aligned} \quad (3.34)$$

$n = n_p$ ,  $m = p = 2m_p$ ,  $x_0 = x_0^*$  and the operator  $\Delta$  in (3.10), defined by (3.30), (3.31) and (3.32) under Hypothesis 2, i.e. (3.26). Then, the sampled-data system  $\mathcal{P}$  can be expressed as the feedback interconnection  $\Sigma - \Delta$ , with  $x = x_p$ .

*Proof.* The proof is given in Appendix 3.8.7.  $\square$

Lemmas 3.7 and 3.8 are used to provide constructive stability criterion for sampled-data system  $\mathcal{P}$  under Hypothesis 2. To this end, the supply function  $\mathcal{S}$  given in Theorem 3.1 needs to be formulated. We proceed in this direction by studying the properties of operators  $\Delta_s$  and  $\Delta_d$ .

### 3.5.2 Stability Analysis

In this section, we characterize the properties of  $\Delta_s$  and  $\Delta_d$ , by functions  $\mathcal{S}_s$  and  $\mathcal{S}_d$ , respectively. Consequently, we formulate the supply function  $\mathcal{S} = \mathcal{S}_s + \mathcal{S}_d$ .

**Lemma 3.9.** *Consider the operator  $\Delta_s$  defined in (3.31),  $\beta \in \mathbb{R}^+$  and  $R_s \in \mathbb{R}^{m_p \times m_p}$  with  $R_s = R_s^T > 0$ . Then,*

$$\int_0^t \mathcal{S}_s(\theta, v(\theta), (\Delta_s v)(\theta)) d\theta \leq 0, \quad \forall t \geq 0, v \in \mathcal{W}^{m_p}, \quad (3.35)$$

where the function  $\mathcal{S}_s : \mathbb{R}^+ \times \mathbb{R}^{m_p} \times \mathbb{R}^{m_p} \mapsto \mathbb{R}$  is defined as

$$\mathcal{S}_s : (\theta, v, \mu) \rightarrow e^{\beta(\theta-a_0)} \begin{bmatrix} v \\ \mu \end{bmatrix}^T \begin{bmatrix} -\gamma_s^2 R_s & \gamma_s^2 \frac{\beta}{2} R_s \\ \gamma_s^2 \frac{\beta}{2} R_s & (1 - \gamma_s^2 \frac{\beta^2}{4}) R_s \end{bmatrix} \begin{bmatrix} v \\ \mu \end{bmatrix}, \quad (3.36)$$

with  $\gamma_s = \frac{2\bar{h}}{\pi}$ .

*Proof.* The proof is given in Appendix 3.8.8.  $\square$

**Lemma 3.10.** *Consider  $\Delta_d$  defined in (3.32) under Assumption 2,  $\beta \in \mathbb{R}^+$  and  $R_d \in \mathbb{R}^{m_p \times m_p}$  with  $R_d = R_d^T > 0$ . Then, for all  $w \in \mathcal{W}^{m_p}$ ,*

$$\int_0^t \mathcal{S}_d(\theta, w(\theta), (\Delta_d w)(\theta)) d\theta \leq 0, \quad \forall t \geq 0, \quad (3.37)$$

where the function  $\mathcal{S}_d : \mathbb{R}^+ \times \mathbb{R}^{m_p} \times \mathbb{R}^{m_p} \mapsto \mathbb{R}$  is defined as

$$\mathcal{S}_d : (\theta, w, \varepsilon) \rightarrow e^{\beta(\theta-a_0)} \begin{bmatrix} w \\ \varepsilon \end{bmatrix}^T \begin{bmatrix} -\gamma_d R_d & 0 \\ 0 & R_d \end{bmatrix} \begin{bmatrix} w \\ \varepsilon \end{bmatrix}, \quad (3.38)$$

with  $\gamma_d = \bar{h}\bar{\tau}e^{\beta(\bar{h}+\bar{\tau})}$ .

*Proof.* The proof is given in Appendix 3.8.9.  $\square$



The functions  $\mathcal{S}_s$  and  $\mathcal{S}_d$  given in Lemmas 3.9 and 3.10, provide the sampling and delay component, respectively, of the supply function  $\mathcal{S} = \mathcal{S}_s + \mathcal{S}_d$ . As follows, we use the supply function  $\mathcal{S} = \mathcal{S}_s + \mathcal{S}_d$  to provide a general, more accurate (less conservative) stability criterion for the sampled-data system  $\mathcal{P}$  under Hypothesis 2, i.e., when delay is less than sampling interval.

**Theorem 3.11.** *Consider system  $\mathcal{P}$ , the interconnection  $\Sigma - \Delta$  given by (3.9), (3.10), (3.30), (3.31), (3.32) and (3.34). If there exist functions  $\mathcal{S} = \mathcal{S}_s + \mathcal{S}_d$  defined using (3.36) and (3.38), and  $V : \mathbb{R}^{n_p} \mapsto \mathbb{R}^+$  that satisfy assumptions (3.12), (3.13), (3.14) and (3.15), then system  $\mathcal{P}$  is exponentially stable with a decay-rate  $\alpha/q$ .*

*Proof.* We exploit Lemma 3.8 to establish the equivalence between system  $\mathcal{P}$  under Hypothesis 2 and  $\Sigma - \Delta$  in (3.9), (3.10). Then, by Lemmas 3.9 and 3.10, Assumption 1 in Theorem 3.1 is satisfied for the operator  $\Delta$  defined by (3.30), (3.31) and (3.32). Under the conditions of the theorem, Assumptions 2 and 3 of Theorem 3.1 are satisfied. Applying Theorem 3.1,  $\Sigma - \Delta$  is proved to be exponentially stable and by equivalence, so is system  $\mathcal{P}$ .  $\square$

The result presented in Theorem 3.6 holds for any positive symmetric definite matrices  $R_s$  and  $R_d$  characterizing the supply function. In Section 3.6.1, we will illustrate how Theorem 3.11 provides less conservative results for the sampled-data system  $\mathcal{P}$  under Hypothesis 2, i.e., for the small delay case. The usage of numerical tools to tune matrices  $R_s$  and  $R_d$ , will also be shown.

### 3.5.3 Stability Criterion for Linear Systems

In this section, we recall the linear sampled-data system  $\mathcal{P}_L$  described in Section 3.4.3 by (3.23). Based on the Lemmas 3.9 and 3.10, we provide the following stability criterion for system  $\mathcal{P}_L$  under Hypothesis 2.

**Theorem 3.12.** *Consider a scalar  $\alpha \in \mathbb{R}^+$  and Hypothesis 2. The linear sampled-data system  $\mathcal{P}_L$  is exponentially stable with a decay-rate  $\alpha/2$  if there exist  $P = P^T > 0$ ,  $R_s = R_s^T > 0$ , and  $R_d = R_d^T > 0$  such that*

$$\begin{bmatrix} \bar{A}^T P + P \bar{A} + \alpha P & P \bar{B} \\ \bar{B}^T P & 0 \end{bmatrix} + \begin{bmatrix} K \bar{A} & K \bar{B} \\ 0 & I \end{bmatrix}^T \Phi \begin{bmatrix} K \bar{A} & K \bar{B} \\ 0 & I \end{bmatrix} < 0, \quad (3.39)$$

with  $\bar{A} = A + BK$ ,  $\bar{B} = \begin{bmatrix} B & B \end{bmatrix}$ , and

$$\Phi = \begin{bmatrix} \gamma_s^2 R_s + \gamma_d R_d & -\gamma_s^2 \frac{\alpha}{2} R_s & 0 \\ -\gamma_s^2 \frac{\alpha}{2} R_s & (\gamma_s^2 \frac{\alpha^2}{4} - 1) R_s & 0 \\ 0 & 0 & -R_d \end{bmatrix}, \quad (3.40)$$

where  $\gamma_s = \frac{2\bar{h}}{\pi}$  and  $\gamma_d = \bar{h}\bar{\tau}e^{\alpha(\bar{h}+\bar{\tau})}$ .

*Proof.* The proof is given in Appendix 3.8.10.  $\square$

*Remark:* When  $\alpha = 0, \bar{\tau} = 0$  (implying no delay component in  $\mathcal{S}$ ), the LMI (3.39) translates to a form similar to LMI (3.25). Consequentially, by virtue of the *Kalman-Yakubovich-Popov* lemma, we can recover the frequency domain condition introduced in [84], i.e.,  $\|\tilde{G}\|_\infty < \frac{\pi}{2\bar{h}}$ , where  $\tilde{G}$  is the operator defined by the transfer function  $\tilde{G}(s) = K\bar{A}(sI - \bar{A} - \frac{\alpha}{2}I)^{-1}\bar{B} + K\bar{B}$ .

In Section 3.6.2, we will illustrate with examples, how the LMI (3.39) provides less conservative results for LTI systems under Hypothesis 2, i.e., for the small delay case.

## 3.6 Illustrative Examples

In this section, we illustrate the effectiveness of our proposed results via examples. The provided examples highlight the difference between the single-error approach and the separate-error approach in terms of conservativeness and trade-offs between control performance and the bounds on sampling interval and delay. The result presented in this chapter provides a foundation for deciding the trade-off between maximum delay  $\bar{\tau}$ , maximum sampling period  $\bar{h}$ , and decay-rate  $\alpha$ . By fixing one of the parameters, the trade-off between the remaining parameters can be obtained. For example, by fixing  $\bar{\tau}$ , and gridding over  $\bar{h}$  and  $\alpha$ , a trade-off between the decay-rate and the maximum allowable sampling interval can be obtained. In a similar manner, fixing  $\bar{h}$  will give the trade-off between  $\alpha$  and  $\bar{\tau}$ , and so on.

### 3.6.1 Nonlinear System Example

We consider the following example given in [67], [90], [93],

$$\dot{x}(t) = dx(t)^2 - x(t)^3 + u(t), \quad (3.41)$$

with a bounded time-varying parameter  $|d(t)| \leq 1$ , and a stabilizing control  $u(t) = \kappa(x(t)) = -2x(t)$  subjected to both sampling and delay. Since the function  $f(x) = x^2 - x^3$  is locally Lipschitz, our results will only hold locally on any compact set containing the origin.

#### 3.6.1.1 Large-delay Case

Using the definition in (3.20), we reformulate the system model in the form  $\Sigma - \Delta$ , where  $\Sigma$  is given by

$$\left. \begin{aligned} \dot{x}(t) &= dx^2(t) - x^3(t) \\ y(t) &= -2(dx^2(t) - x^3(t)) \end{aligned} \right\} \forall t \in [0, a_0), \quad (3.42)$$

$$\left. \begin{aligned} \dot{x}(t) &= dx^2(t) - x^3(t) - 2x(t) + w(t) \\ y(t) &= -2(dx^2(t) - x^3(t) - 2x(t) + w(t)) \end{aligned} \right\} \forall t \geq a_0.$$

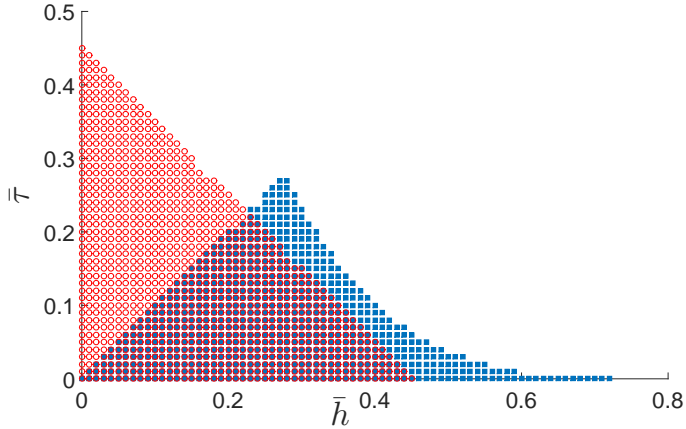

Figure 3.1: Feasible values of  $\bar{h}$  and  $\bar{\tau}$  for the nonlinear system (3.41) with  $\alpha = 0.1$ , in the large-delay case (in red), and in the small-delay case (in blue).

We use a storage function of the form  $V(x) = ax^2 + bx^4$  as given in [93]. Using (3.22), we obtain the supply function

$$\mathcal{S}(\theta, y, w) = e^{\alpha(\theta-a_0)} [Rw^2(\theta) - \gamma^2 Ry^2(\theta)], \quad (3.43)$$

with  $\gamma^2 = (\bar{h} + \bar{\tau})^2 e^{\alpha(\bar{h} + \bar{\tau})}$ . For this case, from condition (3.15), we can infer that the values of  $(\bar{h} + \bar{\tau})$  satisfying the inequality

$$(2ax + 4bx^3)(dx^2 - x^3 - 2x + w) + \alpha(ax^2 + bx^4) - Rw^2 + 4(\bar{h} + \bar{\tau})^2 e^{\alpha(\bar{h} + \bar{\tau})} R(dx^2 - x^3 - 2x + w)^2 \leq 0, \quad (3.44)$$

will guarantee exponential stability. If (3.44) can be expressed as a Sum of Squares (SOS) for all the values of  $(d, d^2) \in \{(1, 0), (1, 1), (-1, 0), (-1, 1)\}$ , then it will be SOS for any time-varying  $|d(t)| \leq 1$ . Using SOSTOOLS [96], Figure 3.1 provides the feasible values of  $\bar{h}$  and  $\bar{\tau}$  (in red) for  $\alpha = 0.1$ , and all values of  $(d, d^2)$ . It can be seen from Figure 3.1 that, for  $\alpha = 0.1$ ,  $\bar{h}$  and  $\bar{\tau}$  satisfy a maximum bound  $\bar{h} + \bar{\tau} \leq 0.45$ , with  $a = 0.7079$ ,  $b = 0.1890$  and  $R = 0.4268$ . The parameters  $a$ ,  $b$  and  $R$  are optimized using SOSTOOLS. Additionally, the trade-off between the desired decay-rate  $\alpha/2$  and  $\bar{h} + \bar{\tau}$  is shown in Figure 3.2.

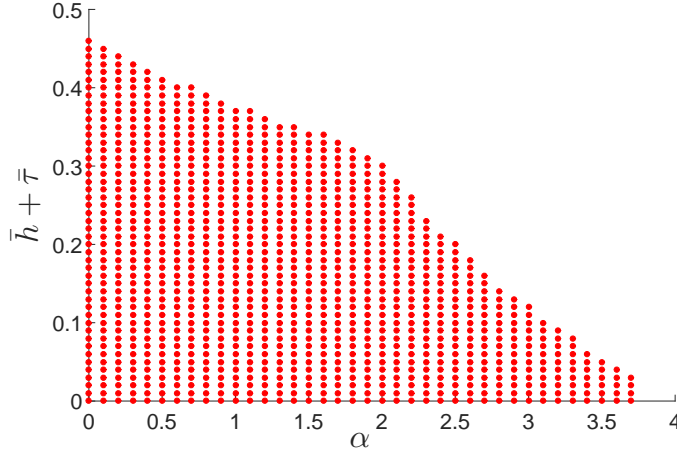

Figure 3.2: Trade-off between desired decay-rate  $\alpha$  and  $\bar{h} + \bar{\tau}$  for the nonlinear system (3.41), in the large-delay case.

### 3.6.1.2 Small-delay Case

Now, we shall provide bounds on  $\bar{h}$  and  $\bar{\tau}$  in the small-delay case, i.e.,  $\tau_k < h_k$ . In this case, the system model is reformulated in the form  $\Sigma$ , given by

$$\left. \begin{aligned} \dot{x}(t) &= dx^2(t) - x^3(t) \\ y(t) &= [y_1^T(t) \quad y_2^T(t)]^T \end{aligned} \right\} \forall t \in [0, a_0), \quad (3.45)$$

with

$$y_1(t) = y_2(t) = -2(dx^2(t) - x^3(t)), \forall t \in [0, a_0), \quad (3.46)$$

and

$$\left. \begin{aligned} \dot{x}(t) &= dx^2(t) - x^3(t) - 2x(t) + w_s(t) + w_d(t), \\ y(t) &= [y_1^T(t) \quad y_2^T(t)]^T, \forall t \geq a_0, \end{aligned} \right\} \quad (3.47)$$

where

$$y_1(t) = y_2(t) = -2(dx^2(t) - x^3(t) - 2x(t) + w_s(t) + w_d(t)), \forall t \geq a_0. \quad (3.48)$$

Using (3.36) and (3.38), we get the supply function

$$\begin{aligned} \mathcal{S}(\theta, y, w) &= \mathcal{S}_s(\theta, y_1, w_s) + \mathcal{S}_d(\theta, y_2, w_d), \\ &= e^{\alpha(\theta - a_0)} \left[ -\gamma_s^2 R_s y_1^2(\theta) - \gamma_d R_d y_2^2(\theta) + \gamma_s^2 \alpha R_s y_1(\theta) w_s(\theta) \right. \\ &\quad \left. + (1 - \gamma_s^2 \frac{\alpha^2}{4}) R_s w_s^2 + R_d w_d^2 \right], \end{aligned} \quad (3.49)$$

where  $\gamma_s = \frac{2\bar{h}}{\pi}$  and  $\gamma_d = \bar{h}\bar{\tau}e^{\beta(\bar{h}+\bar{\tau})}$ . Therefore, by using the supply function (3.49) in condition (3.15), we must deduce the values of  $\bar{h}$  and  $\bar{\tau}$  satisfying the inequality

$$\begin{aligned} & (2ax + 4bx^3)(dx^2 - x^3 - 2x + w_s + w_d) + \alpha(ax^2 + bx^4) \\ & + 4(\gamma_s^2 R_s + \gamma_d R_d)(dx^2 - x^3 - 2x + w_s + w_d)^2 \\ & + 2\gamma_s^2 \alpha R_s(dx^2 - x^3 - 2x + w_s + w_d)w_s - (1 - \gamma_s^2 \frac{\alpha^2}{4})R_s w_s^2 - R_d w_d^2 \leq 0, \end{aligned} \tag{3.50}$$

in order to guarantee exponential stability of the system (3.41), with  $\alpha > 0$ ,  $\tau_k < h_k$ . For the sake of comparison with the feasibility region obtained in the large-delay case, we choose  $\alpha = 0.1$ .

In a similar manner as shown in the large-delay case, we use SOSTOOLS to obtain the feasible values of  $\bar{h}$  and  $\bar{\tau}$  satisfying inequality (3.50), for all values of  $(d, d^2)$ , while optimizing the values of  $a, b, R_s$  and  $R_d$ . The feasibility plot in the small-delay case is given in Figure 3.1 (in blue). In Figure 3.1, it can be seen that the red feasibility plot (indicating feasibility for the large-delay case) and the blue feasibility plot (indicating the small-delay case) overlap. This overlapping region represents the feasible values of  $\bar{h}$  and  $\bar{\tau}$  obtained when the criterion (3.44) provided for the large-delay case, is applied to the small-delay case. In such scenarios, Theorem 3.11 and Theorem 3.12 always provide better results in comparison to the results given by Theorem 3.5 and Theorem 3.6, respectively. In Figure 3.1, when  $\bar{\tau} \rightarrow 0$ , we can see that bounds on  $\bar{h}$  upto 0.72 are feasible while using the tools presented in the small-delay analysis. The tool presented in the large-delay case, on the other hand, accommodates  $\bar{h}$  upto 0.45, thereby implying an improvement of about 60% while using the result provided in the small-delay case. Additionally, when  $\bar{h} = 0.27$ , the feasible values of  $\bar{\tau}$  in the large and small-delay cases, are approximately upto 0.17 and 0.27, respectively, showing an improvement of about 59%. Using these numerical arguments, it can be concluded that for the small-delay case, capturing the effects of sampling and delay using two separate errors gives less conservative results. However, the amount of improvement in the small-delay case over the large-delay case depends on the parameter  $\alpha$ . We illustrate this in the following section for a linear system example.

*Remark:* The less-conservative nature of the results proposed in the small-delay case can also be justified from a theoretical perspective. In the large-delay case, the supply function was formulated using Jensen's inequality, which introduces conservativeness, as shown in [16]. On the other hand, in the small-delay case, Wirtinger's inequality has been used. For this case, the improvement over Jensen's inequality is well known in the literature (see [115]).

For the same example in the absence of delay, in [90] and [67], upper-bounds of 0.368 and 0.143, respectively, were obtained for the sampling intervals without any performance guarantee. This is comparable to the small-delay case we

have considered, with  $\bar{\tau} = 0$ . Additionally, in [93], an upper-bound of 0.72 was proposed for the system (3.41) without delay, with  $\alpha = 0.1$ . From the results proposed for the small-delay case, by setting  $\bar{\tau} = 0$ , indicating sampling without any delay, we can see in Figure 3.1 that we obtain the same upper-bound of 0.72 on the sampling intervals, as proposed in [93], with  $a = 2.9153 \times 10^{-6}$ ,  $b = 7.29 \times 10^{-7}$ ,  $R_s = 1.6964 \times 10^{-6}$  and  $R_d = 1.2465$ . However, our results have an added advantage that we provide tractable stability conditions for the nonlinear sampled-data system in the presence of time-varying delay.

### 3.6.2 Linear System Example

Consider the system (3.23) characterized by the parameters [144]

$$A = \begin{bmatrix} 1 & 3 \\ 2 & 1 \end{bmatrix}, B = \begin{bmatrix} 1 \\ 0.6 \end{bmatrix}, K = -[1 \quad 6]. \quad (3.51)$$

By virtue of Theorem 3.6, we can compute the maximum allowable values of  $\bar{h} + \bar{\tau}$  with respect to  $\alpha$  from the LMI (3.25). The LMI (3.25) is solved using YALMIP, by optimizing parameters  $P$  and  $R$ , for different values of  $\alpha$  and  $\bar{h} + \bar{\tau}$ . The feasibility region thus obtained will aid in deciding the trade-off between a desired decay rate while taking into account the maximum bounds on sampling interval and delay. Considering  $\alpha \in \{0.01, 1, 2\}$ , we obtain the bounds on  $\bar{h}$  and  $\bar{\tau}$  as shown in Figure 3.3 (in red solid, dashed and dotted lines). For the LTI system (3.51), if  $\alpha = 0$  and  $\bar{h} = 0$ , we recover the bound on  $\bar{\tau}$  as given in [65]. For the chosen values of  $\alpha \in \{0.01, 1, 2\}$ , we also compute the bounds on  $\bar{h}$  and  $\bar{\tau}$  in the small-delay case (as shown in Figure 3.3 in blue solid, dashed and dotted lines). Following a similar explanation as given in Section 3.6.1.2, we can conclude that for the small-delay case, differentiating the effects of sampling and delay using two separate errors, the LMI in (3.39) introduced in Theorem 3.12 provides less conservative results in comparison to the criterion provided in (3.25) (applied to the small-delay case). Figure 3.3 also gives the dependence of the amount of improvement in the small-delay case over the large-delay case, on the parameter  $\alpha$ . If  $\alpha = 0$  and  $\bar{\tau} = 0$ , we recover the bound on  $\bar{h}$  as proposed in [84]. Therefore, we can conclude that by applying our generic nonlinear tools to the linear case, we provide bounds on  $\bar{h}$  and  $\bar{\tau}$  that are not more conservative in comparison to the bounds provided in [65], [84]. Also, it has to be noted that despite the fact that the condition in (3.25) is more conservative when applied to the small-delay case, the result is still important since it is applicable to the more generic large-delay case.

## 3.7 Conclusion

In this chapter, novel approaches for stability analysis of aperiodically sampled nonlinear systems with time-varying delay are provided. The framework intro-

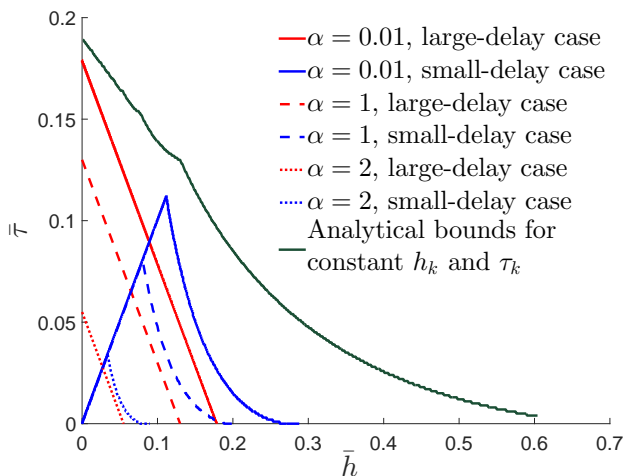

Figure 3.3: Bounds on  $\bar{h}$  and  $\bar{\tau}$  for the LTI system (3.51) in the large-delay case (in red), and in the small-delay case (in blue), for  $\alpha = 0.01$  (solid line),  $\alpha = 1$  (dashed line) and  $\alpha = 2$  (dotted line). The analytical stability bounds on constant  $h_k$  and  $\tau_k$  are given by the green line [134].

duced in this chapter holds for a general class of nonlinear systems and provides tools that help in deciding required trade-offs between the system decay-rate and the bounds on sampling interval and delay. As a preliminary result, an approach inspired from the notion of exponential dissipativity is used to provide stability conditions for a class of feedback interconnected systems, while guaranteeing a desired decay-rate. The nonlinear sampled-data system is remodelled as a feedback interconnection of the nominal closed-loop system and an operator that captures the effects of sampling and delay, thereby leading to constructive stability conditions. The proposed approach leads to conditions on dissipativity properties of the system, for which many results exist in literature. When applying the results to LTI case, we see that they generalize existing frequency domain and LMI conditions in the robust stability framework. For the case when delay is less than sampling interval, a less conservative stability criterion is obtained by considering two separate operators to capture the effects of sampling and delay. The effectiveness of the proposed theoretical results have been corroborated via simulation results for an exemplary nonlinear system. We foresee numerous extensions. For example, a more realistic scenario would involve multiple sensors and actuators, each with unique bounds on sampling interval and delay [39], [129].

## 3.8 Appendix

### 3.8.1 Proof of Theorem 3.1

Let us first upper-bound the response  $x(t)$  for all  $t \geq a_0$ . Consider the function

$$W(t) = e^{\alpha(t-a_0)}V(x(t)) - \int_{a_0}^t \mathcal{S}(\theta, y(\theta), \omega(\theta))d\theta, \forall t \geq a_0, \quad (3.52)$$

From condition (3.15), we have  $\dot{W}(t) \leq 0$ , for all  $t \geq a_0$  and therefore  $W(t) \leq W(a_0)$ , for all  $t \geq a_0$ , which can be stated as  $e^{\alpha(t-a_0)}V(x(t)) - \int_{a_0}^t \mathcal{S}(\theta, y(\theta), \omega(\theta))d\theta \leq V(x(a_0))$ . Therefore, for all  $t \geq a_0$ , we obtain

$$V(x(t)) \leq e^{-\alpha(t-a_0)} \left[ - \int_0^{a_0} \mathcal{S}(\theta, y(\theta), \omega(\theta))d\theta + \int_0^t \mathcal{S}(\theta, y(\theta), \omega(\theta))d\theta + V(x(a_0)) \right], \quad (3.53)$$

and by using (3.11), for all  $\theta \geq 0$ , we have

$$V(x(t)) \leq e^{-\alpha(t-a_0)} \left[ - \int_0^{a_0} \mathcal{S}(\theta, y(\theta), \omega(\theta))d\theta + V(x(a_0)) \right]. \quad (3.54)$$

By integrating condition (3.14) for all  $t \in [0, a_0)$ , we have

$$V(x(a_0)) \geq e^{\lambda(a_0-t)}V(x(t)), \forall t \in [0, a_0). \quad (3.55)$$

Then, by integrating condition (3.13) and using (3.55) for all  $t \in [0, a_0)$ , we have

$$\begin{aligned} - \int_0^{a_0} \mathcal{S}(\theta, y(\theta), \omega(\theta))d\theta &\leq \rho \int_0^{a_0} V(x(\theta))d\theta \\ &\leq \rho \int_0^{a_0} e^{\lambda(\theta-a_0)}V(x(a_0))d\theta \\ &= \eta V(x(a_0)), \end{aligned} \quad (3.56)$$

where

$$\eta := \begin{cases} \frac{\rho e^{-\lambda a_0}}{\lambda} (e^{\lambda a_0} - 1), & \text{if } \lambda \neq 0, \\ \rho a_0, & \text{if } \lambda = 0. \end{cases} \quad (3.57)$$

Consequently, from (3.54),

$$\begin{aligned} V(x(t)) &\leq e^{-\alpha(t-a_0)}(1 + \eta)V(x(a_0)), \\ &= e^{-\alpha(t-a_0)}\mathcal{C}V(x(a_0)), \forall t \geq a_0, \end{aligned} \quad (3.58)$$

with  $\mathcal{C} := \eta + 1 > 1$ . Then, from (3.12), we obtain for all  $t \geq a_0$ ,

$$c_1 \|x(t)\|^q \leq V(x(t)) \leq e^{-\alpha(t-a_0)}\mathcal{C}V(x(a_0)) \leq e^{-\alpha(t-a_0)}\mathcal{C}c_2 \|x(a_0)\|^q, \quad (3.59)$$



and thus

$$\|x(t)\| \leq \sqrt[q]{\mathcal{C} \frac{c_2}{c_1} e^{-\frac{\alpha}{q}(t-a_0)}} \|x(a_0)\|, \forall t \geq a_0. \quad (3.60)$$

Now, let us analyse the response in the interval  $t \in [0, a_0)$ . Using the definition of system  $\Sigma$  in (3.9) for all  $t \in [0, a_0)$ , we have  $\dot{x}(t) = \bar{f}_0(x(t))$ , where  $\bar{f}_0$  is globally Lipschitz continuous with some constant  $k_0$  and  $\bar{f}_0(0) = 0$ . Hence, we have that

$$x(t) - x(0) = \int_0^t \bar{f}_0(x(s)) ds. \quad (3.61)$$

Using the Triangular Inequality, this gives

$$\|x(t)\| \leq \|x(0)\| + \int_0^t \|\bar{f}_0(x(s))\| ds. \quad (3.62)$$

Since  $\bar{f}_0$  is Lipschitz continuous and  $\bar{f}_0(0) = 0$ ,

$$\|\bar{f}_0(x(s))\| = \|\bar{f}_0(x(s)) - \bar{f}_0(0)\| \leq k_0 \|x(s) - 0\| = k_0 \|x(s)\|. \quad (3.63)$$

Consequently, (3.62) leads to

$$\|x(t)\| \leq \|x(0)\| + k_0 \int_0^t \|x(s)\| ds. \quad (3.64)$$

By virtue of Gronwall's inequality, we obtain

$$\|x(t)\| \leq \|x(0)\| e^{k_0 t}, \forall t \in [0, a_0), \quad (3.65)$$

implying  $\|x(a_0)\| \leq e^{k_0 a_0} \|x(0)\|$ . From (3.60), we obtain

$$\|x(t)\| \leq \sqrt[q]{\mathcal{C} \frac{c_2}{c_1} e^{-\frac{\alpha}{q}(t-a_0)}} e^{k_0 a_0} \|x(0)\|, \forall t \geq a_0. \quad (3.66)$$

Additionally, for all  $t \in [0, a_0)$ , we can upper-bound inequality (3.65) by

$$\|x(t)\| \leq e^{k_0 t} \|x(0)\| \leq e^{k_0 a_0} \|x(0)\| \leq \sqrt[q]{\mathcal{C} \frac{c_2}{c_1} e^{-\frac{\alpha}{q}(t-a_0)}} e^{k_0 a_0} \|x(0)\|, \forall t \in [0, a_0), \quad (3.67)$$

since  $\mathcal{C} > 1$  (see (3.58)),  $c_2 \geq c_1$  (see (3.12)), and  $\frac{-\alpha}{q}(t-a_0) \geq 0$ . Consequently, using (3.66), we obtain

$$\|x(t)\| \leq \sqrt[q]{\mathcal{C} \frac{c_2}{c_1} e^{-\frac{\alpha}{q}(t-a_0)}} e^{k_0 a_0} \|x(0)\| = \delta e^{-\frac{\alpha t}{q}} \|x(0)\|, \forall t \geq 0, \quad (3.68)$$

with  $\delta := e^{(k_0 + \frac{\alpha}{q})a_0} \sqrt[q]{\mathcal{C} \frac{c_2}{c_1}}$ , thereby implying that the system  $\Sigma - \Delta$  is exponentially stable with a decay-rate of at least  $\alpha/q$ .

### 3.8.2 Proof of Lemma 3.2

(1) For all  $t \in [0, a_0]$ : As per the definition of  $e(t)$  in (3.17) and  $\Delta$  in (3.18), we have

$$e(t) = 0 = (\Delta \dot{u}_c)(t), \forall t \in [0, a_0]. \quad (3.69)$$

(2) For all  $t \in [a_k, a_{k+1}]$ ,  $k \in \mathbb{N}$ : We have

$$e(t) = \kappa(x_p(s_k)) - \kappa(x_p(t)), \quad (3.70)$$

which can be reformulated as

$$e(t) = - \int_{s_k}^t \frac{d}{ds} \kappa(x_p(s)) ds = - \int_{s_k}^t \dot{u}_c(s) ds. \quad (3.71)$$

Therefore, using the definition of  $\Delta$  in (3.18), it can be concluded that indeed  $e(t) = (\Delta \dot{u}_c)(t)$ .

### 3.8.3 Proof of Lemma 3.3

Consider the system  $\mathcal{P}$  in (3.1), (3.2), (3.4)-(3.8). Moreover, consider the following notational relations:

$$y(t) = \dot{u}_c(t), \quad (3.72)$$

with  $\dot{u}_c(t)$  given by (3.19), and  $\omega(t) = e(t)$ , with  $e(t)$  defined by (3.17). By virtue of Lemma 3.2, we have,

$$\omega(t) = e(t) = (\Delta \dot{u}_c)(t) = (\Delta y)(t), \forall t \geq 0. \quad (3.73)$$

(1) For all  $t \in [0, a_0]$ : As per the definition of system  $\mathcal{P}$ , we have

$$\dot{x}_p(t) = f(x_p(t)), \quad (3.74)$$

and using (3.19),

$$y(t) = \dot{u}_c(t) = \frac{d}{dt} \kappa(x_p(t)) = \frac{\partial \kappa(x_p(t))}{\partial x_p} f(x_p(t)). \quad (3.75)$$

Using (3.20), (3.74) and (3.75) this is equivalent to

$$\dot{x}_p(t) = \bar{f}_0(x_p(t)), y(t) = \bar{h}_0(x_p(t)). \quad (3.76)$$

This expresses the dynamics of system  $\Sigma$  for  $t \in [0, a_0]$ , given by (3.9), with  $\bar{f}_0$  and  $\bar{h}_0$  as defined in (3.20), i.e, for all  $t \in [0, a_0]$ ,  $x(t) = x_p(t)$ . Additionally, using  $\bar{f}_0(x) = f(x)$ , it can be concluded from the definition of system  $\mathcal{P}$  that the function  $\bar{f}_0$  is globally Lipschitz continuous with  $\bar{f}_0(0) = 0$ .

(2) For all  $t \in [a_k, a_{k+1})$ ,  $k \in \mathbb{N}$ : The dynamics of system  $\mathcal{P}$  is given by

$$\begin{aligned}\dot{x}_p(t) &= f(x_p(t)) + g(x_p(t))u(t) = f(x_p(t)) + g(x_p(t))\kappa(x_p(s_k)) \\ &= f(x_p(t)) + g(x_p(t))\kappa(x_p(t)) + g(x_p(t))[\kappa(x_p(s_k)) - \kappa(x_p(t))].\end{aligned}\quad (3.77)$$

Using (3.20), and recalling the definition of  $e(t)$  in (3.17), we obtain

$$\dot{x}_p(t) = \bar{f}(x_p(t)) + \bar{g}(x_p(t))e(t). \quad (3.78)$$

This is equivalent to the dynamics of system  $\Sigma$  for  $t \geq a_0$ , given by (3.9), with  $\omega(t) = e(t)$  and the functions  $\bar{f}$  and  $\bar{g}$  defined by (3.20), i.e., for all  $t \geq a_0$ , we have  $x = x_p$ .

Additionally, from (3.72) and (3.19) we have,

$$y(t) = \frac{d}{dt}\kappa(x_p(t)) = \frac{\partial\kappa(x_p(t))}{\partial x_p}(\bar{f}(x_p(t)) + \bar{g}(x_p(t))e(t)). \quad (3.79)$$

Once again, using notation (3.20) and  $e(t) = \omega(t)$ , we have,

$$y(t) = \bar{h}(x_p(t)) + \bar{l}(x_p(t))\omega(t), \quad (3.80)$$

which is the same as  $y$  defined in (3.9), for all  $t \geq a_0$ , since we have already shown  $x = x_p$ . Therefore, it can be seen that system  $\mathcal{P}$  can be expressed as the feedback interconnection  $\Sigma - \Delta$ , with the functions  $\bar{f}_0$ ,  $\bar{h}_0$ ,  $\bar{f}$ ,  $\bar{g}$ ,  $\bar{h}$ , and  $\bar{l}$  defined by (3.20).

### 3.8.4 Proof of Lemma 3.4

(1) For  $t \in [0, a_0)$ : Using the definition of  $\Delta$  in (3.18), we have  $(\Delta z)(\theta) = 0$ , for all  $\theta \in [0, t)$  and clearly (3.21) holds in this case since

$$S(\theta, z(\theta), (\Delta z)(\theta)) = -\gamma^2 z^T(\theta)Rz(\theta) \leq 0. \quad (3.81)$$

(2) For  $t \geq a_0$ : Let  $w(t)$  denote

$$w(t) = (\Delta z)(t) = - \int_{s_k}^t z(\zeta)d\zeta, \forall t \in [a_k, a_{k+1}), k \in \mathbb{N}. \quad (3.82)$$

Using Jensen's inequality, we obtain

$$w^T(t)Rw(t) \leq (t - s_k) \int_{s_k}^t z^T(\zeta)Rz(\zeta)d\zeta \leq (\bar{h} + \bar{\tau}) \int_{s_k}^t z^T(\zeta)Rz(\zeta)d\zeta. \quad (3.83)$$

Using the change of variable  $s = \zeta - t$ , we obtain

$$\begin{aligned}w^T(t)Rw(t) &\leq (\bar{h} + \bar{\tau}) \int_{s_k-t}^0 z^T(t+s)Rz(t+s)ds \\ &\leq (\bar{h} + \bar{\tau}) \int_{-(\bar{h}+\bar{\tau})}^0 z^T(t+s)Rz(t+s)ds.\end{aligned}\quad (3.84)$$

Therefore,

$$\begin{aligned} & \int_{a_0}^t e^{\alpha(\theta-a_0)} w^T(\theta) R w(\theta) d\theta \\ & \leq (\bar{h} + \bar{\tau}) \int_{a_0}^t e^{\alpha(\theta-a_0)} \left( \int_{-(\bar{h}+\bar{\tau})}^0 z^T(\theta+s) R z(\theta+s) ds \right) d\theta. \end{aligned} \quad (3.85)$$

Substituting  $u = \theta + s$ , we have that

$$\begin{aligned} & \int_{a_0}^t e^{\alpha(\theta-a_0)} w^T(\theta) R w(\theta) d\theta \\ & \leq (\bar{h} + \bar{\tau}) \int_{-(\bar{h}+\bar{\tau})}^0 \left( \int_{a_0+s}^{t+s} e^{\alpha(u-s-a_0)} z^T(u) R z(u) du \right) ds. \end{aligned} \quad (3.86)$$

Since the inner integral in the right-hand side of the inequality in (3.86) is always positive, we can upper bound the left-hand side in (3.86) using the limits of  $s$  and obtain

$$\begin{aligned} & \int_{a_0}^t e^{\alpha(\theta-a_0)} w^T(\theta) R w(\theta) d\theta \\ & \leq (\bar{h} + \bar{\tau}) \int_{-(\bar{h}+\bar{\tau})}^0 \left( \int_{a_0-(\bar{h}+\bar{\tau})}^{t+0} e^{\alpha(u+(\bar{h}+\bar{\tau})-a_0)} z^T(u) R z(u) du \right) ds \\ & \leq (\bar{h} + \bar{\tau}) e^{\alpha(\bar{h}+\bar{\tau})} \int_{-(\bar{h}+\bar{\tau})}^0 \left( \int_0^t e^{\alpha(u-a_0)} z^T(u) R z(u) du \right) ds \\ & = (\bar{h} + \bar{\tau})^2 e^{\alpha(\bar{h}+\bar{\tau})} \int_0^t e^{\alpha(u-a_0)} z^T(u) R z(u) du. \end{aligned} \quad (3.87)$$

As per definition (3.18), we have  $w(t) = 0$  for all  $0 \leq t < a_0$  and, consequently,

$$\begin{aligned} \int_0^t e^{\alpha(\theta-a_0)} w^T(\theta) R w(\theta) d\theta & = \int_{a_0}^t e^{\alpha(\theta-a_0)} w^T(\theta) R w(\theta) d\theta \\ & \leq (\bar{h} + \bar{\tau})^2 e^{\alpha(\bar{h}+\bar{\tau})} \int_0^t e^{\alpha(u-a_0)} z^T(u) R z(u) du. \end{aligned} \quad (3.88)$$

Hence, using the definition of  $w(t)$  in (3.82), we have that

$$\int_0^t e^{\alpha(\theta-a_0)} ((\Delta z)^T(\theta) R (\Delta z)(\theta) - (\bar{h} + \bar{\tau})^2 e^{\alpha(\bar{h}+\bar{\tau})} z^T(\theta) R z(\theta)) d\theta \leq 0, \quad (3.89)$$

which proves the integral inequality (3.21), thereby concluding the proof.

### 3.8.5 Proof of Theorem 3.6

Comparing the sampled-data systems  $\mathcal{P}_L$  and  $\mathcal{P}$ , we have,

$$f(x(t)) := Ax(t), g(x(t)) := B, \kappa(x(s_k)) := Kx(s_k). \quad (3.90)$$

Hence, the sampling and delay induced error is given by

$$e(t) = \begin{cases} 0, \forall t \in [0, a_0), \\ Kx(s_k) - Kx(t), \forall t \in [a_k, a_{k+1}), k \in \mathbb{N}, \end{cases} \quad (3.91)$$

thereby implying that using the operator  $\Delta$  defined in (3.18), we can state  $e = \Delta(K\dot{x})$ . Using the inequality in (3.25), we proceed to prove that the assumptions introduced in Theorem 3.1 will hold for  $V(x) = x^T Px$  and  $\mathcal{S}(t, y(t), w(t))$  defined by (3.22). For the LTI system  $\mathcal{P}_L$ , the functions given in (3.20) are given by

$$\begin{aligned} \bar{f}_0(x(t)) &:= Ax(t), \bar{h}_0(x(t)) := KAx(t), \\ \bar{f}(x(t)) &:= \bar{A}x(t), \bar{g}(x(t)) := B, \\ \bar{h}(x(t)) &:= K\bar{A}x(t), \bar{l}(x(t)) := KB, \end{aligned} \quad (3.92)$$

where  $\bar{A} = (A + BK)$ .

(1) Satisfying Assumption 1, i.e., (3.11): By virtue of Lemma 3.4, we can see that the supply function  $\mathcal{S}(t, y(t), w(t))$  defined by (3.22) satisfies assumption (3.11) in Theorem 3.1, i.e.,

$$\int_0^t \mathcal{S}(\theta, y(\theta), (\Delta y)(\theta)) d\theta \leq 0, \forall t \geq 0. \quad (3.93)$$

(2) Satisfying Assumption 2, i.e., (3.12): With  $V(x) = x^T Px$ ,  $P = P^T > 0$  and  $x \in \mathbb{R}^n$ , we have that

$$\delta_{\min}(P)\|x\|^2 \leq x^T Px \leq \delta_{\max}(P)\|x\|^2, \quad (3.94)$$

implying Assumption 2 is satisfied with  $q = 2$ ,  $c_1 = \delta_{\min}(P)$  and  $c_2 = \delta_{\max}(P)$ .

(3) Satisfying Assumption 3, inequality (3.13): Consider the function  $\mathcal{S}(t, y(t), w(t))$  defined by (3.22). Since

$$y(t) = \bar{h}_0(x(t)) = KAx(t), \forall t \in [0, a_0), \quad (3.95)$$

and  $\omega(t) = 0$ , we have that for all  $t \in [0, a_0)$ ,

$$\begin{aligned} -\mathcal{S}(t, y(t), \omega(t)) &= -\mathcal{S}(t, \bar{h}_0(x(t)), 0) \\ &= e^{\alpha(t-a_0)} \gamma^2 x^T(t) (KA)^T R (KA) x(t) \\ &\leq \max_{\theta \in [0, a_0]} \{ \delta_{\max} [e^{\alpha(\theta-a_0)} \gamma^2 (KA)^T R (KA)] \} \|x(t)\|^2 \\ &\leq \rho V(x(t)), \end{aligned} \quad (3.96)$$

with

$$\rho = \frac{\delta_{\max} (\gamma^2 (KA)^T R (KA))}{\delta_{\min}(P)}. \quad (3.97)$$

(4) Satisfying Assumption 3, inequality (3.14): We have  $V(x(t)) = x(t)^T P x(t)$  for all  $t \geq 0$ . Additionally,

$$\dot{x}(t) = \bar{f}_0(x(t)) = Ax(t), \forall t \in [0, a_0], \quad (3.98)$$

and consequently,

$$\dot{V}(x(t)) = x(t)^T [A^T P + PA] x(t) \geq \frac{\delta_{\min}(A^T P + PA)}{\delta_{\max}(P)} V(x(t)). \quad (3.99)$$

Therefore, inequality (3.14) is satisfied for any  $\lambda \leq \frac{\delta_{\min}(A^T P + PA)}{\delta_{\max}(P)}$ .

(5) Satisfying Assumption 3, inequality (3.15): Consider the function

$$W(t) = \dot{V}(x(t)) + \alpha V(x(t)) - e^{-\alpha(t-a_0)} \mathcal{S}(t, y(t), e(t)), \quad (3.100)$$

defined for all  $t \geq a_0$ , with  $V(x) = x^T P x$ , and the function  $\mathcal{S}(t, y(t), e(t))$  defined by (3.22). Clearly, inequality (3.15) in Assumption 3 holds if  $W(t) \leq 0$ , for all  $t \geq a_0$ . We have,

$$\begin{aligned} \mathcal{S}(t, y(t), e(t)) &= e^{\alpha(t-a_0)} \begin{bmatrix} y(t) \\ e(t) \end{bmatrix}^T \begin{bmatrix} -\gamma^2 R & 0 \\ 0 & R \end{bmatrix} \begin{bmatrix} y(t) \\ e(t) \end{bmatrix} \\ &= e^{\alpha(t-a_0)} \begin{bmatrix} x(t) \\ e(t) \end{bmatrix}^T N \begin{bmatrix} x(t) \\ e(t) \end{bmatrix}, \end{aligned} \quad (3.101)$$

where

$$N = \begin{bmatrix} K\bar{A} & KB \\ 0 & I \end{bmatrix}^T \begin{bmatrix} -\gamma^2 R & 0 \\ 0 & R \end{bmatrix} \begin{bmatrix} K\bar{A} & KB \\ 0 & I \end{bmatrix}. \quad (3.102)$$

Therefore, we have that for all  $t \geq a_0$ ,

$$\begin{aligned} W(t) &= \dot{V}(x(t)) + \alpha V(x(t)) - e^{-\alpha(t-a_0)} \mathcal{S}(t, y(t), e(t)) \\ &= \begin{bmatrix} x(t) \\ e(t) \end{bmatrix}^T \left\{ \begin{bmatrix} \bar{A}^T P + P\bar{A} & PB \\ B^T P & 0 \end{bmatrix} + \alpha \begin{bmatrix} P & 0 \\ 0 & 0 \end{bmatrix} - N \right\} \begin{bmatrix} x(t) \\ e(t) \end{bmatrix} \\ &= \begin{bmatrix} x(t) \\ e(t) \end{bmatrix}^T \Gamma \begin{bmatrix} x(t) \\ e(t) \end{bmatrix}, \end{aligned} \quad (3.103)$$

with

$$\Gamma := \begin{bmatrix} \bar{A}^T P + P\bar{A} + \alpha P & PB \\ B^T P & 0 \end{bmatrix} - N. \quad (3.104)$$

Substituting  $N$  in the expression for  $\Gamma$ , gives

$$\begin{aligned} \Gamma &= \begin{bmatrix} \bar{A}^T P + P\bar{A} + \alpha P & PB \\ B^T P & 0 \end{bmatrix} - N \\ &= \begin{bmatrix} \bar{A}^T P + P\bar{A} + \alpha P & PB \\ B^T P & 0 \end{bmatrix} + \begin{bmatrix} K\bar{A} & KB \\ 0 & I \end{bmatrix}^T \begin{bmatrix} \gamma^2 R & 0 \\ 0 & -R \end{bmatrix} \begin{bmatrix} K\bar{A} & KB \\ 0 & I \end{bmatrix}. \end{aligned} \quad (3.105)$$

A sufficient condition for  $W(t) \leq 0$ , for all  $t \geq a_0$ , will therefore be given by  $\Gamma \leq 0$ , which is guaranteed by (3.25). Consequently, we have proved that inequality (3.15) in Assumption 3 is satisfied for the chosen storage and supply functions.

We have shown that all the assumptions of Theorem 3.1 hold for  $V(x) = x^T P x$  and  $\mathcal{S}(t, y(t), e(t))$  defined by (3.22) and, therefore, the exponential stability of system  $\mathcal{P}$  is guaranteed with a decay rate greater than or equal to  $\alpha/2$ .

### 3.8.6 Proof of Lemma 3.7

(1) Expressing  $e_s$  using  $\Delta_s$ : Recalling the definition of  $e_s(t)$  in (3.28), and by using the operator definition for  $\Delta_s$  in (3.31), we can state using (3.19) that

$$e_s(t) = 0 = (\Delta_s \dot{u}_c)(t), \forall t \in [0, s_0]. \quad (3.106)$$

Similarly, for all  $t \in [s_k, s_{k+1})$ ,  $k \in \mathbb{N}$ ,

$$\begin{aligned} e_s(t) &= \kappa(x_p(s_k)) - \kappa(x_p(t)) = - \int_{s_k}^t \frac{d}{ds} \kappa(x_p(s)) ds \\ &= - \int_{s_k}^t \dot{u}_c(s) ds = (\Delta_s \dot{u}_c)(t). \end{aligned} \quad (3.107)$$

Hence, we have

$$e_s(t) = (\Delta_s \dot{u}_c)(t), \forall t \geq 0. \quad (3.108)$$

(2) Expressing  $e_d$  using  $\Delta_d$ : In a similar manner, using the definition of  $e_d(t)$  in (3.29) and the operator definition for  $\Delta_d$  defined in (3.32), we have,

$$e_d(t) = 0 = (\Delta_d \dot{u}_c)(t), \forall t \in [0, a_0] \cup [a_{k-1}, s_k)_{k \in \mathbb{N}^*}. \quad (3.109)$$

Similarly, for all  $t \in [s_k, a_k)$ ,  $k \in \mathbb{N}^*$ ,

$$\begin{aligned} e_d(t) &= \kappa(x_p(s_{k-1})) - \kappa(x_p(s_k)) = - \int_{s_{k-1}}^{s_k} \frac{d}{ds} \kappa(x_p(s)) ds \\ &= - \int_{s_{k-1}}^{s_k} \dot{u}_c(s) ds = (\Delta_d \dot{u}_c)(t). \end{aligned} \quad (3.110)$$

Hence, we obtain

$$e_d(t) = (\Delta_d \dot{u}_c)(t), \forall t \geq 0. \quad (3.111)$$

### 3.8.7 Proof of Lemma 3.8

Consider system  $\mathcal{P}$ , the notations  $y(t) = [y_1^T(t) \ y_2^T(t)]^T = [\dot{u}_c^T(t) \ \dot{u}_c^T(t)]^T$ , with  $\dot{u}_c$  defined by (3.19), and  $\omega(t) = [e_s^T(t) \ e_d^T(t)]^T$ , with  $e_s(t)$  and  $e_d(t)$  given by (3.28) and (3.29), respectively. By virtue of Lemma 3.7, we have

$$\omega(t) = \begin{bmatrix} e_s(t) \\ e_d(t) \end{bmatrix} = \begin{bmatrix} (\Delta_s \dot{u}_c)(t) \\ (\Delta_d \dot{u}_c)(t) \end{bmatrix} = (\Delta y)(t), \forall t \geq 0, \quad (3.112)$$

with  $\Delta_s$  and  $\Delta_d$  given in (3.31) and (3.32), respectively. In order to establish the equivalence between system  $\mathcal{P}$  and the feedback interconnection  $\Sigma - \Delta$ , we begin by reformulating the dynamics of system  $\mathcal{P}$  for all  $t \in [0, a_0)$ ,  $t \in [a_k, s_{k+1})_{k \in \mathbb{N}}$ , and  $t \in [s_{k+1}, a_{k+1})_{k \in \mathbb{N}}$ , i.e., for all  $t \geq 0$ .

(1) For all  $t \in [0, a_0)$ : Consider the system  $\mathcal{P}$ . We have that  $\dot{x}_p(t) = f(x_p(t))$ , and using (3.19),

$$y_1(t) = y_2(t) = \dot{u}_c(t) = \frac{d}{dt} \kappa(x_p(t)) = \frac{\partial \kappa(x_p(t))}{\partial x_p} \dot{x}_p(t) = \frac{\partial \kappa(x_p(t))}{\partial x_p} f(x_p(t)). \quad (3.113)$$

Therefore, using the notation in (3.34), we obtain

$$\dot{x}_p(t) = \bar{f}_0(x_p(t)), y(t) = [y_1^T(t) \quad y_2^T(t)]^T = \bar{h}_0(x_p(t)). \quad (3.114)$$

Note that this is the dynamics of system  $\Sigma$  for  $t \in [0, a_0)$ , given by (3.9), with the functions  $\bar{f}_0$  and  $\bar{h}_0$  as defined in (3.34), i.e., for all  $t \in [0, a_0)$ ,  $x(t) = x_p(t)$ . Additionally, as per the notation in (3.20), since  $\bar{f}_0(x) = f(x)$ , it can be concluded from the definition of system  $\mathcal{P}$  that the function  $\bar{f}_0$  is globally Lipschitz continuous with  $\bar{f}_0(0) = 0$ .

(2) For all  $t \in [a_k, s_{k+1})$ ,  $k \in \mathbb{N}$ : The dynamics of system  $\mathcal{P}$  is given by

$$\begin{aligned} \dot{x}_p(t) &= f(x_p(t)) + g(x_p(t))u(t) \\ &= f(x_p(t)) + g(x_p(t))\kappa(x_p(s_k)) \\ &= f(x_p(t)) + g(x_p(t))\kappa(x_p(t)) + g(x_p(t))[\kappa(x_p(s_k)) - \kappa(x_p(t))]. \end{aligned} \quad (3.115)$$

Using the definitions of sampling and delay induced errors in (3.28) and (3.29), respectively, we have

$$e_s(t) = \kappa(x_p(s_k)) - \kappa(x_p(t)), \forall t \in [a_k, s_{k+1}), \quad (3.116)$$

and  $e_d(t) = 0$  for all  $t \in [a_k, s_{k+1})$ . Therefore, we can reformulate the dynamics of system  $\mathcal{P}$  for all  $t \in [a_k, s_{k+1})$  as

$$\begin{aligned} \dot{x}_p(t) &= f(x_p(t)) + g(x_p(t))\kappa(x_p(t)) + g(x_p(t))e_s(t) + g(x_p(t))e_d(t) \\ &= f(x_p(t)) + g(x_p(t))\kappa(x_p(t)) + \begin{bmatrix} g(x_p(t)) & g(x_p(t)) \end{bmatrix} \begin{bmatrix} e_s(t) \\ e_d(t) \end{bmatrix}. \end{aligned} \quad (3.117)$$

Using the notation in (3.34), this can be written as

$$\dot{x}_p(t) = \bar{f}(x_p(t)) + \bar{g}(x_p(t))\omega(t), \quad (3.118)$$

with  $\omega(t)$  as in (3.112). This is the same as dynamics of system  $\Sigma$  for all  $t \in [a_k, s_{k+1})$ ,  $k \in \mathbb{N}$ , given by (3.9), with  $\omega$  defined in (3.112), and the functions



$\bar{f}$  and  $\bar{g}$  defined by (3.34), i.e., for all  $t \in [a_k, s_{k+1})$ , with  $x = x_p$ . Additionally, we have  $\dot{u}_c(t) = \frac{d}{dt}\kappa(x_p(t))$  and hence,

$$y_1(t) = y_2(t) = \frac{\partial \kappa(x_p(t))}{\partial x_p} (\bar{f}(x_p(t)) + \bar{g}(x_p(t))\omega(t)). \quad (3.119)$$

Therefore, using the notation in (3.34) once again, we obtain

$$y(t) = [y_1^T(t) \quad y_2^T(t)]^T = \bar{h}(x_p(t)) + \bar{l}(x_p(t))\omega(t), \quad (3.120)$$

which is the same as  $y$  defined in (3.9), for  $t \in [a_k, s_{k+1})$ , with  $x = x_p$ .

(3) For all  $t \in [s_{k+1}, a_{k+1})$ ,  $k \in \mathbb{N}$ : Once again, we proceed to reformulate the dynamics of system  $\mathcal{P}$  given by

$$\begin{aligned} \dot{x}_p(t) &= f(x_p(t)) + g(x_p(t))u(t) \\ &= f(x_p(t)) + g(x_p(t))\kappa(x_p(s_k)) \\ &= f(x_p(t)) + g(x_p(t))\kappa(x_p(s_k)) + g(x_p(t))\kappa(x_p(t)) - g(x_p(t))\kappa(x_p(t)) \\ &\quad + g(x_p(t))\kappa(x_p(s_{k+1})) - g(x_p(t))\kappa(x_p(s_{k+1})) \\ &= (f(x_p(t)) + g(x_p(t))\kappa(x_p(t))) + g(x_p(t))[\kappa(x_p(s_{k+1})) - \kappa(x_p(t))] \\ &\quad + g(x_p(t))[\kappa(x_p(s_k)) - \kappa(x_p(s_{k+1}))]. \end{aligned} \quad (3.121)$$

Using the definitions in (3.28) and (3.29) and considering Hypothesis 2, we have that

$$e_s(t) = \kappa(x_p(s_{k+1})) - \kappa(x_p(t)), \forall t \in [s_{k+1}, s_{k+2}) \supset [s_{k+1}, a_{k+1}), \quad (3.122)$$

and

$$e_d(t) = \kappa(x_p(s_k)) - \kappa(x_p(s_{k+1})), \forall t \in [s_{k+1}, a_{k+1}). \quad (3.123)$$

Therefore, using the notation in (3.34), we can reformulate the dynamics of system  $\mathcal{P}$  for all  $t \in [s_{k+1}, a_{k+1})$  as

$$\begin{aligned} \dot{x}_p(t) &= \bar{f}(x_p(t)) + g(x_p(t))e_s(t) + g(x_p(t))e_d(t) \\ &= \bar{f}(x_p(t)) + \bar{g}(x_p(t))\omega(t). \end{aligned} \quad (3.124)$$

This is the same as dynamics of system  $\Sigma$  in (3.9) for all  $t \in [s_{k+1}, a_{k+1})$ ,  $k \in \mathbb{N}$ , with  $\omega(t)$  given by (3.112), and the functions  $\bar{f}$  and  $\bar{g}$  defined by (3.34), with  $x(t) = x_p(t)$ . Additionally, using the notation  $y_1(t) = y_2(t) = \dot{u}_c(t)$ , and following the reasoning given in (3.119), we get,

$$y(t) = [y_1^T(t) \quad y_2^T(t)]^T = \bar{h}(x_p(t)) + \bar{l}(x_p(t))\omega(t), \quad (3.125)$$

which is the same as  $y$  defined in (3.9), for  $t \in [s_{k+1}, a_{k+1})$ ,  $k \in \mathbb{N}$ , with  $x = x_p$ . Therefore, system  $\mathcal{P}$  can be expressed in the form of the interconnection  $\Sigma - \Delta$ , with the functions  $\bar{f}_0$ ,  $\bar{h}_0$ ,  $\bar{f}$ ,  $\bar{g}$ ,  $\bar{h}$ , and  $\bar{l}$  defined by (3.34).

### 3.8.8 Proof of Lemma 3.9

(1) For  $t \in [0, s_0]$ : As per the definition of  $\Delta_s$  in (3.31), we have that

$$(\Delta_s v)(t) = 0, \forall t \in [0, s_0]. \quad (3.126)$$

Therefore, for all  $\theta \in [0, s_0)$ , we have

$$\mathcal{S}_s(\theta, v(\theta), (\Delta_s v)(\theta)) = -\gamma_s^2 v^T(\theta) R_s v(\theta), \quad (3.127)$$

implying that indeed

$$\int_0^t \mathcal{S}_s(\theta, v(\theta), (\Delta_s v)(\theta)) d\theta \leq 0. \quad (3.128)$$

(2) For  $t \in [s_k, s_{k+1})$ ,  $k \in \mathbb{N}$ : We have that

$$\begin{aligned} & \int_{s_k}^t e^{\beta(\theta-a_0)} (\Delta_s v)^T(\theta) R_s (\Delta_s v)(\theta) d\theta \\ &= \int_{s_k}^t \sqrt{e^{\beta(\theta-a_0)}} (\Delta_s v)^T(\theta) R_s \sqrt{e^{\beta(\theta-a_0)}} (\Delta_s v)(\theta) d\theta. \end{aligned} \quad (3.129)$$

Since  $(\Delta_s v)(s_k) = 0$ , by applying Wirtinger's inequality [76], we obtain

$$\begin{aligned} & \int_{s_k}^t e^{\beta(\theta-a_0)} (\Delta_s v)^T(\theta) R_s (\Delta_s v)(\theta) d\theta \\ & \leq \frac{4(t-s_k)^2}{\pi^2} \int_{s_k}^t \frac{d}{d\theta} \left( \sqrt{e^{\beta(\theta-a_0)}} (\Delta_s v)(\theta) \right)^T R_s \frac{d}{d\theta} \left( \sqrt{e^{\beta(\theta-a_0)}} (\Delta_s v)(\theta) \right) d\theta, \end{aligned} \quad (3.130)$$

with

$$\frac{d}{d\theta} \left( \sqrt{e^{\beta(\theta-a_0)}} (\Delta_s v)(\theta) \right) = \sqrt{e^{\beta(\theta-a_0)}} \frac{d}{d\theta} (\Delta_s v)(\theta) + (\Delta_s v)(\theta) \frac{\beta}{2} \sqrt{e^{\beta(\theta-a_0)}}. \quad (3.131)$$

As per the definition of  $\Delta_s$  in (3.31), we have that

$$(\Delta_s v)(\theta) = - \int_{s_k}^{\theta} v(\psi) d\psi, \forall \theta \in [s_k, s_{k+1}), k \in \mathbb{N}, \quad (3.132)$$

implying that  $\frac{d}{d\theta} (\Delta_s v)(\theta) = -v(\theta)$ . Therefore,

$$\frac{d}{d\theta} \left( \sqrt{e^{\beta(\theta-a_0)}} (\Delta_s v)(\theta) \right) = \sqrt{e^{\beta(\theta-a_0)}} (-v(\theta)) + \frac{\beta}{2} (\Delta_s v)(\theta), \quad (3.133)$$

implying that

$$\begin{aligned}
 & \frac{d}{d\theta} \left( \sqrt{e^{\beta(\theta-a_0)}} (\Delta_s v)^T(\theta) \right)^T R_s \frac{d}{d\theta} \left( \sqrt{e^{\beta(\theta-a_0)}} (\Delta_s v)(\theta) \right) \\
 &= e^{\beta(\theta-a_0)} \left( -v(\theta) + \frac{\beta}{2} (\Delta_s v)(\theta) \right)^T R_s \left( -v(\theta) + \frac{\beta}{2} (\Delta_s v)(\theta) \right) \\
 &= e^{\beta(\theta-a_0)} \left( v^T(\theta) R_s v(\theta) - \frac{\beta}{2} v^T(\theta) R_s (\Delta_s v)(\theta) - \frac{\beta}{2} (\Delta_s v)^T(\theta) R_s v(\theta) \right. \\
 &\quad \left. + \frac{\beta^2}{4} (\Delta_s v)^T(\theta) R_s (\Delta_s v)(\theta) \right).
 \end{aligned} \tag{3.134}$$

Hence,

$$\begin{aligned}
 & \frac{d}{d\theta} \left( \sqrt{e^{\beta(\theta-a_0)}} (\Delta_s v)^T(\theta) \right)^T R_s \frac{d}{d\theta} \left( \sqrt{e^{\beta(\theta-a_0)}} (\Delta_s v)(\theta) \right) \\
 &= e^{\beta(\theta-a_0)} \xi(v(\theta), (\Delta_s v)(\theta)),
 \end{aligned} \tag{3.135}$$

where

$$\begin{aligned}
 \xi(v(\theta), (\Delta_s v)(\theta)) &:= \left( v^T(\theta) R_s v(\theta) - \frac{\beta}{2} v^T(\theta) R_s (\Delta_s v)(\theta) \right. \\
 &\quad \left. - \frac{\beta}{2} (\Delta_s v)^T(\theta) R_s v(\theta) + \frac{\beta^2}{4} (\Delta_s v)^T(\theta) R_s (\Delta_s v)(\theta) \right).
 \end{aligned} \tag{3.136}$$

Substituting (3.135) into inequality (3.130), we have for all  $t \in [s_k, s_{k+1})$ ,  $k \in \mathbb{N}$ ,

$$\int_{s_k}^t e^{\beta(\theta-a_0)} (\Delta_s v)^T(\theta) R_s (\Delta_s v)(\theta) d\theta \leq \frac{4\bar{h}^2}{\pi^2} \int_{s_k}^t e^{\beta(\theta-a_0)} \xi(v(\theta), (\Delta_s v)(\theta)) d\theta, \tag{3.137}$$

where we have used that  $(t - s_k) \leq \bar{h}$  for all  $t \in [s_k, s_{k+1})$ . Now, for any  $t \in [s_k, s_{k+1})$ , since  $(\Delta_s v)(t) = 0, \forall t < s_0$  (see (3.31)), we can state that

$$\begin{aligned}
 & \int_0^t e^{\beta(\theta-a_0)} (\Delta_s v)^T(\theta) R_s (\Delta_s v)(\theta) d\theta = \int_{s_0}^t e^{\beta(\theta-a_0)} (\Delta_s v)^T(\theta) R_s (\Delta_s v)(\theta) d\theta \\
 &= \sum_{i=0}^{k-1} \int_{s_i}^{s_{i+1}} e^{\beta(\theta-a_0)} (\Delta_s v)^T(\theta) R_s (\Delta_s v)(\theta) d\theta \\
 &\quad + \int_{s_k}^t e^{\beta(\theta-a_0)} (\Delta_s v)^T(\theta) R_s (\Delta_s v)(\theta) d\theta \\
 &\leq \frac{4\bar{h}^2}{\pi^2} \left( \sum_{i=0}^{k-1} \int_{s_i}^{s_{i+1}} e^{\beta(\theta-a_0)} \xi(v(\theta), (\Delta_s v)(\theta)) d\theta \right. \\
 &\quad \left. + \int_{s_k}^t e^{\beta(\theta-a_0)} \xi(v(\theta), (\Delta_s v)(\theta)) d\theta \right).
 \end{aligned} \tag{3.138}$$

Therefore,

$$\int_0^t e^{\beta(\theta-a_0)} (\Delta_s v)^T(\theta) R_s (\Delta_s v)(\theta) d\theta \leq \frac{4\bar{h}^2}{\pi^2} \int_{s_0}^t e^{\beta(\theta-a_0)} \xi(v(\theta), (\Delta_s v)(\theta)) d\theta. \quad (3.139)$$

Since  $(\Delta_s v)(t) = 0$  for all  $t < s_0$ , and  $v(t) \in \mathcal{W}^{m_p}$ , using the definition of  $\xi(v(\theta), (\Delta_s v)(\theta))$  in (3.136), we have  $\forall t \in [0, s_0]$ ,

$$\frac{4\bar{h}^2}{\pi^2} \int_0^{s_0} e^{\beta(\theta-a_0)} \xi(v(\theta), (\Delta_s v)(\theta)) d\theta = \frac{4\bar{h}^2}{\pi^2} \int_0^{s_0} e^{\beta(\theta-a_0)} v^T(\theta) R_s v(\theta) d\theta \geq 0. \quad (3.140)$$

Therefore, by adding (3.140) and (3.139), we obtain

$$\begin{aligned} \int_0^t e^{\beta(\theta-a_0)} (\Delta_s v)^T(\theta) R_s (\Delta_s v)(\theta) d\theta \\ \leq \gamma_s^2 \int_0^t e^{\beta(\theta-a_0)} \xi(v(\theta), (\Delta_s v)(\theta)) d\theta, \forall t \geq 0, \end{aligned} \quad (3.141)$$

with  $\gamma_s = \frac{2\bar{h}}{\pi}$ . Substituting  $\xi(v(\theta), (\Delta_s v)(\theta))$  from (3.136) in (3.141), we arrive at

$$\int_0^t \mathcal{S}_s(\theta, v(\theta), (\Delta_s v)(\theta)) d\theta \leq 0, \quad (3.142)$$

where  $\mathcal{S}_s$  is given by (3.36).

### 3.8.9 Proof of Lemma 3.10

From the definition of  $\Delta_d$  in (3.32), we have that

$$(\Delta_d w)(t) = \begin{cases} 0, \forall t \in [0, a_0), \\ 0, \forall t \in [a_k, s_{k+1}), k \in \mathbb{N} \\ -\int_{s_{k-1}}^{s_k} w(\theta) d\theta, \forall t \in [s_k, a_k), k \in \mathbb{N}^*. \end{cases} \quad (3.143)$$

(1) For all  $t \in [0, s_1]$ : We have  $(\Delta_d w)(\theta) = 0$  for all  $\theta \in [0, s_1]$ , thereby giving

$$\mathcal{S}_d(\theta, w(\theta), (\Delta_d w)(\theta)) = -e^{\beta(\theta-a_0)} w^T(\theta) R_d w(\theta) d\theta \leq 0, \forall \theta \in [0, s_1], \quad (3.144)$$

which implies

$$\int_0^t \mathcal{S}_d(\theta, w(\theta), (\Delta_d w)(\theta)) d\theta \leq 0, \forall t \in [0, s_1]. \quad (3.145)$$

(2) For all  $t \geq s_1$ : If  $t \in [s_k, a_k)_{k \in \mathbb{N}^*}$ , by virtue of Jensen's inequality, and using (3.143), we have that

$$e^{\beta(t-a_0)} (\Delta_d w)^T(t) R_d (\Delta_d w)(t) \leq \bar{h} e^{\beta(t-a_0)} \int_{s_{k-1}}^{s_k} w^T(\theta) R_d w(\theta) d\theta, \quad (3.146)$$

as here we used that  $s_k - s_{k+1} \leq \bar{h}$ ,  $\forall k \in \mathbb{N}^*$ . Let  $t \in [s_N, s_{N+1})_{N \in \mathbb{N}^*}$ , which implies that

$$\begin{aligned}
 & \int_{s_1}^t e^{\beta(\theta-a_0)} (\Delta_d w)^T(\theta) R_d(\Delta_d w)(\theta) d\theta \\
 &= \sum_{k=1}^{N-1} \left( \int_{s_k}^{a_k} e^{\beta(\theta-a_0)} (\Delta_d w)^T(\theta) R_d(\Delta_d w)(\theta) d\theta \right. \\
 & \quad \left. + \int_{a_k}^{s_{k+1}} e^{\beta(\theta-a_0)} (\Delta_d w)^T(\theta) R_d(\Delta_d w)(\theta) d\theta \right) \\
 & \quad + \begin{cases} \int_{s_N}^t e^{\beta(\theta-a_0)} (\Delta_d w)^T(\theta) R_d(\Delta_d w)(\theta) d\theta, t \in [s_N, a_N) \\ \int_{s_N}^{a_N} e^{\beta(\theta-a_0)} (\Delta_d w)^T(\theta) R_d(\Delta_d w)(\theta) d\theta \\ + \int_{a_N}^t e^{\beta(\theta-a_0)} (\Delta_d w)^T(\theta) R_d(\Delta_d w)(\theta) d\theta, t \in [a_N, s_{N+1}). \end{cases}
 \end{aligned} \tag{3.147}$$

We know that for all  $t \in [a_k, s_{k+1})_{k \in \mathbb{N}}$ ,  $(\Delta_d z)(t) = 0$ . Additionally, using the upper bound in (3.146), we have that

$$\begin{aligned}
 & \int_{s_1}^t e^{\beta(\theta-a_0)} (\Delta_d w)^T(\theta) R_d(\Delta_d w)(\theta) d\theta \\
 & \leq \sum_{k=1}^{N-1} \left( \bar{h} \int_{s_k}^{a_k} e^{\beta(\theta-a_0)} \left( \int_{s_{k-1}}^{s_k} w^T(\eta) R_d w(\eta) d\eta \right) d\theta \right) \\
 & \quad + \begin{cases} \bar{h} \int_{s_N}^t e^{\beta(\theta-a_0)} \left( \int_{s_{N-1}}^{s_N} w^T(\eta) R_d w(\eta) d\eta \right) d\theta, t \in [s_N, a_N) \\ \bar{h} \int_{s_N}^{a_N} e^{\beta(\theta-a_0)} \left( \int_{s_{N-1}}^{s_N} w^T(\eta) R_d w(\eta) d\eta \right) d\theta, t \in [a_N, s_{N+1}). \end{cases}
 \end{aligned} \tag{3.148}$$

Next, we simplify each of the integrals present in the right side of the inequality above. First, consider the term

$$\begin{aligned}
 & \bar{h} \int_{s_k}^{a_k} e^{\beta(\theta-a_0)} \left( \int_{s_{k-1}}^{s_k} w^T(\eta) R_d w(\eta) d\eta \right) d\theta \\
 & \quad = \bar{h} e^{-\beta a_0} \int_{s_k}^{a_k} e^{\beta \theta} \left( \int_{s_{k-1}}^{s_k} w^T(\eta) R_d w(\eta) d\eta \right) d\theta.
 \end{aligned} \tag{3.149}$$

Let  $\theta = s_k + s \Rightarrow d\theta = ds$ . This leads to

$$\begin{aligned}
 & \bar{h} \int_{s_k}^{a_k} e^{\beta(\theta-a_0)} \left( \int_{s_{k-1}}^{s_k} w^T(\eta) R_d w(\eta) d\eta \right) d\theta \\
 & \quad \leq \bar{h} e^{-\beta a_0} \int_0^{\bar{T}} e^{\beta(s_k+s)} \left( \int_{s_{k-1}}^{s_k} w^T(\eta) R_d w(\eta) d\eta \right) ds.
 \end{aligned} \tag{3.150}$$

Since  $s \in [0, \bar{\tau}]$  in (3.150), it can be stated that  $e^{\beta(s_k+s)} \leq e^{\beta(s_k+\bar{\tau})}$ . Hence,

$$\begin{aligned} \bar{h}e^{-\beta a_0} \int_0^{\bar{\tau}} e^{\beta(s_k+s)} \left( \int_{s_{k-1}}^{s_k} w^T(\eta) R_d w(\eta) d\eta \right) ds \\ \leq \bar{h}e^{\beta(-a_0+\bar{\tau})} \int_0^{\bar{\tau}} e^{\beta s_k} \left( \int_{s_{k-1}}^{s_k} w^T(\eta) R_d w(\eta) d\eta \right) ds \quad (3.151) \\ \leq \bar{h}e^{\beta(-a_0+\bar{\tau})} \int_0^{\bar{\tau}} \left( \int_{s_{k-1}}^{s_k} e^{\beta s_k} w^T(\eta) R_d w(\eta) d\eta \right) ds. \end{aligned}$$

Here,  $\eta \in [s_{k-1}, s_k]$ , which allows us to make the upper bounding  $e^{\beta s_k} \leq e^{\beta(\eta+\bar{h})}$ , thereby resulting in

$$\begin{aligned} \bar{h}e^{\beta(-a_0+\bar{\tau})} \int_0^{\bar{\tau}} \left( \int_{s_{k-1}}^{s_k} e^{\beta s_k} w^T(\eta) R_d w(\eta) d\eta \right) ds \\ \leq \bar{h}e^{\beta(\bar{\tau}+\bar{h})} \int_0^{\bar{\tau}} \left( \int_{s_{k-1}}^{s_k} e^{\beta(\eta-a_0)} w^T(\eta) R_d w(\eta) d\eta \right) ds \quad (3.152) \\ \leq \bar{h}\bar{\tau}e^{\beta(\bar{\tau}+\bar{h})} \int_{s_{k-1}}^{s_k} e^{\beta(\eta-a_0)} w^T(\eta) R_d w(\eta) d\eta. \end{aligned}$$

Thus, by combining (3.150)-(3.152), we have that

$$\begin{aligned} \bar{h} \int_{s_k}^{a_k} e^{\beta(\theta-a_0)} \left( \int_{s_{k-1}}^{s_k} w^T(\eta) R_d w(\eta) d\eta \right) d\theta \\ \leq \bar{h}\bar{\tau}e^{\beta(\bar{\tau}+\bar{h})} \int_{s_{k-1}}^{s_k} e^{\beta(\eta-a_0)} w^T(\eta) R_d w(\eta) d\eta. \end{aligned} \quad (3.153)$$

Substituting this in (3.148) gives

$$\begin{aligned} \int_{s_1}^t e^{\beta(\theta-a_0)} (\Delta_d w)^T(\theta) R_d (\Delta_d w)(\theta) d\theta \\ \leq \sum_{k=1}^{N-1} \left( \bar{h}\bar{\tau}e^{\beta(\bar{\tau}+\bar{h})} \int_{s_{k-1}}^{s_k} e^{\beta(\eta-a_0)} w^T(\eta) R_d w(\eta) d\eta \right) \\ + \bar{h}\bar{\tau}e^{\beta(\bar{\tau}+\bar{h})} \int_{s_{N-1}}^{s_N} e^{\beta(\eta-a_0)} w^T(\eta) R_d w(\eta) d\eta \\ \leq \bar{h}\bar{\tau}e^{\beta(\bar{\tau}+\bar{h})} \int_{s_0}^{s_N} e^{\beta(\eta-a_0)} w^T(\eta) R_d w(\eta) d\eta. \end{aligned} \quad (3.154)$$

Therefore,

$$\begin{aligned} \int_{s_1}^t e^{\beta(\theta-a_0)} (\Delta_d w)^T(\theta) R_d (\Delta_d w)(\theta) d\theta \\ \leq \bar{h}\bar{\tau}e^{\beta(\bar{\tau}+\bar{h})} \int_{s_0}^{s_N} e^{\beta(\eta-a_0)} w^T(\eta) R_d w(\eta) d\eta. \end{aligned} \quad (3.155)$$

Since  $(\Delta_d w)(t) = 0$  for  $t < s_1$  (see (3.32)), we have that

$$\begin{aligned} & \int_{s_1}^t e^{\beta(\theta-a_0)} (\Delta_d w)^T(\theta) R_d (\Delta_d w)(\theta) d\theta \\ &= \int_0^t e^{\beta(\theta-a_0)} (\Delta_d w)^T(\theta) R_d (\Delta_d w)(\theta) d\theta. \end{aligned} \quad (3.156)$$

Additionally, since  $w \in \mathcal{W}^{m_p}$ , we can state

$$e^{\beta(\eta-a_0)} w^T(\eta) R_d w(\eta) \geq 0, \quad \forall \eta \geq 0, \quad (3.157)$$

thereby implying that

$$\begin{aligned} & \bar{h}\bar{\tau} e^{\beta(\bar{\tau}+\bar{h})} \int_{s_0}^{s_N} e^{\beta(\eta-a_0)} w^T(\eta) R_d w(\eta) d\eta \\ & \leq \bar{h}\bar{\tau} e^{\beta(\bar{\tau}+\bar{h})} \int_0^t e^{\beta(\eta-a_0)} w^T(\eta) R_d w(\eta) d\eta. \end{aligned} \quad (3.158)$$

Consequently, we can rewrite (3.155) as

$$\begin{aligned} & \int_0^t e^{\beta(\theta-a_0)} (\Delta_d w)^T(\theta) R_d (\Delta_d w)(\theta) d\theta \\ & \leq \bar{h}\bar{\tau} e^{\beta(\bar{\tau}+\bar{h})} \int_0^t e^{\beta(\eta-a_0)} w^T(\eta) R_d w(\eta) d\eta. \end{aligned} \quad (3.159)$$

By rearranging the terms, we have

$$\int_0^t \mathcal{S}_d(\theta, w(\theta), (\Delta_d w)(\theta)) d\theta \leq 0, \quad \forall t \geq 0, \quad (3.160)$$

where  $\mathcal{S}_d(\theta, w(\theta), (\Delta_d w)(\theta))$  is given by (3.38).

### 3.8.10 Proof of Theorem 3.12

Let us recall the linear sampled-data system  $\mathcal{P}_L$  described in Section 3.4.3 by (3.23). The sampling-induced error is given by

$$\begin{aligned} e_s(t) &= \begin{cases} 0, & \forall t \in [0, s_0), \\ Kx(s_k) - Kx(t), & \forall t \in [s_k, s_{k+1}), k \in \mathbb{N}, \end{cases} \\ &= (\Delta_s(K\dot{x}))(t), \end{aligned} \quad (3.161)$$

where  $\Delta_s$  is given by (3.31). Similarly, the delay-induced error is given by

$$\begin{aligned} e_d(t) &= \begin{cases} 0, & \forall t \in [0, a_0), \\ 0, & \forall t \in [a_{k-1}, s_k), k \in \mathbb{N}^*, \\ Kx(s_{k-1}) - Kx(s_k), & \forall t \in [s_k, a_k), k \in \mathbb{N}^*, \end{cases} \\ &= (\Delta_d(K\dot{x}))(t), \end{aligned} \quad (3.162)$$

where  $\Delta_d$  is given by (3.32). Additionally, the functions defined in (3.34) are given by

$$\begin{aligned}\bar{f}_0(x(t)) &= Ax(t), \bar{h}_0(x(t)) = \begin{bmatrix} KAx(t) \\ KAx(t) \end{bmatrix}, \\ \bar{f}(x(t)) &= \bar{A}x(t), \bar{g}(x(t)) = \begin{bmatrix} B & B \end{bmatrix}, \\ \bar{h}(x(t)) &= \begin{bmatrix} K\bar{A}x(t) \\ K\bar{A}x(t) \end{bmatrix}, \bar{l}(x(t)) = \begin{bmatrix} KB \\ KB \end{bmatrix}.\end{aligned}\quad (3.163)$$

Let us consider that condition (3.39) holds. Then, we proceed to prove that the assumptions introduced in Theorem 3.1 will hold for the storage function  $V(x) = x^T Px$  and the supply function  $\mathcal{S} : \mathbb{R}^+ \times \mathbb{R}^{2n} \times \mathbb{R}^{2n} \rightarrow \mathbb{R}$  given by

$$\begin{aligned}\mathcal{S}(t, y(t), \omega(t)) &= \mathcal{S}_s(t, [I \ 0]y(t), [I \ 0]\omega(t)) + \mathcal{S}_d(t, [0 \ I]y(t), [0 \ I]\omega(t)) \\ &= \mathcal{S}_s(t, y_1(t), e_s(t)) + \mathcal{S}_d(t, y_2(t), e_d(t))\end{aligned}\quad (3.164)$$

where  $\mathcal{S}_s$  and  $\mathcal{S}_d$  are defined by (3.36) and (3.38), respectively, with  $\beta = \alpha$ . Additionally, based on the functions given in (3.163), we have  $y_1(t) = y_2(t) = K\dot{x}(t)$ . Let us now show that the assumptions in Theorem 3.1 are validated.

(1) Satisfying Assumption 1, i.e., (3.11): By virtue of Lemmas 3.9 and 3.10, we have that

$$\int_0^t \mathcal{S}_s(\theta, y_1(\theta), (\Delta_s y_1)(\theta)) d\theta \leq 0, \quad \forall t \geq 0, \quad (3.165)$$

and

$$\int_0^t \mathcal{S}_d(\theta, y_2(\theta), (\Delta_d y_2)(\theta)) d\theta \leq 0, \quad \forall t \geq 0. \quad (3.166)$$

Consequently, as per the definition of the supply function in (3.164), we obtain

$$\int_0^t \mathcal{S}(\theta, y(\theta), \omega(\theta)) d\theta \leq 0, \quad \forall t \geq 0. \quad (3.167)$$

(2) Satisfying Assumption 2, i.e., (3.12): With  $V(x) = x^T Px$ ,  $P = P^T > 0$  and  $x \in \mathbb{R}^n$ , we have

$$\delta_{\min}(P)\|x\|^2 \leq x^T Px \leq \delta_{\max}(P)\|x\|^2, \quad (3.168)$$

implying Assumption 2 is satisfied with  $q = 2$ ,  $c_1 = \delta_{\min}(P)$  and  $c_2 = \delta_{\max}(P)$ .

(3) Satisfying Assumption 3, inequality (3.13): Consider the function  $\mathcal{S}(t, y(t), \omega(t))$  given in (3.164). Then, we need to prove that

$$-\mathcal{S}(t, y(t), \omega(t)) \leq \rho V(x(t)), \quad \forall t \in [0, a_0]. \quad (3.169)$$

We proceed to prove this inequality by considering the time intervals  $[0, s_0)$  and  $[s_0, a_0)$  separately.



For all  $t \in [0, s_0)$ : Using the definition of system  $\Sigma$  in (3.9), (3.34), and the operator  $\Delta$  defined in (3.10), (3.32) we have that

$$y(t) = \bar{h}_0(x(t)) = \begin{bmatrix} KAx(t) \\ KAx(t) \end{bmatrix}, \quad (3.170)$$

and

$$\omega(t) = \begin{bmatrix} e_s(t) \\ e_d(t) \end{bmatrix} = \begin{bmatrix} 0 \\ 0 \end{bmatrix}, \quad \forall t \in [0, s_0). \quad (3.171)$$

Hence, for all  $t \in [0, s_0)$ , we have

$$\begin{aligned} -\mathcal{S}(t, y(t), \omega(t)) &= -\mathcal{S}(t, \bar{h}_0(x(t)), 0) \\ &= -(\mathcal{S}_s(t, KAx(t), 0) + \mathcal{S}_d(t, KAx(t), 0)) \\ &= e^{\alpha(t-a_0)} (x^T(t)(KA)^T [\gamma_s^2 R_s + \gamma_d R_d] (KA)x(t)). \end{aligned} \quad (3.172)$$

Therefore,

$$-\mathcal{S}(t, y(t), \omega(t)) \leq \rho_1 V(x(t)), \quad (3.173)$$

with

$$\rho_1 = \frac{e^{-\alpha\tau_0} \delta_{max} [(KA)^T [\gamma_s^2 R_s + \gamma_d R_d] (KA)]}{\delta_{min}(P)}, \quad (3.174)$$

where  $\gamma_s = \frac{2\bar{h}}{\pi}$  and  $\gamma_d = \bar{h}\bar{\tau}e^{\alpha(\bar{h}+\bar{\tau})}$ .

For all  $t \in [s_0, a_0)$ : From (3.163), we have  $y(t) = \begin{bmatrix} y_1(t) \\ y_2(t) \end{bmatrix}$  with

$$y_1(t) = y_2(t) = KAx(t), \quad (3.175)$$

and

$$\omega(t) = \begin{bmatrix} e_s(t) \\ e_d(t) \end{bmatrix} = \begin{bmatrix} Kx(s_0) - Kx(t) \\ 0 \end{bmatrix}. \quad (3.176)$$

Since the system is in open loop for all  $t \in [s_0, a_0)$ , we know

$$x(s_0) = e^{A(s_0-t)}x(t). \quad (3.177)$$

Therefore, we have that

$$\begin{bmatrix} e_s(t) \\ e_d(t) \end{bmatrix} = \begin{bmatrix} K[e^{A(s_0-t)} - I]x(t) \\ 0 \end{bmatrix}, \quad \forall t \in [s_0, a_0). \quad (3.178)$$

Now, consider the function  $\mathcal{S}_s$  defined in (3.36). Since we have already shown in Lemma 3.7 that  $(\Delta_s y_1)(t) = e_s(t)$ , we have that

$$\begin{aligned} \mathcal{S}_s(t, y_1(t), (\Delta_s y_1)(t)) &= \mathcal{S}_s(t, y_1(t), e_s(t)) \\ &= e^{\alpha(t-a_0)} \begin{bmatrix} y_1(t) \\ e_s(t) \end{bmatrix}^T \begin{bmatrix} -\gamma_s^2 R_s & \gamma_s^2 \frac{\alpha}{2} R_s \\ \gamma_s^2 \frac{\alpha}{2} R_s & (1 - \gamma_s^2 \frac{\alpha^2}{4}) R_s \end{bmatrix} \begin{bmatrix} y_1(t) \\ e_s(t) \end{bmatrix}, \end{aligned} \quad (3.179)$$

and thus, from (3.175) and (3.178), we get

$$\begin{aligned}\mathcal{S}_s(t, y_1(t), e_s(t)) &= \mathcal{S}_s(t, KAx(t), K[e^{A(s_0-t)} - I]x(t)) \\ &= x^T(t)\mathcal{M}(t)x(t), \forall t \in [s_0, a_0),\end{aligned}\quad (3.180)$$

where

$$\mathcal{M}(t) = e^{\alpha(t-a_0)} \left[ K \begin{matrix} KA \\ [e^{A(s_0-t)} - I] \end{matrix} \right]^T \begin{bmatrix} -\gamma_s^2 R_s & \gamma_s^2 \frac{\alpha}{2} R_s \\ \gamma_s^2 \frac{\alpha}{2} R_s & (1 - \gamma_s^2 \frac{\alpha^2}{4}) R_s \end{bmatrix} \begin{bmatrix} KA \\ K[e^{A(s_0-t)} - I] \end{bmatrix}. \quad (3.181)$$

Similarly, considering the function  $\mathcal{S}_d$  defined by (3.38), we have that

$$\begin{aligned}\mathcal{S}_d(t, y_2(t), (\Delta_d y_2)(t)) &= \mathcal{S}_d(t, y_2(t), e_d(t)) \\ &= e^{\alpha(t-a_0)} \begin{bmatrix} y_2(t) \\ e_d(t) \end{bmatrix}^T \begin{bmatrix} -\gamma_d R_d & 0 \\ 0 & R_d \end{bmatrix} \begin{bmatrix} y_2(t) \\ e_d(t) \end{bmatrix},\end{aligned}\quad (3.182)$$

and thus, from (3.175) and (3.178),

$$\begin{aligned}\mathcal{S}_d(t, y_2(t), e_d(t)) &= \mathcal{S}_d(t, KAx(t), 0) \\ &= x^T(t)\mathcal{N}(t)x(t), \forall t \in [s_0, a_0),\end{aligned}\quad (3.183)$$

with

$$\mathcal{N}(t) = -\gamma_d e^{\alpha(t-a_0)} (KA)^T R_d (KA). \quad (3.184)$$

Therefore, we have the total supply function  $\mathcal{S}$  satisfying

$$\begin{aligned}-\mathcal{S}(t, y(t), \omega(t)) &= -\mathcal{S}_s(t, y_1(t), e_s(t)) - \mathcal{S}_d(t, y_2(t), e_d(t)) \\ &= x^T(t)M(t)x(t),\end{aligned}\quad (3.185)$$

where

$$M(t) = -\mathcal{M}(t) - \mathcal{N}(t). \quad (3.186)$$

Hence, for all  $t \in [s_0, a_0)$ , we can state that

$$-\mathcal{S}(t, y(t), \omega(t)) \leq \rho_2 V(x(t)), \quad (3.187)$$

where

$$\rho_2 = \frac{\max_{\theta \in [s_0, a_0]} \{\delta_{max}[M(\theta)]\}}{\delta_{min}(P)}. \quad (3.188)$$

Then, from (3.173) and (3.187), we have

$$-\mathcal{S}(t, y(t), \omega(t)) \leq \rho V(x(t)), \forall t \in [0, a_0), \quad (3.189)$$

where  $\rho = \max\{\rho_1, \rho_2\}$  with  $\rho_1$  and  $\rho_2$  given by (3.174) and (3.188), respectively.

(4) Satisfying Assumption 3, inequality (3.14): We have  $V(x(t)) = x(t)^T Px(t)$  for all  $t \geq 0$ . For all  $t \in [0, a_0)$ , since  $\dot{x}(t) = \bar{f}_0(x(t)) = Ax(t)$ , it holds that

$$\begin{aligned} \dot{V}(x(t)) &= x(t)^T [A^T P + PA] x(t) \\ &\geq \frac{\delta_{\min}(A^T P + PA)}{\delta_{\max}(P)} V(x(t)). \end{aligned} \quad (3.190)$$

Therefore, it is clear that inequality (3.14) is satisfied for any  $\lambda \leq \frac{\delta_{\min}(A^T P + PA)}{\delta_{\max}(P)}$ .

(5) Satisfying Assumption 3, inequality (3.15):  
Consider the function

$$W(t) = \dot{V}(x(t)) + \alpha V(x(t)) - e^{-\alpha(t-a_0)} \mathcal{S}(t, y(t), e(t)), \quad (3.191)$$

defined for all  $t \geq a_0$  with  $V(x) = x^T Px$ , and the function  $\mathcal{S}$  defined by (3.164). Clearly, the inequality in (3.15) holds if  $W(t) \leq 0$ , for all  $t \geq a_0$ . Using the definitions of  $\mathcal{S}_s(t, y_1(t), e_s(t))$  and  $\mathcal{S}_d(t, y_2(t), e_d(t))$  in (3.179) and (3.182), respectively, and from (3.163), since  $y_1(t) = y_2(t) = K\dot{x}(t)$ , for all  $t \geq 0$ , we have that

$$\mathcal{S}(t, y(t), \omega(t)) = e^{\alpha(t-a_0)} \begin{bmatrix} K\dot{x}(t) \\ e_s(t) \\ e_d(t) \end{bmatrix}^T \Psi \begin{bmatrix} K\dot{x}(t) \\ e_s(t) \\ e_d(t) \end{bmatrix}, \quad (3.192)$$

with,

$$\Psi = \begin{bmatrix} -\gamma_s^2 R_s - \gamma_d R_d & \gamma_s^2 \frac{\alpha}{2} R_s & 0 \\ \gamma_s^2 \frac{\alpha}{2} R_s & (1 - \gamma_s^2 \frac{\alpha^2}{4}) R_s & 0 \\ 0 & 0 & R_d \end{bmatrix}. \quad (3.193)$$

From the system dynamics defined by (3.9) and (3.163), we have that

$$\begin{aligned} \begin{bmatrix} K\dot{x}(t) \\ e_s(t) \\ e_d(t) \end{bmatrix} &= \begin{bmatrix} K\bar{A} & KB & KB \\ 0 & I & 0 \\ 0 & 0 & I \end{bmatrix} \begin{bmatrix} x(t) \\ e_s(t) \\ e_d(t) \end{bmatrix} \\ &= \begin{bmatrix} K\bar{A} & K\bar{B} \\ 0 & I \end{bmatrix} \begin{bmatrix} x(t) \\ e_s(t) \\ e_d(t) \end{bmatrix}, \end{aligned} \quad (3.194)$$

with  $\bar{A} = A + BK$  and  $\bar{B} = [B \ B]$ . Therefore, from (3.192), we have that

$$\mathcal{S}(t, y(t), \omega(t)) = e^{\alpha(t-a_0)} \begin{bmatrix} x(t) \\ e_s(t) \\ e_d(t) \end{bmatrix}^T N \begin{bmatrix} x(t) \\ e_s(t) \\ e_d(t) \end{bmatrix}, \quad (3.195)$$

where

$$N = \begin{bmatrix} K\bar{A} & K\bar{B} \\ 0 & I \end{bmatrix}^T \Psi \begin{bmatrix} K\bar{A} & K\bar{B} \\ 0 & I \end{bmatrix}. \quad (3.196)$$

Therefore, for all  $t \geq a_0$ , we have that

$$\begin{aligned}
 W(t) &= \dot{V}(x(t)) + \alpha V(x(t)) - e^{-\alpha(t-a_0)} \mathcal{S}(t, y(t), e(t)) \\
 &= \begin{bmatrix} x(t) \\ e_s(t) \\ e_d(t) \end{bmatrix}^T \left\{ \begin{bmatrix} \bar{A}^T P + P \bar{A} & PB & PB \\ B^T P & 0 & 0 \\ B^T P & 0 & 0 \end{bmatrix} + \alpha \begin{bmatrix} P & 0 & 0 \\ 0 & 0 & 0 \\ 0 & 0 & 0 \end{bmatrix} - N \right\} \begin{bmatrix} x(t) \\ e_s(t) \\ e_d(t) \end{bmatrix} \\
 &= \begin{bmatrix} x(t) \\ e_s(t) \\ e_d(t) \end{bmatrix}^T \Gamma \begin{bmatrix} x(t) \\ e_s(t) \\ e_d(t) \end{bmatrix},
 \end{aligned} \tag{3.197}$$

with

$$\Gamma = \begin{bmatrix} \bar{A}^T P + P \bar{A} + \alpha P & P \bar{B} \\ \bar{B}^T P & 0 \end{bmatrix} + \begin{bmatrix} K \bar{A} & K \bar{B} \\ 0 & I \end{bmatrix}^T \Phi \begin{bmatrix} K \bar{A} & K \bar{B} \\ 0 & I \end{bmatrix}, \tag{3.198}$$

with  $\bar{A} = A + BK$ ,  $\bar{B} = \begin{bmatrix} B & B \end{bmatrix}$ , and  $\Phi = -\Psi$  described in (3.40). A sufficient condition for  $W(t) \leq 0, \forall t \geq a_0$  is  $\Gamma \leq 0$ , and guaranteed by (3.39). Consequently, we have proved that the inequality (3.15) is satisfied.

We have shown that all the assumptions of Theorem 3.1 hold for  $V(x) = x^T P x$  and  $\mathcal{S}(t, y(t), \omega(t))$  defined by (3.164) and hence, using Theorem 3.1, system  $\mathcal{P}$  is exponentially stable with a decay rate greater than or equal to  $\alpha/2$ .



## **Part III**

# **Networked Systems: Synchronization Analysis**



## Chapter 4

---

# Exponential Synchronization of Networked Systems Under Asynchronous Sampled-Data Coupling

---

*This chapter presents a novel approach towards synchronization analysis of nonlinear networked systems, directionally coupled via a generic network topology, under asynchronous, aperiodic sampled-data linear coupling. The synchronization dynamics of the networked system is remodelled as a feedback-interconnection of an operator that captures the continuous-time synchronization dynamics, i.e., in the absence of sampled data transmission, and an operator that accounts for these communication constraints. By studying the properties of this feedback-interconnection in the framework of dissipativity theory, we provide a novel criterion that guarantees exponential synchronization. The provided criterion also aids in deciding the trade-off between bounds on time-varying, uncertain sampling intervals, the coupling gain, and the desired transient rate of synchronization, while taking into account the network topology. The theoretical results are illustrated using a networked Fitzhugh-Nagumo neuron system.*

### 4.1 Introduction

In many natural and engineering systems, the phenomenon of synchronization has been investigated by researchers and scientists from various fields. Typical examples of synchronization include flashing fireflies, firing neurons, cooperative control of multi-agent systems, coupling of semiconductor lasers, etc. [74], [118], [126]. In control theory, synchronization of networked nonlinear systems is a topic that has specifically garnered attention owing to its significance in neural processes, communication systems, electronic circuits, etc. [27], [34], [91]. Such



networked scenarios often result in individual sub-systems interacting directionally or bidirectionally. In comparison to weaker definitions of synchronization, i.e., in the form of consensus or synchronization to a set of equilibria, synchronization in the sense of asymptotic matching of time-varying system solutions like persistent oscillations, has been shown to be a more complex and generic problem [104]. Synchronization in this sense has previously been studied by taking network effects such as time-delay into account [103], [123], [125]. Existing works consider modelling the effects on communication links between sub-systems. For example, in [82], [124], continuous-time delay models are used and the conditions for synchronization is related to the topology of the network. However, when digital networks or sampled-data networks are used, asynchrony-induced complexities are known to arise [53], [129]. It is known that in large-scale sampled-data networks (also encountered in network controlled systems), we have to deal with several network effects. For example, transmissions can be aperiodic because of data drop-outs, sensors and actuators need not be synchronized, etc. In the control systems community, it is well known that these effects can induce asynchrony that leads to performance loss or even instability [55], [57], [134]. In the scope of large-scale networks exhibiting synchronization properties, the complexities in synchronization analysis due to the aforementioned network effects and its consequences (asynchronous coupling), has received less attention. More specifically, the associated synchronization problem in large-scale networks has previously been studied only in the synchronous sampling case, or in cases wherein individual sub-systems are linear [72], [77], [117]. In this chapter, we will study the effect of asynchronous sampled-data coupling on synchronization in networks with nonlinear sub-systems. We will consider multi-agent nonlinear systems, connected via a generic network topology, wherein individual systems transmit information over a networked communication channel, asynchronously at possibly different (time-varying and uncertain) sampling intervals.

Synchronization problems in sampled-data systems have been studied in recent years, and different approaches have been proposed to study the relation between sampling period, coupling strength, and synchronization properties [59], [110]. Some of the effects of sampled-data communication in controlled synchronization environment have been shown in [110] for bidirectionally coupled two-agent systems with synchronous transmission. In existing results, it is typically considered that individual systems have synchronous sampling sequences that are constant or time-varying, implying that all the signals are transmitted at the same instant [72], [117]. However, in realistic settings, individual systems usually transmit information at different frequencies over a network, depending upon the communication channel, data traffic, etc. This introduces time-varying and different sampling/communication frequencies for individual links, which leads to asynchronous communication. In the case of nonlinear networked systems coupled via constant time-delayed coupling laws, conditions for synchronization are available in literature [123].

The main contribution of this chapter is a novel approach towards synchronization analysis of a generic networked nonlinear systems, directionally coupled via asynchronous, aperiodic sampled-data communication. We consider the effects of sampling as perturbations to the nominal continuous-time synchronization dynamics (in the absence of sampling events), for which conditions guaranteeing synchronization already exist in literature [103], [123]. By using tools based on input-output methods and dissipativity theory previously used to analyse stability of sampled-data systems [93], we provide a novel criterion that guarantees exponential synchronization in a generic networked nonlinear system, directionally coupled via asynchronous, aperiodic, sampled-data synchronizing laws. In practical scenarios, it is desirable to have a certain measure of system performance. In synchronization problems, this implies achieving a specific transient rate of synchronization, which also depends on the system dynamics, and the network topology. The result provided in this chapter also takes the rate of synchronization into account, and aids in quantitatively analyzing the trade-offs between coupling gain, rate of synchronization, and the maximum bound on the different (time-varying, uncertain) sampling intervals, while considering the network topology. In the special case of periodic sampling, the results in our chapter are related to the ones in [123] concerning constant time-delay systems, since it is known that sampling can be modelled as a special case of (time-varying, resetting) delay. However, an extension of the results in [123] to the case of asynchronous, aperiodic sampling does not exist. Moreover, conditions for stability of system solutions provided in [123], do not hold in the case of asynchronous, aperiodic, sampled-data transmission.

The remainder of this chapter has been structured as follows. In Section 4.2, we introduce the problem setting under consideration, which consists of a generic nonlinear networked system, directionally coupled via asynchronous, aperiodic, sampled-data coupling laws. In Section 4.3, we introduce assumptions on individual system properties, and provide a preliminary result stating conditions guaranteeing uniform ultimate boundedness of the networked system solution. Then, we introduce existing results guaranteeing synchronization in the absence of sampled-data effects. In Section 4.4, we remodel the synchronization dynamics of the networked nonlinear system under consideration as a feedback-interconnection between a continuous-time system operator that captures the synchronization dynamics in the absence of sampling events, and an operator that captures the sampling-induced effects. In Section 4.5, we provide the main result of this chapter, where we use dissipativity theory to study the feedback interconnection introduced in Section 4.4, and provide a novel criterion that guarantees exponential synchronization of the networked nonlinear system. In Section 4.6, we provide a numerical example illustrating the application of our result.

*Notations:*  $\mathbb{R}$  is the set of all real numbers, implying  $\mathbb{R}^n$  is the set of all  $n$ -dimensional real vectors. The set of all natural numbers is denoted by  $\mathbb{N}$ . For

an integer  $n \geq 1$ ,  $I_n$  denotes the  $n \times n$  unit matrix. The dimension  $n$  of a set  $X = \{1, 2, \dots, n\}$  is denoted by  $\dim(X)$ . The Euclidean norm of a vector  $z \in \mathbb{R}^n$  is denoted by  $\|z\| = \sqrt{z^T z}$ , where  $z^T$  denotes the transposition of  $z$ .

## 4.2 Problem Statement

Consider a networked system with individual sub-system dynamics given by

$$\begin{aligned} \dot{x}_i(t) &= f(x_i(t)) + Bu_i(t) \\ y_i(t) &= Cx_i(t), \quad i \in \{1, 2, \dots, N\}, \forall t \geq 0, \end{aligned} \quad (4.1)$$

where  $x_i \in \mathbb{R}^n$ ,  $u_i, y_i \in \mathbb{R}^m$  are the state, input, and output, of the  $i^{\text{th}}$  system, respectively. The function  $f: \mathbb{R}^n \rightarrow \mathbb{R}^n$  is a sufficiently smooth vector field, and  $B$  and  $C$  are matrices with appropriate dimensions, with  $CB =: b \in \mathbb{R}^{m \times m}$  and  $b$  being positive definite and, without loss of generality, diagonal. This implies the system is considered to be of relative degree one. The interconnection between the  $N$  sub-systems is defined by the adjacency matrix

$$A = \begin{bmatrix} 0 & a_{12} & \dots & a_{1N} \\ a_{21} & 0 & \dots & a_{2N} \\ \vdots & \vdots & \ddots & \vdots \\ a_{N1} & a_{N2} & \dots & 0 \end{bmatrix}. \quad (4.2)$$

Here, the constant  $a_{ij} \geq 0$  represents the weight of interconnection from the  $i^{\text{th}}$  sub-system to the  $j^{\text{th}}$  sub-system, for  $j \neq i$ . Only if there is no connection from the  $i^{\text{th}}$  sub-system to the  $j^{\text{th}}$  sub-system, then  $a_{ij} = 0$ . The systems (4.1) whose interconnections are given by (4.2), can be viewed as a directed graph  $\mathcal{G} = (\mathcal{V}, \mathcal{E})$ , where the vertices  $\mathcal{V}$  are individual sub-systems, and  $\mathcal{E}$  is the set of (weighted) edges. The edge  $\mathcal{E}_{(i,j)}$  exists if and only if  $a_{ij} \neq 0$ . Throughout the chapter,  $\mathcal{E}_{(i,j)}$  denotes the weighted edge (interconnection) from the  $i^{\text{th}}$  sub-system to the  $j^{\text{th}}$  sub-system.

**Definition 4.1.** Any sequence of edges that connect the  $i^{\text{th}}$  and  $j^{\text{th}}$  sub-systems is referred to as a directed path from the  $i^{\text{th}}$  sub-system to the  $j^{\text{th}}$  sub-system.

**Assumption 4.2.** The directed graph  $\mathcal{G}$  is strongly connected, i.e., for any  $i^{\text{th}}$  and  $j^{\text{th}}$  sub-systems,  $i, j \in \{1, 2, \dots, N\}$ , there exists a directed path from the  $i^{\text{th}}$  sub-system to  $j^{\text{th}}$  sub-system, and a directed path from the  $j^{\text{th}}$  sub-system to  $i^{\text{th}}$  sub-system.

The output of the  $i^{\text{th}}$  sub-system is transmitted to the  $j^{\text{th}}$  sub-system,  $j \neq i$ , only at instants given by the sampling sequence

$$s_{ij}^{k_{ij}+1} = s_{ij}^{k_{ij}} + h_{ij}^{k_{ij}}, \quad (4.3)$$

with the sampling interval  $h_{ij}^{k_{ij}} \in [\underline{h}_{ij}, \bar{h}_{ij}]$ ,  $k_{ij} \in \mathbb{N}$ , where  $\underline{h}_{ij}$ ,  $\bar{h}_{ij}$  are the upper and lower sampling interval bounds, respectively, satisfying  $0 \leq \underline{h}_{ij} \leq \bar{h}_{ij}$ . Without loss of generality, we consider  $s_{ij}^0 = 0$ ,  $i = \{1, 2, \dots, N\}$ ,  $j \neq i$ . This refers to situations wherein the initial information transmission is synchronous, but due to constraints imposed by the network, asynchronous communication strategies come into play immediately after that.

**Assumption 4.3.** *The  $i^{\text{th}}$  sub-system has access to local output information  $y_i(t)$  at time instants  $t = s_{ji}^{k_{ji}}$ ,  $k_{ji} \in \mathbb{N}$ , where  $j, i = \{1, 2, \dots, N\}$ ,  $i \neq j$ .*

This assumption represents scenarios in which individual sub-systems could be synchronously sampling at identical high frequencies, but transmit information asynchronously at different (and time-varying) frequencies, due to constraints imposed by the communication network. The local information, which is not transmitted over the network, can then be considered to be instantaneously available locally, and can hence be used for local feedback, when the output of the other system is received over the network. A second scenario justifying Assumption 4.3 is that local measurements at the  $i^{\text{th}}$  sub-system could be performed in an event-based fashion, as soon as the sampled output of the  $j^{\text{th}}$  sub-system is received. Under Assumption 4.3, we define the coupling laws between the sub-systems, as supported by the graph interconnection structure, as follows:

$$u_i(t) = \sigma \sum_{j \in \mathcal{E}(j,i)} a_{ji} (\hat{y}_{ji}(t) - \tilde{y}_{ji}(t)), \quad (4.4)$$

where constant  $\sigma > 0$  is called the coupling strength, and

$$\begin{aligned} \hat{y}_{ji}(t) &= y_j(s_{ji}^{k_{ji}}), \forall t \in [s_{ji}^{k_{ji}}, s_{ji}^{k_{ji}+1}), \\ \tilde{y}_{ji}(t) &= y_i(s_{ji}^{k_{ji}}), \forall t \in [s_{ji}^{k_{ji}}, s_{ji}^{k_{ji}+1}), \end{aligned} \quad (4.5)$$

for all  $i, j \in \mathcal{V}$ ,  $j \neq i$ ,  $k_{ji} \in \mathbb{N}$ . Here,  $\hat{y}_{ji}$  is the information transmitted from the  $j^{\text{th}}$  sub-system, to the  $i^{\text{th}}$  sub-system. Similarly,  $\tilde{y}_{ji}$  is the local information at the level of the  $i^{\text{th}}$  sub-system. Let us now formulate the considered synchronization problem.

**Definition 4.4.** *The state-synchronization error between the  $i^{\text{th}}$  and  $j^{\text{th}}$  sub-systems in the coupled system (4.1), (4.4), denoted by  $e_{ij}^x(t)$ , is given by*

$$e_{ij}^x(t) := x_i(t) - x_j(t), i, j \in \{1, 2, \dots, N\}. \quad (4.6)$$

**Definition 4.5.** *The coupled system given by (4.1), (4.4) is said to exponentially synchronize if the state-synchronization error satisfies*

$$\|e_{ij}^x(t)\| \leq \rho e^{-\alpha t} \|e_{ij}^x(0)\|, \forall t \geq 0, \quad (4.7)$$

where  $\rho, \alpha > 0$ ,  $e_{ij}^x(0) \in \mathbb{R}^n$ , for all  $i, j \in \{1, 2, \dots, N\}$ .

The goal of this chapter is to analyse the exponential synchronization of the system (4.1), (4.4) in terms of subsystem dynamics and interaction properties, i.e., sampling, coupling strength and network structure.

### 4.3 Preliminary Results on Boundedness and Synchronization

Before we analyse the synchronization properties of system (4.1), (4.4), it is important to establish conditions under which the solutions of the networked system will remain bounded. In the sense of Definition 4.5, the solution boundedness does not seem to play any role. However, from a practical perspective, it does not make sense to achieve synchronization in systems that are unbounded. This applies to the sampling-free case as well, wherein the boundedness result is obtained by letting nonlinear terms be dominated by linear terms on compact sets. In literature, Krasovskii-type results are often used to prove boundedness of solutions for time-delay systems [123]. However, for interconnected systems with time-varying delay, this problem becomes challenging since this approach is dependent on the rate of change of time-varying delay. On the other hand, Razumikhin-type results, which we will be using in this section, do not pose this challenge. First, we will introduce an assumption of semi-passivity on individual sub-system dynamics. Then, by exploiting this semi-passivity property, we provide a Razumikhin-type result that guarantees boundedness of solutions of system (4.1), (4.4).

#### 4.3.1 Boundedness of Solutions

In this section, in order to establish exponential synchronization of the coupled system (4.1), (4.4), in the sense of Definition 4.5, we introduce an assumption on the system dynamics. First, we define the semi-passivity property.

**Definition 4.6.** [103], [136] Consider a system

$$\dot{x} = f(x) + g(x)u, \quad y = h(x), \quad (4.8)$$

where state  $x \in \mathbb{R}^n$ , input  $u \in \mathbb{R}^m$ , output  $y \in \mathbb{R}^m$ , and  $f, g$  and  $h$  are sufficiently smooth functions. Suppose there exists a positive definite storage function  $V \in C^r : \mathbb{R}^n \rightarrow \mathbb{R}_{>0}$ ,  $V(0) = 0$ ,  $r \geq 1$ , such that the following dissipation inequality

$$\dot{V}(x) \leq y^T u - H(x) \quad (4.9)$$

holds where  $H : \mathbb{R}^n \rightarrow \mathbb{R}$ . The system (4.8) is called

1.  $C^r$ -semi-passive if (4.9) holds with the function  $H(\cdot) \geq 0$  outside a ball  $\mathcal{B} \subset \mathbb{R}^n$  with radius  $\hat{\rho}$ , i.e.,

$$\exists \hat{\rho} > 0, \|x\| \geq \hat{\rho} \implies H(x) \geq \psi(\|x\|), \quad (4.10)$$

with some non-negative continuous function  $\psi(\cdot)$  defined for all  $\|x\| \geq \hat{\rho}$ .

2. strictly  $C^r$ -semi-passive if (4.9) holds with the function  $H(\cdot) > 0$  outside the ball  $\mathcal{B} \subset \mathbb{R}^n$ .

**Assumption 4.7.** Each sub-system in (4.1) is strictly  $C^1$ -semi-passive, i.e., there exists a radially unbounded positive definite storage function  $V \in C^1(\mathbb{R}^n)$  whose derivative along solutions of (4.1) satisfies

$$\dot{V}(x_i(t)) \leq y_i^T(t)u_i(t) - H(x_i(t)), \quad (4.11)$$

where  $H: \mathbb{R}^n \rightarrow \mathbb{R}$  is a scalar continuous function that is positive outside some ball  $\mathcal{B}_i = \{x_i(t) : \|x_i(t)\| \leq \rho\}$ , of radius  $\rho > 0$ :

$$\exists \rho > 0, \forall \|x_i(t)\| \geq \rho \implies H(x_i(t)) \geq \psi(\|x_i(t)\|), \quad (4.12)$$

for some continuous positive function  $\psi(\|x_i(t)\|)$  defined for  $\|x_i(t)\| \geq \rho$ .

Note that since, under Assumption 4.7, the function  $H$  is continuous, we can define

$$\eta = \left| \min_{\|x_i\| \leq \rho} H(x_i) \right| \geq 0. \quad (4.13)$$

Now, by using this constant  $\eta$ , and by exploiting Assumption 4.7, we provide the following result guaranteeing the ultimate boundedness of solutions of system (4.1), (4.4).

**Theorem 4.8.** Consider system (4.1), (4.4). Suppose each sub-system  $i$ ,  $i \in \{1, 2, \dots, N\}$ , satisfies Assumption 4.7, with  $V(x_i) = x_i^T P x_i$ ,  $\rho > 0$ , and  $H(x_i(t))$  satisfying (4.12) with

$$\psi(\|x_i(t)\|) = \sigma\gamma N \|x_i(t)\|^2 \sum_{i,j=1}^N a_{ji} + N\eta, \quad (4.14)$$

and

$$\gamma = \lambda_{\max}(C^T C) \left( 1 + \frac{\kappa \max(\text{eig}(P))}{2 \min(\text{eig}(P))} \right), \quad (4.15)$$

with constant  $\kappa > 1$ , and  $\eta$  given by (4.13). Then, the solutions of the closed-loop system (4.1),(4.4) are uniformly ultimately bounded.

*Proof.* We begin the proof by defining a new time-sequence  $\{s^k\}$ ,  $k \in \mathbb{N}$ , that orders all the sampling-instants of the overall system, i.e.,  $\{s_{ij}^{k_{ij}}\}$ ,  $k_{ij} \in \mathbb{N}$ ,  $i, j \in \{1, 2, \dots, N\}$ , in ascending order. Therefore, we define

$$\begin{aligned} s^0 &= 0, \\ s^{k+1} &:= \min_{i,j} \{s_{ij}^{k_{ij}} : s_{ij}^{k_{ij}} > s^k, k_{ij} \in \mathbb{N}\}, \end{aligned} \quad (4.16)$$

for  $k \in \mathbb{N}$ . In order to prove ultimate boundedness of the solution  $x(t) = [x_1^T(t) \ x_2^T(t) \ \dots \ x_N^T(t)]^T$  under the conditions of the theorem, we will establish the boundedness of solutions for all  $t \in [s^k, s^{k+1})$ , and for all  $k \in \mathbb{N}$ , and, consequently, for all  $t \geq 0$ . Let us define

$$W(x) = V(x_1) + V(x_2) + \dots + V(x_N), \quad (4.17)$$

where  $V(x_i) = x_i^T P x_i, i \in \{1, 2, \dots, N\}$ . The main idea of this proof is to show that for all  $t \in [s^k, s^{k+1}), k \in \mathbb{N}$ , if  $W(x(t))$  is growing with respect to previous values (these values will be detailed later in the proof), and if  $\|x\| > N\rho$  (implying  $\|x_i\| > \rho$  for at least one of the sub-systems  $i \in \{1, 2, \dots, N\}$ ), then under the conditions of the theorem,  $\dot{W} < 0$  will be guaranteed. To that end, we will start by exploiting Assumption 4.7. Consider the term  $y_i(t)u_i(t), i \in \{1, 2, \dots, N\}$ , in (4.11). From the definition of the coupling law in (4.4), and by using *Young's inequality*, we have,

$$\begin{aligned} y_i^T(t)u_i(t) &= \sigma y_i^T(t) \sum_{j=1}^N a_{ji}(\hat{y}_{ji}(t) - \tilde{y}_{ji}(t)) \\ &= \sigma \sum_{j=1}^N a_{ji} (y_i^T(t)\hat{y}_{ji}(t) - y_i^T(t)\tilde{y}_{ji}(t)) \\ &\leq \sigma \sum_{j=1}^N a_{ji} \left( \|y_i(t)\|^2 + \frac{1}{2}(\|\hat{y}_{ji}(t)\|^2 + \|\tilde{y}_{ji}(t)\|^2) \right), \end{aligned} \quad (4.18)$$

where  $\hat{y}_{ji}(t)$  and  $\tilde{y}_{ji}(t)$  are given by (4.5). From (4.16), we know that the sampling sequence  $\{s^k, k \in \mathbb{N}\}$ , is defined such that for all  $t \in [s^k, s^{k+1})$ , every  $\hat{y}_{ji}(t)$  and  $\tilde{y}_{ji}(t)$  will be constant, with  $\hat{y}_{ji}(t) = \hat{y}_{ji}(s^k)$  and  $\tilde{y}_{ji}(t) = \tilde{y}_{ji}(s^k)$ , respectively. This is illustrated in Figure 4.1 for an exemplary 3-agent system connected via a ring topology, i.e., the transmitted outputs are  $\hat{y}_{12}, \hat{y}_{23}$  and  $\hat{y}_{31}$ . Therefore, from (4.18), for all  $t \in [s^k, s^{k+1}), k \in \mathbb{N}$ , we have that

$$y_i^T(t)u_i(t) \leq \sigma \sum_{j=1}^N a_{ji} \left( \|y_i(t)\|^2 + \frac{1}{2}(\|\hat{y}_{ji}(s^k)\|^2 + \|\tilde{y}_{ji}(s^k)\|^2) \right). \quad (4.19)$$

Let  $k_{ji}^*$  denote the index of the last instant when information was transmitted from sub-system  $j$  to sub-system  $i$  before or at  $s^k$ , i.e.,  $s_{ji}^{k_{ji}^*} \leq s^k$ . Therefore,

$$\hat{y}_{ji}(s^k) = \hat{y}_{ji}(s_{ji}^{k_{ji}^*}) = y_j(s_{ji}^{k_{ji}^*}), \forall t \in [s^k, s^{k+1}), \quad (4.20)$$

and

$$\tilde{y}_{ji}(s^k) = \tilde{y}_{ji}(s_{ji}^{k_{ji}^*}) = y_i(s_{ji}^{k_{ji}^*}), \forall t \in [s^k, s^{k+1}). \quad (4.21)$$

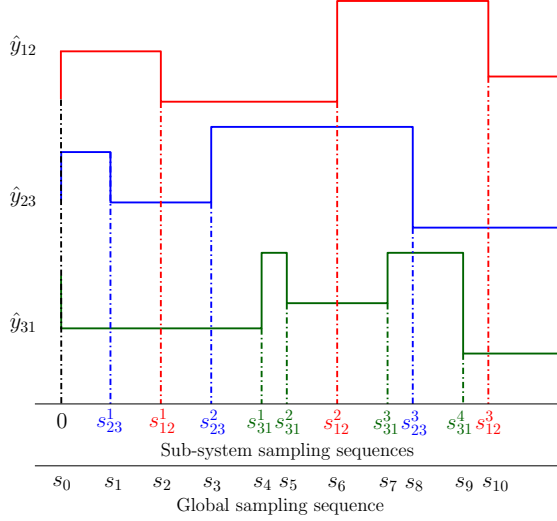

Figure 4.1: At the global level, between any two sampling instants  $s^k$ , all the transmitted signals over the network are constant. This is illustrated using exemplary transmitted signals  $\hat{y}_{12}$ ,  $\hat{y}_{23}$  and  $\hat{y}_{31}$  in a three-agent network connected via a ring topology.

Consequently, from (4.19), for all  $t \in [s^k, s^{k+1})$ , we obtain

$$\begin{aligned} y_i^T(t)u_i(t) &\leq \sigma \sum_{j=1}^N a_{ji} \left( \|y_i(t)\|^2 + \frac{1}{2} (\|y_j(s_{ji}^{k*})\|^2 + \|y_i(s_{ji}^{k*})\|^2) \right) \\ &\leq \sigma \sum_{j=1}^N a_{ji} \left( \|y(t)\|^2 + \frac{1}{2} \|y(s_{ji}^{k*})\|^2 \right), \end{aligned} \quad (4.22)$$

where  $y = [y_1^T \ y_2^T \ \dots \ y_N^T]^T$ . Let us define the index  $k^*$  such that

$$\|y(s^{k^*})\| = \max_{i,j \in \{1,2,\dots,N\}} \{\|y(s_{ji}^{k^*})\|\}. \quad (4.23)$$

Using this index, from (4.22), for all  $t \in [s^k, s^{k+1})$ , we have that

$$y_i^T(t)u_i(t) \leq \sigma \left( \|y(t)\|^2 + \frac{1}{2} \|y(s^{k^*})\|^2 \right) \sum_{j=1}^N a_{ji}. \quad (4.24)$$

Note that multiple  $k^*$  may exist for which (4.23) holds. Nevertheless, (4.24) holds for any such  $k^*$ . Using the system definition (4.1), in particular that



$y_i = Cx_i$ , we have

$$y_i^T(t)u_i(t) \leq \sigma \lambda_{max}(C^T C) \left( \|x(t)\|^2 + \frac{1}{2} \|x(s^{k^*})\|^2 \right) \sum_{j=1}^N a_{ji}. \quad (4.25)$$

We will exploit inequality (4.25) later.

Since sampling can be modelled as a form of time-varying, resetting delay, we will be using classical Razumikhin-type results available in time-delay systems literature (see [52], Theorem 4.3) to prove ultimate boundedness of solutions. As mentioned in the beginning of the proof, the main idea of this proof is to show that for all  $t \in [s^k, s^{k+1})$ ,  $k \in \mathbb{N}$ , if  $\phi(W(x(t))) \geq W(x(s^{k^*}))$  and if  $\|x\| > N\rho$ , then under the conditions of the theorem,  $\dot{W} < 0$  will be guaranteed. Here,  $\phi: \mathbb{R}^+ \rightarrow \mathbb{R}^+$  is a continuous non-decreasing function, with  $\phi(s) > s$  for  $s > 0$ . Choosing the function  $\phi(s) = \kappa s$ ,  $\kappa > 1$ , the proof aims to show that for all  $t \in [s^k, s^{k+1})$ ,  $k \in \mathbb{N}$ , if

$$\sum_{i=1}^N x_i^T(s^{k^*})Px_i(s^{k^*}) \leq \kappa \sum_{i=1}^N x_i^T(t)Px_i(t), \kappa > 1, \quad (4.26)$$

then, under the conditions of the theorem, when  $\|x(t)\| > N\rho$  (implying  $\|x_i\| > \rho$  for at least one of the sub-systems  $i \in \{1, 2, \dots, N\}$ ),  $\dot{W} < 0$  needs to be guaranteed. Now, condition (4.26) implies

$$\|x(s^{k^*})\|^2 \leq \kappa \frac{\max(\text{eig}(P))}{\min(\text{eig}(P))} \|x(t)\|^2, \forall t \in [s^k, s^{k+1}), k \in \mathbb{N}, \quad (4.27)$$

where  $x = [x_1^T \ x_2^T \ \dots \ x_N^T]^T$  and  $s^{k^*}$  is given by (4.23). Under this condition, inequality (4.25) can be rewritten as

$$y_i^T(t)u_i(t) \leq \sigma\gamma \|x(t)\|^2 \sum_{j=1}^N a_{ji}, \quad (4.28)$$

where  $\gamma$  is given by (4.15). Now, from (4.17), using Assumption 4.7, for all  $t \in [s^k, s^{k+1})$ ,  $k \in \mathbb{N}$ , we have

$$\dot{W}(x(t)) \leq \sum_{i=1}^N [y_i^T(t)u_i(t) - H(x_i(t))]. \quad (4.29)$$

Now, consider the set  $\mathcal{I}_\star \subset \{1, 2, \dots, N\}$  defined by

$$\mathcal{I}_\star := \{i \in \{1, 2, \dots, N\} : \|x_i\| > \rho\}, \quad (4.30)$$

and the set  $\tilde{\mathcal{I}} \subset \{1, 2, \dots, N\}$  defined by

$$\tilde{\mathcal{I}} := \{i \in \{1, 2, \dots, N\} : \|x_i\| \leq \rho\}. \quad (4.31)$$

Clearly  $\mathcal{I}_* \cup \tilde{\mathcal{I}} = \mathcal{I} = \{1, 2, \dots, N\}$ . Then, using (4.28), the term  $\sum_{i=1}^N y_i^T(t)u_i(t)$  in (4.29) can be expressed as

$$\begin{aligned} \sum_{i=1}^N y_i^T(t)u_i(t) &= \sum_{i \in \mathcal{I}_*} y_i^T(t)u_i(t) + \sum_{i \in \tilde{\mathcal{I}}} y_i^T(t)u_i(t) \\ &\leq \sum_{i \in \mathcal{I}_*} \sigma\gamma \|x(t)\|^2 \sum_{j \in \mathcal{I}} a_{ji} + \sum_{i \in \tilde{\mathcal{I}}} \sigma\gamma \|x(t)\|^2 \sum_{j \in \mathcal{I}} a_{ji} \\ &= \sigma\gamma \|x(t)\|^2 \sum_{i,j \in \mathcal{I}} a_{ji}, \end{aligned} \quad (4.32)$$

since  $\sum_{i \in \mathcal{I}_*, j \in \mathcal{I}} a_{ji} + \sum_{i \in \tilde{\mathcal{I}}, j \in \mathcal{I}} a_{ji} = \sum_{i,j \in \mathcal{I}} a_{ji}$ . Therefore, by using the fact that  $\|x(t)\|^2 = \sum_{i \in \mathcal{I}_*} \|x_i(t)\|^2 + \sum_{i \in \tilde{\mathcal{I}}} \|x_i(t)\|^2$ , we have

$$\begin{aligned} \sum_{i=1}^N y_i^T(t)u_i(t) &\leq \sigma\gamma \|x(t)\|^2 \sum_{i,j \in \mathcal{I}} a_{ji} \\ &= \sum_{i \in \mathcal{I}_*} \sigma\gamma \|x_i(t)\|^2 \sum_{j,l \in \mathcal{I}} a_{jl} + \sum_{i \in \tilde{\mathcal{I}}} \sigma\gamma \|x_i(t)\|^2 \sum_{j,l \in \mathcal{I}} a_{jl}. \end{aligned} \quad (4.33)$$

Then, using (4.33) and the fact that  $\sum_{i=1}^N H(x_i(t)) = \sum_{i \in \mathcal{I}_*} H(x_i(t)) + \sum_{i \in \tilde{\mathcal{I}}} H(x_i(t))$ , inequality (4.29) can be written as

$$\begin{aligned} \dot{W}(x(t)) &\leq \sum_{i \in \mathcal{I}_*} \left( \sigma\gamma \|x_i(t)\|^2 \sum_{j,l \in \mathcal{I}} a_{jl} - H(x_i(t)) \right) \\ &\quad + \sum_{i \in \tilde{\mathcal{I}}} \left( \sigma\gamma \|x_i(t)\|^2 \sum_{j,l \in \mathcal{I}} a_{jl} - H(x_i(t)) \right). \end{aligned} \quad (4.34)$$

Under the conditions of the theorem, i.e., for  $\|x_i(t)\| > \rho$  for all  $i \in \mathcal{I}_*$ , we have that  $H(x_i(t))$ , satisfies

$$H(x_i(t)) - \sigma\gamma N \|x_i(t)\|^2 \sum_{i,j=1}^N a_{ji} - N\eta > 0, \quad (4.35)$$

with  $\gamma, \eta$  given by (4.15), (4.13), respectively. Therefore, using (4.35), inequality (4.34) implies

$$\begin{aligned} \dot{W}(x(t)) &\leq \sum_{i \in \mathcal{I}_*} \left( \sigma\gamma \|x_i(t)\|^2 \sum_{j,l \in \mathcal{I}} a_{jl} - \sigma\gamma \|x_i(t)\|^2 \sum_{j,l \in \mathcal{I}} a_{jl} \right. \\ &\quad \left. - \sigma\gamma(N-1) \|x_i(t)\|^2 \sum_{j,l \in \mathcal{I}} a_{jl} - N\eta \right) + \sum_{i \in \tilde{\mathcal{I}}} \left( \sigma\gamma \|x_i(t)\|^2 \sum_{j,l \in \mathcal{I}} a_{jl} - H(x_i(t)) \right) \\ &\leq \sum_{i \in \mathcal{I}_*} \left( -\sigma\gamma(N-1) \|x_i(t)\|^2 \sum_{j,l \in \mathcal{I}} a_{jl} - N\eta \right) + \sum_{i \in \tilde{\mathcal{I}}} \left( \sigma\gamma \|x_i(t)\|^2 \sum_{j,l \in \mathcal{I}} a_{jl} - H(x_i(t)) \right), \end{aligned} \quad (4.36)$$

with  $\gamma, \eta$  given by (4.15), (4.13), respectively. It is clear that when at least one subsystem satisfies  $\|x_i\| > \rho$ , i.e.,  $\dim(\mathcal{I}_\star) \geq 1$ , we have that  $\dim(\tilde{\mathcal{I}}) \leq N-1$ . Additionally, from the definition of the sets  $\mathcal{I}_\star$  and  $\tilde{\mathcal{I}}$  in (4.30) and (4.31), respectively, we know  $\|x_i\| > \|x_j\|$ , for any  $i \in \mathcal{I}_\star$  and  $j \in \tilde{\mathcal{I}}$ . Consequently,  $\sum_{i \in \mathcal{I}_\star} (N-1) \|x_i(t)\|^2 > \sum_{i \in \tilde{\mathcal{I}}} \|x_i(t)\|^2$ , i.e.,

$$\sum_{i \in \mathcal{I}_\star} \left| -\sigma\gamma(N-1) \|x_i(t)\|^2 \sum_{j, l \in \mathcal{I}} a_{jl} \right| > \sum_{i \in \tilde{\mathcal{I}}} \sigma\gamma \|x_i(t)\|^2 \sum_{j, l \in \mathcal{I}} a_{jl}, \quad (4.37)$$

implying

$$\sum_{i \in \mathcal{I}_\star} -\sigma\gamma(N-1) \|x_i(t)\|^2 \sum_{j, l \in \mathcal{I}} a_{jl} + \sum_{i \in \tilde{\mathcal{I}}} \sigma\gamma \|x_i(t)\|^2 \sum_{j, l \in \mathcal{I}} a_{jl} < 0, \quad (4.38)$$

with  $\gamma, \eta$  given by (4.15), (4.13), respectively. Therefore, inequality (4.36) clearly implies

$$\dot{W}(x(t)) < -\dim(\mathcal{I}_\star)N\eta - \sum_{i \in \tilde{\mathcal{I}}} H(x_i(t)). \quad (4.39)$$

In the above inequality, if  $\sum_{i \in \tilde{\mathcal{I}}} H(x_i(t)) \geq 0$ , then  $\dot{W} < 0$  since  $\dim(\mathcal{I}_\star)N\eta \geq 0$  (because  $\dim(\mathcal{I}_\star) \geq 1$ ,  $N > 0$  and  $\eta \geq 0$ ). On the other hand, consider  $\sum_{i \in \tilde{\mathcal{I}}} H(x_i(t)) < 0$ . Then, from the definition of  $\eta$  in (4.13), and the fact  $\dim(\tilde{\mathcal{I}}) \leq N-1$  (when  $\dim(\mathcal{I}_\star) \geq 1$ ), it is clear that  $|\sum_{i \in \tilde{\mathcal{I}}} H(x_i(t))| \leq (N-1)\eta$ . Therefore,

$$\dim(\mathcal{I}_\star)N\eta \geq \left| \sum_{i \in \tilde{\mathcal{I}}} H(x_i(t)) \right|, \quad (4.40)$$

and consequently, inequality (4.39) implies

$$\dot{W}(x(t)) < 0. \quad (4.41)$$

Since sampling can be viewed as a time-varying and resetting delay, the condition  $\phi(W(x(t))) \geq W(x(s^{k^*}))$  for the continuous non-decreasing function  $\phi(s) = \kappa s, \kappa > 1$ , can be written as  $\phi(W(x(t))) \geq W(x(t+\theta))$ ,  $\theta \in [-\max_{i,j} \bar{h}_{ij}, 0]$ . Therefore, we have shown that  $\dot{W}(x) < 0$  when  $\phi(W(x(t))) \geq W(x(t+\theta))$ ,  $\theta \in [-\max_{i,j} \bar{h}_{ij}, 0]$ , and  $\|x\| > N\rho$ . Then, by applying the Razumikhin-type theorem for uniform ultimate boundedness of time-delay systems, given in [52], Theorem 4.3, we can directly conclude that the solutions of the system (4.1), (4.4) are uniformly ultimately bounded.  $\square$

Now that conditions for boundedness of solutions has been established, we proceed to study the synchronization properties of system (4.1), (4.4). Since the individual systems under consideration are of relative degree one, we know that there exists a well-defined coordinate transformation  $z_i = \Phi(x_i)$ ,  $z_i \in \mathbb{R}^{n-m}$ ,  $i = \{1, 2, \dots, N\}$ , such that the  $i^{\text{th}}$  sub-system dynamics are represented by

$$\begin{aligned} \dot{z}_i(t) &= q(z_i(t), y_i(t)), \\ \dot{y}_i(t) &= a(z_i(t), y_i(t)) + bu_i(t), i = \{1, 2, \dots, N\}, \end{aligned} \quad (4.42)$$

where  $z_i \in \mathbb{R}^{n-m}$ ,  $u_i, y_i \in \mathbb{R}^m$ ,  $q: \mathbb{R}^{n-m} \times \mathbb{R}^m \rightarrow \mathbb{R}^{n-m}$ , and  $a: \mathbb{R}^{n-m} \times \mathbb{R}^m \rightarrow \mathbb{R}^m$  [104]. In this chapter, we will analyse the exponential synchronization of system (4.42), (4.4), which implies the exponential synchronization of system (4.1), (4.4). The remainder of this chapter deals with system (4.42), (4.4).

### 4.3.2 Continuous-time Synchronization

As mentioned in the introduction, we will consider the effects of sampling as perturbations to the nominal continuous-time synchronization dynamics, i.e., synchronization dynamics in the absence of sampling. In this section, we will study the synchronization properties of system (4.42) with the coupling law  $u_i = u_i^*$ , where  $u_i^*$  is the ideal (continuous-time) coupling law given by

$$u_i^*(t) = \sigma \sum_{j \in \mathcal{E}(j,i)} a_{ji}(y_j(t) - y_i(t)), \forall t \geq 0. \quad (4.43)$$

In order to achieve incremental stabilization via output feedback, we require incremental stability conditions on the internal dynamics  $\dot{z}_i$  in (4.42). To this end, we will first introduce a definition of the convergence property, which will also be exploited later to ensure certain synchronization properties.

**Definition 4.9.** [28] *The dynamics  $\dot{x} = g(x, u(t))$ , with  $u : \mathbb{R} \mapsto \mathbb{R}$  being a piecewise continuous function, are said to be convergent if*

- *there exists a solution  $\bar{x}(t)$  which is bounded for all  $t \in \mathbb{R}$ ,*
- *$\bar{x}(t)$  is a globally asymptotically stable solution.*

The second point implies that for any initial condition  $x_0$ , the solution  $x(t)$  converges to the bounded solution  $\bar{x}(t)$ . The solution  $\bar{x}(t)$  is called the steady-state solution. If  $\bar{x}(t)$  is in addition exponentially stable, then the system is called *exponentially convergent*. Once synchronization is achieved, the diffusive coupling law (4.4) (or the continuous-time coupling law (4.43)) vanishes. Consequently, having certain incremental stability properties on the internal dynamics  $\dot{z}_i$  in (4.42) will guarantee convergence towards an asymptotically stable solution.

Now, we will recall the following sufficient condition for exponential convergence.

**Theorem 4.10.** (Demidovich Condition [98]) *Consider the system dynamics  $\dot{x} = g(x, u)$ , where  $g$  is a sufficiently smooth function, and  $u$  is a piecewise continuous function that takes values in a compact set. If there exists a positive definite matrix  $P = P^T > 0$  such that*

$$P \frac{\partial g}{\partial x}(x, u) + \frac{\partial g^T}{\partial x}(x, u) P \leq -\delta I, \quad (4.44)$$

where  $\delta > 0$ , and  $I$  is of appropriate dimension, then the system  $\dot{x} = g(x, u)$  is exponentially convergent.

Next, we consider the following assumption guaranteeing exponential convergence of internal dynamics of (4.42).

**Assumption 4.11.** *The internal state dynamics of (4.42) given by  $\dot{z}_i(t) = q(z_i(t), y_i(t))$ ,  $i = \{1, 2, \dots, N\}$ , satisfies condition (4.44), i.e., there exists  $P_z = P_z^T > 0$  and  $\delta > 0$ , such that*

$$P_z \frac{\partial q}{\partial z_i}(z_i, y_i) + \frac{\partial q^T}{\partial z_i}(z_i, y_i) P_z \leq -\delta I_{n-m}. \quad (4.45)$$

Now, we introduce a preliminary result on the interconnected system (4.42), in the absence of sampling, i.e., with  $u_i(t) = u_i^*(t)$  given by the coupling law in (4.43). This result guaranteeing exponential synchronization of the continuous-time system (4.42) with coupling law (4.43), is an extension of the result provided in [104] for a two-agent system, to a generic multi-agent system.

**Theorem 4.12.** [104], [123] *Consider system (4.42) with  $u_i(t) = u_i^*(t)$  given by (4.43), and let Assumption 4.2 and Assumption 4.11 hold. Then, there exists a constant  $\bar{\sigma}$  such that for all  $\sigma > \bar{\sigma}$ , the (directionally) coupled system given by (4.42) with  $u_i(t) = u_i^*(t)$ , achieves exponential synchronization.*

Under the conditions of Theorem 4.12 (continuous-time exponential synchronization), there exists a matrix  $\mathbf{P}_y$  such that a storage function

$$W(e(t)) = \begin{bmatrix} e_z(t) \\ e_y(t) \end{bmatrix}^T \begin{bmatrix} \mathbf{P}_z & 0 \\ 0 & \mathbf{P}_y \end{bmatrix} \begin{bmatrix} e_z(t) \\ e_y(t) \end{bmatrix}, \quad (4.46)$$

where  $\mathbf{P}_z = I_{(N-1) \times (N-1)} \otimes P_z$  exists satisfying the inequality in Assumption 4.11 [123], and the synchronization errors  $e_y(t)$  and  $e_z(t)$  are defined by

$$e_z(t) = \begin{bmatrix} z_1(t) - z_2(t) \\ z_1(t) - z_3(t) \\ \vdots \\ z_1(t) - z_N(t) \end{bmatrix}, e_y(t) = \begin{bmatrix} y_1(t) - y_2(t) \\ y_1(t) - y_3(t) \\ \vdots \\ y_1(t) - y_N(t) \end{bmatrix}. \quad (4.47)$$

This storage function can be used to characterize the exponential stability properties of the synchronization manifold defined by

$$\mathcal{M} := \left\{ \text{col}(z_1, z_2 \dots z_N, y_1, y_2 \dots y_N) \in \mathbb{R}^{Nn} : z_1 = z_2 = \dots = z_N, y_1 = y_2 = \dots = y_N \right\}. \quad (4.48)$$

Therefore, using such a storage function, it can be shown that  $\dot{W} + \alpha W \leq 0$ , where  $\alpha > 0$  [123]. While the matrix  $\mathbf{P}_z$  results from Assumption 4.11, it has previously been shown that with a diagonal matrix  $\mathbf{P}_y > 0$ , a candidate storage function of the form given in (4.46), can be used to characterize the exponential stability properties of the synchronization manifold (see Theorem 3, Lemma 7, and Proposition 2 in [123]).

In the following lemma, we establish positive invariance of the synchronization manifold for system (4.42), (4.4), i.e., for the system with sampled-data coupling.

**Lemma 4.13.** *The synchronization manifold defined by (4.48) is positively invariant under the directionally coupled system (4.42), with  $u_i(t), i \in \{1, 2, \dots, N\}$ , given by (4.4).*

*Proof.* From (4.4), we know that on the synchronization manifold,  $u_i(t) = 0$  for all  $i \in \{1, 2, \dots, N\}$ ,  $t \in \mathbb{R}$ , since  $y_1(t) = y_2(t) = \dots = y_N(t)$ . As a consequence of identical system (input-output) dynamics, from (4.42), since on the synchronization manifold  $\mathcal{M}$ ,  $y_1(t) = y_2(t) = \dots = y_N(t)$  and  $z_1(t) = z_2(t) = \dots = z_N(t)$ , we have that  $\dot{y}_1(t) = \dot{y}_2(t) = \dots = \dot{y}_N(t)$  and  $\dot{z}_1(t) = \dot{z}_2(t) = \dots = \dot{z}_N(t)$ . Therefore, we have that  $\mathcal{M}$  is positively invariant.  $\square$

Given the positive invariance of the synchronization manifold, we proceed to analyse the exponential synchronization of system (4.42), (4.4), which relates to the exponential stability properties of this manifold, as follows. In the next section, the effects of sampling on the synchronization error dynamics of system (4.1), (4.4), given by  $[\dot{e}_y^T(t) \quad \dot{e}_z^T(t)]^T$  with  $e_z(t)$ ,  $e_y(t)$  defined by (4.47), are modelled as perturbations to the nominal continuous-time networked system given by (4.42), with  $u_i(t) = u_i^*(t)$  in (4.43). The properties of these perturbations are then studied, which aid in obtaining conditions that help analyse the synchronization robustness of the nominal continuous-time dynamics, with respect to the sampling-induced perturbations.

## 4.4 Synchronization Error Dynamics

In this section, we reformulate the synchronization error dynamics of system (4.42), (4.4) as the feedback interconnection between a system operator that captures the continuous-time synchronization error dynamics (system (4.42), (4.43)), and an operator that captures the sampling-induced effects.

### 4.4.1 Continuous-time Synchronization Error Dynamics

For  $i \in \{1, 2, \dots, N\}$ , consider the notation for synchronization error

$$\begin{aligned} e_{1i}^z(t) &= \begin{cases} 0, \forall t \in [-\max_{i,j}(\bar{h}_{ij}), 0) \\ z_1(t) - z_i(t), \forall t \geq 0, \end{cases} \\ e_{1i}^y(t) &= \begin{cases} 0, \forall t \in [-\max_{i,j}(\bar{h}_{ij}), 0) \\ y_1(t) - y_i(t), \forall t \geq 0. \end{cases} \end{aligned} \quad (4.49)$$

Then, the synchronization errors are defined as

$$e_z(t) = \begin{bmatrix} e_{12}^z(t) \\ e_{13}^z(t) \\ \vdots \\ e_{1N}^z(t) \end{bmatrix}, e_y(t) = \begin{bmatrix} e_{12}^y(t) \\ e_{13}^y(t) \\ \vdots \\ e_{1N}^y(t) \end{bmatrix}, \quad (4.50)$$

with  $e_{1i}^z(t), e_{1i}^y(t)$  given by (4.49) for all  $t \geq 0$ . Consequently, for all  $t \geq 0$ , the synchronization error dynamics for the internal dynamics is given by

$$\dot{e}_z(t) = \begin{bmatrix} \dot{e}_{12}^z(t) \\ \dot{e}_{13}^z(t) \\ \vdots \\ \dot{e}_{1N}^z(t) \end{bmatrix}, \quad (4.51)$$

where, for  $i \in \{2, 3, \dots, N\}$ ,

$$\begin{aligned} \dot{e}_{1i}^z(t) &= \dot{z}_1(t) - \dot{z}_i(t) = q(z_1(t), y_1(t)) - q(z_i(t), y_i(t)), \\ &= f_z(e_{1i}^z(t), e_{1i}^y(t), z_1(t), y_1(t)), \end{aligned} \quad (4.52)$$

with

$$f_z(e_{1i}^z(t), e_{1i}^y(t), z_1(t), y_1(t)) = q(z_1(t), y_1(t)) - q(z_1(t) - e_{1i}^z(t), y_1(t) - e_{1i}^y(t)). \quad (4.53)$$

Similarly, the output synchronization error dynamics is given by

$$\dot{e}_y(t) = \begin{bmatrix} \dot{e}_{12}^y(t) \\ \dot{e}_{13}^y(t) \\ \vdots \\ \dot{e}_{1N}^y(t) \end{bmatrix}, \quad (4.54)$$

where, for  $i \in \{2, 3, \dots, N\}$ ,

$$\begin{aligned} \dot{e}_{1i}^y(t) &= \dot{y}_1(t) - \dot{y}_i(t) = a(z_1(t), y_1(t)) - a(z_i(t), y_i(t)) + b(u_1(t) - u_i(t)), \\ &= f_y(e_{1i}^z(t), e_{1i}^y(t), z_1(t), y_1(t)) + b(u_1(t) - u_i(t)), \end{aligned} \quad (4.55)$$

with the coupling laws for  $u_1(t), u_i(t), i \in \{2, 3, \dots, N\}$ , given by (4.4), and

$$f_y(e_{1i}^z(t), e_{1i}^y(t), z_1(t), y_1(t)) = a(z_1(t), y_1(t)) - a(z_1(t) - e_{1i}^z(t), y_1(t) - e_{1i}^y(t)). \quad (4.56)$$

We shall now formulate the synchronization error dynamics in the absence of any sampling effects, i.e., with the ideal continuous-time coupling law (4.43).

**Lemma 4.14.** *Consider the continuous-time system (4.42), (4.43). Then, the synchronization error dynamics (4.51), (4.52), (4.54), (4.55) with continuous-time coupling laws (4.43), is given by*

$$\begin{aligned} \dot{e}_{1i}^z &= f_z(e_{1i}^z(t), e_{1i}^y(t), z_1(t), y_1(t)), \\ \dot{e}_{1i}^y(t) &= f_y(e_{1i}^z(t), e_{1i}^y(t), z_1(t), y_1(t)) - b\sigma \left( a_{1i}e_{1i}^y(t) \right. \\ &\quad \left. + \sum_{j=2}^N (a_{j1}e_{1j}^y(t) + a_{ji}(e_{1i}^y(t) - e_{1j}^y(t))) \right), \forall t \geq 0, \end{aligned} \quad (4.57)$$

for  $i \in \{2, 3, \dots, N\}$ , with functions  $f_z$  and  $f_y$  given by (4.53) and (4.56), respectively.

*Proof.* Let us recall the continuous-time coupling law for sub-system  $i$ , given in (4.43). We have,

$$\begin{aligned} u_i^*(t) &= \sigma \sum_{j=1}^N a_{ji}(y_j(t) - y_i(t)), j \neq i, \\ &= \sigma \sum_{j=1}^N a_{ji}(y_j(t) - y_i(t) + y_1(t) - y_1(t)) \\ &= \sigma \sum_{j=1}^N a_{ji}((y_1(t) - y_i(t)) - (y_1(t) - y_j(t))) \\ &= \sigma \sum_{j=1}^N a_{ji}(e_{1i}^y(t) - e_{1j}^y(t)) = \sigma(a_{1i}e_{1i}^y(t) + \sum_{j=2}^N a_{ji}(e_{1i}^y(t) - e_{1j}^y(t))). \end{aligned} \quad (4.58)$$

Now, from the definition of the synchronization error dynamics in (4.51), (4.54), for the continuous-time system (4.42), (4.43), we have, for all  $t \geq 0$  and  $i \in \{2, 3, \dots, N\}$ ,

$$\begin{aligned} \dot{e}_{1i}^z(t) &= \dot{z}_1(t) - \dot{z}_i(t) = q(z_1(t), y_1(t)) - q(z_i(t), y_i(t)), \\ &= f_z(e_{1i}^z(t), e_{1i}^y(t), z_1(t), y_1(t)), \end{aligned} \quad (4.59)$$

where  $f_z$  is given by (4.53). Similarly, for all  $t \geq 0$ ,

$$\begin{aligned} \dot{e}_{1i}^y(t) &= \dot{y}_1(t) - \dot{y}_i(t) = a(z_1(t), y_1(t)) - a(z_i(t), y_i(t)) + b(u_1^*(t) - u_i^*(t)), \\ &= f_y(e_{1i}^z(t), e_{1i}^y(t), z_1(t), y_1(t)) + b(u_1^*(t) - u_i^*(t)), \end{aligned} \quad (4.60)$$

where  $f_y$  is given by (4.56). From (4.58) and notation (4.49), for sub-system  $i = 1$ , we have

$$u_1^*(t) = -\sigma \sum_{j=2}^N a_{j1}e_{1j}^y(t), \forall t \geq 0. \quad (4.61)$$



Hence, for all  $t \geq 0$ , we can rewrite (4.60) as

$$\begin{aligned}
 e_{1i}^y(t) &= f_y(e_{1i}^z(t), e_{1i}^y(t), z_1(t), y_1(t)) + b\sigma\left(-\sum_{j=2}^N a_{j1}e_{1j}^y(t) - a_{1i}e_{1i}^y(t)\right) \\
 &\quad - \sum_{j=2}^N a_{ji}(e_{1i}^y(t) - e_{1j}^y(t)), \\
 &= f_y(e_{1i}^z(t), e_{1i}^y(t), z_1(t), y_1(t)) - b\sigma(a_{1i}e_{1i}^y(t)) \\
 &\quad + \sum_{j=2}^N (a_{j1}e_{1j}^y(t) + a_{ji}(e_{1i}^y(t) - e_{1j}^y(t))),
 \end{aligned} \tag{4.62}$$

where  $i \in \{2, 3, \dots, N\}$ . Therefore, the synchronization error dynamics for the continuous-time system (4.42), (4.43) is given by (4.59), (4.62), and hence by (4.57).  $\square$

#### 4.4.2 Modelling Sampling Effects

In classical methods studying sampled-data systems, the sampling induced error on any signal  $\eta$  subjected to a sampling sequence  $\{s_k\}_{k \in \mathbb{N}}$  is characterized by

$$w(t) = \eta(s_k) - \eta(t), \forall t \in [s_k, s_{k+1}). \tag{4.63}$$

In a similar manner as proposed in Chapter 2 and Chapter 3, the sampling-induced error  $w(t)$  is expressed using an integral operator  $\Delta$  acting on the derivative of the signal  $\eta$ , i.e.,

$$w(t) = (\Delta \dot{\eta})(t) := - \int_{s^k}^t \dot{\eta}(\theta) d\theta = \eta(s^k) - \eta(t), \forall t \in [s^k, s^{k+1}), k \in \mathbb{N}. \tag{4.64}$$

Here, we use this approach to characterize the sampling-induced error in the links defined by  $a_{ij}$ , with  $i, j \in \{1, 2, \dots, N\}$ . Using definition (4.64), the sampling-induced error in the output of the  $i^{th}$  sub-system, when transmitted to the  $j^{th}$  sub-system along the edge  $\mathcal{E}_{(i,j)}$ , can be characterized using an operator  $\Delta_{\{s_{ij}\}}$  defined by

$$(\Delta_{\{s_{ij}\}} \dot{y}_i)(t) := - \int_{s_{ij}^{k_{ij}}}^{s_{ij}^{k_{ij}+1}} \dot{y}_i(\theta) d\theta = y_i(s_{ij}^{k_{ij}}) - y_i(t), \forall t \in [s_{ij}^{k_{ij}}, s_{ij}^{k_{ij}+1}), k \in \mathbb{N}. \tag{4.65}$$

In the following lemma, we demonstrate how the sampled-data coupling law (4.4) can be expressed in terms of the ideal continuous-time coupling law (4.43) by capturing the effects of sampling using the operator  $\Delta_{\{s_{ij}\}}$ .

**Lemma 4.15.** *Consider the sampled-data coupling law  $u_i$  given by (4.4), the ideal continuous-time coupling law  $u_i^*$  given by (4.43), and the operator  $\Delta_{\{s_{ji}\}}$  given by (4.65). Then,*

$$u_i(t) = u_i^*(t) + \sigma \sum_{j=1}^N a_{ji} (\Delta_{\{s_{ji}\}}(\dot{e}_{1i}^y - \dot{e}_{1j}^y))(t), \forall t \geq 0, \quad (4.66)$$

for all  $i, j \in \{1, 2, \dots, N\}$ , where  $\dot{e}_{1i}^y, \dot{e}_{1j}^y$ , are given by (4.55).

*Proof.* Let us recall the  $i^{\text{th}}$  sampled-data coupling law in (4.4), i.e.,

$$u_i(t) = \sigma \sum_{j \in \mathcal{E}(j,i)} a_{ji} (\hat{y}_{ji}(t) - \tilde{y}_{ji}(t)), j \neq i, \quad (4.67)$$

where

$$\begin{aligned} \hat{y}_{ji}(t) &= y_j(s_{ji}^{k_{ji}}), \forall t \in [s_{ji}^{k_{ji}}, s_{ji}^{k_{ji}+1}), \\ \tilde{y}_{ji}(t) &= y_i(s_{ji}^{k_{ji}}), \forall t \in [s_{ji}^{k_{ji}}, s_{ji}^{k_{ji}+1}), \end{aligned} \quad (4.68)$$

for all  $i, j \in \mathcal{V}, j \neq i$ . We can alternately express  $u_i(t)$  as

$$u_i(t) = u_{1i}(t) + u_{2i}(t) + \dots + u_{Ni}(t), \quad (4.69)$$

where  $u_{ji}, j \neq i$  defines the component of the coupling law  $u_i$  that depends on the information transmitted from the  $j^{\text{th}}$  sub-system, and is given by

$$u_{ji}(t) = \sigma a_{ji} (\hat{y}_{ji}(t) - \tilde{y}_{ji}(t)), \forall t \geq 0, \quad (4.70)$$

where  $\hat{y}_{ji}$  and  $\tilde{y}_{ji}$  are given by (4.68). Therefore, for any  $t \in [s_{ji}^{k_{ji}}, s_{ji}^{k_{ji}+1})$ ,  $k_{ji} \in \mathbb{N}$ ,  $j, i \in \{1, 2, \dots, N\}, j \neq i$ , we have

$$\begin{aligned} u_{ji}(t) &= \sigma a_{ji} \left( y_j(s_{ji}^{k_{ji}}) - y_i(s_{ji}^{k_{ji}}) \right) \\ &= \sigma a_{ji} \left( y_j(s_{ji}^{k_{ji}}) + y_j(t) - y_j(t) - y_i(s_{ji}^{k_{ji}}) + y_i(t) - y_i(t) \right) \\ &= \sigma a_{ji} \left( (y_j(t) - y_i(t)) + (y_j(s_{ji}^{k_{ji}}) - y_j(t)) - (y_i(s_{ji}^{k_{ji}}) - y_i(t)) \right). \end{aligned} \quad (4.71)$$

Using the definition of the operator capturing sampling-induced error in (4.65), since  $\Delta_{\{s_{ji}\}}$  is an integral operator, for all  $i \in \{1, 2, \dots, N\}, j \in \{2, 3, \dots, N\}, j \neq i$ , and  $t \geq 0$ , we have that

$$\begin{aligned} u_{ji}(t) &= \sigma a_{ji} \left( (y_j(t) - y_i(t)) + (\Delta_{\{s_{ji}\}} \dot{y}_j)(t) - (\Delta_{\{s_{ji}\}} \dot{y}_i)(t) \right) \\ &= \sigma a_{ji} \left( (y_j(t) - y_i(t)) + (\Delta_{\{s_{ji}\}}(\dot{y}_j - \dot{y}_i))(t) \right). \end{aligned} \quad (4.72)$$

In a similar manner as stated in (4.69) and (4.70), we can see from the definition of the ideal continuous-time coupling law  $u_i^*(t)$  in (4.43) that the term

$\sigma a_{ji}(y_j(t) - y_i(t))$  is the component of  $u_i^*(t)$ , which depends on the  $j^{\text{th}}$  subsystem. Let us denote this by  $u_{ji}^*(t)$ . Therefore, we have

$$u_{ji}(t) = u_{ji}^*(t) + \sigma a_{ji}(\Delta_{\{s_{ji}\}}(\dot{y}_j - \dot{y}_i))(t). \quad (4.73)$$

In order to express this in terms of the synchronization error vector given in (4.50), let us consider the term

$$y_j(t) - y_i(t) = y_j(t) - y_i(t) + y_1(t) - y_1(t) = e_{1i}^y(t) - e_{1j}^y(t). \quad (4.74)$$

Using (4.74) in (4.73), we obtain

$$u_{ji}(t) = u_{ji}^*(t) + \sigma a_{ji}(\Delta_{\{s_{ji}\}}(\dot{e}_{1i}^y - \dot{e}_{1j}^y))(t). \quad (4.75)$$

Consequently, from (4.69), we have

$$u_i(t) = u_i^*(t) + \sigma \sum_{j=1}^N a_{ji}(\Delta_{\{s_{ji}\}}(\dot{e}_{1i}^y - \dot{e}_{1j}^y))(t), \forall t \geq 0. \quad (4.76)$$

□

Using Lemma 4.15, we will demonstrate how for the system (4.42) with sampled-data coupling (4.4), the synchronization error dynamics defined using (4.51)-(4.56) can be reformulated as a feedback interconnection between an operator that captures the continuous-time synchronization error dynamics given in Lemma 4.14, and an operator that characterizes the effects of sampling, as shown in (4.66).

**Lemma 4.16.** *Consider the operator  $\Delta$  defined by*

$$\tilde{w}(t) = (\Delta \dot{e}_y)(t) = \begin{bmatrix} (\Delta_{12} \dot{e}_y)(t) \\ (\Delta_{13} \dot{e}_y)(t) \\ \vdots \\ (\Delta_{1N} \dot{e}_y)(t) \end{bmatrix} = \begin{bmatrix} \tilde{w}_{12}(t) \\ \tilde{w}_{13}(t) \\ \vdots \\ \tilde{w}_{1N}(t) \end{bmatrix}, \quad (4.77)$$

where

$$\begin{aligned} \tilde{w}_{1i}(t) &= (\Delta_{1i} \dot{e}_y)(t), i \in \{2, 3, \dots, N\} \\ &:= b\sigma a_{1i} w_{1i}(t) + \sum_{j=2}^N b\sigma (a_{j1} w_{j1}(t) + a_{ji} w_{ji}(t)), \end{aligned} \quad (4.78)$$

and

$$w_{ji}(t) = \begin{cases} (\Delta_{\{s_{1i}\}} \dot{e}_{1i}^y)(t), j = 1 \\ (\Delta_{\{s_{j1}\}} \dot{e}_{1j}^y)(t), i = 1 \\ (\Delta_{\{s_{ji}\}}(\dot{e}_{1i}^y - \dot{e}_{1j}^y))(t), i, j \in \{2, 3 \dots N\} \end{cases} \quad (4.79)$$

with  $\dot{e}_y, \dot{e}_{1i}^y$  given by (4.54), (4.55), and the operators  $\Delta_{\{s_{1i}\}}, \Delta_{\{s_{j1}\}}$  and  $\Delta_{\{s_{ji}\}}$  given by (4.65). Then, for all  $t \geq 0$ , the synchronization error dynamics of

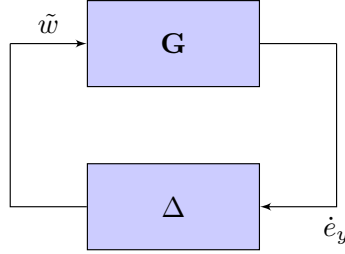

Figure 4.2: The feedback interconnection of  $\mathbf{G}$  and  $\Delta$ , representing the synchronization error dynamics of system (4.42), (4.4).

system (4.42), (4.4) can be remodelled as the feedback interconnection between a system operator  $\mathbf{G}$  and  $\Delta$ , with  $\mathbf{G}$  given by (4.51)-(4.54), and

$$\begin{aligned} \dot{e}_{1i}^y(t) &= \dot{y}_1(t) - \dot{y}_i(t) \\ &= f_y(e_{1i}^z(t), e_{1i}^y(t), z_1(t), y_1(t)) - b\sigma(a_{1i}e_{1i}^y(t) + \sum_{j=2}^N (a_{j1}e_{1j}^y(t) \\ &\quad + a_{ji}(e_{1i}^y(t) - e_{1j}^y(t)))) - \tilde{w}_{1i}(t), \end{aligned} \quad (4.80)$$

for  $i \in \{2, 3, \dots, N\}$ , with  $f_y$  given by (4.56).

*Proof.* Considering the  $i^{th}$  system dynamics in (4.42), (4.4),  $i \in \{1, 2, \dots, N\}$ , we have

$$\begin{aligned} \dot{z}_i(t) &= q(z_i(t), y_i(t)) \\ \dot{y}_i(t) &= a(z_i(t), y_i(t)) + bu_i(t), \end{aligned} \quad (4.81)$$

where the sampled-data coupling law  $u_i(t)$  can be expressed as given in Lemma 4.15.

Using Lemma 4.15, we have that

$$u_i(t) = u_i^*(t) + \sigma \sum_{j=1}^N a_{ji}(\Delta_{\{s_{ji}\}}(\dot{e}_{1i}^y - \dot{e}_{1j}^y))(t), \quad \forall t \geq 0, \quad (4.82)$$

where

$$u_i^*(t) = \sigma \sum_{j=1}^N a_{ji}(y_j(t) - y_i(t)), \quad \forall t \geq 0. \quad (4.83)$$

In the proof of Lemma 4.15, in (4.74), we have already shown that  $y_j(t) - y_i(t) = e_{1i}^y(t) - e_{1j}^y(t)$ . Therefore, for all  $t \geq 0$ ,

$$u_i(t) = \sigma \sum_{j=1}^N a_{ji}(e_{1i}^y(t) - e_{1j}^y(t) + (\Delta_{\{s_{ji}\}}(\dot{e}_{1i}^y - \dot{e}_{1j}^y))(t)). \quad (4.84)$$

By definition of the synchronization error in (4.49), we know  $e_{11}^y = 0$ . Therefore,

$$u_i(t) = \sigma \left( a_{1i} (e_{1i}^y(t) + (\Delta_{\{s_{1i}\}} \dot{e}_{1i}^y)(t)) \right. \\ \left. + \sum_{j=2}^N a_{ji} (e_{1i}^y(t) - e_{1j}^y(t) + (\Delta_{\{s_{ji}\}} (\dot{e}_{1i}^y - \dot{e}_{1j}^y))(t)) \right), \forall t \geq 0. \quad (4.85)$$

Using (4.85) and (4.81), the dynamics of the  $i^{th}$  sub-system,  $i \in \{1, 2 \dots N\}$ , for all  $t \geq 0$ , is given by

$$\dot{z}_i(t) = q(z_i(t), y_i(t)), \\ \dot{y}_i(t) = a(z_i(t), y_i(t)) + b\sigma \left( a_{1i} (e_{1i}^y(t) + (\Delta_{\{s_{1i}\}} \dot{e}_{1i}^y)(t)) \right. \\ \left. + \sum_{j=2}^N a_{ji} (e_{1i}^y(t) - e_{1j}^y(t) + (\Delta_{\{s_{ji}\}} (\dot{e}_{1i}^y - \dot{e}_{1j}^y))(t)) \right). \quad (4.86)$$

Therefore, the system dynamics of sub-system  $i = 1$  can be rewritten as

$$\dot{z}_1(t) = q(z_1(t), y_1(t)) \\ \dot{y}_1(t) = a(z_1(t), y_1(t)) - b\sigma \sum_{j=2}^N a_{j1} (e_{1j}^y(t) + (\Delta_{\{s_{j1}\}} \dot{e}_{1j}^y)(t)). \quad (4.87)$$

Now, considering the synchronization error vector for  $z$ -dynamics given in (4.50), we have

$$\dot{e}_z(t) = \begin{bmatrix} \dot{e}_{12}^z(t) \\ \dot{e}_{13}^z(t) \\ \vdots \\ \dot{e}_{1N}^z(t) \end{bmatrix} = \begin{bmatrix} \dot{z}_1(t) - \dot{z}_2(t) \\ \dot{z}_1(t) - \dot{z}_3(t) \\ \vdots \\ \dot{z}_1(t) - \dot{z}_N(t) \end{bmatrix}, \quad (4.88)$$

where, using (4.87) and (4.86),

$$\dot{z}_1(t) - \dot{z}_i(t) = f_z(e_{1i}^z(t), e_{1i}^y(t), z_1(t), y_1(t)), i \in \{2, 3, \dots, N\}, \quad (4.89)$$

with  $f_z$  given by (4.53). Similarly, considering the synchronization error vector for  $y$ -dynamics given in (4.50), we have

$$\dot{e}_y(t) = \begin{bmatrix} \dot{e}_{12}^y(t) \\ \dot{e}_{13}^y(t) \\ \vdots \\ \dot{e}_{1N}^y(t) \end{bmatrix} = \begin{bmatrix} \dot{y}_1(t) - \dot{y}_2(t) \\ \dot{y}_1(t) - \dot{y}_3(t) \\ \vdots \\ \dot{y}_1(t) - \dot{y}_N(t) \end{bmatrix}, \quad (4.90)$$

where, using (4.87) and (4.86), for  $i \in \{2, 3, \dots, N\}$ , we have

$$\begin{aligned}
\dot{y}_1(t) - \dot{y}_i(t) &= f_y(e_{1i}^z(t), e_{1i}^y(t), z_1(t), y_1(t)) \\
&\quad - b\sigma \left( \sum_{j=2}^N a_{j1} e_{1j}^y(t) + a_{1i} e_{1i}^y(t) + \sum_{j=2}^N a_{ji} (e_{1i}^y(t) - e_{1j}^y(t)) \right) \\
&\quad - b\sigma \left( \sum_{j=2}^N a_{j1} (\Delta_{\{s_{j1}\}} \dot{e}_{1j}^y)(t) + a_{1i} (\Delta_{\{s_{1i}\}} \dot{e}_{1i}^y)(t) \right. \\
&\quad \left. + \sum_{j=2}^N a_{ji} (\Delta_{\{s_{ji}\}} (\dot{e}_{1i}^y - \dot{e}_{1j}^y))(t) \right), j \neq i,
\end{aligned} \tag{4.91}$$

with  $f_y$  given by (4.56). The individual terms  $\dot{e}_{1i}^y(t)$ ,  $i \in \{2, 3, \dots, N\}$ , in the synchronization error dynamics (4.90), are therefore given by

$$\begin{aligned}
\dot{e}_{1i}^y(t) &= \underbrace{f_y(e_{1i}^z(t), e_{1i}^y(t), z_1(t), y_1(t)) - b\sigma(a_{1i} e_{1i}^y(t))}_{\text{continuous-time synchronization error dynamics}} \\
&\quad + \underbrace{\sum_{j=2}^N (a_{j1} e_{1j}^y(t) + a_{ji} (e_{1i}^y(t) - e_{1j}^y(t)))}_{\text{continuous-time synchronization error dynamics}} \\
&\quad - \underbrace{\tilde{w}_{1i}(t)}_{\text{sampling-induced perturbation}},
\end{aligned} \tag{4.92}$$

where  $\tilde{w}_{1i}(t)$  is given by (4.78). In the reformulated synchronization error dynamics (4.92), (4.78) the terms representing the synchronization error dynamics in continuous-time, i.e., in the absence of sampling, with the coupling law (4.43), as given in Lemma 4.14, have been mentioned specifically. Similarly, the term indicating the sampling-induced perturbations acting on the continuous-time synchronization error dynamics have been shown.

Therefore, it is evident that for all  $t \geq 0$ , the synchronization error dynamics of system (4.42), (4.4), can be viewed as a feedback-interconnection between a system operator  $\mathbf{G}$  and an operator  $\Delta$  as shown in Figure 4.2, the dynamics of which are given by (4.88), (4.89), (4.90), (4.92), and

$$\tilde{w}(t) = \begin{bmatrix} \tilde{w}_{12}(t) \\ \tilde{w}_{13}(t) \\ \vdots \\ \tilde{w}_{1N}(t) \end{bmatrix} = (\Delta \dot{e}_y)(t), \tag{4.93}$$

with  $\Delta$  as defined in (4.77) and (4.78).  $\square$

Now that the synchronization error dynamics of system (4.42), (4.4) has been reformulated as a feedback-interconnection, we will exploit the properties of the

operator  $\Delta$ , as shown in the next section, to arrive at functions that will be used to provide our main result guaranteeing exponential synchronization.

## 4.5 Synchronization Criterion

In this section, we will provide conditions that guarantee exponential synchronization of system (4.42), (4.4). Hereto, we will exploit the system reformulation introduced in Section 4.4 and dissipativity theory.

First, we study the properties related to the  $\mathcal{L}_2$  norm of the operator  $\Delta$  as defined in (4.77) and (4.78) in the following lemma.

**Lemma 4.17.** *Consider the operator  $\Delta$  defined in (4.77), (4.78). Then, for any  $R_{1i}, R_{j1}, R_{ji} \in \mathbb{R}^{m \times m}$ , with  $R_{1i} = R_{1i}^T > 0$ ,  $R_{j1} = R_{j1}^T > 0$ ,  $R_{ji} = R_{ji}^T > 0$ , and  $i, j \in \{2, 3, \dots, N\}$ ,  $j \neq i$ ,*

$$\int_0^t \mathcal{S}(\theta, \dot{e}_y(\theta), (\Delta \dot{e}_y)(\theta)) \leq 0, \quad (4.94)$$

where  $\dot{e}_y(t)$  is given by (4.54), (4.80) and the function  $\mathcal{S} : \mathbb{R}^+ \times \mathbb{R}^{(N-1)m} \times \mathbb{R}^{(N-1)m} \rightarrow \mathbb{R}$  is given by

$$\begin{aligned} \mathcal{S}(t, \dot{e}_y(t), (\Delta \dot{e}_y)(t)) &= e^{\alpha t} \left( \sum_{i=2}^N \left[ w_{1i}^T(t) R_{1i} w_{1i}(t) - \bar{h}_{1i}^2 e^{\alpha \bar{h}_{1i}} (\dot{e}_{1i}^y)^T(t) R_{1i} \dot{e}_{1i}^y(t) \right] \right. \\ &\quad + (N-1) \sum_{j=2}^N \left[ w_{j1}^T(t) R_{j1} w_{j1}(t) - \bar{h}_{j1}^2 e^{\alpha \bar{h}_{j1}} (\dot{e}_{1j}^y)^T(t) R_{j1} \dot{e}_{1j}^y(t) \right] \\ &\quad \left. + \sum_{i=2}^N \sum_{j=2}^N \left[ w_{ji}^T(t) R_{ji} w_{ji}(t) - \bar{h}_{ji}^2 e^{\alpha \bar{h}_{ji}} (\dot{e}_{1i}^y - \dot{e}_{1j}^y)^T(t) R_{ji} (\dot{e}_{1i}^y - \dot{e}_{1j}^y)(t) \right] \right), \end{aligned} \quad (4.95)$$

with  $\alpha > 0$ , and  $w_{1i}(t)$ ,  $w_{j1}(t)$  and  $w_{ji}(t)$  given by (4.79).

*Proof.* We will evaluate the different terms in  $\mathcal{S}$  in (4.95) in order to evidence the validity of the inequality in (4.94). Let us first consider the term

$$w_{1i}(t) = (\Delta_{\{s_{1i}\}} \dot{e}_{1i}^y)(t). \quad (4.96)$$

Using the definition of the operator  $\Delta_{\{s_{1i}\}}$  as given in (4.65), we have

$$\begin{aligned} w_{1i}(t) &= - \int_{s_{1i}^k}^t \dot{e}_{1i}^y(s) ds, \forall t \in [s_{1i}^k, s_{1i}^{k+1}), k \in \mathbb{N}, \\ &= e_{1i}^y(s_{1i}^k) - e_{1i}^y(t). \end{aligned} \quad (4.97)$$

Using Jensen's inequality [48], we obtain

$$\begin{aligned} w_{1i}^T(t) R_{1i} w_{1i}(t) &\leq (t - s_{1i}^k) \int_{s_{1i}^k}^t (\dot{e}_{1i}^y)^T(\zeta) R_{1i} \dot{e}_{1i}^y(\zeta) d\zeta \\ &\leq \bar{h}_{1i} \int_{s_{1i}^k}^t (\dot{e}_{1i}^y)^T(\zeta) R_{1i} \dot{e}_{1i}^y(\zeta) d\zeta. \end{aligned} \quad (4.98)$$

Using the change of variable  $s = \zeta - t$ , we obtain

$$\begin{aligned} w_{1i}^T(t)R_{1i}w_{1i}(t) &\leq \bar{h}_{1i} \int_{s_{1i}^k-t}^0 (\dot{e}_{1i}^y)^T(t+s)R_{1i}\dot{e}_{1i}^y(t+s)ds \\ &\leq \bar{h}_{1i} \int_{-\bar{h}_{1i}}^0 (\dot{e}_{1i}^y)^T(t+s)R_{1i}\dot{e}_{1i}^y(t+s)ds. \end{aligned} \quad (4.99)$$

Therefore,

$$\int_0^t e^{\alpha\theta} w_{1i}^T(\theta)R_{1i}w_{1i}(\theta)d\theta \leq \bar{h}_{1i} \int_0^t e^{\alpha\theta} \left( \int_{-\bar{h}_{1i}}^0 (\dot{e}_{1i}^y)^T(\theta+s)R_{1i}\dot{e}_{1i}^y(\theta+s)ds \right) d\theta. \quad (4.100)$$

Substituting  $u = \theta + s$ , we have that

$$\int_0^t e^{\alpha\theta} w_{1i}^T(\theta)R_{1i}w_{1i}(\theta)d\theta \leq \bar{h}_{1i} \int_{-\bar{h}_{1i}}^0 \left( \int_s^{t+s} e^{\alpha(u-s)} (\dot{e}_{1i}^y)^T(u)R_{1i}\dot{e}_{1i}^y(u)du \right) ds. \quad (4.101)$$

Since the inner integral in the right-hand side of the inequality in (4.101) is always non-negative because  $R_{1i}$  is positive definite, we can upper bound the left-hand side in (4.101) using the limits of  $s$  and obtain

$$\begin{aligned} \int_0^t e^{\alpha\theta} w_{1i}^T(\theta)R_{1i}w_{1i}(\theta)d\theta &\leq \bar{h}_{1i} \int_{-\bar{h}_{1i}}^0 \left( \int_0^t e^{\alpha(u+\bar{h}_{1i})} (\dot{e}_{1i}^y)^T(u)R_{1i}\dot{e}_{1i}^y(u)du \right) ds \\ &= \bar{h}_{1i} e^{\alpha\bar{h}_{1i}} \int_{-\bar{h}_{1i}}^0 \left( \int_0^t e^{\alpha u} (\dot{e}_{1i}^y)^T(u)R_{1i}\dot{e}_{1i}^y(u)du \right) ds \\ &= \bar{h}_{1i}^2 e^{\alpha\bar{h}_{1i}} \int_0^t e^{\alpha\theta} (\dot{e}_{1i}^y)^T(\theta)R_{1i}\dot{e}_{1i}^y(\theta)d\theta. \end{aligned} \quad (4.102)$$

Therefore, we have

$$\int_0^t e^{\alpha\theta} (w_{1i}^T(\theta)R_{1i}w_{1i}(\theta) - \bar{h}_{1i}^2 e^{\alpha\bar{h}_{1i}} (\dot{e}_{1i}^y)^T(\theta)R_{1i}\dot{e}_{1i}^y(\theta))d\theta \leq 0. \quad (4.103)$$

From (4.65), it is evident that the operators  $\Delta_{\{s_{1i}\}}$ ,  $\Delta_{\{s_{j1}\}}$  and  $\Delta_{\{s_{ji}\}}$  have the same structure. Therefore, for the expressions

$$w_{j1}(t) = (\Delta_{\{s_{j1}\}}\dot{e}_{1j}^y)(t), \quad (4.104)$$

and

$$w_{ji}(t) = (\Delta_{\{s_{ji}\}}(\dot{e}_{1i}^y - \dot{e}_{1j}^y))(t), \quad (4.105)$$

we can classify the properties of the operators  $\Delta_{\{s_{j1}\}}$  and  $\Delta_{\{s_{ji}\}}$  by

$$\int_0^t e^{\alpha\theta} (w_{j1}^T(\theta)R_{j1}w_{j1}(\theta) - \bar{h}_{j1}^2 e^{\alpha\bar{h}_{j1}} (\dot{e}_{1j}^y)^T(\theta)R_{j1}\dot{e}_{1j}^y(\theta))d\theta \leq 0, \quad (4.106)$$

and

$$\begin{aligned} \int_0^t e^{\alpha\theta} (w_{ji}^T(\theta)R_{ji}w_{ji}(\theta) - \bar{h}_{ji}^2 e^{\alpha\bar{h}_{ji}} (\dot{e}_{1i}^y(\theta) \\ - \dot{e}_{1j}^y(\theta))^T R_{ji}(\dot{e}_{1i}^y(\theta) - \dot{e}_{1j}^y(\theta)))d\theta \leq 0. \end{aligned} \quad (4.107)$$



The expressions (4.103), (4.106), (4.107), classify the properties of operators  $\Delta_{\{s_{1i}\}}$ ,  $\Delta_{\{s_{j1}\}}$  and  $\Delta_{\{s_{ji}\}}$ , respectively. It can be understood directly from (4.78) that the operator  $\Delta_{\{s_{1i}\}}$  influences the synchronization error dynamics for all  $i \in \{2, 3, \dots, N\}$ . Therefore, from (4.103), we can state that

$$\int_0^t e^{\alpha\theta} \sum_{i=2}^N (w_{1i}^T(\theta)R_{1i}w_{1i}(\theta) - \bar{h}_{1i}^2 e^{\alpha\bar{h}_{1i}} (\dot{e}_{1i}^y)^T(\theta)R_{1i}\dot{e}_{1i}^y(\theta))d\theta \leq 0. \quad (4.108)$$

Similarly, from (4.78), we know that the operator  $\Delta_{\{s_{j1}\}}$  characterizes the total influence of every  $j^{th}$  system,  $j \in \{2, 3, \dots, N\}$ , on the dynamics of the sub-system  $i = 1$ . And since every term in the synchronization error vector uses the first system as a reference, we can state, using (4.106), that

$$(N-1) \int_0^t e^{\alpha\theta} \sum_{j=2}^N (w_{j1}^T(\theta)R_{j1}w_{j1}(\theta) - \bar{h}_{j1}^2 e^{\alpha\bar{h}_{j1}} (\dot{e}_{1j}^y)^T(\theta)R_{j1}\dot{e}_{1j}^y(\theta))d\theta \leq 0. \quad (4.109)$$

We can also observe from (4.78) that the operator  $\Delta_{\{s_{ji}\}}$  characterizes the influence of every  $j^{th}$  system,  $j \in \{2, 3, \dots, N\}$ , on every  $i^{th}$  system,  $i \in \{2, 3, \dots, N\}$ ,  $j \neq i$ . Therefore, we have from (4.107) that

$$\int_0^t \sum_{i=2}^N \sum_{j=2}^N e^{\alpha\theta} (w_{ji}^T(\theta)R_{ji}w_{ji}(\theta) - \bar{h}_{ji}^2 e^{\alpha\bar{h}_{ji}} (\dot{e}_{1i}^y(\theta) - \dot{e}_{1j}^y(\theta))^T R_{ji}(\dot{e}_{1i}^y(\theta) - \dot{e}_{1j}^y(\theta)))d\theta \leq 0. \quad (4.110)$$

Consequently, by adding the inequalities (4.108), (4.109), and (4.110), we have

$$\int_0^t \mathcal{S}(\theta, \dot{e}_y(\theta), \tilde{w}(\theta)) \leq 0, \quad (4.111)$$

where  $\tilde{w}(t) = (\Delta \dot{e}_y)(t)$ , and the function  $\mathcal{S}$  is as defined in (4.95). □

Note that the result provided in Lemma 4.17 can be related to the developments in Chapter 3, since the property of every single operator  $\Delta_{\{s_{ij}\}}$  can be characterized using supply functions of the form given in Lemma 3.4 (in the absence of delay). In Lemma 4.17, the variable  $\alpha$  corresponds to the decay-rate that we will use in the next theorem giving exponential synchronization. When  $\alpha = 0$ ,  $\mathcal{S}$  characterizes the  $\mathcal{L}_2$  boundedness property of the operator  $\Delta$  [65], which is composed of the operators  $\Delta_{\{s_{1i}\}}$ ,  $\Delta_{\{s_{j1}\}}$  and  $\Delta_{\{s_{ji}\}}$ ,  $i, j \in \{1, 2, \dots, N\}$ ,  $j \neq i$ , as shown in (4.77), (4.78). However, we also have a weighted element  $\alpha$  in order to take into account system decay rate. Now, in the following theorem, using the supply function  $\mathcal{S}$  in (4.95), a positive definite storage function  $W$ , and the notion of dissipativity theory, we obtain inequalities that check if exponential synchronization can be attained in the presence of sampling-induced perturbations. Then, we remark how the exponential synchronization property

of the system in continuous-time, i.e., in the absence of sampling-induced effects, can be used to obtain a storage function  $W$ . First, we introduce the following dissipativity-based theorem that guarantees exponential synchronization, under the assumption that a positive definite storage function  $W$  exists, i.e., synchronization is achieved in continuous-time.

**Theorem 4.18.** *Consider the feedback interconnection  $\mathbf{G} - \Delta$  given by (4.51), (4.52), (4.54), (4.80), and (4.78), and assume that there exists a continuously differentiable storage function  $W : \mathbb{R}^n \rightarrow \mathbb{R}^+$  and scalars  $0 < c_1 < c_2$ ,  $\alpha > 0$  such that*

$$c_1 \|e\|^2 \leq W(e) \leq c_2 \|e\|^2, \quad (4.112)$$

and

$$\dot{W}(e(t)) + \alpha W(e(t)) \leq e^{-\alpha t} \mathcal{S}(t, \dot{e}_y(t), \tilde{w}(t)), \forall t \geq 0, \quad (4.113)$$

where the function  $\mathcal{S}(t, \dot{e}_y(t), \tilde{w}(t))$  is given by (4.95), and  $e(t) = [e_y^T(t) \ e_z^T(t)]^T$  is governed by (4.51), (4.54). Then, for given coupling gain  $\sigma$ , and sampling interval bounds  $\bar{h}_{ij}$ , for all  $i, j \in \{1, 2, \dots, N\}, i \neq j$ , the system (4.42), (4.4) exponentially synchronizes with a decay rate of at least  $\alpha/2$ .

*Proof.* Consider the function

$$U(t) = e^{\alpha t} W(e(t)) - \int_0^t \mathcal{S}(\theta, \dot{e}_y(\theta), \tilde{w}(\theta)) d\theta, \forall t \geq 0, \quad (4.114)$$

where  $e(t) = [e_y^T(t) \ e_z^T(t)]^T$ . From condition (4.113), we can conclude  $\dot{U}(t) \leq 0, \forall t \geq 0$ , implying  $U(t) \leq U(0)$ , i.e.,

$$e^{\alpha t} W(e(t)) - \int_0^t \mathcal{S}(\theta, \dot{e}_y(\theta), \tilde{w}(\theta)) d\theta \leq W(e(0)). \quad (4.115)$$

Therefore,

$$e^{\alpha t} W(e(t)) \leq W(e(0)) + \int_0^t \mathcal{S}(\theta, \dot{e}_y(\theta), \tilde{w}(\theta)) d\theta, \quad (4.116)$$

and using Lemma 4.17, we have

$$W(e(t)) \leq e^{-\alpha t} W(e(0)). \quad (4.117)$$

Consequently, using (4.112), we obtain

$$\|e(t)\|^2 \leq \frac{c_2}{c_1} e^{-\alpha t} \|e(0)\|^2, \quad (4.118)$$

i.e.,

$$\|e(t)\| \leq \sqrt{\frac{c_2}{c_1}} e^{-\frac{\alpha}{2} t} \|e(0)\|, \quad (4.119)$$

implying that the equilibrium  $e = [e_y^T \ e_z^T]^T = [0 \ 0]$ , of the feedback-interconnection  $\mathbf{G} - \Delta$ , given by (4.51), (4.52), (4.54), (4.80), and (4.78), is exponentially stable with a decay rate of at least  $\alpha/2$ .

Now, by virtue of Lemma 4.16, we know that the feedback-interconnection  $\mathbf{G} - \Delta$  represents the synchronization error dynamics of system (4.42), (4.4), given by (4.51), (4.52), (4.54), and (4.55). Therefore, we have that the equilibrium point  $e = 0$  of the synchronization error dynamics for system (4.42), (4.4) is exponentially stable with a decay-rate of at least  $\alpha/2$ . In other words, the system (4.42), (4.4) exponentially synchronizes at a rate of at least  $\alpha/2$ .  $\square$

*Remark:* Theorem 4.18 has been adapted from the result in [93], wherein a similar dissipativity based framework was used to analyse the stability of single-loop input-affine nonlinear systems with sampled-data control. The conditions for synchronization in the sampling-free case imply the existence of storage function  $W$ , provided that  $\sigma$  is sufficiently large (as given in Theorem 4.12). Moreover,  $|e^{-\alpha t} S| \leq \psi(h)|e|^2$ , for some  $\psi \in \mathcal{K}$ , and  $e = [e_y^T \ e_z^T]^T$ . It can be seen from (4.95) that the term  $e^{-\alpha t} S$ , used in the dissipation inequality (4.113), is quadratic in  $\bar{h}_{ij}$ ,  $\dot{e}_{1i}^y$  and  $w_{ij}$ ,  $i, j \in \{1, 2, \dots, N\}$ . By the definition of  $w_{ij}$  in (4.79), it can be estimated that  $|w_{ij}| \leq \bar{h}_{ij}^2 |\dot{e}_{1j}^y - \dot{e}_{1i}^y|$ ,  $i, j \in \{1, 2, \dots, N\}, i \neq j$ . Then,  $|e^{-\alpha t} S| \leq p_1 h^2 |\dot{e}_{1i}^y|^2$  for some constant  $p_1$  and  $h = \max_{i,j} \bar{h}_{ij}$ . Additionally,  $|\dot{e}_{1i}^y| \leq p_2 |e_{1i}^y|$  for some constant  $p_2$ , which exists because the vector field  $f$  is sufficiently smooth and solutions of the coupled system (4.1), (4.4) are uniformly bounded and uniformly ultimately bounded. Thus,  $|e^{-\alpha t} S| \leq p_3 h^2 |e_{1i}^y|^2$ , for some constant  $p_3$ . In addition,  $|e_{1i}^y|^2 \leq p_4 W$  for some constant  $p_4$  as the storage function  $W$  used in the sampling-free case is quadratic. In conclusion,  $|e^{-\alpha t} S| \leq p_5 h^2 W$ , for some constant  $p_5$ , which results in  $\dot{W} + (\alpha - p_5 h^2)W < 0$ . This guarantees exponential synchronization provided that  $\alpha > p_5 h^2$ , which can be guaranteed by choosing a small value of  $h$ .

The value of the synchronization error decay-rate  $\alpha$  cannot be chosen freely, since the upper-bound on  $\alpha$  relates to the slowest time-scale of the  $\dot{z}_i = q(z_i, y_i)$  dynamics of the subsystem given in (4.42). Note that under the constraint of synchronized outputs  $y_1 = y_2 = \dots = y_N$ , the rate of synchronization of the  $z_i$  states is determined by this “slow” time-scale. An estimate of the upper-bound on  $\alpha$  can be obtained from the Demidovich condition. Condition (4.113) can be solved for matrices  $\mathbf{P}_z$  and  $\mathbf{P}_y$  (defining storage function  $W$ ), and  $R_{ij}$  (defining supply function  $\mathcal{S}$ ) using a gridding approach similar to the one given in Algorithm 1 in Chapter 2, using solvers such as SOSTOOLS. It should be noted that in this case, the gridding can be done over  $\alpha$ ,  $\bar{h}_{ij}$  and  $\sigma$ .

## 4.6 Numerical Example

Using a storage function  $W$  of the form (4.46), and the supply function  $\mathcal{S}$  defined in (4.95), we can use the condition (4.113) as a check for exponential synchrono-

nization in the presence of sampling-induced perturbations. Given a network topology defined by the adjacency matrix  $A$  in (4.2), the values for parameters  $\sigma$  and  $\bar{h}_i$ ,  $i \in \{1, 2, \dots, N\}$  for which condition (4.113) is satisfied, can be computed using standard MATLAB routines. This is illustrated in this section.

Let us consider a three-agent Fitzhugh-Nagumo system [40], [87], connected via a ring network, defined by the adjacency matrix

$$A = \begin{bmatrix} 0 & 1 & 0 \\ 0 & 0 & 1 \\ 1 & 0 & 0 \end{bmatrix}. \quad (4.120)$$

The individual sub-system dynamics is given by

$$\begin{aligned} \dot{z}_i(t) &= 0.08(y_i(t) + 0.7 - 0.8z_i(t)) \\ \dot{y}_i(t) &= y_i(t) - \frac{y_i^3(t)}{3} - z_i(t) + 0.5 + u_i(t), \quad i \in \{1, 2, 3\}, \end{aligned} \quad (4.121)$$

where the synchronizing coupling laws are given by (4.4). The semi-passivity property with quadratic storage function for individual sub-systems has been shown in [125].

### 4.6.1 Synchronization Error Dynamics Modelling

The synchronization error  $e(t) = [e_z^T(t) \quad e_y^T(t)]^T$  is defined by

$$e_z(t) = \begin{bmatrix} e_{12}^z(t) \\ e_{13}^z(t) \end{bmatrix} = \begin{bmatrix} z_1(t) - z_2(t) \\ z_1(t) - z_3(t) \end{bmatrix}, \quad (4.122)$$

and

$$e_y(t) = \begin{bmatrix} e_{12}^y(t) \\ e_{13}^y(t) \end{bmatrix} = \begin{bmatrix} y_1(t) - y_2(t) \\ y_1(t) - y_3(t) \end{bmatrix}. \quad (4.123)$$

Consequently, the synchronization error dynamics of the internal state  $z_i$ ,  $i \in \{1, 2, 3\}$ , is as given in (4.52), i.e.,

$$\begin{aligned} \dot{e}_{12}^z(t) &= 0.08(e_{12}^y(t) - 0.8e_{12}^z(t)), \\ \dot{e}_{13}^z(t) &= 0.08(e_{13}^y(t) - 0.8e_{13}^z(t)). \end{aligned} \quad (4.124)$$

Additionally, using (4.80) in Lemma 4.16, and the fact that

$$y_1^3 - y_2^3 = \frac{1}{4} \left( (e_{12}^y)^3 + 3(2y_1 - e_{12}^y)^2 e_{12}^y \right), \quad (4.125)$$

the synchronization error dynamics of the states  $y_i$ ,  $i \in \{1, 2, 3\}$  can be given by

$$\begin{aligned} \dot{e}_{12}^y(t) &= y_1(t) - \frac{y_1^3(t)}{3} - z_1(t) - (y_2(t) - \frac{y_2^3(t)}{3} - z_2(t)) \\ &\quad - \sigma(e_{12}^y(t) + e_{13}^y(t)) - \tilde{w}_{12}(t) \\ &= e_{12}^y(t) - e_{12}^z(t) - \frac{1}{12} \left( (e_{12}^y(t))^3 + 3(2y_1(t) - e_{12}^y(t))^2 e_{12}^y(t) \right) \\ &\quad - \sigma(e_{12}^y(t) + e_{13}^y(t)) - \tilde{w}_{12}(t), \end{aligned} \quad (4.126)$$

and

$$\begin{aligned} \dot{e}_{13}^y(t) &= y_1(t) - \frac{y_1^3(t)}{3} - z_1(t) - (y_3(t) - \frac{y_3^3(t)}{3} - z_3(t)) \\ &\quad - \sigma(e_{13}^y(t) + a_{23}(e_{13}^y(t) - e_{12}^y(t))) - \tilde{w}_{13}(t) \\ &= e_{13}^y(t) - e_{13}^z(t) - \frac{1}{12} \left( (e_{13}^y(t))^3 + 3(2y_1(t) - e_{13}^y(t))^2 e_{13}^y(t) \right) \\ &\quad - \sigma(e_{13}^y(t) + a_{23}(e_{13}^y(t) - e_{12}^y(t))) - \tilde{w}_{13}(t), \end{aligned} \quad (4.127)$$

where the sampling-induced effects in the synchronization error dynamics are as defined in (4.78), i.e.,

$$\begin{aligned} \tilde{w}_{12}(t) &= (\Delta_{12} \dot{e}_y)(t) := \sigma(\Delta_{\{s_{12}\}} \dot{e}_{12}^y)(t) + \sigma(\Delta_{\{s_{31}\}} \dot{e}_{13}^y)(t) \\ &= \sigma w_{12} + \sigma w_{31}, \end{aligned} \quad (4.128)$$

and

$$\begin{aligned} \tilde{w}_{13}(t) &= (\Delta_{13} \dot{e}_y)(t) := \sigma(\Delta_{\{s_{31}\}} \dot{e}_{13}^y)(t) + \sigma(\Delta_{\{s_{23}\}} (\dot{e}_{13}^y - \dot{e}_{12}^y))(t) \\ &= \sigma w_{31} + \sigma w_{23}. \end{aligned} \quad (4.129)$$

Note that the sampling-induced perturbations on each communication link depending on the network topology, is as given in (4.79), i.e.,

$$\begin{aligned} w_{12} &= (\Delta_{\{s_{12}\}} \dot{e}_{12}^y)(t), \\ w_{23} &= (\Delta_{\{s_{23}\}} (\dot{e}_{13}^y - \dot{e}_{12}^y))(t), \\ w_{31} &= (\Delta_{\{s_{31}\}} \dot{e}_{13}^y)(t). \end{aligned} \quad (4.130)$$

## 4.6.2 Synchronization Analysis

Using a storage function of the form given in (4.46), with  $\mathbf{P}_z = I_{2 \times 2} \otimes P_z$ ,  $P_z > 0$  and diagonal matrix  $\mathbf{P}_y = \text{diag}(P_{12}^y, P_{13}^y) > 0$ , we have

$$W(e(t)) = P_z (e_{12}^z(t))^2 + P_z (e_{13}^z(t))^2 + (P_{12}^y e_{12}^y(t))^2 + P_{13}^y (e_{13}^y(t))^2, \quad (4.131)$$

and

$$\begin{aligned} \dot{W}(e(t)) &= 2(P_z e_{12}^z(t) \dot{e}_{12}^z(t) + P_z e_{13}^z(t) \dot{e}_{13}^z(t)) \\ &\quad + P_{12}^y e_{12}^y(t) \dot{e}_{12}^y(t) + P_{13}^y e_{13}^y(t) \dot{e}_{13}^y(t). \end{aligned} \quad (4.132)$$

The sampling-induced perturbations on the synchronization error dynamics i.e.,  $\tilde{w}_{12}(t)$  and  $\tilde{w}_{13}(t)$  given by (4.128) and (4.129), respectively, can collectively be described using the operator  $\Delta$ , as shown in (4.93). Therefore, we have

$$\tilde{w}(t) = \begin{bmatrix} \tilde{w}_{12}(t) \\ \tilde{w}_{13}(t) \end{bmatrix} = (\Delta \dot{e}_y)(t). \quad (4.133)$$

Now, using Lemma 4.17, the supply function characterizing the properties of the operator  $\Delta$  can be given by

$$\begin{aligned} \mathcal{S}(t, \dot{e}_y(t), (\Delta \dot{e}_y)(t)) &= e^{\alpha t} \left( \left( R_{12} w_{12}^2(t) - \bar{h}_{1,2}^2 e^{\alpha \bar{h}_{1,2}} R_{12} (\dot{e}_{12}^y(t))^2 \right) \right. \\ &\quad + 2 \left( R_{31} w_{31}^2(t) - \bar{h}_{3,1}^2 e^{\alpha \bar{h}_{3,1}} R_{31} (\dot{e}_{13}^y(t))^2 \right) \\ &\quad \left. + \left( R_{23} w_{23}^2(t) - \bar{h}_{2,3}^2 e^{\alpha \bar{h}_{2,3}} R_{23} (\dot{e}_{13}^y - \dot{e}_{12}^y)^2(t) \right) \right), \end{aligned} \quad (4.134)$$

where  $\dot{e}_{12}^y$  and  $\dot{e}_{13}^y$  are given by (4.126) and (4.127), respectively. Now that we have  $W(e(t))$ ,  $\dot{W}(e(t))$  given by (4.131), (4.132), respectively, and the supply function  $\mathcal{S}$  in (4.134), the required criterion guaranteeing exponential synchronization can be obtained using the dissipation inequality (4.113) given in Theorem 4.18. The criterion can be used to decide the trade-off between the rate of synchronization  $\alpha$ , the coupling strength  $\sigma$ , and the sampling interval bounds  $\bar{h}_i$ ,  $i \in \{1, 2, 3\}$ . For example, let us fix the rate of synchronization to be 0.01, and assume that all the sensors in the networked system have the same sampling-interval bound, i.e.,  $\bar{h}_1 = \bar{h}_2 = \bar{h}_3 = \bar{h}$ . Note that this still implies that the communication between the individual sub-systems can still be asynchronous. Standard MATLAB routines such as SOSTOOLS [96] can be used to compute the values of  $\sigma$  and  $\bar{h}$  for which condition (4.113) is satisfied with (4.132), (4.131) and (4.134). Figure 4.3 gives the trade-off between the sampling-interval bound  $\bar{h}$  and the coupling strength  $\sigma$ . The critical value of  $\sigma$ , below which synchronization is not possible, was found to be  $\sigma = \bar{\sigma} = 1.1$ . The profile of the synchronization feasibility region shown in Figure 4.3 is similar to the profile obtained for two Fitzhugh-Nagumo systems with time-delayed coupling [124] and asynchronous sampled-data coupling [130].

*Remark:* Note that for the chosen example, the sufficiency condition for boundedness of solutions given in Theorem 4.8 may not be satisfied for some values of coupling strength  $\sigma$ . However, the exponential synchronization property is still guaranteed under an additional assumption of ultimate boundedness of solutions.

## 4.7 Conclusion

In this chapter, a novel dissipativity-based approach towards synchronization analysis of nonlinear networked systems, directionally coupled via a generic

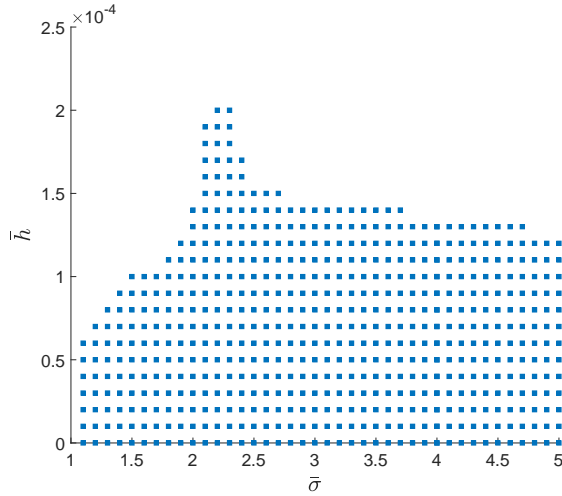

Figure 4.3: Trade-off between coupling strength  $\sigma$  and maximum sampling interval  $\bar{h}_1 = \bar{h}_2 = \bar{h}_3 = \bar{h}$ , for the three-agent Fitzhugh-Nagumo system, with  $\alpha = 0.01$ .

network topology under asynchronous, aperiodic sampled-data coupling, is introduced. The approach builds on remodelling the sampled-data system as a feedback-interconnection of a continuous-time system operator that captures the synchronization dynamics of the networked system in the absence of sampling, and an operator that characterizes the sampling effects. The properties of this feedback-interconnection are then studied to provide a dissipativity-based criterion that checks for exponential synchronization of the networked nonlinear system with sampled-data coupling. Using a networked three-agent Fitzhugh-Nagumo neuron system, the effectiveness of the provided criterion in guaranteeing exponential synchronization and deciding the trade-off between coupling strength, sampling-interval bounds, and rate of synchronization, is illustrated. In the context of large-scale networked systems, an interesting future research direction would be the exploitation of the framework introduced in this chapter to study the relation between dropping/inclusion of more network connections and synchronization properties.

**Part IV**

**Closing**





## Chapter 5

---

# Conclusions and Recommendations

---

In this thesis, complex networked systems which are well known to be relevant in numerous scientific and technological applications such as mobile sensor networks, swarm robotics, smart grids, etc., have been studied. The thesis focussed on large-scale networked systems which involve information transmission over communication channels/networks. These communication networks are known to be difficult to analyse due to inherent effects such as sampling and delay, which lead to complex asynchronous sensing and actuation throughout the networked system, at local and global levels. In this thesis, for settings with multiple control loops, we show that the overall system can be unstable in scenarios wherein individual control loops sample asynchronously with respect to each other. The detrimental effects of delay-induced asynchrony on global networked system properties such as synchronization is also well established in literature and scientific/technological examples. Consequently, this thesis focussed on providing techniques that can guarantee stability and synchronization properties of large-scale networked systems under asynchronous communication.

### 5.1 General conclusions on the results

Different methods that analyse system properties in the presence of sampling and/or delay induced asynchrony, are available in literature. Among these existing methods, this thesis focussed on the *input-output approach*. This approach is valuable from an engineering perspective due to advantages such as it allows for clear separation of continuous-time dynamics and communication network effects, and the fact that it provides conditions for desired system properties in the robust control framework, which is widely popular in engineering applications. To this date, in the scope of large-scale networked systems subject to asynchronous sensing and actuation, the input-output analysis framework has

not received much attention. In this direction, this thesis has explored the following research objectives:

1. To develop modelling and analysis tools for large-scale networked linear dynamical control systems subjected to asynchrony induced by sampling and delay, at local and global levels.
2. To develop modelling and analysis tools for single-loop nonlinear networked control systems subjected to asynchronous sensing and actuation.
3. To develop modelling and analysis tools that guarantee stability and synchronization properties within large-scale nonlinear networked control systems subjected to asynchronous communication.

The research carried out to achieve the aforementioned objectives led to a number of contributions, which can be summarized as follows. In this list, the numbering of the contributions corresponds to the numbering of the aforementioned research objectives.

1. *Development of a novel modelling and frequency-domain based analysis approach, using Integral Quadratic Constraints, for stability analysis of (possibly large-scale) decentralized linear networked control systems with asynchronous, aperiodic sampling and delay.*

In Chapter 2, first, an approach is introduced to represent the state-space model of a single-loop LTI control system with asynchronous sensors and actuators, as an interconnection between a continuous-time system operator and an operator that captures the effects of asynchrony. Consequently, by extending this preliminary result, the decentralized, sampled-data, asynchronous LTI state-space model under consideration, is reformulated as a feedback interconnection. By characterizing the properties of the operator that captures asynchrony effects, using an IQC, stability results on the feedback interconnection are provided, which imply global exponential stability of the decentralized system. Two scenarios, namely the large-delay case and the small delay case, are considered. In the large-delay case, the effects of asynchrony induced by sampling and delay are captured using a single operator. In contrast, these effects are captured using two separate operators in the small-delay case, which allows for less conservative results, in comparison to the result one could have obtained by keeping one single operator as in the large-delay case. The effectiveness of the proposed results have been illustrated using a numerical example.

2. *Development of a novel modelling and analysis approach based on dissipativity Theory, for stability analysis of single-loop nonlinear networked control systems subject to asynchronous, aperiodic sampling and delay.*

In Chapter 3, a framework that holds for a general class of nonlinear systems was introduced. A preliminary result inspired from the notion of exponential dissipativity is used to provide stability conditions for a class of feedback interconnected systems, while guaranteeing a desired decay-rate. The nonlinear sampled-data system is remodelled as a feedback interconnection of the nominal closed-loop system without any communication induced asynchrony, and an operator that captures the effects of sampling and delay, thereby leading to constructive stability conditions. The proposed approach leads to conditions expressed in terms of dissipativity-type properties of the system, for which many results exist in literature. Additionally, the developed conditions aid in making trade-offs between control performance and the bounds on sampling interval and delay.

3. *Development of a novel modelling and analysis approach for synchronization analysis of generic multi-agent networked systems with directed, weighted, diffusive, coupling laws and asynchronous information transmission.*

In Chapter 4, the proposed approach builds on remodelling the multi-agent asynchronous networked system as a feedback interconnection of a continuous-time system operator that captures the synchronization dynamics of the networked system in the absence of sampling, and an operator that characterizes the effects of sampling-induced asynchrony. The properties of this feedback-interconnection are then studied to provide a dissipativity-based criterion that checks for exponential synchronization of the networked nonlinear system with sampled-data coupling. The developed condition aids in making trade-offs between the coupling (gain) between sub-systems, and the bounds on sampling intervals for each communication channel. Using a networked three-agent Fitzhugh-Nagumo neuron system, the effectiveness of the provided criterion in guaranteeing exponential synchronization is illustrated.

## 5.2 Recommendations

Although the contributions given in this thesis address the research objectives of this thesis, when considered in the context of the high-level open challenges there is scope for further work.

### 5.2.1 Recommendations for Stability Analysis

1. The stability analysis part of this thesis considers asynchrony arising from two main communication network effects, i.e., sampling and delay. However, in realistic scenarios, there are other effects such as quantization, event-triggered communications, complex data scheduling protocols, etc.,

that introduce perturbations in the networked system. Considering these effects in the scope of Chapters 2 and 3 is still a largely open problem. For networked dynamical systems, [36] provides initial work on incorporating quantization along with sampling and delay in an input-output framework.

2. The mathematical computation of upper bounds for the norm of operators characterizing sampling and delay (Chapter 2 and Chapter 3), as well as the evaluation of supply function (Chapter 4) introduce conservativeness in the results. Exploring other methods could lead to less conservative results. For example, the gain bound presented in [18] is based on Wirtinger's Inequality. Additionally, less conservative versions of Wirtinger's Inequality have been proposed in [115]. It would be useful to exploit these properties in future works. Moreover, in the scope of Chapter 3, it would be interesting to extend the approach to take into account other anti-passivity characterizations of sampling effects [18], [37], [46], and obtain less conservative results.
3. The framework in Chapter 2 holds for decentralized LTI systems. Considering a more generic distributed setting with communication among individual controllers is a possible extension of the result.
4. Extending the dissipativity-based approach proposed in Chapter 3 to problem settings considering large-scale systems is still an open problem.
5. In Chapter 3 (and Chapter 4), it is considered that all the states of the sub-systems (the single-loop nonlinear system in Chapter 3), have a single sensor-actuator pair. It would be interesting to explore a more realistic scenario which includes multiple sensors and actuators, with different sampling and actuation sequences.

### 5.2.2 Recommendations for Synchronization Analysis

1. In Chapter 4, only sampling-induced asynchrony has been considered. While there are other sources of asynchrony as mentioned previously, even considering delay in this framework is a non-trivial extension that needs to be explored. The synchronization manifold invariance result provided in Chapter 5 will not hold if sampling and delay induced asynchrony come into effect together. In such scenarios, instead of full state synchronization, practical synchronization<sup>1</sup>, i.e., state synchronization by allowing certain tolerance in synchronization error, needs to be considered.
2. In Chapter 4, the quadratic storage function that is considered in the dissipativity based synchronization criterion, arises from the condition that for systems that exponentially synchronize in continuous-time, such a storage

---

<sup>1</sup>In real experimental contexts, practical synchronization might be hard to define and verify.

function exists. While this is a good starting point in analysing exponential synchronization in the presence of sampling induced asynchrony, exploring other candidates for storage function can be an interesting research direction.

3. The framework in Chapter 4 could be extended to consider large-scale nonlinear interconnected systems with heterogeneous sub-systems. This extension could be interesting in the scope of problems such as ensemble control, synchronization in heterogeneous systems, etc. By considering sampling- and delay-induced asynchrony as perturbations to the large-scale system (with heterogeneous subsystems), it could be possible to develop a similar framework that builds upon existing results in continuous-time, i.e., in the absence of sampling induced asynchrony.

A global recommendation is that the frameworks developed in this thesis, in Chapters 2, 3, and 4, can be utilized in experimental settings and engineering applications. In automatic cruise control, vehicle platooning [29], [31], applications that require mobile robot control over communication networks [62], etc., it could be interesting to apply the approaches proposed in Chapter 2 and Chapter 3 to obtain trade-offs between sampling periods, delays, and performance requirements. The framework proposed in Chapter 4 can be utilized to study synchronization properties of Hindmarsh-Rose neurons in the presence of sampling induced asynchrony. A similar study in the case of asynchronous network communication due to transmission delay can be found in [123].



---

## Bibliography

---

- [1] K. Åström and B. Wittenmark, *Computer-Controlled Systems: Theory and Design*. Prentice Hall, 1996.
- [2] J. Ackermann, “Robust control prevents car skidding”, *IEEE Control Systems Magazine*, volume 17, number 3, pages 23–31, 1997.
- [3] B. Adhikari, I. Morărescu, and E. Panteley, “An Emerging Dynamics Approach for Synchronization of Linear Heterogeneous Agents Interconnected Over Switching Topologies”, *IEEE Control Systems Letters*, volume 5, number 1, pages 43–48, 2021.
- [4] S. An, B. Lee, and D. Shin, “A Survey of Intelligent Transportation Systems”, in *2011 Third International Conference on Computational Intelligence, Communication Systems and Networks*, 2011, pages 332–337.
- [5] V. Andrieu, B. Jayawardhana, and S. Tarbouriech, “Some Results on Exponential Synchronization of Nonlinear Systems”, *IEEE Transactions on Automatic Control*, volume 63, number 4, pages 1213–1219, 2018.
- [6] D. Antunes, J. Hespanha, and C. Silvestre, “Stability of networked control systems with asynchronous renewal links: An impulsive systems approach”, *Automatica*, volume 49, number 2, pages 402–413, 2013.
- [7] A. Arenas, A. Díaz-Guilera, J. Kurths, Y. Moreno, and C. Zhou, “Synchronization in complex networks”, *Physics Reports*, volume 469, number 3, pages 93–153, 2008.
- [8] L. Bakule and J. Lunze, *Decentralized Design of Feedback Control for Large-scale Systems*, series Kybernetika: Příloha. Academia, 1988.
- [9] L. Bakule, “Decentralized control: An overview”, *Annual Reviews in Control*, volume 32, number 1, pages 87–98, 2008.
- [10] J. C. Barca and Y. A. Sekercioglu, “Swarm robotics reviewed”, *Robotica*, volume 31, number 3, pages 345–359, 2013.



- [11] I. Belykh, V. Belykh, and M. Hasler, “Generalized connection graph method for synchronization in asymmetrical networks”, *Physica D: Nonlinear Phenomena*, volume 224, number 1, pages 42–51, 2006, Dynamics on Complex Networks and Applications.
- [12] V. N. Belykh, I. V. Belykh, and M. Hasler, “Connection graph stability method for synchronized coupled chaotic systems”, *Physica D: Nonlinear Phenomena*, volume 195, number 1, pages 159–187, 2004.
- [13] I. I. Blekhman, “Synchronization in science and technology”, New York: ASME Press Transactions, 1988.
- [14] E. Bompard, A. Estebarsari, T. Huang, and G. Fulli, “A framework for analyzing cascading failure in large interconnected power systems: A post-contingency evolution simulator”, *International Journal of Electrical Power & Energy Systems*, volume 81, pages 12–21, 2016.
- [15] D. Borgers, R. Geiselhart, and W. Heemels, “Tradeoffs between quality-of-control and quality-of-service in large-scale nonlinear networked control systems”, *Nonlinear Analysis: Hybrid Systems*, volume 23, pages 142–165, 2017.
- [16] C. Briat, “Convergence and Equivalence Results for the Jensen’s Inequality - Application to Time-Delay and Sampled-Data Systems”, *IEEE Transactions on Automatic Control*, volume 56, number 7, pages 1660–1665, 2011.
- [17] M. Cantoni, M. A. Fabbro, and C. Kao, “Stability of Aperiodic Sampled-Data Feedback for Systems with Inputs that Update Asynchronously”, in *2018 IEEE Conference on Decision and Control (CDC)*, 2018, pages 7118–7123.
- [18] M. Cantoni, C. Y. Kao, and M. A. Fabbro, “Integral Quadratic Constraints for Asynchronous Sample-and-Hold Links”, *IEEE Transactions on Automatic Control*, 2020.
- [19] D. Carnevale, A. R. Teel, and D. Nesic, “A Lyapunov Proof of an Improved Maximum Allowable Transfer Interval for Networked Control Systems”, *IEEE Transactions on Automatic Control*, volume 52, number 5, pages 892–897, 2007.
- [20] Chai Wah Wu and L. O. Chua, “Synchronization in an array of linearly coupled dynamical systems”, *IEEE Transactions on Circuits and Systems I: Fundamental Theory and Applications*, volume 42, number 8, pages 430–447, 1995.
- [21] V. Chellaboina and W. M. Haddad, “Exponentially dissipative nonlinear dynamical systems: a nonlinear extension of strict positive realness”, in *Proceedings of the 2000 American Control Conference. ACC (IEEE Cat. No.00CH36334)*, volume 5, 2000, 3123–3127 vol.5.

- [22] T. Chen and B. A. Francis, *Optimal Sampled-Data Control Systems*. Secaucus, NJ, USA: Springer-Verlag New York, Inc., 1995.
- [23] S. Chung, A. A. Paranjape, P. Dames, S. Shen, and V. Kumar, “A Survey on Aerial Swarm Robotics”, *IEEE Transactions on Robotics*, volume 34, number 4, pages 837–855, 2018.
- [24] M. Cloosterman, N. van de Wouw, M. Heemels, and H. Nijmeijer, “Robust Stability of Networked Control Systems with Time-varying Network-induced Delays”, in *Proceedings of the 45th IEEE Conference on Decision and Control*, 2006, pages 4980–4985.
- [25] M. B. G. Cloosterman, N. van de Wouw, W. P. M. H. Heemels, and H. Nijmeijer, “Stability of Networked Control Systems With Uncertain Time-Varying Delays”, *IEEE Transactions on Automatic Control*, volume 54, number 7, pages 1575–1580, 2009.
- [26] M. Cloosterman, L. Hetel, N. van de Wouw, W. Heemels, J. Daafouz, and H. Nijmeijer, “Controller synthesis for networked control systems”, *Automatica*, volume 46, number 10, pages 1584–1594, 2010.
- [27] J. Cosp, J. Madrenas, E. Alarcon, E. Vidal, and G. Villar, “Synchronization of nonlinear electronic oscillators for neural computation”, *IEEE Transactions on Neural Networks*, volume 15, number 5, pages 1315–1327, 2004.
- [28] B. P. Demidovich, “Lectures on the Mathematical Stability Theory (in Russian)”, *Nauka, Moscow*, 1967.
- [29] D. Dileep, M. Fusco, J. Verhaegh, L. Hetel, J. Richard, and W. Michiels, “Achieving an  $\mathcal{L}_2$  string stable one vehicle look-ahead platoon with heterogeneity in time-delays”, in *2019 18th European Control Conference (ECC)*, 2019, pages 1220–1226.
- [30] V. S. Dolk, D. P. Borgers, and W. P. M. H. Heemels, “Output-Based and Decentralized Dynamic Event-Triggered Control With Guaranteed  $\mathcal{L}_p$ -Gain Performance and Zero-Freeness”, *IEEE Transactions on Automatic Control*, volume 62, number 1, pages 34–49, 2017.
- [31] V. S. Dolk, J. Ploeg, and W. P. M. H. Heemels, “Event-Triggered Control for String-Stable Vehicle Platooning”, *IEEE Transactions on Intelligent Transportation Systems*, volume 18, number 12, pages 3486–3500, 2017.
- [32] L. Donetti, P. I. Hurtado, and M. A. Muñoz, “Synchronization in Network Structures: Entangled Topology as Optimal Architecture for Network Design”, in *Computational Science – ICCS 2006*, V. N. Alexandrov, G. D. van Albada, P. M. A. Sloot, and J. Dongarra, Eds., Berlin, Heidelberg: Springer Berlin Heidelberg, 2006, pages 1075–1082.

- [33] M. C. F. Donkers, W. P. M. H. Heemels, N. van de Wouw, and L. Hetel, “Stability Analysis of Networked Control Systems Using a Switched Linear Systems Approach”, *IEEE Transactions on Automatic Control*, volume 56, number 9, pages 2101–2115, 2011.
- [34] F. Dörfler and F. Bullo, “Exploring synchronization in complex oscillator networks”, in *51st IEEE Conference on Decision and Control (CDC)*, 2012, pages 7157–7170.
- [35] S. N. Dorogovtsev and J. F. F. Mendes, “Evolution of networks”, *Advances in Physics*, volume 51, number 4, pages 1079–1187, 2002.
- [36] M. Fabbro, “An Input-Output Framework for Stability and Performance Analysis of Networked Systems”, English, Ph.D. dissertation, Department of Electrical and Electronic Engineering, 2019.
- [37] M. A. Fabbro, M. Cantoni, and C.-Y. Kao, “Performance analysis of feedback loops with asynchronous sampling in the forward and return paths”, *IFAC-PapersOnLine*, volume 49, number 22, pages 256–261, 2016, 6th IFAC Workshop on Distributed Estimation and Control in Networked Systems NECSYS 2016.
- [38] F. Ferrante, F. Gouaisbaut, and S. Tarbouriech, “Stabilization of continuous-time linear systems subject to input quantization”, *Automatica*, volume 58, pages 167–172, 2015.
- [39] C. Fiter, T.-E. Korabi, L. Etienne, and L. Hetel, “Stability of LTI Systems with Distributed Sensors and Aperiodic Sampling”, in *Control Subject to Computational and Communication Constraints: Current Challenges*, S. Tarbouriech, A. Girard, and L. Hetel, Eds. Cham: Springer International Publishing, 2018, pages 63–82.
- [40] R. FitzHugh, “Impulses and Physiological States in Theoretical Models of Nerve Membrane”, *Biophysical Journal*, volume 1, number 6, pages 445–466, 1961.
- [41] D. Freirich and E. Fridman, “Decentralized networked control of systems with local networks: A time-delay approach”, *Automatica*, volume 69, pages 201–209, 2016.
- [42] E. Fridman, *Introduction to Time-Delay Systems: Analysis and Control*, series Systems & Control: Foundations & Applications. Springer International Publishing, 2014.
- [43] E. Fridman, A. Seuret, and J.-P. Richard, “Robust sampled-data stabilization of linear systems: an input delay approach”, *Automatica*, volume 40, number 8, pages 1441–1446, 2004.
- [44] E. Fridman and U. Shaked, “Input-output approach to stability and L2-gain analysis of systems with time-varying delays”, *Systems & Control Letters*, volume 55, number 12, pages 1041–1053, 2006.

- [45] H. Fujioka, “A Discrete-Time Approach to Stability Analysis of Systems With Aperiodic Sample-and-Hold Devices”, *IEEE Transactions on Automatic Control*, volume 54, number 10, pages 2440–2445, 2009.
- [46] H. Fujioka, “Stability analysis of systems with aperiodic sample-and-hold devices”, *Automatica*, volume 45, number 3, pages 771–775, 2009.
- [47] R. Goebel, R. G. Sanfelice, and A. R. Teel, “Hybrid dynamical systems”, *IEEE Control Systems*, volume 29, number 2, pages 28–93, 2009.
- [48] K. Gu, J. Chen, and V. Kharitonov, *Stability of Time-Delay Systems*. Birkhauser Boston, 2003.
- [49] O. Gupta, D. McDuff, and R. Raskar, “Real-Time Physiological Measurement and Visualization Using a Synchronized Multi-camera System”, in *2016 IEEE Conference on Computer Vision and Pattern Recognition Workshops (CVPRW)*, 2016, pages 312–319.
- [50] W. M. Haddad, V. Chellaboina, and S. G. Nersesov, *Impulsive and Hybrid Dynamical Systems: Stability, Dissipativity, and Control*. Princeton University Press, 2006.
- [51] T. Hagiwara and M. Araki, “Absolute stability of sampled-data systems with a sector nonlinearity”, *Systems & Control Letters*, volume 27, number 5, pages 293–304, 1996.
- [52] J. Hale, *Theory of Functional Differential Equations*, series Applied Mathematical Sciences. Springer New York, 1977.
- [53] W. P. M. H. Heemels, A. R. Teel, N. van de Wouw, and D. Nesic, “Networked Control Systems With Communication Constraints: Tradeoffs Between Transmission Intervals, Delays and Performance”, *IEEE Transactions on Automatic Control*, volume 55, number 8, pages 1781–1796, 2010.
- [54] W. P. M. H. Heemels and N. van de Wouw, “Stability and Stabilization of Networked Control Systems”, in *Networked Control Systems*, A. Bemporad, M. Heemels, and M. Johansson, Eds. London: Springer London, 2010, pages 203–253.
- [55] J. P. Hespanha, P. Naghshtabrizi, and Y. Xu, “A Survey of Recent Results in Networked Control Systems”, *Proceedings of the IEEE*, volume 95, number 1, pages 138–162, 2007.
- [56] L. Hetel, A. Kruszewski, W. Perruquetti, and J. Richard, “Discrete and Intersample Analysis of Systems With Aperiodic Sampling”, *IEEE Transactions on Automatic Control*, volume 56, number 7, pages 1696–1701, 2011.
- [57] L. Hetel, C. Fiter, H. Omran, A. Seuret, E. Fridman, J. P. Richard, and S. I. Niculescu, “Recent developments on the stability of systems with aperiodic sampling: An overview”, *Automatica*, volume 76, pages 309–335, 2017.

- [58] L.-S. Hu, T. Bai, P. Shi, and Z. Wu, “Sampled-data control of networked linear control systems”, *Automatica*, volume 43, number 5, pages 903 – 911, 2007.
- [59] C. Hua, C. Ge, and X. Guan, “Synchronization of Chaotic Lur’e Systems With Time Delays Using Sampled-Data Control”, *IEEE Transactions on Neural Networks and Learning Systems*, volume 26, number 6, pages 1214–1221, 2015.
- [60] D. Hutchison and J. P. Sterbenz, “Architecture and design for resilient networked systems”, *Computer Communications*, volume 131, pages 13 –21, 2018.
- [61] IEEE, “IEEE Standard for a Precision Clock Synchronization Protocol for Networked Measurement and Control Systems”, *IEEE Std 1588-2008 (Revision of IEEE Std 1588-2002)*, pages 1–300, 2008.
- [62] Joo-Ho Lee and H. Hashimoto, “Controlling mobile robots in distributed intelligent sensor network”, *IEEE Transactions on Industrial Electronics*, volume 50, number 5, pages 890–902, 2003.
- [63] M. Jun and M. G. Safonov, “IQC robustness analysis for time-delay systems”, *International Journal of Robust and Nonlinear Control*, volume 11, number 15, pages 1455–1468, 2001.
- [64] C. Kao and M. Cantoni, “Robust performance analysis of aperiodic sampled-data feedback control systems”, in *2015 54th IEEE Conference on Decision and Control (CDC)*, 2015, pages 1421–1426.
- [65] C.-Y. Kao and B. Lincoln, “Simple stability criteria for systems with time-varying delays”, *Automatica*, volume 40, number 8, pages 1429 – 1434, 2004.
- [66] C.-Y. Kao and A. Rantzer, “Stability analysis of systems with uncertain time-varying delays”, *Automatica*, volume 43, number 6, pages 959 –970, 2007.
- [67] I. Karafyllis and C. Kravaris, “Global stability results for systems under sampled-data control”, in *2007 European Control Conference (ECC)*, 2007, pages 5761–5768.
- [68] I. Karafyllis and M. Krstic, “Nonlinear Stabilization Under Sampled and Delayed Measurements, and With Inputs Subject to Delay and Zero-Order Hold”, *IEEE Transactions on Automatic Control*, volume 57, number 5, pages 1141–1154, 2012.
- [69] B. Karg and S. Lucia, “Towards low-energy, low-cost and high-performance IoT-based operation of interconnected systems”, in *2018 IEEE 4th World Forum on Internet of Things (WF-IoT)*, 2018, pages 706–711.
- [70] H. K. Khalil, *Nonlinear systems; 3rd ed.* Prentice-Hall, 2002.

- [71] A. Kruszewski, W. Jiang, E. Fridman, J. P. Richard, and A. Toguyeni, “A Switched System Approach to Exponential Stabilization Through Communication Network”, *IEEE Transactions on Control Systems Technology*, volume 20, number 4, pages 887–900, 2012.
- [72] T. H. Lee and J. H. Park, “Improved criteria for sampled-data synchronization of chaotic Lur’e systems using two new approaches”, *Nonlinear Analysis: Hybrid Systems*, volume 24, pages 132–145, 2017.
- [73] G. Leen and D. Heffernan, “Expanding automotive electronic systems”, *Computer*, volume 35, number 1, pages 88–93, 2002.
- [74] F. L. Lewis, H. Zhang, K. Hengster-Movric, and A. Das, *Introduction to Synchronization in Nature and Physics and Cooperative Control for Multi-Agent Systems on Graphs*. London: Springer London, 2014, pages 1–21.
- [75] K. Liu, E. Fridman, and L. Hetel, “Network-based control via a novel analysis of hybrid systems with time-varying delays”, in *2012 IEEE 51st IEEE Conference on Decision and Control (CDC)*, 2012, pages 3886–3891.
- [76] K. Liu, V. Suplin, and E. Fridman, “Stability of linear systems with general sawtooth delay”, *IMA Journal of Mathematical Control and Information*, volume 27, number 4, page 419, 2010.
- [77] J. Lu and D. J. Hill, “Global Asymptotical Synchronization of Chaotic Lur’e Systems Using Sampled Data: A Linear Matrix Inequality Approach”, *IEEE Transactions on Circuits and Systems II: Express Briefs*, volume 55, number 6, pages 586–590, 2008.
- [78] M. Lévesque and D. Tipper, “A Survey of Clock Synchronization Over Packet-Switched Networks”, *IEEE Communications Surveys Tutorials*, volume 18, number 4, pages 2926–2947, 2016.
- [79] M. Mattioni, S. Monaco, and D. Normand-Cyrot, “Nonlinear discrete-time systems with delayed control: A reduction”, *Systems & Control Letters*, volume 114, pages 31–37, 2018.
- [80] F. Mazenc, M. Malisoff, and T. N. Dinh, “Robustness of nonlinear systems with respect to delay and sampling of the controls”, *Automatica*, volume 49, number 6, pages 1925–1931, 2013.
- [81] A. Megretski and A. Rantzer, “System analysis via integral quadratic constraints”, *IEEE Transactions on Automatic Control*, volume 42, number 6, pages 819–830, 1997.
- [82] W. Michiels and H. Nijmeijer, “Synchronization of delay-coupled nonlinear oscillators: An approach based on the stability analysis of synchronized equilibria”, *Chaos: An Interdisciplinary Journal of Nonlinear Science*, volume 19, number 3, page 033 110, 2009.

- [83] Y. Mikheev, V. Sobolev, and E. Fridman, “Asymptotic analysis of digital control systems”, *Automation and Remote Control*, volume 49, number 9, pages 1175–1180, 1988, cited By 111.
- [84] L. Mirkin, “Some Remarks on the Use of Time-Varying Delay to Model Sample-and-Hold Circuits”, *IEEE Transactions on Automatic Control*, volume 52, number 6, pages 1109–1112, 2007.
- [85] J. Mohammed, C. Lung, A. Ocneanu, A. Thakral, C. Jones, and A. Adler, “Internet of Things: Remote Patient Monitoring Using Web Services and Cloud Computing”, in *2014 IEEE International Conference on Internet of Things (iThings), and IEEE Green Computing and Communications (GreenCom) and IEEE Cyber, Physical and Social Computing (CPSCom)*, 2014, pages 256–263.
- [86] C. Murguia, R. H. B. Fey, and H. Nijmeijer, “Synchronization of Identical Linear Systems and Diffusive Time-Delayed Couplings”, *IEEE Transactions on Circuits and Systems I: Regular Papers*, volume 61, number 6, pages 1801–1814, 2014.
- [87] J. Nagumo, S. Arimoto, and S. Yoshizawa, “An Active Pulse Transmission Line Simulating Nerve Axon”, *Proceedings of the IRE*, volume 50, number 10, pages 2061–2070, 1962.
- [88] D. Nešić, A. Teel, and E. Sontag, “Formulas relating KL stability estimates of discrete-time and sampled-data nonlinear systems”, *Systems & Control Letters*, volume 38, number 1, pages 49–60, 1999.
- [89] D. Nesic and A. R. Teel, “Input-output stability properties of networked control systems”, *IEEE Transactions on Automatic Control*, volume 49, number 10, pages 1650–1667, 2004.
- [90] D. Nesic, A. R. Teel, and D. Carnevale, “Explicit Computation of the Sampling Period in Emulation of Controllers for Nonlinear Sampled-Data Systems”, *IEEE Transactions on Automatic Control*, volume 54, number 3, pages 619–624, 2009.
- [91] H. Nijmeijer and I. M. Y. Mareels, “An observer looks at synchronization”, *IEEE Transactions on Circuits and Systems I: Fundamental Theory and Applications*, volume 44, number 10, pages 882–890, 1997.
- [92] T. Oguchi and H. Nijmeijer, “A SYNCHRONIZATION CONDITION FOR COUPLED NONLINEAR SYSTEMS WITH TIME-DELAY: A FREQUENCY DOMAIN APPROACH”, *International Journal of Bifurcation and Chaos*, volume 21, number 09, pages 2525–2538, 2011.
- [93] H. Omran, L. Hetel, M. Petreczky, J. P. Richard, and F. Lamnabhi-Lagarrigue, “Stability analysis of some classes of input-affine nonlinear systems with aperiodic sampled-data control”, *Automatica*, volume 70, pages 266–274, 2016.

- [94] H. Omran, L. Hetel, J.-P. Richard, and F. Lamnabhi-Lagarrigue, “Stability analysis of bilinear systems under aperiodic sampled-data control”, *Automatica*, volume 50, number 4, pages 1288–1295, 2014.
- [95] E. Panteley and A. Loría, “Synchronization and Dynamic Consensus of Heterogeneous Networked Systems”, *IEEE Transactions on Automatic Control*, volume 62, number 8, pages 3758–3773, 2017.
- [96] A. Papachristodoulou, J. Anderson, G. Valmorbida, S. Prajna, P. Seiler, and P. A. Parrilo, *SOSTOOLS: Sum of squares optimization toolbox for MATLAB*, 2013.
- [97] A. Pavlov, A. V. Proskurnikov, E. Steur, and N. van de Wouw, “Synchronization of networked oscillators under nonlinear integral coupling”, *IFAC-PapersOnLine*, volume 51, number 33, pages 56–61, 2018, 5th IFAC Conference on Analysis and Control of Chaotic Systems CHAOS 2018.
- [98] A. Pavlov, N. van de Wouw, and H. Nijmeijer, “Convergent Systems: Analysis and Synthesis”, in *Control and Observer Design for Nonlinear Finite and Infinite Dimensional Systems*, T. Meurer, K. Graichen, and E. D. Gilles, Eds. Berlin, Heidelberg: Springer Berlin Heidelberg, 2005, pages 131–146.
- [99] P. Pepe, G. Pola, and M. D. D. Benedetto, “On Lyapunov Krasovskii Characterizations of Stability Notions for Discrete-Time Systems With Uncertain Time-Varying Time Delays”, *IEEE Transactions on Automatic Control*, volume 63, number 6, pages 1603–1617, 2018.
- [100] K. Pettersen, J. Gravdahl, and H. Nijmeijer, Eds., *Group coordination and cooperative control*, English, series Lecture notes in control and information sciences. Germany: Springer, 2006.
- [101] A. Pikovsky, M. Rosenblum, and J. Kurths, *Synchronization: A Universal Concept in Nonlinear Sciences*, series Cambridge Nonlinear Science Series. Cambridge University Press, 2001.
- [102] J. Ploeg, N. van de Wouw, and H. Nijmeijer, “Lp String Stability of Cascaded Systems: Application to Vehicle Platooning”, *IEEE Transactions on Control Systems Technology*, volume 22, number 2, pages 786–793, 2014.
- [103] A. Pogromsky and H. Nijmeijer, “Cooperative oscillatory behavior of mutually coupled dynamical systems”, *IEEE Transactions on Circuits and Systems I: Fundamental Theory and Applications*, volume 48, number 2, pages 152–162, 2001.
- [104] A. Y. Pogromsky, “Passivity Based Design of Synchronizing Systems”, *International Journal of Bifurcation and Chaos*, volume 08, number 02, pages 295–319, 1998.



- [105] I. G. Polushin and H. J. Marquez, “Multirate versions of sampled-data stabilization of nonlinear systems”, *Automatica*, volume 40, number 6, pages 1035–1041, 2004.
- [106] A. Pomerance, E. Ott, M. Girvan, and W. Losert, “The effect of network topology on the stability of discrete state models of genetic control”, *Proceedings of the National Academy of Sciences*, volume 106, number 20, pages 8209–8214, 2009.
- [107] M. Posthumus - Cloosterman, “Control over communication networks : modeling, analysis, and synthesis”, English, Ph.D. dissertation, Department of Mechanical Engineering, TU Eindhoven, 2008.
- [108] R. Postoyan, P. Tabuada, D. Nešić, and A. Anta, “A Framework for the Event-Triggered Stabilization of Nonlinear Systems”, *IEEE Transactions on Automatic Control*, volume 60, number 4, pages 982–996, 2015.
- [109] J. P. Ramirez, L. A. Olvera, H. Nijmeijer, and J. Alvarez, “Synchronization and Dynamic Consensus of Heterogeneous Networked Systems”, *Scientific Reports*, volume 6, number 23580, 2016.
- [110] K. Sakai and T. Oguchi, “Synchronization of Coupled Nonlinear Systems with Bidirectional Sampled-data Couplings”, *IFAC-PapersOnLine*, volume 52, number 16, pages 634–639, 2019, 11th IFAC Symposium on Nonlinear Control Systems NOLCOS 2019.
- [111] H. Sandberg, S. Amin, and K. H. Johansson, “Cyberphysical Security in Networked Control Systems: An Introduction to the Issue”, *IEEE Control Systems Magazine*, volume 35, number 1, pages 20–23, 2015.
- [112] I. W. Sandberg, “On the  $\mathcal{L}_2$ -Boundedness of Solutions of Nonlinear Functional Equations”, *Bell System Technical Journal*, volume 43, number 4, pages 1581–1599, 1964.
- [113] B. Schafer, D. Witthaut, M. Timme, and V. Latora, “Dynamically induced cascading failures in power grids”, *Nature Communications*, volume 9, May 2018.
- [114] P. Seiler, “Stability Analysis With Dissipation Inequalities and Integral Quadratic Constraints”, *IEEE Transactions on Automatic Control*, volume 60, number 6, pages 1704–1709, 2015.
- [115] A. Seuret and F. Gouaisbaut, “Jensen’s and Wirtinger’s inequalities for time-delay systems”, *IFAC Proceedings Volumes*, volume 46, number 3, pages 343–348, 2013, 11th Workshop on Time-Delay Systems.
- [116] A. Seuret, “A novel stability analysis of linear systems under asynchronous samplings”, *Automatica*, volume 48, number 1, pages 177–182, 2012.

- [117] B. Shen, Z. Wang, and X. Liu, “Sampled-Data Synchronization Control of Dynamical Networks With Stochastic Sampling”, *IEEE Transactions on Automatic Control*, volume 57, number 10, pages 2644–2650, 2012.
- [118] H. Shen, S. Jiao, J. Cao, and T. Huang, “An Improved Result on Sampled-Data Synchronization of Markov Jump Delayed Neural Networks”, *IEEE Transactions on Systems, Man, and Cybernetics: Systems*, pages 1–9, 2019.
- [119] Q. Shuang, M. Zhang, and Y. Yuan, “Node vulnerability of water distribution networks under cascading failures”, *Reliability Engineering & System Safety*, volume 124, pages 132–141, 2014.
- [120] P. Siano, “Demand response and smart grids—A survey”, *Renewable and Sustainable Energy Reviews*, volume 30, pages 461–478, 2014.
- [121] N. Sivashankar and P. P. Khargonekar, “Robust stability and performance analysis of sampled-data systems”, *IEEE Transactions on Automatic Control*, volume 38, number 1, pages 58–69, 1993.
- [122] T. Sommer, M. Sulzer, M. Wetter, A. Sotnikov, S. Mennel, and C. Stettler, “The reservoir network: A new network topology for district heating and cooling”, *Energy*, volume 199, page 117418, 2020.
- [123] E. Steur and H. Nijmeijer, “Synchronization in Networks of Diffusively Time-Delay Coupled (Semi-)Passive Systems”, *IEEE Transactions on Circuits and Systems I: Regular Papers*, volume 58, number 6, pages 1358–1371, 2011.
- [124] E. Steur, W. Michiels, H. Huijberts, and H. Nijmeijer, “Networks of diffusively time-delay coupled systems: Conditions for synchronization and its relation to the network topology”, *Physica D: Nonlinear Phenomena*, volume 277, pages 22–39, 2014.
- [125] E. Steur, I. Tyukin, and H. Nijmeijer, “Semi-passivity and synchronization of diffusively coupled neuronal oscillators”, *Physica D: Nonlinear Phenomena*, volume 238, number 21, pages 2119–2128, 2009.
- [126] S. H. Strogatz and I. Stewart, “Coupled oscillators and biological synchronization”, *Scientific American*, volume 269, number 6, pages 102–109, 1993.
- [127] L. A. Tawalbeh, R. Mehmood, E. Benkhelifa, and H. Song, “Mobile Cloud Computing Model and Big Data Analysis for Healthcare Applications”, *IEEE Access*, volume 4, pages 6171–6180, 2016.
- [128] J. Thomas, C. Fiter, L. Hetel, N. Wouw, and J. P. Richard, “Dissipativity-based Framework for Stability Analysis of Aperiodically Sampled Nonlinear Systems with Time-varying Delay”, *Automatica*, in press, 2021.

- [129] J. Thomas, L. Hetel, C. Fiter, N. van de Wouw, and J. Richard, “ $L_2$ -Stability Criterion for Systems with Decentralized Asynchronous Controllers”, in *2018 IEEE Conference on Decision and Control (CDC)*, 2018, pages 6638–6643.
- [130] J. Thomas, E. Steur, C. Fiter, L. Hetel, and N. van de Wouw, “Exponential Synchronization of Nonlinear Oscillators Under Sampled-Data Coupling”, in *2020 59th IEEE Conference on Decision and Control (CDC)*, 2020, pages 1824–1829.
- [131] A. van der Schaft, *L2-Gain and passivity techniques in nonlinear control*, English. Germany: Springer, 2000.
- [132] M. Wakaiki, K. Okano, and J. P. Hespanha, “Stabilization of systems with asynchronous sensors and controllers”, *Automatica*, volume 81, pages 314–321, 2017.
- [133] G. C. Walsh, Hong Ye, and L. G. Bushnell, “Stability analysis of networked control systems”, *IEEE Transactions on Control Systems Technology*, volume 10, number 3, pages 438–446, 2002.
- [134] Wei Zhang, M. S. Branicky, and S. M. Phillips, “Stability of networked control systems”, *IEEE Control Systems Magazine*, volume 21, number 1, pages 84–99, 2001.
- [135] J. C. Willems, “Dissipative dynamical systems Part II: Linear systems with quadratic supply rates”, *Archive for Rational Mechanics and Analysis*, volume 45, number 5, pages 352–393, 1972.
- [136] J. C. Willems, “Dissipative Dynamical Systems”, *European Journal of Control*, volume 13, number 2, pages 134–151, 2007.
- [137] N. van de Wouw, P. Naghshtabrizi, M. B. G. Cloosterman, and J. P. Hespanha, “Tracking control for sampled-data systems with uncertain time-varying sampling intervals and delays”, *International Journal of Robust and Nonlinear Control*, volume 20, number 4, pages 387–411, 2010.
- [138] N. van de Wouw, D. Nešić, and W. Heemels, “A discrete-time framework for stability analysis of nonlinear networked control systems”, *Automatica*, volume 48, number 6, pages 1144–1153, 2012.
- [139] C. W. Wu and L. O. Chua, “On a conjecture regarding the synchronization in an array of linearly coupled dynamical systems”, *IEEE Transactions on Circuits and Systems I: Fundamental Theory and Applications*, volume 43, number 2, pages 161–165, 1996.
- [140] F. Xiao, Y. Shi, and W. Ren, “Robustness Analysis of Asynchronous Sampled-Data Multiagent Networks With Time-Varying Delays”, *IEEE Transactions on Automatic Control*, volume 63, number 7, pages 2145–2152, 2018.

- 
- [141] S. Yanchuk, A. Stefanski, T. Kapitaniak, and J. Wojewoda, “Dynamics of an array of mutually coupled semiconductor lasers”, *Phys. Rev. E*, volume 73, page 016 209, 1 2006.
- [142] B. Yao and M. Tomizuka, “Adaptive robust control of SISO nonlinear systems in a semi-strict feedback form”, *Automatica*, volume 33, number 5, pages 893 –900, 1997.
- [143] G. Zames, “On the input-output stability of time-varying nonlinear feedback systems Part one: Conditions derived using concepts of loop gain, conicity, and positivity”, *IEEE Transactions on Automatic Control*, volume 11, number 2, pages 228–238, 1966.
- [144] W. Zhang, “Stability Analysis of Networked Control Systems”, Ph.D. dissertation, 2001.
- [145] K. Zhou, J. C. Doyle, and K. Glover, *Robust and Optimal Control*. Upper Saddle River, NJ, USA: Prentice-Hall, Inc., 1996.
- [146] H. Zou, S. Mao, Y. Wang, F. Zhang, X. Chen, and L. Cheng, “A Survey of Energy Management in Interconnected Multi-Microgrids”, *IEEE Access*, volume 7, pages 72 158–72 169, 2019.



---

## Acknowledgement

---

It is often said that the journey makes reaching your destination worth it. When I look back on the last four years of my life, I have no doubt that the wonderful associations I have made, and the experiences I have had give a deeper meaning to the accomplishment that is this thesis. The gratitude I have for all the people who played their part in this incredible journey will remain forever.

First and foremost, I want to thank Laurentiu Hetel, Nathan van de Wouw and Jean-Pierre Richard for giving me the opportunity to be a part of Project UCoCoS. I would also like to thank Christophe Fiter and Erik Steur, who along with Laurentiu, Nathan and Jean-Pierre, formed the supervisory team that I was fortunate to work with. Four years ago, when I arrived in Lille, I remember being excited and intimidated by the path that awaited me. Laurentiu, Christophe, Jean-Pierre and Nathan, I am really grateful for the patience, guidance and understanding you showed throughout the last four years. In the early stages, it is thanks to you that the intimidating aspect of the research that awaited me disappeared rather quickly. Erik, thanks a lot for your involvement and supervision in the later stages of my Ph.D. research. I have learned a lot from all of you over the last four years.

My sincere gratitude also goes to Philip de Goey, who agreed to be the chair of my doctoral committee, and Sophie Tarbouriech, Elena Panteley, Michael Cantoni and Henk Nijmeijer, who agreed to be members of my doctoral committee and reviewed this thesis in detail.

One of the things I value the most from the last four years is the vibrant group dynamics I was fortunate to experience within and outside research, thanks to an incredible group of people I met along the way. Jean-Pierre, your support extended beyond research and helped me a lot over the past four years. Right from the very beginning, your involvement in making sure that my transition to a new professional environment at Centrale Lille helped me adapt to life in Lille. I will forever be grateful to you for sharing your insights on various research topics over the years, and not to mention your willingness to help me in numerous occasions throughout this Ph.D. journey. Laurentiu and Christophe, I thoroughly enjoyed our football, basketball, badminton sessions in addition to

the casual conversations and drinks we have had. I will always remember how you would try to spontaneously set aside time for discussing any questions I had, be it regarding research or otherwise. Even after I moved to Eindhoven, this did not change. That attribute played a huge role in the progress I made over the years. Thank you! My colleagues at CRISAL Lille, Centrale Lille, and INRIA Lille, I enjoyed our everyday group lunch at Barrois and post lunch discussions at Café Culture. It was exactly the type of recharging I needed midday to continue working. I also enjoyed playing football with you during spring and summer. Thank you Paco, Haik, Mert, Lucien, Zohra, Faten, Tania, Kostya, Desiré, Youness, Yue, Yacine, Maxime, Alex, Nelson, Siyuan, Tona and everyone else in the group. Our time in Lille will always be fondly remembered. I would also like to thank Brigitte Foncez, Magdalena Baidan and the rest of the administrative staff at Centrale Lille for their assistance in many occasions over the last four years.

The wonderful colleagues within the Dynamics and Control (D&C) group at TU Eindhoven (TU/e) welcomed me with open arms when I moved here in 2019. I am really grateful to Nathan for giving me the opportunity to be a Teaching Assistant for the course ‘4DM10: Multibody and Nonlinear Dynamics’. Additionally, thank you for trusting me with the responsibility of organizing the group lunch colloquia for the academic year 2019-2020. You were always very understanding of the bureaucratic difficulties I faced in the last two years and supported me. I will always remember the effort you took in the final stages of my Ph.D. to help me ensure that the procedures leading up to the defence were taken care of smoothly. Your involvement in supervising my research right from the very beginning of my Ph.D. life when I lived in Lille helped me a lot to learn and grow professionally. Thank you Nathan! Nathan and Erik, I am especially thankful to you for the manner in which you adapted your supervision of my research during the COVID-19 pandemic. It helped me in finishing the final research contribution of this thesis within the stipulated time. I would also like to thank the members of the futsal team Atlético Bitterballen. Our league matches and our promotion to the first division will always be cherished. Fahim, thank you for introducing me to Atlético Bitterballen, and for being a great team-mate while organizing the group lunch colloquia and while being Teaching Assistants for the course 4DM10. I would also like to thank you Geertje, for all the times you have helped me, be it related to administrative procedures or otherwise. Your efficiency and quick response saved me a lot of time in many scenarios. Thanks a lot! Sajad, thank you for helping me out in the last stage with matters related to the defence procedure. My sincere gratitude goes to every single member of the D&C group.

I would like to thank Project UCoCoS and its members. Haik, Kirill, Quentin, Libo and Deesh, I thoroughly enjoyed every single workshop we attended together as a group, and the numerous discussions we have had. Libo, I would like to thank you additionally for being a very nice colleague and office-

mate for the last two years at TU/e. My sincere gratitude goes to Wim Michiels, with whom I had interesting discussions during my time at KU Leuven as a Visiting Researcher. Thank you Wim, for it was those discussions that paved the way for the paper Deesh co-authored with me.

I would like to express my gratitude to Justin Ruths, with whom I worked at the Singapore University of Technology and Design, prior to commencing my doctoral research. Thank you Justin, because my interest in Networked Control Systems stems from our work.

Right from the first day I left India to pursue my dreams, my family never stopped believing in me. Thank you Achacha, for just being you! I am yet to meet a kinder, more empathetic soul than you, and everyday, I try my best to be like you. Thank you Amma, for always being an inspiration and positive influence in my life. It is also thanks to you that I got interested in Control Systems in the first place. Thank you Sajju, my brother, for always being the jovial presence that you are. My sincere gratitude goes to my extended family, my in-laws, with whom I had numerous jolly conversations that helped clear my mind in many occasions.

Finally, my heartfelt gratitude goes to my loving wife Meryl. Your constant support, motivation and belief is what spurred me on. As is the case with most Ph.D. students, there were times when I doubted myself and you made me regain the conviction I needed to keep working. Your love, support, and understanding was especially vital during the many weekends I had to work on my research, sometimes in short notice despite having made other plans. Overall, this thesis would never have been possible without you. Thank you, my dear.

*Jijju Thomas*  
*April 2021*  
*'s-Hertogenbosch, the Netherlands*





---

## About the author

---

Jijju Thomas was born on May 4, 1990 in Ernakulam, India. He obtained the Bachelor of Technology (with Honors) degree in Instrumentation and Control Engineering from the University of Calicut, India in 2011. In September 2012, he moved to the Netherlands and in December 2014, he obtained the Master of Science degree in Systems and Control Engineering, from the Delft University of Technology, the Netherlands. His Master's thesis entitled 'Interaction Control Using External Forces' was completed at the Delft Center for Systems and Control. From January 2015 to April 2016, he was a Research Engineer within the Engineering Systems and Design pillar at the Singapore University of Technology Design (SUTD), Singapore. His research at SUTD focussed on application of pseudo-spectral optimal control methods on epileptic seizure abatement, and robustness analysis of synthetic networks.



In 2016, he was selected as a Marie Curie Early Stage Researcher within the framework of the European project 'Understanding and Controlling of Complex Systems' (UCoCoS), to pursue his Ph.D. in Dynamics and Control Engineering jointly at Centrale Lille, France and the Department of Mechanical Engineering at the Eindhoven University of Technology (TU/e), the Netherlands. Under the supervision of Laurentiu Hetel (CRIStAL, Lille), Christophe Fiter (University of Lille, France), Jean-Pierre Richard (Centrale Lille, France), Erik Steur (TU/e) and Nathan van de Wouw (TU/e), he worked on sampled-data systems, time-delay systems, stability and synchronization analysis in large-scale networked linear/nonlinear systems. The first half of his tenure as a doctoral candidate, from December 2016 to January 2019, was spent in Lille, France. In April 2018, he held a visiting researcher position at the Numerical Analysis and Applied Mathematics (NUMA) research center at Katholieke Universiteit Leuven, Belgium. From October 2018 to January 2019, he held an additional appointment as a Project Intern at CITC EuraRFID, Lille. In February 2019, he moved to Eindhoven, the Netherlands for the latter half of his doctoral research.



## **Systèmes Dynamiques en Réseau: Nouvelles Approches Entrée-Sortie pour l'analyse de la Stabilité et de la Synchronisation**

La révolution des technologies de communication a généré de nombreuses opportunités applicatives mettant en œuvre une ingénierie de réseaux et systèmes: systèmes de transport, réseaux de distribution électrique, robotique coopérative, etc. Dans chacun de ces domaines, des processus, des capteurs, des actionneurs et des contrôleurs sont connectés à travers un réseau de communication. Dans ce contexte de multi-agents connectés, les effets d'échantillonnage (digitalisation) et de retards (qualité de service du réseau) ont été clairement identifiés comme des dynamiques additionnelles sources d'instabilité ou de désynchronisation du réseau. La principale contribution de cette thèse est le développement de nouveaux outils de modélisation et d'analyse permettant de garantir la stabilité ou la synchronisation de systèmes en réseau, tout en tenant compte des effets complexes d'asynchronisme des échantillonneurs (non périodiques) et de retard dans le réseau. Ainsi, en se plaçant dans un contexte entrée-sortie, nous proposons une nouvelle approche de modélisation et d'analyse de stabilité. Les outils ainsi définis permettent d'obtenir un compromis entre, d'une part, les performances requises pour la dynamique du système contrôlé (stabilité, convergence exponentielle/rapidité, synchronisation) et, d'autre part, des caractéristiques temporelles du réseau (bornes des intervalles de variation des échantillonnages et des retards) liées à sa qualité de service.

Mots-clés: *Systèmes interconnectés; Systèmes à retards, Synchronisation, Systèmes en Réseau*

### **Networked Dynamical Systems: An Input-Output Approach towards Stability and Synchronization Analysis**

Recent advances in communication technology have given rise to a wide range of applications for networked engineering systems such as, e.g., transportation systems, power grids, cooperative robotics, etc., in which systems, sensors, actuators and controllers are linked over a (wireless) communication network. In such networked systems, information transmission over the network is not continuous (sampling effect), delayed and often asynchronous. A well-known challenge in this context is that sampling and delay effects induced by the communication network can render systems unstable and destroy synchronization properties in. The main contribution of this thesis is the development of novel modelling and analysis tools for stability and synchronization analysis in complex networked systems, while considering asynchronous, aperiodic sampling and delay effects. To that end, this thesis exploits the Input-Output approach, which is well known to be appealing from an engineering perspective. The proposed analysis tools aid in obtaining a trade-off between, on the one hand, system performance requirements (guaranteeing system stability and synchronization properties), and, on the other hand, communication network requirements (sampling period and delay bounds).

Keywords: *Large-scale interconnected systems, time-delay systems, Synchronisation, Networked Systems.*

