



HAL
open science

The discret Anderson model: integrated density of states, principal eigenvalue and landscape function

Daniel Sánchez Mendoza

► **To cite this version:**

Daniel Sánchez Mendoza. The discret Anderson model: integrated density of states, principal eigenvalue and landscape function. Spectral Theory [math.SP]. Université de Strasbourg, 2022. English. NNT : 2022STRAD030 . tel-04023258v2

HAL Id: tel-04023258

<https://theses.hal.science/tel-04023258v2>

Submitted on 10 Mar 2023

HAL is a multi-disciplinary open access archive for the deposit and dissemination of scientific research documents, whether they are published or not. The documents may come from teaching and research institutions in France or abroad, or from public or private research centers.

L'archive ouverte pluridisciplinaire **HAL**, est destinée au dépôt et à la diffusion de documents scientifiques de niveau recherche, publiés ou non, émanant des établissements d'enseignement et de recherche français ou étrangers, des laboratoires publics ou privés.

**ÉCOLE DOCTORALE MATHÉMATIQUES, SCIENCES DE L'INFORMATION ET DE
L'INGÉNIEUR – ED269**

Institut de Recherche Mathématique Avancée (IRMA)

THÈSE présentée par :

Daniel SÁNCHEZ MENDOZA

soutenue le : 26 Août 2022

pour obtenir le grade de : **Docteur de l'université de Strasbourg**

Discipline/ Spécialité : Mathématiques

**The Discrete Anderson Model :
Integrated Density of States,
Principal Eigenvalue and Landscape Function**

THÈSE dirigée par :

Mme ANANTHARAMAN Nalini

Professeure, Université de Strasbourg

RAPPORTEURS :

M. KLOPP Frédéric

Professeur, Sorbonne Université

M. KÖNIG Wolfgang

Professeur, Technischen Universität Berlin

AUTRES MEMBRES DU JURY :

M. ZENG Xiaolin

Maître de conférence, Université de Strasbourg

Mme ROJAS-MOLINA Constanza

Enseignante-chercheuse, CY Cergy Paris Université

M. KLEVTSOV Semyon

Professeur, Université de Strasbourg

UNIVERSITÉ DE STRASBOURG
INSTITUT DE RECHERCHE MATHÉMATIQUE AVANCÉE
ÉCOLE DOCTORALE MSII

**The Discrete Anderson Model:
Integrated Density of States, Principal
Eigenvalue and Landscape Function**

Daniel Sánchez Mendoza

Thèse de doctorat réalisée sous la direction de

Nalini Anantharaman

soutenue le 26 Août 2022 devant le jury composé de :

Nalini Anantharaman	Université de Strasbourg	directrice
Frédéric Klopp	Sorbonne Université	rapporteur
Wolfgang König	Technischen Universität Berlin	rapporteur
Xiaolin Zeng	Université de Strasbourg	examinateur
Constanza Rojas-Molina	CY Cergy Paris Université	examinatrice
Semyon Klevtsov	Université de Strasbourg	examinateur



Abstract

In this PhD thesis we accomplish two objectives:

- We show there is countable dense set at which the integrated density of states of the Anderson-Bernoulli model on \mathbb{Z} can be explicitly computed, provided the disorder parameter is large enough.
- We give a partial proof of a conjecture, first stated in a 2012 article by Filoche and Mayboroda, concerning the product of principal eigenvalue and sup-norm of the landscape function of the Anderson model operator restricted to a large box of \mathbb{Z}^d . For the one dimensional case, we give a full proof of such conjecture.

Résumé

Dans cette thèse de doctorat, nous atteignons deux objectifs :

- Nous montrons qu'il existe un ensemble dense dénombrable auquel la densité d'états intégrée du modèle d'Anderson-Bernoulli sur \mathbb{Z} peut être explicitement calculée, à condition que le paramètre de désordre soit suffisamment grand.
- Nous donnons une preuve partielle d'une conjecture, énoncée pour la première fois dans un article de 2012 par Filoche et Mayboroda, concernant le produit de la valeur propre principale et la sup-norme de la fonction landscape de l'opérateur du modèle d'Anderson restreint à une grande boîte de \mathbb{Z}^d . Pour le cas unidimensionnel, nous donnons une preuve complète de cette conjecture.

Contents

Introduction (English)	7
Introduction (Français)	15
1 The IDS of the 1d Anderson-Bernoulli Model	23
1.1 Proof of Theorem 1.1	26
1.2 Proof of Theorem 1.2	34
1.3 Some Numeric Computations and Insights	37
1.4 Lifshitz Tails and Other Distributions	39
2 Principal Eigenvalue and Landscape Function	45
2.1 Principal Eigenvalue (Proof of Theorem 2.1)	50
2.1.1 Upper Bound of $\lambda_{n,V}$	50
2.1.2 Lower Bound of $\lambda_{n,V}$	53
2.2 Landscape Function	57
2.2.1 Proof of Theorem 2.2 i)	62
2.2.2 Proof of Theorem 2.2 ii)	64
2.2.3 Alternative Proof of Theorem 2.2 ii) for (C1)	68
References	71

Introduction (English)

The aim of this thesis is to study three objects associated to the Anderson model on \mathbb{Z}^d . The first is the integrated density of states (IDS) when $d = 1$ and the potential follows a Bernoulli distribution. The second and third, which are intrinsically connected, are the principal eigenvalue and the landscape function of the Anderson Hamiltonian restricted to a large box. The thesis is split in two chapters: Chapter 1 deals with the one dimensional IDS for the Bernoulli potential, while Chapter 2 is for the principal eigenvalue and the landscape function. These two chapters are completely disjoint. For this reason, we use slightly different notations better suited for the results and proofs presented in each chapter.

Most of the content of the thesis is already part of my published articles

- Daniel Sánchez-Mendoza, “Sharp bounds for the integrated density of states of a strongly disordered 1D Anderson–Bernoulli model”, *J. Math. Phys.* 62, 072107 (2021).
<https://doi.org/10.1063/5.0037707>
- Daniel Sánchez-Mendoza, “The integrated density of states of the 1D discrete Anderson–Bernoulli model at rational energies”, *J. Math. Phys.* 63, 012103 (2022).
<https://doi.org/10.1063/5.0073805>

and the preprint, already submitted to *Communications in Mathematical Physics*,

- Daniel Sánchez-Mendoza, “Principal Eigenvalue and Landscape Function of the Anderson Model on a Large Box”, arXiv:2203.01059 (2022).
<https://arxiv.org/abs/2203.01059>

We now proceed to introduce the Anderson model, define our objects of study and state the results we obtained.

Some Facts About the Anderson Model

In the mid-fifties, physicist Philip W. Anderson (1923 – 2020) introduced a model to explain insulators. In crystals, the atoms are distributed on a periodic way, forming a lattice. If such lattice is perfect, then the electrons are always allowed to move through the crystal; and therefore perfect crystals are always electrical conductors. However, some crystals found in nature are insulators, which is simply explained by the fact that crystal are never perfect. They always have defects or impurities that deviate them from the idealized model. The grand idea of Anderson was to model the appearance of such impurities by random variables in the simplest of ways: independent and identically distributed random variables, one for each lattice site.

Mathematically, the Anderson model on the lattice \mathbb{Z}^d is defined as follows. Let $\{V_\omega(j)\}_{j \in \mathbb{Z}^d}$ be independent, identically distributed, real random variables defined over a probability space $(\Omega, \mathcal{F}, \mathbb{P})$, with common distribution ν . The *Anderson model* is given by the random Schrödinger operator

$$H := -\Delta + V : \ell^2(\mathbb{Z}^d) \supset \mathcal{D} \longrightarrow \ell^2(\mathbb{Z}^d)$$

$$\phi \longmapsto H\phi(j) := \sum_{|y-x|=1} [\phi(x) - \phi(y)] + V(x)\phi(x).$$

Since V is real valued and $-\Delta$ is bounded and self-adjoint we can always define H on the subspace of finitely supported functions, and then find a self adjoint extension. If ν has compact support then H is a bounded self-adjoint operator \mathbb{P} -a.s.

A remarkable property of the Anderson model is that its spectrum is not random, in fact, the spectrum is \mathbb{P} -a.s. equal to some deterministic set:

Theorem (Corollary 3.13 of [AW15]).

$$\sigma(H) = \sigma(-\Delta) + \text{supp } \mu = [0, 4d] + \text{supp } \mu \quad \mathbb{P}\text{-a.s.}$$

We can now define our first object of interest, the *integrated density of states* (IDS), defined by

$$I(x) := \lim_{n \rightarrow \infty} \frac{1}{\#\Lambda_n} \#\{\lambda \in \sigma(H|_{\Lambda_n}) \mid \lambda \leq x\}, \quad x \in \mathbb{R},$$

where $\Lambda_n := [-n, n]^d \cap \mathbb{Z}^d$, the restricted operator has Dirichlet boundary conditions outside Λ_n , and the eigenvalues are counted with multiplicities.

Theorem (Corollary 3.16 of [AW15]). *The IDS is a deterministic distribution function, whose associated probability measure, called the density of states measure, is supported on the almost sure spectrum of H .*

The IDS is known to be exponentially small when x approaches the bottom of the almost sure spectrum of H . This phenomenon is called Lifshitz tails in honor of Ilya M. Lifshitz (1917-1982), the physicist who predicted it. The most usual statement of this behavior is given in the next theorem.

Theorem (Theorem 4.14 of [AW15]). *Suppose $a = \inf \sigma(H) = \inf \text{supp } \nu > -\infty$ and $\mathbb{P}[V(0) \leq a + \varepsilon] \geq C\varepsilon^\eta$ for some $C, \eta > 0$. Then*

$$\lim_{x \searrow a} \frac{\ln |\ln I(x)|}{\ln(x-a)} = -\frac{d}{2}.$$

Lifshitz tails can also be found (under similar hypothesis) at the top of the spectrum or at any other edge of the almost sure spectrum of H . We will see that there are stronger version of Lifshitz tails in Chapters 1 and 2.

Finally, there is the phenomenon of Anderson localization. Under some hypothesis on the regularity of ν (the distribution of the potential), it has been proved that H has only pure point spectrum near a and the corresponding eigenvectors have exponential decay. Localization will not be a part of this thesis, except as part of the motivation for landscape functions.

The IDS of the 1d Anderson-Bernoulli Model

When the potential in the Anderson model follows a Bernoulli distribution we use the name Anderson-Bernoulli model. Chapter 1 is dedicated to the IDS of the one dimensional Anderson-Bernoulli model when the potential takes values the 0 and $\zeta > 0$, with the probability of ζ being some $p \in (0, 1)$. The number ζ is called the disorder parameter and measures the strength of the disorder in the model.

Much is known about the Anderson-Bernoulli model on \mathbb{Z} . In 1984, Delyon and Souillard [DS84] gave an elementary proof of the continuity of the IDS. Spectral localization on the whole spectrum at any disorder was proven in 1987 by Carmona, Klein and Martinelli [CKM87] using Furstenberg's theorem and multi-scale analysis. Later that same year Martinelli and Micheli [MM87] gave a lower

bound, uniform over the spectrum, on the asymptotic of the Lyapunov exponent as the disorder parameter goes to infinity, and in doing so showed the density of states measure is purely singular continuous if the disorder parameter is large enough. More recently, in 2004, Schulz-Baldes [SB03] showed that the IDS exhibits a strong version of Lifshitz tails in which the Lifshitz constant can be computed at all spectral edges.

In Chapter 1 we aim to answer, to some extent, the questions: What value does the IDS assign to a given energy? How does its plot look like? More precisely, we show that for every energy x in a countable dense set (which will be called the set of rational energies), the IDS evaluated at x can be given explicitly and it does not depend on the disorder parameter, whenever the latter is above an x -dependent critical value.

To mathematically state our results we need some notation. We index the IDS with the parameters p, ζ . We define the functions

$$\beta(x) := \frac{\pi}{2 \arcsin(\sqrt{x}/2)}, \quad I_p^{\leq}(x) := p^2 \sum_{y=1}^{\infty} (1-p)^y \left\lfloor \frac{y+1}{\beta(x)} \right\rfloor, \quad x \in (0, 4),$$

where $\lfloor \cdot \rfloor$ is the floor function; and the set of *rational energies*

$$R := \{\beta^{-1}(b/a) \mid a, b \in \mathbb{N}, a < b\}.$$

With this definitions, the main result of Chapter 1 reads

Theorem. *For all $x \in R$ there is a critical $\zeta_c(x) \in (0, \infty)$ such that*

$$\zeta \geq \zeta_c(x) \implies I_{p,\zeta}(x) = I_p^{\leq}(x).$$

For $a, b \in \mathbb{N}$ with $a < b$, $\gcd(a, b) = 1$ we have

$$\zeta_c(\beta^{-1}(b/a)) \leq \max \left\{ 8, \frac{4b}{\pi} + 4 \right\}$$

and

$$I_p^{\leq}(\beta^{-1}(b/a)) = \frac{p^2}{1 - (1-p)^b} \left(\frac{a(1-p)^b}{p} + \sum_{r=0}^{b-1} (1-p)^r \left\lfloor \frac{a(r+1)}{b} \right\rfloor \right).$$

Moreover $\lim_{\zeta \rightarrow \infty} I_{p,\zeta}(x) = I_p^{\leq}(x)$ for all $x \in (0, 4)$.

For the case where $a = 1$ or $a = b - 1$ we give a better upper bound on the critical ζ :

Theorem.

- i) $\zeta_c(\beta^{-1}(b/1)) \leq 4$ for all $b \in \mathbb{N} \setminus \{1\}$.
- ii) $\zeta_c(\beta^{-1}(b/(b-1))) \leq \beta^{-1}(b/(b-1))$ for all $b \in \mathbb{N} \setminus \{1\}$.

In addition to this two theorems we obtain a stronger version of Lifshitz tails at every edge of the almost sure spectrum.

Principal Eigenvalue and Landscape Function of the Anderson Model on a Large Box

We now turn our attention to the operator $-\Delta_{\Lambda_n} + V (= H|_{\Lambda_n})$ when n is large, and V is non-negative. Physicists are interested in the ground state of this operator as well as the first few (relative to n) excited states. However, computing numerically this eigenvalues and eigenvectors can be computational expensive since one has to solve many equations of the form

$$(-\Delta_{\Lambda_n} + V)\phi = \lambda\phi.$$

Filоче and Mayboroda proposed in [FM12] that we can obtain significant information on the eigensystem by solving for the *landscape function* $L_{\Lambda_n, V}$, defined by the equation

$$(-\Delta_{\Lambda_n} + V)L_{\Lambda_n, V} = \mathbf{1}_{\Lambda_n}.$$

They conjectured that if we order the local maxima of the landscape function decreasingly, and the eigenvalues increasingly

$$L_{\Lambda_n, V}^1 \geq L_{\Lambda_n, V}^2 \geq \dots, \quad \lambda_{\Lambda_n, V}^1 \leq \lambda_{\Lambda_n, V}^2 \leq \dots,$$

then we have

$$\lambda_{\Lambda_n, V}^i L_{\Lambda_n, V}^i \approx C(d) = 1 + \frac{d}{4}, \quad i \ll n^d.$$

They also conjectured that the location of the local maxima is the localization center of corresponding ordered eigenvector. Numerical experiments support this conjecture, as can be seen in the next two figures.

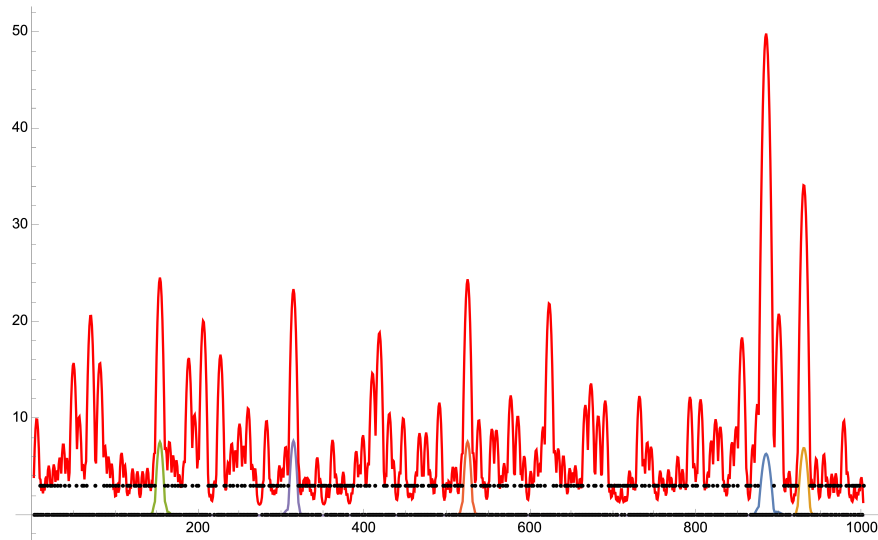

Figure 1: One realization of a potential $V(0) \stackrel{d}{=} \text{Bernoulli}(0.3)$ (black), its first 5 eigenvectors (colors), and its landscape function (red).

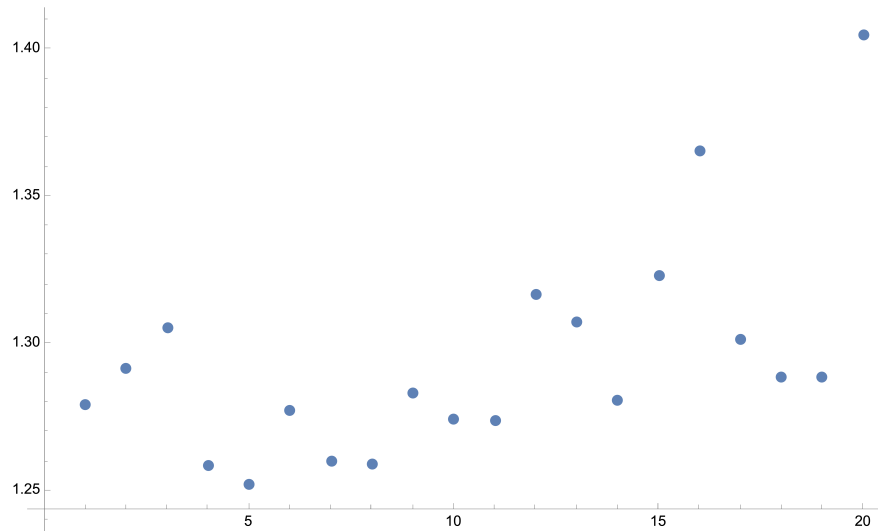

Figure 2: The products $\lambda_{\Lambda_n, V}^i L_{\Lambda_n, V}^i$ for $i = 1, \dots, 20$ in the same potential realization as Figure 1.

In Figure 1 we show a realization of a Bernoulli potential on a one-dimensional box of size 1000, the landscape function, and the first five eigenvectors; in it the correspondence between the location of the maxima of the landscape function

and the eigenvectors is evident. In Figure 2 we show the first twenty products $\lambda_{\Lambda_n, V}^i L_{\Lambda_n, V}^i$ of the same realization of the potential, from which we can observe that such products are always of “order 1”.

In Chapter 2, we tackle the part of the conjecture that concerns the principal (smallest) eigenvalue and the absolute maxima of the landscape function. We will assume that the distribution function $F(t) = \mathbb{P}[V(0) \leq t]$ satisfies one of the following conditions:

$$\text{(C1)} \quad 0 < F(0) < 1,$$

$$\text{(C2)} \quad F(t) = ct^\eta(1 + o(1)) \text{ as } t \downarrow 0 \text{ for some } c, \eta > 0.$$

Under these hypothesis we claim that

$$\lim_{n \rightarrow \infty} \lambda_{n, V}^1 L_{n, V}^1 = \frac{\mu_d}{2d} \quad \mathbb{P}\text{-a.s.}, \quad (1)$$

where μ_d is the principal eigenvalue of the continuous Laplacian $(-\sum_{i=1}^d \partial^2 / \partial x_i^2)$ on the unit ball with Dirichlet boundary conditions. The disagreement between the dimensional constants $\frac{\mu_d}{2d}$ and $1 + \frac{d}{4}$ is simply explained by the fact that $1 + \frac{d}{4}$ was “guessed” from the numerical experiments, and the two constants are close to each other. For example, for $d = 1$ we have $1 + \frac{1}{4} = 1.25$ and $\frac{\mu_1}{2} = \frac{\pi^2}{8} \approx 1.23$.

In order to prove (1), we first compute the almost sure asymptotic of the principal eigenvalue

Theorem.

- i) For (C1), $\lim_{n \rightarrow \infty} \lambda_{\Lambda_n, V}^1 \left(\frac{\omega_d |\ln F(0)|}{d \ln n} \right)^{-2/d} = \mu_d \quad \mathbb{P}\text{-a.s.},$
- ii) For (C2), $\lim_{n \rightarrow \infty} \lambda_{\Lambda_n, V}^1 \left(\frac{2\eta\omega_d \ln \ln n}{d^2 \ln n} \right)^{-2/d} = \mu_d \quad \mathbb{P}\text{-a.s.},$

where ω_d is the volume of the unit ball in \mathbb{R}^d . Then we use such asymptotic to give a partial proof of (1), with a complete proof for the one-dimensional case:

Theorem.

- i) $\varliminf_{n \rightarrow \infty} \lambda_{\Lambda_n, V}^1 L_{\Lambda_n, V}^1 \geq \frac{\mu_d}{2d} \quad \mathbb{P}\text{-a.s.}$
- ii) If $d = 1$ then $\lim_{n \rightarrow \infty} \lambda_{\Lambda_n, V}^1 L_{\Lambda_n, V}^1 = \frac{\mu_1}{2} \quad \mathbb{P}\text{-a.s.}$

Introduction (Français)

Le but de cette thèse est d'étudier trois objets associés au modèle d'Anderson sur \mathbb{Z}^d . La première est la densité d'états intégrée (DEI) lorsque $d = 1$ et le potentiel suit une distribution de Bernoulli. Le deuxième et le troisième, qui sont intrinsèquement liés, sont la valeur propre principale et la fonction landscape de l'hamiltonien d'Anderson restreint à une grande boîte. La thèse est divisée en deux chapitres : le chapitre 1 traite de l'IDS unidimensionnel pour le potentiel de Bernoulli, tandis que le chapitre 2 concerne la valeur propre principale et la fonction landscape. Ces deux chapitres sont complètement disjoints. Pour cette raison, nous utilisons des notations légèrement différentes, mieux adaptées aux résultats et aux preuves présentés dans chaque chapitre.

La majeure partie du contenu de la thèse fait déjà partie de mes articles publiés

- Daniel Sánchez-Mendoza, “Sharp bounds for the integrated density of states of a strongly disordered 1D Anderson–Bernoulli model”, *J. Math. Phys.* 62, 072107 (2021).
<https://doi.org/10.1063/5.0037707>
- Daniel Sánchez-Mendoza, “The integrated density of states of the 1D discrete Anderson–Bernoulli model at rational energies”, *J. Math. Phys.* 63, 012103 (2022).
<https://doi.org/10.1063/5.0073805>

et le preprint, déjà soumis à *Communications in Mathematical Physics*,

- Daniel Sánchez-Mendoza, “Principal Eigenvalue and Landscape Function of the Anderson Model on a Large Box”, arXiv:2203.01059 (2022).
<https://arxiv.org/abs/2203.01059>

Nous allons maintenant introduire le modèle d'Anderson, définir nos objets d'étude et énoncer les résultats que nous avons obtenus.

Quelques faits sur le modèle d'Anderson

Au milieu des années 50, le physicien Philip W. Anderson (1923 - 2020) a introduit un modèle pour expliquer les isolants. Dans les cristaux, les atomes sont répartis de manière périodique, formant un réseau. Si un tel réseau est parfait, alors les électrons sont toujours autorisés à se déplacer à travers le cristal; et donc les cristaux parfaits sont toujours des conducteurs électriques. Cependant, certains cristaux trouvés dans la nature sont des isolants, ce qui s'explique simplement par le fait que les cristaux ne sont jamais parfaits. Ils ont toujours des défauts ou des impuretés qui les différencient du modèle idéalisé. La grande idée d'Anderson était de modéliser l'apparition de telles impuretés par des variables aléatoires indépendantes et identiquement distribuées, une pour chaque site du réseau.

Mathématiquement, le modèle d'Anderson sur \mathbb{Z}^d est défini comme suit. Soit $\{V_\omega(j)\}_{j \in \mathbb{Z}^d}$ des variables réelles aléatoires indépendantes, identiquement distribuées, définies sur un espace de probabilité $(\Omega, \mathcal{F}, \mathbb{P})$, avec une distribution commune ν . Le modèle d'Anderson est donné par l'opérateur de Schrödinger aléatoire

$$H := -\Delta + V : \ell^2(\mathbb{Z}^d) \supset \mathcal{D} \longrightarrow \ell^2(\mathbb{Z}^d)$$

$$\phi \longmapsto H\phi(j) := \sum_{|y-x|=1} [\phi(x) - \phi(y)] + V(x)\phi(x).$$

Puisque V est à valeur réelle et $-\Delta$ est borné et auto-adjoint, nous pouvons toujours définir H sur le sous-espace des fonctions à support fini, puis trouver une extension auto-adjointe. Si ν a un support compact alors H est un opérateur auto-adjoint borné \mathbb{P} -p.s.

La première propriété remarquable du modèle d'Anderson est que son spectre n'est pas aléatoire, en fait, le spectre est \mathbb{P} -p.s. égal à un ensemble déterministe:

Théorème (Corollaire 3.13 de [AW15]).

$$\sigma(H) = \sigma(-\Delta) + \text{supp } \mu = [0, 4d] + \text{supp } \mu \quad \mathbb{P}\text{-p.s.}$$

Nous pouvons maintenant définir notre premier objet d'intérêt, la *densité d'états intégrée* (DEI), définie par

$$I(x) := \lim_{n \rightarrow \infty} \frac{1}{\#\Lambda_n} \#\{\lambda \in \sigma(H|_{\Lambda_n}) \mid \lambda \leq x\}, \quad x \in \mathbb{R},$$

où $\Lambda_n := [-n, n]^d \cap \mathbb{Z}^d$, l'opérateur restreint a des conditions aux limites de Dirichlet aux en dehors de Λ_n , et les valeurs propres sont comptées avec des multiplicités.

Théorème (Corollaire 3.16 de [AW15]). *La DEI est une fonction de distribution déterministe, dont la mesure de probabilité associée, appelée mesure de densité d'états, est supportée sur le spectre presque sûr de H .*

On sait que l'IDS est exponentiellement petit lorsque x s'approche du bas du spectre presque sûr de H . Ce phénomène est appelé les asymptotiques de Lifshitz en l'honneur d'Ilya M. Lifshitz (1917-1982), le physicien qui l'a prédit. L'énoncé le plus courant de ce comportement est donné dans le théorème suivant.

Théorème (Théorème 4.14 de [AW15]). *Supposons que $a = \inf \sigma(H) > -\infty$ et $\mathbb{P}[V(0) \leq a + \varepsilon] \geq C\varepsilon^\eta$ pour certains $C, \eta > 0$. Alors*

$$\lim_{x \searrow a} \frac{\ln |\ln I(x)|}{\ln(x - a)} = -\frac{d}{2}.$$

Les asymptotiques de Lifshitz peuvent également être trouvées (sous une hypothèse similaire) au sommet du spectre ou à tout autre bord du spectre presque sûr de H . Nous verrons qu'il existe des versions plus fortes des queues de Lifshitz dans les chapitres 1 et 2.

Finalement, il y a le phénomène de localisation d'Anderson. Sous certaines hypothèses sur la régularité de ν (la distribution du potentiel), il a été prouvé que H n'a que du spectre ponctuel près de a et que les vecteurs propres correspondants ont une décroissance exponentielle. La localisation ne fera pas partie de cette thèse, sauf dans le cadre de la motivation des fonctions landscape.

La DEI du modèle unidimensionnel d'Anderson-Bernoulli

Lorsque le potentiel dans le modèle d'Anderson suit une distribution de Bernoulli, nous utilisons le nom de modèle d'Anderson-Bernoulli. Le chapitre 1 est consacré à la DEI du modèle unidimensionnel d'Anderson-Bernoulli lorsque le potentiel prend les valeurs 0 et $\zeta > 0$, avec la probabilité d'obtenir ζ égal à un certain $p \in (0, 1)$. Le nombre ζ est appelé paramètre de désordre et. Il mesure la intensité du désordre dans le modèle.

On en sait beaucoup sur le modèle d'Anderson-Bernoulli sur \mathbb{Z} . En 1984, Delyon et Souillard [DS84] donnent une preuve élémentaire de la continuité de

la DEI. La localisation spectrale sur tout le spectre à n'importe quel désordre a été prouvée en 1987 par Carmona, Klein et Martinelli [CKM87] en utilisant le théorème de Furstenberg et l'analyse multi-échelle. Plus tard la même année, Martinelli et Micheli [MM87] ont donné une borne inférieure, uniforme sur tout le spectre, sur l'asymptotique de l'exposant de Lyapunov lorsque le paramètre de désordre tend vers l'infini, et ce faisant, ils ont montré que la mesure de densité d'états est singulière continue si le paramètre de désordre est suffisamment grand. Plus récemment, en 2004, Schulz-Baldes [SB03] a montré que la DEI présente une version forte des asymptotiques de Lifshitz dans laquelle la constante de Lifshitz peut être calculée à tous les bords spectraux.

Dans le chapitre 1, nous répondons, dans une certaine mesure, à question: quelle valeur la DEI attribue-t-il à une énergie donnée? Plus précisément, nous montrons qu'il existe un ensemble dense dénombrable d'énergies (que l'on appellera l'ensemble des énergies rationnelles) auxquelles la DEI peut être calculé explicitement, à condition que ζ est assez grand.

Pour énoncer nos résultats, nous avons besoin de quelques notations. Nous indexons l'DIE avec les paramètres p, ζ . Nous définissons les fonctions

$$\beta(x) := \frac{\pi}{2 \arcsin(\sqrt{x}/2)}, \quad I_p^{\leq}(x) := p^2 \sum_{y=1}^{\infty} (1-p)^y \left\lfloor \frac{y+1}{\beta(x)} \right\rfloor, \quad x \in (0, 4),$$

où $\lfloor \cdot \rfloor$ est la fonction partie entière; et l'ensemble des *énergies rationnelles*

$$R := \{ \beta^{-1}(b/a) \mid a, b \in \mathbb{N}, a < b \}.$$

Avec ces définitions, le résultat principal du chapitre 1 est:

Théorème. *Pour tout $x \in R$ il existe un $\zeta_c(x) \in (0, \infty)$ critique tel que*

$$\zeta \geq \zeta_c(x) \implies I_{p,\zeta}(x) = I_p^{\leq}(x).$$

Pour $a, b \in \mathbb{N}$ avec $a < b$, $\gcd(a, b) = 1$ nous avons

$$\zeta_c(\beta^{-1}(b/a)) \leq \max \left\{ 8, \frac{4b}{\pi} + 4 \right\}$$

et

$$I_p^{\leq}(\beta^{-1}(b/a)) = \frac{p^2}{1 - (1-p)^b} \left(\frac{a(1-p)^b}{p} + \sum_{r=0}^{b-1} (1-p)^r \left\lfloor \frac{a(r+1)}{b} \right\rfloor \right).$$

De plus $\lim_{\zeta \rightarrow \infty} I_{p,\zeta}(x) = I_p^{\leq}(x)$ pour tout $x \in (0, 4)$.

Pour le cas où $a = 1$ ou $a = b - 1$ nous donnons une meilleure borne supérieure sur le ζ critique :

Théorème.

$$\text{i) } \zeta_c(\beta^{-1}(b/1)) \leq 4 \text{ pour tout } b \in \mathbb{N} \setminus \{1\}.$$

$$\text{ii) } \zeta_c(\beta^{-1}(b/(b-1))) \leq \beta^{-1}(b/(b-1)) \text{ pour tout } b \in \mathbb{N} \setminus \{1\}.$$

En plus de ces deux théorèmes, nous obtenons une version plus forte des asymptotiques de Lifshitz à chaque bord du spectre presque sûr.

Valeur propre principale et fonction landscape du modèle d'Anderson sur une grande boîte

Intéressons-nous maintenant à l'opérateur $-\Delta_{\Lambda_n} + V (= H|_{\Lambda_n})$ lorsque n est grand et V non négatif. Les physiciens s'intéressent à l'état fondamental de cet opérateur ainsi qu'aux premiers états excités (par rapport à n). Cependant, le calcul numérique de ces valeurs propres et vecteurs propres peut être coûteux car il faut résoudre de nombreuses équations de la forme

$$(-\Delta_{\Lambda_n} + V)\phi = \lambda\phi.$$

Filoché et Mayboroda ont proposé dans [FM12] que nous pouvons obtenir des informations significatives sur le système de valeurs propres et de vecteurs propres en résolvant la *fonction landscape* $L_{\Lambda_n, V}$, définie par l'équation

$$(-\Delta_{\Lambda_n} + V)L_{\Lambda_n, V} = \mathbf{1}_{\Lambda_n}.$$

Ils ont conjecturé que si nous ordonnons les maxima locaux de la fonction de landscape de manière décroissante, et les valeurs propres de manière croissante

$$L_{\Lambda_n, V}^1 \geq L_{\Lambda_n, V}^2 \geq \dots, \quad \lambda_{\Lambda_n, V}^1 \leq \lambda_{\Lambda_n, V}^2 \leq \dots,$$

alors nous avons

$$\lambda_{\Lambda_n, V}^i L_{\Lambda_n, V}^i \approx C(d) = 1 + \frac{d}{4}, \quad i \ll n^d.$$

Ils ont également supposé que la position des maxima locaux coïncidait avec le centre de localisation des vecteurs propres ordonnés correspondants. Des expériences numériques soutiennent cette conjecture, comme on peut le voir dans les deux figures suivantes.

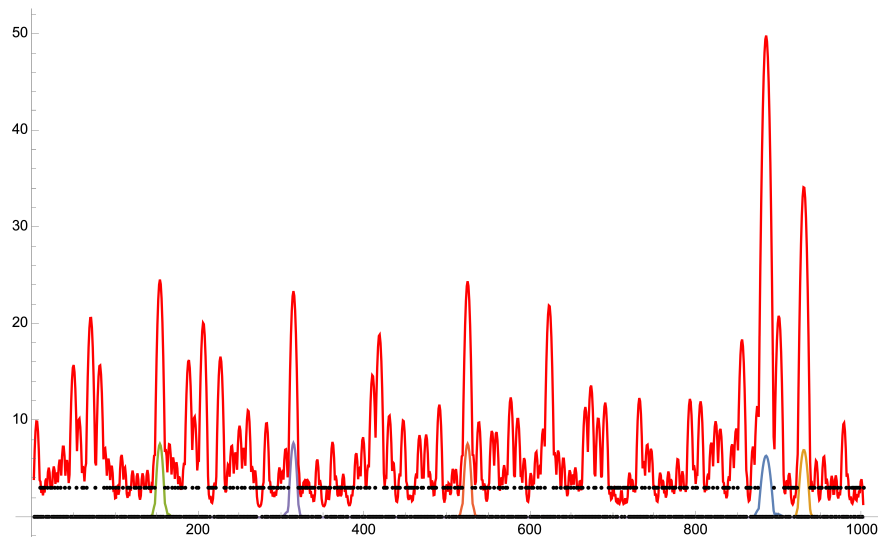

Figure 3: Une réalisation d'un potentiel $V(0) \stackrel{d}{=} \text{Bernoulli}(0.3)$ (noir), ses 5 premiers vecteurs propres (couleurs) et sa fonction landscape (rouge).

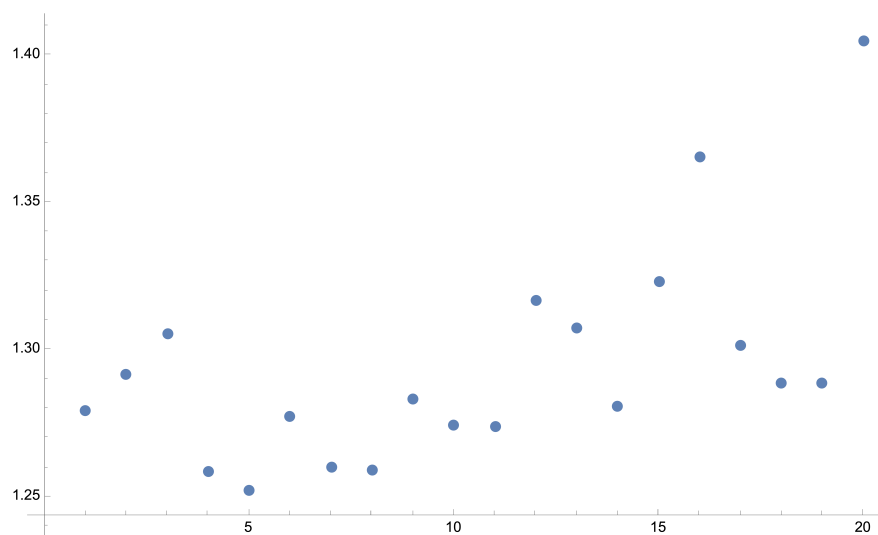

Figure 4: Les produits $\lambda_{\Lambda_n, V}^i L_{\Lambda_n, V}^i$ pour $i = 1, \dots, 20$ dans la même réalisation potentielle que la figure 3.

Dans la figure 3, nous montrons une réalisation d'un potentiel de Bernoulli sur une boîte unidimensionnelle de taille 1000, la fonction landscape et les cinq premiers vecteurs propres. Dans la figure 4, nous montrons les vingt premiers produits $\lambda_{\Lambda_n, V}^i L_{\Lambda_n, V}^i$ de la même réalisation du potentiel, à partir desquels nous pouvons observer que ces produits sont toujours d'ordre 1.

Au chapitre 2, nous abordons la partie de la conjecture qui concerne la valeur propre principale (la plus petite) et les maximum de la fonction landscape. Nous supposons que la fonction de répartition $F(t) = \mathbb{P}[V(0) \leq t]$ vérifie l'une des conditions suivantes:

$$(C1) \quad 0 < F(0) < 1,$$

$$(C2) \quad F(t) = ct^\eta(1 + o(1)) \text{ lorsque } t \downarrow 0 \text{ pour certains } c, \eta > 0.$$

Sous ces hypothèses nous affirmons que

$$\lim_{n \rightarrow \infty} \lambda_{n, V}^1 L_{n, V}^1 = \frac{\mu_d}{2d} \quad \mathbb{P}\text{-p.s.}, \quad (2)$$

où μ_d est la valeur propre principale du Laplacien continu $(-\sum_{i=1}^d \partial^2 / \partial x_i^2)$ sur la boule unité avec conditions aux limites de Dirichlet. Le désaccord entre les constantes dimensionnelles $\frac{\mu_d}{2d}$ et $1 + \frac{d}{4}$ s'explique simplement par le fait que $1 + \frac{d}{4}$ a été "deviné" des expériences numériques, et les deux constantes sont proches l'une de l'autre. Par exemple, pour $d = 1$ nous avons $1 + \frac{1}{4} = 1,25$ et $\frac{\mu_1}{2} = \frac{\pi^2}{8} \approx 1.23$.

Afin de prouver (2), on calcule d'abord l'asymptotique presque sûre de la valeur propre principale

Théorème.

$$i) \text{ Pour (C1), } \lim_{n \rightarrow \infty} \lambda_{\Lambda_n, V}^1 \left(\frac{\omega_d |\ln F(0)|}{d \ln n} \right)^{-2/d} = \mu_d \quad \mathbb{P}\text{-p.s.},$$

$$ii) \text{ Pour (C2), } \lim_{n \rightarrow \infty} \lambda_{\Lambda_n, V}^1 \left(\frac{2\eta\omega_d \ln \ln n}{d^2 \ln n} \right)^{-2/d} = \mu_d \quad \mathbb{P}\text{-p.s.},$$

où ω_d est le volume de la boule unité dans \mathbb{R}^d . Et puis nous utilisons une telle asymptotique pour donner une preuve partielle de (2), avec une preuve complète pour le cas unidimensionnel:

Théorème.

$$i) \quad \liminf_{n \rightarrow \infty} \lambda_{\Lambda_n, V}^1 L_{\Lambda_n, V}^1 \geq \frac{\mu_d}{2d} \quad \mathbb{P}\text{-p.s.}$$

$$ii) \text{ Si } d = 1 \text{ alors } \lim_{n \rightarrow \infty} \lambda_{\Lambda_n, V}^1 L_{\Lambda_n, V}^1 = \frac{\mu_1}{2} \quad \mathbb{P}\text{-p.s.}$$

Chapter 1

The IDS of the 1d Anderson-Bernoulli Model

The operator we are concerned with is

$$\begin{aligned} H_{p,\zeta} &:= -\Delta + \zeta V_p : \ell^2(\mathbb{N}) \longrightarrow \ell^2(\mathbb{N}) \\ (H_{p,\zeta}\phi)(j) &:= [2\phi(j) - \phi(j+1) - \phi(j-1)] + \zeta V_p(j)\phi(j), \quad \phi \in \ell^2(\mathbb{N}), \end{aligned}$$

where the Laplacian has the Dirichlet boundary condition $\phi(0) = 0$, the disorder parameter ζ is assumed to be positive, and the potential $\{V_p(j)\}_{j \in \mathbb{N}}$ is an independent and identically distributed (i.i.d.) sequence of random variables defined over a probability space $(\Omega, \mathcal{F}, \mathbb{P})$ following a non-degenerate Bernoulli(p) distribution, i.e. $\mathbb{P}[V_p(j) = 1] = p = 1 - \mathbb{P}[V_p(j) = 0]$. The IDS, denoted $I_{p,\zeta}$, is given by the almost sure limit

$$I_{p,\zeta}(x) := \lim_{L \rightarrow \infty} \frac{1}{L} \# \left\{ \lambda \in \sigma \left(H_{p,\zeta}|_{\ell^2(\{1, \dots, L\})} \right) \mid \lambda \leq x \right\}, \quad x \in \mathbb{R},$$

where $H_{p,\zeta}|_{\ell^2(\{1, \dots, L\})}$ has Dirichlet boundary conditions at $j = 0$ and $j = L + 1$. Defining $H_{p,\zeta}$ on \mathbb{N} instead of \mathbb{Z} simplifies the proof of our main results and makes no difference on the IDS, as can be seen from [AW15, Lemma 4.12]. However, it makes a difference on the spectrum, since $H_{p,\zeta}$ may not have an almost sure spectrum (see [CL12]). Regardless of the spectrum of $H_{p,\zeta}$, the support of the density of states measure, i.e. the closure of set of points at which $I_{p,\zeta}$ increases, is

$$[0, 4] + \{0, \zeta\} = [0, 4] \cup [\zeta, \zeta + 4].$$

We will focus on describing $I_{p,\zeta}$ on the interval $[0, 4]$ since one can use the unitary map $(U\phi)(j) = (-1)^j \phi(j)$ to obtain analogous statements for $[\zeta, \zeta + 4]$.

Indeed, U transforms $H_{p,\zeta}$ as $UH_{p,\zeta}U^* = 4 + \zeta - (-\Delta + \zeta[1 - V_p])$, since $\{1 - V_p(j)\}_{j \in \mathbb{N}}$ is an i.i.d. Bernoulli($1 - p$) potential, we have

$$I_{p,\zeta}(x) = 1 - I_{1-p,\zeta}(4 + \zeta - x). \quad (1.1)$$

This equality exchanges $[0, 4] \leftrightarrow [\zeta, \zeta + 4]$ at the cost of also exchanging $p \leftrightarrow 1 - p$.

Before stating our main results we define the functions

$$\beta(x) := \frac{\pi}{2 \arcsin(\sqrt{x}/2)}, \quad I_p^{\leq}(x) := p^2 \sum_{y=1}^{\infty} (1-p)^y \left\lfloor \frac{y+1}{\beta(x)} \right\rfloor, \quad x \in (0, 4),$$

where $\lfloor \cdot \rfloor$ is the floor function. We also define the set of *rational energies*

$$R := \left\{ \beta^{-1}(b/a) \left(= 4 \sin^2 \left(\frac{\pi a}{2b} \right) \right) \mid a, b \in \mathbb{N}, a < b \right\},$$

which is countable and dense in $[0, 4]$. The appearance of the floor function makes I_p^{\leq} right-continuous everywhere, but discontinuous at every point of R .

Theorem 1.1. *For all $x \in R$ there is a critical $\zeta_c(x) \in (0, \infty)$ such that*

$$\zeta \geq \zeta_c(x) \implies I_{p,\zeta}(x) = I_p^{\leq}(x).$$

For $a, b \in \mathbb{N}$ with $a < b$, $\gcd(a, b) = 1$ we have

$$\zeta_c(\beta^{-1}(b/a)) \leq \max \left\{ 8, \frac{4b}{\pi} + 4 \right\},$$

$$I_p^{\leq}(\beta^{-1}(b/a)) = \frac{p^2}{1 - (1-p)^b} \left(\frac{a(1-p)^b}{p} + \sum_{r=0}^{b-1} (1-p)^r \left\lfloor \frac{a(r+1)}{b} \right\rfloor \right).$$

Moreover $\lim_{\zeta \rightarrow \infty} I_{p,\zeta}(x) = I_p^{\leq}(x)$ for all $x \in (0, 4)$.

Remark. 1. We have excluded $x = 0$ from the definition of R and I_p^{\leq} to avoid the singularity of β , however $I_{p,\zeta}(0) = 0$ for all $\zeta \geq 0$. We have also excluded $x = 4$ because (we will later see that) $I_{p,\zeta}(4) = 1 - p$ for $\zeta \geq 4$, but

$$p^2 \sum_{y=1}^{\infty} (1-p)^y \left\lfloor \frac{y+1}{1} \right\rfloor = (1-p)(1+p) > 1-p.$$

2. For any $x \in \mathbb{R}$, $\lim_{\zeta \rightarrow \infty} I_{p,\zeta}(x)$ exists since $\zeta \mapsto I_{p,\zeta}(x)$ is decreasing and bounded from below by 0. Clearly, $\lim_{\zeta \rightarrow \infty} I_{p,\zeta}(x) = 0$ for $x \leq 0$, and $\lim_{\zeta \rightarrow \infty} I_{p,\zeta}(x) = 1 - p$ for $x \geq 4$. In $(0, 4)$ the limit $\lim_{\zeta \rightarrow \infty} I_{p,\zeta} = I_p^{\leq}$ is only point-wise since $I_{p,\zeta}$ is continuous for every ζ while I_p^{\leq} is discontinuous.

Within R we find the subset of rational energies where $a = 1$ or $a = b - 1$,

$$R' := \{\beta^{-1}(b/1) \mid b \in \mathbb{N} \setminus \{1\}\} \cup \{\beta^{-1}(b/(b-1)) \mid b \in \mathbb{N} \setminus \{1\}\} \subseteq R.$$

For the energies of R' we can give a better upper bound on $\zeta_c(\cdot)$:

Theorem 1.2.

- i) $\zeta_c(\beta^{-1}(b/1)) \leq 4$ for all $b \in \mathbb{N} \setminus \{1\}$.
- ii) $\zeta_c(\beta^{-1}(b/(b-1))) \leq \beta^{-1}(b/(b-1))$ for all $b \in \mathbb{N} \setminus \{1\}$.

Theorem 1.2 implies that $I_{p,\zeta} = I_p^{\leq}$ on R' if $\zeta \geq 4$, as shown in Figure 1.1. We also can use Theorems 1.1 and 1.2 to obtain a granular idea of the plot of $I_{p,\zeta}$ for any given $\zeta \geq 8$. Indeed, if $\zeta \geq 8$ and we define $n = n(\zeta) := \lfloor \frac{\pi(\zeta-4)}{4} \rfloor \in \mathbb{N}$ and

$$R_n := \{\beta^{-1}(b/a) \mid a, b \in \mathbb{N}, a < b \leq n\} \cup R' \subseteq R,$$

we have $I_{p,\zeta} = I_p^{\leq}$ on R_n , as shown in Figure 1.2. Naturally, as ζ increases so does n and $R_n \uparrow R$.

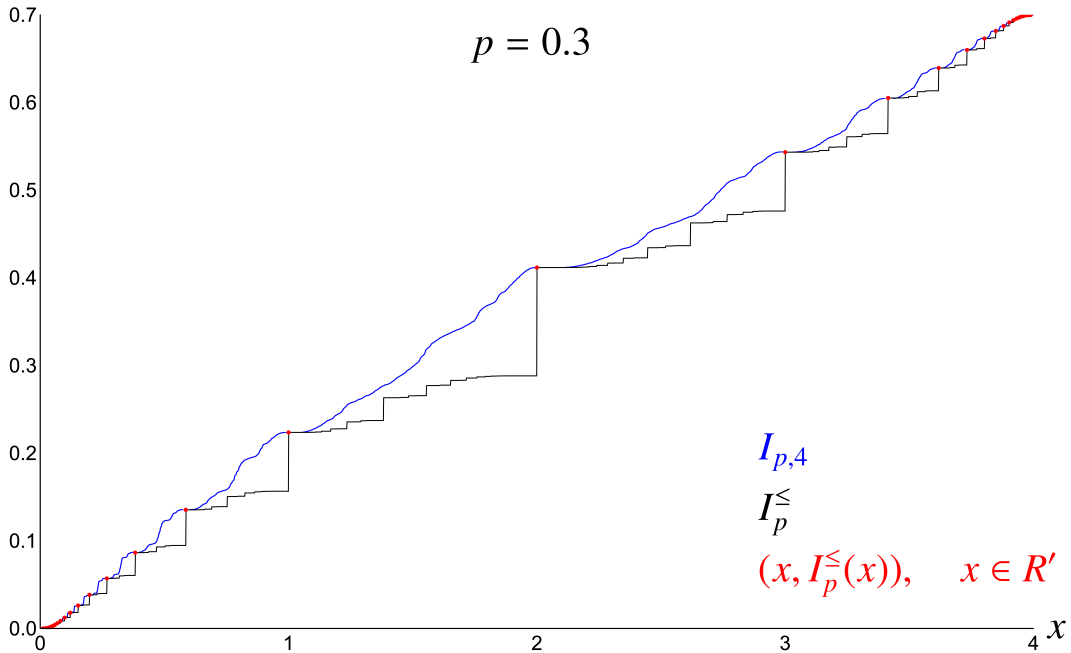

Figure 1.1: Plot of $I_{p,4}$, I_p^{\leq} and the points $\{(x, I_p^{\leq}(x)) \mid x \in R'\}$ for $p = 0.3$. $I_{p,4}$ was computed numerically from a $10^5 \times 10^5$ matrix.

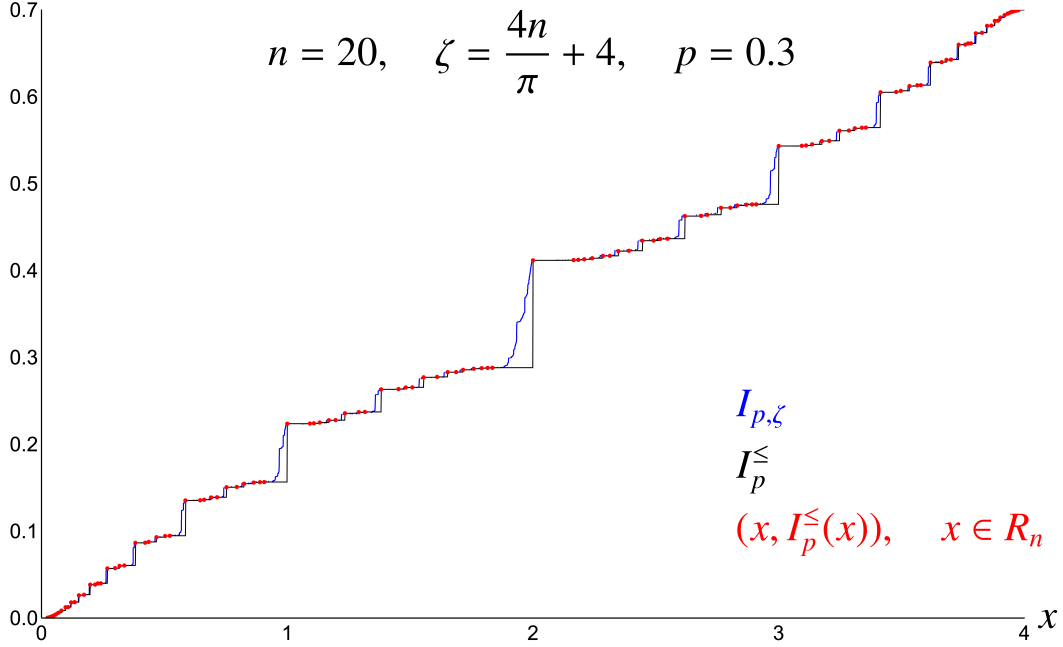

Figure 1.2: Plot of $I_{p,\zeta}$, I_p^{\leq} and the points $\{(x, I_p^{\leq}(x)) \mid x \in R_n\}$ for $n = 20$, $\zeta = \frac{4n}{\pi} + 4$, $p = 0.3$. $I_{p,\zeta}$ was computed numerically from a $10^5 \times 10^5$ matrix.

The proof of Theorems 1.1 and 1.2 consists of bounding $I_{p,\zeta}$, from above and below, by the IDS of a direct sum of i.i.d. random operators whose spectra is explicit or we can approximate very well. This is done by applying a modified Dirichlet-Neumann bracketing to the finite volume restriction of $H_{p,\zeta}$. It is worth noting that a stronger upper bound on $\zeta_c(x)$ than the one given in Theorem 1.1 may be achieved by refining Proposition 1.3. In particular, a more careful treatment of equation (1.7) and its solutions may lead to an upper bound on $\zeta_c(\beta^{-1}(b/a))$ that depends on a and not just b .

1.1 Proof of Theorem 1.1

We start by giving all the necessary definitions and notations.

We define two sequences of random variables

$$\begin{aligned} L_1 &:= \min\{j > 0 \mid V_p(j) = 1\}, & Y_1 &:= L_1 - 1, \\ L_{n+1} &:= \min\{j > L_n \mid V_p(j) = 1\}, & Y_{n+1} &:= L_{n+1} - L_n - 1, \end{aligned}$$

which give respectively, the position of the 1's of V_p and the number of 0's between them, as shown in Figure 1.3. The Y_i are i.i.d. following a geometric distribution $\mathbb{P}[Y_i = y] = (1-p)^y p$ for $y \in \mathbb{N} \cup \{0\}$, and by definition $L_n = n + \sum_{i=1}^n Y_i$. By applying the Law of Large Numbers we obtain $\lim_{n \rightarrow \infty} \frac{L_n}{n} = 1 + \mathbb{E}[Y_1] = \frac{1}{p}$, and therefore we can use the random subsequence $\{L_n\}_{n \in \mathbb{N}}$ in the definition of $I_{p,\zeta}(x)$.

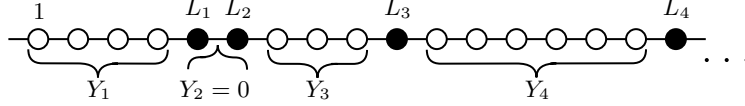

Figure 1.3: A possible realization of $H_{p,\zeta}$. The Laplacian is given by the graph structure and the potential by the color of the vertices. White (resp. black) vertices represent points where $V_p(j) = 0$ (resp. $V_p(j) = 1$).

We order the eigenvalues of any self-adjoint n -dimensional operator O increasingly allowing for multiplicities

$$\lambda_1(O) \leq \lambda_2(O) \leq \dots \leq \lambda_n(O),$$

and introduce the $n \times n$ matrices

$$A_n(i, j) := \delta_{1,i} \delta_{1,j} + \delta_{n,i} \delta_{n,j} \quad \text{and} \quad -\Delta_n := \begin{pmatrix} 2 & -1 & & \\ -1 & \ddots & \ddots & \\ & \ddots & \ddots & -1 \\ & & -1 & 2 \end{pmatrix}.$$

The eigenvalues of $-\Delta_n$ are known to be $\lambda_k(-\Delta_n) = 4 \sin^2\left(\frac{\pi k}{2(n+1)}\right)$.

We identify $H_{p,\zeta}|_{\ell^2(\{1,\dots,L_n\})}$ with $-\Delta_{L_n} + \zeta V_p$ (where the restriction of V_p is implicit) and remark that the continuity of $x \mapsto I_{p,\zeta}(x)$ means it can be computed by counting eigenvalues less or equal (\leq) or less ($<$) than x :

$$\begin{aligned} I_{p,\zeta}(x) &= \lim_{n \rightarrow \infty} \frac{1}{L_n} \# \{ \lambda \in \sigma(-\Delta_{L_n} + \zeta V_p) \mid \lambda \leq x \} \\ &= \lim_{n \rightarrow \infty} \frac{1}{L_n} \# \{ \lambda \in \sigma(-\Delta_{L_n} + \zeta V_p) \mid \lambda < x \}. \end{aligned}$$

The lower bound of $I_{p,\zeta}$ just requires an application of the Cauchy Eigenvalue Interlacing Theorem to $-\Delta_{L_n} + \zeta V_p$. Indeed, if we delete from $-\Delta_{L_n} + \zeta V_p$ the

j -th row and j -th column for all $j \in \{1, \dots, L_n\}$ such that $V_p(j) = 1$, the resulting sub-matrix is $\bigoplus_{i=1}^n -\Delta_{Y_i}$ and therefore

$$\lambda_k(-\Delta_{L_n} + \zeta V_p) \leq \lambda_k \left(\bigoplus_{i=1}^n -\Delta_{Y_i} \right), \quad k = 1, \dots, \sum_{i=1}^n Y_i.$$

By counting eigenvalues less or equal (\leq) than x and applying the Law of Large Numbers we obtain the lower bound

$$\begin{aligned} I_{p,\zeta}(x) &\geq \lim_{n \rightarrow \infty} \frac{1}{L_n} \# \left\{ \lambda \in \sigma \left(\bigoplus_{i=1}^n -\Delta_{Y_i} \right) \mid \lambda \leq x \right\} \\ &= p \mathbb{E} [\# \{ \lambda \in \sigma(-\Delta_{Y_1}) \mid \lambda \leq x \}], \quad x \in \mathbb{R}, \zeta \geq 0. \end{aligned} \quad (1.2)$$

The right-hand side of (1.2) is equal to $I_p^{\leq}(x)$ if $x \in (0, 4)$:

$$\begin{aligned} &p \mathbb{E} [\# \{ \lambda \in \sigma(-\Delta_{Y_1}) \mid \lambda \leq x \}] \\ &= p \sum_{y=0}^{\infty} \mathbb{P}[Y_1 = y] \# \{ \lambda \in \sigma(-\Delta_y) \mid \lambda \leq x \} \\ &= p^2 \sum_{y=1}^{\infty} (1-p)^y \max \{ k \in \mathbb{N} \mid k \leq y, \lambda_k(-\Delta_y) \leq x \} \\ &= p^2 \sum_{y=1}^{\infty} (1-p)^y \max \left\{ k \in \mathbb{N} \mid k \leq \min \left\{ y, \frac{y+1}{\beta(x)} \right\} \right\} \\ &= p^2 \sum_{y=1}^{\infty} (1-p)^y \left\lfloor \frac{y+1}{\beta(x)} \right\rfloor = I_p^{\leq}(x). \end{aligned}$$

Hence we have shown

$$I_p^{\leq}(x) \leq I_{p,\zeta}(x), \quad x \in (0, 4), \zeta \geq 0. \quad (1.3)$$

The upper bound is a bit more involved. From $-\Delta_{L_n} + \zeta V_p$ we define a new (dimensionally larger) operator $-\Delta_{L_n+n} + \frac{\zeta}{2} V'$ where V' is constructed by doubling each point at which $V_p(j) = 1$ while maintaining the Y_i 's, as shown in Figure 1.4. To be precise,

$$V'(j) := \sum_{k=1}^{\infty} (\delta_{L_k+k-1,j} + \delta_{L_k+k,j}) \quad \text{whereas} \quad V_p(j) = \sum_{k=1}^{\infty} \delta_{L_k,j}.$$

In order to compare these two operators we define the linear map

$$T : \ell^2(\{1, \dots, L_n\}) \longrightarrow \ell^2(\{1, \dots, L_n + n\})$$

$$(T\phi)(j) := \begin{cases} \phi(j - k), & \text{if } L_k + k + 1 \leq j \leq L_{k+1} + (k + 1) - 1, \\ \phi(L_k), & \text{if } j = L_k + k, \end{cases}$$

with the convention $L_0 = 0$, which assigns to $T\phi$ the same values of ϕ according to Figure 1.4.

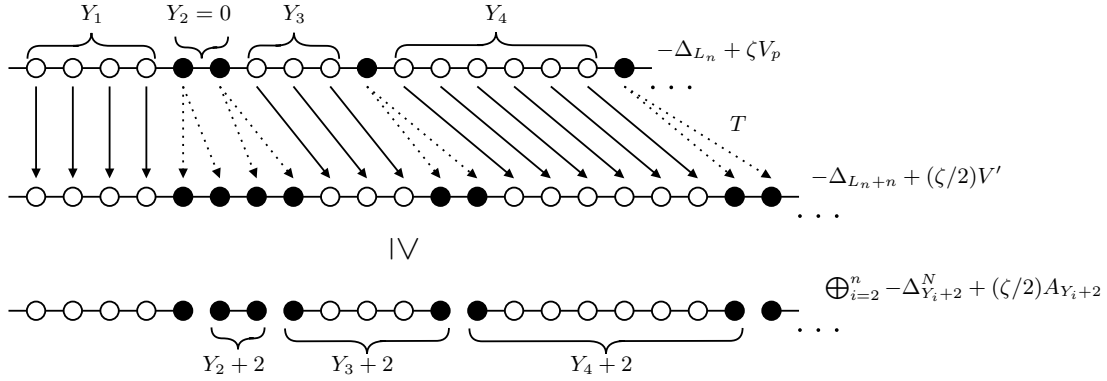

Figure 1.4: The first two rows show the of construction of V' and the action of T . From the second to the third row we have deleted edges, which lowers the operator and decomposes it into a direct sum.

For all $\phi \in \ell^2(\{1, \dots, L_n\})$ the map T satisfies

$$\left\langle T\phi, \left(-\Delta_{L_n+n} + \frac{\zeta}{2}V' \right) T\phi \right\rangle = \langle \phi, (-\Delta_{L_n} + \zeta V_p)\phi \rangle,$$

$$\|T\phi\| \geq \|\phi\|. \quad (T \text{ is injective})$$

Let ϕ_i be the normalized eigenvector associated to $\lambda_i(-\Delta_{L_n} + \zeta V_p)$. Then, by the Min-Max Principle we have for $k \leq L_n$

$$\begin{aligned} \lambda_k \left(-\Delta_{L_n+n} + \frac{\zeta}{2}V' \right) &\leq \sup_{\phi \in \text{Vect}\{\phi_1, \dots, \phi_k\} \setminus \{0\}} \frac{\langle T\phi, (-\Delta_{L_n+n} + \frac{\zeta}{2}V')T\phi \rangle}{\|T\phi\|^2} \\ &\leq \sup_{\phi \in \text{Vect}\{\phi_1, \dots, \phi_k\} \setminus \{0\}} \frac{\langle \phi, (-\Delta_{L_n} + \zeta V_p)\phi \rangle}{\|\phi\|^2} \\ &= \lambda_k(-\Delta_{L_n} + \zeta V_p). \end{aligned}$$

We can construct from $-\Delta_{L_n+n} + \frac{\zeta}{2}V'$ an operator with even lower eigenvalues by disconnecting each Y_i (except Y_1) together with its two adjacent points at

the cost of having Neumann boundary conditions on the Laplacians, as shown in Figure 1.4. Since Y_1 has no point to its left and the right-most point ($j = L_n + n$) ends up isolated, we have a boundary term of dimension $Y_1 + 2$. This, together with the previous lower bound on $\lambda_k(-\Delta_{L_n} + \zeta V_p)$ and the fact that we can write the Neumann Laplacian as $-\Delta_n^N = -\Delta_n - A_n$, gives

$$\lambda_k \left((\text{Boundary term}) \oplus \bigoplus_{i=2}^n -\Delta_{Y_i+2} + \left(\frac{\zeta}{2} - 1 \right) A_{Y_i+2} \right) \leq \lambda_k(-\Delta_{L_n} + \zeta V_p),$$

for $k = 1, \dots, L_n$. Counting eigenvalues less ($<$) than x we obtain

$$\begin{aligned} I_{p,\zeta}(x) &\leq \lim_{n \rightarrow \infty} \frac{1}{L_n} \# \left\{ \lambda \in \sigma \left(\bigoplus_{i=2}^n -\Delta_{Y_i+2} + \left(\frac{\zeta}{2} - 1 \right) A_{Y_i+2} \right) \mid \lambda < x \right\} \\ &\quad + \lim_{n \rightarrow \infty} \frac{Y_1 + 2}{L_n} \\ &= p \mathbb{E} \left[\# \left\{ \lambda \in \sigma \left(-\Delta_{Y_1+2} + \left(\frac{\zeta}{2} - 1 \right) A_{Y_1+2} \right) \mid \lambda < x \right\} \right], \quad x \in \mathbb{R}, \zeta \geq 0. \end{aligned} \tag{1.4}$$

To further bound (1.4) we need to estimate the eigenvalues that appear in it, which is the purpose of the next proposition. These eigenvalues are always simple since their eigenvectors satisfy a second order difference equation with two boundary conditions.

Proposition 1.3. *Let $n \in \mathbb{N} \cup \{0\}$ and define $\mu_{k,n+2}(t) := \lambda_k(-\Delta_{n+2} + tA_{n+2})$. If $t \geq 3$ then:*

- i) $0 < \lambda_k(-\Delta_{n+2}) \leq \mu_{k,n+2}(t) \leq \lambda_k(-\Delta_n) < 4$ for $1 \leq k \leq n$.
- ii) $4 \leq \mu_{n+1,n+2}(t) < \mu_{n+2,n+2}(t)$.
- iii) $\mu_{k,n+2}(t) \geq 4 \sin^2 \left(\frac{\pi}{2(n+1)} \left[k - \frac{2}{\pi(t-1)} \right] \right)$ for $1 \leq k \leq n$.

Proof.

- i) The lower bound on $\mu_{k,n+2}(t)$ follows from $tA_{n+2} \geq 0$, while the upper one follows from the Cauchy Eigenvalue Interlacing Theorem by deleting from $-\Delta_{n+2} + tA_{n+2}$ the rows (and columns) where t appears.

ii) For $n = 0$ we compute directly

$$\sigma(-\Delta_2 + tA_2) = \sigma \begin{pmatrix} 2+t & -1 \\ -1 & 2+t \end{pmatrix} = \{1+t, 3+t\}.$$

For $n \geq 1$ we apply the Min-Max Principle (Max-Min in this case):

$$\begin{aligned} \mu_{n+1, n+2}(t) &\geq \min_{\substack{\phi \in \text{Vect}\{e_1, e_{n+2}\} \\ \|\phi\|=1}} \langle \phi, (-\Delta_{n+2} + tA_{n+2})\phi \rangle \\ &= \min_{\substack{\phi \in \text{Vect}\{e_1, e_{n+2}\} \\ \|\phi\|=1}} (2+t) \|\phi\|^2 = 2+t \geq 4, \end{aligned}$$

where e_i denotes the canonical basis of $\ell^2(\{1, \dots, n+2\})$.

iii) We recall that the characteristic polynomial of $-\Delta_n$ can be written as

$$\det(-\Delta_n - x) = (-1)^n U_n \left(\frac{x-2}{2} \right),$$

where U_n is the n -th Chebyshev polynomial of the second kind. For completeness we list here the properties of U_n (see [MH03, Section 1.2.2]) that we will need:

- Recurrent definition:

$$U_0(x) := 1, \quad U_1(x) := 2x, \quad U_{n+1}(x) := 2xU_n(x) - U_{n-1}(x).$$

- Parity:

$$U_n(-x) = (-1)^n U_n(x).$$

- Image of $(-1, 1)$:

$$U_n(\cos \theta) = \frac{\sin((n+1)\theta)}{\sin \theta}.$$

Now we start with the proof. A straight forward computation shows that we can expand the characteristic polynomial of $-\Delta_{n+2} + tA_{n+2}$ as

$$\begin{aligned} &\det(-\Delta_{n+2} + tA_{n+2} - x) \\ &= (2+t-x)^2 \det(-\Delta_n - x) - 2(2+t-x) \det(-\Delta_{n-1} - x) + \det(-\Delta_{n-2} - x) \\ &= (-1)^n [(t-2x')^2 U_n(x') + 2(t-2x') U_{n-1}(x') + U_{n-2}(x')], \end{aligned}$$

where we have used the change of variable $x' := \frac{x-2}{2}$. Using twice the recurrent definition of U_n , the previous expression can be reduced to

$$\det(-\Delta_{n+2} + tA_{n+2} - x) = (-1)^n [(t^2 - 1)U_n(x') - 2(t - x')U_{n+1}(x')]. \quad (1.5)$$

By i) and ii), $-\Delta_{n+2} + tA_{n+2}$ has exactly n simple eigenvalues in $(0, 4)$. With this in mind, we introduce a parameter $\theta \in (0, \pi)$ and notice, by evaluating the characteristic polynomial at $x' = -\cos(\theta)$, that $4\sin^2(\theta/2) \in \sigma(-\Delta_{n+2} + tA_{n+2})$ if and only if

$$(t^2 - 1)\sin((n+1)\theta) = -2(t + \cos\theta)\sin((n+2)\theta). \quad (1.6)$$

The condition $t \geq 3$ and the trigonometric identity

$$\sin((n+2)\theta) = \sin((n+1)\theta)\cos\theta + \cos((n+1)\theta)\sin\theta$$

guaranty that there is no solution to (1.6) in the set $\frac{\pi}{n+1}\mathbb{Z}$, hence we can rewrite the equation as

$$\begin{aligned} \frac{\sin((n+2)\theta)}{\sin((n+1)\theta)} &= -\frac{t^2 - 1}{2(t + \cos\theta)}, \\ \cos\theta + \cot((n+1)\theta)\sin\theta &= -\frac{t^2 - 1}{2(t + \cos\theta)}, \\ \tan((n+1)\theta) &= -\frac{2(t + \cos\theta)\sin\theta}{t^2 + 2t\cos\theta + \cos(2\theta)}. \end{aligned} \quad (1.7)$$

To abbreviate we define

$$f_t(\theta) := \frac{2(t + \cos\theta)\sin\theta}{t^2 + 2t\cos\theta + \cos(2\theta)}, \quad \theta \in (0, \pi),$$

and remark that $t \geq 3$ implies $0 < f_t(\theta) < \infty$.

Applying arc-tangent to (1.7) and considering that i) actually constrains θ to be in $[\frac{\pi}{n+3}, \frac{\pi n}{n+1}]$, we conclude for $k = 1, \dots, n$ that

$$\mu_{k,n+2}(t) = 4\sin^2(\theta_k/2) \quad \text{where } \theta_k \text{ is defined by } \theta_k = \frac{\pi k - \arctan f_t(\theta_k)}{n+1}.$$

The existence of θ_k is a consequence of tangent going from $-\infty$ to $+\infty$ over a period. Uniqueness comes from $|\theta_{k+1} - \theta_k| \geq \frac{\pi}{2(n+1)}$ and the fact that $-\Delta_{n+2} + tA_{n+2}$ has exactly n eigenvalues in $(0, 4)$.

After bounding uniformly $f_t(\theta)$

$$\begin{aligned} \sup_{\theta \in (0, \pi)} f_t(\theta) &= \sup_{\theta \in (0, \pi)} \frac{2(t + \cos \theta) \sin \theta}{t^2 + 2t \cos \theta + \cos(2\theta)} \\ &\leq 2 \sup_{\theta \in (0, \pi)} \frac{t + \cos \theta}{t^2 + 2t \cos \theta + \cos(2\theta)} \\ &= 2 \frac{t + \cos \theta}{t^2 + 2t \cos \theta + \cos(2\theta)} \Big|_{\theta=\pi} = \frac{2}{t-1}, \end{aligned}$$

and using the inequality $\arctan(x) \leq x$ for $x \geq 0$ we obtain

$$\mu_{k, n+2}(t) \geq 4 \sin^2 \left(\frac{\pi}{2(n+1)} \left[k - \frac{2}{\pi(t-1)} \right] \right), \quad k = 1, \dots, n. \quad \square$$

We now use ii) and iii) of Proposition 1.3 with $t = \frac{\zeta}{2} - 1 \geq 3$ (equivalently $\zeta \geq 8$) to further bound (1.4) for $x \in (0, 4)$:

$$\begin{aligned} I_{p, \zeta}(x) &\leq p \mathbb{E} [\# \{ \lambda \in \sigma(-\Delta_{Y_1+2} + tA_{Y_1+2}) \mid \lambda < x \}] \\ &= p^2 \sum_{y=0}^{\infty} (1-p)^y \max \{ k \in \mathbb{N} \mid k \leq y+2, \mu_{k, y+2}(t) < x \} \\ &= p^2 \sum_{y=1}^{\infty} (1-p)^y \max \{ k \in \mathbb{N} \mid k \leq y, \mu_{k, y+2}(t) < x \} \\ &\leq p^2 \sum_{y=1}^{\infty} (1-p)^y \max \left\{ k \in \mathbb{N} \mid 4 \sin^2 \left(\frac{\pi}{2(y+1)} \left[k - \frac{4}{\pi(\zeta-4)} \right] \right) < x \right\} \\ &= p^2 \sum_{y=1}^{\infty} (1-p)^y \max \left\{ k \in \mathbb{N} \mid k < \frac{y+1}{\beta(x)} + \frac{4}{\pi(\zeta-4)} \right\} \\ &= p^2 \sum_{y=1}^{\infty} (1-p)^y \left(\left\lceil \frac{y+1}{\beta(x)} + \frac{4}{\pi(\zeta-4)} \right\rceil - 1 \right), \quad x \in (0, 4), \zeta \geq 8, \quad (1.8) \end{aligned}$$

where $\lceil \cdot \rceil$ is the ceiling function. From (1.3), (1.8), the inequality $\lceil \cdot \rceil - 1 \leq \lfloor \cdot \rfloor$, the right continuity of $\lfloor \cdot \rfloor$, and the Dominated Convergence Theorem we conclude

$$\lim_{\zeta \rightarrow \infty} I_{p, \zeta}(x) = I_p^{\leq}(x), \quad x \in (0, 4).$$

Now, fix $a, b \in \mathbb{N}$ with $a < b$, $\gcd(a, b) = 1$ and further assume $\zeta \geq \frac{4b}{\pi} + 4$.

This implies for all $y \in \mathbb{N}$

$$\begin{aligned} \left\lceil \frac{a(y+1)}{b} + \frac{4}{\pi(\zeta-4)} \right\rceil - 1 &= \left\lfloor \frac{a(y+1)}{b} \right\rfloor + \left\lceil \left\{ \frac{a(y+1)}{b} \right\} + \frac{4}{\pi(\zeta-4)} \right\rceil - 1 \\ &\leq \left\lfloor \frac{a(y+1)}{b} \right\rfloor + \left\lceil \frac{b-1}{b} + \frac{1}{b} \right\rceil - 1 = \left\lfloor \frac{a(y+1)}{b} \right\rfloor, \end{aligned}$$

where we have used the fractional part $\{x\} = x - \lfloor x \rfloor$. The last inequality, together with (1.3) and (1.8), gives

$$I_{p,\zeta}(\beta^{-1}(b/a)) = I_p^{\leq}(\beta^{-1}(b/a)) = p^2 \sum_{y=1}^{\infty} (1-p)^y \left\lfloor \frac{a(y+1)}{b} \right\rfloor.$$

The existence of $\zeta_c(\beta^{-1}(b/a))$ and the bound $\zeta_c(\beta^{-1}(b/a)) \leq \max\{8, \frac{4b}{\pi} + 4\}$ follow.

It only remains to prove that we can replace the infinite series by a finite sum. This is simply done by using the euclidean division $y = bn + r$ and splitting the series over all possible remainders:

$$\begin{aligned} I_p^{\leq}(\beta^{-1}(b/a)) &= p^2 \sum_{y=1}^{\infty} (1-p)^y \left\lfloor \frac{a(y+1)}{b} \right\rfloor \\ &= p^2 \sum_{r=0}^{b-1} (1-p)^r \sum_{n=0}^{\infty} (1-p)^{bn} \left(an + \left\lfloor \frac{a(r+1)}{b} \right\rfloor \right) \\ &= p^2 \sum_{r=0}^{b-1} (1-p)^r \left(\frac{a(1-p)^b}{[1-(1-p)^b]^2} + \left\lfloor \frac{a(r+1)}{b} \right\rfloor \frac{1}{1-(1-p)^b} \right) \\ &= \frac{p^2}{1-(1-p)^b} \left(\frac{a(1-p)^b}{p} + \sum_{r=0}^{b-1} (1-p)^r \left\lfloor \frac{a(r+1)}{b} \right\rfloor \right). \end{aligned}$$

1.2 Proof of Theorem 1.2

We start by proving i). From (1.4) evaluated at $\zeta = 4$ we have

$$I_{p,4}(x) \leq p \mathbb{E}[\#\{\lambda \in \sigma(-\Delta_{Y_{1+2}} + A_{Y_{1+2}}) \mid \lambda < x\}], \quad x \in \mathbb{R},$$

and from (1.5) evaluated at $t = 1$ and the properties of U_n follows that

$$\lambda_k(-\Delta_{n+2} + A_{n+2}) = 4 \sin^2 \left(\frac{\pi k}{2(n+2)} \right).$$

The derivation of (1.5) required $n \geq 1$ but we can easily check that the formula above holds for $n = 0$:

$$\sigma(-\Delta_2 + A_2) = \sigma \begin{pmatrix} 3 & -1 \\ -1 & 3 \end{pmatrix} = \{2, 4\}.$$

Having the explicit eigenvalues, we now compute

$$\begin{aligned} I_{p,4}(x) &\leq p \mathbb{E} [\#\{\lambda \in \sigma(-\Delta_{Y_1+2} + A_{Y_1+2}) \mid \lambda < x\}] \\ &= p^2 \sum_{y=0}^{\infty} (1-p)^y \max\{k \in \mathbb{N} \mid k \leq y+2, \lambda_k(-\Delta_{y+2} + A_{y+2}) < x\} \\ &= p^2 \sum_{y=0}^{\infty} (1-p)^y \left(\left\lceil \frac{y+2}{\beta(x)} \right\rceil - 1 \right), \quad x \in (0, 4). \end{aligned} \quad (1.9)$$

Evaluating $x = \beta^{-1}(b/1)$ for some $b \in \mathbb{N} \setminus \{1\}$ gives

$$\begin{aligned} I_{p,4}(\beta^{-1}(b/1)) &\leq p^2 \sum_{y=0}^{\infty} (1-p)^y \left(\left\lceil \frac{y+2}{b} \right\rceil - 1 \right) \\ &= p^2 \sum_{y=0}^{\infty} (1-p)^y \left(\left\lfloor \frac{y+1}{b} \right\rfloor + \left\lceil \left\{ \frac{y+1}{b} \right\} + \frac{1}{b} \right\rceil - 1 \right) \\ &\leq p^2 \sum_{y=0}^{\infty} (1-p)^y \left(\left\lfloor \frac{y+1}{b} \right\rfloor + \left\lceil \frac{b-1}{b} + \frac{1}{b} \right\rceil - 1 \right) \\ &= p^2 \sum_{y=0}^{\infty} (1-p)^y \left\lfloor \frac{y+1}{b} \right\rfloor = p^2 \sum_{y=1}^{\infty} (1-p)^y \left\lfloor \frac{y+1}{b} \right\rfloor. \end{aligned}$$

The last inequality, (1.3) and the monotonicity of $\zeta \mapsto I_{p,\zeta}(x)$ finish the proof.

Now we prove ii). As in the proof of Theorem 1.1, we construct from $-\Delta_{L_n} + \zeta V_p$ a lower operator by disconnecting all the Y_i and all the point where $V_p(j) = 1$ at the cost of having Neumann boundary conditions on the Laplacians, as shown in Figure 1.5.

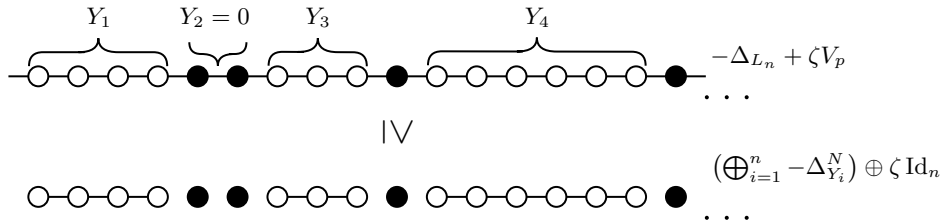

Figure 1.5: Resulting operator after applying the Neumann part of Dirichlet-Neumann bracketing to $-\Delta_{L_n} + \zeta V_p$ in order to disconnect all the Y_i 's.

From this new operator we have

$$\left(\bigoplus_{i=1}^n -\Delta_{Y_i}^N \right) \oplus \zeta \text{Id}_n \leq -\Delta_{L_n} + \zeta V_p, \quad \text{all } L_n \text{ eigenvalues,}$$

which, by counting eigenvalues less ($<$) than x , leads to

$$\begin{aligned} I_{p,\zeta}(x) &\leq \lim_{n \rightarrow \infty} \frac{1}{L_n} \# \left\{ \lambda \in \sigma \left(\bigoplus_{i=1}^n -\Delta_{Y_i}^N \right) \mid \lambda < x \right\} + \lim_{n \rightarrow \infty} \frac{n \mathbb{1}_{\zeta < x}}{L_n} \\ &= p \mathbb{E} [\# \{ \lambda \in \sigma(-\Delta_{Y_1}^N) \mid \lambda < x \}] + p \mathbb{1}_{\zeta < x}, \quad x \in \mathbb{R}, \zeta \geq 0. \end{aligned} \quad (1.10)$$

The eigenvalues of the Neumann Laplacian $-\Delta_n^N = \Delta_n - A_n$ are known to be $\lambda_k(-\Delta_n^N) = 4 \sin^2 \left(\frac{\pi(k-1)}{2} \right)$ (this also follows from (1.5)), therefore

$$\begin{aligned} I_{p,\zeta}(x) &\leq p \mathbb{E} [\# \{ \lambda \in \sigma(-\Delta_{Y_1}^N) \mid \lambda < x \}] + p \mathbb{1}_{\zeta < x} \\ &= p^2 \sum_{y=1}^{\infty} (1-p)^y \max \{ k \in \mathbb{N} \mid k \leq y, \lambda_k(-\Delta_y^N) < x \} + p \mathbb{1}_{\zeta < x} \\ &= p^2 \sum_{y=1}^{\infty} (1-p)^y \left(\left\lceil \frac{y}{\beta(x)} + 1 \right\rceil - 1 \right) + p \mathbb{1}_{\zeta < x}, \quad x \in (0, 4), \zeta \geq 0. \end{aligned} \quad (1.11)$$

Plugging in $\zeta = x = \beta^{-1}(b/(b-1))$ for some $b \in \mathbb{N} \setminus \{1\}$ we obtain

$$\begin{aligned} &I_{p,\beta^{-1}(b/(b-1))}(\beta^{-1}(b/(b-1))) \\ &\leq p^2 \sum_{y=1}^{\infty} (1-p)^y \left(\left\lceil \frac{y(b-1)}{b} + 1 \right\rceil - 1 \right) \\ &= p^2 \sum_{y=1}^{\infty} (1-p)^y \left(\left\lfloor \frac{(y+1)(b-1)}{b} \right\rfloor + \left\lceil \left\{ \frac{(y+1)(b-1)}{b} \right\} + \frac{1}{b} \right\rceil - 1 \right) \\ &\leq p^2 \sum_{y=1}^{\infty} (1-p)^y \left(\left\lfloor \frac{(y+1)(b-1)}{b} \right\rfloor + \left\lceil \frac{b-1}{b} + \frac{1}{b} \right\rceil - 1 \right) \\ &= p^2 \sum_{y=1}^{\infty} (1-p)^y \left\lfloor \frac{(y+1)(b-1)}{b} \right\rfloor. \end{aligned}$$

Once again, (1.3) and the monotonicity of $\zeta \mapsto I_{p,\zeta}(x)$ finish the proof.

1.3 Some Numeric Computations and Insights

The question of exactly determining $\zeta_c(x)$ for any given $x \in R$ seems out of reach from the methods used to proof Theorems 1.1 and 1.2. However, for the case $x \in R'$, we can give some insights based on numerical computations.

Concerning the energies of the form $\beta^{-1}(b/(b-1))$, $b \in \mathbb{N} \setminus \{1\}$, we claim that Theorem 1.2 ii) is sharp, that is, we claim

$$\zeta_c(\beta^{-1}(b/(b-1))) = \beta^{-1}(b/(b-1)), \quad b \in \mathbb{N} \setminus \{1\}.$$

We support this claim with the following reasoning. When $\zeta < \beta^{-1}(b/(b-1))$ the energy $\beta^{-1}(b/(b-1))$ is in the overlap of the two “bands” $[0, 4]$ and $[\zeta, \zeta + 4]$. Therefore, the contribution to $I_{p,\zeta}(\beta^{-1}(b/(b-1)))$ of the eigenvalues coming from connected components with potential identically ζ is not negligible, as it is for $I_p^\leq(\beta^{-1}(b/(b-1)))$, when the bands are infinitely far apart. Numerical computations also support this claim. We show in Figure 1.6, that when ζ is slightly below $\beta^{-1}(2/1) = 2$ there is a gap between $I_{p,\zeta}$ and I_p^\leq at 2.

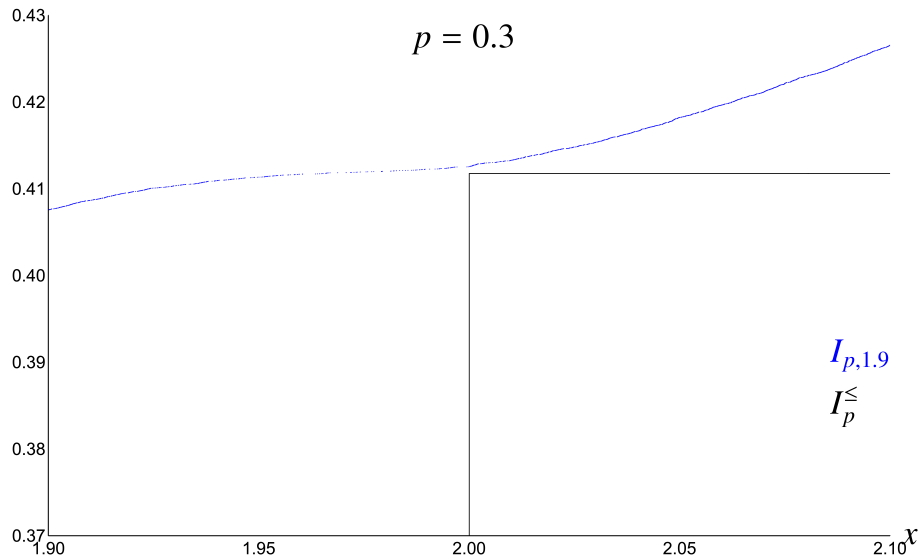

Figure 1.6: Plot of $I_{p,1.9}$ and I_p^\leq for $p = 0.3$. $I_{p,1.9}$ was computed numerically from a $10^5 \times 10^5$ matrix.

We cannot say much about the critical ζ of energies of the form $\beta^{-1}(b/1)$, $b \in \mathbb{N} \setminus \{1, 2\}$ ($b = 2$ is covered above). At $\zeta = 2$ there is not equality between

$I_{p,2}$ and I_p^\leq at any of these energies, as shown in Figure 1.7. Theorem 1.2 i) states that their critical ζ is below 4, but it seems that it is in fact somewhere between 2 and 3, since the numeric computation of $I_{p,3}$, shown in Figure 1.8, indicates that $I_{p,3}$ and I_p^\leq coincide at all such energies.

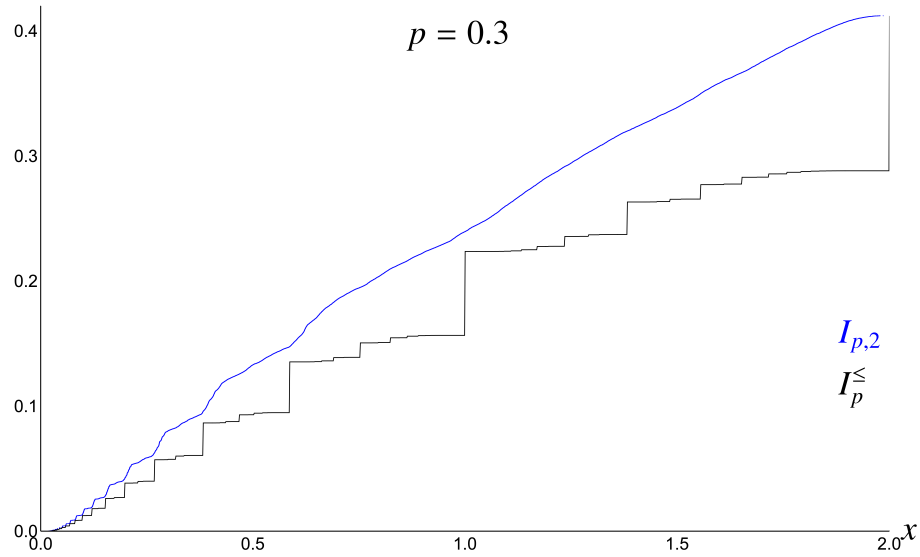

Figure 1.7: Plot of $I_{p,2}$ and I_p^\leq for $p = 0.3$. $I_{p,2}$ was computed numerically from a $10^5 \times 10^5$ matrix.

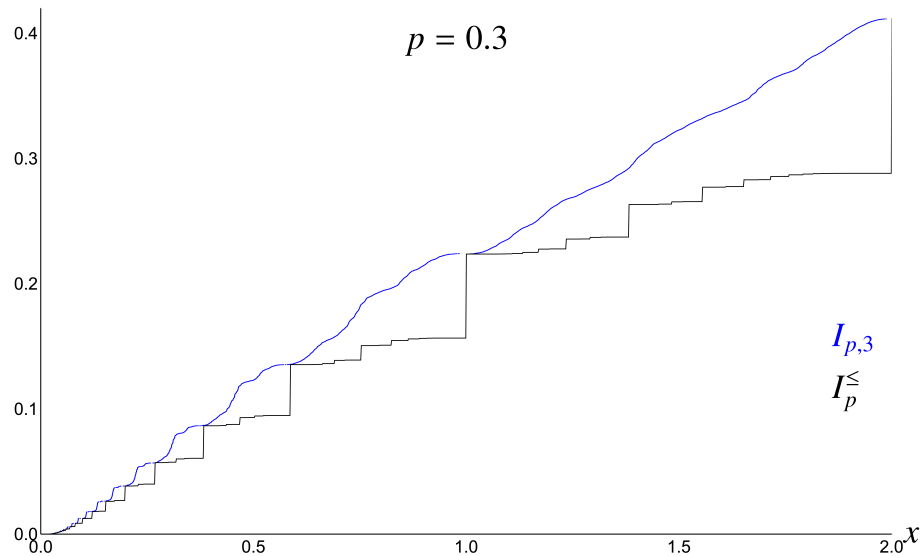

Figure 1.8: Plot of $I_{p,3}$ and I_p^\leq for $p = 0.3$. $I_{p,3}$ was computed numerically from a $10^5 \times 10^5$ matrix.

1.4 Lifshitz Tails and Other Distributions

In this section we show $I_{p,\zeta}$ exhibits, at all spectral edges, a strong version of Lifshitz Tails characterized by the existence of the Lifshitz constant as defined in [AW15, Equation 4.45]. We later extend this to a larger set of distributions on the random potential. All Lifshitz Tails results presented in this section have already been given in [SB03] and/or [BK01, Theorem 1.3] with different proofs and different levels of generality.

We recall that the support of the probability measure defined by $I_{p,\zeta}$ is $[0, 4] \cup [\zeta, \zeta + 4]$ and therefore depending on the value of ζ compared to 4, we have 2 or 4 spectral edges (for the case $\zeta = 4$ we count the energy $x = 4$ as an edge to both sides). We only need to consider $x = 0$ and $x = 4$ (if $\zeta \geq 4$), thanks to (1.1), which maps the tail at $x = 0$ to the one at $x = \zeta + 4$ and, (if they exist) the tail at $x = 4$ to the one at $x = \zeta$.

We start by computing the Lifshitz constants of I_p^\leq :

Proposition 1.4.

- $\lim_{x \downarrow 0} \sqrt{x} \ln I_p^\leq(x) = \pi \ln(1 - p)$.
- $\lim_{x \uparrow 4} \sqrt{4 - x} \ln [(1 - p) - I_p^\leq(x)] = \pi \ln(1 - p)$.

Proof. By Theorem 1.1 we have

$$I_p^\leq(\beta^{-1}(b/1)) = \frac{p(1-p)^{b-1}}{1 - (1-p)^b}, \quad b \in \mathbb{N} \setminus \{1\}.$$

Since $\beta^{-1}(b/1) = 4 \sin^2\left(\frac{\pi}{2b}\right)$ for $b \in \mathbb{N} \setminus \{1\}$ is a decreasing sequence converging to 0 we can find for any $0 < x \leq 2$ a $b = b(x) \in \mathbb{N} \setminus \{1\}$ such that

$$\beta^{-1}((b+1)/1) < x \leq \beta^{-1}(b/1).$$

Therefore, by using that $x \mapsto I_p^\leq(x)$ is increasing, we obtain

$$\begin{aligned} \overline{\lim}_{x \downarrow 0} \sqrt{x} \ln I_p^\leq(x) &\leq \lim_{b \rightarrow \infty} \sqrt{\beta^{-1}((b+1)/1)} \ln I_p^\leq(\beta^{-1}(b/1)) \\ &= \lim_{b \rightarrow \infty} 2 \sin\left(\frac{\pi}{2(b+1)}\right) \ln \left[\frac{p(1-p)^{b-1}}{1 - (1-p)^b} \right] = \pi \ln(1 - p), \\ \underline{\lim}_{x \downarrow 0} \sqrt{x} \ln I_p^\leq(x) &\geq \lim_{b \rightarrow \infty} \sqrt{\beta^{-1}(b/1)} \ln I_p^\leq(\beta^{-1}((b+1)/1)) \\ &= \lim_{b \rightarrow \infty} 2 \sin\left(\frac{\pi}{2b}\right) \ln \left[\frac{p(1-p)^b}{1 - (1-p)^{b+1}} \right] = \pi \ln(1 - p). \end{aligned}$$

The limit towards $x = 4$ has exactly the same proof using the increasing sequence $\beta^{-1}(b/(b-1))$. We just need to notice that for $b \in \mathbb{N} \setminus \{1\}$ we have $\beta^{-1}(b/(b-1)) = 4 - 4 \sin^2\left(\frac{\pi}{2b}\right)$ and

$$\begin{aligned}
& I_p^{\leq}(\beta^{-1}(b/(b-1))) \\
&= \frac{p^2}{1 - (1-p)^b} \left(\frac{(b-1)(1-p)^b}{p} + \sum_{r=0}^{b-1} (1-p)^r \left\lfloor \frac{(b-1)(r+1)}{b} \right\rfloor \right) \\
&= \frac{p^2}{1 - (1-p)^b} \left(\frac{(b-1)(1-p)^b}{p} + \sum_{r=0}^{b-1} (1-p)^r r \right) \\
&= 1 - p - \frac{p(1-p)^b}{1 - (1-p)^b}. \quad \square
\end{aligned}$$

As an immediate Corollary of Proposition 1.4 and Theorem 1.2 we have

Corollary 1.5. *If $\zeta \geq 4$ then*

- $\lim_{x \downarrow 0} \sqrt{x} \ln I_{p,\zeta}(x) = \pi \ln(1-p)$.
- $\lim_{x \uparrow 4} \sqrt{4-x} \ln [(1-p) - I_{p,\zeta}(x)] = \pi \ln(1-p)$.

Remark.

1. From the limit towards $x = 4$ and the continuity of $x \mapsto I_{p,\zeta}(x)$ follows $I_{p,\zeta}(4) = 1 - p$ for $\zeta \geq 4$.
2. This these limits we can recover the the weaker statement of Lifshitz tails

$$\lim_{x \downarrow 0} \frac{\ln |\ln I_{p,\zeta}(x)|}{\ln x} = -\frac{1}{2}, \quad \lim_{x \uparrow 4} \frac{\ln |\ln [I_{p,\zeta}(4) - I_{p,\zeta}(x)]|}{\ln(4-x)} = -\frac{1}{2}.$$

Proof. The map $x \mapsto I_{p,\zeta}(x)$ is increasing, just as $x \mapsto I_p^{\leq}(x)$. Moreover, Theorem 1.2 and $\zeta \geq 4$ imply that $I_{p,\zeta} = I_p^{\leq}$ on R' , which contains the incising and decreasing sequences used in the proof of Proposition 1.4. Therefore, the proof of Proposition 1.4 applies also for $I_{p,\zeta}$. \square

It remains to show that the Lifshitz constant exists at $x = 0$ when $\zeta < 4$. We present a proof of this that works for any positive ζ .

Proposition 1.6. *For all $\zeta > 0$ we have*

$$\pi \ln(1-p) = \lim_{x \downarrow 0} \sqrt{x} \ln I_{p,\zeta}(x).$$

Proof. Fix $\zeta > 0$. From (1.3) and Proposition 1.4 we have

$$\liminf_{x \downarrow 0} \sqrt{x} \ln I_{p,\zeta}(x) \geq \liminf_{x \downarrow 0} \sqrt{x} \ln I_p^\leq(x) = \pi \ln(1-p).$$

Form (1.4) follows the bound

$$\begin{aligned} I_{p,\zeta}(x) &\leq p \mathbb{E} \left[\# \left\{ \lambda \in \sigma \left(-\Delta_{Y_1+2} + \left(\frac{\zeta}{2} - 1 \right) A_{Y_1+2} \right) \mid \lambda < x \right\} \right] \\ &\leq p \mathbb{E} \left[(Y+2) \mathbf{1}_{\nu(Y+2) < x} \right], \quad x \in \mathbb{R}. \end{aligned} \quad (1.12)$$

where we have introduced $\nu(n) := \lambda_1 \left(-\Delta_n + \left(\frac{\zeta}{2} - 1 \right) A_n \right) = \lambda_1 \left(-\Delta_n^N + \frac{\zeta}{2} A_n \right)$. To proceed, we need to bound from below $\nu(n)$ for $n \in \mathbb{N} \setminus \{1\}$. The case $n = 2$ is special but can be dealt with explicitly:

$$\nu(2) = \lambda_1 \begin{pmatrix} 1 + \zeta/2 & -1 \\ -1 & 1 + \zeta/2 \end{pmatrix} = \frac{\zeta}{2}.$$

Now, suppose $n \geq 3$ and let ϕ be the ground state of $-\Delta_n^N + \frac{\zeta}{2} A_n$ which we chose to be positive and normalized (this is always possible). Because of the symmetry of $-\Delta_n^N + \frac{\zeta}{2} A_n$ we have $\phi(1) = \phi(n)$, so the vector $\psi(j) = \phi(j) - \phi(1)$ satisfies $\psi(1) = \psi(n) = 0$. An application of the Min-Max principle gives

$$\begin{aligned} \nu(n) &= \left\langle \phi, \left(-\Delta_n^N + \frac{\zeta}{2} A_n \right) \phi \right\rangle = \frac{2\zeta}{2} \phi(1)^2 + \langle \phi, -\Delta_n^N \phi \rangle = \zeta \phi(1)^2 + \langle \psi, -\Delta_n^N \psi \rangle \\ &\geq \zeta \phi(1)^2 + \lambda_1(-\Delta_{n-2}) \|\psi\|^2. \end{aligned}$$

For the term $\|\psi\|$ we use the triangle inequality $1 = \|\phi\| \leq \|\psi\| + \sqrt{n} \phi(1)$ to get

$$\begin{aligned} \nu(n) &\geq \zeta \phi(1)^2 + \lambda_1(-\Delta_{n-2}) \max \{ 1 - \sqrt{n} \phi(1), 0 \}^2 \\ &\geq \min_{0 \leq y \leq \sqrt{1/2}} \zeta y^2 + \lambda_1(-\Delta_{n-2}) \max \{ 1 - \sqrt{n} y, 0 \}^2 \\ &= \min \left\{ \min_{0 \leq y \leq \sqrt{1/n}} \zeta y^2 + \lambda_1(-\Delta_{n-2}) (1 - \sqrt{n} y)^2, \min_{\sqrt{1/n} \leq y \leq \sqrt{1/2}} \zeta y^2 \right\}. \end{aligned}$$

The second internal minimum is trivial, and for the first one we need to consider the two boundary points and critical value $y = \left(\sqrt{n} + \frac{\zeta}{\lambda_1(-\Delta_{n-2})\sqrt{n}} \right)^{-1} < \sqrt{\frac{1}{n}}$ to get our desired bound

$$\begin{aligned} \nu(n) &\geq \min \left\{ \frac{\lambda_1(-\Delta_{n-2})}{1 + \frac{n}{\zeta}\lambda_1(-\Delta_{n-2})}, \lambda_1(-\Delta_{n-2}), \frac{\zeta}{n} \right\} \\ &= \frac{\lambda_1(-\Delta_{n-2})}{1 + \frac{n}{\zeta}\lambda_1(-\Delta_{n-2})} =: g(n). \end{aligned}$$

Since $\lambda_1(-\Delta_n) = 4 \sin^2 \left(\frac{\pi}{2(n+1)} \right)$ we can extend g to a function of a continuous parameter $n \in [2, \infty)$. It is straightforward to check that $g(2) = \left(\frac{1}{4} + \frac{2}{\zeta} \right)^{-1} < \min\{\frac{\zeta}{2}, 4\}$, $\lim_{n \rightarrow \infty} g(n) = 0$ and

$$g'(n) = \frac{-4\zeta \sin \left(\frac{\pi}{2(n-1)} \right) \left[\pi\zeta \cos \left(\frac{\pi}{2(n-1)} \right) + 4(n-1)^2 \sin^3 \left(\frac{\pi}{2(n-1)} \right) \right]}{(n-1)^2 \left[\zeta + 2n \left(1 - \cos \left(\frac{\pi}{n-1} \right) \right) \right]} < 0$$

for $n \in [2, \infty)$. In particular $g(n) \leq \nu(n)$ for all $n \in \mathbb{N} \setminus \{1\}$, and g is strictly decreasing with range $(0, g(2)]$. Therefore, as soon as $x \leq g(2)$ we can use g^{-1} in (1.12) and get

$$\begin{aligned} I_{p,\zeta}(x) &\leq p\mathbb{E} \left[(Y+2) \mathbf{1}_{\nu(Y+2) < x} \right] \\ &\leq p\mathbb{E} \left[(Y+2) \mathbf{1}_{g(Y+2) < x} \right] = p\mathbb{E} \left[(Y+2) \mathbf{1}_{Y+2 > g^{-1}(x)} \right] \\ &= p \sum_{y=\lfloor g^{-1}(x) \rfloor - 1}^{\infty} (y+2) \mathbb{P}[Y_1 = y] = p^2 \sum_{y=\lfloor g^{-1}(x) \rfloor - 1}^{\infty} (y+2)(1-p)^y \\ &= (1-p) \lfloor g^{-1}(x) \rfloor^{-1} [1 + p + p(\lfloor g^{-1}(x) \rfloor - 1)] \\ &\leq (1-p)^{g^{-1}(x)-2} [1 + p + p(g^{-1}(x) - 1)]. \end{aligned}$$

From the definition of g we can write $g^{-1}(x) - 1 = \beta(x\delta(x))$ where $\delta(x) := 1 + \frac{4g^{-1}(x)}{\zeta} \sin^2 \left(\frac{\pi}{2(g^{-1}(x)-1)} \right)$. Since $\lim_{n \rightarrow \infty} g(n) = 0$ we have $\lim_{x \downarrow 0} \delta(x) = 1$ and finally

$$\begin{aligned} \overline{\lim}_{x \downarrow 0} \sqrt{x} \ln I_{p,\zeta}(x) &\leq \overline{\lim}_{x \downarrow 0} \sqrt{x} \beta(x\delta(x)) \ln(1-p) + \overline{\lim}_{x \downarrow 0} \sqrt{x} \ln \beta(x\delta(x)) \\ &= \overline{\lim}_{x \downarrow 0} \frac{\pi}{\sqrt{\delta(x)}} \ln(1-p) + \overline{\lim}_{x \downarrow 0} \sqrt{x} \ln \left(\frac{\pi}{\sqrt{x\delta(x)}} \right) \\ &= \pi \ln(1-p). \end{aligned} \quad \square$$

We finish this chapter by characterizing the existence of the Lifshitz constant, and its value, at the bottom of the spectrum of any 1d discrete Anderson model with a potential bounded from below. Without loss of generality we assume that 0 is the bottom of the spectrum.

Proposition 1.7. *Let $\{V(j)\}_{j \in \mathbb{N}}$ be an i.i.d. real random potential satisfying $\inf \text{supp}(V(1)) = 0$. Let F be the cumulative distribution function of $V(1)$ and I be the IDS of the operator $-\Delta + V$ on $\ell^2(\mathbb{N})$, then:*

- $F(0) > 0 \implies \lim_{x \downarrow 0} \sqrt{x} \ln I(x) = \pi \ln F(0)$.
- $F(0) = 0 \implies \lim_{x \downarrow 0} \sqrt{x} \ln I(x) = -\infty$.

Proof. For any $\zeta > 0$ we have $\zeta \mathbf{1}_{V(j) > \zeta} \leq V(j)$ for all $j \in \mathbb{N}$. Since $\{\mathbf{1}_{V(j) > \zeta}\}_{j \in \mathbb{N}}$ is an i.i.d. random sequence following a Bernoulli($1 - F(\zeta)$) distribution, we have $I \leq I_{1-F(\zeta), \zeta}$ and therefore Proposition 1.6 gives

$$\overline{\lim}_{x \downarrow 0} \sqrt{x} \ln I(x) \leq \overline{\lim}_{x \downarrow 0} \sqrt{x} \ln I_{1-F(\zeta), \zeta}(x) = \pi \ln(F(\zeta)).$$

If $F(0) = 0$, taking $\zeta \rightarrow 0$ in the above inequality yields $\lim_{x \downarrow 0} \sqrt{x} \ln I(x) = -\infty$. Hence, we assume from now on that $F(0) > 0$, in which case the same limit gives

$$\overline{\lim}_{x \downarrow 0} \sqrt{x} \ln I(x) \leq \pi \ln(F(0)).$$

The other inequality follows from deleting from the finite volume restrictions of $-\Delta + V$ all rows and columns in which $V(j) > 0$ and then using the Cauchy Eigenvalue Interlacing Theorem to obtain $I_{1-F(0)}^{\leq} \leq I$, just as in the proof of (1.2). We conclude, using Proposition 1.4, that

$$\underline{\lim}_{x \downarrow 0} \sqrt{x} \ln I(x) \geq \underline{\lim}_{x \downarrow 0} \sqrt{x} \ln I_{1-F(0)}^{\leq} = \pi \ln(F(0)). \quad \square$$

Chapter 2

Principal Eigenvalue and Landscape Function

We start with some definitions and notation. Given a non-empty and finite $A \subseteq \mathbb{Z}^d$ and a positive potential $W : A \rightarrow [0, \infty)$ we consider the Schrödinger operator

$$\begin{aligned} -\Delta_A + W : \ell^2(A) &\longrightarrow \ell^2(A), \\ \phi &\longmapsto (-\Delta_A + W)\phi(x) := \sum_{|y-x|=1} [\phi(x) - \phi(y)] + W(x)\phi(x), \end{aligned}$$

where $-\Delta_A$ has Dirichlet boundary conditions. From it, we define its principal eigenvalue and landscape function

$$\lambda_{A,W} := \inf \sigma(-\Delta_A + W), \quad L_{A,W} := (-\Delta_A + W)^{-1} \mathbb{1}_A.$$

Notice that $\lambda_{A,W} > 0$ and $L_{A,W}$ is always well defined on A since $-\Delta_A > 0$ and $W \geq 0$.

Let $V = \{V(x)\}_{x \in \mathbb{Z}^d}$ be an i.i.d. random non-negative potential whose probability measure and expectation we denote \mathbb{P} and \mathbb{E} . In addition to V being non-negative (i.e., $\mathbb{P}[V(0) \in (-\infty, 0)] = 0$) we will always assume the distribution function $F(t) = \mathbb{P}[V(0) \leq t]$ satisfies one of the following mutually exclusive conditions:

(C1) $0 < F(0) < 1$, (Ex: Bernoulli(p))

(C2) $F(t) = ct^\eta(1 + o(1))$ as $t \downarrow 0$ for some $c, \eta > 0$. (Ex: Uniform($0, 1$))

Our main objectives are the asymptotics of $\lambda_{\Lambda_n, V}$ and $\|L_{\Lambda_n, V}\|_\infty$ as $n \rightarrow \infty$, where $\Lambda_n := [-n, n]^d \cap \mathbb{Z}^d$. We write n instead of Λ_n whenever convenient (e.g. $-\Delta_n = -\Delta_{\Lambda_n}$, $\lambda_{n, V} = \lambda_{\Lambda_n, V}$). We denote by ω_d and μ_d respectively, the volume of the unit ball in \mathbb{R}^d and the principal eigenvalue of the continuous Laplacian ($-\sum_{i=1}^d \partial^2/\partial x_i^2$) on such ball with Dirichlet boundary conditions.

We now state our conjecture and results. We are always assuming that V is non-negative and satisfies **(C1)** or **(C2)**. We claim that:

Conjecture A. $\lim_{n \rightarrow \infty} \lambda_{n, V} \|L_{n, V}\|_\infty = \frac{\mu_d}{2d} \quad \mathbb{P}\text{-a.s.}$

The heuristic argument behind this conjecture is that both $\lambda_{n, V}$ and $\|L_{n, V}\|_\infty$ are controlled by the largest ball inside of Λ_n with zero or very low potential. If the radius of such ball is r then, roughly, $\lambda_{n, V}$ is proportional to r^{-2} and $\|L_{n, V}\|_\infty$ is proportional to r^2 , making the product of order one in r . The appearance of the continuous constant $\frac{\mu_d}{2d}$ is another instance of the solution of a discrete problem converging to the solution of the corresponding continuous one.

Using the Min-Max Principle and our hypothesis on V it is straightforward to show that $\lambda_{n, V}$ is decreasing in n and converges to 0. Our first result is on the speed of this convergence, depending on whether V satisfies **(C1)** or **(C2)**:

Theorem 2.1.

- i) For **(C1)**, $\lim_{n \rightarrow \infty} \lambda_{n, V} \left(\frac{\omega_d |\ln F(0)|}{d \ln n} \right)^{-2/d} = \mu_d \quad \mathbb{P}\text{-a.s.}$
- ii) For **(C2)**, $\lim_{n \rightarrow \infty} \lambda_{n, V} \left(\frac{2\eta\omega_d \ln \ln n}{d^2 \ln n} \right)^{-2/d} = \mu_d \quad \mathbb{P}\text{-a.s.}$

The proof of Theorem 2.1 is given in Section 2.1, and it is divided into the upper and lower bounds of $\lambda_{n, V}$. The upper bound follows from the Min-Max Principle and the previously mentioned heuristic of the largest ball with zero or very low potential. The lower bound is a bit more involved; it uses a Lifshitz tails result from [BK01] and the connection between the integrated density of states of the (infinite) Anderson model and the distribution function of $\lambda_{n, V}$.

In Figure 2.1 we tried to illustrate Theorem 2.1 i) by plotting a single realization of the sequence $\lambda_{n, V} \left(\frac{\omega_1 |\ln F(0)|}{\ln n} \right)^{-2}$ when $d = 1$ and $V(0) \stackrel{d}{=} \text{Bernoulli}(p)$.

However, the plot does not show accumulation towards μ_1 , suggesting the convergence is very slow. The jumps we observe on the plot are caused by the $(n = 100)$ -step used to construct it, but even these artificial jumps fit well with the heuristic of the largest ball with zero potential. If the size of the largest ball does not increase then the eigenvalue remains (almost) constant, and the growth on the plot is caused by the $(\ln n)^2$ term; but if over one step a new largest ball is introduced then the eigenvalue decreases substantially, producing the jumps. As a complement we present histograms of the empirical distributions of $\lambda_{n,V} \left(\frac{\omega_1 |\ln F(0)|}{\ln n} \right)^{-2} - \mu_1$ (resp. $\lambda_{n,V} \left(\frac{2\eta\omega_1 \ln \ln n}{\ln n} \right)^{-2} - \mu_1$) for $n = 10^2, 10^3, 10^4, 10^5$ computed from 10^5 realizations. These are given in Figure 2.2, from which we can see that the empirical mean and empirical standard deviation approach very slowly 0, as n increases.

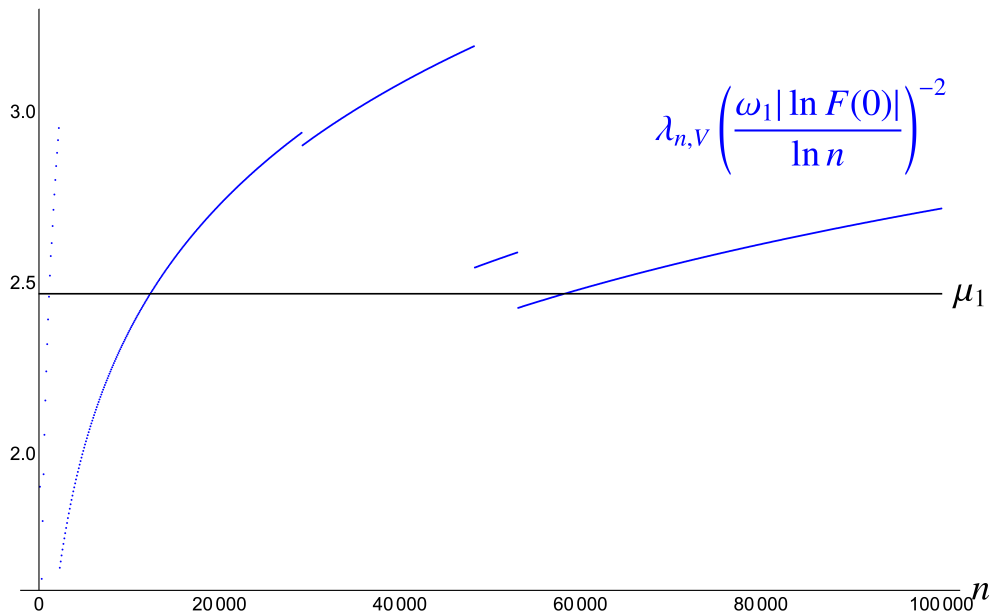

Figure 2.1: One realization of the sequence $\lambda_{n,V} \left(\frac{\omega_1 |\ln F(0)|}{\ln n} \right)^{-2}$ for $d = 1$ and $V(0) \stackrel{d}{=} \text{Bernoulli}(0.3)$.

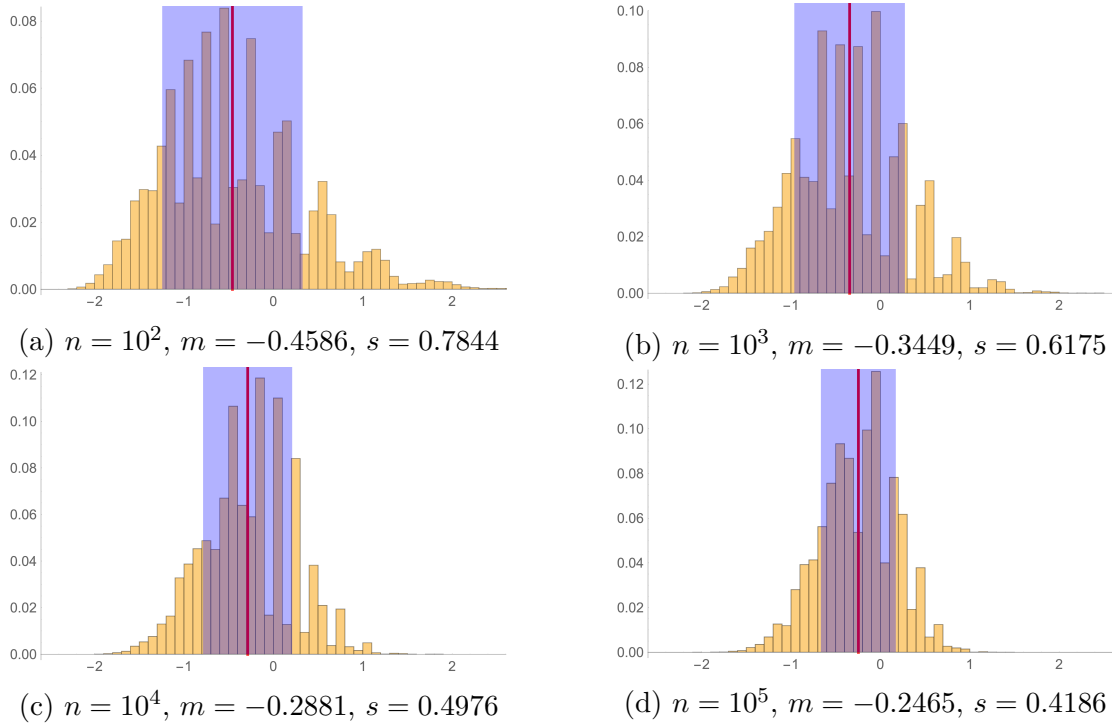

Figure 2.2: Empirical distribution of $\lambda_{n,V} \left(\frac{\omega_1 |\ln F(0)|}{\ln n} \right)^{-2} - \mu_1$ for $d = 1$ and $V(0) \stackrel{d}{=} \text{Bernoulli}(0.3)$ computed from 10^5 samples. The empirical mean (m) and empirical standard deviation (s) are shown in red and blue respectively.

Our second result is a partial proof of Conjecture A, and a complete proof when $d = 1$.

Theorem 2.2.

i) $\liminf_{n \rightarrow \infty} \lambda_{n,V} \|L_{n,V}\|_{\infty} \geq \frac{\mu_d}{2d} \quad \mathbb{P}\text{-a.s.}$

ii) If $d = 1$ then $\lim_{n \rightarrow \infty} \lambda_{n,V} \|L_{n,V}\|_{\infty} = \frac{\mu_1}{2} \quad \mathbb{P}\text{-a.s.}$

Remark. The preprint [CWZ21] has a proof of ii) in the continuous setting for the (C1) case. Both proofs follow the heuristic of the largest ball with zero or very low potential, but differ on how to obtain the lower bound of $\lambda_{n,V}$ and the upper bound of $L_{n,V}$.

We prove Theorem 2.2 in Section 2.2 after deriving some general properties of landscape functions. Most notable among these properties is Proposition 2.9,

which states that $\lambda_{A,W} \|L_{A,W}\|_\infty$ is bounded from above and below by two dimensional constants uniformly on A and W . This is a consequence of an upper bound of the $\ell^\infty \rightarrow \ell^\infty$ norm of the semigroup generated by the Schrödinger operator, which we adapted from the book [Szn98] to the discrete setting. The statement i) of Theorem 2.2 follows from domain monotonicity of the landscape function and the asymptotic of $\lambda_{n,V}$ given in Theorem 2.1, while ii) is based on the geometric resolvent identity and the restrictions of one dimensional geometry. In Figure 2.3 we illustrate Theorem 2.2 ii) by plotting, over a single realization of the potential, $\lambda_{n,V} \|L_{n,V}\|_\infty$ v.s. n when $d = 1$ and V follows a Bernoulli(p) distribution. Once again, the convergence is too slow to be appreciated in the plot, so we also give the corresponding empirical distribution in Figure 2.4.

Theorem 2.2 is just a first step towards the full conjecture of Filoche and Mayboroda [FM12] described in the introduction. The obvious next step is to prove Conjecture A in any dimension. There is still the question of whether the ground state localizes around the position of the absolute maxima of $L_{n,V}$, as well as the corresponding limits for the excited eigenvalues. It would also be of interest to quantify the speed of convergence in probability in order to obtain confidence intervals on the eigenvalues using only the landscape function.

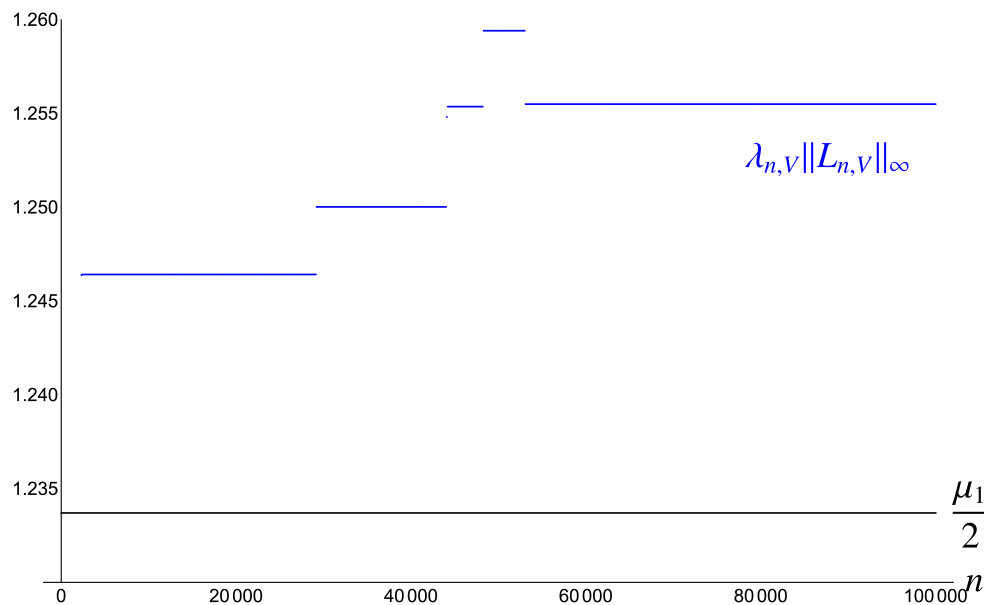

Figure 2.3: One realization of the sequence $\lambda_{n,V} \|L_{n,V}\|_\infty$ for $d = 1$ and $V(0) \stackrel{d}{=} \text{Bernoulli}(0.3)$.

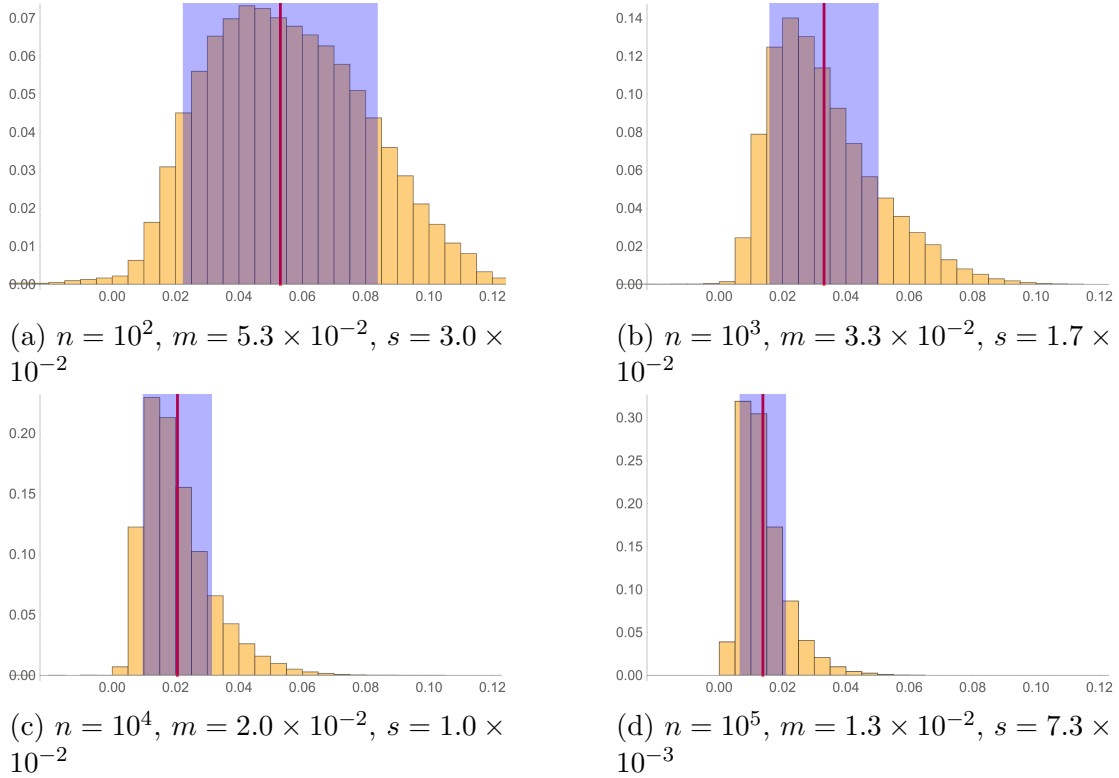

Figure 2.4: Empirical distribution of $\lambda_{n,V} \|L_{n,V}\|_{\infty} - \frac{\mu_1}{2}$ for $d = 1$ and $V(0) \stackrel{d}{=} \text{Bernoulli}(0.3)$ computed from 10^5 samples. The empirical mean (m) and empirical standard deviation (s) are shown in red and blue respectively.

In the proofs that follow, $C(d)$ is a finite positive constant that may only depend on the dimension and can change from line to line. By $a_t \sim_t b_t$ we mean $\lim_{t \rightarrow \infty} \frac{a_t}{b_t} = 1$.

2.1 Principal Eigenvalue (Proof of Theorem 2.1)

2.1.1 Upper Bound of $\lambda_{n,V}$

We introduce the sequences

$$\varepsilon_n := \begin{cases} 0, & \text{(C1),} \\ (\ln n)^{-2/d}, & \text{(C2),} \end{cases} \quad y_n := \left(\frac{d \ln n}{\omega_d |\ln F(\varepsilon_n)|} \right)^{1/d},$$

so we can write the goal of this subsection as

$$\overline{\lim}_{n \rightarrow \infty} y_n^2 \lambda_{n,V} \leq \mu_d \quad \mathbb{P}\text{-a.s.} \quad (2.1)$$

As usual, getting a sharp upper bound on $\lambda_{n,V}$ is much easier than a sharp lower bound. It just requires choosing a good test function and applying the Min-Max Principle.

Let Y_n be the radius of the largest open euclidean ball contained in Λ_n in which V is uniformly bounded by ε_n , that is,

$$Y_n := \max \{r \in \mathbb{N} \mid \exists x \in \Lambda_n \text{ such that } B(x, r) \cap \mathbb{Z}^d \subseteq \Lambda_n \cap V^{-1}([0, \varepsilon_n])\},$$

where $B(x, r) = \{x' \in \mathbb{R}^d \mid |x - x'| < r\} \subseteq \mathbb{R}^d$. Also, let $x_n \in \Lambda_n$ be the center of a ball at which the maximum is attained (it may not be unique). The asymptotic growth of Y_n is given in the next proposition, whose proof we delay a short moment.

Proposition 2.3. $Y_n \sim_n y_n$ \mathbb{P} -a.s.

Let $\phi \in \ell^2(B(x_n, Y_n) \cap \mathbb{Z}^d)$ be the normalized eigenvector of $-\Delta_{B(x_n, Y_n)}$ associated to $\lambda_{B(x_n, Y_n) \cap \mathbb{Z}^d, 0}$ and extend it by 0 to Λ_n . Then, by the Min-Max Principle, we have

$$\begin{aligned} \lambda_{n,V} &\leq \langle \phi, (-\Delta_n + V) \phi \rangle_{\ell^2(\Lambda_n)} = \langle \phi, (-\Delta_{B(x_n, Y_n) \cap \mathbb{Z}^d} + V) \phi \rangle_{\ell^2(B(x_n, Y_n) \cap \mathbb{Z}^d)} \\ &\leq \lambda_{B(x_n, Y_n) \cap \mathbb{Z}^d, 0} + \varepsilon_n \end{aligned}$$

and therefore

$$\begin{aligned} \overline{\lim}_{n \rightarrow \infty} y_n^2 \lambda_{n,V} &\leq \lim_{n \rightarrow \infty} y_n^2 (\lambda_{B(x_n, Y_n) \cap \mathbb{Z}^d, 0} + \varepsilon_n) \\ &= \lim_{n \rightarrow \infty} \frac{y_n^2}{Y_n^2} Y_n^2 \lambda_{B(x_n, Y_n) \cap \mathbb{Z}^d, 0} = \mu_d \quad \mathbb{P}\text{-a.s.}, \end{aligned}$$

where we have used Proposition 2.3, $\lim_{r \rightarrow \infty} r^2 \lambda_{B(0,r) \cap \mathbb{Z}^d, 0} = \mu_d$ and translation invariance. This last limit is a consequence of the discrete Laplacian converging to the continuous one, or random walk converging to Brownian motion. A proof following the latter approach can be found in [LL10, Proposition 8.4.2], where an extra factor d appears as a result of the probabilistic normalization of the Laplacian.

Proof of Proposition 2.3. If $Y_n < y_n(1 - \delta)^{1/d}$ for some $0 < \delta < 1$, then the inscribed ball of each of the $\left(\frac{2n}{2y_n(1-\delta)^{1/d}}\right)^d (1 + o(1))$ disjoint cubes, of side length

$\lceil 2y_n(1-\delta)^{1/d} \rceil$, that make up Λ_n contains a point x with $V(x) > \varepsilon_n$. Approximating the number of points in such balls by $\#(B(0, r) \cap \mathbb{Z}^d) \sim_r \text{Vol}(B(0, r)) = \omega_d r^d$, we obtain for large n

$$\begin{aligned} \mathbb{P} [Y_n < y_n(1-\delta)^{1/d}] &\leq \left(1 - F(\varepsilon_n) \omega_d y_n^d (1-\delta)^{(1+o(1))}\right)^{\frac{n^d}{y_n^d (1-\delta)^{(1+o(1))}}} \\ &= \left(1 - \frac{1}{n^{d(1-\delta)(1+o(1))}}\right)^{\frac{n^d \omega_d |\ln F(\varepsilon_n)|}{d(\ln n)(1-\delta)} (1+o(1))} \\ &\leq \exp\left(-\frac{n^\delta \omega_d |\ln F(\varepsilon_n)|}{2d(\ln n)(1-\delta)}\right), \end{aligned}$$

which is summable. Therefore, the Borel–Cantelli Lemma and sending $\delta \rightarrow 0$ give

$$1 \leq \varliminf_{n \rightarrow \infty} y_n^{-1} Y_n \quad \mathbb{P}\text{-a.s.}$$

We show the limsup bound first on an exponential sub-sequence and then we extend it to the whole sequence. The extending argument requires a monotone sequence of random variables, which Y_n may fail to be if **(C2)** holds. For this reason we introduce

$$Y_{n,n'} := \max \{r \in \mathbb{N} \mid \exists x \in \Lambda_n \text{ such that } B(x, r) \cap \mathbb{Z}^d \subseteq \Lambda_n \cap V^{-1}([0, \varepsilon_{n'}])\},$$

which is increasing on n , decreasing on n' and satisfies $Y_{n,n} = Y_n$. Since for $\delta > 0$ and large m we have

$$\begin{aligned} \mathbb{P} [Y_{\lfloor e^{m+1} \rfloor, \lfloor e^m \rfloor} > y_{\lfloor e^m \rfloor} (1+\delta)^{1/d}] &\leq \sum_{x \in \Lambda_{\lfloor e^{m+1} \rfloor}} \mathbb{P} [B(x, y_{\lfloor e^m \rfloor} (1+\delta)^{1/d}) \cap \mathbb{Z}^d \subseteq V^{-1}[0, \varepsilon_{\lfloor e^m \rfloor}]] \\ &= \#\Lambda_{\lfloor e^{m+1} \rfloor} F(\varepsilon_{\lfloor e^m \rfloor}) \omega_d y_{\lfloor e^m \rfloor}^d (1+\delta)^{(1+o(1))} \\ &= \frac{\#\Lambda_{\lfloor e^{m+1} \rfloor}}{\lfloor e^m \rfloor^{d(1+\delta)(1+o(1))}} \\ &\leq C(d) e^{-md\delta/2}, \end{aligned}$$

the Borel–Cantelli Lemma and the limit $\delta \rightarrow 0$ give

$$\overline{\lim}_{m \rightarrow \infty} y_{\lfloor e^m \rfloor}^{-1} Y_{\lfloor e^{m+1} \rfloor, \lfloor e^m \rfloor} \leq 1 \quad \mathbb{P}\text{-a.s.}$$

For $n \in \mathbb{N}$ define $m(n) \in \mathbb{N}$ by $\lfloor e^{m(n)} \rfloor \leq n < \lfloor e^{m(n)+1} \rfloor$. Since $y_n \sim_n y_{\lfloor e^{m(n)} \rfloor}$ and $Y_n \leq Y_{\lfloor e^{m(n)+1} \rfloor, \lfloor e^{m(n)} \rfloor}$ we conclude

$$\begin{aligned} \overline{\lim}_{n \rightarrow \infty} y_n^{-1} Y_n &\leq \overline{\lim}_{n \rightarrow \infty} y_n^{-1} Y_{\lfloor e^{m(n)+1} \rfloor, \lfloor e^{m(n)} \rfloor} \\ &= \overline{\lim}_{n \rightarrow \infty} y_{\lfloor e^{m(n)} \rfloor}^{-1} Y_{\lfloor e^{m(n)+1} \rfloor, \lfloor e^{m(n)} \rfloor} \leq 1 \quad \mathbb{P}\text{-a.s.} \quad \square \end{aligned}$$

2.1.2 Lower Bound of $\lambda_{n,V}$

In this subsection we show that \mathbb{P} -a.s. we have

$$1 \leq \underline{\lim}_{n \rightarrow \infty} \frac{\lambda_{n,V}}{\mu_d \left(\frac{\omega_d |\ln F(0)|}{d \ln n} \right)^{2/d}} \quad \text{and} \quad 1 \leq \underline{\lim}_{n \rightarrow \infty} \frac{\lambda_{n,V}}{\mu_d \left(\frac{2\eta \omega_d \ln \ln n}{d^2 \ln n} \right)^{2/d}} \quad (2.2)$$

for **(C1)** and **(C2)** respectively. The main input for this is a Lifshitz tail result on the integrated density of states from [BK01]. We recall the integrated density of states of the Anderson model is a deterministic distribution function given by the \mathbb{P} -a.s. limit

$$I(t) := \lim_{n \rightarrow \infty} \frac{1}{\#\Lambda_n} \#\{\lambda \in \sigma(-\Delta_n + V) \mid \lambda \leq t\}, \quad t \in \mathbb{R},$$

where the eigenvalues are counted with multiplicities. The central hypothesis of [BK01] is a scaling assumption of the cumulant-generating function $H(t) := \ln \mathbb{E} [e^{-tV(0)}]$ of $V(0)$, which we prove in the following proposition. To state it, we first need to define

$$(1, \infty) \ni t \mapsto \alpha(t) := \begin{cases} t^{1/(d+2)}, & \text{(C1),} \\ \left(\frac{t}{\ln t}\right)^{1/(d+2)}, & \text{(C2),} \end{cases} \quad \tilde{H} := \begin{cases} |\ln F(0)|, & \text{(C1),} \\ \frac{2\eta}{d+2}, & \text{(C2).} \end{cases}$$

Proposition 2.4. *For any compact $K \subseteq (0, \infty)$ we have*

$$\lim_{t \rightarrow \infty} \frac{\alpha^{d+2}(t)}{t} H \left(\frac{t}{\alpha^d(t)} y \right) = -\tilde{H}$$

uniformly on $y \in K$.

Proof. First assume **(C1)**. In this case $\frac{\alpha^{d+2}(t)}{t} = 1$ and $\frac{t}{\alpha^d(t)} = t^{2/(d+2)}$. Since for $t > 0$ we have

$$\begin{aligned} \ln F(0) \leq H(t) &= \ln \left(\mathbb{E} \left[e^{-tV(0)} \mathbf{1}_{V(0) \leq \frac{1}{\sqrt{t}}} \right] + \mathbb{E} \left[e^{-tV(0)} \mathbf{1}_{V(0) > \frac{1}{\sqrt{t}}} \right] \right) \\ &\leq \ln \left(F \left(1/\sqrt{t} \right) + e^{-\sqrt{t}} \right), \end{aligned}$$

we conclude that

$$\begin{aligned}
& \sup_{y \in K} \left| \frac{\alpha^{d+2}(t)}{t} H \left(\frac{t}{\alpha^d(t)} y \right) - \ln F(0) \right| \\
& \leq \sup_{y \in K} \ln \left(F \left(\frac{1}{t^{1/d+2} \sqrt{y}} \right) + e^{-t^{1/d+2} \sqrt{y}} \right) - \ln F(0) \\
& = \ln \left(F \left(\frac{1}{t^{1/d+2} \sqrt{\min K}} \right) + e^{-t^{1/d+2} \sqrt{\min K}} \right) - \ln F(0) \\
& \xrightarrow{t \rightarrow \infty} 0.
\end{aligned}$$

Now assume **(C2)**. In this case $\frac{\alpha^{d+2}(t)}{t} = \frac{1}{\ln t}$ and $\frac{t}{\alpha^d(t)} = t^{2/(d+2)} (\ln t)^{d/(d+2)}$. We introduce a parameter $0 < \delta < 1$ and observe

$$\begin{aligned}
H(t) &= \ln \left(\mathbb{E} \left[e^{-tV(0)} \mathbf{1}_{V(0) \leq t^{-\delta}} \right] + \mathbb{E} \left[e^{-tV(0)} \mathbf{1}_{V(0) > t^{-\delta}} \right] \right) \\
&\leq \ln \left(F(t^{-\delta}) + e^{-t^{1-\delta}} \right), \quad t > 0,
\end{aligned}$$

which implies

$$\begin{aligned}
& \overline{\lim}_{t \rightarrow \infty} \sup_{y \in K} \frac{\alpha^{d+2}(t)}{t} H \left(\frac{t}{\alpha^d(t)} y \right) \\
& \leq \overline{\lim}_{t \rightarrow \infty} \sup_{y \in K} \frac{1}{\ln t} \ln \left(F \left(\left[\frac{t}{\alpha^d(t)} y \right]^{-\delta} \right) + \exp \left(- \left[\frac{t}{\alpha^d(t)} y \right]^{1-\delta} \right) \right) \\
& = \overline{\lim}_{t \rightarrow \infty} \frac{1}{\ln t} \ln \left(F \left(\left[\frac{t}{\alpha^d(t)} \min K \right]^{-\delta} \right) + \exp \left(- \left[\frac{t}{\alpha^d(t)} \min K \right]^{1-\delta} \right) \right) \\
& = -\frac{2\delta\eta}{d+2} \xrightarrow{\delta \rightarrow 1} -\frac{2\eta}{d+2}.
\end{aligned}$$

For the $\underline{\lim}_{t \rightarrow \infty} \inf_{y \in K}$ we use

$$\begin{aligned}
H(t) &= \ln \left(\mathbb{E} \left[e^{-tV(0)} \mathbf{1}_{V(0) \leq t^{-1}} \right] + \mathbb{E} \left[e^{-tV(0)} \mathbf{1}_{V(0) > t^{-1}} \right] \right) \\
&\geq \ln \left(e^{-1} F(t^{-1}) \right), \quad t > 0
\end{aligned}$$

to obtain

$$\begin{aligned}
& \underline{\lim}_{t \rightarrow \infty} \inf_{y \in K} \frac{\alpha^{d+2}(t)}{t} H \left(\frac{t}{\alpha^d(t)} y \right) \\
& \geq \underline{\lim}_{t \rightarrow \infty} \inf_{y \in K} \frac{1}{\ln t} \ln \left(e^{-1} F \left(\left[\frac{t}{\alpha^d(t)} y \right]^{-1} \right) \right) \\
& \geq \underline{\lim}_{t \rightarrow \infty} \frac{1}{\ln t} \ln \left(e^{-1} F \left(\left[\frac{t}{\alpha^d(t)} \max K \right]^{-1} \right) \right) = -\frac{2\eta}{d+2}. \quad \square
\end{aligned}$$

Having checked the scaling assumption on H , we now have the Lifshitz tail result:

Theorem 2.5 (Theorem 1.3 of [BK01]). *If V satisfies (C1) or (C2) then*

$$\lim_{t \downarrow 0} \frac{\ln I(t)}{t \alpha^{-1}(t^{-1/2})} = -2 d^{d/2} \left(\frac{\chi}{d+2} \right)^{(d+2)/2},$$

where $\chi := \inf_{g \in H^1(\mathbb{R}^d), \|g\|_2=1} \left(\|\nabla g\|_2^2 + \tilde{H} \text{Vol}(\text{supp } g) \right)$.

Remark. The function $t \mapsto \alpha(t)$ is eventually increasing so $\alpha^{-1}(t)$ is well defined for large t . The original statement from [BK01] is far more general; our conditions on V make H fall into, what is there called, the $(\gamma = 0)$ -class.

The constant χ can be explicitly computed by means of the Faber-Krahn inequality:

$$\textbf{Proposition 2.6. } \chi = (d+2) \left(\frac{\tilde{H} \omega_d}{2} \right)^{2/(d+2)} \left(\frac{\mu_d}{d} \right)^{d/(d+2)}.$$

Proof. Starting from $\chi = \inf_{g \in H^1(\mathbb{R}^d), \|g\|_2=1} \left(\|\nabla g\|_2^2 + D \text{Vol}(\text{supp } g) \right)$ we see that we only need to consider the finite volume case. Hence

$$\chi = \inf_{\substack{A \subset \mathbb{R}^d, \\ \text{Vol}(A) < \infty}} \inf_{\substack{g \in H^1(\mathbb{R}^d), \|g\|_2=1, \\ \text{supp } g = A}} \left(\|\nabla g\|_2^2 + \tilde{H} \text{Vol}(A) \right) = \inf_{\substack{A \subset \mathbb{R}^d, \\ \text{Vol}(A) < \infty}} \left(\mu(A) + \tilde{H} \text{Vol}(A) \right),$$

where $\mu(A)$ is the principal eigenvalue of the continuous Laplacian $(-\sum_{i=1}^d \frac{\partial^2}{\partial x_i^2})$ defined on A with Dirichlet boundary conditions. The Faber-Krahn inequality states that over all domains of a given volume the one with the lowest principal eigenvalue is the ball, therefore, using $\mu(B(0, r)) = \mu_d/r^2$ and $\text{Vol}(B(0, r)) = \omega_d r^d$ we obtain

$$\chi = \inf_{0 < r < \infty} \left(\frac{\mu_d}{r^2} + \tilde{H} \omega_d r^d \right).$$

Evaluating at the only critical point $r = \left(\frac{2\mu_d}{\tilde{H}\omega_d} \right)^{1/(d+2)}$ finishes the proof. \square

We now exploit the connection between I and the distribution of $\lambda_{n,V}$. This is a classic argument that can be found, for instance, in [AW15, Equation 4.46]. We present here a slightly modified version. Let $n \in \mathbb{N}$ and define a new potential

$$V'(x) := \begin{cases} \infty, & x \in \Gamma, \\ V(x), & x \in \mathbb{Z}^d \setminus \Gamma, \end{cases}$$

where $\Gamma := \{x = (x_1, \dots, x_d) \in \mathbb{Z}^d \mid x_i \in (2n+2)\mathbb{Z} \text{ for some } i = 1, \dots, d\} \subseteq \mathbb{Z}^d$. Clearly $V \leq V'$ so for any $k \in \mathbb{N}$ and $t \in \mathbb{R}$ we have

$$\frac{\#\{\lambda \in \sigma(-\Delta_{(2n+2)k} + V) \mid \lambda \leq t\}}{\#\Lambda_{(2n+2)k}} \geq \frac{\#\{\lambda \in \sigma(-\Delta_{(2n+2)k} + V') \mid \lambda \leq t\}}{\#\Lambda_{(2n+2)k}},$$

where $-\Delta_{(2n+2)k} + V'$ has (by definition) Dirichlet boundary conditions at Γ . These Dirichlet boundary conditions at Γ imply that $-\Delta_{(2n+2)k} + V'$ is a direct sum of $(2k)^d$ independent terms, all equal in distribution to $-\Delta_n + V$. Therefore, by taking the limit $k \rightarrow \infty$ on the above inequality and applying the Law of Large Numbers, we obtain

$$\begin{aligned} I(t) &\geq \left(\lim_{k \rightarrow \infty} \frac{(2k)^d}{\#\Lambda_{(2n+2)k}} \right) \mathbb{E}[\#\{\lambda \in \sigma(-\Delta_n + V) \mid \lambda \leq t\}] \\ &\geq \left(\frac{1}{2n+2} \right)^d \mathbb{P}[\lambda_{n,V} \leq t]. \end{aligned}$$

From the previous inequality, Theorem 2.5 and Proposition 2.6 we have

$$\mathbb{P}[\lambda_{n,V} \leq t] \leq C(d)n^d I(t) \leq C(d)n^d \exp[-f(1/t)(1+o(1))] \quad \text{as } t \downarrow 0, \quad (2.3)$$

where we have introduced $f(t) := \frac{\tilde{H}\omega_d\mu_d^{d/2}\alpha^{-1}(t^{1/2})}{t}$. To finish the proof we need the asymptotic of $f^{-1}(t)$ as $t \rightarrow \infty$:

Proposition 2.7.

- For (C1), $f^{-1}(t) = \frac{1}{\mu_d} \left(\frac{t}{\omega_d |\ln F(0)|} \right)^{2/d}$.
- For (C2), $f^{-1}(t) \sim_t \frac{1}{\mu_d} \left(\frac{dt}{2\eta\omega_d \ln t} \right)^{2/d}$.

Proof. For (C1) there is nothing to prove since $f(t) = \omega_d |\ln F(0)| \mu_d^{d/2} t^{d/2}$. For (C2) we have

$$f(t) = \frac{k\alpha^{-1}(t^{1/2})}{t} = kt^{d/2} \ln \alpha^{-1}(t^{1/2}),$$

with all the constants collected in $k = \frac{2\eta\omega_d\mu_d^{d/2}}{d+2}$. Since α is eventually increasing and has infinite limit, the same is true for f , in particular $f^{-1}(t)$ exists for large t .

By solving for the α^{-1} term in the first equality above, applying α and simplifying some exponents we arrive at $t = \left(\frac{f(t)}{k \ln [tf(t)/k]}\right)^{2/d}$. Replacing t by $f^{-1}(t)$ we obtain

$$f^{-1}(t) = \left(\frac{t}{k \ln [tf^{-1}(t)/k]}\right)^{2/d},$$

and then multiplying by t and taking the logarithm leads to

$$\ln[tf^{-1}(t)] = \frac{d+2}{d} \ln t - \frac{2}{d} \ln [k \ln [tf^{-1}(t)/k]],$$

which implies

$$f^{-1}(t) \sim_t \left(\frac{dt}{(d+2)k \ln t}\right)^{2/d} = \frac{1}{\mu_d} \left(\frac{dt}{2\eta\omega_d \ln t}\right)^{2/d}. \quad \square$$

Going back to (2.3) with $n = \lfloor e^m \rfloor$ and $t = 1/f^{-1}((1+\delta)dm)$ for some $m \in \mathbb{N}$ and $\delta > 0$, we see that

$$\begin{aligned} \mathbb{P} [\lambda_{\lfloor e^m \rfloor, V} f^{-1}((1+\delta)dm) \leq 1] &\leq C(d) (\lfloor e^m \rfloor)^d \exp[-(1+\delta)dm(1+o(1))] \\ &\leq C(d) e^{-md\delta/2}, \end{aligned}$$

which is summable over $m \in \mathbb{N}$. Therefore, by the Borel–Cantelli Lemma we have

$$1 \leq \varliminf_{m \rightarrow \infty} \lambda_{\lfloor e^m \rfloor, V} f^{-1}((1+\delta)dm) = (1+\delta)^{2/d} \varliminf_{m \rightarrow \infty} \lambda_{\lfloor e^m \rfloor, V} f^{-1}(dm) \quad \mathbb{P}\text{-a.s.}$$

As in the proof of Proposition 2.3, we define $m(n) \in \mathbb{N}$ by $\lfloor e^{m(n)} \rfloor \leq n < \lfloor e^{m(n)+1} \rfloor$, so that $\ln n \sim_n (m(n) + 1)$. Since $n \mapsto \lambda_{n, V}$ is monotone decreasing we have

$$\begin{aligned} \varliminf_{n \rightarrow \infty} \lambda_{n, V} f^{-1}(d \ln n) &\geq \varliminf_{n \rightarrow \infty} \lambda_{\lfloor e^{m(n)+1} \rfloor, V} f^{-1}(d \ln n) \\ &= \varliminf_{n \rightarrow \infty} \lambda_{\lfloor e^{m(n)+1} \rfloor, V} f^{-1}(d(m(n) + 1)) \geq (1+\delta)^{-2/d} \quad \mathbb{P}\text{-a.s.} \end{aligned}$$

By sending $\delta \rightarrow 0$ and replacing the f^{-1} term by its asymptotic given in Proposition 2.7 we obtain the desired result of this subsection.

2.2 Landscape Function

We start this section by deriving some general properties of landscape functions by means of the Feynman–Kac formula. Let $(X_t)_{t \geq 0}$ be a continuous time simple

symmetric random walk on \mathbb{Z}^d with jump intensity 1, and let P_x, E_x be the associated probability measure and expectation conditioned on $X_0 = x$. We remark that $(X_t)_{t \geq 0}$ is the Markov process of generator $-\Delta/(2d)$ on $\ell^2(\mathbb{Z}^d)$.

For a finite $A \subseteq \mathbb{Z}^d$ and $W : A \rightarrow [0, \infty)$, the Feynman–Kac formula lets us write the semigroup generated by $-\Delta_A + W$ acting on $\phi \in \ell^2(A)$ and evaluated at $x \in A$ as

$$\exp\left(-\frac{t}{2d}[-\Delta_A + W]\right)\phi(x) = E_x\left[\phi(X_t) \exp\left(-\int_0^t \frac{W(X_s)}{2d} ds\right) \mathbb{1}_{t < \tau_A}\right],$$

where $\tau_A := \inf\{t \geq 0 \mid X_t \notin A\}$ is the exit time of A . By integrating the semigroup we obtain the resolvent, hence

$$\begin{aligned} L_{A,W}(x) &= (-\Delta_A + W)^{-1}\mathbb{1}_A(x) = \frac{1}{2d} \int_0^\infty \exp\left(-\frac{t}{2d}[-\Delta_A + W]\right) \mathbb{1}_A(x) dt \\ &= \frac{1}{2d} \int_0^\infty E_x\left[\mathbb{1}_A(X_t) \exp\left(-\int_0^t \frac{W(X_s)}{2d} ds\right) \mathbb{1}_{t < \tau_A}\right] dt \\ &= \frac{1}{2d} E_x\left[\int_0^{\tau_A} \exp\left(-\int_0^t \frac{W(X_s)}{2d} ds\right) dt\right], \quad x \in A. \end{aligned} \quad (2.4)$$

From the last line we see that $L_{A,W}$ is positive on A and that it can be naturally extended by 0 outside of A . It also implies monotonicity on both the potential and the domain:

- $0 \leq W' \leq W \implies L_{A,W'} \geq L_{A,W}$.
- $A' \subseteq A \implies L_{A',W} \leq L_{A,W}$.

With an application of the strong Markov property we also have for $A' \subseteq A$:

$$\begin{aligned} L_{A,W}(x) &= \frac{1}{2d} E_x\left[\int_0^{\tau_{A'}} \exp\left(-\int_0^t \frac{W(X_s)}{2d} ds\right) dt\right] \\ &\quad + \frac{1}{2d} E_x\left[\int_{\tau_{A'}}^{\tau_A} \exp\left(-\int_0^t \frac{W(X_s)}{2d} ds\right) dt\right] \\ &= L_{A',W}(x) \\ &\quad + \frac{1}{2d} E_x\left[\exp\left(-\int_0^{\tau_{A'}} \frac{W(X_s)}{2d} ds\right) \int_{\tau_{A'}}^{\tau_A} \exp\left(-\int_{\tau_{A'}}^t \frac{W(X_s)}{2d} ds\right) dt\right] \\ &= L_{A',W}(x) + E_x\left[\exp\left(-\int_0^{\tau_{A'}} \frac{W(X_s)}{2d} ds\right) L_{A,W}(X_{\tau_{A'}})\right]. \end{aligned} \quad (2.5)$$

Our last general property is that $\lambda_{A,W} \|L_{A,W}\|_\infty$ is bounded from above and below by two positive constants uniformly on A and W . This is based on the following upper bound of the $\ell^\infty \rightarrow \ell^\infty$ norm of the semigroup, which can be found, for the continuous setting, in [Szn98, Chapter 3, Theorem 1.2]. We could not find a proof in the literature for the discrete case, so we provide one here.

Theorem 2.8. *For any finite $A \subseteq \mathbb{Z}^d$ and $W : A \rightarrow [0, \infty)$ we have for $t \geq 0$*

$$\left\| \exp\left(-\frac{t}{2d}[-\Delta_A + W]\right) \mathbb{1}_A \right\|_\infty \leq C(d) \left(1 + \left[\frac{\lambda_{A,W} t}{2d}\right]^{d/2}\right) \exp\left(-\frac{\lambda_{A,W} t}{2d}\right).$$

Proof. Given A and W we write $\lambda = \frac{\lambda_{A,W}}{2d}$, $K_t = \exp\left(-\frac{t}{2d}[-\Delta_A + W]\right)$ and $k_t(x, y) = \langle \delta_x, K_t \delta_y \rangle_{\ell^2(A)}$ (the kernel of the semigroup). Depending on λ we distinguish two cases.

- Case $\lambda \leq \frac{1}{d}$.

Let $\overline{B_\infty}(x, r) := \{y \in \mathbb{R}^d \mid \|x - y\|_\infty \leq r\}$. For $t \geq 1$ and $x \in A$ we have

$$\begin{aligned} K_{t/\lambda} \mathbb{1}_A(x) &= K_{t/\lambda} \mathbb{1}_{A \cap \overline{B_\infty}(x, r)}(x) + K_{t/\lambda} \mathbb{1}_{A \setminus \overline{B_\infty}(x, r)}(x) \\ &\leq \left\langle k_{1/\lambda}(x, \cdot), K_{(t-1)/\lambda} \mathbb{1}_{A \cap \overline{B_\infty}(x, r)} \right\rangle_{\ell^2(A)} + \mathbb{P}_0 [X_{t/\lambda} \notin \overline{B_\infty}(0, r)] \\ &\leq C(d) \sqrt{\mathbb{P}_0 [X_{2/\lambda} = 0]} r^{d/2} e^{-(t-1)} + \mathbb{P}_0 [X_{t/\lambda} \notin \overline{B_\infty}(0, r)], \end{aligned}$$

where we chose $r = 2t \sqrt{\frac{e}{\lambda d}}$.

The term $\mathbb{P}_0 [X_{2/\lambda} = 0]$ can be estimated using the characteristic function of X_s , which is $\phi_s(\theta) = \exp\left(-s + \frac{s}{d} \sum_{i=1}^d \cos(\theta_i)\right)$, by means of

$$\mathbb{P}_0 [X_s = 0] = \frac{1}{(2\pi)^d} \int_{[-\pi, \pi]^d} \phi_s(\theta) d\theta = \frac{e^{-s}}{(2\pi)^d} \left[\int_{[-\pi, \pi]} \exp\left(\frac{s}{d} \cos \theta_1\right) d\theta_1 \right]^d.$$

Laplace's method applied to the right-most integral yields $\mathbb{P}_0 [X_s = 0] s^{d/2} \xrightarrow{s \rightarrow \infty} \left(\frac{d}{2\pi}\right)^{d/2}$ and therefore $\mathbb{P}_0 [X_{2/\lambda} = 0] \leq C(d) \lambda^{d/2}$.

For the other probability we use the bound (see [Bar17, Lemma 4.6])

$$P[S_n > y] \leq e^{-y^2/(2n)}, \quad y > 0,$$

where S_n is a discrete time simple symmetric random walk on \mathbb{Z} starting at 0, and P is its probability measure. Recalling that the first component of X_t , which we denote X_t^1 , is a continuous time simple symmetric random walk on \mathbb{Z} with jump intensity $1/d$ we have

$$P_0 [X_{t/\lambda} \notin \overline{B_\infty}(0, r)] \leq 2dP_0 [X_{t/\lambda}^1 > r] \leq 2d \sum_{n \geq 0} \frac{e^{-t/(\lambda d)}}{n!} \left(\frac{t}{\lambda d}\right)^n P[S_n > r].$$

We split the series at $n = \frac{2et}{\lambda d}$ and bound the two terms separately:

$$\begin{aligned} \sum_{n \leq \frac{2et}{\lambda d}} \frac{e^{-t/(\lambda d)}}{n!} \left(\frac{t}{\lambda d}\right)^n P[S_n > r] &\leq \sum_{n \leq \frac{2et}{\lambda d}} \frac{e^{-t/(\lambda d)}}{n!} \left(\frac{t}{\lambda d}\right)^n e^{-r^2/(2n)} \\ &\leq \exp\left(-\frac{r^2 \lambda d}{4et}\right) \sum_{n \leq \frac{2et}{\lambda d}} \frac{e^{-t/(\lambda d)}}{n!} \left(\frac{t}{\lambda d}\right)^n \\ &\leq \exp\left(-\frac{r^2 \lambda d}{4et}\right) = e^{-t}, \\ \sum_{n \geq \frac{2et}{\lambda d}} \frac{e^{-t/(\lambda d)}}{n!} \left(\frac{t}{\lambda d}\right)^n P[S_n > r] &\leq e^{-t/(\lambda d)} \sum_{n \geq \frac{2et}{\lambda d}} \frac{1}{n!} \left(\frac{t}{\lambda d}\right)^n \\ &\leq e^{-t/(\lambda d)} \sum_{n \geq 0} \frac{1}{n!} \left(\frac{n}{2e}\right)^n \leq C(1)e^{-t}. \end{aligned}$$

Hence we have shown $\|K_{t/\lambda} \mathbf{1}_A\|_\infty \leq C(d) (1 + t^{d/2}) e^{-t}$ for $t \geq 1$. Since $K_{t/\lambda} \mathbf{1}(x)$ is always bounded by 1 we can add $(\inf_{0 \leq t \leq 1} (1 + t^{d/2}) e^{-t})^{-1}$ to $C(d)$, if necessary, to have

$$\|K_{t/\lambda} \mathbf{1}_A\|_\infty \leq C(d) (1 + t^{d/2}) e^{-t}, \quad t \geq 0.$$

Replacing t by λt and gives the desired bound.

- Case $\lambda \geq \frac{1}{d}$.

This case follows from the heat kernel bound (see [Bar17, Theorem 5.17])

$$P_0 [X_t = y] \leq C(d) \exp\left[-t - \|y\|_1 \ln\left(\frac{\|y\|_1}{et}\right)\right], \quad \|y\|_1 \geq et.$$

We proceed as before but now we use $\overline{B_1}(x, r) := \{y \in \mathbb{R}^d \mid \|x - y\|_1 \leq r\}$. For

$t \geq 0$ we have

$$\begin{aligned} K_t \mathbf{1}_A(x) &= K_t \mathbf{1}_{A \cap \overline{B_1}(x,r)}(x) + K_t \mathbf{1}_{A \setminus \overline{B_1}(x,r)}(x) \\ &\leq \left\langle \delta_x, K_t \mathbf{1}_{A \cap \overline{B_1}(x,r)} \right\rangle_{\ell^2(A)} + \mathbb{P}_0 [X_t \notin \overline{B_1}(0,r)] \\ &\leq C(d) r^{d/2} e^{-\lambda t} + \mathbb{P}_0 [X_t \notin \overline{B_1}(0,r)], \end{aligned}$$

with $r = \lambda t d e^2$. Clearly $r \geq e t$, so we can apply the heat kernel bound to obtain

$$\begin{aligned} \mathbb{P}_0 [X_t^1 \notin \overline{B_1}(0,r)] &\leq C(d) \sum_{\substack{y \in \mathbb{Z}^d \\ \|y\|_1 > r}} \exp \left[-t - \|y\|_1 \ln \left(\frac{\|y\|_1}{e t} \right) \right] \\ &\leq C(d) \sum_{\substack{y \in \mathbb{Z}^d \\ \|y\|_1 > r}} \exp [-\|y\|_1 \ln(ed)] \\ &\leq C(d) e^{-r} \sum_{y \in \mathbb{Z}^d} \exp [-\|y\|_1] \\ &= C(d) e^{-r} \leq C(d) e^{-\lambda t}, \end{aligned}$$

and therefore $\|K_t \mathbf{1}_A\|_\infty \leq C(d) (1 + [\lambda t]^{d/2}) e^{-\lambda t}$. \square

As an immediate consequence we obtain:

Proposition 2.9. *For any finite $A \subseteq \mathbb{Z}^d$ and $W : A \rightarrow [0, \infty)$ we have*

$$1 \leq \lambda_{A,W} \|L_{A,W}\|_\infty \leq C(d).$$

Remark. The lower bound is sharp. It is attained when A is a single point of \mathbb{Z}^d .

Proof. For the lower bound we just need to notice that the second line of (2.4) implies

$$\|L_{A,W}\|_\infty = \sup_{\phi \in \ell^2(A) \setminus \{0\}} \frac{\|(-\Delta_A + W)^{-1} \phi\|_\infty}{\|\phi\|_\infty}.$$

Plugging in the eigenvector associated to $\lambda_{A,W}$ we obtain $\|L_{A,W}\|_\infty \geq \frac{1}{\lambda_{A,W}}$.

For the upper bound we use (2.4), Theorem 2.8 and the substitution $u = \frac{\lambda_{A,W} t}{2d}$:

$$\begin{aligned} \|L_{A,W}\|_\infty &\leq \frac{1}{2d} \int_0^\infty \left\| \exp \left(-\frac{t}{2d} [-\Delta_A + W] \right) \mathbf{1}_A \right\|_\infty dt \\ &\leq \frac{C(d)}{2d} \int_0^\infty \left(1 + \left[\frac{\lambda_{A,W} t}{2d} \right]^{d/2} \right) \exp \left(-\frac{\lambda_{A,W} t}{2d} \right) dt \\ &= \frac{C(d)}{\lambda_{A,W}} \int_0^\infty (1 + u^{d/2}) e^{-u} du = \frac{C(d)}{\lambda_{A,W}}. \end{aligned} \quad \square$$

Instead of random walks and the Feynman–Kac formula, we can use Green functions to obtain an equivalent expansion of $L_{A,W}$. We introduce the Green function (with 0 as spectral parameter)

$$\begin{aligned} G_{A,W}(x,y) &:= \begin{cases} \langle \delta_x, (-\Delta_A + W)^{-1} \delta_y \rangle_{\ell^2(A)}, & (x,y) \in A \times A, \\ 0, & (x,y) \in (\mathbb{Z}^d \times \mathbb{Z}^d) \setminus (A \times A). \end{cases} \\ &= \frac{1}{2d} \mathbb{E}_x \left[\int_0^{\tau_A} \delta_y(X_t) \exp\left(-\int_0^t \frac{W(X_s)}{2d} ds\right) dt \right] \end{aligned}$$

This function is symmetric, non-negative, decreasing on the potential W ; and it satisfies the geometric resolvent identity (see [Kir08, Section 5.3]): If $A' \subseteq A$ then

$$G_{A,W}(x,y) = G_{A',W}(x,y) + \sum_{(i,j) \in \partial A'} G_{A',W}(x,i) G_{A,W}(j,y),$$

where $\partial A' := \{(i,j) \in A' \times (\mathbb{Z}^d \setminus A') \mid |i-j|=1\}$ is the boundary of A' . Since $L_{A,W}(x) = \sum_{y \in \mathbb{Z}^d} G_{A,W}(x,y)$ for all $x \in \mathbb{Z}^d$, we have for $A' \subseteq A$

$$L_{A,W}(x) = L_{A',W}(x) + \sum_{(i,j) \in \partial A'} G_{A',W}(x,i) L_{A,W}(j). \quad (2.6)$$

Equation (2.6) is equivalent to equation (2.5). We will prefer the former in the proof of Theorem 2.2 ii) since $G_{A,W}$ can be computed using basic linear algebra, such as determinants and Cramer's rule for the inverse of a matrix.

2.2.1 Proof of Theorem 2.2 i)

We start with the asymptotic of the sup-norm of the landscape function on balls with 0 potential.

Proposition 2.10. $\|L_{B(0,r) \cap \mathbb{Z}^d, 0}\|_\infty \sim_r \frac{r^2}{2d}$.

Remark. In one dimension it is straightforward to check that for $r \in \mathbb{N}$

$$L_{B(0,r) \cap \mathbb{Z}, 0}(x) = \frac{r^2 - x^2}{2}, \quad x \in B(0,r).$$

Proof. Let $r > 0$ and consider the function $\phi_r(x) := \frac{r^2 - |x|^2}{2d}$ defined on \mathbb{Z}^d . Clearly $-\Delta \phi_r(x) = 1$ for all $x \in \mathbb{Z}^d$ and therefore $L_{B(0,r) \cap \mathbb{Z}^d, 0} - \phi_r$ is harmonic in $B(0,r) \cap$

\mathbb{Z}^d . By the Maximum Principle we have

$$\begin{aligned}
\left| \left\| L_{B(0,r) \cap \mathbb{Z}^d, 0} \right\|_\infty - \frac{r^2}{2d} \right| &= \left| \sup_{x \in B(0,r) \cap \mathbb{Z}^d} L_{B(0,r) \cap \mathbb{Z}^d, 0}(x) - \sup_{x \in B(0,r) \cap \mathbb{Z}^d} \phi_r(x) \right| \\
&\leq \sup_{x \in B(0,r) \cap \mathbb{Z}^d} \left| L_{B(0,r) \cap \mathbb{Z}^d, 0}(x) - \phi_r(x) \right| \\
&= \sup_{x \in \partial^+ [B(0,r) \cap \mathbb{Z}^d]} \left| L_{B(0,r) \cap \mathbb{Z}^d, 0}(x) - \phi_r(x) \right| \\
&= \sup_{x \in \partial^+ [B(0,r) \cap \mathbb{Z}^d]} |\phi_r(x)| \leq C(d) r(1 + o(1))
\end{aligned}$$

where $\partial^+ A := \{x \in \mathbb{Z}^d \setminus A \mid \exists y \in A \text{ such that } |x - y| = 1\}$ is the outer boundary of $A \subseteq \mathbb{Z}^d$. Dividing by $\frac{r^2}{2d}$ and taking the limit $r \rightarrow \infty$ give the proposition. \square

Recall the definitions of ε_n , Y_n , x_n and y_n from Subsection 2.1 and notice that Theorem 2.1 can be restated as $\lambda_{n,V} \sim_n \frac{\mu_d}{y_n^2}$ \mathbb{P} -a.s. From domain monotonicity of landscape functions we have

$$L_{n,V} \geq L_{B(x_n, Y_n) \cap \mathbb{Z}^d, V}.$$

For **(C1)**, V is identically 0 in $B(x_n, Y_n) \cap \mathbb{Z}^d$ so Theorem 2.1, Proposition 2.10 and translation invariance give

$$\underline{\lim}_{n \rightarrow \infty} \lambda_{n,V} \|L_{n,V}\|_\infty \geq \lim_{n \rightarrow \infty} \lambda_{n,V} \|L_{B(x_n, Y_n) \cap \mathbb{Z}^d, 0}\|_\infty = \lim_{n \rightarrow \infty} \frac{\mu_d Y_n^2}{y_n^2 2d} = \frac{\mu_d}{2d} \quad \mathbb{P}\text{-a.s.}$$

For **(C2)**, we use the second resolvent identity, domain monotonicity of the eigenvalue, and Propositions 2.9, 2.10, 2.3 to obtain

$$\begin{aligned}
&\lambda_{n,V} \left\| L_{B(x_n, Y_n) \cap \mathbb{Z}^d, 0} - L_{B(x_n, Y_n) \cap \mathbb{Z}^d, V} \right\|_\infty \\
&= \lambda_{n,V} \left\| (-\Delta_{B(x_n, Y_n) \cap \mathbb{Z}^d, 0})^{-1} V L_{B(x_n, Y_n) \cap \mathbb{Z}^d, V} \right\|_\infty \\
&\leq C(d) \varepsilon_n \left\| L_{B(x_n, Y_n) \cap \mathbb{Z}^d, 0} \right\|_\infty \\
&\leq C(d) \varepsilon_n Y_n^2 \xrightarrow[n \rightarrow \infty]{\mathbb{P}\text{-a.s.}} 0,
\end{aligned}$$

which implies

$$\begin{aligned}
\underline{\lim}_{n \rightarrow \infty} \lambda_{n,V} \|L_{n,V}\|_\infty &\geq \lim_{n \rightarrow \infty} \lambda_{n,V} \left\| L_{B(x_n, Y_n) \cap \mathbb{Z}^d, V} \right\|_\infty \\
&= \lim_{n \rightarrow \infty} \lambda_{n,V} \left\| L_{B(x_n, Y_n) \cap \mathbb{Z}^d, 0} \right\|_\infty = \frac{\mu_d}{2d} \quad \mathbb{P}\text{-a.s.}
\end{aligned}$$

This concludes the proof of Theorem 2.2 i).

2.2.2 Proof of Theorem 2.2 ii)

We assume from this point on that $d = 1$. We set $\llbracket a, b \rrbracket := [a, b] \cap \mathbb{Z}$ for any two $a, b \in \mathbb{Z}$. This proof is based on the following deterministic bound of the Green function in terms of the values of the potential.

Proposition 2.11. *Let $n \in \mathbb{N}$ and $W : \llbracket 1, n \rrbracket \rightarrow [0, \infty)$. For any $y \in \llbracket 1, n \rrbracket$ we have*

$$G_{\llbracket 1, n \rrbracket, W}(1, y) \leq \left(\sum_{j=0}^{y-1} (y-j)W(y-j) \right)^{-1},$$

$$G_{\llbracket 1, n \rrbracket, W}(y, n) \leq \left(\sum_{j=0}^{n-y} (n-y+1-j)W(y+j) \right)^{-1}.$$

Proof. We only prove the first inequality; the second one follows from reflecting W across the midpoint of $\llbracket 1, n \rrbracket$ and the symmetry of the Green function.

Fix some $y \in \llbracket 1, n \rrbracket$. By potential monotonicity we have

$$G_{\llbracket 1, n \rrbracket, W}(1, y) \leq G_{\llbracket 1, n \rrbracket, W\mathbf{1}_{\llbracket 1, y \rrbracket}}(1, y)$$

The Cramer's rule lets us write

$$G_{\llbracket 1, n \rrbracket, W\mathbf{1}_{\llbracket 1, y \rrbracket}}(1, y) = \frac{\det([- \Delta_{\llbracket 1, n \rrbracket} + W\mathbf{1}_{\llbracket 1, y \rrbracket}]_{1 \rightarrow \delta_y})}{\det(- \Delta_{\llbracket 1, n \rrbracket} + W\mathbf{1}_{\llbracket 1, y \rrbracket})},$$

where $[- \Delta_{\llbracket 1, n \rrbracket} + W\mathbf{1}_{\llbracket 1, y \rrbracket}]_{1 \rightarrow \delta_y}$ is the matrix obtained by replacing the first column (in the canonical δ_j basis) of $- \Delta_{\llbracket 1, n \rrbracket} + W\mathbf{1}_{\llbracket 1, y \rrbracket}$ by δ_y . By computing the determinant from such first column we see that

$$\begin{aligned} \det([- \Delta_{\llbracket 1, n \rrbracket} + W\mathbf{1}_{\llbracket 1, y \rrbracket}]_{1 \rightarrow \delta_y}) &= (-1)^{y+1} \det \left(\begin{array}{c|c} T & 0 \\ \hline M & -\Delta_{\llbracket 1, n-y \rrbracket} \end{array} \right) \\ &= (-1)^{y+1} \det(T) \det(-\Delta_{\llbracket 1, n-y \rrbracket}) = n - y + 1, \end{aligned}$$

since T is a lower triangular square matrix of size $y-1$ with (-1) on all the diagonal, and $\det(-\Delta_{\llbracket 1, k \rrbracket}) = k+1$ for all $k \in \mathbb{N}$ (we use the convention $\det(-\Delta_{\emptyset}) = 1$).

Consider $\det(-\Delta_{\llbracket 1, n \rrbracket} + W\mathbf{1}_{\llbracket 1, y \rrbracket})$ as a polynomial in $(W(j))_{j=1}^y$. It is clear that it does not contain squares, or greater powers, of any $W(j)$. Moreover, a straightforward computation shows that the coefficient of $W(j_1)W(j_2) \cdots W(j_{k-1})W(j_k)$,

with $1 \leq j_1 < j_2 < \dots < j_{k-1} < j_k \leq y$ and $1 \leq k \leq y$, is

$$\begin{aligned} & \det(-\Delta_{\llbracket 1, j_1-1 \rrbracket}) \det(-\Delta_{\llbracket j_1+1, j_2-1 \rrbracket}) \cdots \det(-\Delta_{\llbracket j_{k-1}+1, j_k-1 \rrbracket}) \det(-\Delta_{\llbracket j_k+1, n \rrbracket}) \\ &= j_1(j_2 - j_1) \cdots (j_k - j_{k-1})(n + 1 - j_k). \end{aligned}$$

The remaining coefficient (the constant one) is $\det(-\Delta_{\llbracket 1, n \rrbracket}) = n + 1$, which means all coefficients of $\det(-\Delta_{\llbracket 1, n \rrbracket} + W\mathbf{1}_{\llbracket 1, y \rrbracket})$ are positive and therefore

$$\begin{aligned} G_{\llbracket 1, n \rrbracket, W}(1, y) &\leq \frac{n + 1 - y}{\det(-\Delta_{\llbracket 1, n \rrbracket} + W\mathbf{1}_{\llbracket 1, y \rrbracket})} \leq \frac{n + 1 - y}{\sum_{j=1}^y j(n + 1 - j)W(x)} \\ &\leq \left(\sum_{j=1}^y jW(j) \right)^{-1} = \left(\sum_{j=0}^{y-1} (y - j)W(y - j) \right)^{-1}. \quad \square \end{aligned}$$

With the previous proposition in mind we define for $\delta > 0$ and $x \in \mathbb{Z}^d$

$$\begin{aligned} Z_\delta^+(x) &:= \min \left\{ n \in \mathbb{N} \left| \sum_{j=1}^n (n + 1 - j)V(x + j) > \delta^{-1} \right. \right\}, \\ Z_\delta^-(x) &:= \min \left\{ n \in \mathbb{N} \left| \sum_{j=1}^n (n + 1 - j)V(x - j) > \delta^{-1} \right. \right\}, \\ A_\delta(x) &:= \llbracket x - Z_\delta^-(x), x + Z_\delta^+(x) \rrbracket. \end{aligned}$$

Notice that $V(x)$ is not included in the definition of $Z_\delta^\pm(x)$ and therefore $Z_\delta^+(x)$ and $Z_\delta^-(x)$ are independent for all $x \in \mathbb{Z}$.

It follows from (2.6), the definitions above, potential monotonicity, and Propositions 2.9, 2.11 that

$$\begin{aligned} \lambda_{n, V} \|L_{n, V}\|_\infty &\leq \lambda_{n, V} \max_{x \in \Lambda_n} [L_{A_\delta(x), 0}(x) + 2\delta \|L_{n, V}\|_\infty] \\ &\leq \lambda_{n, V} \max_{x \in \Lambda_n} \|L_{A_\delta(x), 0}\|_\infty + 2\delta C(1). \end{aligned}$$

By domain monotonicity and translation invariance, the last maximum above is attained at the $x \in \Lambda_n$ that also maximises $\#A_\delta(x) = Z_\delta^+(x) + Z_\delta^-(x) + 1$. Moreover, V being i.i.d. implies $\lim_{n \rightarrow \infty} \max_{x \in \Lambda_n} Z_\delta^+(x) + Z_\delta^-(x) = \infty$ \mathbb{P} -a.s. and therefore Proposition 2.10 and Theorem 2.1 give

$$\overline{\lim}_{n \rightarrow \infty} \lambda_{n, V} \|L_{n, V}\|_\infty \leq \frac{\mu_1}{2} \overline{\lim}_{n \rightarrow \infty} \left(\frac{\max_{x \in \Lambda_n} Z_\delta^+(x) + Z_\delta^-(x)}{2y_n} \right)^2 + 2\delta C(1) \quad \mathbb{P}\text{-a.s.}$$

The proof of Theorem 2.2 ii) is finished with the next proposition followed by the limit $\delta \rightarrow 0$.

Proposition 2.12. For all $\delta > 0$, $\overline{\lim}_{n \rightarrow \infty} \frac{1}{2y_n} \max_{x \in \Lambda_n} [Z_\delta^+(x) + Z_\delta^-(x)] \leq 1$ \mathbb{P} -a.s.

Proof. We will prove this over an exponential subsequence; the extension is done as in the proof of Proposition 2.3 using the monotonicity of $n \mapsto \max_{x \in \Lambda_n} [Z_\delta^+(x) + Z_\delta^-(x)]$. In addition to $Z_\delta^+(x)$ being independent of $Z_\delta^-(x)$ for all $x \in \mathbb{Z}^d$, we also have that all $Z_\delta^\pm(x)$ are equal in distribution to $Z_\delta^\pm(0)$.

Assume **(C1)** and recall $y_n = \frac{\ln n}{2|\ln F(0)|}$. For all $t > 0$ we have

$$\mathbb{E} [e^{-tV(0)}] = \mathbb{E} \left[e^{-tV(0)} \mathbb{1}_{V(0) \leq \frac{1}{\sqrt{t}}} \right] + \mathbb{E} \left[e^{-tV(0)} \mathbb{1}_{V(0) > \frac{1}{\sqrt{t}}} \right] \leq F \left(1/\sqrt{t} \right) + e^{-\sqrt{t}}.$$

With this, we use the exponential Markov inequality and independence to obtain

$$\begin{aligned} \mathbb{P} [Z_\delta^+(0) > n] &= \mathbb{P} \left[\sum_{j=1}^n (n+1-j)V(x+j) \leq \delta^{-1} \right] \\ &\leq e^{t/\delta} \prod_{j=1}^n \mathbb{E} [\exp(-tjV(0))] \leq e^{t/\delta} \left(F \left(1/\sqrt{t} \right) + e^{-\sqrt{t}} \right)^n, \quad n \in \mathbb{N}. \end{aligned}$$

Now we proceed with the distribution of $Z_\delta^+(0) + Z_\delta^-(0)$ as

$$\begin{aligned} \mathbb{P} [Z_\delta^+(0) + Z_\delta^-(0) > n] &= \mathbb{P} [Z_\delta^+(0) > n-1] + \sum_{j=1}^{n-1} \mathbb{P} [Z_\delta^+(0) = j] \mathbb{P} [Z_\delta^-(0) > n-j] \\ &\leq 2\mathbb{P} [Z_\delta^+(0) > n-1] + \sum_{j=2}^{n-1} \mathbb{P} [Z_\delta^+(0) > j-1] \mathbb{P} [Z_\delta^+(0) > n-j] \\ &\leq 2e^{t/\delta} \left(F \left(1/\sqrt{t} \right) + e^{-\sqrt{t}} \right)^{n-1} + (n-2)e^{2t/\delta} \left(F \left(1/\sqrt{t} \right) + e^{-\sqrt{t}} \right)^{n-1} \\ &\leq ne^{2t/\delta} \left(F \left(1/\sqrt{t} \right) + e^{-\sqrt{t}} \right)^{n-1}. \end{aligned}$$

For any $\varepsilon > 0$ define $t(\varepsilon)$ by $\ln \left(F \left(1/\sqrt{t(\varepsilon)} \right) + e^{-\sqrt{t(\varepsilon)}} \right) \leq \frac{\ln F(0)}{1+\varepsilon}$ so that

$$\begin{aligned} \mathbb{P} \left[\max_{x \in \Lambda_n} [Z_\delta^+(x) + Z_\delta^-(x)] > \lfloor (1+\varepsilon)^2 2y_n \rfloor \right] &\leq C(1)n \mathbb{P} [Z_\delta^+(0) + Z_\delta^-(0) > \lfloor (1+\varepsilon)^2 2y_n \rfloor] \\ &\leq C(1)e^{2t(\varepsilon)/\delta} n \exp \left[\lfloor (1+\varepsilon)^2 2y_n \frac{\ln F(0)}{1+\varepsilon} (1+o(1)) \rfloor \right] \\ &= C(1)e^{2t(\varepsilon)/\delta} n^{-\varepsilon(1+o(1))}, \end{aligned}$$

which is summable over the exponential subsequence $n = \lfloor e^m \rfloor$, $m \in \mathbb{N}$.

Assume **(C2)** and recall $y_n = \frac{\ln n}{2|\ln F((\ln n)^{-2})|} \sim_n \frac{\ln n}{4\eta \ln \ln n}$. We follow the same steps as for **(C1)** above. To bound the Laplace transform of $V(0)$ we consider the function $f(t) := a[F(t)]^{1/\eta}$ for some $a > 0$. From **(C2)** follows that there exists $t_0 \in (0, \infty)$ such that $F(t) \leq 2ct^\eta$ for all $t \in [0, t_0]$. Therefore, by choosing $a := (t_0^{-1} + (2c)^{1/\eta})^{-1}$ we obtain

$$0 \leq f(t) \leq \begin{cases} a(2c)^{1/\eta}t \leq t, & t \in [0, t_0], \\ a \leq t_0 \leq t, & t \in (t_0, \infty). \end{cases}$$

Moreover, since $\mathbb{P}[f(V(0)) \leq t] = \left(\frac{t}{a}\right)^\eta$ for $t \in [0, a]$, we have

$$\begin{aligned} \mathbb{E}[\exp(-tV(0))] &\leq \mathbb{E}[\exp(-tf(V(0)))] = \frac{\eta}{(a)^\eta} \int_0^a e^{-ty} y^{\eta-1} dy \\ &\leq \frac{\eta}{(a)^\eta} \int_0^\infty e^{-ty} y^{\eta-1} dy = \frac{\eta \Gamma(\eta)}{(at)^\eta}, \quad t > 0. \end{aligned}$$

The exponential Markov inequality at $t = n\eta\delta$, independence, and the Stirling bound $(n/e)^n \leq n!$ lead us to

$$\begin{aligned} \mathbb{P}[Z_\delta^+(0) > n] &\leq e^{t/\delta} \prod_{j=1}^n \mathbb{E}[\exp(-tjV(0))] \leq \left(\frac{\eta \Gamma(\eta)}{(at)^\eta}\right)^n \frac{e^{t/\delta}}{(n!)^\eta} \\ &\leq \left(\frac{\eta^{1-\eta} \Gamma(\eta) e^{2\eta}}{a^\eta \delta}\right)^n n^{-2\eta n} =: K_\delta^n n^{-2\eta n}, \quad n \in \mathbb{N}, \end{aligned}$$

from which follows

$$\begin{aligned} \mathbb{P}[Z_\delta^+(0) + Z_\delta^-(0) > n] &\leq 2\mathbb{P}[Z_\delta^+(0) > n-1] + \sum_{j=2}^{n-1} \mathbb{P}[Z_\delta^+(0) > j-1] \mathbb{P}[Z_\delta^+(0) > n-j] \\ &\leq 2K_\delta^{n-1} (n-1)^{-2\eta(n-1)} + K_\delta^{n-1} \sum_{j=2}^{n-1} (j-1)^{-2\eta(j-1)} (n-j)^{-2\eta(n-j)}. \end{aligned}$$

The function $[2, n-1] \ni j \mapsto (j-1)^{-(j-1)} (n-j)^{-(n-j)}$ attains its unique maximum at $j = (n+1)/2$, therefore

$$\begin{aligned} \mathbb{P}[Z_\delta^+(0) + Z_\delta^-(0) > n] &\leq 2K_\delta^{n-1} (n-1)^{-2\eta(n-1)} + (4^\eta K_\delta)^{n-1} (n-2)(n-1)^{-2\eta(n-1)} \\ &\leq (4^\eta K_\delta)^{n-1} n(n-1)^{-2\eta(n-1)}. \end{aligned}$$

Finally, for $\varepsilon > 0$ we have

$$\begin{aligned}
& \mathbb{P} \left[\max_{x \in \Lambda_n} [Z_\delta^+(x) + Z_\delta^-(x)] > \lfloor (1 + \varepsilon)2y_n \rfloor \right] \\
& \leq C(1)n \mathbb{P} [Z_\delta^+(0) + Z_\delta^-(0) > \lfloor (1 + \varepsilon)2y_n \rfloor] \\
& = C(1)n \exp [-(1 + \varepsilon)4\eta y_n (\ln y_n)(1 + o(1))] \\
& = C(1)n \exp [-(1 + \varepsilon)4\eta y_n (\ln \ln n)(1 + o(1))] \\
& = C(1)n^{-\varepsilon(1+o(1))},
\end{aligned}$$

which is summable over the exponential subsequence $n = \lfloor e^m \rfloor$, $m \in \mathbb{N}$. \square

2.2.3 Alternative Proof of Theorem 2.2 ii) for (C1)

We present an alternative proof of Theorem 2.2 ii) for the (C1) case. This proof is simpler and shorter than the previous one, but when applied to (C2), it fails to give the desired upper bound on $\overline{\lim}_{n \rightarrow \infty} \lambda_{n,V} \|L_{n,V}\|_\infty$.

In the previous subsection we avoided including $V(x)$ in the definitions of $Z_\delta^\pm(x)$ to obtain their independence. Here we only need that $V(x) > 0$ to show $L_{n,V}(x)$ is small.

Assume (C1) and recall $y_n = \frac{\ln n}{2|\ln F(0)|}$. Fix some $\delta > 0$ and define

$$\mathcal{I}_{n,\delta} := (V^{-1}((\delta, \infty)) \cap \Lambda_n) \cup \{-(n+1), n+1\}.$$

For any $x \in \mathcal{I}_{n,\delta}$ we consider the closed ball of radius $\lfloor \delta y_n \rfloor$ centered around x . Then equation (2.6), potential monotonicity, and Proposition 2.11 give

$$\begin{aligned}
L_{n,V}(x) & \leq L_{\llbracket x - \lfloor \delta y_n \rfloor, x + \lfloor \delta y_n \rfloor \rrbracket, 0}(x) + \frac{2}{(\lfloor \delta y_n \rfloor + 1)V(x)} \|L_{n,V}\|_\infty \\
& \leq \|L_{\llbracket -\lfloor \delta y_n \rfloor, \lfloor \delta y_n \rfloor \rrbracket, 0}\|_\infty + \frac{2}{\delta^2 y_n} \|L_{n,V}\|_\infty, \quad x \in \mathcal{I}_{n,\delta}.
\end{aligned}$$

Multiplying by $\lambda_{n,V}$ and using Propositions 2.10, 2.9 and Theorem 2.1 we arrive at

$$\overline{\lim}_{n \rightarrow \infty} \max_{x \in \mathcal{I}_{n,\delta}} \lambda_{n,V} L_{n,V}(x) \leq \overline{\lim}_{n \rightarrow \infty} \left(\frac{\lambda_{n,V} \delta^2 y_n^2}{2} + \frac{2C(1)}{\delta^2 y_n} \right) = \frac{\mu_1 \delta^2}{2} \quad \mathbb{P}\text{-a.s.}$$

Let $n-1 = x_1 < x_2 < \dots < x_{\#\mathcal{I}_{n,\delta}-1} < x_{\#\mathcal{I}_{n,\delta}} = n+1$ be an enumeration of the elements of $\mathcal{I}_{n,\delta}$ so that, for every $x \in \Lambda_n \setminus \mathcal{I}_{n,\delta}$ we can find an $i \in \llbracket 1, \#\mathcal{I}_{n,\delta} - 1 \rrbracket$

that satisfies $x_i < x < x_{i+1}$. This, together with (2.5) and potential monotonicity, imply

$$\begin{aligned} L_{n,V}(x) &\leq L_{\llbracket x_i, x_{i+1} \rrbracket, 0}(x) + \max\{L_{n,V}(x_i), L_{n,V}(x_{i+1})\} \\ &\leq \max_{i \in \llbracket 1, \#\mathcal{I}_{n,\delta} - 1 \rrbracket} \left\| L_{\llbracket x_i, x_{i+1} \rrbracket, 0} \right\|_\infty + \max_{x \in \mathcal{I}_{n,\delta}} L_{n,V}(x), \quad x \in \Lambda_n \setminus \mathcal{I}_{n,\delta}. \end{aligned}$$

By domain monotonicity and Proposition 2.10 we have that

$$\max_{i \in \llbracket 1, \#\mathcal{I}_{n,\delta} - 1 \rrbracket} \left\| L_{\llbracket x_i, x_{i+1} \rrbracket, 0} \right\|_\infty \sim_n \frac{1}{8} \left(\max_{i \in \llbracket 1, \#\mathcal{I}_{n,\delta} - 1 \rrbracket} x_{i+1} - x_i \right)^2$$

provided the right-hand side diverges to $+\infty$ as $n \rightarrow \infty$. Since the maximum in the right-hand side is, up to ± 1 depending on its parity, the diameter of the largest ball inside Λ_n with potential uniformly bounded by δ , then by (a slight modification of) Proposition 2.3 we have

$$\left(\max_{i \in \llbracket 1, \#\mathcal{I}_{n,\delta} - 1 \rrbracket} x_{i+1} - x_i \right) \sim_n \frac{\ln n}{|\ln F(\delta)|} = 2y_n \frac{|\ln F(0)|}{|\ln F(\delta)|} \quad \mathbb{P}\text{-a.s.}$$

With the above asymptotics and Theorem 2.1, we now conclude

$$\begin{aligned} \overline{\lim}_{n \rightarrow \infty} \lambda_{n,V} \|L_{n,V}\|_\infty &\leq \overline{\lim}_{n \rightarrow \infty} \frac{\lambda_{n,V}}{8} \left(\max_{i \in \llbracket 1, \#\mathcal{I}_{n,\delta} - 1 \rrbracket} x_{i+1} - x_i \right)^2 + \overline{\lim}_{n \rightarrow \infty} \max_{x \in \mathcal{I}_{n,\delta}} \lambda_{n,V} L_{n,V}(x) \\ &\leq \frac{\mu_1}{2} \left(\frac{|F(0)|}{|F(\delta)|} \right)^2 + \frac{\mu_1 \delta^2}{2} \quad \mathbb{P}\text{-a.s.} \end{aligned}$$

Sending $\delta \rightarrow 0$ finishes the proof.

Now we try to apply the above reasoning when **(C2)** holds. Assume **(C2)** and recall $y_n = \frac{\ln n}{2|\ln F((\ln n)^{-2})|} \sim_n \frac{\ln n}{4\eta \ln \ln n}$. If we let the δ in $\mathcal{I}_{n,\delta}$ be constant with respect to n , then we will have

$$\lim_{n \rightarrow \infty} \frac{\lambda_{n,V}}{8} \left(\max_{i \in \llbracket 1, \#\mathcal{I}_{n,\delta} - 1 \rrbracket} x_{i+1} - x_i \right)^2 = \lim_{n \rightarrow \infty} \frac{\mu_1}{8y_n^2} \left(\frac{\ln n}{|\ln F(\delta)|} \right)^2 = \infty \quad \mathbb{P}\text{-a.s.}$$

because of the $\ln \ln n$ term in y_n . Since we also require $\frac{1}{\delta y_n V(x)}$ to be small if $V(x)$ is above a threshold, we set such threshold to be $(\delta^2 y_n)^{-1}$.

More precisely, for a fixed $\delta > 0$ we consider the set $\mathcal{I}_{n,(\delta^2 y_n)^{-1}}$. For any $x \in \mathcal{I}_{n,(\delta^2 y_n)^{-1}}$ we have

$$\begin{aligned} L_{n,V}(x) &\leq L_{\llbracket x - \lfloor \delta y_n \rfloor, x + \lfloor \delta y_n \rfloor \rrbracket, 0}(x) + \frac{2}{(\lfloor \delta y_n \rfloor + 1)V(x)} \|L_{n,V}\|_\infty \\ &\leq \left\| L_{\llbracket -\lfloor \delta y_n \rfloor, \lfloor \delta y_n \rfloor \rrbracket, 0} \right\|_\infty + 2\delta \|L_{n,V}\|_\infty \end{aligned}$$

from which follows

$$\overline{\lim}_{n \rightarrow \infty} \max_{x \in \mathcal{I}_{n, (\delta^2 y_n)^{-1}}} \lambda_{n,V} L_{n,V}(x) \leq \frac{\mu_1 \delta^2}{2} + 2\delta C(1) \quad \mathbb{P}\text{-a.s.}$$

Since $\left(\max_{i \in \llbracket 1, \#\mathcal{I}_{n, (\delta^2 y_n)^{-1}} - 1 \rrbracket} x_{i+1} - x_i \right)$ is the diameter of the largest ball in Λ_n with potential bounded by $(\delta^2 y_n)^{-1}$, Proposition 2.3 gives

$$\left(\max_{i \in \llbracket 1, \#\mathcal{I}_{n, (\delta^2 y_n)^{-1}} - 1 \rrbracket} x_{i+1} - x_i \right) \sim_n \frac{2 \ln n}{2 |\ln F((\delta^2 y_n)^{-1})|} \sim_n \frac{\ln n}{\eta \ln \ln n}$$

and therefore

$$\begin{aligned} \overline{\lim}_{n \rightarrow \infty} \lambda_{n,V} \|L_{n,V}\|_\infty &\leq \overline{\lim}_{n \rightarrow \infty} \frac{\lambda_{n,V}}{8} \left(\max_{i \in \llbracket 1, \#\mathcal{I}_{n, \delta} - 1 \rrbracket} x_{i+1} - x_i \right)^2 + \overline{\lim}_{n \rightarrow \infty} \max_{x \in \mathcal{I}_{n, \delta}} \lambda_{n,V} L_{n,V}(x) \\ &\leq 2\mu_1 + \frac{\mu_1 \delta^2}{2} + 2\delta C(1) \quad \mathbb{P}\text{-a.s.} \end{aligned}$$

By sending $\delta \rightarrow 0$ we obtain $\overline{\lim}_{n \rightarrow \infty} \lambda_{n,V} \|L_{n,V}\|_\infty \leq 2\mu_1$ which is 4 times the correct bound. This factor of 4 comes from using $(\delta^2 y_n)^{-1}$ as the threshold of the potential instead of $\varepsilon_n = (\ln n)^{-2}$ as in the definition of Y_n . Since we cannot decrease such threshold without making the term $\frac{1}{\delta y_n V(x)}$ explode, we cannot improve the factor of 4 with the current method.

References

- [AW15] Michael Aizenman and Simone Warzel. *Random operators: disorder effects on quantum spectra and dynamics*, volume 168 of *Graduate Studies in Mathematics*. American Mathematical Society, Providence, RI, 2015.
- [Bar17] Martin T. Barlow. *Random walks and heat kernels on graphs*, volume 438 of *London Mathematical Society Lecture Note Series*. Cambridge University Press, Cambridge, 2017.
- [BK01] Marek Biskup and Wolfgang König. Long-time tails in the parabolic Anderson model with bounded potential. *The Annals of Probability*, 29(2):636 – 682, 2001.
- [CKM87] René Carmona, Abel Klein, and Fabio Martinelli. Anderson localization for bernoulli and other singular potentials. *Communications in Mathematical Physics*, 108(1):41–66, 1987.
- [CL12] René Carmona and Jean Lacroix. *Spectral theory of random Schrödinger operators*. Springer Science & Business Media, 2012.
- [CWZ21] Ilias Chenn, Wei Wang, and Shiwen Zhang. Approximating the ground state eigenvalue via the effective potential. *arXiv preprint arXiv:2107.04969*, 2021.
- [DS84] François Delyon and Bernard Souillard. Remark on the continuity of the density of states of ergodic finite difference operators. *Communications in Mathematical Physics*, 94(2):289–291, 1984.
- [FM12] Marcel Filoche and Svitlana Mayboroda. Universal mechanism for anderson and weak localization. *Proceedings of the National Academy of Sciences*, 109(37):14761–14766, 2012.

-
- [Kir08] Werner Kirsch. An invitation to random Schrödinger operators. In *Random Schrödinger operators*, volume 25 of *Panoramas et Synthèses*. Société Mathématique de France, Paris, 2008.
- [LL10] Gregory F. Lawler and Vlada Limic. *Random walk: a modern introduction*, volume 123 of *Cambridge Studies in Advanced Mathematics*. Cambridge University Press, Cambridge, 2010.
- [MH03] J. C. Mason and D. C. Handscomb. *Chebyshev polynomials*. Chapman & Hall/CRC, Boca Raton, FL, 2003.
- [MM87] F Martinelli and L Micheli. On the large-coupling-constant behavior of the liapunov exponent in a binary alloy. *Journal of statistical physics*, 48(1):1–18, 1987.
- [SB03] Hermann Schulz-Baldes. Lifshitz tails for the 1D Bernoulli-Anderson model. *Markov Processes and Related Fields*, 9(4):795–802, 2003.
- [Szn98] Alain-Sol Sznitman. *Brownian motion, obstacles and random media*. Springer Monographs in Mathematics. Springer-Verlag, Berlin, 1998.

Daniel SÁNCHEZ MENDOZA
The Discrete Anderson Model :
Integrated Density of States,
Principal Eigenvalue and
Landscape Function

Résumé

Dans cette thèse de doctorat, nous atteignons deux objectifs :

- Nous montrons qu'il existe un ensemble dense dénombrable auquel la densité d'états intégrée du modèle d'Anderson-Bernoulli sur \mathbb{Z} peut être explicitement calculée, à condition que le paramètre de désordre soit suffisamment grand.
- Nous donnons une preuve partielle d'une conjecture, énoncée pour la première fois dans un article de 2012 par Filoche et Mayboroda, concernant le produit de la valeur propre principale et la sup-norme de la fonction landscape de l'opérateur du modèle d'Anderson restreint à une grande boîte de \mathbb{Z}^d . Pour le cas unidimensionnel, nous donnons une preuve complète de cette conjecture.

Mots clés :

Modèle d'Anderson, Densité d'états, Valeur propre principale, Fonction landscape.

Résumé en anglais

In this PhD thesis we accomplish two objectives:

- We show there is countable dense set at which the integrated density of states of the Anderson-Bernoulli model on \mathbb{Z} can be explicitly computed, provided the disorder parameter is large enough.
- We give a partial proof of a conjecture, first stated in a 2012 article by Filoche and Mayboroda, concerning the product of principal eigenvalue and sup-norm of the landscape function of the Anderson model operator restricted to a large box of \mathbb{Z}^d . For the one dimensional case, we give a full proof of such conjecture.

Keywords :

Anderson model, Density of states, Principal eigenvalue, Landscape function.