



HAL
open science

How do teachers support students' coordination of perception and logical reasoning in 3D dynamic geometry environments: French and Chinese cases

Mingyu Shao

► **To cite this version:**

Mingyu Shao. How do teachers support students' coordination of perception and logical reasoning in 3D dynamic geometry environments: French and Chinese cases. Education. Ecole normale supérieure de lyon - ENS LYON; East China normal university (Shanghai), 2022. English. NNT : 2022ENSL0060 . tel-04027736

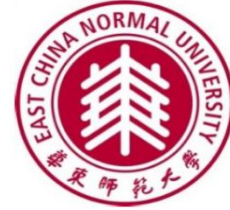
HAL Id: tel-04027736

<https://theses.hal.science/tel-04027736v1>

Submitted on 14 Mar 2023

HAL is a multi-disciplinary open access archive for the deposit and dissemination of scientific research documents, whether they are published or not. The documents may come from teaching and research institutions in France or abroad, or from public or private research centers.

L'archive ouverte pluridisciplinaire **HAL**, est destinée au dépôt et à la diffusion de documents scientifiques de niveau recherche, publiés ou non, émanant des établissements d'enseignement et de recherche français ou étrangers, des laboratoires publics ou privés.



Numéro National de Thèse : 2022ENSL0060

THESE

en vue de l'obtention du grade de Docteur, délivré par
l'ECOLE NORMALE SUPERIEURE DE LYON
en cotutelle avec
EAST CHINA NORMAL UNIVERSITY

Ecole Doctorale N° 485

Ecole doctorale Education, Psychologie, Information et Communication

Discipline : Sciences de l'éducation

Soutenue publiquement le 13/12/2022, par :

SHAO Mingyu

How do teachers support students' coordination of perception and logical reasoning in 3D dynamic geometry environments: French and Chinese cases

Comment les professeurs soutiennent-ils la coordination, par les étudiants, de la perception et du raisonnement ? Etude de cas en France et en Chine

Après l'avis de : SINCLAIR Nathalie, Simon Fraser university - FAN Lianghuo, ECNU

Devant le jury composé de :

FAN, Lianghuo	Professeur	ECNU, Chine	Rapporteur
BALACHEFF, Nicolas	Directeur de recherche	CNRS	Président du jury
MITHALAL, Joris	Maître de conférences	Université Lyon 1	Examinateur
XU, Binyan	Professeure	ECNU, Chine	Examinatrice
TRGALOVA, Jana	MCF HDR	Université Lyon 1	Co-encadrante
TROUCHE, Luc	Professeur émérite	ENS de Lyon	Directeur de thèse
BAO, Jiansheng	Professeur	ECNU, Chine	Cotuteur de thèse

Acknowledgements

I would like to express my gratitude to all those who helped me and supported my work during the four years of my PhD study.

Firstly, my deepest gratitude goes to the two supervisors of my thesis, Professor Luc Trouche and Professor Jiansheng Bao, the associated supervisor of my thesis, Professor Jana Trgalova. The final stage of writing the thesis was full of accidents and chaos, and I was often unable to catch up with the deadlines. The three teachers did their best to adapt to my pace. Without their patience, encouragement, and unreserved support, I could not have gone through this tough period.

Secondly, I would like to express my thanks to the institutions that have sponsored my study and life over the past four years: Chinese Scholarship Council (CSC), Laboratory S2HEP, Doctoral School EPIC, and the MoMaTrE Intensive Study Programme from the Goethe-University Frankfurt. Thanks to their financial support, I was able to participate in fruitful scientific communications and see the various landscapes in the academic world. In particular, the financial support allows me to follow the professional practices of teachers in the two countries – China and France, which has greatly broadened my horizon.

Thirdly, I thank the other four members of the jury, Nicolas Balacheff, Lianghuo Fan, Joris Mithalal, Binyan Xu, and another reporter which unfortunately did not attend my defense, Nathalie Sinclair. They proposed valuable feedback that allowed me to reflected on and improve the work in my thesis and better prepare for the defense. I am also grateful to the teachers who voluntarily participated in the research – José Vilas Boas, Wei He, Delphine Therez, Sylvie Di Fazio, Fang Xia and Bing Deng. I would also like to thank my colleagues in the laboratory S2HEP, IFÉ, ENS de Lyon and ECNU: Gilles Aldon, Christian Mercat, Hang Su, Ulises, Kaouther, Valentin, Sophie, Youcef, Iman, Lina, Ghislaine, Birgit, Chongyang, Fangchun, Danyang Li and Yi Zhang. They either helped me to collect data or gave me valuable suggestions with respect to the issues in scientific research or daily life. Without the cooperation and support from the teachers and colleagues, this thesis could not be realized.

Fourthly, I would like to thank Martine, the wife of my supervisor Luc. Over the past four years, she and Luc invited me to their house almost every year. They spared time to cook for me, took care of me, and took me to visit their French friends, which offered me a valuable window into the French culture and society. With a closer contact with the supervisor, I was able to improve my study more efficiently.

Last but not least, I want to express my deep appreciation to my parents and friends, Lu Liu, Siying Cai, Rui Ma, Si Chen, Sheng Xu, Meng Li, Fangchun Zhu, Wei Chen, Xiuru Wu, and Shiliang Zhang. They gave me precious spiritual support when I was anxious and frustrated. They are an important source of strength for me, allowing me to overcome the solitude and the hardship of studying abroad.

The four-year PhD study was like an adventure during which I met with many unanticipated obstacles. It was the people above who taught me to directly face critiques, patiently make improvements, not hesitate to seek for help, and combine “critical” thinking with “positive” actions. Now near the endpoint of the adventure and meanwhile a start point of another adventure, with a clearer direction for actions in the future, I am pleased to assume my responsibilities, contributing to mathematics education as a researcher, and to passing on the kindness as a world citizen.

Résumé

L'apprentissage de la géométrie 3D pose des problèmes depuis longtemps. Les environnements de géométrie dynamique 3D (EGD 3D) offrent aux enseignants de nouvelles possibilités pour développer la visualisation des élèves, mais soulèvent également des problèmes, tels que, pour les élèves, la tension entre la perception et le raisonnement logique. Cette étude examine un comportement essentiel, mais difficile, pour les enseignants dans les EGD 3D : la *conduite de coordination* visant à aider les élèves à coordonner leur propre perception et les différents modes de raisonnement logique, qui comprennent non seulement le raisonnement théorique *déductif*, mais aussi le raisonnement *inductif* et *abductif*.

Notre étude se déroule, tant en France qu'en Chine, à l'époque de l'épidémie de Covid 19.

Afin d'approfondir notre compréhension des conduites de coordination des enseignants et leurs connaissances et points de vue qui y sont liés, et d'informer les enseignants et les formateurs, nous étudions les questions de recherche suivantes :

- (1) Dans le cadre de l'enseignement en présence, quelle conduite de coordination l'enseignant mobilise-t-il lorsqu'il aide les élèves à résoudre des tâches de géométrie 3D dans des EGD 3D? Quelles sont les connaissances et les points de vue de l'enseignant qui sous-tendent cette conduite de coordination ? De quelle manière la conduite de coordination peut-elle être influencée par les caractéristiques des tâches de géométrie 3D et des EGD 3D ?
- (2) Dans le cadre de l'enseignement à distance pendant l'épidémie de Covid-19, comment les tâches de géométrie 3D et les EGD 3D mobilisés par l'enseignant et sa conduite de coordination peuvent-ils être différents de ceux dans la salle réelle ? Comment les connaissances et les points de vue de l'enseignant ont-ils été développés pour soutenir ces évolutions ? Dans quelle mesure ces développements peuvent-elles être attribués à l'épidémie ?

Un cadre théorique composite est établi pour répondre à ces questions. L'Approche Documentaire du Didactique (ADD, Trouche et al., 2020) sert d'un cadre structurant qui intègre les régularités dans la conduite de coordination de l'enseignant, et ses connaissances et points de vue, dans une unité cohérente – le schème d'usage (renommé "schème de coordination" dans cette étude). Chaque schème de coordination correspond à une classe de situations qui intègre les tâches de géométrie 3D, les EGD 3D, les configurations d'enseignement et les autres éléments pertinents pour ce schème. Les caractéristiques des tâches de géométrie 3D et des EGD 3D sont respectivement décrites selon plusieurs dimensions, lesquelles sont identifiées d'après les travaux de Piaget et al. (1973) et Morgan et al. (2009). Les règles d'action (renommées "règles de coordination" dans cette étude) dans le schème de coordination sont en outre connectées à un sous-cadre de conduite de coordination, qui est construit sur le diagramme d'argumentation de Toulmin (1958) et le cadre de Conner et al. (2014) du soutien de l'enseignant à l'argumentation collective. Les invariants opératoires dans le schème de coordination sont en outre connectés à un sous-cadre de catégorisation, qui est construit sur le cadre TPACK (Koehler & Mishra, 2009) et d'autres études sur les points de vue des enseignants concernant le contrôle du comportement, les normes sociales et l'économie temporelle (Pierce

& Ball, 2009 ; Ruthven, 2014). Le cadre composite permet d'une part de reformuler les questions de recherche ci-dessus, et d'autre part fournit un outil d'analyse.

Adoptant une méthodologie d'études de cas et se situant dans un projet de cotutelle sino-français, cette étude suit des séries de leçons intégrant des EGD 3D de trois enseignants, dont deux enseignantes françaises et un enseignant chinois. Les trois enseignants ont une grande expérience de l'utilisation des EGD 3D pour enseigner la géométrie 3D. Pour chaque série de leçons, nous recueillons les ressources liées aux tâches de géométrie 3D et aux EGD 3D, les vidéos de classe/les vidéos d'enregistrement d'écran/le compte rendu écrit de l'enseignant sur les procédures du cours, et les entretiens généraux semi-structurés intégrant parfois des épisodes de 'rappels stimulés'. Les données de chaque série de leçons sont analysées avec le cadre théorique composite ci-dessus, le cadre lui-même étant adapté en fonction des besoins de l'étude.

L'analyse des cas des trois enseignants nous permet de répondre aux deux groupes de questions de recherche.

Pour le premier groupe de questions, les cas dans cette étude montrent d'abord la diversité des conduites de coordination des enseignants. Quelques conduites typiques peuvent être : guider les élèves à développer un raisonnement théorique déductif pour valider les résultats perçus par eux dans un DGE 3D ; encourager les élèves à prendre les évidences perceptives directement comme des faits pour développer le raisonnement théorique déductif suivant ; ou guider les élèves à expliquer la conclusion du raisonnement inductif basé sur la perception avec un raisonnement théorique déductif. En outre, les cas montrent différents types de liens entre la conduite de coordination des enseignants, leurs connaissances et points de vue, et les caractéristiques des tâches de géométrie 3D et des EGD 3D. Les deux enseignantes françaises mettent toujours l'accent, dans leur conduite de coordination, sur le raisonnement théorique déductif des élèves ; ils attachent plus d'importance à la perception des élèves seulement lorsque l'aide fournie par des gestes de simulation/ objets réels en 3D/ EGD 3D est particulièrement utile. C'est influencé par les tâches de géométrie 3D, les prescriptions du programme d'enseignement et les exigences de l'examen, les caractéristiques des représentations figuratives dans les EGD 3D, ainsi que leur propre compréhension des solutions des tâches et des potentiels des gestes de simulation/ objets réels en 3D/ DGEs 3D pour la perception des élèves. L'enseignant chinois met l'accent soit sur le raisonnement théorique déductif, soit sur le raisonnement abductif, le raisonnement inductif ou la perception des élèves dans sa conduite de coordination. C'est principalement influencé par les tâches de géométrie 3D, les exigences de l'examen (mais pas les prescriptions du programme d'enseignement) et sa propre réflexion sur la possibilité du raisonnement logique et de la perception de permettre aux élèves de résoudre efficacement les tâches dans le cadre des exigences de l'examen. Les trois enseignants adoptent différentes stratégies pour soutenir le raisonnement logique et la perception des élèves dans leur conduite de coordination. Les stratégies qu'ils adoptent sont principalement déterminées par leurs connaissances générales sur la pédagogie du contenu, leurs connaissances et points de vue sur les potentiels et les effets secondaires des EGD 3D, et les stratégies pédagogiques pour exploiter les potentiels ou surmonter les effets secondaires. De plus, un niveau élevé de connaissance de la technologie et du contenu lié et un niveau élevé de confiance dans le contrôle du comportement, ou la disponibilité de DGEs 3D bien structurés,

augmenteraient la probabilité qu'un enseignant utilise les EGD 3D dans sa conduite de coordination.

Pour le deuxième groupe de questions, cette étude concerne uniquement le cas de l'enseignant chinois. L'influence de l'épidémie Covid-19 sur sa conduite de coordination se reflète par : l'absence de simulation et de dénotation des gestes de la main, l'utilisation plus fréquente de travail guidé pas à pas mobilisant des EGD 3D, et l'absence de questions et d'actions pour susciter la contribution des élèves dans l'enseignement à distance. Néanmoins, la partie essentielle de sa conduite de coordination n'a pas été beaucoup affectée. Cette stabilité semble liée à son ouverture aux nouveaux outils technologiques, à la facilité qu'il a ressentie dans l'apprentissage de ces outils, et à sa compétence d'utilisation et de conception d'EGD 3D.

Les développements théoriques apportés dans cette étude nous semblent être :

- l'exploration de certains éléments cruciaux dans les situations professionnelles dans le cadre de l'ADD ; l'introduction dans ce cadre des nouveaux concepts de classes de situations identiques/proches/distantes, et de genèse documentaire directe/indirecte ;
- l'introduction des différentes caractéristiques des composants argumentatifs, telles que les données (perceptive, intuitive, factuelle) et les garanties (abductive, inductive, déductive), dans le sous-cadre de la conduite de coordination ; la prise en compte non seulement des contributions directes de l'enseignant aux composants argumentatifs, mais aussi ses contributions indirectes telles que les questions, les actions de soutien et l'utilisation des ressources, dans le sous-cadre ; faire la distinction entre les actions de validation et les actions de réfutation dans ce sous-cadre ;
- la proposition d'un sous-cadre de catégorisation pour les invariants opératoires, intégrant trois catégories de points de vue sur l'économie temporelle, le contrôle du comportement et les normes sociales, avec cinq autres catégories adaptées du cadre TPACK.

Ces constructions théoriques nous permettent de repérer les caractéristiques essentielles des activités de coordination des enseignants, et de mieux examiner la transformation de ces activités d'une série de leçons en classe à une série de leçons à distance. Néanmoins, ces constructions théoriques soulèvent quelques problèmes, tels que l'intégration des classes de situations identiques/proches/distantes dans les constructions initiales de l'ADD, ce qui devrait être traité par les études futures.

Cette étude a des implications pour la formation des enseignants en plusieurs points. Concernant le curriculum, les concepteurs d'examens pourraient intégrer une proportion raisonnable de petites questions afin d'encourager les enseignants, dans leurs pratiques de coordination, à développer le raisonnement non-déductif ou la perception des élèves. En ce qui concerne la construction de ressources, la disponibilité d'EGD 3D bien structurés, avec des représentations fidèles, des outils fonctionnels et des rétroactions informatives, peut grandement augmenter la volonté des enseignants d'utiliser des EGD 3D dans leurs pratiques de coordination.

Concernant les projets de formation des enseignants, la formation devrait accorder plus d'attention aux connaissances générales des enseignants sur la pédagogie du contenu, aux potentiels et aux effets secondaires des EGD 3D pour la perception et le raisonnement logique des élèves, et aux stratégies pédagogiques pour exploiter les potentiels ou surmonter les effets

secondaires. L'étude montre également l'importance du soutien du collectif autour d'un enseignant, donc l'influence du travail collectif sur les activités de coordination des enseignants individuels nécessite des investigations plus approfondies.

Mots clés : Conduite de coordination des enseignants, connaissances et points de vue des enseignants, environnement de géométrie dynamique 3D (EGD 3D), perception, raisonnement logique

摘要

在立体几何的视觉化方面，长期以来一直存在着学习上的挑战。三维动态几何环境（3D Dynamic Geometry Environments）为教师支持学生的视觉化提供了新的机会，但也带来了一些问题，比如学生的直观感知和演绎推理之间的冲突。本研究调查了在三维动态几何学习环境下的一项关键的教师实践：即帮助学生协调直观感知和不同逻辑推理（不仅包括基于理论的演绎推理，也包括归纳推理和溯因推理）的教师“协调行为”（coordination behavior）。研究置身于中法合作框架下，为了深化了解教师的协调行为及其背后的知识观念，为在职教师和教师教育工作者提供启示，同时考虑到新冠肺炎疫情全球大流行的背景，确定了如下研究问题。

- (1) 在线下课堂教学中，教师在三维动态几何环境下帮助学生解决立体几何任务时，会调动哪些协调行为？这些协调行为需要哪些知识和观念的支撑？立体几何任务和三维动态几何环境的特征如何影响教师的协调行为？
- (2) 在新冠疫情期间的远程在线教学中，教师使用的立体几何任务和三维动态几何环境，以及她的协调行为相比线下课堂有何不同？在这一过程中，教师的知识和观念是如何更新的？这些行为，知识和观念的差异有多少是受到疫情的影响？

为解决上述问题，本文建立一个复合的理论框架。其中，文献纪录教学论（Documentational Approach to Didactics, Trouche 等人, 2020）作为一个全局框架，将教师协调行为中的行为规律和教师的知识观念整合为一个连贯的统一体——“协调方案”（coordination scheme）。教师的协调行为规律和知识观念分别对应于协调方案中的“行动规则”（rules of coordination）和“操作不变量”（international invariants）。进一步地，每一个协调方案都与一类“情境”（situations）联系起来，它整合了立体几何任务、三维动态几何环境，教学场景，以及与该协调方案相关的其他元素。在本研究中，立体几何任务和三维动态几何环境的特征将分别从几个维度刻画，这些维度是基于 Piaget 等人（1973）和 Morgan 等人（2009）的工作发展起来的。协调方案中的行为规则概念将与一个协调行为子框架联系起来，该子框架是基于 Toulmin（1958）的论证图和 Conner 等人（2014）的工作建立的。协调方案中的操作不变量概念也将与一个分类子框架联系起来，该子框架是基于 Koehler 和 Mishra（2009）的 TPACK 知识框架和其他关于教师观念的研究（Pierce 和 Ball, 2009; Ruthven, 2014）建立起来的。上述复合框架一方面指导着研究问题的重塑，另一方面则是研究的分析工具。

本文采用案例研究法，在中法合作的框架下，跟踪三位教师使用三维动态几何环境的立体几何课程系列。三位教师两位来自法国，一位来自中国，均在使用动态几何环境方面经验颇丰。研究把每位教师的课程系列（包括线上和线下）视作一个案例；针对每个课程系列，收集教师使用的任务和三维动态几何资源，收集线下课堂视频，线上屏幕录制视频，或教师对课堂过程的书面回忆记录，并结合“刺激性回忆”（stimulated recall）（Calderhead, 1981）技术对每位教师进行半结构化的访谈。研究者应用上述复合框架，

对每个课程系列的数据进行分析，并在此过程中不断修正该框架，最后根据数据分析的结果回答上述两组研究问题。

针对第一组研究问题，本研究中的案例呈现了多样化的教师协调行为。一些典型的协调行为如：指导学生开展理论-演绎推理，以验证他们在三维动态几何环境中的直观感知结果；鼓励学生把直观感知的结果作为事实前提来发展后续的理论-演绎推理，指导学生用理论-演绎推理来解释基于直观证据的归纳推理的结论。其次，本研究的结果表明，教师的协调行为背后的知识观念多样，这些行为也不同程度地受到立体几何任务和三维动态几何环境的特点的影响。两位法国教师在协调行为中总是强调学生的理论-演绎推理；只有在模拟手势/三维实物/三维动态几何环境的视觉支持特别有帮助时，他们才会强调学生的直观感知。这一行为规律主要受到如下因素的影响：任务中立体几何主题、课程规定和考试要求、三维动态几何环境中图形表征的特点、以及教师自己对任务解决方案的理解，和对模拟手势/三维实物/三维动态几何环境的视觉支持的认识。中国教师在协调行为中会根据不同的情境强调不同的逻辑推理或学生的直观感知。这主要是受相应任务的立体几何主题和考试（而非课程）要求的影响；在整个协调行为中，该教师主要考虑特定的逻辑推理或/和直观感知是否能让学生在考试要求下高效地解决任务。在协调行为中，三位教师采取了各种策略来支持学生的逻辑推理和直观感知。这些策略主要是由他们一般性的教学内容知识、他们对三维动态几何环境的潜能和缺陷的认识、以及能够发挥这些潜能或克服这些缺陷的教学策略而决定的。此外，高水平的技术内容知识和对行为控制的信心，或是具有结构良好的三维动态几何资源，将增加教师在协调行为中使用三维动态几何环境的可能性。

针对第二组研究问题，本文只调查来中国教师的情形（法国教师未在线上课堂中使用三维动态几何环境）。疫情对这一中国教师协调行为的影响主要体现在：（在远程在线教学中）缺乏模拟性手势和指示性手势，更频繁地使用辅助线和三维动态几何环境，以及缺乏对学生的提问和其他互动行为。然而，该教师协调行为中的关键部分——他所强调的逻辑推理，以及直观证据在逻辑推理中扮演的角色——并没有因为疫情受到太大的影响；这要归功于他对新技术工具的开放态度，他学习新技术工具的容易度，以及他在使用和设计三维动态几何环境方面的熟练性。

相较于过往研究，本研究在理论上的拓展包括以下几点。

- 探索了文献纪录教学论中“情境”概念的一些关键要素；在该理论中引入“相同的情境类别/相近的情境类别/迥异的情境类别”，以及“直接文献生成/间接文献生成”的概念。
- 在协调行为的子框架中引入论证成分的特征，如（感知的、直觉的、事实的）数据，（溯因的、归纳的、演绎的）权证，等；在子框架中不仅考虑教师对这些论证成分的直接贡献，也考虑其间接贡献，如“提问”、“支持性行动”和“资源使用”；在支持性行动中区分“验证性行动”和“反驳性行动”。

-
- 提出一个操作性不变量的分类子框架；该框架整合了根据 TPACK 知识框架重建的五类教师知识类别，以及另外三类关于时间效益、行为控制和社会规范的三类教师观念。

上述理论建构使研究者能够捕捉到教师协调活动的关键特征，并更好地研究这种活动从线下真实课堂到远程在线课堂的转变。但与此同时，这些理论建构也带来了一些问题。例如：如何将“相同的情境类别/相近的情境类别/迥异的情境类别”纳入到文献纪录教学论原有的理论架构之中？这些问题需要通过后续的研究予以解决。

本研究从几个方面为教师教育提供了启示。在政策制定方面，考试设计者可以设置一定比例的小型任务，以鼓励教师在协调实践中提升学生的非演绎性逻辑推理或直观感知能力。在资源建设方面，提供结构良好的三维动态几何环境（即具有可靠的图形表征，功能强大的工具，和信息量丰富的反馈），可以大提高教师在协调实践中引入该环境的意愿。在教师培训项目方面，应当更加关注教师的一般性教学内容知识、三维动态几何环境在支持学生的直观感知和逻辑推理方面的潜能和局限，以及能够发挥潜能或克服局限的教学策略。研究还显示了来自集体的支持对教师工作的重要性：研究集体工作对个体教师的协调实践的影响将是未来一个有前景的研究方向。

关键词：教师协调行为；教师知识观念；三维动态几何环境；直观感知；逻辑推理

Abstract

There have been long-standing challenges in learning 3D geometry. 3D dynamic geometry environments (3D DGEs) offer teachers new opportunities for supporting student visualization but also raise issues, such as the tension between students' perception and logical reasoning. This study investigates an essential but challenging teacher practice in the learning environments integrated with 3D DGEs: the *coordination behavior* in support of students' coordination of their own perception and different modes of logical reasoning which not only include theoretical deductive reasoning but also inductive and abductive reasoning.

Our study happens, both in France and China, in a time of the Covid-19 epidemic.

To deepen our understanding of teachers' coordination practice and the related knowledge and views, and to provide implications for in-service teachers and teacher educators, we investigate the following research questions.

- (1) In real classroom teaching, what coordination behavior would a teacher mobilize when she is helping students solve 3D geometry tasks and using 3D DGEs? What knowledge and views are underpinning the coordination behavior? How is the coordination behavior be influenced by the characteristics of the 3D geometry tasks-3D DGEs?
- (2) In distance online teaching during the Covid-19 epidemic, how can the 3D geometry tasks-3D DGEs used by a teacher and her coordination behavior be different from those in real classroom teaching? How have the knowledge and views of the teacher been updated to support the different coordination behavior? To what extent can the differences be attributed to the epidemic?

A compound theoretical framework is established to address these questions. The Documentational Approach to Didactics (DAD, Trouche et al., 2020) serves as a global framework to integrate the regularities in the teacher's coordination behavior and their knowledge and views into a coherent unity – usage scheme (renamed “coordination scheme” in this study). Every coordination scheme corresponds to a class of situations which integrates the 3D geometry tasks, 3D DGEs, teaching settings, and other elements relevant to that scheme. The characteristics of 3D geometry tasks and 3D DGEs are respectively described from several dimensions according to the works of Piaget et al. (1973) and Morgan et al. (2009). The rules of action (renamed “rules of coordination” in this study) in the coordination scheme are further connected with a sub-framework of coordination behavior, which is built on Toulmin's (1958) diagram of argumentation and Conner et al.'s (2014) framework of teacher support for collective argumentation. The operational invariants in the coordination scheme are connected with a categorization sub-framework, which is built on the TPACK knowledge framework (Koehler & Mishra, 2009) and other studies on teachers' views about behavior control, social norms and time economy (Pierce & Ball, 2009; Ruthven, 2014). The compound framework allows reformulating the research questions above on the one hand, and serves as the tool of analysis on the other hand.

Adopting a case study methodology and being situated in a Sino-French cooperation project, this study follows the 3D DGE-integrated lessons series of three teachers, with two teachers from France and one teacher from China. All the three teachers are experienced in using 3D

DGEs to teach 3D geometry. For each lesson series, we collect the resources related to the tasks and 3D DGEs, the classroom videos/ screen recording videos/ teacher's written memoir of the lesson procedures, and the semi-structured general interviews integrated with stimulated recall techniques (Calderhead, 1981). The data of each lesson series are analyzed with the compound framework above, with framework itself being revised from time to time.

According to the results of the analysis of the data, we can answer the two groups of research questions.

Concerning the first group of research questions, the cases in this study show the diversity of teachers' coordination behavior. Some typical pieces of coordination behavior include: guide students to develop theoretical deductive reasoning to validate the results perceived by them in a 3D DGE, encourage students to take the perceptive evidences as factual premise to develop the following theoretical deductive reasoning, guide students to explain the conclusion of perception based-inductive reasoning with theoretical deductive reasoning. Besides, the cases in this study show that teachers' coordination behavior is underpinned by different categories of knowledge and views, and the coordination behavior is influenced by the 3D geometry tasks and the 3D DGEs to different extents. The two French teachers always emphasize students' theoretical deductive reasoning in their coordination behavior; they would attach more importance to students' perception only when the perceptive support from simulating gestures/ 3D real objects/ 3D DGEs is especially helpful. This is influenced by the 3D geometry topics of the tasks, the curriculum prescriptions and examination requirements, the features of the figural representations in the 3D DGEs, their own understanding of the task solutions, and their views about the perceptive support of the simulating gestures/ 3D real objects/ 3D DGEs. The Chinese teacher would emphasize, in his coordination behavior, different modes of logical reasoning or the perception of students according to different situations. This is mainly influenced by the 3D geometry topics of the corresponding tasks, the examination (but not curriculum) requirements, and his own consideration about whether the particular logical reasoning and perception would allow students to solve the tasks efficiently under the examination requirements. In their coordination behavior, the three teachers also adopt various strategies to support students' logical reasoning and perception. The strategies are mainly determined by their general pedagogical content knowledge, their knowledge and views about the potentials and side effects of 3D DGEs, and their pedagogical strategies for exploiting the potentials or overcoming the side effects. In addition, abundant technological content knowledge and a high level of confidence in behavior control, or the availability of well-structured 3D DGEs would increase the probability that a teacher uses 3D DGEs in her coordination practice.

Concerning the questions in the second group, this study only investigates the case of the Chinese teacher. The influence of the Covid-19 epidemic on his coordination behavior are reflected in: (for the distance online teaching) the lack of simulating and denoting hand gestures, the more frequent use of scaffolding lines and 3D DGEs, and the lack of the questions and actions for eliciting students' input. Nevertheless, the essential part of his coordination behavior – the mode of logical reasoning mainly promoted, and the role of perceptive evidences in the logical reasoning – has not been much affected by the epidemic; it is attributed to his openness

to new technological tools, the ease felt by him in learning to use the new technological tools, and his proficiency in using and designing 3D DGEs.

The theoretical developments made in this study consist in the following points.

- explore some critical elements in the professional situations in the DAD framework; introduce to DAD the new concepts of *the same/close/distant classes of situations*, and *direct/indirect documentational genesis*.
- introduce the different features of argumentation components, such as (perceptive, intuitive, factual) data and (abductive, inductive, deductive) warrants, to the sub-framework of coordination behavior; take into account not only the teacher's direct contributions of these argumentation components, but also her indirect contributions such as *questions*, *supportive actions*, and *use of resources*, in the sub-framework; distinguish between the *validating* actions and *rebutting* actions in the supportive actions;
- propose a categorization sub-framework for operational invariants, integrating three categories of views about time economy, behavior control and social norms, with another five categories adapted from the TPACK knowledge framework.

These theoretical constructs allow us to capture the essential features of teachers' coordination activities, and to better examine the transformation of such activities from a real classroom lesson series to a distance online lesson series. The theoretical constructs meanwhile bring some issues, such as the integration of the same/close/distant classes of situations into the initial constructs of DAD, which should be addressed through future studies.

This study provides implications for teacher education in several perspectives. With respect to the examination policy, examination designers could set a reasonable proportion of small items to encourage teachers to foster non-deductive logical reasoning or perception of students in their coordination practices. With respect to the construction of resources, the availability of well-structured 3D DGEs, which are equipped with faithful figural representations, functional tools and informative feedback, can greatly enhance the willingness of teachers to use 3D DGEs in support of their coordination. With respect to the teacher training projects, the training should pay more attention to teachers' general pedagogical content knowledge, the potentials and the constraints of 3D DGEs for supporting students' perception and logical reasoning, and the pedagogical strategies for exploiting the potentials or overcoming the side effects. The study also shows the importance of the support from the collective around a teacher: studying the influence of collective work on individual teachers' coordination practices is a promising direction for future research.

Keywords: Teachers' coordination behavior, teachers' knowledge and views, 3D dynamic geometry environment (3D DGE), perception, logical reasoning

Table of content

Résumé.....	i
摘要.....	v
Abstract.....	viii
1 Introduction.....	1
2 Literature review and preliminary research questions	3
2.1 Abilities of visualization in 3D geometry	3
2.2 3D DGE for students' visualization and solving of 3D geometry tasks: need to coordinate perception and logical reasoning.....	4
2.2.1 Potentials and constraints of 3D DGE for students' visualization.....	4
2.2.2 Solving 3D geometry tasks with the help of 3D DGEs	6
2.2.3 Need for students to coordinate perception and logical reasoning	6
2.3 Interest in teachers' coordination behavior	7
2.4 Factors possibly influencing teachers' coordination behavior.....	8
2.4.1 First group of factors: knowledge and views of teacher	8
2.4.2 Second group of factors: teaching resources	10
2.4.3 Third group of factors: social-cultural factors	13
2.5 Focus on some factors to formulate preliminary research questions.....	13
3 Theoretical framework and reformulated research questions.....	16
3.1 Documentational Approach to Didactics (DAD).....	16
3.1.1 Origin and main content of DAD.....	16
3.1.2 Concept of situation in connection with 3D geometry tasks and 3D DGEs	20
3.1.3 Interest of DAD and concept of coordination scheme.....	24
3.1.4 New concepts: direct/indirect documentational genesis and the same/close/distant classes of situations	27
3.2 Research questions reformulated in light of DAD.....	35
3.3 Characteristics of 3D geometry tasks and 3D DGEs.....	36
3.3.1 Characterizing a 3D geometry task.....	36
3.3.2 Characterizing a 3D DGE	42
3.4 Sub-framework for identifying rules of coordination in a coordination scheme.....	44
3.4.1 Toulmin's diagram of argumentation: a basic tool	45
3.4.2 Toward a sub-framework of coordination behavior.....	46
3.4.3 From coordination behavior to rules of coordination	50
3.5 Sub-framework for categorizing operational invariants in a coordination scheme	50
3.5.1 Procedures of developing the sub-framework	51
3.5.2 Eight categories of operational invariants in the sub-framework	56
4 Methodology.....	60
4.1 Case study as a basic method.....	60
4.1.1 Definition, field of application and characteristics of case study	60
4.1.2 General research design of this thesis.....	61

4.2	Criteria of case selection: French and Chinese cases.....	62
4.3	Data collection strategy.....	63
4.3.1	Lesson series covered by each case	63
4.3.2	Methodological principles proposed by DAD	64
4.3.3	List of data for every lesson series.....	69
4.4	Data analysis	70
4.4.1	Analyzing real classroom lesson series.....	70
4.4.2	Analyzing distance online lesson series and contrast with real classroom lesson series	75
5	Results of the analysis of cases	77
5.1	Case of Dora: French teacher in a real classroom.....	78
5.1.1	Context of Lesson Series D.I	78
5.1.2	Characteristics of 3D geometry tasks-3D DGEs in Lesson Series D.I.....	83
5.1.3	Rules of coordination in Lesson Series D.I	96
5.1.4	Operational invariants in Lesson Series D.I	124
5.1.5	Summary of Lesson Series D.I	134
5.2	Case of Sonia: French teacher in real classroom	144
5.2.1	Context of Lesson Series S.I.....	144
5.2.2	Characteristics of 3D geometry tasks-3D DGEs in Lesson Series S.I.....	146
5.2.3	Rules of coordination in Lesson Series S.I	147
5.2.4	Operational invariants in Lesson Series S.I.....	164
5.2.5	Summary of Lesson Series S.I.....	170
5.3	Case of Huang: Chinese teacher in real classrooms	176
	Lesson Series H.I	176
5.3.1	Context of Lesson Series H.I	176
5.3.2	Characteristics of 3D geometry tasks-3D DGEs in Lesson Series H.I.....	179
5.3.3	Rules of coordination in Lesson Series H.I	191
5.3.4	Operational invariants in Lesson Series H.I	212
5.3.5	Summary of Lesson Series H.I	221
	Lesson Series H.II.....	229
5.3.6	Context of Lesson Series H.II.....	229
5.3.7	Characteristics of 3D geometry tasks-3D DGEs in Lesson Series H.II.....	235
5.3.8	Rules of coordination in Lesson Series H.II	240
5.3.9	Operational invariants in Lesson Series H.II	264
5.3.10	Summary of Lesson Series H.II.....	273
5.4	Case of Huang: Chinese teacher in distance online settings.....	282
5.4.1	Context of Lesson Series H.III.....	282
5.4.2	Characteristics of 3D geometry tasks-3D DGEs in Lesson Series H.III ...	289
5.4.3	Rules of coordination in Lesson Series H.III.....	300
5.4.4	Operational invariants in Lesson Series H.III.....	321
5.4.5	Summary of Lesson Series H.III.....	331
5.5	Contrast real classroom and distance online teaching in case of Huang	336
6	Conclusion, reflection and perspective	352

6.1	Conclusion	352
6.1.1	Answers to research question 1.1.....	352
6.1.2	Answers to research question 1.2.....	359
6.1.3	Answers to research questions 2.1 ~ 2.3.....	363
6.2	Reflection and perspectives	365
6.2.1	Reflection on conclusions	365
6.2.2	Reflection on theoretical framework	368
6.2.3	Reflection on Methodology	376
6.2.4	Perspectives for future research and teacher education	378
6.2.5	Final remarks	379
	References.....	381

1 Introduction

This thesis is firstly motivated by the challenge in learning and teaching visualization in 3D geometry (Bridoux & Nihoul, 2015; Clements & Battista, 1992; Parzysz, 1988). The 3D dynamic geometry environments (3D DGE) available in recent decades have provided new opportunities for teachers to promote students' visualization, but they meanwhile bring about issues. In this thesis, 3D DGEs are defined as the digital courseware designed with a mathematics software such as GeoGebra and Cabri 3D, which integrates the function of 3D visual display and allows constructing, transforming, manipulating 3D dynamic models and observing the corresponding feedback (Hohenwarter & Jones, 2007; Laborde, 2008). The 3D DGEs thus have the potential for supporting students' visualization. Nevertheless, the conflict between the immediate perception and theoretical deductive reasoning of students may be accentuated in 3D DGEs. We borrow from (Fischbein, 2002) the concept of perception to refer to what one perceives from external stimuli, which will be elaborated on in the next chapter. On the one hand, the vivid perceptive effects in 3D DGEs may induce students to over-rely on their perception without feeling the need for theoretical deductive reasoning or proof, which is the most valid way to solve 3D geometry tasks and can also deepen some aspects of student visualization. On the other hand, some aspects of visualization may only need perceptive support, and such perception can be exploited to maximum benefit when being connected with non-deductive reasoning such as inductive or abductive reasoning. The perception and perception-based inductive/abductive reasoning, though lacking validity, preserve their rationality in solving particular tasks. This leads to the first focus of this thesis: to investigate teachers' coordination behavior, which is defined as what a teacher does to support students in coordinating their own perception and different types of logical reasoning (i.e., theoretical deductive, inductive, and abductive reasoning) in the 3D DGE integrated teaching environments.

On this basis, we further explore a range of factors that might influence teachers' coordination behavior, and finally focus on three of them – 3D geometry tasks, 3D DGEs used together with tasks, and teachers' knowledge and views. This leads to the second focus of this thesis: to investigate the relationship between the characteristics of 3D geometry tasks-3D DGEs and teachers' coordination behavior, and to investigate teachers' knowledge and views underpinning this coordination behavior. The Sino-French cooperation framework covering this Ph.D. project provides an opportunity to contrast the cases of Chinese and French teachers. The different social-cultural contexts of the Chinese and French cases result in different knowledge and views of teachers and the different 3D geometry tasks-3D DGEs, allowing us better to identify their relationships with teachers' coordination behavior.

Finally, the outbreak of the Covid-19 epidemic offers both an added complexity, and an opportunity to examine the effect of the transition of teaching setting (from real classrooms to distance online, for example) on teachers' coordination behavior and how teachers would update their knowledge and views to adapt to this transition; this constitutes the third focus of this thesis.

After this introduction, chapter 2 presents the literature review which has led us to the three foci of investigation in this thesis. On that basis, we formulate the preliminary version of the research questions. Then chapter 3 presents a compound theoretic framework and the research questions that are reformulated in light of this framework. Chapter 4 introduces the research methodology in which the compound theoretic framework is applied to analyze the cases of Chinese and French teachers. Chapter 5 presents the particular cases and their analysis. According to the analysis results, we give the conclusions in response to the research questions, discuss the limitations and contributions of this thesis, and open new perspectives for teacher education and further research in chapter 6.

2 Literature review and preliminary research questions

This section is dedicated to introducing the problematic of this thesis on the basis of a literature review. We firstly clarify the connotation of the ability of visualization investigated by this study (section 2.1), and secondly discuss the potentials and challenges of using 3D DGEs for promoting student visualization. The discussion allows us to introduce the need for students to coordinate their perception and logical reasoning (section 2.2). We then introduce our specific interest in teachers' coordination behavior (section 2.3) and explore a range of factors that could influence such behavior (section 2.4). By focusing on some of the influencing factors, we formulate the preliminary version of our research questions (section 2.5).

2.1 Abilities of visualization in 3D geometry

Following Zimmermann & Cunningham (1991) and Gutierrez (1996), we set the visualization ability in the context where *mental images* and *external representations* interact with each other. The *mental image* is a cognitive representation of mathematical concepts or properties that involve visual elements (Gutierrez, 1996); the *external representation* is an external means of denoting mathematical concepts or properties (Gutierrez, 1996). Both mental images and external representations can be in textual, graphical, diagrammatic, and pictorial forms (Zimmermann & Cunningham, 1991; Gutierrez, 1996).

In 3D geometry, one main concept is the figure, which refers to a theoretical geometrical object described by a text defining it (Parzysz, 1988); and one kind of representations that could influence students' visualization are the figural representations, i.e., representations in graphical or diagrammatic form. Therefore, we let the *mental images* only refer to the figural ones related to 3D geometric objects, and mainly consider their interactions with the *external figural representations* of 3D geometric objects, such as 2D drawings, 3D real models, 2D/3D dynamic models, gestures, and pictures. The *mental images* (only the figural ones) can be seen as the internalization of the *external figural representations*, and the emergence of the *mental images* in people's minds can also motivate their production of *external figural representations* in the outside world (Duval, 2000; Marchand, 2006).

Reviewing the literature on the notions of mental image and external figural representation, we find that visualization in 3D geometry cannot be simply reduced to one single ability but involves a set of abilities. We divide them into two groups, which will be introduced below with the corresponding literature.

The first group is "Visual Processing (VP)" (Bishop, 1983), including the abilities to produce, manipulate, extrapolate and transform mental images, externalized forms of these activities with external figural representations, and translate abstract relationships and non-figural data into mental images. As can be seen, the first group of abilities evolve around mental images. In 3D geometry, the mental images to be constructed, manipulated, and transformed are mostly 3D ones (Gutierrez, 1996), but there are also abilities involving both 3D and 2D mental images related to a 3D geometry object, such as constructing unfolded nets of a solid (Pittalis & Christou, 2010), imagining how a solid looks like from different perspectives (Battista et al., 2018; Hegarty & Waller, 2004) and imagining a section of a solid cut by a plane (Bartolini

Bussi & Mariotti, 1999). These abilities are also included in the first group of visualization abilities in this study.

The second group of visualization abilities concerns the interpretation of mental images/ external figural representations in order to obtain information beyond their visual effects, that is closely linked with the abilities of “Interpretation of Figural Information (IFI)” in Bishop’s (1983) work. According to Bishop, such interpretation requires knowledge of visual conventions and spatial vocabulary. Furthermore, Duval’s (2005) constructs of iconic and non-iconic visualization provide a more refined differentiation among the different abilities of interpreting drawings. The iconic visualization means perceiving drawings as indecomposable icons; the non-iconic visualization means perceiving drawings as decomposable ones, which include three ways of decomposing drawings – thinking how to rebuild drawings with instruments (instrumental deconstruction), splitting them up into subparts like doing a puzzle (heuristic breaking down of the shapes), and decomposing them into figural units linked through geometric properties (dimensional deconstruction). From instrumental deconstruction to dimensional deconstruction, more and more complex geometric knowledge and theoretical deductive reasoning are involved (Mithalal, 2010). These iconic and non-iconic visualization abilities can be integrated into the second group of visualization abilities in 3D geometry. Inspired by that we make a distinction, in this group, between the superficial interpretation of mental images/figural external representations simply based on perception and the deep interpretation based on theoretical deductive reasoning.

2.2 3D DGE for students’ visualization and solving of 3D geometry tasks: need to coordinate perception and logical reasoning

2.2.1 Potentials and constraints of 3D DGE for students’ visualization

The difficulties of visualization in 3D geometry mainly concern the interpretation of 2D external figural representations and the production of 3D mental images without the presence of corresponding 3D external figural representations (Bridoux & Nihoul, 2015; Clements & Battista, 1992; Parzysz, 1988). Researchers suggested that students should be exposed to enough 3D external figural representations before they can construct reliable 3D mental images without their presence (Clements & Battista, 1992; Parzysz, 1988). The 3D figural representations mainly included real models or 3D manipulatives in the 1990s, which were nevertheless not easy to make, cut off or recover. The 3D DGEs emerging in recent decades have provided new possibilities for promoting students’ visualization, as they give flexible and easy access to a quasi-3D external representation – the 3D DGE model. Although what we see in a 3D DGE at a fixed moment is actually a 2D projection of the model on the screen, the models can be rotated, translated, flipped, (un)folded to various degrees in a continuous process (Accascina & Rogora, 2006; Christou et al., 2006; Gutierrez, 1996). This allows students to accumulate various forms of 3D mental images and coordinate them with the 2D surfaces or perspectives of 3D figures, which belongs to the first group of visualization abilities in 3D geometry.

The second group of visualization abilities, however, cannot always be facilitated by 3D DGEs, at least not for a deep interpretation. This can be due to the conflict between one's immediate *perception* and theoretical deductive reasoning. According to Fischbein (2002), the perception is defined as what one perceives from external stimuli. One's perception can be triggered by many kinds of stimuli, including auditory, tactile, and visual stimuli. In this study, we only consider the perception triggered by visual stimuli, especially external figural representations. With such perception, students can immediately produce the corresponding mental images (Yakimanskaya, 1991) and may also have the intention to mentally complete the spatial information lacking in the external figural representations (theories of Gestalt psychology, Koffka, 2013). The 3D DGEs can support such perception, facilitating their production and manipulation of mental images, and thus promoting students' visualization abilities in the first group. Nevertheless, the second group of abilities involves not only one's mental images but also one's geometric knowledge and even theoretical deductive reasoning (Battista et al., 2018; Duval, 2005). Many studies found that the DGEs (including 3D and 2D ones), with vivid perceptive effects, would induce students to take what they perceive as granted and feel no need for proof (Connor et al., 2007; Mariotti & Pedemonte, 2019; Sinclair & Robutti, 2013). There do exist teaching projects in which students successfully developed mathematics proofs in DGEs, but it usually required a clear didactic contract asking for proofs (Mariotti & Pedemonte, 2019) or a carefully designed activity sequence, such as discussing a unified norm of accepting/rejecting mathematical ideas in class (Marrades & Gutiérrez, 2000) or evoking conflicting phenomena (Accascina & Rogora, 2006), to create in students a "social need" or "intellectual need" for proofs (Harel & Sowder, 1998).

In this study, we consider theoretical deductive reasoning to be close to mathematical proof, which refers to the process of determining the truth of a conclusion solely from the truth of some premises in reference to the rules/theories widely accepted by the mathematician community (Harel & Weber, 2018); one nuance between theoretical deductive reasoning and mathematical proof is that the latter is usually expressed in a more formal way with conventionalized terms (Stylianides & Ball, 2008).

Compared to theoretical deductive reasoning, other reasoning that follows a different logic, such as *inductive* or *abductive reasoning*, can usually be connected with students' perception in 3D DGEs more fluently and allows them to develop and benefit more from their mental images (or the first group of visualization abilities). The *inductive reasoning* concerns generalizing a conclusion that has only been checked in a limited number of cases to a larger set of cases (Harel & Sowder, 1998). In 3D DGEs, the parameter slider, the dragging functionality, and measuring and tracing tools can help students perceive many visual examples quickly, which would facilitate their inductive reasoning (De Villiers, 1999; Højsted, 2019). The *abductive reasoning* is to infer the truth of some premises from a fact according to the rules indicating that these premises necessarily lead to the fact (Peirce, 1960). Leung (2011) proposed several dragging modalities in (3D) DGEs, with which students could perceive and reconstruct the simultaneous visual invariants in the geometrical configurations being dragged, develop abductive conjectures and even prove them; however, Baccaglini-Frank (2019) found that the processes alike withhold a potential fragility with respect to proof due to the scarce theoretical evidence therein.

We call the theoretical deductive, inductive and abductive reasoning uniformly *logical reasoning*, to better distinguish them from the reasoning totally based on one's mental images or perception (Pittalis & Christou, 2010) – what we call *purely perceptive reasoning*. The latter type of reasoning totally falls in the first group of visualization abilities in 3D geometry.

2.2.2 Solving 3D geometry tasks with the help of 3D DGEs

While being exposed to 3D DGEs, students always need to deal with 3D geometry tasks. Theoretical deductive reasoning or mathematical proofs can provide a *valid* way to solve tasks involving generalized conclusions (Balacheff, 1987; Inglis et al., 2007; Stylianides & Ball, 2008). The term *valid* means that the reasoning can well remove people's uncertainty about a conclusion, and that its truth is widely recognized by the mathematician community, independent of any institutional context, person or time. Duval (2005) points out that the reasoning that involves the use of properties and theorems can be done with no reference to external figural representations and sometimes even goes against the perceptive effects on them. The other two types of logical reasoning, inductive or abductive reasoning, lack the *validity* for justifying a generalized conclusion, as the confirming evidence in limited cases cannot truly determine the truth of other cases (Lin et al., 2012), but these modes of reasoning preserve *rationality* for certain tasks involving generalized conclusions – they can lead to a correct conjecture for these tasks and help reduce people's uncertainty about a conclusion (Inglis et al., 2007; Knipping, 2008). This is especially the case when inductive or abductive reasoning are combined with perceptive effects in 3D DGEs. In addition, many mathematicians appreciate the value of inductive and abductive reasoning, taking them as important motivators of mathematical discoveries and research work (Lakatos et al., 1976; Poincaré, 1905; Pólya, 1954). For more specific 3D geometry tasks like those only concerning the truth of finite many cases or the falsity of infinite/finite many cases, the *valid* solutions are not limited to theoretical deductive reasoning but also include counterexamples, strategic enumeration of cases (Stylianides & Ball, 2008); and the rational solutions are even more – sometimes merely the perceptive effects in 3D DGEs /drawings or the self-generating mental images would allow students to advance towards the achievement of the task.

2.2.3 Need for students to coordinate perception and logical reasoning

In summary, on the one hand, to achieve a deep interpretation of figural representations (i.e., improve the second group of visualization abilities) in 3D geometry and to find a valid solution to a task, students need to develop theoretical deductive reasoning, which is nevertheless not easy when 3D DGEs intervene and a careful design of lesson activities is required. On the other hand, to develop or exploit more of students' mental images (i.e., improve the first group of visualization abilities) in 3D geometry and get a correct solution to some tasks more efficiently, it would be preferred that students take profit of their perception in 3D DGEs, developing non-deductive logical reasoning which is possibly combined with perceptive evidences or even with pure perceptive reasoning. That is, while dealing with 3D geometry tasks with the help of 3D DGEs, students need to *coordinate* their perception with different modes of logical reasoning, choosing the appropriate mode(s) of logical reasoning for the task at stake and connecting them with their perception in 3D DGEs. It is therefore a critical teacher's work to help students with

such coordination and ultimately promote their visualization and learning in 3D geometry. This leads to our interest in teacher's *coordination behavior* that we will elaborate on in the following section.

2.3 Interest in teachers' coordination behavior

As already mentioned, while explaining 3D geometry tasks with the use of 3D DGEs, it is important for a teacher to help students coordinate their own perception in 3D DGEs with different modes of logical reasoning, to ultimately promote students' abilities of visualization and their 3D geometry learning. We define such behavior of a teacher to support students' own coordination as the teacher's *coordination behavior*.

The word "coordination" is used in its natural meaning, in which we highlight the ideas of "coexisting at the same time", and "choosing the appropriate activities and making them get along well with each other". Firstly, the perceptive and logical reasoning activities of students are what can coexist when they are solving a task with the help of 3D DGEs; and thus the teacher needs to monitor the different activities (perceptive or logical reasoning) at the same time. By "monitoring", we mean the teacher takes some actions that she¹ thinks will foster these activities and watch for the relevant performances of students to ensure that they develop the logical reasoning and perceptive activities to a proper level. Secondly, the teacher also needs to choose a mode of logical reasoning appropriate for solving the task at stake, and help students connect the logical reasoning with their perception in 3D DGEs. It is not always necessary to develop rigorous theoretical deductive reasoning; besides, the level of the ease of the connection varies, since the perception in 3D DGEs is more easily connected with inductive/abductive reasoning than theoretical deductive reasoning according to the previous studies. The second point is exactly where the teacher could help through coordination--let the logical reasoning and the perception interact in a proper way, so that they can get along well. The components of the coordination behavior can be: evoke perceptive evidences with 3D DGEs, simulating gestures or external figural representations; give hints on some critical steps in the particular reasoning that s/he would like students to develop and reject the ideas related to other modes of reasoning; or persuade students to accept the conclusion of the less valid reasoning with certainty.

The coordination behavior is limited here to the domain of 3D geometry and has a specific connection with the use of 3D DGEs in this thesis, but in general, the coordination behavior can apply to the teaching of any mathematics domain in which the digital technologies that have dynamic visual display functionalities could have an effect. That is, the coordination behavior in this thesis falls in the scope of the practice of teaching mathematics with digital technology.

While being an essential teacher practice in the teaching environment integrated with 3D DGEs and 3D geometry tasks, the coordination behavior would also bring many challenges for teachers as they need to monitor different aspects of student thinking in parallel, react to

¹ In this thesis, the pronoun "she" is used to refer to a general teacher as many teachers in secondary schools are female. The "he" is only used when the teacher in a particular case is male.

students' proposals flexibly according to the situation, and adapt the teaching techniques to the integration of 3D DGEs. In this context, this thesis is dedicated to exploring a framework to help structure the coordination behavior, and on that basis, to identify regularities in the coordination behavior of some mathematics teachers who have rich experiences at least in using 3D DGEs. We would also like to investigate the factors that could influence the coordination behavior of these teachers, to provide implication for in-service teachers on how to implement the coordination according to different situations in class, and also to enlighten the design of the related teacher training projects.

2.4 Factors possibly influencing teachers' coordination behavior

In this section, we try to systematically explore a wide range of factors that could have an effect on teachers' coordination behavior, and then focus on several of them in the next section. We start from the factors that could influence the mathematics teaching with digital technology, and then narrow their scope, inferring the factors that could influence teachers' coordination behavior – which is situated 3D geometry teaching with 3D DGEs.

2.4.1 First group of factors: knowledge and views of teacher

Among the various factors, teachers' *knowledge* and *views* have been identified as the most fundamental ones that determine their success in mathematics teaching with digital technology (Artigue et al., 2009; Drijvers et al., 2013; Even & Ball, 2009; Koehler & Mishra, 2009; Pierce & Ball, 2009; Thomas & Palmer, 2014).

The *knowledge* in mathematics education is usually taken as a term that everyone understands by default but not having a universal, standard definition. Inspired by the discussions in (Ball et al., 2008; Bonnat et al., 2020; Koehler & Mishra, 2009; Shulman, 1986), we define *knowledge* as the cognitive aspects of human mind and use it as an overarching umbrella concept that covers the information, understanding, skills and memories that a person can acquire through education and empirical experiences. Previous researchers have identified various kinds of teacher knowledge that are essential for teaching mathematics with digital technology, such as mathematics content knowledge (including knowledge of the concepts and theorems in the discipline's body, knowledge of processes of deriving results and warrants for these processes, awareness of definitions' implications, awareness of representations and rationales for problem-solving processes) (Ball et al., 2008); pedagogical knowledge about how to make mathematics easy to learn with digital technology (including knowledge of student psychology, general and mathematics-specific principles and methods for teaching with digital technology, how different mathematics topics are related over the span of curriculum) (Ball et al., 2008; Koehler & Mishra, 2009); memories of students' previous performances and difficulties of students, the teacher's previous didactical decisions and the effects of these decisions (Bonnat et al., 2020); knowledge of the affordances and constraints of digital technologies for teaching mathematics and skills of using digital technologies (Koehler & Mishra, 2009); knowledge of how to teach technological skills to students and connect these skills with mathematics knowledge (Haspekian, 2014).

The term of *views* is proposed in contrast with *knowledge*, and following Hannula (2019), we define *views* as the non-cognitive aspects of the human mind which include opinions, beliefs, attitudes, motivation, orientation, personal dispositions, and working habits. It has been widely identified that teachers' views, in addition to their knowledge, is another critical factor influencing their mathematics teaching with digital technology. These views include: orientations about the nature of mathematics, students' abilities, the kind of pedagogy appropriate for teaching mathematics to particular students with digital technology, and what should be taken as a goal of a mathematics lesson (Pierce & Ball, 2009; Schoenfeld, 2011); opinions on or beliefs in the contributions and constraints of digital technology for teaching mathematics (Drijvers et al., 2010; Pierce & Ball, 2009); openness to the use of digital technology in mathematics teaching (Thomas & Palmer, 2014); confidence in one's own technological skills and perceived difficulty of behavior control when using digital technology in the classroom (Pierce & Ball, 2009; Thomas & Palmer, 2014); perceived social pressure to integrate or not digital technology into mathematics teaching (Pierce & Ball, 2009); and perceived time economy of using digital technology in the classroom (Ruthven, 2014).

Sometimes knowledge and views may not be easy to distinguish. For instance, a teacher's statement "discussing mistakes and original approaches is fruitful for learning, and that both of these are more visible within a technological environment" is identified by Drijvers et al. (2010) as the teacher's belief in the contributions of digital technology in learning mathematics, but it can also be considered as the knowledge of a general method for teaching with digital technology – what may be learned by the teacher in the college of education. This leads us to investigating teachers' knowledge together with their views, without specific distinction between the two concepts.

Based on the discussion above, we take teachers' views and knowledge as the first group of factors influencing their coordination behavior. Furthermore, when we narrow the scope of knowledge and views to the coordination behavior in 3D geometry that involves the use of 3D DGEs, the word "mathematics" in the expression of knowledge and views should be replaced by "3D geometry" or "the development of students' mental images/perception and logical reasoning in 3D geometry"; and the word "digital technology" should be replaced by "3D DGEs".

In this way, we can list knowledge and views of teachers likely to influence the coordination behavior investigated in this study, such as the knowledge and views about:

- the nature of 3D geometry and the roles of the perception with figural representations and the logical reasoning in learning 3D geometry;
- students' difficulties in 3D geometry with respect to generation and manipulation of mental images and logical reasoning;
- potentials and constraints of 3D DGEs for students' perception and logical reasoning in 3D geometry;
- the principles or methods of using 3D DGEs to teach 3D geometry and support students' perception and logical reasoning in this domain;
- the difficulty of behavior control when using 3D DGEs in the classroom.
-

Obviously, these knowledge and views need to be listed in a more structured way. We will specifically address this issue in section 3.5 by developing a classification framework of knowledge and views.

2.4.2 Second group of factors: teaching resources

Since mathematics teaching with digital technology involves the use of a specific resource – digital technology with dynamic visual display functionalities – and requires the teacher to adapt other resources to the technology integration, it is natural to suppose that the teaching resources available is another factor influencing teachers' coordination behavior. In this research, we adopt a broad perspective on the teaching resources and refer to the definition given in the Documentational Approach to Didactics (DAD, Trouche et al., 2020). The DAD is a theoretical framework that proposes a paradigm for analyzing teachers' work through their interaction with *resources*, in which anything that has the potential to re-source² teachers' professional practices and can get renewed by/in these practices will be taken into account as a teaching resource. We will introduce the framework in detail in section 3.1.

The teaching resources can further be divided into *mathematics curriculum resources* and *general resources*.

Mathematics curriculum resources, according to Pepin and Gueudet (2018), refer to the “material” resources that are developed and used by teachers and students in their interaction with mathematics in/for teaching and learning, inside and outside the classroom. The material curriculum resources can be text resources (e.g., textbooks, teacher curricular guidelines, websites, worksheets, syllabi, tests), digital-/ICT-based curriculum resources (e.g., interactive e-textbooks) and other material resources (e.g., manipulatives, calculators). Pepin and Gueudet (2018) also mentioned “nonmaterial” curriculum resources used by teachers that are related to curriculum, including social resources (e.g., direct and/or web-based conversations with colleagues) and cognitive resources (e.g., conceptual frames that are used, for example, in professional development sessions to develop particular competencies). To keep consistent with the scope of DAD in which the knowledge is not considered as a resource but evolve with resources, we let alone the category of cognitive resources (but take into account the category of social resources) when talking about curriculum resources in this thesis.

Pepin and Gueudet (2018) distinguished between digital curriculum resources and instructional technology such as digital instructional tools or educational software programmes, in the sense that the former pay a specific attention to the sequencing of learning topics or associated content that cover a curriculum specification, whereas the latter does not. While the software GeoGebra belongs to instructional technology, a GeoGebra file designed by the teacher for teaching particular mathematics topic belongs to digital curriculum resources. The latter is considered as a 3D DGE in this thesis.

Inspired by the distinction above, we consider some *general resources* used by teachers which do not cover a curriculum specification. Studies show that many general resources also have

² The verb re-source meets Adler's (2000) proposition of “think[ing] of a resource as the verb resource, to source again or differently” (p. 207).

an effect on the implementation of digital technology into mathematics education, and thus they are supposed to influence teachers' coordination behavior. Apart from the instructional technological equipment in the teaching environment, the general resources can also be: the spatial layout of the teaching environment (e.g., a real classroom in which students are seated in rows and can interact with the teacher face-to-face, a distance online setting in which individual students and the teacher are seated in different places and can only interact virtually) (Albano et al., 2021), the time that allows the teacher to learn, design, use or even teach digital technologies in the lesson and the on-site technological support (Bingimlas, 2009; Ince-Muslu & Erduran, 2020; Thomas, 2006).

Following a similar hierarchy, we can consider the resources that could influence the coordination behavior of a teacher. That is, the relevant resources are those likely to affect students' perception or logical reasoning in 3D geometry, or influence the order of priority the teacher has in mind for the promotion of these activities.

The mathematics curriculum resources likely to influence teachers' coordination behavior include:

- Curricula and important examinations

The curricula and important examinations in an institution play important roles in shaping teachers' professional practices (Remillard, 2005). The requirements in these documents on students' abilities in 3D geometry, especially those related to mental images and logical reasoning, are thus supposed to have an effect on teachers' coordination behavior.

- 3D geometry tasks

The characteristics of the task, like the 3D geometric topic and the context (e.g., 2D paper, 3D DGE and 3D reality) of the task, determine fundamentally the perception and logical reasoning activities required for solving the task (Lin et al., 2012; Marchand, 2006; Piaget et al., 1973; Stylianides & Ball, 2008). If a task is selected from the curriculum or examinations, the curriculum/examination prescriptions with respect to the task could also influence teachers' preferences in the coordination.

- 3D DGEs

The characteristics of the external representations (3D dynamic models) and the functionalities available in the 3D DGEs used by the teacher determine what kinds of perceptive support students can get and what types of logical reasoning are easier to develop (Baccaglioni-Frank & Mariotti, 2010; Fahlgren & Brunström, 2014; Højsted, 2019; Morgan et al., 2009), and thus are essentially related to teachers' coordination behavior.

- External figural representations other than those in 3D DGEs:

The representations include 2D drawings, 3D real manipulatives, 3D real models, and real objects. Apart from the 3D dynamic models in 3D DGEs, these representations are also important stimuli of student perception, facilitating or raising challenges for student visualization (Clements & Battista, 1992; Parzysz, 1988, 1991). While performing the coordination behavior, the teacher also needs to take into account the characteristics of these representations.

-
- Exchange with colleagues/discipline coordinators/school leaders on how to design and use 3D DGEs in the lessons of 3D geometry, and how to balance the role of perception with external figural representations and the role of logical reasoning in this domain.
 - Students' class performances related to perception and logical reasoning in 3D geometry
Students' perception and logical reasoning are what the teacher will mainly monitor while performing the coordination. According to students' performances and difficulties in these aspects shown in the class, the teacher's coordination behavior will probably be varied.

The general resources that could influence teachers' coordination behavior include:

- Dynamic geometric software (e.g., GeoGebra, Cabri 3D) and availability of the supporting hardware (e.g., computer and overhead projector) in the teaching setting

Since the dynamic geometric software constitutes the base of the curriculum resource – 3D DGEs, the availability of the software and the related hardware determines whether and how 3D DGEs can be used, and thus has a relation with teachers' coordination behavior. The innate potentialities and constraints of the dynamic geometric software itself set a boundary for the potentialities and constraints of the 3D DGEs.

- Spatial layout of the teaching setting

The spatial layout concerns the positions of all the students, the teacher and the educational equipment in the teaching setting. It determines what forms of interactions are allowed (Engelbrecht et al., 2020). If a teacher cannot make gestures in a lesson, she would have less methods to support students' perception; if the simultaneous teacher-student interactions are not possible, there may be less informal ideas appearing in the lesson. All these could influence teachers' coordination behavior.

- Availability of on-site technological support related to the dynamic geometric software and the supporting hardware

The use of 3D DGEs (and possibly other digital curriculum resources) puts high demands on teachers' technological skills of operating the dynamic geometric software and the related supporting hardware. If teachers feel that they are not able to cope with unexpected technical problems or perform the technological operations skillfully, they may avoid using digital technologies in their lessons (Pierce & Ball, 2009), and the digital technologies can certainly include 3D DGEs. Here the availability of the on-site technological support would influence a teacher's feelings about the difficulty of behavior control in integrating 3D DGEs, which would further influence her choices of using 3D DGEs and coordination behavior.

- Availability of time for learning about, designing and using 3D DGEs

If the time is limited, teachers may not spend much time in learning the technological knowledge related to 3D DGEs or designing them. Instead, they would probably take profit of what they have at hand and implement the coordination on that basis. Also, with limited lesson time, a teacher may be reluctant to use 3D DGEs or give students opportunities to explore them, which may lead to a falling proportion of the perceptive elements or the non-deductive logical reasoning in the coordination behavior.

2.4.3 Third group of factors: social-cultural factors

The coordination behavior, as a kind of professional practice of teachers, is inevitably influenced by the social-cultural factors of a country. The factors include values and expectations of the society (Pierce & Ball, 2009), administrative policies and regulations (Bonnat et al., 2020), classroom cultures, didactics tradition of mathematics (including curriculum tradition) (Klieme & Baumert, 2001).

The social-cultural factors likely to influence teachers' coordination behavior in 3D geometry should be what could influence their views about the roles of perception with figural representations and logical reasoning in 3D geometry. Here we only mention two of them:

- Social expectations and values concerning how to teach 3D geometry

Here the social expectations mainly refer to the opinions of colleagues, school and discipline principles, teacher educators, teaching inspectors, and the criteria of teacher evaluations in a country. Research shows that these expectations and the values attached to different ways of teaching would influence a teacher's subjective norms, putting some pressure on them to perform or not a particular behavior in class (Pierce & Ball, 2009), and this may also apply to the coordination behavior. For example, if the head of the discipline thinks that it is important for students to solve 3D geometry tasks and imagine the 3D figures without the help of technologies, a teacher may avoid using 3D DGEs too and support students' perception and logical reasoning through other means.

- Tradition of teaching 3D geometry in a country

The influence of the tradition of teaching 3D geometry is easy to understand: if rigorous geometric proof is always emphasized in the tradition of a country, we can expect to see the important status of theoretical deductive reasoning in the teachers' coordination behavior; if the tradition is practice-oriented, we can expect that more elements which are informal but efficient for solving tasks, like inductive reasoning based on perceptive evidences, would be emphasized in the teachers' coordination behavior.

2.5 Focus on some factors to formulate preliminary research questions

Since there is a number of factors potentially influencing teachers' coordination behavior, it is impossible to investigate them all. In this section, we explain our interest in particular influencing factors presented in section 2.4, and formulate the preliminary version of research questions on that basis.

We first set our sights on 3D geometry tasks, because one important goal of the coordination behavior in this thesis is to help students solve tasks, balancing the validity of different modes of logical reasoning for solving the tasks and the benefit of them for student visualization. Furthermore, in mathematics education, tasks play an important role in teaching activities, sometimes a teaching scenario is directly constituted by a series of tasks with increasing levels of difficulty (Watson & Ohtani, 2015). Examining how experienced teachers develop their coordination behavior in face of different mathematics tasks (in this thesis the 3D geometry tasks) can thus provide valuable implications for in-service teachers' practice. Apart from 3D geometry tasks, the 3D DGEs used together with some tasks are also worth noticing. The

affordances and constraints of 3D DGEs for student perception and logical reasoning determine “how far” teachers’ coordination can go, and it is especially the intervention of 3D DGEs that makes teachers’ coordination essential and challenging. This motivates our first choice: to investigate the relations between characteristics of the two curriculum resources – 3D geometry tasks and 3D DGEs – and the coordination behavior of experienced teachers (at least in using 3D DGEs).

We secondly set sights on the internal teacher-related factors – teachers’ knowledge and views, because they fundamentally determine whether and how a teacher will perform coordination behavior. This factor can further explain why a teacher’s coordination behavior can be varied according to the characteristics of 3D geometry tasks-3D DGEs. For example, if a teacher does not appreciate the value of 3D DGEs for visual display, she may not evoke too many perceptive effects in 3D DGEs in their coordination. Teachers’ knowledge and views are also relevant to the design or adaptation of the curriculum resources themselves, when there are no proper 3D geometry tasks or 3D DGEs available. What’s more, many other influencing factors, such as the (availability of) general teaching resources and the social-cultural factors need to be firstly perceived by a teacher to have an effect on her coordination behavior (Hennessy et al., 2005; Pierce & Ball, 2009; Schoenfeld, 2011; Thomas & Palmer, 2014). All these motivate our choice to investigate the relation between the knowledge and views of experienced teachers and their coordination behavior, with the prospect of informing the design of related teacher training projects.

Finally, the outbreak of Covid-19 epidemic has forced the teachers in most of the countries to transit from real classrooms to distance online settings. In real classrooms the lessons are given in a face-to-face, synchronous way; whilst in the distance online settings the lessons can be given either synchronously or asynchronously, but the teacher and the students are always distant from each other (Albano et al., 2021). Also, some teaching resources available in real classrooms and are important for teachers’ coordination (e.g., gestures, 3D real models) would become more difficult to demonstrate in distance online settings (Engelbrecht et al., 2020), with some new resources and facilities appearing (Albano et al., 2021). Hence, it shall be interesting to investigate how the change of teaching setting can influence the teacher’s coordination behavior. At the same time, we should be careful about the interaction between the change of teaching setting and the factors that have been mentioned previously. For example, the change of teaching setting may firstly lead to the teacher’s adjustment of the 3D geometry tasks and 3D DGEs and then influence her coordination behavior, and the transformation of the coordination behavior may go along with an update of her knowledge and views.

Based on the discussions above, we formulate the preliminary version of the research questions.

- (1) In real classroom teaching, what coordination behavior does a teacher mobilize when s/he is helping students solve 3D geometry tasks and using 3D DGEs? What teacher knowledge and views are underpinning this coordination behavior? To what extent can the coordination behavior be influenced by the characteristics of the 3D geometry tasks-3D DGEs?
- (2) In distance online teaching during the Covid-19 epidemic, how can the 3D geometry tasks-3D DGEs used by a teacher and the coordination behavior be different from those

in real classroom teaching? How have the knowledge and views of the teacher been updated to support the renewed coordination behavior? To what extent can the differences be attributed to the epidemic?

3 Theoretical framework and reformulated research questions

In this section we propose a theoretical framework to better understand the research questions formulated in section 2.5 and inform the methodological design of this research. First of all, the Documentational Approach to Didactics (DAD, Trouche et al., 2020) serves as a backbone of the framework as it can integrate 3D geometry tasks and 3D DGEs, teachers' coordination behavior, and their knowledge and views into a coherent unity. On that basis, the necessity to characterize the 3D geometry tasks-3D DGEs, the coordination behavior, and the knowledge and views in a more refined way leads us to searching for other theoretical constructs as a complement.

After this introduction, we present five sections: section 3.1 introduces the general frame of DAD and some specific concepts connected with this thesis; section 3.2 presents the reformulated research questions in terms of the DAD concepts; section 3.3 addresses the issues of characterizing 3D geometry tasks and 3D DGEs; and in sections 3.4 and 3.5, we respectively construct two sub-frameworks for teachers' coordination behavior and teachers' knowledge and views. All these constructs are combined together to constitute the global framework for the research reported in this thesis.

3.1 Documentational Approach to Didactics (DAD)

This section is divided into four parts: in section 3.1.1 we introduce the origin of DAD and some main concepts in this theory; in section 3.1.2 we deepen the concept of situation in DAD; in section 3.1.3, we connect the framework of DAD to the problematic of this thesis; in section 3.1.4 we integrate some new notions into DAD to better meet the need of research of this thesis.

3.1.1 Origin and main content of DAD

The Documentational Approach to Didactics (DAD, Trouche et al., 2020) was firstly proposed in (Gueudet & Trouche, 2009). At that time, a large number of digital teaching resources have emerged in the working environment of mathematics teachers, but teachers themselves usually have difficulties in choosing the most didactically suitable resources and using them properly for mathematics teaching. The DAD was introduced in reaction to this phenomenon, investigating teachers' work with resources, including selecting, modifying, creating and using of resources in-class and out-of-class, and this creative work is globally termed as teachers' documentation work (Trouche et al., 2020). DAD also has a particular interest in digital resources, but this interest "is not directed towards the promotion of such resources; it is meant to shed light on the use of resources as a whole, including digital and non-digital pieces" (Gueudet & Trouche, 2009, p. 200). While being originally dedicated to the investigation of teachers' work, DAD is also used by researchers later to study the work of teacher educators (Psycharis & Kalogeria, 2018) or students' interactions with resources (Kock & Pepin, 2018). In this thesis we only talk about the DAD with respect to teachers' work.

As a theory emerging in the French community, DAD is naturally grounded in the French didactics tradition in mathematics (Trouche, 2016). In addition, a main foundation for DAD is the instrumental approach to mathematics didactics (Guin et al., 2005; Trouche, 2003), which

is itself built from the *instrumental approach* proposed by Rabardel (1995). The author distinguishes between artifact and instrument. According to him, an *artifact* is a cultural and social means provided by human activity to mediate another human activity, including materials (e.g. a computer) and languages; while an *instrument* is built from the artifact by a subject through his/her goal-directed activity. The process of generating an instrument is defined as *instrumental genesis*; it concerns the interaction between the subject and the artifact and consists of two dialectic processes – *instrumentation* and *instrumentalisation*. DAD keeps these ideas and structure, and replaces the *artifact* by a set of *resources* to respond to the need of research in the information and digital era with easy and quick access to various forms of resources. Furthermore, DAD adopts a broader view on the *resources* in light of Alder’s proposition of “think(ing) of the resource as the verb re-source, to source again or differently” (Adler, 2000, p. 207). With this idea, *resources* in DAD span a wide spectrum, including any resource that has the potential to support and shape teachers’ practice in- and out-of-class (e.g. textbooks, general instructional technologies like GeoGebra, courseware designed with instructional technologies like GeoGebra files or other 3D DGEs, colleague conversations in the office or on the web, student worksheets, knowledge framework presented to students). Furthermore, these resources can get renewed in/by the teachers’ practice to serve for their work next time.

Based on the definition of resources, we now introduce the definitions of other critical concepts in DAD.

During the interaction with a particular *resource* or a set of *resources*, a teacher develops a *scheme of usage* with these resources for the same class of situations (a notion elaborated on in section 3.1.2) across a variety of contexts, and generates a *document* as outcome. That is:

$$\text{resources} + \text{scheme of usage} = \text{document}$$

The *scheme* in the formula comes from Vergnaud (1998), meaning a subject’s invariant organization of activities for a given class of situations. The schemes developed are likely to be different according to different teachers, although they may use the same resource, depending on their dispositions and knowledge.

The process of developing a document from the resource/s (with one scheme of usage) is coined a *documentational genesis* (Trouche et al., 2020). This process works in two ways: as shown in Fig. 3.1, on the one hand, the affordances and constraints of the resource/s influence or shape teachers’ practice, that is the *instrumentation* process; on the other hand, teachers’ dispositions, knowledge and views guide their choices, appropriation and transformation of resources, that is the *instrumentalisation* process. These processes include the design or re-design of the resources in preparation for teaching, or “design-in-use” practices (the teacher changes a document according to her emerging instructional needs “in the moment” of using the document in teaching). The concepts of instrumentation and instrumentalisation emphasize the dialectic nature of the teacher-resource interactions, and also show that the “use” of resources is viewed as an interactive and potentially transformative process in DAD (Trouche et al., 2020).

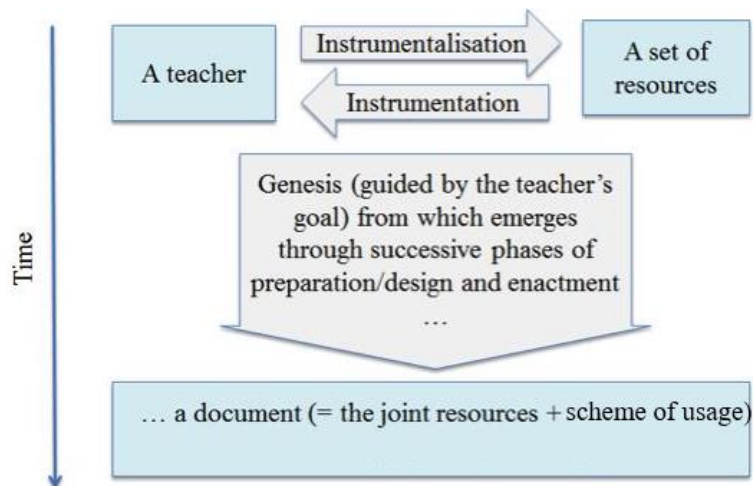


Fig. 3.1 A representation of documentational genesis, adapted from (Trouche et al., 2020, p. 240)

Now we elaborate on the concept of scheme, which is borrowed from the theory of conceptual fields (Vergnaud, 1996, 1998, 2009). Vergnaud redefined the scheme, firstly introduced by Piaget, as the “invariant organization of activity for a given class of situations” and “a functional dynamic totality” (Vergnaud, 2009, p. 88). According to Vergnaud (1998), “The main role of the schemes is to generalize efficient behavior to new objects” (p. 228). Furthermore, Vergnaud (2009) claims that “Schemes allow an individual to assimilate new situations by accommodating to them” (p. 88). To understand the functions and the dynamics of the scheme, we should know about the four components of a scheme: the goal of the activity, the rules of action, the operational invariants and the possibilities of inferences.

Goal of the activity. “A scheme always applies to a class of situation in which the subject can identify a possible target for his/her activity, and sometimes intermediary sub-targets too” (Vergnaud 1996, p. 189).

Rules of action. The generative part of the scheme that “generates the behavior as a functional outcome depending on some situation variables” (Vergnaud, 1998, p. 229), “engendering a series of activities aimed at transforming reality, seeking information and controlling the outcome of the activities; this makes it possible to ensure the success of the activity in a context that may be constantly evolving” (Vergnaud 1996, p. 189).

Operational invariants. The epistemic aspect of the scheme, the implicit conceptual basis which allows a subject to “pick up and select the relevant information and infer from it goals and rules of action” (Vergnaud, 2009, p. 88). There are mainly two kinds of operational invariants: concept-in-action and theorem-in-action: “A theorem-in-action is a proposition concerning reality which is held to be true; and a concept-in-action is a category of thought that is held to be relevant” (Vergnaud, 1996, p. 189).

Possibilities of inferences. The intense computational activities in the subject’s thinking which involves seeking for alternative rules of action or making choices among different possible rules of action that can apply to a situation (Vergnaud, 2009). They will probably lead to a correspondence between a class of situations and several different rules of actions established in the subject’s mind.

From the definitions above, we know that the rules of action are directly linked with the behavior aspect in a subject's activity; they can approximately be considered as the properties of techniques or the regularities in the behavior allowing the subject to reach the goal.

Trouche (2004) compares a scheme to an iceberg: the emerged part being the gestures, and the submerged part being the operational invariants. He pointed out the dialectic relationship between gestures and operational invariants: "operative invariants involved in the scheme guide the gestures and, at the same time, the repetition of such gestures, in a given environment, installs in the mind a particular knowledge" (ibid, p. 286). The gestures here, defined as an elementary piece of behavior that may be observed (Trouche, 2004), can be seen as a unit of the rules of action. Hence the dialectic relationship also reflects the relationship between the rules of action and the operational invariants.

Among the four components of a scheme, operational invariants are emphasized most:

Why are operational invariants so crucial? Because action is always efficient under certain conditions; because action is driven by rules of the form 'if C_1, C_2, \dots then $A_k, \dots A_j$ '; and finally, because the possibility for such rules to emerge would not be understandable if there were no cognitive categories to analyze these conditions, to analyze the relationships between goals, conditions and actions (Vergnaud 1998, p. 230).

According to Vergnaud (1996), the analysis of the conditions, which mainly concerns categorizing, seeking for and selecting information in a situation, is based on the system of concepts-in-action at the disposal of the subject; the analysis of the relationships between goals, conditions and rules of actions is based on theorems-in-action of the subject.

Vergnaud (2009) presents examples of schemes of students for doing mathematics activities, in which the concepts-in-action are all about students' knowledge of mathematics concepts and properties (e.g., the concept of cardinal, invariant properties of symmetry), and the only theorem-in-action being given is about student understanding of the rules of inverting a transformation (e.g., inverting the increase of 7 by subtracting 7 from the final result). In the DAD entry in the Encyclopedia of Mathematics Education, Trouche et al. (2020) identify some operational invariants of a teacher, who asked students to discover on their own the principles of using an abacus in a grade 3 class. The related operational invariants include a theorem-in-action like "the students must discover by themselves as far as possible the new tools they meet" (Trouche et al., 2020, p. 242) and a concept-in-action about "self-discovery" (Trouche et al., 2020, p. 242). Combining these examples with the definition of operational invariants presented above, we can see that these elements of operational invariants, whether concepts-in-action or theorems-in-action, are mostly concerned with the subject's knowledge, understanding, and views about the activities s/he is engaging with, and the boundaries between knowledge and views are kind of blurred.

In DAD, and also in Vergnaud's work, a scheme is defined in connection with *a class of situations*. Vergnaud highlights the necessity of taking into account the *situation* of a subject's activities:

In his operatory theory of representation: Piaget speaks of subject-object interaction, when he could have been more precise and spoken of the scheme-situation interaction. A theory of representation needs a theory of reference, and the reference does not consist only of

objects and their properties but also of situations in which his or her activity is involved, and which provide him/her with the basis for organization of his/her activity (Vergnaud, 1996, p. 190).

From the expression above we know that a *situation* is what provides basis for the subject's organization of his/her activities. Later, Vergnaud (2013) points out that the identity of a *situation* is dependent on the identity of a scheme: "there is no scheme without a *situation*, and no *situation* without a scheme" (ibid, p.50). In the context of DAD, Trouche et al. (2020) use the expression *a class of situations* to designate a set of professional situations corresponding to the same aim of activity, and propose "managing the heterogeneity of the grade 8 class" (ibid, p.241) as one example of a class of situations. However, up to now we still cannot see what elements should be included in a *situation* or a *class of situations* in general. For example, should a mathematics task, a software, or any other elements in the teaching and learning environment matter as important elements in a situation for mathematics teachers with the aim of supporting students' coordination? This is relevant to our discussion about the characteristics of mathematics tasks and 3D DGEs likely to influence teachers' coordination later on.

3.1.2 Concept of situation in connection with 3D geometry tasks and 3D DGEs

Now we clarify the notion of situation in DAD. Here we only consider mathematics teachers' professional situations, which correspond to the aim of supporting students' coordination in mathematics. We hypothesize the elements by drawing on the Theory of Didactical Situations (TSD, Brousseau, 2002) in mathematics which is also rooted in the French research community, paying attention to the nuances between the concepts of the situation in the two theories, DAD and TSD.

The TSD in mathematics education, firstly introduced in the 1970s (Brousseau, 1978), is a theory modelling the conditions under which human beings diffuse and acquire mathematics knowledge. The *didactical situation*, as a key concept in the theory, refers to a circumstance encompassing (i) the teacher, (ii) an *adidactical situation* that encompasses students, (iii) a *milieu* and their interaction, and (iv) other possible conditions created by the teacher to support student learning (Brousseau, 2002). The *milieu* is a learning environment (1) upon which the subject (here the students) can act, (2) from which the subject can receive information and (3) which can react to students' actions (Margolinas, 2004). The core element in the *milieu* is a "game" chosen by the teacher for which the target knowledge is related to the essential winning strategy. The "game" is also called "mathematics task" or "mathematics problem" in later studies, and the targeted mathematics knowledge provides the appropriate solution for such a task. Therefore, a mathematics task, as the core of the *milieu*, can be an important element in the adidactical situation. In addition, some digital educational technologies equipped with a feedback system can also count as an important element in the *milieu* and thus be included in the adidactical situation (Laborde & Capponi, 1994). By interacting with the *milieu* and comparing their expectations with the feedback to their actions provided by the *milieu*, students can gradually refine their actions and mathematical understanding, learning the target knowledge autonomously in the adidactical situation (Brousseau, 2002).

The above is only about the elements in the adidactical situation which is related to students, but we are more concerned with the didactical situation for teachers. In fact, the "teacher" was

already an element in the didactical situation of TSD at the beginning, but at that time Brousseau concentrated more on the adidactical situations for students (i.e., the adidactical part in the didactical situation), supposing that a well-designed adidactical situation would make students learn autonomously. As time goes by, the significant role of the teacher is more and more recognized. As Brousseau (1997) later claimed, while making students face an adidactical situation, a teacher herself is facing a didactical situation in which she is interacting with the whole system of student-*milieu* (the adidactical situation). Brousseau considers the whole system of interactions as a *milieu* for the teacher, who will react to the *milieu* through her actions, knowledge and skills. Margolinas (2002) labels the didactical situation and the *milieu* for the teacher respectively as S0 and M0, taking them as the basic situation and *milieu* that concern activities in-class and further identifies some situations for the teacher beyond the level of the class. Margolinas (2004) gave an example about how a teacher can interact with the M0 in a didactical situation S0: the teacher poses mathematics tasks to students, creates a system of conditions to ensure students solve the mathematics tasks in the adidactical situation (M0) as independently as possible, and constantly adjusts the task posed when the information received from M0, such as students' answers to the mathematics tasks, does not match his/her anticipation. We provide Fig. 3.2 to illustrate the structure of S0.

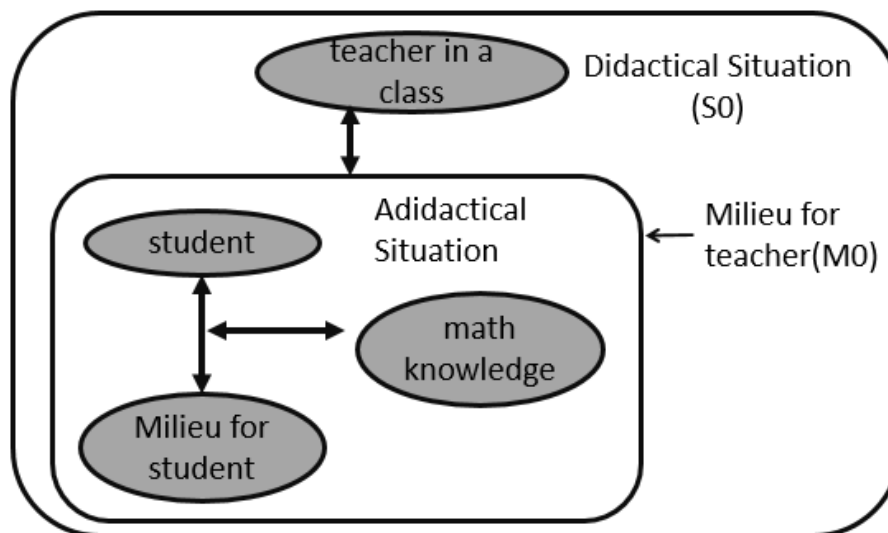


Fig. 3.2 Didactical situation in TSD, adapted from (Margolinas, 2004, p. 4)

Contrasting the didactical situation in TSD and the professional situation for teachers in DAD, we can see that, although the role of the teacher is getting more emphasized in TSD, the constructivist tradition remains predominant in the didactical situations: the teacher always tries to enable students learn autonomously within the adidactical situation, and within the didactical situation, the teacher herself tries to manage the adidactical situation. This is different from the professional situation in DAD in which there is no particular didactical approach privileged; the teaching activities in a situation in DAD can be either a lecture-type transmission of knowledge, or based on constructivist principles. However, one commonality of TSD situations and DAD situations is that they are both underpinned by a particular aim of the teacher. In TSD the aim is always about supporting students' learning of a mathematics

knowledge which is characterized by tasks; in DAD the aim can be either mathematics specific or not (like the situation of “managing the heterogeneity of the grade 8 class” mentioned in section 3.1.1). In the frame of DAD, we mainly consider in this thesis the professional situations corresponding to the aim of coordination, that is to support students’ coordination of perception and logical reasoning in mathematics – what falls in the scope of supporting students’ learning of mathematics topics. This renders the situation in DAD comparable to didactical situations in TSD, and thus some elements in the latter which are not specific to the constructivist approach and meanwhile can influence teachers’ coordination can be transferred to the former. The elements can be a mathematics task, and dynamic visual display technology such as 3D DGE.

Besides the *milieu*, the didactical situation in TSD also includes conditions that support a smooth operation of the system of student-*milieu* interaction and finally support students’ learning. Therefore, some conditions shaping students’ learning which are not specific to the constructivist approach and meanwhile can influence teachers’ coordination can also be counted as critical elements in the situation in DAD. The conditions include: substance of the classroom (a real classroom, or a virtual online one), technological and non-technological material equipment and their distribution in the classroom (e.g., tables, blackboard, overhead projector, and computers for individual students or only for the teacher), and form of organization of teaching activities (teaching towards individual students, groups of students, or the whole class of students). All these will be called uniformly the *teaching setting* of a class.

Based on the discussions above, we consider the “dynamic visual technology” (technology with functionalities of dynamic visual display), the “teaching setting” and the “mathematics task” as three critical elements in the professional situation in DAD corresponding to the aim of coordination. One example of such a situation could be supporting students’ coordination with respect to certain 3D geometry tasks in a teaching setting in which all the computers are equipped with 3D DGEs and accessible for students. However, these are just our hypotheses. In this study, the elements in a situation and a class of situations are determined only after one scheme of the teacher has been identified. All the mathematics tasks, dynamic visual display technologies, teaching settings, and other elements that are relevant to this scheme (excluding the scheme itself) will be gathered together to constitute a class of situations. Accordingly, the mathematics tasks involved in the same class of situations are put into one group, referred to as “a group of tasks”.

The concept of situation brings the issue of situation variables. Vergnaud considered the rules of action as a function of some “situation variables” (Vergnaud, 1998, p. 229), which seems to be linked with the relevant differences between classes of situations that affect the actions generated by the subject in the corresponding schemes, but the precise definition of the notion was not given by Vergnaud. In TSD, there does exist the concept of *didactical variable*, which refers to a variable at the disposal of the teacher whose relevant values can change the optimal strategy for winning the “game” or solving the mathematics task in a situation, and further change the target mathematics knowledge to be learned (Brousseau, 2002). According to Brousseau, the values of certain pertinent didactical variables constitute the characteristics of a “game”, and these variables need to be determined according to the teacher’s particular didactical objective in every didactical situation. As can be seen, didactical variables in TSD

are essentially related to a game, or a mathematics task, and they determine what target mathematics knowledge students can learn by solving the task.

Combining Vergnaud's notion of situation variable with the definition of didactical variable in TSD, we consider variables in a professional situation in DAD as the variables whose relevant values can affect the teacher's corresponding actions. In this thesis, we focus on the situation variables whose relevant values can change teachers' coordination behavior in support of students' coordination of perception and logical reasoning in mathematics. From the previous discussions in section 2.4, we know that there are many factors likely to affect teachers' coordination behavior and what we will focus on in this thesis are the characteristics of 3D geometry tasks and the characteristics of 3D DGEs. A task and a 3D DGE are also the elements taken into account in the DAD situations investigated in this thesis; in addition, there is the element of teaching setting and other possibly relevant elements. Hence we distinguish between four groups of variables in a DAD situation here: variables in the mathematics task, variables in the dynamic visual technology, variables in the teaching setting, and variables in other relevant elements in the situation. In this thesis, we only consider 3D geometry tasks for the "mathematics task", and only consider 3D DGEs for the "dynamic visual technology". Then we focus on the variables in the 3D geometry task, variables in the 3D DGE, variables in the teaching setting, and variables in other relevant elements.

As regards a 3D geometry task, we identify three variables relevant to teachers' coordination according to the literature (will be specified in section 3.3.1): (1) 3D geometry topic of the task, (2) status of the task in the curriculum and important examination, and (3) context of and innate support in the task. These are the variables at the first level. For each 3D geometry topic of a task, we further identify several variables within the topic to consider the content of the topic in more detail; these are the variables at the second level. We will elaborate on these variables and their possible values in section 3.3.1, referring to the literature to explain why they are relevant to teachers' coordination. The variables are exactly the dimensions according to which we will analyze the characteristics of 3D geometry tasks in this thesis. That is, for a 3D geometry task, the values of the first and the second levels of variables together constitute its characteristics.

As regards a 3D DGE, we identify four variables relevant to teachers' coordination according to the literature (will be specified in section 3.3.2): (1) figural representations and tools in the 3D DGE, (2) help and control in 3D DGE, (3) feedback in 3D DGE, and (4) curricular distance of 3D DGE. Similarly, we will elaborate on these variables and their possible values in section 3.3.2, and the variables are the dimensions according to which we will analyze the characteristics of a 3D DGE in this thesis. That is, for a 3D DGE, the values of these variables constitute its characteristics.

Fig. 3.3 illustrates the hierarchy of the variables in a 3D geometry task in contrast the variables in a 3D DGE.

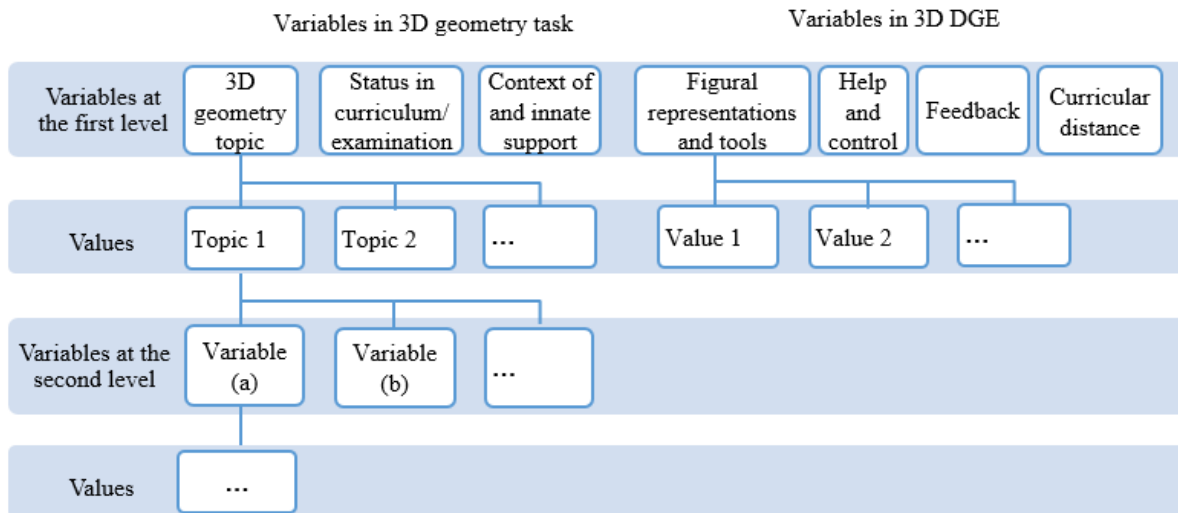


Fig. 3.3 Hierarchy of the variables in a 3D geometry task in contrast to the variables in a 3D DGE

As regards a teaching setting, according to the discussions above, the variables include: substance of the classroom, technological or non-technological material equipment in the classroom, and form of organization of teaching activities. Combining the three variables together, with particular values assigned to them respectively, we can get different kinds of teaching settings. Instead of giving possible values of the variables, we directly consider three teaching settings, which are enough to cover the teaching settings encountered in this thesis:

- ordinary real classroom: the classroom is a real one with a computer and a projector; only the teacher has access to the computer; all the students are facing towards the blackboard and the screen to which the computer screen is projected;
- computer real classroom: the classroom is a real one; both the teacher and individual students have access to a computer; students are seated in rows or a circle;
- distance online setting: the classroom is a virtual online one; both the teacher and individual students have access to a technological device for connecting the online classroom; the teacher and every student are located at different places;

As regards other relevant elements, the variables therein will only be determined after we have identified one particular class of situations every time. As these variables are not of interest in this thesis, we will not explore them and focus on the variables related the first three elements. We mainly refer to the variables in the 3D geometry task to distinguish between *the same*, *close* and *distant* classes of situations. This will be elaborated on in section 3.1.4.

3.1.3 Interest of DAD and concept of coordination scheme

The framework of DAD satisfies the interests of this thesis in several aspects.

Firstly, DAD integrates regularities in teachers' behavior and knowledge and views into a systematic entity – scheme of usage, with the behavior and knowledge and views respectively corresponding to the rules of actions and operational invariants therein. The scheme of usage is further linked with a class of situations that contains 3D DGEs, 3D geometry tasks, teaching settings and other relevant elements. These specificities make DAD suitable for investigating

the link of teachers' coordination behavior with 3D geometry tasks-3D DGEs. Secondly, the concept of operational invariants implies both the knowledge and views of teachers, satisfying our need to investigate the teacher knowledge and views together without clearly distinguishing between the two. Thirdly, DAD pays specific attention to the ongoing development of the scheme of usage of the teacher, taking it as the result of the documentational genesis in which the teacher is supposed to interact with the resources at her disposal. This matches well our interest in the transformation of teachers' coordination behavior and knowledge and views from real classroom teaching to distance online teaching, and teachers' specific interaction with the resource – distance online setting – during the transition. Finally, as already mentioned in 3.1.2, DAD does not privilege a particular didactical approach; the teaching activity in a professional situation can be either a lecture-type transmission of knowledge, or supporting students' self-discovery based on the constructivist principles. This makes DAD, though originated in France, also applicable to investigate the professional work of Chinese mathematics teachers (Pepin et al., 2017; Wang, 2019).

In this thesis, we consider teachers' coordination behavior as the behavior corresponding to the “common goal” of supporting students' coordination of their perception and logical reasoning; we are particularly interested in their coordination behavior in 3D DGE integrated 3D geometry lessons. However, this common goal may not be perceived by the teacher him/herself in the 3D geometry lessons. It is just introduced from a researcher's perspective with the theoretical construct of *coordination*. From the teacher's own perspective, there would exist many other goals for a 3D geometry lesson, e.g., consolidate students' knowledge, improve students' ability of proving or motivate students' interest in learning. All these goals correspond to different lens of looking at teachers' in-class activities and can be seen as sub-goals involved in a teacher's overarching didactical goal for the lesson. The relationships among the sub-goals are complex (one sub-goal may contain or overlap with another one) and go beyond the scope of this thesis. Here we focus merely on one of the sub-goals – supporting students' coordination, and rename the *scheme* with this sub-goal as the *coordination scheme*. Accordingly, the *rules of action* in the coordination scheme are renamed *rules of coordination*.

Looking back at the first group of research questions in section 2.5, they are concerned with teachers' coordination behavior in real classrooms, their relations with the characteristics of 3D geometry tasks-3D DGEs being used, and the teachers' knowledge and views. The regularities in teachers' coordination behavior and the knowledge and views can respectively be conceptualized as *rules of coordination* and *operational invariants* in the *coordination scheme* developed by the teacher for *a class of situations*, which include 3D geometry tasks, 3D DGEs and other elements relevant to the coordination scheme. Therefore, the first group of research questions are actually about the relations between teachers' coordination schemes and the characteristics of the 3D geometry tasks-3D DGEs in the corresponding classes of situations in real classrooms. Here we retain the hierarchy in the previous version of questions in section 2.5, firstly investigating the links between the rules of coordination and the different operational invariants within the same coordination schemes, and secondly investigating how the rules of coordination can be influenced by the characteristics of the 3D geometry tasks and 3D DGEs, with the operational invariants as evidences for the influence identified.

As for another component of the scheme – the *possibilities of inferences*, it is also a concept worth investigating as it reveals how a teacher adapts the existing rules of coordination to the specific features of a newly encountered situation, leads to some new actions in place of original rules of coordination, and finally establishes a link between a larger class of situations and the rules of coordination with some possibilities of inferences. To avoid a too complex discussion going beyond the interest of this research, we focus on the rules of coordination and operational invariants in every coordination scheme and only discuss the possibilities of inferences when a teacher develops specific actions, for one or two tasks, in place of some of the rules of coordination in that scheme.

The second group of research questions in section 2.5 are concerned with the transformation of teachers' coordination behavior and the related knowledge and views when they move from real classrooms to distance online teaching settings due to the Covid-19 epidemic, with the 3D geometry tasks and the 3D DGEs remaining the same or not. The transformation can be conceptualized as the transformation of the *rules of coordination* and the *operational invariants* in teachers' *coordination schemes*, and the transformation due to the change of teaching setting can be considered as a result of the *documentational geneses* with respect to the classes of situations related to distance online teaching. Through the documentational geneses, teachers are supposed to interact with the new resource condition, including both constraints and affordances, in the online environment. To avoid an overly complex discussion, and given that the teachers involved in this study all stick to the normal curriculum during the epidemic period, we decide to focus on the teachers' coordination activities under similar 3D geometry tasks. That is, we focus on every pair of classes of situations which involve similar 3D geometry tasks but different teaching settings (real classrooms and distance online settings respectively), to investigate how the documentational genesis in the online environment has led to the variations in the 3D DGEs used by the teacher, and the transformation of her coordination scheme between the two classes of situations in this pair.

In this thesis, we take one *lesson series* on Euclidean 3D geometry as a unit to identify one version of a coordination scheme, taking the state of the scheme at the end of the lesson series as one version of the scheme. It is the researcher's own choice to capture the state of a scheme at some moment as one version of the scheme; these versions do not necessarily exist innately in the continuous evolution process of a scheme. With this choice, we can identify the consecutive versions of a same scheme from several lesson series if they cover the same class of situations. In addition, each lesson series may cover different classes of situations for which different coordination schemes can be identified.

In this thesis, one *lesson series* consists of several (not necessarily consecutive) 3D DGE-integrated lessons that take place during a short period (usually two or three weeks, see section 4.3.1 for more detail) when a teacher teaches 3D geometry intensively. The interval between two lesson series on 3D geometry may be several months in which the teacher will teach other mathematics domains such as 2D geometry, vectors, functions or even statistics.

Within each lesson series, a teacher is directly teaching 3D geometry with 3D DGEs, that is, she will directly undertake the coordination behavior and develop some behavior regularities; what can be identified as the "direct" development of coordination schemes. Whereas during the interval between two lesson series, a teacher will not directly teach 3D geometry but may

still reflect on how to improve the way of teaching 3D geometry, which may lead to the different coordination behavior in the subsequent lesson series; this implicit reflection process can be considered as the “indirect” development of coordination schemes. The differences between the “direct” and “indirect” development of coordination schemes make it necessary to distinguish between *direct* and *indirect* documentational geneses; that is what we will discuss in the next section.

3.1.4 New concepts: direct/indirect documentational genesis and the same/close/distant classes of situations

In DAD, every scheme of usage related to a document needs time to develop, through one ongoing documentational genesis, and stays in a dynamic equilibrium (Trouche et al., 2020). We distinguish between two states that one single documentational genesis can have in different periods – the direct and the indirect geneses – which will both lead to an updated version of the scheme being developed.

The *direct documentational genesis* related to a scheme or class of situations, is the genesis that a teacher is supposed to engage with while she is directly undertaking actions related to the scheme, or directly faced the corresponding class of situations. A teacher adapts the actions from time to time while undertaking them and gradually stabilizes the actions into a version of scheme for a class of situations; we call this process a *direct documentational genesis*.

When the teacher meets with the “same” class of situations again, the direct documentational genesis is supposed to start from the version of the scheme that has been developed. When the teacher meets with new situations, in the direct documentational genesis she is supposed draw inspiration from the schemes for a previous class of situations which is similar, or in another word, “close” to the current situations. That is, the teacher might transfer or adapt the regular actions and knowledge and views related to a previous scheme to face the current situations. Vergnaud (2013) once described the process of learning from a previous scheme as taking into account what is to be varied and what is not in the previous scheme, “a process that demands for generalization and analogical reasoning” (p. 49). It is thus a conscious learning process involved in the direct documentational genesis.

Vergnaud also talked about the assimilation of new situations into a previous class of situations, with the similarities between the former and the latter being the relation node. He proposed that the previous and new schemes for two similar (or “close”) classes of situations can be combined into a more general scheme, with the scope of application extended to a *super class* of situations parenthesizing both the previous and new classes of situations (Vergnaud, 2013). In this thesis we will not go further to consider a *super class* of situations, just taking the previous and new classes of situations as two separated classes, in order to compare the corresponding schemes.

The *indirect documentational genesis* related to a scheme or class of situations, is the genesis that a teacher is supposed to engage with when she is NOT directly undertaking the actions related to the scheme, or NOT directly facing the class of situations. In this case, the other activities that the teacher is undertaking will possibly trigger the teacher’s reflection on the actions and knowledge and views related to the previous scheme. For example, the teacher can be in a training or teaching research project, communicating with discipline coordinators, or directly undertaking actions for another class of situations about teaching functions. All these

could provide the teacher with inspiration on how to improve the actions and knowledge and views related to the scheme for teaching 3D geometry. This inspiration is supposed to lead to the renewed scheme of the teacher when she is directly facing the class of situations about teaching 3D geometry. The word “trigger” is used to mean that such reflection may not be what the teacher seeks for consciously. Therefore, we suppose that while not directly facing a class of situations, the teacher would possibly develop an implicit new version of scheme. The new version of the scheme is supposed to be the starting point of the teacher’s activities when she directly encounters the corresponding class of situations, and she is supposed to continue with a direct genesis since then, transforming the new version of scheme into an even newer version. We clarify that both the direct and the indirect documental geneses are evoked with respect to one scheme: while engaging with a direct genesis related to scheme A, a teacher could meanwhile be engaged with the indirect genesis related to scheme B. Either the direct or indirect documental genesis with respect to a scheme or a class of situations involves “learning” from the other schemes corresponding to other classes of situations (when there are no “same” classes of situations with the situations at stake). Nevertheless, the direct genesis involves a more conscious learning process than the indirect genesis: the direct genesis is supposed to be an active process of seeking for the previous classes of situations in one’s memory which are “close” to the current situations and learning from the corresponding schemes developed previously, whereas the latter is more like a natural professional development over time in which not only “close” but also “distant” classes of situations being encountered currently could provide inspiration for the teacher on a previous scheme.

The discussion above involves the notions of “the same”, “close” and “distant” classes of situations, which need to be clarified. In this thesis, a class of situations is identified only after a coordination scheme has been identified, and the class of situations integrates all the 3D geometry tasks, 3D DGEs, teaching settings and other relevant elements to that scheme. Thus, the relationship between two classes of situations is identified a posteriori, according to the values of the situation variables (already introduced in section 3.1.2), especially the value of the “3D geometry topic” variable related to the task. The general idea for identifying the relationship is: the more similar the 3D geometry topics of the tasks in the two classes of situations, the closer the two classes of situations are. With this idea, we distinguish between the *same*, *close*, and *distant* classes of situations, and their specific definitions are as follows.

Two classes of situations are considered *the same*, if the corresponding two groups of tasks have the *same values* in all the three variables – i.e., the tasks have the same “general” 3D geometry topic and status in the curriculum and important examination, and are situated in the same context and equipped with the same innate support; furthermore, the variables in 3D DGEs, the teaching settings and other relevant elements involved in the two classes of situations also have the same values. The “general” 3D geometry topic corresponds to the value of the variable at the first level – 3D geometry topic – in a task. As what will be elaborated in section 3.3.1, we have identified five possible values for the variable of 3D geometry topic in a task, that is five “general” 3D geometry topics: (1) identify geometric relationships in space, (2) identify shapes of geometric figures in space, (3) construct representations of geometric objects in space, (4) determine geometric magnitudes in space, and (5) justify a given 3D geometry statement. Therefore, one example for two same classes of situations could be those

both in real classrooms, in which the teacher helps students deal with tasks of the same “general” 3D geometry topic – identifying geometric relationships in a solid, with the tasks all being in a paper-pencil context and equipped with a drawing of the solid at stake, and the 3D DGEs all containing the solid at stake and its different views.

For two classes of situations being *close* to each other (not the same), there are two possibilities. The first possibility is that the corresponding two groups of tasks have the same “general” 3D geometry topics, but there are differences in values of at least one of the other variables between the two classes of situations. One example could be two classes of situations respectively in real classrooms and distance online settings, with the tasks having the same 3D geometry topics and the teacher using the same 3D DGEs in both classes of situations.

The second possibility is that the corresponding two groups of tasks have different “general” 3D geometry topics but their “detailed” 3D geometry topics overlap more or less, and then we will not consider the values of the other variables in the two classes of situations. The “detailed” 3D geometry topic is determined by the values of all the variables at the second level – variables within the general topic– in a task. When the detailed 3D geometry topics of two (groups of) tasks overlap, it means the student activities for solving the tasks overlap. In section 3.3.1, we will see many examples of detailed 3D geometry topics under one general topic overlapping detailed 3D geometry topics under another general topic, when the variables in the former general topic take particular values. For example, a detailed 3D geometry topic under general topic 3 – construct the intersection of a line and a plane on a pyramid – overlaps with a detailed topic under general topic 1 – identify the relative position between a line and a plane on a pyramid. This is because students need to first identify the relative position between the line and the plane and then use the identification result to construct the intersection; in other words, the activities of solving the former task involve solving the latter task. Then one example for two *close* classes of situations could be those respectively in a computer room and those in an ordinary real classroom, with the corresponding two groups of tasks respectively having the detailed 3D geometry topics under topic 3 and topic 1, and the teacher using 3D DGEs in the former class of situations but not in the latter.

Two classes of situations are considered *distant* from each other, if the detailed 3D geometry topics of the two groups of tasks have little overlap or the topics of the tasks directly belong to different mathematics domains. Then we will not consider the values of the other variables in the two classes of situations. We can often see examples of distant classes of situations when a teacher moves from a 3D geometry lesson series to a lesson series about another mathematics domain, with the lesson series being in real classrooms, distance online settings or other teaching settings. The two distant classes of situations are respectively in the two lesson series: the teacher deals with tasks with 3D geometry topics in the first one whilst dealing with tasks with algebra, statistics or vector topics in the second one.

Table 3.1 gives a summary of the criteria for distinguishing between the *same*, *close* and *distant* classes of situations.

Table 3.1 Criteria for distinguishing between the same, close and distant classes of situations

Mathematics (3D geometry) topics of tasks		Other variables in tasks (status in curriculum and exam; context and innate support)	Variables in 3D DGEs	Variables in teaching settings	Relationship between two class of situations
General version	Detailed version				
same	same	same	same	same	same
same	different in at least one variable				close
different	overlapping	–			close
different	little overlapping	–			distant
in different mathematics domains		–			distant

Here the “3D geometry topic” is taken as the main criteria for the distinction because we would like to focus on the pairs of classes of situations involving different teaching settings but similar 3D geometry tasks – what shall be identified as *close* classes of situations – to investigate the transformation of the 3D DGEs used by the teacher and the transformation of her coordination schemes, as mentioned in section 2.5. This also matches our assumption about the direct genesis that the teacher would consciously seek for a previous class of situations which are *close* – i.e., involving similar 3D geometry tasks but perhaps different teaching settings – to the current situations and learning from the corresponding schemes developed previously.

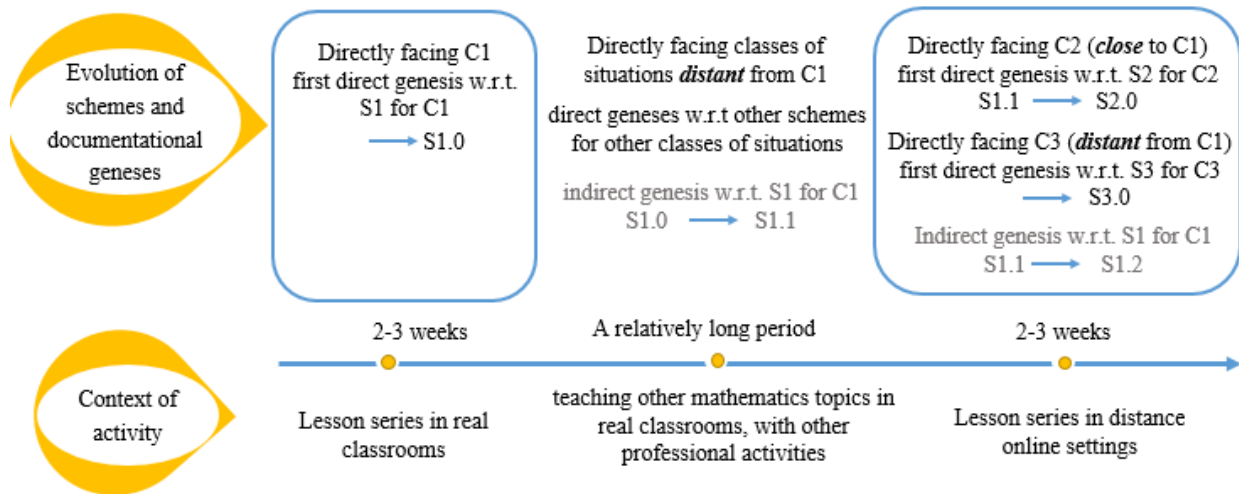
In our data analysis, classes of situations are determined after the schemes have been identified. Therefore, the assumptions about the *same*, *close*, and *distant* classes of situations and the *direct* and *indirect* documental geneses are made a posteriori. To be specific, after having identified the schemes in the lesson series, we will gather all the 3D geometry tasks, 3D DGEs, teaching settings, and other elements relevant to a scheme, into one class of situations corresponding to that scheme. Within the same lesson series, different schemes will correspond to different classes of situations. For the classes of situations corresponding to two schemes in different lesson series, we will determine, when necessary, whether they are the *same*, *close to* or *distant from* each other according to the values of the situation variables, especially the 3D geometry topics of the tasks in the classes of situations. However, since we only consider the elements within the class of situations as the distinction criteria without taking into account the corresponding scheme, we risk the possibility of identifying two same schemes (respectively in a real classroom and a distance online lesson series, for example) with their classes of situations being *close* or *distant*. In this thesis, we have not come across such phenomenon during the data analysis, so we maintain the preliminary distinction criteria, but we will reflect on this theoretical issue in the final chapter (see section 6.2.2).

With the concepts above, three models can be established to simulate how a teacher’s coordination schemes transform from one lesson series to another. In this thesis we are

especially interested in the transformation from a real classroom lessons series in normal time to a distance online lesson series in the epidemic time. Thus, we will introduce in detail the model for this case; for the theoretical coherence, the models for the transformation between two real classroom lesson series, and the transformation from a distance online lesson series back to a real classroom lesson series, will also be introduced briefly.

Model 1: From real classroom to distance online lesson series

Fig. 3.4 models the case from one real classroom lesson series to a distance online lesson series. Both lesson series are about teaching 3D geometry.



- S1, S2, ... : schemes of coordination; S1.0, 1.1,... : different versions of the same scheme
- C1, C2, ... : classes of situations;

Fig. 3.4 Teacher’s activities from a real classroom lesson series to a distance online lesson series

In the first lesson series in real classrooms, C1 is a class of situations corresponding to a coordination scheme S1 (or more precisely its first version, S1.0) that has been identified by the researcher. Actually, we can identify several coordination schemes of a teacher in one lesson series; scheme S1 (S1.0) is just one representative of them, and it is supposed to be developed by the teacher through a direct genesis while she is directly facing C1.

During the interval period after the first lesson series, the teacher would teach other mathematics topics than Euclidean 3D geometry, so we know a priori that classes of situations to be connected to the coordination schemes in this period will be *distant* from C1. While directly facing those classes of situations in this period, the teacher will not directly face C1, but her professional activities are still organized around real classroom teaching, and she probably has not anticipated that the Covid-19 epidemic would break out. Therefore, the teaching and other professional activities in the intermediate period will possibly enlighten the teacher on how to improve the actions and knowledge and views related to S1 for C1, with C1 being restrained to real classrooms. We can conceptualize this process as an indirect genesis with respect to S1 or C1, which would result in S1 being implicitly transformed from S1.0 to S1.1, a new version of the scheme.

When it comes to the distance online lesson series, we can also identify several coordination schemes and corresponding classes of situations. There will not be the same classes of situations with C1 as the teaching settings have changed. But there can exist C2 which is close

to C1, that is, the two classes of situations can contain the tasks with the same or overlapping detailed 3D geometry topics. Then the process leading to the scheme S2 (more precisely its first version, S2.0) corresponding to C2 is supposed to be a direct genesis in light of S1. That is, in the direct genesis the teacher may adapt her actions and knowledge and views related to the current version of S1 (S1.1) to the new affordances and constraints of the class of situations C2, through generalization and analogical reasoning, and finally lead to the scheme S2.0. While S1.1 is still a scheme in real classrooms and S2.0 is a scheme in distance online settings, the transformation from S1.1 to S2.0 essentially reflects the impact of the change of teaching settings on the teacher's coordination schemes. For example, if the actions related to S1.1 involve the use of gestures, the teacher has to adapt the actions when she has to move her lessons into distance online settings due to the Covid-19 epidemic, as it is not convenient to integrate gestures into the distance online teaching. Then the adaptation of actions must be reflected in the S2.0 identified by the researcher. Therefore, the transitions like that from S1.1 to S2.0 and the related direct geneses will be the focus of our investigation in the second group of research questions.

There can also be C3 which is distant from C1 in the distance online lesson series, and the process that has led to the scheme S3 (more precisely its first version S3.0) is supposed to be a direct genesis with no particular reference to other schemes.

It is worth noting that in the distance online lesson series, the teacher might also engage with the indirect genesis with respect to S1 or C1, which would lead to S1 transforming implicitly from S1.1 to S1.2. While the teacher is not directly facing the C1 here, the experience of implementing the coordination practice in distance online settings will very likely trigger her reflection on her actions and knowledge and views in real classrooms, such as those related to S1 for C1.

Model 2: From real classroom to real classroom lesson series

Fig. 3.5 models the case from one real classroom lesson series to another real classroom lesson series which are both on 3D geometry.

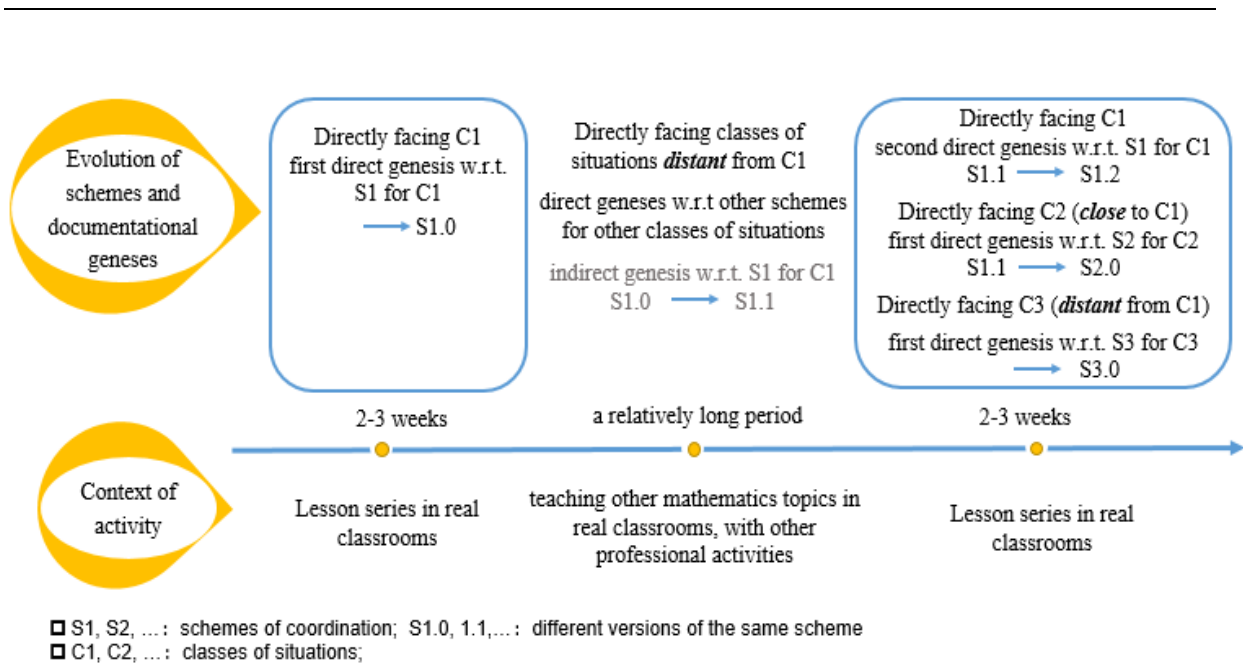


Fig. 3.5 Teacher's activities between two lesson series in real classrooms

The distribution of coordination schemes, classes of situations, and the corresponding direct and indirect documental genes among different periods in this model are generally the same as in the first model, except that in the second lesson series, there can be a class of situations which is the same as C1 in the first lesson series. That is, the two classes of situations involve the same 3D geometry tasks, 3D DGEs, teaching settings (both in real classrooms) and the other relevant elements. We also label the second class of situations as C1, and the process that has led to the corresponding scheme is supposed to be a direct genesis with respect to S1, which would start from the latest version of S1 (S1.1) and end with a newer version (S1.2).

Model 3: From distance online to real classroom lesson series

Fig. 3.6 models the case when a teacher moves from a distance online lesson series to a real classroom lesson series which are both on 3D geometry.

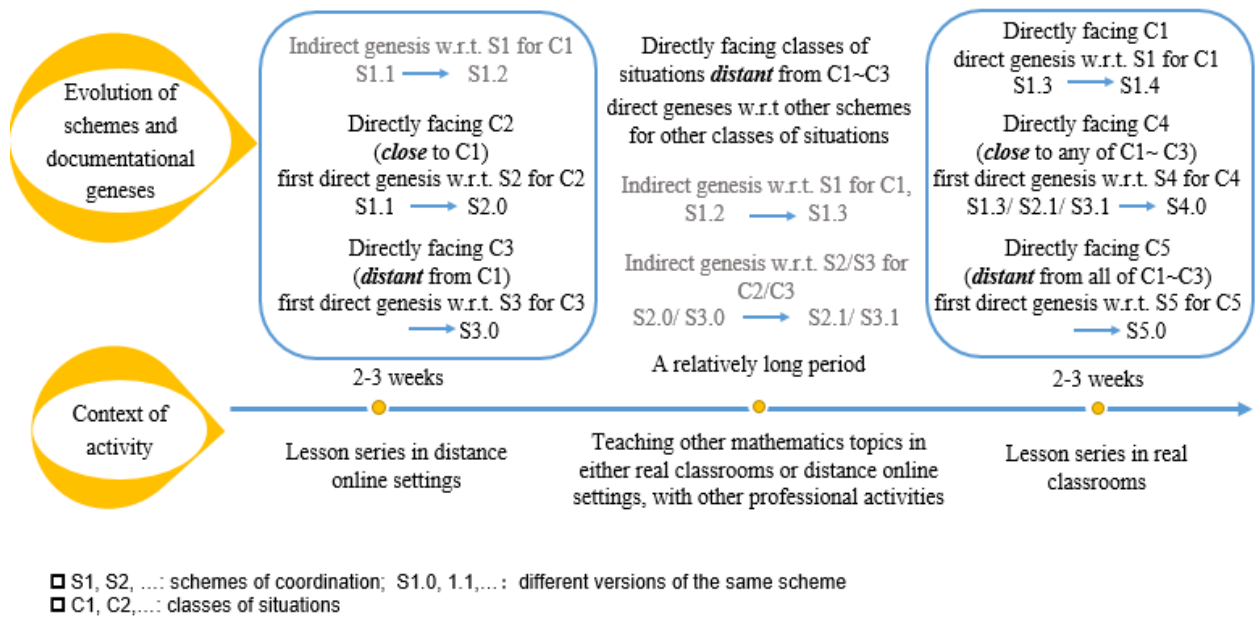


Fig. 3.6 Teacher’s activities from a distance online lesson series to a real classroom lesson series

In the distance online lesson series at the beginning of this model, the teacher’s activities are the same as those in Model 1, in which we can find several coordination schemes respectively corresponding to C1 (in real classrooms), C2 and C3 (both in distance online settings), and the related direct/indirect documental genes.

In the subsequent intermediate period, the teacher will directly face some classes of situations which are related to other mathematics domains and are thus distant from anyone of C1 ~ C3. Here she is supposed to engage with some indirect genes with respect to the corresponding schemes – S1, S2, or S3 – transforming the schemes respectively into newer versions.

When it comes back to a real classroom lesson series, we can get several classes of situations in real classrooms that correspond to the coordination schemes that have been identified. There can be a class of situations which is the same as the previous class C1, and we also note the latter class as C1. Then the process leading to the coordination scheme for the latter C1 is supposed to be a direct genesis as the teacher is directly facing C1 at this time. The direct genesis should start from the latest version of S1, i.e., S1.3, and end with a newer version of the scheme, i.e., S1.4. There can also be C4 which is close to C1 (or C2, C3), as it is possible that C4 and C1 (or C2, C3) contain the tasks with overlapping detailed 3D geometry topics, despite the possible different teaching settings in the two classes of situations. Then the process that has led to the scheme S4 (more precisely its first version S4.0) is supposed to be a direct genesis in light of S1 (or S2, S3). That is, in the direct genesis the teacher may adapt her actions and knowledge and views related to the schemes S1.3, S2.1 or S3.1, to develop the actions and knowledge and views related to S4.0. As for the classes of situations in the second lesson series which are distant from anyone of C1 ~ C3, we use C5 to represent them, and the process leading to its corresponding scheme S5 (more precisely the first version S5.0) is supposed to be a direct genesis with no particular reference to other schemes.

3.2 Research questions reformulated in light of DAD

In light of the DAD concepts and the theoretical models introduced in previous sections, we reformulate the research questions proposed in section 2.5.

Regarding the first group of research questions, they are concerned with the link between teachers' coordination schemes in REAL CLASSROOMS and the characteristics of the 3D geometry tasks and 3D DGEs in the corresponding classes of situations. We are interested in the coordination schemes themselves in each separate lesson series, not their connections with the previous/subsequent versions of schemes in the previous/subsequent lesson series, nor the related direct or indirect documentational geneses. Therefore, we will not apply any of the three models introduced in the last section and only reformulate the first group of research questions in terms of DAD concepts, as presented below:

1. In real classroom lesson series, to what extent can the coordination schemes of a teacher be linked with the characteristics of 3D geometry tasks-3D DGEs in the corresponding classes of situations? More precisely:
 - 1.1 How the rules of coordination of a teacher can be linked with the different categories of operational invariants in the corresponding coordination schemes?
 - 1.2 How can the coordination schemes be influenced by the characteristics of the 3D geometry tasks-3D DGEs in the corresponding classes of situations?

The second group of research questions are about contrasting the characteristics of 3D DGEs and teachers' coordination schemes in DISTANCE ONLINE SETTINGS during the Covid-19 epidemic with those in REAL CLASSROOMS. We are interested in the connections between the coordination schemes before and during the epidemic, and the related indirect and direct documentational geneses. This interest matches well with the Model 1 (Fig. 3.4) in the last section. Thus, we adopt the model to reformulate the second group of research questions and focus on the connections between the first two lesson series in that model, which are respectively before and during the epidemic. Furthermore, we focus on the comparison of coordination schemes like S1.0 and S2.0 in Model 1 (see Fig. 3.4), which correspond to two *close* classes of situations that contain different teaching settings but the same or overlapping 3D geometry tasks. It is worth noting that there is also an implicit intermediate state – S1.1 – between S1.0 and S2.0, and thus the transition from S1.0 to S2.0 is the combined result of both *indirect genesis* during the interval before the distance online lesson series and *direct genesis* during that lesson series. While focusing on the effect of *direct geneses*, we will try to distinguish them from *indirect geneses*, even though the latter may be difficult to capture due to its casualness and implicitness. With all that said, we reformulate the second group of research questions as:

2. For two classes of situations respectively in a real classroom and a distance online lesson series before and during the Covid-19 epidemic, how can the differences between the corresponding 3D DGEs and the differences between the corresponding coordination schemes be explained by direct and indirect documentational geneses? More precisely:
 - 2.1 To what extent can the 3D DGEs in one class of situations be different from those in another?

2.2 To what extent can the coordination scheme for one class of situations be different from the coordination scheme for another

2.3 Among the differences identified above, which ones are related to the indirect/direct documental genesis before/during the distance online lesson series, respectively?

It is worth noting that, although we have introduced three theoretical models in the last section, we finally apply only one model in this thesis. The other two models are created for the sake of a theoretical coherence but go beyond the scope of investigation of this thesis. They can be left for future research and we will come back to this point in the final chapter of this thesis.

3.3 Characteristics of 3D geometry tasks and 3D DGEs

In this section we respectively propose several dimensions of characteristics of 3D geometry tasks (section 3.3.1) and several dimensions of characteristics of 3D DGEs (section 3.3.2). All the dimensions are closely linked with students' perception and logical reasoning in 3D geometry and thus have the potential of influencing teachers' coordination behavior.

3.3.1 Characterizing a 3D geometry task

Before introducing the dimensions, we clarify what a 3D geometry task (more generally, a mathematics task) is. In this research, we consider the "mathematics tasks" as a wide range of things and thus adopt the broad definition given in the ICMI Study on task design (Margolinas, 2013):

(Tasks) include repetitive exercises, constructing objects, exemplifying definitions, solving single-stage and multi-stage problems, deciding between two possibilities, or carrying out an experiment or investigation. Indeed, a task is anything that a teacher uses to demonstrate mathematics, to pursue interactively with students, or to ask students to do. Task can also be anything that students decide to do for themselves in a particular situation... (ibid, p. 11-12)

For a 3D geometry task, we propose three dimensions of characteristics based on literature review. As mentioned in section 3.1.2, the three dimensions are actually the three variables at the first level in the 3D geometry task; they fall in the frame of the situation variables in DAD. Different values of the variables would lead to different solutions to the task. We focus on the values that would affect perception and logical reasoning activities in the possible solutions, which would further affect teachers' coordination behavior. Here the effects of the variable values are what we hypothesized (sometimes with the literature as a support), and their actual effect will be examined with the data in this thesis.

Dimension 1: 3D geometry topic of task

The mathematics topic of a task is one of the fundamental factors that determine the perception and logical reasoning activities required for solving this task (Lin et al., 2012; Marchand, 2006) and thus would have an effect on teachers' coordination behavior. Piaget et al. (1973) proposed several typical topics in the domain of geometry, including observation-reproduction, identification, description, construction, representation, exploration-anticipation, and justification. Combining this work and later studies (mentioned in the paragraphs following

each topic below), we propose the following five topics and restrict them to the domain of 3D geometry.

Within each 3D geometry topic, we further identify from literature some variables whose relevant values are supposed to affect the activities (in particular perception and logical reasoning activities) required for solving a task of that topic. These are the variables in the second level in the 3D geometry task mentioned in section 3.1.2. In the following paragraphs, we elaborate on the perception and logical reasoning activities that are hypothesized to be involved in the task solving activities when the variables take different values, and indicate the literature that supports some hypothesis.

- Topic 1 – identify geometric relationships in space.

Variables in the topic:

- (a) nature of the relationships to be identified and the geometric objects involved in the relationships – possible values: intersection of a line and a plane; parallelism between two planes; others;
- (b) structure of the background solid in which the relationships are situated – possible values: simple solid like pyramid or cube; complex solid like a cube circumscribed by a sphere; others;
- (c) relative positions of the geometric objects at stake in the background solid – possible values: inscribed on the front surfaces; inscribed on the back surfaces; passing through the inside of the background solid; others.

Regarding variables (a) and (b), as the geometric objects, the relationships or the background solid getting more and more complex, the task solving activities will become more and more challenging and some heuristic strategies might be needed. Regarding variable (c), when the objects are positioned at the back or inside the background solid, students would have some difficulty in perceiving them or imagining their spatial structure.

According to the variable (a) and the forms of representation being given (the third dimension of the task characteristics, to be introduced later), the task solutions will be different. For some tasks, such as identifying parallelism between lines or other relationships that can be faithfully represented in a drawing, students can give the right answer only by mental images or perception (Parzysz, 1991). In other cases, students may need to conduct inductive/abductive reasoning in combination with the perceptive evidences; then the process of task-solving approximates to the process of conjecture formulation and the truth of the conjecture remains to be further justified. Of course, students can also solve the tasks by conducting theoretical deductive reasoning referring to the system of Euclidean geometry, completing with undefined or defined concepts, axioms and theorems therein (Burger & Shaughnessy, 1986; Parzysz, 1988). In the latter case, the task solution is a valid one that can remove people's uncertainty about the result.

- Topic 2 – identify shapes of figures in space

Variables in the topic:

- (a) Classification system according to which the shape is identified – possible values: a rough classification system such as triangle-quadrilateral-pentagon-hexagon-..., and

tetrahedron-pyramid-cube-...; a refined classification system involving relationships between components parts of a shape such as regular tetrahedron-regular pyramid-cube-cuboid-...; when not specifically stated, the series of shapes prescribed in the curriculum or textbooks is usually the classification system that students refer to by default;

- (b) Relative position of the figures whose shapes are to be identified in the background solid – possible values: the figure is the background solid itself; the figure is the section of the background solid; the figure is the trajectory of a dynamic point in the background solid; others;
- (c) Geometric structure of the background solid – possible values: complex structure or simple structure, to be discussed according to every specific task.

This topic concerns classifying a given geometric object in reference to a classification system of shapes, and it is usually the set of shapes introduced in the current curriculum or textbooks that constitute the reference classification system.

Regarding variables (a) and (b), when the shape to be identified is a 3D one in reference to a rough classification system, it is enough for students to perceptually consider the geometric figure and connect it to the perceptively similar shapes they once observed, without explicit regard to the component parts and properties of the figure; that is the level 0 (Visualizing) in van Hiele levels (Burger & Shaughnessy, 1986). When the shape to be identified is a 3D one in reference to a refined classification system or a 2D shape (within a background solid), students would need to consider the component parts of the geometric figure and the necessity and sufficiency of properties in determining a concept of geometric figure, integrating their perception with deductive or non-deductive logical reasoning. These correspond to levels 1 (Analysis) to 4 (Rigor) in van Hiele levels (Burger & Shaughnessy, 1986). Besides, the identification of a 2D shape within a 3D background solid also necessitates the integration of 3D and 2D worlds with respect to mental images and geometric properties (Bartolini Bussi & Mariotti, 1999).

Regarding the variable (c), when the structure of the background solid gets more complex, the difficulty of the task would also increase.

- Topic 3 – construct (representations of) geometric objects in space

Variables in the topic:

- (a) whether students have previously observed the geometric objects to be constructed – possible values: yes, or no;
- (b) properties that the geometric objects constructed should have according to the task description – possible values: construct a cube that retains its shape while being dragged in a 3D DGE; construct a solid whose top, front, and lateral views match the given three-view diagram; construct the intersection of a line and a plane in the space; others.

In this topic, the variable (a) is relevant to the mental image activities that students have to perform to solve the task. To construct an object that has been observed previously requires the “reproduction” of mental images; whereas to construct an object without prior observation requires the “anticipation” of mental images (Marchand, 2006); the latter

would impose higher demand on students' mental images. On that basis, the variables (b) determine if additional geometric knowledge and logical reasoning processes are needed. For example, to construct a "robust" solid (Healy, 2000) that retains its shape regardless of which of its components are manipulated in a 3D DGE, students should know the determinant geometric properties of the solid and possibly develop some theoretic-deduction; the construction of the representation of a cube in a 2D environment requires the knowledge of the parallel projection rules (Parzysz, 1991). As can be seen, the context of the construction task would also have an effect on students' perception and logical reasoning in solving the task. We will discuss the latter point in the third dimension "context of and innate support in the task".

Sometimes the "properties of the geometric object to be constructed", as the variable (b) in this topic, are closely linked with the "geometric relationships" in Topic 1. For example, the intersection of a line and a plane to be constructed in a task is linked with the relationship between the line and the plane; students need to first identify how exactly the two objects will be intersected and then use the identification result to construct the intersection. Therefore, the detailed 3D geometry topic under Topic 3 with the variable (b) taking the particular value can overlap with that under Topic 1; when it is the case, the variables in Topic 1 would also matter for Topic 3.

- Topic 4 – determine geometric magnitudes in space

The detailed 3D geometry topics under this topic usually overlap with those under Topic 1, 2 and/or 3 as a part. Take "determine the area of the section of a cube" as an example, students need to identify its shape and apply the corresponding formula of area to calculate the area of the section; sometimes students even need to construct the section by themselves. All the variables in the former three general topics can play a role in Topic 4, and we will not list them here again. Student activities for the tasks of this topic, apart from those mentioned in previous topics, also include algebraic and arithmetic calculations.

- Topic 5 – justify a given 3D geometry statement

Variables in this topic:

- (a) truth or falsity of the statement itself – possible values: it is a true statement; it is a false statement;
- (b) whether a valid justification is demanded for the statement – possible values: yes, or no.

Here we consider the two variables together. When the task gives a true 3D geometry statement that involves a general conclusion and demands a valid justification, the valid justification for the task can only be theoretical deductive reasoning or mathematics proof (Stylianides & Ball, 2008). In fact, when a task demands to prove a 3D geometry statement, it always implies that the statement is true.

When the task gives a false statement that involves a general conclusion and asks for a valid justification (i.e., to refute the statement), students can justify the falsity of the statement with either a counterexample or a proof by *reductio ad absurdum*; the latter is also a kind of theoretic-deduction (Stylianides & Ball, 2008).

When the task does not demand a valid justification, students can justify it in various ways, including: verifying whether the statement can hold in particular cases, developing inductive or abductive reasoning and possibly taking profit of the dynamic perceptive evidences in 3D DGEs (Baccaglioni-Frank & Mariotti, 2010; Fahlgren & Brunström, 2014; Højsted, 2019). More examples can be seen in real data in chapter 5.

This topic can overlap with Topics 1, 2 or 4, when the 3D geometry statement to be justified is about geometric relationships/properties, shapes of geometric figures, or geometric magnitudes in space. The main difference between Topic 5 and the previous topics resides in: the statement is given by others and to be justified by students in Topic 5, whereas the statement is to be established by students themselves in the previous topics, with a (valid) justification or not. Notwithstanding the difference, the logical reasoning and perception activities for solving tasks of these topics are similar.

Dimension 2: Status of task in the curriculum and important examination

We propose this dimension to consider the mark of institutional factors (such as curriculum and examinations) on the coordination behavior of teachers in that institution. As known widely, the regional or national curricula and examinations would influence professional practices of teachers (Remillard, 2005). Then the curriculum and examination prescriptions with respect to 3D geometry tasks are supposed to influence teachers' practices of explaining the tasks in the lesson and further influence their coordination behavior.

The dimension includes two aspects.

The first aspect is the status of the 3D geometry task in a curriculum, which refers to relationships between the 3D geometry topic of the task and other topics over the span of geometry included in the curriculum, and the student abilities and activity experiences prescribed in the curriculum with respect to the 3D geometry topic, especially those related to perception/mental images and logical reasoning.

The second aspect refers to the status of the 3D geometry task in an examination, which refers to the examination requirements with respect to the tasks of the same 3D geometry topic, including the answer form required by the task (e.g., a choice, a simple answer like number, word or phrases, a short essay with justification...), and particular procedures and methods to be included in the solutions of the task.

The two countries involved in this thesis, France and China, both adopt a unified nationwide mathematics curriculum and both countries have experienced a curriculum reform during the period of this Ph.D. project. Therefore, with respect to a 3D geometry task used in a lesson series, we will take the versions of the French and Chinese curricula which were in effect during the period of the lesson series, to examine the status of the task. With regard to the important examination, we consider the college entrance examination GAO KAO (高考) in China and diploma examination Baccalauréate (abbreviated to BAC) for higher secondary education in France.

The characteristics of a 3D geometry task in this dimension, or values of this variable, can be: the curriculum prescribes students to study the corresponding 3D geometry topic with theoretical deductive reasoning in reference to theorems and facts in Euclidean geometry

whereas the examination only demands a choice as the answer for the tasks with a similar 3D geometry topic; or, the curriculum highlights the development of students' vision with respect to the corresponding 3D geometry topic and the examination demands a valid justification for the tasks with a similar 3D geometry topic. More values will be discussed together with the actual data in chapter 5.

Dimension 3: Context of and innate support in the task

This dimension is proposed according to Laborde's (2002) work, which shows that the tasks with the same content in different contexts, which are equipped with different figural representations and tools, would lead to different task solving strategies, in which the perception and logical reasoning play different roles. Context, figural representations and tools are thus supposed to have an effect on teachers' coordination behavior.

We define the context of a task as the media in which the task statement and the solutions are provided; it can be a paper-pencil context, a 2D/3D DGE, or the 3D reality; and we let the innate support in a task refer to the external figural representations and the tools given together with the task statement which are at the disposal of students to support their task solving activities.

According to the context in which the task is presented, the innate support can be varied. Table 3.2 shows the correspondence between the two aspects in this dimension, and the possible characteristics that a 3D geometry task can have in the two aspects in the dimension, which are the possible values of the variable.

Table 3.2 Possible context of a 3D geometry task and possible innate support equipped therein

Possible context of a task	Possible innate support
Paper-pencil environment	Drawing, paper and pencil, calculator, ruler, etc.
3D DGE	3D dynamic model, restrained or complete toolset from the software underpinning the 3D DGE, etc.
3D reality	3D real model, manipulative, scissor, piece of paper, object or container with particular shapes, etc.

We establish the table above partly according to the literature and partly according to the actual data in this thesis. Research shows that to identify geometric relationships in space in a paper-pencil environment with the support of drawings will be more difficult for students than to identify the relationships in the 3D reality (Bridoux & Nihoul, 2015). To construct a "robust" solid that retains its shape regardless of which of its components are manipulated with a restrained toolset in a 3D DGE, students should know the determinant geometric properties of the solid and possibly develop theoretical deductive reasoning (Healy, 2000; Mithalal & Balacheff, 2019). However, when students are equipped with a full toolset of the software in the 3D DGE, such as the toolset of GeoGebra that contains the *Cube*, *Pyramid* and other tools, students can use these tools to make the "robust" solids appear automatically without needing to know its determinant geometric properties (Artigue et al., 2019). In addition, to construct (the drawing of) a cube in a paper-pencil environment requires students to create the corresponding mental image and have the knowledge of parallel projection rules (Parzysz,

1991). As can be seen, for the tasks with the same 3D geometry topic, being situated in different contexts and presented together with different innate support would render the task solutions different, for which students need to coordinate their perception and logical reasoning in different ways. We will discuss more examples together with the actual data in chapter 5.

When a task is in the context of a 3D DGE, its characteristics in the third dimension are just the characteristics of the 3D DGE, and we will elaborate on this in the following section.

3.3.2 Characterizing a 3D DGE

For characterizing a 3D DGE, we consider the dimensions that are relevant to the potentials and constraints of a 3D DGE for students' coordination, which would further have an effect on teachers' coordination behavior. These dimensions constitute the variables in the 3D DGE that have been mentioned in section 3.1.2, and they are in the frame of the situation variables in DAD.

We first introduce the notion of "distance" related to computational environments, which, according to Morgan et al. (2009), means the gap between the representations and the means of manipulating provided by the tools in a computational environment and those used in the paper-pencil environment, within a particular subject domain. Talking about the distance requires at first the consideration of characteristics of the computational environment (for example, 3D DGE) itself. Morgan et al. (2009) proposed two major distances: Epistemological Distance and Social Distance, with the latter including Curricular Distance, Pedagogic Distance and Didactic Distance. Next, we will refer to Morgan et al.'s definitions of the four distances and accordingly propose four dimensions of characteristics of a 3D DGE.

The Epistemological Distance refers to the distance between the representation system in a computational environment and that used in the paper-pencil based work, including the distance in terms of the affordances of the representations for mathematics meaning, distance in terms of manipulations that are possible with the representations and the related tools, the distance in terms of the conversion between different forms of representations, and the possibilities for dynamic representations (which have special affordances for the mathematics concepts of continuity, variation and dependency of variation, and non-deductive reasoning activities) (Morgan et al., 2009). The representation systems, according to Morgan et al. (2009), are similar to semiotic systems, which include natural language, conventional systems of numeric and algebraic notation, external figural representations, diagrams, idiosyncratic systems developed for didactic purposes or invented by students themselves in an environment. The Epistemological Distance introduces the necessity of considering not only the appearances of representation systems, but also their uses. Here we focus on external figural representations and tools in the 3D DGE, formulating the first dimension of its characteristics.

The Pedagogic Distance refers to the distance between the form of pedagogy or pedagogical discourse existing in a computational environment and the general pedagogy applicable to any ordinary classroom without the computational environment. The form of pedagogy is represented by the set of identities – students, teachers, technological participants such as a software or a virtual tutor online, and the subject matter – and their relationships within a given environment. More precisely, it is reflected in the forms of instructions/help available for students and the ways in which they are provided, and the location of control over the ordering

and pace of activities (Morgan et al., 2009). This leads to the second dimension of characteristics of a 3D DGE in this thesis.

The Didactic Distance refers to the differences between the types of the feedback on student activity that are provided by a computational environment and a paper-pencil based classroom. Morgan et al. (2009) consider two broad categories of feedback: those external to the working space, and those internal to the working space and originated from its logical functioning. This leads to a third dimension of characteristics of a 3D DGE in this thesis.

According to the three dimensions of characteristics mentioned above, we can identify the target mathematics content and the approach to the content suggested by a 3D DGE. For example, by providing 3D dynamic models of pyramids that students can manipulate, setting drill-and-practice exercises and delivering feedback to students' actions, 3D DGE allows students to learn geometric properties of pyramids autonomously. Students can compare their expectations with the actual outcome of their actions and, by interpreting the feedback provided by the environment, refine their understanding of the mathematics content.

The last distance – Curriculum Distance – refers to the mismatch between the expected age at which the content and approach involved in a computational environment might be met within the curriculum, and the perceived age at which the computational environment is introduced to students. Morgan et al. (2009) gave an example of a big distance: the fractions microworld of ARI-LAB2, which represents a fraction based on intercept theorem³. Thales theorem is a piece of mathematical content that students will meet far later than the actual stage of learning fractions. Obviously, this distance is proposed to examine the legitimacy of a computational environment with respect to the (regional or national) curriculum. Inspired by this distance, we can propose a dimension concerning the legitimacy of a 3D DGE with respect to the curriculum. The four dimensions of characteristics of a 3D DGE are introduced in the following.

Dimension 1: Figural representations and tools in 3D DGE

The “figural representations” in a 3D DGE are mainly the 3D dynamic models that can be turned around in 3D DGE, and they integrate points, lines, faces that can be constructed in the 3D DGE. The “tools” here are mainly those related to the manipulations that can be done on the figural representations. For the characteristics in this dimension, we consider the features of the figural representations and the functionalities of the tools. The features of the figural representations refer to the geometric objects they can represent, and to what extent these representations can be dynamic. The functionalities of the tools refer to the effects that can be achieved through the manipulations with the tools. Previous studies have widely recognized the potentials of the figural representations and tools in DGEs for students' perception and non-deductive logical reasoning (Accascina & Rogora, 2006; Baccaglioni-Frank, 2019; Højsted, 2019), so we do not elaborate on the particular values for this dimension (variable) here, but discuss them together with the actual data in chapter 5.

Dimension 2: Help and control in 3D DGE

For this dimension, we particularly consider the form of help and the location of control in a 3D DGE. The form of help can be technical instructions on how to manipulate a tool or

³ See https://en.wikipedia.org/wiki/Intercept_theorem for more information about the theorem.

visual/verbal hints on how to solve a task, which are supposed to affect students' perception and logical reasoning activities; more values in this aspect can be seen in chapter 5. The location of control means the entity who controls the pace and ordering of the learning activities in the 3D DGE, it can be the technology, the teacher, the student, or the combination of them.

Dimension 3: Feedback in 3D DGE

In line with Morgan et al. (2009), we consider two types of feedback – external and internal ones – of a 3D DGE. Each type of feedback includes many values for this dimension (variable).

The external feedback refers to the feedback added by the 3D DGE designer to the basic software underpinning a 3D DGE such as GeoGebra or Cabri 3D. Such feedback can be: the answer checking feedback indicating the correctness or incorrectness of the answer input by the user, or the pop-up message triggered by particular operations of the user.

The internal feedback means the feedback determined by the intrinsic functioning logic of the basic software. Such feedback can be: the impossibility of constructing particular objects (e.g., the intersection of two non-coplanar lines) in the 3D DGE, the effect of a cube no longer keeping its shape after dragging some parts of it.

Previous studies have pointed out that the action/feedback loop between a learner and a learning environment can evoke the intellectual conflict of the learner and promote the update of her conception which allows recovering the equilibrium of the system of the learner and the environment (Balacheff, 2013). In particular, the feedback related to the dragging tool in dynamic geometry environments can help students discover geometric properties of figures (Erez & Yerushalmy, 2006; Mithalal & Balacheff, 2019). We therefore take the previous examples of feedback as values for this dimension (variable); they are relevant to students' learning of mathematics and the related deductive reasoning. We will discuss more values together with the actual data in chapter 5.

Dimension 4: Curricular distance of 3D DGE

The curricular distance means the gap between the approach to particular mathematics content provided by a 3D DGE and the approach prescribed in the curriculum. Morgan et al. (2009) points out that the larger the curricular distance of a 3D DGE, the less likely a teacher would accept to use the 3D DGE; the dimension is thus relevant to the teacher's coordination behavior. As for the values in this dimension (variable), they are simply big and small. But we will give this result based on the analysis of the approach provided by the 3D DGE; see chapter 5 for more detail.

3.4 Sub-framework for identifying rules of coordination in a coordination scheme

In this section, we develop a sub-framework of coordination behavior, which will allow identifying rules of coordination in a coordination scheme. After this introduction, four further sections are presented: section 3.4.1 introduces Toulmin's diagram of argumentation and how it matches the interest of this study; section 3.4.2 introduces a sub-framework newly constructed in this thesis on the basis of Toulmin's diagram and Conner et al.'s (2014)

framework; section 3.4.3 presents how we intend to use the new sub-framework to identify teachers' rules of coordination.

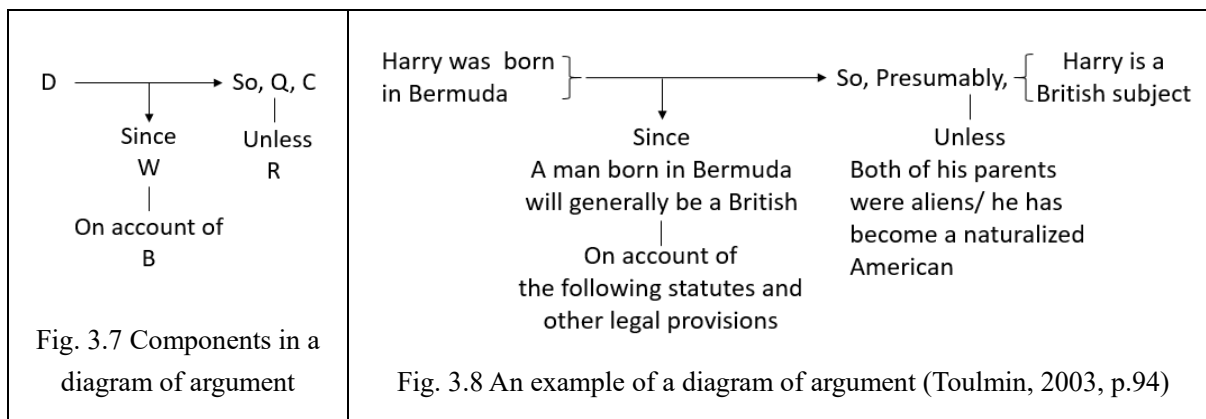
3.4.1 Toulmin's diagram of argumentation: a basic tool

- Relationships between argumentation and teachers' coordination behavior

From sections 2.2 and 2.3, we know that teachers' coordination behavior not only deals with theoretical deductive reasoning, but also non-deductive reasoning and some possible perceptive support which can help students better understand the 3D geometry problems at stake and lead them to rational mathematical conjectures. They are most likely to happen in the *argumentation* processes in mathematics lessons, which, in addition to proving practice, also incorporate many informal manners of justification and pedagogical and practical considerations (Pedemonte, 2007). Following (Castro et al., 2021; Conner et al., 2014), we cast sight on the collective argumentation which is defined as a discussion process in which the participants propose evidences or refutations to get a mutually accepted mathematical conclusion. The *collective argumentation* is a social, collaborative, rational and verbal process (Castro et al., 2021). We further adopt a broad perspective on the collective argumentation in this thesis, considering the argumentation participated either by the teacher, by the students, or both the teacher and the students. The teacher's coordination behavior can be seen as a specific, critical teacher support for the collective argumentation.

- Toulmin's diagram: a tool for modeling argumentation

The *collective argumentation* can firstly be modeled by Toulmin's (1958) diagram of argumentation. With this diagram, Toulmin (1958) wanted to provide a tool for analyzing the structure of informal argumentation in contrast to the analysis of formal proof which focuses on whether it follows a formal deductive logic. Toulmin was less concerned about the absolute *validity* of an argumentation, but more concerned about its *rationality* with respect to a particular semantic field. This is consistent with our standpoint of highlighting the rationality of non-deductive reasoning and perception in this thesis. The whole diagram of argumentation (Toulmin, 1958, 2003) contains six functional components. As shown in Fig. 3.7, Claim (C) is the final conclusion to be derived through the argumentation; Data (D) is the information that can support the conclusion; Warrant (W) can be a rule, a principle, a license that the data can appeal to in support of the conclusion; Backing (B) is a categorical statement of a fact that helps establish the authority or legitimacy of the warrant in a particular field; Qualifier (Q) qualifies the conclusion by expressing degrees of confidence; Rebuttal (R) potentially refutes the conclusion by stating the cases in which it would not hold. Usually, not all of these components will be explicitly verbalized in an argumentation. The legitimacy of Warrant and Backing depend on the semantic field or professional context where the argumentation is developed. Fig. 3.8 gives a diagram of argumentation proposed by Toulmin himself, where the warrant and backing are situated in the field of law.



Nowadays, Toulmin’s diagram has been employed by many mathematics education researchers not only to analyze the structure of informal mathematics argumentation, but also to model formal mathematical proof that emerges in an educational environment (Inglis et al., 2007; Pedemonte, 2007; Zazkis et al., 2016). In the latter case, the warrants can be for example rules of symbolic operations in the algebraic field, theorems in the geometric field. Therefore, the diagram of argumentation can help to analyze the structure of the collective argumentation processes in mathematics lessons, and further to structure teachers’ coordination behavior in it.

3.4.2 Toward a sub-framework of coordination behavior

Based on diagrams of argumentation, Conner et al. (2014) distinguished three aspects of teacher support for collective argumentation: teacher’s direct contributions of components in the diagram of argumentation, the questions posed and other supportive actions used to facilitate the development of argumentation. The latter two are used to elicit students’ direct contributions of argumentation components. Under each aspect, Conner et al. (2014) developed several codes. In this thesis, we inherit Conner et al.’s (2014) constructs and additionally integrate some codes and aspects which are identified partly from a literature review and partly from the real data analysis, to formulate a new framework of the teacher’s coordination behavior. The new framework includes the following three aspects.

- Teacher’s direct contributions to collective argumentation

The first aspect of teacher’s coordination behavior is also the first aspect in Conner et al.’s (2014) constructs, i.e., the teacher’s direct contributions of argumentation components in the diagram. In this aspect, Conner et al. (2014) only give the codes Data, Warrants, Rebuttals, Claims, Qualifiers, and Backings⁴. To highlight features of teacher’s coordination (i.e., which modes of reasoning are exactly promoted, what role students’ perception has played in the logical reasoning), it is necessary to clarify the specific feature of the argumentation components in the diagram. By synthesizing on the features of argumentation components that have appeared in previous studies (Inglis et al., 2007; Knipping, 2008; Mariotti & Pedemonte, 2019; Peirce, 1960; Reid et al., 2011), we establish Table 3.3.

⁴ Here and also in the data analysis in chapter 5, we capitalize the first letter of the codes for teacher’s direct contributions and use italics to present the codes in other aspects in the sub-framework.

Table 3.3 Teacher’s direct contributions to diagram of argumentation

Component	Possible feature (codes)
Data	Perceptive, Intuitive, Factual
Warrant	Inductive, Deductive, Abductive, Structural-Intuitive, Graphical-Symbolic
Qualifier	Absolute (certainly, definitely...), Non-Absolute (perhaps, seems, probably ...)
Rebuttal	Rebuttal to Conclusion, Rebuttal to Warrant, Rebuttal to Data
Claim	–

Here, the Perceptive Data refers to the perceptive effects of drawings, 3D DGE models, and gestures. Intuitive Data is what a subject considers as true with little awareness of the rationale by which he has reached it, possibly related to one’s prior knowledge. The Factual Data refers to mathematical facts widely accepted or at least accepted by the class, or information given in the task (Mariotti & Pedemonte, 2019).

The Deductive Warrant refers to the geometric theorems or rules of algebraic operations, with which one can draw a claim in a deductive way as long as the data satisfies the precondition in the theorem/rule. A Deductive Warrant can be connected with different kinds of data, and when it is connected with a factual data to lead to a claim, we consider it as a theoretical deductive reasoning process. The Inductive Warrant refers to the logic rules of inductive reasoning; it is identified when participants establish a generalized claim from the data based only on a limited number of cases (Inglis et al., 2007). Similarly, we add Abductive Warrant in this study to refer to the logic rules of abductive reasoning; it is identified when participants get a claim concerning a premise from a data that can be considered as a result of the premise according to some geometric theorem or algebraic rule, and the theorem or rule constitute the content of the abductive warrant itself (Peirce, 1960). Graphical-Symbolic Warrant means one transforms the graphical/figural relationships into symbolic expressions or vice versa (Knipping, 2008). Structural-Intuitive Warrant refers to participant’s intuitive understanding of mathematical knowledge (Inglis et al., 2007).

The Qualifier indicates the level of certainty an interlocutor attaches to a statement: it is absolute when there are words “certainly”, “definitely” appearing in the interlocutor’s discourses; and it is non-absolute when there are words “perhaps”, “seems” appearing.

The Rebuttal to Claim/Data/Warrant is respectively the refutation proposed by interlocutors towards the argumentation component claim/data/warrant, and the rebuttal is usually proposed with some strategies. For example, the Rebuttal to a Warrant can be proposed by inferring a wrong result on the basis of a coincidence or analogy; the Rebuttal to Claim can be proposed by giving a counterexample or directly by the teacher’s authority.

In this thesis, we do not consider the argumentation components Backings as they are always confused with Warrants. We do consider the Claims as argumentation components, but we do not attach particular features to them as their features are rarely considered specifically in the literature.

As can be seen, the adjectives deductive, inductive and abductive are indicators of the mode of logical reasoning mobilized in the argumentation. The other warrants, perceptive data and intuitive data are concerned with the use of perception or intuition. Students can directly get a claim starting from perceptive/intuitive data without a warrant (Mariotti & Pedemonte, 2019). This means that they make a superficial interpretation of figural representations only based on perception. The rebuttals and qualifiers respectively reflect how a mathematical claim can be rejected, and the level of certainty that participants attach to a claim. Although we mainly consider teacher's contributions (coordination behavior), these argumentation components can also be proposed by students and considered by the teacher as well in his/her coordination behavior.

- Questions posed and other supportive actions

The second aspect of teacher's coordination behavior is the combination of the other two aspects in Conner et al.'s (2014) framework, i.e., the questions posed and other supportive actions of a teacher. For *questions posed*, Conner et al.'s initial 5 codes are enough to code the questions posed by the teachers in this study, therefore we directly integrate them in our framework, and their descriptions are shown in [错误!书签自引用无效](#). For *other supportive actions*, Conner et al. also propose 5 codes, which are *directing*, *informing*, *promoting*, *evaluating*, and *repeating*. We split the code *evaluating* into two codes: *validating* and *rebutting*, and keep the other four codes in our framework. Indeed, the original code *evaluating* implies both meanings of validating and rebutting – it refers to the teacher's action of correcting a student's incorrect statement, validating a student's statement, or verifying the correctness of a statement. Nevertheless, in the actual data analysis, we find many typical validating and rebutting actions of teachers and feel it necessary to distinguish between the two categories of actions to investigate them respectively. For example, in the lesson series, teachers would validate conclusions directly by their authority, with 3D DGE effects, or with a third part (neither the teacher nor the students) evaluation system. They would also rebut incorrect students' ideas in many different ways, such as present conflicting perceptive phenomenon in 3D DGEs, or directly reject by teacher's authority. The actions of rebutting always go along with the contributions of Rebuttals, as mentioned previously. Furthermore, researchers have identified other rebutting actions such as give counterexamples where a mathematical statement does not hold, infer wrong conclusions by following a similar warrant (Reid et al., 2011). Since previous studies have pointed out the importance of *rebutting* actions with respect to students' need for proof (Lin et al., 2012) and the importance of *validating* actions with respect to students' certainty in claims, we finally decide to take them as two separate codes and get six codes in *other supportive actions*. Their descriptions are presented in [错误!书签自引用无效](#).

Table 3.4 Questions posed and other supportive actions of teacher

Codes	Description
-------	-------------

Questions posed

<i>Requesting a factual answer</i>	Ask students to provide a mathematical fact (a calculation result, an identification result, a recalled fact)
<i>Requesting an idea</i>	Ask students to make comparison, to construct a result, to generate mathematical conjectures
<i>Requesting a method</i>	Ask students to demonstrate/describe the procedures of doing something
<i>Requesting elaboration</i>	Ask students to elaborate on some statement, make interpretation, describe what they perceive, provide explanation or justification for their own or a given idea
<i>Requesting evaluation</i>	Ask students to confirm or reconsider a statement of their own or others

Other supportive actions

<i>Directing</i>	Direct students' attention or gives hints
<i>Informing</i>	Illustrate, reformulate or expand on what students said
<i>Promoting</i>	Give encouragement or suggestions without pointing out a specific direction
<i>Validate</i>	Confirm the correctness of a mathematical statement by teacher's authority, perceptive evidences, or a third-part evaluation system
<i>Repeating</i>	Restate or display what has been stated
<i>Rebutting</i>	Reject a mathematical idea by teacher's authority, referring to third-part evaluation system, presenting conflicting effects, inferring a wrong conclusion on the basis of coincidence or analogy, or providing a counterexample against an idea or its inferences

- Use of particular resources

To highlight the role of digital technologies in teacher's coordination behavior, we will describe how a teacher uses digital technologies together with the two aspects of coordination behavior mentioned above. In this thesis, the digital technology is 3D DGE. Besides, teacher's use of drawings, gestures, metaphors, and cognitive models are also closely related to the perception and logical reasoning that students will have (Castro et al., 2021), and thus will be discussed in this study too. Usually, one's gestures can have several functions: simulating, or denoting; and we mainly consider the simulating gestures which can evoke the corresponding mental images in students.

Now we have set up a framework, in which the three aspects are all about the teacher's contributions to the collective argumentation. Questions posed, other supportive actions, use of particular resources are together considered as indirect contributions.

In actual data analysis, we always draw a diagram of argumentation describing the structure of a whole argumentation process at first, integrating both the teacher's and students' direct contributions of argumentation components. Then we integrate the teacher's indirect

contributions into the diagram. The teacher's indirect and direct contributions reflected in the diagram together constitute her coordination behavior in the argumentation process.

3.4.3 From coordination behavior to rules of coordination

In a mathematics lesson, the discussion around a task participated by the teacher and/or students can be considered as one collective argumentation process. It begins when the teacher starts explaining the task to students, or intervenes into the discussions of students themselves, and ends when the teacher finishes the explanation or stops her intervention leaving the students to continue their own work. Such an argumentation process will be segmented by several *argumentation nodes*, corresponding each to the achievement of successive subtasks. The main claims could have been anticipated by the researcher in the a priori analysis, or marked by the typical expressions of the participants in the discussion, like “now half of the work is done, then...”, “next we need...”. We define the discussion occurring between two nodes as an *argumentation episode*. In this way, every *argumentation episode* can be modeled by one diagram of argumentation whose final claim is the main claim achieved in that episode. Then the teacher's coordination behavior in the episode is described structurally as her contributions reflected in the diagram of argumentation.

The *rules of coordination* are the regularities in a teacher's coordination behavior across different *argumentation episodes* in one or more consecutive mathematics lessons. To identify them, we firstly classify the argumentation episodes with the same *basic structure* into one group. The *basic structure* is reflected in the diagram of argumentation modelling an episode, or more specifically, it concerns the source and feature of data, the feature of warrants, and teacher's indirect contributions and use of resources for prompting these components. We take these aspects as the criteria for distinguishing argumentation episodes because they essentially reflect how students' perception and logical reasoning have been coordinated in an episode. As a result, the argumentation episodes within each group share one basic structure distinct from the other groups, and the basic structure can be modelled by a more *general* diagram of argument. Secondly, we summarize the regularities of a teacher's coordination behavior across one group of argumentation episodes as one *rule of coordination*. These regularities are meanwhile reflected in the *general* diagram of argumentation as the teacher's contributions.

In the case where one argumentation episode is solely classified into one group, we summarize teacher's coordination behavior therein as a distinct *rule of coordination* if they can match the operational invariants inferred later on.

The precise data analysis procedures will be introduced in section 4.4.1.

3.5 Sub-framework for categorizing operational invariants in a coordination scheme

In this section we develop a sub-framework for categorizing the operational invariants in a coordination scheme, i.e., the knowledge and views underpinning the rules of coordination of a teacher. Consistent with the discussion in section 2.4, we situate the operational invariants within a general classification framework of operational invariants for mathematics teaching

with technology, and then confine the components within each category to the coordination in 3D geometry with the use of 3D DGEs. The categories in the general framework are established in a top-down manner, partly driven by the literature review of teacher knowledge and views, partly driven by actual data analysis. After this introduction, we subsequently introduce the procedures of developing the framework (section 3.5.1) and the framework finally developed (section 3.5.2).

3.5.1 Procedures of developing the sub-framework

(1) Reconstruct 5 categories of knowledge based on the TPACK framework

TPACK (Koehler & Mishra, 2009) is a framework that classifies teacher knowledge for the integration of technology into subject teaching, and thus is a suitable base of the framework we are trying to construct here. Based on Shulman's (1986) Pedagogical Content Knowledge [PCK] framework which inserts a pedagogical insight into teachers' content knowledge, [TPACK] draws attention to the need of evolutions of teachers' pedagogical knowledge, content knowledge and pedagogical content knowledge in adaptation to the integration of technology. According to the Venn diagram of TPACK (Fig. 3.9), it has made clear the existence of "intersections" between knowledge of technology and knowledge of pedagogy and/or content" (Ruthven, 2014, p. 375).

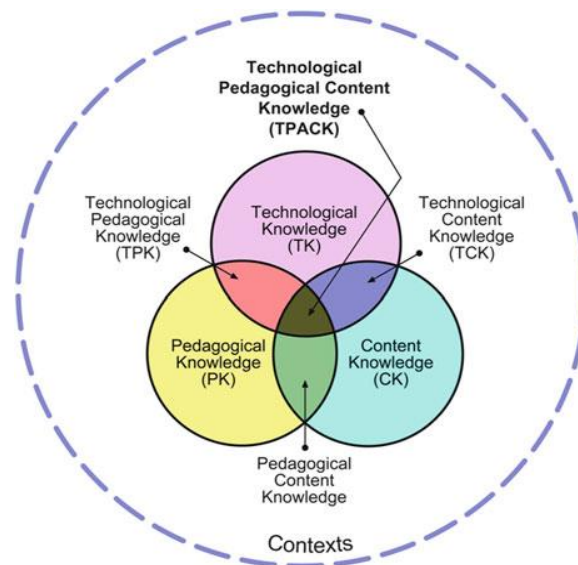


Fig. 3.9 Venn diagram metaphor for the TPACK framework (<http://tpack.org/>)

According to the definitions in (Koehler & Mishra, 2009, pp.63-67), we give a synthesis of the meaning of each categories in Fig. 3.9 –

- PK is the knowledge about the processes, practices or methods of teaching and learning and how they encompass overall educational purposes, values, and aims;
- CK is the knowledge about the actual subject matter that is to be learned or taught;
- PCK is the knowledge about what teaching approaches fit the content, and likewise, knowing how elements of the content can be arranged, adapted and represented for better teaching;

-
- TK includes the knowledge of operating systems and computer hardware, the abilities of using standard sets of software tools, recognizing when digital technology can assist or impede the achievement of a goal;
 - TPK is the knowledge of the existence, components and capabilities of various technologies as they are used in teaching and learning settings, and conversely, knowing how teaching might change as the result of using particular technologies.
 - TCK is the knowledge about the manner in which technology and content are reciprocally related, including the knowledge about how technologies afford particular representations of content elements and flexibility in navigating them, and the knowledge of how the subject matter can be involved in and changed by the application of technology;
 - TPACK is an emergent form of knowledge that goes beyond all three “core” components (content, pedagogy, and technology), including the understanding of the representation of concepts using technologies; pedagogical techniques that use technologies in constructive ways to teach content; knowledge of what makes concepts difficult or easy to learn and how technology can help redress some of the problems that students face and so on.

As can be seen, the TPACK framework provides a relatively complete categorization of teacher knowledge for integration of technology. However, it is also widely criticized for the ambiguities between its boundaries between some of its categories (Graham, 2011; Ruthven, 2014; Voogt et al., 2013).

The first type of ambiguities exists between TK and TCK, PK, CK and PCK, TPK, TCK and TPACK. As Ruthven (2014) comments:

Where technologies are content specific, such as dynamic algebra or geometry software, it can be particularly difficult to differentiate between TK and TCK. While knowledge of features and techniques that are generic to much software (such as the basic use of menus and pointers) clearly should be classed as TK, it can be hard to decide when knowledge becomes so content specific (such as the individual operations listed on menus and the particular functions for which the pointer is used) that it should be assigned to TCK.

Given that understanding of certain types of representation forms part of CK, it is problematic to assign “understanding of the representation of concepts using technologies” in general to TPACK rather than TCK. There may be a risk of confusion here with the more specific usage of “representation”, based on the idea that there are specifically “pedagogical” or “didactical” organizations of representations, that go beyond those canonical forms of representation constituting part of subject content knowledge.

Indeed, pursuing the logic of Shulman’s original argument, the constructs of CK, TK and TCK should be free of any specifically pedagogical aspect and applicable as much to the knowledge of students as that of teachers (Ruthven, 2014, p. 377).

As for the ambiguities between PK and PCK, TPK and TPACK not mentioned by Ruthven, they were evidenced in other studies. These ambiguities are mainly due to the difficulty to decide whether a pedagogical knowledge is specific to particular subject or applicable to any subject. For example, the teaching principles of assisting students in noticing connections between various concepts in a curriculum can either be PK or PCK (Archambault & Barnett, 2010). Likewise, the understanding of technological tools’ potential for helping students make

connections between effects of manipulating graphs and solving inequalities was classed as TPK by Richardson (2009), but it could also be TPCK for being related to mathematics content. Above all, it seems appropriate to combine together the categories that could cause confusion, and to delete the parts overlapping with other categories. Therefore, we combine PK and PCK, TPK and TPCK; we delete the pedagogical aspect in CK, TK and TCK; and finally we combine the remaining part of TK and TCK, keeping the remaining part of CK as a distinct category.

A second type of ambiguities exists in the hierarchy implied in the labelling rules of the intersection categories, especially TPCK. It may represent

an amalgamation of what might have been termed PTCK – pedagogical knowledge relating specifically to the development (by students) of particular forms of technological content knowledge – with what might have been termed TPCK – technological knowledge relating specifically to particular aspects of pedagogical content knowledge (Ruthven, 2014, pp. 376).

The PTCK is closely related to a special process that students will experience in a classroom where they have access to technologies – the instrumental genesis in which the development of technological and mathematical proficiency is intertwined. Hence, it may be beneficial to distinguish PTCK from the initial TPCK, to give a separate consideration to the teacher knowledge in a teaching setting in which students have access to technologies.

Up to now we have reconstructed 5 categories of teacher knowledge for mathematics teaching with technology: (1) Knowledge about content (initial CK without pedagogical aspect), (2) Knowledge about technology and related content (combination of initial TK and TCK without pedagogical aspect), (3) Knowledge about pedagogy of content (combination of initial PK and PCK), (4) Knowledge about technology in pedagogy of content (initial TPCK without the aspect of PTCK) and (5) Knowledge about pedagogy for linking technology and content (PTCK implied in initial TPCK). Fig. 3.10 illustrates how the five categories are reconstructed from the initial knowledge categories in the TPACK framework.

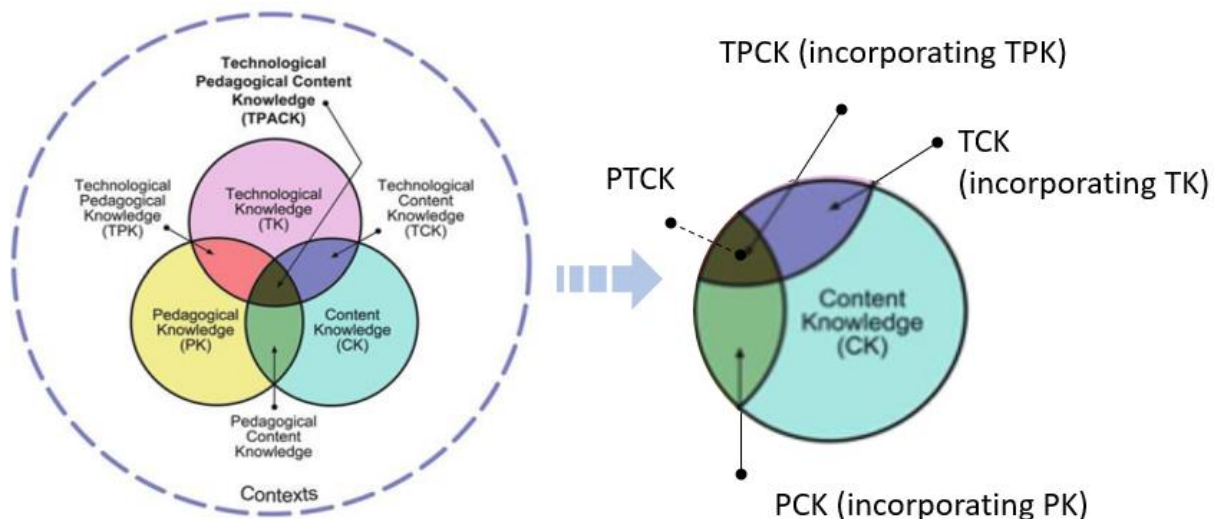


Fig. 3.10 Reconstruction of the five categories of knowledge from the TPACK framework

(2) Expand the new categories of *knowledge* into categories of *knowledge and views*, and confine all the “content” elements to the field of mathematics, with a specific focus on the perceptive elements and logical reasoning in the field.

By “expand” we mean that for the categories of *knowledge* newly established, we replace them by categories of *knowledge and views*. For example, the Knowledge of Content – which is defined as teachers’ knowledge about the subject matter to be learned or taught – is replaced by Knowledge and Views about Content, which is defined as teachers’ knowledge and views about the mathematics subject to be learned or taught. In this way we get five categories of *knowledge and views*: (1) Knowledge and Views of Content, (2) Knowledge and Views of Technology and related Content, (3) Knowledge and Views of Pedagogy of Content, (4) Knowledge and Views of Technology in Pedagogy of Content, and (5) Knowledge and Views of Pedagogy for linking Technology and Content.

As for the concrete components in the expanded categories, sometimes a *knowledge* component in the previous five categories can itself be a *view*, especially the one related to pedagogy. For instance, a teacher’s statement “discussing mistakes and original approaches with student is fruitful for learning” in (Drijvers et al., 2010) can be seen as some pedagogical *knowledge* that the teacher learned at university, but it can also be a *view* of the teacher concerning how to make a subject easy to learn. In this case, we take “the knowledge or views about the pedagogical techniques that can make the content easy to learn” as a component in the expanded category – Knowledge and Views about Pedagogy of Content.

Sometimes the *knowledge* components in the previous 5 categories are not concerned with *views*. Like in the category of Knowledge of Content, there is only teachers’ *knowledge* of the subject, but not their *views* on the nature of the subject which are also essential for their teaching activities. In this case, we add “the view of teachers on the nature of the subject to be learned or taught” as a component into the corresponding expanded category – Knowledge and Views about Content.

Up to now, the knowledge and views in the expanded categories are all generic to the teaching of any subject matter, to make the categories specific for mathematics teaching, and especially for the coordination practice, we confine all the components related to “content” to the field of mathematics, and further to the perceptive elements and logical reasoning in mathematics if possible. For instance, “teachers’ views on the nature of the subject to be learned or taught” in the category of Knowledge and Views about Content is reformulated as “teachers’ views on the nature of mathematics and the role of perception and logical reasoning in mathematics”.

(3) Incorporate the relevant knowledge and views identified in other research into the corresponding categories

This step is to enrich the categories of *knowledge and views*, making them more exhaustive. By “relevant” we mean the knowledge and views relevant to the mathematics teaching with technology, especially the mathematics teaching engaging students in perceptive and logical reasoning activities. In fact, there do exist many relevant knowledge and views in other research which are not captured by the TPACK framework. For example, teachers’ views on the validity and efficiency of mathematical proof and empirical argumentation (Stylianides & Ball, 2008) can be incorporated into the category Knowledge and Views about Content. Some

components in Ball et al.'s (2008) MTK framework, which is dedicated to structuring the pedagogical content knowledge for mathematics teaching, can be cited to enrich the category of Knowledge and Views about Pedagogy of Content.

Finally, the category of Knowledge and Views about Pedagogy for linking Technology and Content concerns the pedagogy with respect to the development (by students) of particular forms of technological content knowledge. It overlaps a lot with the knowledge required by teachers for managing students' instrumental geneses in the class (Hollebrands & Okumuş, 2018), as the instrumental genesis process is taken as having the growth of students' TCK at its core (Ruthven, 2014). Hence we absorb such knowledge in Hollebrands & Okumuş' (2018) to enrich the category constructed in this study.

(4) Identify another three categories of views relevant to mathematics teaching with technology

There are also some views identified by previous researchers which are closely related to teachers' intention to use technologies in mathematics classes, but they can hardly be classified into any of the five categories of knowledge and views, as they do not involve significant cognitive elements. These views can mainly be distinguished into three categories: teacher's perceived ease or difficulty of performing the behavior of using technologies in mathematics classes (Drijvers et al., 2010; Pierce & Ball, 2009); teachers' perceived social pressure (from school directors, colleagues, student parents...) to conduct or not a pedagogical approach, with or without the use of technologies (Pierce & Ball, 2009); and teachers' views on the time economy of the mathematics lessons integrated with technologies (i.e., whether the time invested is worth costing) (Drijvers et al., 2010; Ruthven, 2014). These views determine whether or not teachers will use or not technologies in their mathematics classes and how they will use the technologies, and thus will certainly influence their coordination practice. We take them as another three categories of knowledge and views in these study, respectively named as (6) Knowledge and Views about Behavior Control, (7) Knowledge and Views about Social Norms, (8) Knowledge and Views about Time Economy.

In this way, we get 8 categories of knowledge and views. We further replace the term of "knowledge and views" by "operational invariants", hereby getting eight categories of operational invariants. They are (1) Operational Invariants about Content, (2) Operational Invariants about Technology and related Content, (3) Operational Invariants about Pedagogy of Content, (4) Operational Invariants about Technology in Pedagogy of Content, (5) Operational Invariants about Pedagogy for linking Technology and Content, (6) Operational Invariants about Behavior Control, (7) Operational Invariants about Social Norms, (8) Operational Invariants about Time Economy.

(5) Revising the framework according to the results of actual data analysis.

We use the preliminary framework of operational invariants to analyze the actual data of teachers and incorporate the newly emerging knowledge and views into the framework until all the data can be covered by the categories in it. We adopt this manner to test and improve the applicability of the framework. The precise data analysis procedures will be introduced in section 4.4.1.

It should be noted that the framework of operational invariants developed here is a general one, which structures teachers' knowledge and views for general mathematics teaching integrated with technology, as well as the general coordination practice therein. Whilst the actual data may only involve the knowledge and views for the specific coordination in 3D geometry integrated with 3D DGEs. Therefore, we should be careful with the different levels of generality of knowledge and views while coming back and forth between the framework and actual data.

3.5.2 Eight categories of operational invariants in the sub-framework

Category 1: COI (Operational Invariants about Content)

Teachers' knowledge and views about mathematics. It includes:

- Knowledge of mathematics facts/concepts/theorems/procedures/models/methods;
- Knowledge of the rules of evidencing and proof in mathematics, as well as established approaches for generating new knowledge (Koehler & Mishra, 2009);
- Views on the nature of mathematics (Haspekian, 2014);
- Knowledge or views about the validity, rationality and efficiency of different logical reasoning (deduction, induction, abduction) and the reasoning merely based on perceptive evidences (Stylianides & Ball, 2008).

Category 2: PCOI (Operational Invariants about Pedagogy of Content)

Teachers' knowledge and views about the pedagogy applicable to the teaching of mathematics. It includes:

- Knowledge or views about the general pedagogical principles and strategies: including those to motivate student learning, manage classroom, develop and implement lesson plan, and evaluate students;
- Knowledge or views about the specific pedagogical principles and strategies to support students' mathematics learning, in particular the mental imagination/perception or logical reasoning in mathematics (Koehler & Mishra, 2009);
- Knowledge of alternative teaching strategies, and different interpretations of the same mathematical idea or problem;
- Knowledge or views about the curriculum/examination prescriptions with respect to tasks, (Ball et al., 2008), in particular the status of the related mental imagination/perception or logical reasoning activities in the prescriptions;
- Knowledge or views about how different topics are related over the span of mathematics included in the curriculum (Ball et al., 2008);
- Knowledge or memories of students' (at a grade, class, or individual student level) previous knowledge, performances, understanding, misconceptions, or difficulties in mathematics learning (Bonnat et al., 2020), in particular in mental imagination, interpretation of figural representations, or logical reasoning activities;
- Views on what is important in teaching and learning mathematics (Thomas & Palmer, 2014), in particular the importance of mental imagination/perception or logical reasoning in a mathematics domain;

-
- Knowledge or views about the potentials or constraints of non-technological resources for supporting students' perception or logical reasoning.

Category 3: TCOI (Operational Invariants about Technology and the related Content)

Teachers' knowledge and views about the use of digital technologies (both standard and advanced ones) and how the technologies and mathematical content are reciprocally related. It includes:

- Skills of operating technological hardware, including the skills of installing and removing peripheral devices, the skills of installing and removing software programs, etc;
- Mathematical knowledge underpinning the technological skills of using mathematics-specific software/hardware (e.g., GeoGebra, Cabri 3D, and calculator);
- Knowledge of the manner in which the mathematics content can be changed by the application of technology (Koehler & Mishra, 2009);
- General attitude to digital technologies and openness to the learning of them (Thomas & Palmer, 2014);
- Knowledge and views about how the solutions to mathematics tasks in a digital technological environment would be different from those in a paper-pencil environment (Laborde & Laborde, 2011).

Category 4: TPCOI (Operational Invariants about Technology in Pedagogy of Content)

Knowledge and views about how to teach mathematics effectively with digital technology. It includes:

- Knowledge or views about the existence of various digital technologies and their potentials for general teaching and learning;
- Knowledge of how teaching might change as the result of using particular technologies;
- Knowledge or views about the general pedagogical principles of teaching with digital technologies;
- Knowledge or views about the existence of mathematics-specific digital technologies (Koehler & Mishra, 2009);
- Knowledge or views about the impact of digital technologies on students' engagement or interest in mathematics learning;
- Knowledge or views about the side effects of digital technologies for general teaching and learning;
- Knowledge or views about the potentials and side effects/constraints of digital technologies for mathematics teaching and learning (especially for students' perception or logical reasoning) (Pierce & Ball, 2009);
- Knowledge or views about the specific pedagogical strategies to exploit the potentials of digital technologies for student mathematics learning, perception or logical reasoning;

-
- Knowledge or views about the specific pedagogical strategies to make up for the side effects of digital technologies for student mathematics learning, perception or logical reasoning;
 - Knowledge of the curriculum prescriptions on how to use digital technologies for teaching mathematics (Ball et al., 2008), in particular for supporting students' perception or logical reasoning;
 - Understanding the priority of mathematics activities in paper-pencil environment versus the activities in a digital technological environment: e.g., the order and difficulty level in which the two kinds of activities should be experienced by students; how the work with paper-pencil or digital technologies can represent students' understanding of mathematics.

Category 5: PTCOI (Operational Invariants about Pedagogy for linking Technology and Content)

Knowledge and views about how to help students connect mathematics content with technological knowledge and skills. It includes:

- Views on the relationship between learning technology and learning mathematics (in particular the developing of mental imagination or logical reasoning);
- Views on the educational value of technological techniques, or which techniques need to be taught or learnt;
- Knowledge of the pedagogical strategies to teach students technological techniques and the related mathematics content: e.g., step-by-step direction with or without the introduction of mathematical ideas, direct students' attention to the mathematical knowledge underlying the technological skills, guide students to explore mathematics with the technological skills already learned (Hollebrands & Okumuş, 2018; Pierce & Ball, 2009);
- Awareness of the distance between the paper-pencil techniques and the technological techniques for solving the task of the same mathematics topic (Haspekian, 2014);
- Knowledge of the curriculum or examination prescriptions and with respect to students' use digital technologies (Pierce & Ball, 2009).

Category 6: BCOI (Operational Invariants about Behavior Control)

Teacher's perceived ease for designing or implementing digital technologies in mathematics lessons. It includes:

- Teacher confidence of his own knowledge and skills related to a digital technology;
- Perceived ease or difficulty with respect to designing digital resources for mathematics lessons;
- Perceived ease or difficulty with respect to using digital resources by the teacher him/herself in mathematics lessons;
- Perceived ease for organizing students' interaction with digital technologies in mathematics lessons (Pierce & Ball, 2009).

Category 7: SNOI (Operational Invariants about Social Norms)

Teachers' perceived social pressure to perform or not the mathematics teaching with digital technologies. It includes:

- Pressure perceived from the preferences of directors, principals or discipline coordinators in the school;
- Pressure perceived from the opinions of teacher colleagues;
- Pressure perceived from the criteria of teaching competition/evaluation at the school/district/national level;
- Pressure perceived from the expectations of students' parents (Pierce & Ball, 2009).

Category 8: TEOI (Operational Invariants about Time Economy)

Teachers' perceptions of whether the time for implementing digital technologies in mathematics lessons is worth costing. It includes:

- Anticipation of the time required for the teacher itself or the students to learn adequate digital technological skills (Pierce & Ball, 2009);
- Knowledge or views about the time constraint (in the school teaching calendar or the grade teaching schedule) on a mathematics lesson;
- Knowledge or views about how to improve the didactical return (in terms of students' mathematics advancement) of the time costed in a mathematics lesson, or how to save the time on certain unessential activities (Ruthven, 2014).

4 Methodology

This section introduces the research methods used in this thesis and motivates the choice of these methods. We first introduce the case study as a basic method (section 4.1). We then present in detail the criteria for case selection (section 4.2), the principle for data collection (section 4.3) and the data analysis procedures (section 4.4).

4.1 Case study as a basic method

We situate our interest in a case study method. In the following paragraphs, we firstly introduce the definition, field of application and characteristics of the case study and how it matches the interest of this thesis. Then we discuss the general research design of this thesis.

4.1.1 Definition, field of application and characteristics of case study

Case study is a method in which the researcher selects one or several scenes, systematically collects data and information about the cases, and conducts in-depth study to explore the status of a phenomenon or system of actions in the real social situation (Lu, 2013). This method is usually applied when the boundaries between the phenomenon and the real situation are unclear and not easy to distinguish, or when the researcher is unable to design precise, quantifiable, and systematically controlled variables, to answer research questions with “how”, “why”, and “what” (Yin, 1994). The quintessential characteristic of case study is that it strives towards a holistic understanding of the phenomenon or system of actions being examined (Feagin et al., 1991), and can get as close as possible to the object of study, partly by their direct access to subjective factors (observation, in-depth interview), partly by their wide net for evidence collection (Bromley, 1986). This is consistent with our interest in mathematics teacher’s coordination behavior, i.e., a system of actions, in the educational situations that contain both 3D geometry tasks and 3D DGEs.

Case studies can have different aims, such *describe* individual cases, *explore* reasons for or solutions to problems, *explain* some phenomenon, and *explore* relationships between factors (Bromley, 1986). This thesis conforms with the last aim, trying to identify some relationships between the characteristics of 3D geometry tasks, the teacher’s coordination behavior and her knowledge and views.

As for the case study aimed at exploring relationships (ibid. pp.134-141), Bromley (1986) introduces the following steps:

- First, list the features of the case and sort them into groups which can probably be connected with one another in a functional sense (or even causal sense).
- Second, connect the features in one group to another group through functional relationships, explicating the reasons for connecting the features.
- Third, follow up this tentative grouping and connection by checking with further evidence and developing interpretations, until no further ideas of a creative or critical relationship and no further empirical evidences are forthcoming. This step reflects the principle of “triangulation of evidences” in case study.

4.1.2 General research design of this thesis

According to the steps above, we consider the general research design of this thesis, which can also be divided into several steps.

The first step is crucial in the whole research, for which we should decide the criteria of case selection, the number of cases to be collected, and how the features within one case can be analyzed. Regarding the case selection, according to the objective of this thesis, we take one teacher's activities in 3D DGE integrated-3D geometry lessons, both in real classrooms or distant online settings, as *one case*. Hence, the case selection is mainly about the teacher selection. Here we are particularly interested in the cases of the teachers with rich experiences or the teachers being enthusiastic about 3D DGE use, so as to provide good examples for in-service teachers; this will be elaborated in section 4.2. Regarding the data collection for each case, we will collect the relevant data which allow for analyzing three groups of features: the characteristics of the 3D geometry tasks and 3D DGEs, rules of coordination and their corresponding operational invariants, with the latter two constituting the main part of the coordination schemes of the teacher. Here DAD proposes some specific principles for data collection and we will elaborate them in section 4.3. With the data collected, we will analyze the features in different groups mentioned above. In case study, the data of case can be analyzed with the theoretical frameworks set up either in a bottom-up or up-bottom manner (Yin, 1994). In this thesis, we use the up-bottom manner, i.e., firstly set up the frameworks according to literature review, and then test the frameworks with actual data.

For the second step, we connect the features in different groups, using the strategies of contrasting, inductive and abductive inferences. Here we firstly connect a teacher's rules of coordination with operational invariants, and then connect the rules of coordination with the characteristics of 3D geometry tasks-3D DGEs.

For the third step, we follow up this the grouping and connection by checking with further evidence and developing interpretations. Here the operational invariants can serve as the evidences for justifying the connection between rules of coordination with the characteristics of 3D geometry tasks-3D DGEs.

The whole data analysis procedures will be detailed in section 4.4.

As for the validity and reliability of this study, we use theories that have been well acknowledged in the corresponding fields to establish the theoretical frameworks and try to clearly explain the reasons for choosing these theories. For every case, we try to refer to multiple forms of data (class videos, teacher's written memoirs, structured/stimulated recalled interviews etc.) while performing the analysis. The triangulation of evidences in the third step can also help deepen our analysis and improve the validity of the study. Regarding the reliability of this study, we try to improve it by presenting clearly the procedures of data collection and data analysis, showing the replicability of these procedures, and giving detailed information about the data we referred to while presenting the analysis result.

4.2 Criteria of case selection: French and Chinese cases

As mentioned above, this thesis takes one teacher's coordination activities over one or more lesson series on 3D geometry as one case. But only one case is not enough to present the diversity and complexity of teachers' coordination behavior, nor enough to reveal their relations with the tasks-3D DGEs and the knowledge and views, so we need to seek for multiple cases. This thesis is thus a multiple-case study

The case selection in a multiple-case study follows the replication logic rather than the sampling logic. That is, the cases needn't to be inclusively representative but should allow studying the issues at stake to the maximum extent in the period of time available for the study (Tellis, 1997). In this thesis, the replication logic is reflected in the fact that all the teachers we seek for are proficient (3D) DGE users or at least are enthusiastic about using 3D DGEs in 3D geometry lessons, but we meanwhile try to enlarge the heterogeneity of the tasks and teacher's knowledge and views (operational invariant) between cases, so as to better identify their relations with teacher's coordination behavior (rules of coordination). The cases from France and China, under the global frame of Sino-French cooperation that this Ph.D. project is situated, are chosen for this sake – the different mathematics education traditions, curriculum and examination policies of the two countries would cause the different tasks and teacher's knowledge and views. Next we introduce how we have searched for cases respectively in France and in China

Regarding the cases from France, we searched for the teachers mainly via universities and educational research institutions, such as IFé (French institute of education) and IREM (institute of research on mathematics teaching). The two institutions have supported many collaborative work of university mathematicians, researchers in mathematics education, teacher educators, secondary and primary teachers. The middle school teachers engaged in these institutions, as they would more often participate innovative teaching-research activities, are more likely to use 3D DGE in their daily lessons than other teachers. We first let the university professors engaged in these institutions recommend the typical teachers they know, and then ask for the teachers' opinions. According to the teachers' availability and willingness, we are finally able to follow 2 French teachers' cases in this thesis. Both of them didn't use 3D DGEs in distance online lessons during the epidemic.

The basic information of the two French mathematics teachers (with pseudonyms) is presented below.

- Dora: Female, 23-year teaching experience, often using 3D DGE both in computer room (where each student can have access to a computer) and ordinary classroom, proficient in 3D DGE, often design the courseware by herself, an active member in IREM of Lyon– a teacher-researcher community that organizes many teaching research projects and teacher training courses⁵.
- Sonia: Female, 20-year teaching experience, seldom using 3D DGE in ordinary classroom but often using it in computer room, not proficient in 3D DGE.

⁵ Institut de recherche sur l'enseignement des mathématiques de Lyon, <http://math.univ-lyon1.fr/irem/>

Regarding the cases from China, we also searched the teachers through the mediation of universities and educational research institutions (near Shanghai), but have got little reactions. We then try paid attention to the teacher training programs on the use of (3D) DGE posted on the social media like WeChat and internet. Either the teachers as the trainer or the trainee in such programs would be of our interest. Usually it's the researcher who contact these teachers through the personal information they left on the social media. Again, according to the teachers' availability and willingness, we are finally able to follow the cases of three Chinese teachers. However, due to the time limit for this thesis, we are only able to analyze the case of one Chinese teacher who has used 3D DGEs in both real classrooms before the epidemic and the distance online lessons during the epidemic. The basic information of the one Chinese teacher (with pseudonym) is presented below.

- Huang: Male, 6-year teaching experience, never uses 3D DGE in computer room, but often uses it in ordinary classroom, proficient in 3D DGE, developer of an online video tutorial on the design of educational GeoGebra files.

In this thesis, we have followed and analyzed three lesson series of this teacher, which cover enough examples of 3D geometry tasks, 3D DGEs, and coordination schemes on the Chinese part and allow us to study the transformation of teacher's coordination activities from real classrooms to distance online settings. As for the other two Chinese teachers, one of them uses 3D DGEs only in distance online lessons during the epidemic, and the other uses 3D DGEs only in real classrooms after the epidemic. Their cases may not cover so much valuable information as Huang's case. We therefore leave the other two teachers' cases for the future research, and we will come back to this point in section 6.2.3.

4.3 Data collection strategy

According to the discussions in section 4.1, the data collected for this study should allow us to get the information about the teachers' coordination schemes emerging in 3D DGE integrated-3D geometry lessons, which take place either in real classrooms or in distance online settings. After this introduction, we present four further sections: section 4.3.1 gives an overview of the lessons we have actually followed; section 4.3.2 introduces the data collection principles proposed by the DAD framework, specifying the principles we have followed and the compensatory strategies for the principles we have not followed; section 4.3.3 gives a list of the data finally collected in each teacher's case.

4.3.1 Lesson series covered by each case

Fig. 4.1 gives an overview of the lesson series we have followed of each teacher and the date on which the series took place. As mentioned in section 3.1.3, one series of lessons refers to several 3D geometry lessons in which a teacher has used 3D DGEs across a short period. The short period was usually less than two weeks, in which a teacher would intensively implement lessons all about 3D geometry but would not use 3D DGEs in each lesson, and we only follow those integrated with 3D DGEs.

At the beginning, we would like to follow the 3D DGE integrated-3D geometry lessons of each teacher before and during the epidemic-distance online lesson series. But in reality, such

lessons wouldn't appear in all the three periods in each teacher's case. For example, the Sonia and Dora only use 3D DGEs before the epidemic. What's more, the number of the lessons we have followed in each series are not always the same, and this depends on how many lessons in which the teacher has used 3D DGEs. Sonia only uses 3D DGEs in only one lesson, but the lesson takes place in a real computer classroom where every student had direct access to 3D DGEs and there are fruitful perceptive elements and informal reasoning ideas in this lesson. So we still take the one lesson of the teacher as the case worth investigating. Besides the lesson series in the real computer classroom, there are lesson series in the real ordinary classroom where only the teacher has access to the computer and 3D DGEs; they appear in the cases of both Dora and Huang. The distance online lesson series only appear in case of Huang.

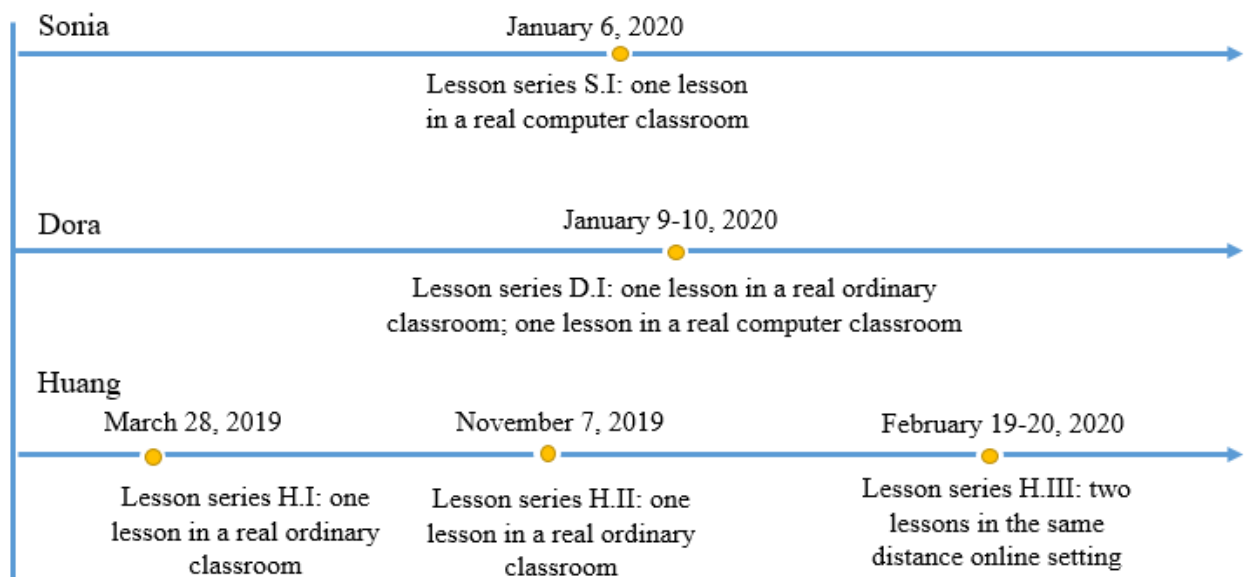


Fig. 4.1 overview of the lesson sessions of the three teachers followed in this thesis

4.3.2 Methodological principles proposed by DAD

To collect data that allows to infer a teacher's schemes and documentational geneses, DAD proposes some methodological principles: (1) broad collection of material resources, (2) long-term follow-up, (3) in- and out-of-class follow-up, (4) reflective follow-up, and (5) confronting the teacher's views with the materiality of this work. The content of the five principles are presented below.

- (1) Principle of broad collection of material resources. The variety of resources feeding, and produced by, teachers' documentation work requires the broad collection of the material resources used and produced in the course of this work.
- (2) Principle of long-term follow-up. This principle is aimed to capture the ongoing documentational geneses which usually span over a long period of time before the stable schemes could be developed.
- (3) Principle of in- and out-of-class follow-up. The classroom is an important place where the

teaching elaborated is implemented, bringing adaptations, revisions and improvisations. However, an important part of teachers' work takes place outside the classroom: at school (e.g. in staff rooms), at home, in teacher development centers/programs.

- (4) Principle of reflective follow-up. This principle concerns involving the teacher as a significant actor in the data collection process, trying to elicit the teacher's own understanding of his/her documentation work, as s/he is the one that have access to this work. It can also lead the teacher to an introspective attitude.
- (5) Principle of confronting the teacher' views on her documentation work, and the materiality of this work (materiality coming for example from the collection of material resources; from the teacher's practices in her classrooms)

Now we introduce how we have followed principles (1), (4) (5) in this thesis. For the other two principles not followed, we give the reason or the alternative measures we have adopted.

We follow principle (1) by collecting both the material resources and digital resources related to the 3D geometry tasks and 3D DGEs used and produced by each teacher in each of their lessons. The resources include: PowerPoint slides, paper or digital handouts containing 3D geometry tasks, GeoGebra files, and websites in which 3D DGEs are embedded. These resources will allow us to get the information about the characteristics of the 3D geometry tasks-3D DGEs in each teacher's case.

Concerning principles (4) and (5), we follow them by means of the general semi-structured interview which is possibly integrated with the stimulated recall interview. The stimulated recall interview is a specific interview used to elicit the thought or decision making of a subject at particular moments (Calderhead, 1981).

In compliance with the reflective follow-up principle in (4), the general semi-structured interview with a teacher mainly involves the questions on:

- her overall didactical objective, her reasons for choosing, adapting, or creating the tasks to be used in the lesson at stake
- the technological issues related to the design of 3D DGEs
- the adaptation of other resources for the integration of 3D DGEs
- her understanding of the task solutions
- her understanding of student difficulties
- her understanding of the role of each 3D DGE in student perception and logical reasoning with respect to the corresponding task.

These questions apply to both real classroom lessons and distance online lessons. For the distance online lessons, the interview also involves the questions on:

- her understanding of the functions of the distance online teaching platform
- the differences between the resources available before and during the epidemic-distance online teaching,
- the difference between the resources she designed such as 3D DGEs
- the adjustment of teaching activities, especially those for supporting students' perception and logical reasoning in reaction to these difference.

The general semi-structured interview is usually conducted after a lesson series and sometimes also before the lesson series. For the interview after a lesson, the stimulated recall interview would be integrated, and this is in compliance with the principle (5) - confronting the teacher's views on her documentation work and the materiality of this work in. Specifically, the stimulated recall interview is conducted in the manner as follows.

After a lesson, the researcher looks at the lesson videos or the teacher's written memoir of the lesson proceedings (a specific data collection tool to make up for the lack of lesson videos, to be introduced later on) to locate the extracts related to interesting coordination behavior, i.e., the extracts covering interesting perceptive or logical reasoning activities in the lesson. After that the stimulated recall interview is conducted (embedded within the general semi-structured interview): the researcher replays these extracts to the teacher, inviting the teacher to comment freely, describe what she was doing at that time, explain her thinking and decision making at that moment. The researcher would also request the teacher to explain some behavior regularities or the transformation of her behavior in these extracts.

The whole general semi-structured is audio-recorded, with the part of the stimulated recall interview also being video-recorded. The corresponding transcript of general interview includes not only the interview questions, teacher's answers, but also certain screenshots of the video of the stimulate recall interview or the videos played to the teacher. The transcript data will allow us to infer the operational invariants in the coordination schemes in each teacher's case.

As regards the principle of long-term follow-up. and the principle of in- and out-of-class follow-up in (2) and (3), we have mainly achieved the in-class follow-up and this is partly because of the research questions and partly because of the travel limitations during the epidemic period.

In section 3.2, we already mentioned that for the REAL CLASSROOM lesson series, we are only interested in teachers' coordination schemes and the classes of situations within each separate lesson series, but not the connections between the different versions of schemes in different lesson series nor the related documentational geneses. That is why we mainly implement the in-class follow-up for the real classroom lesson series of the teachers. Of course, there might be out-of-class activities which are critical to the teacher's coordination in the lesson, such as the choice and adaptation of 3D geometry tasks, the design of 3D DGEs, and the reflection after the lesson. For such activities, we would request the related information in the general semi-structured interview, and the questions to be involved are already shown previously. In addition, the long-term follow-up between two real classroom lesson series would not be implemented.

As regards the DISTANCE ONLINE lesson series, we are not only interested in teachers' coordination schemes and the classes of situations within the lesson series, but also their connections with the schemes and classes of situations in the previous REAL CLASSROOM lesson series, and the related documentational geneses. At this time, in addition to the in-class follow-up, the out-of-class follow-up and long-term follow-up are also necessary. However, due to the travel restriction during the epidemic period, the researcher was not able to come to the site of the teacher. As the result, we were only able to implement the in-class follow-up and we replaced the out-of-class and the long-term follow-up with a general semi-structured

interview. The review questions to be involved are already introduced previously. Nevertheless, the interview cannot replace the actual follow-up, lacking the detailed information about the teacher's activities during the transition period has bring us difficulties in distinguishing between the direct and indirect documentational geneses. We will also discuss this point in section 6.2.3.

Now we introduce how we implement in-class follow-up. In general, we will record videos for each lesson – camera videos of the lessons in real classrooms, and screen recording videos of the live-streaming lesson in distance online settings. In the corresponding video transcript, the researcher integrates not only the teacher-student collective discourses around all the tasks used in the lesson, but also the gestures and tool use of the teacher and students, and the video screenshots capturing critical drawings, writings, 3D DGE effects displaced in the lesson. In this way, the video transcripts will enable us to get the information about the teachers' coordination behavior and infer rules of coordination.

Even for in-class follow-up, there are lessons in the real classrooms when the researcher was not able to come to the classrooms to record the videos. Since the lessons of our interest – those on 3D geometry integrated with 3D DGEs – are already quite rare, to avoid missing an interesting lesson, we try to reconstruct the lesson proceedings with a “written memoir” produced by the teacher and a “compensatory interview” after that. In this thesis, we only do this for lesson series H.I of Huang.

The written memoir is something that depicts the teacher-student discourses around all the tasks in a lesson. It is produced by the teacher on the researcher's request after the lesson. At first, the researcher would imagine what could have happened in the lesson according to her first contact with the teacher and the tasks and 3D DGEs collected. On that basis, the researcher produces a piece of written memoir with respect to one task and presents it to the teacher, requesting her to produce a written memoir in the same form with respect to all the tasks used in the lesson. Table 4.1 shows an extract of Huang's written memoir with respect to Task H.I-5.

After that, the researcher conducts a compensatory interview to make up for the information missed in the written memoir, like teacher's gestures, drawings and writings. The compensatory interview is actually a semi-structured interview, in which the researcher requests the teacher to specify some discussion processes in the lesson, to reproduce some writings and drawings he has made, and to replay some 3D DGE effects (on his personal computer) he has played in that lesson, with the written memoir as a reference. Sometimes the teacher would connect his gestures with the effects on the screen. The compensatory interview is also aimed to reduce the subjective bias of the teacher reflected in the written memoir. Since the teacher would have the tendency of idealization and oversimplification, some actions and dialogues in the written memoir may not have happened in the real lesson. Then in the interview the researcher will question about the dialogues and actions. Based on the compensatory interview and the written memoir, the researcher produces a reconstructed transcript of the lesson at stake in a similar way to that for making the video transcript. The gestures, paper writings and drawings, and the 3D DGE displayed on the teacher's personal computers are supposed to have appeared in the real lesson. Table 4.2 presents a part of the reconstructed transcript of the lesson of Huang. Compared to the written memoir in Table 4.1, we can see that the reconstructed transcript

integrates some 3D DGE effects and teacher gestures, and some student words in the former file are removed to the teacher's words in the latter file.

Of course, reconstructed transcripts cannot totally reconstruct the activities in the real lessons, but they at least presented the real perspectives of teachers. Since the coordination behavior investigated in this thesis is mainly discussed from the perspective of teachers – i.e., how teachers take into account of students' perception and logical reasoning and take measures in the hope that these activities could interact in a particular way – we claim that the reconstructed transcript can be a valid data for infer teachers' coordination behavior and rules of coordination. We will discuss the limitation of the data again in section 6.2.3.

Table 4.1 Extract of Huang's written memoir

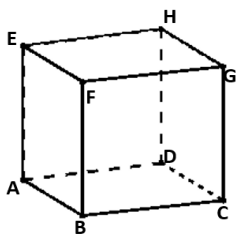
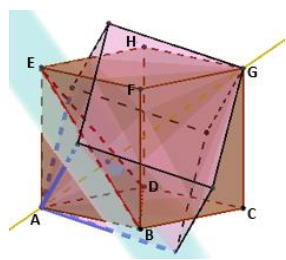
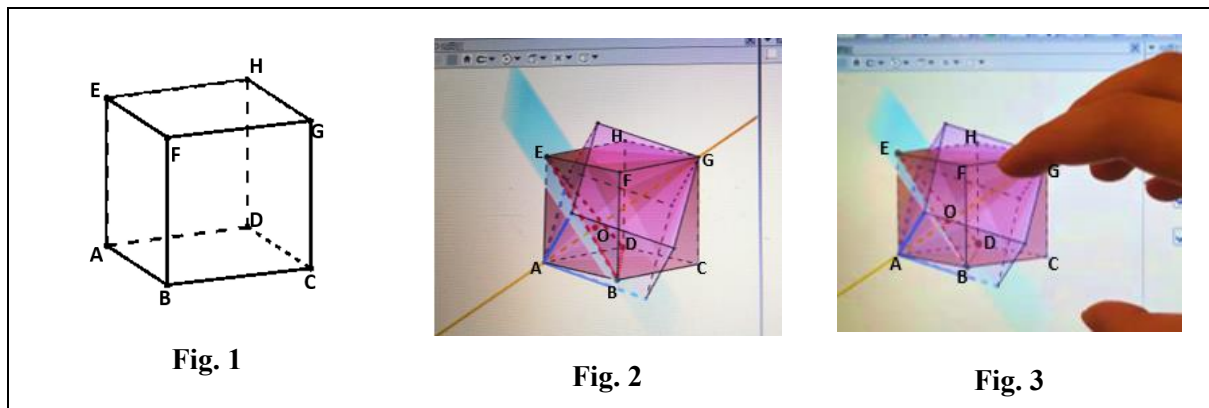
Task H.I-5	T-teacher	S-students
	<p>T: Let's see next task (Fig. (1), how can we find the plane α?</p> <p>S: Can it be plane EBD?</p> <p>T: Why?</p> <p>S: Just guess...since a cube has the property of symmetry.</p> <p>T: <i>The symmetry, a good idea.</i> Let's see it together in GeoGebra. I make the cube rotate around its diagonal (AG), now tell me, what can you observe in this process? (Fig.2)</p> <p>S: AE will rotate to the initial place of AB...</p>	
	<div style="display: flex; justify-content: space-around; align-items: center;"> <div style="text-align: center;">  <p>Fig. 1</p> </div> <div style="text-align: center;">  <p>Fig. 2</p> </div> </div>	

Table 4.2 Part of the reconstructed transcript of the lesson of Huang

Task H.I-5	T-teacher	S-students
	<p>T: Let's see next task (Fig. (1), how can we find the plane α?</p> <p>S: Can it be plane EBD?</p> <p>T: Why?</p> <p>S: Just guess...since a cube has the property of symmetry.</p> <p>T: The symmetry, a good idea. What do you think is the axis of symmetry?</p> <p>S: The diagonal of the cube?</p> <p>T: OK, actually, the cube can be rotated around its diagonal AG, and will coincide with itself after being rotated by less than 360°. Let's see it in GeoGebra (Fig. 2). I let the cube rotate around the diagonal. Can you imagine how the cube is rotated (Fig. 3)? Line segment AE will rotate to AB, and $\triangle AEO$ will rotate to $\triangle ABO$...</p>	



4.3.3 List of data for every lesson series

Up to now, we can get a list of the data that have been collected in this study –

- ① Material and digital resources related to the 3D geometry tasks and 3D DGEs used by the teachers in each lesson (including the modifications they made in class)
- ② Camera videos of a real classroom lesson – one fixed camera recording the dynamics of the whole class, one moving camera along with the teacher – and the video transcript of the lesson
- ③ Screen recording video of a live-streaming lesson and the video transcript of the lesson
- ④ Compensatory interview after a lesson and the reconstructed transcript of the lesson (when lesson videos were not available, only in the case of Huang)
- ⑤ Written memoir of the teacher (when lesson videos were not available, only in the case of Huang)
- ⑥ General semi-structured interview possibly integrated with “stimulated recall” interview transcript of interview

We locate these data on the timeline of lesson series of each teacher, as shown in Fig. 4.2. More detailed information about the data will be given in chapter 5, at the beginning of the section about each lesson series.

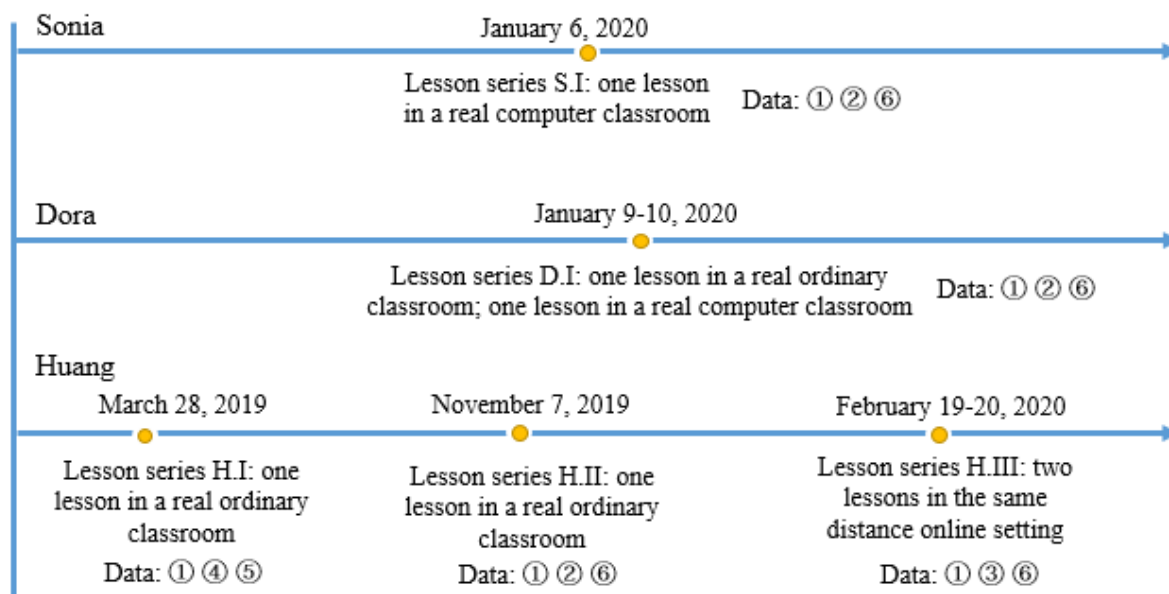


Fig. 4.2 Data collected about the lesson series of the three teachers in this thesis

4.4 Data analysis

This section introduces the data analysis procedures and how they allow to answer the research questions in section 3.2. The analysis procedures consist of two parts. The first part (section 4.4.1) is conducted to the real classroom lesson series in cases of Dora, Sonia and Huang, which allows answering the first group of research questions. The second part (section 4.4.2) is for contrasting the distance online and real classroom lesson series of Huang, which allows answering the second group of research questions.

4.4.1 Analyzing real classroom lesson series

For each real classroom lesson series of each teacher, we firstly examine its context, including: the date of the lesson series and its status in the school teaching calendar, the teaching setting of each lesson (form of classroom, technological and non-technological equipment in the space, arrangement of student seats, see section 3.1.2 for more detail), the subject matter of each lesson within the field of mathematics, teacher's global didactical objective with respect to each lesson, students' prior knowledge of the subject matter, students' prior knowledge of 3D DGEs (if students can operate with them directly) and the flow or sequencing of the topics of activities emerging in the lesson. The context information will be given at the beginning of each lesson series in chapter 5, before the presentation of the formal analysis results for that series.

The formal analysis of the lesson series includes 5 steps as follows.

Step 1: Analyze the 3D geometry tasks-3D DGEs used in every lesson to get their characteristics in the dimensions in section 3.3

The 3D geometry tasks and 3D DGEs to be analyzed here are extracted from the material and digital resources used in the lesson collected by the researcher (data ① in section 4.3.3).

Referring to the dimensions in section 3.3.1, we analyze the characteristics of each task in the following dimensions:

- 3D geometric topic of the task
- status of the task in the curriculum and important examination
- context of and innate support equipped in the task

Referring to the dimensions in 3.3.2, we analyzed the characteristics of each 3D DGE in the following dimensions:

- representations/tools available in the 3D DGE
- form of help and location of the control over the learning activities in the 3D DGE
- feedback in the 3D DGE;
- didactical distance of the 3D DGE to the curriculum

Step2: Analyze the transcript of the lesson, identify the coordination behavior according to the sub-framework in section 3.4

The transcript of the lesson to be analyzed is what the researcher compiles according to the lesson videos or the compensatory interview and the written memoir (data ② or ④ in section 4.3.3).

Here the unit of analysis was the transcript of one argumentation episode. The researcher identifies, from the transcript of the whole lesson, the whole *collective argumentation* around each task according to its definition in section 3.4.1. The transcript of the whole *collective argumentation* is then divided into several argumentation episodes by *argumentation nodes*, which are mainly marked by teachers' words like "next", "now half of the task" in the collective argumentation. After that the researcher sorts out the transcript of each argumentation episode, getting the unit of analysis, and analyzes it in reference to the sub-framework in section 3.4.2. This process can further be divided into several sub-steps:

- 1) Identify the students' and the teacher's direct contributions – the argumentation components like Claims, Data, Warrants, and Rebuttals –from the transcript of the episode and analyze their features according to Table 3.3 in section 3.4.2. The Qualifiers would only be analyzed when students' certainty of a claim was questioned. Then, we add component tags to the corresponding discourse sentences, together with their feature and the number indicating the order they have appeared.
- 2) For the components not explicitly expressed in the episode, such as Warrants, we infer them from the contextual information – inspect what has been discussed in previous episodes or presented on the board, and then analyze their features. Also, the features of warrants may be difficult to identify when there are no evidences to show what mode of reasoning the students being examined are conducting. In this case, we mainly consider the teacher's perspective according to her views expressed in the later interviews. For

example, if the teacher thinks the students are conducting deductive reasoning at that moment, we will attach the “deductive” feature to the corresponding warrant.

- 3) Represent the argumentation components with boxes (real line borders for explicit components and dotted borders for implicit components); indicate the feature and the order number of the components in the boxes, and organize them into a diagram of argument; add different colors to the boxes to denote different contributors of argumentation components;
- 4) Identify teacher’s indirect contributions – questions posed, other supportive actions, use of 3D DGEs, gestures and so on – from the transcript of the episode; analyze the category of the questions posed and the category of other supportive actions according to The second aspect of teacher’s coordination behavior is the combination of the other two aspects in Conner et al.’s (2014) framework, i.e., the questions posed and other supportive actions of a teacher. For *questions posed*, Conner et al.’s initial 5 codes are enough to code the questions posed by the teachers in this study, therefore we directly integrate them in our framework, and their descriptions are shown in [错误!书签自引用无效](#)。 . For *other supportive actions*, Conner et al. also propose 5 codes, which are *directing*, *informing*, *promoting*, *evaluating*, and *repeating*. We split the code *evaluating* into two codes: *validating* and *rebutting*, and keep the other four codes in our framework. Indeed, the original code *evaluating* implies both meanings of validating and rebutting – it refers to the teacher’s action of correcting a student’s incorrect statement, validating a student’s statement, or verifying the correctness of a statement. Nevertheless, in the actual data analysis, we find many typical validating and rebutting actions of teachers and feel it necessary to distinguish between the two categories of actions to investigate them respectively. For example, in the lesson series, teachers would validate conclusions directly by their authority, with 3D DGE effects, or with a third part (neither the teacher nor the students) evaluation system. They would also rebut incorrect students’ ideas in many different ways, such as present conflicting perceptible phenomenon in 3D DGEs, or directly reject by teacher’s authority. The actions of rebutting always go along with the contributions of Rebuttals, as mentioned previously. Furthermore, researchers have identified other rebutting actions such as give counterexamples where a mathematical statement does not hold, infer wrong conclusions by following a similar warrant (Reid et al., 2011). Since previous studies have pointed out the importance of *rebutting* actions with respect to students’ need for proof (Lin et al., 2012) and the importance of *validating* actions with respect to students’ certainty in claims, we finally decide to take them as two separate codes and get six codes in *other supportive actions*. Their descriptions are presented in [错误!书签自引用无效](#)。 .
- 5) Table 3.4 in section 3.4.2.
- 6) Use talk bubbles to represent the indirect contributions and integrate them into the diagram of argument drawn previously (connected to the relevant argumentation components). Now the complete diagram of argument in this study was completed.

-
- 7) Describe the teacher's coordination behavior in the argumentation episode, which consists of her direct and indirect contributions to the diagram of argument.

Step3: Infer the teacher's rules of coordination based on her coordination behavior across all the argumentation episodes in the lesson series.

As already discussed in section 3.4.3, the rules of coordination are actually the regularities in the teacher's coordination behavior across different argumentation episodes. Then the identification of rules of coordination is actually based on the structuring and classification of argumentation episodes.

According to the *basic structures* reflected in their diagrams of argument, the researcher classifies the *argumentation episodes* in the whole series into several *groups*, so that each group of episodes have the same basic structure distinct from the other groups. The basic structure concerns: features of the *data*, *warrants*, *qualifiers* and *rebuttals*, origins of the *perceptive data*, interaction mode of the *perceptive data* and different kinds of *warrants* in the diagram. The common basic structure of the argumentation episodes in each group can further be modeled by a more *general diagram of argument*.

Obviously, the teacher's coordination behavior in each group of episodes must show some regularities, which would be reflected as the teacher's contributions in the *general diagram of argument*. These behavior regularities (contributions in the general diagram) are summarized into one group of *rules of coordination*. The rules of coordination are initially expressed in terms of the direct argumentation components and teacher's indirect contributions. Later we reformulated them in terms of "perception" and modes of logical reasoning like "inductive reasoning", "theoretical deductive reasoning" and "abductive reasoning".

In particular, if some argumentation episode is solely classified into one group in this process, we still summarize the coordination behavior therein as one group of rules of coordination if they could be corresponded to the operational invariants identified later on.

Step4: Infer operational invariants underpinning the rules of coordination according to the sub-framework in section 3.5

The data to be analyzed here include all the data related to the rules of coordination, i.e., the related 3D geometry tasks and 3D DGEs, video transcript or reconstructed transcript of the lessons (in particular the parts concerning argumentation episodes), transcript of the general semi-structured interview or the compensatory interview.

In general, we infer the operational invariants from teacher's behavior regularities in terms of rules of coordination, with a reference to the argumentation episodes, 3D geometry tasks and 3D DGEs, and then verify them with teacher discourses in the interviews. For example, the rule of coordination for the tasks of intersection construction – “directly tell students the 3D geometry theorems/facts to be used in theoretical deductive reasoning” – suggests an operational invariant – “students should determine the intersection in space by theoretical deductive reasoning referring to geometric theorems/facts”; and this operational invariant needs to be verified with the interview data. Once an operational invariant can be evidenced by some interview discourses, it will be attributed to the rules of coordination as one underpinning operational invariant. We search for the related teacher discourses in three ways. Firstly, when the behavior regularities are questioned about in the interviews, the corresponding teacher answers are taken as related discourses. Secondly, when the extracts of lesson videos covering the rules of coordination are played in the simulated recall interview, the corresponding teacher comments are taken as related discourses. Thirdly, any teacher discourse with a specific regard to perceptive or logical reasoning elements in the interviews is taken as a related one.

Sometimes the operational invariants may not be clearly verbalized by the teacher in the interviews, but they are self-evident in the rules of coordination which are connected with the argumentation episodes, 3D geometry tasks and 3D DGEs. The operational invariants usually concern the mathematics knowledge, technological skills that the teacher should have a priori, or the tacit practical knowledge. For example, the rule of coordination presented above shows that the teacher must have the prior knowledge of the 3D geometry theorems/facts to be used for solving the corresponding tasks; the 3D geometry theorems/facts may be already expressed by the teacher in the argumentation episodes, and they can be considered as operational invariants underpinning the rule of coordination. Similarly, a rule of coordination like “rebut students' incorrect statement with perceptive evidences in a 3D DGE” requires the teacher to have the technological skills of displaying particular perceptive effects, and perhaps also the technological and mathematical knowledge for designing the 3D DGE, which can both be considered as operational invariants essential for the rule of coordination.

The operational invariants having been inferred are then grouped into different categories according to the sub-framework in section 3.5.2. This approximates to a content analysis process. The eight categories of operational invariants in section 3.5.2 serves as a coding system, every operational invariant obtained previously is coded with a category, if it can reflect some knowledge and view listed in that category. If the knowledge and view reflected in the operational invariant don't belong to any category, we will either integrate the new knowledge and view into one of the existing categories, or create a new category to cover the new knowledge and view, with the operational invariant being attributed to the corresponding category. The iterative process continued until all the operational invariants are coded with one

category in the framework. This is also a process in which the applicability of the framework could be improved.

Step5: Give a summary for the lesson series

After having conducted all the analysis procedures above, we give a synthesis of this lesson series, connecting the groups of coordination rules to the underpinning operational invariants to make up the main parts of different coordination schemes, and further connecting them to different classes of situations. A class of situations gathers all the 3D geometry tasks, 3D DGEs, the teaching settings and the other elements relevant to the corresponding coordination scheme. Based on the summary, we identify the commonalities and differences between the different groups of rules of coordination, and then link the commonalities and differences with the operational invariants in the corresponding schemes; this will lead to answers to research question 1.1. After that, we infer the links between the groups of rules of coordination and the characteristics of 3D geometry tasks-3D DGEs, and then refer to the corresponding operational invariants as further evidences; this will lead to answers to research question 1.2.

The results for all the real classroom series of all the teachers will be synthesized in section 6.1, leading to the final response to the first group of research questions in this thesis.

4.4.2 Analyzing distance online lesson series and contrast with real classroom lesson series

The analysis procedures in this part can further be divided into two subparts. The first subpart concerns the analysis of the single distance online lesson series which exists in the case of Huang. The second subpart concerns the contrast of the distance online lesson series with the previous real classroom lesson series of Huang.

Regarding the single distance online series, again, we introduce some context information at first. Besides the information mentioned for real classroom lesson series, the context information also includes a brief introduction to the whole set of functionalities available in the software which serves as the platform of the distance online teaching. The context information will also be given at the beginning of the section on this lesson series in chapter 5, before the presentation of the formal analysis results.

Then the formal analysis of the lesson series is performed in the following steps.

Steps 1-5: similar to Steps 1-4 for the real classroom lesson series

The first four steps are generally the same with those in the last section, except that the video transcripts of lessons which allow us to identify coordination behavior should be changed to the transcripts of the screen recording videos of the live-streaming online lessons (③ in section 4.3.3).

In step 5, we give a synthesis of the distance online lesson series. That is, we integrate rules of coordination and the corresponding operational invariants to constitute the main parts of coordination schemes, and then connect the schemes to the classes of situations which gathers all the related 3D geometry tasks, 3D DGEs, the teaching settings and the other elements relevant to the corresponding schemes.

Step 6: Identify pairs of close classes of situations in real classroom and distance online lesson series of Huang, according to the criteria in section 3.1.4.

The data to be analyzed here is the all the synthetic results for the lesson series of Huang.

Regarding the data, we search the real classroom lesson series of Huang for classes of situations that which can be “close” to those in the distance online lesson series. The criteria for judging whether two classes of situations are close has been introduced in section 3.1.4. Guided by that we only consider two possibilities: (1) the tasks corresponding to the two classes of situations have the same “general” 3D geometry topics; 2) the tasks corresponding to the two classes of situations have different “general” 3D geometry topics but their “detailed” 3D geometry topics overlap more or less.

As a result, we identify three pairs of close classes of situations in Huang’s case, with one class in each pair in distance online lesson series H.III, and the other class always located in real classroom lessons series H.II-

Step 7: identify the differences between the 3D DGEs, coordination schemes related to two close classes; connect the differences with indirect/direct documental genesis

For each pair of close classes of situations identified in step 6, we firstly construct a table to integrate the information of the corresponding 3D geometry tasks, 3D DGEs, rules of coordination, and operational invariants all together. The table is exactly the data to be analyzed in this step.

Secondly, we identify the differences between the 3D DGEs in the two classes of situations.

Thirdly, we identify the differences between the coordination schemes under the two classes of situations. Here we start from the differences in rules of coordination between two schemes, and then examine the related differences in operational invariants. This process will also allow us to see whether the differences between the coordination schemes are resulted from the teacher’s reflection during the interval period (triggered by exchange with colleagues, teaching of other mathematics topics or other professional activities), or from his specific interaction with the classes of situations in distance online lesson series. The first kind of differences are considered as the result of an indirect documental genesis, and the second kind of differences are considered as the result of a direct documental genesis.

The results for all the three pairs of close of situations will be synthesized in section 6.2, leading to the final answer to the second group of research questions in this thesis

5 Results of the analysis of cases

In this chapter, we present the results of the analysis of the cases of all the participant teachers, whose basic information has been introduced in section 4.2. Section 5.1 and section 5.2 respectively introduce the results of two French teachers' cases, Dora and Sonia, which only contain lesson series in real classrooms. section 5.3 and section 5.4 introduce the results of the case of a Chinese teacher, Huang, respectively in a real classroom and in online distance setting. section 5.5 is about comparing and contrasting the results related to the real classroom and online distance setting. For every lesson series of every teacher, the results are organized in five sub-sections:

- Context of the lesson series,
- Characteristics of the 3D geometry tasks and 3D DGEs that have been used in the lesson series,
- Rules of coordination of the teacher in the lesson series,
- Operational invariants underpinning each group of rules of coordination,
- Summary.

All the results are obtained following the analyses procedures described in section 4.4.

In the first part, the context of a lesson series includes the date of the lesson series, its position in the school calendar, teaching settings, the subject matter, the teacher's global didactical objective, students' prior knowledge, and the flow of topic activities in every lesson.

In the second part, the characteristics of every 3D geometry task are described from three dimensions which have been introduced in section 3.3.1: (1) 3D geometry topic of task, (2) status of task in curriculum and important examination, and (3) context of and innate support in task. The characteristics of every 3D DGE are described from four dimensions which have been introduced in section 3.3.2: (1) representations and tools in 3D DGE, (2) help and control in 3D DGE, (3) feedback in 3D DGE, and (4) curricula distance of 3D DGE.

In the third part, the rules of coordination are analyzed according to the sub-framework presented in section 3.4. For saving space, we only choose two related argumentation episodes for each group of rules of coordination, to show how the analysis of argumentation episodes have led to the rules of coordination in that group and how the rules of coordination can reflect the regularities in teacher's coordination behavior in more than one episode. If some coordination behavior only emerged in one episode, we explain why it can still be considered as rules of coordination by referring to operational invariants introduced in the subsequent part.

In the fourth part, the operational invariants are analyzed according to the sub-framework presented in section 3.5, or more precisely, in section 3.5.2. For each group of rules of coordination, we firstly give an overarching table in which all the operational invariants underpinning the rules of coordination are organized by category, and then present how we infer the operational invariants and place them into the corresponding category.

In the fifth part, we give a summary of the previous three parts, integrating the rules of coordination and the underpinning operational invariants into different coordination schemes, and identifying the classes of situations that contain the related 3D geometry tasks and 3D

DGEs. We also discuss how the operational invariants vary with the rules of coordination in different coordination schemes, and how the coordination schemes can be linked to the characteristics of the 3D geometry tasks-3D DGEs, as a preparation for answering the first group of research questions.

5.1 Case of Dora: French teacher in a real classroom

This section presents the results of analysis of the case of a French teacher, Dora (see section 4.2 for more information about the teacher). Throughout the Ph. D. period, we have been able to follow one real classroom lesson series of Dora, noted as Lesson Series D.I. It contains two lessons integrated with 3D DGEs.

Lesson Series I

Fig. 5.1 presents the timeline of our follow-up of Lesson Series D.I and the data collected.

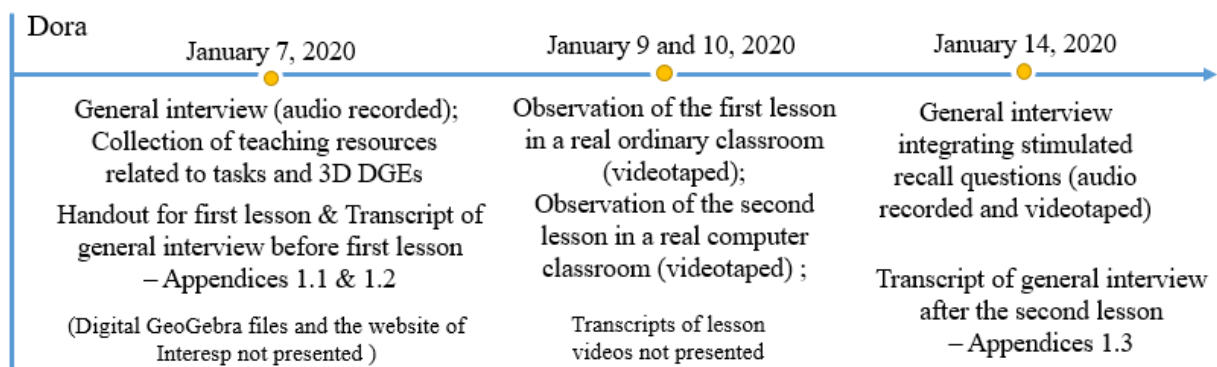


Fig. 5.1 Timeline of follow-up of Lesson Series D.I

5.1.1 Context of Lesson Series D.I

This section introduces the context of the two lessons in Lesson Series I conducted by Dora. The information is obtained by crossing the handout, interview (Appendices 1.1, 1.2) and the transcripts of the two lesson videos. The main points of the context information to be introduced have been mentioned in the methodology (§ 4.4.1).

The two lessons in the lesson series respectively took place on 9th and 10th January 2020. At that time the students just entered the second trimester of grade 12 – the final year in French upper secondary education before the university. The first lesson took place in an ordinary real classroom; a whole class of students has attended the lesson and they were all facing away from the camera of the researcher. The second lesson took place in a computer real classroom; the same class of students was cut in half to attend two lessons separately, and we only recorded a half of the class who had consent to be filmed. The two lessons were also the earliest lessons on 3D geometry in the trimester, the Euclidean 3D geometry content in January is promising to set foundations for the introduction of the vector approach to 3D geometry in April. As the two lessons were located in different teaching settings and focused on different aspects of 3D geometry, we introduce them separately.

(1) First lesson

The teaching setting for the lesson on 9th January was an ordinary real classroom in which only the teacher had access to a computer; the teaching setting contained this computer connected with an overhead projector, the dynamic mathematics software GeoGebra installed on the computer, a projection curtain, a blackboard, desks and chairs. Students were seated in rows facing the blackboard and the projection curtain, Fig. 5.2 shows the plan layout of the classroom. The subject matter of this lesson was the relative position of two lines, two planes, or a line and a plane in space. Dora’s didactical objective was to introduce what is a line and a plane in space and the “rules of incidence” (“règles d’incidence” in French), meaning the rules about the possible relative positions between lines and planes in space. Before the lesson, only one-third of the students had learned a little of 3D geometry in grade 10 (there is no 3D geometry in grade 11 in the French curriculum of the stream).

Regarding the lesson activities, the following topic activities are identified.

- Activity 1: Introduce the notions of the line and the plane in space and display a GeoGebra file (3D DGE) which contains a dynamic model of house;
- Activity 2: Contrast geometric relationships in a 3D real toy house and the relationships in a 2D representation (screen projection of the dynamic model of house);
- Activity 3: Introduce formal definitions of the possible relative position between two lines in space and the corresponding examples in a drawing of a house;
- Activity 4: Synthesis.

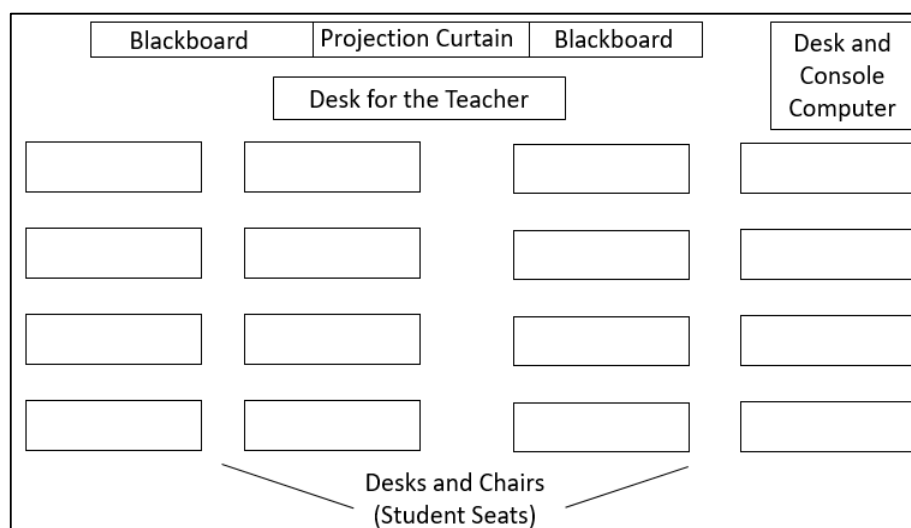


Fig. 5.2 Layout of teaching setting for Dora’s first lesson

Now we elaborate on the content of the lesson activities. Dora started the lesson by displaying a GeoGebra file that contains a 3D dynamic model of “house” on the projection curtain. She firstly set the 3D dynamic model of “house” at a fixed orientation, combining its image on the screen with a real toy house and the structure of the real classroom, to explain how an infinite line/plane can be represented in the plane (Activity 1, also see Fig. 5.3). Then Dora launched a discussion about the gap between the geometric relationships in a 3D real toy house and those in the 2D representation – the screen image of the 3D dynamic model (Activity 2, also see Fig.

5.4). After that, Dora distributed a paper handout to every student and projected the handout onto the curtain. As shown in Fig. 5.5, the handout listed all the rules of incidence with respect to two lines, two planes, a line and a plane in the space. In the lesson, Dora only had time to explain the rules with respect to two lines. Here came the final two activities: Dora introduced the possible relative positions between two lines in space and guided students to determine the corresponding examples in the drawing of a house (Activity 3); then she made a synthesis of the possible relative positions between two lines in space (Activity 4). The GeoGebra file that Dora used in Activities 1 and 2 was the single 3D DGE used in the first lesson, and its characteristics will be elaborated in section 5.1.2.

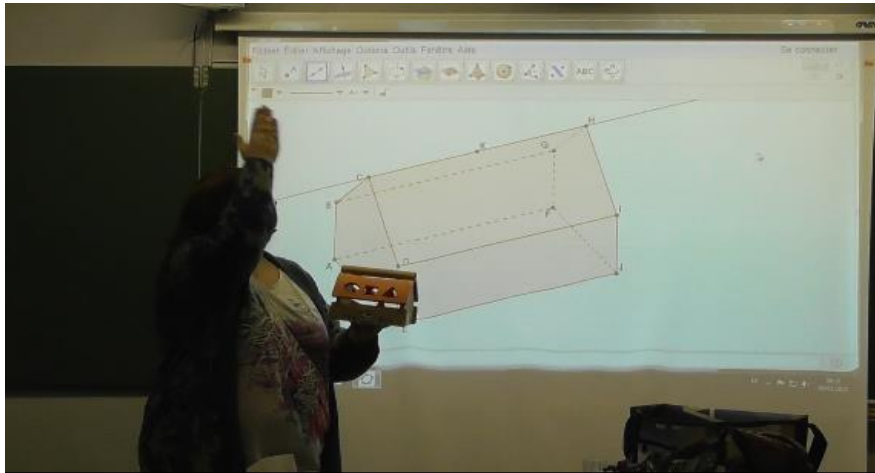


Fig. 5.3 Dora is making a gesture to simulate the plane represented by a vertical face of the 3D toy house

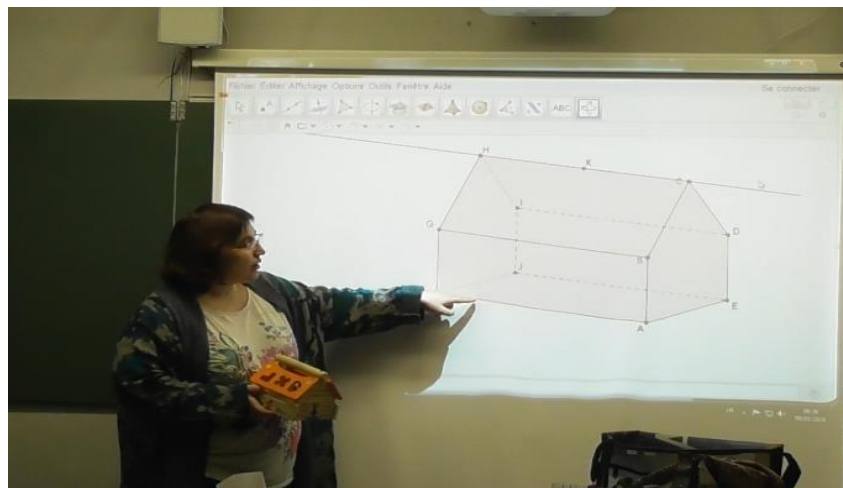
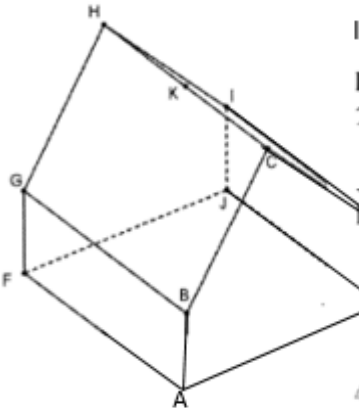


Fig. 5.4 Dora points at an angle in the screen image of a GeoGebra model

Part A: lines and planes in the space-geometric point of view



In the whole lesson, we will consider the solid ABCDEFGHIJK

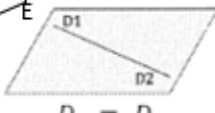
I. The rules of incidence

1] Relative position of two lines in the space

Two lines are *coplanar* if they are contained in the same plane

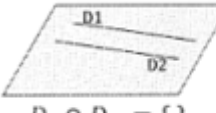
In this case, they can be

coinciding



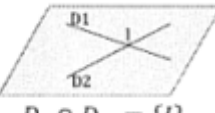
$D_1 = D_2$

Strictly Parallel



$D_1 \cap D_2 = \{ \}$

secant



$D_1 \cap D_2 = \{ I \}$

Examples (in the house):

We can then apply all the properties and theorems in 2D geometry

Definition

Two lines are *non-coplanar* if they are not contained in the same plane. $D_1 \cap D_2 = \{ \emptyset \}$

Examples (in the house):

Synthesis

Number of common points	Relative position of two lines
0	The lines are non-coplanar or coplanar and strictly parallel
1	The lines are secant and (coplanar)
more than 2	The lines are coinciding (if there are 2 common points then all the points are common)

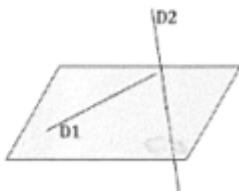


Fig. 5.5 Part of the handout used in Dora's first lesson (our translation from French to English, red words are to be filled by students)

(2) Second lesson

The teaching setting for the second lesson was a computer real classroom in which not only the teacher but also individual students had access to a computer; the teaching setting contained a computer for the teacher connected with an overhead projector, and the computers for individual students, access to internet in every computer, a projection curtain, a blackboard, desks and chairs. Students firstly sit in the middle of the classroom and then came to the seats with computers. Fig. 5.6 shows the plan layout of the teaching setting; with the numbers indicating different individual students.

The subject matter of this lesson was the intersection of a line and a plane and the intersection of two planes in space. The teacher's didactical objectives were to help students understand "what the intersections are, and how to construct them", to promote students' appropriation of the rules of incidence they have learned the day before, and to develop their "vision in space" (see Appendix 1.2.2) with 3D DGEs. The 3D DGEs used in this lesson all came from Interesp⁶,

⁶ http://lycee-valin.fr/math/exercices_en_ligne/espace.html

an online interactive tutorial designed by third-part institutions (neither the teacher nor the researcher in this thesis have participated to its design)⁷ in France. There are thirty-six 3D geometry tasks in Interesp, each embedded in a GeoGebra file online. In addition to the task statement, the GeoGebra file also integrates a 3D dynamic model, a limited range of GeoGebra tools and an external feedback system. We consider one GeoGebra file as a 3D DGE and will elaborate on their characteristics in section 5.1.2.

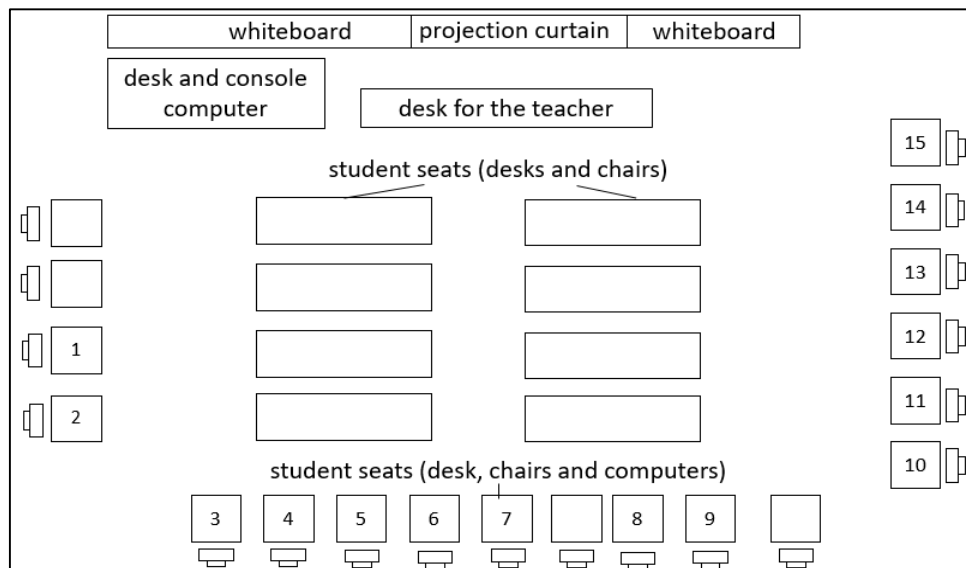


Fig. 5.6 Layout of the teaching setting of Dora’s second lesson

Regarding the prior knowledge of the students, they had learned all the possible relative positions between two lines in space, and the fact that for two lines to be secant, they should be coplanar at first, in the lesson before. This could provide a foundation for their construction of the intersection of a line/plane and a plane in the second lesson. The students had no experiences of manipulating in 3D DGEs before this lesson.

Regarding the lesson activities, we can list a flow of activities as follows:

- Activity 1: Introduce the subject matter of the lesson;
- Activity 2: Let students solve tasks in 3D DGEs autonomously and provide individualized support when necessary.

Now we elaborate on content of the lesson activities. Dora started the lesson with a brief introduction of the subject matter of the lesson, while the students were sitting in the middle of the classroom (Activity 1, also see Fig. 5.7). Then she sent students to the seats with computers, let them go to the website where Interesp was presented, and encouraged them to solve the tasks autonomously, with herself circulating around to give support to one or two neighboring students when necessary (Activity 2, also see Fig. 5.8).

⁷ The tasks are initially designed with the software Geoplan-Geospace by the research institution [CREEM](#) and then adapted by the [mathematics team in René Josué Valin high school](#) with the software of GeoGebra.



Fig. 5.7 Dora gives an introduction at the beginning of the lesson



Fig. 5.8 Dora offers individualized support to one student

5.1.2 Characteristics of 3D geometry tasks-3D DGEs in Lesson Series D.I

This section presents the characteristics of the 3D geometry tasks and the 3D DGEs used in this lesson series, which are analyzed according to the dimensions of characteristics described in section 3.3.1 and section 3.3.2 . The content of the tasks is sorted out from the video transcript of the first lesson, the handout for the first lesson (Appendix 1.1), and the webpage of the online tutorial Interesp. The content of the 3D DGEs is sorted out from the GeoGebra file used by Dora in the first lesson and the webpage of Interesp used in the second lesson.

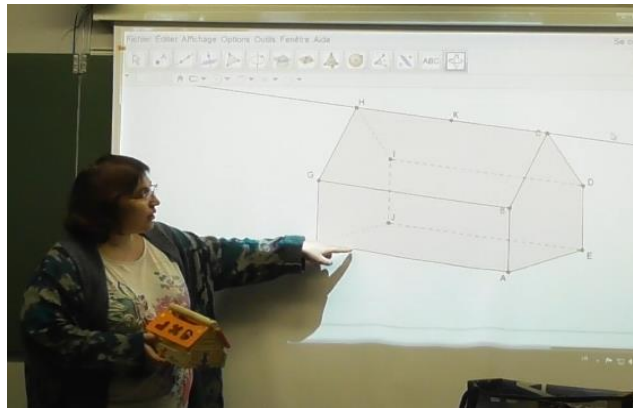
(1) First Lesson

Characteristics of tasks

In Dora's first lesson, we have identified two 3D geometry tasks, which are the oral questions proposed by Dora respectively during Activity 2 and Activity 3. The two tasks are presented below.

Task 1 What properties are conserved, from the physical object and the representation on the screen (as shown below)? I hear you say the angles? ... what about parallel lines, do they keep

parallel in the representation? ... If I see two intersecting lines on my figure, are they necessarily secant in space?



Task 2 In the house (the drawing in the handout, also shown in Fig. 5.10), please give me two lines which coincide with each other. ... Now I would like to have two lines which are strictly parallel. ... OK, the secant lines? ... Then, give me the names of two non-coplanar lines.

Concerning the 3D geometry topic of Task 1, it consists of three questions, so we a priori divide them into three subtasks. The three subtasks have the same general 3D geometry topic – identify geometric relationships in space (Topic 1 in section 3.3.1).

In terms of the variable (a) in Topic 1, “nature of the relationships to be identified and the geometric objects involved therein”, concerns the consistency between the perceptive effect of the spatial relationship of lines in a 3D real object – a toy house – and the corresponding effect on a 2D figural representation – a screen projection of a 3D dynamic model of house. The variable (b), “structure of the background solid in which the relationships are situated”, concerns a “house” which is a common shape in daily life and contains all the important relative positions in space (e.g., secant, parallel, perpendicular, and non-coplanar lines). The variable (c), “relative position of geometric objects in the background solid”, all the lines reside on the surfaces of the “house”. To summarize, the detailed 3D geometry topics of the subtasks are all about identifying the consistency between the perceptive effect of the spatial relationship of lines residing on a 3D real toy house and the corresponding effect on a 2D figural representation. The particular spatial relationships to be examined in the three subtasks are respectively the angle between two lines, parallelism between two lines, and intersection of two lines.

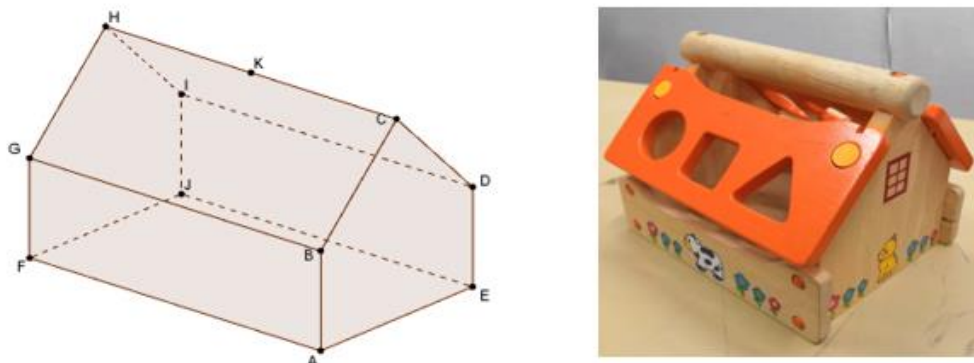


Fig. 5.9 The 3D dynamic model of house and the 3D real toy house in Task 1

Concerning the 3D geometry topic of Task 2, it consists of four subtasks. The four subtasks have the same general 3D geometry topic – identify geometric relationships in space (Topic 1 in section 3.3.1).

We analyze the detailed 3D geometry topics of the four subtasks of Task 2 in a similar way to Task 1. As the result, the detailed 3D geometric topics of the subtasks are all about identifying the relative positions between two lines in the drawing of a house (Fig. 5.10), with the lines to be determined by students themselves. The particular relative positions examined in the four subtasks are respectively coinciding, parallel, secant, and non-coplanar lines.

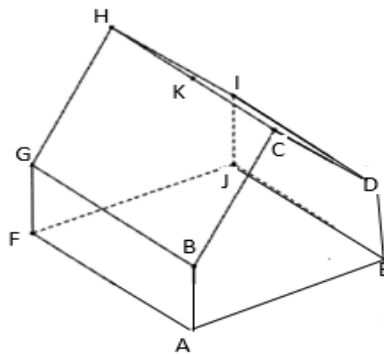


Fig. 5.10 Drawing of house in Task 2

Concerning the status of the tasks in the French curriculum and BAC examination: since the tasks similar to Task 1 and Task 2 do not appear in the BAC examination, we focus their status in the curriculum. Here we only consider the French mathematics curriculum for the general branch (Ministère de l'Éducation Nationale, 2019), which is the branch that the students in the lesson belong to. The 3D geometry topics of the subtasks of Task 1 do not appear in the curriculum. The 3D geometry topics of the subtasks of Task 2 appear in the French curriculum, and the corresponding prescriptions are “describe the relative positions of two lines, of a line and a plane, and of two planes” and “geometrically study simple position problems in space (alignment/ collinearity/ parallelism/ coplanarity/ orthogonality)” (ibid., p. 7-8, our translation). As shown in the text, the curriculum prescribes a “geometric approach” (i.e., deductive reasoning referring to theorems or facts in Euclidean geometry) to the position problems, but it highlights more the vector approach to the same problems that students will work with later on. The interest of studying the position problems here is to develop students’ spatial vision and help them exercise their regard with external figural representations (Ministère de l'Éducation Nationale, 2019). This vision is expected to prepare students for the learning of vectors and parametric/equation representations of lines/planes in space.

Concerning the context of and the innate support in the tasks, the context of Task 1 is the real space combined with a 3D DGE designed with GeoGebra; the innate support in the task, for students, includes a 3D real object and a 2D representation of a 3D dynamic model on the screen, as shown in Fig. 5.9. The 2D representation reflects one view of the 3D dynamic model, and it can be continuously transformed to another view of the same model (will be elaborated later). For Task 2, it is presented on the paper handout and students are expected to solve it by writing down the answer with their pens; so the context of the task is the paper-pencil one. The

innate support for students includes a drawing of house (Fig. 5.10), and the definitions of relative positions of lines in space (Fig. 5.5) placed on the same handout.

Characteristics of 3D DGEs

Now we describe the characteristics of the unique 3D DGE used in the lesson; it is just the GeoGebra file that Dora displays at the beginning of the first lesson and uses throughout Activities 1 and 2.

The only figural representation in the 3D DGE is the 3D dynamic model incorporating both the background solid of “house” and the possible constructions made by the teacher (Fig. 5.11). The 3D DGE model has a structure similar to the 3D real toy house. It is firstly fixed at a particular orientation, and its parallel projection on the screen at this time is exactly the 2D representation to be compared with the toy house. Although the 3D DGE model is displayed on the flat screen, it can be continuously turned around to another orientation, showing another parallel projection (view) of the same model, and the latter view might present some geometric properties in space more faithfully. For example, the line (IJ) and (GB) seem secant in the view in Fig. 5.11, but they can be separated in another view shown in Fig. 5.12. The tools theoretically available in this 3D DGE are all the GeoGebra tools, but they are not accessible to students and the teacher focuses on the Dragging tool and the Line tool, which allow rotating the 3D dynamic model and constructing lines, respectively.

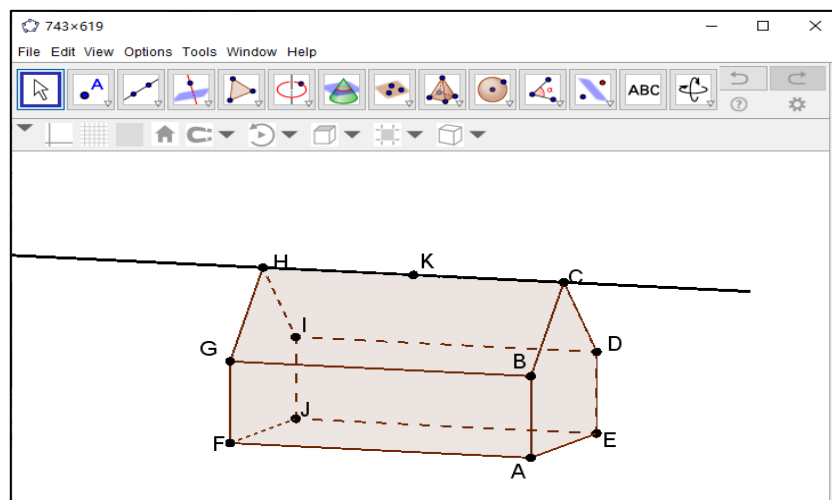


Fig. 5.11 The 3D dynamic model and tools in the 3D DGE for Task 1

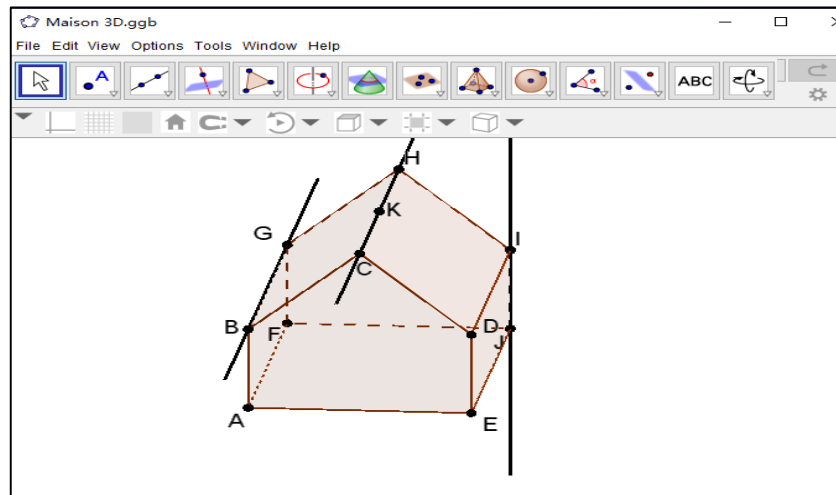


Fig. 5.12 Another view of the 3D dynamic model

There is no specific form of help in the 3D DGE. The difficulty levels of learning activities in the 3D DGE depend on the tasks in the lesson, which are relatively stable; the ordering and pace of learning activities are mainly controlled by the teacher, with possible variations according to students' reactions.

The feedback only concerns the internal feedback in GeoGebra: by dragging the 3D dynamic model around, one can have different views of the model in which some geometric relations can be faithfully represented while some cannot. For example, the lines that are non-coplanar appear secant in one view will not appear so in another view, whereas parallel lines are always parallel in different views.

Regarding the curricular distance of the 3D DGE, the main didactical potential of the 3D DGE is displaying different 2D images of a 3D object from different perspectives, helping students to connect the relationships perceived from 2D representations and their actual state in 3D objects, i.e., helping students to "see" the spatial situations described by 2D representations. This is consistent with the didactical suggestion in the French curriculum: "develop representations of geometric objects especially with the help of dynamic geometric software, allowing students exercise their sight and develop their vision in space" (Ministère de l'Éducation Nationale, 2019, p. 7, our translation). In this sense, we claim that the 3D DGE is close to the curriculum.

Finally, we give in Table 5.1 a summary of the characteristics of the 3D geometry tasks and the 3D DGE used in the first lesson.

Table 5.1 Characteristics of the 3D geometry tasks-3D DGEs in the first lesson of Dora

		Task 1 (3 subtasks)	Task 2 (4 subtasks)
Characteristics of 3D geometry tasks	3D geometry topic	<p>Contrast perceptive effects of geometric relationships (angles/ parallelism/ intersection between lines) on a 3D toy house and the counterpart perceptive effects on a 2D figural representation</p> <p>Lines all rely on the edges of the “house”</p>	<p>Identify the lines with a particular relative position (coinciding/ strictly parallel/ secant/ non-coplanar) in a drawing of house</p> <p>The “house” in the drawing is in a similar structure to the 3D toy house in Task 1.</p>
	Status in curriculum and examination	<p>Does not appear in BAC</p> <p>No prescriptions in curricula</p>	<p>Does not appear in BAC</p> <p>Curricula prescriptions: relative positions between lines and planes to be studied with the Euclidean geometric approach (and later with vector approach); develop vision in space</p>
	Context and innate support	<p>Context: 3D reality combined with a 3D DGE</p> <p>Innate support: a 3D real object, a 2D screen projection of a 3D dynamic model</p>	<p>Context: paper-pencil</p> <p>Innate support: a drawing of house, definitions of relative positions of lines in the handout</p>
Characteristics of 3D DGEs	Representations, and tools	<p>Representations: 3D dynamic model of house possibly integrated with lines</p> <p>Manipulations and tools: turn around the 3D dynamic model with the Dragging tool and construct lines with the Line tool</p>	<p>No use of 3D DGE</p>
	Help and control	<p>No help</p> <p>Controlled by the teacher</p>	
	Feedback	<p>Innate feedback in GeoGebra: different views of the 3D dynamic model when the user rotates model</p>	
	Curricular distance	<p>Close to didactical suggestions of the curriculum</p>	

(2) Second lesson

Characteristics of tasks

In the second lesson, all the 3D geometry tasks being used are integrated in the 3D DGEs in Interesp. Fig. 5.13 gives a partial image of Interesp, in which we only consider the first 10 tasks (exercises 1 ~ 10 in Fig. 5.13), the only ones that the students managed to deal with in the lesson. Clicking the corresponding icon of a task, students can enter a new webpage presenting the content of the task and the 3D DGE in which it is embedded. Following the labelling of the tasks in the first lesson, we relabel the 10 tasks here Tasks 3 ~ 12.

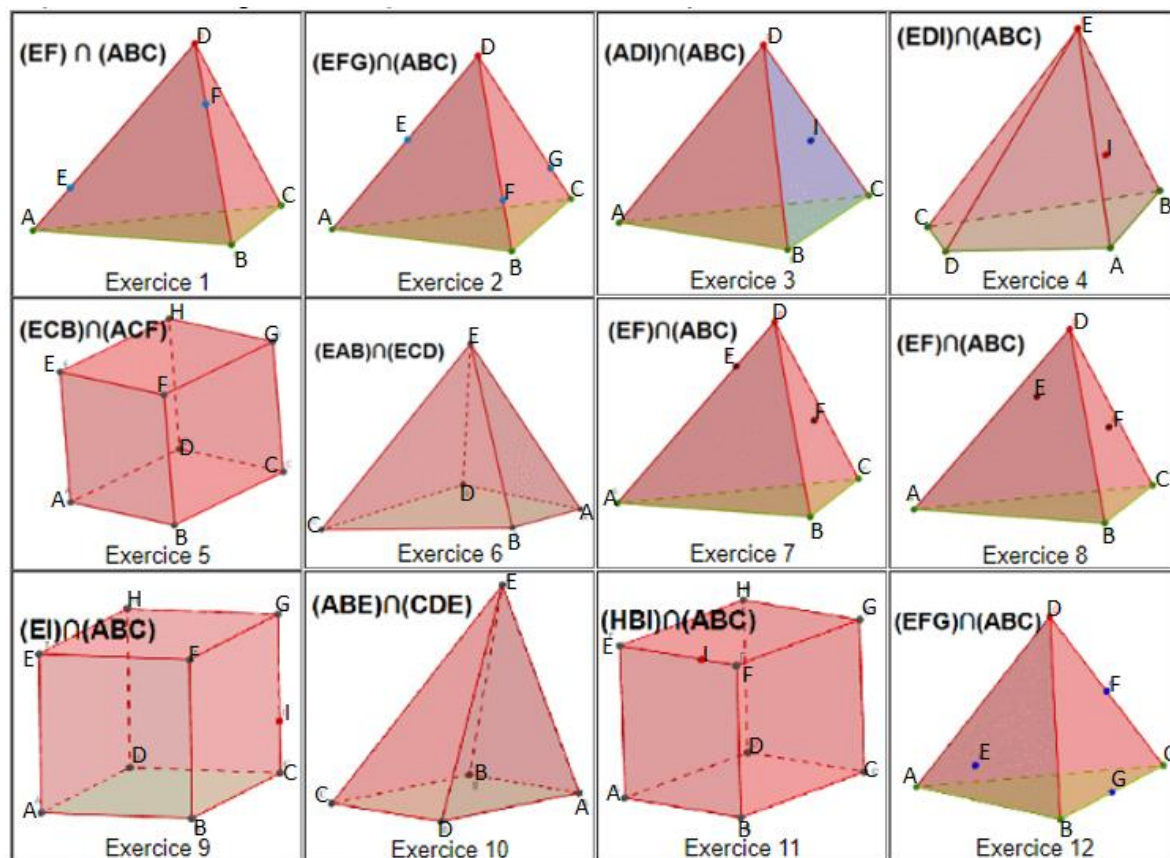


Fig. 5.13 Partial image of Interesp and the 10 tasks used in Dora’s second lesson

The general 3D geometry topics of the 10 tasks are all concerned with constructing geometric objects in space (Topic 3 in section 3.3.1). Next, we present the analysis of the detailed 3D geometry topic of the first task, Task 3; the other 9 tasks will be analyzed in the same way and we will directly give the corresponding analysis results.

The variable (a) in Topic 3, the “geometric object to be constructed’ in Task 3, is the point of intersection of a line and a plane. The variable (b) in Topic 3, the “properties of the geometric object to be constructed according to the task description”, concerns the property of the point being the intersection of a line and a plane in space. Furthermore, the construction of the point of intersection requires students to identify the spatial relationship between the line and the plane at first, so the geometric topic of Task 3 overlaps with Topic 1 (in section 3.3.1) and thus the variables in Topic 1 also matter here. The variable (a) in Topic 1, the “nature of the relationships to be identified and the geometric objects involved in the relationships’, concerns

the intersection of a line and a plane in the space. The variable (b) in Topic 1, the “structure of the background solid in which the relationships are situated”, concerns an ordinary pyramid. Regarding the variable (c) in Topic 1, the “relative positions of the geometric objects at stake in the background solid”, the line and the plane at stake both rely on the surface of the pyramid. To summarize, the detailed 3D geometric topic of Task 3 is to construct the intersection of a line and a plane which both reside on the surface of a pyramid.

After a similar analysis, we get that the detailed 3D geometric topic of Task 4 ~8 are all about constructing the intersection of two planes, with the critical lines (i.e., the lines for which students need to construct the intersection to determine the target line of intersection of the two planes) all residing on the surface of the background solid – a pyramid or cube. Furthermore, in Task 6 and Task 8, the two planes to be intersected contain one common point and this point is a vertex of the background solid; in Task 6 the common vertex is not evidently indicated in the notations of the two planes whereas in Task 8 it is.

The detailed 3D geometric topics of Task 9 ~ 11 are all about constructing the intersection of a line and a plane which respectively pass through the inside and on the surface of a background solid – a pyramid or a cube.

The detailed 3D geometric topics of Task 12 is about constructing the intersection of two planes with the critical lines all being inscribed on the surface of the background solid – a pyramid. Furthermore, the two planes to be intersected pass through two parallel edges at the base of the pyramid.

Concerning the status of the 10 tasks in curricula and important examinations, the French curriculum for grade 12 and the general branch (Ministère de l'Éducation Nationale, 2019) does not specifically mention “constructing intersections of lines and/or planes in space”, but it does mention the relative positions between lines and planes, and simple position problems in space (alignment/ collinearity/ parallelism/ coplanarity/ orthogonality) situated in usual solids (cube, tetrahedron, pyramid), which are highly relevant to the tasks of intersection construction. However, the curriculum emphasizes the vector approach rather than the geometric approach and highlights the development of students' vision with respect to these problems in Euclidean 3D geometry, which will set a foundation for the learning of 3D vectors. Notwithstanding a weakened status in the curriculum, “constructing planar sections of a cube” remains a common topic of the paper-pencil items in the BAC examination; the topic falls in the scope of the general 3D geometry topic identified here, as the planar sections of a cube are in fact formed by the intersections of planes. For answering the examination item, students have not only to construct (draw) the section on the paper, but also give mathematical justification (proof) for their construction.

Concerning the context of and innate support equipped in the task, each of the 10 tasks is presented in a 3D DGE underpinned by GeoGebra; the innate support includes a GeoGebra model, a limited number of GeoGebra tools, technological instructions, and the hints for solving the task implied in the task statement. We will elaborate this later in the “characteristics of 3D DGEs”. It is worth noting that the tasks with the same 3D geometry topics can also exist in the paper-pencil environment.

Characteristics of 3D DGEs

Now we describe the characteristics of the 3D DGEs used in the second lesson. As mentioned previously, each task in Interesp is integrated into a 3D DGE designed with GeoGebra. There are thus ten 3D DGEs used in the lesson. As an example, Fig. 5.14 gives the interface of the 3D DGE for Task 4 in Interesp.

Concerning figural representations and tools, each 3D DGE contains a 3D dynamic model incorporating both the background solid of the task and the possible constructions made by students, as exemplified in Fig. 5.14. The model can be dragged or turned around to different orientations, allowing students to see different views of a 3D figure, to separate two non-coplanar lines which could appear secant, and even to see the intersection of two lines such as $(EF) \cap (AB)$ in Fig. 5.14. This is exactly the potential of the 3D DGEs for students' perception, but it can meanwhile be an impediment for them to use geometric theorem and develop theoretical deductive reasoning. For the first 3D DGEs, the tools available only include the GeoGebra tools *Select*, *Intersect two lines* and *Line* (Fig. 5.14), which allow students to select objects, construct lines and intersect lines. For Task 10, the tools also include *Parallel Line* for constructing the line parallel to a selected line from a point outside the line. It is the designers' intentional choice to remove tools such as "Intersect two planes", so as to impede the blind constructions that make the intersections of lines appear automatically (Authier et al., 1998). The objects constructed can be easily deleted and reconstructed in all 3D DGEs. There is also an innate *Dragging* tool in all 3D DGEs, allowing one to turn the 3D dynamic models around.

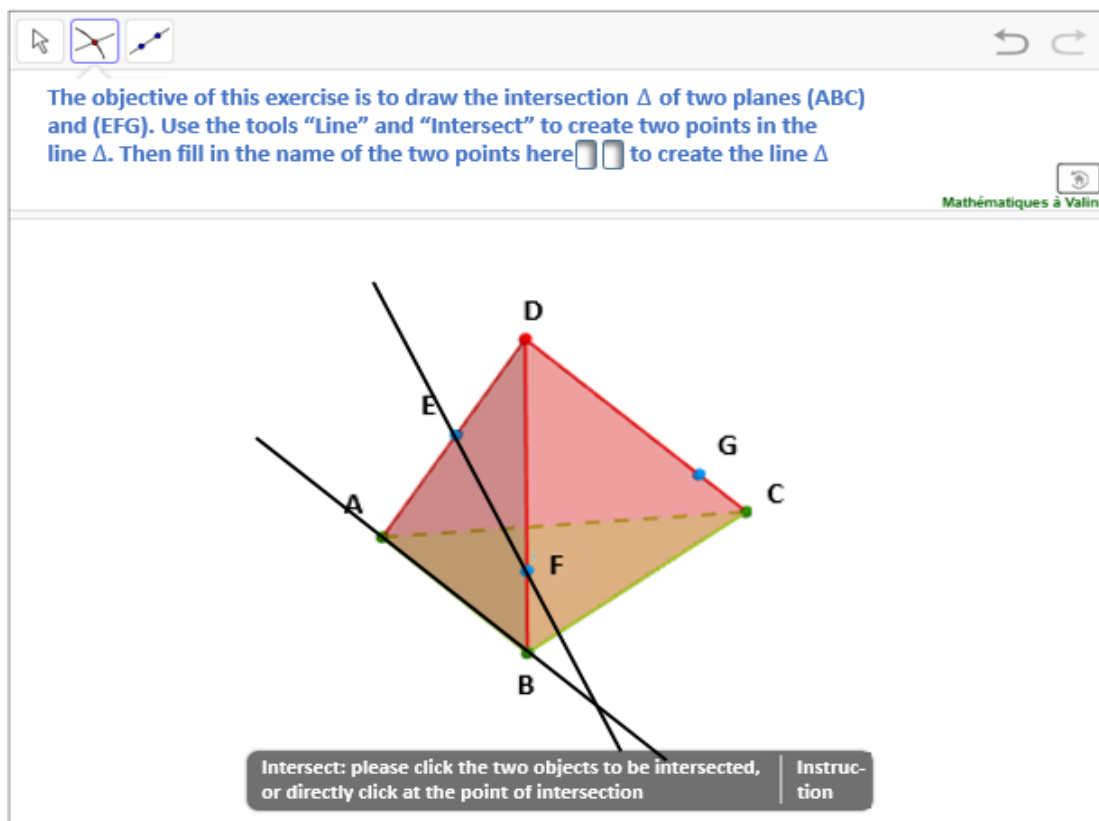


Fig. 5.14 3D dynamic model, tools and instruction available in the 3D DGE for Task 2

Concerning help and control, one form of help available in every 3D DGE is the technological instructions of using the GeoGebra tools - with the mouse hovering on the tool icons, students can see the related instructions at the bottom of the 3D DGE interface (Fig. 5.14). Another help

available in every 3D DGE is the hints given in the task statement about the critical procedures to be accomplished before solving the task. For example, the statement of task 4 suggests students constructing two points at first and then constructing the target line of intersection (Fig. 5.14). The difficulty levels of the tasks are gradually increasing according to the order they are presented in Interesp. The teacher suggested students to skip to the subsequent task only after having correctly solved the previous one. It can nevertheless happen that students randomly come to one task neglecting the previous ones. In this sense, the level, ordering, and pace of learning activities in the 3D DGEs are controlled by students themselves.

Concerning feedback, there are two types of feedback in every 3D DGE: (1) innate feedback in GeoGebra, such as refusing the construction of the intersection that does not exist, the different views of a 3D dynamic model with non-coplanar lines appearing secant in some views and being separated in other views; 2) external feedback additionally inserted into GeoGebra, like showing the intersection indicated by a student in the blank (line (IJ) in Fig. 5.15), presenting the evaluation results of students' answer in the blank (words "correct response" in Fig. 5.15), and the possibility of showing extended intersecting planes when the answer is right (planes (EFG) and (ABC) triggered by the button on the top-right in Fig. 5.15).

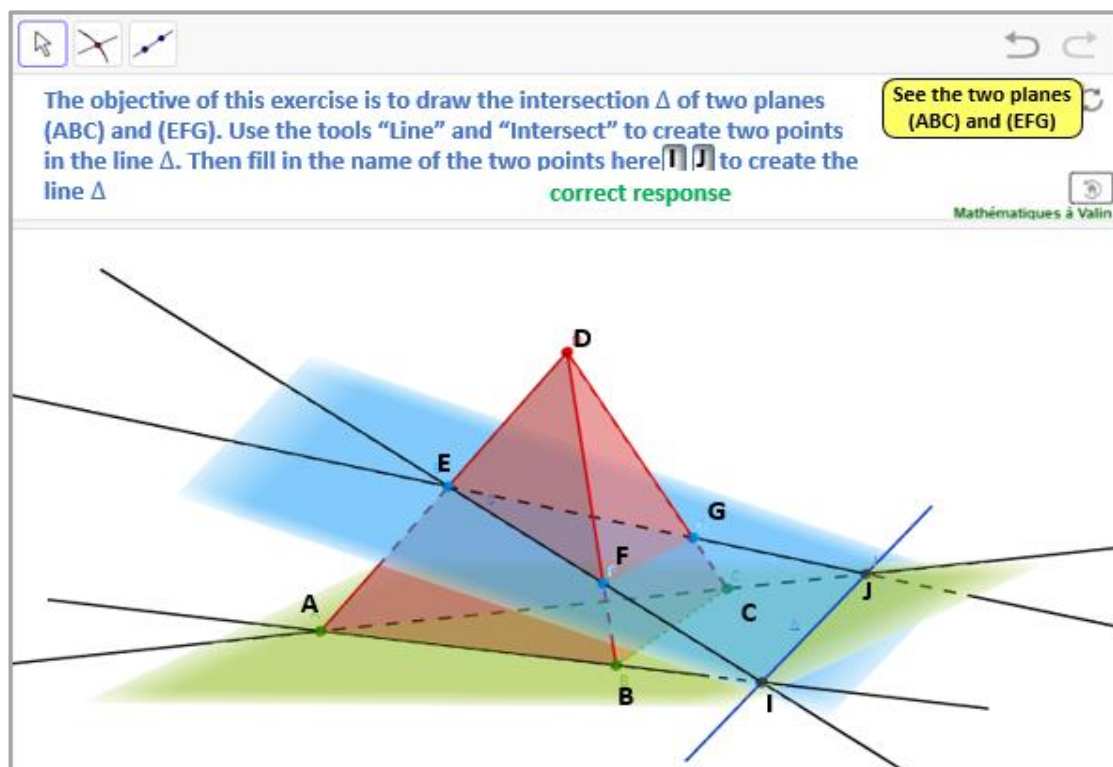


Fig. 5.15 Feedback in the 3D DGE for Task 4

Now we consider the didactical approach represented by the 3D DGEs and its distance from the approach suggested in the French curriculum. Firstly, the mathematics content covered by the 3D DGEs is an important content in the French curriculum in grade 12. Secondly, the possibility to drag and rotate the 3D dynamic models, and the possibility to observe the extended section plans after getting the correct answer in the 3D DGEs can facilitate students' perception of 3D figures; this matches well the curriculum prescriptions of using dynamic geometry software, both by students and teachers, to "allow students to exercise sight and

develop vision in space” (Ministère de l’Éducation Nationale, 2019, p. 7, our translation). Thirdly, the restrained number of tools for constructing the intersections in the 3D DGEs will force students to mobilize some geometric theorems or facts, such as “two planes intersect in a line” and “a point can be defined by the intersection of two lines”. However, there are no specific hints on the geometric theorems to be used, and when it comes to the intersection of two lines, like $(EF) \cap (AB)$ in Task 4 (Fig. 5.14), this is not consistent with the curriculum prescriptions of using an (Euclidean) geometric approach to solve the tasks on relative positions. Synthesizing the three points, we say that the 3D DGEs have a slight gap with the French curriculum.

Finally, we give a summary of the characteristics of the 3D geometry tasks and the 3D DGEs used in this lesson, as shown in

Table 5.2.

Table 5.2 Characteristics of the 3D geometry tasks-3D DGEs in the second lesson of Dora

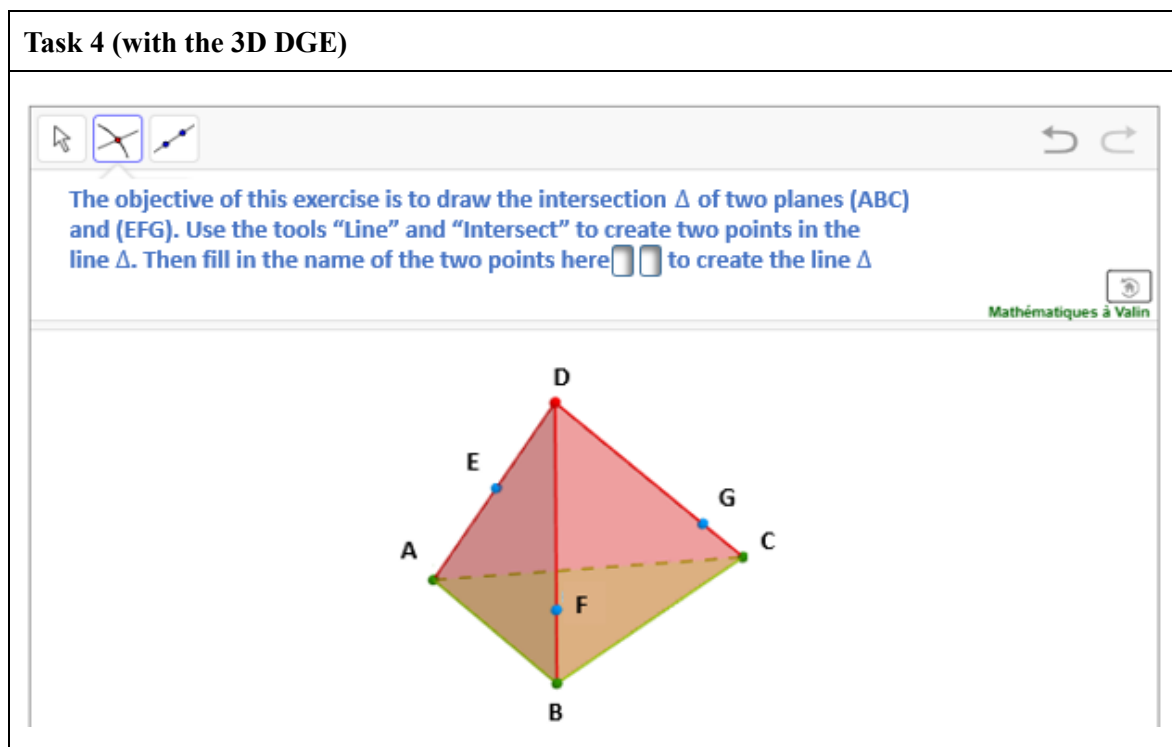
		Task 3 ~ 8	Task 9 ~ 11	Task 12
Characteristics of 3D geometry tasks	3D geometry topic	Construct the intersection of a plane/line and a plane which are both inscribed on the surface of a tetrahedron/cube/pyramid	Construct the intersection of a line passing through the inside of a cube/tetrahedron and another plane on the surface of the cube/tetrahedron	Construct the intersection of two planes inscribed on two lateral faces (covering two parallel edges) of a rectangular pyramid
	Status in curricula and exams	BAC requirements: construct planar sections of a cube on the paper, with mathematical justification (proof) Curricula prescriptions: Euclidean geometric approach to relative position problems in space; develop vision in space to prepare for vector 3D geometry		
	Context and innate support	Context: 3D DGE Support: see “characteristics of 3D DGEs”		
Characteristics of 3D DGEs	Figural Representations and tools,	Representations: 3D dynamic model of a cube/tetrahedron/pyramid Tools and manipulations: turn around the 3D dynamic model with the Dragging tool, construct lines/ parallel lines/ intersection of lines on the model with the Line, Intersect and Parallel Line tool		
	Help and control	Technological instructions for using GeoGebra tools; Hints about solutions in the task statement; Difficulty level and pace of learning activities are controlled by students.		
	Feedback	Innate feedback in GeoGebra: refusing the construction of the intersection which does not exist, different views of 3D dynamic models and in particular non-coplanar lines in them; External feedback: verifying students’ answer, showing the intersection indicated in the blanks in the task, showing extended intersecting planes;		
	Curricular distance	A gap from the Euclidean geometric (theoretical deductive) approach prescribed in the curriculum, as the 3D DGEs allows to solve tasks by perception and trial-and-error;		

5.1.3 Rules of coordination in Lesson Series D.I

This part presents five groups of rules of coordination in Lesson Series D.I, which are labeled D.I-A, D.I-B, D.I-C, D.I-D and D.I-E. The data analyzed here are the transcripts of argumentation episodes, which are sorted out from the transcripts of the lesson videos. The analysis procedures that lead to these rules of coordination have been introduced in the methodology part (§ 4.4.1)

Rules of coordination D.I-A: (1) tell students the 3D geometry theorems/facts and guide them to use the theorems/facts in theoretical deductive reasoning; (2) support students' perception of the theorems/facts with simulating gestures

The first example episode related to the rules of coordination is the Episode 1 in the collective argumentation between the teacher and two students (S5, S6 in the classroom layout in Fig. 5.6) around Task 4. For convenience of reading, we present the task again here.



As can be seen, Task 4 concerns the intersection of two planes: (ABC) and (EFG). The whole argumentation started when the teacher intervened in the students' discussion hearing them say “I know nothing”. Through the intervention, the teacher helped students understand that the expected intersection is a line to be defined by two points, with each point being the intersection of two lines (argumentation node). Then, the teacher successfully led students to determine one point in the target intersection and left the students to determine another point on their own, which was the end of the whole argumentation.

The argumentation process between the beginning and the first argumentation node is identified as Episode 1, with the rest being Episode 2. The argumentation node is decided according to the teacher's words “Now let's decide the first point in it”. Here it is Episode 1 being related to the rules of coordination D.I-A. The following is its transcript integrated with codes of argumentation components.

Episode 1-S5, S6-Task 4

S5: I know nothing...

T: No you don't understand nothing, according to what I see. Tell me what are you looking for?

S5: The intersection of this line... (Fig. 1⁸) **[1-Perceptive-Data]**

T: Yes, we agree that even you see it like this, it's actually infinite, OK? **[2-Claim/Factual-Data]**
However, the question I wanted to propose is that the intersection of two planes, it's what?

S6: One point? **[3-Intuitive Data]**

T: It will not be a point, intersection of two planes will be a line (Fig. 2). **[4-Rebuttal –to-Data/Factual-Data]** However, your line, you need what to define the line?

S6: Two points **[5-Deductive-Warrant].**

T: Two points, OK? If you find two points of intersection, it's done. Here it says: input the names of the two points. So the intersection of (EFG) and (ABC), as if you take a big knife, you cut the tetrahedron along with the direction of (EFG), and the knife will arrive where it will arrive somewhere on the ground, here (Fig. 3) **[echoing 2-Claim/Factual-Data]**. To construct the two points in the line, you should construct each point as intersection of two lines, like in the first task, agree? For each point, as intersection of two lines **[6-Claim]**.

Now let's decide the first point in it...

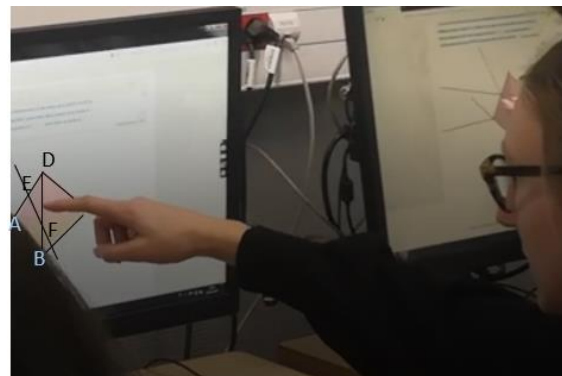


Fig. 1 S5 traces line (EF) and prolongs it until somewhere on the bottom plane

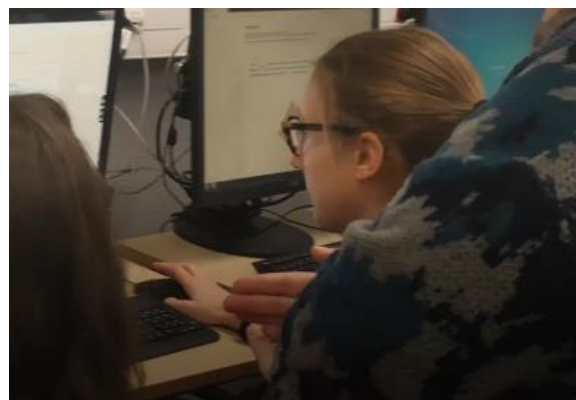


Fig. 2 The teacher's gestures simulating two intersecting planes

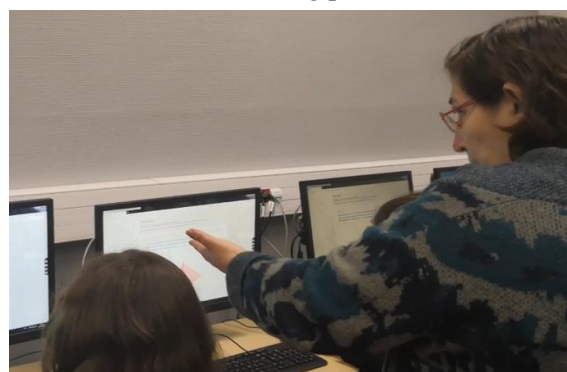


Fig. 3 The teacher's gestures simulating a knife cutting down to the ground

⁸ For each transcript of episode in this thesis, we use independent figure numbering system which restarts at Fig. 1 every time.

We firstly look at the argumentation components directly contributed by the students and the teacher. At the beginning of the episode, the 1-Perceptive-Data and the gestures in Fig. 1 show S5's understanding of infiniteness of the line (EF); on that basis, Dora gave a 2-Claim confirming that the line is infinite. Then, she quickly shifts to another topic – the nature of the intersection of two planes – and S6's response shows that she has an incorrect intuition about the intersection, which is thus identified as 3-Intuitive-Data. As a reaction, the teacher directly gives the correct answer that two planes should intersect at a line (4-Rebuttal-to-Data), illustrating it with gestures in Fig. 2. From 2-Claim and 4-Rebuttal-to-Data, together with S6's idea that a line can be defined by two points (it is a geometric theorem and thus labeled 5-Deductive-Warrant), the teacher led students to 6-Claim. Therefore, 2-Claim and 4-Rebuttal-to-Data were meanwhile the Factual-Data that supports 6-Claim, but there lacks one Deductive-Warrant for deriving the final claim rigorously, which is “a point can be defined as the intersection of two lines”. From the teacher's final sentence, we know that this is an implicit warrant that both the teacher and the students take for granted. All these argumentation components identified are integrated into the diagram in Fig. 5.16.

Dora's contributions to the episode, apart from the direct argumentation components mentioned above, also include indirect contributions. The questions she poses include those *requesting an idea* (to elicit 1-Perceptive-Data) and *requesting a factual answer* (to elicit 3-Intuitive-Data and 5-Deductive-Warrant); other supportive actions include *promoting* with general encouragement (to elicit 1-Perceptive-Data) and *rebutting* by directly correcting improper ideas (to react to 3-Intuitive-Data). Dora also uses gestures to perceptively *inform* her own contributions, such as the simulating gestures in Fig. 3 (to illustrate 2-Claim/Factual-Data). The gestures could trigger students' perception of the spatial structure involved in the argumentation components, allowing students to easily accept the components and use them in the following argumentation. These indirect contributions are also integrated into Fig. 5.16. Dora's direct contributions (yellow boxes) and indirect contributions (talk bubbles) together constitute her coordination behavior in this episode.

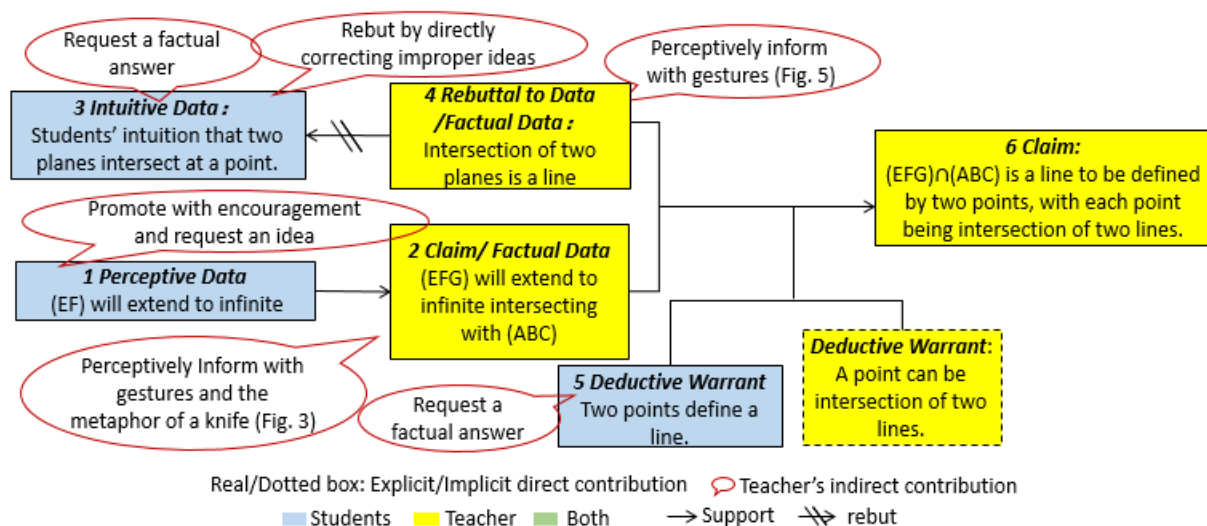
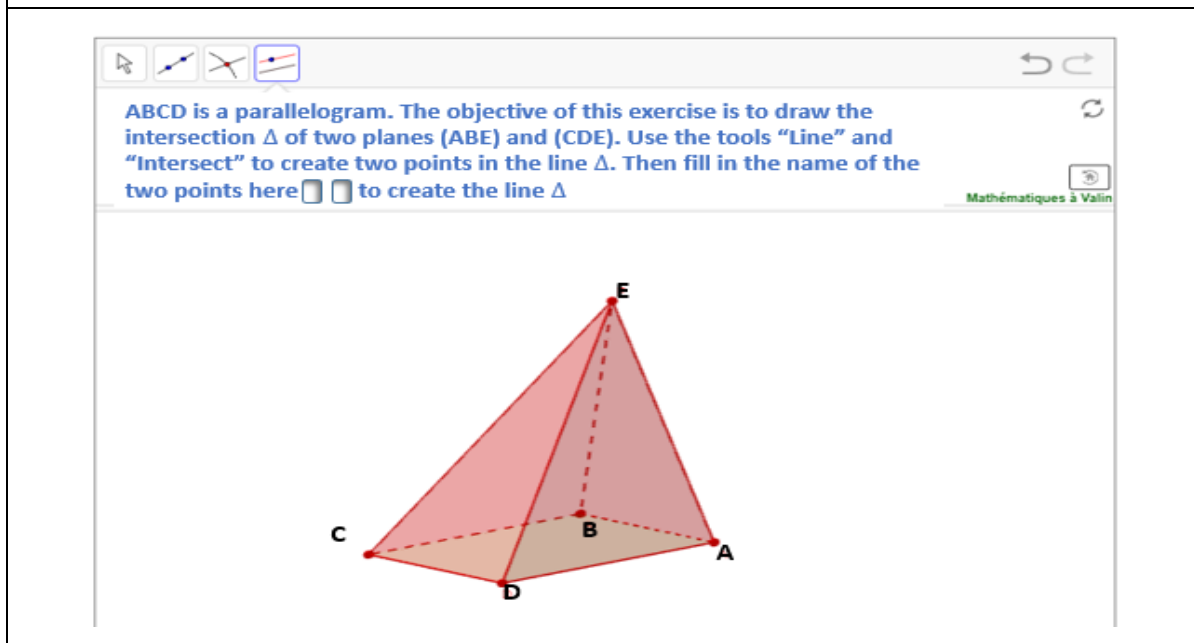


Fig. 5.16 Diagram of argumentation for Episode 1-S5, S6-Task 4

The second example episode related to the rules of coordination D.I-A covers the whole collective argumentation between the teacher and two students, S10 and S11, around Task 12.

The task demands the intersection of two planes (ABE) and (CDE), which contain two parallel lines (AB) and (CD), as shown below.

Task 12 (with the 3D DGE)



The collective argumentation began when Dora launched a talk with S10 and S11, who, at the moment, had stopped their construction after having created some lines on the screen; then, the teacher told them a theorem about spatial parallelism and directly led them to the main claim about the demanded intersection. At the end of the argumentation, students met with some technical problems and could not verify their answer within the 3D DGE, but the teacher told them that they had already solved the task “mathematically”. We consider the whole argumentation process as a single episode. Below is its transcript.

Episode-S10, S11-Task 12

T: (ABE) and (CDE) it's that? Does this recall you some theorem? You know the theorem of “roof” in 3D geometry or not?

S11: Not much

T: Not much or not? Not at all?

S11: We did geometry in the space in the first grade?

S10: What? No.

T: Ok I will explain to you. Imagine a roof, look at me, you have a house, the roof of the house is two planes, imagine a line in the first plane, a line in the second plane, which are parallel. I will find that the lines are also parallel with the intersection of the two planes, that is, the roof (Fig. (1)). This is just the theorem of “roof” **[1-Deductive-Warrant]** Is that the task you have here? You've found (AB), and (CD) they are what? They are parallel, (AB) is the line in (ABE), (CD) in (CDE)... **[2-Factual-Data]**

S11: Ah I know, I should find E and F, the points... **[part of 3-Claim]**

T: However, the point, how are you going to construct it?

S11: Just as...

T: So construct the parallel line, parallel to (CD), passing through... (Fig. 2) [part of 3-Claim]. That's it, then, it's... (S11 tries to find a second point in the line as the task demands to give two points to name the line) but it was already the end. We've already constructed the intersection, mathematically, it's right, for the software I don't know...



Fig. 1 The teacher's gestures simulating a roof of house

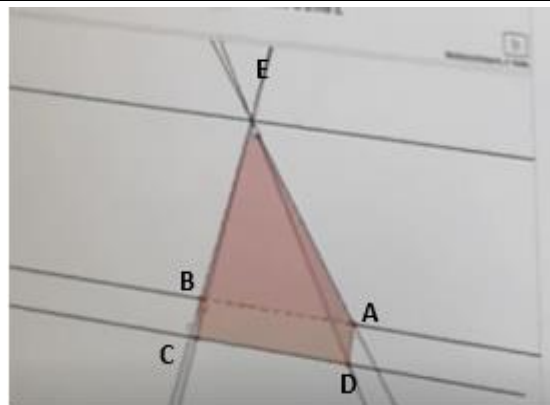


Fig. 2 S11 is constructing a parallel to (CD) according to the teacher's instruction

We first look at the argumentation components directly contributed by the students and the teacher. At the beginning, Dora directly tells students the geometric theorem of “roof” (théorème du toit in French) after confirming that they knew nothing about it. On that basis, she leads students to search for the information in the task that can be matched with the precondition in the theorem. Once they (mainly the teacher) find something relevant (2-Factual-Data), the theorem of “roof” would allow them to get the claim about the intersection demanded by the task, that is the main claim of this episode. We label the theorem of “roof” and the main claim respectively as 1-Deductive-Warrant and 3-Claim. These argumentation components identified are integrated into the diagram of argument in Fig. 5.17.

Secondly, we look at Dora's indirect contributions. The questions she poses include the one *requesting a method* (to elicit S11's contribution of 3-Claim); other supportive actions include the *evaluating* action (to react to S11's actions in Fig. 2), and the *informing* action with the use of gestures (to illustrate her own contribution of 2-Deductive-Warrant), which provides students perceptive support for the theorem of “roof”. The indirect contributions and the direct contributions colored in yellow in Fig. 5.17 together constitute Dora's coordination behavior in this episode.

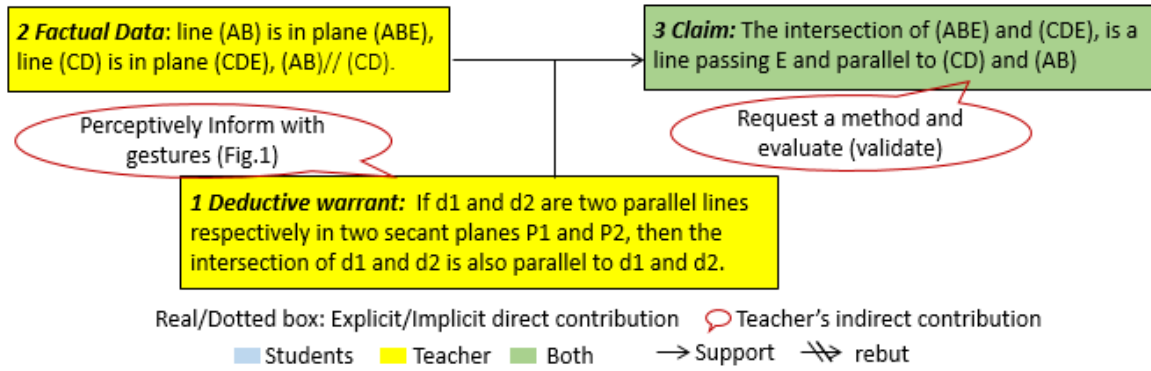


Fig. 5.17 Diagram of argumentation for Episode 1-S10, S11-Task 12

The two argumentation episodes are underpinned by the same basic structure. As the two diagrams of argumentation (Fig. 5.16, Fig. 5.17) show, they both cover a chain of Factual Data – Deductive Warrant(s) – Claim, which can be interpreted as a complete theoretical deductive reasoning. The Factual Data and Deductive Warrant(s), apart from those given in the task statement or already known by students, are all contributed by Dora and concerned with the basic theorems/facts in Euclidean 3D geometry. At the same time, Dora always uses gestures to simulate the spatial structure or real objects related to these theorems or facts, as a way of *informing* the Factual Data and Deductive Warrants. The gestures support students' perception (and 3D mental images) of the properties and theorems, allowing students to easily accept their truth and apply them to the theoretical deductive reasoning. The same basic structure has also been found in the episodes around Tasks 3-8 and these episodes are all about linking the target intersection to be constructed with the point of intersection of lines. We classify these episodes into one group, and to keep consistent with the label of the rules of coordination, this group of episodes is also labeled D.I-A. Their common basic structure is represented by the general diagram of argumentation in Fig. 5.18.

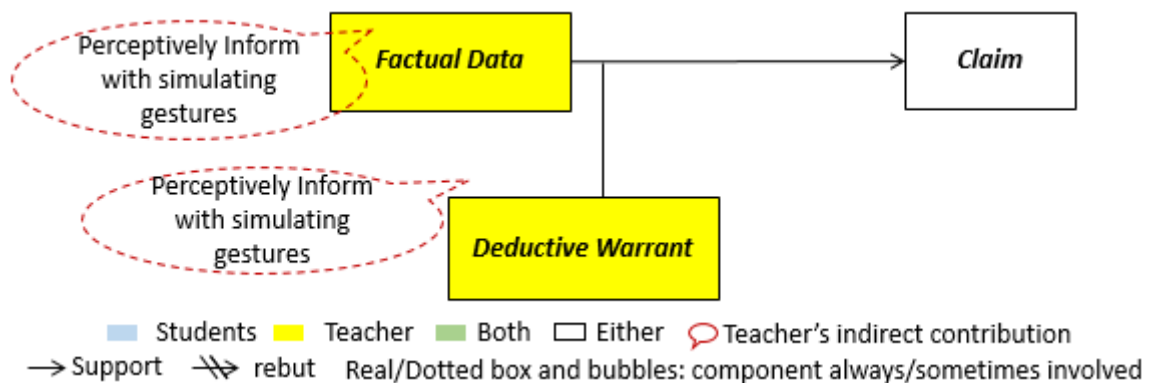


Fig. 5.18 General diagram of argumentation for episodes of Group D.I-A

The regularities of Dora's coordination behavior across this group of episodes, as reflected in her contributions to the general diagram, mainly consist in: (1) direct contributions of Factual Data and Deductive Warrants in the complete theoretical deductive reasoning, and (2) perceptively *informing* these argumentation components with the use of simulating gestures. They respectively correspond to two rules of coordination: (1) directly tell students the 3D

geometry theorems or facts and guide them to use the theorems and facts in theoretical deductive reasoning; (2) support students' perception of the theorems/facts with simulating gestures. They constitute the rules of coordination of Group D.I-A.

Rules of Coordination D.I-B: (1) request students' evaluation of and explanation for their statements; (2) rebut students' improper perception in a 3D DGE with feedback in the same 3D DGE; (3) guide students to validate a statement by theoretical deductive reasoning instead of by perception.

One episode related these rules of coordination is the Episode 2 of the collective argumentation around Task 4 between the teacher, and the students S5 and S6. It is just the episode coming after the first example episode in Group D.I-A. In this episode, the teacher guided students to determine that one point in the line of $(EFG) \cap (ABC)$ is just the intersection of line (EF) and line (AB). Below is the episode transcript.

Episode 2-S5, S6-Task 4

T: Now let's decide the first point in it... (EF) is good, could you let it intersect with another line?

S5: (AB) [1-Claim]?

T: Are you sure that (AB) will intersect (EF) or not? why?

S6: They could [2-Non-Absolute-Qualifier].

T: They could? Why they could? Why they couldn't?

S5: Because it's just like this (Fig. (1)) [3-Perceptive-Data] ... because (AB) and (EF) are not parallel [4-Perceptive/Factual-Data].

T: Yes, in space, the lines are secant or parallel when they are? It's what I am waiting for as info [part of 5-Deductive-Warrant]?

S6: Coplanar. [part of 5-Deductive-Warrant]

T: That's it. It's also because they are coplanar. [6-Factual-Data] So it can work. [7-Absolute-Qualifier] Construct (AB), and you're going to see an intersection... [echoing 1-Claim].

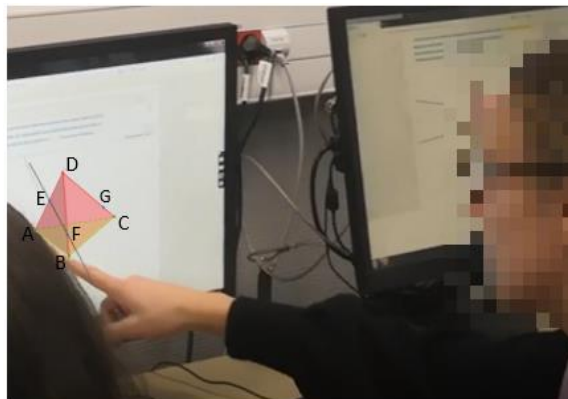


Fig.1 S5 uses gestures to simulate how (EF) and (AB) could intersect

We first look at the argumentation components directly contributed by the students and Dora. At the beginning, S5 gives, under the teacher's question, the Claim (labeled 1) that (AB) will intersect (EF). From the following sentences of S5 and her gestures in Fig.1, we see that the claim is only based on the perceptive effects in the 3D DGE (3-Perceptive-Data) and she is not certain (2-Non-Absolute-Qualifier) of the truth of the claim. Later S5 tries to give another explanation concerning the non-parallelism of (AB) and (EF). The non-parallelism might be a result of perceiving as S5 made the gestures in Fig.1, but it is also the information that can be correctly perceived from a 3D dynamic model and its screen image, so we identify it as 4-Perceptive/Factual-Data. Nevertheless, this data is not what Dora really wants. So she directly

tells the expected geometric theorem – for two non-parallel lines in the space to be secant, they should firstly be coplanar – and leaves the key word “coplanar” to be answered by the students (5-Deductive-Warrant). The teacher further indicates the coplanarity of (EF) and (AB) (6-Factual-Data), which meets up with the premise in 5-Deductive-Warrant, so that the latter warrant can be applied to connect the 6-Factual-Data to the 1-Claim they would like to confirm. Dora also attaches the 7-Absolute-Qualifier to this Claim, trying to convey a belief to students that they can only be certain of a conclusion drawn through theoretical deductive reasoning. These argumentation components are integrated into the diagram in Fig. 5.19.

Secondly, we look at Dora’s indirect contributions. The questions posed include *requesting an idea* (to elicit students’ contribution of 1-Claim), *requesting evaluation* by asking students to confirm their own statement (to elicit students’ contribution of 2-Non-Absolute-Qualifier), and *requesting elaboration* with more and more transparent hints (to elicit students’ contribution in 3-Perceptive-Data and 5-Deductive-Warrant). There are no specific supportive actions or use of resources. These indirect contributions are also integrated into Fig. 5.19. Dora’s direct contributions (yellow and green boxes) and indirect contributions (talk bubbles) in Fig. 5.19 together constitute her coordination behavior in this episode.

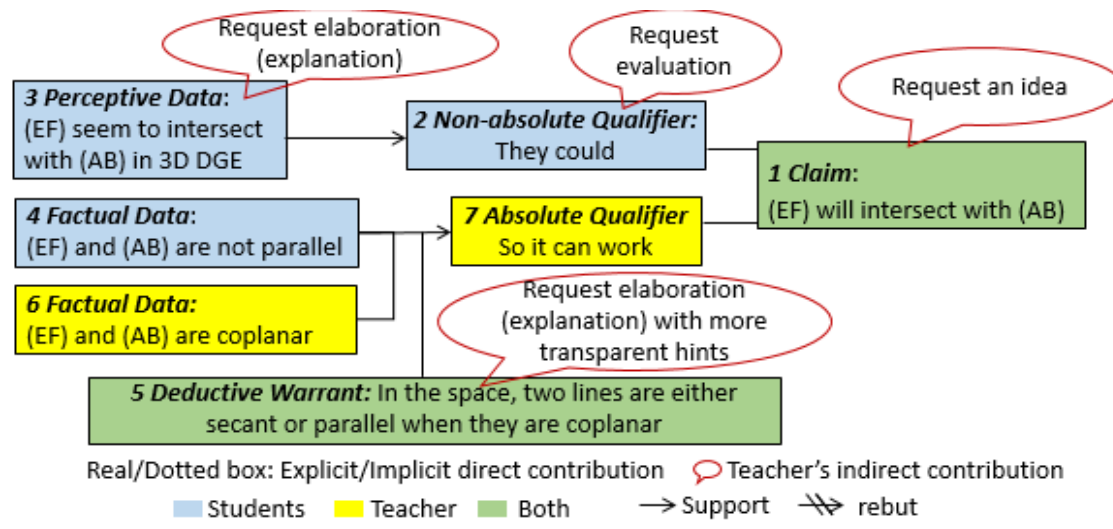
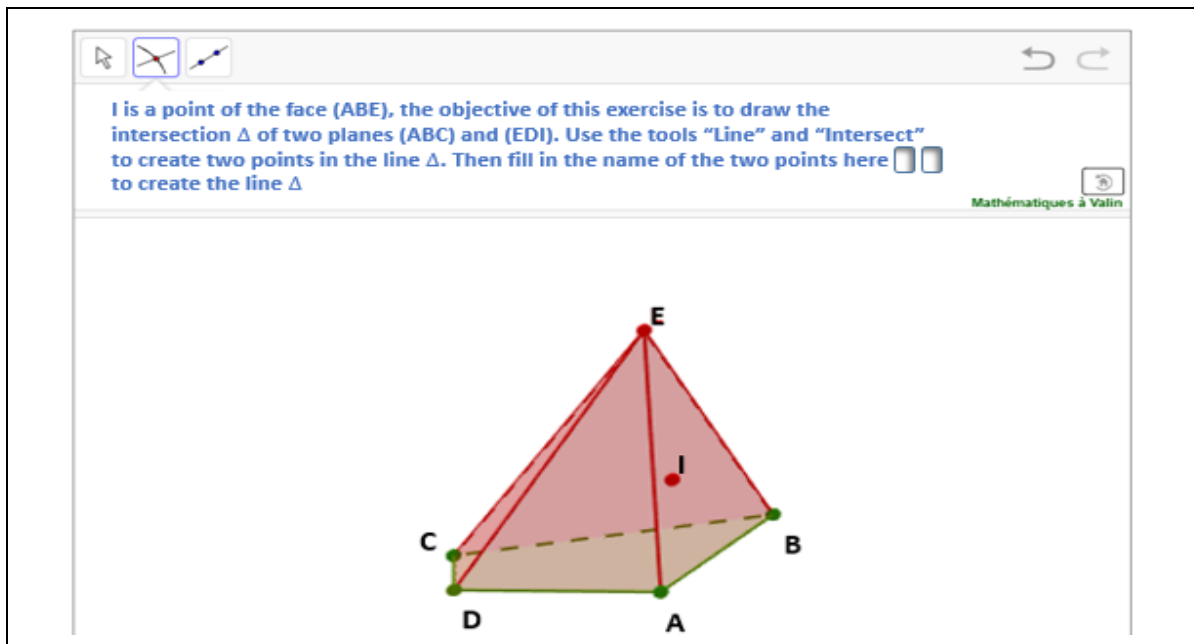


Fig. 5.19 Diagram of argumentation for Episode 2- S5, S6- Task 4

The second example episode related to rules of coordination D.I-B is the Episode 2 in the collective argumentation around Task 6 between the teacher Dora and two students, S1 and S2. The task requires students to construct the intersection of two planes (EID) and (ABC), as shown below.

Task 6 (with the 3D DGE)



The collective argumentation began when S1 asked for the teacher's help when she tried to construct $(EI) \cap (AC)$ as one point of intersection in $(EID) \cap (ABC)$. Through intervention, Dora made S1 realize that (EI) and (AC) are not coplanar and thus cannot intersect. Then Dora turned to ask for S2's idea (first argumentation node). S2 gave a wrong intersection at first and Dora guided the students to find the correct answer (second argumentation node). After that, they went on to looking for another point of intersection in $(EID) \cap (ABC)$ and finally determine the whole line of intersection.

Here the two argumentation nodes are decided according to Dora's words: "So Thomas, do you have any idea?" and "OK, we've finished half of the work, now we need to find another point...". The whole argumentation process is divided into three episodes by the two argumentation nodes, and here we investigate Episode 2.

Episode 2-S1, S2-Task 6

T: So Thomas, do you have any idea?

S2: wait... (Fig. (1))

T: OK. stop here if it's what you want.

S2: you see something?

T: Me? yes I see something. The line (EI) , the line (AD) , they intersect with each other?

S2: Yes [1-Claim]

T: Because?

S2: They are in the same plane [2-Perceptive Data].

T: OK, you make the intersection of them.

S1: They will intersect?

S2: I don't know [3 Non-Absolute-Qualifier].

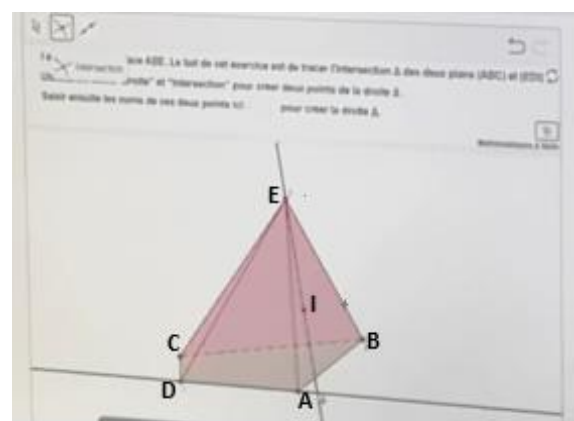


Fig. 1 S2 draws lines (EI) and (AD) in the 3D DGE

T: Turn it around a little.

S2: How this? turn around...

T: You've never rotated the figure? what a pity!
Look, here we can see it better (Fig. 2) [4
Rebuttal-to-Data/Perceptive-Data].

S2: Ah so they will not intersect.

T: It's exactly in the 3D geometry that the non-coplanar lines, we have the perception that they intersect with each other, but it's not the case. So you may look for another line in (ABC) which could well intersect with (EI).

S1: It's (BA) [5-Claim].

T: You are sure? Why?

S1: They are coplanar

T: Yes, they are both in which plane?

S1: ...

T: Look at the task statement, I is in which plane?

S1: Oh they are both in (EAB). [6-Factual-Data].

T: That's it, all agree? The two lines must [7-Absolute-Qualifier] intersect because they are coplanar. OK, half of the work, now we need to find another point...

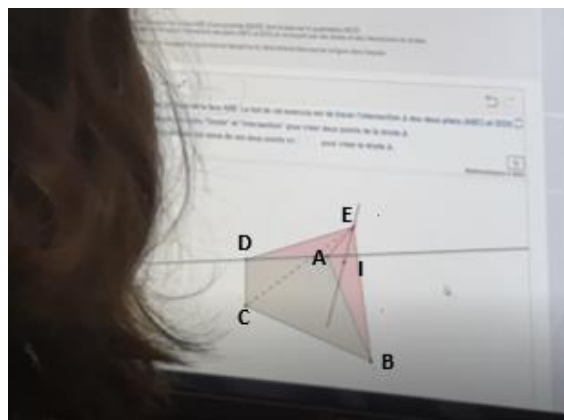


Fig.2 The teacher turns the model in the 3D DGE around then stops at one perspective

We first consider the argumentation components directly contributed by the students and Dora. At the beginning, S2 points out a line, (AD), which he thinks would intersect with (EI), that is 1-Claim. He explains that it is because (AD) and (EI) “are in the same plane”. He gives the information probably based on the perceptive effects in the 3D DGE at that moment (Fig. 1), which are thus identified as 2-Perceptive-Data. The connection made by S2 between 2-Perceptive-Data and 1-Claim shows his knowledge of the geometric theorem: “two lines in space are either secant or parallel when they are coplanar” (an implicit Deductive-Warrant); but obviously he has difficulties in identifying coplanar lines and is not sure (3 Non-Absolute Qualifier) of the truth of 1-Claim. As a reaction, Dora rotates the solid in 3D DGE to another perspective (Fig. 2), prompting the 4-Rebuttal-to-Data which goes against the 2-Perceptive-Data. This Rebuttal is meanwhile a perceptive data that allows S1 and S2 to replace 1-Claim with a new claim: (EI) intersects with (AB) (5-Claim). However, to ensure that the students do not stay on the visual perception, Dora guides them to explicit the plane to which (EI) and (AB) both belong (6-Factual-Data). Here she implicitly refers to the same Deductive-Warrant as before. Only after the students gives the name of the plane (6-Factual-Data) would Dora totally confirm the truth of the 5-Claim, so we identify an Absolute-Qualifier here (labeled 7). The diagram of argument integrating these argumentation components is shown in Fig. 5.20.

We secondly consider Dora's indirect contributions. The questions posed include *requesting an idea* (to elicit students' contributions of 1-Claim and 4-Claim), *requesting elaboration* by asking for the reason and possibly giving hints (to elicit students' contributions of 2-Perceptive-

Data and 6-Factual Data), *requesting* students' *evaluation* (certainty) of their claims, which has elicited the contribution of 3-Non-Absolute-Qualifier. Other supportive actions mainly include *rebutting* by evoking conflicting effects (to react to students' contribution of 2-Perceptive Data). The *rebutting* actions is combined with the use of the 3D DGE. These indirect contributions are also integrated into Fig. 5.20. The indirect contributions (talk bubbles) and the direct contributions (yellow boxes) in Fig. 5.20 together constitute Dora's coordination behavior in this episode.

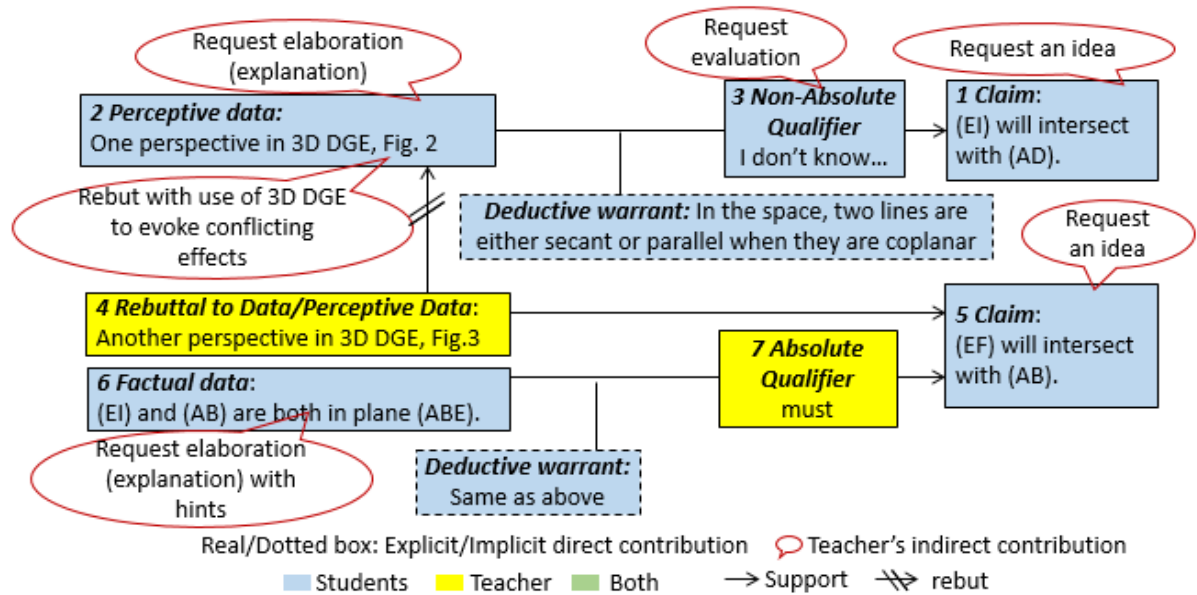


Fig. 5.20 Diagram of argument Episode 2-S1, S2- Task 6

The two argumentation episodes modelled by the diagrams in Fig. 5.19 and Fig. 5.20 are underpinned by the same basic structure. They both involve a chain of Factual Data – Deductive Warrant(s) – Claim, which represents a complete theoretical deductive reasoning; but compared to the episodes of Group D.I-A, the Factual Data and Deductive Warrant(s) here are less contributed by the teacher and more by students. There are also Perceptive Data from the corresponding 3D DGE, which haven't played an important role in Group D.I-A. The Claims based on these Perceptive Data are either *rebutted* by the teacher who mobilizes the feedback system of the 3D DGE, or reconfirmed through the complete theoretical deductive reasoning. In this way, the teacher weakened students' dependency on the Perceptive Data and moves them to theoretical deductive reasoning. The same basic structure is also found in the episodes of Tasks 3-8 that concern the determination of the point of intersection of two specific lines. We classify these episodes into Group D.I-B, and their common basic structure is represented by the general diagram in Fig. 5.21.

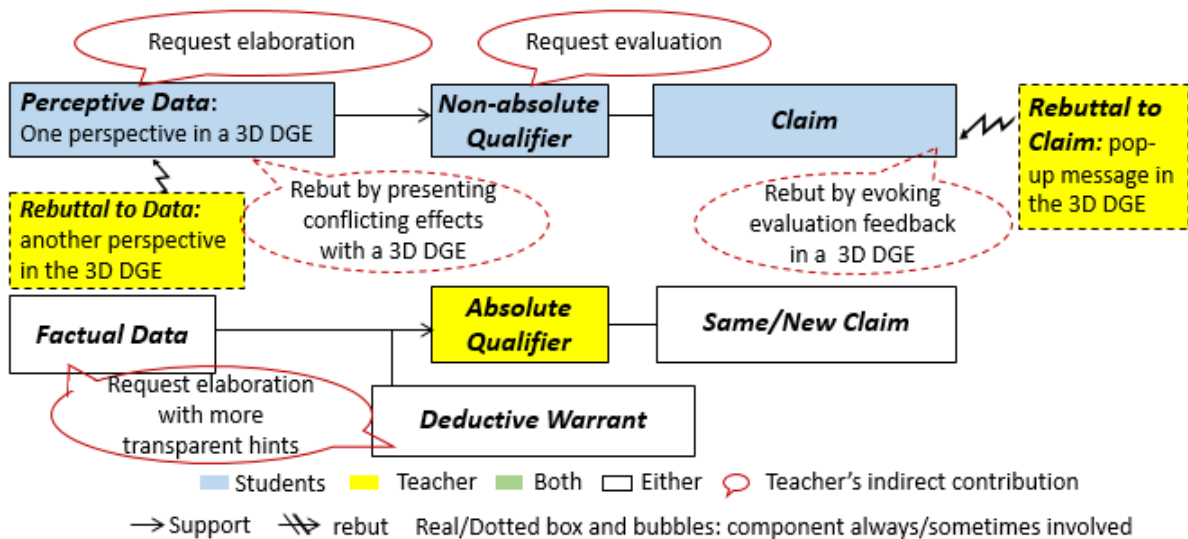


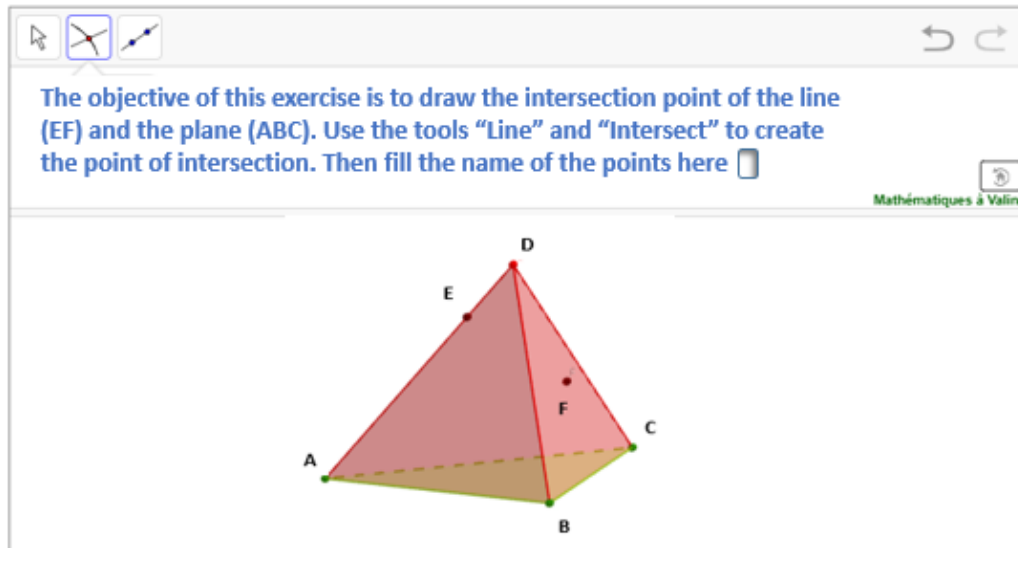
Fig. 5.21 General Diagram of argumentation for Episodes of Group D.I-B

The teacher's contributions to the general diagram consist in: (1) *requesting* students' *evaluation* of their Claims; 2) *rebutting* the biased Claims that students drew from Perceptive Data or *rebutting* the biased Perceptive Data itself with the use of a 3D DGE; 3) *requesting* students' *elaboration* for their Claims with increasingly transparent hints and only *validating* the Claims supported by Factual Data and Deductive Warrants. In terms of perception and logical reasoning, these contributions can be transformed into 3 rules of coordination: (1) request students' evaluation of and explanation for their statements; (2) rebut students' improper perception in a 3D DGE with feedback in the same 3D DGE; (3) guide students to validate a statement by theoretical deductive reasoning instead of by perception. These are the rules of coordination of Group D.I-B.

Rules of Coordination D.I-C: (1) encourage students to explore perceptive evidences in a 3D DGE with the guidance of geometric theorems; (2) let students' take their perception as a fact to develop the following theoretical deductive reasoning

Here we give two examples of argumentation episodes which are both concerned with Task 9. The task demands students to construct the intersection of a line (EF) and a plane (ABC); and (EF) passes through the inside of the background solid, as shown below.

Task 9 (with the 3D DGE)



The first example is the episode that covers the whole collective argumentation between the teacher and one student S7 around Task 9. The collective argumentation began when S7 asked for the teacher's help. During the argumentation process, the teacher successfully led students to find a plane that contains both (EF) and a line in (ABC), which allowed S7 to fix the intersection quickly. Hence, we identify the whole collective argumentation as a single episode; its transcript is presented below.

Episode-S7-Task 9

S7: Madame, I have a plan, look for a point like this (Fig. (1)). **[1-Perceptive-Data]**

T: Yes, but this point, you should construct it in a good way. It's quite, quite good that you have this idea, why you want to make a point here?

S7: So that the line could intersect with (EF) (Fig. 2)

T: So that it could intersect with (EF), you should search for a point that could be in the same plane, in fact, with all these, you should construct a point that could work...

S7: (trying to connect F and some point else to make a line in the 3D DGE)

T: Point F is indeed interesting, but with which you could connect it?

S7: (construction in Fig. 3)

T: OK, if you want C, just make (FC). But you told me that you would like something here, near the middle of (BC) (Fig. 4), F what could cut it here?

S7: Ah, (FD). **[part of 2-Claim/Perceptive-Data]**

T: Yes, at this time the E, F, A and this point, they are in which plane?

S7: (Turning the solid around) plane (ADF) **[part of 2-Claim/Perceptive-Data]**

T: Very very good. A good vision in space, right? OK, go on!

S7: (constructing line (FD) and let it intersect (BC) at G, constructing line (AG) and letting it intersect (EF) at H, inputting H in the task blank and finally getting a "correct response") **[3-Claim]**.

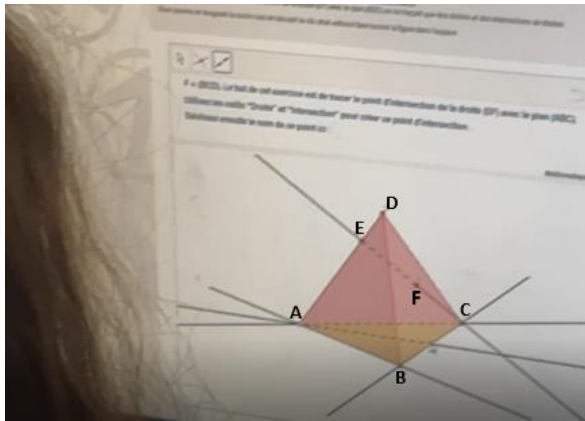


Fig. 1 S7 connects A and some point in (BC) in the 3D DGE

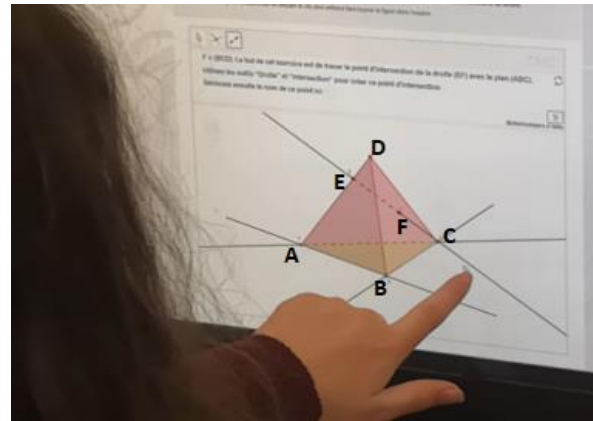


Fig. 2 S7 points at the position of the intersection she would like to construct

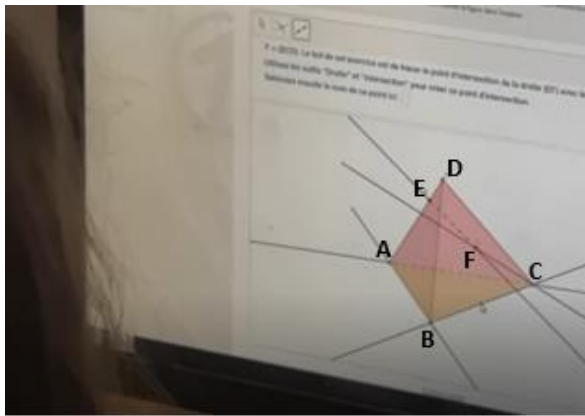


Fig. 3 S7 finally connects F and C in the 3D DGE

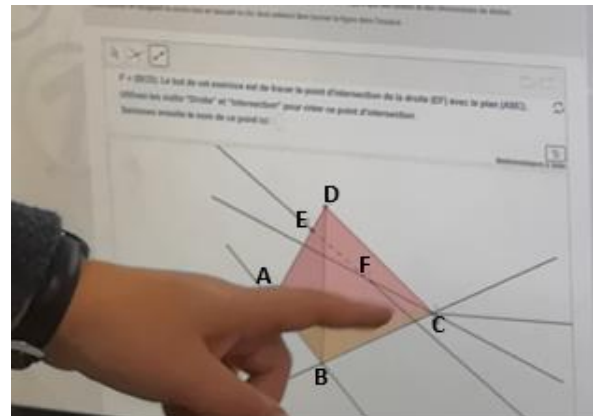


Fig. 4 The teacher's gesture pointing at the middle of segment [BC]

At the beginning of this episode, S7 describes her observation that (EF) would probably intersect a line passing through A and some other point (we temporarily name it X) in (BC). As this observation is actually her perception in the 3D DGE, we identify it as 1-Perceptive-Data. As a reaction, Dora positively *confirms* the idea, and further *directs* S7's exploration of the point by *giving a hint* that the point X should be in the same plane with (EF). Obviously, this hint is inspired by the geometric theorem – for two lines in space to be secant. Guided by the hint, S7 continues to search for the point X that could meet with the “coplanar” condition and, as Fig. 3 illustrates, she firstly thinks that the point X is on the line (FC) and coplanar with (EF) in the plane (EFC). As a reaction, Dora just puts her answer aside and *repeats* the previous idea of S7: point X should be near the middle of [BC]. After that S7 realizes that X should be the intersection $(DF) \cap [BC]$, which is actually point G; the teacher further *requests* S7's *idea (judgement)* and gets her answer that points G, A, E, F are all in the plane (ADF). The two answers of S7 together constitute 2-Claim. Since S7 only rotates the 3D dynamic model while giving this Claim, we suppose that she might have mentally constructed the line (FD) and imagined it intersecting with [BC] at its midpoint and imagined the plane (ADF). These mental images are the student's self-generated images with the tendency to complement the lack of perceptive information in the 3D DGEs. So we consider the 2-Claim meanwhile as a Perceptive

Data, based on which the previous geometric theorem could be applied to lead to the claim that (AG) and (EF) will intersect. Here Dora directly *confirms* the 1-Claim/Perceptive-Data proposed by S7 and *promotes (with general encouragement)* her to construct the intersection of (AG) and (EF), which is exactly the intersection of (ABC) and (EF) demanded by the task. In this way, the 2-Claim/Perceptive-Data is directly connected (with the previous geometric theorem serving as an implicit Deductive Warrant) to the final solution of the task, which is embodied in S7's actions in the end. We identify the actions as an implicit Claim; it is meanwhile the main claim of this episode.

The description above has integrated all the argumentation components directly contributed by students and Dora and the indirect contributions (in italics) of Dora in this episode; on this basis, we establish the diagram of argumentation in Fig. 5.22. Dora's indirect contributions (talk bubbles) and the direct contributions (yellow boxes) in Fig. 5.20 together constitute her coordination behavior in this episode.

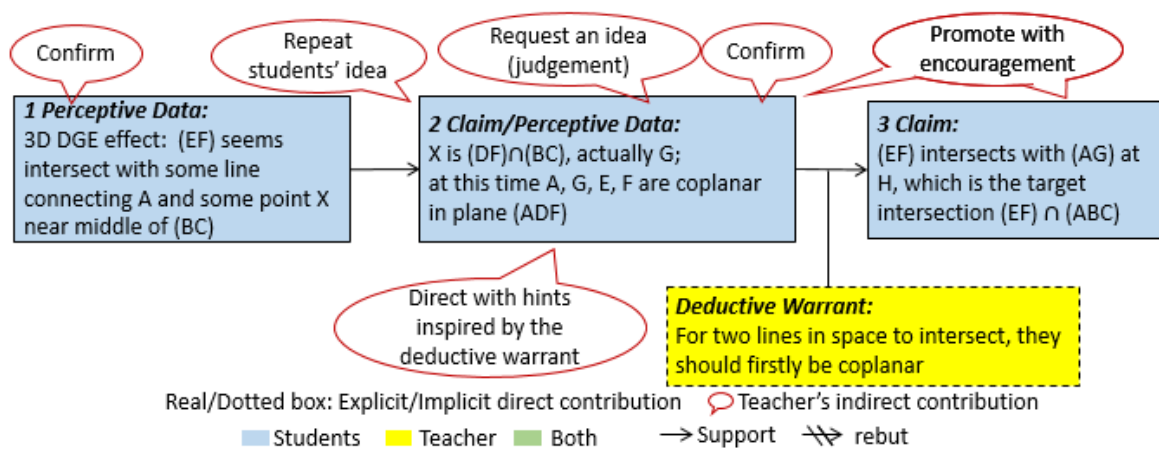


Fig. 5.22 Diagram of argumentation for Episode-S7-Task 9

Another example episode related to the rules of coordination is the whole collective argumentation around the same task between the teacher and another student S5. The transcript of the episode is presented below.

Episode-S5-Task 9
T: Here it is not so evident, because you should construct a point so that, later on, we could find a line in (ABC) which would be coplanar with (EF), agree?
S5: From here (Fig. (1) [1-Perceptive-Data])
T: Exactly, exactly. But to have this line, you need something more precise.
S5: So draw the (FD), and then... (Fig. 2) [2-Claim/Perceptive-Data])
T: That's it, you have seen that... you have a good vision, it's very good, but anyway you are analyzing what you want, you've seen that to get the intersection, there should be something coplanar here, opp, then it's (AFD) that can cut here. Very good, then you look for the intersection, OK?

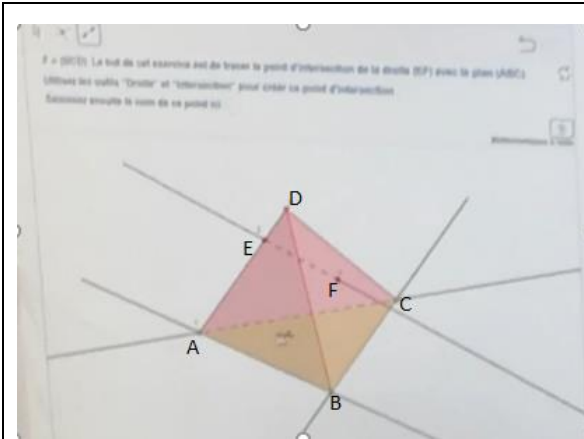


Fig.1 S5 moves the cursor from A to somewhere near the midpoint of [BC]

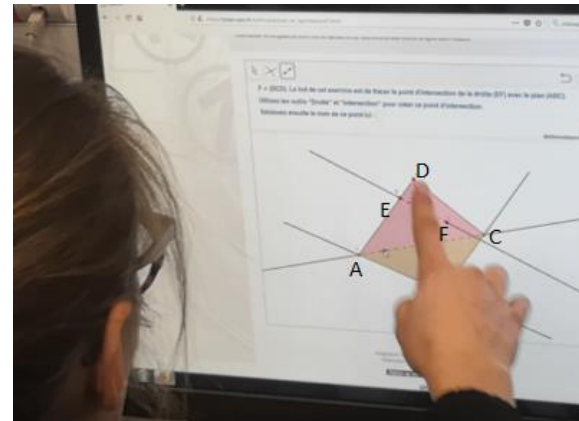


Fig.2 S5 traces along (DF) until some point in [BC], and then connects A and the point

The structure of argumentation in this episode is generally similar to the previous episode, except that the teacher's *direction* – the line to be searched in plane (ABC) should be coplanar with line (EF) – is given at very first. Following the direction and the *promoting* action (the suggestion of defining the line precisely) of the teacher, S5 comes up with the two Perceptive Data smoothly. Her actions in Fig. 2 show that she has a good mental image (or “vision” in the teacher’s words) of the auxiliary plane (ADF) that contains both (EF) and (AX), with point X being the intersection of (DF) and (BC). (AX) is just the line to be searched in plane (ABC). Here Dora highly appreciates S5’s use of vision and allows her to directly integrate the related Perceptive Data into the argumentation. Referring to the geometric theorem – for two lines in space to intersect they should firstly be coplanar, the Perceptive Data can lead to a Claim that is not clearly mentioned but can be inferred from this episode – (EF) will intersect (AX) and the intersection is what the task demands. The diagram of argumentation modelling this episode is in Fig. 5.23, in which Dora’s indirect contributions (talk bubbles) and the direct contributions (yellow boxes) together constitute her coordination behavior in this episode.

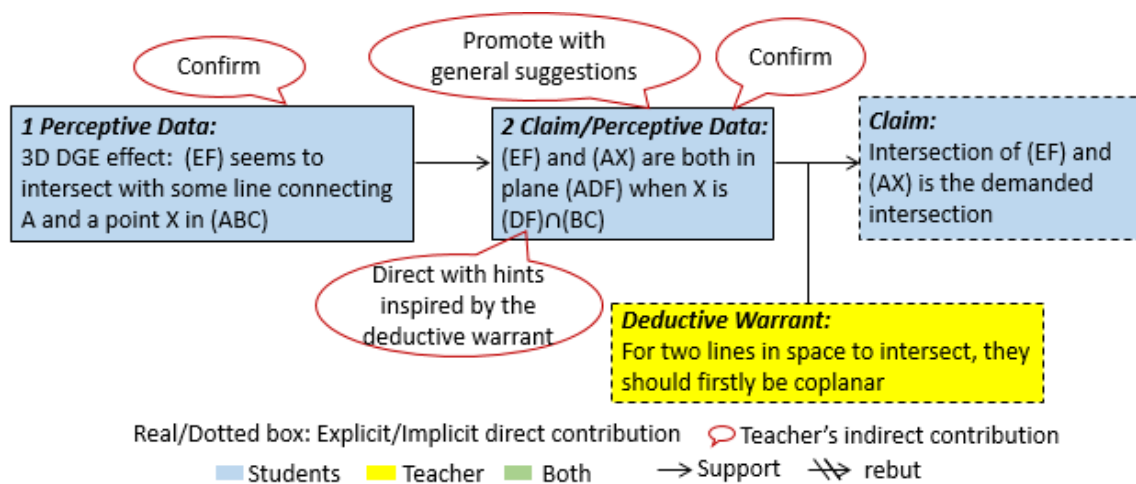


Fig. 5.23 Diagram of argumentation for Episode-S5-Task 9

The two episodes above are underpinned by the same basic structure. Firstly, both of them contain a chain of Perceptive Data – Deductive Warrant – Claim; the Factual Data in the previous two groups of episodes is replaced by Perceptive Data here. Secondly, the Perceptive Data originate from a 3D DGE, which is similar to episodes of Group D.I-B; but the Perceptive Data here are always contributed by students under the teacher’s *direction* inspired by the idea of applying a geometric theorem (conceptualized as Deductive Warrant) instead of being casually captured by students. Once the Perceptive Data proposed by students can satisfy the condition of applying the geometric theorem, the teacher encourages them to directly proceed with the following argumentation, taking the Perceptive Data as a fact. The same structure has been found in most of the episodes concerning Tasks 9-11, in which an auxiliary plane is always needed to create a “coplanar” condition for the target line and another line in the target plane, so that the two lines could intersect. We classify these episodes into Group D.I-C; their common basic structure is represented by the general diagram in Fig. 5.24.

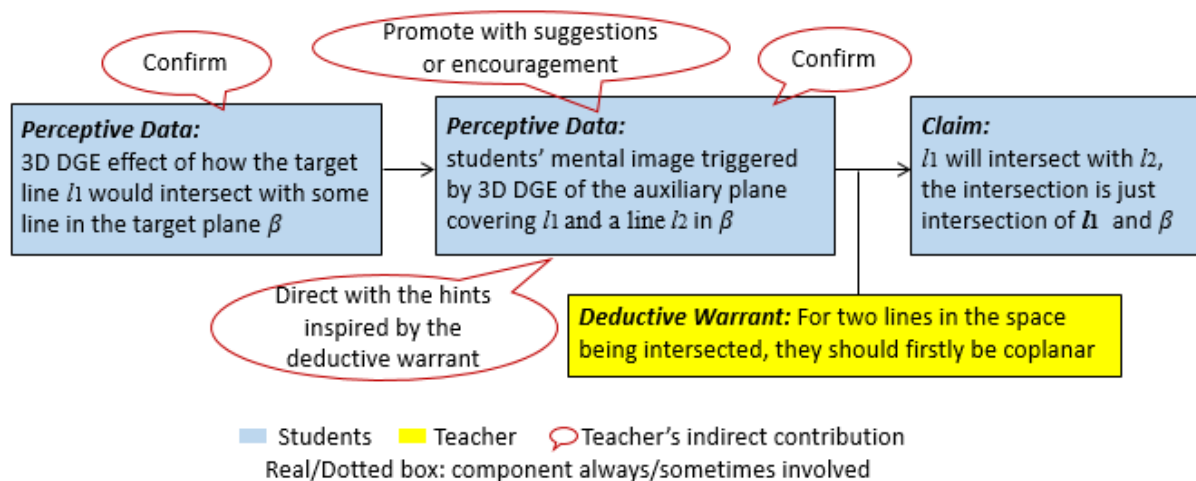


Fig. 5.24 General Diagram of argumentation for Episodes in Group D.I-C

The teacher’s contributions to the general diagram mainly lie in: (1) *directing* students’ exploration in a 3D DGE with the idea consistent with the Deductive Warrant; 2) *confirming* the Perceptive Data that students explored under the guidance of the deductive idea and *promoting* them to use the Perceptive Data together with the Deductive Warrant. Correspondingly, we can extract two rules of coordination and put them into one group labeled D.I-C: (1) encourage students to explore perceptive evidences in a 3D DGE with the guidance of geometric theorems; (2) let students’ take their perception as a fact to develop the following theoretical deductive reasoning.

Rules of coordination D.I-D: (1) guide students to perform theoretical deductive reasoning in reference to a formal geometric definition; (2) support students’ perception of the theoretical deductive reasoning result or the formal definition with real objects or the real classroom;

The two example episodes related to these rules of coordination both come from the collective argumentation around Task 1, which happened between the teacher and the whole class of students. We present the content of the task again here.

Task 1

What properties are maintained, from the physical object and the representation? I hear you say the angles ... what about parallel lines, is this maintained in the representation? ...and the middle point?... If I see two secant lines on my figure, are they necessarily secant in space?

As introduced previously, the whole task consists of four subtasks, according to which we a priori divide the whole collective argumentation into four episodes. The Episode 1 that covers the discussion around the first subtask is the first example episode we will present here.

Episode 1-Task1

T: what is faithfully represented, what properties keep invariant when moving from the physical object to the representation (Fig. 1)?

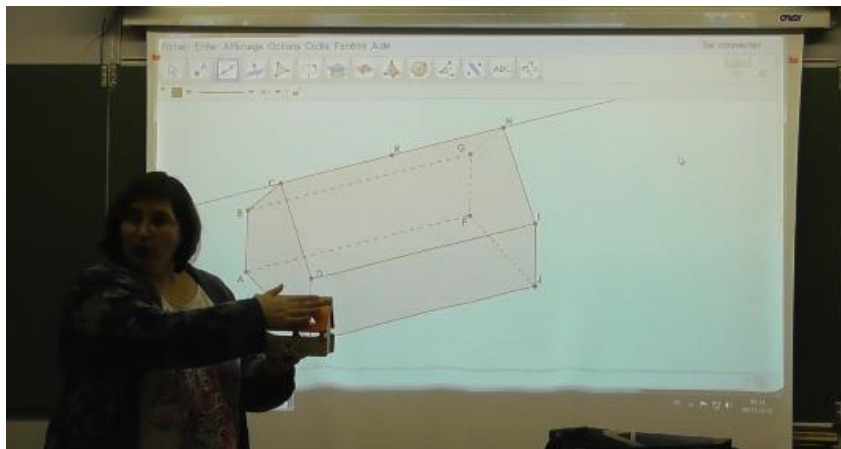


Fig. 1 The teacher denotes the physical object (a toy house) and lets students compare it with the representation on the screen (a parallel projection of the 3D DGE model of house)

S: the angles [1-Claim]

T: I hear one says the angles, let's see an example, what kind of angle is this (Fig 2)? What degree should it have in reality? (Fig. 2)?

S: 90 degrees

T: 90 degrees, but is it 90 degrees there?

S: No [2 Rebuttal-to-Claim / Perceptive-Data],

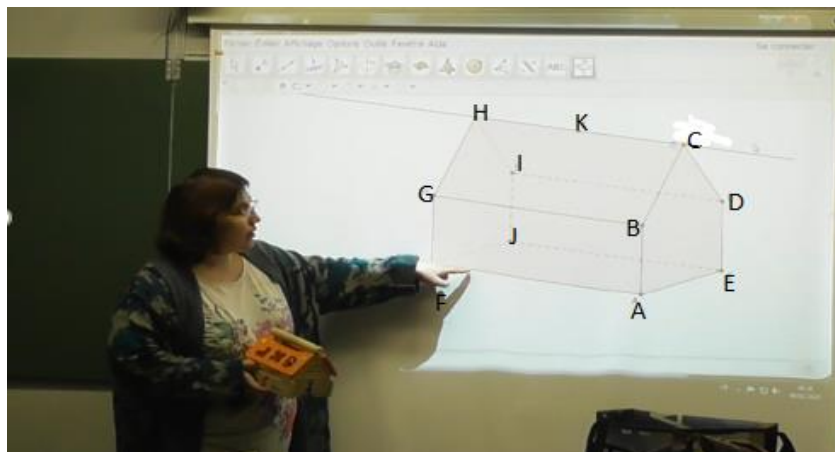


Fig. 2 The teacher points at $\angle JFA$ on the screen

T: we don't have 90 degrees, so the angles, not like the parallelism, the angles are not always maintained [part of 4-Claim], so when will they be faithfully represented? It's not the case of this angle, but, for all the angles in the face right in front of us, like this (Fig. 3) or here (Fig. 4) [3-Perceptive-Data], the measures of the angles will be respected for the face that we have in front, and also the face behind which is parallel to it – we will introduce later what does the parallel faces mean – anyway, in these faces, the angles, their magnitudes, will be faithfully represented in the plane [part of 4-Claim], OK?

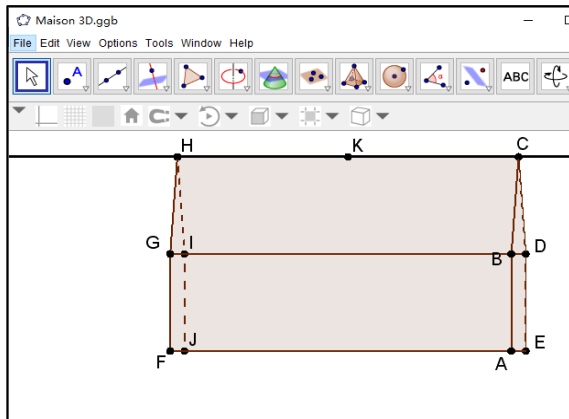


Fig. 3 Face GFAB is rotated to the front in the 3D DGE (screen reproduced)

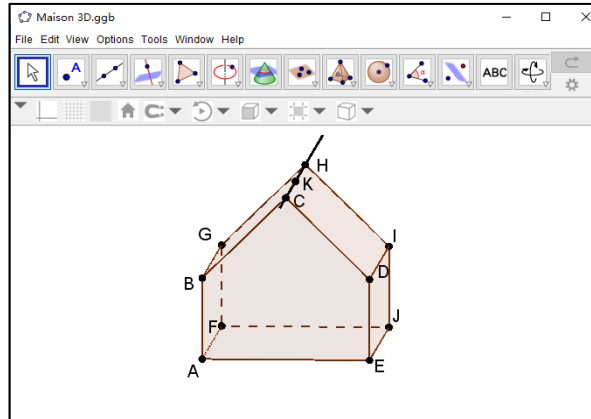


Fig. 4 Face CBAED is rotated to the front in the 3D DGE (screen reproduced)

T: But as soon as it is not from the face right in front of us, well here (Fig. 5), the angles will not be faithfully represented [part of 4-Claim]

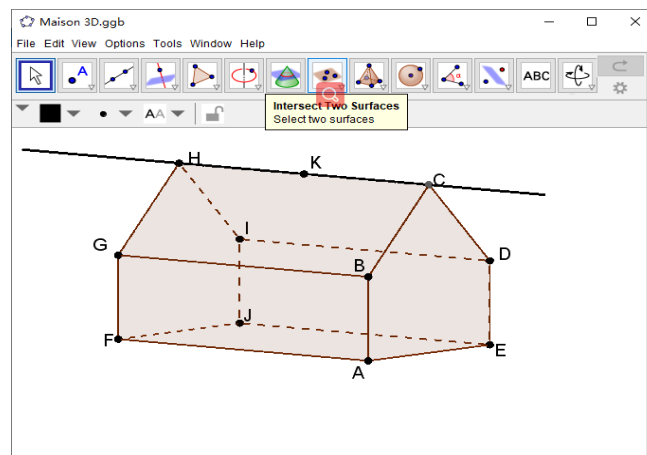


Fig. 5 The 3D DGE model is rotated to the initial place as in Fig. 2 (screen reproduced)

We firstly discuss the argumentation components directly contributed by students or Dora in the episode. At first, when Dora asks about what spatial relationship keep invariantly represented when moving from a 3D toy house to a 2D representation, some students answer “the angles”. This answer might be derived from their perception of some angles in the 3D DGE (Fig. 1), or from their intuition for which we cannot find a rationale; we thus identify the answer as 1-Claim and suppose it to be based on an implicit Intuitive/Perceptive-Data. Then

Dora takes the perceptive effects of one angle on the 2D representation (a parallel projection of the 3D dynamic model on the screen, Fig. 2) as a rebuttal to 1-Claim; the rebuttal is meanwhile a perceptive example so we label it 2-Rebuttal-to-Claim/Perceptive-Data. Dora further rotates the 3D dynamic model, to show that the angles orthogonally oriented to the observer can maintain their magnitudes in a 2D representation (3-Perceptive-Data). These perceptive examples of angles together lead to the 4-Claim: only angles in the faces right in front of the observer or the parallel faces behind can be faithfully represented in a 2D representation.

Secondly, we consider Dora's indirect contributions. The questions posed include: *requesting an idea* (judgement) to elicit students' contribution of 1-Claim, and *requesting elaboration* to elicit students' interpretation of the 3D DGE effects and the contribution of 2-Perceptive Data. The other supportive actions mainly include *rebutting* students' claim with (perceptive) counterexamples. The teacher also uses the dragging tool in the 3D DGE to show the angles at different faces in a 2D representation, contributing 3-Perceptive-Data.

All the argumentation components and the indirect contributions are integrated into the diagram of argumentation in Fig. 5.25. Dora's indirect contributions (talk bubbles) and direct contributions (yellow and green boxes) in Fig. 5.25 together constitute her coordination behavior in this episode.

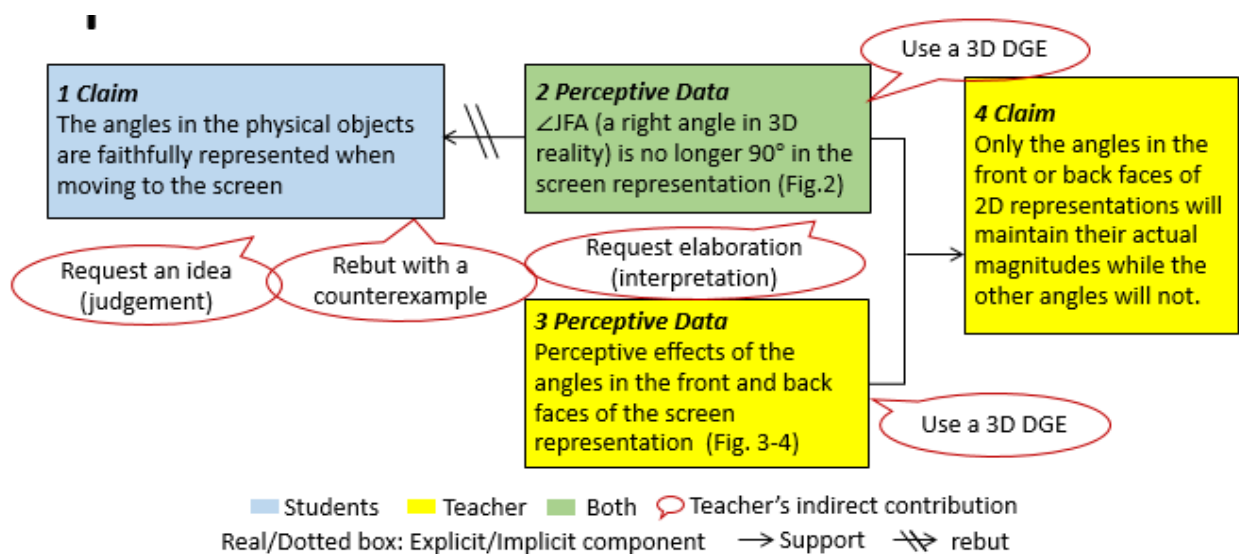


Fig. 5.25 Diagram of argumentation for Episode 2-Task 1

The second example episode is the Episode 3 in the same collective argumentation around Task 1; below is its transcript.

Episode 3-Task1
T: Then if I see two secant lines on the plane, are they necessarily secant in space?
S: No [part of 1-Claim] ...
T: Can you give an example of two straight lines which could appear secant on the screen (Fig. (1), but in reality they are not?

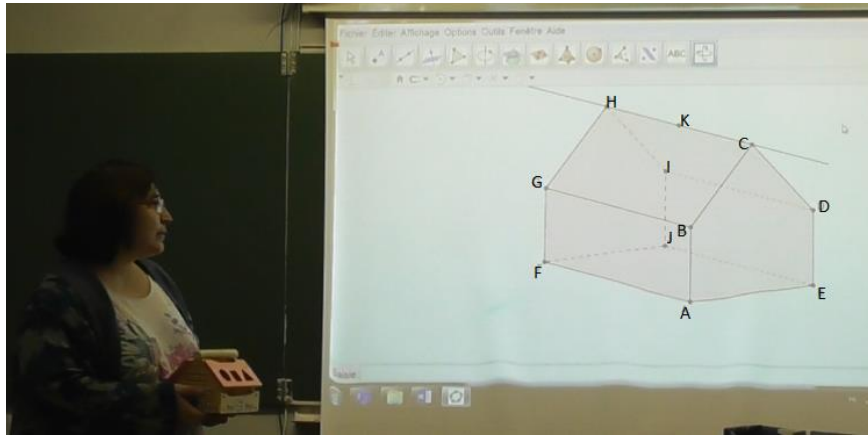


Fig. 1 Dora asks students to find two non-secant lines in the parallel projection of the 3D DGE model on the screen

S: (GB) and (IJ) [part of 2-Perceptive-Data]

T: Well, (GB) and (IJ), very good, I make the line, just like this (Fig. 2) [part of 2-Perceptive-Data]

T: Then in this perspective of the figure, we may have the impression that the two lines will intersect, but is it the actual case? I will show you another view (Fig. 3). [part of 2-Perceptive-Data]. We could see it much better when we rotate the figure in the software, it's the specific advantage since we cannot do this on the paper.

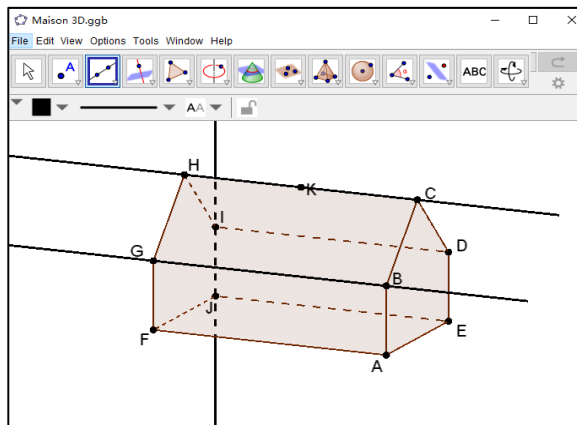


Fig. 2 Line (IJ) and line (GB) are constructed on the screen

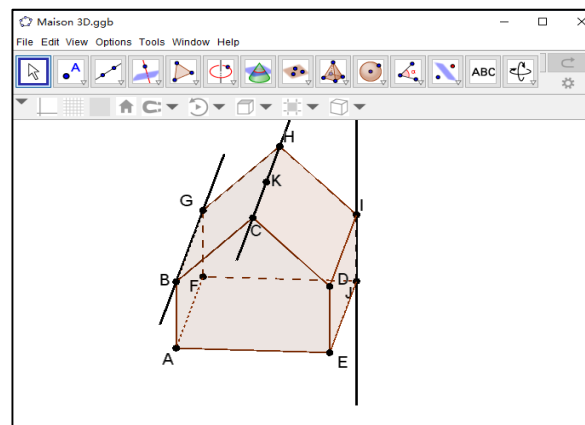


Fig. 3 Another view the 3D DGE model in which line (IJ) and line (GB) are separated

T: Well, is there any criteria to help us determine when they will intersect, when they will not?

S: If they are on the same plane [part of 1-Claim]

T: Exactly, when they are in the same plane, like (AB) and (GB) (Fig. 4), they are intersecting in plan (ABG), and it's also the actual case in the space [3-Perceptive-Data].

T: So we say that for two lines to intersect, they must be on the same plane. We say that the lines are, does anyone remembers the vocabulary? It's what kind of lines... yes?

S: Coplanar [part of 1-Claim].

T: Yes, the coplanar lines, very good. Now we see the handout together (Fig. (1))...

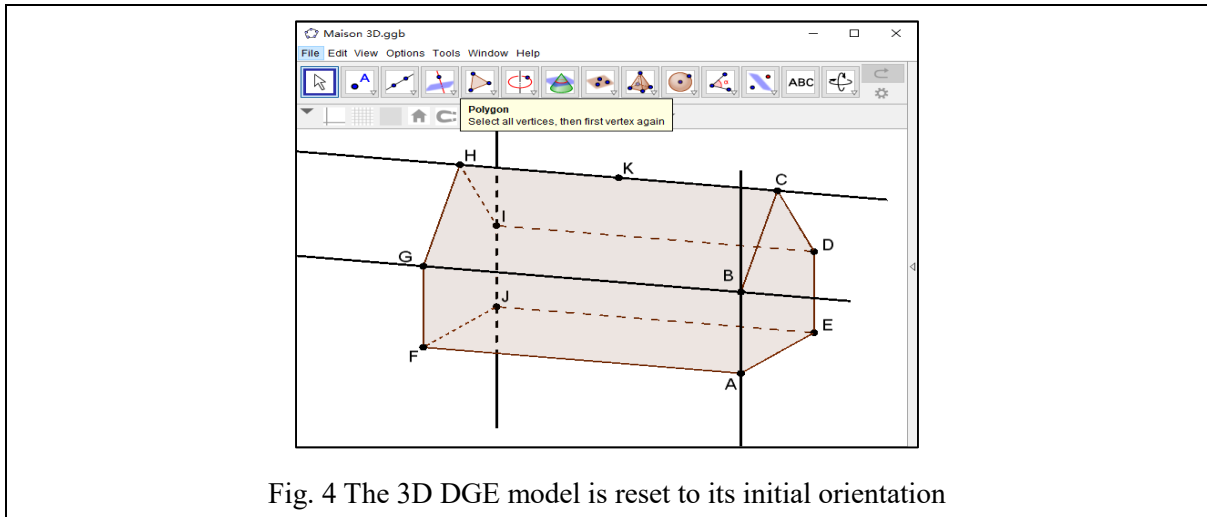


Fig. 4 The 3D DGE model is reset to its initial orientation

We firstly discuss the argumentation components directly contributed by students or Dora. At the beginning of the episode, one student in the class makes a correct judgement (1-Claim) about the inconsistency between the secant lines perceived from a 2D representation (one parallel projection of the 3D DGE model on the screen) and those on the 3D toy house. On the prompt of Dora, the student further provides two lines in the 2D representations, which appear secant but actually are not, to support the 1-Claim; then Dora constructs the two lines in the 3D DGE (Fig. 2) and shows their perceptive effects from another viewpoint (Fig. 3) which are closer to their actual status in the 3D toy house. The proposition of the two non-secant lines and their perceptive effects in different views constitute the 2-Perceptive Data in support of the 1-Claim. After that Dora guides students to consider under which condition the secant lines perceived from a 2D representation could reflect their actual status in space, and she comes up with another pair of lines – (AB) and (GB) – which are in the same plane as an illustration (3-Perceptive-Data). In this way, the teacher manages to extend the 1-Claim together with students, clarifying the criteria for identifying secant lines faithfully represented in a 2D representation.

Secondly, we consider Dora’s indirect contributions. They include the question of *requesting an idea* (judgement) that elicits students’ contribution of 1-Claim, the question of *requesting a factual answer* that elicits the particular word “coplanar” from students, the question of *requesting elaboration* (to provide examples for an idea) that makes students contribute a part of 2-Perceptive-Data. Dora also uses the 3D DGE to present different views of different pairs of lines in space, contributing to the 2-Perceptive Data and 3-Perceptive-Data.

All the argumentation components and the indirect contributions are integrated into the diagram of argument in Fig. 5.26. Dora’s indirect contributions (talk bubbles) and direct contributions (yellow and green boxes) in Fig. 5.26 together constitute her coordination behavior in this episode.

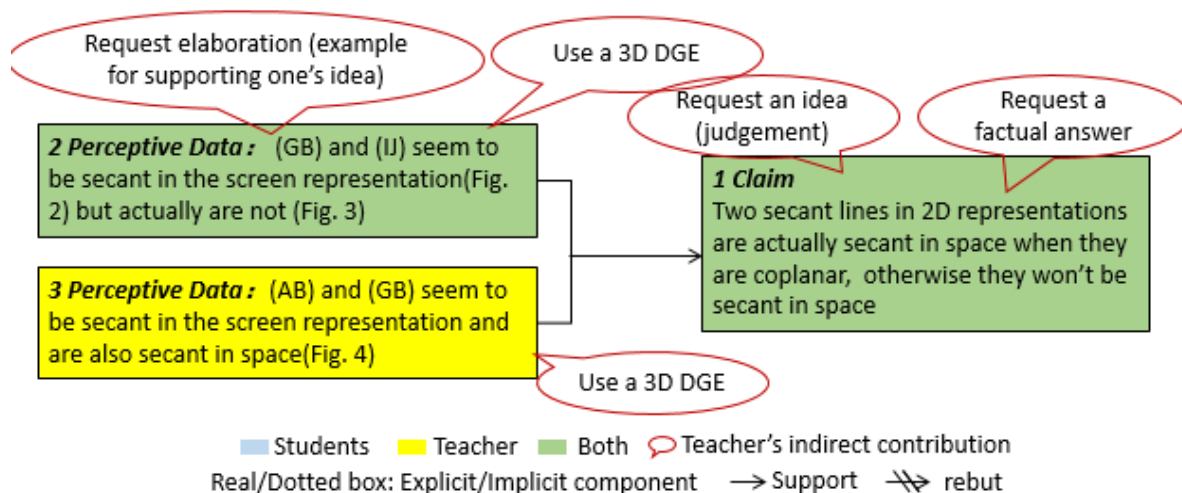


Fig. 5.26 Diagram of argumentation for Episode 3-Task 1

We claim that the two episodes above are underpinned by the same basic structure because they both involve a chain of Perceptive Data – Claim without a particular Warrant in between, which makes the two episodes differ from the previous groups. Usually there are two Perceptive Data, both originate from the 3D DGE; the first is identified by students under the teacher’s questions, concerning the perceptive effects of some cases (e.g., angles not maintained in 2D representations); the second is complemented by the teacher, concerning the perceptive effects of other cases (e.g., angles maintained in 2D representations). The Perceptive Data make the students accept, without any doubt, the Claim covering all the cases at stake. The same basic structure has been found in all the episodes of the subtasks of Task 1. Sometimes students also give an incorrect Claim at very first, then the teacher will evoke perceptive evidences as counterexamples to *rebut* the Claim. We classify all the episodes into Group D.I-D; their common basic structure is modelled by the general diagram in Fig. 5.27.

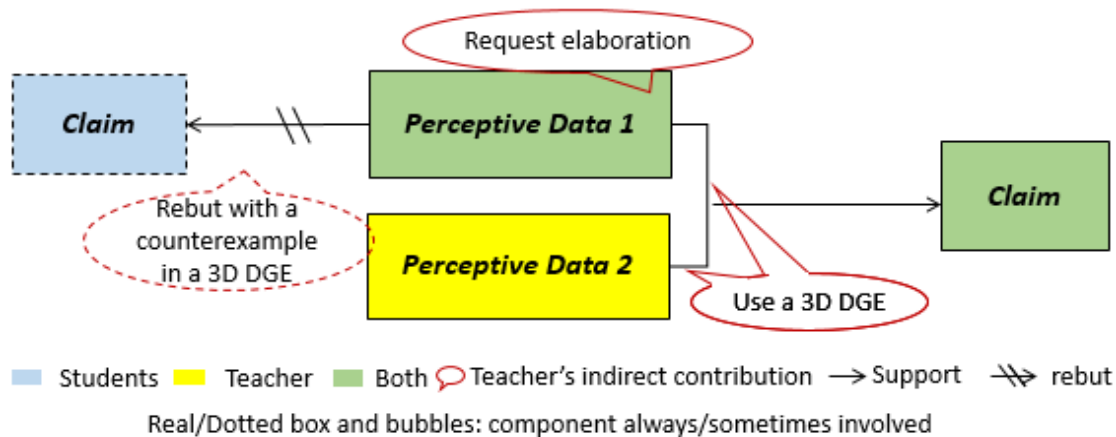


Fig. 5.27 General Diagram of argumentation for Episodes of Group D.I-D

Dora’s contributions to the general diagram mainly consist in: (1) *rebut* students’ incorrect Claim with the Perceptive Data in a 3D DGE; (1) use the 3D DGE to help students contribute Perceptive Data or contribute the Perceptive Data herself, in order to support a new Claim. They can be expressed as two rules of coordination: (1) rebut students’ incorrect statement

about one spatial relationship with perceptive evidences in a 3D DGE; (2) lead students to a new statement that covers multiple spatial relationships with more perceptive evidences. These are the rules of coordination of Group D.I-D.

Rules of coordination D.I-E: (1) guide students to perform theoretical deductive reasoning in reference to a formal geometric definition; (2) support students' perception of the theoretical deductive reasoning result or the formal definition with real objects or the real classroom;

The two example episodes related to the rules of coordination both come from the collective argumentation around Task 2. Below is the content of the task.

Task 2

In the “house” (a drawing in the paper handout), please give me two lines which coincide with each other... now I would like to have two lines which are strictly parallel... then to have two non-coplanar lines...

As mentioned previously, Task 2 consists of three subtasks which have similar 3D geometry topics – identify the relative position of two lines (coinciding, parallel, and non-coplanar) in the drawing of a house. We divide the whole collective argumentation around Task 2 into three episodes, each episode corresponding to one subtask. The Episode 1 that corresponds to the first subtask – identify coinciding lines in the drawing of house – is the first example episode to be presented here. Below is its transcript.

Episode 1-Task 2

T: Now we see the handout together (Fig. (1)) ... we will think about the relative positions of lines in space, and we refer to the house (the drawing in Fig. (1)) **[part of 1-Factual-Data]** if necessary. So if two lines are coplanar, it means that they are contained in the same plane. And when they are in the same plane, there are three possibilities (Fig. (1)), they are?

Examples (in the house):

Fig.1 First part of the handout: drawing of house and three possible relative positions between two coplanar lines in space (our translation from French to English)

S: Coinciding,

T: Yes, and the second case?

S: Parallel.

T: And the third case?

S: Secant.

T: OK, coinciding, strictly parallel, and secant. If you only use the word “parallel”, you can have strictly parallel or coinciding, right? These two cases, we encompass them by saying the two lines are parallel. If you absolutely want to mean that they are not coinciding, you have to say “strictly parallel”.

T: Now give me, in the house, two examples of coinciding lines. Two coinciding lines are in fact the same line... [2-Deductive-Warrant] ...

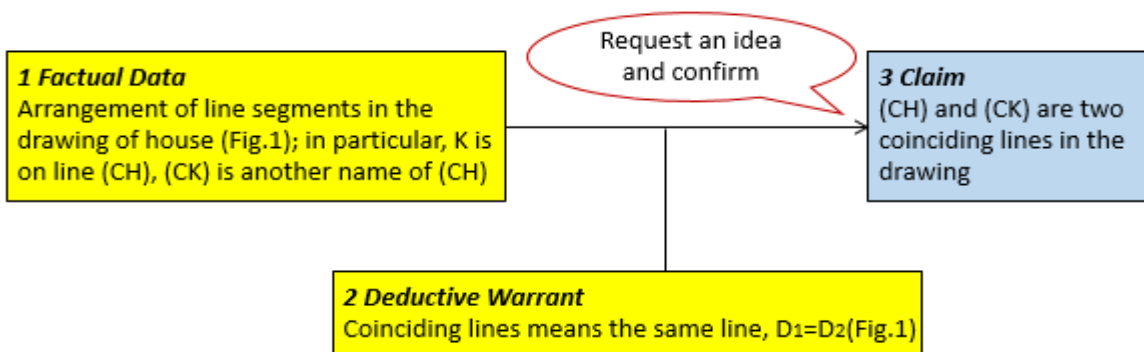
S: (CH) and (KC) [3-Claim].

T: Yes, (CH) and (KC), it's ok for everyone? We gave two different names but it's obviously the same line. The point K is on the line (CH), it is given just for us to name the line in an alternative way [part of 1-Factual-Data]. So (CH) and (KC), good. Now I would like to have two strictly parallel lines...

The argumentation structure of this episode is simple, Dora firstly mentions the drawing of house included in the handout (Fig. (1)). The line segments in the “house” are arranged in such a way serving as reference for students to identify pairs of lines with a particular relative position. This arrangement thus constitutes the first Factual Data, i.e., 1-Factual-Data. Then Dora introduces, assisted with the handout, the three possible relative positions of two coplanar lines and the definition of coinciding lines [2-Deductive-Warrant], according to which students give two examples of coinciding lines– (CH) and (KC) [3-Claim]. Then Dora elaborates the relative position of point K to line (CH), as a further explanation for 3-Claim; we take the explanation as an enrichment of 1-Factual-Data.

Dora’s indirect contributions to the argumentation in the episode consist in the question *requesting an idea* that elicits students’ contribution of 3-Claim and the action of *confirming* 3-Claim.

The argumentation components identified and the indirect contributions are all integrated to the diagram of argumentation in Fig. 5.28. Dora’s indirect contributions (talk bubbles) and the direct contributions (yellow boxes) in Fig. 5.28 together constitute her coordination behavior in this episode.



Real/Dotted box: Explicit/Implicit component → Support ⇨ rebut
■ Students ■ Teacher ■ Both ☞ Teacher's indirect contribution

Fig. 5.28 Diagram of argumentation for Episode1-Task 2

The second example episode is the Episode 3 that corresponds to the third subtask of Task 2.

Episode 3 -Task 2

T: Also, the lines, it can also happen that they are not contained in the same plane, at this moment, their intersection is empty. For the notation, it's $D_1 \cap D_2 = \{\emptyset\}$ (evoking the read words in Fig.1 on the screen) **[part of 1-Deductive-Warrant]**.

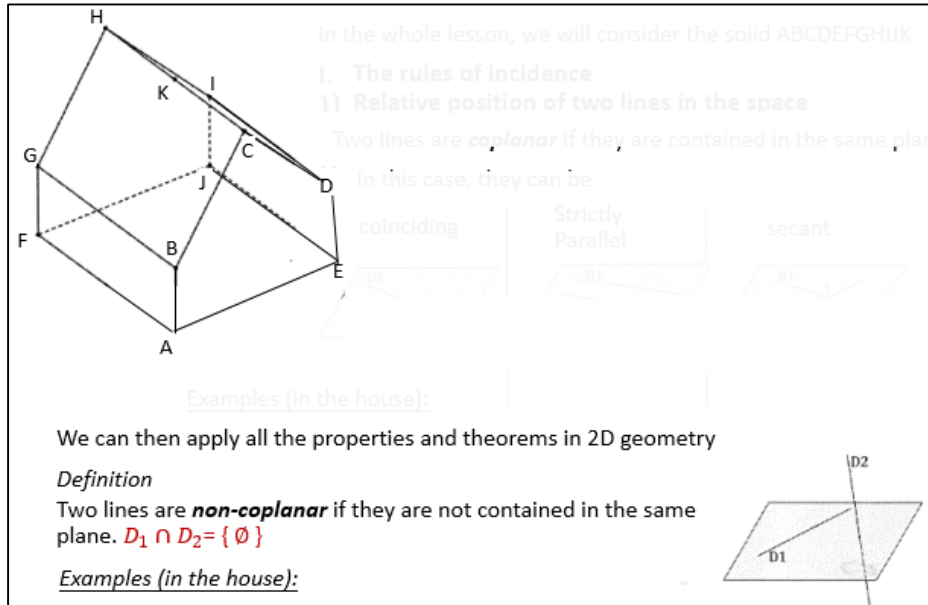


Fig. 1 Second part of the handout: definition and notation of non-coplanar lines in space

S: Non-coplanar, it means we can never find a plane that contains the two lines **[part of 1-Deductive Warrant]**?

T: That's exactly it, you won't be able to find a plane that goes on both. I'll directly show you with pens. Imagine these are two lines, here, no problem, there is a plane covering both lines (Fig. 2); but here you can't (Fig. 3) if you take all the planes that can contain this line, they won't be able to contain this one (Fig. 4).

T: So to give two non-coplanar lines from the drawing **[2-Factual-Data]**, as we have already said, it can be (IJ) and (GB) **[3-Claim]**, we can imagine that this line behind the door, and then this line there (Fig. 5), just like (IJ) and (GB), right? But they will never meet, never at this level **[4-Perceptive-Data]**. So they are non-coplanar lines **[echoing 3-Claim]**.



Fig. 2 The teacher uses two pens to simulate two secant lines



Fig. 3 The teacher uses two pens to simulate two non-coplanar lines



Fig. 4 The teacher uses the gesture of rotation around one pen (in blue) to simulate the various planes containing it

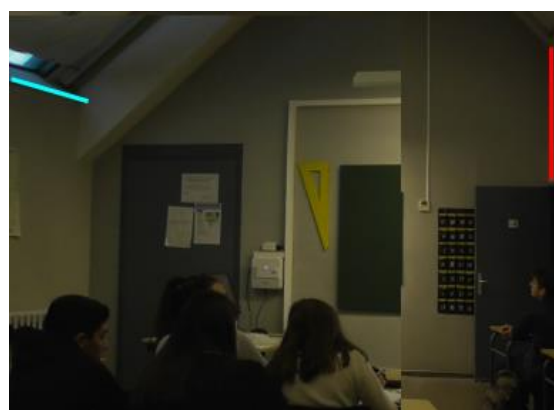


Fig. 5 The two “lines” in the classroom (red and blue lines) connected to lines (IJ) and (GB) by the teacher

Similar to the last example of the episode, in this episode the participants also have identify a pair of lines with a particular relative position (3-Claim) from the drawing of house (2-Factual-Data) in the handout, according to the given definition of the relative position (1-Deductive-Warrant). However, one difference here is that the relative position at stake, “non-coplanar”, is a kind of difficult notion for students, as evidenced by the question they proposed in the lesson. As a reaction, Dora *confirms* students’ understanding of “non-coplanar”, and uses pens and simulating gestures (Fig. 3-4) to perceptively inform this notion. After that, the 3-Claim concerning the non-coplanarity of (IJ) and (GB) is directly given by Dora. At the end, Dora simulates the two lines with a crossbar and a pillar of the real classroom they were located in (Fig. 5). We take the crossbar and the pillar as a Perceptive-Data (labeled 4), which supports 3-Claim, because it perceptively shows how (IJ) and (GB) could be relatively positioned in real space and why the relative position as such is called “non-coplanar”.

We integrate these argumentation components and indirect contributions of Dora into the diagram in Fig. 5.29. Dora’s indirect contributions (talk bubbles) and the direct contributions (yellow and green boxes) in Fig. 5.29 together constitute her coordination behavior in this episode.

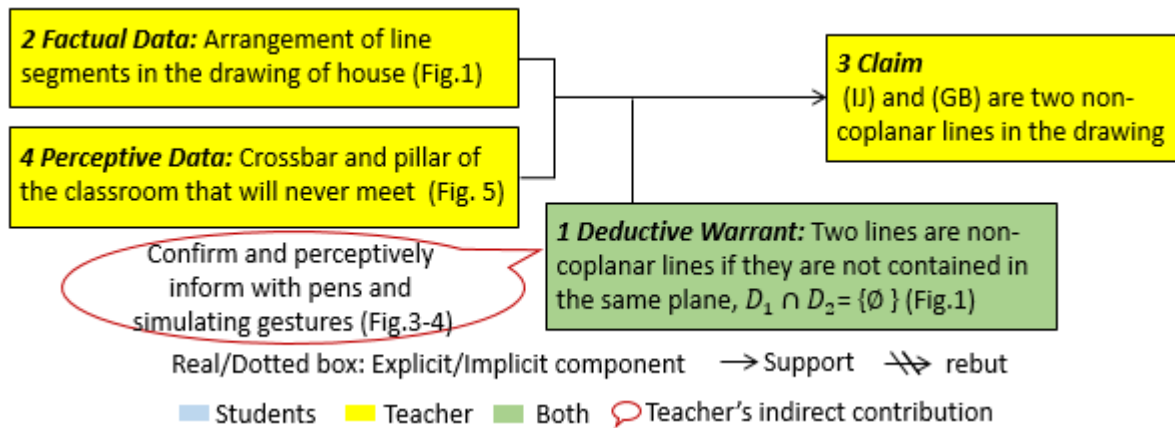


Fig. 5.29 Diagram of argumentation for Episode 3-Task 2

The two episodes are underpinned by the same basic structure. Firstly, both episodes involve a chain of Factual Data – Deductive Warrant – Claim, which signifies a theoretical deductive reasoning process. The Factual Data is the drawing of house given by the teacher; the Deductive Warrant is the formal definition of one relative position of lines in space; it is generally given by the teacher but sometimes also integrated with students' interpretation. The Claim is the examples of lines having the particular relative position in a drawing. In the Episode 3 above, there is also an indirect contribution of the teacher involving perceptive elements and aimed at *informing* the definition in the Deductive Warrant. All these elements can also be found in the episodes of Group D.I-A, but what makes the episodes here different is another Perceptive Data and indirect contributions from the teacher – the effects of 3D real objects – which are only evoked to illustrate complex relative position between lines in space. The same basic structure is identified in all the episodes under Task 2. We classify these episodes into Group D.I-E and the general diagram showing their common basic structure is in Fig. 5.30.

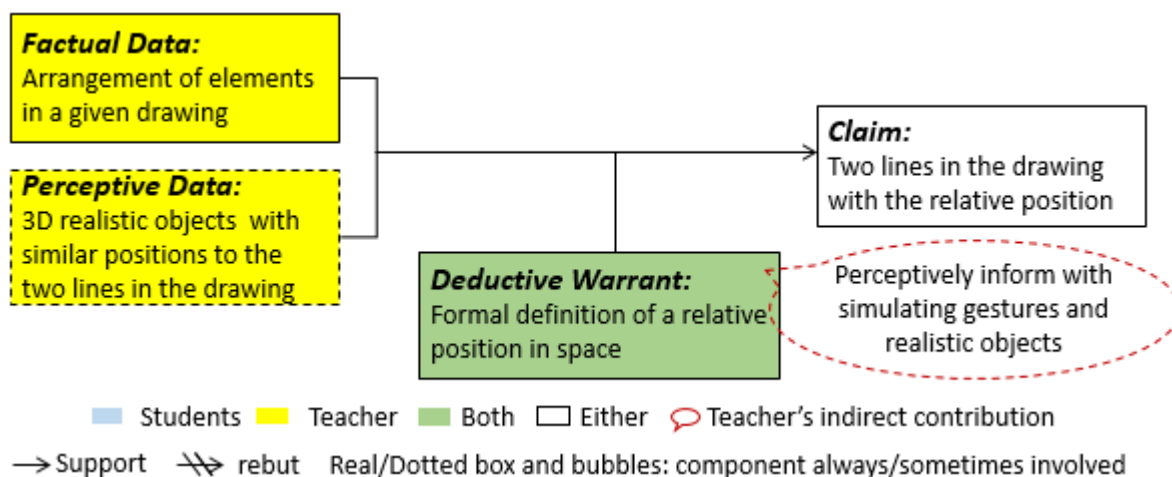


Fig. 5.30 General Diagram of argumentation for Episodes of Group D.I-E

The teacher's contributions to the general diagram of argument consist in: (1) direct contributions of the Factual Data, Deductive Warrant and Claim; (2) possible contribution of the Perceptive Data with the use of 3D real objects; (3) possible indirect contribution – the action of *informing* the Deductive Warrant with the use of gestures and real objects. These

correspond to two rules of coordination, labeled Group D.I-E afterwards: (1) guide students to perform theoretical deductive reasoning in reference to a formal geometric definition; (2) support students' perception of the theoretical deductive reasoning result or the formal definition with real objects or the real classroom.

5.1.4 Operational invariants in Lesson Series D.I

In this part, we present the operational invariants underpinning each group of rules of coordination in the lesson series. The operational invariants are obtained by analyzing all the data related to the lesson series, and all the interview words we cite in below come from the transcripts of the two general interviews (Appendices 1.2 and 1.3). The corresponding data analysis procedures have been presented in the methodology part (§4.4.1).

Operational invariants underpinning rules of coordination D.I-A: (1) directly tell students the 3D geometry theorems or facts and guide them to use the theorems and facts in theoretical deductive reasoning; (2) support students' perception of the theorems/facts with simulating gestures

The operational invariants underpinning these rules of coordination are summarized in Table 5.3, to which we refer in our analysis here.

Table 5.3 Operational invariants for rules of coordination of Group D.I-A

Category	Label and content of operational invariant
COI	[1] In general, tasks of constructing intersections in space need to be solved by theoretical deductive reasoning in reference to geometric theorems or facts.
	[2] Intersection of two planes is a line, which can be defined by two points
	[3] A point can be defined by the intersection of two lines
	[4] Intersection of a line and a plane is a point.
	[5] Any line or plane is infinite.
PCOI	[6] Use of simulating gestures can help illustrate some basic geometric properties/theorems
	[7] Appreciation of geometric theorems and facts and development of the vision in space is important in learning 3D geometry
	[8] Making students apply the geometric theorems and facts to exercises can facilitate their appropriation of the theorems and properties.
TCOI	[9] The solutions to the tasks in Interest won't be much different from the solutions to similar 3D geometry tasks in a paper-pencil environment.
TEOI	[10] If we don't tell students some geometric facts/theorems directly, they would learn little in the limited time of a lesson.

Firstly, the rules of coordination are identified from the argumentation episodes around Tasks 3 – 8 and 12. In these episodes, Dora helps students to determine the nature of the intersection of a line/ plane and a plane to be constructed in the task. In rule (1), Dora directly tells students the 3D geometry theorems/properties to be used in the theoretical deductive reasoning for solving the tasks. So she must have prior knowledge of how to solve these tasks by theoretical

deductive reasoning and the theorems/properties involved therein; this is associated with operational invariants [1] ~ [5] in Table 5.3. Operational invariant [1] reflects Dora's knowledge of solutions to mathematics tasks, and [2] ~ [5] are all about her knowledge of mathematics theorems, concepts and properties. All of them are operational invariants about mathematics content, categorized as COI.

Secondly, in rule (2), Dora takes simulating gestures as a means to support students' perception of theorems/properties in 3D geometry ([6]). From both rule (1) and rule (2), we can see Dora's emphasizing the application of geometric theorems/properties by students and the development of their vision in space ([7], [8]). This emphasis is reflected by her interview words:

"We try to do reasoning every time...it's more about appropriating the properties in space, applying them in exercises, actually... Students should really appreciate the theorems, not just learn by rote."

"I would like them to know some theorems of incidence, and meanwhile develop the vision in space."

Here, [6] and [8] reflect Dora's specific pedagogical strategy for teaching mathematics, and [7] reflects her understanding of what is important in learning mathematics. All these can be classified as the operational invariants about pedagogy of content (PCOI).

Thirdly, we note that Dora pays little attention to the task solutions specific to 3D DGEs in the two rules of coordination. All the theoretical deductive reasoning procedures she has mentioned also apply to the paper-pencil tasks with the same 3D geometry topic. For example, Task 12 requires to construct the intersection of two planes that cover two parallel lines. Referring to the theorem of "roof", Dora lets students construct the target intersection with Parallel Line tool. However, the 3D DGE returns a "wrong response" as it requires two points for naming a line. This may lead students to construct another point in the "parallel line" in the 3D DGE; but Dora just says "we've already constructed the intersection, mathematically it's right, for the software I don't know...". In the interview, she also comments that "the possibility of defining a line with a parallel line" is the function she would like to add to Interesp. From that we infer the operational invariant [9], and it shows Dora's knowledge or views about how the solutions to mathematics tasks in a digital technological environment could be different from those in the paper-pencil environment, belonging to category TCOI.

Finally, there is also a concern for time economy underpinning Dora's action of directly telling students the content of 3D geometry theorems/facts in the rules of coordination. This is confirmed by her words in the interview: "There are really many properties students haven't learned. If I don't come help them out, they would be stuck and not learn much from this lesson... If we had three hours, no problem, I would leave them completely in autonomy on the computer". We hereby infer the operational invariant [10], which falls in category TEOI.

Operational invariants for rules of coordination D.I-B: (1) request students' evaluation of and explanation for their statements; (2) rebut students' improper perception in a 3D DGE with feedback in the same 3D DGE; (3) guide students to validate a statement by theoretical deductive reasoning instead of by perception

The operational invariants underpinning the implementation of these rules of coordination are summarized in Table 5.4.

Table 5.4 Operational invariants for rules of coordination of Group D.I-B

Category	Label and content of operational invariant
COI:	<p>[1] <i>Knowledge or views about the general solution to intersection construction tasks in 3D geometry; [5] infiniteness of lines and planes;</i>⁹</p> <p>[11] For two lines in space to be secant, they should firstly be coplanar.</p> <p>[12] Only theoretical deductive reasoning can validate the intersection constructed in space while perceptive evidences cannot.</p> <p>[13] Non-coplanar lines are a situation only existing in space.</p>
PCOI	<p>[7] <i>Views about what is important in in learning 3D geometry; [8] Knowledge or views about how to promote students' appropriation of geometric theorems and facts.</i></p> <p>[14] Questioning about students' certainty and explanation, and rebutting their perceived results can make students aware of the necessity of theoretical deductive reasoning for validating a statement.</p> <p>[15] Requesting students' explanation with more and more transparent hints could facilitate the development of theoretical deductive reasoning by students.</p> <p>[16] Students usually have difficulty in distinguishing secant lines and non-coplanar lines in drawings.</p> <p>[17] The BAC examination requires students to construct sections of 3D geometric objects on the paper and justify the construction by theoretical deductive reasoning.</p> <p>[18] Students need to finally come to the paper-pencil environment to construct intersection of 3D geometric objects, for which they have to use geometric theorems and facts.</p>
TCOI	<p>[19] Right-clicking and dragging the mouse allows to turn a 3D dynamic model around in GeoGebra.</p> <p>[20] Selecting the <i>Line</i> tool and two points allows to construct a line passing through two points in GeoGebra.</p> <p>[21] Selecting the <i>Intersect</i> tool and two lines allows to construct their intersection and see whether it is possible in GeoGebra.</p> <p>[22] Indicating answers in the blanks and clicking "conform" allows to check the answer in Interesp;</p>
TPCOI	<p>[23] A teacher can rotate the 3D dynamic model in GeoGebra to show students that two non-coplanar lines that seem to intersect will in fact have no intersection.</p> <p>[24] GeoGebra allows students to rotate a 3D dynamic model themselves observing its different views.</p> <p>[25] The Automatic evaluation system in Interesp allows students to learn by themselves.</p> <p>[26] Interesp will not allow students to construct the intersection of non-coplanar lines.</p>

⁹ In all the tables of operational invariants in this thesis, the words in italics are used to express the main ideas of the operational invariants that have appeared before

PTCOI	[27] It is more efficient to let students learn the technological skills in Interesp by trial-and-error and provide individual support only when necessary.
TEOI	[28] We should let students know how to rotate figures in Interesp as soon as possible, so that they can understand the differences between 3D and 2D before going to the paper work. [29] We should not waste much time on the techniques in Interesp if we want to be efficient in one hour.

Firstly, some operational invariants about mathematics content (COI) can be inferred. As Dora guides students to validate a statement by theoretical deductive reasoning in the rule of coordination (3), she must know the theoretical deductive reasoning procedures for solving the tasks and the 3D geometry theorems/facts to be used. As mentioned previously, these rules of coordination are identified from the argumentation episodes around Tasks 3-8 in which Dora helps students to fix the particular intersection of lines that belong to the target intersection of a line/plane and a plane. Hence the 3D geometry theorems/facts necessary for solving the tasks can be identified as the underpinning operational invariants here, such as [1] and [5]. Here the theoretical deductive reasoning is specifically to determine the intersection of a pair of lines, so Dora also needs to prompt students with a theorem: *for two lines in space to be secant, they should firstly be coplanar* ([11]). In the interview, Dora comments that “*non-coplanar lines are a situation only existing in space*”. Also, in rule of coordination (3) the theoretical deductive reasoning is promoted by Dora to replace the perception process of students, implying that she thinks that only theoretical deductive reasoning can validate the intersection constructed in space whereas perceptive evidences cannot ([13]). This operational invariant is evidenced by the interview:

“I really wanted to get it into their heads that to find the intersection of two planes, find a line from one, and a line from the other, which are coplanar, because they tended to perceive it, but I wanted them to understand the fundamental rationale.”

Here, [11] and [12] reflect Dora’s mathematics knowledge, and [13] reflect her understanding of the different validity of theoretical deductive reasoning and purely perceptive reasoning. The three operational invariants and the previous [1] and [5] can all be categorized as COI.

Secondly, there are plenty of operational invariants about pedagogy of content (PCOI). The perceptive feedback that Dora evokes in 3D DGEs (e.g., rotating a 3D dynamic model to separate non-coplanar lines) in rule (2), and her promotion of theoretical deductive reasoning in rule (3) show that she always emphasizes students’ appreciation of theorems/properties and vision in 3D geometry, which echoes operational invariants [7] and [8] for rules of coordination D.I-A. In rules (2) and (3), Dora requests students’ certainty and explanation and rebutted their perception in 3D DGEs. She probably thinks that in this way students could be aware of the necessity of theoretical deductive reasoning for totally validating a statement; we therefore infer the operational invariant [14] in Table 5.4, and it reflects Dora’s knowledge and views about the specific pedagogical strategies for supporting students’ logical reasoning. Another Dora’s pedagogical strategy for supporting students’ logical reasoning is to request students’ explanation with more and more transparent hints ([15]), which is inferred from Dora’s actions related to rule (1) and her words in the interview:

“Sometimes they might already know the rationale but had trouble saying why it worked well. So that's where I could help, to reformulate, to ask them why, give more and more evident hints, repeat again and again.”

In the interview, Dora recalls students' common misconceptions when explaining why the appreciation of 3D geometry theorems/facts is important:

“It's very easy [for students] to make mistakes, especially when seeing 3D figures in the plane, if they don't know that secant lines must be coplanar.”

Dora's insisting on the development of theoretical deductive reasoning is also related to her knowledge of the examination requirements with respect to section construction tasks and her focus on students' abilities in paper-pencil environment, as evidenced by the interview:

“I once had a student who could make correct constructions every time without any explanation, he had excellent vision in space, but since he wouldn't explain, I had to take away points.”

“It's the balance between the two, there's a need to observe the rotation, but they should be able to accomplish the tasks on the paper, for which they need to use theorems.”

These words lead us to infer [17] and [18] in Table 5.4. All the operational invariants fall in the category of PCOI.

Thirdly, Dora mobilizes many kinds of 3D DGE feedback in rule (2), which requires her to have knowledge of the related technological skills, such as rotating a 3D dynamic model to separate non-coplanar lines on it ([19]), constructing “lines” and their “intersection” to see whether it is possible ([20], [21]), checking the correctness of the final answer ([22]). These operational invariants about technology and the related content belong to category TCOI.

Fourthly, the mobilization of 3D DGE feedback in rule (2) also reflects Dora's knowledge and views about the potentials of 3D DGEs for supporting students' mathematics learning and the pedagogical strategies to take profit of the 3D DGEs' potentials. As Dora comments in the interview:

“When we look at an image in GeoGebra, we may have the impression that two non-coplanar lines would intersect with each other. It's necessary to move the figure around and to see well that the intersection doesn't exist. It's the biggest advantage of GeoGebra...”

“The Interesp will give the evaluation automatically, so I don't need to go and correct them one by one. It's really interesting for the students who want to practice, they are autonomous.”

This leads us to inferring operational invariants [23] to [26], and all of them can be categorized as TPCOI – the operational invariants about technology in pedagogy of content.

Fifthly, the three rules of coordination don't involve a specific regard to students' learning of technological skills, being concentrated on the mathematics content. In the interview, Dora says that it is because the technological skills to be used are simple, and it would be more efficient “for students to make their own mistakes and for me to explain behind”. Dora puts more attention to the mathematics exploration of students. From that we infer the operational invariant [27], which concerns Dora's pedagogical strategies to teach technological skills and together with mathematics, falling into category PTCOI.

Sixthly, there are also operational invariants about time economy (TEOI). In rule (2), Dora usually rotates the 3D dynamic models herself as she thinks it was better to let students know how to rotate the models “as soon as possible”, so that “they could understand the differences between 2D and 3D” before passing to paper. Also, she chooses not to specifically introduce the 3D DGE technological skills because she “wants to be very efficient in an hour”. From these actions and interview words, we infer the operational invariants [28] and [29]. They reflect Dora’s perception of the time available in the school calendar for the lessons in the computer room and her intention to improve the didactical return of these lessons, thus being categorized as TEOI.

Operational invariants for rules of coordination D.I-C: (1) encourage students to explore perceptive evidences in a 3D DGE with the guidance of geometric theorems; (2) let students’ take their perception as a fact to develop the following theoretical deductive reasoning

The operational invariants for these rules of coordination are summarized in Table 5.5.

Table 5.5 Operational invariants for rules of coordination of Group D.I-C

Category	Label and content of operational invariant
COI	[1] Knowledge or views about the general solution to intersection construction tasks in 3D geometry; [10] Theorem about coplanarity of two lines in space. [30] To find the intersection of a line and a plane, we should find an auxiliary plane covering both the line and a line in the plane.
PCOI	[7] Views about what is important learning 3D geometry; [8] Knowledge or views about how to promote students’ appropriation of geometric theorems and facts. [31] A teacher should encourage students’ exploration which is in the right direction. [32] A teacher should affirm students’ good vision in space.
TCOI	[19] Techniques for turning around a 3D dynamic model in GeoGebra; [20] Technological for constructing a line in GeoGebra; [21] Techniques for constructing the intersection of two lines in GeoGebra
TPCOI	[33] Students’ exploration of perceptive evidences in 3D DGEs should be guided by geometric theorems. [34] In Interesp, students can easily “see” the auxiliary plane covering both a line and another line in a plane. [35] Interesp allows students to make many heuristic constructions.
PTCOI	[27] Knowledge or views about how to teach students the techniques in GeoGebra
TEOI	[36] It will save more time to let students use perceived results in theoretical deductive reasoning than let them develop theoretical deductive reasoning step by step.

Firstly, the rules of coordination are aimed at helping students to solve Tasks 9-11, which ask to construct the intersection of a line passing through the inside of the background solid and a plane residing on the background solid. So the teacher must know the solutions of the tasks, in which one critical point is to introduce the auxiliary plane covering both the line and another line in the plane to create a “coplanar condition” for two lines to intersect. This is inspired by

the theorem “for two lines in space to intersect, they should firstly be coplanar”, which is taken as a relevant operational invariant here ([10]). The perceptive evidences that Dora encourages students to explore in rule (1) are exactly about the auxiliary plane, and this allows us to infer the operational invariant [30]. Once the auxiliary plane is determined, the teacher would let students seek for the target intersection in the auxiliary plane referring to the previous theorem, that is rule (2). It shows that for Dora, the tasks like 9-11 should still be solved by theoretical deductive reasoning basically; this corresponds to the previous operational invariant [1].

Secondly, the rules of coordination are also related to operational invariants about pedagogy of content (PCOI). In rule (1), Dora encourages students to continue with the exploration once they realize that the line seems to intersect with another line in the plane; and she highly appreciates student’s vision of the auxiliary plane in 3D DGEs. In the interview, Dora expresses the idea of encouraging students’ vision and exploration: “*the students have a good vision about the plane, but they did not dare to go. It’s my role to reassure them that it’s a right direction, encourage them to proceed and make experiment*”. All these lead us to operational invariants [31] and [32], which respectively reflect Dora’s pedagogical principles for supporting students’ mathematics learning and perception. Besides, the idea of introducing an auxiliary plane is inspired by the geometric theorem, so the two rules of coordination are still underpinned by the idea of promoting students’ application and appreciation of geometric theorems, that is [7] and [8] that have been identified previously. The two operational invariants, together with [31] and [32], fall into the category PCOI.

Thirdly, Dora’s action of directing students’ exploration in 3D DGEs with the idea of geometric theorems in rule (1) suggests her pedagogical strategy of utilizing 3D DGEs to support students’ perception and logical reasoning, which is expressed as [33]. Dora’s words “*you have a good vision, it’s very good, but meanwhile you are analyzing... to get the intersection, there should be something coplanar here, then you see (AFD)*” in the argumentation episodes evidences her understanding of the interest of Interest for students’ vision and this is associated with [34]. In the interview, Dora also talks about the potentials of Interest for the general mathematics learning: “*that’s exactly how Interest can be more interesting than paper because you can do a lot of tests, erase the lines easily without pollution, and go back to the initial status...*”, from which we infer the operational invariant [35]. The three operational invariants are all about technology in pedagogy of content (TPCOI).

Fourthly, since the exploration of perceptive evidences involves rotation of the 3D dynamic model in the 3D DGE and heuristic construction of lines and their intersection, Dora still needs, when necessary, to teach students’ the related techniques in Interest (or GeoGebra) in these rules of coordination. Therefore, she should know the techniques in GeoGebra herself, that corresponds to operational invariants [19] – [21] in TCOI; her pedagogical strategy about how to teach students the techniques, which has been expressed as [27] in PTCOI, is also one underlying factor for the rules of coordination here.

Finally, there may be a concern for time economy underpinning the rule of coordination (2), since Dora lets students directly integrate some perceptive results into theoretical deductive reasoning here. Earlier in the lesson, she explains why the auxiliary plane could cover both lines at stake with step-by-step deductive reasoning. It can be inferred that she probably thinks it more time-saving to let students directly use some perceived results as facts ([36]). The

operational invariant reflects Dora’s intention to save time on certain lesson activities, belonging to category TEOI.

Operational invariants for rules of coordination D.I-D: (1) rebut students’ incorrect statement about one spatial relationship with perceptive evidences in a 3D DGE; (2) lead students to a new statement that covers multiple spatial relationships with more perceptive evidences

The operational invariants underpinning these rules of coordination are summarized in Table 5.6.

Table 5.6 Operational invariants for rules of coordination of group D.I-D

Category	Label and content of operational invariant
COI	[37] The angles, secant lines in a 3D object cannot be faithfully represented in its 2D figural representation.
	[38] The parallel lines, midpoints in a 3D object can be faithfully represented in its 2D figural representation.
PCOI	[39] The house is an ideal model for presenting typical geometric relationships in space.
	[40] Students often have difficulty in identifying the properties of 3D figures which are not faithfully represented in their 2D representations.
TCOI	[19] <i>Techniques for turning around a 3D dynamic model in GeoGebra.</i>
	[41] The 3D dynamic model of house in GeoGebra can be created by constructing its vertices with fixed 3D coordinates and then connecting these vertices with the Segment tool.
TPCOI	[42] 3D dynamic models in GeoGebra are especially appropriate for helping students connect the perceptive effects on a 3D object to those on a 2D figural representation.
	[43] A teacher can rotate the 3D dynamic model in GeoGebra to show which geometric relationships in 3D objects can be faithfully represented in 2D parallel projections, and which ones cannot.

Firstly, the rules of coordination are implemented by Dora to help students solve Task 1, which concerns contrasting the perceptive effects of spatial relationships on a 3D real object – a toy house – to those on a 2D representation—a parallel projection of a 3D dynamic model of house on the screen. So Dora should know the answer of the task a priori, such as the parallel lines, midpoints in a 3D object can be faithfully represented in its 2D representation and the secant lines, angles are not always so. From that we infer operational invariants [37] and [38], which represent Dora’s knowledge of mathematics and thus come under the category COI.

Secondly, some operational invariants about pedagogy of content (PCOI) can be inferred. In Task 1, Dora chooses the shape of “house” to let students contrast a 3D realistic object and a 2D image in 3D DGE. Dora explains the choice in the interview: “*I really like the house because we can discuss and observe all the possible relative positions, including intersecting planes in the shape of roof*” ([39]). This reflects her knowledge or views about the pedagogical strategies for presenting geometric properties. In the interview, Dora also recalls that when she was teaching in grade 10, “*the rules of representation in the plane for 3D figures were*

complicated for students, there were usually something they can see but it is not the actual case”, what is associated with the operational invariant [40]. It reflects Dora’s memories about students’ difficulties in interpreting 2D figural representations, constituting one reason for Dora’s use of 3D DGE in the rules of coordination. [40] is thus considered as another operational invariant underpinning the rules of coordination. Both [39] and [40] are categorized as PCOI.

Thirdly, the 3D DGE that Dora uses in the two rules of coordination is designed by herself, so she must have knowledge of the related technological skills and mathematics content. This allowed us to infer the operational invariant [41], and it is evidenced by Dora’s answer in the complementary questionnaire: *“I can build a 3D model in GeoGebra only by inputting the coordinates of points. I don't find it very easy because I have to do some calculations with the coordinates”*. In addition, Dora evokes the perceptive evidences of different cases in the 3D DGE by rotating the 3D dynamic model, which requires her to know the techniques of rotating a 3D dynamic model in GeoGebra. The techniques are underpinned by the operational invariant [19]. Both [41] and [19] can be categorized as the operational invariants about technology and content (TCOI).

Finally, some operational invariants about technology in pedagogy of content (TPCOI) can be inferred from the way that Dora uses the 3D DGE, including: rotate the 3D dynamic model to evoke the perceptive evidences that go against students’ statement, and reconstruct a new statement based on the perceptive evidences in different views of the 3D dynamic model. As Dora says in the interview:

“The biggest interest of GeoGebra is that we can turn the figures around; this allows students to realize that two lines seem to intersect on the screen, and after I rotate it, they can see that they will not intersect. Also they will see the right angles in some faces are no longer right angles on the screen...”

Dora also mentions the complementarity between 3D real objects and GeoGebra models:

“With GeoGebra I can show all the 3D figures on a flat screen...not all students have the same visualizing ability in space, for some students, a real “house” makes it easier to see the different properties of space, the GeoGebra will allow them to transit from space to plane”

The actions and words lead us to infer Dora’s operational invariants [42] and [43], which concern her pedagogical strategies about how to utilize a 3D DGE and what the potentials of the 3D DGE are. They are thus categorized as TPCOI.

Operational invariants for rules of coordination D.I-E: (1) guide students to perform theoretical deductive reasoning in reference to a formal geometric definition; (2) support students’ perception of the theoretical deductive reasoning result or the formal definition with real objects or the real classroom;

The operational invariants underpinning these rules of coordination are summarized in Table 5.7.

Table 5.7 Operational invariants for rules of coordination of group D.I-E

Category	Label and content of operational invariant
----------	--

COI	<p>[44] When two lines in space are coinciding/ strictly parallel/ secant/ non-coplanar, their intersection is the whole line/ empty/ a point/ empty.</p> <p>[45] When we say two lines are non-coplanar, it means there is no plane covering both lines.</p> <p>[46] Parallel lines in a drawing of 3D object are also parallel in reality.</p> <p>[47] Secant lines in a drawing of 3D object are also secant only if they are coplanar.</p>
PCOI	<p>[7] Views about <i>what is important learning 3D geometry</i>; [8] <i>knowledge or views about how to promote students' appropriation of geometric theorems and facts</i>; [39] <i>advantages of a house for presenting 3D geometry relationships</i>; [40] <i>Students often have difficulty in identifying the properties of 3D figures which are not faithfully represented in their 2D representations</i>.</p> <p>[48] Connect the drawing of house with the real classroom students are situated in could help them better understand spatial relationships in the drawing.</p> <p>[49] Sometimes 3D real objects or the classroom do better than screen images of GeoGebra models in illustrating spatial relationships.</p>

Firstly, these rules of coordination are implemented with respect to Task 2, in the aim of helping students to identify the examples of coinciding/ strictly parallel/ secant/ non-coplanar lines in a drawing of a house. Furthermore, the formal geometric definitions Dora introduces in rule (1) are especially about the four possible relative positions of lines in space. Hence Dora must know the formal definitions a priori, and know how their instances in a drawing can be like, especially how to distinguish from secant lines and non-coplanar lines in a drawing. We thus identify operational invariants [44] – [47], which reflect the teacher's knowledge of mathematics facts and rules and thus categorized as operational invariants about content (COI). Secondly, some operational invariants about pedagogy of content (PCOI) can be inferred with respect to these rules of coordination and many of them reverberate those for previous rules of coordination. For example, the formal geometric definition that Dora asks students to follow in rule (1) shows that her coordination is still underpinned by the idea of promoting students' application and appreciation of geometric theorems, that is operational invariants [7] and [8]. Also, Dora chooses a drawing of "house", because of her understanding of the advantages of a house for presenting 3D geometry relationships, which has been expressed as [39]. In rule (2), Dora refers to 3D real objects or the spatial structure of the classroom to support students' perception of the definition or conclusion about 3D geometry relationships, reflecting her knowledge of students' difficulties in identifying 3D geometry relationship in drawings ([40]) and the potentials of the real classroom and real objects for helping overcome the difficulty ([48], [49]). The [41] has been introduced previously, and the [48] and [49] are evidenced by Dora's words in the interview:

"For some students, being in a real 'house' makes it easier to see the different properties of space... Usually we see a cube from far, but when you put students inside the space, they can see the relative positions around themselves, it can help them to understand what exactly geometry in space means."

All these operational invariants reflect Dora's knowledge or views about the pedagogy of mathematics, belonging to category PCOI.

Finally, Dora also mentions the shortage of GeoGebra compared to 3D real objects:

“There are times when GeoGebra doesn't work or because of the screen projector, we can't see it well...so we might as well do it with real objects, in the real environment.”

This can explain why she prefers to use real objects and the real classroom than a 3D DGE to make the perceptive illustration in rule (2). So we infer another operational invariant [49] and place it also into the category PCOI.

5.1.5 Summary of Lesson Series D.I

In this section, we give a summary of the analysis results of this lesson series in light of the first group of research questions.

Table 5.8 lists the main content of the analysis results, including the coordination schemes of Sonia and the 3D geometry tasks-3D DGEs in the corresponding classes of situations. The coordination schemes mainly include rules of coordination and operational invariants. In consistency with the labelling of the groups of rules of coordination, we use “class D.I-A, D.I-B, ...” and “scheme D.I-A, D.I-B, ...” to label the corresponding classes of situations and coordination schemes. To save space, we only integrate the main ideas of the operational invariants and the main characteristics of tasks and 3D DGEs; for a more complete description, please refer to the corresponding sections, 5.1.4 and 5.1.2.

Table 5.8 Summary of the analysis results of Lesson Series I of Dora

Coordination schemes	3D geometry tasks-3D DGEs
	Class of situations
<p>Scheme D.I-A</p> <p>Rules of coordination:</p> <p>(1) directly tell students the 3D geometry theorems or facts and guide them to use the theorems and facts in theoretical deductive reasoning; (2) support students' perception of the theorems/facts with simulating gestures</p> <p>Operational invariants:</p> <p>COI: [1] intersection construction tasks in 3D geometry should be solved through theoretical deductive reasoning; [2] – [5] other math knowledge;</p> <p>PCOI: [6] potentials of simulating gestures for illustrating 3D geometry theorems and facts, [7] views about what is important in learning 3D geometry, [8] pedagogical strategies for promoting students' appreciation of geometric theorems and facts;</p> <p>PTCOI: [9] solutions to tasks in Interesp won't be much different from paper-pencil tasks;</p>	<p>Class of situations D.I-A</p> <p>Tasks 3 – 8 (Subtask 1), Task 12:</p> <p>3D geometry topic: construct intersection of a plane and a line/plane on a solid (to determine the nature of the target intersection and construct them directly with the existing tools if possible);</p> <p>Status in curriculum and exam: to be studied with the theoretical deductive approach in curriculum/ exam;</p> <p>Context and innate support: see 3D DGEs below</p> <p>3D DGEs:</p> <p>Figural representations and tools: restrained toolset including <i>Line</i>, <i>Move</i> and <i>Intersect</i>; a 3D dynamic model with no additional constructions;</p>

<p>TEOI: [10] directly tell students some geometric knowledge to save time;</p>	<p>Help and control: technical instructions, control in students;</p> <p>Feedback: innate feedback in GeoGebra; answer checking feedback;</p> <p>Curricular distance: a gap from the theoretical deductive approach prescribed by the curriculum</p> <hr/> <p>Support students' coordination, in a computer classroom, first contact with the tasks</p>
<p>Scheme D.I-B</p> <p>Rule of coordination:</p> <p>(1) request students' evaluation of and explanation for their statements; (2) rebut students' improper perception in a 3D DGE with feedback in the same 3D DGE; (3) guide students to validate a statement by theoretical deductive reasoning instead of by perception</p> <p>Operational invariants:</p> <p>COI: [1]; [11] "Coplanarity" condition for two lines in space being secant; [12] different validities of theoretical deductive reasoning and perceptive evidences</p> <p>PCOI: [7]; [8]; [14] – [15] knowledge or views about how to make students aware of the necessity of developing theoretical deductive reasoning and provide some support; [16] knowledge of students' difficulty; [17] knowledge of the BAC requirements with respect to tasks of section construction; [18] students should be able to construct within the paper-pencil environment the intersection of lines and planes in space</p> <p>TCOI: [19]–[22] techniques for turning around 3D dynamic models, constructing lines, constructing intersection of lines, and evoking the answer checking feedback in the 3D DGEs</p> <p>TPCOI: [24] knowledge the potentials of 3D dynamic models for students' perception; [23], [25]. [26] knowledge about how the feedback in the 3D DGEs can stimulate students' need for using theorems</p> <p>PTCOI: [27] pedagogical strategies for teaching the technological techniques in the 3D DGEs</p> <p>TEOI: [28] teachers should let students know how to rotate 3D dynamic models quickly in the 3D DGEs; [29]</p>	<p>Class of situations D.I-B</p> <p>Tasks 3 – 8 (Subtask 2):</p> <p>3D geometry topic: construct intersection of a plane and a line/planes on a solid (to construct intersection of two particular lines on the solid);</p> <p>Status in curriculum and exam: to be studied with theoretical deductive approach in curriculum/exam;</p> <p>Context and innate support: see 3D DGEs below</p> <p>3D DGEs:</p> <p>same as above, except the 3D dynamic model has been added with students' constructions of lines;</p> <hr/> <p>Support students' coordination, in a computer classroom, students mainly rely on perception to solve the tasks</p>

<p>technological skills related to the 3D DGEs in Interesp are not worth teaching specifically</p>	
<p>Scheme D.I-C</p> <p>Rule of coordination:</p> <p>(1) encourage students to explore perceptive evidences in a 3D DGE with the guidance of geometric theorems; (2) let students' take their perception as a fact to develop the following theoretical deductive reasoning</p> <p>Operational invariants:</p> <p>COI: [1]; [11]; [30] the “auxiliary plane” strategy for determining the intersection of a line and a plane</p> <p>PCOI: [31] – [32] view about teachers' role in promoting students' exploration and use of perception</p> <p>TPCOI: [33] knowledge or views about how students' exploration in 3D DGEs should be guided; [34] potentials of 3D dynamic models for supporting students' perception of planes; [35] potentials of the 3D DGEs for students' heuristic constructions</p> <p>TCOI: [19]-[21]: techniques for turning around 3D dynamic models, constructing lines, and constructing intersection of lines in the 3D DGEs</p> <p>PTCOI: [27]</p> <p>TEOI: [36] it will save time to let students use perceived results in theoretical deductive reasoning instead of developing theoretical deductive reasoning step by step.</p>	<p>Class of situations D.I-C</p> <p>Tasks 9-11:</p> <p>3D geometry topic: construct intersection of a line and a plane respectively on and inside a solid;</p> <p>Status in curriculum and exam: to be studied with theoretical deductive approach in curriculum/ exam.</p> <p>Context and innate support: see 3D DGEs below</p> <p>3D DGEs: same as the first group</p> <p>Support students' coordination, in a computer classroom, first contact with the tasks</p>
<p>Class of situations D.I-D</p> <p>Rule of coordination:</p> <p>(1) rebut students' incorrect statement about one spatial relationship with perceptive evidences in a 3D DGE; (2) lead students to a new statement that covers multiple spatial relationships with more perceptive evidences</p> <p>Operational invariants:</p> <p>COI: [37] – [38] knowledge about what spatial relationships can be faithfully represented in 2D figural representations and what cannot</p>	<p>Class of situations D.I-D</p> <p>Task 1 (3 subtasks):</p> <p>3D geometry topic: identify spatial relationships faithfully represented by 2D figural representations;</p> <p>Status in curriculum and exam: no specific prescriptions in curriculum and exam;</p> <p>Context and innate support: in a 3D DGE integrated real context;</p> <p>3D DGEs:</p>

<p>PCOI: [39] views about how to choose the shapes appropriate for introducing spatial relationships; [40] knowledge about students' difficulty in identifying spatial relationships in 2D representations</p> <p>TCOI: [19]; [41] techniques for constructing a 3D dynamic model with fixed points in GeoGebra</p> <p>TPCOI: [42] potentials 3D dynamic models for helping students connect spatial relationships in 3D objects with those in 2D figural representations; [43] knowledge or view about how to exploit the potentials</p>	<p>Figural representations and tools: a 3D dynamic model of house; GeoGebra tools;</p> <p>Feedback: innate feedback in GeoGebra</p> <p>Help and control: no specific help, control in teacher</p> <p>Curricular distance: close to the curriculum prescriptions</p> <hr/> <p>Support students' coordination, in an ordinary classroom with one computer, first contact with the tasks</p>
<p>Scheme D.I-E</p> <p>Rule of coordination:</p> <p>(1) guide students to perform theoretical deductive reasoning in reference to a formal geometric definition; (2) support students' perception of the theoretical deductive reasoning result or the formal definition with real objects or the real classroom</p> <p>Operational invariants:</p> <p>COI: [44] – [47]: definitions of relative positions between lines in space and their reflection in drawings</p> <p>PCOI: [39]; [40]; [48]–[49] potentials of the real classroom, and advantages of 3D real objects over screen projections in illustrating spatial relationships</p>	<p>Class of situations D.I-E</p> <p>Tasks 2 (3 subtasks):</p> <p>3D geometry topic: identify relative positions of lines in a drawing of house;</p> <p>Status in curriculum and exam: to be studied with theoretical deductive approach in curriculum and exam;</p> <p>Context and innate support: in a paper-pencil environment;</p> <p>No 3D DGEs</p> <hr/> <p>Support students' coordination, in an ordinary classroom with one computer, first contact with the tasks</p>

Research question 1.1 of this thesis concerns how can the rules of coordination be linked with the different categories of operational invariants in the corresponding schemes. To answer this question, we firstly identify the commonalities and differences between the different groups of rules of coordination in Table 5.8, and then link the commonalities and differences with the operational invariants in the corresponding schemes.

Contrasting the 5 groups of rules of coordination, we see that interaction mode between the logical reasoning and the perception of students under Dora's intervention differs between groups, with Dora's main emphasis being laid either theoretical deductive reasoning or the perception of students. In rules of coordination of D.I-D, Dora emphasizes students' use of perception; she fosters their perception with a 3D DGE, rebutting their statement that only applies to one case and leading them to a new one that can apply to multiple cases. In the other four groups, she emphasizes the development of theoretical deductive reasoning of students and places the perception at an auxiliary status. While being placed at an auxiliary status, students' perception interacts with their logical reasoning activities in different modes in the four groups. In D.I-C, Dora encourages students to apply the result perceived in a 3D DGE directly as a fact in the theoretical deductive reasoning. In D.I-B, students' perception naturally

supported by a 3D DGE makes them unaware of the necessity of theoretical deductive reasoning; then Dora rebuts the incorrect results perceived by students and insists that they develop theoretical deductive reasoning. In the other two groups, A and E, Dora supports students' perception to illustrate some geometric theorems or facts so that students can use them in theoretical deductive reasoning later on.

We also see differences and commonalities between groups in the particular strategies that Dora adopts to support students' perception or logical reasoning. The strategies are actually about Dora's supportive actions, questions, and her use of resources. Dora supports students' perception with respect to geometric theorems or facts in both D.I-A and D.I-E, but she uses simulating gestures in D.I-A and uses the real classroom and 3D real objects in D.I-E. In D.I-B, Dora either rebuts students' perception with the feedback in the 3D DGE, or constantly requests students' evaluation and explanation for their perception result, forcing them to develop theoretical deductive reasoning. In D.I-C, Dora directs students' exploration of perceptive evidences in the 3D DGE with ideas of a geometric theorem and encourages their use of the evidences in theoretical deductive reasoning. In D.I-D, Dora rebuts students' statement only with the perceptive evidences (from different viewpoints) in the 3D DGE, supporting their perception of spatial relationships.

Next we compare the operational invariants in different schemes, in relation with commonalities and differences between the rules of coordination.

Firstly, all the five groups of rules of coordination are underpinned by some operational invariants about content (COI). The COI are concerned with Dora's knowledge and views about solutions to the corresponding tasks, and are linked with Dora's emphasis on students' theoretical deductive reasoning in all the rules of coordination except D.I-D. For example, the tasks corresponding to D.I-A, B, and C are all about constructing intersection of lines and planes in the background of a solid. Then in the COI, we can find [1]– “in general, tasks of constructing intersections in space need to be solved by theoretical deductive reasoning in reference to geometric theorems or facts”– for all the three groups, and [12]- “only theoretical deductive reasoning can validate the intersection constructed in space while perceptive evidences cannot” for both D.I-B and C. The tasks corresponding to D.I-E are about identifying spatial relationships between lines in a drawing of a solid; in the corresponding COI, we can find [44] – [45] concerning the formal definitions of relative positions between lines in space. These operational invariants show that it is necessary for Dora to promote students' theoretical deductive reasoning in reference to geometric theorems, facts and definitions in rules of coordination of the four groups, so as to help students solve the corresponding tasks.

Secondly, all the groups of rules of coordination are underpinned by operational invariants about pedagogy of content (PCOI). For the rules of coordination involving the teacher's use of 3D DGE, some operational invariants about technology in pedagogy of content (TPCOI) are also identified as underpinning factors. The PCOI and TPCOI are varied according to the respective emphasis that Dora lays on students' theoretical deductive reasoning or perception in different groups of rules of coordination. To be specific, among the PCOI for D.I-A, B, C and E, we find the common operational invariants [7]- “appreciation of theorems and facts is important in learning 3D geometry”, and [8]- “making students apply the geometric theorems and facts to exercises can facilitate their appropriation of the theorems and facts”, but in the

PCOI for D.I-D there are no such things. Instead, we can find [43] – concerning potentials of 3D dynamic models for helping students connect spatial relationships in 3D objects with those in 2D figural representations – in the TPCOI for D.I-D. This shows students’ perception with 3D dynamic models are especially helpful in solving the tasks corresponding to D.I-D. The different operational invariants are consistent with the different emphasis that Dora lays to students’ theoretical deductive reasoning or perception in the five groups of rules of coordination. In addition, there are some unique PCOI for D.I-B being related to Dora’s emphasis on theoretical deductive reasoning in that group of rules, that is [17] concerning Dora’s knowledge of the BAC examination requirements on the tasks of section construction, and [18] concerning Dora’s emphasis on students’ abilities of constructing the intersections in space within the paper-pencil environment ([18]).

The PCOI and TPCOI are also linked with the strategies that Dora adopts in the corresponding rules of coordination to support students’ logical reasoning or perception. For example, the different resources that Dora uses to support students’ perception in D.I- A and E are consistent with the respective PCOI for the two groups – [6] and [48]-[49]. The [6] concerns the potentials of simulating gestures for illustrating 3D geometry theorems or facts, whereas the [48]-[49] concern the advantages of 3D real objects (including the real classroom) over 3D dynamic models in illustrating 3D geometry definitions. Dora’s strategies of requesting evaluation and explanation in D.I- B are specifically underpinned by the PCOI about how to make students aware of the necessity of developing theoretical deductive reasoning and provide some support ([14], [15]). Again in D.I- B, Dora’s action of rebutting with the 3D DGE feedback are specifically related to PCOI [16] and TPCOI [23]-[24], which reflect her understanding of students’ difficulty in distinguishing secant and non-coplanar lines and how 3D DGEs could help. In D.I- C, Dora’s action of directing with geometric theorems is underlined by her TPCOI [33], the knowledge or view about how students’ exploration in 3D DGEs should be guided. Finally, we can find two common PCOI – [39] and [40] – for D.I- D and E. [39] is about how to choose the appropriate shapes for introducing spatial relationships; [40] is about students’ difficulty in identifying spatial relationships in 2D representations; they allow to understand why Dora uses the model of house in the two groups of rules. However, Dora uses a 3D dynamic model of house to illustrate spatial relationships in D.I- D, and uses a 3D real model of house and a real house – the classroom in D.I- E; this is consistent with the TPCOI [42]-[43] for D.I-D and PCOI [48]-[49] for D.I-E, which respectively concern the pedagogical potentials of 3D dynamic models and 3D real objects (including the real classroom).

Thirdly, the rules of coordination in which Dora needs to guide students to use 3D DGEs, that is D.I- B and D.I-C, are underpinned by some operational invariants about pedagogy for linking technology and content (PTCOI). Actually, the PTCOI underpinning the two groups of rules are the same one: [27]- “it’s more efficient to let students learn the technological skills in Interest by trial-and-error and provide individual support only when necessary”. With this idea, Dora focuses on the mathematical aspect and pays little attention to the technological aspect of students’ activities in both groups of rules of coordination.

Fourthly, when Dora needs to use 3D DGEs or guides students to use 3D DGEs in a group of rules of coordination, such as in D.I-B, C and D, the rules are underpinned by operational invariants about technology and the related content (TCOI). The TCOI are about the

technological techniques and mathematics knowledge necessary for the general 3D DGE use without a pedagogical intention, and they are linked with the operations Dora needs to perform or guides students to perform in the 3D DGEs in the corresponding rules of coordination. To be specific, in rules of coordination D.I-B and D.I-C, Dora turns around the 3D dynamic models and constructs lines and their intersection in the 3D DGEs, or she encourages students' operations and give technical support when necessary. Then in the TCOI for D.I-B and C, we can find the common elements [19]-[21] concerning the techniques for turning around 3D dynamic models, constructing lines and their intersections; they support Dora's actions in the corresponding rules of coordination. The TCOI for D.I-B also contains [22] – the techniques for evoking the answer checking result in the 3D DGE; it is specially linked with Dora's operation of evoking 3D DGE feedback in the D.I- B. The TCOI for D.I-D also include [19], as Dora also displays different views of a 3D dynamic model in the corresponding rules of coordination; besides, the 3D DGE used here is designed by herself, which requires her to know the techniques for constructing a 3D dynamic model, that is the content of the TCOI [41] specifically for D.I-D.

Finally, there are operational invariants about time economy (TEOI) underlying the rules of coordination in the real computer classroom – that is D.I-A, B and C. The operational invariants concern the teacher's ideas about how to be more efficient within the limited lesson time in a computer classroom, and they are linked with certain actions in the rules of coordination (especially the encouragement to students' use of perception in theoretical deductive reasoning) that Dora would probably not perform in an ordinary classroom. For example, the TEOI [10] for D.I-A is about the strategy of directly telling students geometric theorems or facts to let them learn more in the lesson in the computer room; whereas in a lesson in the ordinary classroom, Dora would take more time to introduce the theorems or facts. TEOI [36] for D.I-C concerns the strategy of letting students use perceived results in the 3D DGEs as a fact in theoretical deductive reasoning, whereas in a lesson in the ordinary room, Dora would guide students to develop theoretical deductive reasoning step by step in the paper-pencil environment.

Research question 1.2 of this thesis concerns how the coordination schemes can be influenced by the characteristics of 3D geometry tasks-3D DGEs. To answer this question, we identify the links between the groups of rules of coordination and the characteristics of the corresponding 3D geometry tasks-3D DGEs, and then refer to operational invariants as evidences for the links identified.

Firstly, the respective importance that Dora attaches to students' logical reasoning and perception (or the interaction mode of the two activities) in the rules of coordination is influenced by the 3D geometry topics of the tasks, their status in French curriculum and the BAC examination, and the features of figural representations in the 3D DGEs.

To be specific, Dora emphasizes students' theoretical deductive reasoning in rules of coordination of D.I-A, B, C and E and emphasizes students' perception in rules of coordination of D.I-D. The tasks corresponding to D.I-A, B, C and E are either about constructing the intersection of lines and planes or about identifying spatial relationships between lines and planes. To solve these tasks, Dora thinks students should refer to Euclidian geometric theorems or facts to derive the answers, as reflected in operational invariants [1]. The tasks corresponding to D.I- D are about contrasting the perceptive effects of spatial relationships in a 3D real object

and a 2D figural representation, for which the 3D dynamic models in the 3D DGEs are especially helpful, as reflected in operational invariant [42]. These operational invariants allow us to confirm the link between Dora's emphasis in the rules of coordination with 3D geometry topics of tasks and figural representations in the 3D DGEs. Dora's emphasis on students' theoretical deduction in rules of coordination of D.I-B can also be attributed to the status of the corresponding tasks in the curriculum and the BAC examination. The tasks are about constructing intersection of two lines in a 3D DGE, which can be solved merely by perception and trial-and-error, but Dora insists that students develop theoretical deductive reasoning and use the theorem about the "coplanarity" condition for two lines in space being secant. In the interview, Dora explains that she insists on this because the BAC examination also requires students to justify, as reflected in operational invariant [17].

Secondly, Dora's strategies to support students' logical reasoning or perception in the rules of coordination are influenced by the characteristics of 3D DGEs in terms of figural representations and tools, help, and feedback, and also the innate support in the corresponding tasks.

To be specific, for rules of coordination of D.I-E, there are no 3D DGEs being used. The corresponding tasks only provide a drawing of house as the innate support, asking students to identifying spatial relationships between lines in the drawing. The drawing can provide little perceptive support and may cause students to confuse intersecting lines with non-coplanar lines in the solid represented by the drawing. This limitation is well understood by Dora, as reflected in the operational invariant [40]. Dora also mentions the advantages of 3D real objects over the screen projections of 3D dynamic models in illustrating spatial relationships, as expressed in [49]. The operational invariants show that Dora's action of referring to the real classroom and the 3D real objects in D.I- E is intentional to make up for the limited perceptive support from the drawing and 3D dynamic models in 3D DGEs. We hereby establish a link between Dora's strategies to support students' perception in D.I- E with the limited perceptive support from the innate support in the tasks and the 3D dynamic models in the 3D DGEs.

Regarding rules of coordination of D.I-A and of D.I-B, the corresponding 3D DGEs are those in *Intersep* (already introduced in section 5.1.1) corresponding to tasks 3 – 8 and 12. The tasks ask students to construct the intersections of a plane and a line/plane on a solid. The restrained toolset in the 3D DGEs (only the GeoGebra tools *Line*, *Intersect* and *Dragging*) do not allow students to directly observe or construct the target intersection. So Dora guides students to solve tasks 3 – 8 in two steps, which correspond to the rules of coordination of D.I-A and of D.I-B.

With respect to rules of coordination D.I-A that corresponds to the first step of tasks 3 – 8, Dora tries to let students understand that the target intersection of a plane and a line/plane can be transformed into the intersection of lines, and she needs to get to the conclusion in reference to some geometric theorems or facts, such as "two planes intersect at a line" and "a line can be defined by two points". However, students are not yet familiar with the geometric theorems or facts, neither do the 3D DGEs provide related help. It is similar to the 3D DGE for task 12, which does not mention the geometric theorem about parallelism that would enable students to directly determine the target intersection between the two planes covering two parallel lines. In rules of coordination of D.I-A, Dora's simulating gestures are intended to make up for the

limitation of the perceptive support from the 3D dynamic models and the little mathematics help in the 3D DGEs, to support students' perception of the geometric theorems or facts. We thus identify a link between Dora's strategies to support students' perception in D.I- A and the limited perceptive support from the 3D dynamic models and the lack of mathematical help in the corresponding 3D DGEs.

With respect to rules of coordination D.I-B that correspond to the second step of tasks 3 – 8, Dora guides students to determine the particular pairs of lines whose intersections will allow to determine the target intersection. This is where students tend to over-rely on their perception as they can directly see the intersection of lines in the 3D DGEs. So Dora tries to move students from the perception to theoretical deductive reasoning in rules of coordination of D.I-B, by dragging the 3D dynamic models, separating non-coplanar lines, or letting students evoke other feedback such as answer checking results and the pop-up messages indicating the impossibility of the construction. We hereby identify a link between the interaction mode of students' perception and logical reasoning under Dora's coordination of D.I-B and the perceptive support provided by the 3D dynamic models, and the feedback available in the 3D DGEs. The link is supported by Dora's operational invariants about how to rebut students' perception results and make them aware of the necessity of theoretical deductive reasoning ([14]), as well as the operational invariants about the didactical potentials of Interesp ([23] – [26]).

Regarding rules of coordination of D.I-C, Dora lets students directly take the perception in the 3D DGEs as a fact to develop the following theoretical deductive reasoning. This is partly because the corresponding tasks require the intersection of a line and a plane with the line passing through the inside of the background solid. Students need to find an auxiliary plane covering both the line at stake and another line in the plane at stake; it is difficult for students but the corresponding 3D DGEs allow them to make heuristic constructions and "perceive" the auxiliary plane. To save time, Dora encourages students to directly develop the following theoretical deductive reasoning based on the auxiliary plane they perceived in the 3D DGEs. This idea is evidenced in the operational invariants [30]- "To find the intersection of a line and a plane, we should find an auxiliary plane covering both the line and a line in the plane", [34]- "In Interesp, students can easily 'see' the auxiliary plane covering both a line and another line in a plane" and [36]- "It will save time to let students use perceived results in theoretical deductive reasoning rather than letting them develop theoretical deductive reasoning step by step". We hereby establish a link between the interaction mode of students' perception and logical reasoning in D.I- C with the strength of the 3D dynamic models in perceptive support, the construction tools in the 3D DGEs, and Dora's own knowledge and views about time economy.

Regarding rules of coordination of D.I-D, Dora uses the 3D DGE to support students' perception helping them understand which geometric relationships in 3D reality can be faithfully represented in a 2D figural representation and which cannot. In the interview, Dora explains that 3D dynamic models in the 3D DGE are especially appropriate for helping students connect the perceptive effects on a 3D object to those on a 2D figural representation, which corresponds to the operational invariant [43]. With this evidence, we can establish a link between Dora's strategies to support students' perception in D.I- D and the strength of the 3D dynamic models in perceptive support.



5.2 Case of Sonia: French teacher in real classroom

This section presents the analysis results with respect to the real classroom lesson series of a French teacher, Sonia (see section 4.2 for more information about the teacher). Throughout the Ph. D. period, we have been able to follow one real classroom lesson series of Dora, noted as Lesson Series S.I. It contains one lesson integrated with 3D DGEs.

Fig. 5.31 presents the timeline of our follow-up of Lesson Series S.I and the data collected.

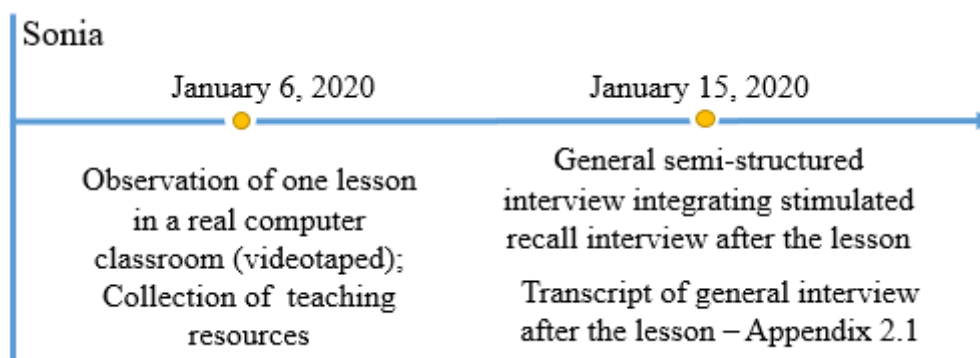


Fig. 5.31 Timeline of the follow-up of Lesson Series S.I

5.2.1 Context of Lesson Series S.I

This section introduces the context of the lesson series. The information is obtained from the video data and interview data related to the lesson (Appendix 2.1). The main points of the context information to be introduced have been mentioned in the methodology part (§ 4.4.1).

The only lesson in this lesson series took place on January 6, 2020. At that time the students just entered the second trimester of grade 12 – the final year of French upper secondary education before the university. The lesson was also the first lesson on 3D geometry during grade 12. Like Dora, Sonia also planned to teach pure Euclidean 3D geometry for about two weeks in January, so that students could have known some basic 3D geometry notions when she returned to 3D geometry with a vector approach in April.

The teaching setting for the lesson was a real computer classroom in which not only the teacher but also individual students had access to a computer. Fig. 5.32 shows the layout of the teaching setting of Sonia's lesson, which was similar to the setting of Dora's second lesson. The numbers in Fig. 5.32 indicate different individual students, and they sat in front of the computers all over the lesson.

The 3D geometry subject matter of this lesson was the intersection of a line/plane and a plane in space. The teacher's didactical objectives were to elicit what students already know (or what they have learned in grade 10) about 3D geometry, to motivate students to explore and construct the intersections in 3D DGEs, and to expose them to some figural representations close to 3D physical objects. The 3D DGEs used here were the same as those used in the second lesson of Dora – both coming from the website of Interesp¹⁰. However, students' vision in 3D DGEs was not so much highlighted by Sonia as by Dora: for Sonia, the potentials of the 3D DGEs mainly

¹⁰ http://lycee-valin.fr/maths/exercices_en_ligne/espace.html

concern the convenience of making constructions and the punctual feedback in the 3D DGEs that allow getting correct answers by trial-and-error, but students should also know how to justify the constructions and this is, for Sonia, what the 3D DGEs cannot help with.

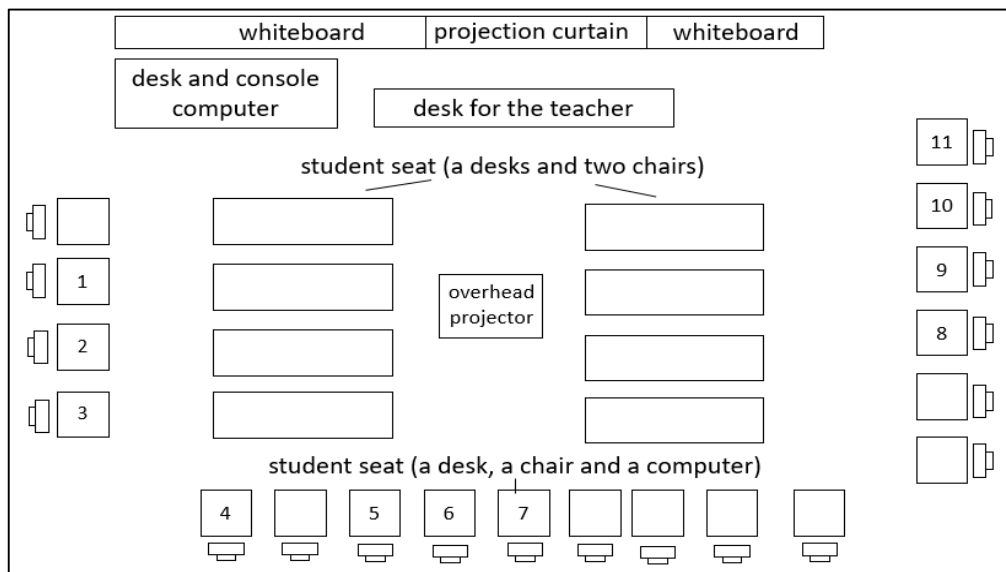


Fig. 5.32 Layout of the teaching setting of Sonia’s first lesson

Regarding students’ prior knowledge, from their performances in the lesson, we know that they had some basic knowledge of 3D geometry, such as “a line and a plane can intersect at a point” and “two lines in space can be secant, parallel, or non-coplanar”, but they could not systematically list all the possible intersections between lines and planes in space. The students had no experiences of manipulating in 3D DGEs before the lesson.

Regarding the lesson activities, the following activities have been identified.

- Activity 1: Demonstrate basic manipulations in the 3D DGEs;
- Activity 2: Let students solve the intersection tasks in the 3D DGEs autonomously and provide individualized support;
- Activity 3: Summarize all the possible intersections between two lines, a line and a plane, and two planes.

Now we elaborate on the content of the lesson activities. Sonia firstly demonstrated some manipulations students can do in the 3D DGEs in Interesp, like constructing lines and their intersections or dragging the 3D dynamic model around to show its different views (Activity 1, also see Fig. 5.33); at this time the students were all at the computer equipped seats but all facing toward the projection curtain. Secondly, Sonia let students solve the tasks in Interesp autonomously without teaching any new content in 3D geometry; she also allowed for the cooperation between two neighboring students, with herself circulating around and providing individual support when necessary (Activity 2, see also Fig. 5.34). Finally, together with the students, Sonia made an inventory of all the possible intersections between two lines, a line and a plane, and two planes in space (Activity 3, see also Fig. 5.35).

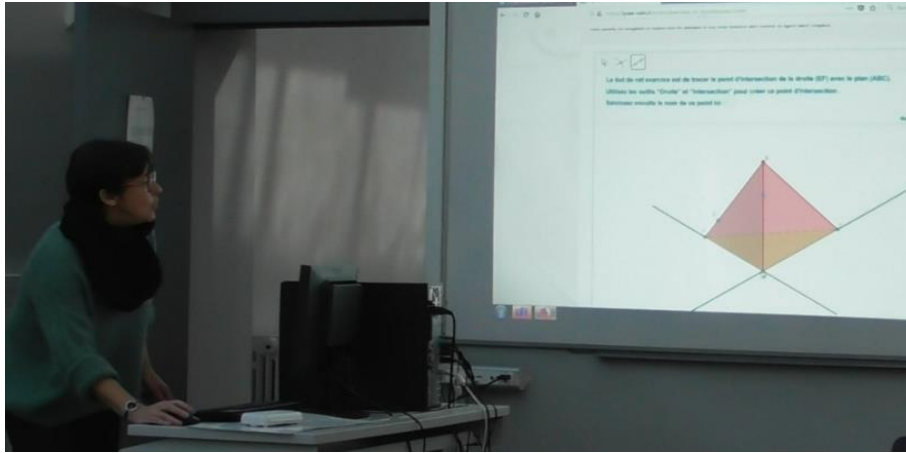


Fig. 5.33 Sonia demonstrates some basic manipulations in the 3D DGEs in Interestp

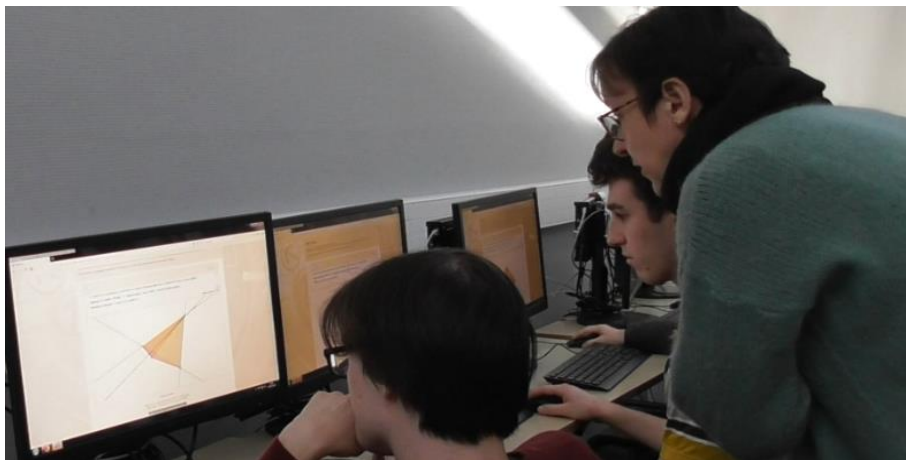


Fig. 5.34 Sonia provides individualized support for two students

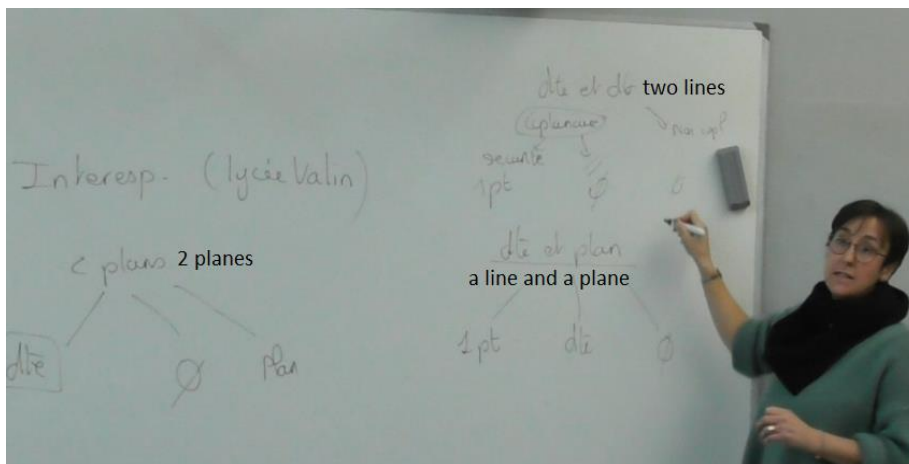


Fig. 5.35 Sonia writes all the possible intersections between two lines, a line and a plane, and two planes on the white board

5.2.2 Characteristics of 3D geometry tasks-3D DGEs in Lesson Series S.I

All the 3D geometry tasks and 3D DGEs used in Lesson Series S.I come from Interestp. Here we focus on the first 7 exercises in Interestp (see Fig. 5.13), the only 7 exercises that the students

dealt with in this lesson. In Sonia’s case, the 7 exercises are relabeled as Tasks 1 ~ 7, they corresponding to Tasks 3 ~ 9 in Dora’s case; we do not elaborate the characteristics of the tasks and the 3D DGEs anymore as all have been described in Dora’s cases (see section 5.1.2).

5.2.3 Rules of coordination in Lesson Series S.I

This part presents three groups of rules of coordination identified from the Sonia’s Lesson Series I, which are thus labeled Groups S.I-A to S.I-C. The data analyzed here are the transcripts of argumentation episodes, which are sorted out from the transcripts of the lesson videos. The analysis procedures that lead to these rules of coordination have been introduced in the methodology part (§ 4.4.1).

Rules of coordination S.I-A: (1) request multiple students’ ideas about a geometric statement; (2) guide students to explain the statement by theoretical deductive reasoning instead of by perception in a 3D DGE.

The first example episode related to the rules of coordination is the Episode 1 in the collective argumentation between Sonia and two students S3 and S4 (see the classroom layout in Fig. 5.32) around Task 1, which is presented below.

Task 1 (with the 3D DGE)

The objective of this exercise is to construct the point of intersection of (ABC) and (EF). Use the tools “Line” and “Intersect” to create this point of intersection. Then fill in the name of the point here

Task 1 concerns the intersection of a line (EF) and a plane (ABC). The whole argumentation started when Sonia launched a discussion with S4 when seeing that he has constructed many lines on the screen. Later Sonia engaged S3 into the discussion and helped students determine that the intersection of (EF) and (ABC) falls at the intersection of (EF) and (AB) (first argumentation node). Then Sonia discussed the nature of the intersection of a plane and a line with the two students and reached a conclusion that the intersection is not always a point but can also be an entire line or an empty set; this was the end of the whole argumentation.

The argumentation process between the beginning and the first argumentation node is identified as Episode 1, and the remainder is Episode 2. The argumentation node is inserted because it marks the completion of the task while the argumentation after this node concerns a general

discussion not so pertinent to this task. The episode at stake here is Episode 1 and the following is its transcript integrated with codes of argumentation components.

Episode 1-S3 S4-Task 1

T: So you drew a lot of straight lines, for what purpose, why (Fig. (1))?

S4: For a better perspective (*rotating the GeoGebra model in Fig. (1)*)

T: Stop moving, get back here they are in the same plane, put yourself in a configuration.

T: What will the intersection be like for you?

S4: It's about this point (Fig. 2) [**1-Claim**] ...I would say that it enters this line (pointing at line AC), for me this line (line EF) is just above the plane (ABC) that I am making, it will fall somewhere in AC. About this line (AB), I imagine that I extend it... (Fig. 3) [**2-Perceptive-Data**].

T: But E and F, where are they?

S4: E, F, they are right here.

T: Where is it, right here, how can you interpret it mathematically in relation to the tetrahedron?

S4: It passes through two edges; it might be...wait...

T: Pass through two edges, we have more than that, where are they too? E is on which edge, look at the task statement.

S4: Edge [AD] [**part of 3-Factual-Data**]

T: F is on which edge?

S4: [BD] [**part of 3-Factual-Data**]

T: So line (EF) is in the plane? (ABD) [**4-Claim/Factual-Data**]. Is that important here?

S4: Yes

T: Why is it important?

S4: Because it helps to see...

T: (turns to S4) Can you help him Thomas? Have you made any progress or not?

S3: No... (Fig. 4)

T: What is the point you placed there?

S3: For me, it would be...because F is on the plane...

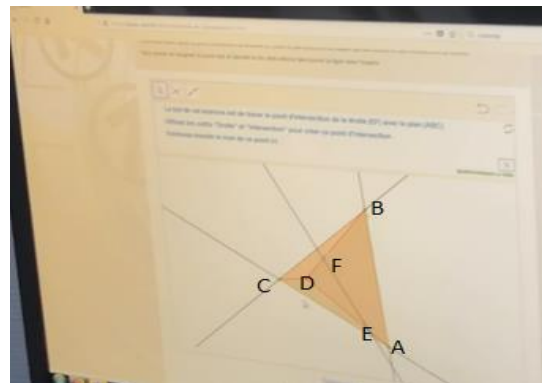


Fig. 1 Screen of S4

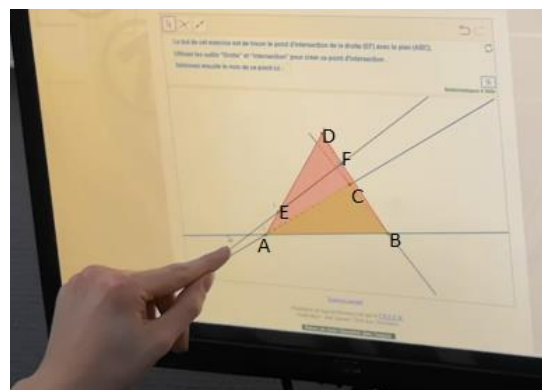


Fig. 2 S4 Points at where (EF) and (AC) seem to intersect

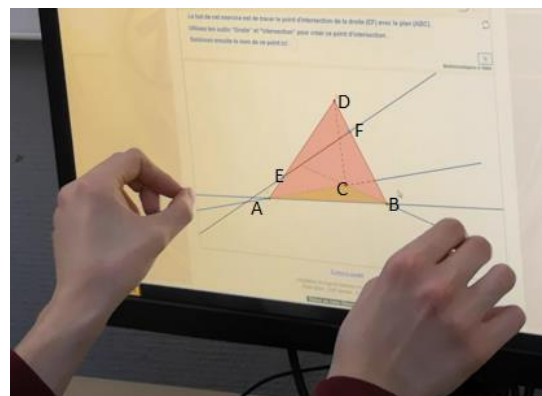


Fig. 3 S4's gestures showing how segment [AB] can be extended

T: E, F are in the plane (ABD) [**echoing 4-Claim/ Factual-Data**], we've already said, and we look for the intersection of the line (EF) and (ABC)

S3: So, just here (pointing at H on the screen, as shown in Fig. 4)

T: How have you made it

S3: By intersecting (EF) and (AB) [**5-Claim**]

T: Can you justify to me that the target intersection is exactly the point you show me? Why the line (EF) and (AB), they can intersect [**6-Claim**]?

S3: Because they are both in plane (ABD) [**echoing 4-Claim/ Factual-Data**]

T: Perfect, then why is it the intersection of line (EF) and plane (ABC)?

S3: Because it belongs to (EF) [**part of 7-Factual-Data**].

T: It belongs to the line (EF), OK.

S3: And it belongs to (ABC) [**part of 7-Factual-Data**]?

T: Perfect. So it is the intersection of (EF) and (ABC) [**echoing 5-Claim**]. Here as stated in the task, type in the name of the point, okay? Just the point you created here, you can make it and then go to the next question.

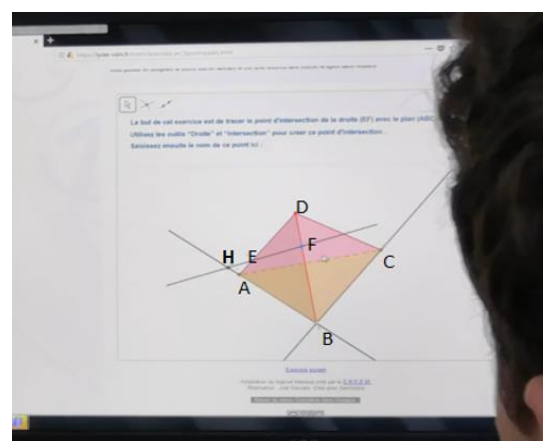


Fig. 4 Screen of S3

We firstly discuss the argumentation components directly contributed by the participants in this episode. At the beginning, S4 proposes the 1-Claim with some explanation and the gestures in Fig.2-3. From the gestures and explanation, we know that he has an impression that (EF) will pass over line (AB) and finally intersect with (AC); this impression is probably caused by the perceptive effects in the 3D DGE so we consider them as 2-Perceptive-Data, which allows S4 to draw 1-Claim. Sonia does not clearly accept or reject S4's explanation, but requests him to determine on which plane the (EF) lies. With S4's contribution of 3-Factual-Data, Sonia directly tells that (EF) belongs to plane (ABD) (4-Claim/Factual-Data). Then the discussion reaches an impasse, and Sonia turns to ask for S3's idea. After S3 gives 5-Claim – $(EF) \cap (AB)$ is the target intersection $(ABC) \cap (EF)$, Sonia further asks for his explanation, and why (EF) and (AB) could intersect (6-Claim) in particular. Here, S3's first explanation "they are both in plane (ABD)" echoes the 4-Claim/Factual-Data proposed by the teacher and is probably referring to an implicit Deductive Warrant: for two lines to intersect, they must be coplanar. S3 then indicates that $(AB) \cap (EF)$ belongs to both (EF) and (ABC), to explain why $(AB) \cap (EF)$ is meanwhile the $(ABC) \cap (EF)$; here he probably refers to the rules of intersection of sets of points (an implicit Deductive Warrant). We identify S3's second explanation as 8-Factual-Data and it can support the truth of 5-Claim together with 6-Claim, which then become a Factual-Data. In this way, Sonia and the students establish a coherent chain of inference from 3-Factual-

Data to 5-Claim, which is all underpinned by implicit deductive warrants, as shown in Fig. 5.36.

Secondly, we consider Sonia's indirect contributions to the argumentation. The questions she poses include those *requesting an idea/a method/a simple answer* (to elicit students' contributions of 1-Claim, 3-Factual-Data and 5-Claim), and the "why" questions *requesting elaboration* (to elicited S3's contributions of 4-Claim/Factual-Data and 7-Factual-Data). Other supportive actions only include *confirming* S3's contributions.

The argumentation components and the indirect contributions are organized together in the diagram in Fig. 5.36. Sonia's direct contributions (yellow and green boxes) and indirect contributions (talk bubbles) together constitute her coordination behavior in this episode.

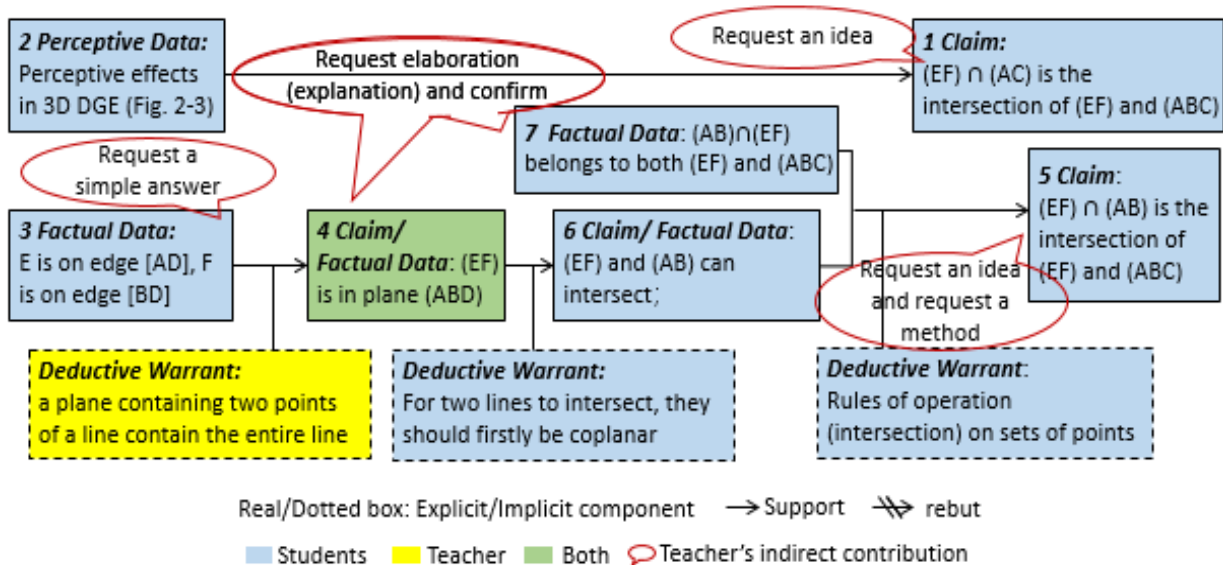


Fig. 5.36 Diagram of argumentation for Episode 1-T, S3 S4-Task 1

The second example episode comes from the collective argumentation between the teacher and two students (S7 and S8 in the classroom layout in Fig. 5.32) around Task 7, as shown below.

Task 1 (translated from French to English by the researcher)

The objective of this exercise is to draw the intersection point of the line (EF) and the plane (ABC). Use the tools "Line" and "Intersect" to create the point of intersection. Then fill the name of the points here

The whole argumentation episode started when Sonia let S6 introduce the constructions he planned to do in the 3D DGE. As what S6 said, he would like to construct the intersection of (DF) and (BC), which is G, and to construct lines (AG) and (EF) letting them intersect at J, with J being the intersection of (ABC) and (EF) demanded by the task. Sonia further requested S6's justification for the constructions and S7 joined their discussion a bit later. In this process, Sonia firstly helped students to understand that it is because (EF) and (AG) both belong to plane (DEF) that they could intersect (first argumentation node); then she let the students explain why $(EF) \cap (AG)$ is meanwhile $(EF) \cap (ABC)$, and stopped the discussion when she got a satisfactory explanation.

The argumentation process between the starting point and the first argumentation node is identified as Episode 1, and the remainder is Episode 2. The argumentation node is inserted according to the teacher's words "then can you tell me, why the intersection of (EF) and (AG), it is exactly intersection we look for". What we are interested in here is Episode 1 and the following is its transcript integrated with codes of argumentation components.

Episode1-S7, S8-Task 7

T: What are you going to make? [**part of 1-Claim**]

S6: The intersection of DF and BC

T: Why is it important?

S6: Because we can draw a line from A which goes from this point in the middle, until this point (Fig. (1) [**2-Perceptive-Data**].

T: Speak slowly, please, you know we are online, you are all on the software and quickly get the answer as it allows you to do, but I would like to hear your justification.

S6: OK, justification... (Fig. 2)

T: Why would you like to create the intersection of (DF) and (BC), the point G?

S6: Because it's at the middle of BC [**3-Perceptive-Data**], and then we can make a line passing through the middle, which will intersect with (EF) [**part of 1-Claim**].

T: Which line are you going to construct, passing through which point and which point?

S6: Through A and through...G

T: Why do you think (AG) is important?

S6: It's important for being able to find the intersection of (EF) and this plane (Fig. 3) [**part of 1-Claim**].

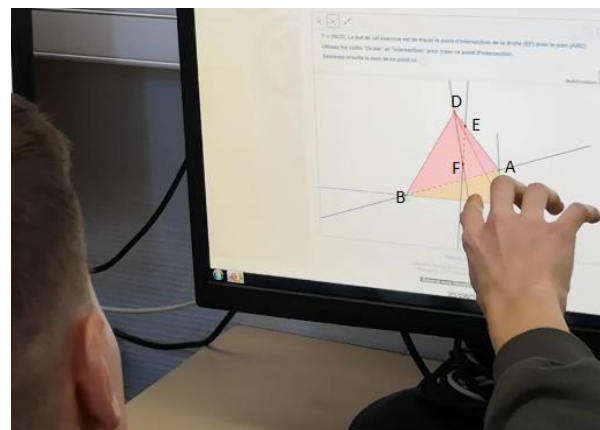


Fig. 1 S6 uses a gesture to indicate the line he wants to construct from A

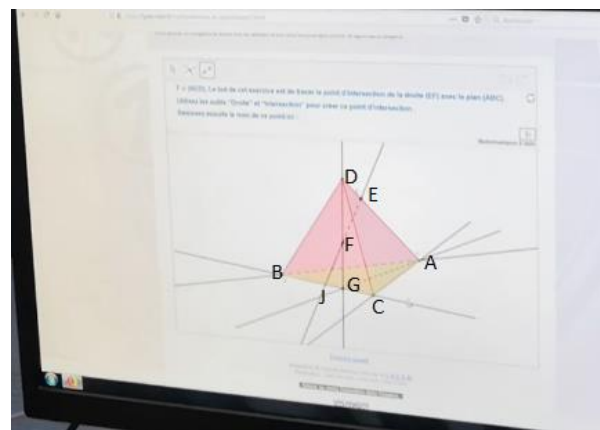


Fig. 2 S6 constructs the intersection of (DF) and (BC) – point G – and then constructs line (AG)

T: Then (EF) and (AG) they are?

S7: They are secant [**repeating 1-Claim**].

S6: They are on the same plane [**4-Claim/Factual-Data**].

T: Stop moving the figure, please. Why they are coplanar, t'at's wha' I'm interested in exactly. if you can show that they are coplanar, you can show that they are secant, you can find an intersection [**echoing 1-Claim**].

S6: It's what, coplanar?

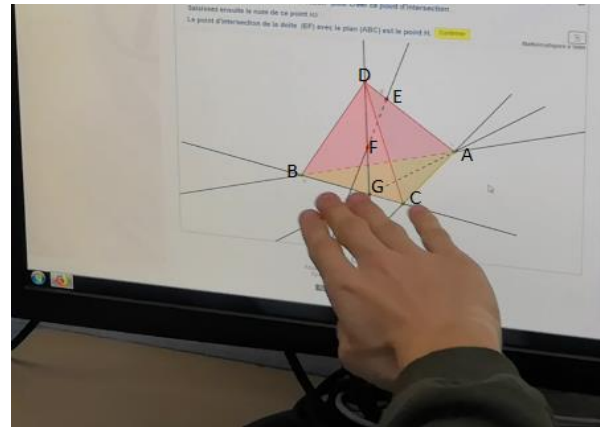


Fig.3 S6's gesture simulating plane (ABC)

T: Coplanar means "in the same plane", okay? If the lines are coplanar, they can be secant or parallel. If they are secant, they are necessarily coplanar [**5-Deductive-Warrant**]. But to look for the intersection, we must first ask the question if they are coplanar, the lines EF and AG?

S7: They are coplanar because G is on the line.....

T: In fact, G it is the intersection of which lines?

S7: Intersection of (DF) and (BC) [**6-Factual-Data**].

T: So G belongs to?

S6: (DF) [**7-Claim/Factual-Data**] and (BC).

T: And A is also on the line (DE) [**8-Factual-Data**], right? So (AG) can also belong to which plane, besides (ABC)?

S6: Ah, (DEF) (turning around the GeoGebra model) [**part of 9-Claim/Factual-Data**]

T: That's it. It's the plane that cuts down here, like this (Fig. 4). This plane (tracing the outline of DEAJF), it was important because it contained (EF) [**part of 9-Claim/Factual-Data**], t'at's why (EF), and (AG) are coplanar [**echoing of 4-Claim/Factual-Data**]. OK?

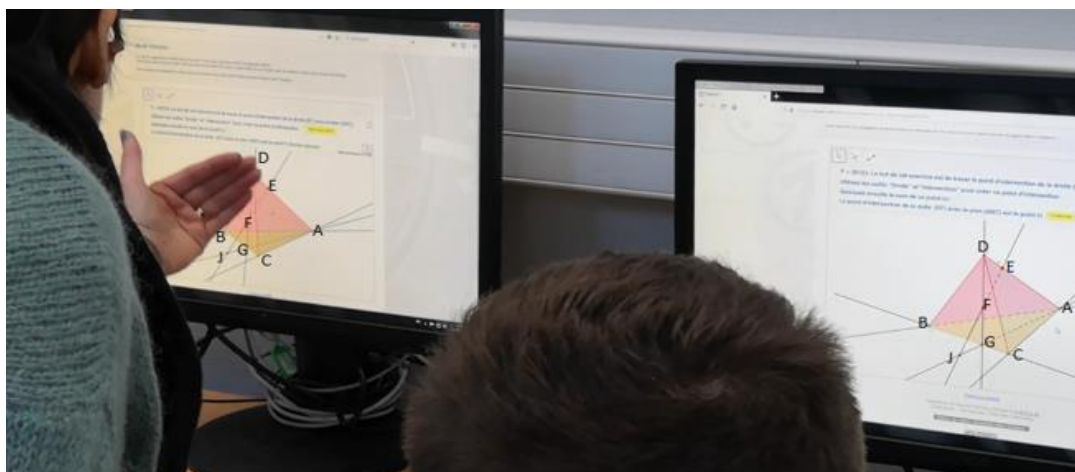


Fig. 4 Sonia's uses gesture to simulate the plane (DEF) on S7's screen

S6: OK, thank you.

T: Then can you tell me, why the intersection of (EF) and (AG), it is exactly the intersection we look for?

We firstly look at the argumentation components directly contributed by the participants in this episode. At first, S6 introduces how he would construct the target intersection (1-Claim). From the rationale of constructions he explained later and gestures in Fig. 1 and 3, we know he has an impression that (EF) would intersect with the line passing through A and the midpoint of [BC], and that $(DF) \cap (BC)$ would exactly give rise to the midpoint of [BC] (named G). The impression reflects the perceptive effects he can receive from the 3D DGE, so we label them respectively as 1-Perceptive-Data and 2-Perceptive-Data, based on which S6 gets the 1-Claim directly. Here S6 thinks the intersection of (EF) and the line connecting A and G – that is (AG) – is just the target intersection $(EF) \cap (AG)$. As a reaction, Sonia firstly focuses on the former part of the claim and questions about the relationship between (EF) and (AG). She helps students to understand that the coplanarity of (EF) and (AG) (4-Claim/Factual-Data) is a necessary condition for the two lines to be secant (5-Deductive-Warrant) and lets students reflect why (EF) and (AG) are coplanar. What follows then is a consecutive deductive reasoning processes: the participants subsequently obtain 7-Claim/Factual-Data and 9-Claim/Factual-Data, according to 6-Factual-Data and 8-Factual-Data. Here they probably refer to some geometric facts/theorems implicitly, i.e., implicit Deductive-Warrants. The way that the argumentation components are organized is shown in the diagram in Fig. 5.37.

Secondly, we consider Sonia's indirect contributions. There are the questions *requesting an idea/method/a simple answer* (which elicit 1-Claim, 6-Data and 7-Claim); there are also the questions *requesting* students' *elaboration* for 1-Claim (which elicit 2-Perceptive-Data and 3-Perceptive-Data), the questions *requesting* students' *idea* about the relationship between (AG) and (EF) (which elicit 9-Claim and 4-Claim), the supportive actions of *informing (reformulating)* 9-Claim and 4-Claim, and the questions *requesting* students' *elaboration* for 4-Claim.

The indirect contributions are also integrated into Fig. 5.37; they and the argumentation components in yellow and green boxes together constitute Sonia's coordination behavior in the episode.

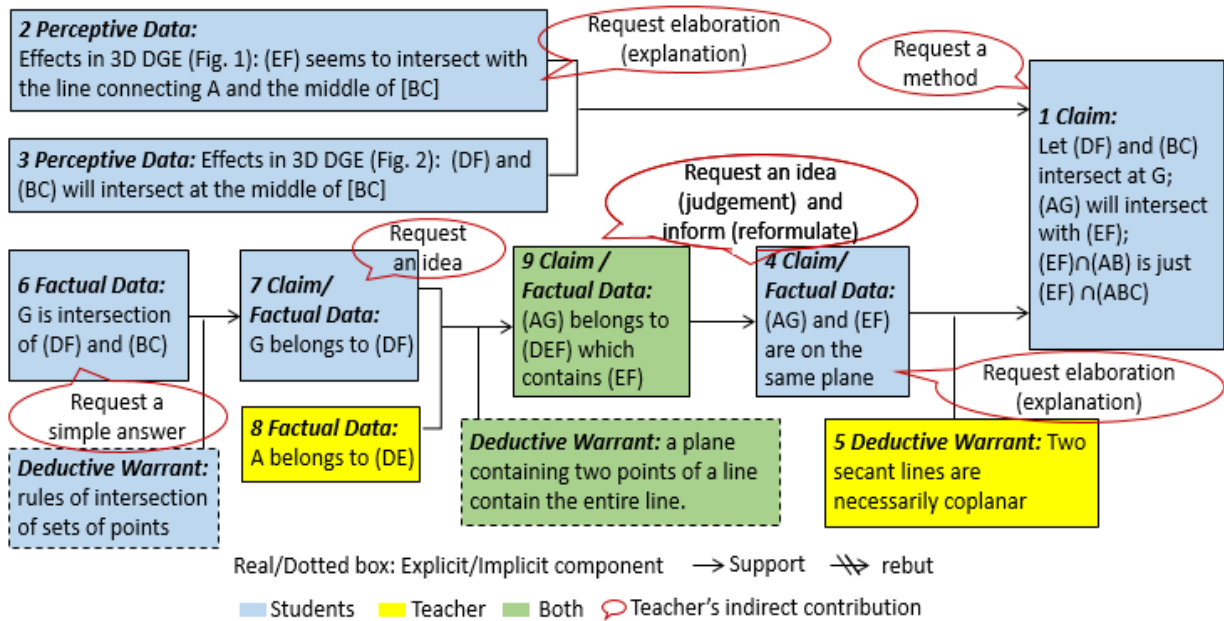


Fig. 5.37 Diagram of argumentation for Episode1-S7, S8-Task 7

The two argumentation episodes modelled by the diagrams in Fig. 5.36 and Fig. 5.37 are underpinned by the same basic structure. Both episodes involve a first Claim drawn by students directly from the Perceptive Data from a 3D DGE. However, Sonia does not encourage the reasoning only based on perceptive evidences. Instead, she constantly requests students to develop theoretical deductive reasoning referring to geometric rules or theorems. As a consequence, there are usually more than one chains of Factual Data – Deductive Warrant – Claim being developed to justify a target Claim either the same or different from the first Claim. The Factual Data at the beginning of the chains usually concerns a basic fact that is given in the task statement or resulted from students' constructions in the 3D DGE. The Claim at an end point of one chain meanwhile serves as the starting point of the next chain; it can be considered as an intermediate conclusion. The same basic structure has been found in the episodes related to Tasks 1 ~ 7, which concern the determination of particular intersection of lines. We classify these episodes into Group S.I-A, and their common basic structure is represented by the general diagram of argumentation in Fig. 5.38.

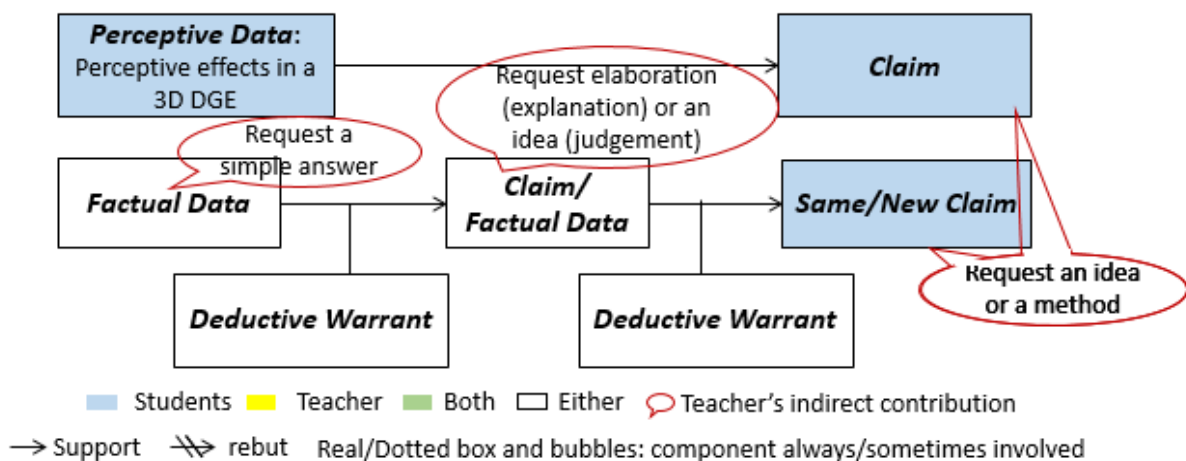
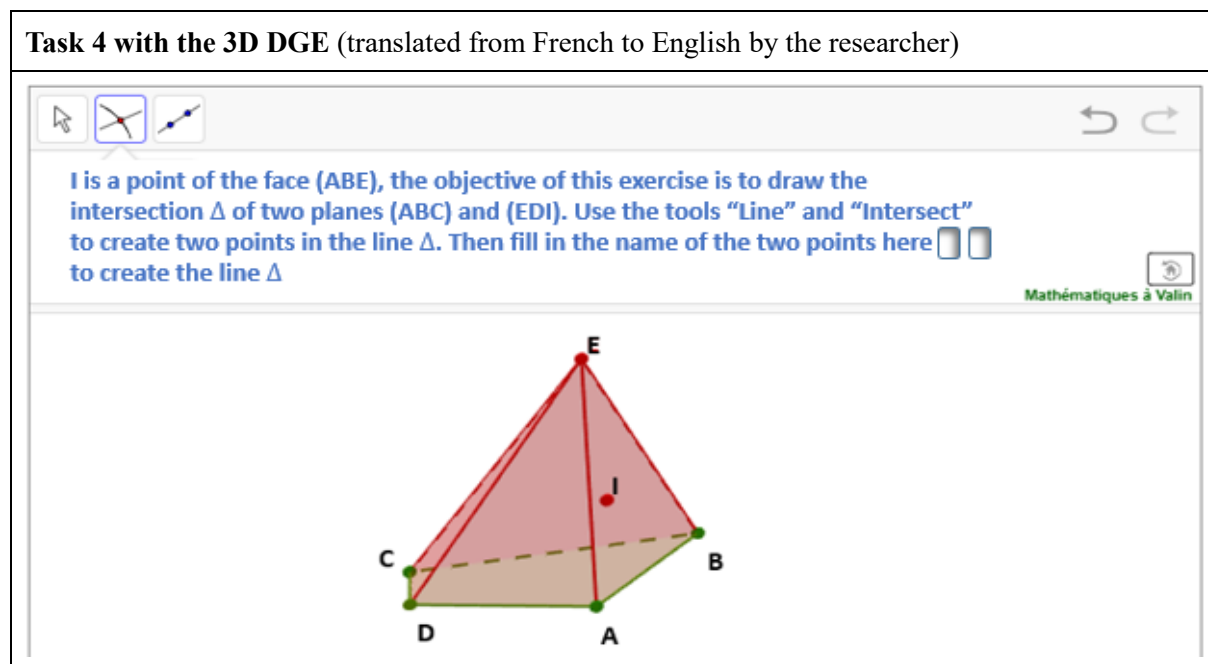


Fig. 5.38 General diagram of argument of the episodes in Group S.I-A

Sonia's contributions in the general diagram consist in: (1) *requesting an idea or method* to elicit students' Claims, which are usually based on Perceptive Data; (2) *requesting elaboration/ an idea/a simple answer* to elicit students' contributions of Factual Data and Deductive Warrants, sometimes with the teacher's own contributions of Factual Data and Deductive Warrants. In terms of "perception" and "logical reasoning", these contributions can be expressed into two rules of coordination: (1) request multiple students' ideas about a geometric statement; (2) guide students to explain the statement by theoretical deductive reasoning instead of by perception in a 3D DGE.

Rules of coordination S.I-B: (1) request students' idea about a geometric statement; (2) rebut (or invite other students to rebut) students' incorrect statement with other perceptive evidences from real objects or simulating gestures; (3) lead students to a correct geometric statement based on all the perceptive evidences

The first example episode related to these rules of coordination is the Episode 1 in the collective argumentation between the teacher Sonia and two students S7 and S8 around Task 4. The task asks for the intersection of two planes in to a rectangular pyramid, as shown below.



The whole collective argumentation is initiated by Sonia, who came to the two students trying to get informed of what task they were dealing with and how they would solve the task. At that moment the students have already "seen" one point of intersection – $(EI) \cap (AB)$ – as one point in the target intersection, but Sonia insists that they should determine the intersection by "reasoning" and she launched a discussion on the relative position between lines in space and the condition for the intersection of lines. After clarifying that "non-parallelism" and "coplanarity" are both necessary conditions for two lines to intersect in space (first argumentation node), Sonia let students connect this geometric rule to the point of intersection identified previously. The whole argumentation ended when the students get to the conclusion that (EI) and (AB) are coplanar.

We consider the argumentation process from the beginning to the first argumentation node as Episode 1, with the remainder being Episode 2. The argumentation node is set there because until that moment the argumentation was almost about general geometric facts/theorems, and then in Episode 2 the geometric facts/theorems were connected to the solution of the task. What interests us here is Episode 1 and below is its transcript integrated with codes of argumentation components.

Episode 1-S7 S8-Task 4

T: So what do we have now? A point I on the face (ABE) and we look for what (Fig. (1))

S7: We look for the intersection of (ABC) and (EDI).

T: Do you have any ideas or not?

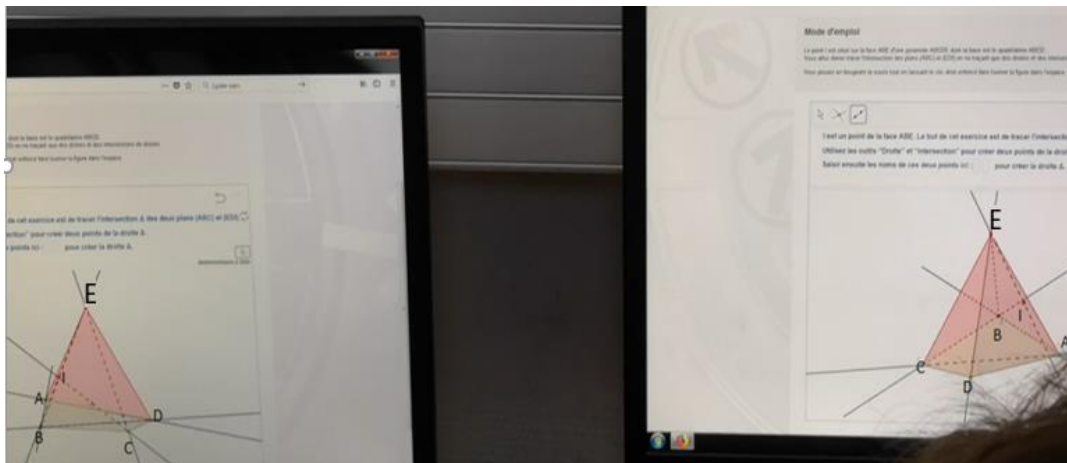


Fig.1 Screens of S8 and S7 (from left to right)

S7: uh, to visualize the plans... and I try to see...

T: OK, you try to see, but how do you reason afterwards to determine the intersection, what do you try to look for?

S7: Well, generally, may there be lines intersecting with each other (Fig.2), there is a point of intersection on the line...

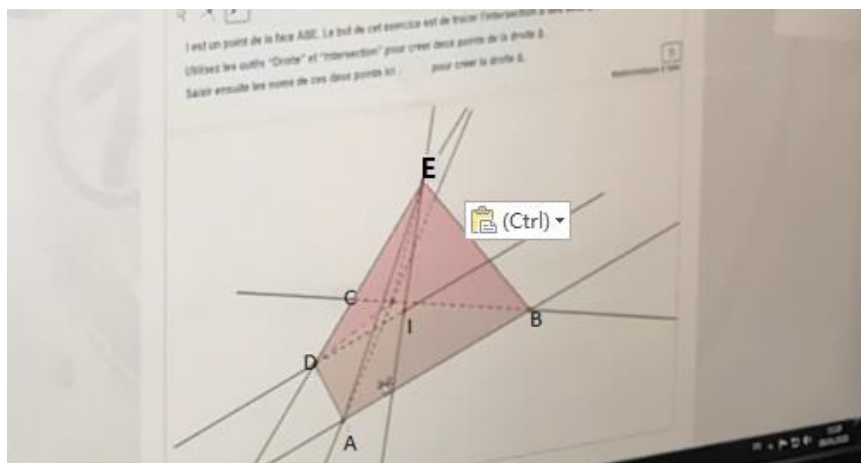


Fig. 2 S7 points at the intersection of (EI) and (AB) with the mouse

T: Like in the previous exercises, for the point of intersection of two lines being possible, the two lines must be how?

S8: Secant?

T: Yes, but for them to be secant, they have to be how? Are two lines always secant in space?

S8: If they are not parallel [**1-Claim**]?

T: Two lines in space, they must be secant if they are not parallel?

S7: Yes [**2-Absolute-Qualifier**].

T: Do you agree? Both of you? In space, they are either secant or parallel?

S7: Oh no... sorry...

T: Can you give counterexamples with two lines?

S7: Like this (Fig.3) [**3-Perceptive-Data/ Rebuttal-to-Claim**]



Fig. 3 S7 shows the examples of two non-coplanar lines with a gesture

T: Perfect, to be able to make the intersection of two lines, they have to be coplanar [**4-Claim**]. So to find your intersection, you have to find two lines that are coplanar, with a line belonging to (ABC), and another line belonging (EDI)...

We discuss the participants' direct contributions of argumentation components together with Sonia's indirect contributions in this episode. Before eliciting the 1-Claim from students, Sonia gets to know that S7 plans to construct the intersection of (EI) and (AB) (Fig. 2) as the first step of solving the task, and that he decides the intersection mainly by "seeing". Then Sonia insists that students have to "reason" to determine the intersection and *requests* their *idea* about the condition under which two lines could intersect. As a response, the 1-Claim from S8 shows his conception that two lines in space are either parallel or secant, which might be an extension of what they have learnt in 2D geometry, or based on their perception in 3D reality. After that, Sonia constantly asks the two students about their certainty of 1-Claim (i.e., *request evaluation*), which makes S7 firstly confirm the claim and then quickly rebut it. Sonia further requests him to give counterexamples (i.e., *request elaboration*) for this, eliciting the gestures simulating two non-coplanar lines. We thus consider the gestures as 3-Perceptive-Data/ Rebuttal-to-Claim.

On that basis, Sonia directly proposes that the “coplanar” should be a prerequisite for the intersection of two lines in space, that is 4-Claim.

These argumentation components and indirect contributions are integrated together into the diagram of argument in Fig. 5.39; here Sonia’s indirect contributions (talk bubbles) and direct contributions (yellow boxes) together constitute her coordination behavior in the episode.

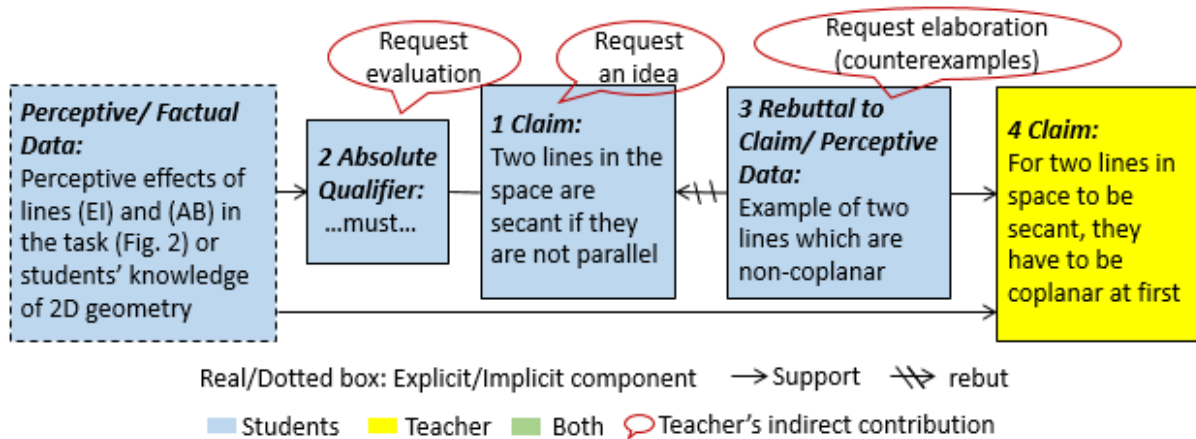


Fig. 5.39 Diagram of argument Episode 1-S7 S8-Task 4

The second example episode relates to the rules of coordination of Group S.I-B is the Episode 2 in the collective argumentation between the teacher Sonia and two students S3, S4 around Task 1. It is exactly the episode coming after the first episode in Group S.I-A. As mentioned previously, Task 1 asks for the intersection of line (EF) and plane (ABC) which are situated in a tetrahedron. In Episode 1 Sonia had led the students to correctly solve the task and in Episode 2 she discussed the possible nature of the intersection of a line and a plane in space. What we will investigate next is Episode 2 and the following is its transcript integrated with codes of argumentation components.

Episode 2-S3 S4-Task 1	
<p>T: Now we come back to the topic: is it always a point, the intersection of a line and a plane. what do you think?</p> <p>S3: ...</p> <p>T: Is it always a point, the intersection of a line and a plane?</p> <p>S3: If it's a line and a plane...yes, it's a point [1-Claim], simply like this (pointing at the 3D dynamic model for the current task on the screen) [2-Perceptive-Data].</p> <p>T: How can it be that? It is a line and a plane (Fig. (1), is the intersection of a line and a plane always a point? You say yes, and if the line is in the plane of the desk (Fig.2) [part of 3-</p>	<p>Fig. 1 Sonia uses a pencil and a desk in the classroom to simulate a line and a plane</p>

Perceptive-Data/ Rebuttal-to-Claim], what is the intersection?

S3: Well it's the entire line [**part of 4-Claim**]

T: It's the entire line, and if I put my line here now (Fig. 3) [**part of 3-Perceptive Data/ Rebuttal-to-Claim**],

S4: it's empty [**part of 4-Claim**].

T: Yes, it is not always a point [**part of 4-Claim**]. OK, go on, I'll see the others.

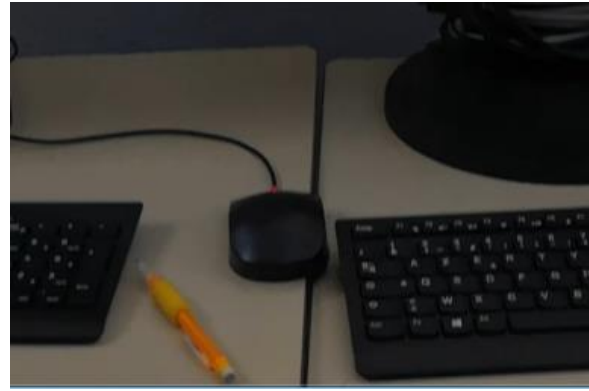


Fig.2 The pencil is put on the desk

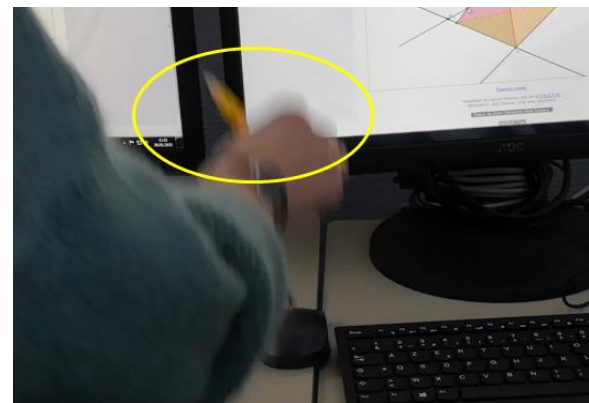


Fig.3 Sonia lifts the pencil up in the air trying to make it parallel to the desk

Similar to the last episode, we discuss participants' direct contributions of argumentation components together with the teacher's indirect contributions in this episode. At first, Sonia asks students to make a judgement (i.e., *requested an idea*) on the nature of the intersection of a line and a plane, and S3 provides 1-Claim based on the case of the intersection of a line and a plane in Task 1; we classify the case as a perceptive one, i.e., 2-Perceptive-Data, because students can directly see the particular point of intersection. Then Sonia makes use of an existing table and a pencil to represent another two cases in which the intersection of a line and a plane can be an entire line or empty. The two cases serve as two counterexamples for *rebutting* 1-Claim. We therefore identify the two cases as 3-Perceptive-Data/Rebuttal-to-Claim. Based on the two cases, Sonia and the students draw a conclusion that the intersection can also be an entire line or empty and not always be a point, that is 4-Claim.

We integrate these argumentation components and teacher's indirect contributions into the diagram in Fig. 5.40; Sonia's direct contributions (yellow and green boxes) and indirect contributions (talk bubbles) together constitute her coordination behavior in the episode.

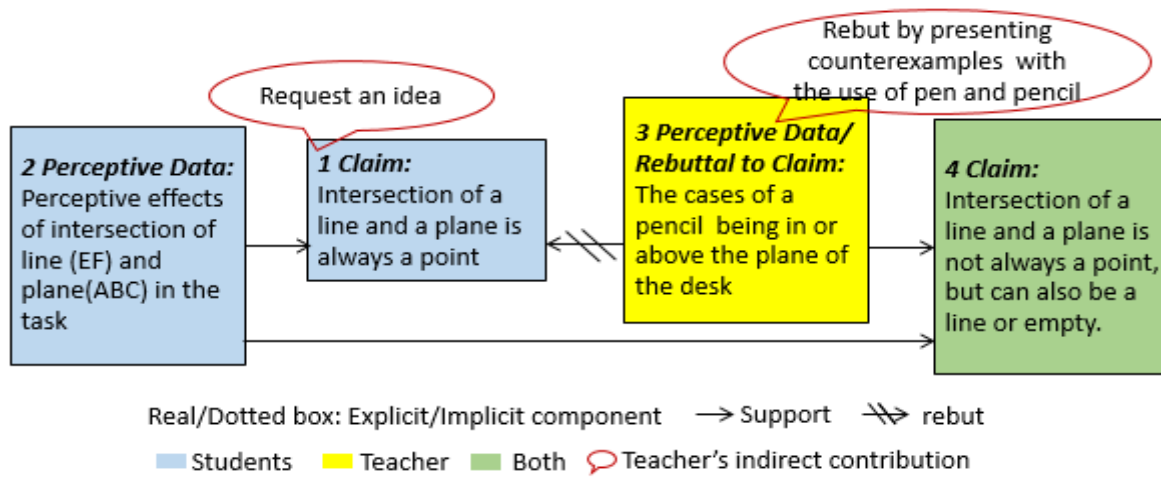


Fig. 5.40 Diagram of argumentation for Episode 2-S3 S4-Task 1

The two episodes above are underpinned by the same basic structure. As the two diagrams of argumentation (Fig. 5.39, Fig. 5.40) show, they both cover a Claim supported by a Perceptive/Factual Data; the Claim always concerns the possible relative positions between lines and planes in space, which is drawn by students either according to their perception of the case in the task/3D DGE (Perceptive Data) or according to their prior knowledge in 2D geometry (Factual Data). The chain of Perceptive Data – Claim also exists in the episodes of Group S.I-A; but here the Claim is no longer related to a chain of theoretical deductive reasoning; instead, it is rebutted by another Perceptive Data involving other possible relative positions of the geometric objects at stake. From both the previous and the new Perceptive Data, Sonia directly leads students to a Claim summarizing all the relative positions having been discussed. The Perceptive Data are proposed by either students or Sonia with the use of real objects or gestures, which perceptively simulate the other cases (or counterexamples) not included in the previous Claim, making students easily accept the existence of various cases and accept the truth of the new Claim. The same basic structure has also been found in the episodes under Tasks 1 ~ 7 in which Sonia tries to directly introduce students to some basic facts/theorems in 3D geometry. We classify these episodes into Group S.I-B; their common basic structure is represented by the general diagram in Fig. 5.41.

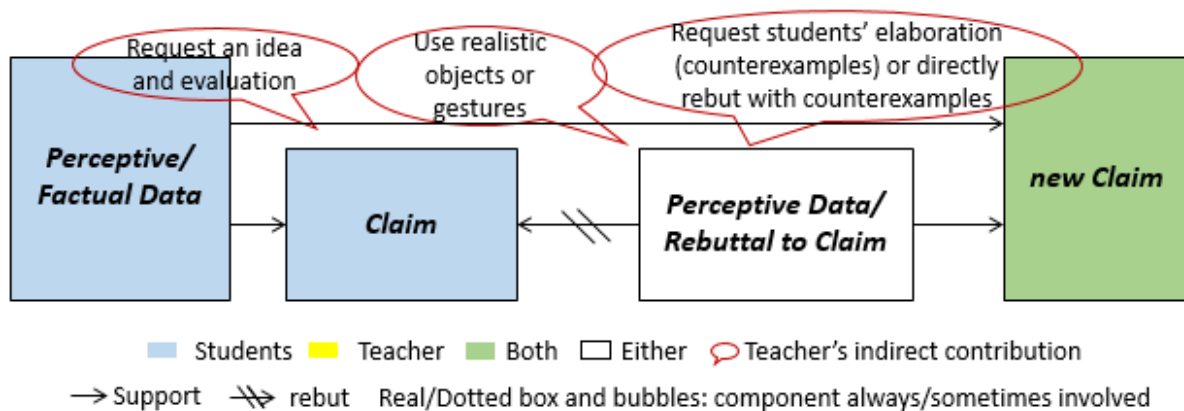


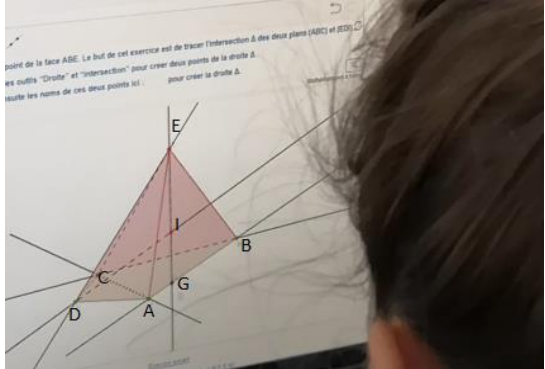
Fig. 5.41 General diagram of argumentation for the episodes of Group S.I-B

Sonia's contributions to the general diagram lie in: (1) *requesting an idea* to elicit students' Claim and *requesting* students' *evaluation* of the Claim; 2) *requesting* students' *elaboration* (*counterexamples*) for their evaluation or directly *rebutting with counterexamples* with the *use of real objects or simulating gestures*, which led to another Perceptive Data; 3) direct contribution of the new Claim based on all the Perceptive Data. They correspond to three rules of coordination which are later put into a group labeled S.I-B: (1) request students' idea about a geometric statement; (2) rebut (or invite other students to rebut) students' incorrect statement with perceptive evidences from real objects or simulating gestures; (3) lead students to a correct geometric statement based on all the perceptive evidences.

Rules of coordination S.I-C: (1) use a 3D DGE and simulating gestures to support students' perception; (2) directly validate the perception result and let students take it as a fact to develop the following theoretical deductive reasoning

These rules of coordination are identified from only one argumentation episode, which is the whole collective argumentation between the teacher Sonia and the student S11 (indicated in classroom layout in Fig. 5.32) around Task 4. The task has already been presented for the rules of coordination S.I-B. Students are required to construct the line of intersection of plane (EID) and plane (ABC) in the task, in which points E, D, A, B, C are all vertices of a rectangular pyramid and point I is on one of its faces (see Fig. 1 in the episode below).

The collective argumentation started when S11 asked for the teacher's help with the task. At that moment, she has already identified one point of intersection of planes (EID) and (ABC), which is $(EI) \cap (AB)$; but she could not find another point of intersection of the two planes, which is in fact D, a vertex covered by both planes but not explicitly indicated in their notations. Through the argumentation, Sonia made S11 understand that D is exactly the second point in the target intersection. The whole argumentation only concerns the determination of one point of intersection and thus it is considered as a single episode; its transcript is as follows.

Episode-S11-Task 4	
<p>S11: There is a plane (EDI)...the line (EI) intersects (AB) at G (Fig.1).</p> <p>T: (EI) intersects with (AB) at G, OK.</p> <p>S11: I have this point and I am searching for another one (turning around the 3D DGE model)</p> <p>T: So can you well visualize it? the plane ABC it is in which plane?</p> <p>S11: Well (ABC) it's like this (Fig. 2), (EDI) it's like...</p> <p>T: ABC it is at the bottom, isn't here a point which could be more evident than what you draw here?</p> <p>S11: No...</p>	 <p data-bbox="842 1711 1337 1749">Fig. 1 S11's constructions in the 3D DGE</p>

T: When you see plane (EDI), it consists of which points? Which are the points belonging to this plane evidently?

S11: E, D, I [1-Factual-Data]?

T: Yes, E it is what, as we call it?

S11: The summit.

T: And D?

S11: D it's on the quadrilateral face [part of 2-Factual-Data]

T: Yes, and?

S11: It's [CDAB] [part of 2-Factual-Data]. But the problem is that here AC and D, can they form a plane belonging to plane ABC? (Fig. 3)

T: Why you would like D to belong to...you said D belongs to (EDI) in an evident manner; in fact, it also belongs to the quadrilateral face [CDAB], at the moment that we know a quadrilateral face, we can draw the quadrilateral in a plane. and it's the single plane, coinciding with (ABC) [part of 3-Claim] OK?

S11: So D belongs to plane (ABCD) [part of 3-Claim]

T: Yes, it is the single base of the pyramid, where you put your pyramid, and then you have your summit E (Fig 4) [4-Perceptive-Data], you succeed in visualizing it or not? D belongs to, on the one hand, (EDI), and on the other hand, can you see? Maybe we can turn it around to help with the observation. Like this, here it is a view from below, we are on the quadrilateral plane, D it's well in the face, in one plane (Fig. 5) [5-Perceptive-Data]. Now I turn it back.

S11: So the point of intersection, I just name it D [6-Claim]?

T: Yes, just fill D, it's the point already existing.

S11: Alright, thank you.

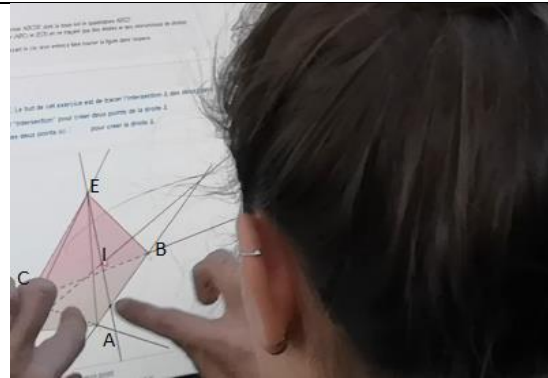


Fig. 2 S11 traces the outline of plane (ABC) with fingers

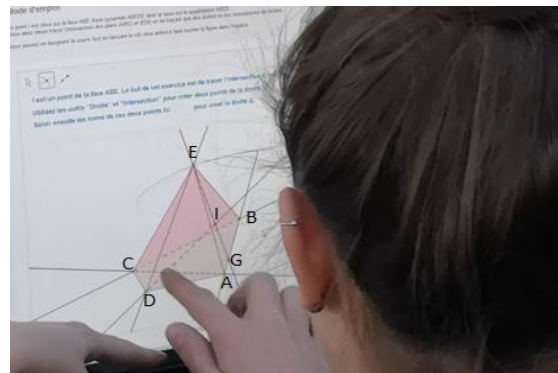


Fig. 3 S11 points at the plane defined by line (AC) and point D



Fig. 4 Sonia's gesture simulating the base of the rectangular pyramid

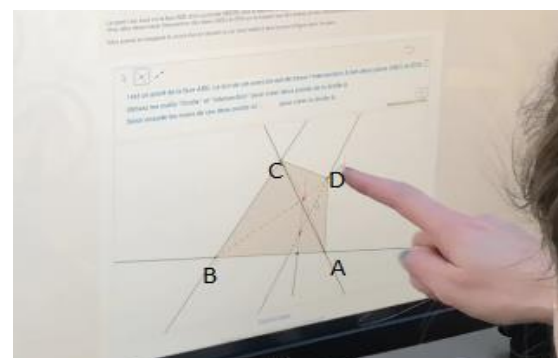


Fig. 5 Sonia points at D and then trances the outline of face (DCBA)

We first discuss the argumentation components directly contributed by the participants. At the beginning, Sonia gets informed that S11 could not “see” the common vertex D contained in both plane (ABC) and plane (EDI); then Sonia lets S11 consider the three vertices in plane (EDI) one by one, eliciting S11’s contribution of 1-Factual-Data. Sonia further requests S11 to describe the positions of the points with respect to the rectangular pyramid. As a response, S11 indicates that D is on the quadrilateral base [CBAD], what is considered as a Factual-Data (labeled 2); but she seems to think that the base is not flat and plane (ACD) might be different from plane (ACB), as evidenced by her sentence “AC and D, can they form a plane belonging to plane ABC”. To respond to the question, Sonia highlights that the face [CBAD] is actually in a unique and flat plane coinciding with (ABC), making S11 understand that D belongs to (ABC) (3-Claim). Sonia also uses gestures to simulate the base of the pyramid (4-Perceptive-Data) and rotates the 3D dynamic model to evoke the view from below (5-Perceptive-Data). The two perceptive data constitute the grounds for 3-Claim. With 1-Factual-Data, 2-Factual-Data, 3-Claim, and probably also the rules about the intersection of sets of points (an implicit Deductive-Warrant), S11 realizes that D is another point of intersection of (ABC) and (EDI) (6-Claim), which is confirmed by Sonia.

Sonia’s indirect contributions to the argumentation episode include: the questions *requesting a simple answer* which elicits S11’s contributions of 1-Factual-Data and 2-Factual-Data and the actions of *confirming* these factual data, the *use of simulating gestures* and *the 3D DGE* which allows herself to contribute 4-Perceptive-Data and 5-Perceptive-Data, and the action of *confirming* the 3-Claim/Factual-Data and 6-Claim given by S11.

All the argumentation components and indirect contributions above are integrated into the diagram in Fig. 5.42; Sonia’s direct contributions (yellow and green boxes) and indirect contributions (talk bubbles) together constitute her coordination behavior in the episode.

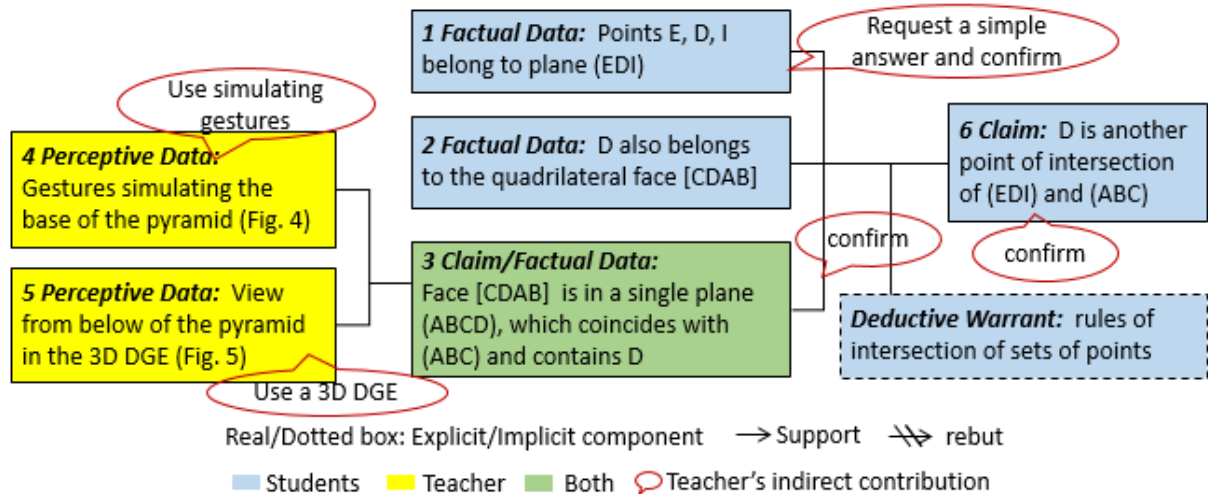


Fig. 5.42 Diagram of argumentation for Episode-S11-Task 4

The basic structure of this episode is distinct from any other episode in this lesson series. It is the only episode in the lesson that involves the Perceptive Data from a 3D DGE evoked by the teacher. With this Perceptive Data and another Perceptive Data related to her gestures, Sonia

makes students understand the flatness and uniqueness of the base plane of the rectangular pyramid without other argumentation components. Then the Claim based on Perceptive Data is directly taken as one of the Factual Data in the chain of Factual Data – Deductive Warrant – Claim, i.e., as a precondition in the following theoretical deductive reasoning. This is different from the episodes of Group S.I-A and Group S.I-B, in which the Claim based on Perceptive Data is either rebutted by another Perceptive Data, or confirmed/rebutted by an independent chain of theoretical deductive reasoning.

Sonia’s coordination behavior (her direct and indirect contributions) in this episode can be divided into two parts: (1) the *use of gestures and the 3D DGE* in relation with the contributions of 4-Perceptive-Data and 5-Perceptive-Data, (2) the actions of *confirming* S11’s Claims. In terms of “perceptive evidences” and “logical reasoning”, the coordination behavior can be reformulated as: (1) use a 3D DGE and simulating gestures to support students’ perception; (2) directly validate the perception result and let students take it as a fact to develop the following theoretical deductive reasoning.

The coordination behavior can be supported by some operational invariants of Sonia, which will be elaborated in the next section. On that basis, we consider the coordination behavior in this episode as reflecting some regular actions of Sonia which are distinct from those in the other episodes. The episode is thus classified into an independent group labeled S.I-C and the coordination behavior therein is considered as rules of coordination of Group S.I-C.

5.2.4 Operational invariants in Lesson Series S.I

In this part, we present the operational invariants underpinning each group of rules of coordination of this lesson series. The operational invariants are obtained by analyzing all the data related to the lesson series, and all the interview words we cite in below come from the transcripts of the general interview (Appendices 2.1). The corresponding data analysis procedures have been presented in the methodology part (§4.4.1).

Operational invariants for rules of coordination S.I-A: (1) request multiple students’ ideas about a geometric statement; (2) guide students to explain the statement by theoretical deductive reasoning instead of by perception in a 3D DGE.

These rules of coordination appeared in the argumentation episodes in the frame of Tasks 1 ~ 7. The episodes are about finding the particular intersection point of lines that constitutes a part of the target intersection of a line/plane and a plane.

The operational invariants for these rules of coordination are summarized in Table 5.9.

Table 5.9 Operational invariants for rules of coordination of group S.I-A

Category	Label and content of operational invariant
COI	[1] Tasks of constructing intersections in space need to be solved by theoretical deductive reasoning in reference to theorems/properties in 3D geometry.
	[2] A point can be defined as the intersection of two lines.
	[3] Intersection of two planes is a line, which can be defined by two points, with each point being the intersection of two lines that come from the two planes respectively.

	[4] Intersection of a line and a plane is a point, which should be the intersection of the line and another line in the plane.
	[5] Any line or plane is infinite. For two lines in space to be secant, they should firstly be coplanar.
	[6] To find the intersection of a line and a plane, we should find an auxiliary plane covering both the line and a line in the plane.
PCOI	[7] Requesting more than one student's ideas or evaluation regarding a statement provides the teacher opportunities to identify their typical mistakes and correcting the mistakes collectively.
	[8] If we let students solve mathematics tasks autonomously and making mistakes by themselves, they will retain the content better and we can also identify their prior knowledge and difficulties.
	[9] Request students' explanation constantly and let them go beyond perceptive evidences could facilitate the development of theoretical deductive reasoning of students.
	[10] Students should be able to construct the intersection of lines and planes in space and meanwhile to justify the construction using theorems in 3D geometry.
TPCOI	[11] Interesp is suitable for autonomous learning since it provides various types and levels of tasks, the instant feedback showing the intersection of non-coplanar lines that students tend to make is impossible, the evaluation result, and allows to rotate figures.
	[12] 3D DGEs make students more courageous and active in constructing intersections than paper environments do.
	[13] The limit of the 3D DGEs in Interesp is it allows students to solve the tasks merely by perception and trial-and-error without using geometric theorems; it is thus important for the teacher to demand justification.
TCOI	[14] Right-clicking and dragging the mouse allows to turn a 3D dynamic model around in Interesp.
	[15] By selecting the <i>Line</i> tool and selecting two points, one can construct a line through the two points in Interesp.
	[16] By selecting the <i>Intersect</i> tool and selecting two lines (segments), one can construct the intersection of the two lines (segments) in Interesp.
	[17] Inputting answers in the blanks and clicking "conform", one can check if the answer is "correct" or "wrong" in Interesp
PTCOI	[18] Teaching students the necessary technological techniques beforehand will facilitate students' exploration of mathematics in 3D DGEs.
	[19] The technological techniques can be taught through step-by-step direction.

Firstly, some operational invariants about content (COI) can be inferred. The rules of coordination are implemented with respect to Tasks 1 to 7. While requesting students' ideas about how to solve the tasks and requesting the corresponding theoretical deductive reasoning, Sonia must have preconceived some answers in her mind, including the reasoning procedures

for solving Tasks 1 to 7, and the 3D geometry theorems /facts involved therein. Similar information can also be found in the interview of Sonia:

“There are two things to make an intersection, 'construct' and 'justify'... justify at each time: what procedures to do for making a section, why are these, what theorems are used.”

“It is not acceptable to just say ‘according to my eyes’... they should manage to justify, to reason, use theorems...”

These words allow inferring operational invariant [1], which reflects Sonia’s views about the solutions to mathematics tasks of constructing intersections. From Sonia’s reactions to students’ ideas in the related episodes, we infer the knowledge of mathematics theorems or properties ([2]–[6]) she must have. All the operational invariants fall in the category COI.

Secondly, the rules of coordination imply some operational invariants about pedagogy of content (PCOI). Sonia’s behavior in terms of rule (1) shows that she prefers to request more than one student’s ideas in class and her words in the interview show that she takes it as an effective way to elicit students’ common misconceptions and correct them collectively ([7]):

“I like to do that, let a student evaluate the remark of another student... When it concerns typical mistakes, like someone saying: ‘if two lines are not parallel then they are secant’, I would ask the neighbors ‘what do you think of that?’ to see whether they can understand that it’s a mistake or they agree with the mistake, if the latter, it’s an opportunity to collectively demonstrate it’s not true, to take profit of other students, in fact...”

Before requesting students’ ideas, Sonia tries not to tell students the related concepts a priori but lets them explore in Interest by themselves, as she thinks that it could help *“elicit the notions they already have and not yet have”* and *“if they (students) begin by making errors, they will be ‘annoyed’ by the errors at very first, this perhaps makes them they retain things better and longer”*. This is associated with another operational invariant [8]. What’s more, Sonia’s behavior in terms of rule (2) shows her pedagogical strategy to facilitate students’ theoretical deductive reasoning ([9]). In the interview, Sonia highlights that *“construct”* and *“justify [with theorems]”* are *“two things to confirm an intersection”* ([10]). Among these operational invariants, [7] – [9] reflect Sonia’s knowledge or views about the pedagogical strategies for teaching mathematics; [10] reflects her knowledge or views about the importance of perception/logical reasoning in learning mathematics. All of them belong to the category PCOI.

Thirdly, Sonia mentions, in the interview, the limitations and advantages of Interest when explaining why she would let students explore in Interest and demand for their justification, and this brings out several operational invariants. For example, Sonia says that Interest is really good in *“allowing students to practice with many exercises of different types and different levels”* and in providing *“punctual correction”* so that students *“can explore more autonomously”*; she also mentions that the big advantage of Interest over the paper environment is *“when they (students) are going to construct the intersection of lines that are non-coplanar, the software (Interest) will tell it’s not possible”*. We summarize this as the operational invariant [11] and it concerns Sonia’s knowledge or views about the general potentials of 3D DGEs for mathematics learning of students. Sonia also tells that *“Students are more active in front of the computer”* and less *“afraid of mistakes”* as Interest will not permit

them to make impossible constructions ([12]). However, one limitation of Interesp, for Sonia, is that “students can construct the right intersection by trying a lot” without knowing “how to justify” or “what is the theorem behind”, and this is why she would “ask students to justify every time” ([13]). Here, [12] reflects Sonia’s knowledge of the impact of 3D DGEs on students’ engagement in mathematics learning, and [13] reflects Sonia’s knowledge of the side effects of 3D DGEs for students’ theoretical deductive reasoning activities and her pedagogical strategies to make up for the side effects. All these belong to the category TPCOI.

Finally, for preparing students for the exploration in Interesp, Sonia teaches them the technological skills at the beginning of the lesson. This implies that Sonia has the knowledge of technological skills related to Interesp – what are synthesized as operational invariants [14] to [17] in Table 5.9. These are the operational invariants about technology and content (TCOI). Furthermore, Sonia’s choice of teaching the technological skills through step-by-step direction reveals her knowledge or views about the pedagogy for linking technology and content – this makes us infer [18] and [19] which belong to the category PTCOI.

Operational invariants for rules of coordination S.I-B: (1) request students’ idea about a geometric statement; (2) rebut (or invite other students to rebut) students’ incorrect statement with other perceptive evidences from real objects or simulating gestures; (3) lead students to a correct geometric statement based on all the perceptive evidences.

The operational invariants underpinning this group of rules of coordination are summarized in Table 5.10.

Table 5.10 Operational invariants for rules of coordination S.I-B.

Category	Label and content of operational invariant
COI	<p>[1] <i>General solution to intersection construction tasks in 3D geometry.</i></p> <p>[20] The relative position between two lines in space can be secant, coinciding, strictly parallel and non-coplanar.</p> <p>[21] For two lines to be secant in space, they should firstly be coplanar.</p> <p>[22] Intersection of two lines in space can be a point, the whole line, or empty (when the two lines are parallel or non-coplanar).</p> <p>[23] Intersection of a line and a plane in space can be a point/ the whole line/ or empty (when the line is parallel to the plane).</p> <p>[24] Intersection of two planes in space can be a line, the whole plane, or empty (when the two planes are parallel).</p>
PCOI	<p>[7] <i>Pedagogical benefit of requesting more than one student’s ideas.</i></p> <p>[25] The geometric theorems/properties which are true in 2D geometry but not true in 3D geometry (e.g., two lines which are not parallel must be secant) is where students often get confused.</p> <p>[26] It is important for the teacher to tell and emphasize basic geometric theorems/properties, especially those students often get confused with.</p>

[27] Using gestures is an effective way to illustrate lines and planes in space in support of students' perception.

[28] 3D real objects work better than 3D dynamic models in supporting students' perception with respect to spatial figures and relationships.

Firstly, some operational invariants about content (COI) can be inferred. Since the “new statement” that Sonia finally leads students to construct in rule (3) is always a theorem/fact concerning the relative positions between lines and planes (or the possible intersection of lines and planes) in space, she should have the prior knowledge of the theorems or properties in 3D geometry. That leads to operational invariants [20] ~ [24] in Table 5.10, which are categorized as COI. Besides, these theorems/facts are introduced to serve the task solving activities of students, as Sonia requests students to apply them to determine the target intersection of Tasks 1 ~ 7. This shows Sonia still expects students to solve the tasks by theoretical deductive reasoning in general – what corresponds to [1], an operational invariant also belonging to COI. Secondly, there are operational invariants about pedagogy of content (PCOI). In the interview, Sonia tells that the statements she would like to discuss in detail are what students often get confused with, especially those held as true in 2D geometry but not true in 3D geometry. This is especially embodied in her rules of coordination (1) and (2). From her words we infer two operational invariants [25] and [26]: the former concerns Sonia's knowledge or memories of students' common misconceptions in 3D geometry; the latter concerns her views on what is important in teaching 3D geometry. Also, Sonia requests more than one student's ideas about a statement here, as in rules of coordination S.I-A; so the operational invariant [7] that has been introduced previously is also relevant here. Furthermore, in rule (1) and rule (2), Sonia taps on other resources than 3D DGEs to provide perceptive evidences, such as 3D real objects and gestures, which shows her appreciation of the different resources for supporting students' perception. This is also evidenced by her words in the interview:

“I really wish that we could have the materials, some natural things, to say ‘look at this straight line which is parallel to a plane, or which intersects with a plane’...I would like to have cubes, some real volumes to show students what the sections could be like, but we lack these in high school... After all, the Interesp can help to see the objects in space, it's already good.”

“That's where I find it important to have concrete things, in fact, to simulate lines and planes in space with our hands, it's natural I think.”

This leads us to operational invariants [27], [28] (see Table 5.10), which respectively reflect Sonia's understanding of the potentials of gestures, and 3D real objects for students' perception in comparison with 3D DGEs. Therefore, we place them into the category PCOI.

Operational invariants for rules of coordination S.I-C: (1) use a 3D DGE and simulating gestures to support students' perception; (2) directly validate the perception result and let students take it as a fact to develop the following theoretical deductive reasoning

These rules of coordination are identified from the argumentation episode around Task 4, which concerns the determination of the vertex of the background pyramid which is contained in both planes (but not clearly indicated in their notations) at stake.

The operational invariants related to these rules of coordination are summarized in Table 5.11.

Table 5.11 Operational invariants for rules of coordination S.I-C

Category	Label and content of operational invariant
COI	[1] <i>General solution to intersection construction tasks in 3D geometry.</i> [29] If two planes inscribed on a solid contain a common vertex of the solid, the vertex belongs to the intersection of the two planes.
PCOI	[27] <i>Potentials of simulating gestures for supporting students' perception.</i>
TPCOI	[30] 3D dynamic models allow students to observe 3D objects from different viewpoints. [31] The teacher can rotate 3D dynamic models to an unusual orientation to show the faces of 3D figures that are not easy to be observed.
TCOI	[14] <i>Techniques for turning around 3D dynamic models in Interesp;</i>

Firstly, operational invariants about content (COI) are always indispensable in the rules of coordination. Sonia's behavior of letting students develop theoretical deductive reasoning in rule (2) shows that she thinks the tasks like 4 should be solved by theoretical deductive reasoning globally, that is associated with [1], the operational invariant repetitively appearing in previous rules of coordination. In particular, the theorem referred to in the theoretical deductive reasoning is the rules about the intersection of sets of points – any point belonging to both sets of points belongs to the intersection of the two sets ([29]), which is also the knowledge that Sonia should have here. The [1] and [29] are both categorized as operational invariants about content (COI).

Secondly, there are operational invariants about pedagogy and content (PCOI) and operational invariants about technology in pedagogy of content (TPCOI). Sonia's use of simulating gestures in rule (1) of group S.I-C is consistent with her use of gestures in rules of coordination S.I-B, which are underpinned by the same operational invariant in category PCOI: [27]. In rule (1), Sonia also uses the function in 3D DGE – rotating the 3D dynamic model to display the bottom view of the rectangular pyramid – and this behavior is elaborated by her in the interview:

“I think that in this task, they had not seen that the point D, it also belongs to the base plane (ABC)...Here I am trying to find a bottom view so that the pyramid looks like sitting on the quadrilateral face, to show that the bottom face is in a single plane, it is all flat, covering D. Based on that they could see that D belongs to both the bottom plane and the other...”

From this we infer operational invariant [31]. In addition, Sonia comments in the interview that different students would have different visions and *“the interest of rotating is that everyone can find the best possible viewpoint for himself”*. This corresponds to operational invariant [30]. The [30] ~ [31] reflect Sonia's knowledge or views about the potentials of 3D DGEs for supporting students' perception and her pedagogical strategies to take profit of these potentials, belonging to the category TPCOI.

Finally, the behavior of rotating the 3D dynamic model requires Sonia to know the corresponding technological skills – those expressed in the operational invariant [14]. As analyzed previously, this is an operational invariant in the category TCOI.

5.2.5 Summary of Lesson Series S.I

In this section, we give a summary of the analysis results of this lesson series in light of the first group of research questions.

Table 5.12 lists the main content of the analysis results, including the coordination schemes of Sonia and the 3D geometry tasks-3D DGEs in the corresponding classes of situations. The coordination schemes mainly include rules of coordination and operational invariants. In consistency with the labelling of the groups of rules of coordination, we use “class S.I-A, S.I-B, ...” and “scheme S.I-A, S.I-B, ...” to label the corresponding classes of situations and coordination schemes. To save space, we only integrate the main ideas of the operational invariants and the main characteristics of tasks and 3D DGEs; for a more complete description, please refer to the corresponding sections, 5.2.4 and 5.2.2.

Table 5.12 Summary of the analysis results of Lesson Series I of Sonia

Coordination schemes	3D geometry tasks-3D DGEs
	Class of situations
<p>Scheme S.I-A</p> <p>Rules of coordination:</p> <p>(1) request multiple students’ ideas about a geometric statement;</p> <p>(2) guide students to explain the statement by theoretical deductive reasoning instead of by perception in a 3D DGE.</p> <p>Operational invariants:</p> <p>COI: [1] intersection construction tasks in 3D geometry should be solved through theoretical deductive reasoning; [2] ~ [6] other geometric knowledge required for solving the tasks;</p> <p>PCOI: [7] pedagogical benefit of requesting multiple students’ ideas; [8] pedagogical benefit of students’ autonomous learning; [9] knowledge or views about how to promote students’ theoretical deductive reasoning. [10] students should be able to “construct” the intersections in space and also to “justify” their construction with theorems;</p> <p>TPCOI: [11] ~ [12] potentials of the 3D DGEs for students’ autonomous learning; [13] side effects of 3D DGEs for students’ theoretical deductive reasoning and pedagogical strategy for overcoming them;</p> <p>TCOI: [14] ~ [17] technological skills (and possibly the math knowledge) for turning around 3D dynamic models, constructing</p>	<p>Class of situations S.I-A</p> <p>Tasks 1 ~ 7 (Step 1):</p> <p>3D geometry topic: construct intersection of a plane and a line/planes which are on or inside a solid (to construct the intersection point of two particular lines as a part of target intersection);</p> <p>Status in curriculum/exam: study relative position problems in a geometric approach which is mainly prepared for vector approach; vision in space prepared for vector geometry; proof required for section construction tasks in the BAC exam;</p> <p>Context and innate support: see 3D DGEs below.</p> <p>3D DGEs:</p> <p>Figural representations and tools: restrained toolset including Line, Move and Intersect; a 3D dynamic model possibly with students’ constructions;</p>

<p>lines and intersection of lines, and checking answers in the 3D DGEs;</p> <p>PTCOI: [18] ~ [19] benefit of teaching technological techniques at very beginning, the corresponding pedagogical strategy.</p>	<p>Help and control: technical instructions, control in students</p> <p>Feedback: innate feedback in GeoGebra; answer checking feedback;</p> <p>Curricular distance: a gap from the theoretical deductive approach prescribed by the curriculum.</p> <hr/> <p>Support students' coordination, in a computer classroom, first contact with the tasks and exploration of task solving strategies</p>
<p>Scheme S.I-B</p> <p>Rule of coordination:</p> <p>(1) request students' idea about a geometric statement; (2) rebut (or invite other students to rebut) students' incorrect statement with other perceptive evidences from real objects or simulating gestures; (3) lead students to a correct geometric statement based on all the perceptive evidences.</p> <p>Operational invariants:</p> <p>COI: [20] ~ [24] geometric theorems about the possible relative positions between lines and planes in space and the nature of their intersection;</p> <p>PCOI: [7]; [25] knowledge of students' difficulty in 3D geometry; [26] importance of clarifying the content where students have difficulty; [27] ~ [28] advantages of simulating gestures and 3D real objects, over 3D dynamic models, in supporting students' perception in space.</p>	<p>Class of situations S.I-B</p> <p>Tasks 1 ~ 7 (Step 2):</p> <p>3D geometry topic: construct intersection of a plane and a line/planes which are on or inside a solid (after solving the task);</p> <p>Other information: same as above.</p> <p>No 3D DGEs used</p> <hr/> <p>Support students' coordination, in a computer classroom, construct geometric theorems related to the tasks</p>
<p>Scheme S.I-C</p> <p>Rule of coordination:</p> <p>(1) use a 3D DGE and simulating gestures to support students' perception; (2) directly validate the perception result and let students take it as a fact to develop the following theoretical deductive reasoning.</p> <p>Operational invariants:</p> <p>COI: [1]; [29] definition of intersection of two geometric objects;</p> <p>PCOI: [27] potentials of simulating gestures for supporting students' perception;</p>	<p>Class of situations S.I-C</p> <p>Tasks 4:</p> <p>3D geometry topic: construct intersection of two planes on a solid (to find out a vertex of the solid which is contained by both planes);</p> <p>Other information: same as above.</p> <p>3D DGE: same as the 3D DGEs above.</p> <hr/> <p>Support students' coordination, in a computer classroom, when students have difficulty in perception</p>

TPCOI: [30] potentials of 3D dynamic models for supporting students' perception; [31] pedagogical strategy for exploiting the potentials in [30];	
TCOI: [14] techniques for turning around 3D dynamic models.	

Research question 1.1 of this thesis concerns how the rules of coordination can be linked with the different categories of operational invariants in the corresponding schemes. To answer this question, we firstly identify the commonalities and differences between the different groups of rules of coordination in Table 5.12, and then link the commonalities and differences with the operational invariants in the corresponding schemes.

Contrasting the three groups of rules of coordination, we see that the interaction modes between the logical reasoning and the perception of students differ by group, with Sonia's emphasis laid on different kinds of activities of students. In S.I-A, Sonia mainly promotes students' theoretical deductive reasoning, guiding them to confirm or replace the perception results with theoretical deductive reasoning. In S.I-B, Sonia only supports students' perception. In S.I-C, Sonia also promotes students' theoretical deductive reasoning in general, which is similar to the case of S.I-A, but here she attaches more importance to students' perception – it is taken as a factual premise for the theoretical deductive reasoning.

The three groups of rules of coordination also show some commonalities and differences in the particular strategies that Sonia adopts to promote the perception or logical reasoning of students; the strategy is actually about Sonia's supportive actions, questions, and her use of resources. To be specific, in S.I-A, Sonia requests multiple students' ideas and constantly requests their explanation until they develop theoretical deductive reasoning; she does not use particular resources here and also restrains students' use of their perception in the 3D DGEs. In S.I-B, Sonia also requests multiple students' ideas like in S.I-A, but here she only invites students to give perceptive examples or counterexamples, with herself also giving perceptive examples with simulating gestures and real objects; in this way Sonia supports students' perception and the resources she uses include simulating gestures and real objects, but not 3D DGEs. In S.I-C, Sonia supports students' perception with both simulating gestures and 3D DGEs and the perception results are latter applied by students in their theoretical deductive reasoning.

It is worth noting that the important digital resources – 3D DGEs – are not always mobilized in the three groups of rules of coordination, and the subjects who mobilize the 3D DGEs also differ. In S.I-A, the 3D DGE are always at the disposition of students, who will make constructions from time to time while giving ideas or explanation under the teacher's request. In S.I-B there is no use of 3D DGEs. In S.I-C, the 3D DGEs are mainly used by the teacher in a specific way.

Next we compare the operational invariants in different schemes, in relation with the corresponding rules of coordination.

Regarding Sonia's emphasis on students' perception or logical reasoning in the rules of coordination, when she mainly promotes students' theoretical deductive reasoning, it is linked with some operational invariants about content (COI) and pedagogy of content (PCOI). For example, Sonia's common emphasis on students' theoretical deductive reasoning in S.I-A and C is related to a common COI for the two groups – Sonia's knowledge of the general solution

to intersection construction tasks in 3D geometry ([1]). The other operational invariants in the COI are varied by group, in consistency with the different 3D geometry tasks corresponding to the groups. Sonia's emphasis on theoretical deductive reasoning in S.I-A is also related to her views about the abilities that students should achieve with respect to the intersection construction tasks, that is [10], an operational invariant in PCOI.

When Sonia mainly promotes students' perception in the rules of coordination, it is linked with some operational invariants about pedagogy of content (PCOI) and technology in pedagogy of content (TPCOI). For example, Sonia's behavior of supporting students' perception with simulating gestures and real objects in S.I-B is related to three PCOI for that group – her knowledge of students' common difficulties in 3D geometry ([25]) and the potentials of the simulating gestures ([27]) and real objects for addressing the difficulties ([28]). Her behavior of supporting students' perception with simulating gestures and 3D DGEs in S.I-C is also related with the PCOI [27], and with a TPCOI concerning her knowledge of the potentials of 3D dynamic models for students' perception ([30]).

Regarding the particular strategies that Sonia adopts to promote students' perception or logical reasoning in the rules of coordination, they are mainly linked with operational invariants about pedagogy of content (PCOI) and technology in pedagogy of content (TPCOI). For example, in the rules of coordination S.I- A and B, Sonia both requests multiple students' ideas about a geometric statement making them rebut or validate each other; this is consistent with a common PCOI for the two groups – Sonia's knowledge or views about the pedagogical benefit of requesting multiple students' ideas ([7]). Later in S.I-A, Sonia allows students to explore in 3D DGEs but insists that students develop theoretical deductive reasoning, because she knows the potentials of the 3D DGEs for students' autonomous learning ([11] in TPCOI) but she also wants to overcome the side effects of the 3D DGEs for students' theoretical deductive reasoning ([12] in TPCOI) with some pedagogical strategy ([13] in TPCOI). In S.I-B, Sonia mainly supports students' perception with simulating gestures and real objects, because she knows students' difficulty in perceiving 3D geometry theorems and knows that it is important to exploit the potentials of the simulating gestures and real objects to address students' difficulty ([25] ~ [28] in PCOI). In S.I-C, Sonia permits students to use the perception results in 3D DGEs, because here she especially wants students to benefit from the perceptive evidences in the 3D DGEs ([30] in TPCOI) and she knows how to evoke the evidences properly to support students' perception ([31] in TPCOI). She also supports students' perception with simulating gestures in S.I-C, as she does in S.I-B; correspondingly we can find a common PCOI concerning Sonia's knowledge of the potentials of simulating gestures ([27]) for the two groups.

Finally, for the rules of coordination in which only Sonia uses 3D DGEs, we can find some operational invariants about technology and content (TCOI), such as the [14] for S.I-C. For the rules of coordination in which students also use 3D DGEs, the underpinning operational invariants also include those about pedagogy for linking technology and the related content (PTCOI), as exemplified by the operational invariants [18] ~ [19] and [14] ~ [17] for S.I-A.

Research question 1.2 of this thesis concerns how the coordination schemes can be influenced by the characteristics of 3D geometry tasks-3D DGEs. To answer this question, we identify the links between the groups of rules of coordination and the characteristics of the corresponding

3D geometry tasks-3D DGEs, and then refer to operational invariants to justify the links identified.

Firstly, Sonia's emphasis on students' theoretical deductive reasoning in rules of coordination S.I-A and S.I-C are influenced by the 3D geometry topics of the corresponding tasks and the status of the tasks in the curriculum. In fact, the corresponding tasks are both about constructing the intersection (identifying relative positions) of particular lines and planes in space, and the French curriculum prescribes a geometric approach for such tasks, i.e., to study them in reference to Euclidean geometric theorems. In the COI corresponding to S.I-A and S.I-C, Sonia shows her understanding of the task solutions which are consistent with the curriculum prescriptions ([1]), evidencing the influence mentioned at the beginning of this paragraph.

Secondly, Sonia's emphasis on students' perception in rules of coordination S.I-B is not only influenced by the 3D geometry topics of the tasks, but also by the features of some non-technological resources rather than 3D DGEs. Here the tasks Sonia deals with are not about Tasks 1 ~ 7 themselves, but about the basic geometric facts concerning the relative positions in space, which are related to Task 1 ~ 7. The French curriculum does not prescribe a particular way for illustrating the basic geometric facts. According to the operational invariants [25] ~ [28] for S.I-B, we see that Sonia mainly uses the simulating gestures and real objects, based on her own pedagogical knowledge and views about the potentials of these resources, to students' perception in the rules of coordination.

Thirdly, Sonia's strategies (especially the resources used) to support students' perception are influenced by the features of the figural representations in the 3D DGEs. The influence is mainly reflected in rules of coordination S.I-C and S.I-B. In S.I-C, Sonia makes students integrate some results perceived from the 3D DGEs directly into the theoretical deductive reasoning process, because it is exactly where the 3D dynamic models can play to their strength – they allow students to observe 3D objects from various viewpoints and see the faces which are not easy to be observed from a common viewpoint. The operational invariants [30] ~ [31] demonstrate Sonia's knowledge of the strengths of the 3D dynamic models and her pedagogical strategy to exploit these strengths, providing evidences for the link between the rules of coordination S.I-C and the powerful perceptive support of the 3D dynamic models. In S.I-B, Sonia's action of using simulating gestures and real objects to support students' perception can be linked with the limitation of the 3D dynamic models in presenting the different kinds of spatial relationships. Actually, the 3D dynamic model in each 3D DGE here could only provide good illustration for one kind of spatial relationship (between a line and a plane or two planes), which concerns the target intersection of the corresponding task. Sonia's use of simulating gestures and real objects in S.I-B aims to illustrate other kinds of spatial relationships overcoming the limitation of one 3D dynamic model, so that she can lead students to a more inclusive theorem that covers all the possible spatial relationships between two elements in the space. We hereby establish a link between Sonia's rules coordination of S.I-B with the limitation of the 3D dynamic models; the link is further supported by operational invariants [27] ~ [28], which reflect Sonia's knowledge of the advantages of simulating gestures and real objects over 3D dynamic models.

As for the strategies that Sonia adopts to foster students' theoretical deductive reasoning in the rules of coordination, we have not observed a strong link between them and the characteristics

of the tasks or 3D DGEs. According to operational invariants [11] ~ [13] and [30] ~ [31], we know that Sonia uses the 3D DGEs mainly for the benefit of students' autonomous learning and perception, and that she thinks the 3D DGEs could hinder students' theoretical deductive reasoning. This explain why there is no strong link between the strategies and the characteristics of the 3D DGEs. Actually, the strategies for supporting students' theoretical deductive reasoning are mainly determined by Sonia's own knowledge and views, which are reflected in some PCOI such as [9] - "request students' explanation constantly could facilitate students' theoretical deductive reasoning of students".

5.3 Case of Huang: Chinese teacher in real classrooms

This section presents the results of analysis of real classroom lesson series of a Chinese teacher, Huang (see section 4.2 for more information about the teacher). Throughout the Ph. D. period, we have been able to follow two real classroom lesson series in which Huang used 3D DGEs, noted as Lesson Series H.I and H.II respectively. The results of the two lesson series are respectively presented in sections 5.3.1 ~ 5.3.5 and sections 5.3.6 ~ 5.3.10.

Lesson Series H.I

Fig. 5.43 presents the timeline of our follow-up of Lesson Series H.I and the data collected.

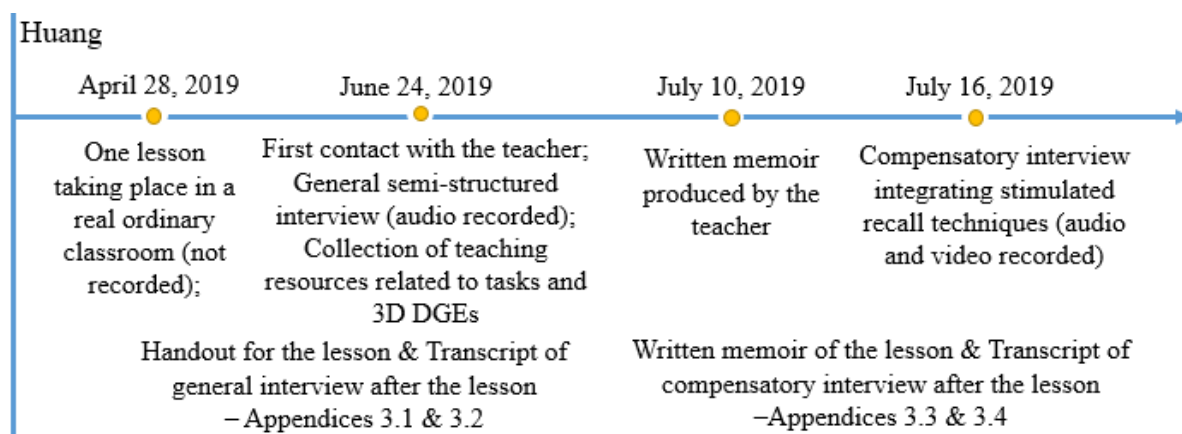


Fig. 5.43 Timeline of follow-up of Lesson Series H.I

5.3.1 Context of Lesson Series H.I

This section introduces the context of the single lesson in Lesson Series H.I. The context information to be introduced here have been mentioned in the methodology part (§ 4.4.1), and the information is obtained from the data of the general interview and the handout related to the lesson (Appendices 3.1, 3.2).

The lesson in the series took place on April 28, 2019. The students in the lesson belonged to the scientific stream in the general branch of Chinese upper secondary education. At the time of the observation, they were in the second semester of grade 12 – the final year of the upper secondary education– and in the second round of reviewing in preparation for GAOKAO (Chinese university entrance examination). It was an open lesson that Huang was invited to give in another district of the city (different from the district he was in at the time). The leaders of the Board of Education of that district invited Huang, in the hope that he could demonstrate how to integrate 3D DGEs into the reviewing lessons on 3D geometry for GAOKAO. It was the first time that Huang met with the students in the lesson, and many teachers and education researchers in the district came to observe the lesson. In the lesson of Huang, the 3D DGEs are just the GeoGebra files used by him and these files are all designed by himself. The characteristics of the 3D DGEs will be elaborated in section 5.3.2.

The teaching setting for the lesson is shown in Fig. 5.44. It was an ordinary real classroom in which only the teacher had access to a computer and student work was limited to the paper. In

the classroom, the computer was connected with an overhead projector, which projected the content of the computer to a projection curtain. The computer was installed with many software, such as GeoGebra, PowerPoint and PDF Reader. Other elements in the teaching setting included a blackboard, a desk for the teacher, desks and chairs for students, and seats for teachers and education researchers who came to observe the lesson. Students were seated in rows facing towards the blackboard and the projection curtain.

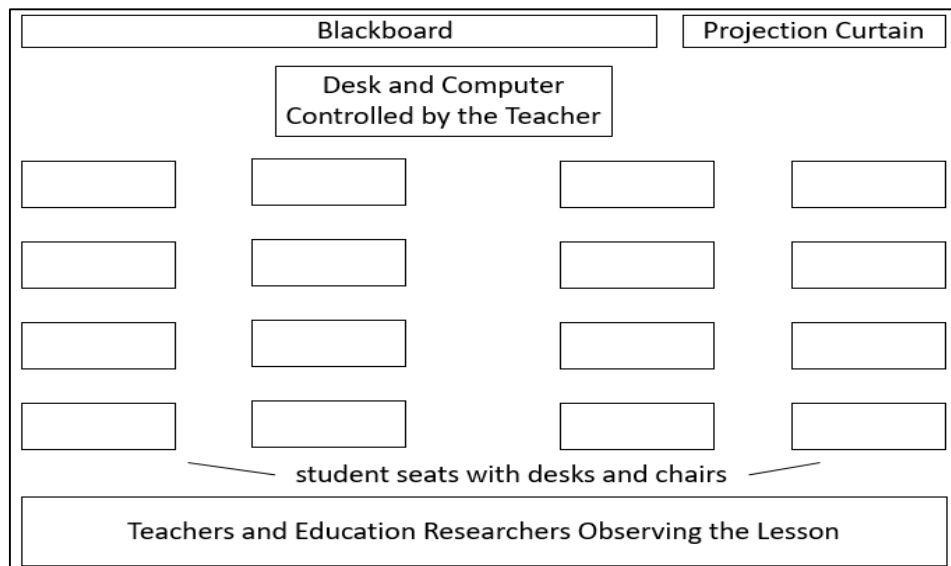


Fig. 5.44 Layout of teaching setting for Huang’s lesson in Lesson Series I

The subject matter of this lesson was “the sectioned cube”. The didactical objective of the teacher was to make students familiar with some figural patterns related to a sectioned cube, so that they could directly apply conclusions about the figural patterns to the examination tasks to improve the task solving efficiency. Before the lesson, the students had already learned much about 3D geometry, including properties of common solids such as straight prisms, regular pyramids, spheres, cubes and cuboids, properties of inscribed and circumscribed spheres of the common solids, and theorems about intersection, angles, parallelism and perpendicularity between lines and planes. The students had no prior experience of directly operating on GeoGebra, but they may have seen teachers display GeoGebra files in other lessons.

Huang organized the lesson around a handout, and the paper handout was distributed to every student at the beginning of the lesson. The handout consists of three parts which respectively concern three groups of figural patterns related to the cube: (1) sub-objects of cube, (2) cube and sphere, and (3) section of cube, as shown in Fig. 5.45-47 (for the complete version of the handout, see Appendix 3.1). Here Huang refers to three special solids in an ancient Chinese mathematics book *Nine Chapters on Arithmetic* (九章算术 jiǔ zhāng suàn shù) – 嵌堵 (QIANDU), 阳马 (YANGMA) and 鳖臑 (BIENAO). As shown at the bottom of Fig. 5.45, QIANDU refers to a triangular prism, YANGMA and BIENAO refer to a rectangular and a triangular pyramid respectively. Huang got to know the three “ancient” solids from the GAOKAO examination of one year, since then he has kept these solids as typical figural patterns that can be used to facilitate the process of solving 3D geometry tasks. For each group of figural patterns, the handout either gives the drawings of the figural patterns (Fig. 5.46),

either asks students to construct them in the frame of cubes (Fig. 5.45 and Fig. 5.47). Each group of figural patterns is followed by two 3D geometry tasks related to the figural patterns. All of the tasks were selected by Huang from the past local or national (GAOKAO) examinations. The characteristics of the tasks will be elaborated in section 5.3.2.

1. Sub-objects of cube

Please cut the cube to obtain the target figural pattern

Frustum of pyramid	壅堵 (QIAN DU)	阳马 (YANG MA)	鳖臑 (BIE NAO)	Regular tetrahedron
<p>阳马(YANG MA): a rectangle pyramid in which two lateral triangle faces are perpendicular to the rectangle base. 鳖臑(BIE NAO): a triangle pyramid in which all the four faces are all right triangles. Cutting a cuboid by its diagonal face will lead to two equal triangle prisms called 壅堵 (QIAN DU); Cutting one of the two triangle prisms will lead to one 阳马 (YANG MA), and one 鳖臑 (BIE NAO).—<i>Nine Chapters on Arithmetic</i></p>				

Fig. 5.45 First group of figural patterns in Lesson Series I of Huang (our translation from Chinese)

2. Cube and sphere

Are you familiar with the circumscribed sphere of the following figural patterns?

Corner of wall	壅堵 (qiàn dǔ)	阳马 (yáng mǎ)	鳖臑 (biē nǎo)	Pyramid with equal opposite edges	Inscribed sphere of a cube

Fig. 5.46 Second group of figural patterns in Lesson Series I of Huang (our translation from Chinese)

3. Sections of Cube

Please draw the corresponding sections in the following cubes

Triangle section	Quadrilateral section		Pentagon section	Hexagon section

Fig. 5.47 Third group of figural patterns in Lesson Series I of Huang (our translation from Chinese)

Evolving around the handout, there were three recurring activities in the lesson:

- Activity 1: Introduce or guide students to construct a group of figural patterns related to the cube;

- Activity 2: Allow time for students to solve tasks of that group in the paper-pencil environment;
- Activity 3: Explain the group of tasks with 3D DGEs and relate some tasks to figural patterns in the corresponding group.

Now we elaborate on the content of the lesson activities. Firstly, Huang introduced cube-related figural patterns of one group; the figural patterns were either already given in the handout, either to be constructed by the students on the handout (Activity 1). Then he left time for students to deal with the tasks of that group in the paper-pencil environment, with himself circulating around the class (Activity 2). Finally, he explained the tasks publicly, making writings and drawings on the blackboard, displaying GeoGebra animations on the screen, and linking some tasks with figural patterns in that group (Activity 3). It should be stated that not every task was clearly linked to a figural pattern by Huang. For the tasks of the last two groups, although the figures at stake were close to the corresponding figural patterns, Huang did not really apply the conclusions about the figural patterns for solving the tasks. The three activities repeated for each group of figural patterns and tasks.

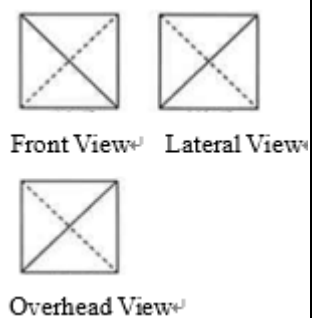
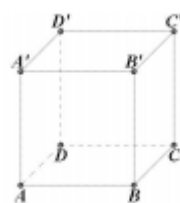
5.3.2 Characteristics of 3D geometry tasks-3D DGEs in Lesson Series H.I

This section presents how we analyze characteristics of the 3D geometry tasks and the 3D DGEs used in Lesson Series H.I, which are analyzed according to the dimensions of characteristics described in sections 3.3.1 and 3.3.2 . The content of the tasks is sorted out from handout (Appendix 3.1); the content of the 3D DGEs is sorted out from the GeoGebra files used by Huang in the lesson series.

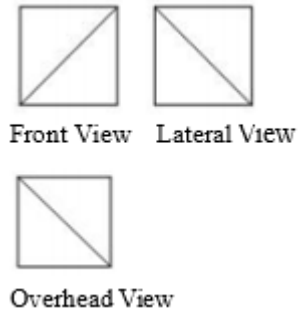
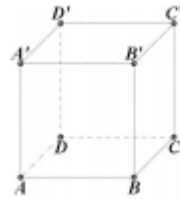
Characteristics of 3D geometry tasks

The 6 tasks dealt with in the lesson series are presented below. Tasks 1 ~ 2, 3 ~ 4, 5 ~ 6 respectively correspond to the three groups of figural patterns in Fig. 5.45, Fig. 5.46, Fig. 5.47. For the characteristics of the tasks, we firstly discuss the 3D geometry topic of every task one by one.

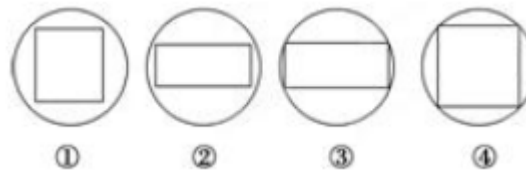
Task 1 The three-view diagram of a solid is shown on the right, the front, overhead and the lateral views are all squares with side length of 1, so the surface area of the circumscribed sphere of the solid is ____.



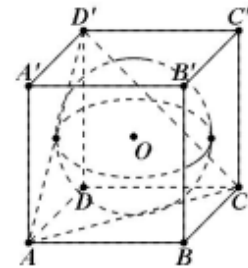
Task 2 A cube is cut off a part by a plane, the three-view diagram of the remaining part is as shown. The ratio of the volume of the cut-off part to the remaining part is ____.



Task 3 A cube is circumscribed by a sphere. Let a plane passing through the center of the cube cut the cube and the sphere at the same time. The section would be which one(s) __?



Task 4 As shown on the right, the sphere O is inscribed in the cube ABCD-A'B'C'D' with the side length of 1. The area of the section of the sphere O cut by plane ACD' is ____?



Task 5 The side length of a cube is 1, the angle between a plane α and each edge of the cube are all the same, then the maximum area of the cube's section cut by α is ()

- A $\frac{3\sqrt{3}}{4}$ B $\frac{2\sqrt{3}}{3}$ C $\frac{3\sqrt{2}}{4}$ D $\frac{\sqrt{3}}{2}$

Task 6 A plane α passes through the vertex A of a cube ABCD - A'B'C'D', $\alpha \parallel$ face CB'D', $\alpha \cap$ plane ABCD is m , $\alpha \cap$ plane ABB'A' is n , then the value of the sine function of the angle between m and n is ()

- A $\frac{\sqrt{3}}{2}$ B $\frac{\sqrt{2}}{2}$ C $\frac{\sqrt{3}}{3}$ D $\frac{1}{3}$

The general 3D geometry topic of Task 1 belongs to Topic 4 in section 3.3.1– determine geometric magnitudes in space; the geometric magnitude to be determined here is the surface area of the circumscribed sphere of a particular solid, and the particular solid needs to be constructed by students themselves. Hence the task topic overlaps with Topic 3 in section 3.3.1 – construct (representations of) geometric objects in space. Regarding variables (a) and (b) in Topic 3, the “geometric object” to be constructed is a solid whose top, front, and lateral views match the three-view diagram, and it has not been observed by students before the construction. Also, to determine the surface area of the circumscribed sphere of the original solid, students need to identify the shape of the original solid, taking into account its component parts that can be related to the radius of the circumscribed sphere. Therefore, the task topic also overlaps with

Topic 2 in section 3.3.1 – identify shapes of geometric figures in space, with the geometric figure being the original solid corresponding to the three-view diagram. To summarize, the detailed 3D geometry topic of Task 1 is to construct a solid according to a given three-view diagram, identify the shape of the solid and determine the surface area of its circumscribed sphere.

The 3D geometry topic of Task 2 also belongs to Topic 4 and overlaps with Topic 3 and Topic 2. After a similar analysis, we get that the detailed 3D geometry topic of Task 2 is to construct a sub-object of a cube according to a given three-view diagram, identify the shape of the sub-solid, and determine the ratio of its volume with the volume of the rest part of the cube.

The general 3D geometry topic of Task 3 belongs to Topic 2 in section 3.3.1, i.e., to identify shapes of geometric figures in space. The geometric figure whose shape is to be identified is the possible section of the composite solid of a cube and its circumscribed sphere. The variable (a) in Topic 2, the “classification system of shapes” is the set of the four sections provided by the task; this is a rough classification system only concerning the outlines of shapes. Regarding variables (b) and (c), the “background solid” of the sections whose shapes are to be identified is the composite solid of a cube and its circumscribed sphere, and the sections all pass through the center of the composite solid. In summary, the 3D geometry topic of Task 3, in a detailed version, is to identify the shapes of sections of the composite solid of a cube and its circumscribed cube, with the sections all passing through the center of the cube.

The 3D geometry topic of Task 4 belongs to Topic 4 generally, i.e., to determine geometric magnitudes in space. The geometric magnitude to be determined here is the area of a particular section of a sphere inscribed in a cube, for which students need to identify the shape of the particular section in advance. Thus the topic of the task overlaps with Topic 2 – identify shapes of geometric figures in space; and the geometric figure whose shape is to be identified is the particular section. The variable (a) in Topic 2, the “classification system of shapes” is a refined system because students should determine the section of a sphere is a circle and meanwhile determine the radius of the circle, for which they need to relate the circle to the diagonals of the cube’s three faces to see that the circle is inscribed to an equilateral triangle. The variable (b) in Topic 2, the “background solid” of the section is the sphere and its circumscribed cube. Regarding the variable (c) of Topic 2, the “relative position” of the section with respect to the background solid, we will say that the section is cut by a triangle face defined by three non-adjacent vertices of the cube. To summarize, the detailed 3D geometry topic of Task 4 is to determine the area of the section of a sphere inscribed in a cube, with the section being cut by the triangle defined by three non-adjacent vertices of the cube.

The 3D geometry topic of Task 5 also belongs to Topic 4 in general – determine geometric magnitudes in space, and the geometric magnitude to be determined is the maximum area of the varying section of a cube cut by a moving plane. Calculating the area requires students to identify the shape of the section that will have the maximum area and take into account the attributes of the component parts of the section. Then the task is related to Topic 2 – Identify shapes of geometric figures in space. After an analysis similar to the previous task, we get that the detailed 3D geometry topic of Task 5 is to determine the maximum area of a varying section of a cube, with the section being cut by a plane that forms the same angles with all the edges of the cube.

The 3D geometry topic of Task 6 generally belongs to Topic 4 – determine a geometric magnitude in space, and the geometric magnitude here is the value of sine function of the angle between two line segments on the surface of a cube. The determination of the sine function requires students to identify the angle between the two lines, which is associated with Topic 1 – identity geometric relationships in space. The variable (a) in Topic 1, the “relationship to be identified and the geometric objects involved in the relationship”, concerns the angle between two line segments. The variable (b) in Topic 1, the “background solid” of the angle is a cube. The variable (c) in Topic 1, the “relative position” of the two lines segments with respect to the background cube is a little complex: firstly, the two line segments are the intersection of a plane α and two adjacent faces – ABCD and ABB'A' – of the cube; secondly, plane α is parallel to a triangle face CB'D', with C, B', D' being three non-adjacent vertices of the cube. In summary, the detailed 3D geometry topic of Task 6 is to determine the sine function of the angle between two line segments on two adjacent faces of a cube, which are cut by a plane parallel to the triangle defined by three non-adjacent vertices of the cube

Now we discuss the status of the 3D geometry topics of the six tasks in Chinese curriculum. Since the students in this lesson series were at grade 12 in 2019, they fall in the scope of the old version of Chinese upper secondary mathematics curriculum. Furthermore, the students are in the scientific stream of the general branch, so in the following paragraphs, we focus on this part of the old version of Chinese curriculum to examine the prescriptions related to the tasks.

Tasks 1 and 2 both involve constructing the (2D representations of) original solid corresponding to a three-view diagram; this echoes the curriculum prescription that students should “be able to recognize the original solids (e.g., cuboids, spheres, cylinders, cones, pyramids and their simple combinations), from their three-view diagrams and construct drawings of these solids following parallel projection rules” (Ministry of Education of the People’s Republic of China, 2003, our translation). However, the curriculum does not clarify the particular methods to achieve this. The topics of the two tasks also involve identifying the shape of a solid and calculating some areas or volumes related to the solid. The identification of shapes of a solid corresponds to the curriculum prescription that “students should learn about structural attributes of common solids (e.g., prisms/cylinders, pyramids/cones, spheres, truncated pyramids/cones)”; whereas the calculation of areas and volumes corresponds to the curriculum prescriptions that students should “learn about (but not necessarily memorize) the formulae of surface area or volume of prism, pyramid, sphere, and truncated pyramid” (ibid, p.20).

Task 3, 4 and 5 all involve identifying shapes of sections of a cube, a sphere, or a composite solid of the two. Task 6 involves identifying the angle between two line segments which are the intersection of a plane and a cube. Both cases require students to analyze geometric relationships in the cubes and/or spheres, and link the relationships in 3D figures with those in 2D figures. For the analysis as such, the curriculum prescribes a “Euclidean geometric approach” – to “prove statements concerning relative positions in space with the conclusions already obtained” (ibid., p. 21). The conclusions include some basic facts and theorems in 3D Euclidean geometry, so the “Euclidean geometric approach” is actually a theoretical deductive approach in reference to the system of Euclidean geometric theorems. Also, the curriculum requires students to have perceptive and manipulation experiences with respect to (the proof

of) geometric properties of 3D figures, for which the use of information technology is suggested as an aid (Ministry of Education of the People's Republic of China, 2003).

In the Chinese curriculum for the scientific stream, the 3D geometry topics of the tasks are mainly related to 2D and 3D Euclidean geometry and 3D vector geometry. Many problems concerning geometric relationships in space can be solved through vector operations. The curriculum encourages students to make flexible choices between vector approach and geometric approach, solving 3D geometry tasks from different perspectives (*ibid.*).

Concerning the status of the six tasks in GAOKAO examination, all the tasks are close to the multiple-choice or fill-in-blank items in GAOKAO. These items only ask for a choice or a word/ sentence/ number/ magnitude to be filled in the blank. That means students can use any approach (including inductive reasoning, abductive reasoning, observation, imagination, random choice or guessing) to solve the tasks as long as the approach can yield a right answer. Every item as such takes up 5 points, out of the full mark of 150 points of GAOKAO. As can be seen, although the Chinese curriculum prescribes a Euclidean geometric approach or vector approach to the six tasks, the two approaches are both complex and not so economic in terms of the time for a multiple-choice or fill-in-blank item in GAOKAO.

Concerning the contexts of the tasks, we see that all the tasks are situated in the paper-pencil environment, as the task statements are presented on the paper handout and students need to write down their solutions on the paper with pens. Regarding the innate support, Tasks 1 and 2 are each equipped with a three-view diagram and a drawing of a cube. The three-view diagram is already given in the task, whilst the drawing is later integrated by the teacher. Here he who would like to provide a frame of a cube to help students locate the critical elements in the target solid defined by the three-view diagram. In Task 3 students are expected to choose from four drawings the correct sections of the composite of a cube and its circumscribed sphere. However, the drawing of the composite solid itself is not provided, so students have to imagine its spatial structure to determine the correct sections. Task 4 is equipped with a drawing of the composite solid. Task 5 and Task H.I.6 are equipped with no specific support, so students have to imagine the related solids and construct drawings by themselves, for which they should also know parallel projection rules.

Characteristics of 3D DGEs

Now we describe the characteristics of the 3D DGEs used in this lesson series one by one. As mentioned previously, each of the 3D geometry tasks is explained together with a 3D DGE designed by Huang with GeoGebra. Hence there are six 3D DGEs in total.

The figural representation in the 3D DGE for Task 1 is a 3D dynamic model of a regular pyramid being situated in a frame of a cube, as shown in Fig. 5.48. The pyramid is the original solid corresponding to the three-view diagram in Task 1. The frame of a cube is consistent with the drawing of a cube that Huang has integrated into the task on the paper. All the GeoGebra tools are retained in the 3D DGE, but Huang focuses on the Dragging tool and thus the manipulations are limited to turning around the 3D dynamic model. There is no specific form of help in the 3D DGE; the difficulty level and pace of learning activities in the 3D DGE are under the teacher's control. As for the feedback, there is only innate feedback in GeoGebra: by dragging the 3D dynamic model around, one can see the front, lateral and overhead views of

the pyramid and contrast them with the three-view diagram, as exemplified in Fig. 5.49. The 3D DGE is close to the Chinese curriculum (old version, hereafter the same) because (1) the 3D DGE can help students connect the three unfamiliar views with a pyramid, while the translation between common 3D figures and their three-view diagrams is an important content in the curriculum; (2) the 3D DGE illustrates how the spatial structure of the pyramid can be related to a frame of a cube, matching the didactical suggestion in the curriculum: “present 3D figures with computer software to help students understand their structural properties” (Ministry of Education of the People’s Republic of China, 2003, p. 22, our translation).

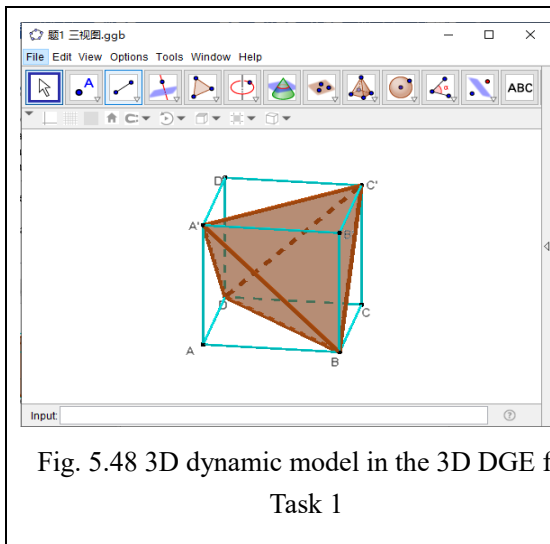


Fig. 5.48 3D dynamic model in the 3D DGE for Task 1

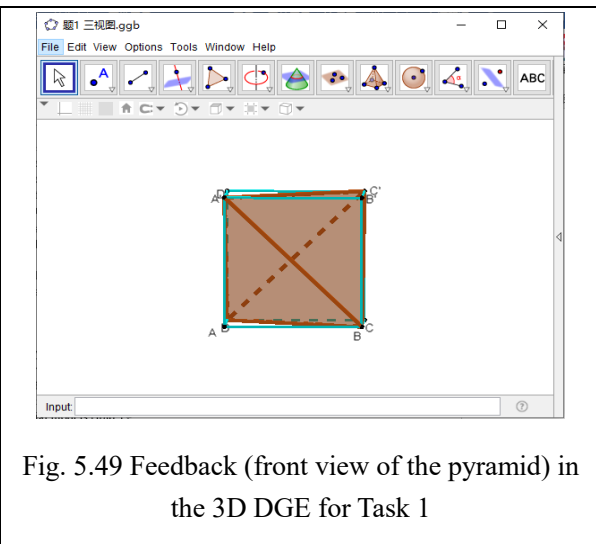


Fig. 5.49 Feedback (front view of the pyramid) in the 3D DGE for Task 1

The characteristics of the 3D DGE for Task 2 are generally the same with the 3D DGE for Task 1, except the 3D dynamic models therein. The 3D dynamic model for Task 2 is a sub-object of a cube, as shown in Fig. 5.50. The sub-object corresponds to the three-view diagram in Task 2, which is considered as the remaining part of the cube that has been cut off a corner. The feedback in this 3D DGE also concerns the front, lateral and overhead views of the original solid, and Fig. 51 shows the front view as an example.

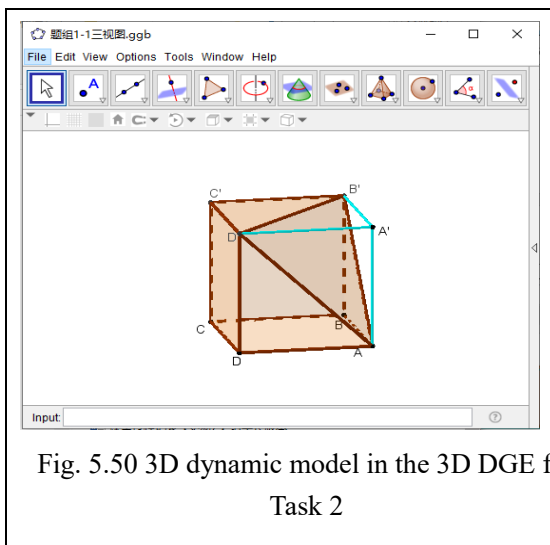


Fig. 5.50 3D dynamic model in the 3D DGE for Task 2

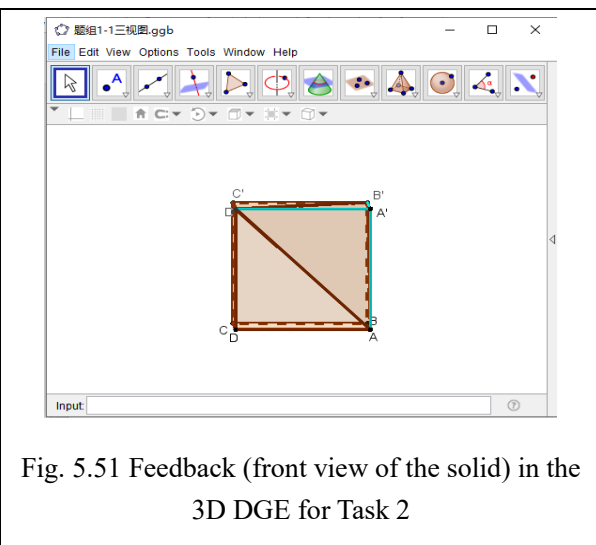


Fig. 5.51 Feedback (front view of the solid) in the 3D DGE for Task 2

Regarding the 3D DGE for Task 3, the figural representation in it is a 3D dynamic model incorporating a cube, the circumscribed sphere of the cube, and a plane passing through the center of the cube cutting the cube and the sphere at the same time; the sections of the cube and

the sphere cut by the plane are respectively traced with a shaded face and a bold outline, as shown in Fig. 5.52. The tools mobilized here, besides the Dragging, also include a slider of α (Fig. 5.52) that controls the angle by which the cutting plane is rotated around the center axis of the cube. Thus the manipulations in the 3D DGE mainly include dragging the point on the slider α to rotate the cutting plane, and dragging the whole 3D dynamic model to turn it around. The feedback in the 3D DGE is the innate feedback in GeoGebra which comes along with the two manipulations: by adjusting the angle α , one can rotate the cutting plane and observe the different sections of the cube and its circumscribed sphere; by turning around the whole 3D dynamic model, one can have different views of the model and choose the viewpoint allowing to observe the section best. Fig. 5.53 presents the section of the composite solid in a different view from Fig. 5.52 when α takes another value. The form of help and location of control in the 3D DGE are the same as in the previous 3D DGEs. Also, this 3D DGE is close to the curriculum as it can support students' perception of different sections of a cube and its circumscribed sphere, helping them understand the spatial structure of the combination of the two solids; this matches the didactical suggestion of "presenting 3D figures with computer software to help students understand their structural attributes" in the curriculum (Ministry of Education of the People's Republic of China, 2003, p. 22, our translation).

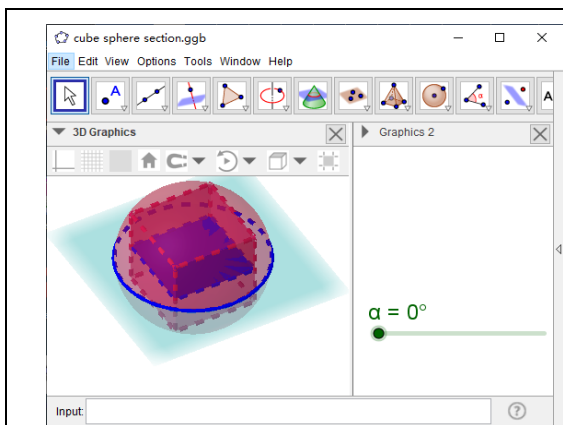


Fig. 5.52 3D dynamic model and the slider tool in the 3D DGE for Task 3

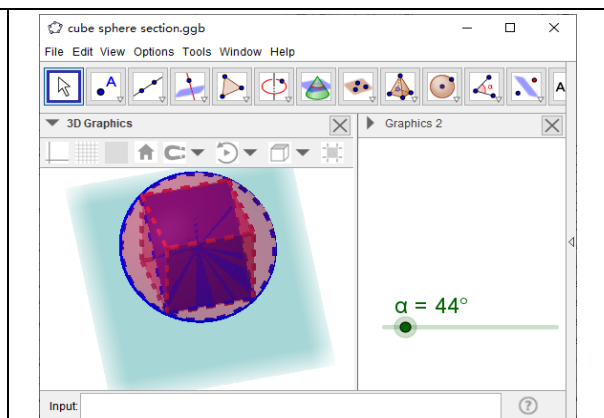


Fig. 5.53 Feedback (another view of another section) in the 3D DGE for Task 3

Regarding the 3D DGE for Task 4, the figural representation in it is a 3D dynamic model incorporating a cube $ABCD - A'B'C'D'$, a sphere inscribed in the cube, $\triangle AD'C$, and the midpoints of the three edges of $\triangle AD'C$. The section of the sphere cut by triangle face $AD'C$ is traced with a bold outline, as shown in Fig. 5.54. The tool mobilized in the 3D DGE is only the Dragging. Hence the manipulations in the 3D DGE are limited to turning around the 3D dynamic model, and the feedback is just the different views of the section when the whole model is rotated as exemplified in Fig. 5.55. From these views the teacher can choose the one that can well show that the section of the sphere is tangent to $\triangle AD'C$ at the midpoints of its three edges. The form of help and location of control in the 3D DGE are the same as in the previous 3D DGEs. The 3D DGE for Task 4, similar to the 3D DGE for Task 3, is close to the curriculum as its main didactical potential is also about supporting students' perception of the section of a composite solid – a sphere and its circumscribed cube – and helping students to

understand its spatial structure, matching the didactical suggestion in the curriculum mentioned above.

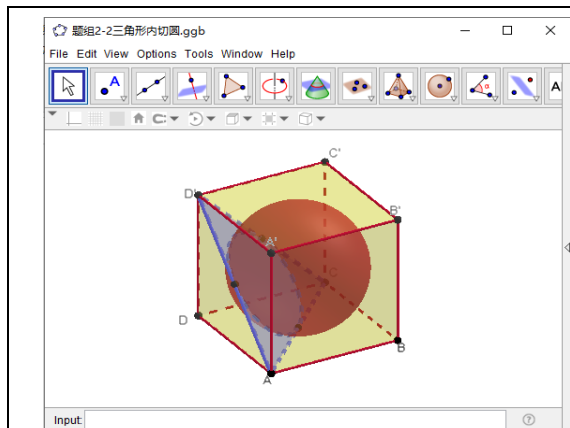


Fig. 5.54 3D dynamic model in the 3D DGE for Task 4

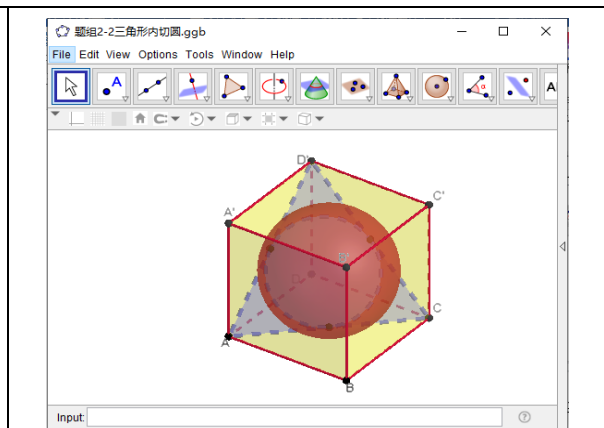


Fig. 5.55 Feedback (another view of section) in the 3D DGE for Task 4

Regarding the 3D DGE for Task 5, the figural representation is a complex 3D dynamic model incorporating a cube $ABCD-EFGH$, its diagonal AG , $\triangle EBD$, a free plane cutting the cube in an orientation parallel to $\triangle EBD$ (thus perpendicular to AG), and a point on the cutting plane. The section of the cube resulting from the cutting plane is outlined with bold line segments, as shown in Fig. 5.56. The tools used in the 3D DGE, besides the Dragging, include also a slider of α controlling the angle by which the cube is rotated around the diagonal AG , and two checkboxes controlling the display of the diagonal and the cutting plane parallel to $\triangle EBD$ (Fig. 5.56). The manipulations in the 3D DGE include: dragging the point on the slider α to rotate the cube around the diagonal AG (Fig. 5.57), dragging the point O on the cutting plane to translate it along AG while keeping it perpendicular to AG (Fig. 5.58-5.59), and dragging the whole 3D dynamic model to turn it around. The feedback here is the innate feedback of GeoGebra triggered by the manipulations: perceptive effect of the cube coinciding with itself after a rotation of 120° ; varying sections of the cube when the cutting plane is translated along AG (Fig. 5.58-5.59), and the different views of the whole 3D dynamic model. The availability of help, the location of control over learning activities in the 3D DGE are the same as in the previous 3D DGEs. With respect to the curricular distance, the didactical approach represented by the 3D DGE involves the “rotational symmetry” of a cube, but this is a concept out of the scope of the curriculum. Nevertheless, with the rotation process, the 3D DGE illustrates the equivalent angles and sides in the cube; this is consistent with the curriculum suggestion of “presenting 3D figures with computer software to help students understand the structural properties of 3D figures” (ibid.). The 3D DGE also allows students to observe the varying sections of the cube which are all perpendicular to AG , and further determine the section with the maximum area by inductive reasoning. This matches the curriculum suggestions of “using information technology to present 3D figures, providing perceptive support for the understanding and master geometric properties and their proof” (ibid.) Therefore, we say that the 3D DGE is slightly distant from the curriculum.

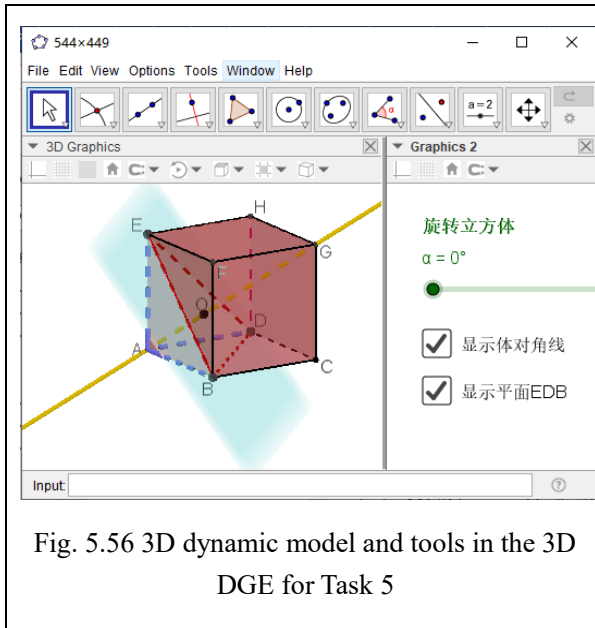


Fig. 5.56 3D dynamic model and tools in the 3D DGE for Task 5

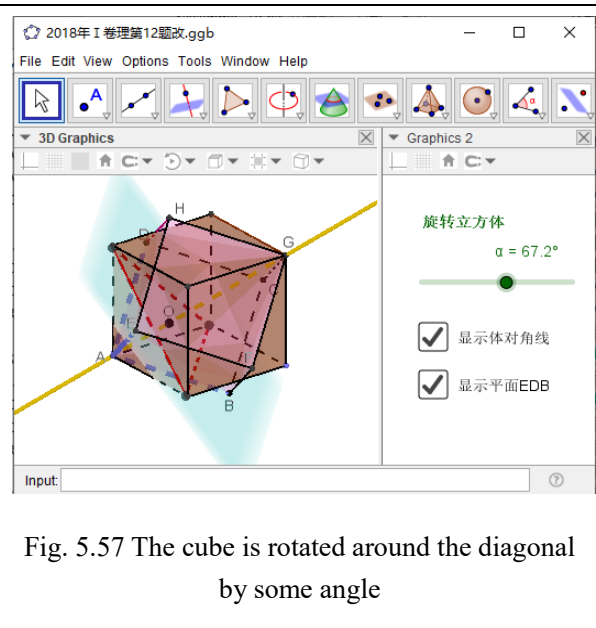


Fig. 5.57 The cube is rotated around the diagonal by some angle

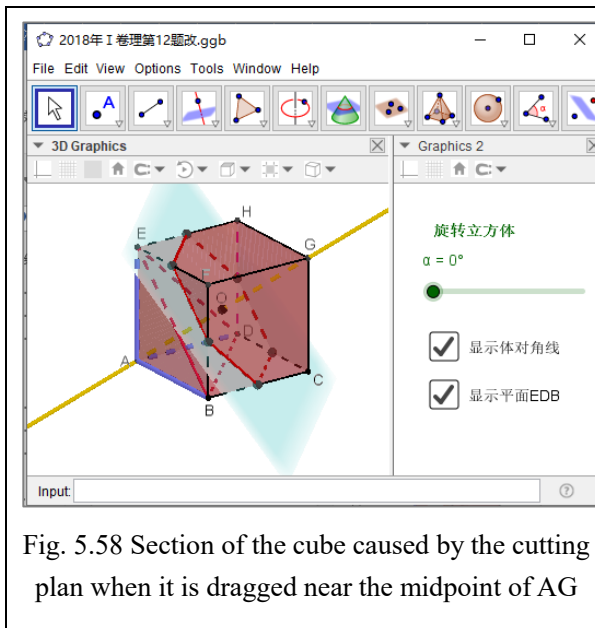


Fig. 5.58 Section of the cube caused by the cutting plan when it is dragged near the midpoint of AG

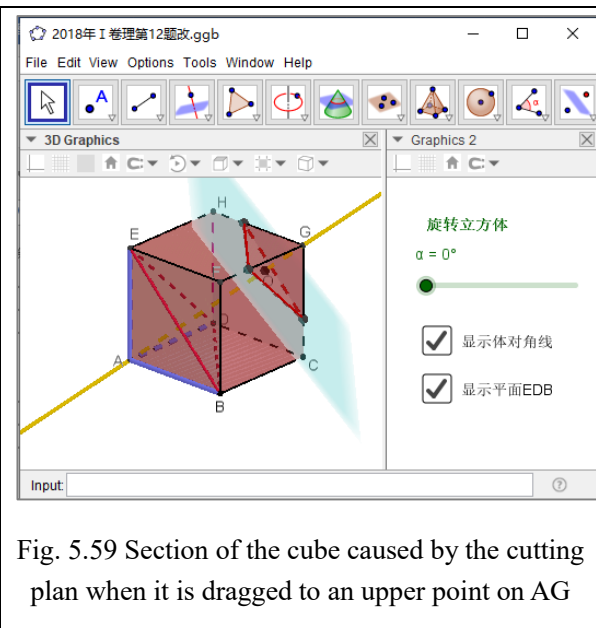
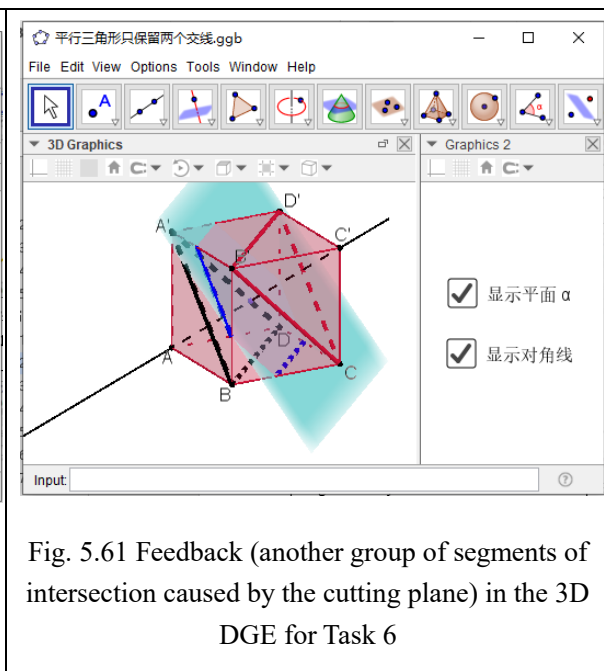
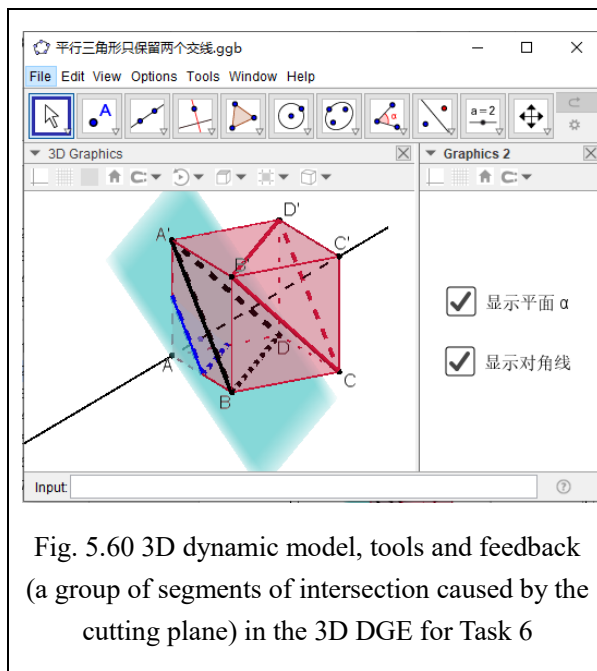


Fig. 5.59 Section of the cube caused by the cutting plan when it is dragged to an upper point on AG

Regarding the 3D DGE for Task 6, the figural representation is the 3D dynamic model incorporating cube $ABCD - A'B'C'D'$, diagonal line of the cube AC' , $\triangle CB'D'$, $\triangle A'BD$, a free point on the diagonal, and a free plane α passing through the free point and parallel to face $CB'D'$, as shown in Fig. 5.60. The intersection of plane α with two faces of the cube – $ABB'A'$ and $ABCD$ – are traced with bold segments. The tools mobilized in the 3D DGE mainly concern the Dragging; in addition to that, there are two check-boxes controlling the display of plane α and the diagonal (Fig. 5.60). Accordingly, the main manipulations in the 3D DGE are those related to the Dragging tool: (1) dragging free point on a plane α to translate it along the diagonal and keep α parallel to face $CB'D'$, and (2) dragging the whole dynamic model to turn it around. The feedback is all about innate feedback in GeoGebra, including: different intersection edges left on faces $ABB'A'$ and $ABCD$ when plane α is translated along the diagonal (Fig. 5.60-5.61), and the different views of the whole 3D dynamic

model. The $\triangle A'BD$ is later added by the teacher in the lesson, as he would like to introduce an intermediate face parallel to $CB'D'$ (and thus also parallel to the cutting plane α), so that students could realize that the intersection edges of α and the cube are always parallel to $A'B$ and BD . As for the help, the location of control over learning activities in the 3D DGE, they are all similar to those in the previous 3D DGEs. The didactical potentials of the 3D DGE mainly consist in the perceptive illustration of the parallel planes that intersect with a cube, and the display of invariant parallel relationship between the intersections left on the same face of the cube. The parallelism is actually related to a geometric theorem prescribed in the curriculum: the intersection of a third plane with two parallel planes are two parallel lines. In this sense, the 3D DGE is close to the curriculum because it complies with the curriculum suggestions which are already mentioned in the previous paragraph.



Finally, we give a summary of the characteristics of the 3D geometry tasks and the 3D DGEs used in this lesson, as shown in Table 5.13.

Table 5.13 Characteristics of tasks and 3D DGEs in lesson series H.I

		Task 1 ~ 2	Task 3	Task 4
Characteristics of 3D geometry tasks	3D geometry topic	Construct a solid according to a three-view diagram, identify the shape of the solid, and determine a magnitude related to the solid	Identify shapes of sections of the composite of a cube and its circumscribed sphere, with the sections all passing through the center of the cube	Determine the area of the section of a sphere inscribed in a cube, with the section being cut by the triangle surrounded by three diagonals of the cube's three faces.

	Status in curricula and exams	GAOKAO requirements: only a simple answer or option Curricular prescriptions: learn about structural attributes of common solids; know formulae of surface areas and volumes	GAOKAO requirements: only a simple answer or option Curricular prescriptions: Prove (Euclidean geometric approach to) relative positions in space with basic facts and theorems; have perceptive and manipulation experiences with respect to (the proof of) geometric properties of 3D figures; flexible choices between Euclidean geometry approach and vector approach	
	Innate support	Paper-pencil context A three-view diagram and a drawing of cube.	Paper-pencil environment 4 drawings of the composite of a square and a circle	Paper-pencil environment Drawing of the composite of a sphere and its circumscribed cube
Characteristics of 3D DGEs	Figural representations and tools	Representations: 3D dynamic model of the original solid being situated in a frame of a cube Tools and manipulations: turn around the 3D dynamic model to its front, overhead and lateral views with the Dragging tool	Representations: 3D dynamic model incorporating a cube, the circumscribed sphere, and a plane passing through the center of the cube Tools and manipulations: turn around the 3D dynamic model with the Dragging tool; control the angle of rotation of the cutting plane with slider α	Representations: 3D dynamic model incorporating a cube, the inscribed sphere, an equilateral triangle passing through three vertices of the cube, midpoints of three edges of the triangle Tools and manipulations: turn around the 3D dynamic model with the Dragging tool
	Help and control	No specific help; Difficulty level and pace of learning activities controlled by the teacher		
	Feedback	Innate feedback in GeoGebra: front, overhead and lateral views of the 3D dynamic model	Innate feedback in GeoGebra: different sections of the cube and its circumscribed sphere when the cutting plane is rotated; different views of the whole 3D dynamic model and the section therein	Innate feedback in GeoGebra: different views of the whole 3D dynamic model and the section of the sphere cut by the triangle in the model
	Curricular distance	Close to didactical suggestions of the curriculum		
	Task 5		Task 6	

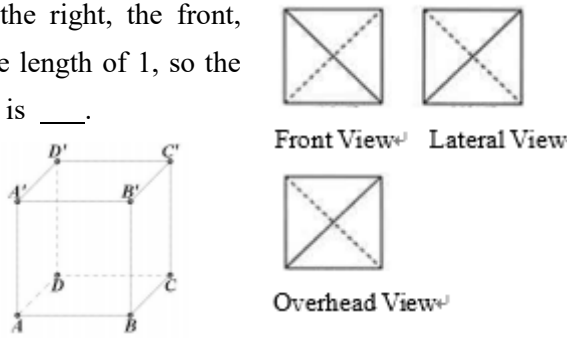
Characteristics of 3D geometry tasks	3D geometry topic	Determine the maximum area of a varying section of a cube, with the section being cut by a plane that forms the same angle with all the edges of the cube.	Determine the sine function of the angle between two line segments on two adjacent faces of a cube, which are cut by a plane parallel to the triangle surrounded by three diagonals of the cube's three faces.	
	Status in curricula and exam	GAOKAO requirements: only a simple answer or option Curricular prescriptions: Prove (Euclidean geometric approach to) relative positions in space with basic facts and theorems; have perceptive and manipulation experiences with respect to (the proof of) geometric properties of 3D figures; flexible choices between Euclidean geometry approach and vector approach		
	Context and innate support	Paper-pencil environment No specific innate support		
Characteristics of 3D DGEs	Figural representations and tools	Representations: 3D dynamic model incorporating a cube, its diagonal, an equilateral triangle passing through three vertices of the cube, a free plane parallel to the triangle, a point on the free plane and meanwhile the diagonal Tools and manipulations: rotate the cube around its diagonal with slider α ; translate the free plane along the diagonal by dragging the point on it; turn around the whole 3D dynamic model with Dragging tool.	Representations: 3D dynamic model incorporating a cube, its diagonal, two equilateral triangles respectively passing through three vertices of the cube, a free plane parallel to the triangle, a point on the free plane and meanwhile the diagonal Tools and manipulations: translate the free plane along the diagonal by dragging the point on it; turn around the whole 3D dynamic model with the Dragging tool	
	Help and control	No specific help; Difficulty level and pace of learning activities controlled by the teacher		
	Feedback	Innate feedback in GeoGebra: effect of the cube coinciding with itself after a rotation of 120° ; varying sections of the cube cut by the free plane when it is translated; different views of the whole 3D dynamic mode	Innate feedback in GeoGebra: different intersection edges left on the cube's two faces when the free plane is translated along the diagonal; different views of the whole 3D dynamic model	
	Curricular distance	Close to didactical suggestions of the curriculum		

5.3.3 Rules of coordination in Lesson Series H.I

This section presents three groups of rules of coordination and how we have identified them through the analysis of argumentation episodes. The rules of coordination fall in Lesson Series H.I, they are thus labeled as Groups H.I-A, H.I-B, and H.I-C. The argumentation episodes all come from the reconstructed transcript of the lesson. The analysis procedures that lead to these rules of coordination have been introduced in the methodology part (section 4.4.1)

Rules of coordination H.I-A: (1) provide students with a frame of cuboid and remind them of the rules of drawing three-view diagrams to promote their abductive reasoning; (2) use a 3D DGE to support students' perception making them certain of the abductive reasoning result.

The first example episode related to these rules of coordination is the episode of the whole collective argumentation around Task 1, which happened between Huang and the whole class of students. For convenience of reading, we present the task again here.

Task 1	
<p>The three-view diagram of a solid is shown on the right, the front, overhead and lateral views are all squares with side length of 1, so the surface area of the circumscribed sphere of the solid is ____.</p>	

The task asks for the surface area of the circumscribed sphere of a solid that could correspond to the given three-view diagram. The collective argumentation began when Huang started his public explanation in class after reading the task statement. In the process, he guided students to construct the original solid corresponding to the three-view diagram and briefly discussed the shape of the original solid with students. In the end, Huang let students calculate the surface area requested by the task after class.

Since Huang talked little about the shape of the original solid and the related calculation work, we consider the whole argumentation as a single episode which concerns the construction of the original solid. Below is presented the episode transcript integrated with the codes of argumentation components.

Episode – T, S – Task 1
<p>T: Now look at the first task (<i>presenting task H.I.1 on the projection curtain in the classroom</i>), the difficulty of this task is how to find the original solid, we can do this within the frame of a cube (Fig. (1), do you have any idea?</p> <p>S: Connect A'B and A'D. [1-Claim]</p> <p>T: Why would you like to connect A'B and A'D?</p>

S: ...

T: Can you imagine that, in each of the three views, the real lines indicate protruding edges in the original solid, while the dashed lines indicate the edges sinking to the backwards. **[2-Abductive Warrant]** So, given the three-view diagram as the result, can we speculate the original solid in reverse? The real line in the front view could correspond to $A'B$ in the cube, and similarly, the real lines in the lateral and overhead views correspond to $A'D$ and $A'C$, don't they? In this way, we can fix three edges and four vertices of the original solid. The same, we add the edges corresponding to the dashed lines (Fig.2), and this is just the original solid, agree? **[3-Claim]**

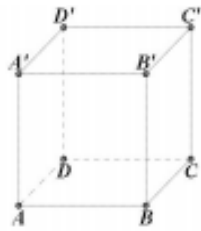


Fig. 1 Drawing of a cube that the teacher makes on the blackboard¹¹

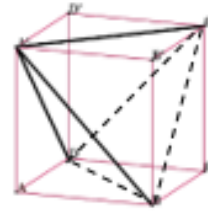


Fig. 2 Original solid that the teacher constructs within the drawing of a cube

S: Its front view is surely a square? **[4-Non-Absolute-Qualifier]**

T: OK, let's see what it is like in GeoGebra. This is the solid we constructed just now (Fig. 9). Now I turn it to the front view, is that exactly the front view in the task? then lateral view, and overhead view (Fig. 3-6) **[5-Perceptive-Data]**, are they exactly the three-views given in the task?

S: Yes. **[6-Absolute-Qualifier]**

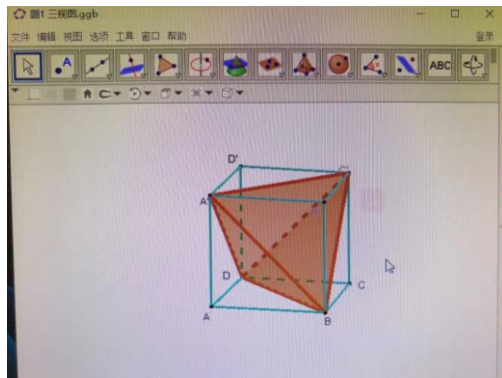


Fig. 3 3D dynamic model of the original solid being situated in a cube¹²

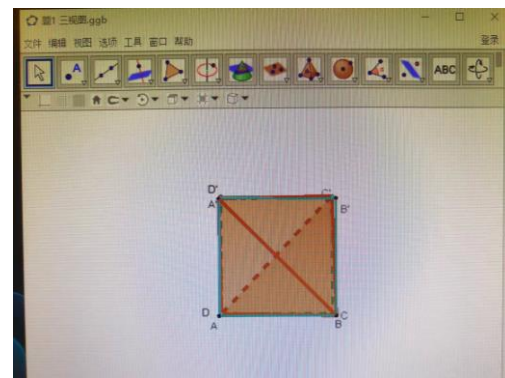


Fig. 4 Front view of the original solid

¹¹ In Lesson Series I, all the digital drawings of 3D figures were provided by the teacher in the written memoir, as a representation of what he had presented on the blackboard in the real classroom.

¹² All the images of screen in Lesson Series I are the photos taken by the researcher during the compensatory interview. The teacher was presenting digital (PDF, PowerPoint slides or GeoGebra) files on his computer, to reproduce what he had presented on the projection curtain in the real classroom.

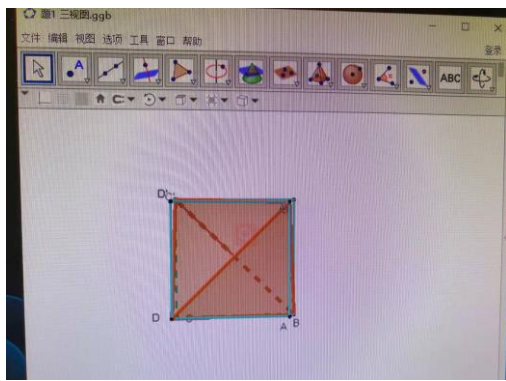


Fig. 5 Lateral view of the original solid

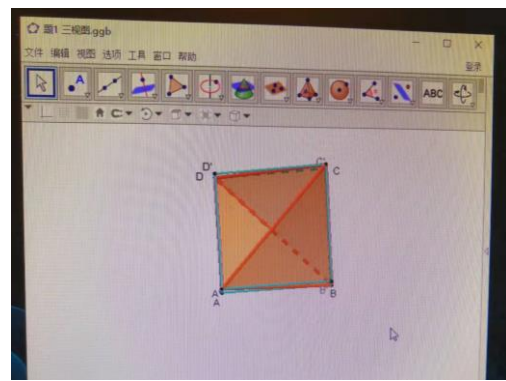


Fig.6 Overhead view of the original solid

T: So it is a solid of what shape?

S: Regular pyramid.

T: Exactly, we all know how to calculate the radius of the circumscribed sphere of the pyramid, right?
You complete this task after class.

We firstly discuss the argumentation components directly contributed by the participants in this episode. After presenting the task and the three view-diagram on the projection curtain, Huang lets students construct the original solid within the frame of a cube (Fig. (1) and asks for their ideas. Some students propose that the original solid should include edges $A'B$ and $A'D$ of the cube (1-Claim), and they probably make the claim according to the given three-view diagram, which is thus taken as an implicit Perceptive-Data. As the response, Huang asks them why but the students cannot give further explanation. Then Huang directly introduces the sketching rules for drawing a three-view diagram of a solid, and guides students to speculate the original solid reversely, taking the given three-view diagram as a result of applying the sketching rules. This process of seeking the likely conditions for a conclusion already observed is abductive reasoning, and thus we identify the sketching rules as 2-Abductive-Warrant. Following the abductive warrant, and also referring to the given three-view diagram, Huang draws all the edges of the original solid (Fig. 2), that is 3-Claim. However, students seem doubtful about the original solid as they cannot link a pyramid as shown in Fig. 2 to a front view of a square, which reflects a Non-Absolute Qualifier (labeled 4) from them for 3-Claim. After that, Huang shows the three views of the 3D dynamic model of the original solid in GeoGebra (5-Perceptive-Data), to confirm that the solid constructed can really have the target three views. The following discourses of students show that the demonstration in GeoGebra has removed their uncertainty about 3-Claim, and thus we attach another Non-Absolute-Qualifier (labeled 6) to the Claim.

Secondly, we discuss Huang's indirect contributions to the argumentation. They include: questions *requesting an idea* and *requesting elaboration* which elicit students' contributions of 1-Claim, and the *use of 3D DGE* related to his own contribution of 5-Perceptive Data. The argumentation components and the indirect contributions are organized together in the diagram in Fig. 5.62. Huang's direct contributions (yellow and green boxes) and indirect contributions (talk bubbles) together constitute her coordination behavior in this episode.

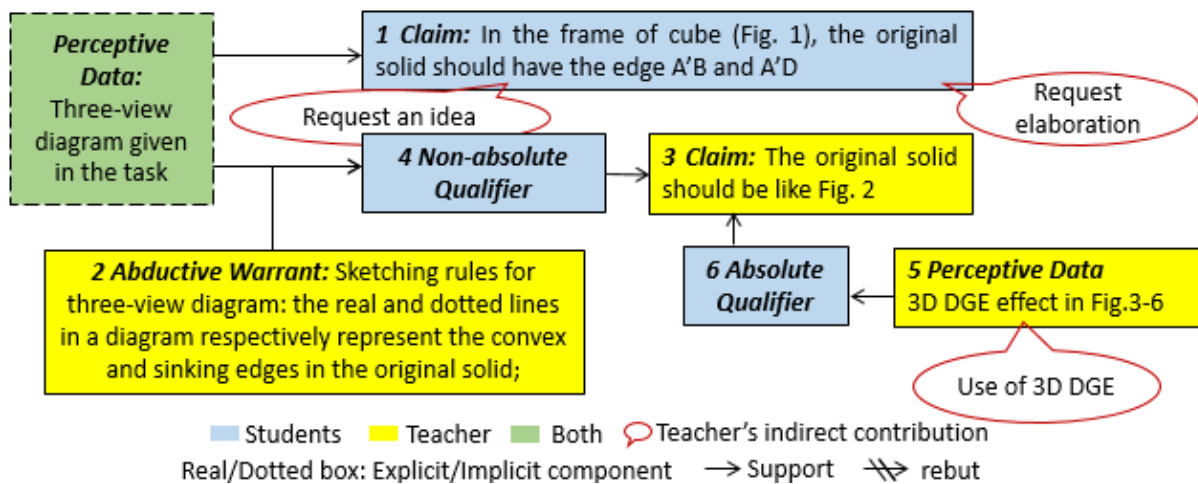
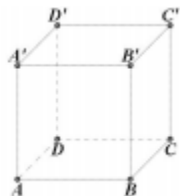


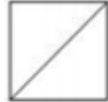
Fig. 5.62 Diagram of argumentation for Episode-T, S-Task 1


The second example episode is the episode covering the whole collective argumentation around Task 2, as presented below. The collective argumentation, like that in the first task, also happened between Huang and the whole class of students.


Task 2

A cube is cut off a part by a plane, the three-view diagram of the remaining part is as shown. The ratio of the volume of the cut-off part to the volume of the remaining part is ____.




Front View


Lateral View


Overhead View

With respect to this task, Huang firstly left some time for the students to construct the original solid within the drawing of a cube by themselves, and Huang himself walked around the classroom to inspect students' work. The collective argumentation began when Huang asks a student about his construction while circulating around. After a short discussion with the student, Huang went back to the blackboard, guides the whole class of students to determine the original solid matching the three-view diagram given in the task. Then, Huang pointed out the shape of the part being cut off from the cube, and let students calculate the target magnitude after class. That was the end of the collective argumentation.

For a similar reason to the first example episode, we consider the whole argumentation as a single episode which mainly concerns the construction of the original solid according to the three-view diagram. Below is shown its transcript integrated with the codes of argumentation components.

Episode-T, S-Task 2

T: Please try to accomplish task 2 according to task 1 (*presenting task 2 on the projection curtain in the classroom*).

T: (*Approaching a student after several minutes*)
Ok, how do you plan to make the solid?

S1: I can only make it to this extent (Fig.1).

[1-Claim]

T: Then can you calculate its volume?

S1: I am not sure whether there are edges hidden behind **[2-Non-Absolute-Qualifier]**, there is no dotted lines...

T: (*Walking back to the blackboard*) OK, I saw some students have already constructed a solid like this (Fig.1) In the three-view diagram there is no dashed lines, it indicates what?

S: ...

T: That is, there are no specific edges hidden behind **[3-Claim/Factual-Data]**, We've already constructed the original solid. Let's check it in GeoGebra, you see this is the solid, then the front view, lateral view, and overhead view (Fig. 2-5) **[4-Perceptive-Data]**. Now do you still have questions?

S: NO, it's OK. **[5-Absolute-Qualifier]**

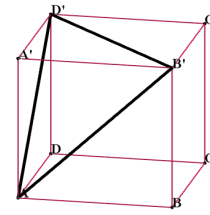


Fig. 1 Drawing made by the teacher on the blackboard to reproduce a student's work on the paper

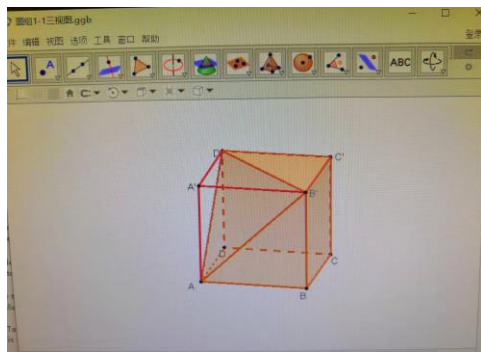


Fig.2 3D dynamic model of the original solid being situated in a cube

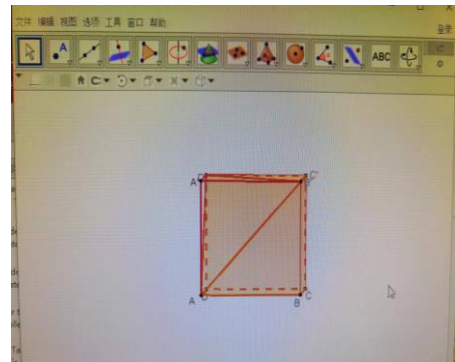


Fig.3 Front view of the 3D dynamic model

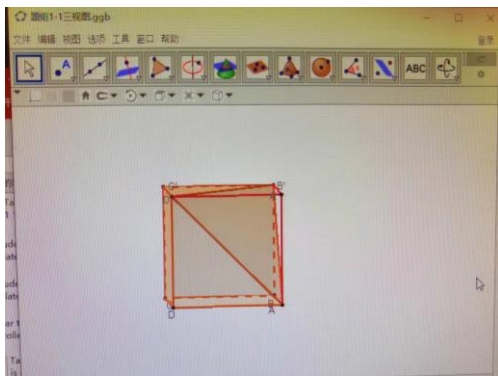


Fig.4 Lateral view of the 3D dynamic model

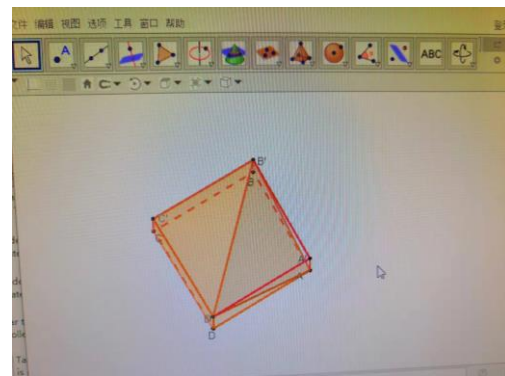


Fig.5 Overhead view of the 3D dynamic model

T: So the solid, as a remaining part of a cube after a corner is cut off the cube, right? Then what's the shape of the corner?

S: A triangle pyramid.

T: Yes, and its height is exactly the edge of the cube, isn't it? After calculating the volume of the pyramid, we can then get the volume of the remaining part. You complete this after class.

We firstly discuss the argumentation components directly contributed by the participants in this episode. At the beginning, when Huang asks one student S1 how he will construct the original solid, he proposes a Claim (labeled (1)) that the original solid should be like in Fig. 1. However, the absence of “dotted” lines in the three-view diagram makes S1 not sure whether there are edges behind he has missed, i.e., the edges actually existing but perhaps not reflected in the three-view diagram given in the task. This reflects a Non-Absolute-Qualifier (labeled 2) that S1 attaches to 1-Claim, and also shows that he strictly follows the method taught by the teacher in the last task, to speculate the convex and sinking edges in the original solid reversely according to the “real” and “dotted” lines in the given three-view diagram. Therefore, the 1-Claim is supposed to be built on an implicit Perceptive-Data concerning the given three-view diagram and an implicit Abductive-Warrant related to the sketching rules for drawing three-view diagrams. As a response, Huang repeats S1's words, and explains publicly that the absence of “dotted” lines in the three-view diagram means there is no edges hidden behind the solid (3-Claim), validating the solid already constructed (1-Claim). Huang further helps students check the solid with GeoGebra: he displays and rotates the 3D dynamic model of the original solid in GeoGebra, showing that the front, lateral and overhead views of the solid match well the given three-view diagram, that is 4-Perceptive-Data, with which the students finally have no problems with the solid constructed and continue discussing the shape of the solid with the teacher. Therefore, we consider that there is finally an Absolute-Qualifier (labeled 5) from students for 1-Claim.

Secondly, we discuss Huang's indirect contributions to the argumentation. They include: the question of *requesting a method* that elicits students' contribution of 1-Claim; the action of *validating 1-Claim by drawing a consistent conclusion following the same* (abductive) *logic*, which elicits 5-Absolute-Qualifier from students; and the *use of 3D DGE* that goes together with his contribution of 4-Perceptive-Data. All the direct contributions of participants and Huang's indirect contributions are integrated into the diagram of Fig. 5.63. Huang's direct contributions (yellow and green boxes) and indirect contributions (talk bubbles) together constitute her coordination behavior in this episode.

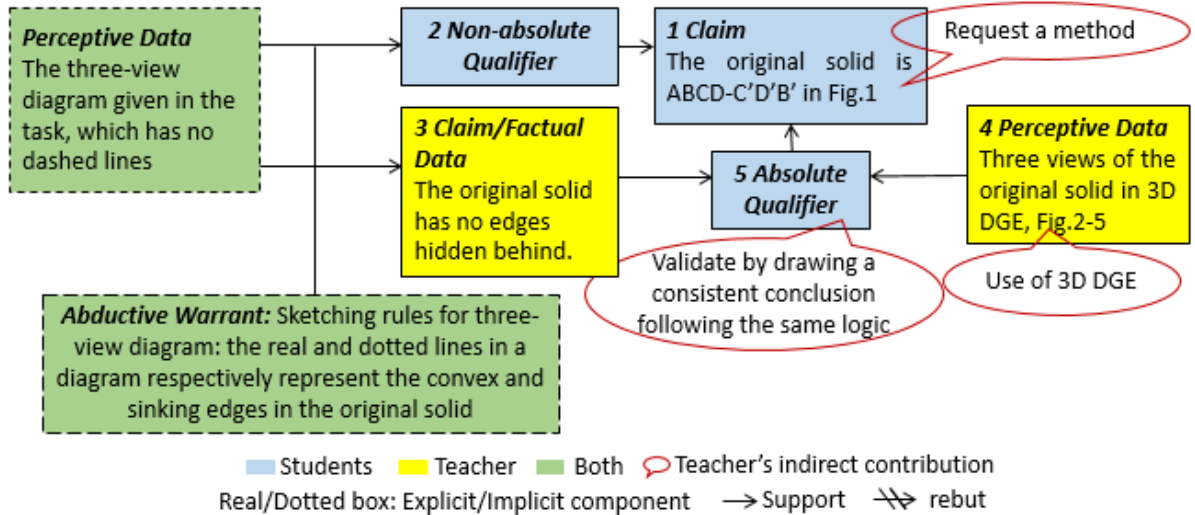


Fig. 5.63 Diagram of argumentation for Episode – T, S – Task 2

The two argumentation episodes are underpinned by the same *basic structure*. As the two diagrams of argument (Fig. 5.62, Fig. 5.63) show, they both cover a chain of Perceptive Data – Abductive Warrant – Claim, which represents an abductive reasoning process; the Claim concerns the original solid matching the three-view diagram drawn either by Huang or by the students in reference to the Perceptive Data of the three-view diagram; the Abductive Warrant concerns the sketching rules for three-view diagrams which is always introduced by the teacher. At the first time that the Claim is drawn, students tend to attach a Non-Absolute Qualifier to it. The Non-Absolute Qualifier is replaced by an Absolute Qualifier (i.e., their uncertainty is removed) only after Huang evokes the perceptive data in the 3D DGE showing that the solid constructed could really have the three views specified in the three-view diagram. The two episodes related to Task 1 and Task 2 are therefore classified into Group H.I-A, and their common basic structure is represented by the general diagram in Fig. 5.64.

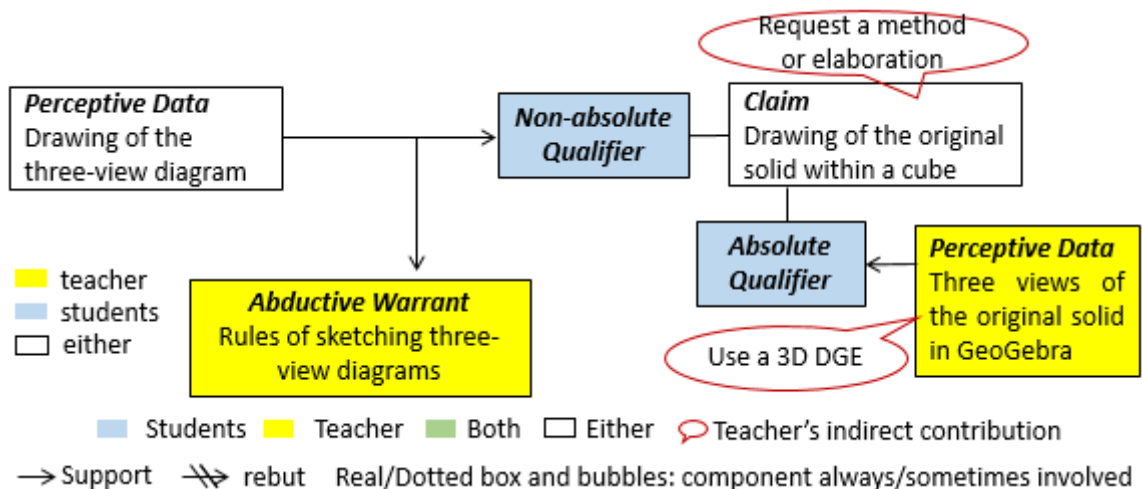


Fig. 5.64 General diagram of argumentation for the episodes of Group H.I-A

Teacher's contributions to the general diagram reside in: (1) direct contribution of the Abductive Warrant (rules of sketching three-view diagrams) after his questions *requesting a method* or *idea* of students about how to construct the original solid; 2) direct contribution of

the Perceptive Data with the *use of a 3D DGE*, which makes students attach an Absolute Qualifier to the claim in place of a non-absolute qualifier. These contributions can be synthesized as two rules of coordination: (1) provide students with a frame of cuboid and remind them of the rules of drawing three-view diagrams to promote their abductive reasoning; (2) use a 3D DGE to support students' perception making them certain of the abductive reasoning result.

Rule of coordination H.I-B: (1) use a 3D DGE and simulating gestures to support students' perception; (2) ask students to draw a conclusion by perception or perception-based inductive reasoning; (3) guide students to explain the conclusion with theoretical deductive reasoning.

The first example episode related to these rules of coordination is the Episode 1 of the collective argumentation around Task 3, and the argumentation happens between Huang and the whole class of students. The task concerns the section of the composite solid of a cube and its circumscribed sphere, as presented below.

Task 3
A cube is circumscribed by a sphere. Let a plane passing through the center of the cube cut the cube and the sphere at the same time, the section would be which one(s) __?

The collective argumentation begins when Huang directly launched a discussion with the students after reading the task statement. In the argumentation, the participants discussed the four options of sections in the task one by one, according to which we divide the whole argumentation into four episodes. The following is the transcript of the first episode which evolves around section ①.

Episode 1-Task 3
T: Please think about this task (<i>presenting task 3 on the projection curtain in the classroom</i>).
S: (One student) It's ②③④?
(Another student) should it be ①②③?
(Another student) or ①②③④?
T: First, let's look at ①, we choose it or not?
S: No [1- Claim], I feel that the vertices of a square section should touch the border of a circle section [2-Structural-Intuitive-Warrant].
T: Is it possible that, the cutting plane passes through the edges of the cube that don't touch the sphere [3-Claim/Rebuttal-to-Warrant]?
S: ... (<i>silence for a while</i>) ...

T: Let's directly observe the model in GeoGebra (Fig. 1) [4-Perceptive-Data], do you notice that the plane should pass through the center of the sphere and also the center of the cube (Fig. 1) [5-Factual-Data]? So it will intersect with the edges of the cube, and then with the sphere, but these edges won't touch the surface of the sphere (rotating the GeoGebra model, Fig. 2) [echoing 3-Claim/Rebuttal-to-Warrant], right? So shall we select ①?

S: Yes! [6-Claim]

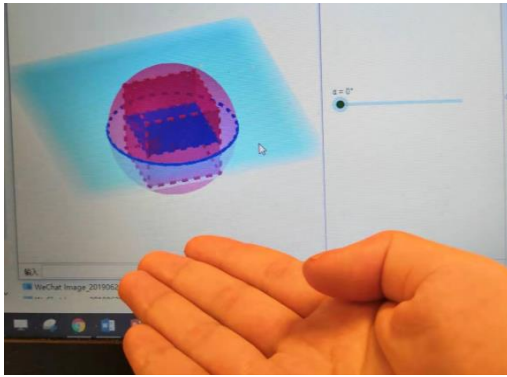


Fig. 1 The teacher makes the plane cut the cube-sphere horizontally ($\alpha=0^\circ$ on the slider) from their center and uses a gesture to simulate the cutting process

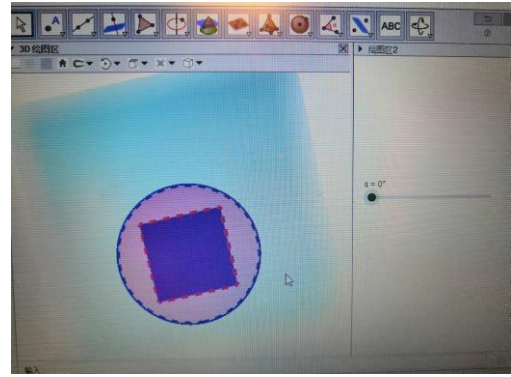


Fig. 2 Another view of the 3D dynamic model in Fig.1 during the process of the teacher rotating the model

We firstly consider the argumentation components directly contributed by the participants in the episode. At the beginning, Huang finds that students' answers for the task are various and quickly decides to talk about the four options of sections one by one. With respect to the first option, section ①, Huang requests students to make a judgement on whether it should be selected and got a negative answer (1-Claim) from some, who feel that "the square section should touch the border of the circle section". This reflects the students' structural intuition about the relation between a composite solid of a cube and a sphere and its sections: if a cube is circumscribed by a sphere, any (square) section of the former should also be circumscribed by the (circle) section of the latter. Hence we suppose that 1-Claim is derived from the task information of a cube being circumscribed by a sphere (implicit Factual-Data) in reference to a Structural-Intuitive-Warrant (labeled 2). The warrant is then rebutted by Huang who proposes a possibility that the section plane only passes through the cube's edges with the edges not touching the sphere, that is 3-Claim/-Rebuttal-to-Warrant. As can be seen, this claim involves the structural features of the composite solid, and the interaction of the section plane with the composite solid. In the later discussion, Huang also mentions the fact that the section plane passes through the center of the cube (5-Factual-Data) to support 3-Claim. So we consider that the 3-Claim is drawn in reference to an implicit Deductive-Warrant about the structural features of the composite solid and the properties of its sections. Huang further provides perceptive examples with the help of 3D DGE and gestures (4-Perceptive-Data), showing that the possibility in 3-Claim does exist. All these make the students well accept the existence of section ① (6-Claim).

Secondly, we consider Huang's indirect contributions to the argumentation. They include: the questions of *requesting an idea (judgement)* which elicits students' contributions of 1-Claim and 6-Claim; the supportive action of *rebutting with a counterexample* in reaction to the 2-

Structural-Intuitive-Warrant from students; and the *use of 3D DGE* which goes together with his own contribution of 4-Perceptive Data. All the participants' direct contributions and Huang's indirect contributions are integrated into Fig. 5.65. Huang's direct contributions (yellow boxes) and indirect contributions (talk bubbles) together constitute her coordination behavior in this episode.

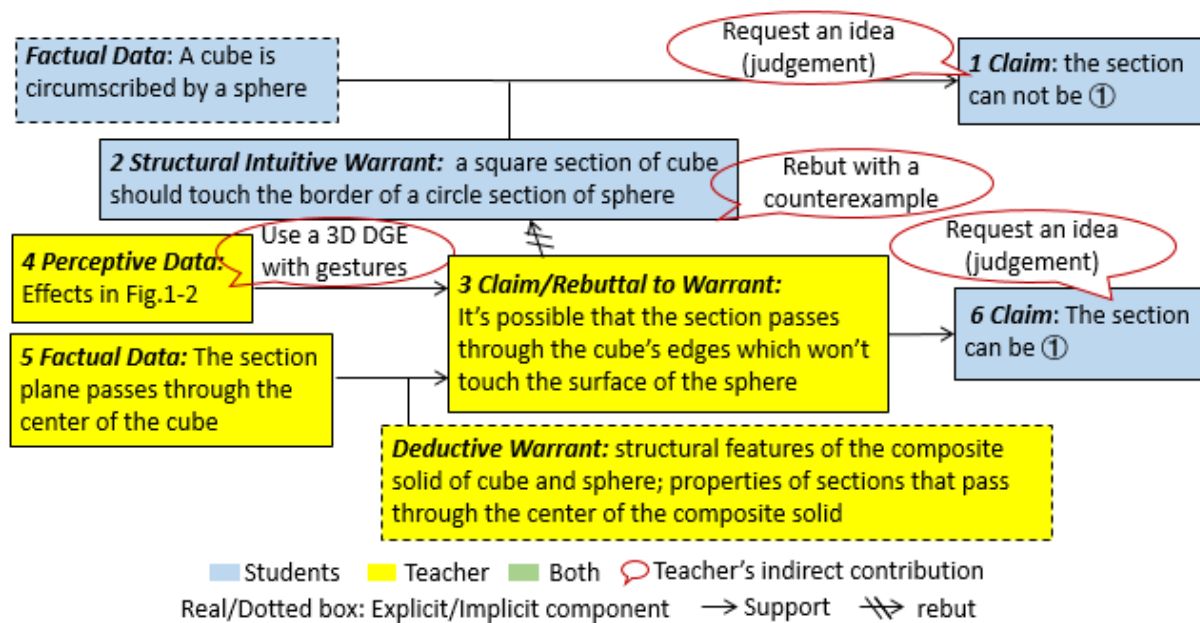


Fig. 5.65 Diagram of argumentation for Episode 1 – T, S – Task 3

The second example episode is the Episode 1 of the collective argumentation around Task 6, as presented below. The collective argumentation also happened between Huang and the whole class of students.

Task 6			
Plane α passes through vertex A of cube ABCD – A'B'C'D', $\alpha //$ face CB'D', $\alpha \cap$ face ABCD is m , $\alpha \cap$ face ABB'A' is n , then the value of the sine function of the angle between m and n is ()			
A $\frac{\sqrt{3}}{2}$	B $\frac{\sqrt{2}}{2}$	C $\frac{\sqrt{3}}{3}$	D $\frac{1}{3}$

For this task, Huang first left some time for students to solve the task by themselves, and himself walked around the classroom to inspect student work. Then he came back to the blackboard, making a drawing on the blackboard and starting his explanation. That was the beginning of the whole collective argumentation. In the following argumentation, Huang helped students to understand that m , n are always parallel with $A'B$ and BD in $\Delta A'BD$ on the cube (one argumentation node). After that, Huang guided students to calculate the angle between m and n and to transform it into the angle between $A'B$ and BD , which is an interior angle of an equilateral triangle $\Delta A'BD$. Students quickly realized that the angle is 60° and this was the end of the whole argumentation.

The process from the beginning to the argumentation node is considered as Episode 1 of the collective argumentation, with the remained part being Episode 2. The argumentation node is

decided according to Huang’s words “Then how to calculate the angle between m and n ?”, which marks the beginning of a new phase of argumentation concerning the calculation of the angle. Here we focus on Episode 1 and its transcript is presented below. Episode 2 is a purely theoretical deductive reasoning process and will not be specifically analyzed in this thesis.

Episode 1 – T, S – Task 6

T: (Fig. 1) So Task 6, how do you calculate the angle between m and n ?

S: ...How to find a plane α ?

T: α is parallel to $CB'D'$, it’s just like the last task (task 5), it is perpendicular to the diagonal of the cube, right? Let’s see it in GeoGebra, here the plane $CB'D'$ is just the red triangle, α is the cutting plane, m is the intersection of α and the face $ABCD$, n is the intersection of α and the face $ABB'A'$, here, and here (Fig. 2) [part of 1-Perceptive Data]. Now I only retain these two line segments and translate the plane up and down, keeping it parallel to $CB'D'$ (Fig.3), have you found any regularities?

S: ...(silence for a while)...

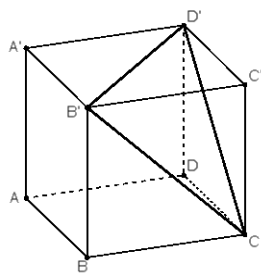


Fig. 1 Drawing for the task that the teacher makes on the blackboard

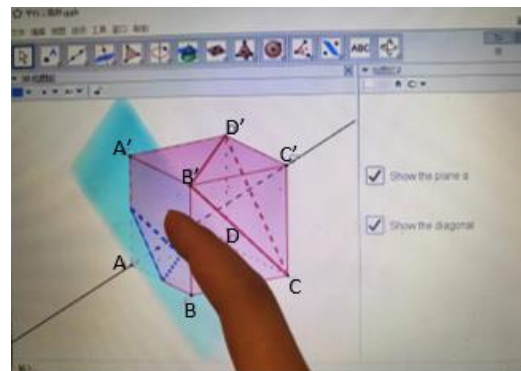


Fig.2 The teacher displays the 3D dynamic model on the projection screen and traces m and n on it with gestures (blue line segments on faces $ABCD$ and $ABB'A'$)

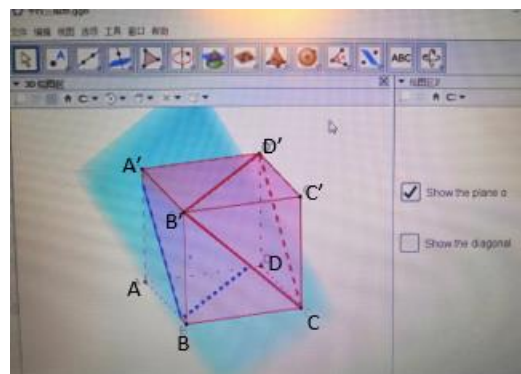
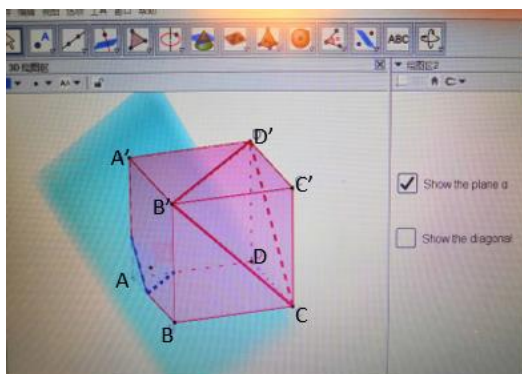


Fig. 3 Plane α is translated up and down with the corresponding m and n shown on the cube

T: OK, I construct another plane $A'BD$, with black lines, and I drag α again (Fig. 4) [part of 1-Perceptive Data], do you have any idea?

S: m and n are parallel with BD and $A'B$ [2-Claim]

T: Yes, but do you know why?

S: α is parallel to the plane of the black triangle [3-Claim/-Factual-Data]

T: Yes, in fact the two planes, $A'BD$ and $CB'D'$ they are parallel, right? [4-Factual-Data]

S: Ah, yes!

T: We know that α should be parallel to $CB'D'$ [5-Factual Data], so it should also be parallel to $A'BD$ to satisfy the condition in the task [echoing 3-Claim/-Factual-Data], and further we get m is parallel to $A'B$ and n is parallel to BD [echoing 2-Claim], everyone is OK with that? Then, how to calculate the angle between m and n ?

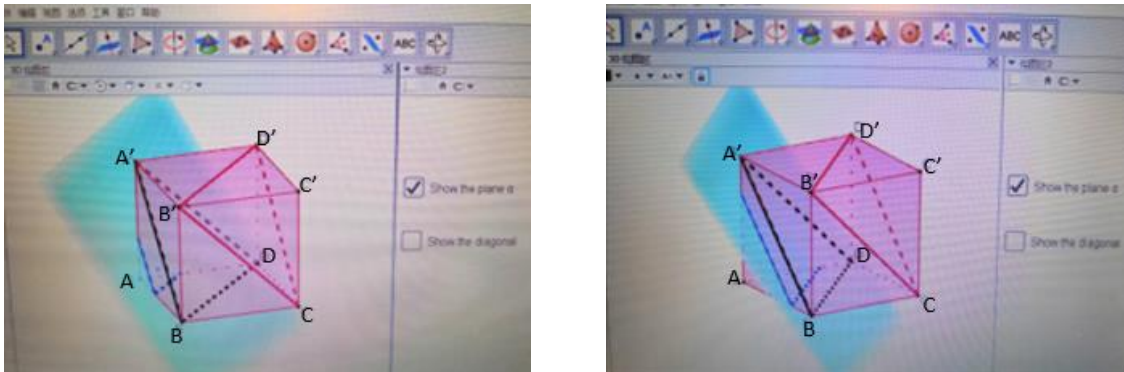


Fig. 4 Plane $A'BD$ is added to the 3D dynamic model and then α is translated up and down again, with the corresponding m and n shown on the cube

Regarding the argumentation components directly contributed by the participants in the episode, Huang firstly gives the first part of 1-Perceptive-Data with the help of the 3D DGE, asking students to discover some invariant properties of m and n when they are moving up and down on the cube according to the cutting plane α . Here the teacher is actually asking students to draw a conclusion by inductive reasoning. However, the discovery process of students does not go smoothly and they only realize that m and n are always parallel to two line segments BD and $A'B$ (2-Claim) when Huang has constructed the lines segments (in $\triangle A'BD$) in the 3D DGE, as shown in Fig. 4. The traces of m and n in Fig. 4 constitute the other part of 1-Perceptive-Data, and the warrant connecting it with 2-Claim is an implicit Inductive-Warrant. Then Huang lets students try to explain 2-Claim, and students' answer concerning the parallelism between α and the plane $A'BD$ (3-Claim) shows their understanding of the geometric theorem that the lines of intersection of a plane with other two parallel planes are parallel. We consider the geometric theorem as a Deductive-Warrant that the students refer to implicitly to connect 3-Claim and 2-Claim. The 3-Claim thus becomes also a Factual-Data that supports 2-Claim. Huang further explains the 3-Claim by mentioning two facts: the plane $CB'D'$ and the plane $A'BD$ are parallel (4-Factual-Data), and α is parallel to $CB'D'$ (5-Factual-Data); and he probably refers to the transitivity of parallelism (implicit Deductive Warrant) here. In this way, a chain of factual data and deductive warrant leading to 2-Claim is constructed.

Regarding Huang's indirect contribution to the episode, the questions he poses include: *requesting an idea* (asking students to discover regularities in the 3D DGE following an

inductive logic) which elicits students' contribution of 2-Claim, and *requesting elaboration* (asking for explanation) which elicits students' contribution of 3-Claim/-Factual-Data. Besides, Huang *uses a 3D DGE* to make his own contribution of 1-Perceptive-Data. The indirect contributions of Huang and all the direct contributions mentioned above are integrated into Fig. 5.66; Huang's direct (yellow and green boxes) and indirect (talk bubbles) contributions together constitute his coordination behavior in this episode.

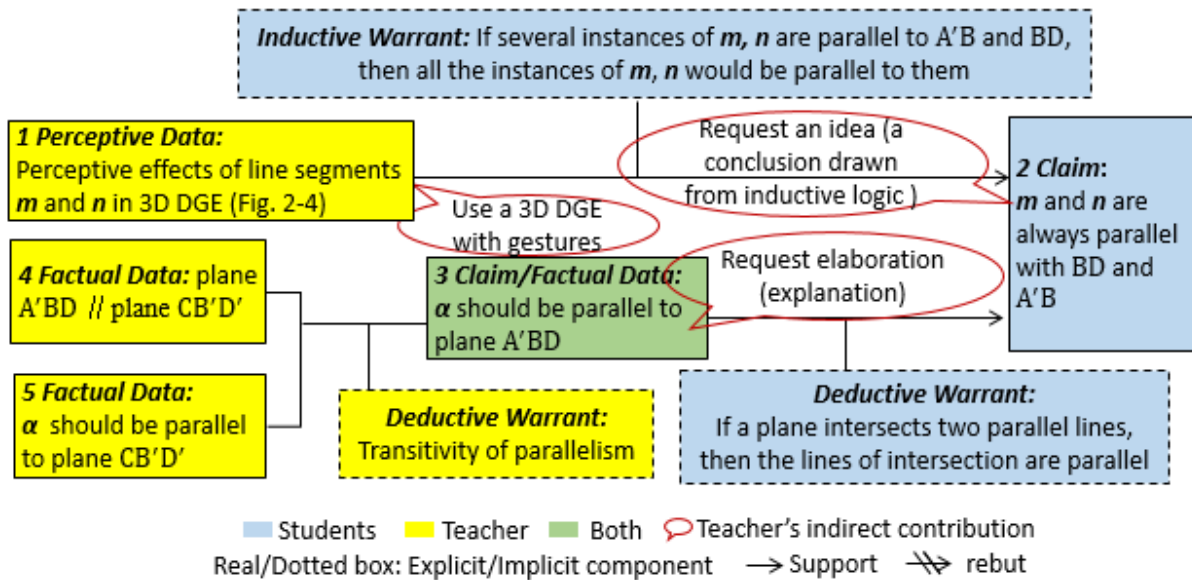


Fig. 5.66 Diagram of argumentation for Episode 1 – T, S –Task 6

The two argumentation episodes in the frame of Task 3 and Task 6 are underpinned by the same basic structure. There is always a Perceptive Data concerning the perceptive effects in a 3D DGE which are displayed by the teacher with gestures, and a Claim directly drawn from the Perceptive Data, with a possible Inductive Warrant in between. The Claim is either contributed by the teacher or by some students; whilst the Intuitive Warrant is contributed by students only when the teacher requests them to draw a conclusion about regularities in the perceptive effects presented, that is to follow an inductive logic. The Claim obtained in this way is usually a correct answer, but the teacher would always develop a chain of Factual Data – Deductive Warrant – Claim, that is, develops theoretical deductive reasoning to further explain the Claim. In this way, the conclusion based on perceptive evidences (and possibly also inductive reasoning) are confirmed by theoretical deductive reasoning. This is different from the case of the episodes of Group H.I-A, in which it is the Perceptive Data that helps to verify the Claim drawn from an Abductive Warrant. Over this lesson series, the episode under Task 4 has the same basic structure with the episodes under Task 3 and Task 6. We therefore classify these episodes into another group labeled H.I-B, and represent the common basic structure with the general diagram in Fig. 5.67.

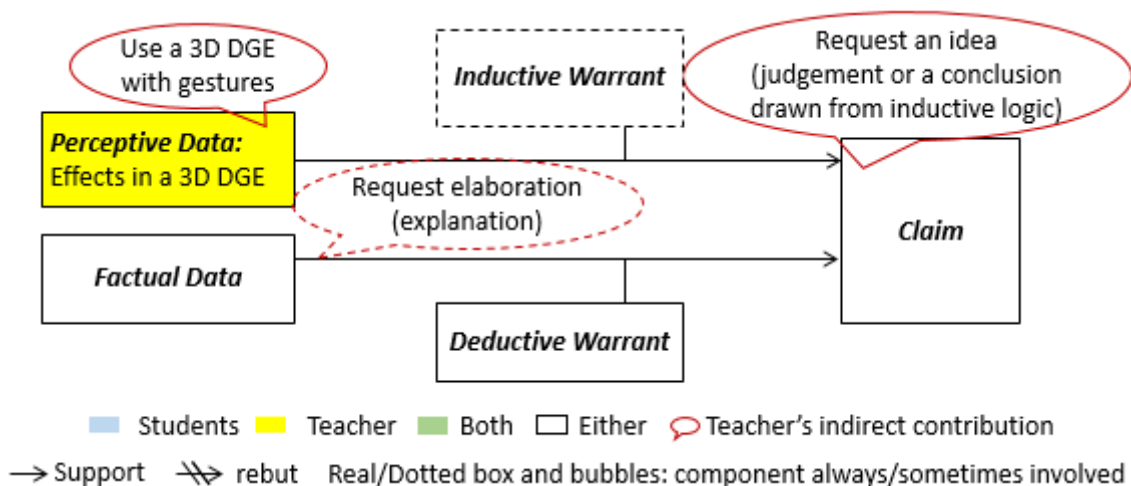


Fig. 5.67 General diagram of argument for the episodes of Group H.I-B

Teacher's contributions to the general diagram mainly lie in: (1) directly contributing the Perceptive Data with the use of a 3D DGE and gestures; (2) directly contributing the Claim based on that data, or *requesting* students' *idea* to elicit their contributions of the Claim and the possible Inductive Warrant (3) directly contributing the Factual Data and the Deductive Warrant in support of the Claim, possibly *requesting* students' *explanation* to elicit their contribution to the Factual Data and Deductive Warrant. According to the two points, we get two rules of coordination in Group H.I-B: (1) use a 3D DGE and simulating gestures to support students' perception; (2) ask students to draw a conclusion by perception or perception-based inductive reasoning; (3) guide students to explain the conclusion with theoretical deductive reasoning.

Rules of coordination H.I-C: (1) use a 3D DGE to support students' perception or inductive reasoning and draw a conclusion together with them on that basis (2) directly validate the conclusion and let students take it as a factual premise for the following theoretical deductive reasoning.

The first example episode related to these rules of coordination is the Episode 1 of the collective argumentation between Huang and the whole class of students around Task 5. The content of the task is presented below.

<p>Task 5</p> <p>The side length of a cube is 1, the angle between plane α and each edge of the cube are all the same, then the maximum area of the cube's section cut by α is ()</p> <p>A $\frac{3\sqrt{3}}{4}$ B $\frac{2\sqrt{3}}{3}$ C $\frac{3\sqrt{2}}{4}$ D $\frac{\sqrt{3}}{2}$</p>

The collective argumentation around this task began when Huang started his explanation to all the students soon after he had read the text of the task. During the argumentation, he firstly guided students to determine one possible α – plane EDB – that satisfies the condition indicated by the task (first argumentation node). Then Huang guided students to get a conclusion that the planes parallel to EDB can all be α that satisfies the target condition (second argumentation node). After that Huang helped students to determine at which place the section of the cube cut

by α gets its maximum area and its shape. The whole collective argumentation ended when Huang let students calculate the precise area of the section after class.

The process from the beginning of the argumentation to the first argumentation node is Episode 1; the process from the first to the second argumentation node is Episode 2; and the process from the second argumentation node to the end of the whole argumentation is Episode 3. The first argumentation node is decided by Huang's words "OK now, this plane is only one of the planes..., can you find others?". The second argumentation node is decided according to Huang's words "How do you think the section would change when α is moving" which led to a new phase of discussion on the shapes of the sections in the argumentation. In this thesis, we focus on Episode 1 and 3 and neglect Episode 2 as the latter only involves a purely deductive reasoning process. The transcript of Episode 1 is presented as follows.

Episode 1 – T, S –Task 5

T: Let's see next task (Fig. (1), how can we find the plane α ?

S1: Can it be [1-Non-Absolute-Qualifier] the plane EBD? [2-Claim]

T: Why?

S1: Just guess...since a cube has the property of symmetry [part of 3-Intuitive-Data].

T: The symmetry, a good idea. What do you think is the axis of symmetry?

S1: The diagonal of the cube [part of 3-Intuitive-Data]?

T: OK, actually, the cube can be rotated around its diagonal AG, and will coincide with itself after being rotated by less than 360° . Let's see it in GeoGebra (Fig. 2, *coexisting with the drawing in Fig. 1 on the blackboard*). I let the cube rotate around the diagonal. Can you imagine how the cube is rotated (Fig. 3) [4-Perceptive Data]? Line segment AE will rotate to AB, and ΔAEO will rotate to ΔABO (Fig. 4-5) [part of 5-Perceptive Data]

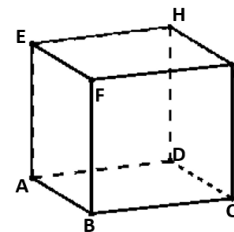


Fig. 1 Drawing for the task on the blackboard

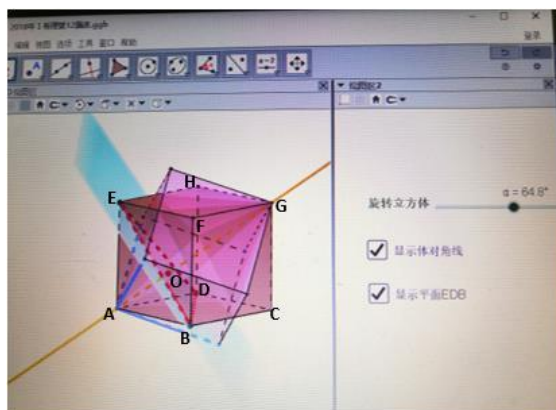


Fig. 2 The teacher presents the 3D dynamic model in GeoGebra on screen, displays the plane EDB, and rotates the cube around AG in a clockwise direction

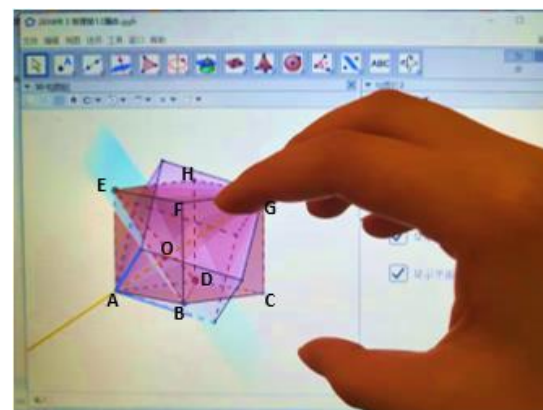


Fig. 3 The teacher use gestures to simulate the rotation of the cube

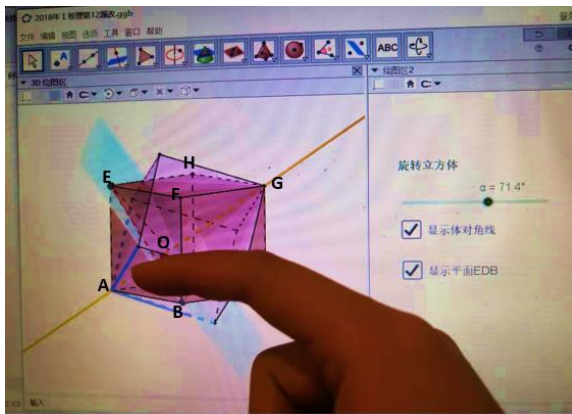


Fig. 4 The teacher uses gestures to show how AE is rotated to AB with the blue line segment being the intermediate status

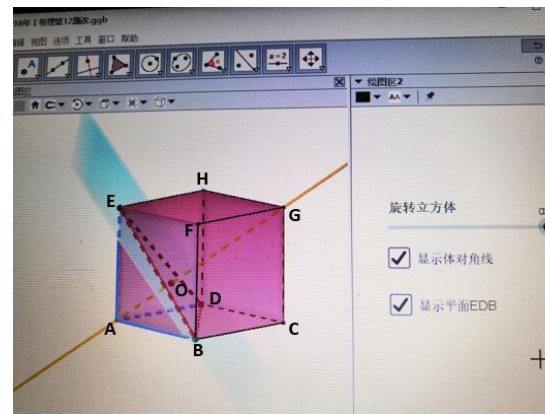


Fig. 5 The cube overlaps with its initial position after it has been rotated by 120°

T: We know a figure always keeps its shape and size while being rotated, right? **[6-Deductive Warrant]** So the two triangles are congruent, the positions of AE and AB with respect to the plane EDB are equivalent, they form the same angle with EDB **[part of 7-Claim/-Factual-Data]**. Similarly, can you get other results?

S: (One student) The $\triangle ABO$ will rotate to $\triangle ADO$... **[part of 5-Perceptive Data]**

(Another student) the three triangles are congruent with one another...

T: I hear someone say these triangles are all congruent **[part of 7-Claim/-Factual-Data]**, then the three edges AB, AE, AD, their angles with respect to the plane (EDB) are...?

S: All the same **[part of 7-Claim/-Factual-Data]**.

T: Pretty good, but now we only consider three edges of the cube, what about the other edges?

S: Shall we rotate the other edges?

T: Yes, or no? Think about the relations among the edges, we know the other edges are either parallel to AB, AE, or AD, right? **[8-Factual-Data]** So the angles between EDB with all these edges must be what?

S: The same **[echoing 2-Claim]**.

T: Right. Ok now, this plane is only one of the planes with equal angles to all the edges, can you find others?

In this paragraph we discuss the argumentation components directly contributed by the participants in this episode. At the beginning, S1 makes the conjecture that the plane EDB (in Fig. (1) “can be” (1-Non-Absolute-Qualifier) the α satisfying the condition designated in the task (2-Claim). Later, under the teacher’s request, S1 gives the idea of the cube being symmetric with respect to its diagonal. This idea has no particular reference and thus we suppose it to be derived from students’ intuition and label it 3-Intuitive-Data. The connection between 2-Claim and 3-Intuitive-Data made by S1 reflects his understanding of the geometric properties of a 3D symmetric figure, which is probably based on the analogy with 2D symmetric figures. Specifically, he thinks the plane EDB can form equivalent angles with the edges of the cube probably because the plane is perpendicular to the axis of symmetry of the

cube, like the line perpendicular to the axis of symmetry of a polygon will form the same angles with reciprocal sides in the polygon. Hence we attach an implicit Structural-Intuitive-Warrant here. As a response, Huang validates the idea of “symmetry” and further relates it to the concept of spatial rotation. He then evokes the corresponding perceptive effects of the rotation of a cube in the 3D DGE (4-Perceptive-Data) and makes the students focus on the local effects of $\triangle ABO$ being rotated to $\triangle AEO$ (part of 5-Perceptive-Data). Meanwhile, Huang reminds students of the invariance of the shapes and sizes of geometric objects during spatial rotation, which is a fact in Euclidean 3D geometry and thus labeled 5-Deductive-Warrant. Since the previous part of 5-Perceptive-Data satisfies the precondition of applying 6-Deductive-Warrant (the process of $\triangle AEO$ coming to $\triangle ABO$ is a rotation process), it can be directly connected to the warrant leading to that fact that $\triangle ABO$ keeps its shape during the rotation and is congruent with $\triangle AEO$ (7-Claim). After that, Huang invites students to seek similar perceptive effects and get conclusions following the same deductive logic, making students propose other parts of 5-Perceptive-Data and 7-Claim, and the 7-Claim also involves the fact that the plane EBD has equal angles with edges AE, AD and AB. On that basis, Huang guides them to think about other edges and the parallelism between edges of a cube (8-Factual-Data), making students soon realize that the plane EBD has equal angles with all the edges and thus is one α to be sought for, that is the 2-Claim. In this process, students probably use a basic geometric theorem concerning equal angles in space and they seem not doubtful about the 2-Claim, so we attach an implicit Deductive-Warrant and an Absolute-Qualifier here. Now we get the diagram of argumentation in Fig. 5.68.

Huang’s indirect contributions to the argumentation include: *requesting an idea* to elicit students’ contribution of 2-Claim, *requesting elaboration* (asking for reason) to elicit students’ contribution of 3-Intuitive-Data and *validating* the intuitive data, *requesting elaboration* (asking students to describe what they perceive) and *an idea* (a conclusion drawn from the same deductive logic) to elicit students’ contributions of 5-Perceptive –Data and 7-Claim and *validating* their contributions by teacher’s authority. The 7-Claim is later complemented by students under Huang’s question of *requesting a simple answer*. Besides all these, Huang *uses a 3D DGE* together with *gestures* to make his contribution of 5-Perceptive Data. The indirect contributions are also integrated into Fig. 5.68. Huang’s direct contributions (yellow and green boxes) and indirect contributions (talk bubbles) together constitute her coordination behavior in this episode.

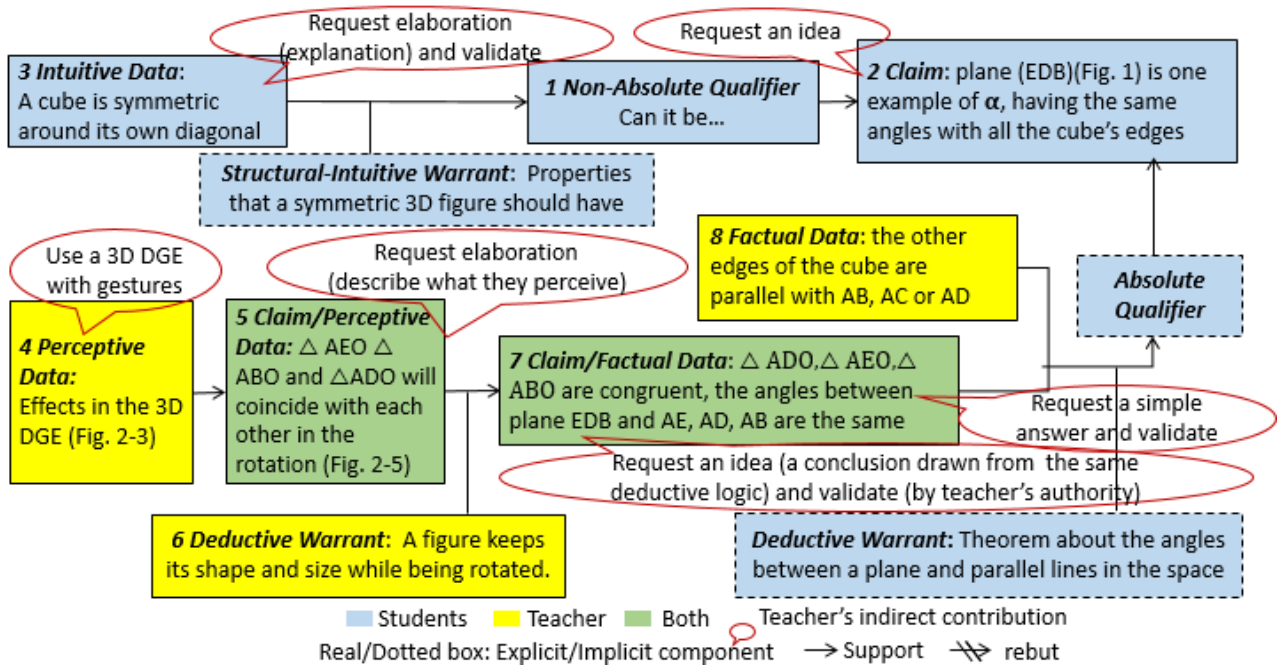


Fig. 5.68 Diagram of argumentation for Episode 1 – T, S – Task 5

The second example episode is the Episode 3 of the collective argumentation between the teacher and the whole class of students around the same task, Task 5. The task and the main activities in the episode have been introduced above. During the whole Episode 2 between Episode 1 and Episode 3, Huang did not use the 3D DGE, so the image in Fig.5 in Episode 1 was the starting point of the 3D DGE animation that Huang would demonstrate in Episode 3. The following is the transcript of Episode 3.

Episode 3 – T, S – Task 5

T: So we can drag the plane (plane EDB in Fig. 5 in Episode (1) up and down, and as long as it is perpendicular to AG, it can be α satisfying the condition, OK? How do you think the section would change in this process?

S: From a point to a triangle, ...then I don't know, and finally return to triangle... **[part of 1-Perceptive-Data]**

T: Well, let me demonstrate this with GeoGebra, and here we can trace the outlines of sections (Fig. (1). You see, at first it's a small triangle, later a bigger triangle. Near the middle it becomes an ordinary hexagon. In the accurate midpoint it is what?

S: a regular hexagon. **[part of 1-Perceptive-Data]**

T: Then it turns back to?

S: An ordinary hexagon, and a triangle **[part of 1-Perceptive-Data]**.

T: Now tell me, at which position you think the section will have the maximum area?

S: Perhaps **[2-Non-Absolute-Qualifier]** at the midpoint of AG? **[3-Claim/-Factual-Data]**

T: Exactly. Do you notice that the shape of the section changes symmetrically along AG, and its area firstly increases and later decreases **[part of 1-Perceptive-Data]**? So the section with the maximum area must **[4-Absolute-Qualifier]** fall at the midpoint **[echoing 3-Claim/-Factual-**

Data], and it is indeed the correct answer. You know it's just a multiple-choice task; as long as you can speculate the correct answer, that's enough. But for a short-essay task, you should not just guess, OK? Now let's calculate the precise value of the maximum area (Fig. 2), what is the shape of the section at the midpoint?

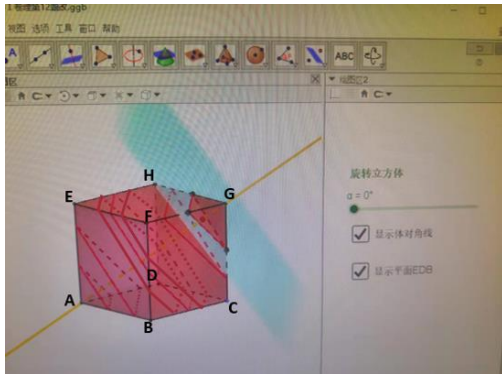


Fig. 1 The plane perpendicular to AG is dragged up and down to cut the cube, with the corresponding sections being traced in the 3D DGE

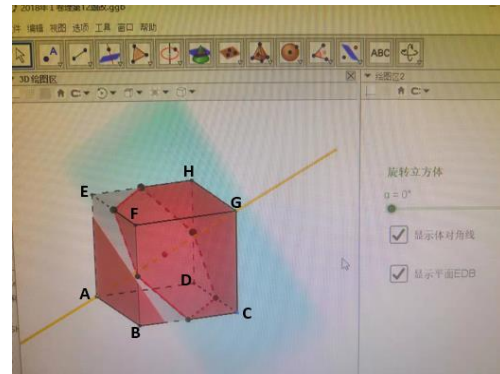


Fig. 2 The cutting plane is fixed at the midpoint of AG by the teacher

S: A regular hexagon [**5-Factual-Data**]

T: Yes, let's draw it in the plane environment (Fig. 3). Here what's the side length of the regular hexagon?

S: $\sqrt{2}/2$ [**6-Claim**]

T: Good! As we can see, one side of the hexagon is exactly the hypotenuse of an isosceles right triangle in the cube, right (Fig. 4)? And the two legs of the triangle are both? (points at the corresponding edges in the cube in the 3D DGE, Fig. 4) $1/2$ [**7-Factual-Data**]. You complete the rest of the calculation work after class.

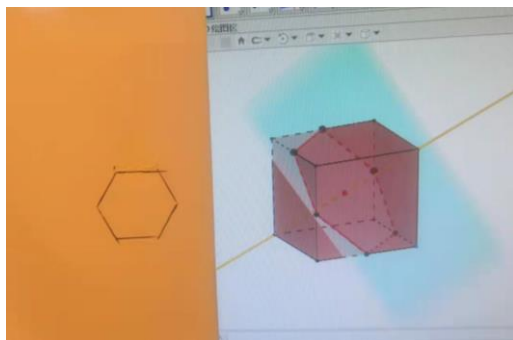


Fig. 3 Regular hexagon drawn by the teacher on the blackboard next to the screen where the 3D DGE is presented¹³

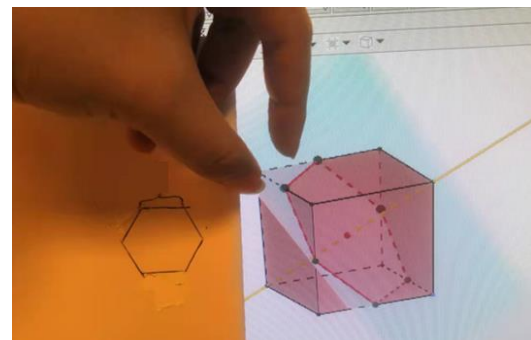


Fig. 4 The teacher points at the two legs of an isosceles right triangle in the top face of the cube in the 3D DGE

¹³ This is a photo taken by the researcher in the compensatory interview, when the teacher was presenting his drawing on the paper next to his personal computer, as a simulation of what had been presented on the blackboard and the projection screen and in the real classroom. It is also the case of Fig. 39.

We first look at the argumentation components directly contributed by the participants in the episode. At the beginning, Huang points out that he can drag the plane up and down keeping it perpendicular to AG, to simulate the various α designated in the task. He then invites students to imagine the variation process of the section caused by the plane being dragged. Students' answer afterwards implies that they have probably perceived triangle sections of a cube, such as the triangle EDB presented in Episode 1; and thus we identify the answer as a part of 1-Perceptive-Data. After that, Huang demonstrates the real sections caused by the moving plane (Fig. 1), makes students describe the different shapes of the sections they can observe, as complement to 1-Perceptive-Data. On that basis, students make a conjecture that the section with the maximum area will fall at the midpoint of AG (3-Claim) but their word "perhaps" shows their uncertainty about the truth of the claim (2-Non-Absolute-Qualifier). The 3-Claim is then directly confirmed by Huang (4-Absolute-Data), who meanwhile complements the 1-Perceptive-Data by highlighting the symmetric variation of the shape and the size of the section. Here the connection of 1-Perceptive-Data to 3-Claim is underpinned by an implicit Inductive-Warrant, as the participants determine the variation pattern of the section along the whole AG according to the instances of the section at several particular positions. While knowing the inductive approach cannot work for all the similar tasks, Huang still lets students accept 3-Claim as a fact (i.e., 3-Claim/-Factual-Data) and take the regular hexagon shape of the section at the midpoint (5-Factual-Data), to determine the side length of the shape (6-Claim) which is required for the calculation of area. In this process, Huang also explains the relation between sides of the hexagon and edges of the cube, as another Factual-Data (labeled 7) in support of 6-Claim. The process of deriving 6-Claim from the data in 3, 5, 7 are underpinned by the Pythagorean theorem and thus we attach an implicit Deductive-Warrant here. All these argumentation components are integrated into the diagram of argument in Fig. 5.69.

We then look at the indirect contributions of Huang. Huang poses the questions of *requesting an idea* to elicit students' contribution of 3-Claim and 5-Factual-Data and he directly *validates* the two contributions by teacher's authority; he also *uses a 3D DGE* and *requests* students' *elaboration* of what they perceive from the 3D DGE, facilitating students' contribution of 1-Perceptive-Data; finally, he poses the question of *requesting a simple answer* to elicit students' contribution of 6-Claim. The indirect contributions are also integrated into Fig. 5.69 in terms of talk bubbles. Huang's direct contributions (yellow and green boxes) and indirect contributions (talk bubbles) together constitute his coordination behavior in this episode.

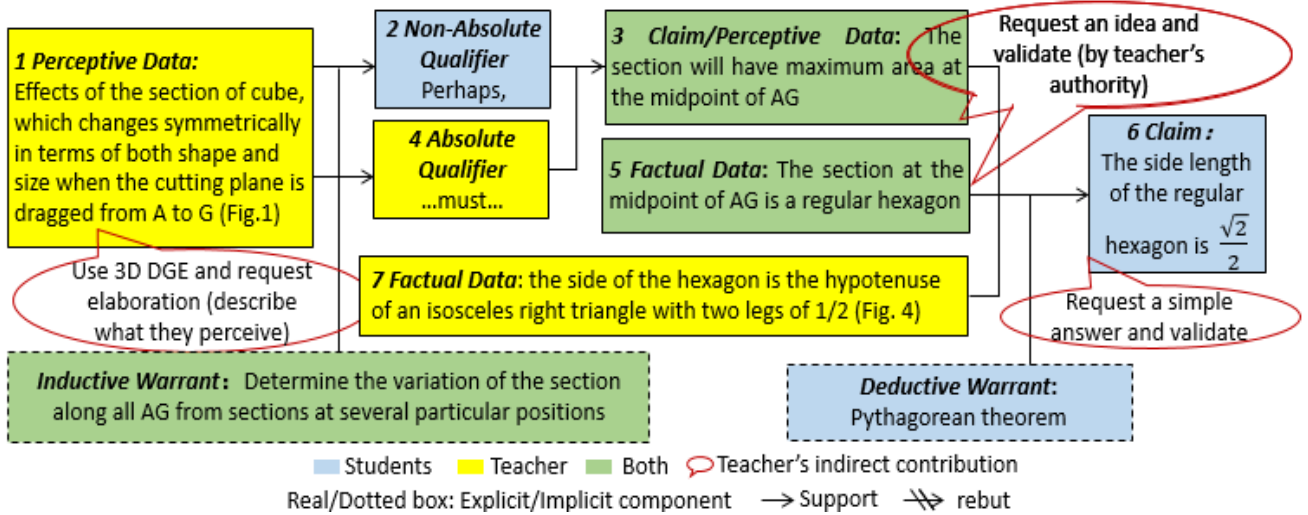


Fig. 5.69 Diagram of argumentation for Episode 3 – T, S – Task 5

The two argumentation episodes modelled by the diagrams in Fig. 5.68 and Fig. 5.69 are underpinned by the same basic structure. They both involve a chain of Perceptive Data – Claim, possibly with an Inductive Warrant in between. This is similar to the episodes of Group H.I-B, but a difference here is that the Claim and the possible Inductive Warrant are contributed “together” by the teacher and students, with the teacher’s contributions serving as a model for students to follow or helping consolidate students’ contributions. Furthermore, the previous Claim, as a new Perceptive Data, is no longer confirmed by a chain of theoretical deductive reasoning, but directly validated by the teacher and connected with a Deductive Warrant to lead to a new Claim. The Deductive Warrant and the new Claim can also be proposed by students. In fact, as long as the new Perceptive Data is consistent with the fact and satisfies the condition of applying the Deductive Warrant, the teacher would encourage students to directly integrate the two and validate the new Claim obtained by them. Sometimes the previous Claim are combined with other Factual Data to support the new Claim. In this way, the perception-based conclusion is directly applied to a theoretical deductive reasoning as one precondition in it. This basic structure is only found in the two argumentation episodes around Task 5, which are thus classified into Group H.I-C. The corresponding general diagram of argument is shown in Fig. 5.70.

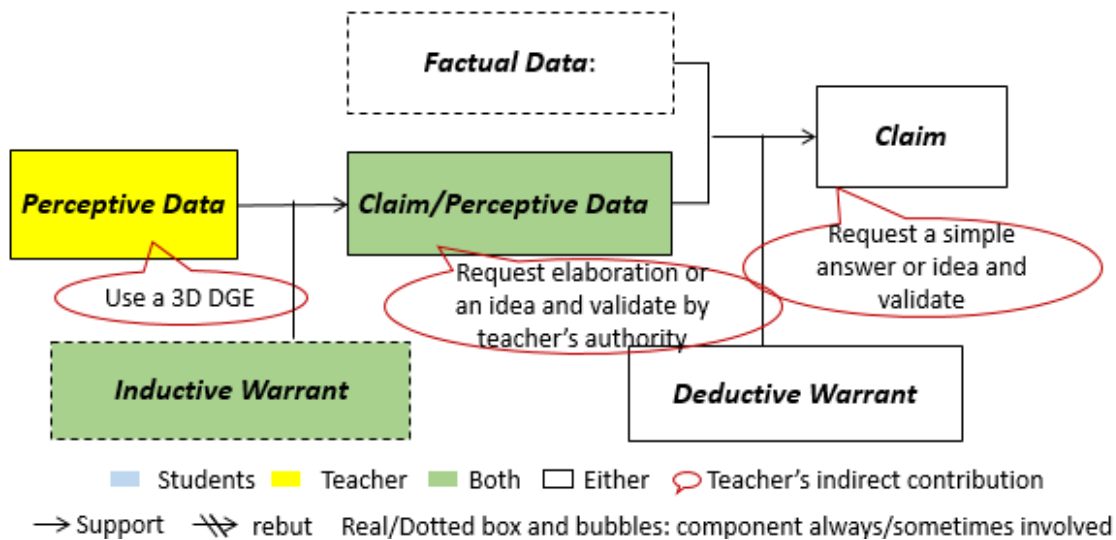


Fig. 5.70 General Diagram of argumentation for Episodes of Group H.I-C

The teacher's contributions to the general diagram consist in: (1) direct contribution of Perceptive Data with the use of a 3D DGE, *requesting* students' *idea* or *elaboration* and *validating* (by teacher's authority) the first Claim drawn by them according to the Perceptive Data and perhaps also an Inductive Warrant, together with the teacher's own contributions in the first Claim and the possible Inductive Warrant; (3) direct contributions of the final Claim and a Deductive Warrant that can be connected to the first Claim, or *requesting* student's *answer* or *idea* to make them contribute these components and *validating* their contributions. These can be transformed into two rules of coordination which are put into a group labeled H.I-C: (1) use a 3D DGE to support students' perception or inductive reasoning and draw a conclusion together with them on that basis (2) directly validate the conclusion and let students take it as a factual premise for the following theoretical deductive reasoning.

5.3.4 Operational invariants in Lesson Series H.I

In this part, we present the operational invariants underpinning each group of rules of coordination. The operational invariants are obtained by analyzing all the data of the lesson series. The corresponding data analysis procedures have been introduced in section 4.4.1. In particular, all the interview words we cite below come from the transcripts of the general interview and the compensatory interview after the lesson (Appendices 3.2 and 3.4).

Operational invariants for rules of coordination H.I-A: (1) provide students with a frame of cuboid and remind them of the rules of drawing three-view diagrams to promote their abductive reasoning; (2) use a 3D DGE to support students' perception making them certain of the abductive reasoning result

These rules of coordination appeared in the argumentation episodes in the frame of Tasks 1 ~ 2. The episodes are mainly about constructing the original solid within the frame of a cube on the paper according to a given three-view diagram.

The operational invariants for these rules of coordination are summarized in Table 5.14.

Table 5.14 Operational invariants for rules of coordination of Group H.I-A

Category	Label and content of operational invariant
COI	<p>[1] The three-view diagram of a solid is the projection of the solid in three orthogonal directions, such as front, lateral and overhead.</p> <p>[2] Rules for drawing three-view diagrams: the convex edges and the edges hidden at the back of the original solid are respectively represented by real and dotted lines in the three-view diagram.</p> <p>[3] To construct the original solid on the paper according to a three-view diagram, one should start from a drawing of a cube and follow the drawing rules in [2] in an abductive way.</p>
PCOI	<p>[4] Providing a frame of a cube or cuboid can help students quickly locate the critical elements in the original solid corresponding to the three-view diagram.</p> <p>[5] It is challenging for students to directly imagine the whole original solid only with a given three-view diagram on the paper.</p> <p>[6] 3D real models are proper to illustrate 3D geometric objects and their sub-objects, but they do not allow for more variations.</p> <p>[7] In the GAOKAO examination, students are required to accomplish the tasks in a paper-pencil environment without the aid of computer software</p>
TPCOI	<p>[8] GeoGebra can help students to better understand the link between a solid and its three views.</p> <p>[9] If we present the original solid in GeoGebra at very first, students will still have difficulty when drawing the solid according to its three-view diagram without the help of software.</p> <p>[10] The display of a 3D dynamic model and its three views in GeoGebra should be done when students have already constructed the solid on the paper but are still confused about it.</p> <p>[11] For presenting the three views of a solid, I only need to display the 3D dynamic model in GeoGebra, turn it around and specifically show its views in the three directions.</p> <p>[12] The animation of 3D dynamic models in GeoGebra can trigger students' learning interest.</p> <p>[13] If a 3D geometry task clearly indicates some values in the task figure, then in the GeoGebra courseware for teaching, the teacher has to construct the 3D dynamic model by defining their vertices with precise coordinates.</p>
TCOI	<p>[14] By right-clicking and moving the mouse in GeoGebra, one can turn around the 3D dynamic models therein.</p> <p>[15] The functioning mechanism of GeoGebra is similar to the 3D Math software, so I can transfer many techniques of using the latter to the former.</p>
BCOI	<p>[16] I am familiar with the technological skills to be used in GeoGebra.</p> <p>[17] To design a GeoGebra courseware for teaching is easy for me and takes me little time.</p>

Firstly, some operational invariants about content (COI) can be inferred. In rule (1), Huang reminds students of the rules of sketching three-view diagrams, so that they could speculate in reverse the original solid that could allow one to draw the given three-view diagram following the sketching rules. This implies that Huang must know these sketching rules a priori (operational invariants [1] and [2]) and he thinks the construction of the original solid requires using the sketching rules in an abductive way (operational invariant [3]). The last operational invariant is also expressed by Huang in the interview:

“Usually students can figure out when I give them a solid and let them to think about its three views, but here it is a reversed process, and they usually cannot imagine what the original solid could be like.”

The three operational invariants reflect Huang’s knowledge of mathematics rules or solutions to mathematics tasks, thus placed to the category COI.

Secondly, there are operational invariants about pedagogy of content (PCOI). With respect to rule (1), Huang provides a drawing of a cube as a frame for students to construct the original solid, showing his knowledge of the specific pedagogical methods for supporting students’ mathematics learning; we express this knowledge as the operational invariant [4]. Huang provides the frame of a cube also because he knows that students can hardly imagine the original solid without any scaffolding ([5]), and Huang’s interview words related to [3] which are presented above also support [5]. In the interview, Huang mentions: *“3D real models are also good (for illustrating how a cube can be cut into some sub-objects), but they won’t allow for more variations in the sub-object”* ([6]); this explains why he uses 3D DGEs to support students’ perception in rule (2). Here, the display of the original solid in the 3D DGE is conducted after the students have constructed the solid on the paper, because Huang knows that students *“won’t have any aid except for the paper, pens and drawings in GAOKAO”* ([7]). The operational invariant [5] reflects the teacher’s understanding of students’ difficulties in mental imagination; [6] reflects his knowledge and views about the constraints of non-technological resources for supporting students’ perception; [7] reflects his knowledge about the examination requirements on students’ abilities for solving the tasks in the paper context. All these belong to the category PCOI.

Thirdly, Huang’s use of a 3D DGE in rule (2) allows us to infer several operational invariants about technology in pedagogy of content (TPCOI), which are evidenced by his words in the interview, such as *“For three-view diagram tasks involving a complex original solid, GeoGebra is very helpful”* (operational invariant [8]); and *“it’s better to display the original solid in GeoGebra when students have already constructed it on the paper but still doubt about its reliability”* ([10]), because *“If you present the original solid in GeoGebra at very first, students will still have difficulties in constructing the drawing of the solid without the help of software”* ([9]). As for how the teacher would display the solid in GeoGebra, he said that *“since it’s a fixed solid, I only need to evoke it, turn it around and specifically show its views in the three directions”* ([11]). He mentions that students are usually very interested in the animation of the solids in GeoGebra, which corresponds to [12]. These operational invariants either reflect the teacher’s knowledge and views about the potentials of the 3D DGE for students’ mathematics learning and motivation ([9], [13]), or the order in which the activities in the 3D DGE and in the paper-pencil environment should be experienced by students ([10] [11]), or the

pedagogical strategies to exploit the potentials of 3D DGEs ([12]). They are thus classified into the category of TPCOI.

Fourthly, as the 3D DGE used in rule (2) is designed by Huang himself, this requires some operational invariants about technology and the related content (TCOI). Huang talks about this in the interview:

“I’d rather construct points casually in GeoGebra, and then use concrete 3D coordinates to fix them; it’s more accurate...and the points won’t vary...It also depends on the situation...some of the tasks clearly prescribe the length of the edges, or the proportion, then thus I have to precisely define the points...”

These sentences lead us to [13] and [14]; the former is about when to construct precise fixed points while preparing GeoGebra files for teaching, belonging to the category TPCOI, whereas the latter is about the technological skills for constructing fixed points in GeoGebra, belonging to TCOI.

Besides, Huang evoked in the interview a software similar to GeoGebra that he once operated with, and many techniques in the software can be transferred to GeoGebra. This can also be identified as an operational invariant ([15]), which reflects Huang’s knowledge of the technological skills to be used in GeoGebra.

Finally, Huang expresses his ease of designing and using 3D DGEs in mathematics lessons in the interview: *“when you get familiar with GeoGebra, a courseware like this can be done in 10 minutes or so, very quickly.”* This allows us to infer operational invariants [16] and [17], both are operational invariants about behavior control (BCOI) and they determine the teacher’s willingness of using 3D DGEs in rule (1).

Operational invariants for rule of coordination H.I-B: (1) use a 3D DGE and simulating gestures to support students’ perception; (2) ask students to draw a conclusion by perception or perception-based inductive reasoning; (3) guide students to explain the conclusion with theoretical deductive reasoning.

These rules of coordination appeared in the argumentation episodes in the frame of Tasks 3, 4 and 6. The episodes are mainly about identifying the shapes of, or geometric relationships in, the section(s) of a solid cut by a plane. The solid can be a cube, a sphere, or a combination of a sphere and a cube, with the cutting plane being at a specific position relative to the solid.

The operational invariants related to these rules of coordination are summarized in Table 5.15.

Table 5.15 Operational invariants for rules of coordination of Group H.I-B

Category	Label and content of operational invariant
COI	[18] If a cube and its inscribed sphere are cut by the equilateral triangle which is defined by three non-adjacent vertices of the cube, the section is a circle inscribed in the triangle.
	[19] If a plane is cut with two parallel planes, the lines of intersection are parallel to each other.
	[20] If the two sides of one angle are respectively parallel to the two sides of another one, the two angles are equal or supplementary.

	[21] The triangle surrounded by three diagonals of the cube's three faces is an equilateral triangle.
	[22] If a sphere is inscribed in a cube, the tangent points fall at the centers of the cube's faces.
	[23] The common elements of two geometric objects must belong to their intersection.
	[24] The equilateral triangle surrounded by three diagonals of the cube's three faces is perpendicular to the diagonal of the cube.
	[25] The tasks involving complex 3D figures requires students to mobilize spatial imagination together with their geometry knowledge.
PCOI	[7] <i>GAOKAO requirements on students' abilities for solving the tasks.</i>
	[26] Experiences of observing 3D objects in GeoGebra can help students imagine them in the paper context when the 3D objects are absent.
	[27] Requesting students' explanation with more and more transparent hints could facilitate the development of their theoretical deductive reasoning.
TPCOI	[28] GeoGebra allows students to observe 3D dynamic models from various perspectives, supporting their perception/imagination of the corresponding 3D figures.
	[29] It is important to let students pay attention to some component parts and attributes when displaying 3D dynamic models in GeoGebra.
	[30] The teacher can cut a solid in GeoGebra with a moving plane to generate various sections in a short time.
	[31] Requesting students to discover regularities from the multiple observable examples displayed in GeoGebra can promote their inductive reasoning.
	[32] GeoGebra is suitable for displaying composite solids of spheres and their inscribed/circumscribed polyhedrons in support of students' perception.
	[33] The initial direction that a 3D dynamic model is presented in GeoGebra should be consistent with the drawing of solids given in the task, so that students could compare and contrast the drawing and the dynamic model.
	[34] Usually, turning 3D dynamic models for a round in GeoGebra would enable students to imagine the corresponding 3D figures.
	[35] If a 3D geometry task does not clearly indicate some values in the task figure, the teacher can construct the 3D dynamic model in the GeoGebra courseware with automatic construction tools.
TCOI	[15] <i>Analogy between the software of 3D Math and GeoGebra; [14] Techniques for turning around 3D dynamic models in GeoGebra.</i>
	[36] In GeoGebra, one can control the movement of a plane with a free point after defining the plane with the point and a fixed orientation (using the <i>Parallel Plane</i> or <i>Perpendicular Plane</i> tool).
	[37] By selecting the <i>Intersect Two Surfaces</i> tool and then selecting two surfaces in GeoGebra, one can construct the intersection of the two surfaces.

[38] By selecting the *Rotate Around Line* tool, then an object, a line and entering an angle in GeoGebra, one can rotate the object around the line by a particular angle.

[39] Using an angle slider together with the *Rotate Around Line* tool, one can adjust dynamically the angle by which the object is rotated around the line.

[40] The effect of a group of parallel planes can be simulated by dragging a plane along the same direction.

BCOI [16] *Confidence in one's own technological skills related to GeoGebra*; [17] *Perceived ease or difficulty with respect to designing GeoGebra courseware for teaching*;

Firstly, some operational invariants about content (COI) can be inferred. Since these rules of coordination are mobilized by Huang to help students solve Tasks 3, 4 and 6, he must know how to solve the tasks and have the related geometric knowledge, which corresponds to operational invariants [18] ~ [24]. Besides, when being asked about the main student abilities required for the last four tasks used in the lesson, Huang answered that students need to have “*the ability of spatial imagination*” (in this thesis, it means the abilities of generating mental images of 3D figures and their structures) and a good repertoire of “*geometry knowledge*”; which leads us to infer the operational invariant [25]. These operational invariants reflect Huang’s knowledge and views about solutions to mathematics tasks and the related mathematics theorems and facts, and thus are categorized as COI.

Secondly, there are some operational invariants about pedagogy of content (PCOI). The previous operational invariant about the examination prescriptions on students’ performances in the paper-pencil environment – [7] – is also relevant here. It is because students have difficulties in imagining the 3D figures in the tasks on the paper, that Huang decides to use 3D DGEs and simulating gestures to support students’ perception in rule (1) and then helps them develop theoretical deductive reasoning in rule (2). We know this from Huang’s words in the interview and infer two operational invariants accordingly:

“*If they have never seen a 3D figure in space, it will be quite hard for them to imagine it only with a paper drawing.*” ([26])

“*You show them a model in the software (GeoGebra), and turn it for several rounds, they can easily figure it out.*” ([28])

[26] concerns Huang’s pedagogical strategy to support students’ spatial imagination and thus is categorized as PCOI. [28] concerns his knowledge of how to combine the pedagogical strategy with the potentials of 3D DGEs, belonging to TPCOI (introduced next). In addition, according to Huang’s action of requesting students’ explanation with more and more transparent hints in the rules of coordination, we suppose that he takes this as an effective strategy to promote students’ theoretical deductive reasoning, that is [27], another operational invariant in PCOI.

Thirdly, the way that Huang uses 3D DGEs in rule (1) allows to infer some operational invariants about technology in pedagogy of content (TPCOI). While displaying 3D dynamic models in GeoGebra, Huang often turns students’ attention to some component parts and attributes, and students’ discoveries are just the conclusions to be explained with theoretical deductive reasoning in rule (2). Huang also explains his behavior in the interview:

“In general, students know that a cube’s sections are squares or rectangles, a sphere’s sections are all circles, but I will ask a little bit more, making them pay attention to the critical points and sides in the sections and leaving them a deeper impression.”

These words allow us to infer the operational invariant [29]. Also, Huang uses GeoGebra to display multiple sections of a solid and possibly requests students to discover regularities therein, implying his knowledge of the potential of GeoGebra in producing sections of solids ([30] and his knowledge of the strategy to promote students’ inductive reasoning ([31]). Besides, the following words of Huang in the interview are also relevant for the rules of coordination:

“GeoGebra is very suitable for displaying the composite figures with spheres.” ([32])

“The direction in which the 3D dynamic model is presented is firstly consistent with the drawing in the task. Taking that as a starting point, I will turn it for a round, and that would be enough for students to imagine the spatial structures.” ([33], [34])

These operational invariants are all about the teacher’s knowledge and views about the pedagogical strategies to exploit potentials of 3D DGEs, belonging to the category TPCOI.

Fourthly, the design of the 3D DGEs requires Huang to know the techniques to be used in GeoGebra and the related mathematics content, which correspond to operational invariants about technology and the related content (TCOI). The operational invariants include the previous one concerning the analogy between the software of 3D Math and GeoGebra ([16]), the techniques for turning around 3D dynamic models ([14]), and the techniques for translating a plane, for intersecting two planes, and the like ([36] – [40]).

Finally, these rules of coordination cannot be implemented without Huang’s confidence in using and designing 3D DGEs, which are also expressed by him in the interview. So the operational invariants about behavior control (BCOI) that have been inferred previously – [16], [17]) – are also relevant here.

Operational invariants for rules of coordination H.I-C: (1) use a 3D DGE to support students’ perception or inductive reasoning and draw a conclusion together with them on that basis (2) directly validate the conclusion and let students take it as a factual premise for the following theoretical deductive reasoning.

These rules of coordination are identified from two argumentation episodes which are both in the frame of Tasks 5. The two episodes are respectively about identifying the cutting plane(s) that can form equal angles with all the edges of a cube, and identifying the shape of the maximum section of the cube caused by the cutting plane.

The operational invariants underpinning these rules of coordination are summarized in Table 5.16.

Table 5.16 Operational invariants for rules of coordination of group H.I-C

Category	Label and content of operational invariant
COI	[25] <i>Importance of spatial imagination for solving the tasks with complex solids.</i>
	[41] The plane perpendicular to the diagonal of a cube forms equal angles with all the edges of the cube.
	[42] A cube can coincide with the initial one after a rotation of 120° around its own diagonal.

	<p>[43] The edges of a cube can be divided into three groups of parallel lines, respectively represented by three edges that meet at one vertex.</p> <p>[44] If a line intersects a plane at some angle, any line parallel to this line will also intersect the plane at a same angle.</p> <p>[45] The section of a cube cut by a plane perpendicular to its diagonal will get its maximum area at the midpoint of the diagonal.</p> <p>[46] The section of a cube cut by a plane perpendicular to its diagonal is in a regular hexagon shape at the midpoint of the diagonal.</p> <p>[47] Symmetric change of the cube's section along the diagonal is a necessary condition for determining where the section can get its maximum area.</p>
PCOI	<p>[7] <i>GAOKAO requirements on students' abilities for solving the tasks; [26] experiences of observing 3D objects can support students' spatial imagination in paper context.</i></p> <p>[48] For multiple-choice tasks on 3D geometry in GAOKAO, it is not necessary for students to develop very rigorous proof if they can get the correct answer quickly with the help of spatial imagination and/or inductive reasoning.</p> <p>[49] If we aim at promoting students' spatial imagination, we should better put the rigorous proof aside but focus on their perception of structures of 3D figures.</p> <p>[50] Students should not spend too much time on a multiple-choice task in GAOKAO, which only takes up a little portion of the full mark.</p>
TPCOI	<p>[35] <i>Principles for designing 3D DGEs for the tasks without precise magnitudes; [29] Knowledge or views about how to direct students' attention while displaying 3D dynamic models H.I.[30] and [31] Pedagogical strategy for exploiting the potentials of 3D DGEs in support of students' inductive reasoning.</i></p> <p>[51] The teacher can display the effect of a solid being rotated around some line and coinciding with the initial solid in GeoGebra, to support students' perception, helping them understand of the rotational symmetry in space.</p> <p>[52] If the teacher would like to promote students to formulate conjectures about geometric magnitudes, it is better not to show their precise values in GeoGebra.</p> <p>[53] It is important to highlight that the symmetric variation of a magnitude is a necessary condition for determining its maximum/minimum value in the variation.</p> <p>[54] To facilitate students' observation of the examples of a dynamic object in GeoGebra at particular positions, it is better to slow down the dragging at those positions.</p>
TCOI	<p>[15] <i>Analogy between the software of 3D Math and GeoGebra.</i></p> <p>[35] ~ [39] <i>Techniques (and possibly the math knowledge) for constructing a translatable plane, constructing the intersection of two surfaces, rotating a 3D object around a line, controlling the dynamic of the rotation of the 3D object, generating a group of parallel planes, in GeoGebra.</i></p>
BCOI	<p>[16] <i>Confidence in one's own technological skills related to GeoGebra; [17] Perceived ease or difficulty with respect to designing GeoGebra courseware for teaching.</i></p>

Firstly, some operational invariants about content (COI) can be inferred. They include the previous operational invariant [25] and the [41] ~ [47] in Table 5.16. They are all about the knowledge of mathematics theorems and facts that Huang should have to help students solve Task 5.

Secondly, there are operational invariants about pedagogy of content (PCOI). In the two rules of coordination, Huang supports students' perception with 3D DGEs and lets students directly take the result of the perception or the perception-based inductive reasoning as a fact. It is because he thinks this task is mainly aimed to inspect students' "spatial imagination" and "global understanding of 3D figures", which will allow students to solve the tasks efficiently. As he says in the interview:

"A task like this (Task 5) doesn't emphasize quite rigorous proof. It is mainly aimed to test your spatial imagination and your global understanding of 3D figures... In the lesson, when I dragged the cutting plane in GeoGebra, the students saw that the sections firstly increased and then decreased in area, they soon made the conjecture that the biggest area must fall in the middle. I said OK, it is enough to guess out the right answer." ([48])

"If we hope to promote students' spatial imagination, we'd better put the rigorous proof aside but focus on their perception of structures of 3D figures." ([49])

"It is already the 12th in multiple-choice items, I believe that for an ordinary student, he will most likely guess. They should address it within 5-6 minutes and so won't have opportunities to think it over." ([50])

As can be seen, from the sentences above, we infer operational invariants [48] ~ [50]. They reflect the teacher's knowledge or views about the pedagogical strategies for supporting students' mental imagination and logical reasoning, and the examination requirements on students' abilities for solving the tasks. All these belong to the category PCOI.

Thirdly, the rules of coordination are also underpinned by some operational invariants about technology in pedagogy of content (TPCOI). According to Huang's behavior related to rule (1) in the corresponding argumentation episodes, we see that Huang rotates a cube around its diagonal in the 3D DGE designed with GeoGebra and lets students notice how the edges will coincide with one another during the rotation, which is linked with the operational invariant [51] as well as the previous one, [29]. Later he drags the plane perpendicular to the diagonal up and down letting it cut the cube in GeoGebra, and requests students to explore regularities in the sections and conjecture at which position the section will have the maximum area; this corresponds to the previous operational invariants [30] and [31]. Huang also slows down the dragging of the section plane at particular positions to facilitate student observation, highlights the variation pattern of the area of the section in the process without indicating particular values of the area. That leads us to infer operational invariants [52] ~ [54]. All the operational invariants reflect the teacher's knowledge or views about the potentials of digital technologies for students' perception and logical reasoning and the pedagogical strategies to exploit these potentials. They are thus categorized as TPCOI.

Fourthly, similar to the case of the last group, the design of the 3D DGE used in this group of rules of coordination also requires Huang to have the knowledge of the technological skills related to GeoGebra and the underpinning mathematics content, that is, the operational

invariants about technology and the related content (TCOI). The content of the operational invariants is basically the same as those in the last group, i.e., [15] and [35] ~ [39], because the functions included in the 3D DGE for Task 5 are similar to the 3D DGEs for Tasks 3, 4 and 6. Finally, the two operational invariants about behavior control (BCOI) that have been inferred previously – [16] and [17] – are also relevant here, as this group of rules of coordination also necessitates a proficient design and use of 3D DGE.

5.3.5 Summary of Lesson Series H.I

In this section, we give a summary of the analysis results of this lesson series in light of the first group of research questions.

Table 5.17 lists the main content of the analysis results, including the coordination schemes of Huang, and the 3D geometry tasks-3D DGEs in the corresponding classes of situations. The coordination schemes mainly include rules of coordination and operational invariants. In consistency with the labelling of the groups of rules of coordination, we use “class H.I-A, H.I-B, ...” and “scheme H.I-A, H.I-B, ...” to label the corresponding classes of situations and coordination schemes. To save space, we only summarize the main content of the operational invariants and the characteristics of tasks and 3D DGEs; for a more complete description, please refer to sections 5.3.4 and 5.3.2.

Table 5.17 Summary of analysis results of Lesson Series H.I

Coordination schemes	3D geometry tasks-3D DGEs
	Class of situations
<p>Scheme H.I-A</p> <p>Rules of coordination:</p> <p>(1) provide students with a frame of cuboid and remind them of the rules of drawing three-view diagrams to promote their abductive reasoning; (2) use a 3D DGE to support students’ perception making them certain of the abductive reasoning result.</p> <p>Operational invariants:</p> <p>COI: [1] ~ [2] definition of a three-view diagram and rules for drawing it; [3] how to construct the original solid of a three-view diagram by following the rules in [2] inversely;</p> <p>PCOI: [4] potentials of the frame of a cuboid for students’ abductive reasoning; [5] students’ difficulty in three-view diagram tasks; [6] potentials and side effects of 3D real models for teaching 3D geometry; [7] examination requirements on students’ activities for solving the tasks in a paper-pencil environment;</p>	<p>Class of situations H.I-A</p> <p>Tasks 1 ~ 2:</p> <p>3D geometry topic: construct a solid according to a three-view diagram;</p> <p>Status in curriculum/exam: students should be able to recognize the original solids from three-view diagrams and construct their drawings on the paper with parallel projection rules; small items in the GAOKAO exam only demanding an answer;</p> <p>Context and innate support: paper-pencil with a three-view diagram.</p> <p>3D DGEs:</p> <p>Figural representations and tools: 3D dynamic model of the original solid being situated in the frame of a cuboid; <i>Dragging</i> tools;</p> <p>Help and control: no specific help; control in the teacher;</p> <p>Feedback: innate feedback in GeoGebra – use <i>Dragging</i> tool to evoke three views of the model;</p>

<p>TPCOI: [8] 3D dynamic models can help students link a solid with its three views; [9] side effects of 3D dynamic models for abductive reasoning activities in the paper context; [10] ~ [11] views about when to display 3D DGEs for three-view diagram tasks; [12] positive effect of 3D DGEs on student learning interest; [13] principles for designing 3D DGEs for the tasks involving precise magnitudes;</p> <p>TCOI: [14] techniques for turning around 3D dynamic models; [15] analogy between different 3D DGE software;</p> <p>BCOI: [16] confidence in his own skills of using GeoGebra; [17] perceived ease for designing 3D DGEs with GeoGebra;</p> <p>SNOI: [18] The Board of Education expects me to use GeoGebra to help students review 3D geometry content in this lesson.</p>	<p>Curricular distance: close to the curriculum prescriptions.</p> <p>Support students' coordination, in an ordinary real classroom with one computer, summarize typical techniques for solving examination tasks.</p>
<p>Scheme H.I-B</p> <p>Rule of coordination:</p> <p>(1) use a 3D DGE and simulating gestures to support students' perception; (2) ask students to draw a conclusion by perception or perception-based inductive reasoning; (3) guide students to explain the conclusion with theoretical deductive reasoning.</p> <p>Operational invariants:</p> <p>COI: [18] ~ [24] mathematics knowledge required for solving the tasks; [25] importance of students' spatial imagination for solving the tasks with complex 3D figures;</p> <p>PCOI: [7]; [26] experiences of observing 3D objects can support students' spatial imagination in paper context; [27] teachers can promote students theoretical deductive reasoning by requesting explanation;</p> <p>TPCOI: [12]; [28] potentials of 3D dynamic models for students' perception; [29] knowledge or views about how to direct students' attention while displaying 3D dynamic models [30] ~ [31] strategy for exploiting 3D DGEs to support students' inductive reasoning; [32] composite solids with spheres are</p>	<p>Class of situations H.I-B</p> <p>Tasks 3, 4, 6:</p> <p>3D geometry topic: determine the shape, properties, or the area, of a section of a solid; the solid can be a cube or a composition of a cube and its inscribed/circumscribed sphere; the section plane is at a specific relative position to the solid;</p> <p>Status in curriculum/exam: solve relative position problems with Euclidean geometric proof or vector approach; have perceptive experiences; know the formulae of areas of regular polygons; small items in the GAOKAO exam only demanding an answer;</p> <p>Context and innate support: paper-pencil; Tasks 3-4 have drawings and Task 6 has no innate support.</p> <p>3D DGEs:</p> <p>Figural representations and tools: 3D dynamic model of the task figure being integrated with a (variable) section plane; <i>Dragging</i> and <i>Slider</i> tools</p> <p>Help and control: no specific help; control in the teacher;</p>

<p>proper to be illustrated in 3D DGEs; [33] ~ [34] strategy for displaying and rotating 3D dynamic models; [35] principles for designing 3D DGEs for the tasks without precise magnitudes;</p> <p>TCOI: [14]; [15], [36] ~ [40] techniques and math knowledge for constructing a translatable plane, constructing the intersection of surfaces, rotating an object around a line in space, and generating a group of parallel planes, in the 3D DGEs;</p> <p>BCOI: [16]; [17];</p> <p>SNOI: [18].</p>	<p>Feedback: innate feedback in GeoGebra –turn around the dynamic model by <i>Dragging</i>; control the rotation/translation of the section plane with the <i>Slider</i> tool/a free point;</p> <p>Curricular distance: close to the curriculum prescriptions.</p>
<p>Scheme H.I-C</p> <p>Rule of coordination:</p> <p>(1) use a 3D DGE to support students’ perception or inductive reasoning and draw a conclusion together with them on that basis (2) directly validate the conclusion and let students take it as a factual premise for the following theoretical deductive reasoning.</p> <p>Operational invariants:</p> <p>COI: [41] ~ [47] mathematics knowledge required for solving the tasks; [25];</p> <p>PCOI: [7]; [26]; [48] students can replace rigorous proof with imagination and inductive reasoning in complex multiple-choice tasks; [49] put aside rigorous proof to promote spatial imagination of students; [50] time limit in the GAOKAO exam;</p> <p>TPCOI: [12]; [35]; [29]; [30] ~ [31]; [51] teachers can use 3D DGEs to help students perceive the rotation of solids; [52] ~ [53] strategy to guide students’ investigation of variation patterns of magnitudes in 3D DGEs; [54] strategy to facilitate students’ observation of examples in 3D DGEs;</p> <p>TCOI: [15]; [36] ~ [40];</p> <p>BCOI: [16]; [17].</p>	<p>Support students’ coordination, in an ordinary classroom with one computer, summarize typical techniques for solving these examination tasks.</p> <p>Class of situations H.I-C</p> <p>Task 5:</p> <p>3D geometry topic: determine the maximum area of a varying section of a cube; the section plane is varied but can always form equal angles with all the edges of the cube;</p> <p>Status in curriculum/exam: similar to above; the last multiple-choice item in the GAOKAO exam;</p> <p>Context and innate support: paper-pencil; no innate support.</p> <p>3D DGE:</p> <p>Figural representations and tools: 3D dynamic model of a cube being integrated with a line of diagonal and a section plane; <i>Slider</i> and <i>Dragging</i> tools</p> <p>Help and control: no specific help; control in the teacher;</p> <p>Feedback: innate feedback in GeoGebra – rotate the cube around its diagonal with the <i>Slider</i> tool; translate the section plane along the diagonal with a free point; turn around the whole dynamic mode;</p> <p>Curricular distance: close to the curriculum prescriptions.</p> <p>Support students’ coordination, in an ordinary classroom with one computer, summarize typical techniques for solving these examination tasks.</p>

Research question 1.1 of this thesis concerns how the rules of coordination can be linked with the different categories of operational invariants in the corresponding schemes. To answer this question, we firstly identify the commonalities and differences between the different groups of

rules of coordination in Table 5.17, and then link the commonalities and differences with the operational invariants in the corresponding schemes.

Contrasting the three groups of rules of coordination, we can see that the interaction modes of the perception and logical reasoning of students in the three groups are quite different, and that Huang does not show a consistent emphasis on particular logical reasoning or perception of students. In H.I-A, Huang mainly promotes the abductive reasoning of students, and he supports students' perception only at the end, helping them accept the abductive reasoning result with certainty. In H.I-B, Huang firstly supports the perception and/or inductive reasoning of students, then he promotes their theoretical deductive reasoning, which helps explain and confirm the perception or inductive reasoning result. In H.I-C, Huang lays more focus on the perception and perception-based inductive reasoning of students; on that basis, he draws a conclusion together with students and lets them directly take the conclusion as a factual premise for the following theoretical deductive reasoning.

Notwithstanding the huge differences in the interaction mode of perception and logical reasoning of students, the three groups of rules of coordination show many commonalities in the particular strategy that Huang adopts to promote the perception or logical reasoning of students. The strategy concerns the supportive actions, questions, and the resources used by Huang. To be specific, in all the three groups, Huang uses 3D DGEs to support students' perception, with H.I-B also involving the use of simulating gestures. In both Groups B and C, Huang promotes students' inductive reasoning by evoking various observable examples (sections) in 3D DGEs and requesting students to discover regularities. In H.I-C, he also highlights the variation pattern of the examples without indicating the particular magnitudes, to facilitate students' inductive reasoning about the magnitudes. In H.I-B, Huang promotes students' theoretical deductive reasoning by requesting their explanation. In H.I-A, he promotes students' abductive reasoning by providing a frame of a cuboid and indicating the sketching rules to be followed reversely.

It is worth noting that the important digital resources – 3D DGEs – have been used in all the three groups of rules of coordination, and it is always the teacher who uses them. The functions of 3D DGEs are also varied by groups: in H.I-A they are used only for supporting students' perception, whereas in Groups B and C they are used for supporting students' perception and/or inductive reasoning, and some overlap content can be found in the 3D DGEs used in the two groups.

Next we compare the operational invariants in different schemes, in relation with the corresponding rules of coordination.

Firstly, all the groups of rules of coordination are underpinned by some operational invariants about content (COI) and operational invariants about pedagogy of content (PCOI). The differences and commonalities in the COI and PCOI between groups are consistent with the interaction mode of students' perception and logical reasoning under the rules of coordination of Huang. To be precise, in rules of coordination H.I-A, Huang emphasizes students' abductive reasoning in the paper context and uses a 3D DGE to support their perception only at the end, because he knows that the three-view diagram tasks should be solved by following some rules reversely ([3] in COI), and that students can hardly be certain of the original solid constructed on the paper and do need some 3D perceptive support ([5] in PCOI). He also mentions that in

GAOKAO examination, students have to solve the task in a paper-pencil environment and the perceptive support cannot help ([7] in PCOI). In rules of coordination H.I- B, Huang firstly fosters the perception and/or inductive reasoning of students and then fosters their theoretical deductive reasoning; Here he maintains the idea about the GAOKAO examination requirements on the tasks, that is [7] in PCOI, but he also notices that the corresponding tasks cannot be solved without a high level of spatial imagination ability ([25] in COI) and that observing 3D objects in space will allow students to imagine them even back to the paper context ([26] in PCOI). That is why Huang provides the 3D perceptive support a priori. In rules of coordination H.I- C, Huang also supports the perception and/or inductive reasoning of students a priori, and he attaches more importance to the perception and inductive reasoning, making students apply the corresponding result directly as a fact in the following theoretical deductive reasoning. Then in the operational invariants for H.I-C, we can find the same elements concerning the importance of spatial imagination in the task solutions ([25] in COI), the GAOKAO examination requirements ([7] in PCOI) and the benefit of observing 3D objects in space ([26] in PCOI). Besides, Huang thinks that for the last multiple-choice item in GAOKAO, students can take profit of their imagination and inductive reasoning without developing rigorous theoretical deductive reasoning ([48] in PCOI) since the time for examination is limited ([50] in PCOI). He also thinks that putting aside rigorous proof can push students to exploit and develop more of the spatial imagination ([49] in PCOI). The [48] ~ [50] together lead to the important status of students' perception and inductive reasoning in Huang's rules of coordination.

Secondly, the COI in different schemes are also linked with to the 3D geometry topics of the corresponding tasks, and PCOI are also linked with the particular strategies of Huang for promoting some logical reasoning of students in the rules of coordination. For example, there are different COI underlying the H.I-A and H.I-B – [1] ~ [2] and [18] ~ [24] – which respectively concern the mathematics knowledge required for solving the 3D geometry tasks corresponding to the two groups. The operational invariant about how the frame of a cuboid can help support students' abductive reasoning ([4]) only appears in the PCOI for H.I-A, being consistent with Huang's use of the cuboid frame in the rules of coordination; the operational invariant about how to promote students theoretical deductive reasoning ([27]) only appears in the PCOI for H.I-B, being consistent with Huang's strategy of requesting students' explanation in the rules of this group.

Thirdly, all the groups of rules of coordination are underpinned by some operational invariants about technology in pedagogy of content (TPCOI), whose differences and commonalities between schemes are especially linked with Huang's strategies for promoting students' perception and inductive reasoning in the rules of coordination. To be precise, in rules of coordination H.I-A, Huang uses a 3D DGE to support students' perception at the end, making them certain that the original solid constructed on the paper is exactly the one corresponding to the three-view diagram. Then in the TPCOI for H.I-A, we can find the operational invariants about potentials and side effects of 3D dynamic models for students' perception and task-solving activities, and when to display the models ([8] ~ [11]). In rules of coordination of both H.I-B and H.I-C, Huang uses 3D DGEs to support students' perception and/or inductive reasoning; consistently. Then we can find common elements in the TPCOI for H.I-B and H.I-

C – [29] ~ [31] – which concerns Huang’s pedagogical strategies for exploiting the potentials of 3D DGEs for students’ perception and inductive reasoning. There are also differences in the TPCOI for rules of coordination H.I- B and H.I-C, in consistency with the specific content of the perception and inductive reasoning to be promoted in the rules of coordination. For example, in the TPCOI for H.I-B we can find [33] ~ [34] which concern how to turn around the 3D dynamic models; this is consistent with the fact that Huang supports students’ perception of the spatial structure of composite solids in rules of coordination H.I- B. In the TPCOI for H.I-C, we can find [51], which concerns how to display the rotation of solids in 3D DGEs. This is consistent with the fact that Huang supports students’ perception of the rotational symmetric properties of a cube in rules of coordination H.I- C. In addition, the three groups of rules are underpinned by a same TPCOI, which reflects Huang’s knowledge about the positive effect of 3D DGEs on student learning interest ([12]).

Fourthly, all the groups of rules of coordination are underpinned by some operational invariants about technology and the related content (TCOI), which are linked with Huang’s operations in the 3D DGEs in all the rules of coordination. The TCOI for rules of coordination H.I-B and H.I-C overlap and they include more elements than the TCOI for H.I-A; this is consistent with the fact that the 3D DGEs used in H.I-B and H.I-C have overlapping content and they are more complex than the 3D DGEs used in H.I-A. The [14] and [15] are two common elements in the TCOI for all the three schemes; they are respectively about the techniques for turning around 3D dynamic models, which has been performed by Huang in every 3D DGE, and the analogy between different 3D DGE software, which suggests how the teacher learns the techniques related to a software in general.

Finally, all the three schemes contain two operational invariants about behavior control (BCOI) – [16] and [17] – which concern Huang’s confidence in his technological skills and the ease perceived by him for designing 3D DGEs. They explain why Huang is willing and can flexibly use 3D DGEs in all the three groups of rules of coordination.

Research question 1.2 of this thesis concerns the how the coordination schemes can be influenced by the characteristics of 3D geometry tasks-3D DGEs. To answer this question, we identify the links between the groups of rules of coordination and the characteristics of the corresponding 3D geometry tasks-3D DGEs, and then refer to operational invariants to justify the links identified.

Firstly, we claim that the respective importance that Huang attaches to students’ logical reasoning and perception (or the interaction mode of the two activities) in the rules of coordination is linked to the 3D geometry topics of the corresponding tasks and their status in the GAOKAO examination.

To be specific, Tasks 1 ~ 2 in class H.I-A are about constructing the original solid according to a given three-view diagram. In the GAOKAO examination, the tasks should be solved within the paper-pencil environment and the only way out is to derive, through abductive reasoning, the critical elements of the original solid within a drawing of a cuboid. Besides, the paper-pencil environment always makes it difficult for students to link the original solid drawn on the paper with the given three views and it is where the 3D DGE can help. This can be linked to Huang’s behavior of promoting students’ abductive reasoning and supporting their perception at the end in rules of coordination H.I-A, and the link can be supported by the operational

invariants of [3], [5], and [7] in the corresponding COI and PCOI. Tasks 3, 4, 6 and 5 are all concerned with sections of a cube (or a cube together with its inscribed/circumscribed sphere). Tasks 3, 4 and 6 corresponding to H.I-B require students to identify the shape or property or determine the area of a section, whilst Task 5 corresponding to H.I-C is more complex – it requires students to determine the maximum area of a group of sections and the section planes are not directly given. The four tasks can be solved with theoretical deductive reasoning, but if students could generate the related 3D mental images or have the experiences of observing the solids and their sections in space, they can solve the task more quickly within the paper-pencil environment. The commonalities in the 3D geometry topics of Tasks 3, 4, 6 and 5 can be linked with the fact that Huang promotes the perception, inductive reasoning, and deductive reasoning in both rules of coordination H.I- B and C. The common operational invariants [7], [25] and [26] in the two corresponding schemes provide evidences for the link. Furthermore, the fact that Huang lays more emphasis on the perception and/or inductive reasoning in rules of coordination H.I- C can be linked with not only the 3D geometry topic of the corresponding task – Task 5 – but also the status of the task in the GAOKAO examination. The link can be evidenced by operational invariants [48] and [50] in scheme H.I-C, which reflect Huang’s views that students should not spend much time on a multiple-choice item in GAOKAO, and that they can exploit more of their perception/imagination and inductive reasoning, to replace rigorous proof for complex multiple-choice items to save time.

Secondly, some of Huang’s strategies in the rules of coordination to support students’ perception and inductive reasoning are linked with the characteristics of the corresponding 3D DGEs in terms of figural representations, tools and feedback. The 3D DGEs here actually refer to the software that allows Huang to design the 3D DGEs, that is GeoGebra. Since Huang designs all the 3D DGEs by himself, there should be an innate link between his rules of coordination and the characteristics of the 3D DGEs. Hence we only consider the software, GeoGebra, instead of the 3D DGEs, and the characteristics the software at stake here are the features of the figural representations, functionalities of the tools, and the innate feedback therein.

To be specific, in rules of coordination of H.I-A, Huang uses a 3D DGE to display the original solid and its three views in support of students’ perception; obviously, it is the characteristic of the 3D dynamic models in GeoGebra – they can be turned to any orientation showing different views of a 3D figure – that provides him with a condition for supporting students’ perception that way. The characteristic of the 3D dynamic models is well recognized by Huang, as reflected in operational invariant [8] in the TPCOI for H.I-A, which serves as evidence for the influence of the features of the figural representations in GeoGebra on rules of coordination H.I-A. In rules of coordination H.I-B and also H.I-C, Huang uses a 3D DGE to display a dynamic section of a solid or to rotate a cube in space around its own diagonal, in support of students’ perception or perception-based inductive reasoning. In the corresponding 3D DGEs, the solid is either a cube or a composite one integrating a cube and its circumscribed/inscribed sphere, and the section(s) are either cut by a fixed plane, cut by a dynamic plane that can be rotated around center axis of the cube or translated along the diagonal of the cube. From the analysis in section 5.3.1, we know that Huang usually uses the tools of *Cube*, *Plane through three points*, *Perpendicular plane*, or *Sphere* to construct the solids and the section planes, and

uses the *Intersect Two Surfaces* tool in GeoGebra to let the outline(s) of the section(s) appear. He also uses the *Slider* tool and the *Rotate* (*<Object>*, *<Angle>*, *<Axis of Rotation>*) command, to control the rotation of objects or the movement of section planes in GeoGebra. Therefore, it is the availability of these tools (and commands) in GeoGebra, the potentials of 3D dynamic models in displaying different views of 3D figures, and the feedback evoked by moving the section plane or rotating a cube around its diagonal in GeoGebra, that allow the teacher to support students' perception or inductive reasoning in the rules of coordination. We thus establish a link between rules of coordination H.I-B and H.I-C and the features of the figural representations, functionalities of tools and the innate feedback in GeoGebra. The link can be supported by operational invariants [30] ~ [34] and [51] in the TPCOI for H.I-B and H.I-C, which show that Huang knows well the potentials of the 3D DGEs based on GeoGebra for students' perception and inductive reasoning, and that he intentionally exploits these potentials in his rules of coordination.

It should be noted that there are other strategies adopted by Huang for supporting students' perception and inductive reasoning, which have no particular link with the characteristics of GeoGebra. The strategies mainly include: direct students' attention to component parts of 3D dynamic models in both H.I-B and H.I-C, and highlight the symmetric variation of the shape and area of a moving section without indicating the precise magnitudes in H.I-C. Since the strategies can be linked to the TPCOI in the corresponding schemes (e.g., [29], [52] and [53]), we suppose that they are mainly determined by Huang's own knowledge and views. It is also the case for Huang's strategies to support students' deductive or abductive reasoning in the rules of coordination. The strategies include providing a frame of a cube or a cuboid (in H.I-A) and requesting students' explanation (in H.I-B), which are respectively reflected in the PCOI for H.I-A and H.I-B – [4] and [27] – but can hardly be linked with the characteristics of the corresponding tasks and 3D DGEs.

Lesson Series H.II

From the next section we will start introducing the results with respect to lesson series H.II. Fig. 5.71 presents the timeline of our follow-up of this lesson series and the data collected.

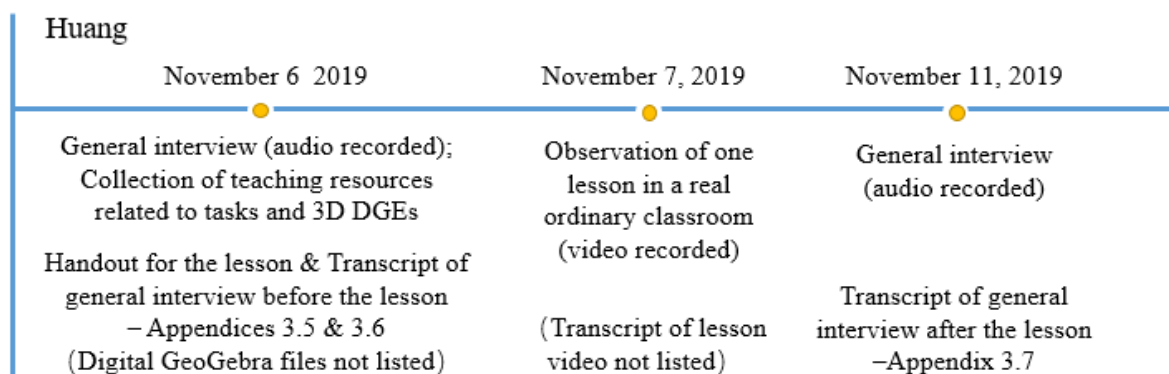


Fig. 5.71 Timeline of follow-up of Lesson Series H.II

5.3.6 Context of Lesson Series H.II

This section introduces the context of the single lesson in Lesson Series H.II. The context information to be introduced have been introduced in the methodology part (section 4.4.1). All the information is obtained by analyzing the data related to the lesson, ranging from Appendix 3.5 to Appendix 3.7.

The lesson in the series took place on November 7, 2019. The students in the lesson were situated in the literature and humanistic stream of the general branch of Chinese upper secondary education. At the time of the observation, they were in the first semester of grade 12 – the final year of the upper secondary education – and in the first round of review in preparation for GAOKAO. Here, the leaders of the school designated Huang to give an open class to his own students on a topic in 3D geometry, and he was expected to use digital technologies in the open class. Meanwhile, another teacher would also give an open class on the same topic, but without the use of digital technologies. The two lessons were attended by all the mathematics teachers of grade 12 of that school, who would compare the two classes and propose suggestions for each in the subsequent meeting. The digital technology that Huang used here was mainly the GeoGebra files designed by himself. The GeoGebra files are just the 3D DGEs in the case of Huang, and their characteristics will be presented in section 5.3.7.

The teaching setting for the lesson is shown in Fig. 5.72. It was an ordinary real classroom in which only the teacher had access to an “interactive intelligent blackboard” and student work stayed in the paper-pencil environment. The “interactive intelligent blackboard” was a combination of computer and projection screen, on which the teacher can directly display GeoGebra files, PowerPoint slides and PDF documents. It was also possible to add some traces or writings on the screen of the “interactive intelligent blackboard” and erase them according to one’s need. Other elements in the teaching setting included an ordinary blackboard, a desk for the teacher, desks and chairs for students, and seats for other teachers who came to observe the lesson. Students were seated in rows facing towards the blackboard.

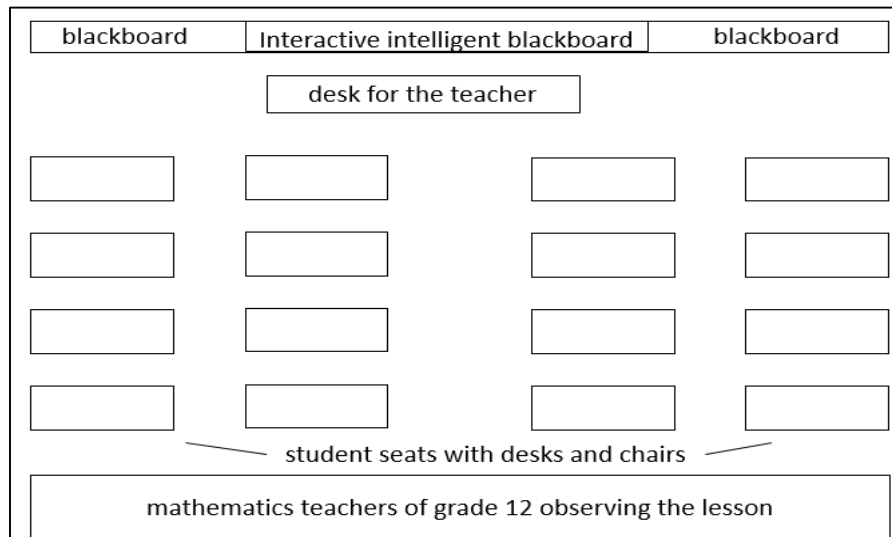


Fig. 5.72 Layout of teaching setting for Lesson Series H.II

The subject matter of this lesson was the distance between a point and a plane in space (shortly called point-plane distance). Huang's didactical objectives were to consolidate students' knowledge and abilities related to the construction and calculation of the point-plane distance, and to introduce students to some figural patterns, so that students could directly apply the conclusions about the figural patterns to solve the point-plane distance tasks more efficiently.

Before the lesson, the students had dealt with a lot of point-plane distance tasks and have learnt the necessary knowledge in Euclidean 3D geometry for finding and calculating the distance, such as theorems about parallelism and perpendicularity between lines and planes, Pythagorean theorem, the formulae of volumes of common solids (straight prisms, regular pyramids, spheres, cubes and cuboids) and other geometric properties of the solids. The students did not learn vector 3D geometry during the upper secondary period. The students had no prior experience of directly operating GeoGebra, but they may have seen teachers display GeoGebra files and operate GeoGebra in previous lessons.

The lesson activities evolved around a handout that Huang prepared beforehand, so we firstly give an introduction of its content before describing the particular lesson activities. The handout consists of three parts:

1. three methods to construct and calculate point-plane distance (Fig. 5.73);
2. eight common figural patterns that involve point-plane distance (Fig. 5.74);
3. seven 3D geometry tasks about point-plane distance.

The tasks in part 3 were all selected by Huang from past GAOKAO examinations or the examinations with a similar level of difficulty held by the school or the district; we will introduce the characteristics of the tasks in section 5.3.7 and introduce the content of the first two parts of the handout in this section.

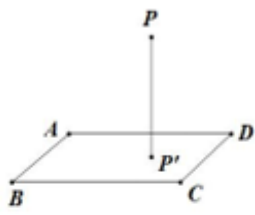
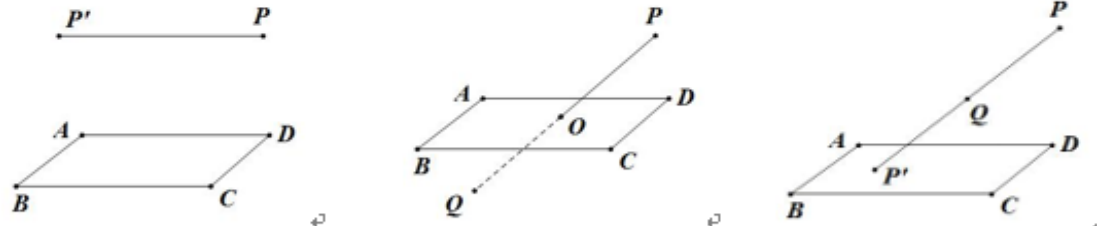
1. Three methods to construct and calculate point-plane distance [□]		
<p>Method 1-direct determination. Construct the perpendicular from the designated point P to the designated plane with the foot of the perpendicular noted as P'. The length of segment PP' is the distance, as shown on the right.[□]</p>		
<p>Method 2-distance transfer. Transfer the distance into an alternative equivalent one, through the parallel lines/planes or similar triangles[□]</p>		
<p>If $PP' \parallel$ plane ABCD then all the points in PP' are at the same distance to the plane[□]</p>	<p>If $PO=OQ$, then P, Q is at the same distance to plane ABCD[□]</p>	<p>If Q is the midpoint of PP', then P, Q is at the same distance to the plane[□]</p>
<p>Method 3-equivalent volume. Establish equations connecting the volumes of the same solid which are calculated with different groups of height and base.[□]</p>		

Fig. 5.73 Part 1 of the handout used in Lesson series H.II

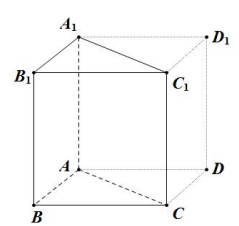
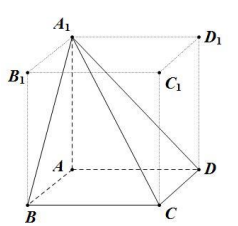
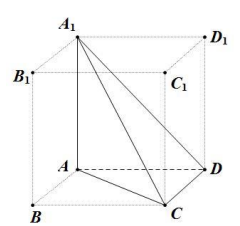
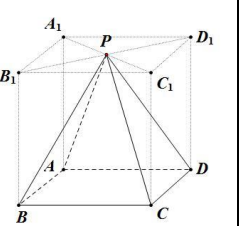
2. Common figural patterns				
(the following patterns are all situated in a cube with side length of 2)				
Figural patterns	 <p style="text-align: center;">①</p>	 <p style="text-align: center;">②</p>	 <p style="text-align: center;">③</p>	 <p style="text-align: center;">④</p>
Question	The distance of B to the plane ACC_1A_1 is _____	The distance of A to the plane A_1BC is _____	The distance of A to the plane A_1DC is _____	The distance of P to plane ABCD is _____
Projection	In a <u>QIANDU</u> , the projection of B onto plane ACC_1 is _____	In a <u>YANGMA</u> , the projection of A onto plane A_1BC is _____	In a <u>BIENAO</u> , the projection of A onto plane A_1DC is _____	In a regular pyramid, the projection of A onto the polygonal base is _____

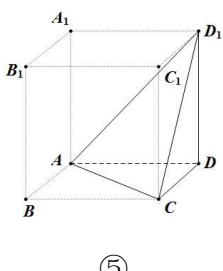
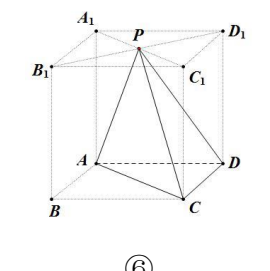
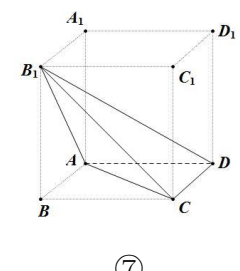
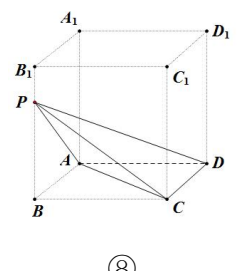
Figure	 <p style="text-align: center;">⑤</p>	 <p style="text-align: center;">⑥</p>	 <p style="text-align: center;">⑦</p>	 <p style="text-align: center;">⑧</p>
Question	The distance of D to the plane ACD_1 is _____	The distance of P to the plane ADC is _____	The distance of B_1 to the plane ACD is _____	In a triangular pyramid P-ACD, P is at the same distance with respect to the two edges of $\angle ADC$ DA, DC. the projection of A onto plane ACD is _____
Projection	In a <u>corner of a wall</u> , the projection of D onto plane A_1BC is _____;	In a triangular pyramid P-ADC, $\angle ADC = 90^\circ$, $PA=PC=PD$, then the projection of P onto plane ADC is _____	In a triangular pyramid B_1-ACD , if $\angle B_1DA = \angle B_1DC$ the projection of B_1 onto plane ACD is _____	

Fig. 5.74 Part 2 of the handout used in Lesson series H.II

Regarding the part 1 of the handout, the three methods are all summarized by Huang himself from the solutions to the past examination tasks and are expected to be used by students for solving the tasks in the third part. Here Huang chooses to omit some text descriptions in the methods and let the drawings brought out the corresponding information, such as P, O, Q should be collinear in the last two cases in Method 2.

Regarding the part 3 of the handout, the figural patterns are all pyramids or prisms situated in a cube with the side length of 2 so that students can quickly determine the relationships in the figural patterns in reference to the properties of a cube. There are two pieces of text under each figural pattern. Both pieces of text are integrated with some blanks to be filled; one piece of text is labeled “question” and the other is labeled “projection”. The text of “question” asks for the precise value of a point-plane distance in the figural pattern. The text of “projection” asks for a position of the orthogonal projection of a given point to a given plane. The orthogonal projection is in fact the foot of the perpendicular line from the point to the plane, on which lies the distance between the point and the plane. To fill in the blanks in the two pieces of text, students will need to apply one of the three methods in the first part of the handout. Through the text of “projection”, Huang would like to give a general conclusion about the position of the projection (also the point-plane distance) in a figural pattern; even though the drawings of the figural patterns are all situated in drawings of cubes, the texts of “projection” are actually about the figural patterns in ordinary cuboids. Specifically, for figural patterns ①②③, the answers expected for the first blank of the text of “projection” are respectively QIANDU (壅堵), YANGMA (阳马) and BIENAO (鳖臑). The three figural patterns, as already introduced in section 5.3.1, respectively refer to a triangular prism, a quadrilateral pyramid and a triangular pyramid that can be cut out of a cube or a cuboid. Similarly, figural pattern ④ concerns any regular pyramid with n-side polygonal base which is not limited to the particular

rectangular pyramid P-ABCD. The “corner of a wall” for figural pattern ⑤ is meant to represent any triangular pyramid in which the three lateral faces are perpendicular to each other. Figural pattern ⑤ concerns any pyramid with equivalent lateral edges extended from the summit. Patterns ⑦ and ⑧ both concern a triangular pyramid with the summit being at the same distance from the two sides of the base (the equivalence of angles in pattern ⑦ can be transformed into the equivalence of distances in pattern ⑧). The blanks in the text of this part are all left empty in the handouts distributed to students. However, they are not to be filled by the students themselves, but to be completed after the explanation of the teacher, who will also display the corresponding answers on the screen. In this sense, the functions of the blanks are more about underlining the critical information in the texts than introducing a task to be accomplished by students. All the figural patterns are summarized by Huang himself, who draws inspiration from past examination tasks, senior colleagues and also the discipline coordinators of their grade.

According to the lesson videos and the handout, we identify three activities:

- Activity 1: Introduce 3 methods of constructing and calculating a point-plane distance;
- Activity 2: Introduce 8 figural patterns related to the point-plane distance and guide students to complete the related conclusions indicated by the text;
- Activity 3: Explain point-plane distance tasks in reference to the methods and figural patterns.

Firstly, Huang distributed the handout to every student, displayed the three methods in part 1 on a slide (which is on the interactive intelligent blackboard, hereafter the same), and gave a quick review of them (Activity 1, also see Fig. 5.75). Secondly, he displayed the 8 figural patterns in part 2 on a slide, guided students to fill in the blanks in the text, and evoked the perpendicular line segments corresponding to the point-plane distances in the figural patterns; for figural patterns ⑤ ~ ⑧, Huang used a 3D DGE to assist with his explanation (Activity 2, also see Fig. 5.76). Thirdly, Huang displayed the tasks in part 3 on slides and publicly explained them one by one after giving students some time for solving the tasks (Activity 3, also see Fig. 5.77). Here he linked the tasks to the previous methods and figural patterns and made drawings and writings on the blackboards. In Activity 3, Huang used a 3D DGE only for the fourth task, which was also the last task he dealt with in the lesson.

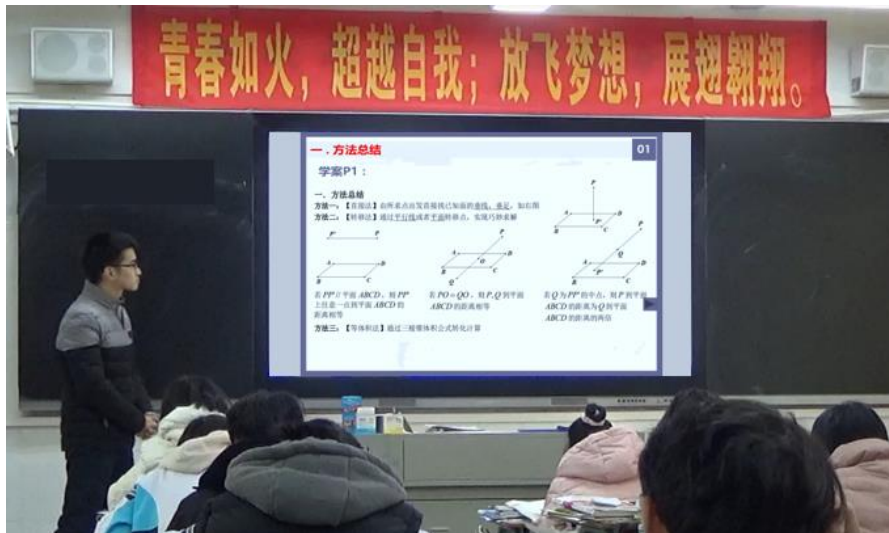


Fig. 5.75 Huang is introducing Part 1 of the handout

图形				
问题	B 到平面 ACC_1A_1 的距离为 $\sqrt{2}$	A 到平面 A_1BC 的距离为 $\sqrt{2}$	A 到平面 A_1DC 的距离为 $\sqrt{2}$	P 到平面 $ABCD$ 的距离为 2
射影	矩堵中, B 在平面 ACC_1A_1 的射影在过 B 作 AC 垂线的垂足 M	阳马中, A 在平面 A_1BC 的射影在过 A 作 A_1B 垂线的垂足 M	鳖臑中, A 在平面 A_1DC 的射影在过 A 作 A_1D 垂线的垂足 M	正四棱锥 $P-ABCD$ 中, P 在平面 $ABCD$ 的射影在底面 $ABCD$ 的中心 M
图形				
问题	D 到平面 ACD_1 的距离为 $\frac{2\sqrt{3}}{3}$	P 到平面 ADC 的距离为 2	B_1 到平面 ACD 的距离为 2	三棱锥 $P-ACD$, 若 P 到 $\angle ADC$ 两边 DA, DC 的距离相等, 则 P 在平面 ACD 的射影落在 $\angle ADC$ 的角平分线上
射影	墙角中, D 在平面 $\triangle ACD$ 的垂心(在此四心合一) 正三棱锥的顶点在底面的射影落在底面的中心 M	三棱锥 $P-ADC$, $\angle ADC = 90^\circ$, $PA = PC = PD$, 则 P 在平面 ADC 上的射影落在 $Rt\triangle ADC$ 的斜边中点 M	三棱锥 B_1-ACD , 若 $\angle B_1DA = \angle B_1DC$, 则 B_1 在平面 ACD 的射影落在 $\angle ADC$ 的角平分线上	

Fig. 5.76 Part 2 of the handout presented on the slide, with the red line segments and the answers in the blanks being evoked by Huang in his explanation

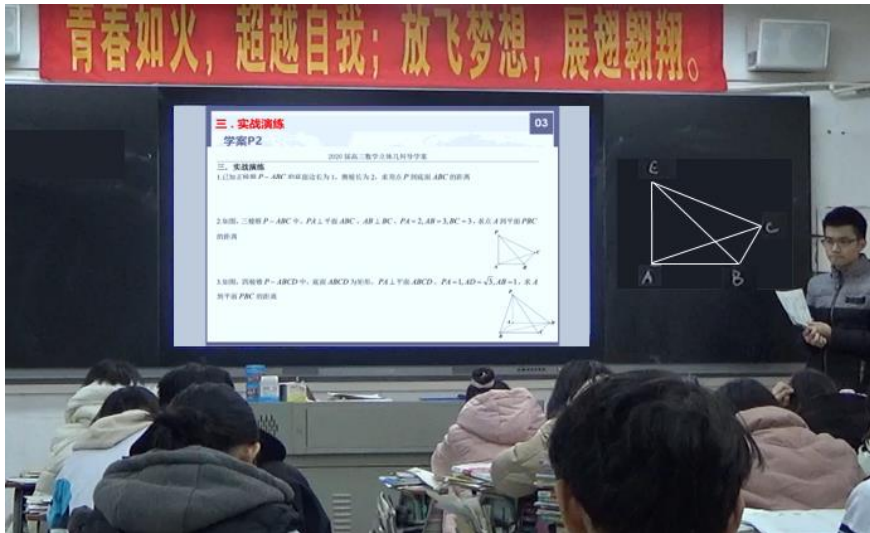


Fig. 5.77 Huang is explaining a task in Part 3 of the handout

5.3.7 Characteristics of 3D geometry tasks-3D DGEs in Lesson Series H.II

This section presents how we analyze the characteristics of the 3D geometry tasks and the 3D DGEs used in this lesson series, which are analyzed according to the dimensions of characteristics described in sections 3.3.1 and 3.3.2. The content of the tasks is sorted out from handout (Appendix 3.5); the content of the 3D DGEs is sorted out from the GeoGebra files used by Huang in the lesson series.

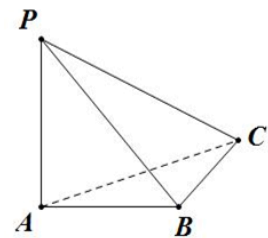
Characteristics of 3D geometry tasks

Since Huang only explained the first four tasks in the handout, we only analyze characteristics of these tasks and relabeled them Tasks 1 ~ 4. Below is presented the task content.

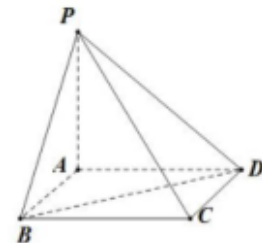
Task 1 Given a regular pyramid P-ABC, the side length of its base is 1, the lateral edge length is 2.

Please calculate the distance from P to the base ABC.

Task 2 As shown on the right, in the triangular pyramid, $(PA) \perp \text{plane } ABC$, $(AB) \perp (BC)$, $PA=2$, $AB=3$, $BC=3$. Please calculate the distance from A to plane PBC.



Task 3 As shown on the right, in the rectangular pyramid, base ABCD is a rectangle, $(PA) \perp \text{plane } ABCD$, $PA=1$, $AD=\sqrt{3}$, $AB=1$. Please calculate the distance from A to plane PBC.



Task 4 Given a right angle $\angle ACB$, P is a point out of plane ABC, $PC=2$, the distances of P to the two sides of $\angle ACB$ are both $\sqrt{3}$, then what is the distance from P to plane ACB?

Concerning the 3D geometry topic of Task 1, it generally belongs to Topic 4 – determine geometric magnitudes in space (already introduced in section 3.3.1, hereafter the same), and the geometric magnitude to be determined is a distance between a point P and a face ABC, or more precisely, the length of the line segment which passes through the point and is meanwhile perpendicular to the face. To determine this length, students need to find out which line segment from the point will be perpendicular to the face. Therefore, the task topic overlaps with Topic 1 – identify geometric relationships in space. The variable (a) in Topic 1, the “nature of the relationships and the geometric objects involved therein”, concerns the perpendicularity between a line segment and a face. The variable (b) in Topic 1, the “structure of the background solid” concerns a regular triangular pyramid, and students can easily associate it with the previous figural pattern ④ without much rotation of mental images. The variable (c) in Topic 1, the “relative positions of the geometric objects in the background solid” are about the line segment passing through the apex of the pyramid and the face being the base of the pyramid. To summarize, the detailed 3D geometry topic of Task 1 is to determine the length of perpendicular segment from the apex to the base of a regular triangular pyramid which fits the figural pattern ④ (i.e., regular pyramid) introduced in the lesson. The association is easy to make as students can easily identify if a pyramid is regular and apply the related properties.

With an analysis similar to the above, we get that the detailed 3D geometry topic of Task 2 is to determine the length of the perpendicular segment from a bottom vertex to one lateral face of a triangular pyramid, which can be associated with figural pattern ③. However, the association may not be easy to make, as the drawing of the pyramid P-ABC in Task 2 is presented in different perspective from the drawing of figural pattern ③. Students have to perform some complex mental rotation to make the essential geometric structure of pyramid P-ABC resemble that of the figural pattern ③. To be specific, in the drawing of pyramid P-ABC in Task 1 (see the table above), the two perpendicular faces – PBC and PBA – are at the fore, while in the drawing of figural pattern ③ (see Fig. 5.76), the two perpendicular faces – A_1DA and A_1DC – are at the back. Therefore, students need to rotate pyramid P-ABC in their mind to link its structure to figural pattern ③, and further to find the correct perpendicular segment marking the distance.

Task 3 is in a same case as Task 1. With a similar analysis, we get that the detailed 3D geometry topic of Task 3 is to determine length of a perpendicular segment from a bottom vertex to a lateral face of a rectangular pyramid. The rectangular pyramid can be easily associated with figural pattern ②, as their drawings are presented in close perspectives.

Task 4 is also similar to Tasks 1. Its detailed 3D geometry topic is to determine the length of the perpendicular segment from the apex to the base of a triangular pyramid which can be easily associated with the figural pattern ③.

Now we discuss the status of the four tasks in the Chinese curriculum. Since the lesson series fell in the scope of the old version of Chinese upper secondary mathematics curriculum and the stream of literature and humanities within the general branch, in the following paragraphs, we focus on this part of the Chinese curriculum to examine the prescriptions related to the tasks. Tasks 1 ~ 4 all ask for a point-plane distance, involving the determination (calculation) of the length of a line segment and the identification of the perpendicularity between the line segment and a plane.

The calculation of the length of a line segment requires the abilities of applying the Pythagorean theorem or the formulae of areas and volumes. Sometimes it is also necessary to transform the line segment into another equivalent one by using the properties of parallelism, or properties of congruent or similar triangles. All of the knowledge and abilities are what students should master according to the Chinese curriculum (Ministry of Education of the People's Republic of China, 2003), with some already learned in lower secondary school.

As for the identification of the perpendicularity between a line segment and a plane within a solid, the related curriculum prescriptions are that students should “prove statements concerning relative positions in space with the conclusions already obtained” (ibid., p. 19-21, our translation). The conclusions already obtained refer to the basic facts and theorems in 3D Euclidean geometry listed in the curriculum, and the most important here are those related to the perpendicularity in space, such as “if a line is perpendicular to two intersecting lines in another plane, the line is perpendicular to the plane” and “if two planes are perpendicular, a line in one plane and meanwhile perpendicular to the intersection of the two planes is also perpendicular to the second plane” (ibid., p. 20-21). Also, the curriculum requires students to have perceptive support with respect to (the proof of) geometric properties of 3D figures, for which the use of information technology is suggested as an aid (Ministry of Education of the People's Republic of China, 2003).

Now we discuss the status of the four tasks in GAOKAO examination. The first three tasks are close to the short essay items in GAOKAO. This kind of items require students to give detailed mathematics proof for their answer. To be specific, for accomplishing a GAOKAO task that demands a point-plane distance in a solid, students should firstly find out a perpendicular line segment from the designated point to the designated plane, then prove that the line segment is actually perpendicular to the plane, and finally calculate the length of the line segment.

The fourth task is close to the fill-in-blank items in GAOKAO. These items only ask for a word/sentence/number/magnitude to be filled in the blank. That means students can use any approach (including inductive reasoning, abductive reasoning, observation, imagination, random choice or guessing) to solve the tasks as long as the approach can yield a right answer. Every such item brings up 5 points, out of the full mark of 150 points of GAOKAO. As can be seen, although the Chinese curriculum prescribes students to solve the task as such with a Euclidean geometric approach, the approach is complex and not so economic in terms of the time for a fill-in-blank item in GAOKAO.

Regarding the contexts of the tasks, we see that all the tasks are situated in the paper-pencil environment, as the task statements are presented on the paper handout and students need to write down their solutions on the paper with pencils or pens. Regarding the innate support of the tasks, Tasks 2 and 3 are both equipped with a drawing of the task figure. Tasks 1 and 2 are equipped with no specific support, so students have to imagine the solids at stake and construct their drawings on the paper.

Characteristics of 3D DGEs

Now we describe the characteristics of the 3D DGEs one by one. Huang used two 3D DGEs in the lesson series. The first one was used together with figural patterns ⑤ ~ ⑧. The second one was used together with Task 4. Since Task 4 can be associated with figural pattern ⑧,

Huang actually used two 3D DGEs for explaining Task4. As for Tasks 1 ~ 3, Huang did not use specific 3D DGEs for either the tasks or the related figural patterns.

As shown in Fig. 5.78, the figural representation in the 3D DGE for ⑤ ~ ⑧ is a 3D dynamic model incorporating a pyramid, a cube in which the pyramid is situated, a plane that passes through the diagonal face (B_1BDD_1) of the cube; the apex of the pyramid (P) can freely move on the diagonal face. When P respectively moves to the vertex D_1 of the cube (Fig. 5.79), to the midpoint of B_1D_1 (Fig. 5.78), to the vertex B_1 (Fig. 5.80), and to a point on BB_1 (Fig. 5.81), the pyramid respectively represents figural patterns ⑤, ⑥, ⑦ and ⑧. In the figural pattern ⑤, Huang also constructs a perpendicular line segment from D to PAC to show the orthogonal projection at stake in the pattern, together with the orthocenter of the triangle PAC (intersection of two altitudes of the triangle). In figural patterns ⑥, ⑦ and ⑧, the orthogonal projection is that from P to the base ADC , so Huang constructs a perpendicular line segment from P to the base, which overlaps with the left edge of the cube in the last two figural patterns. The perpendicular line segment meanwhile reflects the designated point-plane distance in each figural pattern. The 3D DGE retains all the GeoGebra tools but Huang focuses on the *Dragging* tool. The feedback evoked in the 3D DGE belongs to the innate feedback in GeoGebra: by dragging P around on the diagonal face, one can observe the point-plane distances in different figural patterns and where the orthogonal projections fall; by turning around a whole 3D dynamic model, one can observe the whole figural pattern from different perspectives. There is no specific form of help in the 3D DGE; the difficulty level and the pace of learning activities in the 3D DGE are under the teacher's control, as it is the teacher who determines the effects to be displayed. The 3D DGE is close to the curriculum as it has the potential of supporting students' perception of the point-plane distances in the different pyramid figural patterns and the corresponding orthogonal projections. The 3D DGE also allows students to discover regularities from the perceptive effects: as long as P is in the diagonal face of the cube, the orthogonal projection of P to the base will fall at the diagonal of the base (bisector of $\angle ADC$). These didactical potentials match the curriculum suggestions of presenting various 3D figures with computer software to help students understand their structural attributes of common solids and "to provide perceptive support for students' understanding and mastering of geometric properties and their proof" (Ministry of Education of the People's Republic of China, 2003, p. 22, our translation).

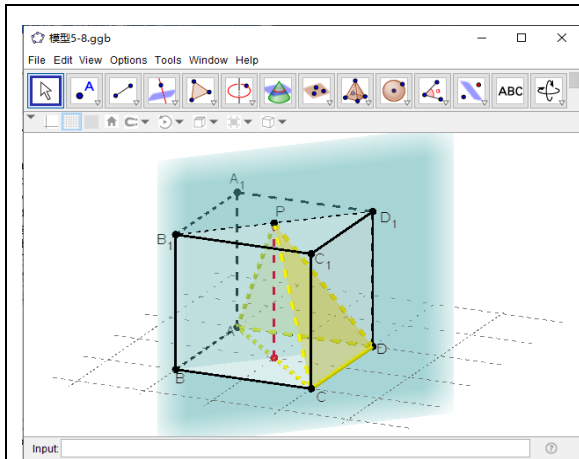


Fig. 5.78 3D dynamic model and feedback for the figural pattern ⑥ in the 3D DGE

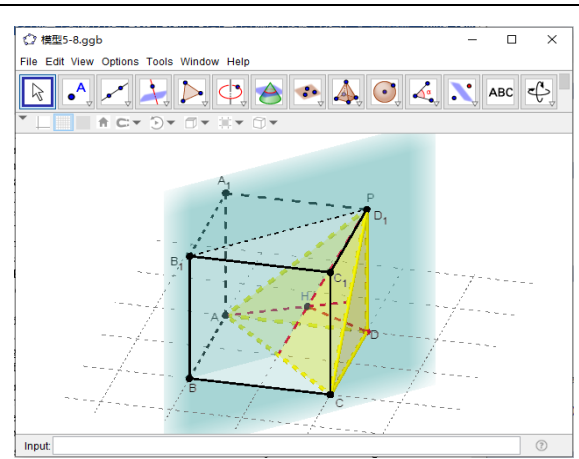


Fig. 5.79 3D dynamic model and feedback for the figural pattern ⑤ in the 3D DGE

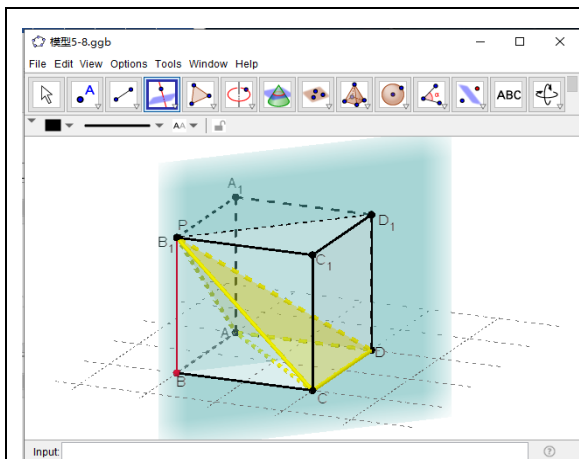


Fig. 5.80 3D dynamic model and feedback for the figural pattern ⑦ in the 3D DGE

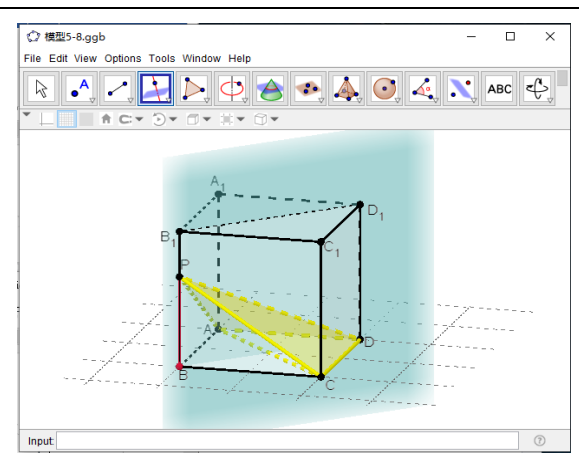


Fig. 5.81 3D dynamic model and feedback for the figural pattern ⑧ in the 3D DGE

Regarding the second 3D DGE for Task 4, the basic figural representation in it is a 3D dynamic model of the figure described in the task, which consists of a right triangle $\triangle ABC$ with the right angle at point C , a point P above the triangle, a ray connecting P and C , and two line segments constructed from P which are respectively perpendicular to CA and CB (Fig. 5.82). The tools mobilized here include construction tools such as Segment, Ray and Perpendicular Line and the Dragging tool. With these tools, Huang subsequently constructs the perpendicular line from P to plane ABC , the foot M of this perpendicular line, ray CM , and line segment MG , and for each newly constructed object, the name of the object is displayed alongside, as exemplified by Fig. 5.83 ~ Fig. 5.84. During the process, Huang timely drags the whole dynamic model to turn it around; he also adds annotations on the screen with the Pen tool on the intelligent interactive blackboard, to mark the magnitudes of line segments and angles in the 3D DGE (Fig. 5.85). The feedback in the 3D DGE resides in the effects of the objects constructed (including their different views) with the manipulations mentioned above, belonging to the innate feedback in GeoGebra. The form of help and location of control in the

3D DGE are the same as in the previous 3D DGE. This 3D DGE is close to the curriculum as it is mainly used as a perceptive support when Huang explains how to solve the task by theoretical deductive reasoning and adds scaffolding lines and annotations to the task figure from time to time. This matches the didactical suggestion of “using information technology to present 3D figures, providing perceptive support for the understanding and master of geometric properties and their proof” in the curriculum (ibid.).

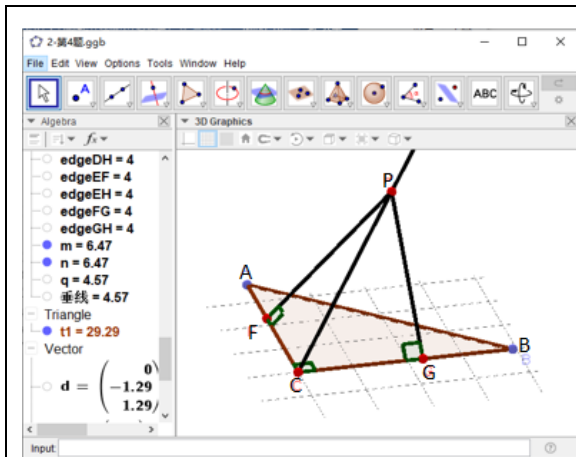


Fig. 5.82 3D dynamic model in the 3D DGE for Task 4

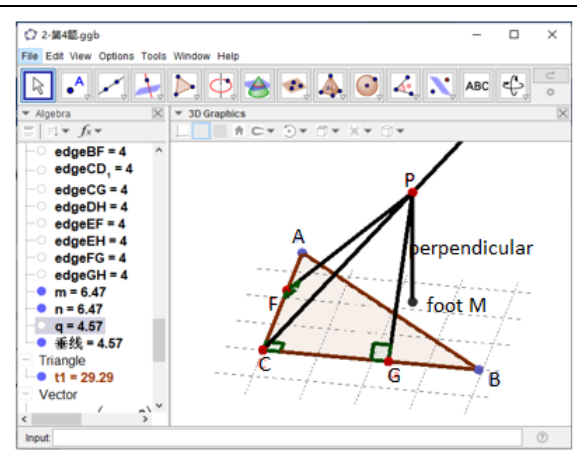


Fig. 5.83 One view of the 3D dynamic model with some constructions

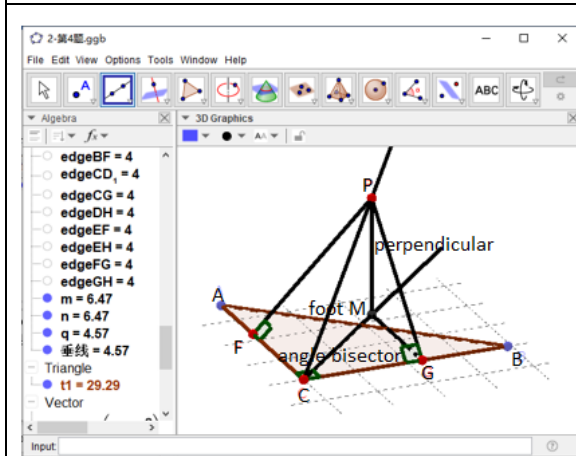


Fig. 5.84 Another view of the 3D dynamic model with more constructions

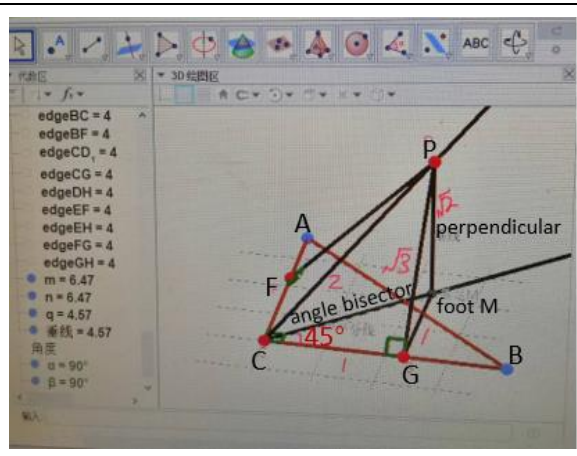


Fig. 5.85 Annotations added to the 3D DGE on the screen¹⁴

5.3.8 Rules of coordination in Lesson Series H.II

This section presents three groups of rules of coordination and how we have identified them through analysis of argumentation episodes. The three groups of rules of coordination are respectively labeled H.II-A, H.II-B and H.II-C. The argumentation episodes all come from the

¹⁴ The GeoGebra images in § 5.3.7 are all selected by us according to the original GeoGebra files provided by the teacher; the annotations on the screen are translated by us from Chinese to English.

transcript of the lesson video. The analysis procedures that lead to these rules of coordination have been introduced in the methodology part (section 4.4.1).

In the actual lesson, the discussions around the 3D geometry tasks only began after all the figural patterns had been introduced, but Huang would call back the relevant figural pattern while explaining a task, helping students to apply the conclusions about the figural pattern for solving the task. Therefore, in the rest of this section, we consider the argumentation around a figural pattern as a part of the whole collective argumentation around the related task.

Rules of coordination H.II-A: (1) draw a 3D figure within the drawing of a cube to support students' perception; (2) generalize a conclusion from the particular 3D figure to a 3D figural pattern through inductive reasoning; (3) develop simplified theoretical deductive reasoning together with students to explain the particular or the generalized conclusion.

The first example episode related to these rules of coordination concerns figural pattern ④, which belongs to the whole collective argumentation around Task 1. The collective argumentation happened between Huang and the whole class of students. For the convenience of reading, we present Task 1 again here.

Task 1

Given a regular pyramid P-ABC, the side length of its base is 1, and the length of its lateral edge is 2. Please calculate the distance from P to base ABC.

The whole collective argumentation started when Huang introduced figural pattern ④ – a regular pyramid. In the process, he guided students to fill in the blank related to the figural pattern, getting the conclusion that the orthogonal projection of the apex on to the base of figural pattern ④ falls at the circumcenter of the base (argumentation node). When Huang turned to explain Task 1, for the given regular pyramid P-ABC, the students soon realized that the orthogonal projection of point P onto the base $\triangle ABC$ falls at its circumcenter. But Huang still associated pyramid P-ABC with figural pattern ④, and then guided students to figure out the target point-plane distance requested by the task. That was the end of the whole argumentation.

The argumentation process between the beginning and the argumentation node is identified as Episode 1, with the remainder being Episode 2. The argumentation node is inserted because of the natural division between the discussion around the figural pattern and the discussion around the task. What we will investigate here is Episode 1 and below is its transcript.

Episode 1 – T, S – Task 1

T: Look at the figural pattern ④ (Fig.1), in the regular rectangular pyramid P-ABCD [1-Factual-Data], to find the distance from P to plane ABCD and its projection, how can we do?

S: Construct the perpendicular line from P to the square base...
--

T: And the projection will fall at?

S: The center of the square ABCD [part of 2-Claim]

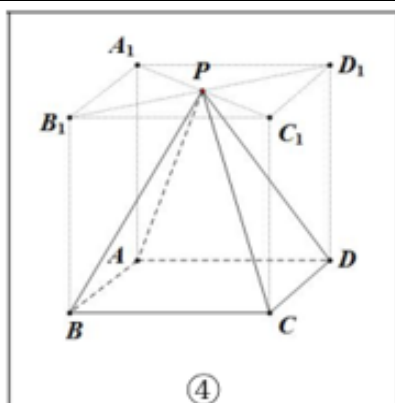
T: Yes, but more precisely, it's the circumcenter of the square [part of 2-Claim]. In fact, for any regular pyramid with the n-side polygonal base [3-Factual-Data], the projection of its apex P onto the polygonal base will be the circumcenter M of that base (Fig.2) [4-Claim], do you know why?

S: These right triangles are congruent? [part of 5-Deductive-Warrant]

T: Yes, these are all congruent triangles (pointing at $\triangle PMA, PMB, PMC, PMD$); we just make use of the equivalent sides of congruent triangles to say that M is the circumcenter [part of 5-Deductive-Warrant]. I don't go into more detail. Here the distance is what?

S: 2.

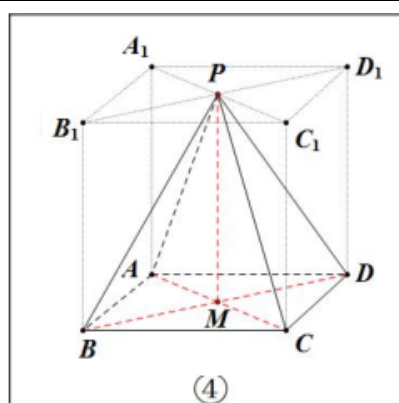
T: Exactly (evoking 2 in the first piece of the text under the figural pattern)! Now we look at the pattern ⑤



The distance of P to base ABCD is ____

In any regular pyramid, the projection of summit P onto the polygonal base is ____

Fig. 1 Huang presents the figural pattern ④ on the interactive blackboard¹⁵



The distance of P to base ABCD is ____

In any regular pyramid, the projection of summit P onto the polygonal base is circumcenter M of the base

Fig. 2 Huang evokes the red line segments in the figural pattern ④ and the answer in the second piece of the text

We firstly discuss the argumentation components directly contributed by the participants in this episode. After displaying the drawing of the figural pattern ④ and indicating the characteristics of the pyramid P-ABCD (1-Factual-Data),Huang directly asks students how to find the distance from P to base ABCD and the orthogonal projection of P. As a response, students firstly judge that the projection of P will fall at the “center” of square ABCD (part of 2-Claim). The answer is probably based on the fact that P-ABCD is a regular rectangular pyramid which is brought out by the teacher at the beginning. After that, Huang reformulated the “center” of the square ABCD as the “circumcenter” of the square ABCD, which constitutes another part of 2-Claim, and soon generalized the conclusion about the pyramid P-ABCD to any regular pyramid with a n-side polygonal base (3-Factual-Data), getting the conclusion that

¹⁵ The two figures (Fig. 1 and Fig. 2) in the episode are all reproductions of what Huang presents on the intelligent interactive blackboard and translated by us from Chinese to English

the orthogonal projection of the pyramid's apex should fall at the circumcenter M of the polygonal base (4-Claim). Here Huang does not clearly indicate the rules he follows for the generalization process, so we attach an implicit Inductive-Warrant to the transition from 2-Claim to 4-Claim. Huang further requests students to explain the 4-Claim, and students refer to the congruence of the right triangles related to M, which shall be resulted from the properties of a regular pyramid (i.e., inference from 3-Factual-Data). Huang confirms students' answer and completes that there are the equivalent sides in the congruent triangles that result in M being the circumcenter. In this way, the properties of congruent triangles serve as a bridge, referring to which the deductive reasoning from 3-Factual-Data to 4-Claim can be realized; we thus identify the properties as 5-Deductive-Warrant and it is contributed by Huang and students together.

Secondly, we discuss Huang's indirect contributions to the argumentation in the episode. They include: the question of *requesting a method* which elicits students' contribution of 2-Claim and the supportive action of *informing* (reformulating) the 2-Claim; the question of *requesting elaboration* (the reason) which elicits students' contribution of 5-Deductive-Warrant and the supportive action of *informing* (expanding) the 5-Deductive-Warrant. There is no use of 3D DGEs or gestures in this episode.

The direct contributions of all the participants and the indirect contributions of Huang are integrated into the diagram in Fig. 5.86. Huang's direct contributions (yellow and green boxes) and indirect contributions (talk bubbles) together constitute his coordination behavior in this episode.

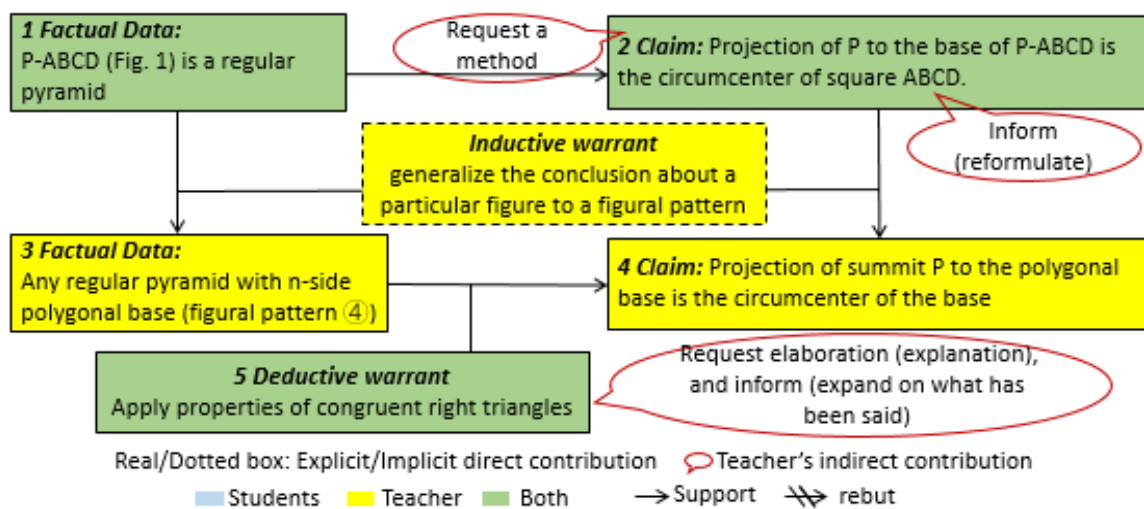
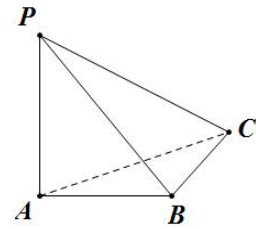


Fig. 5.86 Diagram of argumentation for Episode 1 – T, S – Task 1

The second example episode related to the rules of coordination concerns figural pattern ③, which is further a part of the collective argumentation around Task 2. The collective argumentation happened between Huang and the whole class of students. The task is presented below.

Task 2

As shown on the right, in the triangular pyramid P-ABC, $(PA) \perp \text{plane } ABC$. $(AB) \perp (BC)$, $PA=2$, $AB=3$, $BC=3$. Please calculate the distance from A to plane PBC.



The whole collective argumentation started when Huang introduced the figural pattern ③ – a triangular pyramid with two lateral faces being perpendicular to each other (BIENAO). In the process, he guided students to fill in the blank related to the figural pattern, getting the conclusion about the orthogonal projection of a bottom vertex onto one of the perpendicular lateral faces in figural pattern ③ (argumentation node). Later when Huang turned to explain Task 2, he associated the pyramid P-ABC in the task with figural pattern ③, helping students to understand that the orthogonal projection of point A onto the lateral face PBC in pyramid P-ABC should fall at the foot of the perpendicular from A to PB. Huang let students calculate the target point-plane distance requested by the task after class and this was the end of the whole argumentation.

The argumentation process between the beginning and the argumentation node is identified as Episode 1, with the remainder being Episode 2. The argumentation node is inserted because of the natural division between the discussion around the figural pattern and the discussion around the task. What we will investigate here is Episode 1 and the following is its transcript.

Episode1 – T, S – Task 2

T: OK, then in the third figural pattern (Fig. (1), we need to find the distance from A to plane A_1DC and its projection onto A_1DC . Do you notice that ③ is actually a part of ②? ② is a rectangular pyramid, and ③ is a triangular pyramid. Now that ② is 阳马 (YANGMA), ③ is what? we have said it before... 鳖臑 (BIENAO) [part of 1-Factual-Data], OK? As for the distance between A and A_1DC , how to find it? (*waiting for a while*) We need to find a line passing through A and perpendicular to A_1DC , right? Do you remember the theorem, if two planes are perpendicular, then a line in one plane and perpendicular to the intersection of the planes is also perpendicular to the other plane, OK? [2-Deductive-Warrant]

S: Yes...

T: What could be the plane perpendicular to A_1DC here?

S: A_1AD [part of 1-Factual-Data].

T: Exactly, and it intersects A_1DC at A_1D [part of 1-Factual-Data]. So how can we construct the perpendicular line from A to A_1DC ?

S: Make the perpendicular line from A to A_1D [part of 3-Claim]

T: Good, we construct a perpendicular line, and let the foot be M (Fig.2). M is the projection of A to the plane A_1DC , right? How can you describe the position of M?

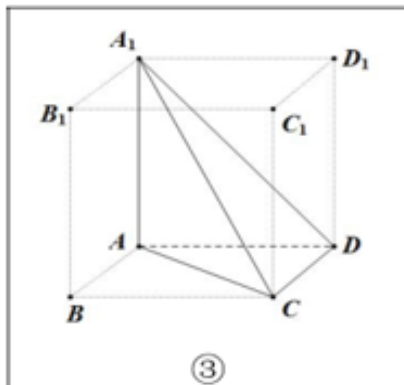
S: The midpoint of the segment A_1D [part of 3-Claim]?

T: In this cube, it is exactly the midpoint. But what if it's a 鳖臑 (BIENAO) in a cuboid, with different the length, width and height [4-Factual-Data], the projection is still the midpoint?

(Waiting for some seconds) In fact, it's enough to say “the foot of the perpendicular from A to AD_1 ” (Fig. 2) [5-Claim], OK? And here the distance is what?

S: $\sqrt{2}$.

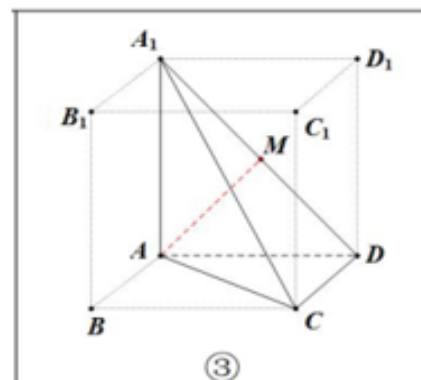
T: Right (evoking 2 in the first piece of the text under the figural pattern ④).



The distance of A to plane A_1DC is ____

In ____, the projection of A to plane A_1DC is ____

Fig. 1 Huang presents the figural pattern ③ on the interactive blackboard¹⁶



The distance of A to plane A_1DC is ____

In **BIE NAO**, the projection of A to plane A_1DC is **the foot M of the perpendicular from A to A_1D** .

Fig. 2 Huang evokes the red line segments in the figural pattern ④ and the answer in the second piece of the text

We firstly discuss the argumentation components directly contributed by the participants in this episode. At the beginning, Huang focuses on the particular triangular pyramid $A_1 - ADC$ in the drawing (situated in a cube) which is used to represent the figural pattern ③, points out that it is an instance of BIENAO (part of 1-Factual-Data), and asks students to find out the perpendicular line from A to the plane A_1DC . While students have no idea, Huang reminds them of a “geometric theorem” about how a line can be perpendicular to a plane, and directs them to seek a plane perpendicular to A_1DC . Students soon realize that the plane A_1AD is perpendicular to A_1DC (part of 1-Factual-Data), and Huang highlights the intersection of the two planes (part of 1-Factual-Data). Now the 1-Factual-Data has gathered all the information that allows to apply the “geometric theorem”, which makes students get the conclusion that the perpendicular line from A to A_1DC is the perpendicular line from A to the segment A_1D , and that the projection of A to A_1DC (the foot of the perpendicular) falls at the midpoint of A_1D (3-Claim). In this way, students have completed a theoretical deductive reasoning in reference to the “geometric theorem”, and thus the geometric theorem is identified as a Deductive-Warrant (labeled 2). With respect to the position of the projection of A to A_1DC , the students’ conclusion in 3-Claim only fits the BIENAO situated within a cube, but Huang would like it

¹⁶ The two figures (Fig. 1 and Fig. 2) in the episode are all reproductions of what Huang presents on the intelligent interactive blackboard and translated by us from Chinese

to fit the BIENAO in an ordinary cuboid, bringing out 4-Factual-Data and 5-Claim. The two components can be seen as the extension from 1-Factual-Data and 3-Claim through an implicit Inductive-Warrant.

Secondly, we discuss Huang’s indirect contributions to the argumentation in the episode. They include: the action of *directing* (with a hint of a geometric theorem) and the question of *requesting a simple answer* which elicit students’ contribution to 1-Factual-Data; the questions of *requesting a method* and *requesting a simple answer* which elicit students’ contribution to 3-Claim; and the action of *requesting* students’ *evaluation* of 3-Claim (request them to reconsider a statement by proposing a case for which the statement does not hold). There is no use of 3D DGEs in this episode.

The direct contributions of all the participants and the indirect contributions of the teacher are integrated into the diagram in Fig. 5.87. Huang’s direct contributions (yellow and green boxes) and indirect contributions (talk bubbles) together constitute his coordination behavior in this episode.

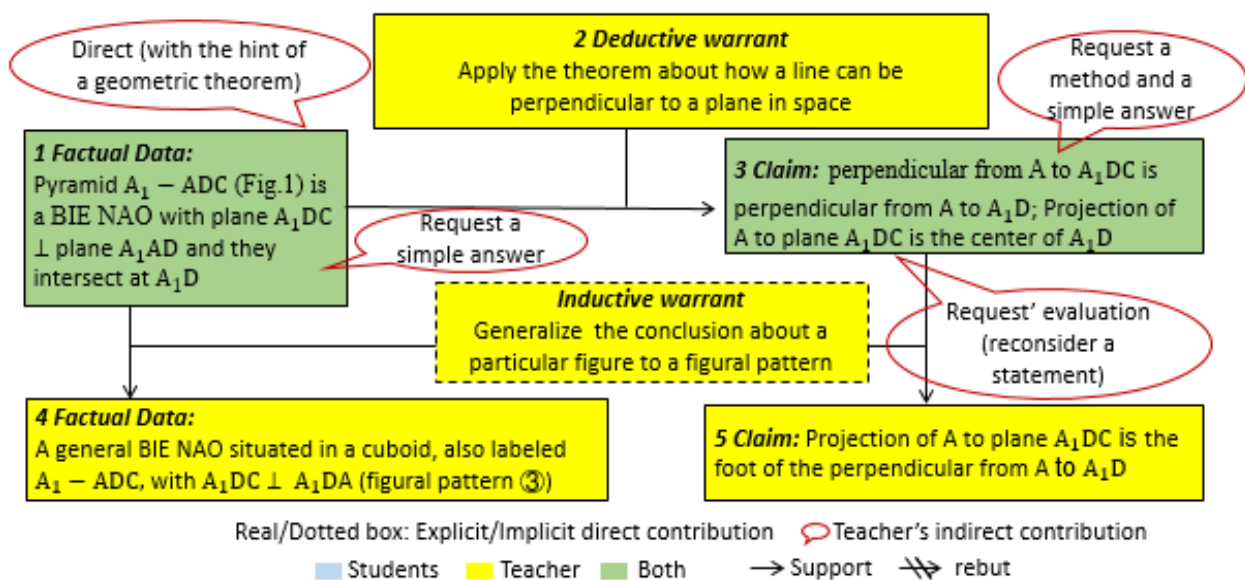


Fig. 5.87 Diagram of argumentation for Episode1 – T, S – Task 2

The two argumentation episodes are underpinned by the same basic structure. As the two diagrams of argument (Fig. 5.86, Fig. 5.87) show, they both cover two groups of Factual Data – Claim. The first group concerns a particular figure reflected in the drawing in the lesson handout, and the components are usually contributed by students and later completed by the teacher. The second group concerns a general figural pattern for which the particular figure is just an instance, and the components are always contributed by the teacher. The transition from the first group of Factual Data – Claim to the second group is underpinned by an Inductive Warrant, as this is inductive reasoning process of generalizing the conclusion about a particular figure to a figural pattern. Besides, the participants would integrate a Deductive Warrant to one of the two groups of Factual Data – Claim, to develop simplified theoretical deductive reasoning (not a rigorous step-by-step deduction) for validating the generalized conclusion. The Deductive Warrant can be contributed by the teacher or by students under the teacher’s request. The same basic structure has been found in the episodes under Tasks 1 ~ 3, where the

teacher introduces the corresponding figural patterns. We therefore classify the episodes into Group H.II-A, with their basic structure being represented by the general diagram in Fig. 5.88.

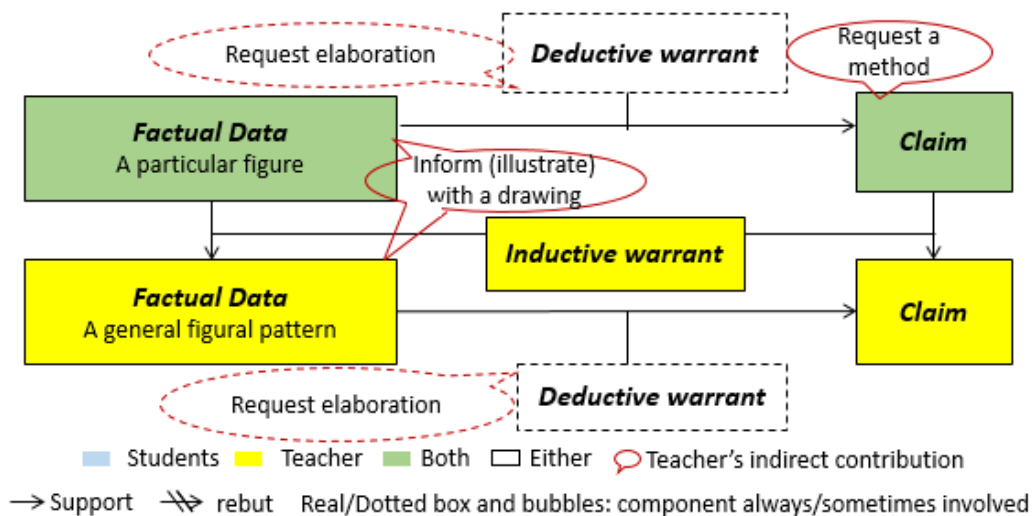


Fig. 5.88 General Diagram of argumentation for Episodes of Group H.II-A

The teacher's contributions to the general diagram mainly include: (1) directly contributing the two Factual Data that concern a particular figure and a general figural pattern, and *use a drawing to inform them* (2) *requesting a method* to elicit students' contribution of the Claim about a particular figure, and directly contributing the Claim about the general figural pattern; (3) directly contributing the Deductive Warrant or *requesting* students' *elaboration* for the generalized Claim to elicit their contribution of the Deductive Warrant. These contributions correspond to two rules of coordination which are classified into Group H.II-A: (1) draw a 3D figure within the drawing of a cube to support students' perception; (2) generalize a conclusion from the particular 3D figure to a 3D figural pattern through inductive reasoning; (3) develop simplified theoretical deductive reasoning together with students to explain the particular or the generalized conclusion.

Rules of coordination H.II-B: (1) draw a 3D figure within the frame of cube to support students' perception; (2) generalize the conclusion from the particular 3D figure to a figural pattern through inductive reasoning; (3) use a 3D DGE to support students' perception making them certain of the generalized conclusion.

These rules of coordination are identified from only one argumentation episode about the figural pattern ⑦ and ⑧, which is further a part of the collective argumentation around Task 4. The collective argumentation happened between Huang and the whole class of students. Below is the content of the task.

Task 4

Given a right angle $\angle ACB$, P is a point out of the plane ABC, $PC=2$, the distances of P with respect to the two sides of $\angle ACB$ are both $\sqrt{3}$, then the distance from P to the plane ABC is ____

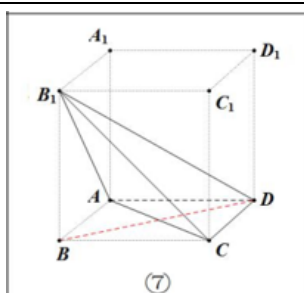
The whole collective argumentation started when Huang introduced figural pattern ⑦ – a triangular pyramid with one lateral edge forming equal angles with two sides at the base. In the

process, he talked about figural pattern ⑦ together with figural pattern ⑧ and guided students to fill in the blanks related to the two figural patterns, getting the conclusion about the orthogonal projection of the apex on to the base in the two figural patterns (argumentation node). Later Huang turned to explain Task 4 and displayed the 3D dynamic model that illustrated the figure in the task (simply called “task figure”). Students quickly associated the task figure with figural pattern ⑧, getting the conclusion that the orthogonal projection of P onto plane ABC in the task figure falls at the angle bisector of $\angle ACB$. Huang then made constructions and added annotations to the 3D dynamic model, guiding students to calculate the distance from P to plane ABC requested by the task. That was the end of the whole argumentation.

The argumentation process between the beginning and the argumentation node is identified as Episode 1, with the remainder being Episode 2. The argumentation node is inserted because of the natural division between the discussion around the figural pattern and the discussion around the task. What we will investigate here is Episode 1 and the following is its transcript.

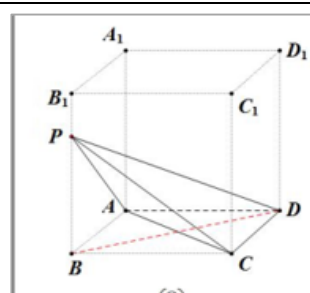
Episode 1 – T, S – Task 4

1 T: Next look at the figural pattern ⑦, the most significant characteristic of this structure is the two angles-- $\angle B_1DA$ and $\angle B_1DC$ – are equal [1-Factual-Data], then what feasible conclusion can we obtain here? The projection of B_1 on plane ADC, you see, it's B, and it falls exactly on the angle bisector of $\angle ADC$ (Fig. (1) [2-Claim]. When B_1 moves down, the projection of P is still B, it also falls at the angle bisector (Fig. 2) [part of 3-Factual-Data]. Here in the pattern ⑧ it says “the distances of P to the two sides of $\angle ADC$ are equal”, isn't it equivalent to say “ $\angle PDA = \angle PDC$ ” [part of 3-Factual-Data]? Here the projection of P also falls at the bisector of $\angle ADC$ [4-Claim]. So the two patterns are of the same nature. In fact, not only these two cases, for any P in the diagonal face of the cube, as $\angle PDC$ always equals $\angle PDA$ [5-Factual-Data], the projection of P will always fall on the angle bisector of $\angle ADC$ [6-Claim]. Does it make sense for you?



The distance of B_1 to plane ADC is 2.

In triangular pyramid B_1 -ADC, if $\angle B_1DA = \angle B_1DC$, the projection of B_1 to plane ADC is the angle bisector of $\angle ADC$.



In triangular P-ACD, the distances from P to the two sides of $\angle ADC$, DA and DC, are equivalent, then the projection of P to plane ACD is the angle bisector of $\angle ADC$.

Fig. 2 Huang presents the figural pattern ⑧ on the interactive blackboard, traces B_1B and BD

<p>Fig. 1 Huang presents the figural pattern ⑦ on the interactive blackboard and then evokes the red line segments and answers in the text¹⁷</p>	<p>with the mouse, and then evokes the red line segment and answers in the text</p>
--	---

4 S: ...Will it always fall on the angle bisector? can you prove that? [7-Non-Absolute-Qualifier]

5 T: The proving process is a little complicated, we should use the properties of congruent triangles. But you don't need to prove it in detail, just remember the conclusion, and it will save us a lot of time for solving tasks.

6 S: ...

7 T: OK, I will show you this in GeoGebra. Look, given a point in the diagonal plane, we move it to B_1 (Fig. 3), it's the case of ⑦, and then move it down (Fig. 4), it's the case of ⑧. Next I move it to a general position (Fig. 5), look, the projection of P, does it always fall on the angle bisector of $\angle ADC$? I let the angle bisector show up to make you see more clearly (Fig. 6) [8-Perceptive-Data]? Now can you accept it?

6: S: Yes! It's evident [9-Absolute-Qualifier].

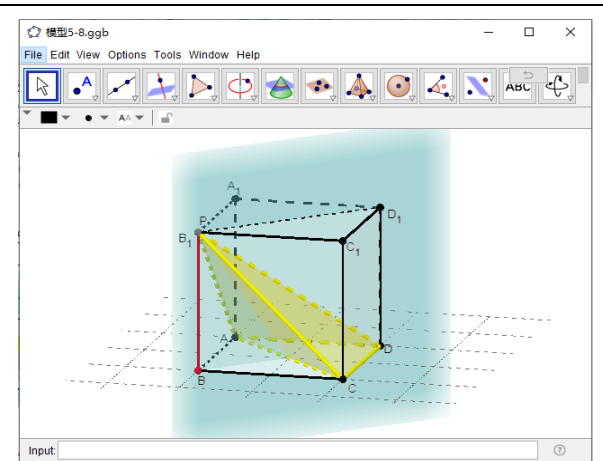


Fig. 3 Huang shows the GeoGebra model for the figural pattern ⑦ on the interactive blackboard¹⁸

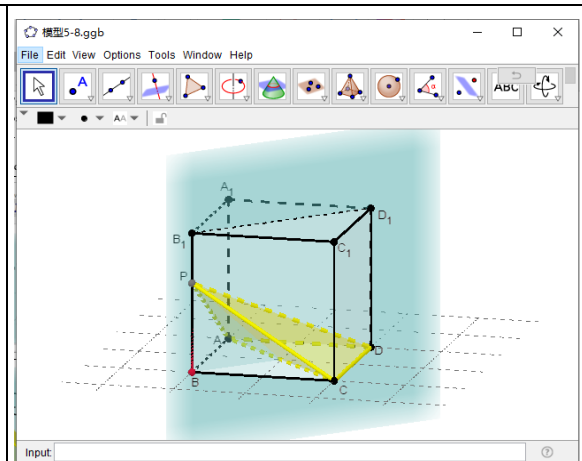


Fig. 4 Huang moves the point P along B_1B to display the model for the figural pattern ⑧

¹⁷ Fig. 1 and Fig. 2 in the episode are all reproductions of what Huang presents on the intelligent interactive blackboard and translated by us from Chinese to English

¹⁸ Fig.3-6 in the episode are all reproductions of what Huang presents on the intelligent interactive blackboard

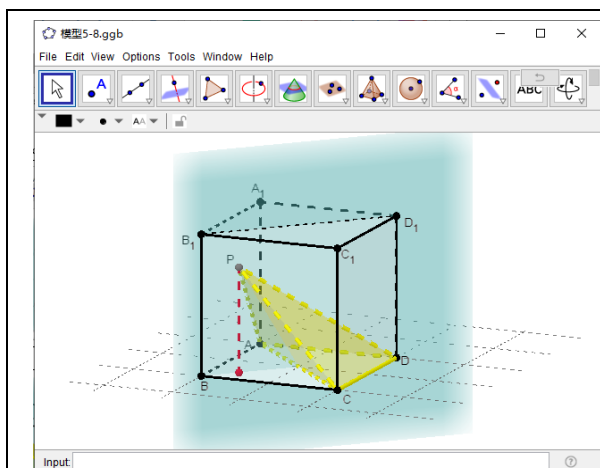


Fig. 5 Huang moves P to a general position in the diagonal plane of the cube

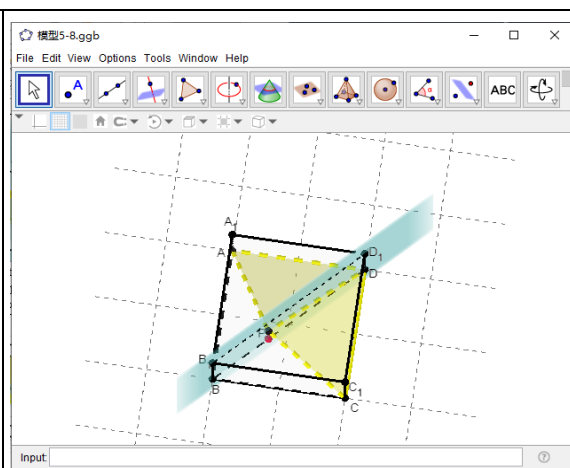


Fig. 6 Huang evokes the angle bisector of $\angle ADC$ and moves the whole GeoGebra model to an overhead view

We first look at the argumentation components directly contributed by the participants in the episode. At the beginning, Huang focuses on the two particular pyramids, B_1 -ADC and P-ADC, in the drawings that are used to represent figural patterns ⑦ and ⑧. After introducing the structural characteristics of the two pyramids (1-Factual-Data and 3-Factual-Data), Huang directly gives the conclusions that the orthogonal projection of B_1 and P to the base plane in the two pyramids both fall at the bisector of $\angle ADC$ (2-Claim and 4-Claim). We consider the structural characteristics as two Factual-Data because they concern the true facts about the particular pyramids that can be easily determined according to the properties of the background cube. Huang also points out that the structural characteristics of B_1 -ADC and P-ADC are in fact the same, and then he extends the conclusions to a more general case – a pyramid P-ADC with P being at any position in the diagonal face of the cube (and thus forming equal angles with DA and DC) (5-Factual-Data)– and get the conclusion that P is always projected to the bisector of $\angle ADC$ (6-Claim). The general pyramid constitutes the essence of figural patterns ⑦ or ⑧ that Huang would like to introduce. The transition from 2-Claim and 4-Claim to 6-Claim can be considered as being underpinned by an implicit Inductive Warrant, as this is an inductive reasoning process of generalizing the conclusion that has been verified in two particular figures to a figural pattern. However, students wonder whether 6-Claim can be hold for any P-ADC and request a proof for this, that is, they attach a Non-Absolute Qualifier (labeled 7) to 6-Claim. As a reaction, Huang directly shows the perceptive effects in GeoGebra instead of developing a proof. After seeing that many P in the diagonal face of the cube are projected orthogonally to the bisector of $\angle ADC$ (8-Perceptive-Data), students accept the conclusion in 6-Claim with certainly; we hereby identify an Absolute-Qualifier (labeled 9) from students. The transition from 8-Perceptive-Data to 6-Claim can also be considered as being underpinned by an implicit Deductive-Warrant, as students just extended the conclusion in more cases (infinitely many) to a general figural pattern by inductive reasoning.

Secondly, we consider Huang's indirect contributions to the argumentation in the episode. They include: the supportive action of *validating* (by teacher's authority) which reacts to 4-Non-

Absolute-Qualifier from students, and the *use of a 3D DGE* which allows himself to contribute 8-Perceptive-Data.

The direct contributions of all the participants and the indirect contributions of the teacher are integrated into the diagram in Fig. 5.89. Huang’s direct contributions (yellow boxes) and indirect contributions (talk bubbles) together constitute his coordination behavior in this episode.

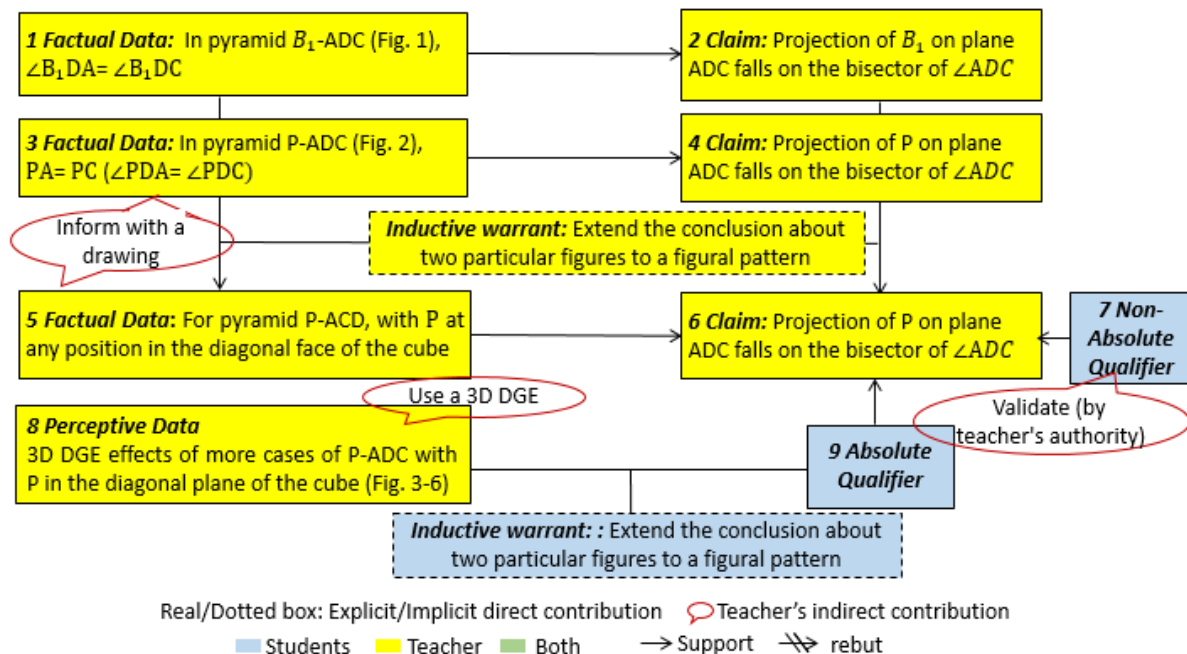


Fig. 5.89 Diagram of argumentation for Episode 1 – T, S – Task 4

The basic structure of this episode is distinct from any other episode in this lesson series, although it also involves several groups of Factual Data – Claim as the episodes of Group H.II-A. Of these groups, some concern the cases of particular figures and one concerns the case of a general figural pattern. This is an inductive reasoning process in which a generalized conclusion is drawn from two particular cases. However, the Claim about the general figural pattern is not validated by a Deductive Warrant, but directly validated by the teacher’s authority and a Perceptive Data that the teacher contributed with the use of a 3D DGE; this is the main difference between this episode and the other ones. All the Factual Data, Claims are contributed by the teacher. The Perceptive Data concerns more cases of particular figures, and it makes students accept the Claim about the general figural pattern with certainty (attach an Absolute Qualifier in place of Non Absolute Qualifier). The whole process keeps an inductive reasoning process in which a generalized conclusion is totally accepted with the evidences in more cases. The teacher’s coordination behavior (his direct and indirect contributions) in this episode can be divided into two aspects: (1) directly contributing all the Factual Data that concern either the particular figures or the general figural pattern, and *use a drawing to inform* them; (2) directly contributing all the Claims that concern either the particular figures or the general figural pattern; (3) directly contributing the Perceptive Data with the *use of a 3D DGE* and *validating* the Claim that concerns the general figural pattern by his own authority. In terms of “logical reasoning” and “perception”, the coordination behavior can be reformulated as: (1)

draw a 3D figure within the frame of cube to support students' perception; (2) generalize the conclusion from the particular 3D figure to a figural pattern through inductive reasoning; (3) use a 3D DGE to support students' perception making them certain of the generalized conclusion.

The coordination behavior can be supported by some of Huang's operational invariants which will be elaborated in section 5.3.9. Therefore, we consider the coordination behavior in this episode as reflecting some regular actions of Huang which are distinct from those in the other episodes. The episode is thus classified into an independent group labeled H.II-B and the coordination behavior is accordingly considered as rules of coordination of Group H.II-B.

Rules of coordination H.II-C: (1) use a 3D DGE or drawing to support students' perception with respect to the task figure; (2) request students to apply the conclusion about a figural pattern to the task figure based on figure-structural analogy; (3) take the conclusion about the task figure as a fact to develop the following theoretical deductive reasoning.

One example episode related to the rules of coordination is Episode 2 of the collective argumentation around Task 1 between the teacher and the whole class of students. As introduced previously, in Episode 2, Huang guided students to figure out the distance from P to the base ABC in pyramid P-ABC, which was the distance requested by Task 1. During the process, Huang associated pyramid P-ABC with figural pattern ④. Below is the episode transcript.

Episode 2 – T, S – Task 1

T: OK let's see the first task (Fig. (1). In the regular pyramid P-ABC [**1-Factual-Data**], PA=2, AB=1 [**2-Factual-Data**], we need to find the distance from P to the base. How to do it?

S: Construct the perpendicular line from P to the base [**part of 3-Claim**] ...

T: And its foot falls at?

A: Circumcenter of $\triangle ABC$ [**part of 3-Claim/Factual-Data**].

T: OK, the circumcenter. Why?

S: It's the regular pyramid [**echoing 1-Factual-Data**].

T: Good, we have said that for any regular pyramid, the projection of P will fall at the circumcenter of the polygon at the base [**4-Deductive-Warrant**], it's just the figural pattern ④ [**5-Claim/Factual-Data**], right? Now I construct the perpendicular line from P to base ABC, with the foot being M (Fig. 2) [**part of 3-Claim/Factual-Data**]. According to the properties of the circumcenter of an equilateral triangle [**part of 6-Deductive-Warrant**], we know AM, BM and CM are all equal, right? Their length is?

S: $\frac{\sqrt{3}}{3}$ [**par of 7-Claim**]

T: Yes, $\frac{\sqrt{3}}{3}$. And the distance from P to the base, it's just PM [echoing 3-Claim/Factual-Data], right?
 In the right triangle $\triangle PMA$, we can use Pythagorean theorem [part of 6-Deductive-Warrant],
 getting the PM is... $\frac{\sqrt{33}}{3}$ (Fig. 3) [par of 7-Claim]. That's it.

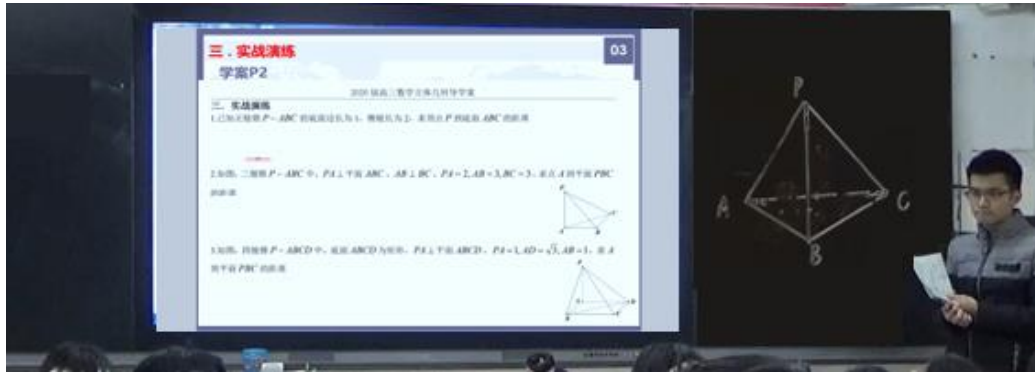


Fig. 1 Huang presents the task on the interactive blackboard and draws a pyramid P-ABC on the blackboard aside

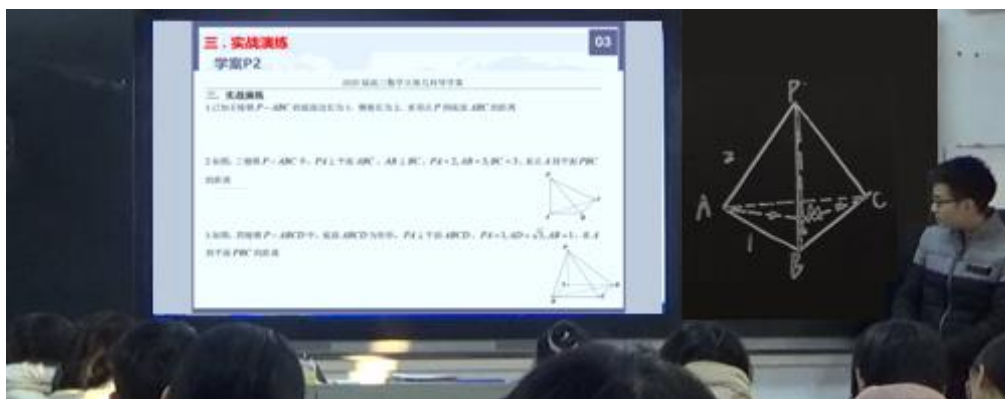


Fig. 2 Huang draws the perpendicular line segment from P to the base ABC, notes the foot as M, and connects AM, BM and CM on the blackboard.

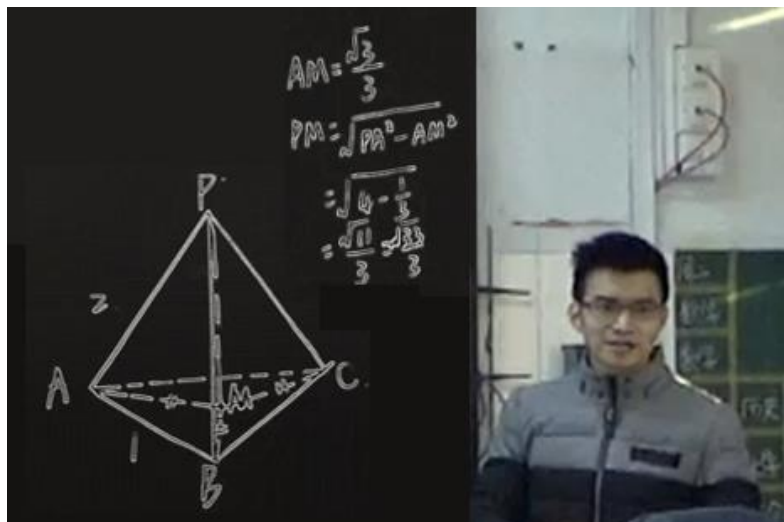


Fig. 3 Huang demonstrates the procedures of calculating PM on the blackboard

We firstly discuss the argumentation components directly contributed by the participants in this episode. After introducing the basic information about the pyramid P-ABC given in the task (1-Factual-Data and 2-Factual-Data), Huang directly asks students how to find the distance from P to the base ABC in the pyramid. As a response, students firstly judge that the distance will fall at the perpendicular line from P to the base of pyramid P-ABC and the foot of the perpendicular will fall at the circumcenter of $\triangle ABC$, named M (3-Claim). The students then explain 3-Claim by referring to 1-Factual-Data. At this time they may not realize the connection between the pyramid P-ABC in the task and the figural pattern ④. In fact, the connection is later mentioned by Huang (5-Claim), and he meanwhile brings out the conclusion about the orthogonal projection of P in the figural pattern ④, which is consistent with 3-Claim about the pyramid P-ABC in the task. In this way, Huang develops a deductive reasoning from 5-Claim to 3-Claim, in reference to the conclusion about the orthogonal projection in the figural pattern. Hence the 5-Claim can also be considered as a Factual-Data and the conclusion can be considered as 4-Deductive-Warrant. Later on, Huang and students subsequently determine the length of MA and the length of PM (7-Claim), and the latter is just the distance demanded by the task. Here they refer to the properties of the circumcenter of an equilateral triangle and the Pythagorean theorem (related to a right triangle $\triangle PMA$), probably because of the facts that PM is perpendicular to the base of the pyramid P-ABC with M being the circumcenter of $\triangle ABC$ and that $\triangle ABC$ is an equilateral triangle. The facts respectively echo 3-Claim and 2-Factual-Data. The process of learning to 7-Claim is actually another deductive reasoning process that starts from 3-Claim and 2-Factual-Data and refers to the geometric properties and theorem mentioned above. The 3-Claim is thus identified also as a Factual-Data, with the geometric properties and theorem identified as a Deductive-Warrant (labeled 6).

Secondly, we discuss Huang's indirect contributions to the argumentation. They include: the supportive action of *informing* (illustrating) 1-Factual-Data with the *use of a drawing*, the questions of *requesting a method* and *requesting a simple answer* which elicit students' contribution of 3-Claim/Factual-Data, the question of *requesting elaboration (explanation)* which elicits students' contribution in 4-Deductive-Warrant, the *use (mention) of a figural pattern* in his own contribution of 5-Claim/Factual-Data and the question of *requesting a simple answer* which elicits students' contribution in 7-Claim.

The direct contributions of all the participants and the indirect contributions of the teacher are integrated into the diagram in Fig. 5.90. Huang's direct contributions (yellow and green boxes) and indirect contributions (talk bubbles) together constitute his coordination behavior in this episode.

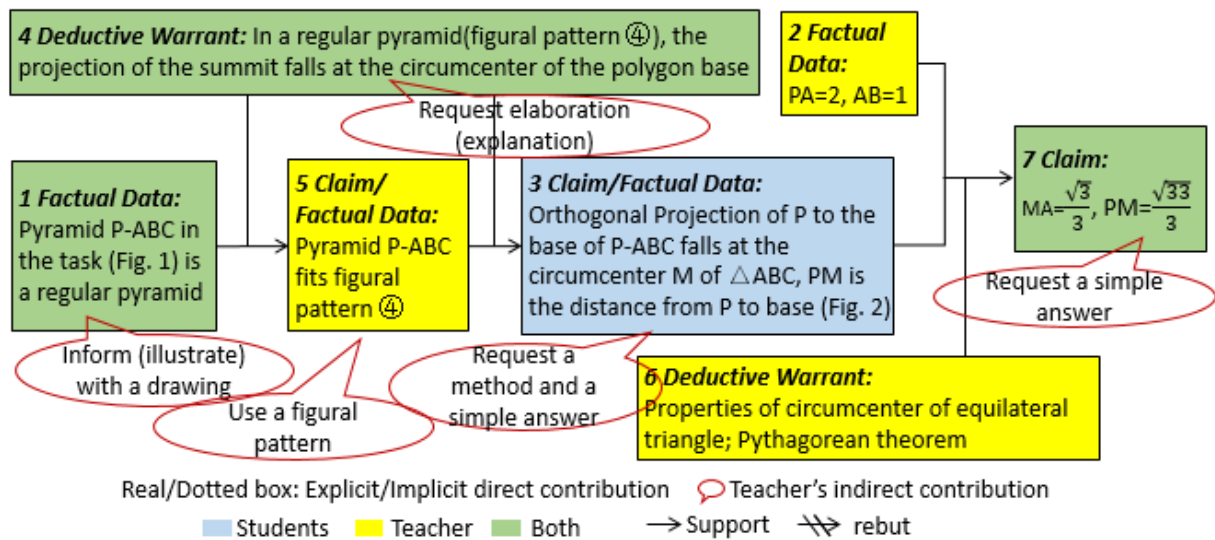


Fig. 5.90 Diagram of argumentation for Episode 2 – T, S – Task 1

Another example episode related to the rules of coordination is Episode 2 of the collective argumentation around Task 4 between the teacher and the whole class of students. As introduced previously, in Episode 2, Huang guided students to figure out the distance from P to the base ACB in the task figure (as illustrated by Fig. 1 in the transcript below). During the process, students associated the task figure with the figural pattern ⑧. Below is the transcript of the episode.

Episode 2 – T, S – Task 4

T: OK now, we come to Task 4. There is a plane ABC, and the distances from P to the two sides AC, BC are equal [1-Factual-Data], just these two segments (Fig. (1)). We should calculate the distance from P to the plane ABC. Does it remind you of any figural pattern?

S: Pattern ⑧ [2-Claim/Factual-Data].

T: Yes, exactly. So when we construct the perpendicular line from P to the base plane, the foot M will fall on (Fig. 2)?

S: The angle bisector of $\angle ACB$ [3-Claim].

T: Yes, we quickly get the conclusion. This is just the angle bisector of $\angle ACB$ (Fig. 3) I rotate it so that you could see better (Fig. 4). In this condition, how can I calculate the distance PM?

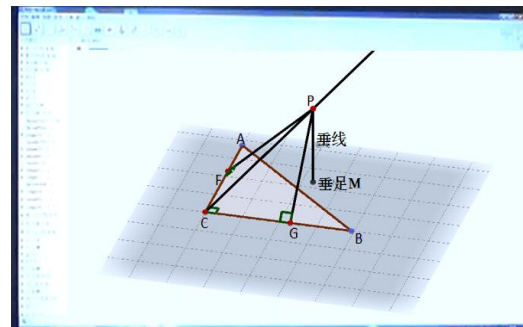
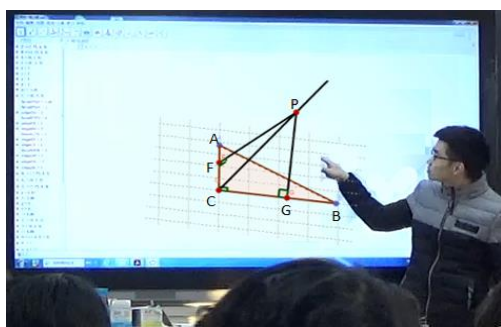


Fig. 1 Huang displays the 3D dynamic model for the task on the interactive blackboard via GeoGebra and points at PG, PF

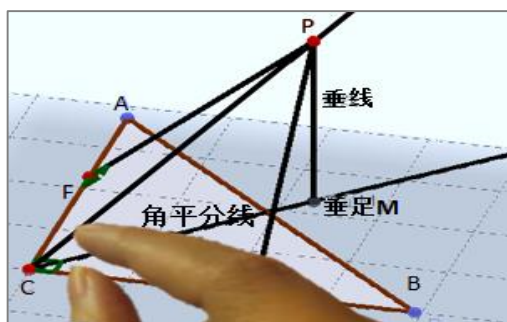


Fig. 3 Huang evokes the angle bisector in the 3D dynamic model and points at two equal angles in $\angle ACB$

Fig. 2 Perpendicular line from P to the plane and the foot of the perpendicular M are displayed in the 3D dynamic model

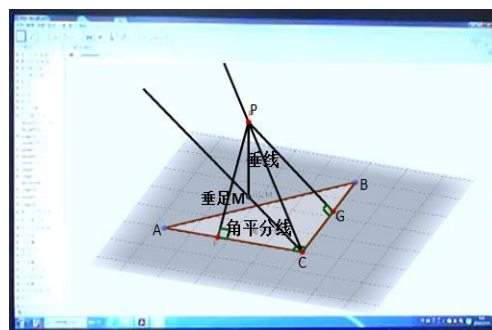


Fig. 4 The 3D dynamic model is rotated to another orientation

T: (waits for one minute) I will connect M and G (Fig. 5). In this way I can get several triangles: firstly $\triangle PCG$ is a right triangle, and since $PC=2$, $PG=\sqrt{3}$ [4-Factual-Data], according to the Pythagorean theorem, I quickly get $CG=1$; secondly $\triangle CGM$ is a right triangle, and CM is the angle bisector, so $\angle MCG$ is 45° , and in the isosceles right triangle $\triangle MGC$, GM equals to CG , which equals to 1; and finally we come to the right triangle $\triangle PGM$, as $PG=\sqrt{3}$, $GM=1$, we use again the Pythagorean theorem [5-Deductive-warrant], getting the distance $PM=\sqrt{2}$ (making annotations on the screen where the GeoGebra model is presented, Fig. 6) [6-Claim]. Look, we figure it out quickly!

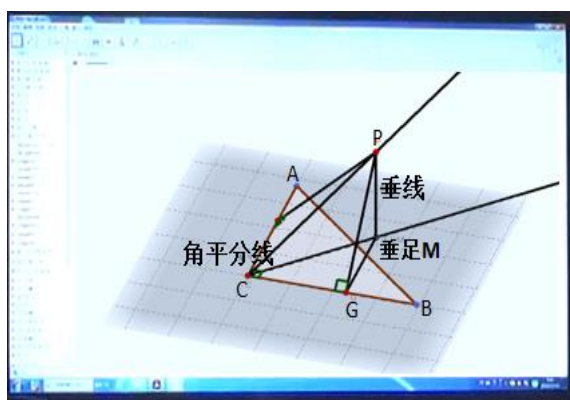


Fig. 5 M and G are connected in the 3D dynamic model

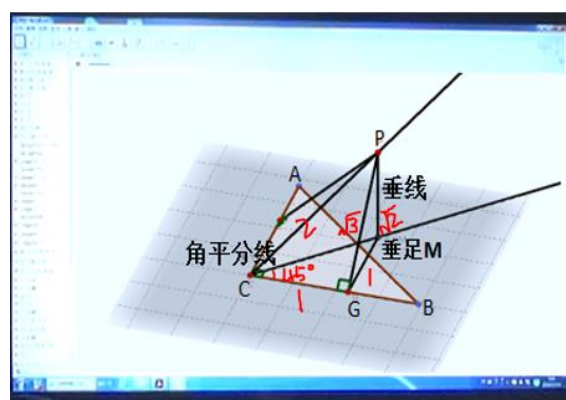


Fig. 6 Annotations are directly added on the 3D dynamic model

We firstly discuss the argumentation components directly contributed by the participants in this episode. At the beginning, Huang introduces the basic information of the task figure (1-Factual-Data) and illustrates it with a 3D dynamic model in GeoGebra. Based on that students judge that the task figure fits the figural pattern ③ (2-Claim) introduced previously in the lesson, and that the foot of the perpendicular from P to the plane ACB falls at the bisector of $\angle ACB$, named M (3-Claim). Although students do not mention it explicitly, it is obvious that they draw

the 3-Claim from 2-Claim in reference to the conclusion about the orthogonal projection of the apex in the figural pattern ⑧. The whole process is deductive reasoning, hence the 2-Claim is identified also as a Factual-Data, and the conclusion about the figural pattern ⑧ is identified as an implicit Deductive-Warrant. Huang confirms the 3-Claim from students and combines it with other information about the task figure (4-Factual-Data) to derive the length of PM (6-Claim), making annotations directly on the 3D dynamic model when necessary. The process constitutes another deductive reasoning in which Huang refers to some geometric theorems explicitly, so the 3-Claim is also a Factual-Data and the theorems can be identified as 5-Deductive-Warrant.

Secondly, we discuss Huang’s indirect contributions to the argumentation. They include: the supportive action of *informing* (illustrating) with the *use of a 3D DGE* which helps with his own contribution of 1-Factual-Data, the questions of *requesting an idea in reference to some figural patterns* (requesting students to compare the task figure and figural patterns previously introduced in the lesson) which elicits students’ contribution of 2-Claim/Factual-Data, the question of *requesting a simple answer* which elicits students’ contribution of 3-Claim/Factual-Data, and the actions of *validating* (by teacher’s authority) the two Claim/Factual-Data from students.

The direct contributions of all the participants and the indirect contributions of Huang are integrated into the diagram in Fig. 5.91. Huang’s direct contributions (yellow boxes) and indirect contributions (talk bubbles) together constitute his coordination behavior in this episode.

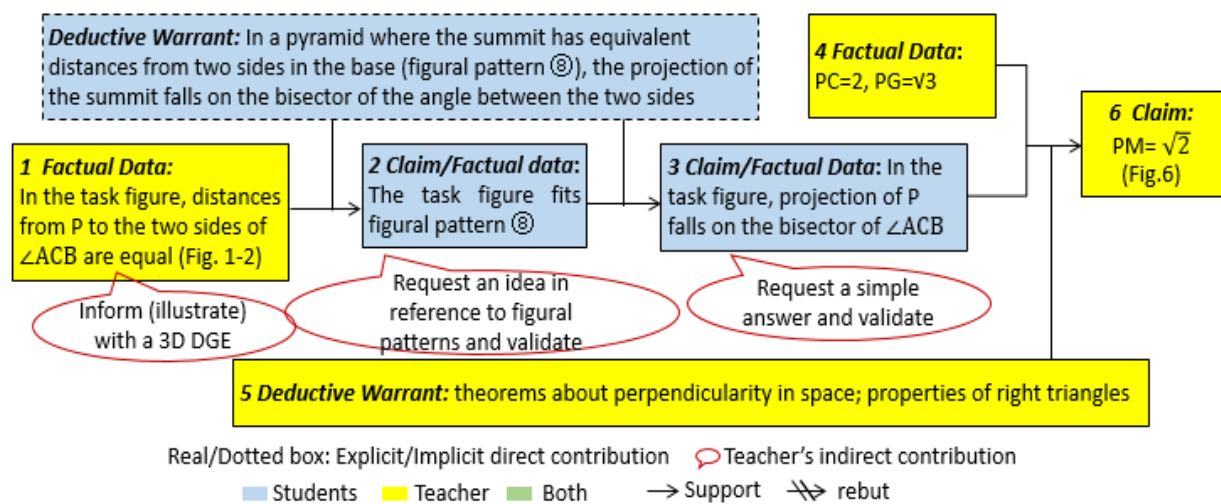


Fig. 5.91 Diagram of argumentation for Episode 2 – T, S – Task 4

The two argumentation episodes are underpinned by the same basic structure. They both involve three consecutive chains of Factual Data – Deductive Warrant – Claim. The beginning Factual Data concerns information about the figure involved in the task (“task figure” for short, hereafter the same); it is usually introduced by the teacher who meanwhile uses a 3D DGE or a drawing as a perceptive illustration. The first intermediate Claim (also an intermediate Factual Data) is about the link between the task figure and a figural pattern previously introduced in the lesson; it is either proposed by the teacher himself or by the students on the teacher’s request. The second intermediate Claim was about the orthogonal projection of a point to a plane in the

task figure; it can be obtained by applying the conclusion about the orthogonal projection in a relevant figural pattern to the task figure, and it is usually contributed by students on the teacher's request. The process is consistently underpinned by one Deductive Warrant – the structural similarities between the figural pattern and the task figure (what we call briefly figural-structural similarities) and the conclusion about the orthogonal projection in a figural pattern. The second intermediate Claim is usually correct, which would be directly validated by the teacher and be combined with other Factual Data and Deductive Warrant to lead to the final Claim that concerns the particular point-plane distance demanded by the task. The same basic structure has been found in the Episode 2 around Task 1, 3 and 4, in which the teacher explains the solutions to the tasks in reference to some figural patterns. We therefore classify these episodes into Group H.II-C and represent the basic structure with the general diagram in Fig. 5.92.

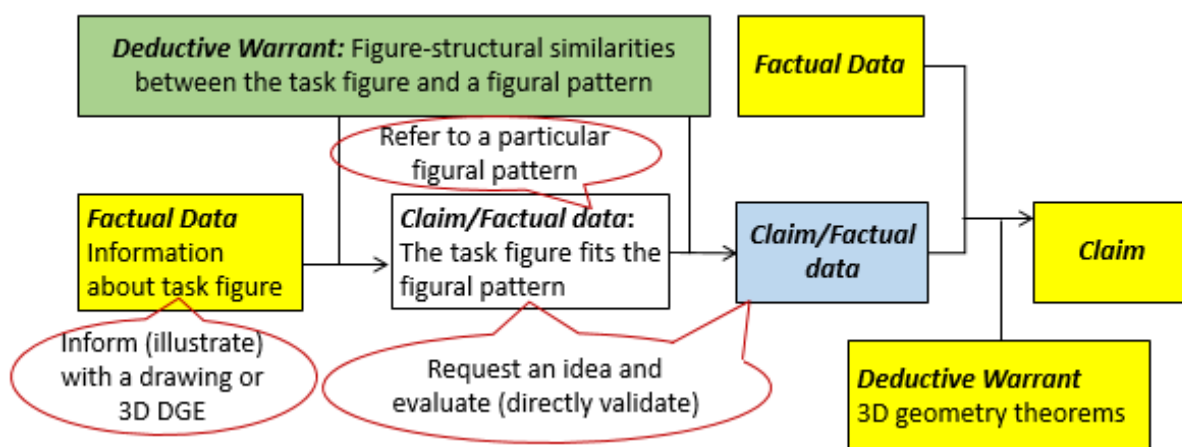


Fig. 5.92 General Diagram of argumentation for Episodes of Group H.II-C

Teacher's contributions to the general diagram mainly reside in: (1) directly contributing the beginning Factual Data and *informing* it with the *use of a drawing or 3D DGE*; (2) directly contributing the intermediate Claims in reference to a figural pattern, or *requesting students' idea* to let them compare the task figure and some figural pattern and contribute the intermediate Claims and *validating* (by teacher's authority) students' Claims; (3) directly contributing the Factual Data and Deductive Warrant that lead to the final Claim about the task solution. In terms of "perception" and "logical reasoning", the contributions can be reformulated as: (1) use a 3D DGE or drawing to support students' perception with respect to the task figure; (2) request students to apply the conclusion about a figural pattern to the task figure based on figure-structural analogy; (3) take the conclusion about the task figure as a fact to develop the following theoretical deductive reasoning, also label H.II-C.

Coordination behavior in the single episode related to Task 2:

(1) use a drawing to support students' perception with respect to the task figure; (2) rebut the drawing-perceptive analogy made by students by highlighting the structural similarities between the figural pattern and the task figure; (3) illustrate the geometric structure of the task figure with scaffolding lines and simulating gestures; (4) guide students to apply the conclusion about a figural pattern to the task figure based on figure-structural analogy.

The single episode related to the coordination behavior is Episode 2 of the collective argumentation around Task 2. As introduced previously, in the episode, Huang guided students to figure out the distance from A to plane PBC in the figure given by the task (see Fig. 1 in the following episode), and he associated the task figure with figural pattern ③. Below is the transcript of the episode.

Episode 2 – T, S – Task 2

T: Next, the second task, given a triangular pyramid, we need to calculate the distance from A to the plane PBC (Fig. 1). I have seen some students use the method of equivalent volume, it's all right, but the calculation workload will be too heavy, you have to spend much time on it. Can we draw any inspiration from the previous figural patterns?

S: ...

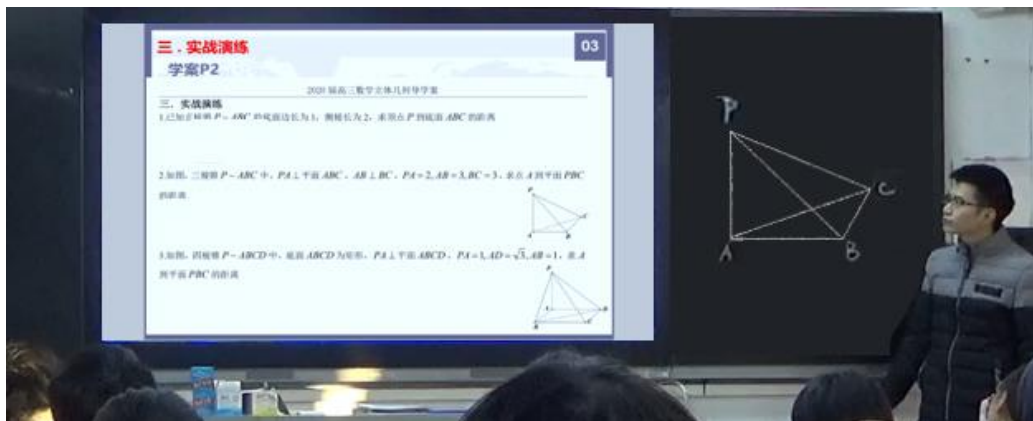


Fig. 1 Huang presents the tasks (1–3) on the interactive board via PowerPoint slide and reproduces the drawing of the pyramid P-ABC on the blackboard

T: P-ABC is a pyramid, and there are some perpendicular relations, does that resemble the figural pattern ③, the 鳖臑 (biē nà) [1-Claim/Factual-Data]?

S: ...Yes...

T: Then let's go back to the pattern ③ (Fig. 2). According to this figural pattern, how can we determine the distance from A to PBC in the task?

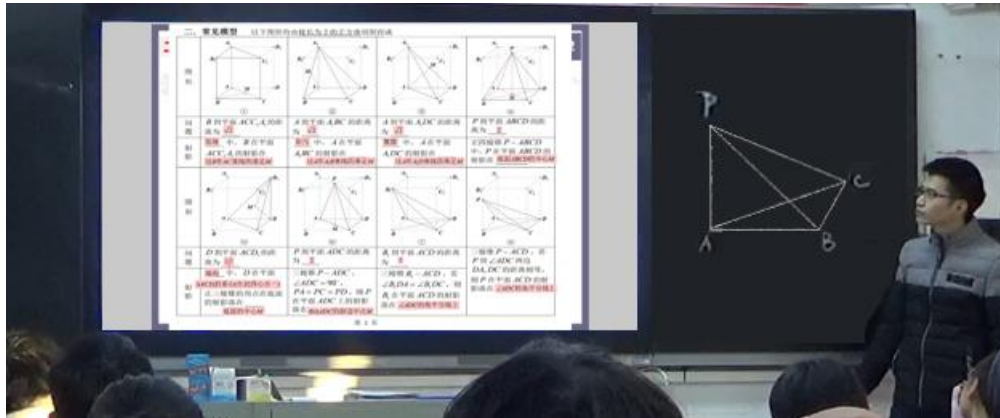


Fig. 2 Huang displays the PowerPoint slide with figural patterns on the interactive blackboard so that they can coexist with the drawing of P-ABC on the blackboard

S: Construct the perpendicular line from A to PC [2-Claim]?

T: Well, we construct the perpendicular segment AM (Fig. 3), you think AM is perpendicular to the plane PBC?

S: Yes... It's in a similar position to the AM in pattern in pattern ③ [3-Inductive-Warrant]...

T: But in pattern ③, how have we constructed AM? we firstly found two planes perpendicular to each other – the AA_1D and A_1DC – and A_1D is their intersection (pointing at the drawing of pattern ③ in Fig. 3), and then we constructed AM perpendicular to their intersection. [4-Deductive-Warrant. But here (pointing at the drawing of P-ABC on the blackboard in Fig. 3), do you think the planes PAC and PBC are perpendicular? (waiting for some seconds)

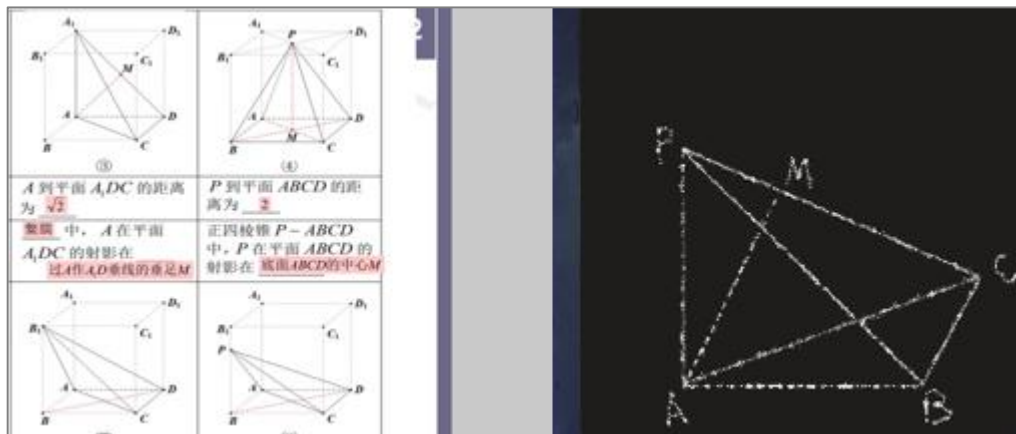


Fig. 3 Huang draws the perpendicular line from A to PC in the pyramid P-ABC and notes its foot as M

T: No [5-Rebuttal-to-Claim]. In fact, in this pyramid, PA is perpendicular to plane ABC, and AB is perpendicular to BC, so BC is perpendicular to both PA and AB [6-Factual-Data], it should be PAB which is perpendicular to PBC, right? So it's actually these two planes, PAB and PBC that are perpendicular (Fig. 4) [7-Claim/Factual Data]

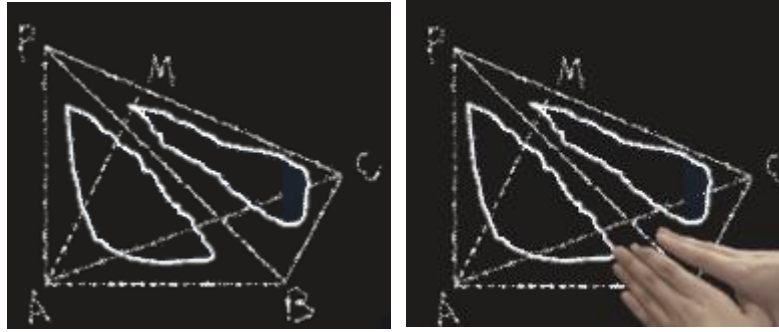


Fig. 4 Huang firstly outlines the two perpendicular faces in the pyramid P-ABC and then simulates them with a gesture

S: Yes...

T: So how can we construct the distance from A to plane PBC?

S: The perpendicular to PB [8-Claim].

T: Exactly (Fig. 5), it's just the length of AM [echoing 8-Claim], right? You calculate it after class

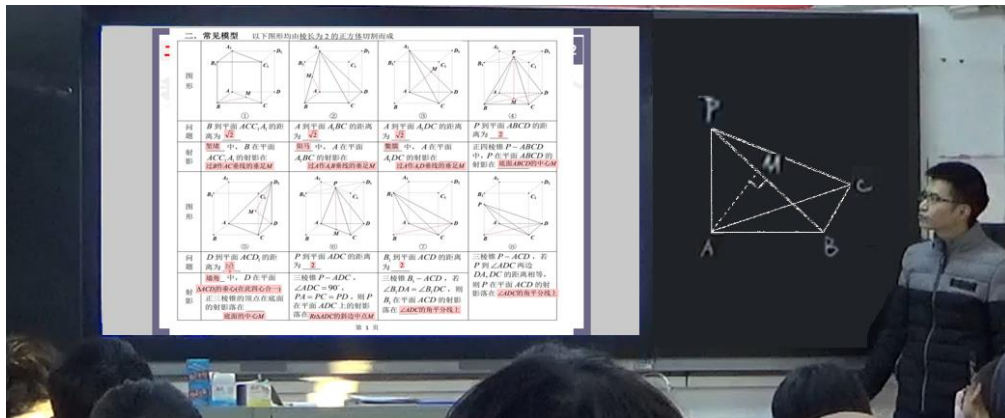


Fig. 5 Huang erases the initial AM and draws a new AM as the perpendicular line from A to PB in the pyramid P-ABC

We firstly discuss the argumentation components directly contributed by the participants in this episode. Having seen that many students have taken much time on the method of equivalent volume to calculate the target point-plane distance, Huang suggests students to refer to a previous figural pattern (pattern ③), to simplify the procedures of solving the task (1-Claim). According to the 1-Claim, students propose 2-Claim: the distance from A to the plane PBC in the pyramid P-ABC demanded by the task is the perpendicular line from A to PC, noted AM (Fig. 3). They made the 2-Claim probably because of the perceptive similarities between the drawing of the pyramid P-ABC and the drawing of the pattern ③ (what we call “perceptive-drawing” similarities), as they say that the AM in the pyramid P-ABC is at a similar position to the AM that corresponds to the particular point-plane distance in the pattern ③. We consider this expression as 3-Inductive-Warrant because it shows students conducting analogical reasoning between two drawings, which belongs to inductive reasoning (Pólya, 1954). As a reaction, Huang highlights the structural characteristics of the figural pattern ③ and points

out that the point-plane distance in the pattern ③ is actually related to the perpendicular to the intersection of two planes which are perpendicular. Following this idea, Huang directs students' attention to the relationship between planes PAC and PBC in the pyramid P-ABC. Since the planes are not perpendicular (5-Factual-Data), the perpendicular line from A to their intersection (PC) will not be the target distance. In this way, Huang rejects the 2-Claim and the 5-Factual-Data is also a Rebuttal-to-Claim. Then Huang turns to seek more geometric relationships in the pyramid P-ABC which may allow students to use the conclusion in the figural pattern ③. Here he gets $(PA) \perp \text{plane } ABC$ and $(AB) \perp (BC)$ (6-Factual-Data), and further $\text{plane } PAB \perp \text{plane } PBC$ (7-Claim), probably in reference to some geometric theorems like "if a line is perpendicular to two intersecting lines in another plane, then the line is perpendicular to the plane" (implicit Deductive-Warrant). The 7-Claim is exactly the Factual-Data that can be connected with 1-Claim (also a Factual-Data) and allows to apply the conclusion in the figural pattern ③; based on that students determine that the target point-plane distance falls on the perpendicular line from A to the intersection of the plane PAC and the plane PBC in P-ABC (8-Claim). The whole process constitutes a deductive reasoning underpinned by the conclusion in the figural pattern ③, which is thus considered as a Deductive-Warrant (labeled 4).

Secondly, we discuss Huang's indirect contributions to the argumentation. They include: the *use of a figural pattern* in relation with his own contribution of 1-Claim, the question of *requesting* students' *evaluation* of 2-Claim which elicits their contribution of 3-Inductive-Warrant, the question of *requesting a method* which elicits students' contribution of 2-Claim, the action of *rebutting* 2-Claim with a question consistent with the idea in the deductive warrant, the supportive action of *informing* (illustrating) with the *use of scaffolding lines and a gesture* which helps with his contribution of 7-Claim, the question of *requesting a simple answer* which elicits students' contribution of 8-Claim and the action of *validating* 8-Claim.

The direct contributions of all the participants and the indirect contributions of Huang are integrated into the diagram in Fig. 5.93. Huang's direct contributions (yellow boxes) and indirect contributions (talk bubbles) together constitute his coordination behavior in this episode.

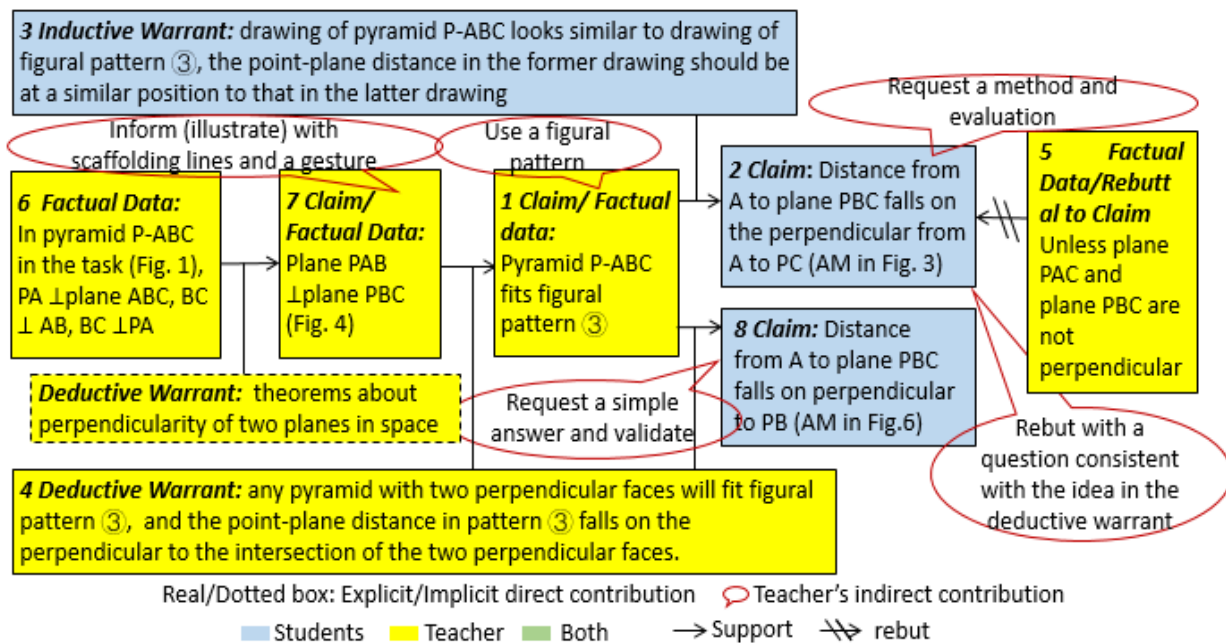


Fig. 5.93 Diagram of argumentation for Episode 2 – T, S – Task 2

Huang's coordination behavior can further be divided into four parts: (1) directly contributing the Factual Data that concerns the link between the task figure and a figural pattern and *inform* the task figure with a *drawing* (2) *requesting* students' *evaluation* of their Claim which is made according to the Inductive Warrant concerning the "drawing-perceptive analogy", and directly contributing the Rebuttal to Claim; (3) directly contributing the Factual Data concerning structural properties of the task figure and *inform* it with *scaffolding lines and gestures*; (4) directly contributing the Deductive Warrant concerning the "figure-structural analogy", *requesting a simple answer* to elicit students' contribution of a new Claim. In terms of "logical reasoning" and "perception", the coordination behavior can be reformulated as: (1) use a drawing to support students' perception with respect to the task figure; (2) rebut the drawing-perceptive analogy made by students and move them to figure-structural analogy between the figural pattern and the task figure; (3) illustrate the geometric structure of the task figure with scaffolding lines and simulating gestures; (4) guide students to apply the conclusion about a figural pattern to the task figure based on figure-structural analogy.

Among the four pieces of coordination behavior, (1) and (4) can also be found in the rules of coordination of Group H.II-C, and (2) ~ (3) can be considered as alternatives for the second rule in Group H.II-C. In the interview, Huang also expresses that the pieces of behavior (2) ~ (3) are his ad hoc actions in reaction to the students' difficulties he has not anticipated before:

"In this task (2), some students make the perpendicular from A to plane PBC, and he lets the foot falls on PC. In fact, I haven't anticipated that, they didn't catch the essence of the figural pattern at all. Then what I can do is to highlight the geometric structure of the figural pattern again and again, saying that it relies on the perpendicularity of two planes. So you have to find two perpendicular planes in the task figure, it is PAB and PBC with PB as the intersection line. So you should make the perpendicular from A to PB, not PC"

Hence we decide not to classify the coordination behavior (1) ~ (4) as another group of rules of coordination, but integrate them into Group H.II-C, taking behavior (2) and (3) as the possibilities of inferences with respect to the second rule of coordination initially in Group H.II-C.

5.3.9 Operational invariants in Lesson Series H.II

In this part, we present the operational invariants underpinning each group of rules of coordination in this lesson series. The corresponding data analysis procedures have been presented in the methodology part (section 4.4.1). The data to be analyzed include all the data related to the lesson series. In particular, all the interview words we cite in below come from the transcripts of the general interviews before and after the lesson (Appendices 3.6 and 3.7).

Operational invariants for rules of coordination H.II-A: (1) draw a 3D figure within the drawing of a cube to support students' perception; (2) generalize a conclusion from the particular 3D figure to a 3D figural pattern through inductive reasoning; (3) develop simplified theoretical deductive reasoning together with students to explain the particular or the generalized conclusion.

The operational invariants underpinning these rules of coordination are summarized in Table 5.18, to which we refer in our analysis here.

Table 5.18 Operational invariants for rules of coordination of Group H.II-A

Category	Label and content of operational invariant
COI	[1] In any regular pyramid with a n-side polygonal base (figural pattern ④), the orthogonal projection of the summit onto the base must fall at the circumcenter of the base.
	[2] In any triangular pyramid with two perpendicular faces (figural pattern ③), the orthogonal projection of a point in one face onto the other is the foot of the perpendicular from the point to the intersection of the two faces.
	[3] In any rectangular pyramid with two perpendicular faces (figural pattern ②), the orthogonal projection of a point in one face onto the other is the foot of the perpendicular from the point to the intersection of the two faces.
	[4] If two planes are perpendicular to each other, then a line within in one plane and perpendicular to their intersection will be perpendicular to another plane.
	[5] The distance from a point to a plane is the length of the perpendicular line segment from the point to the plane, or the distance from the point to its orthogonal projection onto the plane.
	[6] Hypotenuse-Leg Theorem: if the hypotenuse and leg of one right triangle are congruent to the hypotenuse and leg of another right triangle, then the two triangles are congruent.
	[7] If two triangles are congruent, then all three corresponding sides are equal and all the three corresponding angles are equal in measure.
	[8] All the vertices of a triangle are equidistant from the circumcenter of the triangle.
	[9] The essence of a figural pattern resides in its geometric structure (geometric relationships between lines and planes therein)

PCOI	<p>[10] A drawing of a 3D figure situated in the drawing of a cube can help students imagine the spatial structure of the figure.</p> <p>[11] A drawing of a 3D figure situated in the drawing of a cube allows students to easily determine the geometric relationships in the figure.</p> <p>[12] The proof of point-plane distance in common solids (e.g. cubes, regular pyramids, prisms) is not difficult for students.</p> <p>[13] Students are very familiar with the geometric theorems and facts concerning perpendicularity in space.</p> <p>[14] If students are already familiar some math content, it not necessary to elaborate much on the content in the reviewing lessons.</p> <p>[15] It is important to highlight the essential geometric structure of a figural pattern and how the conclusion about the pattern is related to the geometric structure.</p> <p>[16] It's important to make students realize that a 3D figural pattern is not limited to the particular figure in the drawing but concerns general geometric structure, which can also be situated in a cuboid.</p> <p>[17] Students always have difficulty in point-plane distance tasks in GAOKAO examination.</p> <p>[18] For a point-plane distance task, students can solve it more efficiently by applying known conclusions about some figural pattern fit by the task figure than using the equivalent volume method.</p>
SNOI	<p>[19] The assessment criteria for open classes encourages teachers to refer to elements in Chinese ancient mathematics.</p>

Firstly, some operational invariants about content (COI) can be inferred. The rules of coordination are aimed to introduce the geometric conclusions about figural patterns ④, ③, ②, so Huang must know the conclusions a priori, which allows us to infer operational invariants [1] ~ [3]. Furthermore, the geometric theorems or facts required for deriving the conclusions should also be known by Huang, such as the theorem about the perpendicularity between a line and a plane in space, the definition of an orthogonal projection, and so forth, which allows us to infer [4] ~ [8]. Finally, in rule (2), Huang focuses on the geometric structure of a particular figure to generalize it to relates to a figural pattern in the inductive reasoning, as exemplified by his words “a regular rectangular pyramid” in the episode for pattern ④ and “What could be the plane perpendicular to A_1DC here” in the episode for pattern ③. We thus infer operational invariant [9]. While [1] ~ [8] reflect Huang’s knowledge of mathematics facts and theorems, [9] reflects knowledge of mathematics models. All of them belong to the category of COI.

Secondly, there are operational invariants about pedagogy of content (PCOI). The drawing that Huang uses to represent the 3D figural pattern in rule (1) is situated in the drawing of a cube, and he explains this in the interview:

“That’s why I draw them within the frame of cube. Since they are all familiar with a cube, they can easily imagine the spatial structure of the figural pattern at stake. Also they can get why the M in figural pattern ③ falls at the midpoint of A_1D : because here there are many

perpendicular planes, AA_1D will be perpendicular to ADC . If it was in another solid, they wouldn't see the perpendicularity so quickly."

That is, Huang draws the 3D figural pattern in such a way because he thinks it helps students to imagine the spatial structure of the pattern and the geometric relationships therein, which are associated to operational invariants [10] and [11]. In rule (3), Huang develops simplified theoretical deductive reasoning, which is consistent with his interview words

"I only need to give simple oral proof, not necessary to write them down in detail. Students have done a lot of exercises in proving these conclusions, when I introduced the theorems about perpendicularity and perpendicularity previously"

It seems Huang does not want to elaborate in the reviewing lessons what students have been familiar with; this implies [12] ~ [14]. In rule (2) the action of Huang generalizing the conclusion about a particular figure to a figural pattern is related to his words in the interview:

"It is absolutely necessary to highlight that the perpendicular I make here is the perpendicular to the intersection of two planes. There are many perpendicular planes here, and the perpendicular to the intersection in one plane must be perpendicular to another plane. For every figural pattern represented with the drawing, I will constantly highlight how the red segments (corresponding to the point-plane distance) are made..."

"like here, many students wrote that the orthogonal projection falls at the midpoint of AC . It's not so precise, what if it is in a cuboid with the length, width and height of 1, 2, 3, it will no longer be the midpoint of AC , but the red segment is always perpendicular to AC , the intersection"

From that we infer [15] ~ [16]. In addition, the figural patterns involved in these rules of coordination are all collected by Huang from the GAOKAO examination; we can infer corresponding operational invariants according to Huang's words in the interview. Such as "many students have difficulties here, they don't know how to find the point-plane distance in such a figure" ([17]), and

"the figure is related to a pattern that appeared in the textbook a decade ago but has been deleted in current textbooks, and the designer of GAOKAO examination take them out again, if students know some conclusions, they will solve the task more efficiently, otherwise it will be very tough for them" ([18]).

Among all the operational invariants, [10] ~ [11] reflect Huang's specific pedagogical strategies of using drawings; [12] ~ [14] reflect his knowledge or memories of students' previous knowledge and performances; [15] ~ [16] reflect his pedagogical strategy to support student inductive reasoning for getting a generalized conclusion about a figural pattern; [17] ~ [18] reflect his pedagogical strategy to support student mathematics learning, in particular the task solving process in GAOKAO examination. All these are elements of category PCOI.

Finally, there are one operational invariant about social norms (SNOI). While the figural patterns introduced here have all appeared in GAOKAO examination, some figural patterns, like ③ and ②, have a special link with ancient Chinese mathematics. Huang refers to these patterns with their ancient names like BIENAO and QIANDU, instead of more general names like rectangular and triangular pyramid, because he thinks "it will be a strength for an open class to refer to some elements related to ancient Chinese mathematics". We hereby infer

operational invariant [19]. It reflects Huang’s understanding of the assessment criteria for open classes, belonging to SNOI.

Operational invariants for rule of coordination H.II-B: (1) draw a 3D figure within the frame of cube to support students’ perception; (2) generalize the conclusion from the particular 3D figure to a figural pattern through inductive reasoning; (3) use a 3D DGE to support students’ perception making them certain of the generalized conclusion.

The operational invariants underpinning these rules of coordination are summarized in Table 5.19, to which we refer in our analysis here.

Table 5.19 Operational invariants for rules of coordination of Group H.II-B

Category	Label and Content of Operational Invariant
COI	<p>[6] <i>Hypotenuse-Leg Theorem for two right triangles being congruent; H.II-[7] Properties of congruent triangles; [9] The essence of a figural pattern resides in its geometric structure.</i></p> <p>[20] In any triangular pyramid with the summit being equidistant/equiangular to the two sides on the base (figural pattern ⑦/⑧), the orthogonal projection of the summit onto the base must fall at the bisector of the angle between the two sides.</p> <p>[21] Hypotenuse-Angle theorem: if the hypotenuse and an acute angle of a right triangle are congruent to the hypotenuse and corresponding acute angle of another right triangle, then the two triangles are congruent.</p>
PCOI	<p>[10]/ [11] <i>situating drawings of 3D figures in drawings of cubes can help students imagine their spatial structures / determine the geometric relationships therein. [15]~[16] views about what is important when introducing figural patterns and related conclusions [17] students’ difficulty in point-plane distance tasks in GAOKAO examination; [18] knowing some conclusions about typical figural patterns could facilitate the process of solving point-distance tasks of students.</i></p> <p>[22] For the multiple-choice tasks in GAOKAO, students only need to give a right answer without elaborating the particular task solving procedures.</p>
TPCOI	<p>[23] By dragging a free point in GeoGebra, one can control the movement of all the other objects tied to this point showing the variations and invariants in the process.</p> <p>[24] 3D dynamic models in GeoGebra can help students imagine the spatial structures of the corresponding 3D figures.</p> <p>[25] To facilitate students’ observation of the orthogonal projection of point onto a plane in GeoGebra, it’s better to display the plane in the direction orthogonal to the plane.</p> <p>[26] Perceptive evidences of various cases in GeoGebra can make students certain of the truth of a generalized mathematics conclusion without rigorously proving it.</p>
TEOI	<p>[27] With perceptive evidences in GeoGebra, teachers can save the time of developing rigorous proof to persuade students of the truth of a generalized conclusion.</p>
TCOI	<p>[28] By activating the <i>Point</i> tool and clicking on an object, one can create a free point on the object in GeoGebra.</p>

	[29] By dragging a free point around the object it is subordinated, one can control the movement of all the other objects tied to this point in GeoGebra.
	[30] By activating the <i>Pyramid</i> tool and then selecting a polygon as base and a point as apex, one can create a pyramid in GeoGebra.
	[31] By activating the <i>Perpendicular Line</i> tool and then selecting a line and a point, one can create a perpendicular from that point to the line in GeoGebra.
	[32] By activating the <i>Cube</i> tool and selecting two points in the xOy plane, one can construct a cube lying on that plane in GeoGebra, with the two points as vertices.
	[33] By activating the <i>Plane Through Three Points</i> tool and then selecting three points, one can construct a plane through the three points in GeoGebra.
	[34] In GeoGebra, a fixed point can be created by indicating the 3D orthogonal coordinates in the Input Bar.
	[35] By activating the <i>Polygon</i> tool and successively selecting at least three points then the first point, one can create a polygon in GeoGebra with these points as vertices.
	[36] By activating the <i>Segment</i> tool and selecting two points, one can construct a segment between the two points in GeoGebra.
BCOI	[37] I am familiar with the techniques related to GeoGebra.
	[38] It is easy for me to design a GeoGebra courseware.
SNOI	[39] The teaching research group of the grade expects me to use GeoGebra in 3D geometry lessons.

Firstly, some operational invariants about content (COI) can be inferred. Now that the rules of coordination are aimed to introduce the conclusions about figural patterns ⑦ and ⑧, Huang must know a priori the conclusions, that is operational invariant [20]. To get the conclusions, Huang should also know other geometric theorems and facts, and we can see some geometric theorems and facts for Group H.II-A are also relevant. Such as [6] concerning Hypotenuse-Leg Theorem for two right triangles being congruent, [7] that concerning properties of congruent triangles, and [9] that expresses Huang's understanding of the essence of a figural pattern. Apart from the above, Huang also requires to use the Hypotenuse-Angle theorem to explain two right triangles are congruent and further derive the final conclusion; the theorem is expressed in [21]. All these operational invariants reflect Huang's knowledge of mathematics theorems, facts or models, falling in category COI.

Secondly, there are operational invariants about pedagogy of content (PCOI). Similar to last group of rules of coordination, here Huang also generalizes the conclusion about a particular figure to a figural pattern. Hence some operational invariants for Group H.II-A are also relevant here, which are [10], [11] and [15] ~ [18]. Besides, in rule (3), Huang uses 3D DGEs to let students directly accept the generalized conclusion but doesn't develop theoretical deductive reasoning. It is specially because figural patterns ⑦ and ⑧ only appear in the multiple-choice tasks in GAOKAO examination. For such tasks, as Huang said in the interview:

“Students only need to get a right answer quickly; it’s not necessary nor to conduct a rigorous deductive reasoning for every task, that’s really tough, and not possible in two hours...just apply the conclusion directly, then they can solve the task easily”.

We hereby infer [23] as a specific PCOI for rules of coordination H.II-B. It reflects Huang’s understanding of the examination requirements with respect to the tasks related to figural patterns ⑦ and ⑧, and explains why Huang lets students directly accept the corresponding conclusions without the theoretical deductive reasoning process.

Thirdly, the rules of coordination necessitate operational invariants about technology in pedagogy of content (TPCOI), since Huang uses a 3D DGE in rule (3). From the episode around Task 4, we know that with the 3D DGE, Huang firstly demonstrate a triangular pyramid in a cube, and then drags the summit of the pyramid which is a free point around the diagonal face of the cube, showing how the multiple pyramids share the same geometric structure – pattern ⑧. He also turns the whole 3D dynamic model to an overhead view to demonstrate the generalized conclusion about figural pattern ⑧. Therefore, Huang must know how to drag a free point in the 3D DGE to show variations and invariants ([24]), how to rotate the 3D dynamic model to facilitate students’ observation ([25], [26]), and know that the perceptive effects can persuade students of the truth of the generalized conclusion ([27]). These operational invariants are also evidenced in the interview:

“As you can see, students cannot accept a conclusion if you don’t prove it. Then the model in GGB is very utile, I display the animation and adjust to the overhead view. They see B_1D actually coincides with the angle bisector in the base. The they accept the conclusion quickly. Otherwise I would have to develop a long proof. That’s quite time-costing.”

Here [23] ~ [26] all about Huang’s knowledge or views about the advantages of 3D DGEs for teaching and how to exploit the advantages, which are the elements in category PCOI.

Fourthly, from the sentences above, we also see that Huang thinks the perceptive effects in 3D DGEs can help save the teaching time, which corresponds to [27]; it is an operational invariant about how to better utilize lesson, belonging to TEOI.

Fifthly, we can infer some operational invariants about technology and content (TCOI) from the fact that the 3D DGE used in the rules of coordination is designed by Huang himself. According to the content of the 3D DGE introduced in section 5.3.7, we know the design work requires him to have the technological and mathematical knowledge for creating a free point and dragging it in GeoGebra, and constructing a polygon, a polyhedron, a perpendicular line and a plane in GeoGebra. That is operational invariants [28] ~ [36].

Sixthly, the realization of the rules of coordination is also linked to the ease perceived by Huang in designing 3D DGEs. As he expresses in the interview: “the courseware is quite easy to make; just to construct the model and rotate it ... usually I can do that within 10 minutes”. That shows Huang is confident with his knowledge and skills related to GeoGebra ([37]) and he feels the design of GeoGebra files is easy ([38]). Both the operational invariants are about behavior control (BCOI).

Finally, there is one operational invariant about social norms (SNOI). From the interview, we know that Huang uses GeoGebra files in this lesson more often than his ordinary lessons, because

“The teaching research group of the grade expects me to use GeoGebra, in order to compare the lesson with another lesson without GeoGebra.”

This leads to operational invariant [39]. It reflects Huang’s understanding of the expectations of the teaching research group and thus belongs to SNOI

Operational invariants for rule of coordination H.II-C: (1) use a 3D DGE or drawing to support students’ perception with respect to the task figure; (2) request students to apply the conclusion about a figural pattern to the task figure based on figure-structural analogy; (3) take the conclusion about the task figure as a fact to develop the following theoretical deductive reasoning.

The operational invariants that have been inferred for the rules of coordination are listed in Table 5.20, to which we will refer in the analysis that follows.

Table 5.20 Operational invariants for rules of coordination of Group H.II-C

Category	Label and Content of Operational Invariant
COI	<p>[1] ~ [3][20]: Conclusion about figural pattern ④, ③, ② ⑦/⑧ with respect to the orthogonal projection of one point to one plane; [9] The essence of a figural pattern resides in its geometric structure.</p> <p>[40] The conclusions about a figural pattern can be applied to any figure that has the same geometric structure with the figural pattern.</p> <p>[41] Any point on the bisector of an angle is equidistant from the two sides of the angle.</p> <p>[42] Properties of a right triangle (including Pythagorean theorem).</p> <p>[43] Properties of an isosceles triangle (including right isosceles triangle, etc.).</p> <p>[44] If a line is perpendicular to a plane, it is perpendicular to any line in the plane.</p> <p>[45] If a line is perpendicular to two intersecting lines in another plane, it is perpendicular to that plane.</p> <p>[46] If a plane passes through a perpendicular line to another plane, the two planes are perpendicular.</p>
PCOI	<p>[17] students’ difficulty in point-plane distance tasks in GAOKAO examination; [18] views about how the conclusions about typical figural patterns could help students overcome the difficulty; [22] GAOKAO examination requirements with respect to multiple-choice tasks.</p> <p>[47] Drawings of 3D figures can support students’ perception, helping them imagine the spatial structures of the 3D figures.</p> <p>[48] The teacher should elaborate in detail the task solving procedures in which students often make mistakes.</p>

	[49] It's important to link a figural pattern to a figure based on their similarity in geometric structure.
TPCOI	[50] For complex 3D figures, 3D dynamic models work better than drawings in supporting students' perception. [51] The animation of 3D dynamic models in GeoGebra can trigger students' interest of learning. [52] It is important to evoke the corresponding elements in a 3D dynamic model step by step when developing deductive reasoning with it. [53] The teacher can indicate the nature of different elements of a 3D dynamic model with labels, to better illustrate its geometric structure and help students understand its link with a related figural pattern. [54] Teacher can add hand-drawn annotations to the figural representations displayed on the intelligent interactive board, to help illustrate the corresponding figures.
TCOI	[31] [34] [35] [36]: <i>technological and mathematics knowledge for constructing perpendicular, a fixed point, a polygon, and a line segment in GeoGebra.</i> [55] We can designate a label to an object in GeoGebra with the <i>Rename</i> tool in the Context Menu which will appear after right clicking the object. [56] We can make hand-drawn texts or sketches on the intelligent interactive board by activating the <i>Pen</i> tool equipped in the board.
BCOI	[37] <i>confidence in his own technological abilities</i> ; [38] <i>confidence in designing and using GeoGebra courseware in class.</i>
SNOI	[19] <i>understanding of the assessment criteria for open classes</i> ; [39] <i>understanding of the expectation of teaching research group on using GeoGebra.</i>

Firstly, the rules of coordination are underpinned by some operational invariants about content (COI). In rule (2), Huang guides students apply the conclusion about a figural pattern to the task figure, so he must know the conclusion himself. The figural patterns at stake here are ④, ②, ⑦/⑧, and the corresponding conclusions are already expressed in operational invariants [1] ~ [3] and [20]. Huang should also know that the conclusion of the figural pattern can be applied to any figure with the same geometric structure ([40]). In rule (3), Huang develop the following theoretical deductive reasoning based on the conclusion obtained in (2), to solve the tasks at stake. Then he must have the geometric knowledge required for the theoretical deductive reasoning; the knowledge is formulated as operational invariants [41] ~ [46], belonging to the category COI.

Secondly, some operational invariants about pedagogy of content (PCOI) and technology in pedagogy of content (TPCOI) can be inferred. In rules (2) and (3) Huang refers to the conclusion about a figural pattern and guides students to apply them in the theoretical deductive reasoning for solving the task, with the conclusions about some figural patterns (⑦ and ⑧) not yet validly justified. These rules of coordination are consistent with the previous ones through which Huang introduces the conclusion about a figural pattern to students, so that they could apply it later on. Therefore, the related operational invariants inferred previously – [17],

[18] and [22] which concern the teacher's knowledge of students' difficulty in GAOKAO examination tasks, the advantages of knowing some conclusions about typical figural patterns for solving the tasks, and the examination requirements on multiple-choice tasks – are also relevant here. In rule (1), Huang uses either a drawing or a 3D DGE to support students' perception of the task figure; in the interview, Huang mentions how his actions have changed since the last lesson and we identify some operational invariants accordingly:

“In my previous classes I made drawings directly on the board. Tasks 1, 2, and 3 are relatively simple and the students could imagine the figures, but in Task 4 they had trouble in understanding the figure even I gave the drawing. Then I thought I might be better to show the figure in GeoGebra...” ([47])

“Students would also be more interested if you display the animation in GeoGebra. Otherwise they will always face the content in black and white, for students of humanities it's very boring.” ([48])

Huang also highlights the importance of focusing on the structural similarities between a figure and the related figural pattern:

“It is important to highlight that a figure fitting a figural pattern means they have the same geometric structure. In the lesson some students have problems in understanding this. For example, in this task (2) ... they didn't catch the essence of the figural pattern at all. Then what I can do is to highlight the geometric structure of the figural pattern again and again, saying that it relies on the perpendicularity of two planes. So you have to find two perpendicular planes in the task figure...” ([49])

The operational invariants [47] and [48] respectively concern the teacher's view or knowledge about the potential of drawings for students' perception in space, and his general pedagogical strategies to address students' difficulties in solving tasks; [49] reflects Huang's pedagogical strategy to support students' mathematics learning. All the operational invariants belong to category PCOI.

Furthermore, Huang introduces his idea of displaying the GeoGebra file in the stimulated recall interview:

The GeoGebra file, when I open it, the first view is a dynamic model like this, and I have to turn it around so they know the figure is just like this. Here they quickly realize that the summit falls at the angle bisector in the base, but how to apply this conclusion in the following process, it is still a big difficulty and we have to explain to students clearly. As you can see, I give each element a Chinese label, and evoke them step by step in GeoGebra, the perpendicular, the foot of perpendicular, the angle bisector... I can also add annotations to the dynamic model with the pen in the intelligent whiteboard. In this way, they quickly get the essential idea for solving the task”.

From the sentences, we infer [40] ~ [54], which reflect his knowledge about how to utilize the potentials of 3D DGE and the intelligent board, to help with his explanation of mathematics tasks. All these operational invariants fall into the category of TPCOI.

Thirdly, the rules of coordination involve the use of a 3D DGE which is designed by Huang himself, so there should be operational invariants about technology and content (TCOI)

underlying the rules. The 3D DGE here has similar elements to the 3D DGE in last group: both contain fixed points, line segments, polygons, perpendicular lines. Hence the operational invariants mentioned previously, [32] and [35] ~ [37], can also be included into the TCOI here. Besides, the actions of Huang adding labels to some objects in the 3D DGE and adding annotations on the intelligent interactive board require him to know the corresponding techniques, which are expressed in [55] and [56], another operational invariant in TCOI.

Fourthly, the realization of the rules of coordination cannot leave the ease perceived by Huang in designing and using 3D DGEs, similar to the case of the last group. Therefore, the two operational invariants about behavior control (BCOI) mentioned previously are also the underpinning factors here, that is [37] and [38].

Finally, since Huang also uses GeoGebra files and refers to the ancient figural patterns in the rules of coordination, the previous operational invariants about social norms (SNOI), [19] and [39], also play a role here.

5.3.10 Summary of Lesson Series H.II

In this section, we give a summary of the analysis results of this lesson series in light of the first group of research questions.

Table 5.21 lists the main content of the analysis results, including the coordination schemes of Huang, and the 3D geometry tasks-3D DGEs in the corresponding classes of situations. The coordination schemes mainly include rules of coordination and operational invariants. In consistency with the labelling of the groups of rules of coordination, we use “class H.II-A, H.II-B, ...” and “scheme H.II-A, H.II-B, ...” to label the corresponding classes of situations and coordination schemes. To save space, we only integrate the main ideas of the operational invariants and the main characteristics of tasks and 3D DGEs; for a more complete description, please refer to sections 5.3.9 and 5.3.7.

Table 5.21 Summary of analysis results of Lesson Series II of Huang

Coordination schemes	3D geometry tasks-3D DGEs
	Class of situations
<p>Scheme H.II-A</p> <p>Rules of coordination:</p> <p>(1) draw a 3D figure within the drawing of a cube to support students’ perception; (2) generalize a conclusion from the particular 3D figure to a 3D figural pattern through inductive reasoning; (3) develop simplified theoretical deductive reasoning together with students to explain the particular or the generalized conclusion.</p> <p>Operational invariants:</p> <p>COI: [1] ~ [3] geometric conclusions about figural patterns ④, ③ and ②; [4] ~ [8] math knowledge required for</p>	<p>Class of situations H.II-A</p> <p>Tasks 1 ~ 3 (subtask 1):</p> <p>Topic: identify perpendicular relationships (related to a point-plane distance) in a relatively simple 3D figural pattern that can be linked to the 3D figure in the task;</p> <p>Status in curriculum/exam: solve problems concerning perpendicularity with Euclidean geometric proof; have related perceptive support; calculate distance by comprehensively and flexibly using Pythagorean theorem and other math knowledge; short essay items in the</p>

<p>deriving the conclusions; [9] views about the essence of a figural pattern;</p> <p>PCOI: [10] ~ [11] potentials of drawings within the frame of cube for supporting students perception and interpretation of 3D figural patterns; [12] ~ [13] knowledge about students' prior knowledge and experiences; [14] views about how to distribute time in a review lesson; [15] ~ [16] it's importance to describe the conclusions about figural patterns in relation with their geometric structures, and highlight their generality, in teaching; [17] ~ [18] knowledge or views about students' difficulty in GAOKAO exam tasks and how the conclusions about figural patterns could help;</p> <p>SNOI: [19] The open class assessment system appreciates teachers referring to mathematics models in Chinese ancient mathematics works.</p>	<p>GAOKAO exam demanding a proof for the answer;</p> <p>Context and innate support: paper-pencil environment; a drawing equipped for each figural pattern introduced.</p> <p>No 3D DGEs</p>
<p>Scheme H.II-B</p> <p>Rule of coordination:</p> <p>(1) draw a 3D figure within the frame of cube to support students' perception; (2) generalize the conclusion from the particular 3D figure to a figural pattern through inductive reasoning; (3) use a 3D DGE to support students' perception making them certain of the generalized conclusion.</p> <p>Operational invariants:</p> <p>COI: [20] geometric conclusions about figural pattern ⑧; [6] ~ [7] theorems and properties about congruent right triangles; [9]; [21] other math knowledge required for deriving the conclusions;</p> <p>PCOI: [10] ~ [11]; [15] ~ [16]; [17] ~ [18]; [22] GAOKAO examination requirements with respect to multiple-choice tasks;</p> <p>TPCOI: [23] strategy to display the co-variation processes in 3D DGEs; [24] potentials of 3D dynamic models for supporting students' perception of 3D figural patterns; [25] strategy to display the orthogonal projection of a point in 3D DGEs; [26] power of perceptive effects in 3D DGEs in persuading students of the truth of generalized conclusions;</p> <p>TEOI: [27] perceptive evidences in 3D DGEs allows teachers to save the time of developing rigorous proof;</p>	<p>Support students' coordination, in an ordinary real classroom with one computer, introduce common figural patterns in 3D geometry tasks.</p> <p>Class of situations H.II-B</p> <p>Task 4 (subtask 1):</p> <p>3D geometry topic: identify perpendicular relationship in a relatively complex 3D figural pattern that can be linked to the figure in the task;</p> <p>Status in curriculum/exam: solve problems concerning perpendicularity with Euclidean geometric proof; have related perceptive support; calculate distance by comprehensively and flexibly using Pythagorean theorem and other math knowledge; small items in the GAOKAO exam only demanding an answer;</p> <p>Context and innate support: paper-pencil environment; a drawing is equipped for each figural pattern introduced.</p> <p>3D DGEs:</p> <p>Figural representations and tools: 3D dynamic model of the figural pattern being situated in a cube – the summit of the pattern is a free point in the diagonal face of the cube and its base is a triangle in the base of the cube; no specific help; controlled by the teacher; <i>Dragging</i> tool;</p>

<p>TCOI: [28]-[36] techniques and math knowledge for constructing a free point, a fixed point, displaying the co-variation of objects, a pyramid, a perpendicular, a cube, a plane, a polygon, and a segment in GeoGebra;</p> <p>BCOI: [37] confidence in his own skills of using GeoGebra; [38] perceived ease for designing 3D DGEs with GeoGebra</p> <p>SNOI: [39] The teaching research group of the grade expects me to use GeoGebra in the 3D geometry lesson.</p>	<p>Feedback: innate feedback in GeoGebra – drag the summit around the diagonal face to see its orthogonal projection always fall on one angle bisector in the base; drag the whole 3D dynamic model to see its different views;</p> <p>Help and control: no specific help, control in teacher;</p> <p>Curricular distance: close to the curriculum prescriptions.</p> <hr/> <p>Support students’ coordination, in an ordinary real classroom with one computer, introduce common figural patterns in 3D geometry tasks.</p>
<p>Scheme H.II-C</p> <p>Rule of coordination:</p> <p>(1) use a 3D DGE or drawing to support students’ perception with respect to the task figure;</p> <p>(2) request students to apply the conclusion about a figural pattern to the task figure based on figure-structural analogy;</p> <p>Possibilities of inferences when dealing with Task 2:</p> <ul style="list-style-type: none"> – rebut the drawing-perceptive analogy made by students and move them to figure-structural analogy between the figural pattern and the task figure; – illustrate the geometric structure of the task figure with scaffolding lines and simulating gestures <p>(3) take the conclusion about the task figure as a fact to develop the following theoretical deductive reasoning.</p> <p>Operational invariants:</p> <p>COI: [1]-[3]; [20]; [9]; [40] knowledge about the criteria for applying the conclusion about a figural pattern to a figure; [41]-[46] other math knowledge required for solving the tasks at stake;</p> <p>PCOI: [17]; [18]; [47] potentials of drawings for supporting students’ perception of 3D figures; [48] teachers should focus on students’ common mistakes in task solving procedures; [49] importance of linking a figure to a figural pattern based on geometric structural similarities;</p>	<p>Class of situations H.II-C</p> <p>Task 1, 2, 3 and 4 (subtask 2):</p> <p>3D geometry topic: determine the distance from a point to a face in a 3D figure that can be linked to a figural pattern introduced previously;</p> <p>Status in curriculum/exam: similar to the case of Tasks 1- 4 mentioned above</p> <p>Context and innate support: paper-pencil environment; Tasks 1 and 4 provides no drawing for the task figure; Tasks 2 and 3 each provides a drawing for the task figure, which is respectively in a different/ same perspective with the drawing of the corresponding figural pattern.</p> <p>3D DGE for Task 4</p> <p>Figural representations and tools: 3D dynamic model of a complex 3D figure, with labels alongside some elements; no specific help; controlled by the teacher; <i>Selecting</i> and <i>Dragging</i> tool;</p> <p>Feedback: innate feedback in GeoGebra – evoke the labeled elements one by one in the 3D dynamic model by <i>Selecting</i> their names in the Algebra view; turn around the whole 3D dynamic model;</p>

<p>TPCOI: [50] advantages of 3D dynamic models over drawings in supporting students' perception of complex 3D figures; [51] positive effect of 3D dynamic models on student learning interest; [52] views about how to display 3D dynamic models while promoting students' theoretical deductive reasoning; [53]-[54] potentials of labels in 3D DGEs, and the intelligent interactive board, for figure illustration;</p> <p>TCOI: [31]; [34]-[36]; [55] techniques for adding labels to objects in GeoGebra; [56] techniques for making hand-drawn texts or sketches on the intelligent interactive board;</p> <p>BCOI: [37]; [38];</p> <p>SNOI: [19], [39].</p>	<p>Help and control: no specific help, control in teacher</p> <p>Curricular distance: close to the curriculum prescriptions.</p> <hr/> <p>Support students' coordination, in an ordinary real classroom with one computer, summarize typical techniques for solving examination tasks.</p>
--	--

Research question 1.1 of this thesis is how the rules of coordination can be linked with the different categories of operational invariants in the corresponding schemes. To answer this question, we firstly identify the commonalities and differences between the different groups of rules of coordination in Table 5.21, and then link the commonalities and differences with the operational invariants in the corresponding schemes.

Contrasting the three groups of rules of coordination, we observe that Huang always promotes both the perception and some logical reasoning of students, but the interaction mode of the perception and logical reasoning vary by group, with Huang promoting different mode of logical reasoning and attaching different extent of importance to students' perception. To be specific, in both H.II-A and C, students' perception is at an auxiliary status; in H.II-A, students' perception and theoretical deductive reasoning are both at an auxiliary status with respect to the inductive reasoning and the generalized conclusion about a figural pattern led by that; whereas in H.II-C, students' perception is in service of their theoretical deductive reasoning – Huang supports students' perception with respect to the task figure, but it's mainly to help them link the task figure and a figural pattern, so that they could develop the deductive reasoning applying the known conclusion about the figural pattern to the task figure. In H.II-B, Huang also emphasizes inductive reasoning and the generalized conclusion about the figural pattern as in H.II-A, but here he attaches greater importance to students' perception, making them certain of the generalized conclusion merely based on the perception in a 3D DGE.

The three groups of rules of coordination also show commonalities and differences in the particular strategies that Huang adopts to promote the perception or logical reasoning of students. The strategies concern the supportive actions, questions, and the resource used by Huang. To be specific, in H.II-A, Huang uses a drawing in the frame of cube to support students' perception of a figural pattern; in H.II-C, he uses a drawing or a 3D DGE to support students' perception of a task figure. In both of the groups he focuses on the illustration of the geometric relationships in the figures/patterns, taking the perceptive effects as an auxiliary support. In H.II-B, Huang firstly uses a drawing in the frame of cube to illustrate the geometric relationships in a figural pattern; then he uses a 3D DGE and focuses on the perceptive effects therein, making students accept a generalized conclusion directly based on the effects. In H.II-

A, Huang promotes the inductive reasoning by highlighting the generality of the figural pattern which can also be situated in a cuboid. In H.II-C, Huang promotes students' deductive reasoning by highlighting the geometric structural similarities between a figural pattern and a task figure, and emphasizing the relation of the generalized conclusion with respect to the geometric structure of the figural pattern.

As for the important digital resources for teachers' coordination – 3D DGEs, they are all designed by Huang himself and used by Huang in rules of coordination H.II- B and C. Notwithstanding the different ways that Huang uses 3D DGEs in the two groups of rules, there are overlapping content between the 3D DGEs, as they are designed respectively to illustrate the figural pattern and the task figure related to the same task – Task 4.

Next we compare the operational invariants in different schemes, in relation with the corresponding rules of coordination.

Firstly, all the groups of rules of coordination are underpinned by some operational invariants about content (COI), and the COI are linked with the 3D geometry topics of the tasks corresponding to every group, especially the figural patterns involved in the 3D geometry topics. For example, the figural patterns corresponding to H.II-A and H.II-B are respectively patterns ④, ③, ② and ⑧; then in the COI for H.II-A and H.II-B, we can respectively find [1] ~ [8], [20] and [21] which concerns the geometric conclusions about the corresponding figural patterns and other math knowledge required for deriving those conclusions. As regards H.II-C, the corresponding tasks are about determining the distance from a point to a face in a pyramid that can be linked to a figural pattern introduced in Groups A and B; then in the COI for H.II-C, we can find the same elements concerning the geometric conclusions about the figural patterns ([1] ~ [3] and [20]), which also underpin Groups A and B, and some unique elements like [40] ~ [46] concerning Huang's knowledge about the criteria for applying the conclusion about a figural pattern and other math knowledge required for solving the tasks at stake.

Secondly, all the groups of rules of coordination are underpinned by some operational invariants about pedagogical of content (PCOI). The PCOI, together with some elements in COI, are consistent with the different logical reasoning of students emphasized by Huang in different rules of coordination. To be specific, in rules of coordination H.II-A and H.II-B, Huang always emphasizes the generalized conclusion about a figural pattern and the related inductive reasoning; whereas in rules of coordination H.II-C, he mainly promotes students to develop deductive reasoning, in which the conclusion about a figural pattern is applied together with other geometric facts and theorems for solving the task. Consistently, in the COI and PCOI for H.II-A and H.II-B, we can find common elements [9], [15] and [16] – which show that Huang understands a figural pattern as a general geometric structure and that he thinks it important to highlight the generality of the figural pattern. They explain why Huang would like to focus on the inductive reasoning process in the first two groups of rules. In the COI and PCOI for H.II-C, we can find [39] concerning Huang's knowledge about the criteria for applying the conclusion about a figural pattern, [48] concerning Huang's attention to students' common mistakes – the deductive reasoning involved in the calculation of a particular distance, and [49] reflecting Huang's views about the importance of linking a figural pattern to a figure by geometric structural similarities. The three operational invariants explain why he focuses

on the deductive reasoning of students in rules of coordination H.II-C, guiding them to apply the conclusion about a figural pattern to the task figure based on figure-structural analogy and develop further deductive reasoning to solve the task. There are also distinct elements in the PCOI in each scheme. For example, Huang's knowledge about students' prior knowledge and views about how to distribute time in a review lesson ([12] ~ [14]) explains why he puts the theoretical deductive reasoning activities at an auxiliary status in rules of coordination H.II-A. Huang's understanding of the GAOKAO examination requirements with respect to multiple-choice tasks ([22]) is consistent with his emphasis on students' perception in the 3D DGE in rules of coordination H.II-B.

The PCOI are also linked with the strategies that Huang adopts to support students' perception and logical reasoning in the corresponding rules of coordination. In both rules of coordination H.II-A and H.II-B, Huang uses a drawing within a drawing of cube to support students' perception, whereas in H.II-C, he uses an ordinary drawing to support the perception. Then in the PCOI, we can find two common elements [10] ~ [11] for H.II-A and H.II-B and [47] for H.II-C; the operational invariants respectively express Huang's views about the pedagogical benefit of the two kinds of drawings. In the PCOI for H.II-C, the operational invariant [49] reflects Huang's views about the importance of linking a figure to a figural pattern based on geometric structural similarities, and it is especially linked with the strategy of Huang to promote students' deductive reasoning in rules of coordination H.II-C.

Thirdly, for the rules of coordination involving the teacher's use of 3D DGEs, there are also operational invariants about technology in pedagogy of content (TPCOI). The TPCOI, similar to PCOI, are also linked with the strategies that Huang adopts to promote students' perception or logical reasoning in the corresponding rules of coordination. For example, in the TPCOI for H.II-B, Huang's knowledge about strategy to display the co-variation processes in 3D DGEs ([23]) and the strategy to display the orthogonal projections of points in 3D DGEs ([25]) are closely linked with the strategy he actually adopts to support students' perception in rules of coordination H.II-B. In the TPCOI for H.II-C, we can find the teacher's views about how to display 3D dynamic models while promoting students' theoretical deductive reasoning ([53]), and the potentials of labels in 3D DGEs or the intelligent interactive board for figure illustration ([54] ~ [55]). These elements are closely linked with Huang's strategy to support students' perception and theoretical deductive reasoning in rules of coordination H.II-C: he focuses on the geometric relationships in the 3D dynamic model while displaying it in a 3D DG.

Fourthly, some operational invariants about time economy (TEOI), are particularly linked with the specific emphasis that Huang lays on students' perception in rules of coordination H.II-B. The TEOI is exactly [27] – “With perceptive evidences in GeoGebra, teachers can save the time of developing rigorous proof to persuade students' of the truth of a generalized conclusion”.

Fifthly, rules of coordination H.II-B and H.II-C are both underpinned by some operational invariants about technology and the related content (TCOI), and the TCOI are linked with the content of the 3D DGEs and Huang's operations in the 3D DGEs in the corresponding rules of coordination. The TCOI for H.II-C share some elements with the TCOI for H.II-B, such as [31] and [34] ~ [36]; this is consistent with the fact that the 3D DGEs used in the two groups of rules of coordination have overlapping content. Besides, the TCOI for H.II-C also include [55]

and [56], which respectively concern the techniques for adding labels to objects in GeoGebra and the techniques for making hand-drawn texts/sketches on the intelligent interactive board. They are consistent with Huang's particular way of displaying 3D dynamic models in rules of coordination H.II- C.

Finally, all the groups of rules of coordination are underpinned by two operational invariants about behavior control (BCOI) and the rules of H.II-A are also underpinned by one operational invariant about social norm (SNOI). The elements in BCOI – [16] and [17] – reflect Huang's confidence in his technological skills and the ease perceived by him for designing 3D DGEs. They are consistent with Huang's willingness and flexibility in using 3D DGEs in all the three groups of rules. The element in SNOI – [19] – is about Huang's understanding of the norm in Chinese open class assessment system, it explains why Huang refers to the figural patterns descended from Chinese ancient mathematics works in rules of coordination of H.II-A.

Research question 1.2 of this thesis concerns how the coordination schemes can be influenced by the characteristics of 3D geometry tasks-3D DGEs. To answer this question, we identify the links between the groups of rules of coordination and the characteristics of the corresponding 3D geometry tasks-3D DGEs, and then refer to operational invariants to justify the links identified.

Firstly, we claim that the logical reasoning that Huang emphasizes in the rules of coordination are influenced by the 3D geometry topics of the corresponding tasks.

To be specific, in rules of coordination of H.II-A and H.II-B, Huang mainly promotes the inductive reasoning of students; in rules of coordination H.II-C, Huang mainly promotes students' deductive reasoning. The differentiation between rules of coordination is consistent with the differentiation between the 3D geometry topics of the corresponding tasks: the 3D geometry topics of the tasks corresponding to H.II- A and H.II-B are exactly about identifying perpendicular relationships in a general figural pattern, which requires students to get a generalized conclusion and the inductive reasoning is an appropriate approach to achieve that; the 3D geometry topics of the tasks corresponding to H.II-C are about determining the point-plane distance in a solid that fits a previous figural pattern. That means students can solve these tasks through deduction, applying conclusions about the previous figural patterns to the task figures based on figure-structural analogy and combining the results with other geometric facts to lead to the final answers. This idea and the differences between the different groups of tasks are well understood by the teacher, as reflected in operational invariants [17] ~ [18]. They are also the evidences for the link we establish at the beginning of this paragraph.

Secondly, the extent of importance that Huang attaches to students' perception in the rules of coordination is mainly influenced by the status of the corresponding tasks in the GAOKAO examination.

To be specific, Huang places students' perception at an auxiliary status in the rules of coordination H.II-A and H.II-C but emphasizes students' perception in H.II-B. It is consistent with different status of the corresponding tasks in the GAOKAO examination: the tasks corresponding to H.II-A and H.II-C are usually short essay item demanding a proof as the solution, whereas the single task corresponding to H.II-B is usually a multiple-choice or fill-in-blank item demanding a simple answer. In the interview after the lesson series, Huang

clearly expresses that it is because that the GAOKAO examination doesn't require rigorous proof for the tasks corresponding to H.II-B and that he would like to let students rely on perception in 3D DGEs to accept a generalized conclusion for saving time in GOAKAO. He also thinks he can improve the efficiency of the reviewing lessons for GAOKAO by doing this. These ideas are later formulated as operational invariants [22] and [27] (PCOI and TEOI for H.II-B). With these evidences, we establish the link indicated at the beginning of this paragraph. Thirdly, Huang's strategies for supporting students' perception and inductive reasoning in rules of coordination are influenced by the features of figural representations, functionalities of tools and innate feedback in the corresponding 3D DGEs (or more precisely GeoGebra).¹⁹

To be specific, in rules of coordination H.II-B, Huang uses a 3D DGE to display the multiple examples of pyramids that all fit a figural pattern and support students' perception of the orthogonal projection of a point therein. From the analysis of the 3D DGE characteristics in section 5.3.7, we know that the multiple examples of pyramids are created by "dragging" the summit of a dynamic pyramid around the diagonal face of a cube in GeoGebra, with the base of the pyramid always lying on the base of the cube. The whole dynamic model containing the pyramid, the cube and the diagonal face are constructed with the tools of *Point*, *Pyramid*, *Cube*, and *Plane through three points* in GeoGebra. Furthermore, to help students observe the orthogonal projection of the summit in the pyramids, Huang uses the *Perpendicular Line* tool to construct the point of projection and then turns the whole 3D dynamic model to a proper orientation. Therefore, it's the construction tools in GeoGebra, and the characteristic of the 3D dynamic model of being rotatable, the possibility of dragging a free point within the object to which it is attached, and the feedback evoked by dragging the summit of the dynamic pyramid, that allow the teacher to support students' perception in the particular way in rules of coordination H.II- B. In rules of coordination H.II- C, Huang uses a drawing or a 3D DGE to display the task figure, providing students with a perceptive support the geometric relationships therein. Here Huang mainly turns around the 3D dynamic model of the task figure in GeoGebra and evokes certain elements therein step by step with labels indicating their nature. That is to say, the labelling function and the characteristic of the 3D dynamic model of being rotatable in GeoGebra provide the condition for Huang to support students' perception in that way in rules of coordination H.II- C. All these lead us to the link between Huang's rules of coordination and the features of the 3D dynamic models, functionalities of the tools, and the innate feedback available in GeoGebra. The link can be supported by the operational invariants [23] ~ [26], [28] ~ [36], [52] ~ [54] and [56] (TCOI and TPCOI for H.II-B and H.II-C) , which show that Huang knows well the functions of the tools and the related techniques, the characteristics of the 3D dynamic models, and the feedback in GeoGebra, as well as the strategy to exploit them for supporting students' perception.

Besides the supporting strategies mentioned above, some of Huang's strategies for supporting students' inductive or theoretical deductive reasoning in the rules of coordination have no particular link with the characteristics of 3D DGEs and the 3D geometry tasks. The strategies can be: highlight the generality of the figural pattern to promote the inductive reasoning (in H.II- A and B), highlight the geometric structural similarities between a figural pattern and a

¹⁹ As already mentioned in section 5.3.5, in Huang's case we only consider GeoGebra to replace the "3D DGEs".

task figure to promote the deductive reasoning (in H.II-C). According to the PCOI in the corresponding schemes, [15] ~ [16] and [49], we can suppose that the strategies are mainly determined by Huang's own knowledge and views.

Finally, the innate support equipped in 3D geometry tasks also has some effect on the corresponding rules of coordination of teacher Huang. The claim is made according to the differentiation between the coordination behavior of Huang when he faces Tasks 1, 3, 4 and Task 2 respectively in class H.II-C. While Task 2 is equipped with a drawing which is in a different perspective with the drawing of the corresponding figural pattern, students encounter a big difficulty in linking the task figure and the figural pattern. For explaining Task 2, Huang retains the actions that can also be found in rule (1) and rule (3) in H.II-C, but he replaces the rule (2) with other actions – “move students from the drawing-perceptive analogy to the figure-structural analogy between the figural pattern and the task figure by highlighting their structural similarities”, and “illustrate the geometric structure of the task figure with scaffolding lines and simulating gestures”. As can be seen, Huang uses alternative strategies for supporting students' perception. In this sense, the innate support equipped in 3D geometry tasks has the potential to influence Huang's strategies for supporting students' perception in the rules of coordination.

5.4 Case of Huang: Chinese teacher in distance online settings

This section presents the results of analysis of the distance online lesson series of Huang. It is the same teacher who has implemented Lesson Series H.I and H.II. Throughout the Ph. D. period, we have been able to follow only one distance online lesson series of Huang in which he used 3D DGEs. In consistency with the labels H.I and H.II, we label the distance online lesson series as H.III.

Fig. 5.94 presents the timeline of our follow-up of Lesson Series H.III and the data collected.

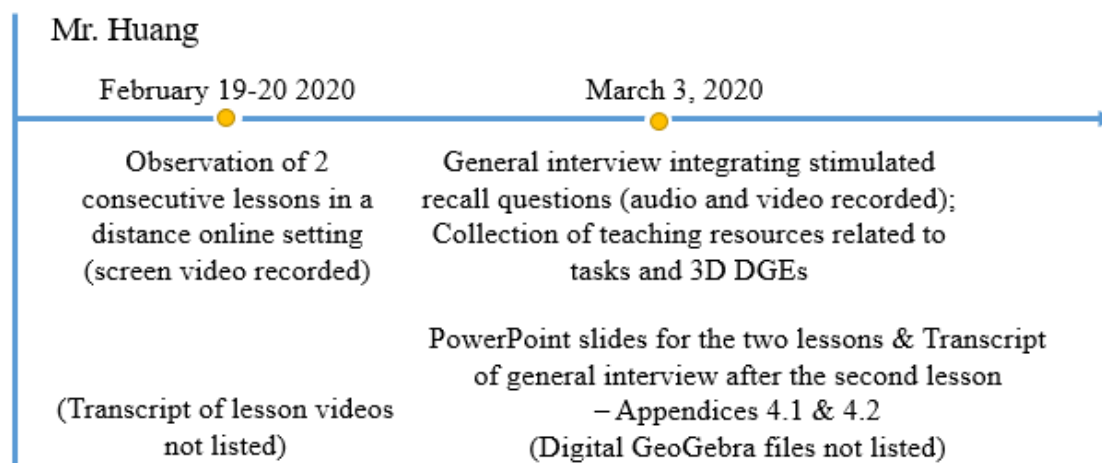


Fig. 5.94 Timeline of follow-up of Lesson Series H.III

5.4.1 Context of Lesson Series H.III

This section introduces the context of the two consecutive lessons in Lesson Series H.III. The context information to be introduced have been mentioned in the methodology part (section 4.4.2), and we get the information from the data of general interview after the lesson series, the PowerPoint slides used (Appendices 4.1 and 4.2) and the video of the lesson series.

The two lessons respectively took place on 19th and 20th February 2020. The students in the lesson were the same as those in Lesson Series H.II and also situated in the stream of literature and humanity within the general branch of Chinese upper secondary education. At the time they were in the second semester of grade 12 – the final year of the upper secondary education – and in the second round of review in preparation for GAOKAO. Due to the sudden outbreak of Covid-19 epidemic at the beginning of 2020 in China, Chinese government ordered high schools to stop real classroom teaching and switch to distance online teaching²⁰. In this background, the school that Huang worked for decided to use Tencent Classroom²¹ to give synchronous live-streaming lessons to students. For the students at grade 12 in the stream of literature and humanity, Huang and other three teachers decided to cooperate to organize one

²⁰ See Ministry of Education of the People's Republic of China. Notice on Several Matters Concerning the Work of Teachers During the Period of Prevention and Control of the Epidemic (In Chinese). http://www.moe.gov.cn/srsite/A10/s3735/202002/t20200213_4_20863.html

²¹ Tencent Classroom is an online teaching platform (it has a webpage version and an application version) developed by Chinese tech giant Tencent Company, allowing teachers to give synchronous or asynchronous lessons online.

single mathematics course toward the students of the whole stream in grade 12. One fourth of the students were from Huang's initial classes. The four teachers divided each mathematics domain (3D geometry, functions...) into several themes, with each of them taking charge of one topic and giving two 45-minute live-streaming lessons on that topic via Tencent Classroom. This mathematics course is bound with a QR code or a link, through which students can add the course into the list of courses in their Tencent Classroom account, and follow the live-streaming lessons either via the webpage of Tencent Classroom or via the application on the computer or mobile phone. Tencent Classroom then became the basis of the teaching setting of this lesson series of Huang.

Fig. 5.95 shows the basic interface of Tencent Classroom (application version on the computer). Before introducing what functionalities of Tencent Classroom that Huang mobilized in Lesson Series H.III, we give an overview of the whole set of functionalities available in Tencent Classroom.

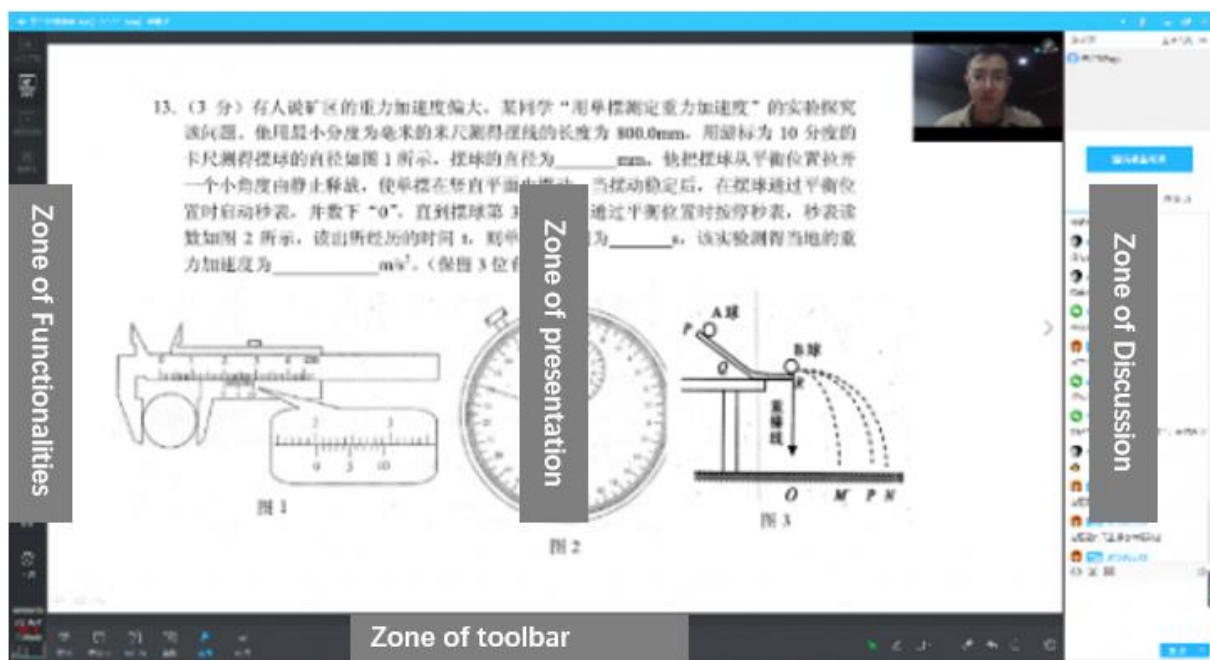


Fig. 5.95 Basic interface of Tencent Classroom (application on the computer)

On the left of the interface in Fig. 5.95, the zone of functionalities provides four modes of presentation: the mode Share-the-Screen allows the teacher to present his computer screen and thus allows to present everything that can be opened on the computer, such as webpages, videos, Microsoft Word files, PowerPoint slides and GeoGebra files; the mode PPT is dedicated to the presentation of local PowerPoint slides; the mode Play-the-Video is dedicated to the presentation of local videos; the mode Open-the-Camera allows the teacher to present the animations synchronously recorded by the built-in camera of the computer, and the camera can also be connected to an external flexible camera to record a wider range of things. With different modes of presentation, the teacher can present different content to the zone of presentation in the middle of the interface. The zone of discussion on the right of the interface allows students to send pictures, texts and emoji. The zone of toolbar provides some auxiliary tools that the teacher can use during the presentation. The tools include: Sketch-Board (for adding a whiteboard in the zone of presentation and making sketches or typing words on it),

Check-In (for counting how many students are now following the lesson), Answer-Sheet (for popping up a multiple-choice quiz), Screen-in-Screen (for creating a small area on the top-right of the zone of presentation and displaying the animation recorded by a camera either internal or external to the computer), Put-Up-Hands (for linking the mic of a student who has “put up hands” virtually), and Preview (for launching another window showing the image of zone of presentation).

For the two lessons in Lesson Series H.III, Huang choose the mode Share-the-Screen and directly presents the things that he plans to present on his computer screen. Fig. 5.96 shows the image that students observe during the lesson series; it also represents the basic layout of the teaching setting of the lessons. Here zone of presentation is extended to the whole computer screen, showing the PowerPoint slides that Huang presented during the lesson series (he would also present GeoGebra files later); the zone of discussion and the zone of functionalities are put together and they can be either minimized to the taskbar at the bottom or evoked onto the screen; the zone of toolbar in Tencent Classroom is hidden backstage. From the zone of discussion Huang would see the nicknames of all the students who were attending the lesson and the information they left, but this zone was minimized to the taskbar for most of the time in the lesson series, because Huang thought that “it’s time wasting to particularly interact with some students in a lesson attended by the whole grade of students”. He mainly interacted with his own students and collected their feedback through a WeChat²² group after the lesson. As can be seen, the functioning of the distance online setting is based on the condition that both the teacher and individual students have access to a computer and internet. However, only the teacher could manipulate the objects in the PowerPoint slides and GeoGebra files that he presented, and students’ work was limited to watching the live-streaming videos and solving tasks in a paper-pencil environment. The students didn’t use the Put-Up-Hands tool to give a voice over the whole lesson series, nor did Huang invite them to do so.

²² A synchronous communication software developed by Tencent Company, allowing the conversion between two people or among a group of people in forms of text, image, or video.



Fig. 5.96 Layout of the teaching setting for Lesson Series H.III.

The subject matter of the two lessons in this series was the same one – common figural patterns (including 2D and 3D ones) in 3D geometry. The lessons were also the first two lessons on 3D geometry in the second round of review for GAOKAO examination. Huang’s didactical objective here was to introduce figural patterns that are often involved in 3D geometry tasks in GAOKAO, so that students could improve their task solving efficiency by directly applying some known conclusions about the figural patterns. During the process, Huang also hoped to consolidate students’ knowledge and abilities in 3D geometry, especially those required by GAOKAO.

Before the lesson series, the students had dealt with a lot of 3D geometry tasks and learnt a lot about Euclidean 3D geometry, such as theorems about parallelism or perpendicularity between lines and planes in space, structural properties of common solids (straight prisms, regular pyramids, spheres, cubes and cuboids), Pythagorean theorem and so on. Then this lesson series was concerned with the comprehensive and flexible application of the knowledge in solving 3D geometry tasks. The students had no prior experience of directly operating GeoGebra, but they had seen Huang display GeoGebra files in previous lessons.

The activities in the two lessons both evolved around the PowerPoint slides that Huang prepared beforehand. The PowerPoint slides for the first lesson include four parts: 1. Introduction; 2. Overview of the 3D geometry tasks in past GAOKAO examinations; 3. 3D geometry knowledge and abilities required by GAOKAO; and 4. 2D figural patterns and the 3D geometry tasks that can be associated with the patterns. The PowerPoint slides for the second lesson followed the first lesson, including two parts: 1. 3D figural patterns and the 3D geometry tasks that can be associated with the patterns; 2. Summary. Based on the content of the PowerPoint slides and the lesson videos, we identify five topics of activities throughout the whole lesson series.

- Activity 1: Introduce the 3D geometry content to be reviewed in the following week and some instructions for the review
- Activity 2: Give an overview of the 3D geometry tasks in past GAOKAO examinations
- Activity 3: Review the 3D geometry knowledge and abilities required by GAOKAO
- Activity 4: Introduce 2D and 3D figural patterns and associate them with the figures in 3D geometry tasks
- Activity 5: Summarize the figural patterns and their application

Firstly, Huang presented Slide 1 on the computer screen (Fig. 5.97). Here he let students to take out a book called 专题透析(zhuān-tí-tòu-xī) and a notebook. The book 专题透析, literally meaning “insight into mathematics subject”, is a reference book that gathers many tasks from past GAOKAO examinations and mock examinations. The 3D geometry tasks that Huang presented in the following slides were all selected from this book. By letting students have the book at hand, Huang could ensure students to have access to the 3D geometry tasks in the paper-pencil environment. After that Huang introduced the 6 themes in 3D geometry to be reviewed in the week and gave some general instructions for the review (see Fig. 5.97). These constituted Activity 1.



Fig. 5.97 Part of Slide 1 in Lesson Series H.III (translated from Chinese by the researcher)

Secondly, Huang skipped to Slide 2 (Fig. 5.98) and gave an overview of the 3D geometry tasks in past GAOKAO examinations and the portion of mark the tasks take up. This was Activity 2.

1		Exam items of past years	01
Year		Number and the content examined by the item	points
2013年 I 卷	【题11】	三视图表面积; 【题12】三视图; 【题17】三视图表面积; 小二致正体积	22
2013年 II 卷	【题9】	三视图; 【题15】外接球表面积; 【题18】证线面平行, 球三棱锥体积	22
2014年 I 卷	【题8】	三视图; 【题16】实际情景题; 【题19】证线线垂直, 求三棱柱的高	22
2014年 II 卷	【题6】	三视图体积比; 【题7】三棱锥体积; 【题19】证线面平行, 求点面距	22
2015年 I 卷	【题6】	圆锥体积应用题; 【题11】三视图表面积; 【题19】证面面垂直, 三棱锥侧面积	22
2015年 II 卷	【题6】	三视图体积比; 【题10】外接球表面积; 【题19】作平行线, 求体积比	22
2016年 I 卷	【题7】	三视图表面积; 【题11】线线角; 【题19】证明中点, 四面体体积	22
2016年 II 卷	【题4】	外接球表面积; 【题7】组合体三视图; 【题19】证线线垂直, 五棱锥体积	22
2016年 III 卷	【题10】	三视图表面积; 【题11】三棱柱体积最值; 【题19】证线面平行, 四棱锥体积	22
2017年 I 卷	【题6】	线面平行判断; 【题16】外接球表面积; 【题18】证线线垂直, 三棱柱体积	22
2017年 II 卷	【题11】	三视图体积; 【题15】外接球; 【题18】证线面平行, 四棱锥体积	22

Fig. 5.98 Part of Slide 2 in Lesson Series H.III (partly translated by the researcher from Chinese into English)

Thirdly, Huang talked about Slides 3 ~ 5, which presented the 3D geometry knowledge and abilities that students must grasp for GAOKAO. With Slide 3 Huang introduced some common solids (prisms/cylinders, pyramids/cones, spheres, truncated pyramids/cones) and the critical elements therein (Fig. 5.99); he specifically mentioned the difference between truncated pyramids and truncated prisms, and displayed a GeoGebra file (Fig. 5.100) to illustrate the structure of a truncated prism which was often identified as a truncated pyramid by mistake. With Slide 4 Huang reminded students of some key points of oblique parallel projection rules for making drawings of 3D figures on the paper (such as the angle of 90° in space will be transformed to 45° after the projection) and asked students to deal with the task after the lesson. As shown in Fig. 5.101, the task was equipped with a drawing of a trapezoid obtained by applying the rules of oblique parallel projection and it asked students to reconstruct the original trapezoid and calculate the length of a side of the trapezoid. When it came to Slide 5 (Fig. 5.102), Huang led students to quickly review the theorems and axioms about the perpendicularity and parallelism in space, without elaborating the particular content of the theorems. All these constituted Activity 3.

Fourthly, Huang introduced several 2D and 3D figural patterns. The 2D figural patterns included triangle patterns, rhombus patterns, kite patterns, parallelogram patterns, trapezoid patterns, and rectangle patterns, as shown in Fig. 5.103 and Fig. 5.104; the 3D figural patterns included the cuboid pattern, and the sub-objects of cuboid such as QIANDU, YANGMA and BIENAO, as shown in Fig. 5.105²³. With respect to each figural pattern, Huang introduced some general geometric conclusions that can be used for solving tasks. For example, in the last rectangle pattern presented in Fig. 5.103, Huang firstly explained that $DM \perp AC$ (the geometric conclusion) in a rectangle with the width and the length being 1 and $\sqrt{2}$ and M being the midpoint of long side. He then generalized the geometric conclusion, explaining that $DM \perp AC$

²³ Consistent with the three figural patterns in Lesson Series I in §5.3.1, QIANDU, YANGMA and BIENAO are three patterns originated from a Chinese ancient mathematics book, referring to a triangular prism, a rectangular pyramid and a triangular pyramid that can be cut out of a cuboid.

can be true in any rectangle with the ratio of width to length being $1:\sqrt{a}$ and M being the point of a -section of the long side (i.e., $AM=\sqrt{a}/a$), as shown in Fig. 5.104. Once Huang had introduced one group of figural patterns, he guided students to solve one or more 3D geometry tasks related to the figural patterns. After that he moved to the next group of figural patterns. This repetitive process continued until the last second slide. Huang also displayed GeoGebra files to help with his explanation. All these constituted Activity 4.

Finally, Huang gave a summary of the figural patterns that have been introduced and the types of tasks in which the figural patterns can be applied (see Fig. 5.106). He then assigned after-class homework to students. This was Activity 5.

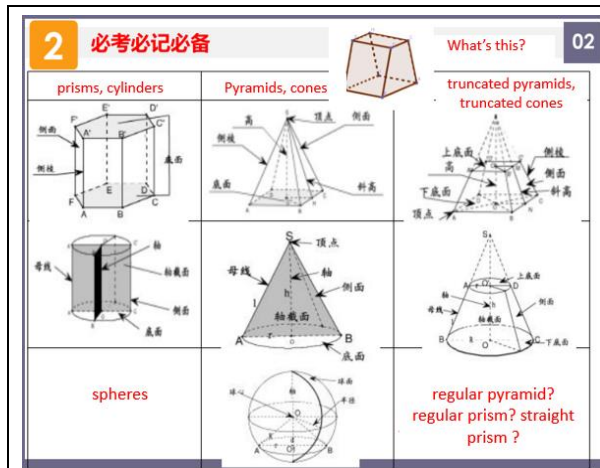


Fig. 5.99 Slide 3 (partly translated by us from Chinese to English)

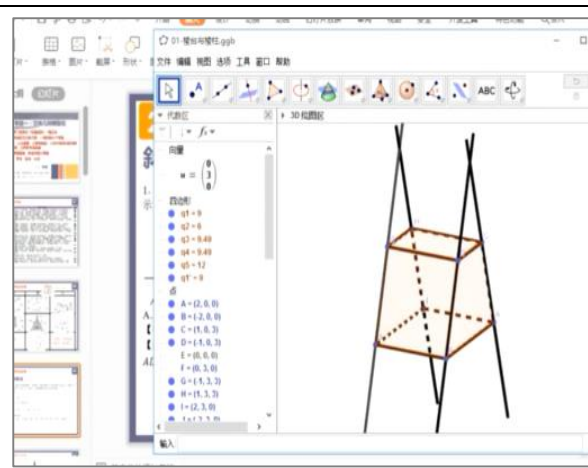


Fig. 5.100 GeoGebra file displayed by Huang in Activity 3

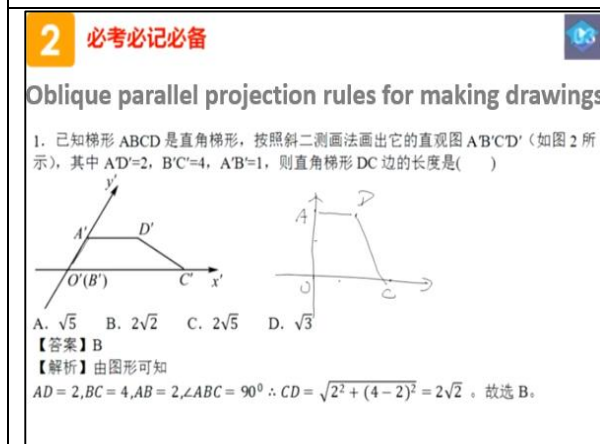


Fig. 5.101 Slide 4 (partly translated by us from Chinese to English)

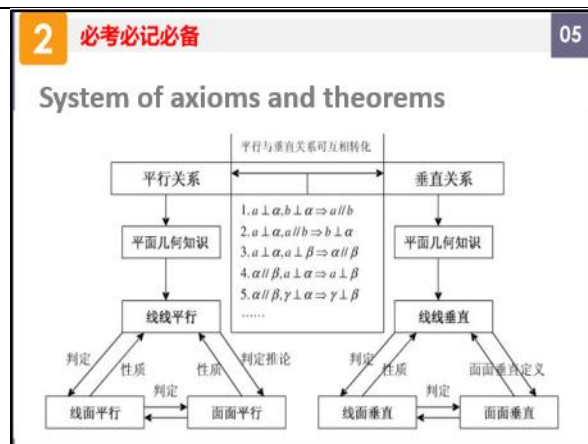
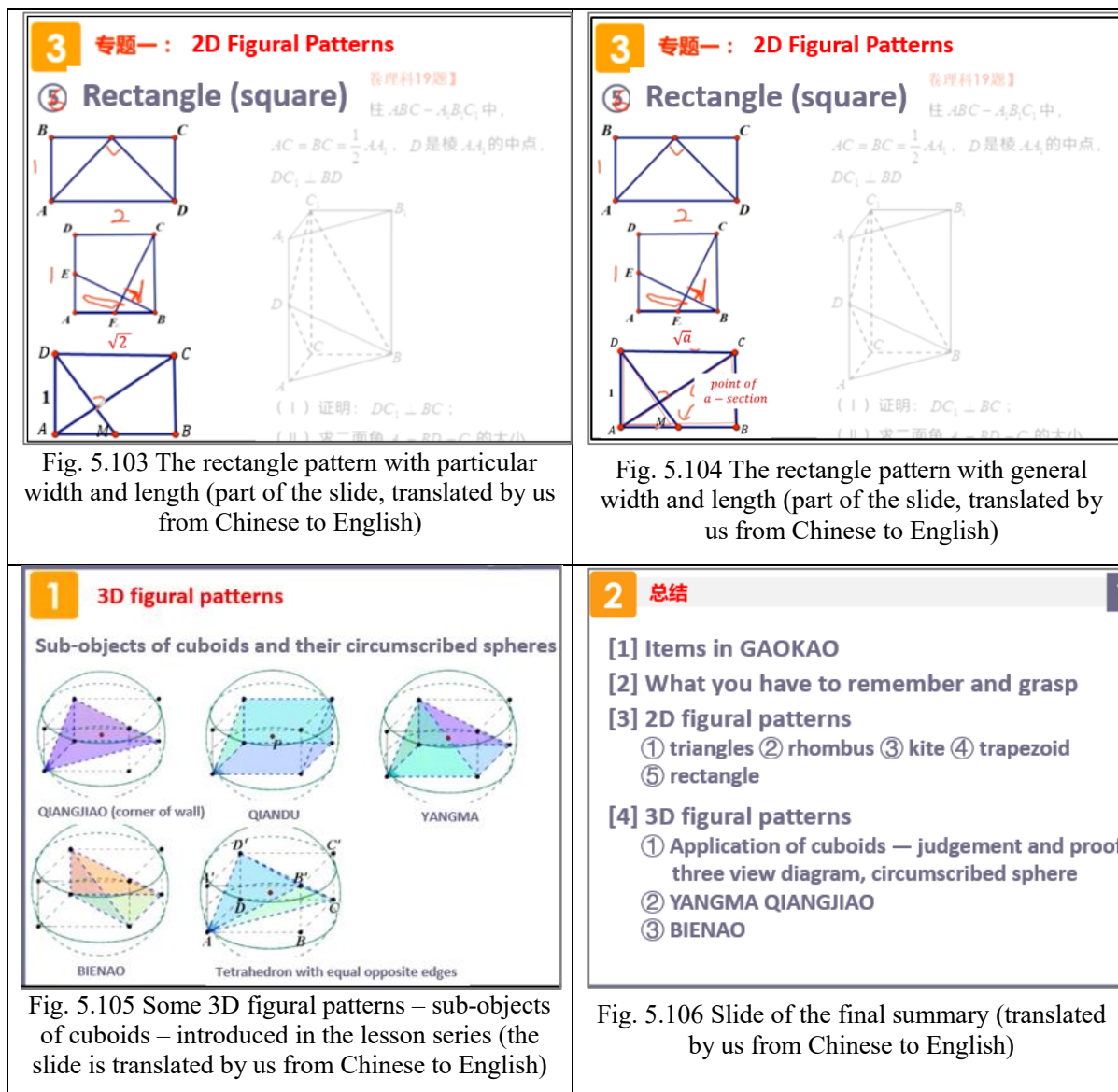


Fig. 5.102 Slide 5 (partly translated by us from Chinese to English)



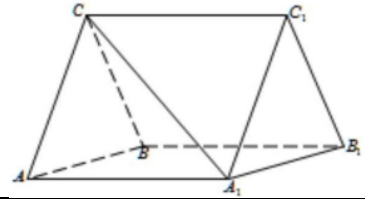
5.4.2 Characteristics of 3D geometry tasks-3D DGEs in Lesson Series H.III

This section presents how we analyze the characteristics of the 3D geometry tasks and the 3D DGEs used in this lesson series, which are analyzed according to the dimensions of characteristics described in sections 3.3.1 and 3.3.2. The content of the tasks is sorted out from the PowerPoint slides (Appendix 4.1); the content of the 3D DGEs is sorted out from the GeoGebra files used by Huang in the lesson series.

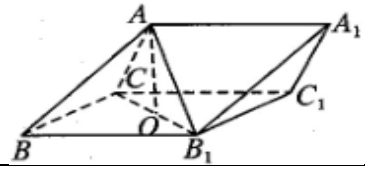
Characteristics of 3D geometry tasks

The 19 tasks dealt with by Huang in Lesson Series H.III are presented below, what we relabel Tasks 1 ~ 19. The original 3D geometry tasks usually contain 2 sub-questions, but we only retain the questions really dealt with by Huang, that is first sub-question that concerns the proof of some geometric relationship. For the characteristics of the tasks, we firstly discuss their 3D geometry topics.

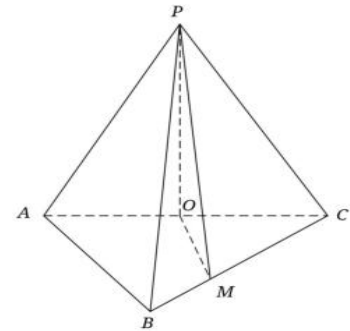
Task 1 As shown on the right, in triangular prism $ABC-A_1B_1C_1$, $CA=CB$, $AB=AA_1$, $\angle BAA_1=60^\circ$. (1) Please prove: $AB=A_1C$.



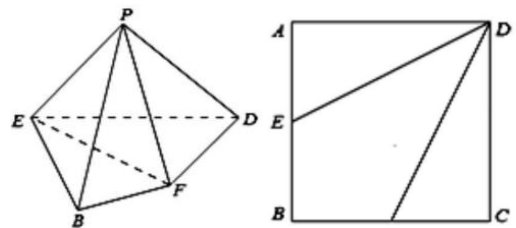
Task 2 As shown on the right, in triangular prism $ABC-A_1B_1C_1$, lateral face BB_1C_1C is a rhombus, the midpoint of B_1C is O , and $AO \perp$ plane BB_1C_1C . Please prove: $B_1C \perp AB$.



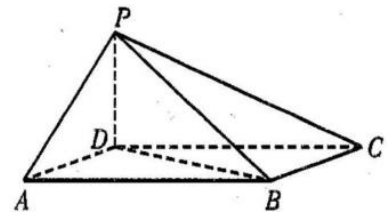
Task 3 As shown on the right, in triangular pyramid $P-ABC$, $AB=BC=2\sqrt{2}$, $PA=PB=PC=AC=4$, O is the midpoint of AC . (1) Please prove: $PC \perp$ plane ABC



Task 4 As shown on the right, in square $ABCD$ with the side length of 4, points E and F are respectively the midpoints of sides AB and BC , fold $\triangle AED$ and $\triangle DCF$ up to make points A and C converge and P . (1) Please prove: $PD \perp EF$



Task 5 As shown on the right, in rectangular pyramid $P-ABCD$, the base $ABCD$ is a parallelogram, $\angle DAB=60^\circ$, $AB=2AD$, $PD \perp$ base $ABCD$. (1) Please prove $PA \perp BD$



Task 6 As shown in figure 1, in right trapezoid $ABCD$, $AD \parallel BC$, $AB \perp BC$, $BD \perp DC$, point E is the midpoint of side BC , fold $\triangle ABD$ up along BD , so that plane $ABD \perp$ plane BCD , connect AE, AC, DE , get the solid in figure 2. Please prove: $AB \perp$ plane ADC .

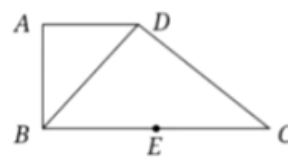


Figure 1

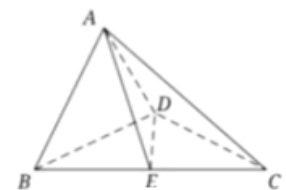
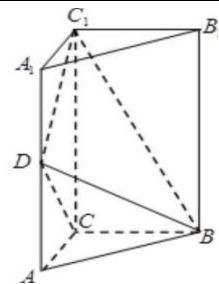
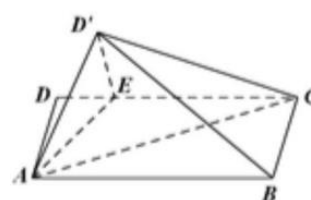


Figure 2

Task 7 As shown on the right, straight triangular prism $ABC-A_1B_1C_1$, D is the midpoint of edge AA_1 , $DC_1 \perp BD$. (1) Please prove $DC_1 \perp BC$.

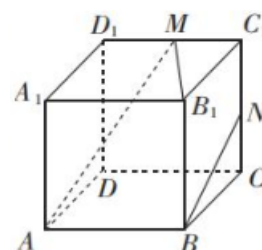


Task 8 As shown in the figure, in the rectangle ABCD, AB=4, AD=2, E is on the side DC, DE=1. Fold $\triangle ADE$ up to $\triangle AD'E$ along AE, so that plane $AD'E \perp$ plane ABCE. (1) Please prove: $AE \perp BD$.



Task 9 As shown on the right, in a cube $ABCD - A_1B_1C_1D_1$, M, N are especially the midpoint of C_1D_1 and C_1C . There are four conclusions:

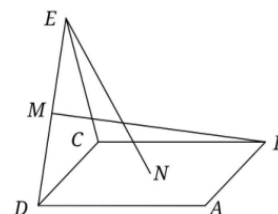
- ① line AM and line C_1C are intersecting
- ② line AM and line BN are parallel
- ③ line BN and line MB_1 are non-coplanar
- ④ line AM and line DD_1 are non-coplanar



Please give the number(s) of the right conclusion(s) _____

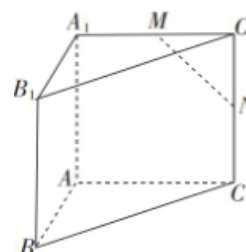
Task 10 As shown on the right, N is the center of square ABCD, $\triangle ECD$ is an equilateral triangle, plane $ECD \perp$ plane ABCD, M is the center of the line segment ED, then ()

- A: $BM=EN$, and the lines BM and EN are intersecting.
- B: $BM \neq EN$, and the lines BM and EN are intersecting.
- C: $BM=EN$, and the lines BM and EN are not coplanar.
- D: $BM \neq EN$, and the lines BM and EN are not coplanar.



Task 11 As shown on the right, in straight triangular pyramid $ABC - A_1B_1C_1$, if $AB=AC=AA_1=1$, $AB \perp AC$, M, N are respectively the midpoints of A_1C_1 and CC_1 . Then the angle between the non-coplanar lines MN and B_1C_1 is ()

- A. 90° B. 60° C. 45° D. 30°



Task 12 China has a fine tradition of goldstone. 印信(yìn xìn, a stamper) is a representative of the goldstone culture. The shape of the 印信 of Dugu Xin, an official in the Northern and Southern Dynasties, is a "semi-regular polyhedron"(Figure (1) – a polyhedron consisting of two or more kinds of regular polygons. Figure 2 shows a semi-regular polyhedron with 48 edges, and all of its vertices are on the surface of one cube. The edge length of the cube is 1. Then the semi-regular polyhedron has _____ faces and the length of its edge is _____

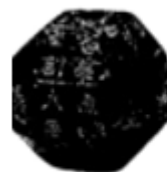


Figure 1

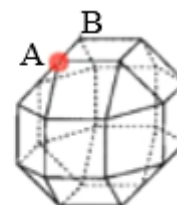
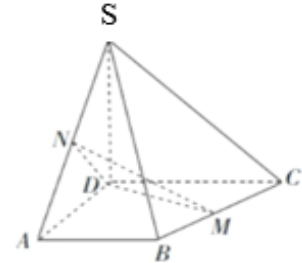


Figure 2

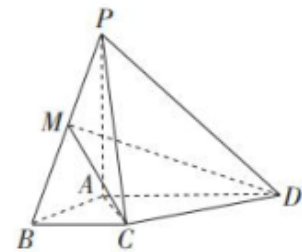
Task 13 Given a triangular pyramid P-ABC, its four vertices are on the surface of the sphere O, $PA=PB=PC$, $\triangle ABC$ is an equilateral triangle with side length of 2. E, F are respectively the midpoints of PA, AB, $\angle CEF=90^\circ$, then the volume of the sphere O is ()

- A. $8\sqrt{6}\pi$ B. $4\sqrt{6}\pi$ C. $2\sqrt{6}\pi$ D. $\sqrt{6}\pi$

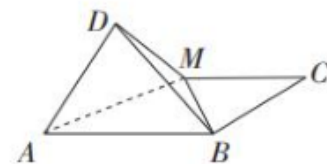
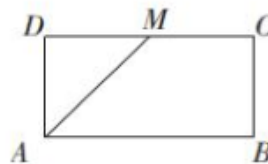
Task 14 As shown on the right, in rectangular pyramid S-ABCD, $SD \perp \text{plane } ABCD$, $AB \parallel CD$, $AD \perp CD$, $SD=CD$, $AB=AD$, $CD=2AD$, M is the midpoint of BC, N is the midpoint of SA. (1) Please prove $MN \parallel \text{plane } SDC$.



Task 15 As shown on the right, in a rectangular pyramid P-ABCD, $PA \perp \text{plane } ABCD$, $\triangle ABC$ is an equilateral triangle, $PA=2AB=2$, $AC \perp CD$, $\tan \angle DPC = \frac{\sqrt{15}}{5}$. (1) Please prove $BC \parallel \text{plane } PAD$



Task 16 As shown on the right, in rectangle ABCD, $AB=2BC=2$, M is the midpoint of DC, fold up $\triangle ADM$ along AM, so that $\triangle ADM$ is perpendicular to plane ABCM. (1) Please prove $AD \perp BM$.



Concerning the general 3D geometry topic of Task 1, it belongs to Topic 5 – make judgement about a given 3D geometry statement and justify it (already introduced in section 3.3.1). Regarding the variables (a) and (b) in Topic 5, the task does demand a “valid justification”—a mathematics proof – for the 3D geometry statement to be justified, which implies the 3D geometry statement itself is “true” and students don’t need to additionally judge its truth. The task topic overlap with Topic 1 – identify geometric relationships in space, as the true 3D geometry statement corresponds to a “geometric relationship’ in space. The variable (a) in Topic 1, the “nature of the relationships and the geometric objects involved therein” concern the equivalence between the length of two line segments, AB and A_1C . The variable (b) of Topic 1, the “structure of the background solid” concerns a triangular prism $ABC-A_1B_1C_1$ with one rhombus lateral face ABB_1A_1 , and the rhombus has an internal angle of 60° . Obviously, the rhombus can be easily associated with a rhombus pattern introduced in the lesson – rhombus with an internal angle of 60° – without much mental rotation. Regarding the variable (c) of Topic 1 – the “relative positions of the geometric objects at stake in the background solid”, both the line segments are on the surface of the prism. To summarize, the detailed 3D geometry topic of Task 1 is to prove the equivalence of the lengths of two line segments on the surface of a triangular prism; the prism contains a lateral face that can be easily associated with a rhombus pattern introduced in the lesson.

Tasks 2 to 8 are in a similar case to Task H.II-1, belonging to belongs to Topic 5 in general and overlapping with Topic 1. After a similar analysis to the above, we get the detailed 3D geometry topics of these tasks as follows.

The detailed 3D geometry topic of Task 2 is to prove the perpendicularity between two line segments on the surface of a triangular prism; the prism contains a lateral face that can be easily associated with a rhombus pattern (which is simply a rhombus) introduced previously in the lesson.

The detailed 3D geometry topic of Task 3 is to prove the perpendicularity between a line and a plane which are both inscribed on the surface of a triangular pyramid; the pyramid contains two lateral faces whose composite shape can be easily associated with a kite pattern (a kite consisting of a right isosceles triangle and an equilateral triangle) introduced previously in the lesson.

The detailed 3D geometry topic of Task 4 is to prove the perpendicularity between two line segments on the surface of a triangular pyramid; the pyramid contains two lateral faces whose composite shape can be easily associated with a kite pattern (an ordinary kite with two pairs of equal-length sides that are adjacent to each other) introduced previously in the lesson.

The detailed 3D geometry topic of Task 5 is to prove the perpendicularity between two line segments on the surface of a rectangular pyramid; the pyramid contains a base that can be easily associated with a parallelogram pattern (a parallelogram with an internal angle of 60° and the ratio of length of the two sides of the angle being 1:2) introduced previously in the lesson.

The detailed 3D geometry topic of Task 6 is to prove the perpendicularity between a line and a plane which are both inscribed on the surface of a triangular pyramid; two adjacent faces of the pyramid are folded from a trapezoid that can be easily associated with a trapezoid pattern (a right trapezoid consisting of two right triangles) introduced previously in the lesson.

The detailed 3D geometry topic of Task 7 is to prove the perpendicularity between two lines segments on the surface of a triangular prism; the prism contains a lateral face that can be easily associated with a rectangle pattern (a rectangle with the ratio of length to width being 2:1) introduced previously in the lesson.

The detailed 3D geometry topic of Task 8 is to prove the perpendicularity between two line segments on the surface of a rectangular pyramid; two adjacent faces of the pyramid are folded from a rectangle that can be easily associated with a rectangle pattern (a rectangle with the ratio of length to width being $\sqrt{a}: 1$ and an a -section point on the side of length) introduced previously in the lesson.

Task 9 offers four conclusions to students and asks them to choose the correct one(s), which are in fact conclusions ③ and ④. Students need to judge the correctness of the four conclusions one by one with valid or not valid justification, so the task can be divided into four subtasks which correspond to the four conclusions (consistently noted as subtask ① ~ ④). The general 3D geometry topics of the subtask ① ~ ④ all belong to Topic 5 and overlap with Topic 1. After a similar analysis, we get the detailed 3D geometry topics of subtasks ①-④ as follows: to make judgement about a 3D geometry statement that concerns the relative position (intersection/parallelism/non-coplanarity/non-coplanarity) of two line segments in a

cube without giving valid justification; the cube can be easily associated with the cuboid(cube) pattern.

Similarly, the detailed 3D geometry topics of the four subtasks of Task 10 can be uniformly expressed as: make judgement about a 3D geometry statement that concerns the length equivalence (equal or not equal) and the relative position (intersecting or non-coplanar) of two line segments in 3D figure without giving valid justification; the 3D figure can be easily associated with the cuboid (cube) pattern.

Task 11 requires students to choose from the four options provided, the correct value corresponding to the value of the angle between two line segments in a solid. Hence the 3D geometry topic of the task generally belongs to Topic 1 – identify geometric relationships in space. The variable (a) in Topic 1, the “nature of the relationships and the geometric objects involved therein” concern the angle between two line segments, MN and B_1C_1 . The variable (b) of Topic 1, the “structure of the background solid” concerns a straight triangular prism $ABC-A_1B_1C_1$, in which the base ABC is an isosceles right triangle and the height equals the two legs of the isosceles right triangle. The prism is actually a half of a cube. Regarding variable (c) of Topic 1 – the “relative positions of the geometric objects at stake in the background solid”, both MN and B_1C_1 are on the surface of the triangular prism, MN connects the two midpoints of two edges of the prism, and B_1C_1 is another edge of the prism. To summarize, the detailed 3D geometry topic of Task 11 is to identify the angle between two lines segments on the surface of a straight triangular prism; the prism can be easily associated with the cuboid (cube) pattern.

The general 3D geometry topic of Task 12 belongs to Topic 4 – determine geometric magnitudes in space, and the magnitudes to be determined are the number of faces and the edge length of a semi-regular polyhedron. To determine the length of the edge require students to figure out the geometric relationship between edges of the polyhedron with edges of its circumscribing cube, since the task already indicates that all the vertices of the polyhedron fall on a cube). Hence the task topic overlaps with Topic 1 – identify geometric relationships in space. The variable (a) in Topic 1, the “nature of the relationships and the geometric objects involved therein” concern the length relationship between an edge of the semi-regular polyhedron which consists of squares and equilateral triangles, and an edge of the cube that circumscribes the polyhedron. The variable (b) in Topic 1, the “structure of the background solid” is exactly the circumscribing cube. Regarding variable (c) in Topic 1 – the “relative positions of the geometric objects at stake in the background solid”, we would say that some edges of the semi-regular polyhedron fall on the faces of the cube while some pass through the inside of the cube, and that all the vertices of the polyhedron fall on the surface of the cube. To summarize, the detailed 3D geometry topic of Task 12 is to determine the number of faces and the edge length of a semi-regular polyhedron whose vertices all fall on the faces of a cube and whose edges can be relate to the edges of the cube.

The general 3D geometry topic of Task 13 generally belongs to Topic 4 – determine geometric magnitudes in space, and the “magnitude” to be determined is the volume of the circumscribed sphere of a triangular pyramid $P-ABC$. The drawing of the pyramid is not equipped in the task, so students need to construct the drawing according to the description of the properties of the pyramid in the task statement. So the task topic overlaps with Topic 3 – construct (representations of) geometric objects in space. Regarding variable (a) in Topic 3, students have

“not” observed a priori the geometric object to be constructed. Regarding variables (b) in Topic 3, the “properties of the geometric objects to be constructed” include that the lateral faces of the pyramid – PA, PB, PC – are equal, that the base of the pyramid – ABC – is an equilateral triangle with side length of 2, and that $\angle CEF=90^\circ$ with E and F respectively being the midpoints of PA and AB. Furthermore, to determine the volume of the circumscribed sphere of the pyramid P-ABC, students need to identify more geometric relationships in the pyramid so that they can relate some magnitudes in it to the radius of the circumscribed sphere. In fact, once students calculate the lengths of lateral faces, they will know that $\angle APB$, $\angle BPC$, $\angle CPA$ are all right angles and pyramid P-ABC fits the pattern of QIANGJIAO introduced in the lesson. Therefore, the task topic also overlaps with Topic 1 – identify geometric relationships in space. Regarding variable (a) in Topic 1, the “nature of the relationships and the geometric objects involved therein” concern the relationships between lengths of edges, the angle between edges. Regarding variable (b) of Topic 1, the “structure of the background solid” concerns the structure of pyramid P-ABC described above. Regarding variable (c) of Topic 1 – the “relative positions of the geometric objects at stake in the background solid” are not determined a priori; they depend on which angles and side lengths that students will be able to identify. To summarize, the detailed 3D geometry topic of Task 13 is to construct (the drawing of) a triangular pyramid according to task descriptions, identify geometric relationships in it and determine the volume of its circumscribed sphere.

Tasks 14 ~ 16 are in a similar case to Task 1: all of them are about proving a true mathematics conclusion that concerns a geometric relationship in a solid. One slight difference is that the solid involved in Task 1 can be easily associated with a figural pattern that the teacher has introduced before, whilst the last 3 tasks can also be associated with a figural pattern introduced in the lesson (YANGMA or BIENAO), but the association requires complex mental rotation or the help of scaffolding lines. After a similar analysis to Task 1, we get the detailed 3D geometry topics of tasks 14 to 16 as follows.

Task 14 is about proving the parallelism between a line that passes through the inside of a rectangular pyramid and a plane on the surface of the pyramid; the pyramid can be associated, but not easily, with the pattern of YANGMA.

Task 15 is about proving the parallelism between a line and a plane that are both inscribed on the surface of a rectangular pyramid; the rectangular pyramid consists of a triangular pyramid which can be associated, but not easily, with the pattern of BIENAO.

Task 16 is about proving the perpendicularity between two edges of a triangular pyramid; the pyramid can be associated, but not easily, with the pattern of BIENAO.

Now we discuss the status of the 16 tasks in Chinese curriculum. Since the students in this lesson series fall in the scope of the old version of Chinese upper secondary mathematics curriculum and are in the stream of literature and humanities within the general branch, we focus on this part of the Chinese curriculum to examine the prescriptions related to the tasks.

Tasks 1 ~ 8, and Tasks 14 ~ 16 all involve proving a statement about one geometric relationship such as perpendicularity or parallelism in space. This echoes the curriculum prescription according to which students should be able to “prove statements concerning relative positions in space with the conclusions already obtained” (Ministry of Education of the People’s

Republic of China, 2003, p. 21). The conclusions already obtained refer to basic facts and theorems in Euclidean geometry, and what matters most here are theorems about the “determination” and “properties” of perpendicularity or parallelism in space.

Tasks 9 ~ 11 are about making judgement on the conclusions about geometric relationships (equivalence of lengths, angle, intersection, parallelism, coplanarity) in space. Although the tasks don't oblige students to provide a valid justification for their judgment, the curriculum does prescribe a Euclidean geometric approach to the tasks with such a topic. The related curriculum prescriptions are the same as those for Tasks 1 ~ 8

Task 12 involves determining two geometric magnitudes related to a polyhedron which is not so regular and identifying geometric relationships between edges of the polyhedron with edges of its circumscribed cube. Task 13 involves constructing the (2D representations of) a solid, identifying some relevant geometric relationships in it and calculating its volume. The curriculum prescriptions with respect to the identification of geometric relationships in space have already mentioned above. The calculation of the geometric magnitudes requires a comprehensive and flexible application of 2D geometry knowledge such as the Pythagorean theorem, the sine and cosine laws in a triangle, and formulae of area and volume. The knowledge are all what students should grasp according to the curriculum prescriptions.

As can be seen, the 3D geometry topics of the tasks are mainly related to the 2D and 3D Euclidean geometry in the Chinese curriculum. This part of curriculum doesn't include vector 3D geometry, so students can only adopt Euclidean geometric approach to solve most of the tasks according to the curriculum prescriptions.

Now we discuss the status of the four tasks in GAOKAO examination. Tasks 1 ~ 8 and 14 ~ 16 are close to the short essay items in GAOKAO. This kind of items require students to give detailed mathematics proof for the given statements. Tasks 9 ~ 13 are close to the multiple-choice or fill-in-blank items in GAOKAO. These items only demand a choice as the answer or word/sentence/number/magnitude to be filled in the blank. That means students can use any approach (including inductive reasoning, abductive reasoning, observation, imagination, random choice or guessing) to solve the tasks as long as the approach can yield a right answer. Every item as such takes up 5 points, out of the full mark of 150 points of GAOKAO. As already mentioned in section 5.3.7, the pure Euclidean geometric approach prescribed in the Chinese curriculum would not be a time-economic approach to the multiple-choice or fill-in-blank items.

Regarding the contexts of the tasks, we see that all the tasks are situated in a paper-pencil environment, as the task statements are presented on both the 2D slide pages and the paper pages in the book 专题透析 (zhuān tí tòu xī) and students need to write down their solutions on the paper pages with pencils or pens. Regarding the innate support quipped in the tasks, Tasks 1 ~ 12 and 14 ~ 16 are each equipped with a drawing of the 3D figure at stake and possibly a drawing of the 2D figure that can be folded up to the 3D figure. Task 12 is also equipped with a picture of the 3D real object that correspond to the 3D figure in the task. Task 13 is equipped with no specific support.

Characteristics of 3D DGEs

Now we describe the characteristics of the 3D DGEs (GeoGebra files) used in this lesson series. Huang uses five 3D DGEs in total in this lesson series. The first is used to illustrate the differences between a truncated pyramid and a truncated prism, and the other four are used when Huang is explaining tasks 10, 12, 15, 16 in the lesson series.

The first 3D DGE has been presented in Fig. 5.100. Huang simply displays and turns around the 3D dynamic model in GeoGebra, so we don't elaborate the characteristics of the 3D DGE here.

In the second 3D DGE which is used together with Task 10, the figural representation is a 3D dynamic model shown in Fig. 5.107. It incorporates an equilateral triangle and a square which are perpendicular to each other according to the task description, a cube with dotted edges in which the triangle and the square are situated, and the two line segments questioned in the task – one connecting a vertex of the square and the midpoint of a side of the triangle, the other connecting a vertex of the triangle and the center of the square. The tools mobilized in the 3D DGE only include the Dragging tool and the Selecting tool, although the 3D DGE has retained all the GeoGebra tools. Accordingly, Huang's manipulations in the 3D DGE only include turning around the 3D dynamic model and selecting the two line segments at stake to highlight them. There is no specific form of help in the 3D DGE; the difficulty level and pace of learning activities in the 3D DGE are in the teacher's control. There is only innate feedback in the 3D DGE: by dragging the 3D dynamic model around, one can have different views of the model and choose the view allowing to observe the relative position between the two line segments best. Fig. 5.108 shows exactly one of the various views. The 3D DGE is close to the Chinese curriculum because it can support students' perception of the spatial structure of the task figure and illustrate how it can be related to a cube structure, matching the curriculum suggestions of presenting various 3D figures with computer software to help students understand their structural properties of common solids such as prisms, pyramids, truncated prisms and pyramids, and spheres (Ministry of Education of the People's Republic of China, 2003).

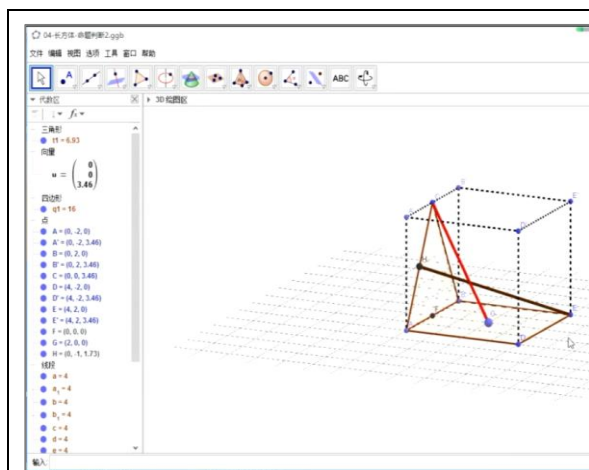


Fig. 5.107 3D dynamic model in the 3D DGE for Task 10

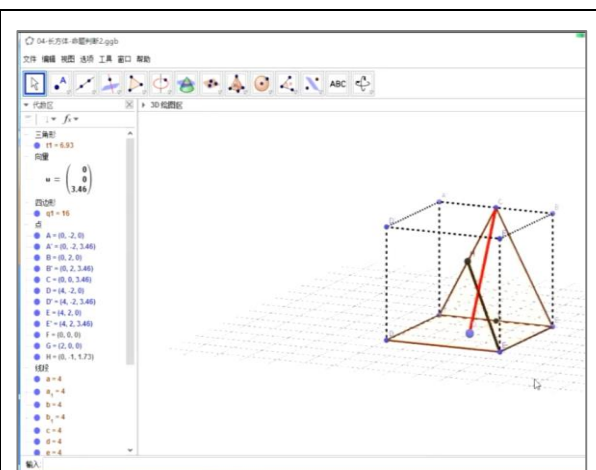


Fig. 5.108 Another view of the 3D dynamic model in the 3D DGE for Task 10

In the 3D DGE for Task 12, the basic figural representation is a 3D dynamic model of a cube (Fig. 5.109) that can be grinded into a sub-object consist of triangles and rectangles (Fig. 5.110). When the rectangles all become squares, the sub-object will become the semi-regular

polyhedron (印信 yìn xìn, shortly noted as YINXIN) mentioned in the task. Another figural representation in the 3D DGE is a plane that passes through eight vertices of the sub-object and cut both cube and the sub-object vertically, as shown in Fig. 5.111. Also, a picture of the real object of YINXIN and a drawing of the semi-regular polyhedron are integrated in to the 3D DGE. The tools mobilized here, besides the Dragging, also include a slider of α (Fig. 5.110) that represents the ratio by which the vertices on every face of the cube are dilated with respect to the center of that face. By dragging the point on the slider α , Huang can “grind” the cube into the sub-object to the extent he would like. This is one of the manipulations Huang conducts in the 3D DGE. Other manipulations include evoking the cutting plane in Fig. 5.111, and dragging the whole 3D dynamic model to turn it around. The feedback in the 3D DGE is the innate feedback in GeoGebra which comes along with the two manipulations: by dragging the point of slider α , one can “grind” the cube and observe the different sub-objects including the semi-regular polyhedron; by evoking the cutting plane and turning around the whole 3D dynamic model, one can have different views of the model and choose the view allowing to observe the sections of the sub-object and the cube best. Fig. 5.112 shows the orthogonal view of the sections which appear as an octagon and a circumscribed square. The form of help and location of control in the 3D DGE are the same as in the previous 3D DGEs. This 3D DGE is close to the curriculum as it can support students’ perception of the animation of a cube being gradually grinded into a semi-regular polyhedron and the sections of the both solids, helping students understand the geometric relationships between the two solids and between their sections. This matches the same curriculum suggestion that has been presented with respect to the 3D DGE for Task 10 in the last paragraph.

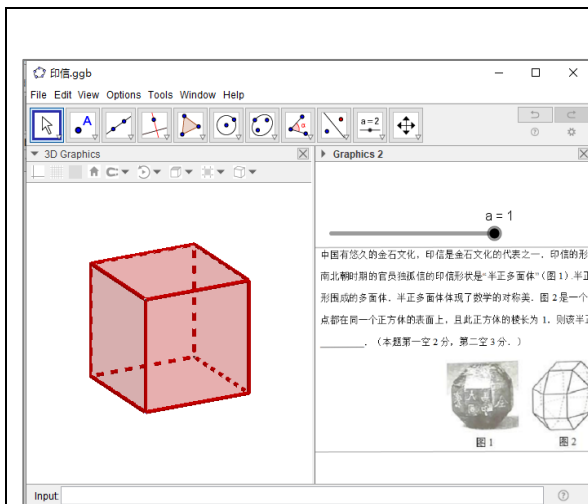


Fig. 5.109 The cube in the 3D DGE for Task 12

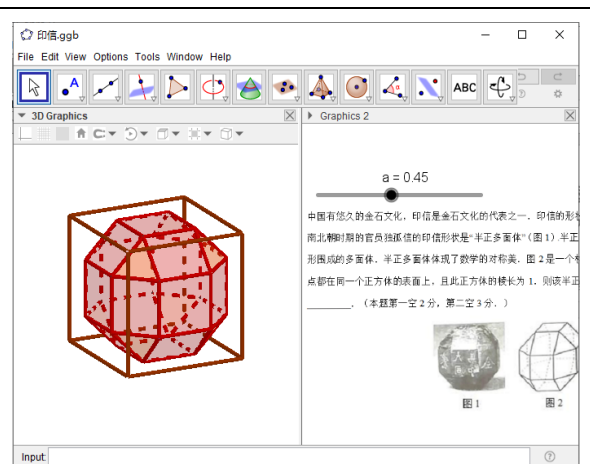


Fig. 5.110 The slider a and the sub-object “grinded” from the cube in the 3D DGE for Task 12

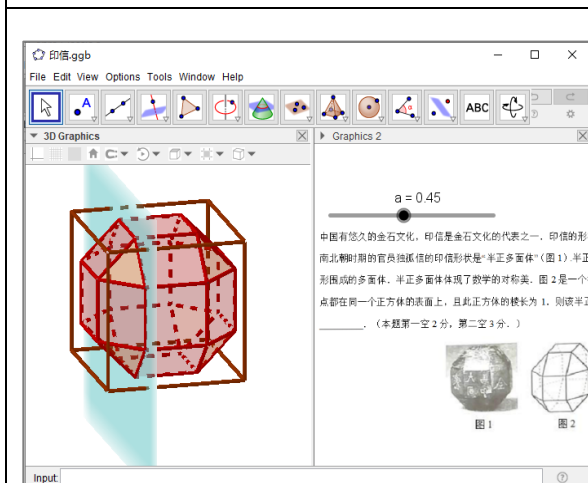


Fig. 5.111 The plane cutting the cube and the sub-object vertically in the 3D DGE for Task 12

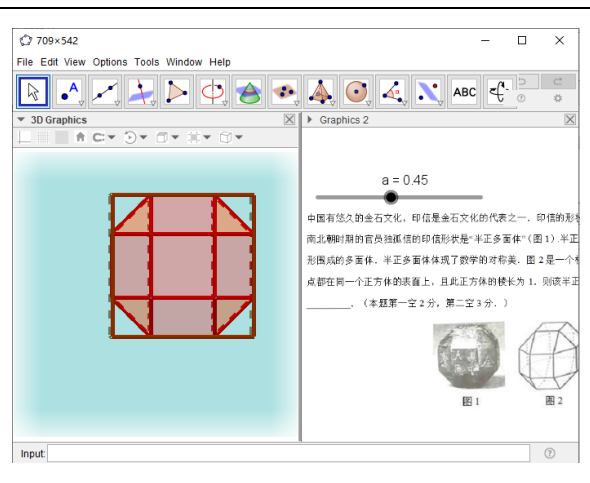


Fig. 5.112 The orthogonal view of the sections of the cube and the sub-object in the 3D DGE for Task 12

In the 3D DGE for Task 15, the basic figural representation is a 3D dynamic model of a rectangular pyramid, as shown in Fig. 5.113. The rectangular pyramid is in the same shape with the pyramid in task 15, and one part of it – the selected triangular pyramid in Fig. 5.113 – fits the pattern of BIENAO and is situated in a cuboid in the 3D DGE. The tools mobilized in the 3D DGE only include the Dragging tool and the Selecting tool, though the 3D DGE has retained all the GeoGebra tools. Accordingly, Huang’s manipulations in the 3D DGE only include turning around the 3D dynamic model and selecting the triangular pyramid or the elements there in to make this part stand out of the whole model. The form of help, the difficulty level and pace of learning activities in this 3D DGE are the same as in the previous 3D DGEs. There is only innate feedback in GeoGebra: by dragging the whole 3D dynamic model around, one can have different views of the model and choose the view allowing to observe best the triangular pyramid within the cuboid. Fig. 5.114 shows one of the different views. The 3D DGE is close to the Chinese curriculum because it can support students’ perception of the spatial structure of the task figure and illustrate how it can be related to the figural pattern of BIENAO

and further a cube; this matches the same curriculum suggestion that has been mentioned with respect to the 3D DGE for Task 10.

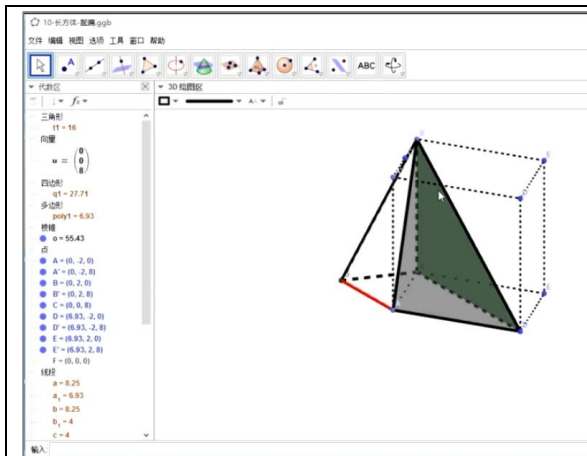


Fig. 5.113 3D dynamic model in the 3D DGE for Task 15

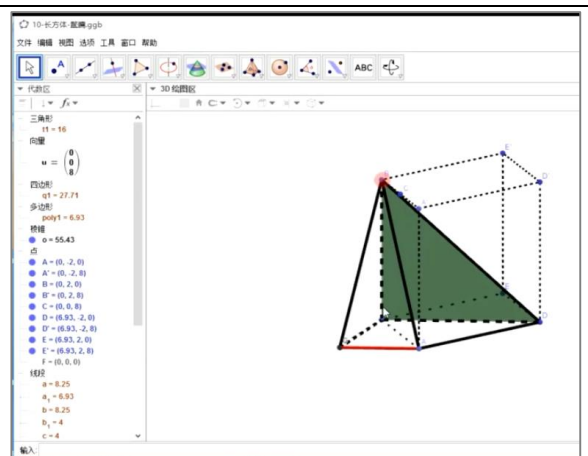


Fig. 5.114 Another view of the 3D dynamic model in the 3D DGE for Task 15

The characteristics of the 3D DGE for Task 16 are generally the same with the 3D DGE for Task 15, except that the 3D dynamic model in the former 3D DGE is directly a triangular pyramid that fits the pattern of BIENAO. It is folded from a rectangle and is further situated in a cuboid in the 3D DGE. The triangular pyramid is in the same shape with the pyramid involved in Task 16. Fig. 5.115 and Fig. 5.116 respectively show two different views of the 3D dynamic model. We don't elaborate the characteristics of the 3D DGE here.

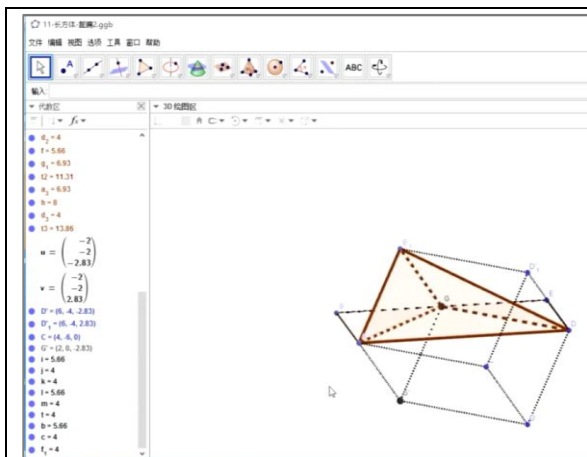


Fig. 5.115 3D dynamic model in the 3D DGE for Task 16

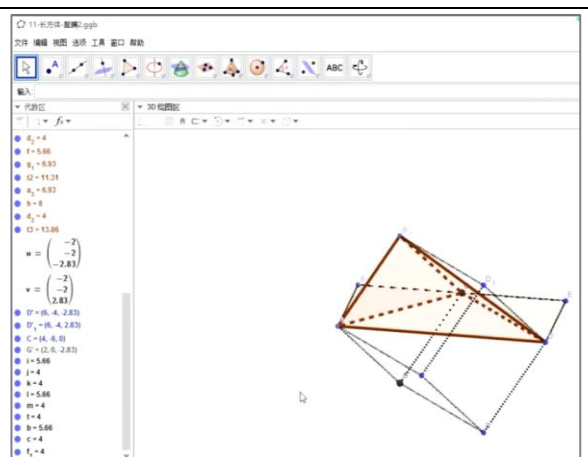


Fig. 5.116 Another 3D dynamic model in the 3D DGE for Task 16

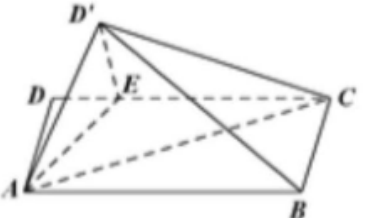
5.4.3 Rules of coordination in Lesson Series H.III

This section presents three groups of rules of coordination and how we have identified them through analysis of argumentation episodes. The three groups of rules of coordination are respectively labeled H.III-A, H.III-B and H.III-C. The argumentation episodes are sorted out from the transcript of the lesson videos. The analysis procedures that lead to these rules of coordination have been introduced in the methodology part (section 4.4.2).

In the actual lesson series, Huang associated every task with a figural pattern and tried to use the conclusions of the figural pattern to solve the task. Therefore, we consider the argumentation around a figural pattern as a part of the whole argumentation around the related task. On that basis, we identify the argumentation episodes in this lesson series and conduct the analysis.

Rule of coordination H.III-A: (1) draw a 2D figure to support students' perception; (2) generalize the conclusion about the particular 2D figure to a 2D figural pattern through inductive reasoning; (3) develop simplified theoretical deductive reasoning to explain the particular or the generalized conclusion

The first example episode related to these rules of coordination concerns a rectangle pattern. It belongs to the whole argumentation around Task 8. Different from the situation in previous lesson series, in this lesson series, the argumentation processes were almost completed by Huang himself. For the convenience of reading, we present Task 8 again here.

Task 8	
<p>Task 8 As shown in the figure, in the rectangle ABCD, $AB=4$, $AD=2$, E is on the side DC, $DE=1$. Fold $\triangle ADE$ up to $\triangle AD'E$ along AE, so that plane $AD'E \perp$ plane ABCE.</p> <p>(1) Please prove: $AE \perp BD'$.</p>	

The whole argumentation started when Huang introduced a drawing of the rectangle pattern, as shown at the bottom of Fig. 1 in the following episode. Through some explanation, He got a geometric conclusion about the rectangle pattern: $DM \perp AC$ (argumentation node). When Huang turned to explain Task 8, he pointed out that rectangle ABCD in the task figure fit the rectangle pattern. He then applied the conclusion about the rectangle pattern and completed the task solving procedures, that was the end of the whole argumentation.

We insert the argumentation node because of the natural division between the discussion around the figural pattern and the discussion around the task. The argumentation process from the beginning and the argumentation node is identified as Episode 1, with the remainder being Episode 2. What we will investigate here is Episode 1 and the following is its transcript.

Episode 1 – T – Task 8
<p>T: OK, another rectangle pattern (Fig. (1)). Teachers might have already mentioned this to you, as what we often see, the ratio of width to length in the rectangle is $1: \sqrt{2}$, we take the midpoint of the AB as M [1-Factual-Data], then these two line segments, DM and AC are perpendicular [2-Claim].</p>

3 专题一：2D Figural Patterns

⑤ Rectangle (square) 【理科19题】

柱 $ABC-A_1B_1C_1$ 中，
 $AC = BC = \frac{1}{2}AA_1$ ， D 是棱 AA_1 的中点，
 $DC_1 \perp BD$

(1) 证明: $DC_1 \perp BC$;
 (2) 求二面角 A_1-BC-C_1 的大小

Fig.1 Huang adds the length of DC and the symbol of perpendicularity in the drawing of the third rectangle pattern

T: We can even go further, let the length be \sqrt{a} , then when we take the a -section point of the AB, I mean here, when the point makes a section of length a on AB (Fig.2) [Factual Data labeled 3], the two internal line segments are also perpendicular [Claim labeled 4]. How to prove it? There must be some students not knowing why. Just use similarity: this big triangle and the small triangle are similar (Fig. 3) [Deductive Warrant 5], and I think you can complete the rest of the proving by yourselves? It's exactly because the two triangles are similar that we can get two perpendicular line segments here.

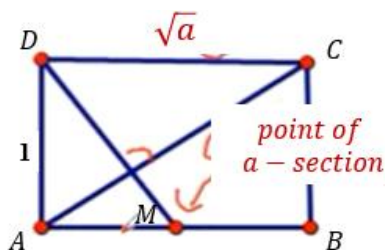


Fig.2 Huang changes the length of DC to a and mark the point of a -section on AB

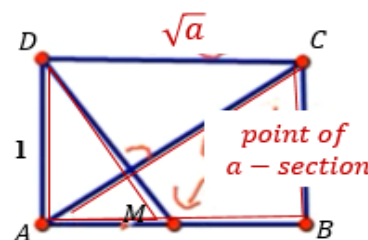


Fig. 3 Huang encircles $\triangle ADM$ and $\triangle BAC$

In this paragraph, we discuss the argumentation components directly contributed by Huang in the episode. After evoking the drawing of the particular rectangle ABCD on the slide (Fig. (1), Huang describes some properties of the figure such as $AD=1$, $DC=2$ and M is the midpoint of AB . These concern the factual information about the rectangle and thus is identified as 1-Factual-Data. The data allows Huang to get the conclusion of $DM \perp AC$, which is identified as 2-Claim. Huang then generalizes the conclusion to any rectangle with the ratio of width to length being $1: \sqrt{a}$ and M being the point of a -section on the side of length; this concerns the factual information about the general rectangle pattern and is identified as 3-Factual-Data. The corresponding conclusion about the figural pattern— DM is also perpendicular to AC —corresponds to 4-Claim. Since the generalization process from 1-Data and 2-Claim to 3-Data

and 4-Claim is an inductive reasoning process, we consider the transition from the former two components to the latter to components is underpinned by an implicit Inductive-Warrant. Huang further explains 4-Claim by the fact that $\triangle ADM$ is similar to $\triangle BAC$ in the figural pattern. The fact is resulted from the properties of the figural pattern (3-Factual-Data) and can lead to the 4-Claim as one of its inferences. The whole process is a deductive reasoning, in which the similarity between $\triangle ADM$ and $\triangle BAC$ and the properties of the similarity serve as a Deductive Warrant (labeled 5) connecting the chain from 3-Factual-Data to 4-Claim. It's worth noting that there still lack some factual data and deductive warrants if we want to rigorously derived 4-Claim from 3-Factual-Data deductively; the deductive reasoning that Huang conducts here is only a simplified one. The argumentation components are integrated into the diagram in Fig. 5.117.

There is no indirect contribution of Huang in this episode, so Huang's direct contributions identified above constitute his coordination behavior in this episode.

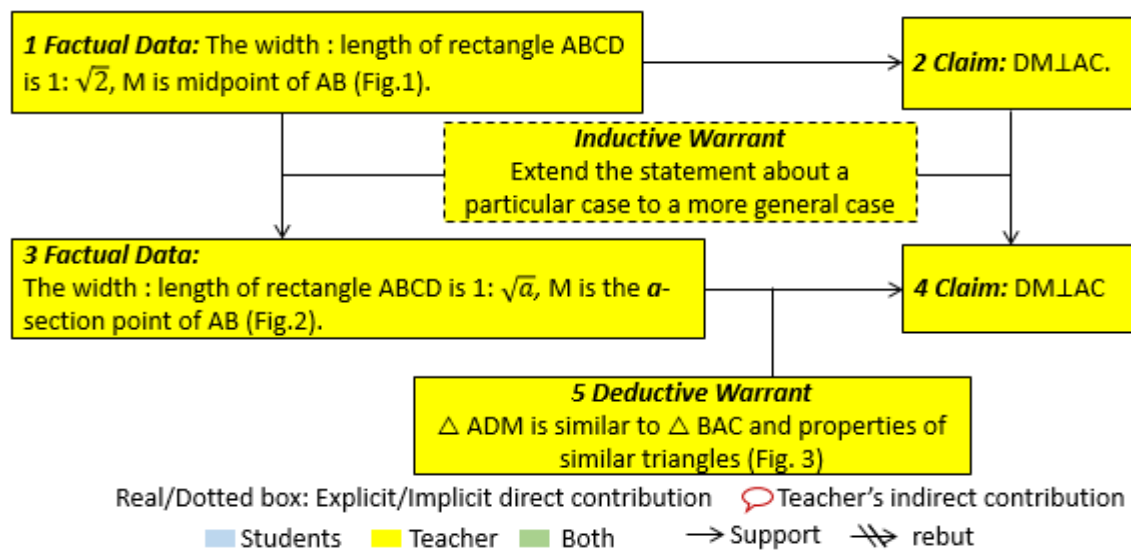


Fig. 5.117 Diagram of argumentation for Episode 1 – T – Task 8

The second example episode related to these rules of coordination concerns a rhombus pattern. It is a part of the whole argumentation around Task 1. The content of Task 1 is presented below.

Task 1	
As shown on the right, in prism $ABC-A_1B_1C_1$, $CA=CB$, $AB=AA_1$, $\angle BAA_1=60^\circ$. (1) Please prove: $AB=A_1C$.	

The whole argumentation started when Huang presented a drawing of the rhombus pattern, as shown at the left-top of Fig. 1 in the episode below. Through some explanation, He got a geometric conclusion about the rhombus pattern (argumentation node). Then Huang turned to explain Task 1. He pointed out that the quadrilateral base ABCD in the task figure fits the

rhombus pattern and then applied the conclusion about the pattern to the task figure. He then developed the following deductive reasoning for solving the task. That was the end of the whole argumentation.

We insert the argumentation node because of the natural division between the discussion around the rhombus pattern and the discussion around the task. The argumentation process from the beginning and the argumentation node is identified as Episode 1, with the remainder being Episode 2. What we will investigate here is Episode 1 and the following is its transcript.

Episode 1 – T – Task 1

T: Next it's a 2D pattern about rhombus, especially when the rhombus has one angle of 60° [1-Factual-Data] like the rhombus ABCD here with $\angle ABC$ equal to 60° . You should pay attention here, how can such a rhombus be cut? we can take the midpoint O of AB and connect O and C [1-Factual-Data], then OC is perpendicular with AB (Fig. (1) [2-Claim], all agree? it's easy to prove it when we consider the properties of the equilateral triangle ABC [3-Deductive-Warrant]. This represents the first rhombus pattern.

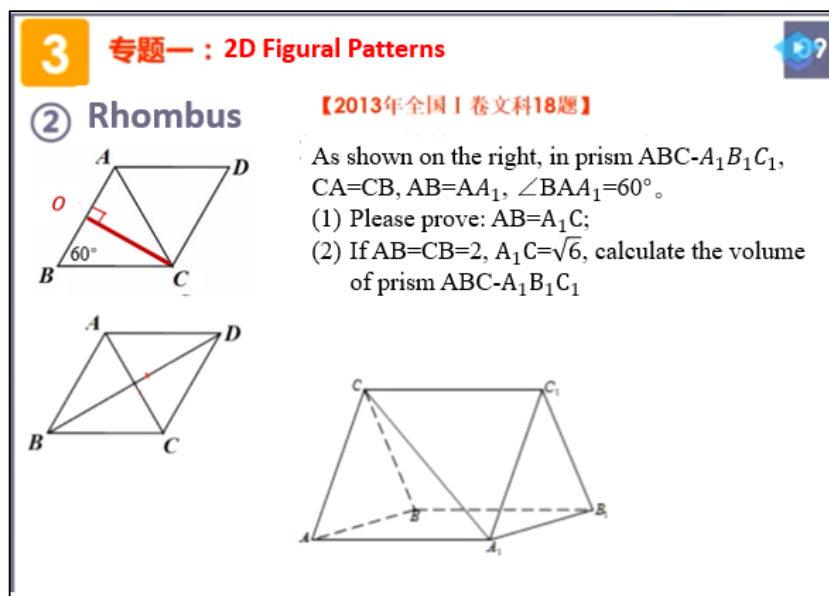


Fig.1 Huang connects C and the midpoint O of AB in the drawing of the first rhombus pattern on the slide

As can be seen, Huang is the single participant of the argumentation, so we only consider the argumentation components directly contributed by him. At the beginning, Huang directly introduce factual information about the general rhombus pattern, indicating that it is a rhombus with an interior angle of 60° ; this is identified as 1-Factual-Data. Then Huang turns to a particular rhombus ABCD on the slide (Fig. 1) and points out that $\angle ABC = 60^\circ$ and O is the midpoint of side AB; these concern the factual information about the particular rhombus and thus are identified as 2-Factual-Data. With the data, Huang derives the conclusion that $OC \perp AB$ (3-Claim), through a simplified deductive reasoning in reference to some properties of equilateral triangle $\triangle ABC$. Although Huang doesn't explain the content of the properties, it's not difficult to know that the properties concern the coincidence of the median and the altitude

of an equilateral triangle. That's why the line connecting C and O (midpoint of AB) could be perpendicular to AB. Also, the fact that $\triangle ABC$ is an equilateral triangle should be a result inferred from the properties of the rhombus in 1-Factual-Data. Therefore, the properties of equilateral triangle $\triangle ABC$ can be identified as a Deductive-Warrant (labeled 4) which connects 2-Factual-Data to 3-Claim. After that, Huang comes back to 1-Factual-Data by saying that the rhombus itself represents a general rhombus pattern. This implies that for any rhombus with an interior angle being 60° and with O being the midpoint of one side of the angle, the side will always be perpendicular to the line that connects O and the other side of the angle—what we identified as an implicit Claim here. The transition from 2-Factual-Data and 3-Claim to 1-Factual-Data and the implicit Claim is an inductive reasoning process in which the conclusion of a particular rhombus is generalized to a rhombus pattern). So we consider the transition is underpinned by an implicit Inductive-Warrant. There are no direct contributions from students or indirect contribution of Huang in this argumentation episode, so Huang's direct contributions mentioned above constitute his coordination behavior in this episode. The direct contributions are integrated into diagram of argumentation in Fig. 5.118.

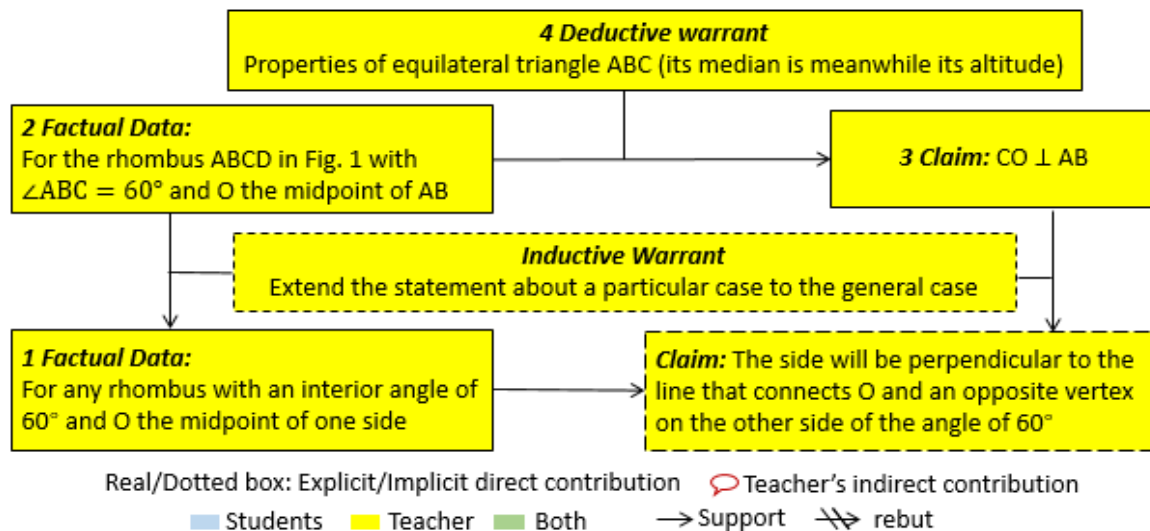


Fig. 5.118 Diagram of argumentation for Episode 1 – T – Task 1

The two argumentation episodes are underpinned by the same basic structure. As the two diagrams of argument (Fig. 5.117, Fig. 5.118) show, they both cover two groups of Factual Data – Claim. The first group concerns the information and the conclusion about a particular figure reflected in the drawing on the slide; the second group concerns the information and the conclusion about a general figural pattern for which the particular figure is one instance. The transition from the first group of Factual Data – Claim to the second group is underpinned by an Inductive Warrant, as this is an inductive reasoning process involving the generalization from a particular figure to a figural pattern. All the components are contributed by the teacher within a distance online teaching setting. He also integrates a Deductive Warrant to one of the two groups of Factual Data – Claim with some immediate Factual Data and Deductive Warrant missing. That means the teacher develops simplified theoretical deductive reasoning to validate either the particular or the generalized conclusion. The same basic structure has been found in the first episode with regard to Tasks 1 ~ 8, where the teacher introduces some conclusions

about a 2D figural patterns which will later be linked to a particular task. We therefore classify the episodes into Group H.III-A, with their basic structure being represented by the general diagram in Fig. 5.119.

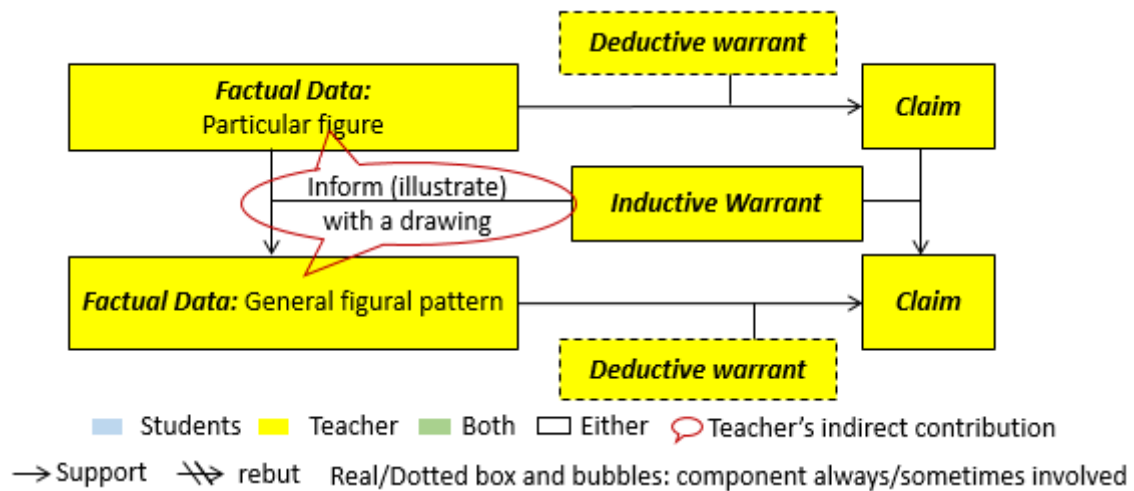


Fig. 5.119 General diagram of argument in the episodes for Group H.III-A

The teacher's contributions to the general diagram mainly include: (1) *informing* the two Factual Data with the *use of a drawing*; (2) directly contributing the Factual Data and the Claim about the particular figure, the Factual Data and the generalized Claim about the general figural pattern, and the Inductive Warrant in support of the connection between the two groups of Factual Data and the Claim; (3) directly contributing the Deductive Warrant to support either of the two Claims above. These contributions correspond to two rules of coordination which are classified into Group H.III-A: (1) draw a 2D figure to support students' perception; (2) generalize the conclusion about the particular 2D figure to a 2D figural pattern through inductive reasoning; (3) develop simplified theoretical deductive reasoning to explain the particular or the generalized conclusion.

Rule of coordination H.III-B: (1) use a 3D DGE and/or a drawing with scaffolding lines to illustrate the task figure and a figural pattern in support of students' perception; (2) apply conclusions about the figural pattern to the task figure based on figure-structural analogy; (3) take the conclusion about the task figure as a fact to develop the following theoretical deductive reasoning

One example episode related to the rules of coordination is the Episode 2 of the argumentation around Task 8. It is the episode after the first example episode in Group H.III-A. As introduced previously, in Episode 2, Huang associated the figure in Task 8 with a rectangle pattern and applied the conclusion about the pattern to solve the task. Below is the transcript of the episode.

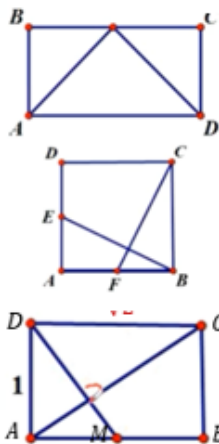
Episode 2 – T – Task 8

T: we mainly look at the next task, this one, I give you some time to think about it. (After 5 seconds)
 Oh I can't give you more time, the lesson is almost over. I just give a brief explanation. Why this task is worth noticing? Look, AB equals 4, AD equals 2, it is a rectangle of 1:2 (Fig. (1), right? **[part of 1-Factual-Data]** Then what point is taken here? Attention here, E is a point on DC so that DE is 1. In fact, everybody, the E, what is it? It's the quartile point of DC, right? **[part of 1-Factual-Data]**

3

2D Figural Patterns

5 Rectangle (square)



As shown in the figure, in the rectangle ABCD, $AB=4$, $AD=2$,

E is on the side DC, $DE=1$. Fold $\triangle ADE$ up to $\triangle AD'E$ along AE, so that plane $AD'E \perp$ plane $ABCE$.

- (1) Please prove: $AE \perp BD'$
- (2) Calculate the volume of pyramid A-BCD'

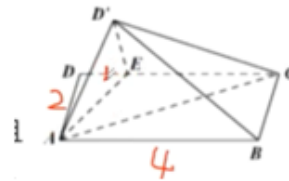


Fig.1 The teacher presents the task on the screen via slide and add annotations to the drawing of the task figure while explaining

T: If you fold the rectangle up, what conclusions can be used? You look at what it requires you to prove? AE is perpendicular to BD' (Fig. 2). What to do? You should be able to react quickly here – connect B and D. Once BD is constructed, it will have an intersection with AE, point O, we can quickly prove that, the plane $D'OB$, represented by the red triangle, is perpendicular to AE, and naturally, BD' is perpendicular to AE [**2-Claim**] (Fig.3).

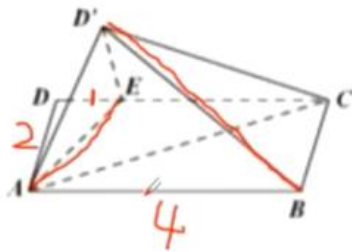


Fig.2 Huang highlights BD' and AE in the drawing of the task figure

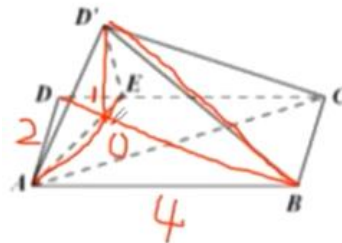


Fig.3 Huang connects BD letting it intersect with AE at O in the drawing of the task figure

T: Why? Try to think about it by yourself? Because here the ABCD at the base fits the rectangle pattern (Fig.4), doesn't it [**3-Claim/Factual-Data**], so there are AE perpendicular to BD [**4-Claim/Factual-Data**]. The perpendicularity keeps what? invariant when the rectangle is folded up [**5-Factual-Data**]. So this task, it is based on what, on this figural pattern (Fig.4). The designer of the task just takes it as the base to create a figure.

3
2D Figural Patterns

⑤ Rectangle (square)

As shown in the figure, in the rectangle ABCD, $AB=4$, $AD=2$, E is on the side DC, $DE=1$. Fold $\triangle ADE$ up to $\triangle AD'E$ along AE, so that plane $AD'E \perp$ plane ABCE.

(1) Please prove: $AE \perp BD$
(2) Calculate the volume of pyramid A-BCD'

Fig. 4 Huang adds a symbol of perpendicularity between BD and AE in in the drawing of the task figure and then encircles the drawing of the third figural pattern

In this paragraph, we discuss the argumentation components directly contributed by Huang, who is the single participant in this episode. After introducing the factual information about rectangle ABCD given in the task such as $AB=4$ and $AD=2$, Huang quickly infers other factual information about the rectangle such as E is a quartile point of DC. The factual information corresponds to the two parts of 1-Factual-Data. With the factual data Huang tells students that they should soon get plane $BOD' \perp AE$, which would allow them to further get $BD' \perp AE$ – the target conclusion to be proved in the task. We identify the two conclusions together as 2-Claim. To justify the claim, Huang firstly points out the fact that $AE \perp BD$ in the task figure (3-Claim), which is further due to the fact that ABCD in the task figure fits the third rectangle pattern on the slide (4-Claim). Here Huang probably refers to the conclusion about the figural pattern, which is $DM \perp AC$, to derive 3-Claim from 4-Claim. As for the 4-Claim, it should be derived from 1-Factual-Data based on the similarities between the geometric structure of the rectangle in the task figure and the geometric structure of the rectangle pattern. In this way, the geometric structure of the rectangle pattern and the conclusion about it serve as an implicit warrant that consistently support the deductive reasoning chain from 1-Factual-Data to 4-Claim, and further to 3-Claim. The warrant is thus a Deductive-Warrant. When Huang gets back to 2-Claim from 3-Claim, he also mentions the fact that the perpendicularity relationship keeps invariant when the rectangle is folded up, which is identified as 5-Factual-Data. The factual data ensures the perpendicularity in a face still exists in the space; it and 3-Claim together constitute the grounds that allows Huang to get 2-Claim through theoretical deductive reasoning. The theorems that Huang refers to for the reasoning are not verbalized, but we can speculate that they are “if a line is perpendicular to two intersecting lines in another plane, the line is perpendicular to the plane”, and “if a line is perpendicular to a plane, it is perpendicular to any line in that plane”. These theorems are identified as an implicit Deductive-Warrant that supports the connection from 3-Claim to 2-Claim.

Huang's indirect contributions to the episode are all related to his own direct contributions, including the supportive action of *informing (illustrating)* 4-Claim, the *use of drawings* on the task figure and the figural pattern (Fig.4), and the *use of a figural pattern*. The last two indirect contributions are also related to the 4-Claim.

The direct and indirect contributions of Huang are integrated into the diagram in Fig. 5.120. These contributions together constitute the coordination behavior of Huang in this episode.

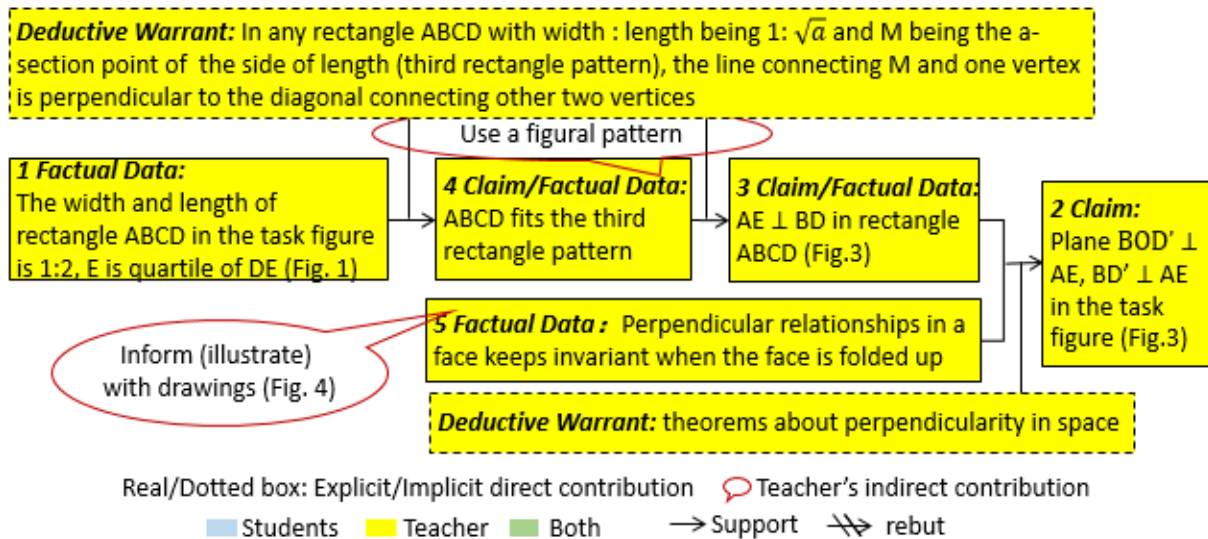


Fig. 5.120 Diagram of argumentation for Episode 2 – T – Task 8

Another example episode related to the rules of coordination is the episode that covers the whole argumentation around Task 12. The task is shown in Fig. 1 in the episode below, and it asks for the number of faces and the edge length of a semi-regular polyhedron called 印信 (yìn xìn, hereafter noted as YINXIN).

The whole argumentation started when Huang associated the task figure, YINXIN, with the figural pattern of cube, but he didn't specifically introduce some conclusions about a cube a priori. Instead, he directly applied some geometric properties of a cube to solve the task, taking the properties as the conclusions students already know. The argumentation ended when Huang draws up an equation about the edge length (defined as an unknown, x) of YINXIN and let students calculate the value of x by themselves. The whole argumentation only concerns how to solve the task at stake so we decide that it only consists of one episode. Below presents the transcript of the episode.

Episode – T – Task 12
T: Look at this task, I give you some time to think about it (Fig. (1)).
T: (After 1 minute) OK, it's easy to say how many faces it has, but why the edge is $\sqrt{2} - 1$ (Fig.1)? So you need to think it over, it's all about a solid cut out of a cube. Here you may need the help of the dynamic model. So let me show you.

1 3D figural patterns

① Application of cuboid

China has a fine tradition of goldstone. 印信 (yìn xìn, a stamper) is a representative of the goldstone culture. The shape of the 印信 of Dokko Shin, an official in the Northern and Southern Dynasties, is a "semi-regular polyhedron" (Figure 1)—a polyhedron consisting of two or more kinds of regular polygons. Figure 2 shows a semi-regular polyhedron with 48, and all of its vertices are on the surface of one cube. The edge length of the cube is 1. Then the semi-regular polyhedron has **26** faces and the length of its edge is $\sqrt{2} - 1$

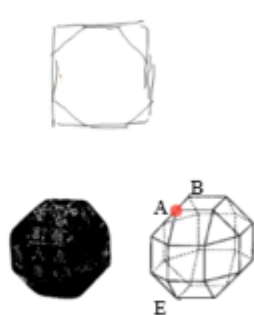


Figure 1 Figure 2

Fig. 1 The teacher first presents the task (with empty blanks) on the screen via PowerPoint slide and then evokes the answers in the two blanks

T: This solid (Fig. 2), since all of its vertices are located on the surface of one cube [1-Factual-Data], we can consider it as an object cut out of a cube. How to cut, just grind off all its corners, to what extent? Until all the faces are squares and triangles, and all the edges are equal (Fig. 3) [2-Claim/-Factual-Data]. You may have watched the Romance of the Three Kingdoms (a TV series adapted from the historical novel with the same name), the 印信 (yìn xìn, hereafter noted as YINXIN) of Sima Yi also looks like this.

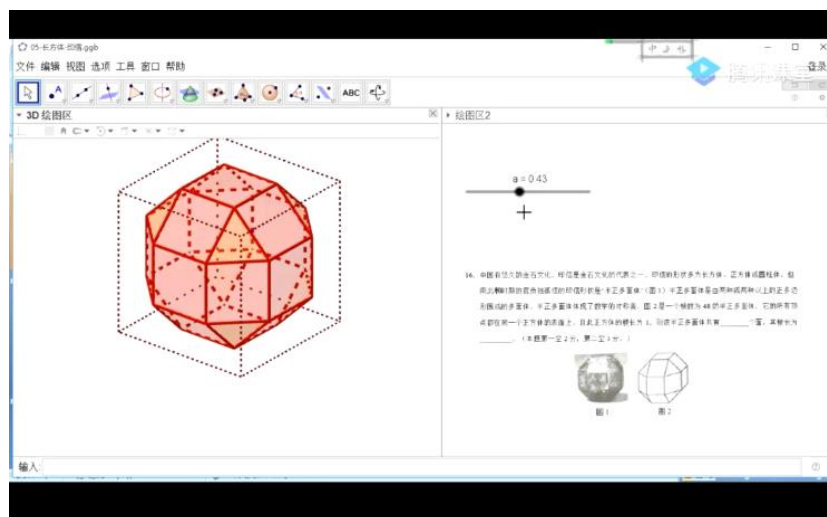


Fig.2 Huang presents the GeoGebra file which includes a 3D dynamic model of YINXIN

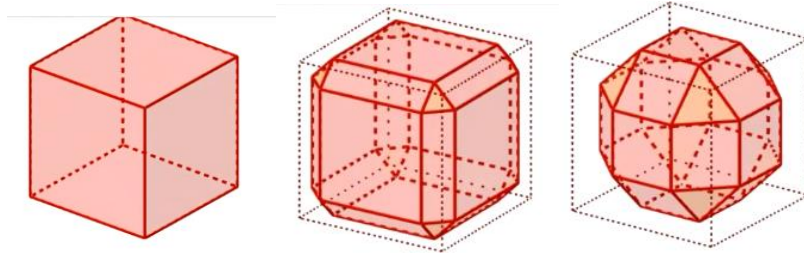


Fig. 3 Huang drags the slider α in GeoGebra showing how a cube is gradually “grinded” into a YINXIN

T: How to calculate the edge length? I believe you already have some idea. It is too simple. Only need to take a plane passing through these points, and use this plane to cut through the cube, getting a square shaped section (Fig. 4). Look, this section, isn't it a octagon embedded in a square with side length of (Fig. 5) [3-Claim/-Factual-Data].

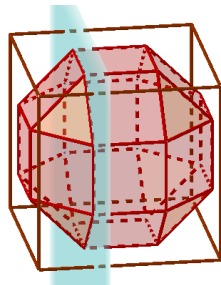


Fig. 4 Huang evokes the plane that cuts through YINXIN in GeoGebra

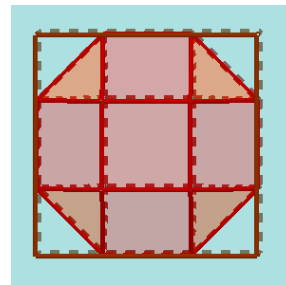


Fig.5 The teacher rotates the dynamic model to show an orthogonal view of the section

T: So back here, it's just cutting the cube from this point, this point and the point below, and after that the section will be like this (Fig. 6) [echoing 3-Claim/-Factual-Data], right?

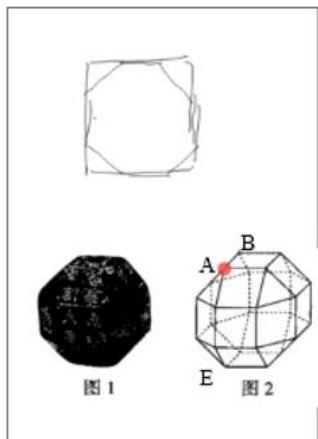


Fig. 6 Huang comes back to the initial slide, point at A, B, E in the drawing of YINXIN and then draws the section of YINXIN cut by plane ABE on the same slide

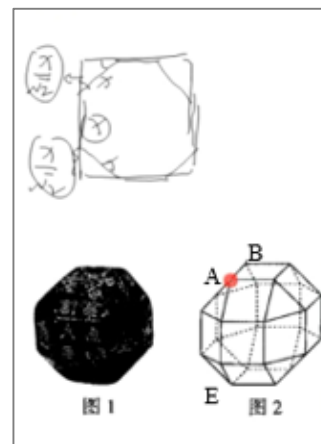


Fig. 7 Huang annotates the supposed lengths of edges on the section of YINXIN on the slide, and then circles the lengths of the three edges related to one side of the square

T: On this basis, I can assume the edge length as x , and all these edges are x . Then because there are isosceles right triangles, this line segment is $\frac{x}{\sqrt{2}}$. The sum of the three line segments (Fig.7) is just

the edge length of the cube, which is 1 [4-Factual-Data], so we get an equation about x , $x + \frac{x}{\sqrt{2}}$ + $\frac{x}{\sqrt{2}} = 1$ [5-Claim], right? Then you can solve the equation easily. In a word, it's very common in the examination items that, a cuboid is cut into some sub-object and then the items question about the properties of the sub-object.

We firstly consider the argumentation components directly contributed by the single participant in the episode, Huang. After introducing some factual information about the figure (YINXIN) in the task (1-Factual-Data), Huang soon gets the conclusion that the semi-regular polyhedron YINXIN can be associated with the pattern of cube (2-Claim); Huang draws this conclusion probably according to the geometric structural similarities between YINXIN and the pattern of cube suggested in the task – all the vertices of YINXIN fall on the surface of one cube. Based on 2-Claim, Huang further gets the conclusion that a section of YINXIN and its circumscribed cube can be an octagon being inscribed in a square (3-Claim); here he probably applies the conclusions about properties of sections of a cube and its sub-object. The inference from 1-Factual-Data to 2-Claim and then to 3-Claim can be seen as a deductive reasoning, in which the conclusions about a cube are applied to a semi-regular polyhedron that can be situated in the pattern of cube. Therefore, the geometric structural similarities between the polyhedron and the pattern of cube and the conclusions about the latter can be identified as an implicit Deductive-Warrant; it consistently supports the connection from 1-Factual-Data to 2-Claim and to 3-Claim. Huang also uses a 3D DGE (the GeoGebra file) to show students the animation of a cube being grinded and the orthogonal view of a section of the composite solid of YINXIN and the cube; this could provide perceptive illustration for 2-Claim and 3-Claim. According to 3-Claim, Huang makes a drawing of YINXIN (a regular octagon) within a square on the slide and begins to study the side length of the octagon in the plane environment. With the fact that the edge length of the cube is 1 (5-Factual-Data), Huang gets the equation which shows the relationship between the side lengths of the octagon and the circumscribed square: $1 = x + \frac{x}{\sqrt{2}}$

+ $\frac{x}{\sqrt{2}}$ (6-Claim). Here Huang probably refers to properties of a square (all sides are equal and all interior angles are of 90°), properties of a regular octagon (all sides are equal), and properties of an isosceles right triangle (the ratio of side lengths is $1 : \frac{1}{\sqrt{2}} : \frac{1}{\sqrt{2}}$). These geometric properties of polygons can be identified as an implicit Deductive-Warrant that supports Huang's deductive reasoning from 3-Claim and 5-Factual-Data to 6-Claim. All these argumentation components are integrated into the diagram of argument in Fig. 5.121. The 2-Claim and 3-Claim, as the endpoint of the precedent chain of argument, also serve as the factual premises for the subsequent chain of argument, so they are both identified as Factual-Data.

Secondly, we discuss Huang's indirect contributions to the argumentation in this episode. The indirect contributions are all related to his own direct contributions, including the supportive action of *informing (illustrating)* 2-Claim with the *use of a 3D DGE* (Fig. 2 ~ 3), the *use of a figural pattern* (cube) in 2-Claim, and the supportive action of *informing (illustrating)* 3-Claim with the *use of a 3D DGE and a drawing* (Fig. 4 ~ 6). The indirect contributions are also

integrated into the diagram in Fig. 5.121. The direct and indirect contributions together constitute the coordination behavior of Huang in this episode.

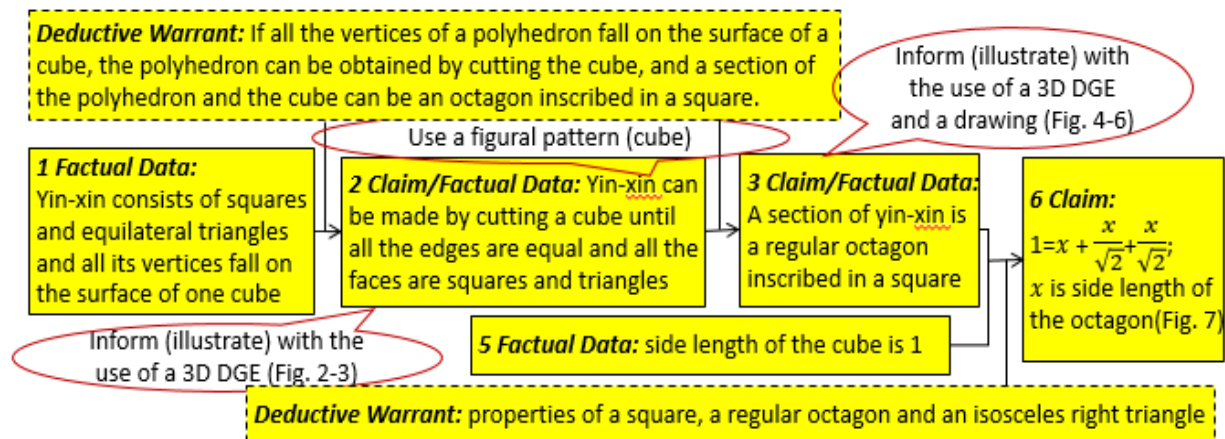


Fig. 5.121 Diagram of argumentation for Episode – T – Task 12

Three consecutive chains of Factual Data – Deductive Warrant – Claim, in which there are two intermediate Claims that also exist as intermediate Factual Data and one final Claim. This is different from the episodes of Group H.III-A that include two separate groups of Factual Data–Claim and the two groups are connected by an Inductive Warrant. In the two episodes here, the First two chains are consistently underpinned by the same Deductive Warrant, which concerns the similarities between the geometric structure of the task figure and the geometric structure of a particular figural pattern (shortly called “figure-structural” analogy). Guided by this warrant and based on the factual information about the task figure (first Factual Data), Huang derives that the task figure fits a particular pattern (first intermediate Claim) and further applies the conclusion about the figural pattern to the task figure, getting a conclusion about the task figure (second intermediate Claim). The intermediate Claim then serves as the Factual Data in the third chain of Factual Data – Deductive Warrant – Claim; the deductive warrant here concerns general 2D/3D geometric theorems in Euclidean geometry system and the final Claim concerns the conclusion that allows students to finally solve the task. That means, Huang directly takes the conclusion about the task figure as a factual premise to develop the following theoretical deductive reasoning for solving the task. The teacher also uses a 3D DGE and/or drawings to illustrate the first and/or the second intermediate Claims, supporting students’ perception of the figure-structural similarities between the task figure and the figural pattern. The same structure has also been found in the second episode in the argumentation around Tasks 1 ~ 8 and the episodes around 9 ~ 13, in which Huang focuses on the solving of a particular task. These episodes are classified into Group H.III-B, with their common basic structure represented by the general diagram in Fig. 5.122.

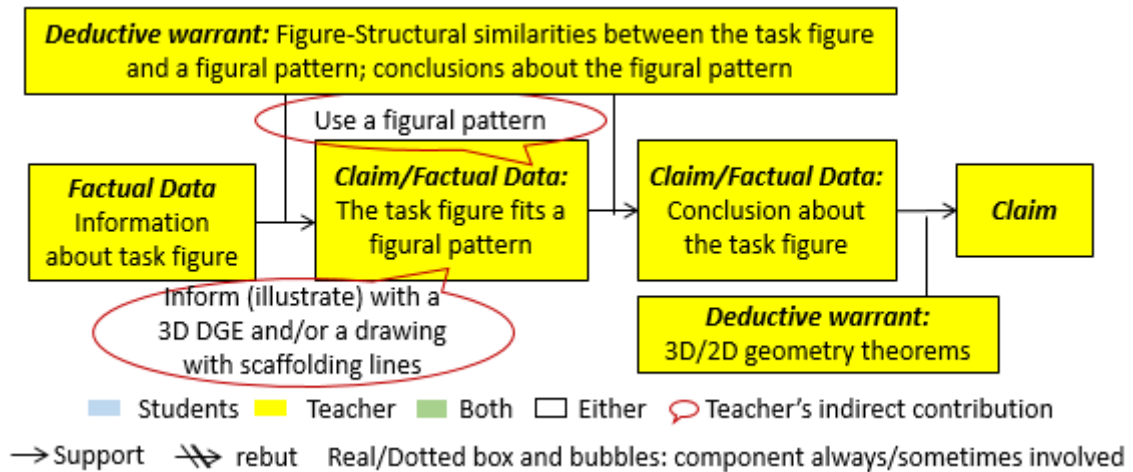


Fig. 5.122 General diagram of argument for the episodes of Group H.III-B

Huang's contributions reflected in the general diagram can be divided into three groups: (1) *informing* (illustrating) the two intermediate Claims with the *use of a 3D DGE and/or a drawing with scaffolding lines* (2) directly contributing the Factual Data, directly contributing the two intermediate Claims in *reference to a figural pattern*, and directly contributing the Deductive Warrant about the figural structural similarities between the task figure and a figural pattern; (3) directly contributing the final Claim and the Deductive Warrant concerning theorems in 3D/2D Euclidean geometry. In terms of “perception” and “logical reasoning”, these contributions can be reformulated as three rules of coordination, which are grouped into Group H.III-B: (1) use a 3D DGE and/or a drawing with scaffolding lines to illustrate the task figure and a figural pattern in support of students' perception; (2) apply conclusions about the figural pattern to the task figure based on figure-structural analogy; (3) take the conclusion about the task figure as a fact to develop the following theoretical deductive reasoning.

Rules of coordination H.III-C: (1) develop theoretical deductive reasoning for solving the task with no reference to any figural pattern and use a drawing to support students' perception of the 3D task figure; (2) relate the 3D task figure with a 3D figural pattern based on figure-structural analogy; (3) use a 3D DGE and/or scaffolding lines to illustrate the link of the task figure with the figural pattern;

The first example argumentation episode related to these rules of coordination is the Episode 1 of the argumentation around Task 15. The argumentation was produced only by teacher Huang. The task is shown in Fig. 1 in the episode below; it asks students to prove $BC \parallel \text{plane PAD}$ within the pyramid P-ABCD.

The whole argumentation started when Huang began to explain Task 15. During the process, Huang firstly derived that $\angle PCD$ in the task figure is 90° and then linked the conclusion about the task figure with the conclusion about a figural pattern 鳖臑 (BIENAO) (argumentation node). With the conclusion of $\angle PCD = 90^\circ$ and other given information, Huang finally proved $BC \parallel \text{plane PAD}$ as requested by the task. That was the end of the argumentation.

We insert the argumentation node because of Huang's words “Now come back to the task, in the right $\triangle PCD$, we can use $\tan \angle DPC \dots$ ”. The argumentation process from the beginning to the argumentation node is identified as Episode 1, with the rest identified as Episode 2. What

we study here is Episode 1 and below is its transcript. Episode 2 only concerns algebraic and numeric calculation and will not be studied in this thesis.

Episode 1 – T – Task 15

T: Then look at this task. This figure, it implies a pattern of BIENAO, I am not sure if you've discovered it while solving the task yourself. As introduced here, $\triangle ABC$ is an equilateral triangle, we can determine its side as $PA=2AB=2$. AB, BC, AC are all 1. Besides, the tangent of $\angle DPC$ is given, we need to prove BC is parallel to PAD . Also, there is a right angle here, AC and CD are perpendicular (Fig.1).

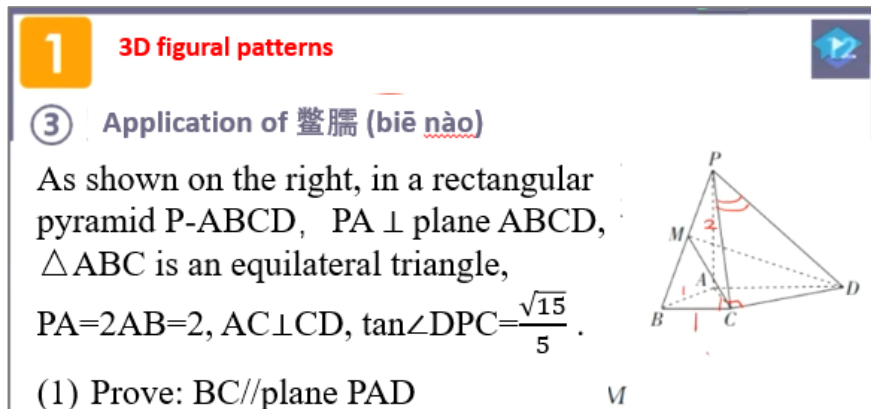


Fig. 1 Part of the slide in which the task at stake is presented (translated by the researcher from Chinese to English)

T: After reading the text, you may be a little confused. What the base actually is. Since the data – $\tan \angle DPC$ – needs to be used. So first we have to prove that CD is perpendicular to PC [1-Claim]. This is quite easy. Because PA is perpendicular to plane $ABCD$ so it must be perpendicular to CD [part of 2-Factual-Data]. As CD is also perpendicular to AC [part of 2-Factual-Data], and then it's obvious that CD is perpendicular to PAC [3-Claim], and I'll soon get $CD \perp PC$, $\angle PCD$ is 90° [echoing 1-Claim].

T: What do I want to say here? I want to say that there is a BIENAO implied in this figure, I don't know if you have identified it. Here, it is the BIENAO (Fig. 2) [4-Claim], as there are PA perpendicular to ACD , and CD perpendicular to AC [echoing 2-Factual-Data], right?

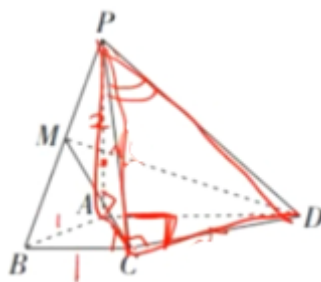


Fig. 2 Huang highlights the part in the task figure that fits pattern of BIENAO

T: Well let's look at it in GeoGebra (*opening the GeoGebra file and share it on the screen*, Fig.3). It's something like this. The task says that the red line segment should be parallel to the green plane, right? The figure in the task is probably viewed from this direction (*moving the 3D dynamic model to the perspective in Fig. 4*), and we need to identify where is the BIENAO, just the green surface

and the blue point, on which my mouse is hovering (Fig. 4). Around the blue point there is a right angle, so the whole pyramid constitutes a BIENAO [echoing 4-Claim]. I put it in a cuboid so that it is more obvious for you.

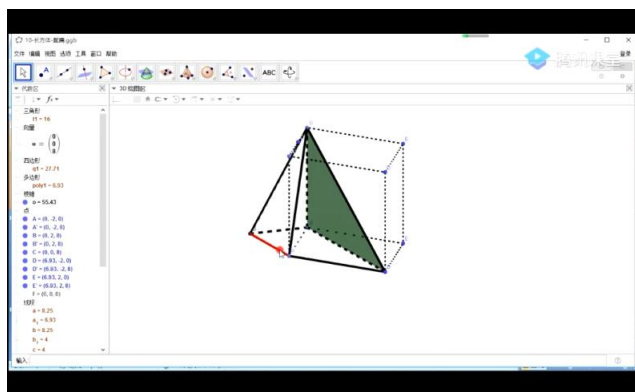


Fig. 3 The GeoGebra file presented on the screen

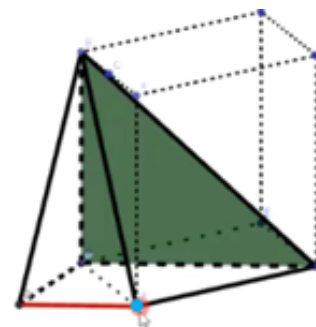


Fig. 4 Another perspective of the 3D dynamic model in GeoGebra

T: So (back to the slide in Fig. 2), the figure in the task is actually a BIENAO with a triangular pyramid alongside, right? In this BIENAO, what conclusion can we derive? $CD \perp$ plane PAC [echoing 3-Claim], which will allow us to derive that $CD \perp PC$, OK. Figural patterns like this are used quite often in solving 3D geometry tasks, you'd better accumulate more of these things. Now come back to the task, in the right $\triangle PCD$, we can use $\tan \angle DPC \dots$

We firstly consider the argumentation components directly contributed by the single participant in the episode, teacher Huang. After introducing some factual information about the figure in the task – pyramid P-ACD, Huang proposes a conclusion: $CD \perp PC$ (1-Claim). He then points out the particular factual information he uses to support the claim, including $PA \perp$ plane ABCD, $PA \perp CD$, and $CD \perp AC$; this is the 2-Factual-Data. Based on the data, Huang derives that $CD \perp$ plane PAC (3-Claim), probably referring to the geometric theorem “if a line is perpendicular to two intersecting lines in another plane, then it is perpendicular to the plane”. The 3-Claim is exactly what allows Huang to get the target 1-Claim; although Huang doesn’t verbalize the geometric theorem referred to here, we can speculate it is “if a line is perpendicular to a plane, then the line is perpendicular to any line in the plane”. The inferring process from 2-Factual-Data to 3-Claim and then to 1-Claim is actually a theoretical deductive reasoning process in reference to two geometric theorems, which are identified as an implicit Deductive-Warrant. Later on, Huang claims that pyramid P-ACD in the task fits the figural pattern of BIENAO (4-Claim), and supports the claim by repeating the structural properties of pyramid P-ACD in 2-Factual-Data. Obviously, it is because of the geometric structural similarities between the pyramid P-ACD and the figural pattern BIENAO that Huang links the 2-Factual-Data to the 4-Claim. Starting from 4-Claim, Huang derives again the 3-Claim which concerns a perpendicular relationship in pyramid P-ACD, and it is probably according to some conclusions about perpendicular relationships in the pattern of BIENAO. The inference from 2-Factual-Data to 4-Claim and then back 3-Claim is actually a deductive reasoning process, in which some conclusions about the pattern of BIENAO is applied to the task figure P-ACD that fits the pattern. Therefore, the geometric structural similarities between P-ACD and the pattern of BIENAO and the conclusions about the latter can be identified as an implicit Deductive-

Warrant; it consistently supports the connection from 2-Factual-Data to 4-Claim and then to 3-Claim. All these argumentation components are integrated into the diagram of argument in Fig. 5.123. The 4-Claim and 3-Claim, as intermediate claims, are meanwhile identified as Factual-Data.

Huang's indirect contributions to this episode are all related to his own direct contributions, including the supportive action of *informing* (illustrating) 4-Claim with the *use of drawings and a 3D DGE*, as shown in Fig. 2 and Fig. 3-4 respectively. The contributions also include the *use of a figural pattern* (BIENAO) together with 4-Claim. The indirect contributions are also integrated into the diagram in Fig. 5.123. The direct and indirect contributions together constitute Huang's coordination behavior in this episode.

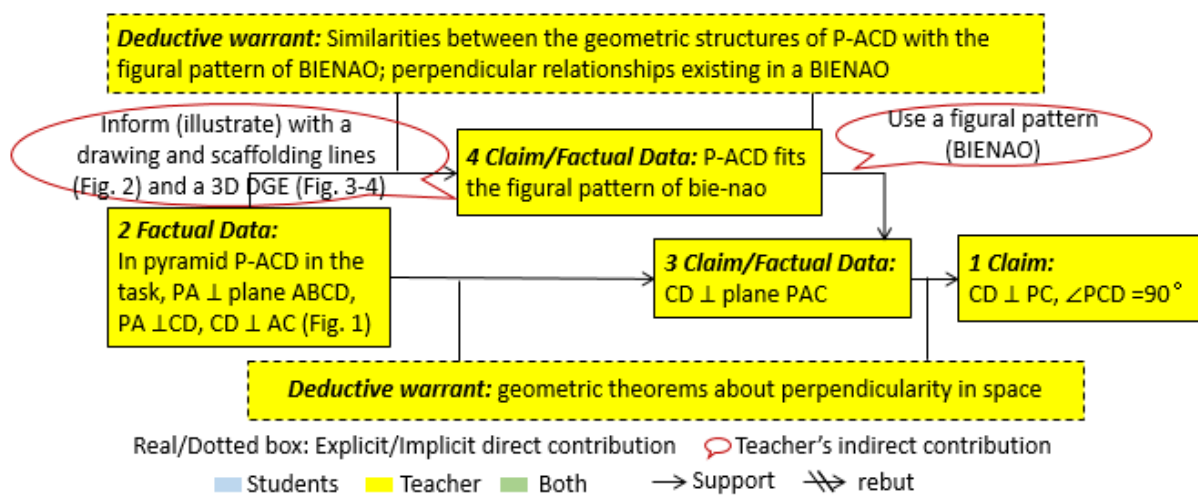


Fig. 5.123 Diagram of argumentation for Episode 1 – T – Task 15

Another example episode related to the rules of coordination is the episode that constitutes the whole argumentation around Task 14. The task is shown in Fig. 1 in the episode below, it asks students to prove MN//plane SDC within the pyramid S-ABCD.

The whole argumentation started when Huang began to explain Task 14. During the process, Huang firstly derived that MN//plane SDC in the pyramid S-ABCD, and then linked the task figure S-ABCD with a conclusion about the figural pattern YANGMA. The whole argumentation only concerns how to solve the task at stake so we decide that it only consists of one episode. Below is the transcript of the episode.

Episode – T – Task 14

T: Okay, move on. As I said just now, apart from the pattern of cuboid, there are other 3D figural patterns such as 阳马 (yáng mǎ, hereinafter noted as YANGMA), 墙角 (qiáng jiǎo, hereinafter noted as QIANGJIAO). Let's look at how these patterns can exist in short-essay tasks. For example, this task, you may feel it quite simple. Here we need prove MN and plane SDC are parallel. From the information given in the task, we know CD equals 2AD, AB and AD are equal, if AB is 1, AD is 1, then DC should be 2, and SD is also 2. N and M are respectively the midpoints of SA and BC (Fig. (1) [part of 1-Factual-Data]).

1 3D figural patterns

② Application of 阳马(yáng mǎ)、墙角(qiáng jiǎo)

As shown in Fig.1, in a rectangular pyramid S-ABCD, $SD \perp \text{plane } ABCD$, $AB \parallel CD$, $AD \perp CD$, $SD = CD$, $AB = AD$, $CD = 2AD$, M is the midpoint of BC, N is the midpoint of SA.

(1) Prove that $MN \parallel \text{plane } SDC$

Fig. 1 Huang presents the task on the slide (translated by the researcher from Chinese to English) and makes annotations to the drawing of pyramid S-ABCD while introducing the task

T: So how do we prove that MN is parallel to plane SDC? The answer is given this way: to prove the parallelism of two planes. Take the midpoint Q of AD [part of 1-Factual-Data], then NQ and MQ are parallel to SD and CD respectively (Fig.2) [2-Claim]. Then, with the parallel planes NQM and ADC [3-Claim], we can prove MN is parallel to SDC [4-Claim].

T: In fact, what I want to say, is that this figure is related to YANGMA [5-Claim]. How can I decide this? As long as we complete it a little, I mean, construct a rectangular pyramid whose rectangular base covers the base ABCD [part of 6-Deductive-Warrant]. Since the rectangular base is also perpendicular to SD [part of 1-Factual-Data], we get a YANGMA. It is further situated in a cuboid (Fig. 3).

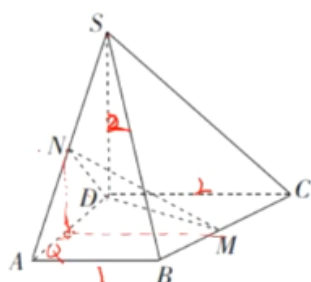


Fig. 2 Huang draws NQ and QM on the drawing of pyramid S-ABCD

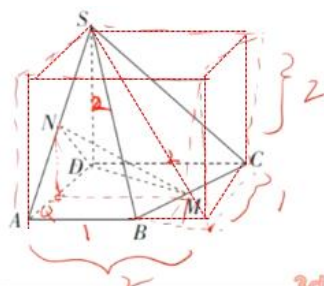


Fig. 3 Huang draws a rectangular pyramid and then a cuboid on pyramid S-ABCD

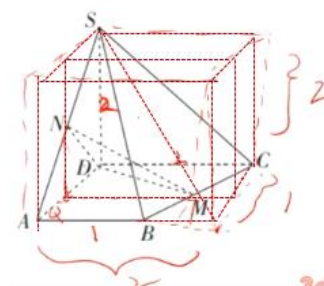


Fig. 4 Huang draws a section of the cuboid cut by plane NQM

T: It's actually about the parallelism between plane NQM and plane SDC, right? We use plane MNQ to cut the whole cuboid (Fig. 4), getting a middle section of the cuboid that passes through the midpoints of the four parallel edges. The middle section must be parallel to the back face [part of 6-Deductive-Warrant], then NM, as one line in the section, is also parallel to the back face [echoing 4-Claim], OK? The conclusion is quite natural. This is the pattern of YANGMA; it is further situated in a cuboid.

We firstly consider the argumentation components directly contributed by the single participant in the episode, Huang. After introducing some factual information about the task figure – pyramid S-ABCD (part of 1-Factual-Data), Huang constructs midpoint Q of AD (another part of 1-Factual-Data) and proposes the conclusion of $NQ \parallel SD$ and $MQ \parallel CD$ (2-Claim). The process of getting 2-Claim can be seen as a theoretical deductive reasoning, in which Huang probably refers to the geometric theorem “the mid segment of a triangle which joins the midpoints of two sides of the triangle is parallel to the third side of the triangle”. Hence we identify the theorems as an implicit Deductive-Warrant. Starting from 2-Claim, Huang further gets the conclusions of Plane NQM//plane SDC (3-Claim) and $NM \parallel$ plane SDC (4-Claim); the process is supposed to be a theoretical deductive reasoning process, in which Huang probably refers to the theorems “if two intersecting lines in one plane are respectively parallel to two intersecting lines in another plane, then the two planes are parallel”, and “if two planes are parallel, then any line in one plane is parallel to the other one”. The theorems are thus identified as an implicit Deductive-Warrant. Later on, Huang claims that pyramid S-ABCD in the task can be situated in the figural pattern of YANGMA which is further situated in a cuboid (5-Claim), mentioning that the rectangular base of YANGMA can overlap with the base ABCD which is perpendicular to SD. In this way, Huang connects the perpendicularity between SD and the base ABCD mentioned in 1-Factual-Data to 5-Claim, by focusing on the geometric structural similarities between pyramid S-ABCD and the figural pattern of YANGMA (plus a cuboid). Huang also uses drawings (Fig.3) to illustrate the link between pyramid S-ABCD and the figural pattern, providing perceptive illustration for 5-Claim. From the 5-Claim, Huang derives again the 4-Claim which concerns a parallel relationship in pyramid S-ABCD, and it is according to some conclusion about parallelism in the figural pattern – the middle section is parallel to the back face of a cube. The inference from 1-Factual-Data to 5-Claim and then back 4-Claim is actually a deductive reasoning process, in which some conclusion about the figural pattern of YANGMA and cuboid is applied to the task figure S-ABCD that fits the figural pattern. Therefore, the geometric structural similarities between S-ABCD and the figural pattern and the conclusions about the latter are identified as a Deductive-Warrant (labeled 6); it consistently supports the connection from 1-Factual-Data to 5-Claim and to 4-Claim. All these argumentation components are integrated into the diagram of argument in Fig. 5.124. The 2-Claim, 3-Claim and 5-Claim, as intermediate claims, are meanwhile identified as Factual-Data.

Secondly, we discuss Huang’s indirect contributions to the argumentation of this episode. The indirect contributions are all related to his own direct contributions, including the supportive action of *informing* 5-Claim with the *use of drawings* (Fig. 3) and *informing* 3-Claim with the *use of drawings* (Fig. 4). The contributions also include the *use of a figural pattern* (YANGMA and cuboid) in 5-Claim. The indirect contributions are also integrated into the diagram in Fig. 5.124. The direct and indirect contributions together constitute Huang’s coordination behavior in this episode.

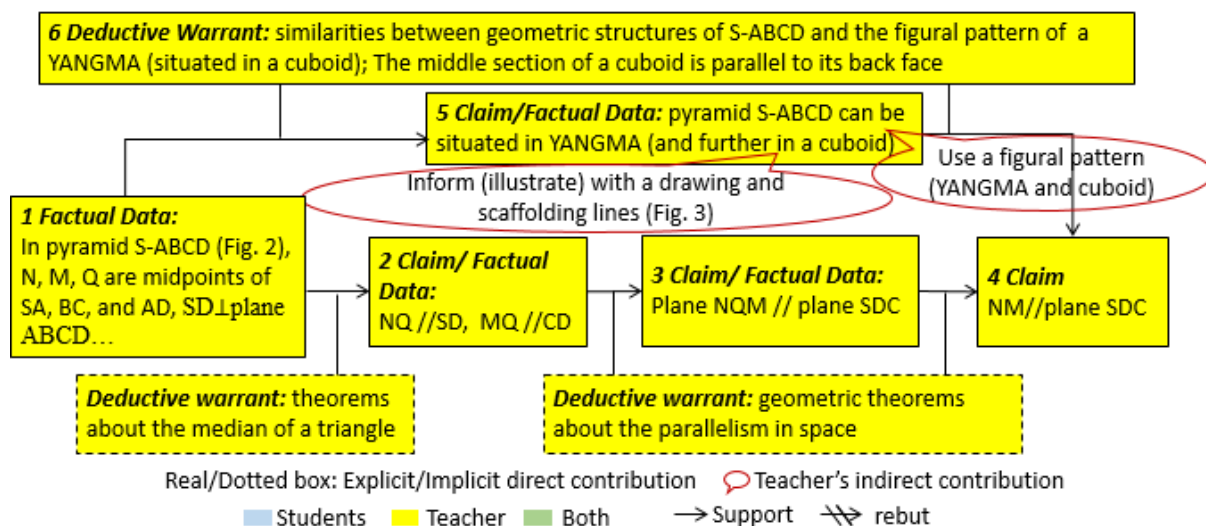


Fig. 5.124 Diagram of argumentation for Episode – T – Task 14

The two argumentation episodes modeled by the diagrams in Fig. 5.123 and Fig. 5.124 are underpinned by the same basic structure. Both of them involve a chain of Factual Data – Deductive Warrant – Claim contributed by the teacher. The Factual Data concerns factual information about the task figure; the Deductive Warrant is made of geometric theorems in 2D/3D Euclidean geometry; the Claim concerns some conclusion about the task figure. When the Claim itself constitutes the answer to the task, the Claim is just the final Claim of that episode; if not, Huang will derive a second Claim that really concerns the task answer, through another Deductive Warrant which concerns Euclidean geometric theorems. The whole chain corresponds to a general theoretical deductive reasoning about the task figure and the task solution without the involvement of a figural pattern. After that, Huang connects the beginning Factual Data to an “intermediate” Claim which indicates the link between the task figure and the figural pattern; the “intermediate” Claim then serves as a Factual Data allowing Huang to draw the same Claim about the task figure in the first chain. The connection is consistently supported by a Deductive Warrant that concerns the structural similarities between the task figure and the figural pattern (shortly called “figure-structural” analogy). That is, Huang links the task figure with a figural pattern and applies some conclusions about the pattern to get the same conclusion about the task figure as before. The main difference of the two episodes here from the previous episodes is that the general theoretical deductive reasoning about the task figure and task solution is developed independently from the theoretical deductive reasoning involving a figural pattern. The same basic structure has also been found in the episode around Task 16. We therefore classify all the related episodes as Group H.III-C, with their common basic structure being represented by the general diagram in Fig. 5.125.

	[2] For any rhombus with an interior angle of 60° and the midpoint of one side of 60° being named O, the segment with O will be perpendicular to the segment which connects O and the opposite vertex on the other side of 60° .
	[3] In a kite, one diagonal is the perpendicular bisector of the other diagonal.
	[4] In a parallelogram with one interior angle of 60° and the ratio of length of the two sides of 60° is 1:2, one diagonal is perpendicular to one pairs of opposite sides.
	[5] If the ratio of the height of a trapezoid to its upper side to its lower side is 1:1:2, the trapezoid can be considered as consist of two isosceles right triangles.
	[6] If the ratio of width to length of a rectangle is $1:\sqrt{a}$ and M is the a-section point of the side of length, the segment connecting M and the closer opposite vertex of the rectangle is perpendicular to the diagonal of the rectangle which doesn't pass through the previous vertex.
	[7] Properties of an isosceles triangle (including right isosceles triangle, equilateral triangle, etc.).
	[8] Properties of similar triangles.
	[9] Properties of a right triangle (including Pythagorean theorem).
	[10] The essence of a figural pattern resides in its geometric structure (geometric relationships between lines and planes therein).
PCOI	[11] Drawings are enough for supporting students' perception with respect to 2D figural patterns.
	[12] We only need to clarify some key points for students but not elaborate every piece of mathematics knowledge in the second round of review.
	[13] Students always cannot see the global idea for solving 3D geometry tasks in GAOKAO examination.
	[14] The conclusions about some fixed figural patterns will provide inspiration for students enabling them to solve 3D geometry tasks more easily.
	[15] It is important to help students extend the cases of particular figures to a general figural pattern (geometric structure), so that they can classify the various 3D geometry tasks into a few categories by the figural patterns (geometric structures) involved therein.
TPCOI	[16] Geometry Sketchpad is more useful than GeoGebra for making drawings of 2D figures.
	[17] It is not convenient to let students answer questions in the distance online lessons based on the Tencent Classroom platform.
TEOI	[18] The time for the second round of review is limited.
	[19] It's time-costing to deal with the problems of particular students in a distance online lesson with hundreds of students.
	[20] It usually takes a long time to get a response from students in a distance online lesson based on the Tencent Classroom platform.

Firstly, some operational invariants about content (COI) can be inferred. The rules of coordination are aimed to introduce geometric conclusions about the figural pattern of rhombus, kite, parallelogram, trapezoid or rectangle, so Huang must know the conclusions a priori and

we express them as operational invariants [1] ~ [6]. Furthermore, the geometric theorems or facts required for deriving the conclusions should also be known by Huang, such as properties of an isosceles triangle, properties of similar triangles, and properties of a right triangle, which are included into [7] ~ [9]. Besides, from Huang's behavior related to rule (2) in the argumentation episodes, we know that the figural pattern for him means a general geometric structure and is not limited to a particular figure, that is [10]. While [1] ~ [6] reflect Huang's knowledge of mathematics facts and theorems, [10] reflects his knowledge of mathematics models. All of them belong to category COI.

Secondly, there are operational invariants about pedagogy of content (PCOI) and about technology in pedagogy of content (TPCOI). In rule (1), Huang uses a drawing to represent a 2D figural pattern, implying that he thinks the drawing is an effective perceptive support for students ([11]). He also mentions the advantage of Geometry Sketchpad over GeoGebra in making the drawings ([19]), as shown in the following interview words:

"I basically used Geometry Sketchpad to make those drawings and then paste them into my Word or PowerPoint files. I tried to use GGB before, but it is very troublesome to take a screenshot or copy-paste some objects. From Geometry Sketchpad the copy-paste is much easier...especially the 2D figure, since they are all about lines, are very convenient to draw in Geometry Sketchpad."

In rule (3), Huang only develops simplified theoretical deductive reasoning because he only has one week for the second round of review of 3D geometry, and he said "it's not possible to elaborate everything; we just clarify some key points for them"; this is related to operational invariant [12]. The figural patterns involved in these rules of coordination are all collected by Huang from the proof tasks in GAOKAO examination; this is because he knows that students often have difficulties in the proof tasks ([13]), and believes that knowing some conclusions about common figural patterns will provide them inspiration ([14]), as he said in the interview:

"I think it's better for students to accumulate some fixed patterns, and accomplish the proof tasks on that basis. If they only rely on deductive reasoning, from the first step till the last one, that would be very painful. Many students don't know where to start...So one of the best ways is that you give them some common patterns, like the 2D patterns here. The perpendicular relationships often questioned in GAOKAO examination will be contained in which patterns, and what patterns contain congruent relationships. I summarize all these for them. Later when they encounter tasks, with the inspiration of from the patterns, they will soon see some direction for solving the tasks"

In rule (2), Huang's behavior of generalizing the conclusion about a particular figure to a figural pattern is because he thinks it could help students summarize the various 3D geometry tasks and understand the essential geometric structure underlying the task figures ([15]). This is evidenced by his interview words:

"In this task, they take a rectangle with the ratio of width and length being 1:2, then take the quadratic point of the side of length and fold the rectangle up. What If I change it to a rectangle of $1:\sqrt{2}$ or $1:\sqrt{3}$. Actually, students have dealt with every kind of rectangle in tasks, and what I need to do now, is to put them together, so that they could see all the tasks"

are of the same class and think about a task from the basic geometric structure involved therein. You tell them the essence of the task, that will make them clearer.”

Huang also mentions in the interview the inconvenience of posing questions to students on the Tencent Classroom platform: “A synchronous teacher-student interaction requires students being willing to “Put-Up-Hands” and then turn on their microphones, whereas very few students are willing to do so”. That leads us to [17]; it partly explains why Huang doesn’t elicit students’ contribution across all the rules of coordination. Among all the operational invariants, [11] reflects Huang’s knowledge or views about the potentials of drawings of 2D figures; [12] reflects his pedagogical principle to support student mathematics learning in reviewing lessons; [13] reflects his knowledge or views about student difficulties in 3D geometry tasks in GAOKAO examination, [14] and [15] reflect his knowledge or views about the potentials of typical figural patterns for student mathematics learning in particular the task solving activities. All these are elements in category PCOI. As for [16] and [17], they respectively reflect Huang’s knowledge or views about the potentials of a software for making drawings in support of students’ perception, and the constraints of distance online teaching platform for the synchronous teacher-student interaction in general teaching activities. Both of them belong to category TPCOI.

Finally, the lack of students’ contribution across the rules of coordination of this group is also related to some operational invariants about time economy (TEOI). As presented in the previous interview words, Huang doesn’t elaborate the theoretical deductive reasoning in rule (3) because the limited time for the second round of review doesn’t allow him to specify every detail ([18]). Huang doesn’t interact with particular students because “in one lesson, there are 400 or so students, so it is impossible to stop when one or two students have problems, I will deal with them after class” ([19]) and “it usually takes a long time to get the response after posing a question, so I generally will not wait” ([20]). Here [18] reflects Huang’s knowledge about the time constraint on the mathematics lessons for review and how to save the time on unessential activities; [19] and [20] reflect Huang’s knowledge or views about how to improve the didactical return of the time for a distance online mathematics lesson; so they belong to category TEOI.

Operational invariants for rules of coordination H.III-B: (1) use a 3D DGE and/or a drawing with scaffolding lines to illustrate the task figure and a figural pattern in support of students’ perception; (2) apply conclusions about the figural pattern to the task figure based on figure-structural analogy; (3) take the conclusion about the task figure as a fact to develop the following theoretical deductive reasoning;

The operational invariants underlying the rules of coordination are summarized in Table 5.23, to which we will refer in the analysis that follows.

Table 5.23 Operational invariants for the rules of coordination of Group H.III-B

Category	Label and content of operational invariant
COI	<i>[1] ~ [6] geometric conclusions about the rhombus, kite, parallelogram, trapezoid, rectangle patterns; [10] The essence of a figural pattern resides in its geometric structure.</i>

	<p>[21] Geometric conclusions about the cuboid pattern: three pairs of parallel faces; all the lateral edges are perpendicular to the upper and the bottom face; (only for cubes) all the faces are squares and all the edges are equal.</p> <p>[22] Geometric conclusions about the QIANGJIAO pattern: for a triangular pyramid with three lateral edges a, b, and c perpendicular to each other, the radius of its circumscribed sphere is $\sqrt{a^2 + b^2 + c^2}$.</p> <p>[23] Students can apply the geometric conclusions about a figural pattern to any figure that has the same geometric structure with that pattern.</p> <p>[24] The objects keep invariant when they are rotated.</p> <p>[25] Theorems about perpendicularity or parallelism in space: e.g., a line is perpendicular to a plane if it is perpendicular to two intersecting lines in the plane.</p> <p>[26] A 3D geometry task should generally be solved through theoretical deductive reasoning in reference to Euclidean geometry theorems and facts.</p>
PCOI	<p>[13] <i>students' difficulty in 3D geometry tasks in GAOKAO examination; [14] knowing some conclusions about typical figural patterns could provide students' inspiration for accomplishing the tasks; [15] general figural patterns can help students classify the various 3D geometry tasks.</i></p> <p>[27] Teachers can support students' perception with the drawing of a 2D/3D figure.</p> <p>[28] Teachers can add scaffolding lines to the drawing of a figure to highlight its geometric structure.</p>
TPCOI	<p>[17] <i>constraints of the Tencent Classroom platform on synchronous interaction between the teacher and students.</i></p> <p>[29] Many students have difficulties in imagining the spatial structures of complex 3D figures, and the display and rotation of 3D dynamic models in GeoGebra are very helpful to support students' perception.</p> <p>[30] The teacher can construct a 3D figure together with a related 3D figural pattern in GeoGebra to provide perceptive support for the link between the figure with the figural pattern.</p> <p>[31] It can turn students more concentrated if the teacher adds some handmade sketches synchronously on the computer screen during distance online teaching.</p> <p>[32] It is easier to display GeoGebra files in distance online setting than in real classrooms.</p> <p>[33] It can help students' better understand 3D figures and the related 3D figural patterns by connecting 3D dynamic models in GeoGebra with drawings and scaffolding lines.</p> <p>[34] It can help students connect a 3D figure with its plane sections if teachers present a 3D dynamic model together with the drawings of the plane sections.</p> <p>[35] Teachers can select particular elements of a 3D dynamic model in GeoGebra, to highlight them within the global structure of the 3D dynamic model.</p> <p>[36] To help students observe the plane section of a 3D dynamic model in GeoGebra, the teacher should turn the model to a perspective orthogonal to the plane of the section.</p>

	[37] The Tencent Classroom (with Share-the-Screen mode) allows the teacher to display various forms of digital files in distance online teaching.
TCOI	<p>[38] One can connect an external graphics tablet to the computer and add hand drawn texts and sketches onto the computer screen with a special stylus.</p> <p>[39] Techniques related to the use of the Tencent Classroom platform.</p> <p>[40] In GeoGebra, a fixed point can be created with 3D coordinates.</p> <p>[41] By selecting the <i>Polygon</i> tool and subsequently selecting several points and then the first one, one can create a polygon in GeoGebra with the selected points as vertices.</p> <p>[42] With the Vector (<Start Point>, <End Point>) command, one can define a vector starting from and ending with two designated points.</p> <p>[43] With the Translate (<Object>, <Vector>) command, one can translate the object by the vector in GeoGebra.</p> <p>[44] By selecting the Segment tool and selecting two points subsequently, one can construct a line segment between the two points in GeoGebra.</p> <p>[45] By right-clicking and dragging the mouse, one can turn the 3D dynamic models around in GeoGebra.</p> <p>[46] One can select objects in GeoGebra by directly clicking on them.</p> <p>[47] By selecting the <i>Plane through 3 Points</i> tool, one can construct a plane that passes through the three points in GeoGebra.</p> <p>[48] By selecting the <i>Cube</i> tool and two points on the xOy plane in GeoGebra, one can construct a cube on that plane with the two points as vertices.</p> <p>[49] Using the Dilate (<Object>, <Dilation Factor>, <Dilation Center Point>) command, one can dilate the object from the dilation center point by the dilation factor in GeoGebra.</p> <p>[50] By integrating a slider-controlled variable into the <Dilation Factor> in the Dilate command, one can vary the extent by which the object is dilated from the dilation center point by dragging the point on the slider.</p>
BCOI	<p>[51] It is easy for me to learn about the technological tools and techniques related to distance online teaching.</p> <p>[52] It is easy for me to design GeoGebra files.</p> <p>[53] It is easy for me to display GeoGebra files in distance online teaching.</p>
TEOI	<i>[18] views about the time limit for the second round of review; [19] ~ [20] views about the time cost in dealing with particular students' problems, and synchronous interactions, in distance online teaching at the Tencent Classroom platform.</i>

Firstly, there are operational invariants about content (COI). In rule (2), Huang applies the conclusion about a figural pattern to the task figure at stake, so he must know the conclusion himself. The conclusions include those about the figural patterns of rhombus, kite, parallelogram, trapezoid, and rectangle which have been expressed as operational invariants [1] ~ [6], and those about the cuboid pattern and the QIANGJIAO pattern which are expressed as [21] and [22]. Huang should also know that the essence of a figural pattern concerns its

geometric structure ([10]) and the conclusion of the figural pattern can be applied to any figure with the same geometric structure ([23]). In rule (3), Huang develops theoretical deductive reasoning based on the conclusion obtained in (2), to solve the task at stake. The tasks at stake here include Tasks 1 ~ 8 and 9 ~ 13, so he must have the geometric knowledge, facts or theorems required for solving these tasks and the knowledge is expressed as [24] ~ [25]. Also, Huang must know that a general proof task in 3D geometry should be solved through theoretical deductive reasoning ([26]). All of the operational invariants reflect Huang's knowledge of mathematics theorems or facts and thus enter into the category COI.

Secondly, some operational invariants about pedagogy of content (PCOI) and technology in pedagogy of content (TPCOI) can be inferred. In rule (1), Huang uses a drawing with scaffolding lines represent the 3D task figure and a related 3D/2D figural pattern; for more complex 3D task figures, Huang would use a 3D DGE to provide the perceptive support. That implies Huang thinks that a drawing of a 3D figure can support students' perception ([27]) and the scaffolding lines can help them link the 3D figure with a figural pattern ([28]), and that the 3D dynamic models in GeoGebra are more powerful in the perceptive support when the 3D figure is complex ([29] and [30]). In rules (2) and (3), Huang's behavior of applying known conclusions about a figural pattern to the theoretical deductive reasoning process for solving the task is consistent with his behavior of introducing conclusions about a figural pattern in rules of coordination A. Hence the operational invariants inferred previously – the [13] ~ [15] also have an effect here, and they reflect Huang's knowledge or views about student difficulties in solving 3D geometry tasks and potentials of typical figural patterns for helping them to overcome the difficulties. Besides the general value of typical figural patterns mentioned in the interview words that are presented in A, Huang also expresses the particular value of the cuboid pattern for one task here:

“Look at this multiple-choice task in GAOKAO, you want to justify the two line segments, they are really intersecting and equal. So what I want to tell them here? There is a triangle face perpendicular to a rectangle face, and once you get two perpendicular planes, you can put them in a cuboid pattern, then the quantitative relationship and the relative positions are obvious...”

Huang also mentions in the interview that *“It can make students more concentrated if we add some sketches synchronously on the computer screen”* ([31]), and that *“I can quickly evoke the effects in GeoGebra with a mouse in the distance online teaching, while the screen touch in real classrooms is not so convenient”* ([32]). The two operational invariants support Huang's use of 3D DGEs and/or drawings with scaffolding lines in rule (1). From the related argumentation episodes, we know that sometimes Huang not only gives the drawing of the 3D task figure with some scaffolding lines highlighting the figural pattern, but also display the task figure and the figural pattern in GeoGebra; this seems to be an efficient way for him to teach with GeoGebra, leading us to [33]. In other times, Huang only uses GeoGebra to present the 3D task figure and the figural pattern, while using a drawing and scaffolding lines to represent their plane sections, which implies [34]. Furthermore, Huang often selects particular elements of a 3D dynamic model to highlight their status in the global structure of the model, which implies [35]. He also turns a 3D dynamic model in GeoGebra to a perspective perpendicular to a plane helping students observe the plane section of the model, leading us to [36]. Furthermore,

Huang presents all the 3D DGEs and drawings under the Share-the-Screen mode of the Tencent Classroom, implying [37]. Among all the operational invariants, [27] and [28] reflect Huang's view or knowledge about the didactical potential of drawings for students' perception, belonging to PCOI. [29] ~ [37] reflect Huang's knowledge and views about the didactical potential of 3D DGEs or the distance online setting for students' perception or general mathematics learning, being the operational invariants in category TPCOI. In addition, Huang doesn't elicit students' contribution in this group of rules of coordination, and it is partly due to the constraint of the distance online teaching platform on the synchronous teacher-student interaction, that is [17] already introduced.

Thirdly, we can infer some operational invariants about technology and content (TCOI) from the facts that He mainly uses the Tencent Classroom, an external tablet and a stylus for distance online teaching and that all 3D DGEs involved in the rules of coordination are designed by Huang himself. The first fact should be supported by Huang's technological knowledge of using Tencent Classroom platform, the external tablet and the stylus, which are formulated as [38] and [39]. According to the analysis in section 5.5.2, we know that in the 3D DGE for task 10, Huang creates fixed points with 3D coordinates, creates faces with the *Polygon* tool, creates line segments with the *Segment* tool, and creates a cuboid with the *Vector* and *Translate* commands; In the 3D DGE for task 12, Huang creates a cube with fixed points and the *Cube* tool, created a plane that cut through the cube with the *Plane through three Points* tool, and created a slider that can control the dynamic process of grinding the cube into a semi-regular polyhedron with the *Dilate* command. In both the 3D DGEs, Huang turns around the 3D dynamic models and select particular elements of the models. The technological and mathematical knowledge required for all the techniques above are formulated as [40] ~ [50].

Fourthly, the rules of coordination are underlined by some operational invariants about behavior control (BCOI). In the interview, Huang expresses his familiarity with the technological tools used in distance online teaching: "*With respect to these tools, of course I will be more familiar than some senior teachers*" ([51]). Huang also expressed his ease in designing the technological resources, GeoGebra files ([52]), and ease in using them in distance online teaching [53]), as evidenced in the interview:

"No, there are no specific constraints (on using the GeoGebra files online) The (GeoGebra) files are simple. I usually prepare them before the lesson and that wouldn't take me much time. Then in the lesson, I just display the dynamic models to provide a perceptive support; there is not complex usages"

As can be seen, all of the operational invariants can be classified as BCOI, and it is especially with them that Huang is willing to use 3D DGEs, and handmade drawings and scaffolding lines in the rules of coordination in distance online settings.

Finally, there are some operational invariants about time economy (TEOI). Similar to the last group, this group of rules of coordination also miss students' contribution, and this is related to Huang's views about the time cost of dealing with particular students' problems and letting students answer questions in the distance online teaching setting. That is just the [19] and [20] introduced previously.

Operational invariants for rules of coordination H.III-C: (1) develop theoretical deductive reasoning for solving the task with no reference to any figural pattern and use a drawing to support students' perception of the 3D task figure; (2) relate the 3D task figure with a 3D figural pattern based on figure-structural analogy; (3) use a 3D DGE and/or scaffolding lines to illustrate the link of the task figure with the figural pattern;

The operational invariants underlying the rules of coordination are summarized in Table 5.24, to which we will refer in the analysis that follows.

Table 5.24 Operational invariants for the rules of coordination of Group H.III-C

Category	Label and content of operational invariant
COI	<p>[24] <i>congruence between the objects before and after rotation; [25] Theorems about perpendicularity or parallelism in space; [26] 3D geometry tasks should be solved through theoretical deductive reasoning; [10] The essence of a figural pattern resides in its geometric structure.</i></p> <p>[54] Midpoint theorem in a triangle: if you connect the midpoints of two sides of a triangle then the resulting line segment will be parallel to the third side.</p> <p>[55] Geometric conclusions about the YANGMA pattern: a rectangular pyramid with two perpendicular faces which are meanwhile perpendicular to the base plane.</p> <p>[56] Geometric conclusions about the BIENAO pattern: a triangular pyramid with two perpendicular lateral faces, one of the lateral face is meanwhile perpendicular to the base plane.</p>
PCOI	<p>[27] [28] <i>drawing of a 3D figure can support students' perception, and scaffolding lines on the drawing can help link to a figural pattern; [15] general figural patterns can help students classify the various 3D geometry tasks.</i></p> <p>[57] For a 3D geometry task, if students can hardly identify the figural pattern fit by the task figure, the teacher should demonstrate the general solution to the task without referring to the figural pattern.</p> <p>[58] It will increase the burden memory of students if the teacher introduces too many figural patterns and related conclusions.</p>
TPCOI	<p>[29] [30] <i>3D dynamic model in 3D DGE can support students' perception with respect to a complex 3D figure, an additional 3D dynamic model on that can help link to a figural pattern; [31] handmade sketches on the computer screen will make students more concentrated in distance online settings; [32] convenience of displaying GeoGebra files in distance online setting; [33] ~ [34] pedagogical benefit of combining 3D dynamic models with drawings and scaffolding lines; [35] Teachers can select particular elements of a 3D dynamic model to highlight them; [37] Tencent Classroom platform allows the teacher to display various forms of digital file; [17] constraints of the distance online teaching platform on synchronous teacher-student interaction.</i></p> <p>[59] Teachers can put colors to particular elements of 3D dynamic models in in GeoGebra, to facilitate the oral explanation which needs to refer to figural elements during distance online teaching.</p>

TCOI	<p>[38] affordances of external tablet and stylus connected to the computer and techniques of using them; [39] Techniques of using Tencent Classroom platform; [40] ~ [44] techniques for constructing a fixed point, a face, a cuboid (with the Vector and Translate commands), and a segment in GeoGebra; [45] techniques for turning around 3D dynamic models in GeoGebra; [46] techniques for selecting objects in GeoGebra.</p> <p>[60] In GeoGebra, after constructing a polygon, one modifies its color using the <i>Color</i> tab in the <i>Properties Dialog</i> window.</p>
BCOI	<p>[51] familiarity with the technological tools used in distance online teaching; [52] perceived ease with respect to designing GeoGebra files; [53] perceived ease with respect to displaying GeoGebra files in distance online teaching.</p>
TEOI	<p>[18] views about the time limit for the second round of review; [19]-[20] views about the time cost in dealing with particular students' problems, and synchronous interactions, in distance online teaching at the Tencent Classroom platform.</p>

Firstly, the rules of coordination are underpinned by some operational invariants about content (COI). In rule (1), Huang develops theoretical deductive reasoning for solving the task at stake, which are Task 14 ~ 16, so he must know the geometric knowledge required for solving these tasks. The geometric knowledge includes congruence between the objects before and after rotation, theorems about perpendicularity or parallelism in space, and general solution to 3D geometry proof tasks – which are already included in previous operational invariants [24], [25] and [26] – and the midpoint theorem in a triangle, which is formulated as [54]. In rule (2), Huang relates the task figure with a figural pattern based on figure-structural analogy, linking some conclusion obtained about the task figure with a conclusion about the figural pattern. So Huang he must know the geometric conclusions about the figural patterns at stake here – YANGMA and BIENAO, and we formulate the conclusions as [55] and [56]. Huang should also know that the essence of a figural pattern resides in its geometric structure, which has been mentioned in operational invariant [10].

Secondly, some operational invariants about pedagogy of content (PCOI) and technology in pedagogy of content (TPCOI). In rule (3), Huang uses a 3D DGE and/or a drawing with scaffolding lines to support students' perception of the task figure and the figural pattern; this is consistent with his behavior in the last group of rules of coordination. Therefore, the operational invariants inferred previously – [27] ~ [32], [33] ~ [34], [35] and [37] – are also relevant here. They reflect Huang's view or knowledge about the didactical potential of drawings or 3D DGEs, the pedagogical strategies to exploit the didactical potentials, and the advantages of the distance online setting for displaying 3D DGEs. Different from what he did in Lesson Series H.II, here Huang relates to a figural pattern only after solving a task instead of using the conclusions about the figural pattern to solve the task. Actually, it is exactly the experience of Lesson Series H.II that make Huang to realize that students usually cannot link the task figures with some complicated patterns like YANGMA and BIENAO, as he mentions in the interview:

“Sometimes the pattern is too complicated for them to remember, as the coordinator of the teaching research group told me last time: too many patterns will increase the burden of

memory of students, if they cannot apply the patterns effectively to solve the tasks, it is better not to introduce the patterns at all. So here I firstly explain the general solution to the task, making them completely clear about every step in the deductive reasoning, and then I refer to the pattern, just to help them better understand the essence of the task figure. It is similar to figures in previous tasks – the same pattern in different orientations.”

From the sentence above, we see that Huang prefers not to refer to a figural pattern in the task solving process when the task figure can hardly be linked to the figural pattern ([57]); he knows that too many patterns will add to the memory burden of students ([58]) and he introduces the patterns only to help students classify tasks ([15]). These operational invariants reflect the teacher’s pedagogical principle to support student mathematics learning and in particular the task solving activities, belonging to the category PCOI. In the interview, Huang also explains his specific way of using 3D DGEs which is related to rule (3):

“(The colors on some key objects) is for the convenience of oral explanation. When I rehearsed for the distance online lessons, I found it difficult to indicate these objects in GeoGebra clearly, I cannot directly point at them and it is slow to read the letters. For example, plane ABC, students still need to search where is A, where is B, what a messy. If you directly refer by color, students will find them quickly.”

This allows us to infer [59]; it reflects Huang’s specific pedagogical strategy to use digital technologies in support of student mathematics learning, belonging to category TPCOI. Also, the lack of students’ contribution in the rules of coordination is partly attributed to the constraints of the distance online teaching platform on student-teacher interaction; this corresponds to [17], an operational invariant (TPCOI) already introduced.

Thirdly, the rules of coordination involve the use of 3D DGEs which are designed by Huang himself and the use of the technological tools specially related to distance online teaching; this is similar to the last group of rules of coordination. Hence some operational invariants about technology and content (TCOI) can be inferred. The operational invariants underpinning the previous group of rules of coordination, [38] ~ [46], also have an effect here. Besides, marking certain objects in 3D DGEs with different colors requires Huang to know the corresponding techniques in GeoGebra, and we formulate the techniques as [60], another operational invariant in the category TCOI.

Fourthly, the realization of the *rules* of coordination cannot leave the ease perceived by Huang for using the various technological tools related to designing and using 3D DGEs, similar to the case of the last group. Therefore, the three operational invariants about behavior control (BCOI) mentioned previously are also the underpinning factors here, that is [51] ~ [53].

Finally, similar to the previous groups, this group of rules of coordination still miss students’ contribution, and this is mainly related to two operational invariants about time economy (TEOI) which have been introduced: [19] and [20]. We don’t elaborate their content here.

5.4.5 Summary of Lesson Series H.III

In this section, we give a summary of the results of analysis of Lesson Series H.III.

Table 5.25 lists the main content of the analysis results, including the coordination schemes of Huang, and the 3D geometry tasks-3D DGEs in the corresponding classes of situations. The coordination schemes mainly include rules of coordination and operational invariants. In consistency with the labelling of the groups of rules of coordination, we use “class H.III-A, H.III-B, ...” and “scheme H.III-A, H.II-B, ...” to label the corresponding classes of situations and coordination schemes. To save space, we only integrate the main ideas of the operational invariants and the main characteristics of the 3D geometry tasks-3D DGEs. For a more complete description, please refer to sections 5.4.2 and 5.4.4.

Table 5.25 Summary of analysis results of Lesson Series H.III

Coordination schemes	3D geometry tasks-3D DGEs
	Class of situations
<p>Scheme H.III-A</p> <p>Rules of coordination:</p> <p>(1) draw a 2D figure to support students’ perception; (2) generalize the conclusion about the particular 2D figure to a 2D figural pattern through inductive reasoning; (3) develop simplified theoretical deductive reasoning to explain the particular or the generalized conclusion.</p> <p>Operational invariants:</p> <p>COI: [1] ~ [6] geometric conclusions about the figural pattern of rhombus, kite, parallelogram, trapezoid and rectangle; [7] ~ [9] properties of isosceles triangles, similar triangles and right triangles; [10] views about the essence of a figural pattern;</p> <p>PCOI: [11] potentials of drawings for supporting students’ perception of 2D figural patterns; [12] views about how to distribute time in lessons for second round of review; [13] ~ [14] knowledge or views about students’ difficulty in GAOKAO exam tasks and how the conclusions about typical figural patterns could help; [15] views about how general figural patterns could help students classify 3D geometry tasks;</p> <p>TPCOI: [16] views about advantages of Geometry Sketchpad over GeoGebra in making drawings; [17] views about the constraints of the Tencent Classroom platform on synchronous teacher-student interaction;</p> <p>TEOI: [18] views about the time limit on the lessons of the second round of review; [19]-[20] views about</p>	<p>Class of situations H.III-A</p> <p>Tasks 1 ~ 8 (subtask 1):</p> <p>3D geometry topic: identify geometric relationships (perpendicularity, parallelism, or angle) in a 2D figural pattern that can be linked to the 3D figure in the task;</p> <p>Status in curriculum/exam: solve problems concerning relative positions in space with Euclidean geometric proof; have related perceptive support; all are short essay items in the GAOKAO exam demanding a proof;</p> <p>Context and innate support: paper-pencil environment; a drawing equipped for each figural pattern introduced.</p> <p>No 3D DGEs</p> <p>Support students’ coordination, in a distance online teaching setting, introduce common figural patterns in 3D geometry tasks.</p>

<p>the time cost in dealing with particular students' problems, and the time cost in synchronous interactions, at the Tencent Classroom platform.</p>	
<p>Scheme H.III-B</p> <p>Rule of coordination:</p> <p>(1) use a 3D DGE and/or a drawing with scaffolding lines to illustrate the task figure and a figural pattern in support of students' perception; (2) apply conclusions about the figural pattern to the task figure based on figure-structural analogy; (3) take the conclusion about the task figure as a fact to develop the following theoretical deductive reasoning.</p> <p>Operational invariants:</p> <p>COI: [1] ~ [6]; [10]; [21] ~ [22] geometric conclusions about the figural pattern of cuboid and QIANGJIAO; [23] knowledge about the criteria for applying conclusions about a figural pattern; [24] ~ [25] congruence between the objects before and after rotation, and theorems about perpendicularity or parallelism in space; [26] 3D geometry tasks should generally be solved by theoretical deductive reasoning;</p> <p>PCOI: [13] ~ [14]; [15]; [27] potentials of drawings for supporting students' perception of 3D/2D figures; [28] scaffolding lines can help illustrate the geometric structure of a figure represented by a drawing;</p> <p>TPCOI: [17]; [29] ~ [30] potentials of 3D dynamic models for supporting students' perception of complex 3D figures and their link with 3D figural patterns; [31] views about how the synchronous hand drawings and writings can support student learning; [32] views about convenience of displaying GeoGebra files in distance online setting; [33] ~ [34] pedagogical benefit of displaying 3D dynamic models with drawings and scaffolding lines. [35] ~ [36] teachers can select certain elements in 3D dynamic models/ turn it to a proper perspective, to facilitate students' observation and his oral explanation; [37] affordances of the Tencent</p>	<p>Class of situations H.III-B</p> <p>Tasks 1 ~ 8 (subtask 2) and Tasks 9 ~ 13:</p> <p>3D geometry topic: justify a statement concerning geometric relationships (parallelism, intersection, coplanarity, equivalence of line segments, perpendicularity, angle), or determine geometric magnitudes (edge length), in a 3D figure that can be linked to a 2D/3D figural pattern;</p> <p>Status in curriculum/exam: solve problems concerning relative positions in space with Euclidean geometric proof; have related perceptive support; calculate geometric magnitudes by comprehensively using properties of triangles, formulae of areas and volumes and so on; Tasks 1-8 and 9-13 are respectively short essay items demanding a proof, and small items demanding a simple answer, in GAOKAO exam;</p> <p>Context and innate support: paper-pencil environment; Tasks 1-12 each provides a drawing for the task figure, which is in a same perspective with the drawing of a related figural pattern; Task 13 has no support.</p> <p>3D DGE for Task 10:</p> <p>Figural representations and tools: 3D dynamic model of the task figure being situated in a cube; no specific help; controlled by the teacher; tools of Dragging, Selecting;</p> <p>Feedback: innate feedback in GeoGebra – drag the whole 3D dynamic model around to show its different views; and select some elements to highlight them;</p> <p>Help and control: no specific help, control in teacher;</p> <p>Curricular distance: close to the curriculum prescriptions.</p> <p>3D DGE for Task 12:</p>

<p>Classroom platform for displaying varieties of digital files;</p> <p>TEOI: [18] ~ [20]</p> <p>TCOI: [38] techniques of using external tablet and stylus to add external tablet and stylus to the computer screen; [39] techniques related to the use of the Tencent Classroom; [40] ~ [50] techniques (and possibly math knowledge) for constructing a fixed point, a polygon, a line segment, a cube or a plane in GeoGebra, or translating an object by a vector, turning around a 3D dynamic model, highlighting certain objects, or dilating the object from a point by a variable factor in GeoGebra;</p> <p>BCOI: [51] perceived ease for learning to use new technological tools for distance online teaching; [52] perceived ease for designing 3D DGEs with GeoGebra; [53] perceived ease for integrating 3D DGEs into the distance online teaching.</p>	<p>Figural representations and tools: 3D dynamic model of the task figure being situated in a cube and integrated with a section plane; no specific help; controlled by the teacher; <i>Slider</i> tool, <i>Dilate</i> command, <i>Dragging</i> tool</p> <p>Feedback: innate feedback in GeoGebra – control the process of the cube being “grinded” into the task figure with the slider tool and the Dilate command; turn around the whole 3D dynamic model around to observing a section of the model;</p> <p>Help and control: no specific help, control in teacher;</p> <p>Curricular distance: close to the curriculum prescriptions.</p> <hr/> <p>Support students’ coordination, in a distance online teaching setting, summarize typical techniques for solving examination tasks.</p>
<p>Scheme H.III-C</p> <p>Rule of coordination:</p> <p>(1) develop theoretical deductive reasoning for solving the task with no reference to any figural pattern and use a drawing to support students’ perception of the 3D task figure</p> <p>(2) relate the 3D task figure with a 3D figural pattern based on figure-structural analogy;</p> <p>(3) use a 3D DGE and/or scaffolding lines to illustrate the link of the task figure with the figural pattern;</p> <p>Operational invariants:</p> <p>COI: [24] ~ [25]; [10]; [26]; [54] midpoint theorem for a triangle; [55] ~ [56] geometric conclusions about the pattern of YANGMA and BIENAO;</p> <p>PCOI: [15]; [27] ~ [28]; [57] views about what kinds of tasks are not proper to be linked with a figural pattern; [58] too many figural patterns and conclusions will increase students’ burden of memory.</p> <p>TPCOI: [17]; [29] ~ [30]; [33]-[34]; [35]; [31]; [32]; [37]; [59] colors designated to certain elements of 3D</p>	<p>Class of situations H.III-B</p> <p>Tasks 14 ~ 16</p> <p>3D geometry topic: validly justify geometric relationships in a 3D figure that can be linked to a 3D figural pattern;</p> <p>Status in curriculum/exam: solve problems concerning relative positions in space with Euclidean geometric proof; have related perceptive support; all are short essay items demanding a proof in GAOKAO exam;</p> <p>Context and innate support: paper-pencil environment; each provides a drawing for the task figure, which is in a different perspective with the drawing of a related figural pattern.</p> <p>Two 3D DGEs for Tasks 15 and 16</p> <p>Figural representations and tools: 3D dynamic model of the task figure, with the part that fits a figural pattern being highlighted with a different color; no specific help; controlled by the teacher; tools of <i>Dragging and Selecting</i>;</p> <p>Feedback: innate feedback in GeoGebra – drag the whole 3D dynamic model around to show its</p>

<p>dynamic models can facilitate students' observation and teachers' oral explanation in distance online teaching.</p> <p>TEOI: [18] ~ [20];</p> <p>TCOI: [38]; [39]; [40] ~ [44] techniques for constructing a fixed point, a face, a cuboid (with the Vector and Translate commands), and a segment, in GeoGebra; [45] ~ [46] techniques for turning around 3D dynamic models, and selecting objects, in GeoGebra; [60] techniques for modifying colors of objects in GeoGebra;</p> <p>BCOI: [51] ~ [53].</p>	<p>different views; and select the part that fits a figural pattern to highlight them;</p> <p>Help and control: no specific help, control in teacher;</p> <p>Curricular distance: close to the curriculum prescriptions.</p> <hr/> <p>Support students' coordination, in a distance online teaching setting, summarize typical techniques for solving examination tasks.</p>
---	--

The results of the distance online lesson series are dedicated to be contrasted with those of the real classroom lesson series, in response to the second group of research questions. So we don't elaborate the links between the elements within the single one lesson series, but directly go to the analysis in the next section.

5.5 Contrast real classroom and distance online teaching in case of Huang

In this section, we contrast Huang's coordination in real classroom lesson series and the distance online lesson series, in light of the second group of research questions. The data analyzed here are the results of the three lesson series of Huang, which are respectively summarized in section 5.3.5, 5.3.10 and 5.4.5.

As the results, we identify three pairs of close class of situations, with one class in distance online lessons series H.III and the other class in real classroom lesson series, and here all the other classes in real classrooms are located in lesson series H.II. The main content of the three pairs of classes of situations and the corresponding coordination schemes are listed in Table 5.26 ~ Table 5.28.

Referring to the three tables, we firstly discuss how we have identified each pair of close classes of situations, secondly compare the corresponding 3D DGEs, and thirdly compare the corresponding coordination schemes. With respect to the third step, we start from the commonalities and differences in rules of coordination between two schemes, and then examine the differences in operational invariants that can help explain the differences in rules of coordination. Finally, we connect the differences to indirect or direct documental geneses.

The first pair of close classes of situations are H.II-A and H.III-A, as shown in Table 5.26.

Table 5.26 First pair of classes of situations and the corresponding coordination schemes

Class of situations	H.II-A, real classroom lesson series	H.III-A, distance online lesson series
Characteristics of 3D geometry tasks and 3D DGEs	<p>Tasks H.II-1 ~ 3 (subtask (1))</p> <p>3D geometry topic: identify perpendicular relationships (related to a point-plane distance) in a simple 3D figural pattern that can be linked to the 3D task figure.</p> <p>No 3D DGEs.</p>	<p>Tasks H.III-1 ~ 8 (subtask (1))</p> <p>Detailed 3D geometry topics of the tasks: identify geometric relationships (perpendicularity, parallelism, or angle) in a 2D figural pattern that can be linked to the 3D task figure.</p> <p>No 3D DGEs.</p>
Coordination scheme	<p>Scheme H.II-A</p> <p>Rules of coordination:</p> <p>(1) use a drawing to represent a 3D figure within the frame of a cube in support of students' perception;</p> <p>(2) guide students to extend the conclusion about the particular 3D figure to a general 3D figural pattern by inductive reasoning;</p> <p>(3) develop simplified theoretical deductive reasoning together with</p>	<p>Scheme H.III-A</p> <p>Rules of coordination:</p> <p>(1) use a drawing to represent a 2D figure in support of students' perception;</p> <p>(2) extend the conclusion about the particular 2D figure to a general 2D figural pattern by inductive reasoning;</p> <p>(3) develop simplified theoretical deductive reasoning to explain the particular or the generalized conclusion.</p> <p>Operational invariants:</p>

	<p>students to explain the particular or the generalized conclusion.</p> <p>Operational invariants:</p> <p>COI: H.II-[1] ~ [8] geometric conclusions about 3D figural patterns concerned and the related math knowledge; H.II-[9] views about the essence of a figural pattern;</p> <p>PCOI: H.II-[10] ~ [11] potentials of drawings within the frame of cube for supporting students perception and interpretation of 3D figural patterns; H.II- [12] ~ [18] knowledge or views about students' prior knowledge and experiences, how to distribute time in a review lesson, how to introduce a figural pattern and related conclusions, how to help students solve GAOKAO exam tasks in reference to figural patterns.</p> <p>SNOI: H.II-[19] perceived norms for open class; H.II-[20] perceived expectation of the coordinator of the teaching research group.</p>	<p>COI: H.III-[1] ~ [9] geometric conclusions about the 2D figural patterns concerned and the related math knowledge; H.III-[10] views about the essence of a figural pattern;</p> <p>PCOI: H.III-[11] potentials of drawings for supporting students' perception of 2D figural patterns; H.III-[12] ~ [15] knowledge or views about how to distribute time in a review lesson, how to help students solve GAOKAO exam tasks and classify the various 3D geometry tasks by referring to figural patterns;</p> <p>TPCOI: H.III-[16] views about advantages of Geometry Sketchpad over GeoGebra in making drawings; H.III-[17] views about the constraints of the Tencent Classroom platform on synchronous teacher-student interaction;</p> <p>TEOI: H.III-[18] views about the time limit on review lessons; H.III-[19] ~ [20] views about the time cost in dealing with particular students' problems, and asynchronous interactions, at the Tencent Classroom platform.</p>
--	--	---

The tasks in class H.II-A are all about identifying perpendicular relationships (related to a point-plane distance) in a simple 3D figural pattern that can be linked to the 3D figure in the task. The tasks in class H.III-A are all about identifying geometric relationships in a 2D figural pattern that can be linked to the 3D figure in the task, and the geometric relationships vary from perpendicularity, parallelism, to the angle between lines. As can be seen, the 3D geometry topics of the tasks in the two classes belong to the same general topic – identify geometric relationships in space (Topic 1 in section 3.3.1). So the two classes of situations are close to each other, with one in the real classroom lesson series H.II and the other in the distance online lessons series H.III.

Regarding 3D DGEs in the two classes of situations, Huang doesn't use 3D DGEs in any of the two classes so we don't compare them here

Regarding the coordination schemes H.II-A and H.III-A, we firstly compare the rules of coordination therein. As can be seen from Table 5.26, Huang uses a drawing to support student' perception both in the rules in scheme H.II-A and the rules in scheme H.III-A. Also, the rules in the two schemes both involve an inductive reasoning in which the conclusion from a particular figure is extended to a general 3D figural pattern, and a theoretical deductive reasoning which aims to explain either the particular or generalized conclusion in the inductive reasoning. The differences in terms of rules of coordination include:

-
- In rules in scheme H.II-A, the drawing is generated by GeoGebra and it represents a 3D figure situated in a cube; in rules in scheme H.III-A, the drawing is generated by Geometry Sketchpad and represents a 2D figure;
 - In rules in scheme H.II-A, the conclusion about the particular figure is given by students on the request of Huang. In rules in scheme H.III-A, the conclusion is formulated all by Huang himself;
 - In rules in scheme H.II-A, the inductive reasoning is launched by Huang with possible reactions to students, that is, he requests them to evaluate (reconsider) whether their conclusion about the particular figure still holds for another similar figure. In rules in scheme H.III-A, Huang develops the inductive reasoning soon after formulating the particular conclusion, without interactions with students;
 - In rules in scheme H.II-A, Huang requests students to tell the main facts or theorems in the theoretical deductive reasoning to explain the previous conclusions. In rules in scheme H.III-A, he directly indicates the main points in the theoretical deductive reasoning.

The first difference concerns the dimensions of the figures which are illustrated with the drawings in the rules of coordination, and the software that Huang uses to produce the drawings. The difference is attributed to Huang's understanding of the advantages of the different software for making drawings of 3D and 2D figures, and the different detailed 3D geometry topics of the tasks in the two classes of situations – the tasks are respectively about identifying geometry relationships in a simple 3D figural pattern and a 2D figural pattern, so Huang represents the different kinds of figures (both with drawings) in the corresponding rules of coordination. The claim above can be justified by some operational invariants respectively in the two schemes. For example, Huang thinks that for a simple 3D figure, a drawing within the drawing of a cube is enough to support students' perception and (H.II-[10] in PCOI) and that Geometry Sketchpad is more suitable for making the drawing of 2D figures than GeoGebra (H.III-[16] in TPCOI). Since the operational invariants involve no clues about the change in the teaching setting or the reflection of Huang during the interval between the two lesson series, we claim that the first difference between two schemes (it consists of the first difference in rules of coordination and the corresponding differences in operational invariants, hereafter the same) is simply a result of direct documentational genesis with no particular link with distance online teaching setting.

The last 3 differences are all about the lack of the direct contribution of students and the indirect contribution (questions requesting students' evaluation or elaboration) of Huang in the rules in scheme H.III-A. In the operational invariants in scheme H.III-A, we can find Huang's views which are consistent with the differences. For example, he thinks it's inconvenient to invite students to answer a question synchronously in the distance online teaching setting based on Tencent Classroom (H.III-[17]), and that it is time consuming to wait for students' asynchronous answers and deal with particular students' difficulties in such a teaching setting (H.III-[19]-[20]). The operational invariants only appear in the TPCOI and TEOI in scheme H.III-A and are specifically related to the distance online teaching setting in class of situations H.III-A. Meanwhile, the operational invariants in scheme H.III-A involve no clues of Huang's reflection during the interval period, so we claim that the last 3 differences between the two schemes can be considered as a result of a direct documentational genesis with respect to class

of situations H.III-A. Through the direct genesis, Huang is supposed to adapt the actions related to a former scheme H.II-A, to the new class of situations H.III-A and develop the corresponding scheme H.III-A. Here Huang particularly interacts with the constraints of the distance online teaching setting in that class of situations (based on the Tencent Classroom platform, hereafter the same), and the constraints mainly concern the inconvenience of inviting students to synchronously answer a question and the time cost in waiting for students' asynchronous responses.

The second pair of close classes of situations are H.II-C and H.III-C, with the former in the real classroom lesson series H.II and the latter in the distance online lessons series H.III, as shown in Table 5.27.

Table 5.27 Second pair of classes of situations and the corresponding coordination schemes

Class of situations	H.II-C, real classroom lesson series	H.III-B, distance online lesson series
<p>Characteristics of 3D geometry tasks and 3D DGEs</p>	<p>Tasks H.II-1 ~ 4 (subtask 2): 3D geometry topic: determine a distance from a point to a plane in a 3D figure that can be linked to a 3D figural pattern; Context and innate support: all tasks in paper-pencil environment; Tasks H.II-2 and H.II-3 respectively provide a drawing of the task figure which is in a different/ same perspective with the drawing of the related figural pattern; Tasks H.II-1 and H.II-4 with no innate support. 3D DGE for Task H.II-4: Figural representations: 3D dynamic model of a complex 3D figure, with labels alongside some elements; Tools and feedback in GeoGebra: evoke labeled elements one by one in the 3D dynamic model by <i>Selecting</i> their names in the Algebra view; turn around the whole 3D dynamic tool with the <i>Dragging tool</i>.</p>	<p>Tasks H.II-8 (subtask 2) and 9 ~ 13: 3D geometry topic: identify geometric relationships (perpendicularity, parallelism, or angle) in a 2D figural pattern that can be linked to the 3D task figure; Context and innate support: All tasks in paper-pencil environment; Tasks H.III-1 ~ 12 each provides a drawing of the task figure which is in a same perspective with the drawing of a related figural pattern; Task H.III-13 with no innate support. 3D DGEs for Task H.III-10 and 12: Figural representations: 3D dynamic model of a complex task figure being situated in a cube; Tools and feedback in GeoGebra: turn around the whole 3D dynamic model with the <i>Dragging</i> tool; highlight some elements in the model by <i>Selecting</i> them; (Specifically for Task H.III-12) control the dynamic process of the cube being “grinded” into the task figure with the <i>Slider</i> and <i>Dilate</i> tool/command.</p>
<p>Coordination scheme</p>	<p>Scheme H.II-C Rules of coordination:</p>	<p>Scheme H.III-B Rules of coordination: (1) use a 3D DGE and/or a drawing with scaffolding lines to illustrate the 3D task</p>

	<p>(1) use a 3D DGE or drawing to illustrate the task figure in support of students' perception;</p> <p>(2) request students to apply the conclusion about a figural pattern to the task figure based on figure-structural analogy;</p> <p>Possibilities of inferences when dealing with Task 2:</p> <ul style="list-style-type: none"> – rebut the drawing-perceptive analogy made by students and move them to figure-structural analogy between the figural pattern and the task figure; – illustrate the geometric structure of the task figure with scaffolding lines and simulating gestures; <p>(3) take the conclusion about the task figure as a fact to develop the following theoretical deductive reasoning.</p> <p>Operational invariants:</p> <p>COI: H.II-[1] ~ [3], [20], [40] ~ [45] geometric conclusions about the 3D figural patterns concerned and other math knowledge required for solving the tasks; H.II-[9], [39] knowledge about the essence of a figural pattern, and the condition for linking it to a figure;</p> <p>PCOI: H.II-[17] ~ [18] knowledge or views about how to help students solve GAOKAO exam tasks in reference to figural patterns; H.II-[46] potentials of drawings for supporting students' perception of 3D figures; H.II-[47] ~ [48] views about what is important in explaining task solving procedures, and linking the task figure to a figural pattern;</p> <p>TPCOI: H.II-[49] potentials of 3D dynamic models over drawings in supporting students' perception of complex 3D figures; H.II-[50] 3D</p>	<p>figure and a figural pattern in support of students' perception;</p> <p>(2) apply conclusions about the figural pattern to the task figure based on figure-structural analogy;</p> <p>(3) take the conclusion about the task figure as a factual premise in the following theoretical deductive reasoning.</p> <p>Operational invariants:</p> <p>COI: H.III-[1] ~ [6], [21] ~ [22], [24] ~ [26] geometric conclusions about the 3D figural patterns concerned and other math knowledge required for solving the tasks; H.III-[10], [23] knowledge about the essence of a figural pattern, and the condition for linking it to a figure;</p> <p>PCOI: H.III-[13] ~ [15] knowledge or views about how to help students solve GAOKAO exam tasks and classify the various 3D geometry tasks by referring to figural patterns; H.III-[27] potentials of drawings for supporting students' perception of 3D/2D figures; H.III-[28] scaffolding lines can help illustrate the geometric structure of the figure represented by a drawing;</p> <p>TPCOI: H.III-[17] views about the constraints of the Tencent Classroom platform on synchronous interaction; H.III-[29] ~ [30] potentials of 3D dynamic models for supporting students' perception of complex 3D figures and their link with 3D figural patterns; H.III-[31] synchronous hand sketches can make students more concentrated; H.III-[32] views about convenience of displaying GeoGebra files in distance online setting; H.III-[33] ~ [34] pedagogical benefit of displaying 3D dynamic models with drawings and scaffolding lines. H.III-[35] ~ [36] teachers can select certain elements in 3D dynamic models/ turn it to a proper perspective, to facilitate students' observation and his oral</p>
--	---	--

	<p>dynamic models can trigger student learning interest; H.II-[51] views about how to display 3D dynamic models while promoting students' theoretical deductive reasoning; H.II-[52] potentials of labels in 3D DGEs for figure illustration, H.II- [53] potentials of the intelligent interactive board for figure illustration;</p> <p>TCOI: H.II-[31], [34]-[36] techniques and math knowledge required for designing the 3D DGEs; H.II- [54] techniques for adding labels in GeoGebra; H.II- [55] techniques for making hand sketches on the intelligent interactive board;</p> <p>BCOI: H.II-[37] confidence in his own skills related to GeoGebra; H.II- [38] perceived ease for designing 3D DGEs with GeoGebra;</p> <p>SNOI: H.II-[19] perceived norms for open class; H.II-[20] perceived expectation of the coordinator of the teaching research group.</p>	<p>explanation; H.III-[37] affordances of the Tencent Classroom platform for displaying various forms of digital files;</p> <p>TEOI: H.III-[18] views about the time limit on review lessons; H.III-[19] ~ [20]views about the time cost in dealing with particular students' problems, and asynchronous interactions, at the Tencent Classroom platform;</p> <p>TCOI: H.III-[38] techniques of using external tablet and stylus which are connected to the computer; H.III-[39] techniques of using the Tencent Classroom platform; H.III-[40] ~ [48] techniques and math knowledge required for designing 3D DGEs and manipulating in them; H.III- [49] ~ [50] techniques for dilating the object from a point by a dynamic factor with <i>Dilate</i> and <i>Slider</i> in GeoGebra;</p> <p>BCOI: H.III-[51] perceived ease for learning to use new technological tools related to distance online teaching; H.III- [52] ~ [53] perceived ease for designing 3D DGEs with GeoGebra, and integrating them into distance online teaching.</p>
--	---	--

The tasks in class of situations H.II-C are all about determining the distance from a point to a plane in a 3D figure that can be linked to a 3D figural pattern. The tasks in class of situations H.III-B can be divided into two groups: the first group are about justifying a statement about geometric relationships in a 3D figure that can be linked to a 2D/3D figural pattern, with the “geometric relationships” ranging from equivalence of line segments, parallelism, intersection, coplanarity, perpendicularity, to the angle between lines and/or planes; the second group are about determining geometric magnitudes in a 3D figure that can be linked to a 2D/3D figural pattern. The second group of tasks in H.III-B and the tasks in H.II-C share the same general 3D geometry topic – determine geometric magnitudes in space (Topic 4 in section 3.3.1). The first group of tasks in H.III-B belong to Topic 5 in section 3.3.1 – justify 3D geometry statements, but the “3D geometry statements” to be justified in the tasks in H.III-B involve the “perpendicularity” between lines and/or planes, and to determine the point-plane distance in the tasks in H.II-C also requires students to “justify the perpendicularity” between a line that passes through the point and the plane. Therefore, the first group of tasks in H.III-B and the tasks in H.II-C have overlapping detailed 3D geometry topics. Furthermore, all the tasks in class H.III-B and class H.II-C have one commonality – the 3D figures in the tasks can each be

linked with a 3D or 2D figural pattern. With all that said, we consider the whole class H.III-B as close to class H.II-C.

It is worth noting that the innate support in Task H.II-2 in class H.II-C is different from the other tasks in the same class: the drawing of the task figure in this task is in a distant perspective from the drawing of the related figural pattern given by the teacher. In class H.III-B there are no such cases; the drawings of task figures, as long as they are provided, are all in a similar perspective with the drawings of the related figural patterns given by the teacher. The specific innate support in Task H.II-2 is the main factor that shifts Huang towards some possibilities of inferences, when dealing with this task, in place of the original rules of coordination in scheme H.II-C. We will also take into account these possibilities of inferences when comparing the rules of coordination in schemes H.II-C and H.III-B.

Regarding the 3D DGEs in the two classes of situations, there are small differences between them in terms of figural representations, the tools mobilized and the feedback evoked, as elaborated below.

- The only one 3D DGE in class H.II-C contains a 3D dynamic model of the task figure, with labels alongside some elements. The two 3D DGEs in class H.III-B each contain a 3D dynamic model of the figure in the corresponding task, and the model is further situated in a cube;
- In the 3D DGE in class H.II-C, the tools mobilized are mainly *Dragging* and *Selecting*; In the 3D DGEs in class H.III-B, the tools mobilized include *Slider* and *Dilate* apart from *Dragging* and *Selecting*;
- With the *Dragging* tool always used to evoke the different views of 3D dynamic models, the *Selecting* tool is mobilized to evoke the labeled elements one by one in the 3D dynamic model in the 3D DGE in class H.II-C, and it is mobilized to highlight elements in 3D dynamic models in the 3D DGEs in class H.III-B;

The *Slider* and the *Dilate* tools in the 3D DGEs in class H.III-B are mobilized to control the extent to which a cube is “grinded” (its vertices are dilated with respect to the centers of the corresponding faces).

The differences above are mainly attributed to the different detailed 3D geometry topics of the tasks in the two classes of situations, Huang’s understanding of the different focus of task explanation and the different potentials of 3D dynamic models; this claim can be justified by some operational invariants respectively in scheme H.II-C and scheme H.III-B. To be specific, the task corresponding to the 3D DGE in H.II-C is about determining a point-plane distance within a 3D figure that can be linked with a 3D figural pattern, with the 3D figure being of the same shape as the figural pattern. So Huang only constructs the 3D dynamic model of the task figure itself in the 3D DGE, thinking that it is enough to support students’ perception (H.II-[49] in TPCOI). The *Selecting* tool is used to evoke the labeled elements one by one in the 3D dynamic model, because Huang thinks this could help with his explanation of the deductive reasoning process of applying the conclusion of the figural pattern and further calculating the point-plane distance (H.II-[51]-[52] in TPCOI), which is usually difficult for students and thus should be carefully explained (H.II-[47]-[48] in PCOI). As for the two tasks in class H.III-B, they are about justifying 3D geometry statements and determining geometric magnitudes in

space; the task figures don't contain the respective figural patterns themselves, instead, they are each embedded in a cube pattern. In particular, the figure in Task H.III-12 is a complex semi-regular polyhedron grinded from a cube. Here, the more important purpose of using the 3D DGEs for Huang is to illustrate the global link between the task figures and the cube pattern rather than the step-by-step calculation of geometric magnitudes, because the latter will finally be transferred into a plane context in the tasks. Therefore, Huang constructs the 3D dynamic models of task figures which are each situated in a cube, and highlights some critical elements within the whole dynamic model with the *Selecting* tool. Specifically, Huang uses the *Slider* tool and the *Dilate* command in the 3D DGE for Task H.III-12 to vividly show the process of a cube being "grinded" into the semi-regular polyhedron. All these are aimed to better illustrate the geometric structures of the task figures and their link with the cube pattern (H.III-[29]-[30], [35] in TPCOI). Huang also needs to know the techniques for adding labels to objects (H.II-[54] in TCOI) and the techniques of using *Slider* and *Dilate* (H.III-[49]-[50] in TCOI) to respectively implement the manipulations in the 3D DGEs for Task H.II-4 and Task H.III-12. Since the operational invariants in the schemes don't involve clues of the change in the teaching setting or Huang's reflection during the interval period, we claim that the differences between the 3D DGEs have no particular link with the distance online teaching setting.

Regarding the coordination schemes H.II-C and H.III-B, we firstly compare the rules of coordination therein. As can be seen from Table 5.27, schemes H.II-C and H.III-B both contain three rules of coordination basically, with scheme H.II-C also containing some possibilities of inferences in place of the second rule in that scheme. The third rule in scheme H.II-C is totally the same as that in scheme H.III-B. The differences only exist in the first two rules in the respective schemes, as elaborated below:

- In rules in scheme H.II-C, Huang only illustrates the 3D task figure itself (which has the same shape with the 3D figural pattern) in support of students' perception. In rules in scheme H.III-B, Huang not only illustrates the 3D task figure but also a related 2D/3D figural pattern;
- In rules in scheme H.II-C, Huang uses a 3D DGE or drawing to illustrate the 3D task figure, and he adds scaffolding lines to the drawing only for Task H.II-2;

In rules in scheme H.III-B, Huang always uses a drawing with handmade scaffolding lines to illustrate the 3D task figure and a related 2D/3D figural pattern; for the task figures linked to 3D figural patterns, he uses 3D DGEs more often than in scheme H.II-C, and the 3D DGEs coexist with the drawings and handmade scaffolding lines;

- In rules in scheme H.II-C, Huang also uses simulating gestures to illustrate the figure in Task H.II-2, whereas there is no use of hand gestures in scheme H.III-B;
- In rules in scheme H.II-C, it is mainly the students who make the figure-structural analogy between the task figure and a figural pattern, with the teacher indicating the particular figural pattern that can be referred to, requesting students' ideas about how to apply the conclusion about the figural pattern to the task figure, and develop the following theoretical deductive reasoning on that basis. In Task H.II-2 students make improper drawing-perceptive analogy between the task figure and the figural pattern. As the reaction, Huang

rebutts their ideas by reiterating that the conclusion should be transferred based on figure-structural analogy, and illustrating the task figure with scaffolding lines and simulating gestures, as mentioned in the first two differences;

In rules in scheme H.III-B, Huang directly makes the figure-structural analogy and develops theoretical deductive reasoning by himself, with students' drawing-perceptive analogy no longer appearing. Here Huang doesn't propose questions for students nor give rebuttals. Besides the resources mentioned in the first difference, he doesn't use other resources like gestures to provide perceptive illustration.

The first difference concerns the particular geometric objects illustrated by Huang in the rules of coordination. We see that it is only the task figure being illustrated in the rules of scheme H.II-C, and that it is both the task figure and the related figural pattern being illustrated in H.III-B. The difference here is similar to the differences between the 3D DGEs: it is simply a result of direct documentational genesis with no particular link with distance online teaching setting. We don't elaborate on the analysis process again.

The second difference concerns the resources used by Huang to illustrate the geometric objects in support of students' perception. We see that Huang uses scaffolding lines and 3D DGEs less frequently in rules in scheme H.II-C than in H.III-B. Here Huang gives explanations in reference to the distance online teaching setting in lesson series H.III, and the explanations are latter formulated as operational invariants. For example, Huang thinks that it can make students more concentrated if the teacher can make synchronous sketches during distance online learning (H.III-[31]); to integrate the synchronous sketches, he learns the techniques of using the external tablet and stylus (H.III-[38]); also, he finds it easy to learn to use new technological tools related to distance online teaching (H.III-[51]). These operational invariants only appear in the TPCOI, TCOI and BCOI in scheme H.III-B, and they allow us to understand why he would integrate handmade scaffolding lines in the corresponding rules of coordination. As for the more frequent use of 3D DGEs, Huang shows the consistent views that it is more convenient to display GeoGebra files and skip between different forms of digital files in distance online settings (H.III-[32], [37]). Then he learns some new techniques related to the use of the Tencent Classroom (H.III-[39]) to take advantage of the conveniences. Also, his perceived ease for integrating 3D DGEs into the distance online teaching (H.III-[53]) supports his willingness to use 3D DGEs in scheme H.III-B. Also, the operational invariants only appear in the TPCOI, TCOI and BCOI in scheme H.III-B. There are also newly appearing operational invariants that concern the potential of scaffolding lines for illustrating geometric structures of 3D figures in the drawings (H.III-[28] in PCOI), and pedagogical benefit of displaying 3D dynamic models together with drawings (H.III-[33]-[34] in TPCOI). Although these operational invariants have no particular link with the distance online teaching setting, they may be resulted from Huang's reflection during the interval period, as the incident encountered with respect to Task H.II-2 in the former class of situations H.II-C may let him realize the benefit of scaffolding lines and trigger his willingness of taking profit of 3D DGEs. We therefore consider the difference between the two schemes as a joint result of an indirect genesis with respect to class H.II-C and a direct documentational genesis with respect to class H.III-B. During the indirect genesis, the teacher is supposed to reflect on and improve his previous actions in lesson series H.II and generate some new knowledge and views. The actions and knowledge and views corresponds

to the implicit new rules of coordination and operational invariants in scheme H.II-C, and they are supposed to be the basis for Huang’s reactions to a new class of situations – H.III-B – which is close to H.II-C, with some implicit rules of coordination and operational invariants in scheme H.II-C being integrated into scheme H.III-B, Then in the direct genesis with respect to class H.III-B, Huang should go further develop his actions and knowledge and views related to scheme H.III-B. Particularly, in the direct genesis he should interact with the affordances of the distance online teaching setting class H.III-B for displaying various forms of digital files and the constraints of the teaching setting on the integration of hand sketches.

The third difference in rules of coordination concerns the use of hand gestures, or more precisely, the lack of hand gestures in rules in scheme H.III-B. For this difference, we cannot find the related operational invariants in the two schemes. This shows that Huang doesn’t recognize much of the pedagogical benefit of hand gestures, and that he is not so concerned about not being able to demonstrate hand gestures in the distance online teaching setting. Also, there are no clues to suggest that he takes any measures in the distance online lesson series to remedy this constraint. Since the constraint of the distance online teaching setting in the class of situations objectively causes the lack of gestures in scheme H.III-B, we simply consider the third difference between the two schemes as a result of a direct documentational genesis with respect to class H.III-B.

The fourth difference concerns the lack of students’ contribution and the teacher’s indirect contribution (requesting students’ ideas, confirming the correct ideas and rebutting incorrect ideas) in the rules in scheme H.III-B. In the interview, Huang explains this difference in reference to the constraints of the distance online teaching setting, and the explanations are later formulated as some TPCOI and TEOI in scheme H.III-B, which are the same as the case of the last pair of schemes. The TPCOI and TEOI concern the inconvenience of inviting students to answer questions synchronously and the time cost in waiting for students’ asynchronous responses in the distance online teaching setting based on Tencent Classroom(H.III-[17], [19] and [20]). Since the operational invariants involve no clues of Huang’s reflection during the interval period, the third difference between the two schemes can also be considered as a result of a direct documentational genesis with respect to class H.III-B, in which Huang also interacts with the constraints of the distance online teaching setting on teacher-student interactions in particular.

The third pair of close classes of situations are H.II-C and H.III-C, with the former in the real classroom lesson series H.II and the latter in the distance online lessons series H.III, as shown in Table 5.28.

Table 5.28 Third pair of classes of situations and the corresponding coordination schemes

Class of situations	H.II-C, real classroom lesson series	H.III-C, distance online lesson series
Characteristics of 3D geometry tasks and 3D DGEs	Tasks H.II-1 ~ 4 (subtask 2): 3D geometry topic: determine a distance from a point to a plane in a 3D figure that can be linked to a 3D figural pattern;	Tasks H.III-14 ~ 16: Detailed 3D geometry topics: validly justify geometric relationships in a 3D

	<p>Context and innate support: all tasks in paper-pencil environment; Tasks H.II-2 and H.II-3 respectively provide a drawing of the task figure which is in a different/ same perspective with the drawing of the related figural pattern; Tasks H.II-1 and H.II-4 with no innate support.</p> <p>3D DGE for Task H.II-4:</p> <p>Figural representations: 3D dynamic model of a complex 3D figure, with labels alongside some elements;</p> <p>Tools and feedback in GeoGebra: evoke labeled elements one by one in the 3D dynamic model by <i>Selecting</i> their names in the Algebra view; turn around the whole 3D dynamic tool with the <i>Dragging tool</i>.</p>	<p>figure that can be linked to a 3D figural pattern;</p> <p>Context and innate support: All tasks in paper-pencil environment; each provides a drawing for the task figure, which is in a similar perspective with the drawing of a related figural pattern.</p> <p>Two 3D DGE for Tasks H.III-15 and 16:</p> <p>Figural representations: 3D dynamic model of the task figure, with the part that fits a figural pattern being highlighted with a different color and further situated in a cube.</p> <p>Tools and feedback in GeoGebra: turn around the whole 3D dynamic model with the <i>Dragging tool</i>; highlight the part that fits a figural pattern with the <i>Selecting tool</i>.</p>
<p>Coordination scheme</p>	<p>Scheme H.II-C</p> <p>Rules of coordination:</p> <p>(1) use a 3D DGE or drawing to represent the task figure in support of students' perception;</p> <p>(2) request students to apply the conclusion about a figural pattern to the task figure based on figure-structural analogy;</p> <p>Possibilities of inferences when dealing with Task 2:</p> <ul style="list-style-type: none"> – rebut the drawing-perceptive analogy made by students and move them to figure-structural analogy between the figural pattern and the task figure; – illustrate the geometric structure of the task figure with scaffolding lines and simulating gestures <p>(3) take the conclusion about the task figure as a fact to develop the following theoretical deductive reasoning.</p> <p>Operational invariants:</p>	<p>Scheme H.III-C</p> <p>Rules of coordination:</p> <p>(1) develop theoretical deductive reasoning for solving the task with no reference to any figural pattern;</p> <p>(2) relate the 3D task figure with a figural pattern based on figure-structural analogy;</p> <p>(3) use a 3D DGE and/or a drawing with scaffolding lines to represent the task figure and the figural pattern in support of students' perception.</p> <p>Operational invariants:</p> <p>COI: H.III-[24] ~ [26], [54] ~ [56]: geometric conclusions about the 3D figural patterns and other math knowledge required for solving the tasks; [10] knowledge about the essence of a figural pattern;</p> <p>PCOI: [15] figural patterns can help students classify the various 3D geometry tasks; [27] potentials of drawings for supporting students' perception of 3D/2D figures; [28] scaffolding lines can help</p>

	<p>COI: H.II-[1] ~ [3], [20], [40] ~ [45] geometric conclusions about the 3D figural patterns and other math knowledge required for solving the tasks; H.II- [9], [39] knowledge about the essence of a figural pattern, and the condition for linking it to a figure;</p> <p>PCOI: H.II-[17] ~ [18] knowledge or views about how to help students solve GAOKAO exam tasks in reference to figural patterns; H.II-[46] potentials of drawings for supporting students' perception of 3D figures; H.II-[47] ~ [48] views about what is important in explaining task solving procedures, and linking the task figure to a figural pattern;</p> <p>TPCOI: H.II-[49] advantages of 3D dynamic models over drawings in supporting students' perception of complex 3D figures; H.II-[50] 3D dynamic models can trigger student learning interest; H.II-[51] views about how to display 3D dynamic models while promoting students' theoretical deductive reasoning; H.II-[52] potentials of labels in 3D DGEs for figure illustration; H.II-[53] potentials of the intelligent interactive board for figure illustration;</p> <p>TCOI: H.II-[31], [34] ~ [36] techniques and math knowledge required for designing 3D DGEs and manipulating in them; H.II-[54] techniques for adding labels in GeoGebra; H.II-[55] techniques for making hand sketches on the intelligent interactive board;</p> <p>BCOI: H.II-[37] confidence in his own skills related to GeoGebra; H.II-[38] perceived ease for designing 3D DGEs with GeoGebra;</p>	<p>illustrate the geometric structure of a figure represented by a drawing; [57] views about what kinds of tasks are not proper to be linked with a figural pattern; [58] too many figural patterns and conclusions will increase students' burden of memory.</p> <p>TPCOI: [17] views about the constraints of the Tencent Classroom platform on synchronous interaction; [29] ~ [30] potentials of 3D dynamic models for supporting students' perception of complex 3D figures and their link with 3D figural patterns; [31] views about how the synchronous hand drawings and writings can support student learning; [32] views about convenience of displaying GeoGebra files in distance online setting; [33] ~ [34] pedagogical benefit of displaying 3D dynamic models with drawings and scaffolding lines. [35] teachers can select certain elements in 3D dynamic models, to facilitate students' observation and his oral explanation; [37] affordances of the Tencent Classroom platform for displaying various forms of digital files; [59] colors designated to certain elements of 3D dynamic models can facilitate students' observation and teachers' oral explanation in distance online teaching.</p> <p>TEOI: H.III-[18] views about the time limit on review lessons; H.III-[19] ~ [20] views about the time cost in dealing with particular students' problems, and asynchronous interactions, at the Tencent Classroom platform;</p> <p>TCOI: [38] techniques of using external tablet and stylus to add external tablet and stylus to the computer screen; [39] techniques of using Tencent Classroom; [40] ~ [46] techniques and math knowledge required for designing 3D DGEs and manipulating in them; [60] techniques for modifying colors of objects in GeoGebra;</p>
--	---	---

	SNOI: H.II-[19] perceived norms for open class; H.II-[20] perceived expectation of the coordinator of the teaching research group.	BCOI: [51] perceived ease for learning to use new technological tools for distance online teaching; [52] ~ [53] perceived ease for designing 3D DGEs with GeoGebra, and integrating them into distance online teaching.
--	--	---

The tasks in class of situations H.II-C are all about determining the distance from a point to a plane in a 3D figure that can be linked to a 3D figural pattern. The tasks in class of situations H.III-C are all about justifying a statement about a geometric relationship in a 3D figure that can be linked to a 3D figural pattern, and the geometric relationship is either the parallelism or the perpendicularity between a line and a plane. As can be seen, the tasks in H.III-C and the tasks in H.II-C don't have the same general 3D geometry topic: they respectively belong to Topic 5 (justify a given 3D geometry statement) and Topic 4 (determining geometric magnitudes in space) in section 3.3.1. Nevertheless, the two groups of tasks have overlapping content in their detailed 3D geometry topics, as the statements to be justified in the tasks in H.III-C involve "perpendicularity" between a line and a plane, and to determine the point-plane distance in the tasks in H.III-C also requires students to "justify the perpendicularity" between a line that passes through the point and the plane. Furthermore, all the tasks in class H.III-C and class H.II-C have one commonality – the 3D figures in the tasks can each be linked with a 3D or 2D figural pattern. With all that said, we consider the whole class H.III-C as close to class H.II-C.

Combining this pair of classes of situations with the second pair, we can find that both class H.III-C and class H.III-B are close to class H.II-C, but there is a divergence between the schemes for classes H.III-C and H.III-B. The divergence can be linked with the differences between the innate support in the tasks in the two classes of situations. The innate support in tasks in class H.III-C are mainly the drawings of task figures which are in a distant perspective from the drawings of the corresponding figural patterns, whereas the innate support in tasks in class H.III-B are mainly the drawings of task figures which are in a similar perspective from the drawings of the corresponding figural patterns. The two kinds of innate support exactly correspond to the cases of Task H.II-2 and the other tasks in class H.II-C, for which we respectively identify some possibilities of inferences and the original rules of coordination in the corresponding scheme H.II-C. Therefore, the transition from class of situations H.II-C to classes H.III-B and H.III-C corresponds to a divergence of scheme, in which the rules of coordination and possibilities of inferences in the single scheme H.II-C in the second lesson series are transformed into two separate schemes H.III-B and H.III-C in the third lessons series, to face the two classes of situations containing the tasks with different innate support. The transformation from scheme H.II-C to scheme H.III-B is already discussed, and in this part, we will mainly discuss the transformation from scheme H.II-C to scheme H.III-C.

Before discussing the transformation of scheme, we need to discuss the differences between the 3D DGEs in classes of situations, H.II-C to scheme H.III-C. The tools mobilized in the 3D DGEs are the same, that is *Dragging* and *Selecting*, but the 3D DGEs have small differences

in terms of the figural representations and the feedback evoked by the *Selecting* tool, as elaborated below:

- In the class H.II-C, the only one 3D DGE contains a 3D dynamic model of the task figure, with labels alongside some elements; in class H.III-C, the two 3D DGE respectively for two tasks each contain a 3D dynamic model of the task figure, and a part of the 3D dynamic model is set in a different color and further situated in a cube;
- In the 3D DGE in class H.II-C, the *Selecting* tool is mobilized to evoke the labeled elements one by one in the 3D dynamic model; in the two 3D DGEs in class H.III-C, the *Selecting* tool is mobilized to highlight some elements in the 3D dynamic models.

The two differences in 3D DGEs mainly result from the different detailed 3D geometry topics of the tasks in the two classes of situations, and Huang's understanding of the different focus of task explanation and the different potentials of 3D dynamic models. This claim can be justified by the operational invariants in the corresponding schemes. For example, the task corresponding to the 3D DGE in H.II-C is about determining a point-plane distance within a 3D figure that can be linked with a 3D figural pattern, with the 3D figure being of the same shape as the figural pattern. So Huang only constructs the 3D dynamic model of the task figure itself in the 3D DGE, thinking that it is enough to support students' perception (H.II-[49] in TPCOI), which is usually difficult for students and thus should be carefully explained (H.II-[47] ~ [48] in PCOI). The *Selecting* tool is used to evoke the labeled elements one by one in the 3D dynamic model, because Huang thinks this could help with his explanation of the deductive reasoning process of applying the conclusion of the figural pattern and further calculating the point-plane distance (H.II-[51] ~ [52] in TPCOI). As for the two tasks corresponding to the 3D DGEs in class H.III-B, they are about justifying 3D geometry statements related to a 3D figure that can be linked with a 3D figural pattern; the 3D figural pattern only constitutes a part of the 3D figure and it is essentially a sub-object of a cube. Then Huang constructs the 3D dynamic models of the task figures and embeds the part linked with a 3D figural pattern within a cube, he also mobilizes the *Selecting* tool to highlight the elements in the particular part; all these are aimed to better illustrate the geometric structure of the 3D figural patterns and their link with the task figures (H.III-[29] ~ [30] and [35] in TPCOI).

The differences in 3D DGEs are also influenced by the change in the teaching setting. In the 3D DGEs in class H.III-C, Huang adds different colors to the critical parts in the 3D dynamic models specially to refer to them more conveniently in the distance online teaching. This can be supported by Huang's words in the interview, which concern the inconvenience of referring to figural elements orally in distance online teaching, and how the different colors added to 3D dynamic models can help. The ideas are later reformulated as operational invariant H.III-[59] in TPCOI. Also, Huang specifically requires to know the techniques for setting different colors to objects in GeoGebra (H.III-[60] in TCOI)

Regarding the coordination schemes corresponding to the two classes of situations, we firstly compare the rules of coordination therein. As can be seen from Table 5.28, scheme H.II-C and scheme H.III-C both contain three rules of coordination basically, with scheme H.II-C also containing some possibilities of inferences in place of the second rule therein. The rules of

coordination in the two schemes differ significantly in both order and content, as elaborated below:

- In rules in scheme H.II-C, the figure-structural analogy between a task figure and a figural pattern is made first and the conclusion obtained is integrated into the theoretical deductive reasoning for solving the task; in rules in scheme H.III-C, the theoretical deductive reasoning for solving the task is implemented independently, and only after that the task figure is linked to a figural pattern;
- In rules in scheme H.II-C, Huang only illustrates the 3D task figure itself (which has the same shape with the 3D figural pattern) in support of students' perception. In rules in scheme H.III-C, Huang not only illustrates the 3D task figure but also a related 3D figural pattern which is further situated in a cube;
- In rules in scheme H.II-C, Huang uses a 3D DGE or drawing to illustrate the 3D task figure, and he uses scaffolding lines and simulating gestures to better illustrate the figure in only one task. In rules in scheme H.III-C, Huang firstly uses a drawing to illustrate the 3D task figure; in the end, he uses a 3D DGE for two of the three tasks and scaffolding lines for all the three tasks in class H.III-C, to better illustrate the 3D task figure but also a related 3D figural pattern;
- In rules in scheme H.II-C, Huang also uses simulating gestures to illustrate the figure in Task H.II-2, whereas there is no use of hand gestures in scheme H.III-C;
- In rules in scheme H.II-C, it is mainly the students who make the figure-structural analogy between the task figure and a figural pattern, with the teacher indicating the particular figural pattern that can be referred to, requesting students' ideas about how to apply the conclusion about the figural pattern to the task figure, and develop the following theoretical deductive reasoning on that basis. There is only one task in which students make improper drawing-perceptive analogy between the task figure and the figural pattern. As the reaction, Huang rebuts their ideas by reiterating that the conclusion should be transferred based on figure-structural analogy; he also illustrates the task figure with scaffolding lines and simulating gestures, as mentioned in the second difference;

In rules in scheme H.III-B, Huang directly makes the figure-structural analogy and develops theoretical deductive reasoning by himself, with students' drawing-perceptive analogy no longer appearing. Here Huang doesn't propose questions for students nor give rebuttals. Besides the resources mentioned in the first difference, he doesn't use other resources like gestures to provide perceptive illustration.

The first difference concerns the relation between figural patterns and the task solving processes. In class of situations H.II-C Huang tries to let students apply the known conclusions about related figural patterns to solve the tasks, but students encounter many difficulties in Task H.II-2 which provides a drawing of the task figure in a distant perspective from the drawing of the figural pattern. Then in class of situations H.III-C, for explaining the tasks with the drawings similar to the case of Task H.II-2, Huang chooses to solve the tasks in a general way without referring to the known conclusion about any figural pattern. With respect to this

difference, Huang mentions his reflection after lesson series H.II and after the exchange with the coordinator of the teaching research group. As what are later integrated into the operational invariants in scheme H.III-C, Huang realizes that if students can hardly identify the figural pattern fit by the task figure, it should be better to let them solve the task with general procedures without referring to the figural pattern (H.III-[57] in PCOI) and that too many patterns will increase the burden of memory of students (H.III-[58] in PCOI). This reflection during the interval period can be considered as an indirect documentational genesis with respect to class of situations H.II-C. The genesis leads to some new operational invariants and implicitly improved rules of actions in a new version of scheme H.II-C, which serve as the base of scheme H.III-C. Therefore, we consider the first difference between the two schemes as the result of an indirect genesis with respect to class H.II-C.

The second difference concerns the particular geometric objects illustrated by Huang in the rules of coordination, the difference here is similar to the first difference between the second pair of schemes – they are both a result of direct documentational genesis with no particular link with distance online teaching setting, we don't elaborate the analysis process again.

The third difference concerns the resources used by Huang to support students' perception. We see that Huang uses scaffolding lines and 3D DGEs in rules in scheme H.II-C less frequently than in H.III-C. Similar to the case of the second pair of scheme, we can see related operational invariants specifically in the TPCOI, TCOI and BCOI in scheme H.III-C, such as H.III-[31], [32], [37], [38], [39], [51] and [53]. They show that Huang uses scaffolding lines and 3D DGEs more frequently because he wants students to be more concentrated in the distance online setting and the setting provides facilities for displaying 3D DGEs and skipping between different forms of digital files. There are also newly appearing operational invariants that concern the potential of scaffolding lines for illustrating geometric structures of figures in the drawings (H.III-[28] in PCOI), and pedagogical benefit of displaying 3D dynamic models together with drawings (H.III-[33]-[34] in TPCOI). We therefore consider the difference in the use of 3D DGEs and scaffolding lines between the two schemes as a joint result of an indirect genesis (with respect to class H.II-C) and a direct genesis (with respect to class H.III-C). During the direct genesis, Huang particularly interacts with the affordances of the distance online teaching setting in displaying digital files and its constraints on the integration of hand sketches

The fourth difference concerns the use of hand gestures, and in particular the lack of hand gestures in rules in scheme H.III-C. Similar to the third difference between the second pair of schemes, the difference here can be considered as a result of a direct documentational genesis with respect to class H.III-B, in which Huang has interacted with the constraint of the distance online teaching setting on the demonstration of hand gestures in that class of situations.

The fifth difference concerns the lack of students' contribution and the teacher's indirect contribution (requesting students' ideas, confirming the correct ideas and rebutting incorrect ideas) in rules of coordination H.III-C. This difference is similar to the fourth difference between the second pair of schemes – they can both be considered as a result of the direct genesis with respect to class H.III-C, in which Huang particularly interacts with the constraints of the distance online teaching setting in that class of situations with respect to synchronous and asynchronous teacher-student interaction.

6 Conclusion, reflection and perspective

This section is divided into two parts: section 6.1 presents the conclusion of this thesis, as a response to the two groups of research questions in this thesis; section 6.2 reflects on this conclusion, the theoretical framework, and the methodology of this thesis, and proposes some perspectives for further research and the improvement of the conditions of teachers' work.

6.1 Conclusion

In this section we examine the results to the two groups of research questions formulated in section 3.2:

- The first group of questions are about teachers' coordination in real classroom lesson series, it consists of two questions: question 1.1 is interested in the link between the rules of coordination and the categories of operational invariants in the corresponding coordination schemes; question 1.2 is interested in the link between the coordination schemes and the characteristics of tasks and 3D DGEs. Since the two questions concerns different levels of links, we answer them separately, respectively in sections 6.1.1 and 6.1.2.
- The second group of questions are about the transformation of teachers' coordination from real classroom lesson series to distance online lesson series. There are three questions in this group, which are respectively about: (2.1) the differences between the 3D DGEs in the pairs of *close* classes of situations; (2.2) the differences between the coordination schemes for the two classes of situations in each pair; and (2.3) how can the differences be related to indirect or direct documentational geneses. Since the indirect or direct geneses are identified as soon as the differences are presented, we answer the three questions together, as presented in section 6.1.3.

6.1.1 Answers to research question 1.1

The complete text of question 1.1 is "How the rules of coordination of a teacher can be linked with the different categories of operational invariants in the corresponding coordination schemes". To answer this question, we firstly give an overview of the rules of coordination of the three teachers in their real classroom lesson series. Here we do not repeat the original content of the rules of coordination but highlight the teachers' emphasis, the interaction between students' perception and logical reasoning, and the teachers' fostering strategies in their rules of coordinaiton, as shown in Table 6.1. Based on the table, we discuss the differences between the groups of rules and link them to the related operational invariants, by synthesizing the summaries in sections 5.1.5, 5.2.5, 5.3.5 and 5.3.10.

Table 6.1 Summary of rules of coordination of Dora, Sonia and Huang

Teacher/ label of rules of coordination	Emphasis	Interaction between students' perception and logical reasoning (and teacher's fostering strategies)
---	----------	--

Dora, D.I-A	Theoretical deductive reasoning	Perceptive support (provided by teacher with simulating gestures) w.r.t the geometric theorems/facts used in theoretical deductive reasoning
Dora, D.I-B	Theoretical deductive reasoning	Perception result in 3D DGE is possibly rebutted 3D DGE feedback (evoked by teacher) and finally replaced by theoretical deductive reasoning result (teacher requests evaluation and explanation and validates the latter result)
Dora, D.I-C	Theoretical deductive reasoning	Perception result explored in 3D DGE (teacher guides the exploration with geometric theorems and validates the result) serves as a fact in theoretical deductive reasoning
Dora, D.I-D	Perception	Perceptive evidences (evoked by teacher with 3D DGE) rebut students' incorrect statements and lead to a correct one (directly validated by teacher)
Dora, D.I-E	Theoretical deductive reasoning	Perceptive support (provided by teacher with simulating gestures or real objects) w.r.t the geometric definitions or conclusions involved in theoretical deductive reasoning
Sonia, S.I-A	Theoretical deductive reasoning	Perception result in 3D DGE replaced by theoretical deductive reasoning result (teacher requests multiple students' evaluation and explanation and validates the latter result)
Sonia, S.I-B	Perception	Perceptive evidences (evoked by teacher with a 3D DGE, real objects, and simulating gestures) rebut incorrect statements and lead to a correct one (directly validated by teacher)
Sonia, S.I-C	Theoretical deductive reasoning	Perception evidence (evoked by teacher with a 3D DGE and simulating gestures) serves as a fact in theoretical deductive reasoning
Huang, H.I-A	Abductive reasoning	Result of abductive reasoning (on a drawing of a cube provided by teacher) is confirmed by perceptive evidences in a 3D DGE (evoked by teacher)
Huang, H.I-B	Perception and inductive reasoning	Result of perception and/or inductive reasoning (teacher uses a 3D DGE and simulating gestures and requests ideas) is explained by theoretical deductive reasoning (teacher requests explanation)
Huang, H.I-C	Theoretical deductive reasoning	Perceptive result explored in 3D DGE (teacher guides the exploration with geometric theorems and validates the result) serves as a fact in theoretical deductive reasoning
Huang, H.II-A	Inductive and theoretical deductive reasoning	Result of perception and/or inductive reasoning (on a drawing provided by teacher) is explained by simplified theoretical deductive reasoning (teacher requests explanation)

Huang, H.II-B	Perception and inductive reasoning	Result of perception and/or inductive reasoning (on a drawing provided by teacher) is confirmed by more perceptive evidence in 3D DGE (evoked by teacher)
Huang, H.II-C	Theoretical deductive reasoning	Perceptive support (provided by teacher with a drawing or 3D DGE) w.r.t the figure-structural analogy involved in theoretical deductive reasoning

As can be seen in Table 6.1, in their rules of coordination, the teachers emphasize different activities of students (a particular logical reasoning or perception), and the interaction between students' logical reasoning and perception also vary by group. This aspect corresponds to the nature of the argumentation components and their organization in the general diagram of argumentation. The two French teachers, Dora and Sonia, both emphasize students' theoretical deductive reasoning in almost all their rules of coordination: sometimes they rebut the results perceived by students in 3D DGEs and move them to theoretical deductive reasoning as in D.I-B and S.I-A; sometimes they let students take the perception results directly as facts but the results are explored with the idea of applying geometric theorems, as in D.I-C and S.I-C. Dora and Sonia focus on students' perception in only one group respectively, that is D.I-D and S.I-B. The Chinese teacher, Huang, shows more flexibility in his emphasis and the interaction between students' logical reasoning and perception. Sometimes he emphasizes students' abductive reasoning and make students to be certain of the result with perceptive evidences in a 3D DGE, as in H.I-A. Sometimes he only emphasizes students' perception and inductive reasoning, supporting these activities with a 3D DGE and directly validating the result, as in H.II-B. Huang would also make students take the perception results in 3D DGEs as facts when the results are explored with the idea of applying geometric theorems, with his emphasis remaining on students theoretical deductive reasoning, as in H.I-C. The last group is similar to D.I-C and S.I-C in the cases of Dora and Sonia.

The three teachers also adopt various strategies to foster students' activities in their rules of coordination. This aspect corresponds to the indirect contribution of the teacher in the general diagram of argumentation. Concerning the strategies to foster students' theoretical deductive reasoning, Dora and Sonia mobilize more diverse strategies than Huang. For example, Dora takes advantages of the feedback in 3D DGEs to promote students' theoretical deductive reasoning (D.I-B); Sonia mobilizes the strategy of requesting multiple students' ideas or evaluation (S.I-A). Concerning the strategies to foster students' perception and non-deductive logical reasoning, both Dora and Sonia use diverse resources including 3D DGEs, simulating gestures and 3D real objects, to support students' perception (D.I-A ~ E, S.I-B ~ C), whereas Huang mainly uses 3D DGEs. However, the perceptive effects that Huang evokes in 3D DGEs are more diverse than Sonia and Dora, including the rotation and translation of sections of solids, the rotation of a cube around its diagonal, the multiple examples of pyramids in a cube when the vertex is dragged around the cube's diagonal face (see H.I-A ~ C, H.II-B). While Dora and Sonia do not foster students' inductive or abductive reasoning in their rules of coordination, Huang fosters students' inductive reasoning with the strategies like: requesting students to discover regularities in a variation process in a 3D DGE (H.I-B and H.II-B), and highlighting the symmetric variation of a magnitude without indicating its precise values in a

3D DGE (H.I-C). In H.I-A, Huang fosters students' abudcitive reasoning by helping students to construct a drawing within a frame of a cube.

As regards to the subjects who perform the operations in the 3D DGEs and the designer of the 3D DGEs, there are differences between the three teachers' cases. In the case of Dora and Sonia, it is mainly the students who perform actions in the 3D DGEs, with the teacher being a monitor. There is only one group of rules in which Dora performs the operations herself, that is D.I-D. In the case of Huang, it is always the teacher who performs operations in the 3D DGEs. In the two French cases, the 3D DGEs are not designed by the teachers themselves except those in D.I-D; whereas in the Chinese case, the 3D DGEs are all designed by the teacher himself. It is worth noting that although Dora and Sonia both monitor students' operations in 3D DGEs in their rules of coordination, they both focus on the mathematics aspects of students' activities in the 3D DGEs and weaken the technological aspect.

Now we discuss how the rules of coordination can be linked with the different categories of operational invariants.

1. For Dora and Sonia, their emphasis on students' theoretical deductive reasoning in most of the rules of coordination is linked with operational invariants about content (COI) and pedagogy of content (PCOI).

The emphasis laid by Dora and Sonia on students' theoretical deductive reasoning is particularly linked with some operational invariants about content (COI) and pedagogy of content (PCOI). These COI and PCOI reflect the teachers' knowledge and views about: what is important in learning and teaching 3D geometry, general solutions to the tasks of intersection construction, the curriculum prescriptions and the BAC requirements with respect to the tasks. For example, in the COI of Dora and Sonia, we can find the common operational invariant "the tasks concerning intersections in space should be solved with geometric theorems and facts". The idea is consistent with French curriculum which prescribes a geometric approach to such tasks at the beginning of learning 3D geometry. In the PCOI of Dora, we can find operational invariants "the appreciation of geometric theorems and facts is the most important in learning 3D geometry". In the PCOI, Dora also shows the concern for the BAC requirements, according to which students have to justify sections of a cube constructed on the paper. In the PCOI of Sonia, we find the operational invariant: "students should be able to construct intersections in space and meanwhile to justify them with geometric theorems".

2. For Dora and Sonia, their emphasis or more attention paid to students' perception in certain rules of coordination (D.I-D, D.I-C, S.I-B and S.I-C) is linked with operational invariants about pedagogy of content (PCOI), and technology in pedagogy of content (TPCOI).

These PCOI and TPCOI reflect the teachers' knowledge and views about: students' difficulties in the 3D geometry tasks at stake, and the great potentials of 3D DGEs/ simulating gestures/ real objects in supporting students' perception.

For example, the tasks corresponding to D.I-D consist in identifying spatial relationships faithfully represented by 2D figural representations. In the corresponding PCOI and TPCOI of Dora, she shows the ideas that such tasks are difficult for students, and that 3D dynamic models can especially help them to connect spatial relationships in 3D objects with those in 2D figural representations. The tasks corresponding to S.I-B consist in summarizing geometric theorems

about the relative positions of a line and a line/plane in space. In the corresponding PCOI of Sonia, she shows the ideas that it's important to emphasize the basic geometric theorems where students often get confused, and that 3D real objects work better than 3D dynamic models for illustrating spatial figures and relationships.

3. *For Huang, his different emphasis in different groups of rules of coordination is linked with operational invariants about content (COI) and pedagogy of content (PCOI).*

Huang emphasizes indeed different modes of logical reasoning in different groups of rules of coordination, with students' perception being attached with different status. This is mainly linked with some operational invariants about content (COI) and pedagogy of content (PCOI). These operational invariants concern Huang's knowledge and views about GAOKAO requirements with respect to the 3D geometry tasks at stake, how to get correct answers to the tasks as efficiently as possible within the constraint of the requirements, and the pedagogical strategies to help students understand the task solutions.

For example, in rules of coordination H.I-A, Huang mainly promotes students' abductive reasoning, and he supports their perception with a 3D DGE only at the end to help them confirm the abductive reasoning result. In the corresponding PCOI and COI of Huang, we can respectively find the operational invariants "GAOKAO examination requires students to solve tasks within a paper-pencil environment without help from computer" and "only way to solve the corresponding tasks – construct the original solid corresponding to a given three-view diagram – is to develop abductive reasoning in from drawing of a cube". In the PCOI, he also shows the knowledge about students' difficulty in getting certain of the solid constructed on the paper; that is why he uses a 3D DGE to provide auxiliary perceptive support in the rules of coordination. In rules of Group H.I-C, Huang supports the perception and/or inductive reasoning of students at first, and he makes students directly apply the corresponding result as a factual premise in the following theoretical deductive reasoning. In the corresponding PCOI, we can see that he maintains the view about the GAOKAO examination requirements on students' task solving abilities in the paper-pencil environment. But in the PCOI we can also find his views about the importance of students' spatial imagination for solving the tasks at stake, and he believes "experiences of observing 3D objects can support students' spatial imagination in paper context". Besides, the tasks in class H.I-C are all multiple-choice item in GAOKAO, for which Huang thinks that students only need to give a right answer and thus they can take advantage of their imagination and inductive reasoning to solve the task more efficiently in the exam; these ideas can all be found in the PCOI corresponding to H.I-C.

4. *For Huang and Dora, the bigger importance they attach to students' perception in certain rules of coordination (D.I-A, D.I-C and H.II-B) is linked with operational invariants about time economy (TEOI).*

We get this result because in the TCOI corresponding to these rules of coordination, Huang and Dora show the similar views about the power of the perceptive effects in simulating gestures and 3D DGEs – they think the perceptive effects can make students certain of the truth of some geometric theorems and facts without rigorous proof, and thus can save their time in explaining the tasks.

5. *For all the three teachers, their strategies to support students' perception and logical reasoning are linked with operational invariants about pedagogy of content (PCOI) and the technology in pedagogy of content (TPCOI).*

These operational invariants concern the teachers' knowledge and views about the potentials and side effects of the available resources with respect to students' perception or logical reasoning, and the pedagogical strategies to exploit the potentials or overcome the side effects. For example, the various resources that Dora and Sonia use to support students' perception in their rules of coordination are underpinned by their knowledge or views about the corresponding potential of simulating gestures, 3D DGEs, and 3D real objects for students' perception, which are involved in the corresponding PCOI and TPCOI. Dora also uses feedback in the 3D DGEs to stimulate students' theoretical deductive reasoning in rules of coordination D.I-B, but Sonia mainly uses non-technological strategies such as requesting multiple students' ideas to promote the theoretical deductive reasoning, as shown in S.I-A. This is consistent with the TPCOI of the two teachers, in which Sonia shows more sensitiveness to the side effects of the 3D DGEs for students' theoretical deductive reasoning, whereas Dora shows her knowledge about the various types of feedback in the 3D DGEs and how to exploit them to stimulate students' need for using theorems. As for Huang, he uses various strategies to support students' perception and inductive reasoning with 3D DGEs in his rules of coordination. This is underpinned by his abundant knowledge reserve about the potentials of 3D DGEs and pedagogical strategies to exploit these potentials, which are reflected in the corresponding TPCOI. In rules of coordination H.I-A, Huang promotes students' abductive reasoning mainly in the paper-pencil environment. In the corresponding TPCOI, he shows the consistent views about the side effects of the 3D DGEs for students' abductive reasoning related to three-view diagram tasks.

6. *Teachers' willingness of designing themselves the 3D DGEs to be used in the rules of coordination is linked with operational invariants about technology and content (TCOI) and behavior control (BCOI).*

Although all the three teachers use 3D DGEs in their rules of coordination, Sonia and Dora mainly use the 3D DGEs available online designed by others, whereas Huang always uses the 3D DGEs designed by himself. This difference is linked with the gap between the TCOI, BCOI of Huang and those of the former two teachers.

To be specific, the TCOI and BCOI in the cases of Sonia and Dora are mostly about the technological skills and the associated mathematics knowledge required for operations in the 3D DGEs, such as turning around 3D dynamic models, constructing lines and intersection of lines, and checking answers. These operations are just what the available 3D DGEs allow users to do. In addition, there is no BCOI being inferred with respect to the two teachers' rules of coordination. They don't show specific concern or confidence in using the available 3D DGEs in class. By contrast, the TCOI in the case of Huang are much more fruitful, in which we can find the technological skills and mathematics knowledge for rotating a cube around its diagonal, for constructing the intersection of surfaces, for translating or rotating a section plane, for displaying multiple examples of pyramids in a cube with their vertex being a free point in the cube's diagonal face. These TCOI allow him to easily and flexibly design 3D DGEs according to his didactical objectives and to use them to support students' perception and inductive

reasoning. Furthermore, there are BCOI being inferred with respect to most of Huang's rules of coordination, as he clearly shows the confidence in his own technological skills, and the ease for him in designing 3D DGEs and using them in class.

From the contrast we can see that the more technological and mathematical knowledge that teachers have about 3D DGEs and the more confident they are in their behavior control related to 3D DGEs, the more likely they are able to design 3D DGEs flexibly according to their own didactical objectives and use them in service of the coordination.

7. *For Dora and Sonia, their focus on students' mathematical or technological activities in the rules of coordination are linked with operational invariants about pedagogy for linking technology and content (PTCOI).*

Both Dora and Sonia need to take into account students' operations in 3D DGEs in some of their rules of coordination, which is not the case for Huang. Then we can find some PTCOI specifically for the rules of coordination of Dora and Sonia. Furthermore, the PTCOI reflect Dora's views about letting students learning the technological skills autonomously, and Sonia's views about introducing the technological skills step-by-step a priori and focusing students on the mathematics content later on. Obviously, it is these views that lead Dora and Sonia both focusing on students' mathematical activities in their rules of coordination. We thus establish a link between the two teachers' focus on students' mathematics activities with PTCOI.

8. *For Huang, his willingness of using 3D DGEs and ancient figural patterns in the rules of coordination are linked with operational invariants about social norms (SNOI).*

These SNOI allow us to understand why Huang would use 3D DGEs so frequently and specifically refer to ancient figural patterns in the rules of coordination. In fact, the two lesson series of Huang are both open classes in which he is expected by the local board of education or the teaching research group of the school to use GeoGebra files (3D DGEs) to teach 3D geometry. The expectation is well recognized by Huang, which are reflected in the SNOI for most of rules of coordination. In rules of coordination H.II-A, Huang specifically refers to the figural patterns in ancient Chinese mathematics; in the corresponding SNOI, he mentions that this is influenced by the assessment criteria for open class. Therefore, we can say that the social norms on open classes, and the expectations from the institution realized by Huang, has motivated his use of 3D DGEs and ancient figural patterns in the rules of coordination.

Based on the discussion above, we can give a synthetic answer to the research question 1.1. Sonia and Dora generally emphasize students' theoretical deductive reasoning in their rules of coordination, and it is mainly based on their understanding of the task solutions, the examination and curriculum prescriptions with respect to the tasks, which belong to COI and PCOI. They would emphasize students' perception only when the perceptive support from 3D DGEs/ simulating gestures/ 3D real objects is especially helpful for solving the 3D geometry tasks, which belong to PCOI and TPCOI. The Chinese teacher shows more flexibility in his emphasis in the rules of coordination, and his main concern is whether the particular logical reasoning and perception activities would allow students to solve the 3D geometry tasks efficiently within the constraint of the examination requirements, which mainly belong to COI and PCOI. In particular, when the GAOKAO examination only requires a simple answer for the 3D geometry tasks, Huang would emphasize non-deductive reasoning and encourage

students' use of perception. It is also linked with their consideration of time economy (TEOI) that Huang and Dora attach more importance to students' perception in certain rules of coordination. The three teachers' strategies to support students' perception and logical reasoning are linked with their general pedagogical content knowledge, their knowledge and views about the potentials and side effects of 3D DGEs, and the pedagogical knowledge for exploiting the potentials or overcoming the side effects of 3D DGEs. These pieces of knowledge and views belong to PCOI and TPCOI. The more knowledge a teacher has about the potentials of 3D DGEs and the pedagogical strategies for exploiting these potentials, the more fruitful their strategies will be. Huang's willingness of using the 3D DGEs designed by himself in the rules of coordination is closely linked with his abundant technological and mathematical knowledge and confidence in behavior control (TCOI and BCOI). Dora's and Sonia's views on how to teach students' technological skills (PTCOI) lead them to both focus on students' mathematical activities in the rules of coordination. Huang's views about social norms (SNOI) are specifically linked with his use of some resources, such as ancient figural patterns and 3D DGEs, in the rules of coordination.

6.1.2 Answers to research question 1.2

The complete text of research question 1.2 is "How can the coordination schemes be influenced by the characteristics of the 3D geometry tasks-3D DGEs in the corresponding classes of situations". Similar to the last question, we answer this question by synthesizing the summaries of the lesson series in sections 5.1.5, 5.2.5, 5.3.5 and 5.3.10. Here we give 6 statements as the response for the question. For each statement, we firstly introduce the link between the rules of coordination in the schemes and the characteristics of the tasks-3D DGEs, and then introduce the operational invariants in the corresponding schemes to justify the link.

1. For Dora and Sonia, their general emphasis on students' theoretical deductive reasoning is influenced by the 3D geometry topics of the tasks and their status in the French curriculum and the BAC examination.

Both Dora and Sonia emphasize the development of students' theoretical deductive reasoning in all the groups of rules of coordination except in D.I-D and S.I-B. The tasks corresponding to the most groups of rules either consist in constructing intersections of lines and/or planes in space or identifying spatial relationships between lines. The tasks can generally be solved through theoretical deductive reasoning in reference to theorems, facts, or definitions in Euclidean 3D geometry. The French curriculum also prescribes a Euclidean geometric approach (approximates to theoretical deductive reasoning) to the problems with the same topics at first, though it puts more emphasis on the vector approach later on. Furthermore, the BAC examination requires students to give mathematics justification in the tasks of constructing sections of a cube, which is closely linked with the intersection construction tasks here. The general task solutions, the curriculum prescriptions and the examination requirements are well understood by Sonia and Dora, as reflected in the corresponding COI and PCOI in their cases, which justify the influence mentioned in the statement above.

2. For Dora and Sonia, their emphasis or more attention paid to students' perception in certain rules of coordination (D.I-D, D.I-C, S.I-B and S.I-C) is influenced by the features of figural representations in the 3D DGEs.

Dora and Sonia emphasize students' perception respectively in rules of coordination D.I-D and S.I-B, and they pay more attention to students' perception respectively in D.I-C and S.I-C. Actually, the tasks in class D.I-D consist in contrasting the perceptive effects of geometric relationships on a 3D real object and a 2D figural representation, which can only be solved by observation, and the 3D dynamic model in the 3D DGE designed by herself can provide efficient perceptive support in this aspect. The tasks in class S.I-B are about summarizing all the possible relative positions between a line and a plane, two lines or two planes in space. This concerns basic geometric facts that students do not need to derive through theoretical deductive reasoning, and Sonia takes advantage of the perceptive effects of simulating gestures and 3D real objects, in completion with those in the 3D DGEs, to make students accept the basic geometric facts with certainty. The tasks in classes D.I-C and S.I-C consist in constructing the intersection of lines and/or planes in space, but students have difficulty in imagining a particular plane, which is essential for constructing the target intersection, then the teachers encourage students to directly perceive some results in 3D dynamic models in the given 3D DGEs and use the perceived results to develop the following theoretical deductive reasoning. In the corresponding PCOI and TPCOI, the two teachers show their knowledge or views about students' difficulties in the spatial imagination related to the tasks, and the distinct potentials and side effects of the 3D dynamic models in the 3D DGEs for supporting students' perception. All these justify the influence of the features of the figural representations in the 3D DGEs, i.e., 3D dynamic models, on the rules of coordination of Dora and Sonia.

3. *For Huang, his different emphasis in different groups of rules of coordination are mainly influenced by 3D geometry topics of the tasks and their status in the GAOKAO examination.*

Huang does not show consistent emphasis on students' logical reasoning or perception in his rules of coordination. In rules of coordination H.I-A, Huang mainly promotes students' abductive reasoning in the paper-pencil environment and weakens their reliance on the perception in the 3D DGE at the beginning. This is supposed to be influenced by the GAOKAO requirements with respect the three-view diagram tasks in class H.I-A: students have to construct the original solid on the paper according to a given three-view diagram, without any help from the computer. The supposed influence can be justified by the corresponding COI and PCOI of Huang, which reflect Huang's views about the paper-pencil solutions to the three-view diagram of tasks and the side effects of the 3D DGEs for students to solve the tasks in the paper-pencil environment. In rules of coordination H.I-C and H.II-A, Huang pays more attention to students' perception and inductive reasoning while mainly promoting their theoretical deductive reasoning, or only promote students inductive reasoning and perception. Regarding the corresponding tasks, they are all small items in GAOKAO – multiple-choice or fill-in-blank ones – which only demand a correct answer and take up a small portion of the full mark of the whole examination. Their 3D geometric topics are about identifying shapes, properties, or variation patterns of sections of a solid, or getting a generalized conclusion about the orthogonal projection in a complex 3D figural pattern. The Chinese curriculum prescribes a theoretical deductive approach to these tasks, indicating that students should be able to prove the related geometric statements. However, if students could imagine the sections of the solid or the orthogonal projections, they could correctly solve the tasks more efficiently even in the paper-pencil environment without rigorous proof. Hence, we can suppose that Huang's

emphasis on students' perception and inductive reasoning in the rules of coordination are mainly influenced by the GAOKAO requirements rather than the curriculum prescriptions. In the corresponding COI and PCOI of Huang, he shows the views that students can take advantages of inductive reasoning or spatial imagination (instead of rigorous proof) to solve the complex multiple-choices 3D geometry tasks in GAOKAO more efficiently. This justifies the influence of the GAOKAO requirements on his choice of emphasis in the rules of coordination.

4. *For Dora, her strategies for supporting student's theoretical deductive reasoning and perception are influenced by the innate support in the tasks, the features of figural representations, functionalities of tools, forms of help and feedback in the 3D DGEs.*

To be specific, Dora uses simulating gestures and 3D real objects, respectively, in support of students' perception in rules of Groups D.I-A and D.I-E. This can be considered as influenced by the limited perceptive support of the drawings in the tasks in class D.I-E, and the limitation of the 3D dynamic models (e.g., biased perceptive effects with respect to intersection of lines, impossibility to show the extended planes or lines at the beginning) in the 3D DGEs in class D.I-A. Dora deals with the same groups of tasks in two separate steps, which respectively correspond to rules of coordination D.I-A and D.I-B. This is mainly influenced by the restrained toolset and the lack of mathematical help in the corresponding 3D DGEs that can be used by students for step 1. Dora also uses the innate feedback in the corresponding 3D DGEs (e.g., pop-up message indicating the impossibility of certain constructions, and turning around 3D dynamic models to separate non-coplanar lines which seem secant) to motivate students' theoretical deductive reasoning in rules of coordination D.I-B. The particular ways that Dora supports students' perception in rules of coordination D.I-C and D.I-D. are closely linked to the construction tools in the 3D DGEs, and the perceptive support of the 3D dynamic models (showing different perspectives of 3D objects) in the corresponding 3D DGEs.

From the TPCOI and PCOI respectively corresponding to the groups above, we see that Dora knows well the limitation of drawings in perceptive support, the existence of the 3D dynamic models, tools and feedback in the 3D DGEs, and their potentials and side effects for either the perception and theoretical deductive reasoning of students. In particular, she recognizes the feedback in the 3D DGEs can be utilized to stimulate students' need for theoretical deductive reasoning. All these lead us to confirming the influence of the innate support in the tasks, and the characteristics of 3D DGEs on Dora's strategies to support students' perception and theoretical deductive reasoning.

5. *For Sonia, her strategies for supporting students' perception are influenced by the features of figural representations in the 3D DGEs.*

Sonia only supports students' perception in rules of coordination S.I-C and S.I-B. In S.I-C, she rotates a 3D dynamic model to an uncommon viewpoint to help students observe a point on the bottom face. In S.I-B, she uses simulating gestures and real objects to illustrate other relative positions, in completion with the relative positions involved in the 3D dynamic models. In the corresponding PCOI and TPCOI, we can see that Sonia recognizes the perceptive support of the 3D dynamic models in the 3D DGEs, but she also recognizes the perceptive support of simulating gestures and real objects (even more than the 3D dynamic models). The PCOI and

TPCOI justified that her strategies to support students' perception are aimed to exploit or overcome the side effects of the 3D dynamic models, and thus are influenced by the 3D dynamic models in the 3D DGEs.

In contrast with Dora, Sonia is more sensitive to the side effects of the 3D DGEs for students' theoretical deductive reasoning, without realizing that she can use the innate feedback in the 3D DGEs to motivating this mode of reasoning of students, as reflected in the TPCOI. This is consistent with the fact that in the rules of coordination, Sonia only uses non-technological strategies to support students' theoretical deductive reasoning, with the strategies having no particular link with the characteristics of the 3D DGEs or the 3D geometry tasks.

6. *Huang's strategies for supporting students' perception and inductive reasoning is influenced by the features of figural representations, functionalities of tools and feedback in GeoGebra and the innate support in the tasks.*

Huang designs all the 3D DGEs – GeoGebra files – by himself in support of the coordination, so the strategies he uses are naturally linked with the characteristics of the 3D DGEs. Here we mainly consider the characteristics of the GeoGebra software (i.e., the characteristics of the figural representations, tools, help and feedback in the software) and their influence on Huang's strategies in the rules of coordination.

Firstly, the features of the figural representations, functionalities of tools and types of feedback in GeoGebra are supposed to shape Huang's strategies to support students' perception and inductive reasoning. For example, in rules of coordination H.I-B and H.I-C, the tools of *Cube*, *Plane through three points*, *Perpendicular plane*, *Sphere*, *Intersect Two Surfaces*, *Slider* and the command of *Rotate* in GeoGebra, the perceptive support of 3D dynamic models, and the innate feedback (multiple sections of solids) evoked by translating or rotating the section plane, provides conditions for Huang to construct the static or dynamic sections of the solids at stake, and further to support students' perception and/or inductive reasoning in those rules of coordination. In the corresponding TPCOI and PCOI, Huang shows his knowledge and views of the availability of the 3D dynamic models, tools and feedback in GeoGebra, their potentials for students' perception and inductive reasoning, and the pedagogical strategy to exploit the potentials, which justify the influence supposed previously.

Secondly, the innate support in the 3D geometry tasks also have an influence on Huang's strategies for supporting students' perception. This is mainly reflected in rules of coordination H.II-C. The task H.II-2 in class H.II-C is different from any other task in the same class, in that it provides a drawing of the task figure which is in a quite different perspective from the drawing of a figural pattern that Huang would like students to refer to. Then Huang uses scaffolding lines and simulating gestures to support students' perception of the task figure specifically for Task H.II-2, in addition to the drawing that he also uses for the other tasks. This distinction between the strategies within the same group of rules of coordination clearly show the influence of the innate support of the 3D geometry tasks, so we don't refer to operational invariants for further evidences.

It is worth noting that Huang doesn't evidently show the views about the role of GeoGebra with respect to students' theoretical deductive reasoning, and he thinks the perceptive support of 3D dynamic models would hinder students' abductive reasoning in the paper-pencil

environment (see TPCOI for H.I-A). This is consistent with the fact that in the rules of coordination, he mainly uses non-technological strategies to support students' theoretical deductive or abductive reasoning, with the strategies having no particular link with the characteristics of GeoGebra or the 3D geometry tasks.

Based on the discussion above, we can give a synthetic answer to research question 1.2. Among the three teachers, Dora's and Sonia's general emphasis on students' theoretical deductive reasoning in their rules of coordination is influenced by the 3D geometry topics of the tasks and their status in the curriculum and important examination. The emphasis or more attention paid by them to students' perception in certain rules of coordination are influenced by the features of the figural representations in the 3D DGEs. As for Huang, his flexible choice of emphasis in the rules of coordination is mainly influenced by the 3D geometry topics of the tasks and their status in the important examination, but not by their status in the curriculum. All these influences can be supported by the operational invariants of the three teachers in the corresponding coordination schemes. For all the three teachers, their strategies for supporting students' perception or logical reasoning are more or less influenced by the characteristics of the 3D DGEs or the related software (when the 3D DGEs are designed by the teacher himself). Sometimes it is mainly the features of the figural representations in the 3D DGEs or software that have an effect on the strategies for supporting students' perception; sometimes the features of the figural representations, functionalities of tools, forms of help and feedback can all play a role in the strategies for supporting students' perception and logical reasoning. This depends on whether the teacher knows well the existence of the figural representations, tools, help and feedback, and appreciates their potentials for supporting students' perception or logical reasoning, which are reflected in their operational invariants in the corresponding coordination schemes.

6.1.3 Answers to research questions 2.1 ~ 2.3

The second group of research questions is related to two *close* classes of situations respectively in a real classroom and a distance online lesson series, and the original texts of the three questions is:

- 2.1 To what extent can the characteristics of 3D DGEs in one class of situations be different from those in another?
- 2.2 To what extent can the coordination scheme for one class of situations be different from the coordination scheme for another
- 2.3 Among the differences identified above, which ones are related to the indirect/direct documentary genesis before/during the distance online lesson series, respectively?

In this section, we answer the three questions by synthesizing the analysis results in section 5.5. As already mentioned, only the case of Huang contains both a real classroom lesson series (H.I, H.II) and a distance online lesson series (H.III), so the answers to the three questions only apply to the one case.

Regarding questions 2.1 and 2.3, the differences between the 3D DGEs used in the real classroom lesson series and the distance online lesson series reside in the shape of 3D dynamic models, the feedback evoked by the *Selecting* tool, and the colors of certain figural elements in

the 3D dynamic models in the 3D DGEs. The three differences can all be considered as the results of direct documentational geneses during the distance online lesson series, but only the latter two are specifically due to the change of teaching setting. Actually, Huang uses the *Selecting* tool more often and adds more different colors to figural elements in the 3D DGEs during the distance online lesson series. From the operational invariants (TPCOI) that are only identified in lesson series H.III, we know that he makes the adjustment specifically to make up for the inconvenience of using “denoting” and “simulating” gestures in the distance online teaching setting.

Regarding questions 2.2 and 2.3, the differences between Huang’s coordination schemes in the real classroom and those in the distance online lesson series mainly reside in: (1) consideration of students’ direct contributions and the indirect contributions of the teacher, (2) use of scaffolding lines and 3D DGEs, (3) use of hand gestures, and (4) relation between figural patterns and the task solving procedures, in the rules of coordination and the corresponding operational invariants.

The first difference is a result of a direct documentational genesis, particularly in adaption to the constraints of the distance online teaching setting on teacher-student interactions. From the real classroom lesson series to the distance online lesson series, we see that students’ direct contributions and Huang’s indirect contributions almost disappear (the diagrams of argumentation change from multiple colors to a single color). This implies the different natures of the flows of argumentation in the two lesson series and the different roles of students’ therein. In the real classroom lesson series, Huang picks from the students what he wants to emphasize to direct the argumentation to a target point. In the distance online lesson series, Huang takes profit from his previous experiences in real classrooms to imagine what generic students could say and develops the argumentation all by himself, supposing that students could have the target understanding. The adjustment of rules of coordination is underpinned by some operational invariants (TPCOI and TEOI) of Huang, which concern the inconvenience of interacting with students “synchronously” and the time cost in waiting for students’ “asynchronous” responses, in the specific distance online teaching platform – Tencent Classroom. These operational invariants justify our claim at the beginning of this paragraph.

The second difference concerns more frequent use of scaffolding lines and 3D DGEs by Huang in the distance online lesson series. This is a joint result of an indirect documentational genesis (natural reflection overtime before the distance online teaching) and a direct documentational genesis (in adaption to the affordances and constraints of the distance online teaching setting). We get this conclusion according to some operational invariants of Huang. Some of the operational invariants are specifically linked with the distance online setting, such as the TPCOI, TCOI and BCOI that concern the difficulty of getting students concentrated and how synchronous handmade sketches can help, the convenience of displaying various forms of digital files including 3D DGEs in the Tencent Classroom platform, the techniques of using an external tablet and a stylus to add synchronous sketches on the screen, and the ease felt by Huang to learn about new technological tools. Some of the operational invariants have no specific link with the distance online setting, such as the PCOI and TPCOI that concern reflect potential of scaffolding lines for illustrating 3D figures drawn on the paper, and the benefit of displaying 3D dynamic models together with drawings.

The third difference concerns the lack of hand gestures (both simulating and denoting ones) in the distance online lesson series. It is simply considered as a result of a direct documentational genesis, particularly reacting to the constraint of the distance online setting on the demonstration of hand gestures.

The fourth difference is a result of an indirect documentational genesis, or more precisely, it is related to Huang's natural reflection on his teaching practice before the distance online teaching. In the real classroom lesson series, Huang makes students apply the known conclusions about figural patterns to solve related tasks, whereas in the distance online lesson series, he only mentions related figural patterns after solving tasks in a general way. From the corresponding PCOI, we see that after the real classroom lesson series (especially the exchange with the teaching research coordinator), Huang realizes that it is not always appropriate to apply the conclusions about a figural pattern for solving a task, and that too many patterns will cause a heavy burden of memory of students. We therefore get the claim at the beginning of this paragraph.

6.2 Reflection and perspectives

In this section, we discuss the conclusions obtained in this thesis, situating them in the context of the research literature (section 6.2.1). After that, we respectively discuss the contribution and limitations of this study with respect to the theoretical framework (section 6.2.2) and the methodology (section 6.2.3). We finally open some new perspectives for further research and teacher education (section 6.2.4).

6.2.1 Reflection on conclusions

In this part, we subsequently reflect on the conclusion with respect to two groups of research questions in this thesis.

The conclusion with respect to the first group of questions are located in sections 6.1.1 ~ 6.1.2, and it firstly presents the various rules of coordination of the three teachers in real classrooms, and then presents the particular answers to the two questions in that group. Here we firstly reflect on the rules of coordination themselves, and then reflect on the answers to the questions.

1. Reflection on the variety of the rules of coordination of teachers

Regarding the rules of coordination presented at the beginning of section 6.1.1, they reflect the diversity of teachers' coordination behavior (we use "coordination behavior" in place of "rules of coordination" hereafter to give a more general discussion) under different kinds of situations; this echoes the first interest in the introduction chapter.

In the coordination behavior, we can firstly see the teachers do show the interest in fostering different modes of logical reasoning or only the perception of students, according to the practical or pedagogical considerations of the lesson time, students' difficulties, curriculum prescriptions and examination requirements. For example, Sonia and Dora generally emphasize students' theoretical deductive reasoning, but there do exist occasions in which they encourage students to apply the perception results directly as a factual premise in deductive reasoning or only foster students' perception. The latter coordination behavior usually appears when the

perceptive support from certain resources is especially helpful and could help save the teaching time in explaining some tasks or geometric facts. Chinese teacher shows more interest in developing students' non-deductive reasoning and supporting their perception, with the idea of letting students take advantages of their perception/spatial imagination and non-deductive reasoning as much as possible to solve the small items in the examination efficiently. These examples support Knipping's (2008) claim that the classroom practices of teachers are not only guided by considerations of the rigorous logic of mathematics but also pedagogical and practical considerations. The examples also show that the coordination is a common and critical teacher practice in mathematics lessons.

Secondly, the coordination behavior of the three teachers involves various strategies adopted by the three teachers for promoting students' perception and logical reasoning. Some of the strategies are also identified in the previous studies while some are not. The ways that theoretical deductive reasoning is prompted in the cases of Dora and Sonia echo the previous research findings that 3D DGE itself cannot move students to theoretical deductive reasoning automatically, and the teacher's careful use of 3D DGE feedback with specific strategies, such as evoking conflict phenomena and questioning about students' certainty, is essential (Accascina & Rogora, 2006). Huang's behavior of promoting students' abductive reasoning within in the paper-pencil environment and using 3D DGE only at the end provides another example of the interaction between DGEs and students' abductive reasoning, which is different from that in (Baccaglini-Frank, 2019). Huang also shows high proficiency in using 3D DGEs to support students' perception and inductive reasoning: some strategies adopted by him, such as "moving the point of view perpendicular to the projection plane" and "requesting students to discover regularities when displaying a covariation process with 3D DGEs" are recognized as the appropriate strategies to realize the potentials of 3D DGEs (Accascina & Rogora, 2006; Højsted, 2019). The cases of the three teachers also show that many resources, in addition to 3D DGEs, could be critical for teachers' coordination in 3D geometry. Finally, all the three teachers use simulating gestures at some critical moments in real classrooms, to illustrate geometric theorems or facts or illustrate essential geometric structure of a 3D figure; this is where the substantial "semiotic potential" (Bartolini & Mariotti, 2008) of gestures could be reflected. The strategies could provide rich implications for in-service teachers' on how to undertake coordination in class, we will come back to this point in section 6.2.4.

2. Reflection on the conclusion to the first group of research questions

Regarding the conclusion with respect to the two questions in the first group, it actually reveals how the different factors – operational invariants and characteristics of 3D geometry tasks and 3D DGEs – could influence teachers' coordination behavior. Next we use "knowledge and views" to replace the "operational invariant" to give a general discussion of this issue, which echoes the second interest in the introduction chapter.

From the conclusion, we can see some knowledge and views are critical for teachers' coordination behavior. Usually, it's the knowledge and views about task solutions (COI) and the curriculum and/or examination prescriptions (PCOI) that are closely linked with teachers' emphasis in their coordination. Sometimes the knowledge and views about the significant potentials of certain resources for students' perception (PCOI and TPCOI), and the views about time economy (TEOI), would also lead teachers to attaching more importance to students'

perception. Teachers' knowledge about the potentials of 3D DGEs and the pedagogical strategies for exploiting these potentials (TPCOI) are critical for their strategies to support students' perception and logical reasoning – the more knowledge they have in this aspect, the more fruitful their strategies will be. By contrast the cases of Sonia and Huang, we see the importance of teachers' technological content knowledge (TCOI) and the confidence in behavior control related to the operation of 3D DGEs (BCOI): the more technological content knowledge they have and the more confident they are, the more likely they can design 3D DGEs flexibly according to their need in coordination. Nevertheless, if there are 3D DGE resources available, teachers are still willing to use them in lessons even without a high level of TCOI and BCOI. These knowledge and views could be the focus of the teacher training projects, and we will talk about this in section 6.1.4.

Compared to the other categories of knowledge and views, the knowledge and views about how to teach students technological skills have a weaker impact on teachers' coordination behavior. This is probably because Huang doesn't let students operate in 3D DGEs and the Dora and Sonia only need students to perform simple operations in 3D DGEs, so the teachers all focus on students' mathematical activities in their coordination behavior. If teachers anticipate more complex interaction of the technological aspect and the mathematical aspect in students' activities – such as let students overcome the technological difficulty with mathematics knowledge, or let them investigate mathematics with the technological skills already learned (Hollebrands & Okumuş, 2018) – this category of knowledge and views may be more relevant to teachers' coordination behavior.

The cases of the three teachers also evidence the influence of characteristics of 3D geometry tasks and 3D DGEs on teachers' coordination behavior. In general, the 3D geometry topics of the tasks and their status in the curriculum would influence the two French teachers' emphasis in the coordination behavior. The Chinese teacher is less influenced by the curriculum in his emphasis but more by the examination.

Finally, some differences can be observed between the French and the Chinese cases. The two French teachers always emphasize students' theoretical deductive reasoning in their coordination behavior, whereas the Chinese teacher's pays more attention to the inductive, abductive or non-rigorous deductive reasoning connected with perception, which allow solving examination tasks more efficiently. Also, the Chinese teacher is more influenced by the examination prescriptions with respect to tasks. All these remind us of the French didactical tradition of emphasizing rigorous and formal mathematical reasoning (Gueudet et al., 2017), and the exam culture and the practice orientation on mathematics education in China (Wang, 2019). In addition, the specific influence of the social expectations for open classes on Huang's coordination behavior draw our attention to the specific teacher professional development activity in China – open class – and the related educational cultures (Liang et al., 2013).

3. Reflection on the conclusion to the second group of research questions

The conclusion with respect to the second group of research questions are located in section 6.1.3, and it presents how the change of teaching setting can influence teachers' coordination schemes and the 3D DGEs they used. Here focus on the influence on teachers' coordination

behavior and the knowledge and views, and the 3D DGEs, to give a more general discussion to this issue; this echoes the third interest of investigation in the introduction chapter.

In this thesis, we only examine the case of Huang, and what surprises us a little is that the change in the teaching setting doesn't influence much the essential of the coordination behavior of Huang. The influence mainly includes: the lack of the consideration of students' contributions and the teacher's indirect contributions, the lack of simulating and denoting hand gestures, and the more frequent use of scaffolding lines and 3D DGEs in the distance online lesson series. These changes are concerned with the subject who will make the contribution and the resources used to provide perceptive support, but the content of the contribution (perception and logical reasoning) and the way they are coordinated – what concerns the essence of the teacher's coordination behavior – have not changed due to the change of teaching setting.

Actually, it is through adjusting the characteristics of 3D DGEs, using more frequently 3D DGEs, and exploring the technological tools for integrating hand sketches onto the computer screen, that make the essential coordination behavior of Huang resistant to the change of teaching setting. They provide a remedy for the lack of simulating gestures and denoting gestures in the distance online teaching setting. During this process, Huang also updates his knowledge and views, such as the techniques of using the external graphics board, the specific stylus, and the distance online teaching platform – Tencent Classroom, and the potentials of 3D DGEs for illustrating the geometric structure of 3D figures. These changes in the coordination behavior and knowledge and views in adaptation to the distance online teaching setting are conceptualized as the result of the direct documentational genesis.

Besides the direct documentational genesis, we also consider indirect documentational geneses, which approximates a reflection process in which Huang reflects, during the interval of two lesson series, on how to improve his actions in the former lesson series. Compared to the direct documentational genesis, the indirect documentational genesis has a greater impact on the essential coordination behavior of Huang: it makes him to adjust the role of a mathematics model (figural pattern) in the deductive reasoning.

For Huang's case, we can say that the transformation of teachers' coordination behavior and the knowledge and views from real classrooms to distance online settings would be the joint result of the direct documentational genesis and the indirect documentational genesis. Or in another word, the transformation is the result of their reflection over time combined with their sudden adaptation to the distance online teaching settings. For Huang, his reflection over time has a greater impact on his essential coordination behavior than the adaptation to the distance online teaching settings. But it is his openness and positive attitude to the new technological tools, the perceived ease for learning about the new technological skills, and his proficiency in using and designing 3D DGEs, that allow him to be less affected in his essential coordination behavior. This provides implications on how to help teachers resist to the constraints of the distance online teaching setting and better keep consistent with their real classroom teaching.

6.2.2 Reflection on theoretical framework

In this thesis we establish a compound framework to address the research questions of our interest. The Documentational Approach to Didactics (DAD, Trouche et al., 2020) serves as a

global framework here. It is then connected with some dimensions for characterizing 3D geometry tasks and 3D DGEs, a sub-framework of coordination behavior, and a categorization sub-framework of operational invariants.

Following this construction, we focus on the three main frameworks or sub-frameworks to discuss the theoretical contributions and issues of this thesis. The discussion includes four points: 1. Possibilities of deepening DAD with new concepts; 2. Sub-framework of coordination behavior; 3. Sub-framework of operational invariants; 4. Revising the sub-frameworks with French and Chinese cases.

1. Possibilities of deepening DAD with new concepts

The framework of Documentational Approach to Didactics (DAD, Trouche et al., 2020) is chosen firstly because it allows integrating the regularities in the teacher's coordination behavior and her knowledge and views into a systematic entity – *scheme of usage* – which is then linked to a *class of situations*. The regularities in the coordination behavior and the related knowledge and views respectively correspond to the *rules of action* and *operational invariants* in the scheme of usage. One theoretical contribution we make here is to hypothesize some critical elements in the DAD *situation* corresponding to the aim of coordination, by comparing the DAD situation to the *didactical situation* for students in the Theory of Didactical Situation (TSD, Brousseau, 2002). The critical elements include the “technology with dynamic visual display functionalities”, the “teaching setting”, the “mathematics task” and “other relevant elements”. In this thesis, we only consider 3D geometry tasks for the “mathematics task” and 3D DGEs for the “technology with dynamic visual display functionalities”. In this way, we manage to link the regularities in coordination behavior of a teacher, her knowledge and views, and the 3D geometry tasks and 3D DGEs altogether.

Furthermore, the critical elements hypothesized in the DAD situation allow us to systematically consider some situation variables whose relevant values could affect the teacher's coordination behavior. The situation variables mainly include variables in the 3D geometry task, variables in the 3D DGE, and variables in the teaching setting in the situation, but we leave a white space for the variables in “other relevant elements”. Regarding variables in the 3D geometry task (such as the 3D geometry topic of the task) or the 3D DGE (such as the figural representations and tools in it), they are all identified from literature, and they are respectively the dimensions according to which we will analyze the characteristics of the 3D geometry tasks/ 3D DGEs in this thesis. Regarding variables in the teaching setting, we consider the whole teaching setting as a variable and only consider three values of it which are enough to cover the cases in this thesis: the distance online setting, the computer real classroom, and the ordinary real classroom. The situation variables are also important for discussing the factors that may cause the transformation of teacher's coordination behavior and the related knowledge and views during the epidemic period. We will elaborate on this point a little later. In this thesis, we mainly consider the variables in the elements that we are interested in. In the future, there are many other relevant elements and variables that can be considered, such as the variables linked to the teacher (position of the task in her resource system: central or marginal), variable linked to the institution (degree of acknowledgement of 3D DGE in the local educational community), and

variable linked to the students. All these may have an effect on the teacher's coordination behavior and worth further investigation.

In this thesis, we mainly consider the concepts of *rules of action* and *operational invariants* in the *scheme of usage* in DAD. The other two components in the scheme of usage are *goal of activities* and *possibilities of inferences*. Since all the schemes of usage investigated in this thesis involve a common goal – supporting students' coordination of their own perception and logical reasoning (interpreted from the researcher's perspective), we rename the *scheme of usage* as *coordination scheme* and weaken other possible goals. The *rules of action* is accordingly renamed as *rules of coordination*. As for the *possibilities of inference*, we choose to neglect it at the beginning so as to focus on the core interest of this thesis – the *rules of coordination* and *operational invariants that correspond to the regularities in the teacher's coordination behavior and her knowledge and views*. However, as the analysis goes on, we find it necessary to take into account the *possibilities of inferences* when a teacher takes some alternative actions under the same classes of situations and the actions are the trigger of the divergence of schemes in the following lesson series. It turns out the possibilities of inferences are important for studying the development of teachers' coordination activities over time, and ignoring it generally in this thesis does leave us missing some information about teachers' coordination.

As regards how the change of teaching setting due to the Covid-19 influences a teacher's coordination behavior and the related knowledge and views, it can be conceptualized as how the transformation of a teacher's coordination schemes can be due to the change of teaching setting. Nevertheless, the coordination schemes can be influenced by many other factors, such as the mathematics topic the teacher is dealing with and the reflection of the teacher from the exchanges with colleagues. The new concepts we propose to DAD is exactly dedicated to distinguish the impact of the other factors from the impact of the change of teaching setting. Here we propose the concepts of the *same*, *close*, and *distant* classes of situations, which are distinguished according to the situation variables mentioned previously and mainly the “3D geometry topic” variable in the task. The more overlap between the 3D geometry topics of the tasks in two classes of situations, the closer the two classes of situations are considered to be. To examine the influence of the change of teaching setting on the teacher's coordination schemes, we particularly consider the coordination schemes under two *close* classes of situations which respectively involve real classroom and distance online teaching settings but with the tasks having similar 3D geometry topics. In this way, we try to “control” some variables that we suppose would have an impact on the teacher's coordination schemes (note that there are still other variables like 3D DGEs cannot be controlled as similar), and focus on the variable of teaching setting and its impact on the coordination schemes.

As can be seen, taking the “3D geometry topic” of the task as the distinction criteria is aimed to facilitate our study of the questions of interest. However, since we only consider the elements within the class of situations themselves in the criteria but not the scheme that corresponds to the class of situations, we risk the possibility of identifying two *same* schemes (respectively from two lesson series) corresponding to two *close* or *distant* classes of situations. We will reflect on how to improve our theoretical constructs to make them more compatible with the

existing constructs in DAD, and to consider the twin notions of the *same*, *close* and *distant* schemes is a promising direction.

We also propose the concepts of *direct/indirect* documentational genesis, based on the original *documentational genesis* in DAD, to conceptualize the teacher's reflection in normal times and her interaction with the resources during the distance online teaching. The direct documentational genesis is the genesis that a teacher is supposed to engage with while s/he is directly undertaking the actions related to the scheme, or directly faced with the class of situations. The indirect documentational genesis is the genesis that a teacher is supposed to engage with when she is NOT directly undertaking the actions related to the scheme, or NOT directly facing the class of situations. In this case, the other activities that the teacher is undertaking actually (such as teacher training activities, another class of situations on teaching functions), will possibly trigger the teacher's reflection and have an effect on the teacher's actions related to the scheme at stake.

With the concepts of direct/indirect documentational genesis, and distance/close/distant classes of situations, we propose three models to simulate how the teacher's professional activities could transform from one lesson series to another. Fig.3.3 is the model for the transition from real classroom lesson series to distance online lessons series, and we give it again here for illustration.

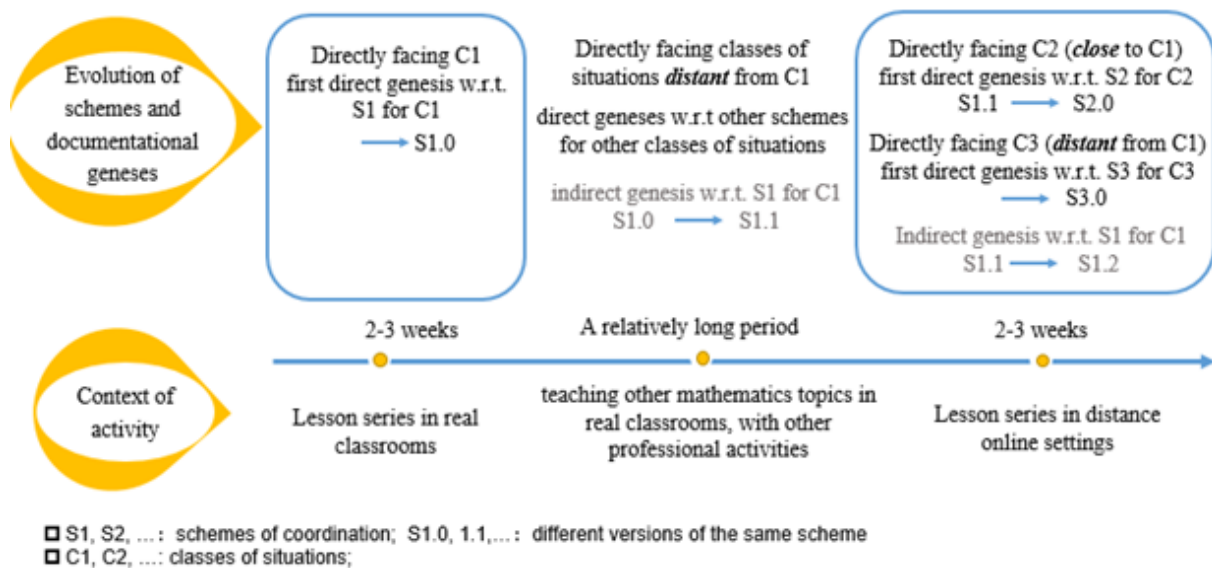


Fig. 3.3 Teacher's activities from a real classroom lesson series to a distance online lesson series

While using the new concepts to analyze the case of Huang, we find that both the direct and indirect documentational genes have influenced the transformation of his coordination schemes, and the *indirect* genesis has a larger impact than the *direct* one, showing the benefit and the necessity of distinguishing between the two concepts.

Huang's case also shows the indirect genesis of a teacher is worth noting. In this thesis, we have only identified how the schemes for teaching 3D geometry are transformed in relation to the indirect genesis, which can be corresponded to $S1.0 \rightarrow S1.1$ in Fig. 3.3. But we have not elaborated how the schemes can be linked with the other schemes for the activities that Huang is actually undertaking. For example, given another class of situations C4 (teaching functions,

for example) during the interval period, as shown in Fig. 6.1, the corresponding scheme S4 would share with some operational invariants with S1 if it can trigger Huang’s reflection with respect to the latter. Then how the S4 itself will transform while the S1, with shared operational invariants with S4, is transforming? This is an aspect of indirect genesis that should be deepened.

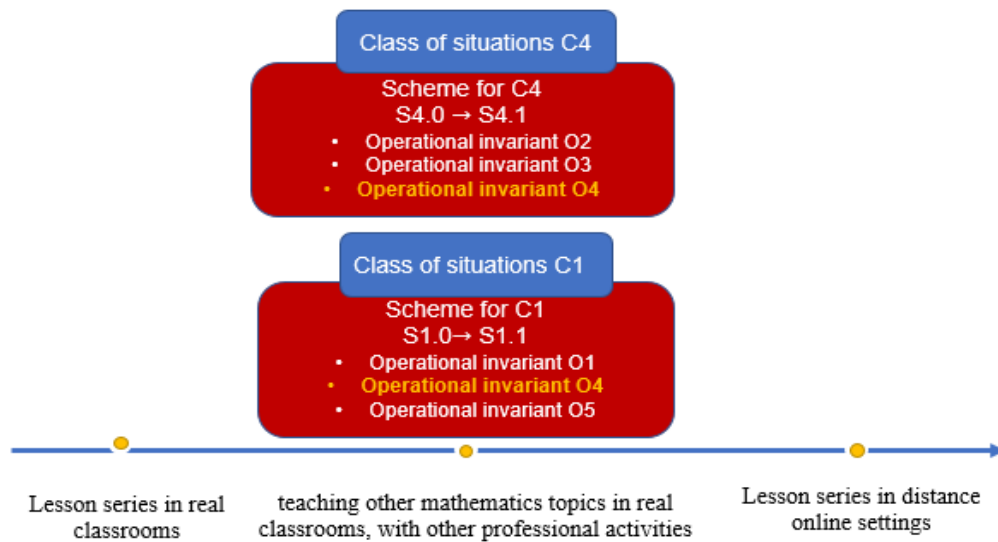


Fig. 6.1 Transformation of two schemes for two classes of situations during the indirect genesis

2. Relevance of the sub-framework of coordination behavior

The concept of *rules of coordination* in DAD is further connected to a sub-framework of coordination behavior. We now discuss the theoretical contributions related to the sub-framework, focusing on how it can capture essential features of coordination behavior and allow identifying rules of coordination.

We situate the teacher’s coordination behavior within the collective argumentation processes in mathematics lessons. The sub-framework is basically an adaptation of Conner et al.’s (2014) framework of teacher support for collective argumentation, and the framework is itself based on Toulmin’s (1958) diagram of argument. Toulmin’s diagram contains 6 argumentation components: claim, data, warrant, backing, qualifier and rebuttal. By proposing this diagram, Toulmin would like to provide a tool for analyzing the structure of informal argumentation in contrast to the analysis of formal proof. Conner et al.’s (2014) framework includes three aspects of teacher support for collective argumentation, the first one – teacher’s *direct contributions* – only have the argumentation components as codes, that is data, claims, warrants, rebuttals, backings and qualifiers. These are not enough to highlight the essential feature of the teacher’s coordination behavior, for which we have to clarify the specific features of the argumentation components. In this thesis, we mainly identify the possible features of data, warrants, qualifiers and rebuttals from literature and get the Table 3.3 in chapter 3. The backings are not considered in the sub-framework as it is usually confused with the warrants; the claims are indeed considered in the sub-framework but they usually have no particular features.

The other two aspects in Conner et al.’s (2014) framework – *questions posed* and *other supportive actions* – concern teacher’s indirect contributions to collective argumentation. We

maintain the two aspects in the sub-framework here, with some codes in the aspects being revised according to the data analysis results. This will be discussed in the final part of this section.

Now we discuss the benefit of introducing the different features of argumentation components into the sub-framework. By introducing the multiple features of data (e.g., perceptive, intuitive) and warrants (e.g., abductive, inductive and deductive), we can precisely see which modes of logical reasoning are developed in the collective argumentation and what role does the perceptive evidences play in the logical reasoning. The features of qualifiers and rebuttals reflect how a teacher could establish the legitimacy of a mode of reasoning and help students attach a proper certainty level to the conclusion obtained. All these are at the core concern of the coordination behavior but cannot be captured by Conner et al.'s initial framework. According to Inglis et al. (2007) and Tall (2004), students should only attach an absolute qualifier to the claim derived from rigorous theoretical deductive reasoning if they want to succeed in *advanced* mathematics. In this study, we emphasize the complex practical conditions and diverse didactical goals in *secondary* mathematics and suggest that teachers be granted the flexibility in their choice of the student activities to promote. That is, with particular didactical goals such as to support students' formulation of 3D mental images or to increase their efficiency in solving tasks, they can make students certain of a claim (i.e., attach an absolute qualifier to it) even it is derived from non-rigorous deductive, inductive or abductive reasoning connected with perceptive evidences, or merely from the perceptive evidences. That is exactly what the Sonia and Dora do in some of their lesson time and what Huang does in most of the lesson time.

Another theoretical contribution we make here is to integrate the teacher's *use of resources* into the sub-framework of coordination behavior, taking it as the other part of the teacher's indirect contributions to collective argumentation. The benefit of integrating this aspect is that it enables us to see the role of various digital resources (such as 3D DGEs) and non-digital resources (such as drawings, simulating gestures, metaphors, and cognitive models) in the teacher's coordination behavior, i.e., how they are used to foster or restrain students' perception and logical reasoning activities. Then the analysis results are supposed to provide implications for in-service teachers on how the use of the resources for coordination.

We would like to highlight that the sub-framework of coordination behavior only contains the direct and indirect contributions of the teacher to the collective argumentation process, but in the actual data analysis, we firstly draw a diagram of argument to structure the whole collective argumentation process, integrating both the direct contributions of students, and the direct and indirect contributions of the teacher. The collective argumentation processes are then divided into several groups, and the teacher's common contributions within one group is just her rules of coordination for that group. That is, the identification of the teacher's rules of coordination is situated in the structuring and classification of collective argumentation processes; the benefit of doing this is we can examine not only the teacher's contributions but also her consideration of students' contributions while investigating her coordination behavior.

3. Relevance of the categorization sub-framework of operational invariants

The concept of *operational invariants* in DAD is further connected to a categorization sub-framework. We now discuss the theoretical contributions related to the sub-framework.

The first contribution related to the sub-framework is that we reconstruct five non-overlapping knowledge categories by separating and recombining the initial knowledge categories in the Koehler & Mishra’s (2009) TPACK framework. Here several measures have been adopted to reduce the ambiguities between the initial knowledge categories, such as combining the two initial categories which have ambiguous boundaries, remove the part from one category that may overlap with another category. We also separate the pedagogical knowledge for developing students’ technological content knowledge (what might have been termed PTCK) from the initial category TPCK, to give a specific consideration to the knowledge required by the teacher when she needs to monitor students’ operations with technologies in mathematics lessons. To give a clearer idea of the reconstruction, we present the Fig. 3.9 again here.

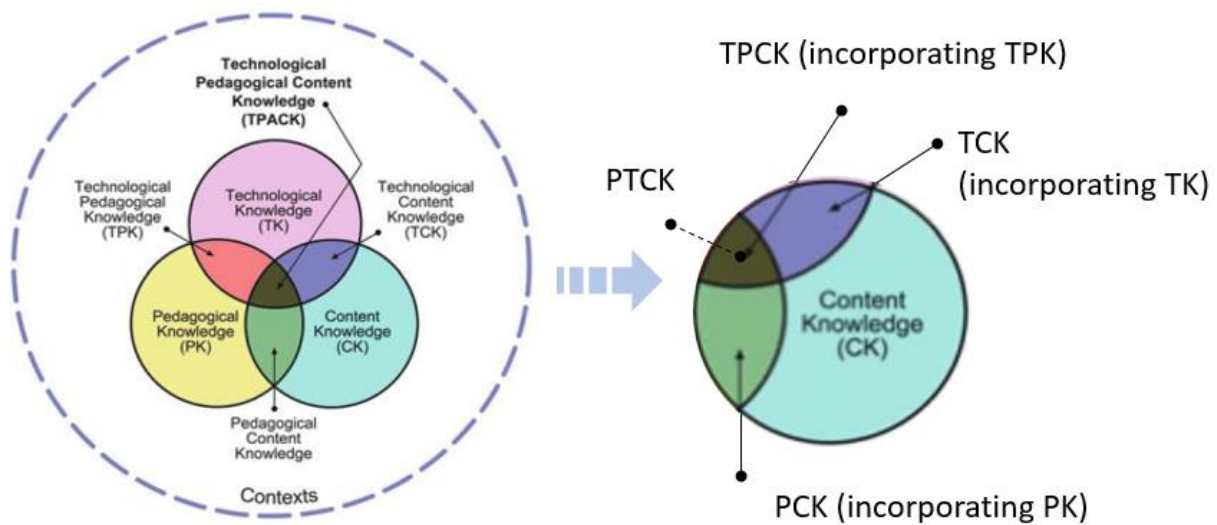


Fig. 3.9 Reconstruct five categories of knowledge from the TPACK framework

The second contribution we’ve made is to expand the new categories of “knowledge” into categories of “knowledge and views”, to get free of the difficulty of distinguishing between the knowledge and views of teachers in the first five categories, especially the those related to pedagogy. The expanded categories are exactly the first five categories of operational invariants in the sub-framework.

The third contribution we’ve made is to identify another three categories of views relevant to mathematics teaching with technology from various literature. The three categories of views constitute the other three categories of operational invariants in the sub-framework, their titles and connotations are presented below.

- Operational invariants about behavior control – teachers’ perceived ease or difficulty of performing the behavior of using technologies in mathematics lessons
- Operational invariants about social norms: teachers’ perceived social pressure (from school directors, colleagues, student parents…) to conduct or not a pedagogical approach, with or without the use of technologies

-
- Operational invariants about time economy: teachers' perceptions of whether the time invested on the time for implementing digital technologies in mathematics lessons is worth costing

The analysis results in this thesis show that the three categories of operational invariants also play critical roles in teachers' coordination, evidencing the benefit of the theoretical construct here. Of course, the three categories of operational invariants with specific regards to teachers' views are not inclusive, it is still possible to discover other categories with more cases or literature being examined.

4. Revising the sub-frameworks with French and Chinese cases

In the French and Chinese cases, we observe divergent 3D geometry tasks, 3D DGEs, coordination behavior and teacher knowledge and views. In addition to allowing us to fully explore the relations between the different factors, the heterogeneous cases provide rich opportunities for the revision of our theoretical frameworks. In this thesis, we mainly revise the two sub-frameworks related to coordination behavior and operational invariants in light of actual data. Next we will respectively give several examples with regard to the revision of each sub-framework.

Regarding the revision of the sub-framework of coordination behavior, the main revision we have made is to divide the code *evaluating* in the aspect of *other supportive actions* into two codes (categories of actions): *validating* and *rebutting*. In fact, the original "Evaluating" code already implies the meanings of validating and rebutting: it refers to the teacher's action of correcting a student's incorrect statement, validating a student's statement, or verifying the correctness of a statement. On the one hand, we feel it necessary to distinguish the actions related to "validating" because Huang usually performs validates conclusions directly by his authority or with 3D DGE effects in lesson series H.I and H.II. The action of validating is an important strategy for him to establish the legitimacy of the non-deductive reasoning and perception and thus worth a specific examination. In lesson series D.I, Dora would let students verify the correctness of their answer with the checking system in 3D DGEs; it is also an action of validating, but in reference to a third-part (neither the teacher nor the students) evaluation system. On the other hand, the teachers reject incorrect ideas of students in many different ways. For example, Dora lets students get feedback from the answer checking system or presents conflicting perceptive phenomenon in 3D DGEs in lesson series D.I; Huang provides counterexamples where a mathematical statement doesn't hold in lessons series H.II; also, all the three teachers once reject students' ideas directly by their authority. Since previous studies already point out the importance of the actions of rebutting with respect to students' need for proof (Lin et al. 2012) and identify many other ways of rebutting in accordance with the rebuttals in the diagram of argument related studies (Reid et al., 2011), we decide to take the actions of rebutting also as a separate category. We hereby get two separate codes in the aspect of *other supportive actions*, their definitions and the corresponding examples are presented as follows.

- Validating, actions that serve to confirm the correctness of a mathematical statement. Examples: validate a statement by teacher's authority, provide perceptive evidences, or validate with a third-part evaluation system

-
- Rebutting, action that serve to reject a mathematical idea. Examples: reject an idea by teacher's authority, reject an idea with a third-part evaluation system, present conflicting effects, infer a wrong result following the same logic, or provide a counterexample contradicting to an idea or its inferences.

Regarding the revision of the sub-framework of operational invariants, we mainly enrich the examples in the categories in the sub-framework in light of the actual data. For example, Sonia would insist students to explain an idea theoretical deductive reasoning in 3D DGEs while interacting individually with students in her lesson; in the interview, she explains that it's because the 3D DGEs allow students to solve the tasks only with perception and trial-and-error, which is she doesn't expect. These words reflect her knowledge about the side effects of digital technologies for students' logical reasoning and the pedagogical strategies to make up for the side effects, which should be categorized as operational invariants about technology in pedagogy of content (TPCOI). In the original TPCOI, however, we focused more on the teacher knowledge about potentials of digital technologies and the pedagogical strategies to exploit the potentials. Hence we integrate the new knowledge elements reflected in Sonia's case into category TPCOI. By doing the similar thing to the other categories, we finally determine the full set of examples for each category in the sub-framework in section 3.5.2

6.2.3 Reflection on Methodology

In this section, we reflect on the methodological choices made in this thesis with respect to the case selection, the data collection for each case, the data analysis method, and the language issues related to the Sino-French study. In the following paragraphs, we respectively discuss the following points: (1) choosing experienced teachers from China and France and examining the work of isolated teacher instead of the collective; (2) unbalanced data collection not following all the DAD principles; (3) particular methodological design related to the diagram of argument; and (4) the language issues aroused by studying French and Chinese cases with English.

With respect to the first point, we chose the cases of experienced teachers who have used 3D DGE in class for many times or at least being enthusiastic about 3D DGE use, so as to provide good examples on how to take profit of this specific digital technology for the coordination in class. Furthermore, we are interested in their existing coordination behavior rather than the development of the behavior under the support of colleagues, that makes focus on the work of isolated teacher instead of the collective around. The choice of French and Chinese cases are due to the Sino-French cooperation background of the Ph.D. project on the one hand, and are aimed to enlarging the heterogeneity of the tasks and teachers' knowledge and views (to better identify the influence of these elements on teachers' coordination behavior) on the other hand.

With respect to the second point, we are not able to collect the full set of the target data for all the cases, with the principles in DAD not all followed. It is mainly due to the travel inconvenience between different countries which is exaggerated during the Covid-19 epidemic period. The researcher should stay in France in most time of the Ph.D. project, which makes it difficult to achieve the in-class follow-up for each lesson series of Chinese teachers. The constraint directly causes the lack of video data for lesson series H.I of Huang and we take a 'written memoir' and a 'compensatory interview' as the alternative. The alternative data only

provide the teacher's unilateral description and may not faithfully record the actual activities in the lesson series, causing the study and the results less valid. The Covid-19 epidemic also brings many challenges to the study. At the beginning, we anticipated that all the 3D DGE-integrated lesson series of both French and Chinese teachers would be in real classrooms. Then the epidemic broke out subsequently in China and France, the Chinese teacher followed in this thesis moved his lessons from real classrooms to distance online settings and still used 3D DGEs. The two French teachers directly abandoned synchronous distance online lessons during the epidemic period and there were no longer the use of 3D DGEs (either by themselves or by students) even after they came back to real classrooms. That's why we followed the distance online lesson series only in the case of Huang but not in the cases of Sonia and Dora. It is also because of the epidemic that we expand our interest of research to take into account the transformation of teachers' coordination activities between different teaching settings, with new theoretical constructs to be introduced, such as the close classes of situations and direct and indirect documental geneses. Furthermore, the travel restriction during the epidemic makes the researcher unable to go to the site of Huang and thus unable to implement the long-term and out-of-class follow-up; this adds to the difficulty of distinguishing between the direct and indirect documental genesis of the teacher during the transition from real classrooms to distance online settings. The unbalanced data collection is a main limitation of this study.

With respect to the third point, we used the diagram of argument to represent the structure of argumentation processes (episodes) in which teachers' coordination behavior is situated. We designed a specific set of procedures for drawing the diagram and classifying them, drawing inspiration from the procedures in Conner et al. (2014). The diagram reveals rich information about the argumentation being represented and teachers' coordination behavior therein, but the procedures for drawing it are indeed tedious. Furthermore, the non-linear features of class discourses make it usually hard to connect all the argumentation components in a linear way as in the diagram. The reflection on the use of diagram of argument and the framework of coordination behavior has led to a paper (Shao et al., in progress). In the future, we expect a simpler manner for constructing the diagram can be found, possibly with the help of data analysis software.

With respect to the fourth point, this thesis is in English while it addresses the French and Chinese cases. Actually, we encounter a lot of problems in translating (transcripts of lesson videos and interviews, for example) which are originally in French and Chinese into English and analyzing them with English termed theoretical concepts. While translating the data, we find that some terms in French and Chinese specific to the respective educational contexts – such as “théorème du toit” and “勾股定理(gōu gǔ dìng lǐ)” – have no perfect linguistic equivalences in English. The researcher simply translates them as “theorem of roof” and “theorem of Pythagorean”, but these terms are not enough to enlighten the cultural tradition in the original terms. The issue of translating “théorème du toit” is also mentioned by (Ruthven, 2022). Also, the researcher herself is a Chinese native speaker and studies in France for Ph.D., which means she doesn't have equivalent understanding of the language of Chinese, French and English may not have the enough skills to undertake a high-quality. While analyzing the data with uniform English terms, the terms may not have the same embodiments in French and Chinese educational contexts, and not necessarily interpreted by the French and Chinese

teachers in the same way. All the translation issues may lead to bias in the analysis results and the final conclusion. The awareness of this complexity leads to considering this issue of translation as a research question, with a contribution to the research forum in last PME (Shao et al., 2022) and to an invited contribution to a ZDM SI (*Deepening the ‘resource’ approach to mathematics education by traveling between languages*) edited by Luc Trouche, Jill Adler and Janine Remillard (to be published in 2023).

6.2.4 Perspectives for future research and teacher education

The discussion above leads to several perspectives for the future research, which are respectively in the following directions: (1) to take advantage of the data already collected, (2) to analyze the teacher work over a long period of time and in larger settings, (3) to deepen the theoretical concepts newly proposed in this thesis, (4) to integrate the DAD framework with other theories, (5) to deepen the contrast between the Chinese and the French cases

Regarding the first point, we have collected the cases of five teachers during the period of the Ph. D. project but finally studied only three of them. As for the two cases not studied, one teacher uses 3D DGEs only in distance online lessons during the epidemic but not in real classroom. The other teacher uses 3D DGEs only in real classrooms, and in one lesson he guides students to design a 3D DGE in a computer classroom. It is clear that the analysis can be deepened by considering these cases as they provide interesting contrasts with the existing cases in this thesis. Regarding the second point, the teacher work over a long period of time and over larger settings is worth exploring further. From the limited data collected in this thesis, we see that a main change in Huang’s coordination behavior is related the exchange with the teaching research group of the school. It becomes clear that through the long-time follow-up of the teacher’ work and taking into account its collective aspect, we can uncover more meaningful factors that contribute to the professional development of teachers. Regarding the third point, the new theoretical concepts introduced in this thesis – same/close/distant classes of situations and direct/indirect documentational genesis – turn out to be complex notions and worth further developing. The compatibility of some concepts with the existing concepts in the DAD framework needs to be addressed. Regarding the fourth point, it seems prospective to consider the integration of DAD with other theories. Besides the theories mentioned in this thesis, the Chinese theory on teaching with variations (Gu et al., 2004) is promising to enrich the notion of situation variables in DAD (Zhang 2022). With respect to the fifth and also the final point, contrasting French and Chinese cases show great advantages on the topic of the mathematics education integrated with 3D DGEs. The influence of the social-cultural factors on teachers’ coordination practice deserves further investigation. With the previous thesis having been developed in the same French-Sino cooperation project (Wang, 2019; Zhu, 2020; Zhang, 2022), more interdisciplinary issues can be proposed and a deeper French-Sino cooperation can be expected.

As mentioned in section 6.2.1, the results of this thesis could provide implications for both in-service teachers and teacher educators. Rethinking the conditions of teachers’ work systematically, we propose the following perspectives for teacher education: (1) policy making for the curriculum and examination, (2) resource construction for teachers, (3) teacher training projects, (4) teachers’ collective work in local communities.

From the perspective of policy making for the curriculum and examination, the influence of curriculum and examination evidenced in the three teachers' cases suggest that the examination designers can set a reasonable proportion of tasks in the important examination, to encourage teachers to foster particular logical reasoning or perception of students. Also, the curriculum can show clear orientation and pedagogical suggestions to help teachers foster students' logical reasoning or perception in a more proper way. From the perspective of resource construction, the availability of well-structured 3D DGEs, with faithful figural representations, functional tools and informative feedback, can greatly enhance the willingness of teachers to use 3D DGEs in support of their coordination. This is where the teacher supporters can especially play a role, as in-service teachers usually do not have the time and sufficient qualities for designing the well-structured 3D DGEs. From the perspective of teacher training projects, section 6.2.1 has pointed out what knowledge and views play critical roles for teachers' coordination practice, and important strategies for supporting students' logical reasoning and perception. The teacher training projects should focus on these aspects of knowledge and views and demonstrate how the supporting strategies can be implemented in reality. The videos of exemplary cases (such as the case in this thesis) could help with the demonstration. In addition, teachers' views about new digital technologies and their values for mathematics education are worth paying specific attention by the training projects, as the attitudes usually determine whether the teachers are willing to take effort and time to integrate digital technologies into mathematics lessons in spite of constraints. From the perspective of teachers' collective work in local communities, the support from the collective around a teacher is situated cannot be ignored. For the cases in this thesis, Dora is an active member of IREM of Lyon – a teacher-researcher community that organizes many teaching research projects and teacher training courses; Huang is invited to give open lessons with 3D DGEs to the teachers in the same teaching research group in the school, and he himself reflects on his teaching thanks to the exchange with the leader of the research group. The influence of the collective support on a teacher's coordination activities deserves further investigation.

6.2.5 Final remarks

The subject of this thesis is situated in the mathematics education integrated with digital technology. Four years' study allows to write a thesis, but it is not enough to reveal the complexity of teachers' work integrated with digital technology. During the four years, the Chinese teacher is more and more expected to demonstrate how to use GeoGebra in mathematics lessons as the software is more and more popular in China, and both the French and the Chinese teachers need to deal with the pedagogical and technological issues in the distance online teaching due to the epidemic. On the one hand, in this digital era full of changes, there are always teachers lagging behind; their requirements are equally important. On the other hand, even the heaviest sands will be lifted by the tide of the era. Through the study, I have updated my knowledge of the teaching practices with digital technologies of both France and Chinese teachers. While highlighting the interest and complexity of teachers' coordination behavior with the use of 3D DGEs, I would like to, though this thesis, draw readers' attention to the situations of teachers, their difficulties, demand for support, knowledge and views, and also feelings in the general professional work integrated with digital technologies. I am happy

to try to help teachers with the issues in these aspects through my future research, and I am sure to have then opportunities to learn from these teachers and creative practices.

References

- Accascina, G., & Rogora, E. (2006). Using Cabri3D Diagrams for Teaching Geometry. *International Journal for Technology in Mathematics Education*, 13(1), 11–22.
- Adler, J. (2000). Conceptualising Resources as a Theme for Teacher Education. *Journal of Mathematics Teacher Education*, 3(3), 205–224. <https://doi.org/10.1023/A:1009903206236>
- Albano, G., Antonini, S., Coppola, C., Dello Iacono, U., & Pierri, A. (2021). “Tell me about”: A logbook of teachers’ changes from face-to-face to distance mathematics education. *Educational Studies in Mathematics*, 108(1), 15–34. <https://doi.org/10.1007/s10649-021-10108-2>
- Archambault, L. M., & Barnett, J. H. (2010). Revisiting technological pedagogical content knowledge: Exploring the TPACK framework. *Computers & Education*, 55(4), 1656–1662. <https://doi.org/10.1016/j.compedu.2010.07.009>
- Artigue, M., Bosch, M., Chaachoua, H., Chellougui, F., Chesnais, A., Durand-Guerrier, V., Knipping, C., Maschietto, M., Romo-Vázquez, A., & Trouche, L. (2019). The French Didactic Tradition in Mathematics. In W. Blum, M. Artigue, M. A. Mariotti, R. Sträßer, & M. Van den Heuvel-Panhuizen (Eds.), *European Traditions in Didactics of Mathematics* (pp. 11–56). Springer International Publishing. https://doi.org/10.1007/978-3-030-05514-1_2
- Artigue, M., Drijvers, P., Lagrange, J., Mariotti, M. A., & Ruthven, K. (2009). Technologies numériques dans l’enseignement des mathématiques, où en est-on dans les recherches et dans leur intégration ? [Technology in mathematics education: How about research and its integration?] In C. Ouvrier-Buffet & M.-J. Perrin-Glorian. *Approches Plurielles En Didactique Des Mathématiques; Apprendre à Faire Des Mathématiques Du Primaire Au Supérieur: Quoi de Neuf? [Multiple Approaches to the Didactics of Mathematics; Learning Mathematics from Primary to Tertiary Level: What’s New?]* (pp. 185–207). LDAR et Université Paris Diderot.
- Authier, A., Grolleau, G., Hocquenghem, M., Hocquenghem, S., Monnet, F., Paquelier, Y., Sérès, P., Serfati, A., & Varoquaux, A. (1998). *Interesp: tutorial of interactive exercices interactifs of construction in the space – Production of CREEM-CNAM* (1st ed.). CRDP de Champagne-Ardenne.
- Baccaglioni-Frank, A. (2019). Dragging, instrumented abduction and evidence, in processes of conjecture generation in a dynamic geometry environment. *ZDM*, 51(5), 779–791. <https://doi.org/10.1007/s11858-019-01046-8>
- Baccaglioni-Frank, A., & Mariotti, M. A. (2010). Generating Conjectures in Dynamic Geometry: The Maintaining Dragging Model. *International Journal of Computers for Mathematical Learning*, 15(3), 225–253. <https://doi.org/10.1007/s10758-010-9169-3>
- Balacheff, N. (1987). Processus de preuves et situations de validation. *Educational Studies in Mathematics*, 18(2), 147–176.

-
- Ball, D. L., Thames, M. H., & Phelps, G. (2008). Content Knowledge for Teaching: What Makes It Special? *Journal of Teacher Education*, 59(5), 389–407. <https://doi.org/10.1177/0022487108324554>
- Bartolini Bussi, M., & Mariotti, M. A. (2008). Semiotic mediation in the mathematics classroom: Artifacts and signs after a Vygotskian perspective. In L. D. English, M. Bartolini Bussi, G. A. Jones, R. A. Lesh, B. Sriraman, & D. Tirosh (Eds.), *Handbook of International Research in Mathematics Education, second revised edition* (pp. 746–783). New York: Routledge. <https://usiena-air.unisi.it/handle/11365/44327#.XeaGM1dKjIU>
- Bartolini Bussi, M. G. B., & Mariotti, M. A. (1999). Semiotic Mediation: From History to the Mathematics Classroom. *For the Learning of Mathematics*, 19(2), 27–35.
- Battista, M. T., Frazee, L. M., & Winer, M. L. (2018). Analyzing the Relation Between Spatial and Geometric Reasoning for Elementary and Middle School Students. In K. S. Mix & M. T. Battista (Eds.), *Visualizing Mathematics: The Role of Spatial Reasoning in Mathematical Thought* (pp. 195–228). Cham: Springer Nature Switzerland AG. https://doi.org/10.1007/978-3-319-98767-5_10
- Bingimlas, K. A. (2009). Barriers to the Successful Integration of ICT in Teaching and Learning Environments: A Review of the Literature. *Eurasia Journal of Mathematics, Science and Technology Education*, 5(3), 235–245. <https://doi.org/10.12973/ejmste/75275>
- Bishop, A. J. (1983). Spatial abilities and mathematical thinking. In M. Zweng, T. Green, J. Kilpatrick, H. O. Pollack, & M. Suydam (Eds.), *Proceedings of the fourth international congress on mathematical education* (pp. 176–178). Boston: Birkhäuser. <https://link.springer.com/content/pdf/10.1007/978-1-4684-8223-2.pdf?pdf=button>
- Bonnat, C., Marzin, P., Luengo, V., Trgalová, J., Chaachoua, H., & Bessot, A. (2020). Proposition d'un modèle pour la compréhension des décisions didactiques d'un enseignant. *Éducation et didactique*, 14–3, 69–90. <https://doi.org/10.4000/educationdidactique.7793>
- Bridoux, S., & Nihoul, C. (2015). Difficultés des élèves à interpréter des constructions dans l'espace. Une étude de cas. *Petit x*, 98, 53–76.
- Brousseau, G. (1978). *La monographie d'un enfant en difficulté l'enfant Gaël* [Document universitaire, Université de Bordeaux]. <https://guy-brousseau.com/2432/la-monographie-d%e2%80%99un-enfant-en-difficulte-l%e2%80%99enfant-gael-1978/>
- Brousseau, G. (1997). *Théories des situations didactiques*. Conférence de Montreal. http://math.unipa.it/~grim/brousseau_montreal_03.pdf
- Brousseau, G. (2002). *Theory of Didactical Situations in Mathematics: Didactique des Mathématiques, 1970–1990*. Springer Netherlands. <https://doi.org/10.1007/0-306-47211-2>
- Brousseau, G. (2010). Glossaire de quelques concepts de la théorie des situations didactiques en mathématiques. *Guy Brousseau-Didactique Des Mathématiques*. <https://guy-brousseau.com/biographie/glossaires/>
- Burger, W. F., & Shaughnessy, J. M. (1986). Characterizing the van Hiele Levels of Development in Geometry. *Journal for Research in Mathematics Education*, 17(1), 31–48. <https://doi.org/10.2307/749317>

-
- Calderhead, J. (1981). Stimulated Recall: A Method for Research on Teaching. *British Journal of Educational Psychology*, 51(2), 211–217. <https://doi.org/10.1111/j.2044-8279.1981.tb02474.x>
- Castro, W. F., Durango-Urrego, J. H., & Pino-Fan, L. R. (2021). Preservice Teachers' Argumentation and Some Relationships to Didactic-Mathematical Knowledge Features. *Eurasia Journal of Mathematics, Science and Technology Education*, 17(9). <https://doi.org/10.29333/ejmste/11139>
- Christou, C., Pittalis, M., Mousoulides, N., & Jones, K. (2006). Developing the 3DMath Dynamic Geometry Software: Theoretical Perspectives on Design. *International Journal for Technology in Mathematics Education*, 13(4), 168–174.
- Clements, D. H., & Battista, M. T. (1992). Geometry and spatial reasoning. In D. A. Grouws (Ed.), *Handbook of research on mathematics teaching and learning: A project of the National Council of Teachers of Mathematics* (pp. 420–464). New York: Macmillan Publishing Co, Inc.
- Conner, A., Singletary, L. M., Smith, R. C., Wagner, P. A., & Francisco, R. T. (2014). Teacher support for collective argumentation: A framework for examining how teachers support students' engagement in mathematical activities. *Educational Studies in Mathematics*, 86(3), 401–429.
- Connor, J., Moss, L., & Grover, B. (2007). Student Evaluation of Mathematical Statements Using Dynamic Geometry Software. *International Journal of Mathematical Education in Science & Technology*, 38(1), 55–63.
- De Villiers, M. (1999). *Rethinking proof with Sketchpad* (Vol. 2). Emeryville: Key Curriculum Press.
- Drijvers, P., Doorman, M., Boon, P., Reed, H., & Gravemeijer, K. (2010). The teacher and the tool: Instrumental orchestrations in the technology-rich mathematics classroom. *Educational Studies in Mathematics*, 75(2), 213–234. <https://doi.org/10.1007/s10649-010-9254-5>
- Drijvers, P., Tacoma, S., Besamusca, A., Doorman, M., & Boon, P. (2013). Digital resources inviting changes in mid-adopting teachers' practices and orchestrations. *ZDM*, 45(7), 987–1001. <https://doi.org/10.1007/s11858-013-0535-1>
- Duval, R. (2000). *Basic Issues for Research in Mathematics Education*. In *Proceedings of the Conference of the International Group for the Psychology of Mathematics Education (PME)* (Vol. 1, pp. 55-69). <https://eric.ed.gov/?id=ED466737>
- Duval, R. (2005). Les conditions cognitives de l'apprentissage de la géométrie : Développement de la visualisation, différenciations des raisonnements et coordination de leurs fonctionnements. *Annales de didactique des mathématiques et de sciences cognitives*, 10, 5–53.
- Engelbrecht, J., Borba, M. C., Llinares, S., & Kaiser, G. (2020). Will 2020 be remembered as the year in which education was changed? *ZDM*, 52(5), 821–824. <https://doi.org/10.1007/s11858-020-01185-3>
- Erez, M. M., & Yerushalmy, M. (2006). “If You Can Turn a Rectangle into a Square, You Can Turn a Square into a Rectangle ...” Young Students Experience the Dragging Tool.

-
- International Journal of Computers for Mathematical Learning*, 11(3), 271–299.
<https://doi.org/10.1007/s10758-006-9106-7>
- Even, R., & Ball, D. L. (Eds.). (2009). *The Professional Education and Development of Teachers of Mathematics: The 15th ICMI Study* (Vol. 11). Springer US.
<https://doi.org/10.1007/978-0-387-09601-8>
- Fahlgren, M., & Brunström, M. (2014). A Model for Task Design with Focus on Exploration, Explanation, and Generalization in a Dynamic Geometry Environment. *Technology, Knowledge and Learning*, 19(3), 287–315. <https://doi.org/10.1007/s10758-014-9213-9>
- Fischbein, H. (2002). *Intuition in Science and Mathematics: An Educational Approach*. Dordrecht: Springer Netherlands. <https://doi.org/10.1007/0-306-47237-6>
- Graham, C. R. (2011). Theoretical considerations for understanding technological pedagogical content knowledge (TPACK). *Computers & Education*, 57(3), 1953–1960. <https://doi.org/10.1016/j.compedu.2011.04.010>
- Gu, L., Hunag, R., & Marton, F. (2004). Teaching with Variation: A Chinese Way of Promoting Effective Mathematics Learning. In *How Chinese Learn Mathematics: Vol. Volume 1* (pp. 309–347). WORLD SCIENTIFIC. https://doi.org/10.1142/9789812562241_0012
- Gueudet, G., & Trouche, L. (2009). Towards new documentation systems for mathematics teachers? *Educational Studies in Mathematics*, 71(3), 199–218. <https://doi.org/10.1007/s10649-008-9159-8>
- Guin, D., Ruthven, K., & Trouche, L. (Eds.). (2005). *The Didactical Challenge of Symbolic Calculators: Turning a Computational Device into a Mathematical Instrument*. Springer US. <https://doi.org/10.1007/b101602>
- Gutierrez, A. (1996). Visualization in 3-Dimensional Geometry: In Search of a Framework. In L. Puig, & A. Gutierrez (Eds.), *Proceedings of the 20th International Conference for the Psychology of Mathematics Education* (Vol. 1, pp. 3–19). Valencia: Universidad de Valencia.
- Hadas, N., Hershkowitz, R., & Schwarz, B. B. (2000). The role of contradiction and uncertainty in promoting the need to prove in Dynamic Geometry environments. *Educational Studies in Mathematics*, 44(1), 127–150. <https://doi.org/10.1023/A:1012781005718>
- Hannula, M. S. (2019). Affect in Mathematics Education. In S. Lerman (Ed.), *Encyclopedia of Mathematics Education* (pp. 1–5). Springer International Publishing. https://doi.org/10.1007/978-3-319-77487-9_174-5
- Harel, G., & Sowder, L. (1998). Students' proof schemes: Results from exploratory studies. In A. H. Schoenfeld, J. Kaput, & E. Dubinsky (Eds.), *Research in Collegiate Mathematics Education* (pub.1089185116; Vol. 3, pp. 234–283). USA: American Mathematical Society and Mathematical Association of America. <https://doi.org/10.1090/cbmath/007/07>
- Harel, G., & Weber, K. (2018). Deductive Reasoning in Mathematics Education. In S. Lerman (Ed.), *Encyclopedia of Mathematics Education* (pp. 1–8). Springer International Publishing. https://doi.org/10.1007/978-3-319-77487-9_43-6
- Haspekian, M. (2014). Teachers' Instrumental Geneses When Integrating Spreadsheet Software. In A. Clark-Wilson, O. Robutti, & N. Sinclair (Eds.), *The Mathematics Teacher in the Digital Era: An International Perspective on Technology Focused Professional*

-
- Development* (pp. 241–275). Springer Netherlands. https://doi.org/10.1007/978-94-007-4638-1_11
- Healy, L. (2000). Identifying and explaining geometrical relationship: Interactions with robust and soft Cabri constructions. In T. Nakahara & M. Koyama (Eds.), *Proceedings of the 24th Conference of the PME* (Vol. 1, pp. 103–117). Hiroshima University.
- Hegarty, M., & Waller, D. (2004). A dissociation between mental rotation and perspective-taking spatial abilities. *Intelligence*, 32(2), 175–191. <https://doi.org/10.1016/j.intell.2003.12.001>
- Hennessy, S., Ruthven, K., & Brindley, S. (2005). Teacher perspectives on integrating ICT into subject teaching: Commitment, constraints, caution, and change. *Journal of Curriculum Studies*, 37(2), 155–192. <https://doi.org/10.1080/0022027032000276961>
- Hohenwarter, M., & Jones, K. (2007). Ways of linking geometry and algebra, the case of Geogebra. *BSRLM Geometry Working Group*, 27, 126–131. <https://eprints.soton.ac.uk/50742/>
- Højsted, I. H. (2019). Guidelines for design of didactic sequences utilizing dynamic geometry affordances related to mathematical reasoning competency. *Eleventh Congress of the European Society for Research in Mathematics Education*, 17. <https://hal.archives-ouvertes.fr/hal-02428249>
- Hollebrands, K., & Okumuş, S. (2018). Secondary mathematics teachers' instrumental integration in technology-rich geometry classrooms. *The Journal of Mathematical Behavior*, 49, 82–94. <https://doi.org/10.1016/j.jmathb.2017.10.003>
- Ince-Muslu, B., & Erduran, A. (2020). A Suggestion of a Framework: Conceptualization of the Factors That Affect Technology Integration in Mathematics Education. *International Electronic Journal of Mathematics Education*, 16(1), em0617. <https://doi.org/10.29333/iejme/9292>
- Inglis, M., Mejia-Ramos, J. P., & Simpson, A. (2007). Modelling mathematical argumentation: The importance of qualification. *Educational Studies in Mathematics*, 66(1), 3–21. <https://doi.org/10.1007/s10649-006-9059-8>
- Klieme, E., & Baumert, J. (2001). Identifying national cultures of mathematics education: Analysis of cognitive demands and differential item functioning in TIMSS. *European Journal of Psychology of Education*, 16(3), 385–402. <https://doi.org/10.1007/BF03173189>
- Knipping, C. (2008). A method for revealing structures of argumentations in classroom proving processes. *ZDM*, 40(3), 427. <https://doi.org/10.1007/s11858-008-0095-y>
- Kock, Z.-J., & Pepin, B. (2018). Student use of resources in Calculus and Linear Algebra. In V. Durand-Guerrier, R. Hochmut, S. Goodchild, & N.-M. Hogstad (Eds.), *Proceedings of INDRUM 2018* (pp. 336–345). University of Agder, Norway and INDRUM. <https://hal.archives-ouvertes.fr/hal-01849945/>
- Koehler, M., & Mishra, P. (2009). What is technological pedagogical content knowledge (TPACK)? *Contemporary Issues in Technology and Teacher Education*, 9(1), 60–70.
- Koffka, K. (2013). *Principles of Gestalt Psychology*. New York: Routledge.

-
- Laborde, C. (2002). Integration of Technology in the Design of Geometry Tasks with Cabri-Geometry. *International Journal of Computers for Mathematical Learning*, 6(3), 283–317. <https://doi.org/10.1023/A:1013309728825>
- Laborde, C. (2008). Experiencing the multiple dimensions of mathematics with dynamic 3D geometry environments: Illustration with Cabri 3D. *Electronic Journal of Mathematics and Technology*, 2(1), 38–54.
- Laborde, C., & Capponi, B. (1994). Cabri-géomètre constituant d'un milieu pour l'apprentissage de la notion de figure géométrique. *Recherches en didactique des mathématiques*, 14(1), 165–210.
- Laborde, C., & Laborde, J. M. (2011). Interactivity in dynamic mathematics environments: What does that mean? *ACTM 2011-16th Asian Technology Conference in Mathematics*, Türkiye: Bolu.
- Lakatos, I., Worrall, J., & Zahar, E. (Eds.). (1976). *Proofs and Refutations: The Logic of Mathematical Discovery*. Cambridge: Cambridge University Press. <https://doi.org/10.1017/CBO9781139171472>
- Leung, A. (2011). An epistemic model of task design in dynamic geometry environment. *ZDM*, 43(3), 325–336. <https://doi.org/10.1007/s11858-011-0329-2>
- Liang, S., Glaz, S., DeFranco, T., Vinsonhaler, C., Grenier, R., & Cardetti, F. (2013). An examination of the preparation and practice of grades 7–12 mathematics teachers from the Shandong Province in China. *Journal of Mathematics Teacher Education*, 16(2), 149–160. <https://doi.org/10.1007/s10857-012-9228-x>
- Lin, F.-L., Yang, K.-L., Lee, K.-H., Tabach, M., & Stylianides, G. (2012). Principles of Task Design for Conjecturing and Proving. In G. Hanna & M. de Villiers (Eds.), *Proof and Proving in Mathematics Education: The 19th ICMI Study* (pp. 305–325). Dordrecht: Springer. https://doi.org/10.1007/978-94-007-2129-6_13
- Marchand, P. (2006). Comment développer les images mentales reliées à l'apprentissage de l'espace en trois dimensions ? *Annales de Didactique et de Sciences Cognitives*, 11, 103–121.
- Margolinas, C. (2002). Situations, milieux, connaissances: Analyse de l'activité du professeur. In J.-L. Dorier, M. Artaud, M. Artigue, R. Berthelot, & R. Floris (Eds.), *Actes de la 11ème Ecole d'Été de Didactique des Mathématiques* (pp. 141–156). La pensée sauvage. <https://halshs.archives-ouvertes.fr/halshs-00421848>
- Margolinas, C. (2004). La situation du professeur et les connaissances en jeu au cours de l'activité mathématique en classe. *Annual Meeting of the Canadian Mathematics Education Study Group / Groupe canadien d'études en didactique des mathématiques*, 3–21. <https://halshs.archives-ouvertes.fr/halshs-00430020>
- Margolinas, C. (Ed.). (2013). *Task Design in Mathematics Education. Proceedings of ICMI Study 22* (Vol. 1).
- Mariotti, M. A., & Pedemonte, B. (2019). Intuition and proof in the solution of conjecturing problems. *ZDM*, 51(5), 759–777. <https://doi.org/10.1007/s11858-019-01059-3>

-
- Marrades, R., & Gutiérrez, Á. (2000). Proofs produced by secondary school students learning geometry in a dynamic computer environment. *Educational Studies in Mathematics*, 44(1), 87–125. <https://doi.org/10.1023/A:1012785106627>
- Ministère de l'Éducation Nationale. (2019). *Programme de l'enseignement de spécialité de mathématiques de la classe terminale de la voie générale*. Ministère de l'Éducation Nationale et de la Jeunesse. <https://www.education.gouv.fr/bo/19/Special8/MENE1921246A.htm>
- Ministry of Education of the People's Republic of China. (2003). *普通高中数学课程标准 (2003)* [Mathematics curriculum standards for general upper secondary education (version 2003)]. 人民教育出版社.
- Ministry of Education of the People's Republic of China. (2018). *普通高中数学课程标准 (2017 年版)* [Mathematics curriculum standards for general upper secondary education (version 2003)]. 人民教育出版社.
- Mithalal. (2010). 3D geometry and learning of mathematical reasoning. In V. Durand-Guerrier et al. (Eds.), *Proceedings of CERME6* (pp. 796–805), INRP.
- Mithalal, J., & Balacheff, N. (2019). The instrumental deconstruction as a link between drawing and geometrical figure. *Educational Studies in Mathematics*, 100(2), 161–176. <https://doi.org/10.1007/s10649-018-9862-z>
- Morgan, C., Mariotti, M. A., & Maffei, L. (2009). Representation in Computational Environments: Epistemological and Social Distance. *International Journal of Computers for Mathematical Learning*, 14(3), 241–263. <https://doi.org/10.1007/s10758-009-9156-8>
- Parzysz, B. (1988). “Knowing” vs “seeing”. Problems of the plane representation of space geometry figures. *Educational Studies in Mathematics*, 19(1), 79–92. <https://doi.org/10.1007/BF00428386>
- Parzysz, B. (1991). Representation of space and students' conceptions at high school level. *Educational Studies in Mathematics*, 22(6), 575–593. <https://doi.org/10.1007/BF00312716>
- Pedemonte, B. (2007). How can the relationship between argumentation and proof be analysed? *Educational Studies in Mathematics*, 66(1), 23–41. <https://doi.org/10.1007/s10649-006-9057-x>
- Peirce, C. S. (1960). *Collected Papers of Charles Sanders Peirce Volume 2, Elements of logic*. Boston: Harvard University Press.
- Pepin, B., & Guedet, G. (2018). Curriculum Resources and Textbooks in Mathematics Education. In S. Lerman (Ed.), *Encyclopedia of Mathematics Education* (pp. 1–5). Springer International Publishing. https://doi.org/10.1007/978-3-319-77487-9_40-7
- Pepin, B., Xu, B., Trouche, L., & Wang, C. (2017). Developing a deeper understanding of mathematics teaching expertise: An examination of three Chinese mathematics teachers' resource systems as windows into their work and expertise. *Educational Studies in Mathematics*, 94(3), 257–274. <https://doi.org/10.1007/s10649-016-9727-2>
- Piaget, J., Inhelder, B., & Szeminska, A. (1973). *La géométrie spontanée chez l'enfant* (2nd ed.). Presses Universitaires de France.

-
- Pierce, R., & Ball, L. (2009). Perceptions that may affect teachers' intention to use technology in secondary mathematics classes. *Educational Studies in Mathematics*, 71(3), 299–317. <https://doi.org/10.1007/s10649-008-9177-6>
- Pittalis, M., & Christou, C. (2010). Types of reasoning in 3D geometry thinking and their relation with spatial ability. *Educational Studies in Mathematics*, 75(2), 191–212. <https://doi.org/10.1007/s10649-010-9251-8>
- Poincaré, H. (1905). *Science and hypothesis*. London: Walter Scott Publishing.
- Polya, G. (1954). *Mathematics and Plausible Reasoning: Induction and analogy in mathematics*. Vol. 1. Princeton: Princeton University Press.
- Presmeg, N. (2006). Research on visualization in learning and teaching mathematics. In A. Gutiérrez & P. Boero (Eds.), *Handbook of Research on the Psychology of Mathematics Education: Past, Present and Future* (pp. 205–236). Rotterdam: Brill | Sense.
- Psycharis, G., & Kalogeria, E. (2018). Studying the process of becoming a teacher educator in technology-enhanced mathematics. *Journal of Mathematics Teacher Education*, 21(6), 631–660. <https://doi.org/10.1007/s10857-017-9371-5>
- Rabardel, P. (1995). *Les hommes et les technologies; approche cognitive des instruments contemporains*. Armand Colin. <https://hal.archives-ouvertes.fr/hal-01017462>
- Reid, D., Knipping, C., & Crosby, M. (2011). Refutations and the logic of practice. *PNA*, 6(1), 1–10.
- Remillard, J. T. (2005). Examining Key Concepts in Research on Teachers' Use of Mathematics Curricula. *Review of Educational Research*, 75(2), 211–246. <https://doi.org/10.3102/00346543075002211>
- Richardson, S. (2009). Mathematics teachers' development, exploration, and advancement of technological pedagogical content knowledge in the teaching and learning of algebra. *Contemporary Issues in Technology and Teacher Education [Online Serial]*, 9(2). <https://citejournal.org/volume-9/issue-2-09/mathematics/mathematics-teachers-development-exploration-and-advancement-of-technological-pedagogical-content-knowledge-in-the-teaching-and-learning-of-algebra>
- Ruthven, K. (2014). Frameworks for Analysing the Expertise That Underpins Successful Integration of Digital Technologies into Everyday Teaching Practice. In A. Clark-Wilson, O. Robutti, & N. Sinclair (Eds.), *The Mathematics Teacher in the Digital Era: An International Perspective on Technology Focused Professional Development* (pp. 373–393). Springer Netherlands. https://doi.org/10.1007/978-94-007-4638-1_16
- Ruthven, K. (2022). Resources in translation: Towards a conceptual and technical apparatus. *ZDM – Mathematics Education*. <https://doi.org/10.1007/s11858-022-01392-0>
- Schoenfeld, A. H. (2011). Toward professional development for teachers grounded in a theory of decision making. *ZDM*, 43(4), 457–469. <https://doi.org/10.1007/s11858-011-0307-8>
- Shao, M.-Y., Kayali, L., Osta, I., Pepin, B., & Trouche, L. (2022). Deepening the conceptualization of teachers' interactions with resources by translating a case analysis in different languages. In C. Fernández, S. Llinares, A. Gutiérrez, & N. Planas (Eds.), *Proceedings of the 45th Conference of the International Group for the Psychology of Mathematics Education* (Vol. 1, pp. 104-107). Alicante, Spain: PME.

-
- Shulman, L. S. (1986). Those who understand: Knowledge growth in teaching. *Educational Researcher*, 15(2), 4–14.
- Sinclair, N., & Robutti, O. (2013). Technology and the Role of Proof: The Case of Dynamic Geometry. In M. A. (Ken) Clements, A. J. Bishop, C. Keitel, J. Kilpatrick, & F. K. S. Leung (Eds.), *Third International Handbook of Mathematics Education* (pp. 571–596). New York: Springer. https://doi.org/10.1007/978-1-4614-4684-2_19
- Stylianides, A. J., & Ball, D. L. (2008). Understanding and describing mathematical knowledge for teaching: Knowledge about proof for engaging students in the activity of proving. *Journal of Mathematics Teacher Education*, 11(4), 307–332. <https://doi.org/10.1007/s10857-008-9077-9>
- Tall, D. (2004). Building theories: The three worlds of mathematics. *For the Learning of Mathematics*, 24(1), 29–32.
- Thomas, M. O. (2006). Teachers using computers in mathematics: A longitudinal study. *Proceedings of the 30th Annual Conference of the International Group for the Psychology of Mathematics Education*, 5, 265–272.
- Thomas, M. O. J., & Palmer, J. M. (2014). Teaching with Digital Technology: Obstacles and Opportunities. In A. Clark-Wilson, O. Robutti, & N. Sinclair (Eds.), *The Mathematics Teacher in the Digital Era: An International Perspective on Technology Focused Professional Development* (pp. 71–89). Springer Netherlands. https://doi.org/10.1007/978-94-007-4638-1_4
- Toulmin, S. E. (2003). *The Uses of Argument* (2nd ed.). Cambridge: Cambridge University Press.
- Toulmin, S. E. (1958). *The uses of argument* (1st ed.). Cambridge: Cambridge University Press.
- Trouche, L. (2003). From artifact to instrument: Mathematics teaching mediated by symbolic calculators. In P. Rabardel & Y. Waern (Eds.), *Special issue of Interacting with Computers* (Vol. 15, pp. 783–800). <https://www.sciencedirect.com/science/article/pii/S0953543803000766>
- Trouche, L. (2004). Managing the Complexity of Human/Machine Interactions in Computerized Learning Environments: Guiding Students' Command Process through Instrumental Orchestrations. *International Journal of Computers for Mathematical Learning*, 9(3), 281. <https://doi.org/10.1007/s10758-004-3468-5>
- Trouche, L. (2016). Didactics of Mathematics: Concepts, Roots, Interactions and Dynamics from France. In J. Monaghan, L. Trouche, & J. M. Borwein (Eds.), *Tools and Mathematics* (pp. 219–256). Springer International Publishing. https://doi.org/10.1007/978-3-319-02396-0_10
- Trouche, L., Gueudet, G., & Pepin, B. (2020). Documentational Approach to Didactics. In S. Lerman (Ed.), *Encyclopedia of Mathematics Education* (pp. 307–313). Cham: Springer International Publishing. https://doi.org/10.1007/978-3-319-77487-9_100011-1
- Vergnaud, G. (1996). Some of Piaget's fundamental ideas concerning didactics. *Prospects*, 26(1), 183–194. <https://doi.org/10.1007/BF02195617>
- Vergnaud, G. (1998). Towards a Cognitive Theory of Practice. In A. Sierpiska & J. Kilpatrick (Eds.), *Mathematics Education as a Research Domain: A Search for Identity. An ICMI*

-
- Study Book 1* (pp. 227–240). Springer Netherlands. https://doi.org/10.1007/978-94-011-5194-8_15
- Vergnaud, G. (2009). The theory of conceptual fields. *Human Development*, 52(2), 83–94. <https://doi.org/10.1159/000202727>
- Vergnaud, G. (2013). Conceptual development and learning. *Curriculum*, 26, 39-59.
- Voogt, J., Fisser, P., Roblin, N. P., Tondeur, J., & Braak, J. van. (2013). Technological pedagogical content knowledge – a review of the literature. *Journal of Computer Assisted Learning*, 29(2), 109–121. <https://doi.org/10.1111/j.1365-2729.2012.00487.x>
- Wang, C. (2019). *An investigation of mathematics teachers' documentation expertise and its development in collectives: Two contrasting cases in China and France* [Phd thesis, Université de Lyon ; Université normale de la Chine de l'Est (Shanghai)]. <https://tel.archives-ouvertes.fr/tel-02275820>
- Watson, A., & Ohtani, M. (Eds., 2015). *Task design in mathematics education: An ICMI study 22*. Springer Nature.
- Yakimanskaya, I. S. (1991). *The Development of Spatial Thinking in Schoolchildren. Soviet Studies in Mathematics Education. Volume 3*. Reston, USA: National Council of Mathematics.
- Zazkis, D., Weber, K., & Mejía-Ramos, J. P. (2016). Bridging the gap between graphical arguments and verbal-symbolic proofs in a real analysis context. *Educational Studies in Mathematics*, 93(2), 155–173. <https://doi.org/10.1007/s10649-016-9698-3>
- Zhang, L. (2022). *From potential to practical variations in the teaching of functions: contrasting Chinese and French cases in two upper secondary schools* [Phd thesis, Université de Lyon ; Université normale de la Chine de l'Est (Shanghai)].
- Zimmermann, W., & Cunningham, S. (Eds.). (1991). *Visualization in teaching and learning mathematics*. USA: Mathematical Association of America.
- Zhu, F. (2020). *Teachers' Knowledge for Integrating Dynamic Geometry Software into Mathematics Lessons: Contrasting Chinese and French Cases* [Phd thesis, Université de Lyon ; Université normale de la Chine de l'Est (Shanghai)]. <http://www.theses.fr/2020LYSEN029>



Numéro National de Thèse : 2022ENSL0060

ANNEXES-APPENDICES DE THESE

l'ECOLE NORMALE SUPERIEURE DE LYON

en cotutelle avec

EAST CHINA NORMAL UNIVERSITY

Ecole Doctorale N° 485
Ecole doctorale Education, Psychologie, Information et Communication

Discipline : Sciences de l'éducation
Soutenue publiquement le 13/12/2022, par :

SHAO Mingyu

How do teachers support students' coordination of perception and logical reasoning in 3D dynamic geometry environments: French and Chinese cases

Comment les professeurs soutiennent-ils la coordination, par les étudiants, de la perception et du raisonnement ? Etude de cas en France et en Chine

Après l'avis de : SINCLAIR Nathalie, Simon Fraser university - FAN Lianghuo, ECNU

Devant le jury composé de :

FAN, Lianghuo	Professeur	ECNU, Chine	Rapporteur
BALACHEFF, Nicolas	Directeur de recherche	CNRS	Président du jury
MITHALAL, Joris	Maître de conférences	Université Lyon 1	Examinateur
XU, Binyan	Professeure	ECNU, Chine	Examinatrice
TRGALOVA, Jana	MCF HDR	Université Lyon 1	Co-encadrante
TROUCHE, Luc	Professeur émérite	ENS de Lyon	Directeur de thèse
BAO, Jiansheng	Professeur	ECNU, Chine	Cotuteur de thèse

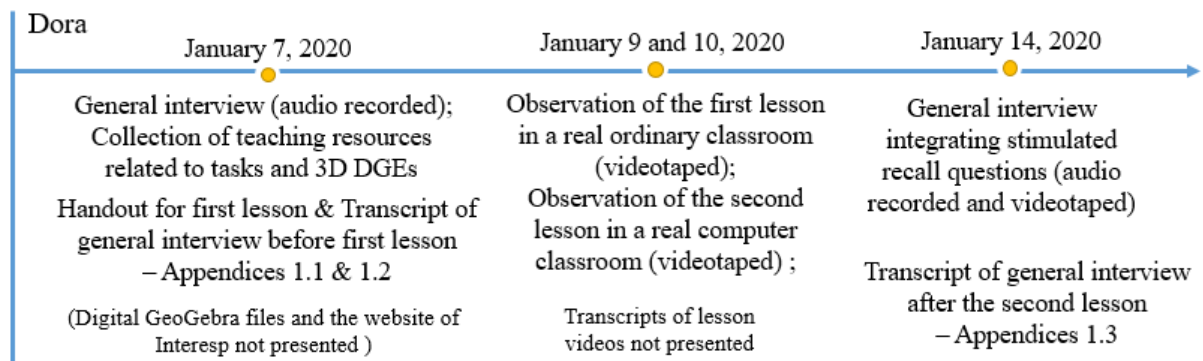
Table of contents

1	Data of Dora, Lesson Series D.I (2 lessons)	1
1.1	Handout for first lesson.....	2
1.2	Transcript of general interview before first lesson	2
1.3	Transcript of general interview after the second lesson	9
2	Data of Sonia, Lesson Series S.I (1 lesson).....	25
2.1	Transcript of general interview after the lesson of Sonia	25
3	Data of Chinese Huang, Lesson Series H.I and H.II (1 lesson for each)	43
3.1	Handout for the lesson in H.I.....	44
3.2	Transcript of general interview after the lesson in H.I	46
3.3	Written memoir of the lesson in H.I	64
3.4	Transcript of compensatory interview after the lesson in H.I.....	71
3.5	Hand out for the lesson in H.II	91
3.6	Transcript of general interview before the lesson in H.II.....	92
3.7	Transcript of general interview after the lesson in H.II.....	96
4	Data of Huang, lesson series H.III (2 lessons)	105
4.1	PowerPoint slides for the two lessons in H.III.....	105
4.2	Transcript of general interview after the second lesson in H.III	119

The appendices in this volume include the transcripts of the interviews with the teachers and some resources related to the tasks and 3D DGEs they used in the lesson series. The transcripts of the interviews are all translated from Chinese/French into English by the researcher. The resources are all presented in the original language as the most parts of them have been translated into English and integrated into the main volume of this thesis. The following chapters respectively present the data about the cases of the three teachers.

1. Data of Dora, Lesson Series D.I (2 lessons)

App-Fig. 1 presents how the data in appendices 1.1, 1.2 and 1.3 (which will be presented below) are situated in the lesson series of Dora.

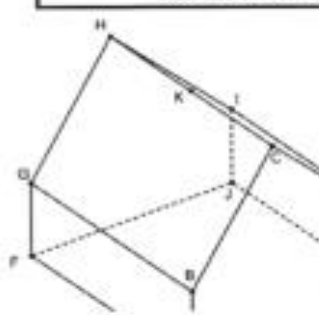


App-Fig. 1 Data about Lesson Series D.I

1.1 Handout for first lesson

Géométrie dans l'espace 1

Partie A : Droites et plans de l'espace - Point de vue géométrique

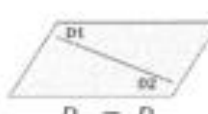
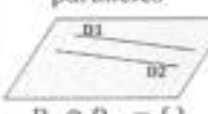
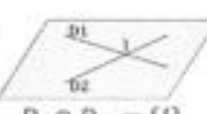


Dans tout le cours, on considérera le solide ABCDEFGHIJK

I. Les règles d'incidence

1) Position de deux droites de l'espace

Deux droites sont **coplanaires** lorsqu'elles sont contenues dans un même plan.
Dans ce cas, elles sont :

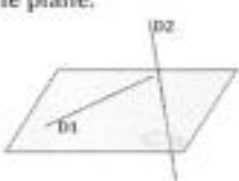
confondues  $D_1 = D_2$	strictement parallèles  $D_1 \cap D_2 = \{ \}$	sécantes  $D_1 \cap D_2 = \{I\}$
--	---	---

Exemples :

On peut alors appliquer les propriétés et théorèmes vu en géométrie plane.

Définition
Deux droites sont **non-coplanaires** quand elles ne sont pas contenues dans un même plan. $D_1 \cap D_2 = \{ \emptyset \}$

Exemple (Dans la maison) :

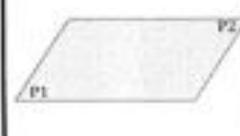

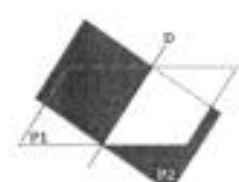


Synthèse :

Nombre de points communs	Position des deux droites
0	Les droites sont non-coplanaires OU Les droites sont coplanaires et strictement parallèles
1	Les droites sont sécantes (elles sont coplanaires)
2 et plus	Les droites sont confondues (s'il y a 2 points communs alors tous les points sont communs)

2) Position de deux plans de l'espace

Deux plans de l'espace peuvent être :

confondues 	strictement parallèles 	Sécants suivant une droite 
---	---	---

Exemples

1.2 Transcript of general interview before first lesson

The first interview with Dora was made in the afternoon of Monday 7th January 2020, before the observation of the two lessons given by Dora on the subsequent Thursday and Friday (9th and 10th January). The topic she taught for the two lessons are respectively “relative positions between lines and planes in space” and “constructing the intersection of lines and planes in space” (content of grade 12). The interview was conducted in a vide classroom of the high

school and it lasted 1 hour 10 minutes. The interview was recorded in audio format, and then transcribed in French, and translated into English. Below presents the English version, it is only a part of the whole interview which covers the words cited in the main volume of the thesis.

R1: Could you tell me your teaching plan on 3D geometry?

Dora2: So the program of 3D geometry, I divide it into 3 chapters. The 1st chapter is from the point of view of pure geometry, we are not talking about coordinates nor equations. Instead, what we will talk about is the point in space, the plane in space, and then the notion of parallelism, the notion of intersection, of two lines, two planes, a plane and a line, but from a purely geometric point of view. In fact, 3D geometry has progressively disappeared from the programs. I know that half of the class have never done 3D geometry. They have calculated volumes in college and that's all.

R2: After Friday's lesson, I mean on Monday, what are you going to do?

Dora2: I'm going to continue next Monday. In fact, we have no lessons on Monday. But next Tuesday yes, I'm going to continue. I hope to finish all the rules of incidence, that is to say, all the relative positions of 2 planes, two lines, a line and a plane. If I have time, I will continue to introduce a little about parallelism, but I am not sure. And then I have a whole job to do with orthogonality. It goes on very quickly anyway. We will only deal with general properties, and some exercises next Tuesday. After that we will go into the sections of the cube. All the properties and notions introduced previously, except orthogonality, are aimed to make sections of the cube. We will do these exercises (in Interesp) again on the paper, with drawings. So I think all next week I'll spend the time in 3D geometry. On Tuesday I have 2 hours, and on Thursday I have 1 hour.

R3: OK now let's focus on the lesson on Friday. The subject of the lesson is the intersection of lines and planes; how do you situate this subject in the whole 3D geometry?

Dora3: It's the beginning. It's actually after the introduction of what it is that a line and a plane. It comes just after that; to understand what it is going to be the intersection of plane essentially and how to build it. What is interesting with the software is that we can turn around the figures therein, to let students realize that 2 lines may seem to be secant when we see them on the plan, but after we turn them around, we can see that they are not secant in fact

R4: Will you refer to any theorems here, like rules of incidence, theorems about parallelism?

Dora4: Yes, some theorems are necessary, especially to make sections of the cube. But I am not sure students will need them at once. It's will depend, because everyone is going to go at his own speed. I mean, on Friday. There are some students who may proceed quite fast than the others, and they've already learned something before Friday.

R5: Before Friday, there will be Thursday's lesson?

Dora5: Yes, it is when I will introduce at least a part of the rules of incidence and if possible a little about parallelism, but we will see. Then Friday it will be the application, put what we have learned into application, to make first constructions.

R6: What is your didactical objective here?

Dora6: The objective, I would like them to know some rules of incidence, and meanwhile develop the vision in space. Since they can rotate the figures in space with the computer, they will really be able to realize that they don't intersect. I mean, if they try to extend two lines in the aim of creating a point of intersection there, they will not be able to create; and by rotating the figure they will see ah yes indeed, the lines are not intersecting, and the point that I suppose to create does not exist. I would like them to understand that for two lines being intersecting, they should firstly be coplanar. It is really the basis, I think, because it is very easy to make mistakes when you have a 3D on the plane.

R7: Okay, do you have any specific goals with respect to the technological operations? For example, there are also operations with the button, like button of lines, of intersection, do you plane to specifically teach students about this?

Dora7: No, the idea is to make them work in Interesp automatically, the operations are very simple and they can explore that by themselves and learn quickly

R8: So the aim of using Interesp is?

Dora8: It's really their vision in the space that I'm trying to develop with Interesp.

R9: How do you decide the didactical objective and your lesson plan. It's in reference to the curriculum, the textbook, or your own understanding of this mathematics subject?

Dora 9: I have taught terminal scientific students for several years. For this chapter, I did it several times in several different ways, and now I really prefer this way: first the point of view of pure geometry, then the point of view of geometric vector, and finally the point of view of analytical geometry. With my experience, I see that that here is the most complicated, it is very essential to apprehend the notions of line and plane. That's why I put them back in the progression and put them earlier in the terminal year. Initially they are put in the classes of second, but now there is nothing any more in the program. Previously there was at least a chapter all about the pure geometry in the class of the second. But now I move it to the beginning of the geometry in the class of the terminal. What I like to do here, usually, is to make them build some models such as the house (Figure 1) and I will organize a contest of 'house building', but in the terminal year we don't have time. With our houses we can calculate volumes therein, and the biggest interest in the house is that the theorem of roof can be well illustrated, and I have all the possible relative positions between lines and planes in it; there are planes which intersect with each other. A cube, by contrast, is not so rich. I could really do a lot of things with the model of house. That's why I usually use a drawing of house as the reference to design tasks. But I have to start with some realistic objects in space to develop their vision in space. I know that to see in space is difficult for students. Then I would like them to do some constructions in pure geometry. As I said before, it is chapter where everyone returns to zero, that is what I like. They don't need have a lot of prior knowledge. Everyone could start off from the same line, and some students who are not very good in algebraic calculation but have a better vision than others could do better here and so

I can put them back in track. This could give students some confidence in learning, that's why I would like to do it at the beginning of 3D geometry, even in the terminal year.



Figure 1

R10: what is the most important for you in teaching this subject and the role of dynamic geometry here?

Dora10: yes, then the most important thing is to develop a vision in space. When we look at an image in GeoGebra, we may have the impression that two non-coplanar lines would intersect with each other. It's necessary to move the figure around and to see well that the intersection doesn't exist. It's the biggest advantage of GeoGebra...If we only work with paper, we would have the impression that some incidences would exist but actually they don't. The rules of representing 3D figures in plane are complicated for them when I was in the class of second, I had to work quite much work on it.

R11: What resources would you use and why do you choose them for this lesson?

Dora 11: I think at the time I started with a textbook. I designed the handout according to a textbook and then as I went along, I added something. There's the figure of house which I used as a basis. I try not to make too many photocopies. The handout of 3D geometry usually contains many figures and I try to keep only the essential ones. After introducing the rules of incidences I will arrange some exercises. We will deal with these quickly but it is important for appropriating the theory. Then I try to use the exercises in the textbook so that I don't make exercise sheets and photocopy them again. Here are the first exercises in the handout, and then in the computer room the students will do some exercises in Interesp. The exercises concern the intersection of lines and planes, the parallelism between lines and planes. The orthogonality is not treated by the software and we will do it after. But the cube sections are included in Interesp.

R 12: So it's like combining the textbook resources and the digital resources in Interesp?

Dora 12: yes, they complement each other.

R13: the baccalaureate is also an important reference for you?

Dora13: yes, that's true. Because when in the final year of high school, the students have two objectives, the 1st objective, it's to succeed in the baccalaureate. So it's a final exam which is at the national level again because it will, there are things that will change but again this year it's that so it's scientific baccalaureates, mathematics, it's important for them, it's a big coefficient of agreement. So that's the 1st objective, it's to prepare them for the exam what they must know how to do to be at ease the day of the exam and to have the maximum of points. The second thing is to prepare for higher studies when you have a place in the final year of high school, so in higher studies, there are not many, only a small proportion who will still be doing mathematics next year, even if they are in scientific studies. Push next year, we have who do applied mathematics but not very advanced mathematics and then from what I know from higher education, I am not a specialist but from what I have seen anyway from what I know the day very in space, it is not very much used in fact. Here we are, we'll talk about moreover i'll put space I had worked a little bit with uh physicists uh, they use all the notions of uh conics of space in fact the ellipsoids, the paraboloids the pyramids here we are but uh but doesn't use so much the quadrics in fact. Uses the quadrics but they don't really use the vision in space, the sections of cube, it's not used too much in any case from what I know. So finally it's the objective of help and to make the day very the space, it's still interesting. To develop one's own vision in space is interesting for oneself, but it is especially to succeed in the exam. So in this objective the exercises, they answer it fully. Ah voilà,

R14: Are you going to do something to overcome the limitations of Interestp?

Dora14: it is that of the blow that it is done on line and one can have this aspect 3 d but at the end the pupils, they must know to make it on paper when even the interest of that it is to see the things but it is necessary to know to make them on the paper. Thus the limitation it must be there, there is a pupil who arrives there only because he sees well in space who will be able to move the figure, it is necessary nevertheless at the end who can understand how the figure functions when it is on the plan thus to remedy that but it is necessary to make exercises of the book. Here and they are. There is also this paper, yes, and did you use the drawing on paper or in this course? Ah yes, yes, of course. In the same course on Friday. No Friday, we do purely computer science because it's precisely the start ah at the start, it's good to see in the space as well as possible but afterwards you have to know how to detach yourself from it to answer the exercises afterwards it's also for that reason that there we do a course finally chapter 1 little short. Since we're going to spend 6 hours in all and that's all, so 6 hours isn't a lot of time to do geometry in space, but that's why we do it early in the year because it's 6 hours where they'll say, "this is very complicated, I'm not going to make it. But between now and June, they'll have time to get it in by doing a little bit regularly, they'll have time to mature all that in fact. That's why we're doing it now a to ripen yes, it's going to ripen ah. So there you go. Yes, it's an image in fact like the fruits, eh the fruits of the tree, we say that they are ripe there you go and there for the learning, it's going to ripen.

R15: what are you going to do to help students determine the intersection in the 3D dynamic models?

Dora15: The Interest will give the evaluation automatically, so I don't need to go and correct them one by one. It's really interesting for the students who want to practice, they are autonomous. There are of course certain pupils who have difficulty in understanding that a plane is something of finished vaccine on the contrary and that one works with figures of space where one works with faces. And the faces it is that euh an emerged part of the plane which is infinite and that sometimes, it is complicated for certain pupils it is the same thing as said therefore there bah it is bah that it is that with the practice on the figures one says ah bah yes one can leave the solid. Sometimes they have difficulties on that, to see two lines as intersecting, but in fact they are non-coplanar lines. It's very easy to make mistakes, especially when seeing 3D figures in the plane, if they don't know that secant lines must be coplanar. To convince him that it is not cut in fact then you can with. By moving that it is easy. I mean it is the interest precisely of the software it is that one can make move the figure what it is the interest it is really there because if one remains that on paper. And that the students say ben no, that cuts, I see myself ben. Yes but no, that does not exist this point. No, it is necessary to see the things. There is a very long time as I had more software, I made build one of the cubes one of the blocks rather and tetrahedrons and one made that a little in direct. Thus I brought pins to simulate the points and we took Mikado to see the lines which is what is cut and which is cut. Ah voilà so at a given moment, it is necessary to manipulate in fact thus there the interest it is that I do not need pin of the gift and construction uh, one can directly make it. But otherwise uh, it is absolutely necessary that the students make the error in fact and to convince themselves of a software, it is the best. Here is and but me I do not know how to convince on paper on paper. I can tell them they will say to me yes ok but I am not sure that he understood if we do not see it I think that we do not realize end. Because we have we really have this difficulty to pass from the space to the plan and the end and the opposite you can in the space rather it is that it is very good, it is really very complicated what.

R16: and how would you evaluate the respective roles played by the direct perception and the reasoning?

Dora16: so yes, at first, I don't ask them to write. So the student who is intuitive, obviously, he'll see well in the basic space, he'll be much further ahead than the others. On the other hand, what I was saying there the reasoning, that is to say if a pupil has difficulties, I'm going to make him do the analysis again in fact theoretical because what I say at the end what I'm convinced of because it's like that that I work me because I function me uh, it's that one can see nothing in space to have big difficulties of vision. And without going out with the properties and the student who is simply intuitive but I will still ask him to explain things and so we come back to that, I look for what intersection of plan what it can be and now that I know what it is how I build it here it is. And we go back to the basics, but by going back to the basics, we manage to build our reasoning. So it's true that some people will have trouble writing afterwards, but it will be absolutely necessary, so in the first instance, I don't evaluate the writing at all, so the student who is very intuitive and who does very well is additive. No what word did you use earlier, the difference between yes, perception, uh, instinct, that's what we're going to perceive, yes, uh, from this end, here's a way, uh, intuition, it's good. I have the impression that it's going to work, like this, and it's true, it's not a reasoning, it's well seen

in the space. But then you have to tell him well now, you have to explain and write but that will be done in a second time. It will be done in class later. For me when you can't see well. There is only by reasoning that we can get out of it. Ah it is my idea in any case, it works for me. In fact, we will do the two at the same time, we must practice. You have to do exercises as much as possible, that's it, but when you're blocked, you're blocked, that's it, and to get unblocked, you have to use theory. No, it's the experience that will make my vision develop, but for the start, you have to go back to theory. So you have to reason like this. The experience of seeing figures. That's it, by dint of a building, the last time I did it like this it worked well, can it still be applied here? Yes, but the first time you are faced with an exercise, you can be completely blocked. But if we as you are said earlier ADI and ABC if I don't know I'm looking for a right already uh, it's not even worth looking for a vision of something. Uh yes. So I can't do otherwise if I don't know that I'm looking for a right, I'm going to make a mistake. Ah that's not going to help me. And sometimes even if on GeoGebra, it will also be wrong.

R17: What do you think are the principle difficulties of students in this topic?

Dora17 : c'est il y a plusieurs la 1ère difficulté, c'est voilà une mauvaise application euh. Enfin le problème des droites non coplaner qui paraissent sur le plan se couper et qui ne se coupant donc ça c'est la 1ère difficulté 2e difficulté c'est de sortir de la figure. It's to consider the plans as finished when in fact they are infinite, eh, that's a second difficulty. It's especially these basic difficulties that I notice and that we try to anticipate. It's really the experience that will make it fit. I don't think that's going to work. I don't think that's going to work either. I don't think that's going to help them overcome or... It's these exercises that I think are really going to help them. How can I know that the rights of my friend do not cut me, I will see it in space and thus thanks to the software, it is easier and then uh to take it out of the figure but one realizes by doing exercises. It's not always obvious at first, but it's with experience, once you're so limited to the face that you can't get out of it, when you have the solution, that's when I can help them, of course, you'll understand that I could get out of it

R19: Now I want you ask about your experience with dynamic software. What difficulty did you encounter because you interact yourself with GeoGebra?

Dora19: I had difficulty in fact to the to make figures with GeoGebra. Yeah, I don't find it very intuitive. Well, it's been a while since I've been able to get over it because it's very difficult, uh, well, I don't know exactly what it is, but yeah, it wasn't intuitive, in fact, uh, and finally, when I want to construct figures for my course, well, I prefer to stay in 2-d. And to make myself the perspective in fact. Ah voilà. Yes, but I have more trouble is that it must calculate with the coordinates in fact, I see so it makes a lot of calculations what. And even for the cube. But after that it bah if it is feasible. No but here but here, I found less intuitive uh than in the plan what. Ah voilà, well voilà and something more difficult for you for example. It was really to do figures of the course eventually uh if I like better mastering because sometimes I've already done it but uh yes, I have I have some difficulties sometimes to move things well uh. Here to come back to the view I wanted uh here is. So uh I gave up a little bit but otherwise the initial idea was to have my figures and to be able to show it in class that the rights of the night were not cut because we managed to move the figure and all

that ah I was doing on my figure of the house at the beginning. But it's been a long time since I've looked. So use so much. Yeah, it's easier. Yes, and the drawing starts where. But the drawings, the drawings that I finally do, that doesn't bother me too much. I'm going to make it simpler. I'm doing it on, I'm doing it on the plan. No, you have to yes and file it yourself.

1.3 Transcript of general interview after the second lesson

The second interview with Dora was made in the afternoon of 14th January 2020, after the observation of the two lessons given by Dora on the previous Thursday and Friday (9th and 10th January). The topic of the two lessons are respectively “relative positions between lines and planes in space” and “constructing the intersection of lines and planes in space” (content of grade 12). The interview was conducted in a vide classroom of the high school (App-Fig. 2) and it lasted 45 minutes.



App-Fig. 2 The setting in which the second interview with Dora was conducted

The interview was recorded in audio format and the part of the stimulated recall interview was also recorded in the video format. The original audio was transcribed in French, and then translated into English. Below presents the whole interview in English.

R1: After the course was disrupted by a strike last Thursday, how did you decide to adjust your progress?

Dora1: We'll see how it goes, no I didn't adjust anything, it's just that it was shorter than expected. It's true that I would have liked to have had some for the next day... Where I adjusted is that during the tutorial, I explained some properties of the course, whereas I would have preferred to do them the day before.... The story that, for two lines to intersect, they had to be coplanar, at one point some of them also needed the roof theorem, I would have liked us to do it in the course, so that they could apply it, there I had to explain it to them, for some

of them, or else they discovered it by dint of manipulating, but, there you go. Whereas Mrs. Sonia, she had it, she had said to herself, I do the intersection right away, and they discover the properties by themselves. I preferred to be a little more efficient for that, that we discover the properties together, and then when they manipulate they will do the things. It's not a big deal either, but there you go. I had to give explanations, which for some were discoveries, whereas I would have preferred that we discover them together the day before. So that's where I had to adjust a little bit, but otherwise, I hope that, in the end, since I'm doing the course later, I hope that we'll be more efficient, I hope that I'll catch up a little bit, because they'll have manipulated it, in the end.

R2: Before, would you have wanted to start a little parallelism?

Dora2: Yes, I would have liked to go as far as parallelism at the beginning, at the beginning I wanted, I thought that, in one hour, one could do all the relative positions of lines and planes, and the properties due to parallelism. But in the end I only did the relative positions of the lines. So I hope that I will finish all the course today, and maybe some exercises, we will see. At least the exercises that are in the course anyway.

R3: Then there are questions about the TP course last Friday, from a general point of view, are there any events that you didn't anticipate during this lesson?

Dora3: No, not especially, but that's more specific to the software in fact, than to... When they wanted to construct a line that was parallel to another passing through a point, the configuration of, it's not really the GeoGebra software, but the person who made the site, it only allows you to define a line by two points, and not by a point and a direction, so you had to look for another point each time, and that, for me, wasn't very useful. So, it is a student who explains us...

R4: How did you react to it?

Dora4 : Well, at the beginning, I said well, no, that's the answer, and as it doesn't work on the software, it's another student who told me in fact, you really have to build a second point, but I don't have a very good vision in space, so. So I did the exercises, but last year, this year I didn't really do them again, and so that's it, that's a difficulty I had, so I didn't really foresee it, but it's not mathematical, it's more technical, so I think it's not very interesting.

R5: To what extent do you think your didactic objective was achieved?

Dora5: I think they all got into the intersection problems, I think they got into the subject well. That was the main objective of this first part of geometry in space, to discover lines, planes and intersections. Some had a lot of difficulties to get out of the figure at the beginning, and then they got out of it, so after we will see if the objective was reached, if they manage to do it afterwards on paper. That's the next step, it's afterwards, to do it on paper.

R6: Were there any student contributions or difficulties that impressed you?

Dora6: Yes there are some groups that went very very fast, that's for sure, small groups, those who were here, there (Figure 1), the two girls they were both on the computer, but they have the same level, they went very very fast, the girls who were completely... These two there,

they were on the same computer, they have... And it's one of the two who came to tell me, well yes to draw the parallel line, here's how to do it... you have to construct a second point and here's the point. I can't build the second point... So it's true that there are some, they really went... There are some who see very well in space, I don't see very well in space so I see that they see better than me, because they moved their face all the time, I couldn't see what was in front, behind, and they saw very well, it didn't bother them...

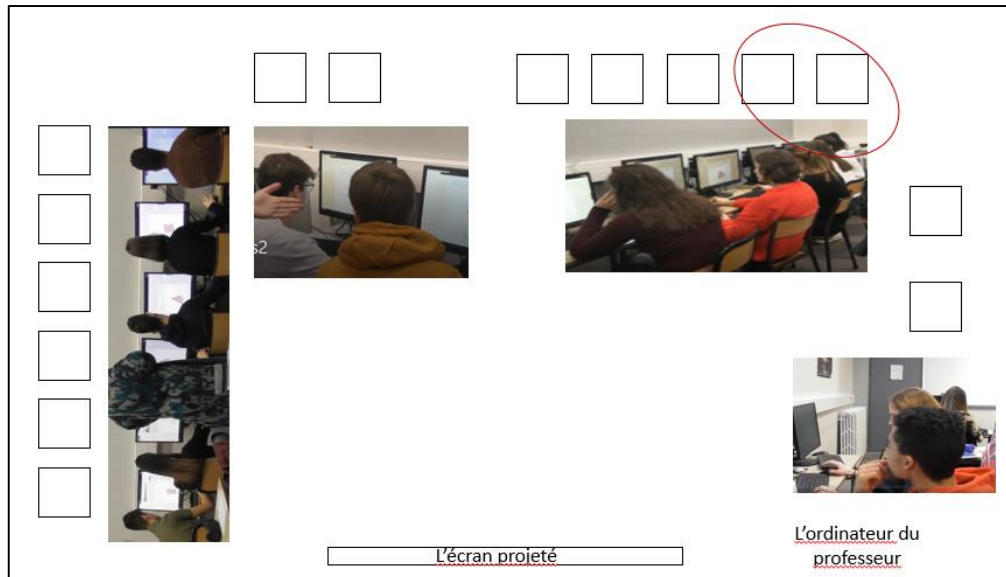


Figure 1

R7: What you haven't planned?

Dora7 : No, I foresee, yes, it has already happened to me, I know that there are many students who can see better than me in space, but it's not a problem, I tell them it's not a problem at all, on the contrary I try to reassure those who can't see well like me by saying that we can still get by.

R8: Have you deepened your understanding of student difficulties?

Dora8 : No, I knew about the difficulties, I've been doing this lesson for a long time, I haven't had any new difficulties.

R9: So it's still what you've had before?

Dora9 : Yes, there was no surprise

R10: How do you think technical failures could be better avoided and the benefits of Interesp better realized?

Dora10: So, either I would be able to reprogram so that there is the possibility to define a line by two points, or by a point and a parallel line, that would be ideal for me. But that's not how the exercises were configured, and the person who made, who took over the exercises that existed... already bravo, because it's still a great tool.

R11: I also saw the students, they were not able to do the exercise again?

Dora11: Yes, because we have..., it's just the time we are on the software, but finally it works.

R12: Then there were also students who clicked directly on the intersection point without activating the "intersect" button...

Dora12: Yes, after a few minutes, these technical difficulties disappear. If they don't have many tools in there...

R13: So for you, are there any technical aspects that should be paid attention to?

Dora13: So I think that we could indeed take some time, look at the board, explain the tools to them, but in the end... Well, I don't think that it wasted much time. It would waste more time to get everyone's attention at the beginning to show them this. If we want to be very efficient in an hour, it's better for them to make their own mistakes and for me to be behind them to explain "look at the intersection, this is how you can do it...". So I'm not sure that a paper or a demonstration is really useful. Afterwards, if we were to do something more complex on GeoGebra itself, I agree that there might be some learning to do but, well, that's not the case.

-----**Beginning of stimulated recall interview**-----

R14: Now I'm going to show you several excerpts from the video. For these excerpts, I would like you to give a description of what you were doing, how you were feeling, what you were thinking, you can stop the video whenever you want...

Extract 1 video of the second lesson 22: 57 - 28: 16

Dora14: They made the intersection of the lines which were not coplanar, that's it, so I asked them to check again and like that the software allowed them to say it effectively. And these pupils there of memory, they had not understood that one could move the figure. **(23:58)** they had a hard time understanding what to do. They didn't understand that, they want, they are telling me that D is in (ABC). **(24:09)** (laugh) they had not understood that D was part of the intersection of what they were looking for. Even if they told me that D was in the same plane, for them (ABC) remained the triangle, and not the point D. I was not able to, I had not perceived that they were still at that level of the exercises. I thought that... Afterwards they understood with this example, it was well made for that.

R15: And then they'll do the intersection of...

Dora15: Yes, and they are going to look for straight lines, **(24:49)** "Ah" in fact it was not very clear... for him. I absolutely wanted them to see that as the straight lines were not coplanar they had to experiment, they had to go all the way because no matter how much I said, it didn't make sense to them. That's when I realized, it seems to me that they couldn't move. They had never moved the software, which meant that they couldn't understand. Even if the student on the right had done spatial geometry in the second year of high school, since I had had it, she had not retained these aspects at all. But it had been two years, well almost,

so it's normal that she hadn't retained more than that. So by moving them a little bit, they saw that it didn't work.

R16: (25:52) Here you said "Here we can't see well", what does that mean we can see well, we can't see well?

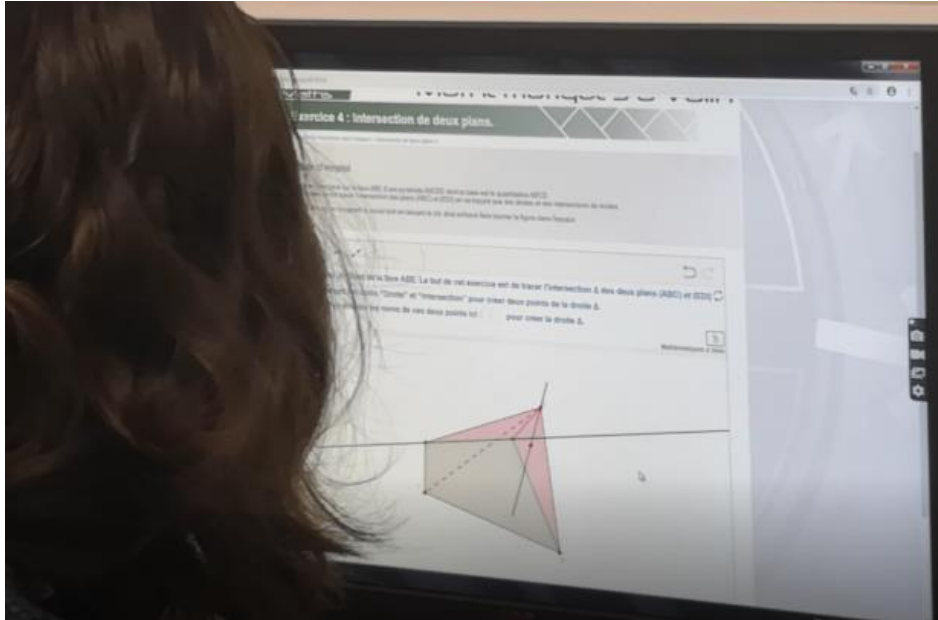


Figure 2

Dora16: Well, that is to say that, for some students who see well in 3D, they realize right away that the straight lines do not intersect. On the other hand, when you look at the image if you see it a little flat, because anyway it's on a computer, flat, the lines have, you have the impression that they intersect, the non-coplanar lines, but to understand that two non-coplanar lines but if they seem to intersect in fact they don't intersect, you have to experience it in space and therefore see that it doesn't work.

R17: So you're trying to find...

Dora17: So you had to move the figure, turn it around a little bit to see that there was no intersection, it's not as obvious as that. But according to the vision, if you can see it well, after all, they don't intersect. But they had never moved, so that's what made them a bit stuck on the rest, they hadn't understood that they could move the figure, so they remained finally in the difficulties of, that they will have afterwards maybe on the sheet. This practical work, we do it as quickly as possible so that they can understand the difference between 2D and 3D. Because to pass immediately on paper it is frankly not simple, for...there he did not stop moving it to realize things. But if we ask someone who has never done geometry in space to say that the lines intersect or not, from the moment we are on a plane, on the plane the lines are parallel or secant, period!

Extract 2 phone video 31 : 17 - 33 : 32

R18: We can move on to the next... (31:32) here you were saying that it's very very good that

she wanted to make a point by that as an idea (Figure 3, Figure 4)

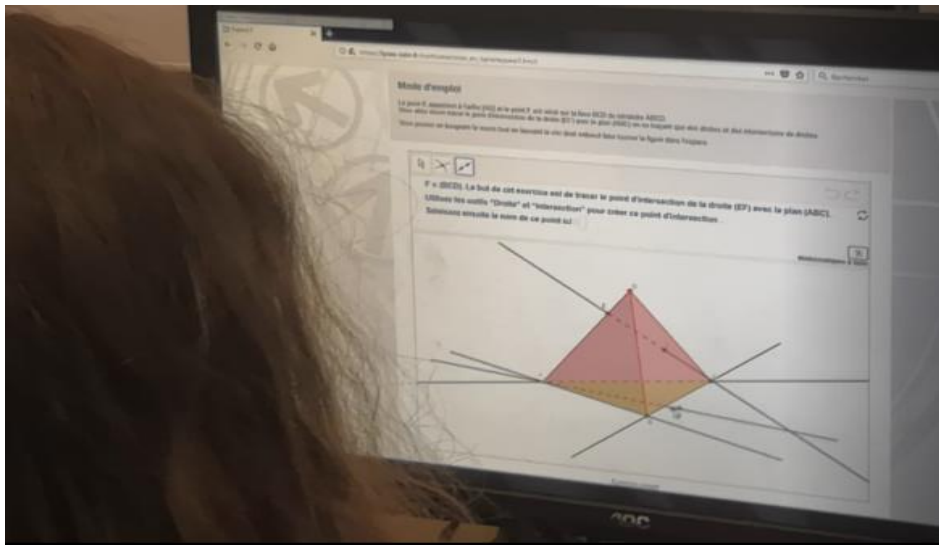


Figure 3

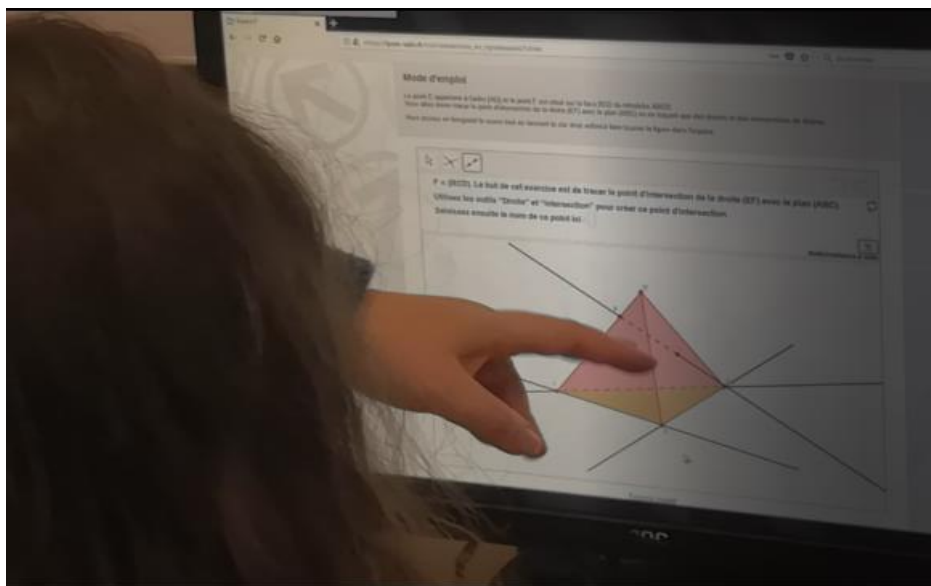


Figure 4

Dora18: Yes, there was a good idea there. After that exercise, I admit, I find it difficult. Too difficult because... And they see better than I do. Because the construction of an auxiliary point is part of what we are looking for, after constructing the intersection. In fact, there is a point missing a priori, so there you have it...**(31:39)** The students made a good analysis of what was needed, they didn't dare to go down because the construction was not direct in fact. So that's why I had to reassure them and encourage them to do it... **(31:52)** Here we had to find a coplanar line, and it's...I don't find it very obvious.

R19: What were you thinking in that moment, encouraging... ?

Dora19: Yes, sometimes they might already know the rationale but had trouble saying why it worked well. So that's where I could help, to reformulate, to ask them why, give more and

more evident hints, repeat again and again. Because if they stay in front of the screen and do nothing, if they feel blocked because it doesn't work, we can't do it. That's what's interesting and it's more interesting than on paper because you can make a lot of tests, you erase them, that's it, when you're on paper, it's in your interest to know what you can do, because...

R20: When you're on paper what?

Dora20: When you're on paper, when you want to do tests, if it's not good, you have to erase afterwards. Here it's much easier to erase, it doesn't pollute, you can even go back to the initial formula. When we work on exercises in the notebook, we don't have this facility, so we have to go there, we have to make tests, that's where we have to go and make tests rather than afterwards on paper. (32:30) I thought they had a good vision, because I didn't find this exercise very easy. (32:54) it was often for the lines of (ABC) we took either (AB), or (BC), or (AC), but here we needed a new point.

R21: (33:29) here you said "you have a good vision", everything before the analysis...

Dora21: Yes, because I found that saying "I need a line here" I don't see it. It's an exercise that, for me, posed a problem, there you go, I didn't find it a simple exercise, so I was happy that they already had a first intuition, to say "yes, you need a line through there", well, that's good. I thought it was not very easy. Maybe it is, but it's not for me.

R22: At that point you didn't want to introduce reasoning, but just enjoy the vision?

Dora22 : Yes, we try to do reasoning every time, because we wonder why it works. But for me, more in terms of reasoning, it's rather to apply the course that we're doing, applying them in exercises, students should really appreciate the theorems, not just learn by rote., it's rather to appropriate the properties of space that they were doing, it's the vision and the properties of space: for the lines to intersect, they must be coplanar. If they already have that in their heads, it's extraordinary for many things. Because, I know from experience that the students... , I know them by heart, the properties, but they have to understand them, they really have to appropriate them perfectly in order to do the exercises afterwards. When, at the end of the year, I will say to them: here is the parametric representation of this line, here is the parametric representation of this line, what can it be, what is the link, what can be the relative positions of these two lines. If in their head, they say to themselves: well, it's simple, either the lines are coplanar or they are non-coplanar, if they are coplanar they are parallel perhaps. So here I am going to look first, because it is the easiest, are they parallel, from the moment they are parallel it is finished, if they are not parallel, they are perhaps secant or they are non-coplanar, if we don't have all these very clear ideas, the exercise which is not so difficult as that because it is calculating, well we don't know how to begin it. So these properties for me are essential to do geometry in space, it is absolutely necessary to know... And to appropriate it. It is not only that it is written on paper, because at their age when they have enormously things to enter in their heads for the baccalaureate, if they did not understand these concepts there, that cannot enter easily. They can work as hard as they want if they haven't understood exactly what non-coplanar lines are, it won't work. And then, I find that we are not all equal when it comes to geometry in space, there are students who see things very well, who manage to cut out, in their head they already have a vision of how the

plane is going to be and how it is going to cut out, that's it. I once had a student who could make correct constructions every time without any explanation, he had excellent vision in space, but since he wouldn't explain, I had to take away points. But sometimes I wondered how he did the construction, because he didn't necessarily have the same reasoning as me, and yet I knew that his (his reasoning) was good, but as he didn't explain, it was very complicated. But he had some facility in that, so we are not all equal on that. Afterwards, on a small calculation, we are not all equal, but me as I master better the calculations, I manage to see more easily the errors of the pupils, here, of reasoning, then finally there are not fifteen ways. In spatial geometry, sometimes there can be really different ways to arrive at the same result, and that's what's a little complicated. So for the pupils who do not see well, it is necessary to hold on to properties, and to appropriate properties it is there of, it is well to practise what. It's the balance between the two, there's a need to observe the rotation, but they should be able to accomplish the tasks on the paper, for which they need to use theorems.

R23: In general, in what situation do you want to introduce reasoning, rules of incidence, etc.?

Dora23 : It's really for the baccalaureate exercises (=the baccalaureate) which are going to be looking for a cube section, the exercise sheet that I sent yesterday, it's baccalaureate exercises.

R24: but in this course...

Dora24: In this course it is the objective. It is to find the sections of the cube. And afterwards, of course, that's not for this chapter, and to be able to work on the equations of lines, parametric representations of lines, equations of planes, and to know, if I'm asked if the planes are secant or not, to have a good vision of what that means, what are the properties that I'm going to use. But there it still passes by the phase of being able to pass also by vectors, the directing vectors, the normal vectors, orthogonal vectors all that, that's it, that's the after.

R25: As you go to different students on the computer from time to time, when did you want to give a few words, when did you want to leave them and move on to the next?

Dora25: So, no, I do it naturally, I don't ask myself questions. The students I see that they drive by themselves, I don't need, because above all, it's a TD where they were in autonomy. In theory, maybe I said too much, that is to say that I should have taken a back seat, that's all.

But what you showed me earlier at 22 minutes, if I hadn't intervened, they were stuck. (22:

57) Earlier they were really stuck those, because there were really full of properties that they had not understood, they had not even understood how to move the figure and all that, if at the given moment I do not pass to unblock them, they remain stuck and they would have learned nothing, in any case they would not have learned much from this session. There to have unblocked them because we don't have fifteen hours, if we had three hours to spend on it, without any problem on the computer, then there I would leave them completely in autonomy, they would work they would learn by themselves, if there, it would be really good. But as I am not sure that they will go back home on it, some will do it, and then there they were really blocked, so... and moreover we didn't have the whole course with some, so at a

given moment I have to help to unblock, so that it is a little faster. But ideally, it would be really nice if they could do it again at home, you have to know how to do it alone. It's by doing it alone that you manage to take ownership of things.

Extract 3 video of the second lesson 7 :27 - 8 :47

R26: After there is another extract, it's only because I don't understand what the students were saying, so I would like to ask you to help me to recall...

Dora26: (7:39) Yes, so I was rephrasing what they said, but that was it. They wondered if they were intersecting, and I made them say that it was because they were coplanar, that's all.

R27: (7:54) They didn't answer here?

Dora27: Yes, they mumbled it, they said it a little bit, but... I really wanted to get it into their heads that to find the intersection of two planes, find a line from one, and a line from the other, which are coplanar, because they tended to perceive it, but I wanted them to understand the fundamental rationale. As they had found it a little bit, I wanted it to be anchored and so I reformulated it. But they were in the process of finding it... well, they found it but they were not able to say why it worked well. So that's where I helped them, even if I hadn't helped them, they would have managed, because maybe they wouldn't have understood, so in the next example, but they were able to do it, in the next example, but they would have had more time to understand what the method is, and then they would have found it. So I allowed them, I gave them a little push, so that it would sink in more quickly, and that in the next example they would be more efficient. Fortunately, there were examples afterwards, of course. It was up to me to hammer home the lesson that unfortunately they hadn't seen. Because they weren't there the day before (because of the strike?) I really wanted to tell them again "for it to cut, the straight lines must be coplanar". It's up to me to hammer, to repeat, for me that's the role of the teacher... it's to repeat, repeat, repeat....

-----End of stimulated recall interview-----

R28: Then I have some questions about the first lesson on Thursday, these are the documents (Figure 5 ~ 6) to be given to the students, could you describe the structure of the content of the documents?

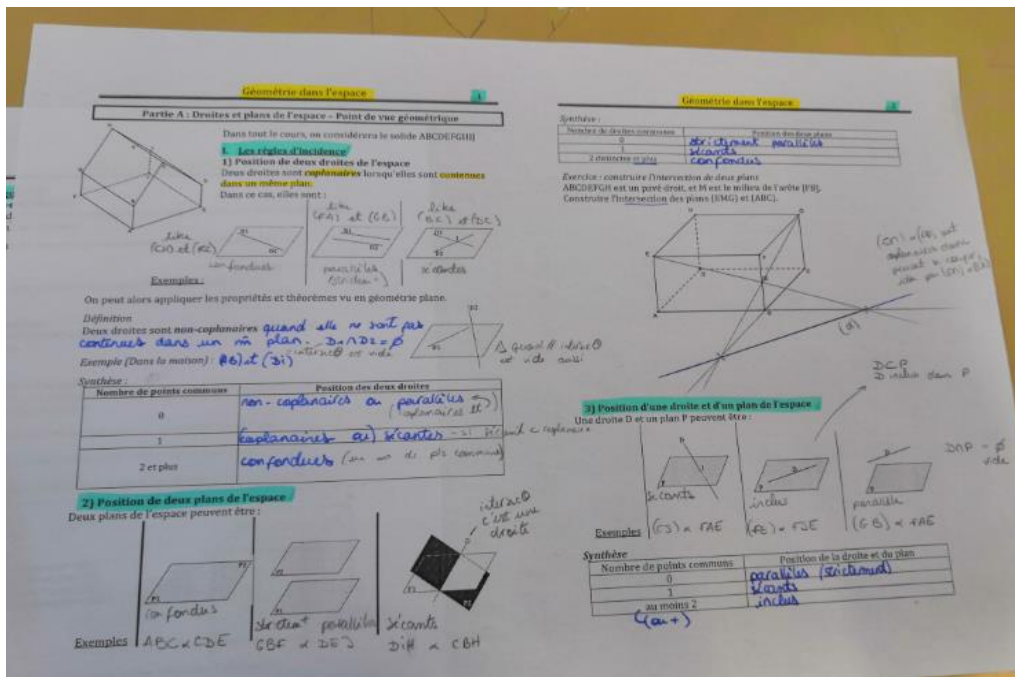


Figure 5

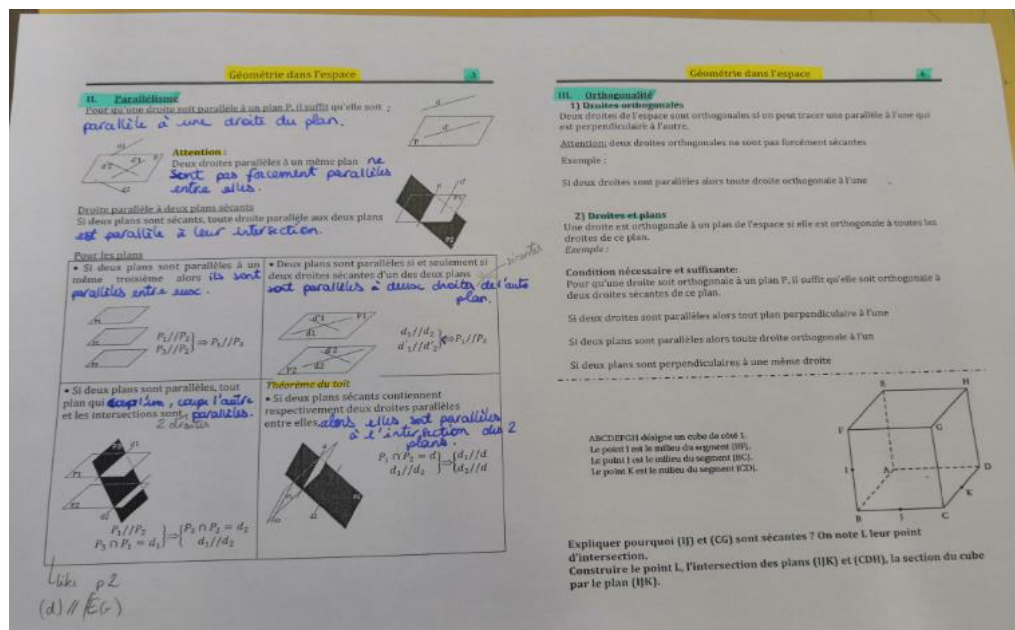


Figure 6

Dora28: So it's very simple for this course, it's to say again the lines and the planes of space what it is, so it's for that. The rules of incidence, and I really extracted this course there from the chapter of the second year which existed before, because now it's not even there anymore. The second year chapter, there was a little bit more that I told them last time, that "a line is defined by two distinct points", OK; and that a plane is defined by three non-aligned points, I told them that last time, OK? And it echoes, and it will echo again in the next part of geometry in space, the fact that a reference point of the plane is defined by three non-aligned

points, so I wanted them to start making a connection by saying why three non-aligned points are enough for a plane. We try, all that is coherent, it's things that they already know a little bit but that they didn't formulate in that way. And that I find that it is extremely important to play on this number of dimensions (= 2D or 3D) in fact. An origin and a point, hop, I have a straight line; an origin and two points which will, all three will not be aligned, hop, that will give me a plane, two dimensions; and if I want to have three dimensions, I need another one, a fourth point which will be non-coplanar, and we, as we do, will not work in terms of points, we will speak of origin and vectors, non-collinear vectors and then non-coplanar vectors to define the plane or to define the space. All this is what I want to get into, I already have the objective of all the dimensions I want to get into. So the basis of geometry in space is first of all how the lines and planes of space intersect, that's it. The first part is that it's a summary of all that, so that it's clear, and the essential thing for me is really the lines, because it seems to me that it's what is the least understandable for some people, this idea of non-coplanar lines. Because the non-coplanar lines when we see them in the plane, we don't see that they are not coplanar, because they are precisely on a plane, they are on the flat, so this is the difficulty that there is. Afterwards, to say again that when we look for the intersection of two planes, it is a straight line, this is perhaps the reproach that I could make to the Interesp software, because in Interesp each time, well that is debatable, both are interesting, but we asked them for intersections of two planes, and we said to them that it will be a straight line. When I asked them about the intersection of two planes, they had to have this property in their heads, because sometimes, as they see that the two planes are defined by three points, in fact they see two triangles, they see that the intersection, as they are limited, they don't do something infinite, they will often see... they will always think that there is only one point in the intersection, whereas it is never possible. It's really to define what the sections, the intersections, can be. What is going to be complicated when we will really make sections, but there are some who have already started to do so, is that we are talking about something infinite, but we are only looking at what happens on the cube. Well, that's a little bit... it's a not so obvious gymnastics, because each time to look for the section of a cube, in fact we have to look for the intersection of the plane that we are given with a plane that is supported by the face, and we only trace the intersection, so we tell them "we have to get out of the figure", but in fact we still look at what happens on the figure, it's a little bit complicated anyway. In any case, in the plane, at the beginning it's that, it's the rules of incidence, and then the basic rules of parallel and orthogonality, that's all, that's all this chapter is about.

R29: And you put an exercise...

Dora29: Yes I have put two exercises in all, the first exercise I ask intersection of two planes, which will illustrate that the intersection of two planes is a line, and that to construct my lines, this line sorry, I need two points, and these two points will be at the intersection of two coplanar lines. So with this example there we are going to say again only the coplanar lines can cut themselves and that the intersection of two planes, it is a line, therefore the base of the base. The exercise itself is not very complicated, but if they have not understood this exercise, they cannot manage to do it afterwards.

R30: Why do you choose these places for students to complete?

Dora30 : So I could have, there are three ways of doing lessons. Firstly, they write everything themselves in the notebook, for spatial geometry, I've hardly ever done that because there are too many figures, I find that a spatial geometry lesson without figures is not possible, they still need to have illustrations, and that's a big time commitment, that's just technical. But if I only prepared small papers that they had to glue each time, we would lose an incredible amount of time, so to make them write everything down in the notebook and eventually glue just small figures, it would be really long to glue the small figures each time, and to dispense with the small figures I find that it doesn't make for a good geometry course in space. There are courses on functions, again functions not because graphs will be needed, but if we were to do a course on arithmetic, for example, it's a lot of properties, a lot of exercises, there's no need for figures, that's it, not enough to say that there's a need to give figures. So there are so many figures in geometry in space, I think it's important that, I don't want to make them write everything down, so that's the first possibility. The second possibility of the extreme in the other direction, is to give them everything complete, I already have the whole course completed, finally it's all completed, but by experience the students, as it's already all completed, are less concentrated on what we do. Now they have to concentrate on what they have to write, and as the video projector doesn't work today, they have to because I'm not going to produce the drawings on the board, they're in Terminale (12th grade) and they're big, so I'm not going to redo the drawings on the board, so they'll have to know where I'm at in order to know where they have to write. So they are a bit concentrated, so the fact of completing...if I complete it myself, some of them can sleep at the same time or not listen, they know in their heads that it's good, it's written on their course, their course is complete. So at that moment, if I gave them a handout (= a printed course document) that was all completed, what I would do is tell them to read it at home, and we would summarize it together, because it's not worth it, they won't be able to concentrate, so that's why I make them write things down. It's true that it's purely technical.

R31: What would be your didactic goals for the following lessons?

Dora31: Well, we'll finish all the properties, we'll finish the course, we'll work on the small examples that I've planned, and then I'd like us to work on orthogonality and small exercises on the book, and then we'll go on to the sections.

R32: Will that be Thursday?

Dora32: I think Thursday, I think it will be more like Thursday, and in TD as well. Because I'm still hoping to finish the course on Friday. But they might have to finish an exercise for Monday, but there you go.

R33: Are these courses related to the previous two courses?

Dora33 : Yes, but on the other hand it is necessary...unfortunately we don't have much time in terminale S, I would prefer that we take one week more, because with one week more we would have done the advantage of exercises. I know that at the end, they won't have mastered everything, but that's why we chose to work on things beforehand.

R34: How might previous courses influence your subsequent courses?

Dora34: No, not so much, it had already unfolded, there was not so much influence. With what we did there was no influence on...no.

R35: Sorry?

Dora35: What I've done before, I haven't done enough of it to have influenced anything. No, no, what I have planned, it's not the first time I've done the course, so I know where I'm going, I know what I'm going to do.

R36: Will you also design GGB files and present them in the classroom?

Dora36: No, I'm afraid I don't have time for that. So if I had the time, ideally I would have liked to, but right now, there's not even a video projector, every other time it doesn't work. But, ideally, it would be to redo the figures from the exercises in the book (i.e. the class textbook) on geogebra 3D, to make them manipulate, to show them, but here, no.

R37: If you have time...

Dora37: Well, if I had the time, I'm not sure I'd have the time during the week to redo the figures in the exercises, that's how to get them moving. And then at a given moment too, it is unfortunately necessary to pass on the paper, because the day of the baccalaureate, they are still on paper what. So it's the balance between the two, there's still a need to see them turn, but it's still necessary to make this passage to paper, because in the end it will still be on paper.

R38: Could you describe the class organization for the following courses?

Dora38: It will be quite vertical, that is to say that I will give the course and they will ask questions, I will let them look for the exercises, but it will be more classical.

R39: Do you want to call students to the board or not?

Dora39: There as well, I repeat, but we don't have the video projector, I think that would be to put them in difficulty for nothing. I would like us to take the time to send the students to the blackboard, but I'm caught up in the time, we've lost time, that's how it is. Ideally, it would be better to send them to the board, but if I want it to be more efficient, unfortunately, I'm the one who's going to do it, I let them look for a while, and then I correct. It takes a little bit more time, but I'd rather have time to make them do lots of exercises on the board, but it would take another month...

R40: There will also be discussions among the students?

Dora40: Yes, when they look for small exercises, and then the last time yes, it was good in autonomy and to work, even those who were on two computers, they worked well there.

R41: Will this organization vary depending on the particular topic of the course?

Dora41: Yes, so depending on the subject, yes it can...we can do a little more group work so that the students work together?

R42: For what subject, for example?



Figure 8

Dora45: The biggest interest of GeoGebra is that we can turn the figures around; this allows students to realize that two lines seem to intersect on the screen, and after I rotate it, they can see that they will not intersect. Also they will see the right angles in some faces are no longer right angles on the screen...But there are times when GeoGebra doesn't work or because of the screen projector, we can't see it well...so we might as well do it with real objects, in the real environment. Not all students see in space in the same way. For some students, being in the house makes it easier to see the different properties of space. For some students, being in a real 'house' makes it easier to see the different properties of space... Usually we see a cube from far, but when you put students inside the space, they can see the relative positions around themselves, it can help them to understand what exactly geometry in space means. But they also need to switch to the image in the plane. The GeoGebra image will allow this, but some students need more concrete points of view first.

R46: How did you build this GeoGebra "house" model? What were the main difficulties you encountered and how did you overcome them?

Dora46: To build a 3D figure on GeoGebra, I don't know how to do otherwise than with point coordinates. I don't find it very easy because I have to do some calculations (even if they are simple) and it's very long to enter point after point to see the figure.

R47: To what extent do you think you have exploited the potential of GeoGebra in the first and the second lessons?

Dora47: I think I could use it more by showing all the figures used in the space but on a flat screen. It helps to go to the "paper" exercises.

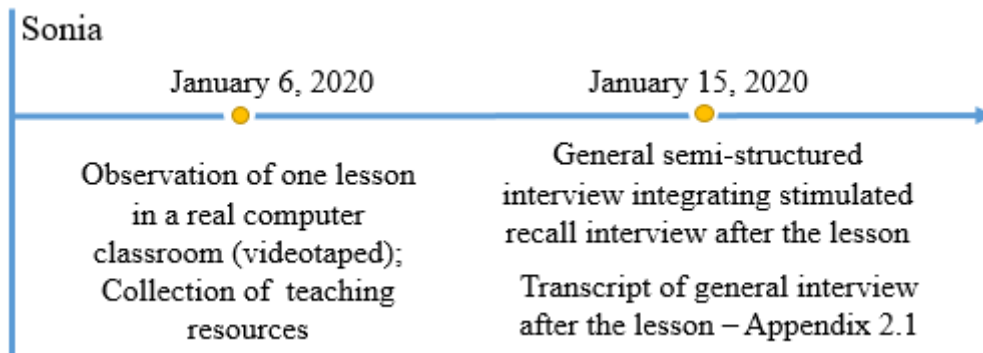
R48: If you were to do this teaching again, what changes would you make to these two courses (the didactic objective, the organization of the class, the resources used)?

Dora 48: I'm not sure. The question is difficult because the programs are changing and space geometry is taking less and less space... With time, I will build 3D objects and do more research on sections. Some students don't have enough time to appropriate properties in space: especially since they haven't done any since middle school...



2. Data of Sonia, Lesson Series S.I (1 lesson)

App-Fig. 3 presents how the data in appendice 2.1 (which will be presented below) are situated in the lesson series of Sonia.



App-Fig. 3 Data about Lesson Series S.I

2.1 Transcript of general interview after the lesson of Sonia

The interview with Sonia was made in the morning of 15th January 2020, after the observation of the lesson given by Sonia in a real computer classroom on the Monday before one week (6th January). The topic of the lesson is “constructing the intersection of lines and planes in space” (content of grade 12). The interview was conducted in a vide classroom of the high school (App-Fig. 4) and it lasted 1 hour and 5 minutes.



App-Fig. 4 The setting in which the interview with Sonia was conducted

The interview was recorded in audio format and the part of the stimulated recall interview was also recorded in the video format. The original audio was transcribed in French, and then translated into English. Below presents the whole interview in English.

R1: What is your overall course progression in this area, of pure geometric space geometry?

Sonia1: Purely geometric, without the vectors, right?

R2: Yes.

Sonia2: So we worked first on the relative positions of lines and planes, they worked first on the interest software? After that, we worked on the parallelism of lines, after the sections, and now we're going to finish with orthogonality.

R3: Will that be in the next week?

Sonia3: Friday I think I'm going to start orthogonality, and one more session next week. I think I'm going to do another two hours, because I have to move on to other things, it's a little fast anyway.

R4: So this quick plan perhaps is decided in reference to the curriculum, the textbook, the baccalaureate application or based on your own understanding of this area?

Sonia4 : No, it was based on the whole program, not only by me, it's to be able to finish the program, and in agreement with... I work quite a bit with Delphine Terez, so here is a progression that we made, and since afterwards we come back with vector geometry in space, and afterwards there is the scalar product also in space, so to spend two weeks on pure vector geometry, we cannot do more.

R5: You say that you decide together, the progression?

Sonia5 : Yes, with Delphine we decide together on our program, because every week we do the same little test, and every three weeks we have the same assignment, so we go at the same rhythm in fact, that's what we do (Figure 1), we have a common progression with Delphine. it's two weeks maximum, what.

R6: And after that, it will be the vector?

Sonia6: After that it will be there, the geometry in space

Semaines	Chapitres	Evaluations
Vacances d'Automne		
04/11 → 08/11	A4. Suites et limites	Test 5; DM1
12/11 → 15/11	G1- G2. Nombres complexes	Pas de test (férié)
19/11 → 23/11		DS3
26/11 → 30/11		Test 6
3/12 → 7/12		Test 7
10/12 → 14/12	P1. Probabilités conditionnelles	DS4
17/12 → 21/12		«relâche»
Vacances de Noël		
06/01 → 10/01	G3 : Géométrie dans l'espace 1	DM2 <i>Test 8</i>
13/01 → 17/01	A5. Limites de fonctions	DS5
20/01 → 24/01		Test 8 <i>9</i>
27/01 → 31/01	A6. Continuité et primitives	Test 9 <i>10</i>
03/02 → 07/02		Test 10 <i>DS C</i>
10/02 → 14/02		Test 11
17/02 → 21/02	BAC BLANC	DS6 <i>135</i>
Vacances de Février		
09/03 → 13/03	P2. Lois à densité	DM3 ?
16/03 → 20/03		Test 12
23/03 → 27/03	A7. Fonction ln	DS7
30/03 → 03/04		Test 13
06/04 → 10/04	G4 : Géométrie dans l'espace 2	Test 14
14/04 → 17/04	G4 : Géométrie dans l'espace 2	DS8
Vacances de printemps		
04/05 → 07/05	A8. Calcul intégral	Test 15, DM4
11/05 → 15/05		Test 16
18/05 → 22/05	A9. Géométrie dans l'espace	DS9 (3h ?)
25/05 → 29/05	P3. Lois normales et estimation	Test 17
01/06 → 05/06	Revisions	

Figure 1

R7: What do you think is most important in teaching space geometry, and the role of the DGS?

Sonia7: I think that Interestp software is really a good software to allow the students to train on many exercises, of different types and to have right away a validation or not of their work. That is to say, when they are going to construct lines, the intersection of lines that are not planar, then the software will say that it is not possible; whereas when they do their tracing, they can always [find an intersection] even if it is not possible in reality, which is why I think it is really a plus, but more in an autonomous way, and afterwards, on the sections, we are going to correct with the software, but it is more punctual.

R8: Do you think it contributes to their understanding of space geometry?

Sonia8: That's right, especially since they can do it as many times as they want, and the number of exercises is still very important, so they have the tools to be able to do a lot of exercises, there are possible aids, it allows them to turn the figure, it's quite effective in fact. The students, those who go on it progress more than those who don't, but we don't have the

time to do sessions in class. I only do the first session to show them the software, and then it's up to them to do the work at home.

R9: So the most important thing in this area for you...

Sonia9: I think it's an indispensable tool.

R10: but only for teaching space geometry, you think that's the most important thing? To make them understand?

Sonia 10: I didn't understand the question?

R11: What do you think is most important in teaching and learning space geometry?

Sonia 11: Well, I think what's important is that they manipulate on a software. I think that's important...

R12: For this class, for today?

Sonia 12: Overall, I'm talking, overall, it's important that they manipulate. Afterwards, the most important thing, as in other subjects, is that they should try, they should dare, they should go for it.... I really wish that we could have the materials, some natural things, to say "look at this straight line which is parallel to a plane, or which intersects with a plane"...I would like to have cubes, some real volumes to show students what the sections could be like, but we lack these in high school...After all, the Interesp can help to see the objects in space, it's already good.

R13: and now we can concentrate on the TP course last Monday, the subject was the intersection of lines and planes...

Sonia13 : the subject was the discovery, to review the notions of second year by using the software, and to see where they were, to see if they still knew things, had some not done, it was a little bit that.

R14: How do you situate this topic in the overall space geometry course?

Sonia14: I think it's essential to start with that, rather than with vector geometry, because it's really something global, it gives us a global idea. They have more difficulty in pure geometry without vectors. I think it's really the beginning, it's to be done at the beginning.

R15: Because it is more difficult?

Sonia15: it's not only because it's more difficult, it's because it's more natural to ask the question,. Naturally, we are not going to put vectors: when we say to ourselves: is it parallel or not. It's afterwards that the vectors came I think.

R16: What is your didactic objective for the course?

Sonia16: TP? It's to reinvest the notions, in fact it's a little bit to take stock of what they know, what they have retained from the second year course, that's the idea; and to manage to bring out at the end of the practical work that the intersection of two planes is a straight line, the intersection of two straight lines what can it be, the intersection of a straight line and a plane what can it be, that's it. The idea is to make them work in Interesp a little alone, without

giving them concepts, to see where they are...to elicit the notions they already have and what they haven't known yet...see what they had retained from grade 10. If we begin with the course telling them the concepts, they will listen, say yes, and then they will possibly make less errors in Interesp, but they may not remember it so well after a week. When they begin by making errors, they will be "annoyed" by the errors at very first, this perhaps makes them they retain things better and longer.

R17: Do you have specific objectives for GeoGebra techniques that students should master?

Sonia17: No, on interesp it's just intersections to do, so they don't need a lot of techniques actually, there's just the intersection and drawing a line, and knowing how to move. And that's what we said at the beginning of the hour, but that's all. We did not use the GeoGebra software in 3D. By the way, I am not very comfortable with GeoGebra, I am doing a course on GeoGebra in 15 days.

R18: Here are the exercises of the interesp (Figure 2), I would like to know what you think about the logical structure of this series of exercises, the relation between them?

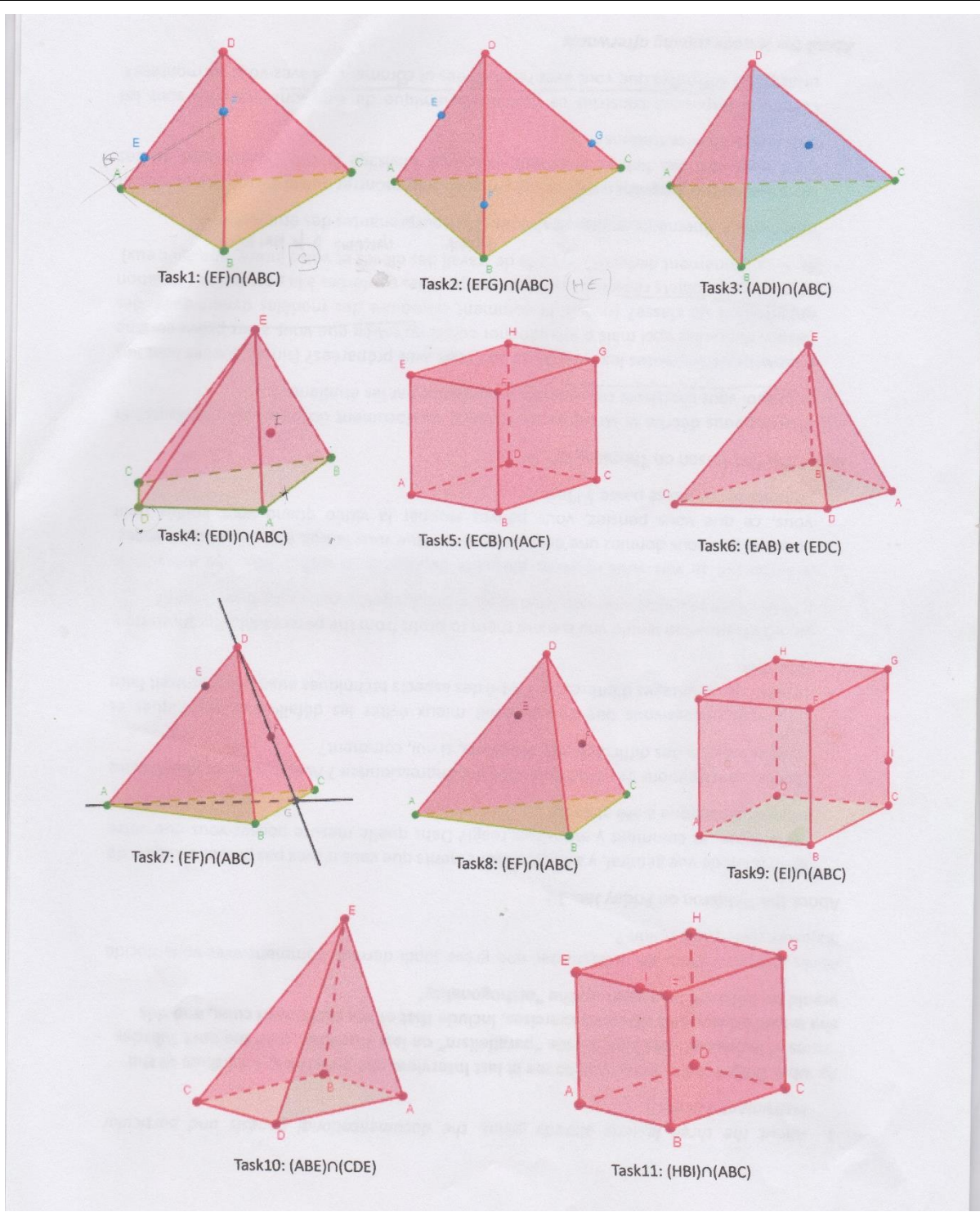


Figure 2

Sonia18: So, at first it's pretty simple, I go one by one?

R19: or globally, as you like.

Sonia19: They mix a little bit the types because there are cubes and there we are on pyramids, but nevertheless the difficulties are rather increasing, I find. So it's true that I didn't give them any exercises that I could have done, I could have told them to do exercise

1, exercise 4, exercise 5, but I left them to their own devices, they did them in the order they wanted. Here, for example, it's the intersection of a line and a plane, 16:06; the advantage is that it sweeps , and here we are on the intersection of planes, and then we come back to the intersection of line and plane with things a little more complicated.

R20: yes and maybe this exercise (exercise 7) is a bit similar to the other one?

Sonia20: I gave it in the... it looks like what I gave a little bit in the example of the course, I don't know if you remember? When we did it, there was I, G, (Figure 3) and we wanted to draw...it looked like the point there.

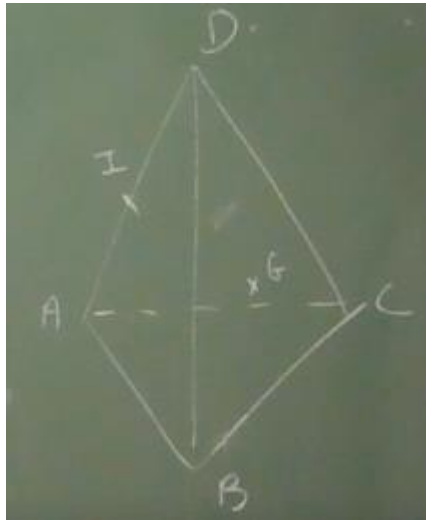


Figure 3

R21: Yes, and you reminded them...?

Sonia21: no, I didn't link to that, just on the sections I linked to interesp.

R22: So, for you, what are the possibilities and limitations of Interest in relation to this lesson?

Sonia22: for me the possibilities, it is the quantity of the exercises, that it is important, it is often of the easiest to the most difficult, therefore there is nevertheless an increasing difficulty. So sometimes we change domains, when we go to the sections or when we change domain it comes back a little bit simpler, but it is still from the easiest to the most difficult.

After the limits is that they can know how to trace things, because they try a lot, but they don't understand, they don't know how to justify, that's the limits. After justifying that, for example, the intersection of the E...is that a good example...here's for example this one (exercise 10 in Interest), so there it's the roof theorem, well the pupils will try to draw that, but perhaps they won't know how to justify that it's the roof theorem, they'll mark "correct" on... There are two things to make an intersection, 'construct' and 'justify'... justify at each time: what procedures to do for making a section, why are these, what theorems are used.

R23: But they have the vision or the impression that it would be...

Sonia23: that's it, it's the intuitive side, so they'll say we're doing the parallel, but then they don't know at... to say "because we're using such and such a theorem". that's a limit for me, if we don't ask them to justify.

R24: that's why you always ask them "why that ..."?

Sonia24 : that's why I ask them to justify all the time, 18:47 they have to know how to do both.

R25: Will you use or have you used other graphical representations in the following courses, in addition to the dynamic ones, the paper ones... e.g., the real objects?

Sonia25: So we don't have, in fact, you see that's what I was telling you, there's a lack... we don't have any real objects in the school. After that, it's going to be 19:21, the box of tissues, it's going to be... I'd like to but we don't have the material.

R26: How did you envisage the complementarity of these different representations?

Sonia26: those of... The real, it's natural, when they tell us, well, if I have two straight lines that belong to two parallel planes, they are parallel. For example, in the true-fals there; and if one says but no look at this straight line which is on this parallel plane, and this straight line there on the parallel plane, they are not parallel (here she may point to the architectural structure of the classroom we were in). So it helps them...it's natural to do things. Now we really lack, we need material. Afterwards, Interesp geometry, I discovered it a long time ago, when it was with Geoplan, it wasn't GeoGebra, it was another software, what's it called, it was Geospace that did the interesp, and we had it on the network, and I took the students of the second year of high school, 7, 8, or 10 years ago. And then we didn't have Geospace to install, and I saw that Valin high school was doing Interesp on a site, I thought that it was a plus, so that's why I use it. The other reason, it's when my son was in Terminale fit, who asked me to help him for geometry in space, and I say you should go on the software, since he didn't go with his class, and in fact he said to me it's too great, I understand everything with that, he said it's really a plus as a student to go there. So that's why I take the students.

R27: How did you hear about Geospace?

Sonia27: It's... so it was installed in the facility, I don't know how, by the facility is it a colleague before, I don't know.

R28: Re you still in that facility?

Sonia28: no, before I was in college but in different colleges because I did 10 years of... what did you call it? TZR, substitute teacher(see here : https://fr.wikipedia.org/wiki/Titulaire_sur_zone_de_replacement). I was for 10 years, I was changing colleges, and then it's been a little while since I'm in high school.

R29: How long have you been here?

Sonia29: It must be 14 years, 15 years, I think.

R30: But before those 15 years, you were 10 years old...

Sonia30 : in college, yes.

R31: During those 10 years, did you always change? or was it just after 10 years that you changed in high school?

Sonia31: it is during the 10 years I was always changing. Every year I changed. It was my status that forced me to change, because I was a substitute teacher...

R32: For this PT course, what did you have planned as a class organization? For example, how to introduce the techniques, when and how to have interaction...

Sonia32: How do I envisage the course, is that it? In fact, what I really wanted was for them to work, but I didn't do the same with the two groups, that is to say that on Monday and Tuesday I didn't do the same. On Monday, I was able to turn on the computers beforehand, so they arrived, I let them go on the computer:", and they had, that was the structure, they worked alone, and it was they who tried to look in their memory what they knew, what they did not know. I was circulating and at the end we did an oral report on the intersections.

With the other group, I had a problem with the computer, it takes a long time to turn on, so we started by doing an oral assessment, what they knew, what was a plan, what was the intersection, etc. So I adapt according to the situation. So I adapt according to the situations.

R33: Had you considered how the students would work, they could be in groups or ...

Sonia33: not on the computer, I find that on the computer it's better to be alone, or with two people, at the most. But afterwards it's good to be with several people when we work on a concrete problem.

R34: I saw that you have another student answer a student's question...

Sonia34: I like to do that, let a student evaluate the remark of another student...When it concerns typical mistakes, like someone saying: "if two lines are not parallel then they are secant", I would ask the neighbors "what do you think of that?" to see whether they can understand that it's a mistake or they agree with the mistake, if the latter, it's an opportunity to collectively demonstrate it's not true, to take profit of other students, in fact...

R35: Sometimes I've also seen that you ask one student's question to all the others...

Sonia35: Yes, I do it often, I do it often because it really allows me to see if the other students have understood or not, so it's either this goal or it's because the student who asks the question, his question is usual, that is to say that there are many students who will make this mistake, we know it, so it allows all the others to understand so that they don't make the mistake.

R36: Often it's in what situation you do...

Sonia36: I often put the students in interaction.

R37: What issue do you want to discuss together like this?

Sonia37: it's the classical errors in fact, the classical errors for example somebody would say : "if two lines are not parallel, then they are secant", there I would say "what do you think

about it"? That's important, it's lines that can be not parallel, not intersecting, because they are not coplanar. But if a pupil writes the two lines are not parallel, therefore they are secant, there I would say well can you say what you found, what do you think of it, to insist on the fact attention in space, lines which are not parallel are not necessarily secant. That's when it's important to insist on something. That's why I put them together.

R38: What about the respective values given to perception/intuition and deductive reasoning, what do you think?

Sonia38: Then the perception in space it is complicated, they have students that we really, sometimes, me too, according to how we are, sometimes we have difficulty to "see" (between quotation marks)

R39: In the interesp sometimes the students, they see better?

Sonia39: Actually the big difference is that in Interesp, they're trying. Because they're in front of the computer, and they're trying to draw lines, they're doing things. Whereas on their paper, they are afraid to draw things, they can draw intersections that don't exist, so for me that's the big difference. The student is active in front of the computer, and sometimes in front of the paper he is rather passive, he waits for the correction on the board. He is afraid of writing nonsense, whereas on the software it's not serious, as everyone has his own screen, it's not serious.

R40: Do you think that the experience on the interesp can contribute to the work on paper?

Sonia40: Yes, I think that ideally it would be...they would have to look on paper and say to themselves I have a doubt, I'm going to test if it's possible on the computer, move my face, go back to paper. Ideally, it would be to do both, in fact.

R41: Sometimes students, as they can move, see the figures better, they don't want to know why anymore, it's just a vision, an impression.

Sonia41: That's right, on the interesp sometimes it's just an impression, that's why you have to go on paper too. But I think that in the exercises, you have to ask for plots, but you also have to ask for justifications, there are several types of things.

R42: It's not enough to just have the vision.

Sonia42 : It's not enough to trace, no, I think that it is necessary, after, each one...

R43: Re there any unexpected events, surprising responses from students?

Sonia43 : So not too much, there was just a problem with turning on the computers, with the other group, it took a long time to turn on.

R44: This is the seating plan in the room (Figure 4).

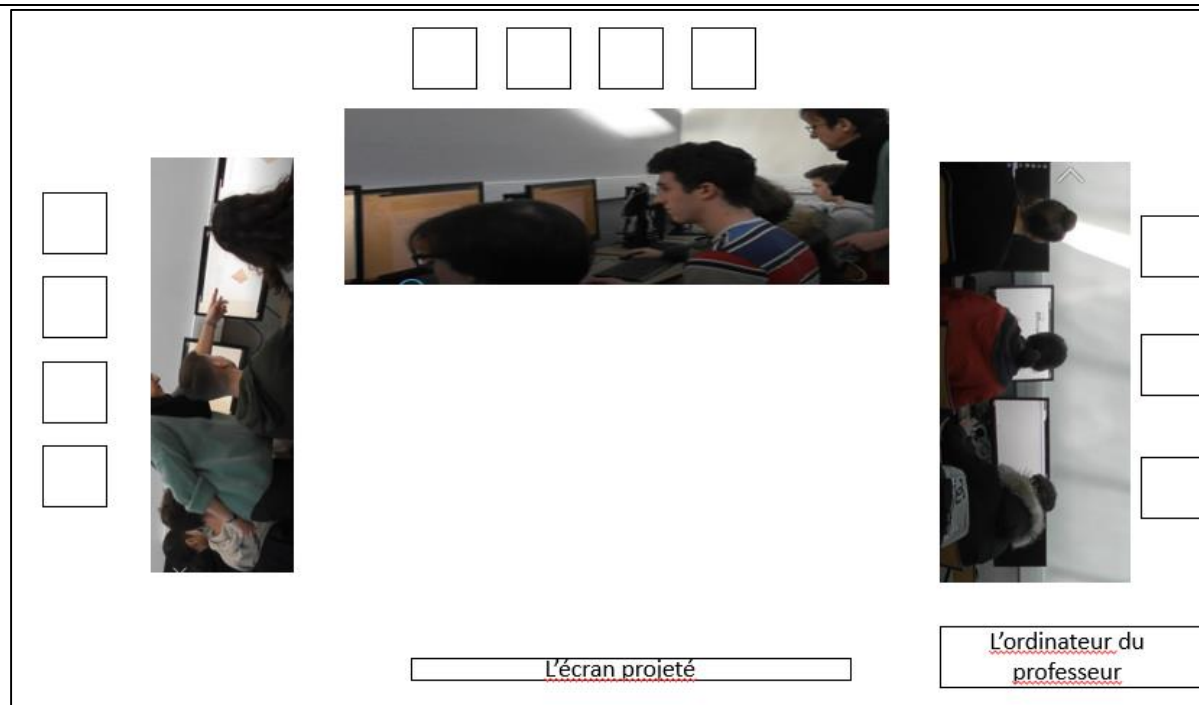


Figure 4

Sonia44: ... no there was no...no, they are more, they are nice

R45: Re there any technical aspects that you think should be paid attention to?

Sonia45: On the software?

R46: Yes, because I've seen sometimes the students, they have trouble creating the intersection, because they haven't activated...

Sonia46: Because it's not coplanar...because they haven't activated...

R47: Yes, that is also a reason perhaps,

Sonia47 : So, I asked them when they started, I told them to click before to activate the tools, I normally tell them at the beginning of the hour.

-----Beginning of stimulated recall interview-----

R48: Okay, now I'm going to show you several clips from the video. For these excerpts, I would like you to give a description of what you were doing, how you were feeling, what you were thinking, you can stop the video however you want...

Sonia48: Ok

Extract 1, video of the lesson, 01 : 36 - 08 : 26

The time point in bold indicates at what time in the video that the teacher gives such comments

R49: The first extract starts at 1mn36s.

Sonia49: So they are already in a...

R50: Exercise two, perhaps.

Sonia50: That's where you need the intermediate shot, right? they're on the second one, are you sure, or not. **(02:35)** In fact, the idea is that I would like it to come from them so that they can find it by themselves, it's not easy to help them without giving too many indications, so I ask them... the idea is that I ask them to find out in which face it will be. That's why I ask them how to characterize in order to know in which face it will be.

I'm not sure it was that exercise...the one with the plan (ABD) actually...

R51: Maybe there it's D, and then it's (RC), but he has a feeling that it's going to cut...

Sonia51: Yes maybe, I don't remember.

R52: **(03:46)** Here you say "stop moving".

Sonia52: Yes, because he turns and turns, well, I couldn't see anything at. I don't know if he can see better, but at some point, turning is good to change face, but you have to position yourself to be able to...

R53: Yes, you said "get over it", get over it somewhere?

Sonia53: Well, to put it on a straight line is badly formulated, but to put it on the side that seems clearest to us. But it's very personal, because it can be clear for a student to see this way, and clear for another student to see another way. So that's why the interest of moving is that it allows everyone to find the best possible view, and understanding.

R54: it seems to me that you don't need to move around too much?

Sonia54: So, if we move all the time, I can't manage to...**(04: 33)** Yes they are in the (ABD) **(04: 39)** So they come back because at the beginning they made the mistake, they come back and they justify that E and F are on (ABD) by saying E belongs...I think that's how he justified it.

R55: Shall we continue?

Sonia55: Yes. **(05:03)** The idea was really to question them to find out in which plane E and F belonged...

R56: **(05:28)** Here the student says (RC) has an intersection with (RD), "according to my eyes".

Sonia56: That's where we see that it's important to have concrete things in fact because we want to do like that with our hands, it's natural I think. *(Here the teacher makes the same gestures with the student in the video, as in Figure 5)*



Figure 5

R57: Rd this is acceptable to you, "in my eyes"?

Sonia57 : It is not acceptable to just say 'according to my eyes'... they should manage to justify, to reason, use theorems...**(05:58)** It was difficult at first to find. **(06:30)** So that's the other step, there's the intuitive step, and there's the justificatory step, justification.

R58: I don't actually understand what the students are saying here

Sonia58: In fact he explains why the point he drew there, this point there (the teacher pointed to the point in Figure 6), why it is the intersection of (EF) and (ABC), he says that it belongs to (AB) so it belongs to (ABC), and it belongs to (EF) so it belongs to the intersection of the plane and the line...

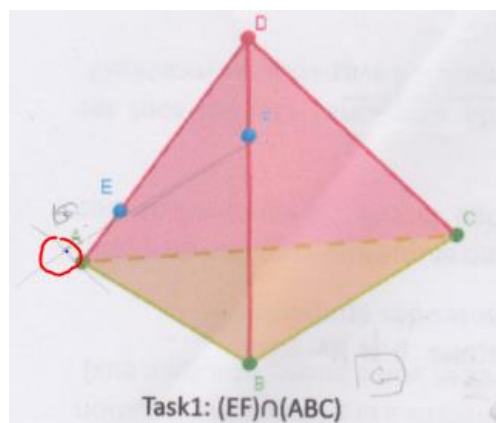


Figure 6

(07:44) So that made it possible to review... in fact what he forgot to say was that if the plane and the line are secant, the intersection is a point, that's it.

R59: You mean it's not always a point?

Sonia59 : A line and a plane, no, that's it. **(08:07)** Yes, he had a problem with the letter now, I remember, we couldn't see well, so he had to redo it because we couldn't see well in terms of...**(08:20)** That's it. I think he did several tracings, so the computer had to write G , H first, so it's hard to see. I think that was the difficulty.

R60: So how do you do it?

Sonia60: there I asked him to rewrite, to redo only with the necessary rights.

Extract 2, Video of the lesson, 04 : 08 - 07 : 02

R61: Then there is also a period that I don't understand very well...

Sonia61: So they are there (exercise 4 as in Figure 7).

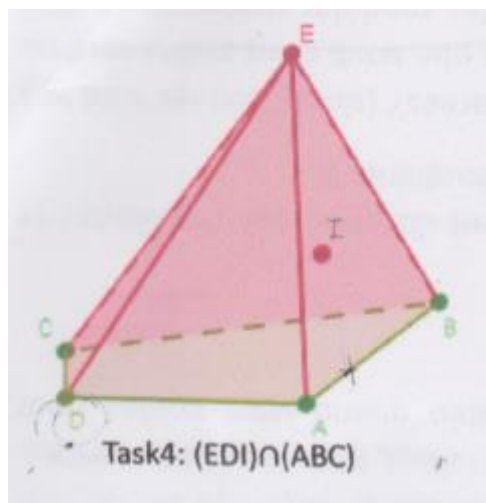


Figure 7

R62: **(04:40)** What did they say here?

Sonia62: In fact, the students, they trace all the lines of the plane...**(05:06)** In fact, I explain to them that if they have traced too many things, you can't see anything anymore.

R63: and they said nothing or?

Sonia63: I don't remember, no, because it was 10 days ago. From memory, I don't think they saw that the D point belonged, right?**(06:56)** Since it's a classic mistake, I ask the neighbors again if they are aware that it's a mistake or if they agree with the mistake. Because if they agree with the mistake, then it's an opportunity to show them that it's not true, in fact. To let others benefit, in fact, from that.

R64: It is to illustrate "if two lines are not parallel, they are not necessarily secant"?

Sonia64: That's it, it's because it's really something, a classic error that they make, the students, as it's true in the plane, they think that it's true in space. That's why I insist quite a bit by telling the others what you think, do you agree or not.

R65: and, as you were telling me, they have trouble finding D?

Sonia65: yes, that's it, I think...From memory, I believe that they had not seen that the point D belonged...it seems to me, from memory, that's it, I think they made the right (EI) with the right (AB)... I think that in this task, they had not seen that the point D, it also belongs to the base plane (ABC)...

R66: Here you were trying to find the bottom view, what is your end?

Sonia66: Yes, trying to find a bottom view that would be more... Here I am trying to find a bottom view so that the pyramid looks like sitting on the quadrilateral face, to show that the bottom face is in a single plane, it is all flat, covering D. Based on that they could see that D belongs to both the bottom plane and the other (Figure 8)

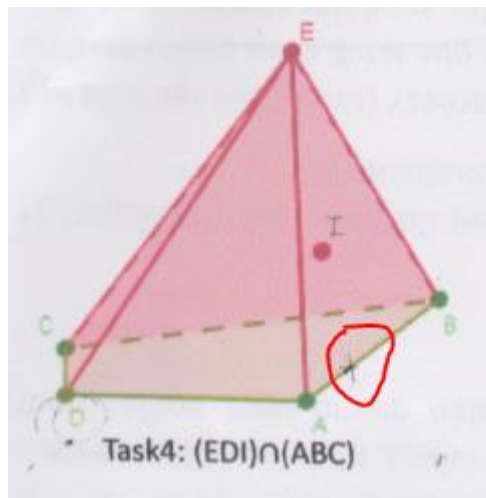


Figure 8

Extract 3, Video of the lesson, 07: 23 - 8: 05

Sonia67: (08:00) That's where the intermediate plane method comes in, and Margot, she's quite comfortable with geometry in space, she answered everything, and she found how to do it.

-----End of the stimulated recall interview-----

R68: The PT course, is that a course you have done before?

Sonia68: just last year, in fact before I was using the software in seconde, but in terminale S I have only had them since last year, so it's only my second year.

R69: What did you learn from this previous experience?

Sonia69: I have a little bit of distance, because I did it only once, in a general way on the geometry of space or on the use of interestp?

R70: Both?

Sonia70: So, on the use of interestp it was really a plus, because the students tell me that it helps them. And geometry in space is still something that is difficult for the students, it's a chapter that is complicated, that needs to be... we need to go back over it, it needs to mature a little bit, because there are still intuitions that are not good at times, it's complicated. It is difficult for the pupils the geometry in space.

R71: What changes to make this time and why?

Sonia71: So this time I started with the software, whereas last year I had started with exercises on paper, with the intersections, I had first done the first part of the course with the examples, and then I had gone on interestp to apply.

I took them to Interestp to see what they knew, what they didn't know, and I made the course from their revision, and then I told them to go back to Interestp.

[I think that doing it this way allows them to...I can see better the difficulties they have, it allows them to get out the difficulties in fact. Whereas when we do the course, we start with the course, they hear, they listen, they say yes, yes, and so they may make fewer mistakes right away in the media, but if they have to do it again a week later, maybe if it's not well recorded, they make the mistake,

while there some start by making the mistake of non-parallel lines, they are secant. And since we "dismantled" it, in quotation marks, the error, maybe they will retain better, I will see with the tests.

R78: To what extent do you feel your learning objective was met during the PT course?

Sonia78: The didactic objective was just to bring out their knowledge on geometry in space, so it works well because they are active, so in fact they try, so we leave this hour there with, nevertheless, already small results which are nevertheless important what, on the intersections of lines, of planes, so that it is rather positive

R79: Do you want to review your course next time for the same topic?

Sonia79: Next year, right?

R80: Yes.

Sonia80: If I will do it again the same or not. In fact, next year, the programs are changing, so I don't really know what we...I haven't yet detailed the contents of next year's program, I don't know what we're going to ask or not ask in geometry in space. I know that there is some, but I haven't delved into it. So I don't know, I can't answer.

R81: as you have known more of the students' difficulties, so can you give some examples of their difficulties?

Sonia81: The difficulties of the pupils, it is properties which are true in plane geometry and which are not true in geometry in space. The example I said several times is typically that two lines are not parallel, so they are secant, that is false in space geometry, that's this kind of thing in fact which is difficult for the students.

R82: How can this understanding influence your teaching plans for subsequent courses?

Sonia82: So, afterwards, we can detail the exercises. What I'm going to do, is as we have quite a lot of work above, is that I'm going to be able to put in a true-false, and to check if they have assimilated or not, building an exercise by saying: John wants to build the intersection of these two lines, Manon says to him it is not possible, who is right, you see there, to check.

R83: For the TP session, it was generally in what situation would you want to leave that group of students for another group, at what point would you want to return? And in what situation would you encourage them to take advantage of the intuitive aspect?

Sonia83: In P.T. when I come to a group I ask them if everything is going well and where they are at. Then I ask them to justify a construction to me to see if it is understood. If they are stuck, I ask them questions and suggest ways to motivate them and I let them look again. I don't think I encourage them to take advantage of the intuitive aspect. However, I do encourage them to follow through with their ideas and try "things".

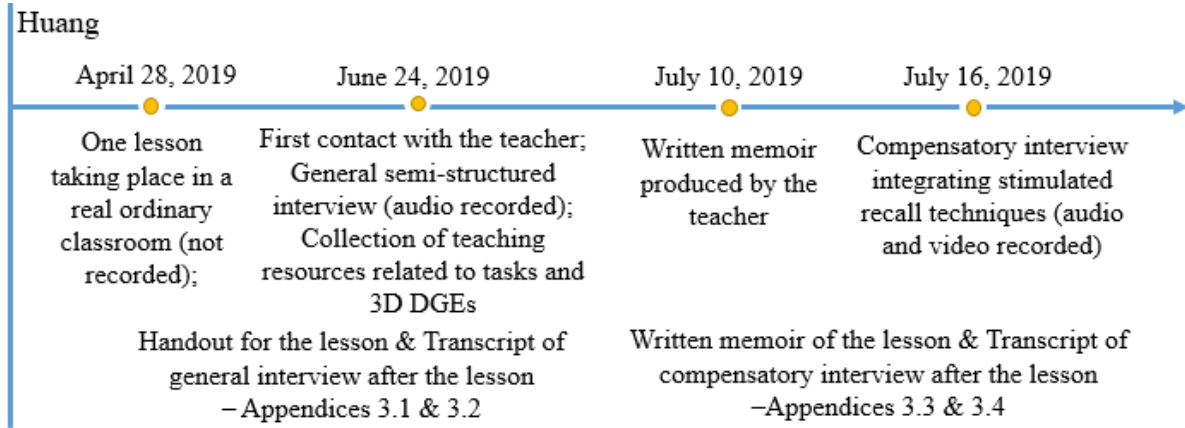
R84: What difficulties have you encountered when interacting with GeoGebra 3D yourself, how did you overcome them?

Sonia84: For the moment I've only used GeoGebra 3D via interesp. I've done an internship and I'm thinking of using it more in the future.

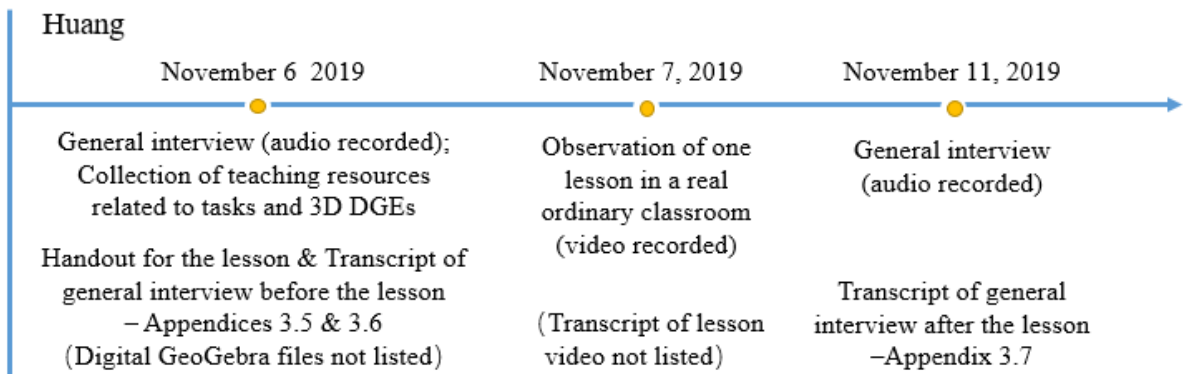


3. Data of Chinese Huang, Lesson Series H.I and H.II (1 lesson for each)

App-Fig. 5 and App-Fig. 6 present how the data in appendices 3.1~3.7 (which will be presented below) are situated in the lesson series of Huang



App-Fig. 5 Data about Lesson Series H.I



App-Fig. 6 Data about Lesson Series H.II

3.1 Handout for the lesson in H.I

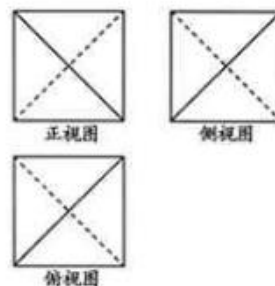
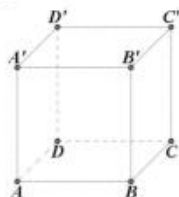
一. 立方体的子物体

请同学们按照要求切割立方体，以下以正方体为例

截出三棱台	截出堑堵	截出阳马	截出鳖臑	截出正四面体
<p>阳马：是底面为长方形，两个三角面与底面垂直的四棱锥体 鳖臑：四个面均为直角三角形的三棱锥 《九章算术·商功》：“斜解立方，得两堑堵。斜解堑堵，其一为阳马，一为鳖臑。阳马居二，鳖臑居一，不易之率也。合两鳖臑三而一，验之以基，其形露矣。”</p>				

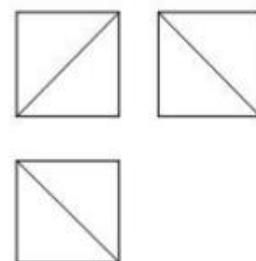
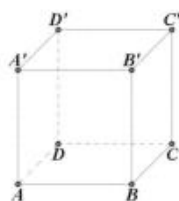
题组 1.

1. (省市模拟) 某几何体的三视图如图所示，正视图、侧视图、俯视图都是边长为1的正方形，则此几何体的外接球的表面积为 ()



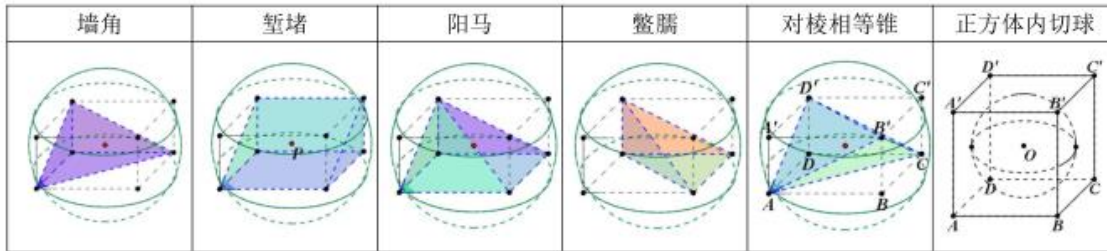
2. (2015年·新课标卷II.7) 一个正方体被一个平面截去一部分后，剩余部分的三视图如右图，则截去部分体积与剩余部分体积的比值为 ()

- A. $\frac{1}{8}$ B. $\frac{1}{7}$ C. $\frac{1}{6}$ D. $\frac{1}{5}$



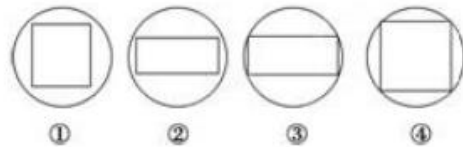
二. 立方体与球

同学们是否熟悉以下模型的外接球？

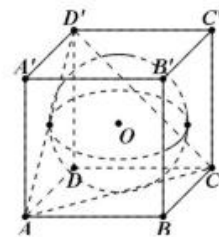


题组 2.

1. (省市模拟) 一个正方体内接于一个球, 经过球心作一个截面, 则截面的可能图形为_____ (只填写序号).

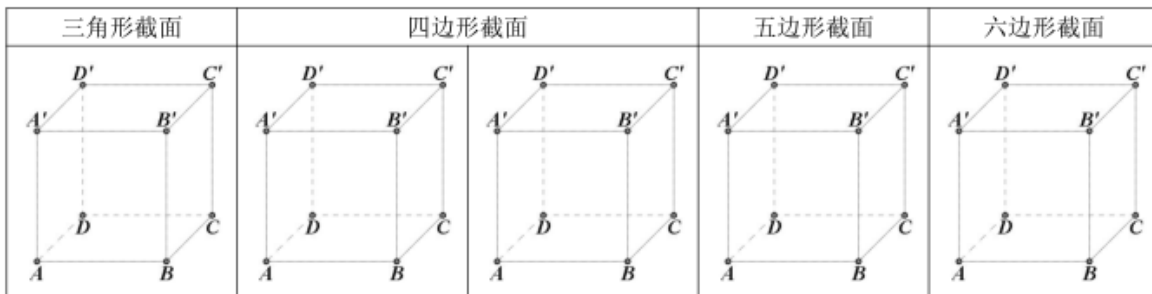


2. (2012年·桂林模拟) 如图, 已知球 O 是棱长为1的正方体 $ABCD-A'B'C'D'$ 的内切球, 则平面 ACD' 截球 O 的截面面积为_____.



三. 立方体的截面

(一) 以正方体为例, 请同学们在下列图中画出相应截面



题组 3.

1. (2018年·新课标卷 I. 12) 已知正方体的棱长为1, 每条棱所在的直线与平面 α 所成的角都相等, 则 α 截此正方体所得截面面积的最大值为 ()

- A. $\frac{3\sqrt{3}}{4}$ B. $\frac{2\sqrt{3}}{3}$ C. $\frac{3\sqrt{2}}{4}$ D. $\frac{\sqrt{3}}{2}$

2. (2016年·新课标卷 I. 11) 平面 α 过正方体 $ABCD-A'B'C'D'$ 的顶点 A , $\alpha \parallel$ 平面 $CB'D'$, $\alpha \cap$ 平面 $ABCD = m$, $\alpha \cap$ 平面 $ABB'A' = n$, 则 m, n 所成角的正弦值为 ()

- A. $\frac{\sqrt{3}}{2}$ B. $\frac{\sqrt{2}}{2}$ C. $\frac{\sqrt{3}}{3}$ D. $\frac{1}{3}$

3.2 Transcript of general interview after the lesson in H.I

The first interview with Huang was made in the morning of 24th June 2019, concerning the lesson given by Huang in a real ordinary classroom in April. The topic of the lesson is “sub-objects of the cube” and the handout used in this lesson is already presented in section 3.1. The topic belongs to the content of grade 10 but here it was reviewed in the lesson of grade 12. The interview was conducted in the office of Huang in the high school, before his desk (App-Fig. 7). and the interview lasted 1 hour and 30 minutes.



App-Fig. 7 A corner of the desk of Huang in his office

The interview was recorded in audio format, transcribed in Chinese and finally translated into English. Below presents the whole interview in English.

R1: In general, for what kind of tasks in solid geometry would you prefer to use GeoGebra?

HE1: For example, the task of moving point, absolutely, good students can figure it out at once, in a cube like this, there is a moving point on the segment A_1B and the maximum of $AP+PD_1$ is questioned (Figure 1). It's a topic quite suitable for GeoGebra to work. Just unfold the plane A_1BCD_1 and let it form a plane together with A_1AB , then connect D_1A . The shortest distance between the two points is the straight line connecting them. In this case, good students can figure it out, but it is beneficial for a slightly weaker student to have something of help. GeoGebra is frequently used in this kind of task.

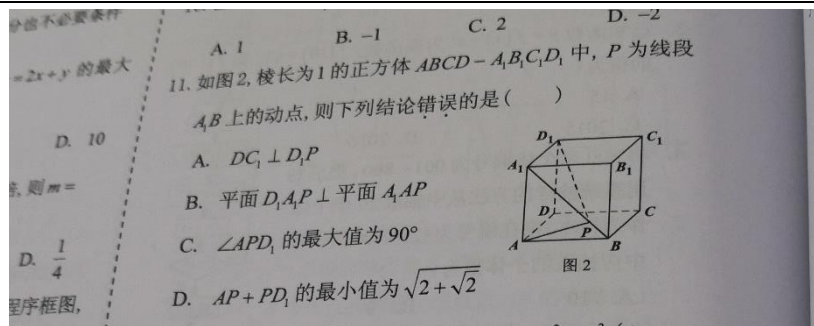


Figure 1

Another topic is 三视图 (hereafter called three-view diagram, the diagram that gives three projections of an object from different points of view). This part is actually the most annoying. The 全国卷1 (National version 1) of 高考 (hereafter called GAOKAO, the college entrance examination in China) once included such a task, didn't it?

R2: I once saw a figural configuration, with its two parts embedding into each other...

HE2: More or less, the structures like a cube from which one corner has been cut off, are all very annoying. Usually the students cannot well imagine. The overhead view of the cube is like this, the front view is also like this (Figure 2), it's about cutting one corner off a cube, and then giving its three projections viewed from different direction. Many students cannot imagine how this cube has been cut. It will be much better if there is a realistic model. In fact, we also have this, which we use in our daily teaching (Figure 3), it's about cutting off the part above the red triangle.

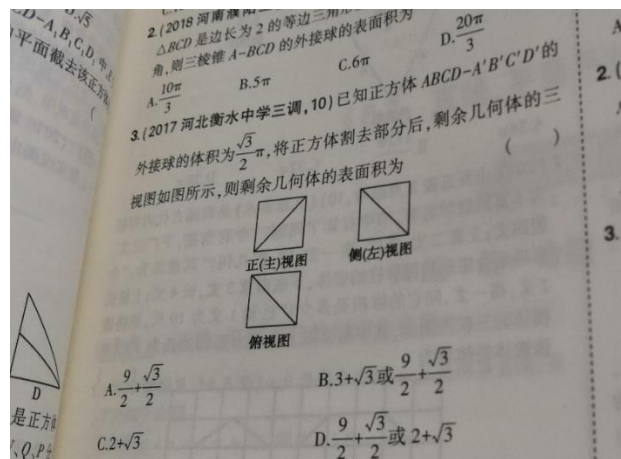


Figure 2



Figure 3

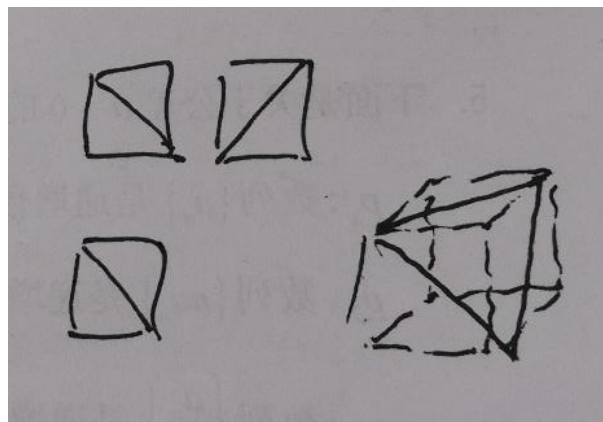


Figure 4

In the past, elder teachers usually used this kind of teaching material. It is also very convenient to use. But it doesn't work anymore when more changes intervene. Take this structure for example (Figure 5), you have to change a lot the initial cube to get the pyramid. So in general how would we teach students to reconstitute the pyramid starting from the given three projections? Just draw a rectangular cuboid or a cube, and then fix up the critical points in the cuboid/cube, such as this point, this point (Figure 5) ... after having determined all those points, connect the line segments when it is necessary, and that's it.

You see, the three-view diagram (Figure 6) is not easy to deal with, either. It is better to have some tools as assistant.

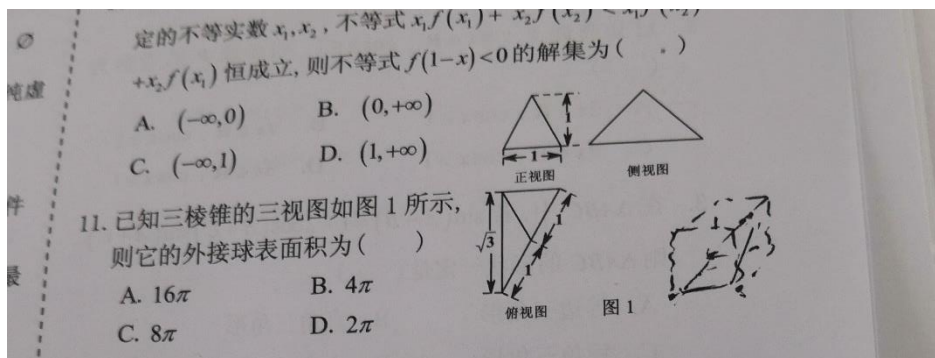


Figure 5

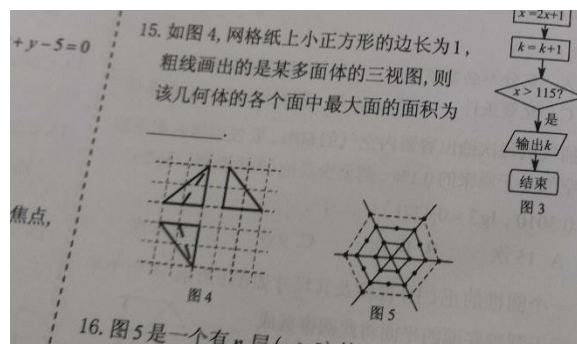


Figure 6

R3: The three-view diagram is the content of grade 10?

HE3: Compulsory II (one mathematics textbook for compulsory stage), we don't learn by order, grade 10 is like this: Compulsory I and III are put together since they both involve functions, and Compulsory III and Compulsory V are learned in the second semester of 10th grade.

When it comes to grade 11, we have Compulsory II together with one textbook of optional stage, and the solid geometry is in Compulsory II.

R4: I remember there are two separate parts on this topic, one is "the preliminary solid geometry", the other is "spatial vectors and solid geometry".

HE4: Yes, they are separated in the textbook.

R6: And you put them together?

HE6: Yes, after finishing the compulsory II we just skipped to the spatial vector in Optional 2-1 (one mathematics textbook for optional stage), combining the two books together. Therefore, the content of the textbooks of grade 11 are broken into different pieces, and they are taught respectively in different months of the year.

Besides the three-view diagram, GeoGebra is very suitable for displaying the composite figures with spheres. This (Figure 7) is an exercise task I once used in my open class. Many students could not solve it, given a cube, with a sphere inscribed in it, cut the cube with the plane of the triangle ACD_1 , obviously the plane will also section through the sphere, the task is to calculate the area of the circle-shape section of the sphere.

I kept saying to them: since the sphere is tangent to the cube and the points of tangency must be the centers of the lateral faces, and the circle-shape section of the sphere is just the inscribed circle of triangle ACD_1 , so you just need to draw a triangle and find the area of its inscribed circle...But they were still confused, then I presented to them the 3D constructions in GeoGebra, they were able understand, more or less.

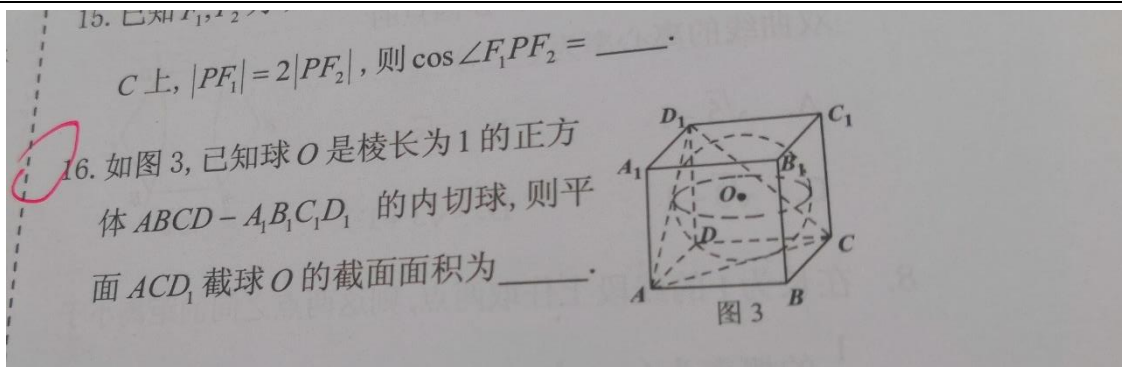


Figure 7

R7: Sometimes the students couldn't be well convinced by the results of deductive reasoning when they can not imagine the hidden spatial structure?

HE7: No, it's the competence of spatial imagination that they need, but If they have never seen a 3D figure in space, it will be quite hard for them to imagine it only with a paper drawing.

If they have a solid object to rotate, with the computer over here, by the way they are very interested in it... You show them a model in the software (GeoGebra), and turn it for several rounds, they can easily figure it out.

R8: What are your didactical objectives with respect to these exercise tasks, for example, what kind of competencies in them do you want to improve or promote?

HE8: There is no ... as regards the competencies, the main one would still be the competence of spatial imagination. Some tasks, like the items in National Version 1 of GAOKAO, which I also included in my open class. In the discussion after this class, some experts commented: Here you merely let students solve tasks by experience, without use of the logical proof in mathematics, that is, not a rigorous proof, it's not very desirable. I said that for this task I exactly don't want them to use rigorous proof, instead, I would prefer them to purely mobilize their spatial imagination. I had a copy of handout, and I can send it to you if you like, this is an open class at the level of municipality, which happened in March this year.

... well, let me directly tell you that, there is a cube, and a plane is at the same angle to all the edges of the cube that it will intersect, the plane will cut through the cube when moving, the exercise asks about the maximum area of the cut face. (item 12 in National Version I of GAOKAO, Scientific Option, Figure 8). Then GeoGebra is the fastest way to approach, because the plane should be perpendicular to the diagonal of the cube or parallel to the plane of the equilateral triangle, such that it could be at equal angles to each of the edges. So just drag this plane along the diagonal, let it cut through the cube and we can see immediately with the help of dynamic geometric software—the plane move from this corner, up to the middle, with the area of equilateral triangle-shape section being increasing ...

1. It's known that the edge length of one cube is 1, a plane α is at the same angle to all the edges of the cube that it will intersect, then the maximum area of the section of the cube cut by the plane α should be \leftarrow

- A $\frac{3\sqrt{3}}{4}$ B $\frac{2\sqrt{3}}{3}$ C $\frac{3\sqrt{2}}{4}$ D $\frac{\sqrt{3}}{2}$ \leftarrow

Figure 8

R9: The condition in this task is the angles between the plane and each edge of the cube are all the same, did you show out the angles and their value?

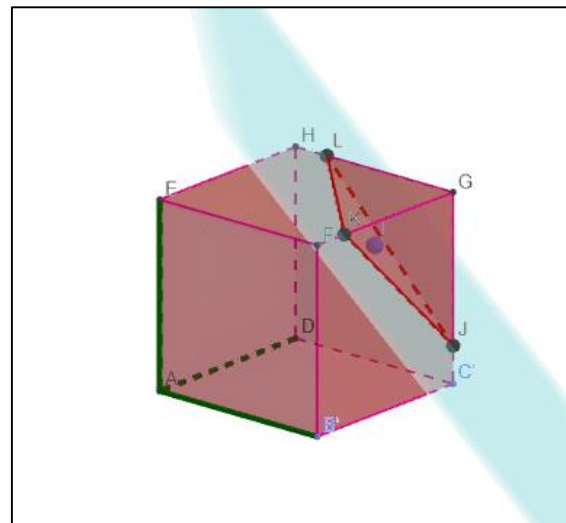
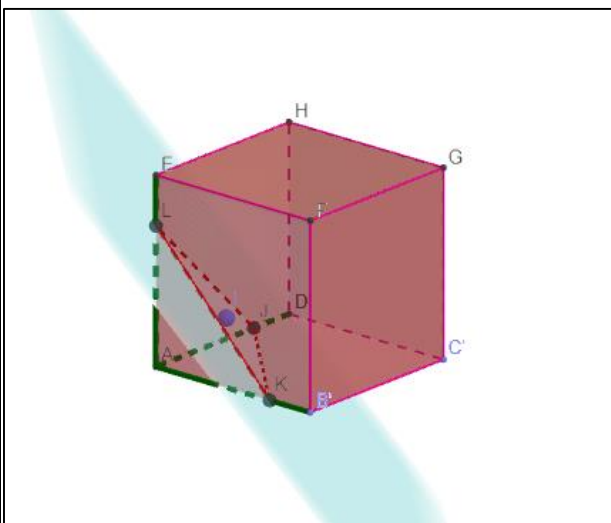
HE9: You can show them, but I didn't do.

R10: So how could you convince them that all these angles are equal?

HE10: I said like this, If I have a plane perpendicular to the diagonal of the cube, and if I rotate the cube around the diagonal, then these edges will respectively arrive at a symmetric position, that is to say this edge will be rotated to that edge, and it is so for all the other edges, the positions of the edge before and after the rotation are equivalent, therefore, the angles between the plane and all these edges are the same. But my explanation is not sufficient to be a proof.

R11: it feels that the thinking is in the right direction...

HE11: Yes, it is already the 12th in multiple-choice items, I believe that for an ordinary student, he will most likely guess. They should address it within 5-6 minutes and so won't have opportunities to think it over. In fact, a task like this doesn't emphasize quite rigorous proof. It is mainly aimed to test your spatial imagination and your global understanding of 3D figures..., I believe that the ordinary exam participants will most like guess the answer when faced with it. It is impossible to completely think it over. In the lesson, when I dragged the cutting plane in GeoGebra, the students saw that the sections firstly increased



and then decreased in area, they soon made the conjecture that the biggest area must fall in the middle. I said OK, it is enough to guess out the right answer (Figure 9).

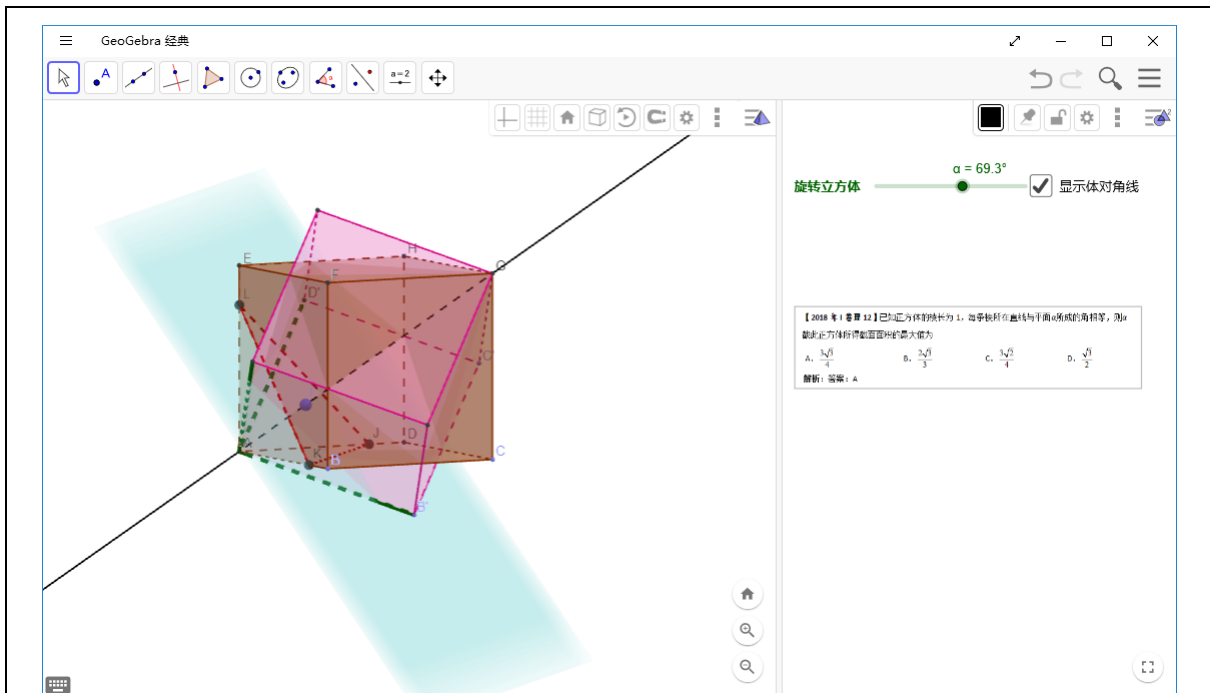


Figure 10

The researcher of teaching also said so, he said that it lacks some mathematical proof, something rational.

R12: Will the different types of GAOKAO items influence the way you teach them? Take this examination task for example, if it is presented as the big items (which may include several sub-questions) in the exam paper, will your teaching strategies be different?

HE12: How to say...Because I keeps a close eye on GAOKAO, how it tests students, how will I guide students to learn. If we hope to promote students' spatial imagination, we'd better put the rigorous proof aside but focus on their perception of structures of 3D figures. The small items like the single-selection ones don't emphasize quite rigorous proof, what it tests is just the imagination competence and the overall master of the figures. The proofs, like that to prove the parallelism between lines and planes, are also targeted in GAOKAO exams, the first big item is almost about this, asking students to rigorously prove, for these tasks I definitely won't give a simple explanation, but write the derivation process step by step. For that part I use GeoGebra less frequently, in fact, it's rarely mobilized. Because students at that time are actually setting out to write, with their pens, thus it's not so necessary to pay much attention to the changes of the figure, in addition, such big items won't involve many changes on the figure.

The only one that impressed me deeply is that the 教研员 (jiào yán yuán, researcher of teaching) once explained how he would design the big items in exam: taking a solid figure initially drawn in the normal perspective, I put it in the software and turn around the scene until a viewpoint where the figure seems not so familiar, I then fix the viewpoint and this will be my exam task.

If you really want to see the integration of GeoGebra in the teaching of big items, it will happen only at this time, that is, let the students feel the variation of tasks. For example, there are many drawings in GAOKAO examination, now that this viewpoint has been familiar to everyone, well next time I would change perspective of viewing the figure and let them address...

R13: But the knowledge tested keeps the same?

He13: Yes, the answer keeps all the same, just change the viewpoint to see the figure, but it might be confusing to some students. This is from the perspective of an exam designer, while to students you can also present some variations like this in the second round of reviewing, aiming at broadening their ways of thinking.

R14: Are there other mathematical topics that you find suitable for the integration of GeoGebra?

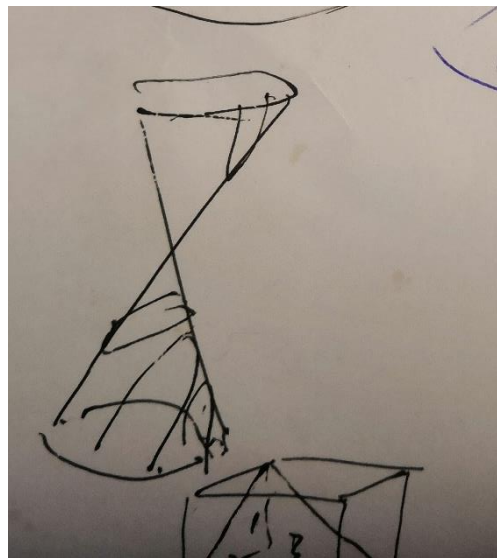


Figure 11

HE14: If you focus on solid geometry, I once wrote about conic sections in my 公众号 (gōng zhòng hào, WeChat subscription), there is something called Dandelin Double Sphere, one sphere at the top and one sphere at the bottom of the pyramid, and there is a plane tangent to both of the spheres, then the points of tangency are just the foci of the ellipse, the section through the pyramid. This part is not required in textbook, I write this just to extend their thinking. If you use GGB for this topic, it would be very fascinating.

Another example is the configuration of two pyramids, what confuse students are why the sections of two pyramids can be parabola, ellipse, or hyperbola, and how the shapes of sections change from one to another (Figure 11). Then GeoGebra is a very convenient tool to construct the dynamic 3D objects. I once tried this using Sketchpad, the construction is badly difficult, while GeoGebra can do this very quickly.

Another type of task is similar to the third type listed in my open class handout. A plane pass through this point (G), this point (E), and the midpoint (F) of the edge, and we need to study the section of the cube cut by the plane.

In contrary to what we've anticipated, some students can not imagine well in this kind of tasks involving dynamic changes. Because there are a variety of shapes of the section which are possible. If the third point is well at the midpoint of the edge and I need draw the outline of the section, the first thing to do is to draw the parallel line, here you can see it's a trapezoid. But when this point gradually moves down, there would be some other shapes showing up; in addition, if you move this point (G) a little forward, then these three point (together with E, F) will result in a pentagon-shaped section. So I tried to integrate GeoGebra in this part, and it works. There are some variations of this task that I've put in the end of that handout, but there was no time left for them.

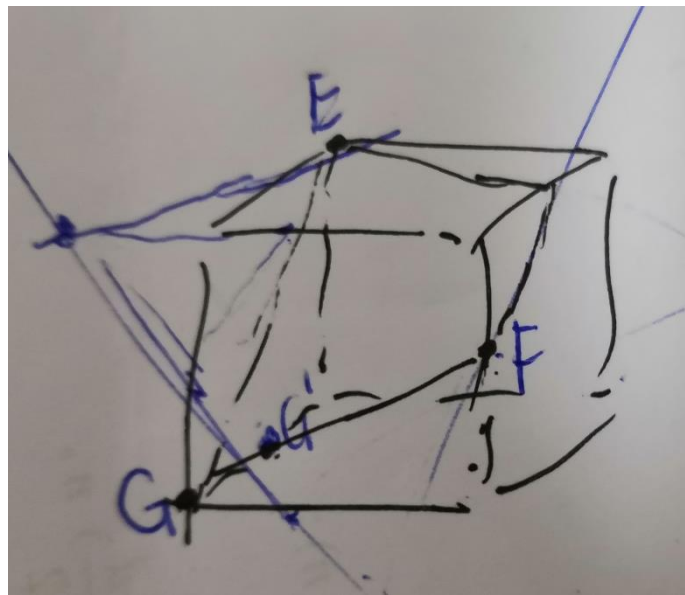


Figure 12

R15: Students are demanded to determine the nature and the property of the sections?

HE15: Yes, it (the task) will also ask about the maxima/minima of the section's area, at which point the area could get $\frac{3}{4}$ of the maxima. As it's also called a sectioned cube, it can be included in this type of tasks. Proof could also be involved; it may be more efficient to present the geometric objects with GeoGebra.

R16: This is a typical part in French textbook, it first invites students to conduct explorations with DGS, next backs to proof, and I find that they emphasize the formal proof, the deductive reasoning based on the properties and theorems.

HE16: In fact, regarding this topic, the head of our discipline group said at that time: "You use this software to teach this topic, it is good that after we show it to the students, they do feel well themselves, but when they are really embarking on the tasks in paper/pencil environment..." We were organizing the 同课异构 (tóng kè yì gòu, different structures of class with respect to the same topic) activities during that period, another teacher, a senior

fellow of mine, didn't do the same in his own class, he didn't use any software, but purely drew the geometric objects on the board, and presented step by step how this planar section can be determined. Like this: you give me a cube drawn on the paper, how can I exactly determine this section. He had spent a lot of time in explaining this, and it also worked with the students, but his students were better in doing exercises than mine. If I merely rely on GeoGebra to present the geometric objects, the students feel clear when listening the lecture, but when they really deal with the exercises by themselves, they almost fail. Because they don't know how this section can be drawn out. Therefore, the better way of teaching, in my opinion, is first adopting what my senior fellow has done, teaching students to fix the section's outline in the paper/pencil environment, and then show them the GeoGebra constructions as a visual assistant.

R17: What was the classroom arrangement when you gave this open class? Was there a screen projector?

HE17: Yes, it was a big, how to say, a lecture room with the capacity of three hundred or four, so you have many places here, and in the front is the podium, just like the ordinary university classroom. And here you have a big screen, the SHUNDE city has much money, and the screen is quite big. We teachers basically stand in the front, students sit opposite, and many teachers take a seat in the back and watched. So the equipment is very convenient for the projection and everybody can see the screen (Figure 13).

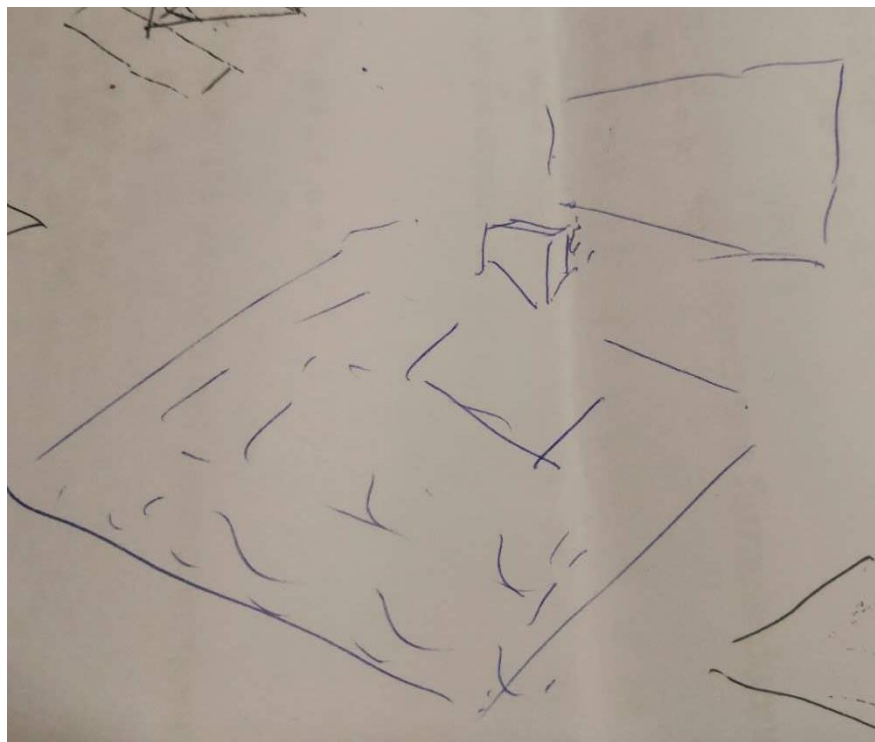


Figure 13

R18: What is the scenario of the class?

HE18: At that time, I didn't ask them to do these tasks in advance, so it was a bit like doing as well as practicing. I first introduced the topic that I'm talking about today, and then I

brought out one GAOKAO item to them, let them try to solve this task in paper/pencil environment, later I explained the traditional solution, if they are still confused, I would display the models constructed in GeoGebra. After they were totally clear about this task, we came to the next one, each item has variations.

R19: What is the traditional solution?

HE19: The traditional solution is that in the pure paper/pencil environment. After students get the item on the exam paper, they just rely on the given drawing, and try to write the solution using the pencil, without any help from computer. In this class, the handout has created a paper/pencil environment similar to the situation of GAOKAO.

R20: Have you drawn on the board?

HE20: Sometimes I still need to draw, because you have to participate GAOKAO after all, there is no other things to appeal to.

R21: will you compare drawings on the board and GeoGebra models?

HE21: No, I didn't do. Maybe it's due to lack of time, anyway, after explaining each task, I will show the GeoGebra model to them, which will be more intuitive. Later came the next one, with no comparison between the board and the GeoGebra interface.

R22: Have you once tried this way: first let students explore in the GeoGebra environment, and then come back to traditional environment?

HE22: It's relatively rare, generally in our teaching we don't do this. It's usually doing the exercise tasks in paper/pencil environment, computer software is utilized only when they cannot understand anyhow. Like the sketchpad is very good at dynamic geometry, like the ellipse with a moving point on it, it's convenient to do this with sketchpad. But we won't directly start off using it, it's often when we cannot go on with the tasks in traditional environment anyhow.

R23: Besides this, you also included other GAOKAO items in your handout?

HE23: Yes, there was another one quite similar to this, it was a GAOKAO item the two years before 2018, but was placed as the 8th single-selection item, nevertheless, the models underpinning these two items are the same.

R24: The National Version 1?

HE24: Yes, how is that item expressed... first there is a plane α which is parallel to the plane of triangle and also pass through the point A. As the plane can be extended to infinity, it must have an intersection with the base face, and also an intersection with the lateral face, we ask the angle between the two lines of intersection (Figure 14).

It's in fact quite easy, I just move forward this plane α , because, anyway, it is parallel to the plane of triangle, so you can move it up to the place of this triangle, the two intersections formed by α and the two faces of the cube must be parallel to these two sides

of the equilateral triangle, so the answer is just 60 degree. If students have this intuition, they can arrive at the answer quickly (Figure 15).

The plane α passes through the vertex A of the cube ABCD - A'B'C'D', $\alpha \parallel$ plane CB'D', $\alpha \cap$ plane ABCD=m, $\alpha \cap$ plane ABB'A'=n, the sine of the angle formed by m and n is ()

- A $\frac{\sqrt{3}}{2}$ B $\frac{\sqrt{2}}{2}$ C $\frac{\sqrt{3}}{3}$ D $\frac{1}{3}$

Figure 14

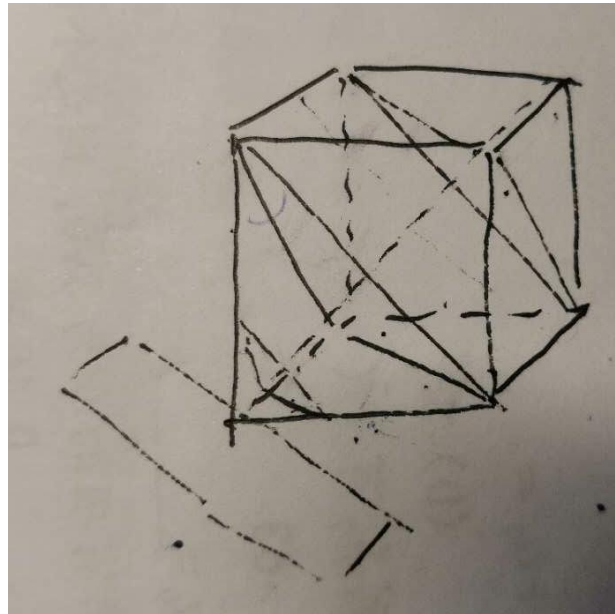


Figure 15

R25: What exactly are the topic of this class, which you introduced at the beginning of the class ?

HE25: The topic is “the sectioned cube”, I think this way, how many different directions of designing an exercise are there from a sectioned cube. I divide into three parts, one is the section of the cube, another is the section of the combination of cube and sphere, the other is auxiliary objects of the cube.

R26: Would you give some introduction before entering into the practice part?

HE26: It depends on what kind of the class you are giving, the one like open class belongs to the second round of review for GAOKAO, for this kind of class I have to give a summary at first, because students have seen many tasks before, I have to help them to summarize the variety of tasks. I presented different means to cut a cube, I mentioned 阳马, 鳖臑 and the like, because my topic is just “the sectioned cube”, these are excerpted from one GAOKAO item in 2015, or 2016.

This can be traced back in the ancient document 九章算术 (jiǔ zhāng suàn shù, a book titled *Nine Chapters on Mathematical Procedures*). There is 鳖臑 (biē nà, a triangular pyramid with four faces that are right triangles), which is a rectangular pyramid, and also 甍

堵(qiàn dǔ), a triangular prism which can be obtained by cutting a cube into two equal parts. So I've made a little introduction to these terms c.

Besides, there is another part of cube, with three faces around the corner, here, here and here (1, 2, 3), I directly called it 墙角 (qiáng jiǎo, corner of wall) in my handout (Figure 17).

Why did I introduce this, if you meet with a circumscribed sphere of some geometric object, it's often a circumscribed sphere of 阳马 (yáng mǎ, a rectangular pyramid with two lateral triangular faces perpendicular to the bottom surface), you are given the lengths of some edges, and are asked to determine the radius, or the volume of the circumscribed sphere of such a pyramid. Then I need to complete the pyramid into the cuboid, if they know this drawing in my handout (Figure. 16), they will understand somehow that it's necessary to complete them into the cuboid. They will be quite clear after my presentation. Like this corner of wall, the faces 1,2,3, forming a corner like this, the students will know how to complete this structure into the cuboid.

➤ 《九章算术》：斜解立方，得两壅堵。斜解壅堵，其一为阳马，一为鳖臑。

[when you section a cube obliquely, you can get two equal Triangular prisms, called 壅堵(qiàn dǔ); then you section one of the triangular prisms into two parts, one is 阳马 (yáng mǎ), which can in turn be sectioned into two 鳖臑(biē nǎo). — *Nine Chapters on Mathematical Procedures*]

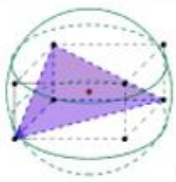
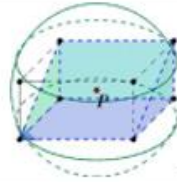
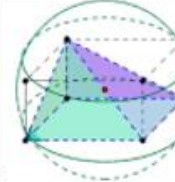
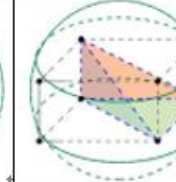
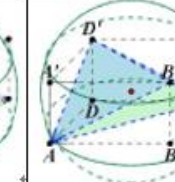
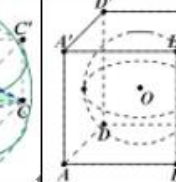
Corner of wall [ⓐ]	壅堵(qiàn dǔ) [ⓐ]	阳马 (yáng mǎ) [ⓐ]	鳖臑(biē nǎo) [ⓐ]	Tetrahedron with equal opposite edges [ⓐ]	Inscribed sphere of the cube [ⓐ]
					

Figure 16

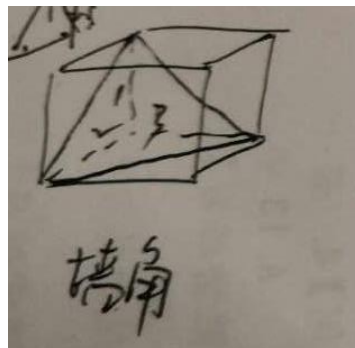


Figure 17

R27: The time and space organization of class remains the same if it's not for the open class?

HE27: You mean an ordinary class? It would be less complicated, there will be projection if computer is used, and the podium, students are all seated opposite, just like a small common classroom, the blackboard is on the front wall, possibly with a piece of projection showing up from here.

R28: It's projected not directly onto the blackboard, but on a curtain?

HE28: We have a white screen that can be rolled up and down for 11th grade, accompanied by the projector. But for grade 12th we will move to another building and have the tangible screen, it's more convenient for me.

R29: Why?

HE29: That's literally equivalent to a panel computer, and I can directly make constructions as soon as the GeoGebra software is installed, it's quite quick. Now I need take the computer myself to the class, sometimes I can't be bothered to take it.

R30: Now you usually use the GeoGebra on the pad or on the computer?

HE30: Mostly on the computer.

R31: Will you arrange group discussion?

HE31: That depends on the time, if we are not in a hurry... Actually we are hurried to work against clock to finish the lessons, the high school like mine may not leave students too relaxed, because students' basic knowledge is at a moderate level, those with high marks have all been picked up by 石门 (shí mén) high school, and those with marks at the second level are here, we follow after 石门 (shí mén). So for these students, it's relatively hard to encourage them discover something independently. Therefore, the basic mode (of teaching) here is just explain-practice-explain-practice, investigation or inquiry activities are rare. We have some activities like this in grade 10, but basically none when it comes to grade 11, every day we are working against clock with the lessons.

R32: In the GeoGebra files that you designed for GAOKAO items, there are some tasks of optimization, for example, when does the area reach a maximum, when does the length get the smallest or biggest value... But in general, you wouldn't show the concrete value of these variables on the interface of GeoGebra...

HE32: Yes, it has one functionality of computing and displaying the area, parameter, the angles, etc. But I haven't put it into effect. Showing these values is also feasible, and you can of course try this. If it's a task of investigation, take this one for instance (Figure 8~10), I can calculate the area using measuring tools and later let them see directly at which point the area reaches the maxima. But it's like what, there is no idea of investigation inside, since the value of the variable being questioned is completely calculated by computer and you haven't worked with your mind, the students haven't conjectured anything even after

the plane has been moved out of the point of maxima, it's only through seeing the results presented that they know this is the maxima, there is no conjecture in it.

R33: So you have intentionally avoided displaying the concrete values?

HE33: I would rather not compute them, yes, instead, you present the GeoGebra constructions and let them make conjectures, only in this way will they really think it over, otherwise they would just sit there curiously watching the changes of the number, they would be very happy but they didn't challenge their mind at all.

R34: They wouldn't think about the reason behind the phenomenon even if you insist them to?

HE34: Yes, they would think it over, that's to say, I already have this result, then I need you to prove it, this is a bit like the idea of proof, I told you that it is the biggest one, and then you give me the justification why it's the biggest, rather than predict that it's the biggest one according to the variation tendency of the value without knowing the concrete conclusion in advance. It's the conjecture part that I can't cut it off, because it's the part students lack most. On the contrary, the proof part is not necessarily what they lack most.

R35: How do you think of the relation of proof and spatial imagination?

HE35: I will say that these two competences should be treated separately. They should be cultivated one by one. If you want to pay attention to the imagination of space, you should always put those rigorous logic proofs aside and don't go into rigor too early. That is, stay at the visualization of the images. You just need to see the geometric objects clearly and understand its figural structure. That is enough. When it comes to the proof, that is, to develop the formal deductive reasoning, to strictly write those procedures, that amounts to dealing with big items. Therefore, I believe that the GAOKAO exams separate the small items and big ones with its own purpose in it. The small items don't aim at too much proof; they just want you to get something(intuition) quickly. So treat these two competencies separately.

R36: Are there something you find inconvenient, or the disadvantage in GeoGebra?

HE36: I haven't found some inconvenience, for solid geometry it's all right, on the whole.

R37: How much time will you spend in creating a GeoGebra file?

HE37: It's rather quick, like when you yourself get familiar with this software, a courseware like this can be done in 10 minutes, more or less. The rotating one might be a little more complicated (Figure 9~10), but it's also a matter of over ten minutes. It can be created quite soon. But it's usually the young teachers who are more engaged in GeoGebra, the senior ones wouldn't even use sketchpad, not to mention GeoGebra. They may integrate it if you give them some well-done courseware, but not very possible to create one by themselves.

In fact, why this is so easy for me, I once learned to use 3D math before, a software specially for 3D modeling. When I look at this software after 3D math, I found it take its source in 3D math in many aspects. It is therefore very natural for me to accept. If one is a totally beginner and haven't been in touch with any software, you suddenly make them engaged in this software, there must exist some problems.

R38: Have you tried to let students manipulate GeoGebra by themselves?

HE38: No, the main problem of this software is that, all its solid figures are equations in the end, they each have an expression, so students cannot handle this, he doesn't know... You give them a planar equation $X+Y+Z=0$, they don't even know what it means, they won't learn this at high school.

So you'd better give students some direct buttons, and avoid them from inputting the command syntax. Students can only do what, click the button "pyramid" and create a pyramid on the interface. They can not handle those commands. But many objects, if you want to locate them precisely, you have to use command syntax and the functionalities available in "algebra view".

R39: I saw you use these functionalities quite frequently...

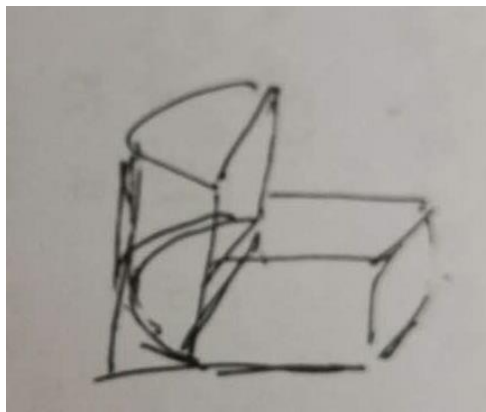


Figure 18

HE39: Yes, you can not handle the construction without the functionalities in "algebra view". Such as a figural configuration like this (Figure. 18), a half cylinder together with a cuboid. You cannot draw it with the existing buttons in the toolbar, it's not even possible to draw the half cylinder, a very common geometric object. So I cannot but create some curve surfaces in "algebra view" and then joined them together. It's, indeed, kind of difficult to put them together. I once used a software "玲珑3D" (líng lóng 3D), have you learned about this? It's already an aged software, but it's very good at construct solids of revolution. For example, if you want to construct a cylinder, a half cylinder, you can directly do it starting from a rectangular, rotating the rectangular around one of its sides to construct the cylinder. But in GeoGebra its more complicated.

R40: Sometimes my GeoGebra will operate very slowly when the constructions become complex, but in the video you've recorded I saw it go very smoothly?

HE40: The computer configuration should be good; it will be blocked when there is large amount of circulations or iterations. Especially the tree of 勾股 (gōu gǔ, the Pythagorean Tree). But the situation now is this, GeoGebra 5 is far less blocked than GeoGebra6, so just wait for its upgrading.

R41: Will the reactions of students influence your design of GeoGebra?

HE41: Yes, I will modify my GGB files. I once taught this part last September, our discipline group has assigned me a task, to give 一人一课(yī rén yī kè one class by one person), it's organized inside our high school, which means every teacher has to give an open class every semester. Then I decided to deal with this topic "the sectioned cube". In that class I just stayed at a relatively easy level, it's just for my students in my own class, and have integrated GeoGebra, hence the content of that class has been refined by me into the open class this March, then you definitely need to modify and redesign.

R42: Could you introduce some improvement you've made?

HE42: Take this task for instance, I needed to prove that all the angles between the plane and the 3 edges of this cube are the same, and I didn't explain this in the idea of rotation, but in the idea of parallelism, I just say the plane α is parallel to the plane of the triangle, and the angles between these 3 edges and the triangle face are equivalent, so are the angles between the edges and the plane α (Figure 19).

I wasn't very satisfied with this explanation, so a bit later I changed to the explanation that the plane α should be perpendicular to the diagonal of the cube, this felt better. But this adjustment is not necessarily an essential one, if I feel it not reasonable I will surely make some adjustment.

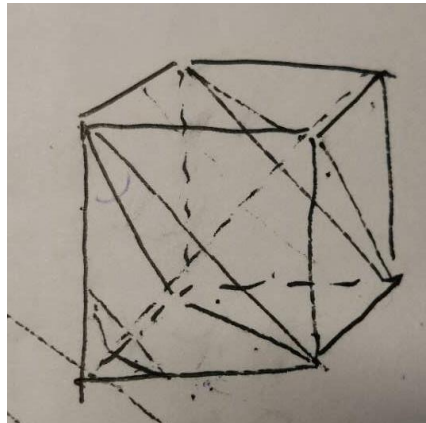


Figure 19

R43: Which explanation went better with the students?

HE43: The idea of rotation is easier to accept, because they have a lot of difficulty to imagine these angles are all the same unless I hold this pyramid upright, but the initial position of this cutting plane is just oblique.

R44: Are there many teachers interested in GeoGebra integrated teaching here?

HE44: From the beginning, in fact, open class activity in March was intended as a pilot of GeoGebra integrated teaching, the organizer wanted to put the teachers forward in this direction, calling the teachers all over the Foshan City together and seeing the effect of their teaching with GeoGebra. If this works well, they will popularize the GeoGebra to a great extent in September, October next semester.

But basically, it's rarely used by teachers here, they are more accustomed to sketchpad. 3D figures are more complex to draw in sketchpad, however those teachers prefer the forms in sketchpad, because the constructions in sketchpad are all wireframes (or drawings), which they can directly use in their paper after copying it, they are satisfied with this. When using GeoGebra, they have to adjust the color from time to time, many people don't know how to deal with this.

R45: I also observed that you spend a lot of time in adjusting the appearance of the objects, it's just for beauty?

HE45: Yes, in fact as you can see, I've made a comparison with them: one is 玲珑 (líng lóng, means exquisite in Chinese) 3D, the other is GeoGebra, it seems that the teachers still like 玲珑 (líng lóng) 3D, which is really pleasing to eyes.

The pictures in GeoGebra are also pretty initially, it's mainly due to the shadows, faces, gaudy and garish which render them less beautiful, and the points are big, the problem can be solved by only a bit of adjustment.

R46: In your video, you often paste the text of GAOKAO item to the "graphics" view, abreast of the "3D graphics" view which present the dynamic 3D constructions, you will also do this in your daily class?

HE46: Yes, it couldn't be better to have the text of the examination task aside, but the disadvantage should be that you have to simultaneously open two windows, you can not put the picture straight in the "3D graphics" view, you can put some text but the typing could be very hard.

R47: You tried to make the text as close as possible to the figural constructions?

HE47: Yes, what's the best: the exercise is situated just beside the figural constructions, because we used to first dealing with the tasks and using the GeoGebra constructions as a supplementary assistant. So I hope to have the content of the task aside.

R48: In addition, I noticed that you usually construct the framework of a solid and then assign the concrete values to the coordinates of the vertexes...

HE48: This is a habit I've gradually developed. You have many means to create a point. One is to construct a point in a fixed axis or a fixed line. Then the point won't have a specific coordinate, but have an algebraic expression "point (the expression of the line)", which is actually more inaccurate, so I'd rather construct points casually in GeoGebra, and then use concrete 3D coordinates to fix them; it's more accurate, and the points won't vary. It also depends on the situation...

But you needn't do this in some exploratory or investigation problems, as you need nothing but a triangular pyramid. Some of the tasks clearly prescribe the length of the edges, or the proportion, then I have to precisely define the points

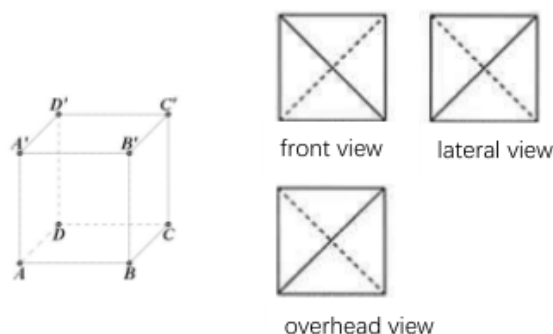
3.3 Written memoir of the lesson in H.I

The written memoir was produced by Huang on the request of the researcher. In the written memoir, Huang recalled the discourses of the lesson that he had given in April. The time that the researcher received the written memoir was 10th July 2019, 16 days after the first interview with Huang.

The written memoir was originally in Chinese, and then translated by the researcher into English. Below presents the whole English version of the written memoir.

Topic Group 1-1

1. The three-view diagram of a solid is as showed, the front, the overhead and the lateral view are all squares with the side length of 1, so the superficial area of the circumscribed sphere of the solid figure is ()



T: The difficulty of this question is how to reconstruct the solid, how do you do it?

S1: It should be a pyramid body

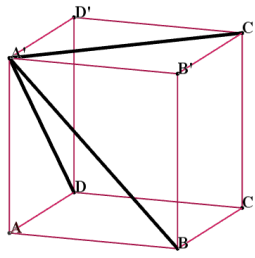
T: Can you tell if it is a triangular or quadrilateral pyramid? Or others?

S1: can not determine

T: Is it possible to imagine that the solid line is convex and the dashed line is concave in each of the three views of ? For example, the diagonal (slanted straight line) in the main view should be for the $A'B$ prongs in the square, we should be able to connect more boldly $A'B$?

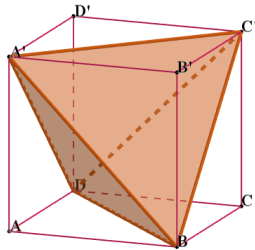
S1: Can imagine

T: Similarly, the oblique solid line in the side view should correspond to $A'D$, and the oblique solid line in the top view should correspond to $A'C$, so that the three prongs and four vertices are determined



S1: Can imagine now

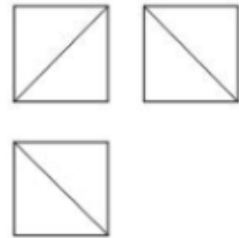
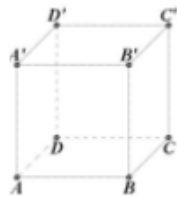
T: In the same way, we can fill the dotted line



Topic group 1-2.

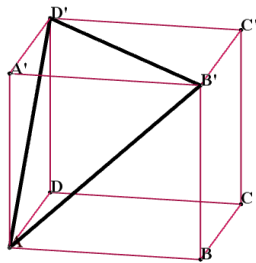
2. A cube is cut off a part by a plane, the three-view drawing of the part that remains is as shown, the ratio of the part being cut off to the part remaining is ()

- A $\frac{1}{8}$ B $\frac{1}{7}$ C $\frac{1}{6}$ D $\frac{1}{5}$

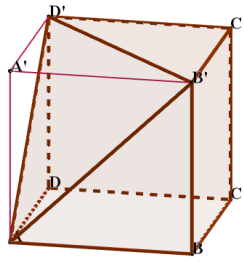


T: Students, please try to solve 1-2 according to 1-1

S1: The dotted line is missing, I can only fill it to this extent

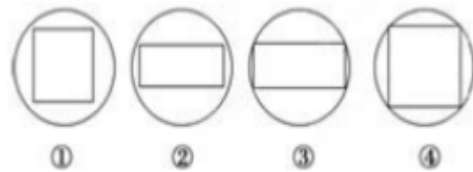


T: This means that the obscured area is not allowed to be prismatic, we can try to connect with the sides of the trapezoid and rectangle



Topic Group 2-1.

1. A cube is inscribed in a sphere, make a section of the cube through the center of the sphere, the possible shape of the section is _____.



T: Please think about how to deal with this task?

S1: Select ② ③ ④

T: Why?

S1: I feel that the vertices of the square section should be on the outline of the circle section...

T: Ask the students to think about how this problem should be handled.

S1: ②③④ should be chosen

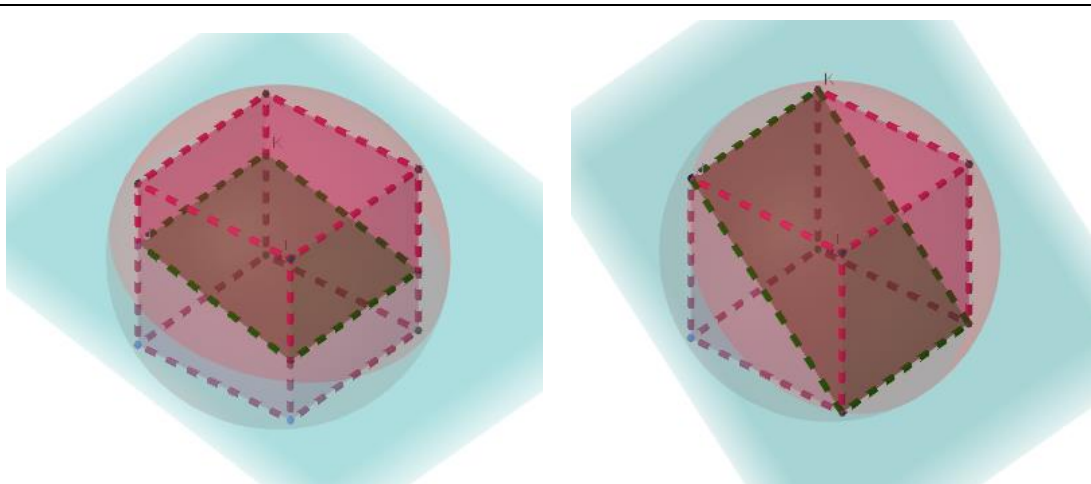
T: Why?

S1: Because I feel that the vertex of the square section should be on the section circle.

T: Is it possible to intercept in such a way that only the prongs of the square are touched and not the vertices?

S1:

T: Come on, let's look at the model (show the process of movement, second to understand)



S1: Choose ①②③

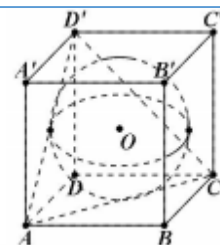
T: Why not ④

S1: The middle cannot be a square, the square section must be like ①, the vertex does not touch the section circle, if you want to make the vertex touch the section circle, then the square must become a rectangle, like ② and ③

Topic Group 2-2.

As showed in the picture, the sphere O is the inscribed sphere of the cube $ABCD-A'B'C'D'$ with the s length of 1. Then the area of the section of the sphere O cut by plane ACD' is _____

2. (2012年·桂林模拟) 如图, 已知球 O 是棱长为1的正方体 $ABCD-A'B'C'D'$ 的内切球, 则平面 ACD' 截球 O 的截面面积为_____.



T: How to solve it?

S1: The cross-section circle should be the inner tangent circle of the triangle ACD'

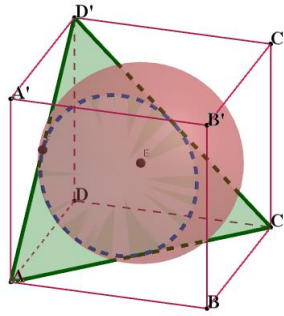
T: Yes, many students were able to quickly find the area of the cross section. Are we all able to make cross sections?

S1: It should be a circle

T: Where is the center of this circle? What points does the circle cross?

S1: Not so good to say

T: Let's all take a look at the GeoGebra display. Is it clear enough?



S1: The original cross-sectional circle must pass through the center of the squares, $A'D'DA$, $D'DCC'$, $ABB'A'$

Topic Group 3-1

1. It's known that the edge length of one cube is 1, a plane α is at the same angle to all the edges of the cube that it will intersect, then the maximum area of the section of the cube cut by the plane can be
- A $\frac{3\sqrt{3}}{4}$ B $\frac{2\sqrt{3}}{3}$ C $\frac{3\sqrt{2}}{4}$ D $\frac{\sqrt{3}}{2}$

T: Let's see next task (Figure 1), how can we find the plane α ?

S: Can it be plane EBD?

T: Why?

S: Just guess...since a cube has the property of symmetry.

T: The symmetry, a good idea. Let's see it together in GeoGebra. I make the cube rotate around its diagonal (AG), now tell me, what can you observe in this process? (Figure 2)

S: AE will rotate to the initial place of AB, AB will rotate to AD...

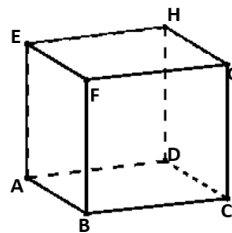


Figure 1

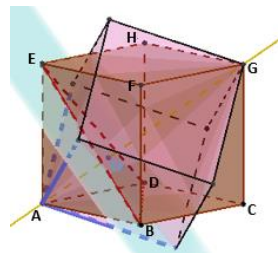


Figure 2

T: Yes, have you observed that, how many degrees I need to turn do make the cube coinciding with the original cube? It's less than 360 degrees.

S: 180?

T: Actually it's 120 degrees. It would be more intuitive to think of it this way: because the solid A-EDB is a regular triangular pyramid with A as its vertex. You just divide 360 by three. OK now only the three green edges AE, AJ, and AB are considered, what about the other edges?

S: Do you want to turn the other edges as well?

T: Can you analyze the other variations in relation to these three green edges?

S: The other prongs are parallel to each of the three green edges, so we only need to find the three green edges as representatives.

T: Yes, the plane EBD can then be the title of the α

S: But the position of the plane α is not fixed in the title

T: This plane α is just one of the planes with equal angles to each of the angles, can you find any others?

S: Make parallel planes

T: How to make it?

S: move a little?

T: Find a geometric quantity and tell us how to move it? Remember which line the plane EDB will be perpendicular to?

S: Oh, yes, the plane EDB will be perpendicular to AG, so the plane α only needs to move perpendicular to AG to satisfy the question

T: How do you think the cross section will change during the move?

S: If you go from A to G, it should first be a point, then a triangle, then not quite sure, then a triangle, and finally back to a point

T: Come, watch us demonstrate

S: Oh, the middle will become a normal hexagon, right in the middle when it is a square hexagon, and then back to a normal hexagon

T: Where do you think the area will be the largest?

S: area is obviously increasing first, and then decreasing, it must be the middle point that the section gets its maximum area

T: Okay, we've done, you know it's a small item, when you guess that the section gets to maximum at the middle point, that is enough.

Topic 3-2.

2. The plane α passes through the vertex A of the cube ABCD - A'B'C'D', $\alpha // \text{plane CB'D'}$, $\alpha \cap \text{plane ABCD} = m$, $\alpha \cap \text{plane ABB'A'} = n$, the sine of the angle formed by m and n is ()

A $\frac{\sqrt{3}}{2}$ B $\frac{\sqrt{2}}{2}$ C $\frac{\sqrt{3}}{3}$ D $\frac{1}{3}$

T: How do people think about this question?

S1: I cannot find this section.

T: Let's go straight to GeoGebra (Figure 1), we have to find a plane, while I am dragging the two blue lines (Figure 2), have you found any regularities?

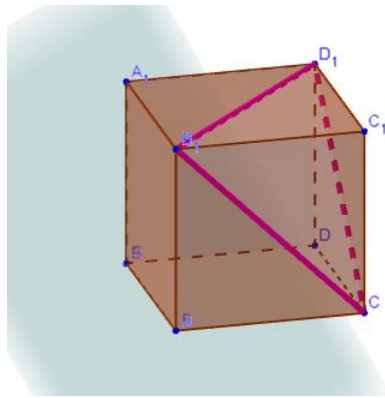


Figure 1

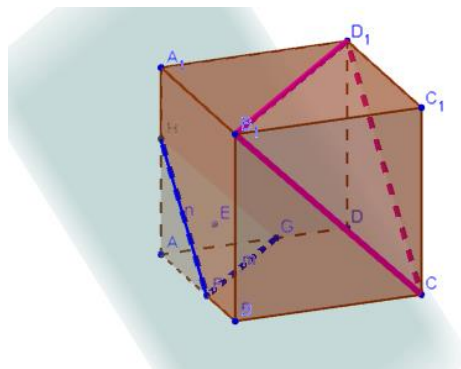


Figure 2

S: The blue line is the corresponding m, n

T: What position has this plane taken to be able to make it parallel to $CB'D'$? I evoke a black plane here (Figure 3).

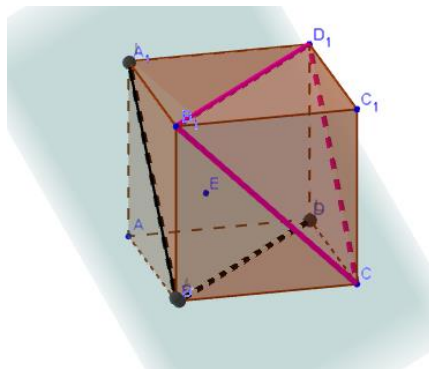


Figure 3

S: The black triangle is parallel to the plane $CB'D'$, so just parallel to the black triangle

T: And who would m, n be parallel to, respectively?

S: to be parallel to $m A_1B$, n to be parallel to BD

T: Right, so actually the α plane just needs to be perpendicular to the body diagonal, consistent with 3-1. So what is the angle of m, n ?

S: It's the angle between A_1B and BD

T: Great.

3.4 Transcript of compensatory interview after the lesson in H.I

The second interview with Huang was made in the morning of 16th July 2019, 6 days after the researcher has received Huang's written memoir of the lesson in April. The interview was conducted in the office of Huang in the high school, and it lasted 1 hour and 30 minutes. The whole interview was recorded in audio format, with the researcher taking photos from time to time. The audio is firstly transcribed in Chinese, with the Chinese transcript integrated with the photos, and finally translated into English. Below presents the whole interview in English.

R: The first question is about question group 1-1 which is related to the three views of geometry. Each one is a cube, with one oblique line and one dotted line. The task is resuming the geometry and calculate the surface area of the circumsphere of geometry. I noticed that you said the difficult point of this question was how to reproduce the geometry and you asked all students about the solution. Then a student said it should be a pyramid. Then you continued to ask if it was possible to determine it as a triangular pyramid or a rectangular pyramid or other students couldn't make a judgment. Was it a collective reply from the students or a reply from a particular student?

Huang: It seems some students were asked about it but nobody could answer. So ...

R: What do you mean by all together?

Huang: Yes, I asked and then all students answered together. Anyone was encouraged to share his or her opinions if any.

R: Did you ask them to draw on the blackboard directly? Isn't it hard to show how to reproduce a solid only through descriptions?

Huang: I didn't ask them to draw on the blackboard. He might say like this. For instance, if I asked him where were the people and he might directly tell me the points to link up, right? Then we can say so.

R: They pointed out some reliable directions?

Huang: Some information can be provided then. Anyway, this question would be talked about every year. The main problem is that the three views are completely the same and they get stuck. Nobody knows what it is. Many people will certainly remain ignorant even after the explanation. But it doesn't matter. I will use geometry software to display it to them and they can basically imagine it. Because geometry is usually cited to work out questions and there is a bunch of instructions that follow. This is a regular tetrahedron.

R: Do you think it is usually cited as a question because it is more difficult? Or any other reason?

Huang: Because it is not difficult actually. It will become very easy if you get familiar with it. It can be expanded much to cover the circumsphere and the like. Does it directly provide a regular tetrahedron and ask the length of edge? For instance, this model is actually used if the edge length of a regular tetrahedron is 2 and it is required to calculate the circumsphere

of it. We need to assume that the side length of a cube is a and then put the regular tetrahedron in the cube for this purpose. I wonder if you have dealt with questions like this.

R: Actually, its circumsphere is the diameter and the diagonal of the cube, isn't it?

Huang: Yes.

R: As you mentioned just now, some students who failed to answer it can answer after some guidance.

Huang: He may have worked on it. Some students responded quickly to this kind of questions and they would directly give the answer. Anyway, students are highly diversified and differentiated.

R: During that public course then?

Huang: Not many people could answer the question, possibly because they felt a little constrained at the beginning of a public course. So they didn't talk much and I had to explain directly.

R: Ok. Did they ask if it should be a pyramid?

Huang: Pyramid is the result of kind of guidance as some people took it to be rectangular in the beginning. As it looked like a square, he assumed there might be a cube inside. Some people said so. How would you guide them? Yes. I asked him if he could make a judgment. Some people said $1/4$ and some others $1/3$. I couldn't follow and I told him directly to imagine boldly. What if the full lines are risen? So I just allowed him to imagine it but he failed actually. Finally, I had to complement all the lines and the geometry before he reconsidered his three views and understood it. Is it all like this for three-view diagram tasks? You have to do it reversely. Usually students can figure out when I give them a solid and let them to think about its three views, but here it is a reversed process, and they usually cannot imagine what the original solid could be like.

R: Right, I saw you later tell him that in the side view, the full lines are corresponding to $A'D$ and $A'C$ in the cuboid, he could draw them. But the graph you gave me is actually the graph you drew on the blackboard, right (Figure 1)?

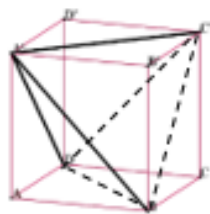


Figure 1

Huang: Yes, I drew this kind of graphs that evening.

R: Is it the beginning for you?

Huang: Aren't there many blank cubes on the study plan (Figure 2)? Such cubes are for drawings.

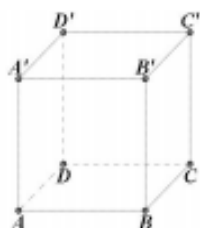


Figure 2

R: Did you design those cubes for them purposefully then?

Huang: For the convenience of my quick drawing.

R: I noticed the graph you gave me had only three full lines. Did you fill up the dotted lines later?

Huang: Yes, the final graph was the one of senior grade 2.

R: Did you do it all by yourself?

Huang: Actually, I basically did it all. Then they checked it themselves. If they still couldn't understand it in the end, I would ...

R: I have a question about the GGB model of the dynamic graph. What did you say then? Aren't there some gestures? What operations were performed on the screen? Please talk about them.

Huang: I didn't perform too many operations, like the public courses I sent you previously. There was a video record for the lesson I sent you. It was basically my operation because it was a fixed geometry. I only need to click on it (Figure 3) and tell all that the structure is like this. Then I will drag it and make a turn (Figure 4 ~ 6).

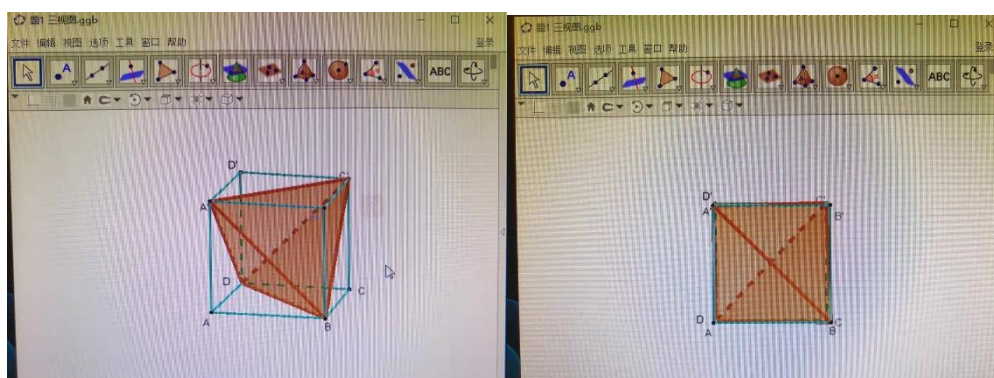


Figure 3

Figure 4

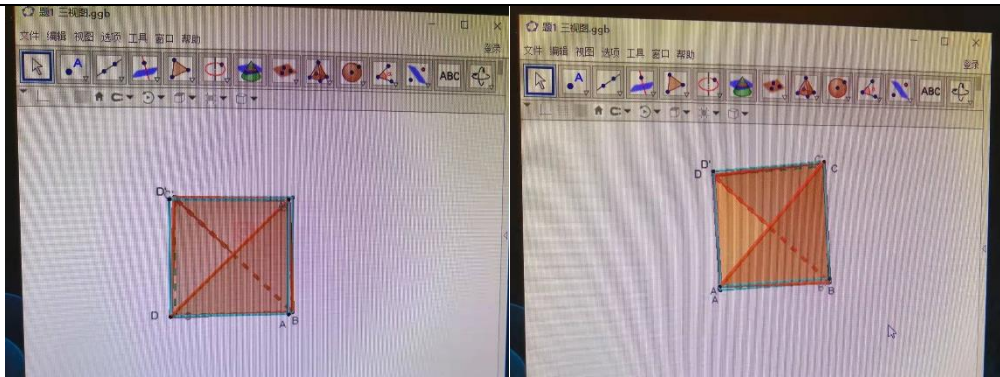


Figure 5

Figure 6

R: Will it turn to a different view?

Huang: Yes, a different view. Then make a turn and check the three directions of the three views. It is done.

R: Then the students can basically understand it, don't they?

Huang: They can imagine it basically. They can accept it.

R: Without the GGB model, students like those mentioned just now, if only there are only pens and paper, you said you hoped they could infer it themselves without software. But it seems they still need to display the graph first and then make a backward induction. He can work it out after lots of exercises. What goals do you expect them to achieve finally in such a context when there are only pens and paper? Or do you have any summary of special teaching skills?

Huang: Do you mean any teaching skills without software? Not many such skills indeed. We seldom make such a summary. We basically draw one cube in the routine way. What kind of teaching skills are you talking about?

R: I have no special idea. OK, it doesn't matter. Do you primarily expect the students to resume it in a pen-and-paper environment?

Huang: Yes, certainly our goal is to be able to do it without using software.

R: Without considering the examination requirements and if GGB software is provided to them to create the original graph according to the three views directly with software, how would you teach them?

Huang: It is a good idea. I used to come across this idea but it wasn't applicable for senior grade 3. It is acceptable for senior grades 1 and 2 anyway. I took it necessary to give such a lesson when I started to teach geometry at senior grade 1. For this, I had to ask them to do two jobs with a cube. The first job was to cut a cube and get a triangular pyramid, a 1/4, a triangular pyramid, a triangular prism with right triangle base, a rectangular pyramid. Then a formal question would be provided so that he could imagine how to cut it. Do you understand me? This is the first job and then... In the second job, what is acquired after a cube is cut by a plane? Is it possible to get a triangle, a quadrangle, a square, a parallelogram, a trapezoid, a pentagon or a hexagon? Can he obtain any of these shapes?

This is the second question. Actually, it can greatly help him to work out this question later. Moreover, you have to fully rely on software because we don't have such a teaching tool in reality. I mean I don't have any practical tool for them to cut. I can display it well via software.

R: Do you mean you still have to work it out yourself?

Huang: You don't have to. Just carry them all into a computer room and ask them to draw by themselves. Use the mouse and the computer themselves. But the students haven't used such sketchpads.

R: Maybe some technological trainings are required.

Huang: Yes, they haven't used it, nor do they know the operations. We think the operations are very simple but they just feel so difficult.

R: Maybe I think the students can learn it quickly.

Huang: No, because it is different. The computers in our classroom have a touch screen. Sometimes, I would leave the model on the computer and ask them to play it by themselves after class. They touched it but the directions changed completely or they clicked to change the direction of mine. It happens easily.

R: It is possibly because the students had to do it on a computer by themselves in France. They may be required to draw lines. I mean just take a cube or a cuboid as the background and find the intersecting line of planes. Finally, this task would be upgraded to a section covering 3 points, or a section of a cuboid. You have to draw it. Actually, the operation is simply to create a line or a plane. But they may still need some kind of inference and guidance and some results can be achieved in the end.

Huang: Do they need to show it?

R: No, the Huang: doesn't require it. They sometimes really did it and verified successfully and continued to the next task, which made them really happy. Actually I just want to know about your teaching sequence if the students are really brought into the computer room. The students may not completely know about the basic principles of cutting a section. They may cut many sections and made observations much. But experiences are really necessary here. How will you guide them for this purpose?

Huang: Generally, we allow them to do it by themselves or draw planes via the software. For instance, we allow them to cut sections first and then we give them some questions in writing. For instance, find three points randomly on a cube. Why is then a pentagon created in this case? Which lines should be drawn first on paper? We got two ways then, i.e. parallel line method and extension line method. If the two methods can be applied well, he can find it out soon basically. Then tell him the axiom of parallelism during application of the two methods, i.e. make an inference with justification. But inference is possibly not the most important. What really matters the most is that he can finish it. So we can divide it up into three parts. Firstly, allow him to do it and make drawings by himself. You can draw anything you like and you must draw a pentagon.

R: Why do you think it must be done first?

Huang: He can experience it himself and cut it whatever he wants. I will give him the requirements, i.e. cut out a hexagon, draw as you like. In the second step, I will tell him carefully why he has to do it. It is just a pentagon or a hexagon, isn't it? In the third step, we will talk about the questions. It is recommended that I give him a question that requires this kind of knowledge.

R: The last step in the context of using pens and paper.

Huang: Except for the use of software at the first step, they have to use a pen for drawing. If they still remain puzzled after drawing, I may help them with the software.

R: OK. Will you still emphasize reasoning in the subsequent process?

Huang: After the drawing work, I may tell him the reasons. Why is an intersecting line created when parallel line method or extension line method is adopted? Can you explain it? Actually, it isn't very important. He can imagine it this way.

R: Maybe you will place greater emphasis on direct imagination of students. OK, no problem. As he still has to calculate the surface area of the circumsphere of the geometry finally, do you have the process to access surface area calculation

Huang: It is OK if you can tell its radius. For instance, when we need to calculate the surface area of a sphere, as we normally do, I directly ask about the radius of the sphere and it is done. I don't have to calculate.

R: The students basically don't encounter this problem, right?

Huang: They can do it themselves as it is only necessary to use the formula for calculation.

R: We can then go to the next question group 1-2. It is about the three views of the remaining part of a cube that is cut by a plane. The three views are actually simpler than the previous one. It seems you ask the students to do it by themselves. Then some students talked about the extent to which they could do (Figure 7). Is it about your checking the students' homework?

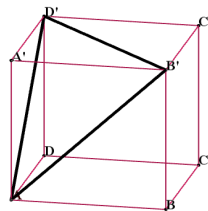


Figure 7

Huang: He has experiences on this question and he knows the full lines should be a black triangle. He will link them up but the finished graph seems to have a corner cut off. He doesn't know how to cut the remaining part. Actually, I can tell him that all the remaining is ok after one corner is cut off.

R: OK, in the beginning, can most students draw out the black triangle?

Huang: Those lines can be drawn out basically.

R: But they don't seem to be very much sure about the sequent ...

Huang: They feel hesitant to cut the subsequent corners. OK.

R: How did you realize it? Did you ask some questions? Or ...

Huang: Just drew three lines but no conclusion was made in a long time; he knew he hesitated.

R: Actually, they didn't make it. No calculation, right?

Huang: The drawing was almost finished. But I felt the answer wasn't available.

R: I see. The display of GGB model is similar to those above?

Huang: Yes, like this (Figure 8 ~ 11)

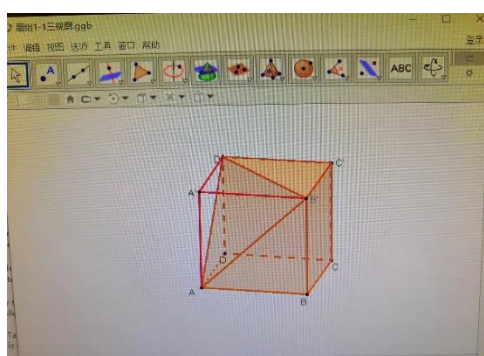


Figure 8

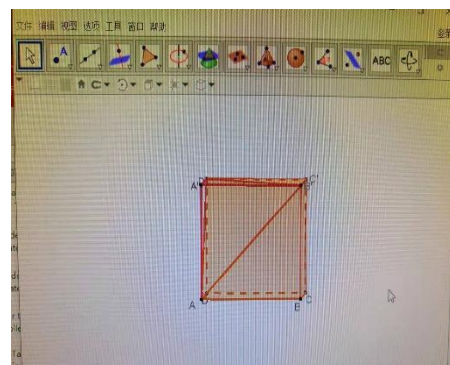


Figure 9

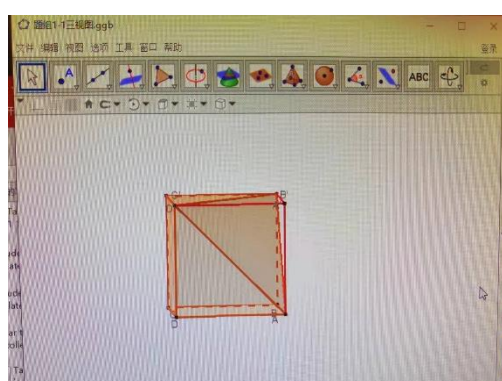


Figure 10

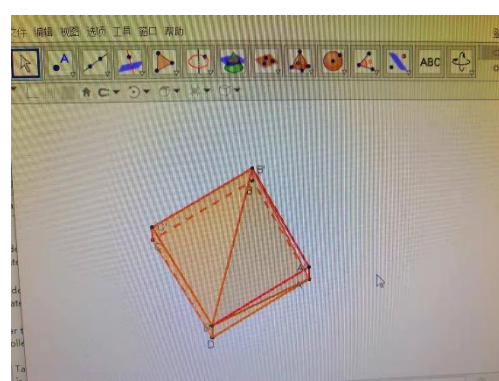


Figure 11

R: How did you talk about the subsequent calculations? Did you go through them quickly in a simple way?

Huang: It can be simply proven to be just a cube with one cut corner, or a rectangular pyramid.

R: OK.

Huang: It is very easy to calculate the remaining part. They can deal with it.

R: OK. Then we can go to Group T 2-1 which is a cube with a sphere inside. Then make a section across the sphere centre and what is the possible shape of the section. Actually, I asked the students how they would choose in the beginning and they told me their choices. Actually, I don't understand it clearly. It doesn't seem to display their choices clearly. Which one do you think the students have chosen?

Huang: All of 2, 3 and 4 are chosen by somebody. Basically each graph is selected when they are working on the question. Some people chose all the options as they took them to be possible. Some people asked why 2 and 3 were the same. But 2 and 3 are different.

R: Were they different previously? One doesn't have its apex on the spherical surface and the other has its apex on the spherical surface, right?

Huang: Exactly.

R: There are some minor distances. Yes.

Huang: So, it is actually ...It is very hard to make a judgment. It is very hard to imagine why it is like this. In particular, some students wondered why there was a square inside a circle, as shown in Graph 1. He thinks it seems to be tangent. All points of a square should be linked to the circle.

R: I noticed you wrote the students' understanding below. In the beginning, all options were chosen. Is it a question to be answered collectively?

Huang: During a class I normally directly asked them which one they would choose and got diversified replies. They would say their replies and there wasn't restriction. Anyone could express his opinions directly and freely.

R: As you can see, some students may wonder why the square isn't on the section. Is it directly mentioned by them?

Huang: Not all of them. As a matter of fact, some may be reluctant to express their ideas directly. I will ask them directly why they didn't choose it. They are expected to give their reasons.

R: OK. But I noticed you displayed the model before you asked them for the reasons in some public courses.

Huang: I asked directly like this during a public course. For instance, some people didn't choose 1 and we would check the answers after full explanation. Which one shall we choose then?

After choosing, I asked him why he chose 1 and he would explain the reasons. As he believed, it seemed to be the apex and on the sphere when the cube was cut through horizontally. I opened GGB software and asked him to check it out (Figure 12 ~ 13).

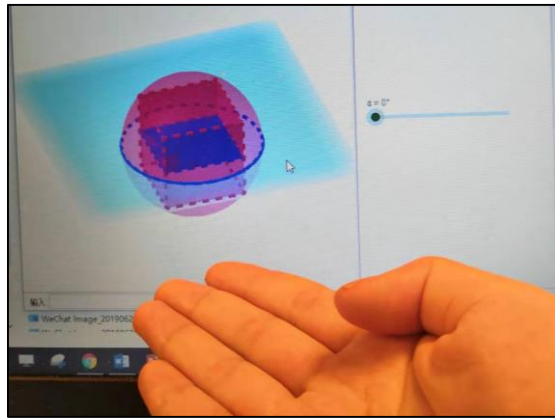


Figure 12

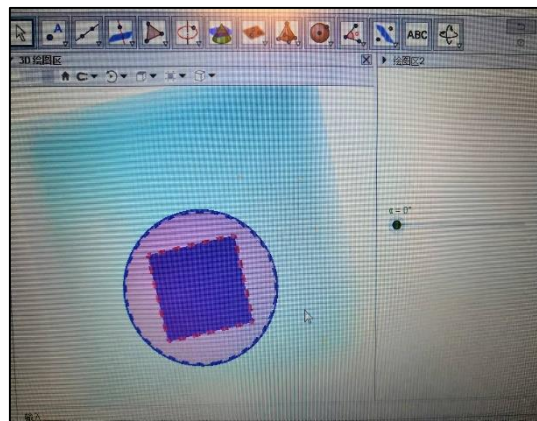


Figure 13

He understood that it wasn't unnecessary and so 1 was not chosen. Look at 2 then and why does rectangle reach there? How did he get the result? He failed to explain it. And then I opened GGB software and showed him (Figure 14). He got it immediately and we continued to 3.

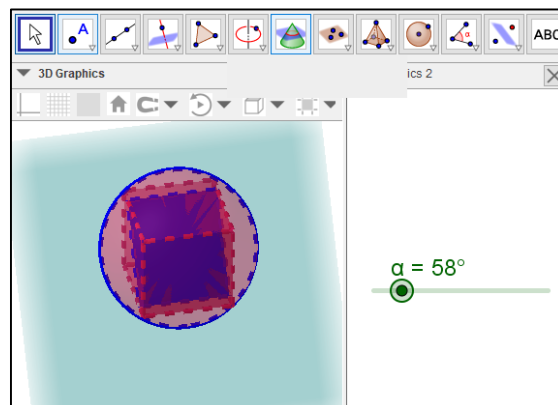


Figure 14

R: OK. Actually, it is because you chose only one here. Why didn't you choose 1? Some students believe it will certainly touch the apex of the cube and its spherical surface will be on the surface of the section circle. Then you displayed 2, 3 and 4. Specifically, couldn't they explain the reasons to choose 2 and 3?

Huang: Most people got it wrong easily. 4 will certainly be chosen. Some people will choose either 2 or 3 normally because he isn't sure about them. Most people will miss either 2 or 3.

R: What is their reason not to choose 2?

Huang: He believes it already reaches the apex for 3 but doesn't consider the conditions of 2.

R: This question about the possibility for them to reach the apex is OK. You actually displayed them directly.

Huang: It is impossible to explain section to them. I have no choice but to show this to them directly.

R: What do you think this question is expected to test?

Huang: The ability of spatial imagination

R: The next one is 2-2 and it is this sphere. There is an inscribed sphere inside the cube. Then use a triangle to cut through it and then calculate the area of the section created by plane ACD'. It seems the students can understand that the section created by an intersecting plane is actually the circle of a triangle.

Huang: It isn't sure that all students have got it.

R: I noticed you wrote some students had answered this way.

Huang: I will normally ask them why they thought the inscribed sphere had no problem. Everybody knows it is a circle. Why is it an inscribed circle of a triangle? They may have to answer it. Normally, many students would ask it if this question is adopted for the exercise. They don't know the reason. They may just ask why. It is necessary to explain it clearly to them that three points are on the triangle and the sphere. One circle can be established if the three midpoints of a triangle are all located at the endpoints. This circle is certainly of a triangle.

R: I have a question. In the beginning, we have to come back to the section circle which seems to be an inscribed circle of ACD'. Are you sure of this conclusion or is it just a guess in the beginning?

Huang: Some students feel troubled with it. Why is the circle made of three points the inscribed circle? If I talk too much about it to prove it, the goal of the class won't be achieved. I don't have to talk about it. The circle of the three points is exactly his circle. I

will take them as having understood it and directly skip it. If someone feels puzzled, I will help him work it out after class. We won't stop there. But I will stop and explain it to him if he feels a little puzzled. Why can't he work out the essential question of inscribed circle after three years of study? We have two classes. The silent one won't inquire about the questions like this. I will explain directly. Some people are fairly imaginative and will tell me directly. I will avail this opportunity and ask him to explain it. In general, students know that a cube's sections are squares or rectangles, a sphere's sections are all circles, but I will ask a little bit more, making them pay attention to the critical points and sides in the sections and leaving them a deeper impression.

R: Deeper impression, OK. The section circle will certainly pass the center of a few side planes. Is it the answer of any student?

Huang: It is certainly their answer. But sometimes they certainly can't explain it. I have to guide them a little bit.

R: Yes, I just feel they don't know the answer without my guide.

R: How will you display GGB? What are your perspectives?

Huang: The direction in which the 3D dynamic model is presented is firstly consistent with the drawing in the task. Taking that as a starting point, I will turn it for a round, and that would be enough for students to imagine the spatial structures.

R: Will you project it to the vertical projection angle of a triangle? It will be clear this way.

Huang: I didn't do it then. I just dragged it by one circle because this question wasn't time-consuming.

R: OK. There is one section alpha later and a question featuring the same angle with the various edges of a cube. You were requested to write about it in June and it seems to involve a complicated process. There seems to be something for many students alike and is it a collective reply from them? Or is it a question you asked then?

Huang: Er, it possibly needs to be asked. I didn't explain it very well then, I didn't explain it very clearly, particularly that the angle between each edge and the plan was the same.

R: But I think it is very interesting. I remember you said a few rounds of changes were made to the public course itself during our conversation in June.

Huang: Before the public course, one of our colleagues said to me that it wasn't a good idea for me to prove the same angle by making a simple turn. He recommended using a box of chalks to make a turn. I used a box of chalks when I was explaining it again later. I put two boxes at the opposite corners and made a turn like this. They got it right away.

R: How do you make a turn like this? I can't imagine it.

Huang: Just make the cubic chalk box stand up on a table and imagine it turning like a top. They understand it right away because you will find that the angle of each edge to the bottom edge is the same. This is exactly what GGB model is expected to show then.

R: Yes, I think it is the same by nature.

Huang: Yes, but the students still don't understand it actually even after my explanation. But he doesn't dare because a lot of them...

R: They don't dare...

Huang: They look puzzled for most of the time. There is no way out. It is always better to show with a real object.

R: OK. I thought they would think about it purely then. Just pick out one equilateral triangle, e.g. a triangle like ededb. Then look for all those parallel to it. With turning, the students will better realize where a plane α should be located. It is not recommended to tell them deb and equal angles in the beginning, or the angles are the same for all the parallel planes, as if there is one important constituent.

Huang: Yes. Actually his reference answer is a plane. Yes.

R: But the students won't have a direction to work it out if you don't tell them and they may not be able to guess a plane or the like.

Huang: It is hard for them to guess it without any previous experience.

R: According to my understanding, if it keeps turning this way, I may feel a cube is symmetric around its diagonal. So the planes vertical to the diagonal can overlap each other in case of turning like this. In case of completely identical triangles, it is easier to get this angle. I mean the triangles can overlap each other by way of turning and the corresponding angle is actually the angle with the plane. I just feel the angle between the edge and the section is very smooth.

Huang: I went through it quickly then. It may take more than 20 to 30 minutes to work out this question if you get stuck on specific points.

R: I feel really curious about your control of time. How do you determine the time to spend on a single question and what are your considerations?

Huang: This one is a college entrance exam question. It is already Question 12. Not all people can work it out. We won't have too much time on such a difficult question during the review at senior grade 3. Basically, all the students work together to solve this question, basically within 5 to 6 minutes. Most students work it out through guessing during college entrance exam actually.

R: If you don't expect to spend too much time on this question, can you replace the inference part with something directly understandable?

Huang: I also think it is one goal to be attained. Don't spend too much time on small things and each detail.

R: OK. Let's go through it sentence by sentence. I still have something to confirm. In the beginning, you said one difficult point of this question was how to find that the angles

between plane α and the various edges of the cube? Er, then one student asked if it is plane EDB, didn't he? OK. Actually, he wasn't very sure about it.

Huang: Actually, he was suspicious about it. He possibly had some experiences and the wall corner was the right one. The first regular triangular pyramid.

R: He said he had talked about it.

Huang: It is like a regular rectangular pyramid. The angles between its side edges and the bottom surface are the same. Possibly have mentioned and known it a little bit.

R: Did he specify the reasons?

Huang: He just looked like it.

R: Did he talk about the symmetry of a cube?

Huang: Actually, he didn't talk about symmetry. He said it was kind of feeling. I said to him directly and it was actually related to symmetry.

R: It seems that it was turned along diagonal AG. Did you start to display GGB then?

Huang: I tell him first and then make a turn. Tell him, right? Just imagine this process and they are confused and have no idea what I am talking about. Then I show GGB model to them and make a turn like this. They will know how to make a turn after that but many still can't understand what I am trying to say, why it is turned like this and the reasons with the angle. Many people are still puzzled.

R: I have to supplement your operations here. Do you show the diagonal first and then the screenshot and then make a turn? Is this the process?

Huang: I did it this way, step by step then, because I was also making drawings in sequence when this model was used then.

R: Allow them to see the process of graphing, right? The display process of Ooo.

Huang: It was displayed later, Okay.

R: Do you have some gestures then? Will you turn this edge over that edge, for instance?

Huang: What happens next? Use the slider (Figure 15) and then make a turn (Figure 16). because direct turning is uncontrollable. I mean it is very hard to drag it by a point.

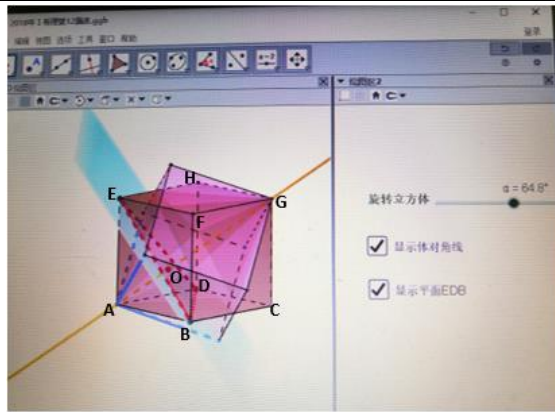


Figure 15

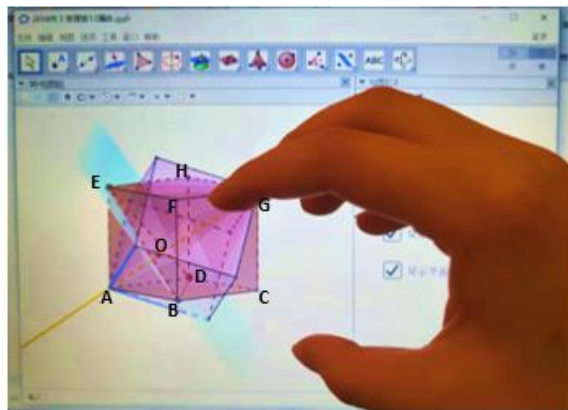


Figure 16

Yes, I use a slider instead to change the turning angle.

R: But how to guide them to make observations. You may expect them to pay attention to the green edges. Do you use color only or make some drawings on the screen with gestures?

Huang: I told them directly. Just observe how a student makes a change (Figure 17).

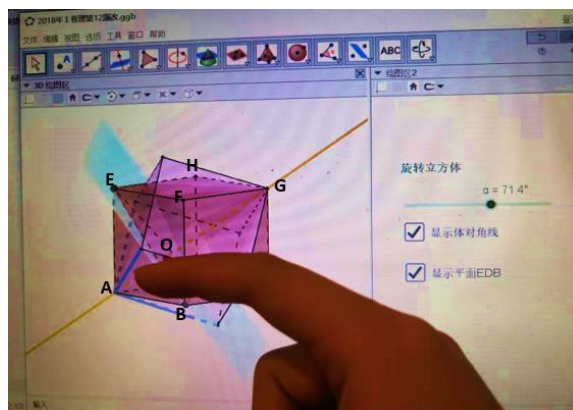


Figure 17

R: Ok, not necessarily, because I remember it is subject to computer control and then projection onto the screen, right? It isn't touch screen.

Huang: Yes, it is done with a computer.

R: Actually, you didn't make some additional gestures on the screen.

Huang: No, I pointed to it at the most. The screen is very high because it is a very big meeting room. I can't reach it basically.

R: I see, actually I wonder if the students will feel more puzzled and clearer if you display the apex of the square and the blue part in the middle, the triangle.

Huang: I didn't talk about it.

R: Then give a try

Huang: I talked very quickly.

R: OK, then you will talk about a few edges, e.g. edge AE, which may be rotated to the position of edge AB and then AB may be rotated to the position of AD. The green edges become overlapped after rotation. How to guide the students to understand it is only necessary to turn the green edges by 180 degrees instead of 360 degrees to resume the original position of the square. What is that?

Huang: I said the three green edges were false. But I think such an expression was problematic. I told him that the green edge might be turned by an angle to return to the position of the next edge, I mean the adjacent green edge. It can come back to the original position by a 360-degree rotation. But it doesn't need to be rotated by 360 degrees actually.

Huang: It can come back to that position through a turn of 120 degrees.

R: The student probably realized it wasn't necessary to turn by 360 degrees. Is this their answer or your idea?

Huang: They certainly can't have such a deep understanding. OK, if asked how many degrees will it be rotated, he will probably say 360 degrees. I told him to think about it and that I would choose 120 instead of 360 (Figure 18). But I didn't tell him why I would choose 120. I don't have to explain. We have three edges. It is 120 if it is divided by 3.

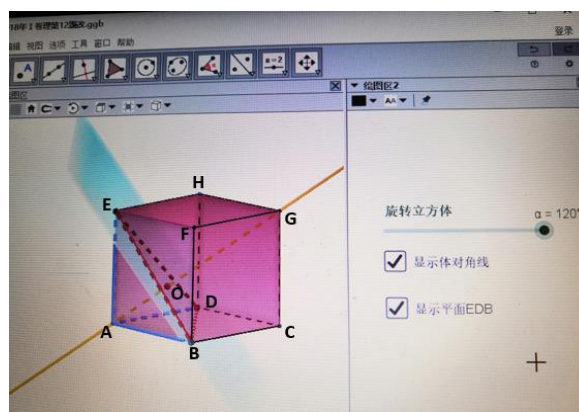


Figure 18

R: So actually here you didn't explain why it is 120?

Huang: No.

R: Then you further said it was a regular triangular pyramid later.

Huang: I mentioned it then because the wall corner was known but this wall corner was a triangular pyramid and it seems not everyone knew it. This question was kind of a dispute actually then.

R: Actually, if it is a regular triangular pyramid, it can be inferred that the angles are the same. I don't think it is highly related to rotation.

Huang: I think so. If he realizes it is a regular triangular pyramid, he can also understand it is equal to the angle of a triangle.

R: It maybe a little abstract. OK.

Huang: Yes, it is.

R: OK, you later talked about regular triangular pyramid and asked them to realize its nature.

Huang: I talked about it a little bit. Actually, they can't absorb what you said completely. I just mentioned it. Look, this wall corner seems to be a regular triangular pyramid. I turn it this way. Why is it the same angle? This is an inborn nature of a triangular pyramid. This is what I said but they just can't understand what I am talking about. So it passes quickly. If you read it in paper, you may have doubts. But it passes very quickly if it is just mentioned in class.

R: It is a very natural process.

Huang: How should it describe it? It is hard to cite an example.

R: OK, it is kind of spur-of-the-moment teaching on your part.

Huang: Yes, I suddenly come across it and talk about it but I find no response from the students. So I just ignore it. Got it?

R: OK, I see. Then you said you only considered the three green edges. Do you have to check if it is the same as the angle with other edges?

Huang: As a matter of fact, you had better explain on this question reversely. Just explain other edges are parallel to the three edges. So I may not consider other people and only consider the three edges. I talked about the three edges before others then.

R: Did the students propose turning other edges later?

Huang: Yes, some people murmured it out then. He said there were only three edges here. If I told him, how about others?

R: Is this student the one who guessed EDB previously?

Huang: No, not the same student.

R: Did you ask the question in public or privately? Isn't it a specific question?

Huang: Not a specific student. Other students will be distracted if so. It is preferred that all students raise their queries and all are expected to contribute their questions.

R: Did you pick out any specific students to answer the questions? No?

Huang: Basically, they answered the questions together because it was quick.

R: OK, did you notice which students kept asking questions, or if just a single student kept asking the question?

Huang: Particularly some hard questions. The students didn't have the same questions. Their questions were different. Some questions were highly different from each other actually. The students won't ask highly logic and consistent questions. They asked whatever they might think of or might follow up on the previous question asked by others.

R: OK, then they mentioned the multitude of plane alpha. I noticed they talked about parallel planes under your guidance. Could they think of it in that case?

Huang: Yes, they thought of it themselves. I just asked if there was any other triangle. They then mentioned parallelism.

R: It seems you guided them to move in a specific direction. They didn't seem to have a problem in movement.

Huang: I believe so.

R: They know running vertical to AG is okay.

Huang: I introduced if there was an equilateral triangle with the cube, it would conform to the internal angle. I used to introduce it and they knew it well.

R: OK, then it is the second phase, or actually something about the section. How does it area change during the cutting process? Did you ask the students to imagine first here?

Huang: I directly showed them the model. I asked them to make a guess in the beginning and some people got the right answer. Then I praised him. I directly showed the model to them.

R: It was firstly one point and then a triangle and finally back to the triangle. Didn't they make the right guess actually?

Huang: They couldn't figure out the right shape. But they knew it once you explained on it or displayed the model because it was very clear. It turned from a triangle slowly into a hexagon and then back to a triangle (Figure 19). So it is the biggest in the middle and he can draw a conclusion right away.

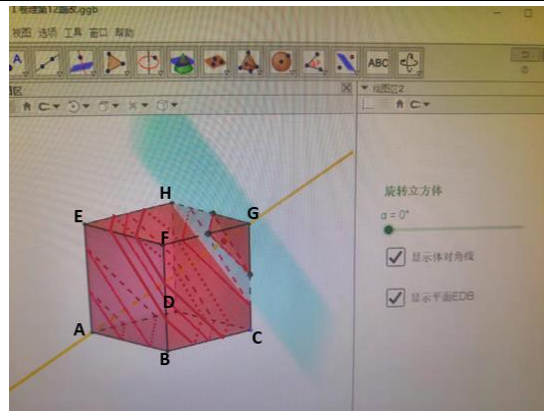


Figure 19

R: OK, did you directly describe its shape and area during your display in the beginning?

Huang: Yes, I displayed directly and then

R: Explaining as you displayed?

Huang: Then some people started to murmur and talk about it.

R: Did you stop on specific graphs? Hexagon or triangles.

Huang: I didn't stop on hexagon. I kept sliding up and down to remind them.

R: How did you remind them here?

Huang: The blue plane could move and when it moved to the regular hexagon, I slow down and drag it up and down (Figure 20). Then they realized it was an important part.

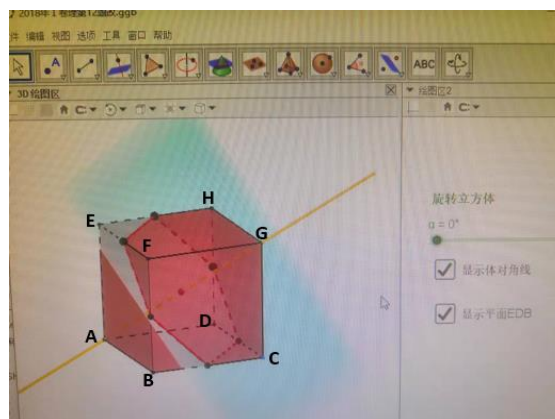


Figure 20

R: What did you say in this process? Did you ask any guiding questions?

Huang: Just moving the graph is enough and they would answer it. Just check the rules and it is the biggest in the middle. No need to explain too much about it.

R: I remember you previous mentioned that it was necessary to emphasize their shape changed symmetrically.

Huang: Yes, you have to.

R: Did you mention it specifically?

Huang: Didn't you move it this way? Moving from the bottommost triangle to the middle into a regular hexagon and further upward into a triangle. This process is a symmetric process. You don't have to explain more. Just make two changes along the diagonal between two zero points.

R: Actually, you didn't talk about its shape specifically because I thought you would still guide them to pay attention to the symmetry of shape.

Huang: Yes, I will certainly talk about it.

R: Yes, I wonder what you said then.

Huang: Yes, I must tell them why it is the endpoint, a little down or up, because it is a symmetric graph, turning from a triangle into a regular hexagon and then another triangle. It is a process of symmetric changes.

R: OK.

R: Did the students guess what it would become in the middle during your movement?

Huang: Yes, they were involved in this process.

R: They were actually very sure about it and didn't query much.

Huang: Then I had to ask them the question, why didn't they think it was the biggest in the middle? They said why did you consider the middle to be the biggest?

R: Did they know the reason?

Huang: They certainly weren't very sure about it because they didn't think about it carefully. They just told me their ideas but couldn't explain it. Then I followed and explained to them directly.

R: And then you turn to the blackboard to calculate the area of the hexagon, how to you explain that exactly.

Huang: I just make a drawing like this (Figure 21), and then you can see that the side of the hexagon is just a hypogenous of a right isosceles triangle (Figure 22), and then you can calculate its length very quickly.

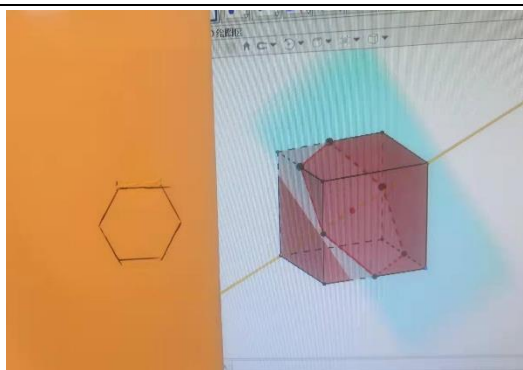


Figure 21

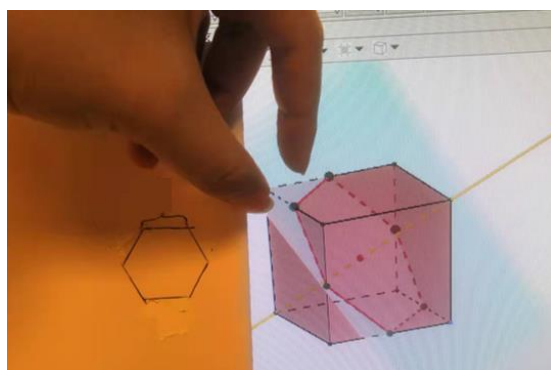


Figure 22

R: I see, OK. In this question, what ability of the students do you think is tested?

Huang: I gave them a dynamic geometry question later. It is actually not expected to test the students' calculating ability in a strict sense. It works to test the students' ability of spatial imagination.

R: Is there any analysis of graphs?

Huang: Yes, of course, because they certainly considered parallelism in this process. They certainly considered some parallel angles below. But I believe students mostly rely on their direct imagination while working on a question. It is impossible that they could explain it like a Huang: in a stringent way. It is impossible to test such an ability of the students. I don't think the question designer bears such an intent in mind. It is expected to test if you can flexibly work it out with some simple skills instead of explaining it clearly like a mathematician. As a minor question, it is expected to test your ability to get the answer correctly and rapidly and it works to test your flexibility. Your stringency is normally tested in a major question.

R: Does flexibility refer to selection of strategies?

Huang: It refers to your ability to guess the right answer of a hard question.

R: I see. OK. That is the end of our interview.

3.5 Hand out for the lesson in H.II

2020 届高三数学立体几何导学案

高考立体几何学案——点面距

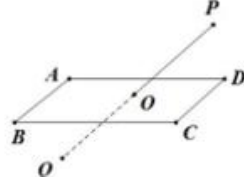
一. 方法总结

方法一: 【直接法】由所求点出发直接找已知面的垂线, 垂足, 如右图

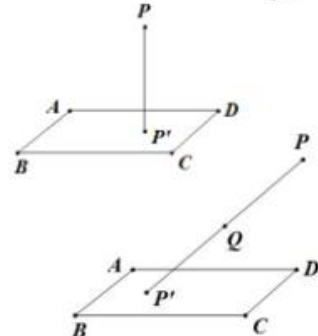
方法二: 【转移法】通过平行线或者平面转移点, 实现巧妙求解



若 $PP' \perp$ 平面 $ABCD$, 则 PP' 上任意一点到平面 $ABCD$ 的距离相等



若 $PO = QO$, 则 P, Q 到平面 $ABCD$ 的距离相等



若 Q 为 PP' 的中点, 则 P 到平面 $ABCD$ 的距离为 Q 到平面 $ABCD$ 的距离的两倍

方法三: 【等体积法】通过三棱锥体积公式转化计算

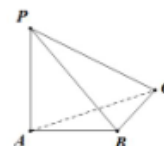
二. 常见模型 以下图形均由棱长为 2 的正方体切割而成

图形				
问题	B 到平面 ACC_1A_1 的距离为 _____	A 到平面 A_1BC 的距离为 _____	A 到平面 A_1DC 的距离为 _____	P 到平面 $ABCD$ 的距离为 _____
射影	_____ 中, B 在平面 ACC_1A_1 的射影在 _____	_____ 中, A 在平面 A_1BC 的射影在 _____	_____ 中, A 在平面 A_1DC 的射影在 _____	正四棱锥 $P-ABCD$ 中, P 在平面 $ABCD$ 的射影在 _____
图形				
问题	D 到平面 ACD_1 的距离为 _____	P 到平面 ADC 的距离为 _____	B_1 到平面 ACD 的距离为 _____	三棱锥 $P-ACD$, 若 P 到 $\angle ADC$ 两边 DA, DC 的距离相等, 则 P 在平面 ACD 的射影落在 _____
射影	_____ 中, D 在平面 ACD_1 的射影为 _____ 正三棱锥的顶点在底面的射影落在 _____	三棱锥 $P-ADC$, $\angle ADC = 90^\circ$, $PA = PC = PD$, 则 P 在平面 ADC 上的射影落在 _____	三棱锥 B_1-ACD , 若 $\angle B_1DA = \angle B_1DC$, 则 B_1 在平面 ACD 的射影落在 _____	

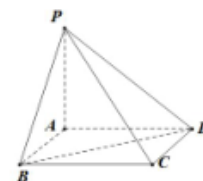
三. 实战演练

1. 已知正棱锥 $P-ABC$ 的底面边长为 1, 侧棱长为 2, 求顶点 P 到底面 ABC 的距离

2. 如图, 三棱锥 $P-ABC$ 中, $PA \perp$ 平面 ABC , $AB \perp BC$, $PA=2, AB=3, BC=3$, 求点 A 到平面 PBC 的距离



3. 如图, 四棱锥 $P-ABCD$ 中, 底面 $ABCD$ 为矩形, $PA \perp$ 平面 $ABCD$, $PA=1, AD=\sqrt{3}, AB=1$, 求 A 到平面 PBC 的距离



4. 已知 $\angle ACB = 90^\circ$, P 为平面 ABC 外一点, $PC=2$, 点 P 到 $\angle ACB$ 两边 AC, BC 的距离均为 $\sqrt{3}$, 那么点 P 到平面 ABC 的距离为 _____

3.6 Transcript of general interview before the lesson in H.II

The third interview with Huang was made in the evening of 6th November 2019, concerning the lesson that He would give in a real ordinary classroom the next day. The topic of the lesson is “point-plane distance” and the handout used in this lesson is already presented in section 3.6. The topic belongs to the content of grade 10 but here it was reviewed in the lesson of grade 12. The interview was conducted via WeChat (a Chinese instant communication software) and it lasted 1 hour and 20 minutes.

The interview was recorded in audio format. The audio was transcribed in Chinese and then translated into English. Below presents the complete English version of the interview transcript.

R: What is this class trying to achieve?

Huang: In fact, it is a round of review, they have learned, learned we will do a summary of some methodological things, after the summary I will guide them to practice some exercises.

R: Is this for seniors? Science or Arts, your own students? Who taught them this content before, the main course or the review round?

Huang: Senior Arts, my own students, we are on here, the college entrance exam review review to the point surface distance, should be the last content of three-dimensional geometry. We were following the sequence, and then it happened to be my turn to have an open class, and then I was in

the same class with a teacher, that is, two teachers on the same topic. I was not the one who gave them the lesson.

R: What role does this lesson play in 3D geometry?

Huang: In fact, it should belong to the application, because we have finished talking about parallel and perpendicular, so the last one, the college entrance examination three-dimensional geometry big question, two questions, the first question is to prove, the second question is to calculate, that for the students of arts, the second question is basically to calculate the point surface distance, is the distance from the point to the plane. So we have a piece of liberal arts inside the three-dimensional geometry is the most troublesome part, and then the students are afraid to calculate, and then imagine the words, generally can imagine, but there are individual graphics more trouble may need a little software to assist, but in fact, it is a flash on the can.

R: or more generally, in geometry?

Huang: should also belong to a more comprehensive application, because after all, the final calculation of three-dimensional geometry is still to be translated into plane geometry, for example, you say to solve the triangle, because he finally has to study some tangent ah, or use the hook and line theorem to solve the length of the corresponding point surface distance, because the point surface distance we say to build a triangle to solve it, so as soon as you involve the triangle that is The point-surface distance is the proof of parallelism and perpendicularity in front of three-dimensional geometry, including the content of plane geometry you learned before, including the sine theorem and cosine theorem in plane geometry, which are also used in point-surface distance.

R: Will vectors be used here to ultimately calculate that distance?

Huang: Liberal Arts is not studying vectors, so they mainly use three methods, one is the direct method, for example, you directly over the point to do the plane of the vertical line, and then the vertical foot and the original point connected, then the length of this section belongs to its point surface distance. The second transfer method, some times a point to the plane distance is not easy to find, then we will be through the parallel line, or plane, the location of the point translate away, translate to a better position to find, this is also a practice, and then the third is the equal volume method, equal volume method should be the most commonly used, but it is generally appropriate for the trigonal pyramid, that is, a trigonal pyramid, I vertex I can choose one other vertex, and then the bottom surface to choose another bottom surface, then with two ways to calculate the volume of well, and then one of the bottom area is known, high unknown, the other is completely calculable volume, that two equal parts can solve the equation to h, on its high solution out.

R: So you think the main difficulty for students is the calculation?

Huang: Yes, because this is how the arts, they are afraid of calculation, calculation accuracy is very low, so we actually really class, in addition to a part of the more difficult to imagine, most of the time is also left to do their own calculations. I've been doing this for my senior year review, you give him a problem to practice, can't do it I'll go up and talk about it, and then continue to calculate, probably this way.

R: Is this the theme that you came up here and settled on?

Huang: Yes, because the class is still in a hurry, so he can't suddenly insert a different topic into it, and generally speaks about whatever open class is going on.

R: You've taken classes on this content before, right?

Huang: No, I am also the first time on this liberal arts point surface distance, the previous science, then the basic use of vector method can be handled.

R: And without using the vector method, would they easily think of the three methods you mentioned?

Huang: slightly more difficult, you say it is very difficult, it is not, they are only three months of the senior round of review, so many students do not respond to normal, but to the second round of review students do not respond, it is really a relatively weak kind.

R: What did you learn from your former experience of teaching the same topic?

Huang: Count basically, in addition to some basic models used, equal volume method inside science is there, there is this piece, but science basically after talking about equal volume method directly jumped over to use vectors, and most students like to use vectors, so we also prefer to use vector method to solve. The coordinate system ah. And then this side is really no way, because he did not learn, did not learn this vector, so I have to this most common, the traditional method of this, to solve.

R: So you're going to be a big adjustment from what you used to teach?

Huang: The adjustment must be great, after all, the content of arts and sciences are different.

R: And would you have done a lesson plan before? Before taking this kind of class.

Huang: I've been to public lectures before, unless I'm doing the larger ones, and then the smaller ones are not done, like this time more people come to listen, so I still have to prepare.

R: Have you ever taken a public class on this content before?

Huang: generally will not be repeated, has been on the he will not say again set an identical topic to you.

R: The role of this learning project in the whole lesson?

Huang: Basically, we followed this lesson plan exactly. 13:35

About the lesson implementation Which kind of representations will you use?

Huang: I still have to plan a bit, but the general plan is, first in the most common way to speak, after speaking if he still do not understand, I will then light up the model, so that the student is also beneficial, because he does not enter the college entrance examination is not something to do to assist, he can only look at the paper to think about so must first speak to him, after speaking do not understand I will then light up the model, and then I will turn off the model and then I've tried it before, directly on the model to it drew most of the day's diagram, it looks like everyone will think, wow great, after not a moment at night to assign a homework to him to do oh completely do not understand, because he on the process ah, you in the diagram when he simply did not remember, can not remember ah, you have a computer, so do to it hands-on, I made on the top you follow me to

make If you have a computer, so that he may still remember, if not then it is basically the same as speaking in vain.

R: And how exactly is that implemented without the help of GGB?

Huang: For example, if you get the 7th question, then I must draw the corresponding diagram on the blackboard, and then I have to tell them how to analyze, how to make auxiliary lines, that is, I also solve the problem without the assistance of any software to show it, and then he found that it seems a little difficult to imagine oh, the method seems to understand, but always feel that the diagram is difficult to imagine, then I will move the model to show it a look, front, top, and left view, and then I will give it a little bit of an idea, and then I will give it a little bit of an impression. Frontal, top view, and left view, all around a circle, and then he probably have an idea of this thing, head has an impression, and then I then a little comment.

R: What do you think are the advantages of GGB here?

Huang: In fact, the teaching research group of the grade expects me to use GeoGebra, in order to compare the lesson with another lesson without GeoGebra. The advantage is that those more complex graphics ah, or need to use him, so imagine up, accept it is also more acceptable, because some things, you will be with him for most of the day, some students just can not figure out, have to give an example. For example, the fourth, the fourth question, he this graph is the need to use my model kind of the 8th, the 8th model below is not a sentence, the trigonal pyramid P-ACD, if P to the angle of the distance between the two sides are equal, then the projection of P falls on the angle ADC angle bisector, I dug the empty, where is the angle bisector. But in fact, this piece of stuff, that some students it just can't figure out, this graph he can't understand, but I have this square above, model 8 of the diagram, then it is imaginable, but run to the 4th question here he can't figure it out, because here is no square at all, completely a pyramid P-ABC, so this time I have to speak after, speak when you must draw a diagram, well. After drawing the diagram, he does not understand, I then get the corresponding model, to show it, so his advantage is reflected here. That is, if you talk to it purely, it speaks most of the day is not quite understand, but I have this more intuitive, like teaching aids to show him, he probably understand. In fact, it is also to exercise their spatial imagination. Otherwise, if the arts students are always black and white, it will be more boring, or to give something new.

R: Will you write down the proof procedures?

Huang: I only need to give simple oral proof, not necessary to write them down in detail. Students have done a lot of exercises in proving these conclusions, when I introduced the theorems about perpendicularity and perpendicularity previously

And I provide them a frame of cube here. Since they are all familiar with a cube, they can easily imagine the spatial structure of the figural pattern at stake. Also they can get why the M in figural pattern ③ falls at the midpoint of A1D: because here there are many perpendicular planes, AA1D will be perpendicular to ADC. If it was in another solid, they wouldn't see the perpendicularity so quickly.

Because you like it the first method is the direct method, the direct method is needed to find the location of the projection.

R: So GGB is there to assist them in observing this stuff?

Huang: Yes to assist them to observe, and then it's best for them to build a better sense of space, his sense of these models, that is, how they change over, the sense of space to get it right.

R: Will you still be making diagrams on the board at this time?

Huang: should not draw, I directly use the PowerPoint show on the line, the PowerPoint click on my corresponding results, he can fill in the blanks to fill in.

3.7 Transcript of general interview after the lesson in H.II

The fourth interview with Huang was made in the evening of 10 November 2019, after Huang had given the lesson at stake on 7th November 2019. The interview was conducted via WeChat (a Chinese instant communication software) and it lasted 1 hour and 30 minutes.

The interview was recorded in audio format, with the teacher sharing some photos from time to time. The audio was transcribed in Chinese with the transcript being integrated with the photos shared by the teacher. Then the whole transcript was translated into English. Below presents the complete English version of the interview transcript.

R: Can you give a general description of how the lesson was conducted?

Huang: with the last time you said similar, but I expected to speak of something much less, originally expected to study the second page of all the exercises to be finished, the results were the 4th question card, that is the 16th question of this year's college entrance examination, fill in the blanks the last question, the results of that question is too difficult to do, so there spent more time. I was expecting to talk about the first three questions together, but it turned out that they did the first question and got stuck on the second one, so I talked about the first two questions first and then let them do the third one after that. Then the introduction of the model took a lot of time, and I expected to speak quickly. But the students were a little slow to respond, so it took a lot of time. Because I have 8 models, they are not familiar with the 6, 7 and 8 of the countdown, maybe they didn't talk about it in the second year of high school.

R: And where does that end up?

Huang: Just got to question 4 and dragged the class a bit.

R: Did the class proceed completely as what you planned over the time, like the coordination of different artifacts/resources, the way to present math

Huang: This is not too much change, model one, two because it will be relatively simple, I did not use GGB, but the inverted model 5, 6, 7, 8 because these are a few can use dynamic display, 5, 6, 7, 8 are triangular ACD as the same base, and then the top vertex position change can be, so this take GGB to engage on a very good.

R: Is it a case of finishing 5, jumping to GGB, and then going back to PPT?

Huang: I directly take this model out, 5 time to show everyone, and then let everyone to find the distance from D to ACD1, this distance can be found out, not afraid of, after seeking I said by the way that projection. Then when I jumped over I directly moved D1 to the P point of model 6 and moved it to the centre, so when I moved it the students knew that ah, it turns out that model is intrinsically linked, the vertex moves a little it will become the next model.

R: Could you please repeat the process of explaining task 2, 4, 5, 8 ?

Huang: Models 1, 2, and 4 can actually be left out, but look at the third model in that school project, (1, 2, and 3) which have names, model 1 is called QIANDU, model 2 is called YANGMA, model 3 is called turtle BIENAO. They are from the *Nine Chapters* (an ancient Chinese mathematics books). Usually, it will be a strength for an open class to refer to some elements related to ancient Chinese mathematics. Model 4 belongs to the regular quadrilateral pyramid, then jump from model 3 to model 5 we call the corner, so from model 3 to model 5, turtle bicep how to jump to a corner it, just move the A1 point to D1 point, so that the projection of P from model 3 to model 5. Model 6 is a pyramid with equal distance to the bottom three points, PA, PC, PD is the same length, so that the projection of P just falls on the outer center of the bottom well, over P to do the vertical line of the bottom ah, the foot just falls on the outer center of the bottom, so this is the sixth model. Then after this understand the P continue to move to B1 that position, the 7th model it is characterized by B1DC and B1DA these two angles are equal, so what good conclusion it is B1 falls on the bottom of the line, is the angle bisector of the ADC. This thing students can not understand it, then the students are still asking, can not prove ah, I said that you prove may have to prove most of the day oh. To use all equal to prove it, it is very troublesome. Then if I have to prove in detail to the end will not be able to finish.

R6: And how do you explain it?

Huang6: So I would say you remember it first, and then the proof we can prove it later, but first remember this model first. And then 7 to 8 is what it is, from B1 and then move down along B1B, in the process of moving down what is constant, that is, in the following I also wrote, P to AD with the distance to CD is equal, to that angle ADC two neighboring sides of the distance is equal, this will lead to what it is, P will also fall on the angle parallelepiped of ADC. In fact, I lay the purpose of this model 8 is to talk about the 4th question well, the 4th I said is more difficult well, it is the last question of the college entrance examination fill-in-the-blank, it will be used in the process of answering model 8 well.

Then I finished talking about these models is training, exercise 1, 2, 3, the first question we have no problem ah, because the prismatic pyramid we will seek, but the second question will be a problem, because some students can not see how to find the distance A-PBC, the vertical foot, he used the method of equal volume to seek a large part of the day. I'm not sure how to find the distance between A and PBC. This is the second question, and it's still relatively quick to get through. The second model in my model, they can still see it quickly, but they can't do the line, they don't know how to do it when they do the vertical line of PB over A. This piece also took a little time. 1, 2, 3 all took some time.

R7: For me, the key to model 2 and 3 is that one of the sides of the base to be projected is perpendicular to the side, so we can find the distance by doing the perpendicular line directly on the side. Did you emphasize this point?

Huang7: Yes, It is important to highlight that a figure fitting a figural pattern means they have the same geometric structure. That us what I have highlighted at the beginning. I say that the perpendicular made in the model is the perpendicular to the intersection of two planes. There are many perpendicular planes here, and the perpendicular to the intersection in one plane must be perpendicular to another plane. For every figural pattern represented with the drawing, I will constantly highlight how the red segments (corresponding to the point-plane distance) are made

R8: That they still can't figure out how to do the perpendicular line in the 2nd and 3rd question?

Huang8: There is a part of the students, he does not quite see out, especially the BIENAO, they are over A to do the vertical line of the PC, he is confused well. He can't see that in fact PAB and PBC are perpendicular to each other. they didn't catch the essence of the figural pattern at all. Then what I can do is to highlight the geometric structure of the figural pattern again and again, saying that it relies on the perpendicularity of two planes. So you have to find two perpendicular planes in the task figure... There are also students who use the equal volume method, but this we do recommend him, that is, if you do not have any ideas, you use the equal volume method, so some students use the equal volume method in there to do. Then the calculation is actually very large, so he calculated most of the day.

R9: Were these situations that you had anticipated?

Huang9: I didn't anticipate it. I think this is very simple, ah, the first, 2, 3 are very simple, and then maybe the fourth card, 5, 6 is relatively simple, ah I expected to talk about the seventh are finished, the result is only to talk about the fourth question.

R: So how did you cope with it?

Huang: For example, question 2, someone used the equal volume method there, it is how to look at it, you ask for the distance A-PBC, first take A as the vertex, that the volume of the whole pyramid = $1/3SPBC * DA-PBC$, and then take P as the vertex, this time the bottom area is ABC, so the volume = $1/3SABC * PA$, PA as the high, so to calculate. This is actually much slower, then we have to keep solving the triangle, that area of PBC it has to be calculated, and some of it can be calculated. I saw them use the equal volume method, and I said, "Well, haven't you gotten some inspiration from the previous model, the equal volume method is not that it doesn't work, but the calculation is slow, so I told them how you should do the line, some students A-PBC vertical line, the vertical foot it ran to the PC above, I said that if you do PC up, in fact, the essence of the thing is not caught, that is to say In fact, I want to rely on the two planes perpendicular ah, then you have to find two perpendicular plane, that is, PAB and PBC is perpendicular well, PB is the line of intersection well, so you should make the vertical line over A PB, so as to find the correct foot.

R: And what is the third question here?

Huang: The third question is also someone with equal volume method there, is the distance of A-PBC ah, he VC-PAB = VA-PBC, but C to PAB high it is wrong, originally BC is high well, they find the wrong, so even if the special pain. But liberal arts students prefer this method, is equal to

the volume method does not require how to think well, do not have to do auxiliary lines, directly grab a volume can not be put.

R: So here you also linked to the previous model?

Huang: Then I definitely need to correct, that is, this question does not need to do so, I can directly do the high A to PBC, I was how to speak, you make a vertical line over A PBC, the foot falls just on PB, why, and then what is equivalent to the high on the hypotenuse of the PAB triangle, so you can use the equal area method. The equal area method quickly finds the distance from A to PB.

R: So here again, they are guided to find the face perpendicular well? PAB and PBC are perpendicular to each other, that's why I can do this.

R: What about the 4th question?

Huang: This I was speaking two ways, "In my previous classes I made drawings directly on the board. Tasks 1, 2, and 3 are relatively simple and the students could imagine the figures, but in Task 4 they had trouble in understanding the figure even I gave the drawing. Then I thought I might be better to show the figure in GeoGebra...Students would also be more interested if you display the animation in GeoGebra. Otherwise they will always face the content in black and white, for students of humanities it's very boring.

R: Will it be pulled to model 8 again?

Huang: Here they know it's model 8, because it's obvious that the distance from P to AC and BC is model 3, and they've been reminded that it's model 8, and they've reacted to it. How to make a line, do it. The real practice, have you seen the image? The GeoGebra file, when I open it, the first view is a dynamic model like this (Figure 1), and I have to turn it around so they know the figure is just like this. Here they quickly realize that the summit falls at the angle bisector in the base, but how to apply this conclusion in the following process, it is still a big difficulty and we have to explain to students clearly. As you can see, I give each element a Chinese label, and evoke them step by step in GeoGebra, the perpendicular (Figure 2), the foot of perpendicular (Figure 3), the angle bisector (Figure 4),.

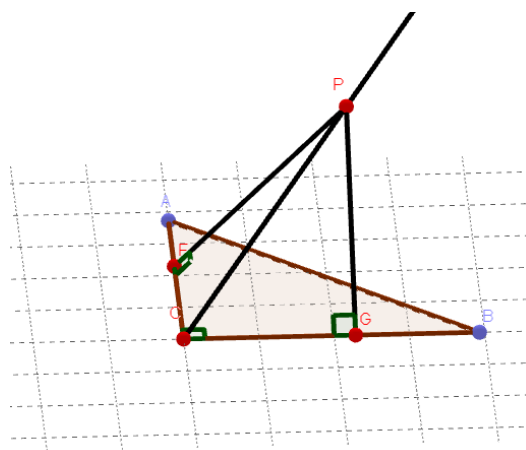


Figure 1

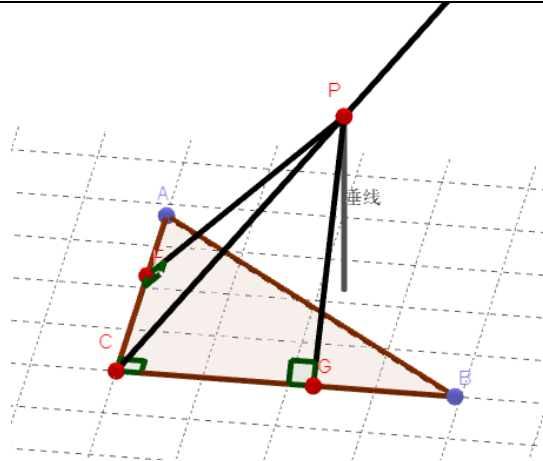


Figure 2

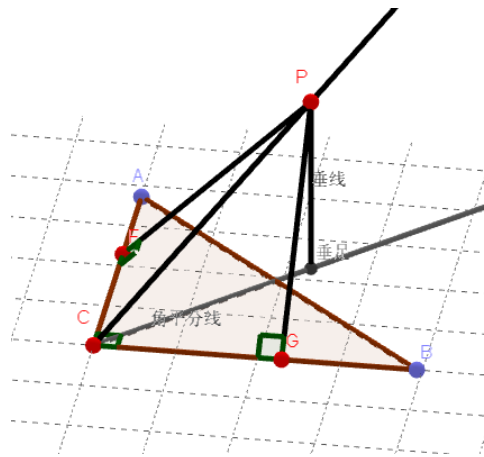


Figure 3

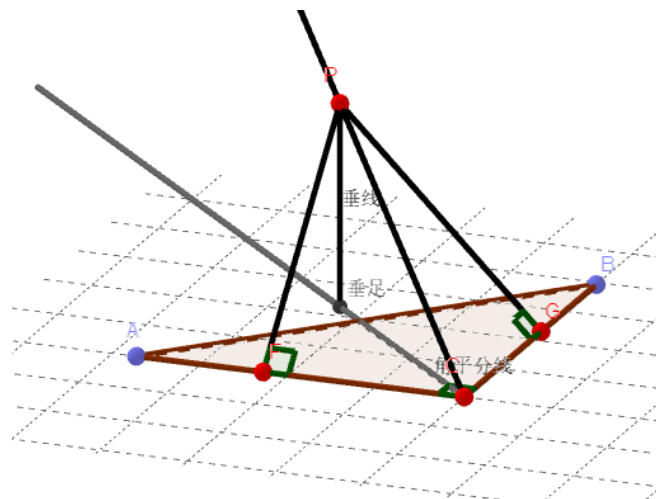


Figure 4

I can also add annotations to the dynamic model with the pen in the intelligent whiteboard. Then how to calculate the distance?

First PCG is a right triangle. Because the topic has said $PC = 2$, $PG = \sqrt{3}$, so I instantly get $CG = 1$, and then because it is the angle bisector, angle GC foot = 45° , then CG foot this triangle is

isosceles triangle, so G to the foot of the distance, that is, I newly connected the black line, G to the foot of the distance should be equal to 1, and then you look at the triangle PG foot, $PG = \sqrt{3}$ Then you look at the triangle PG foot, $PG = 1$, $G \text{ foot} = 1$, then the length of my vertical line segment should be $\sqrt{2}$ Then my vertical segment length should be 1. So the use of GGB graphing is also faster, so you do not have to draw the graph in black and white, in fact, this graph you use chalk to draw, it can not be difficult to draw, but at least for students they still need to think half a day. Especially for liberal arts students, it takes them longer to think.

Especially liberal arts students he thought longer.

R: And did you go back to topics 5, 6, and 7 in that afternoon session?

Huang: I also ran out of time when I talked about this question. The next three questions the next day I spent a class time to finish them all, because the second class I mainly have to catch the big questions, big questions to catch the volume method format so it took a long time.

R: Are those behind useful GGB?

Huang: No more, originally I was doing GGB model, but then mainly, because the big question is mainly write well, write that process of equal volume method, what steps to pay attention to, mainly write these, so I did not use the model again.

R: 5, 6, and 7 all use the equal volume method?

Huang: 5 words is definitely equal volume method, this is the corner well.

R: What did the students' reactions tell you about yourself?

Huang: Maybe they will understand a little bit better. In fact, I may be a little more entrenched in the science side of thinking, that is, I think some things are very obvious, but they just can not accept, think hey this thing you have to prove with me, you do not prove a little I will not accept, for example, the angle bisector, there are indeed many students there to say, is why ah, I said you entangled why, put this conclusion down on OK, and then we The solution will be very easy. He just thought, "No, you have to tell me, otherwise I won't accept it. So I said, sometimes the GGB model is very good, you do not have to prove, you see, I moved out you see the top view is not, oh is overlapping, and then he accepted. Otherwise you will have to give it again verbose, ah this is very time-consuming.

R: That GGB model presentation would make their need for proof a little weaker?

Huang: Yes, in fact, there is no need to be too strict to prove some things, or solve the problem is very tired, everything is very strict in the derivation, originally small questions we say to do small well, choose to fill in the blanks is to be fast, to quickly solve the correct answer can be, do not need to be very strict in the evidence there, if each one is like doing big questions, that is not enough, two hours Where enough.

R10: And then back to the model part, it is the case that there are vertices out of the three sides perpendicular to each other, so I may prefer to use the equal volume method, this is not quite the same as 4 and 6, but when you are dealing with model 456 will they all as a similar case to promote over?

Huang10: The 5th model, I actually thought of it this way, the first one is to say the corner of the

wall, because the corner of the wall is very obvious, you can use the equal volume method to find out the height. But from another angle, it is a square trigon with D as the vertex and ACD1 is an equilateral triangle. So I didn't bother to draw another diagram, because model 4 is a square quadrilateral, and then I had to make a square trigon, so I put model 5 into it. In fact, it is better to distinguish it from the corner, that is to say, another drawing of a trigonal pyramid, but in fact, you can cut a trigonal pyramid from the square, there is no other place to cut out except the corner. So this is also a bit of a tangle.

R11: In the conclusion of model 5, you said that the D projection is in the center of the triangle ACD1, why don't you just say that it is the center of ACD1, in analogy with model 4?

Huang11: Well, a triangle has 4 centers, and it is really more appropriate to say the center of the wall. If I am not a square, that is to say DD1 I take 4, then it is not the center of gravity. But it must be in the center of gravity, this can be proved, this we have proved when we talk about the vertical proof. But I didn't prove the center of gravity in class, they all know that. If you really want to prove it, you have to prove that AM is perpendicular to CD1, how to prove it, you have to prove it with the help of line perpendicular, CD1 is perpendicular to AMD. CD1 will be perpendicular to the AMD plane, so naturally CD1 will be perpendicular to AM.

R: That projection falls on the center of the bottom surface is also previously spoken of? Yang Ma, turtle biceps it.

Huang: Hey, yes, for example, model 6, which has been talked about before. As for Yang Ma, turtle biceps, this is why I chose the square, I chose the square they immediately saw it, quickly see why the M point in model 1 falls at the end of AC it is because it is a square, so there is a face perpendicular in the face, ABC will be perpendicular to ACC1A1, so if with the help of other may also be a little more trouble, then I use the square he quickly see it .

R: And then after models 7 and 8, their conditions could have been very similar, but in model 7 you emphasized equal angles, and in model 8 you emphasized equal distances, why?

Huang: I actually thought about this at that time, whether model 7 and model 8 could be combined, but in fact, it was not particularly suitable. The best idea for model 7 was that B1 should not be fixed and put it on the diagonal of that face of BID to move, in fact, they all met, they all satisfied the angle $B1DA = \text{angle } B1DC$, so I had to get the GGB model out of him, so that the upper vertex B1 was put on that diagonal and let it look, in fact, in the process of this movement are in line with that conclusion that the title says.

R: I observed in your second part, the top question is a particularized example, and the following projection points to a generalized proposition, how do you guide this process from individual to general?

Huang: Actually the figural patterns 7 and 8, this is something that was in the old textbook, but it's just not in the new textbook that we're studying now. So now the 3D geometry question, question 4, it is in this year's college entrance examination, but the figure is related to the figural pattern 8, which appeared in the textbook a decade ago but has been deleted in current textbooks, and the designer of GAOKAO examination take them out again, if students know some conclusions, they will solve the task more efficiently, otherwise it will be very tough for them. So this conclusion is not to say that I inducted myself, in fact, is also the old textbook of some theorems to do a supplement. Here I want them to see clearly how to make the line, like here, many students wrote

that the orthogonal projection falls at the midpoint of AC. It's not so precise, what if it is in a cuboid with the length, width and height of 1, 2, 3, it will no longer be the midpoint of AC, but the red segment is always perpendicular to AC, the intersection.

R: Here models 7 and 8, we know that the vertical foot will fall on the angle bisector, but which point it falls on is important?

Huang: Hey this does not care which point it falls on, because it is a previous GCE question, there are similar, just need to know that there is this vertical foot on the line. I've done a GGB before and posted it in the Tencent classroom at the time. I can show you another GCE question that is very similar, it doesn't care where the top vertex falls, it just cares that it falls on the angle bisector, and then it's related to an external ball, and that's a very good question. We will also take it out as a homework assignment, a test, and give it to people to do. Of course this piece of stuff doesn't require them to know how to prove it, like model 7-8, students only need to get a right answer quickly; it's not necessary nor to conduct a rigorous deductive reasoning for every task, that's really tough, and not possible in two hours...just apply the conclusion directly, then they can solve the task easily.

R: What about the students' acceptance here?

Huang: They accept it a little bit harder, there is not a very strict proof said to him, and then there is no a systematic training, directly to some of the more difficult topics out, it is actually more painful to learn. But the purpose of the 4th question is not 100% of the students understand, I only ask the front 20% of students can listen to understand, on the purpose of. Because those students with poor foundation really can not do this question, after all, you fill in the blanks of 16, multiple-choice questions of 12, are the kind of more differentiated topics, he is for those top students to do, so the back of the students can not understand it is normal.

R: What about models 2-6?

Huang: 2-6 is definitely to master, the 2nd, 3 those people will not that I must be serious about ah, and have to spend some time seriously figure out.

R: Here's how GGB was used, from getting the conclusion to the final proof.

Huang: I used it from 5, 6, 7, 8 in the transformation of how to change to this model I gave it a look, the specific proof I was not to expand in detail.

R: For example, model 7, angle $B1DC = \text{angle } B1DA$, it may not be so from the drawing...

Huang: This will not be, it is square, so I am easy to show that the two triangles $B1DC$ and $B1DA$ are congruent. As you can see, students cannot accept a conclusion if you don't prove it. Then the model in GGB is very utile, I display the animation and adjust to the overhead view. They see $B1D$ actually coincides with the angle bisector in the base. The they accept the conclusion quickly. Otherwise I would have to develop a long proof. That's quite time-costing.

R: So you were the one who guided this process?

Huang: Yes, I actually spent 15-20 minutes there, just this common model.

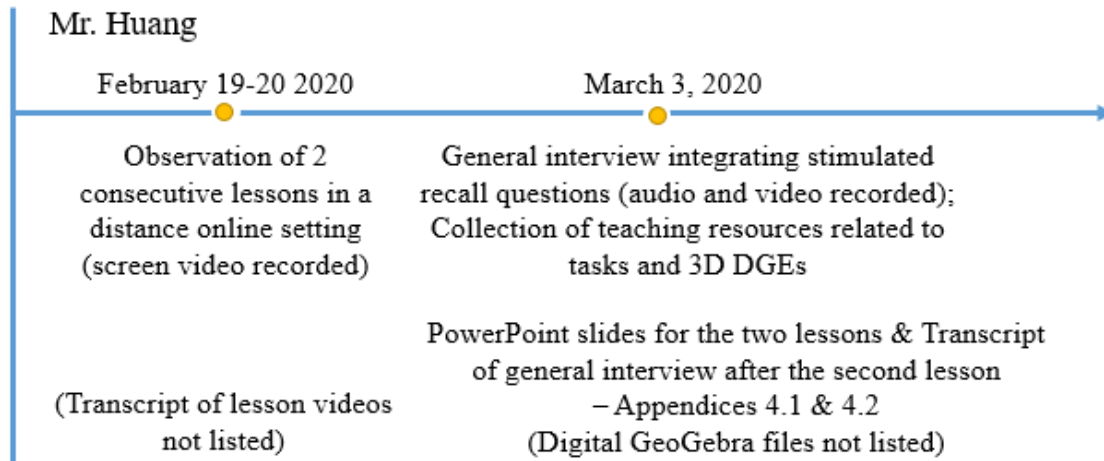
R: Were you in a hurry?

Huang: I was in a hurry. Because I still have a lot of content behind, but there is no way, can not speak fast ah, because the student response is particularly slow, and still have to leave time for him

to do, so then I was thinking I should have known the night before to set them 1, 2, 3 practice to speak about, I will only comment on the same class. This can be done by letting them do it at night, and I will only be responsible for speaking the next day, not leaving time for them to do the exercises, all of which is equivalent to the exercise class, which will save time.

4. Data of Huang, lesson series H.III (2 lessons)

App-Fig. 8 presents how the data in appendices 5.1 and 5.2 (which will be presented below) are situated in the lesson series of Huang.



App-Fig. 8 Data about Lesson Series H.III

4.1 PowerPoint slides for the two lessons in H.III

专题一：立体几何模型化

- 1、准备好二轮资料《专题透析》+笔记本
- 2、今天开始复习立体几何：一周时间六个专题
 - ①模型化；②三视图；③球与截面；④平行垂直命题与判定；⑤证明；⑥体积与点面距
- 3、积累解题套路，体会命题人思路
- 4、眼动，手动，脑动，心动

1

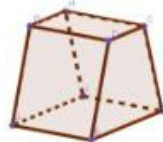
历年考点

01

年份	题号与考点	分值
2013年 I 卷	【题11】三视图体积；【题15】外接球；【题19】证线线垂直，求三棱柱体积	22
2013年 II 卷	【题9】三视图；【题15】外接球表面积；【题18】证线面平行，球三棱锥体积	22
2014年 I 卷	【题8】三视图；【题16】实际情景题；【题19】证线线垂直，求三棱柱的高	22
2014年 II 卷	【题6】三视图体积比；【题7】三棱锥体积；【题19】证线面平行，求点面距	22
2015年 I 卷	【题6】圆锥体积应用题；【题11】三视图表面积；【题19】证面面垂直，三棱锥侧面积	22
2015年 II 卷	【题6】三视图体积比；【题10】外接球表面积；【题19】作平行线，求体积比	22
2016年 I 卷	【题7】三视图表面积；【题11】线线角；【题19】证明中点，四面体体积	22
2016年 II 卷	【题4】外接球表面积；【题7】组合体三视图；【题19】证线线垂直，五棱锥体积	22
2016年 III 卷	【题10】三视图表面积；【题11】三棱柱体积最值；【题19】证线面平行，四棱锥体积	22
2017年 I 卷	【题6】线面平行判断；【题16】外接球表面积；【题18】证线线垂直，三棱柱体积	22
2017年 II 卷	【题11】三视图体积；【题15】外接球；【题18】证线面平行，四棱锥体积	22
2017年 III 卷	【题9】圆柱外接球；【题10】线线垂直判定；【题10】证线线垂直，三棱锥体积比	22
2018年 I 卷	【题5】圆柱截面；【题9】圆柱侧面最短路径；【题10】线面角，求长方体体积；【18】证面面垂直，三棱锥体积	27
2018年 II 卷	【题9】线线角；【题16】圆锥体积；【题19】证线面垂直，求点面距	22
2018年 III 卷	【题3】三视图卯榫；【题12】三棱锥外接球；【题19】证面面垂直，点存在性问题，线面平行	22
2019年 I 卷	【题16】点面距；【题19】证线面平行，点面距	17
2019年 II 卷	【题7】命题判定；【题16】印信；【题17】证线面垂直，四棱锥体积	22
2019年 III 卷	【题8】异面直线判定；【题16】四棱锥体积应用；【题19】证面面垂直，折叠	22
2020年 I 卷		

2

必考必记必备



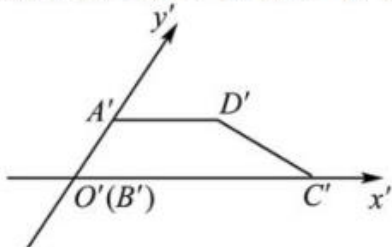
这是什么东东？

02

柱	锥	台
球		<p>正棱锥？正棱柱？ 直棱柱？</p>

斜二侧画法

1. 已知梯形 ABCD 是直角梯形, 按照斜二测画法画出它的直观图 $A'B'C'D'$ (如图 2 所示), 其中 $A'D'=2$, $B'C'=4$, $A'B'=1$, 则直角梯形 DC 边的长度是()



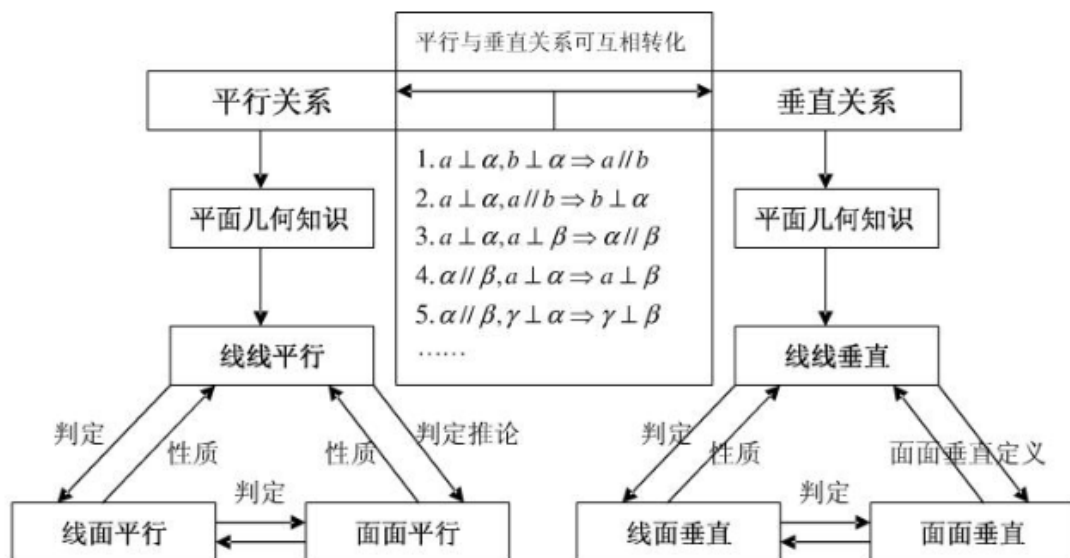
- A. $\sqrt{5}$ B. $2\sqrt{2}$ C. $2\sqrt{5}$ D. $\sqrt{3}$

【答案】B

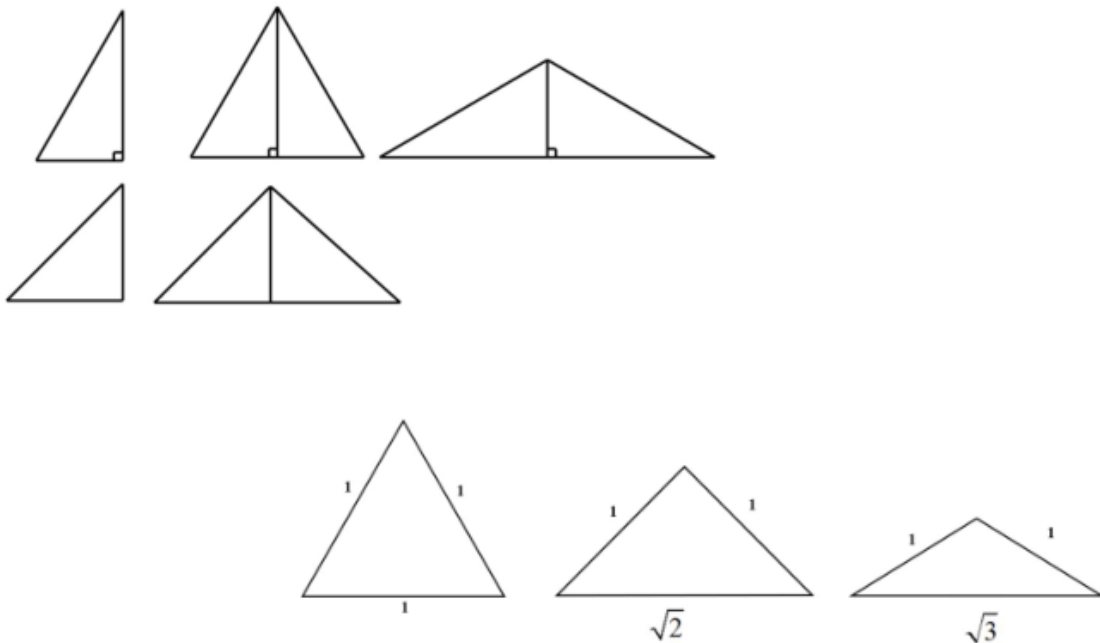
【解析】由图形可知

$AD=2, BC=4, AB=1, \angle ABC=90^\circ \therefore CD=\sqrt{2^2+(4-2)^2}=2\sqrt{2}$ 。故选 B。

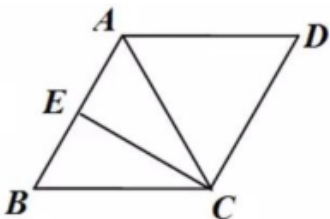
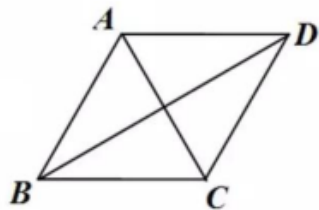
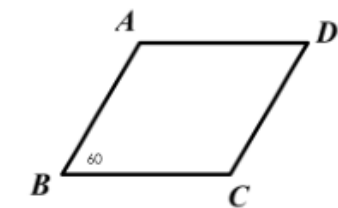
公理、定理体系



① 三角形



② 菱形

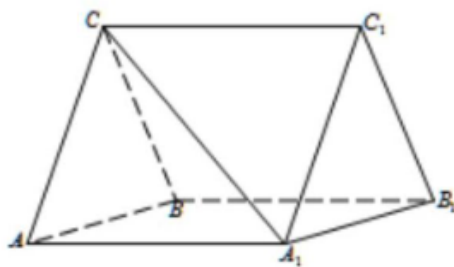


1 【2013年全国 I 卷文科18题】

如图，三棱柱 $ABC - A_1B_1C_1$ 中， $CA = CB$ ， $AB = AA_1$ ， $\angle BAA_1 = 60^\circ$

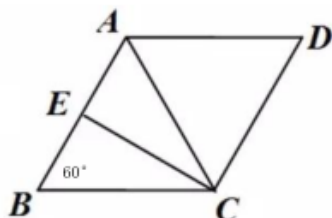
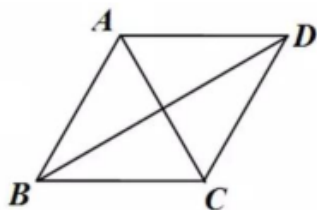
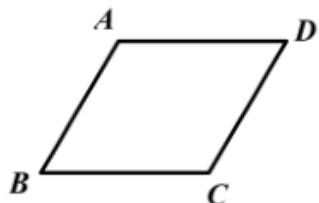
(I) 证明： $AB \perp A_1C$ ；

(II) 若 $AB = CB = 2$ ， $A_1C = \sqrt{6}$ ，求三棱柱 $ABC - A_1B_1C_1$ 的体积。



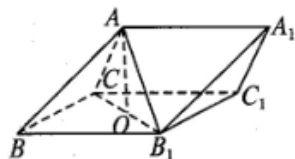
【答案可以翻开对应的金考卷】

② 菱形



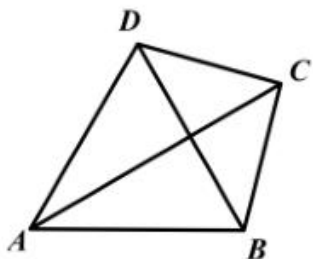
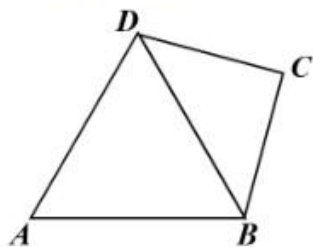
2 【2014年全国 I 卷文科18题(1)】

如图，在三棱柱 $ABC-A_1B_1C_1$ 中，侧面 BB_1C_1C 为菱形， B_1C 的中点为 O ，且 $AO \perp$ 平面 BB_1C_1C 。证明： $B_1C \perp AB$ 。



【答案可以翻开对应的金考卷】

③ 筝形



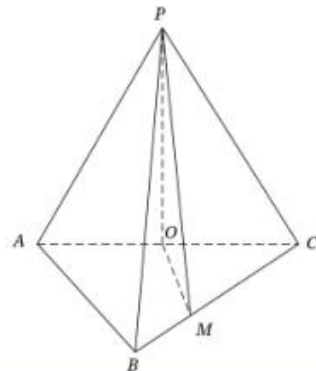
3 【2018年全国 II 卷文科19题】

如图，在三棱锥 $P-ABC$ 中，

$AB = BC = 2\sqrt{2}$ ， $PA = PB = PC = AC = 4$ ， O 为 AC 的中点。

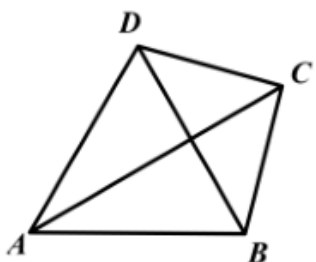
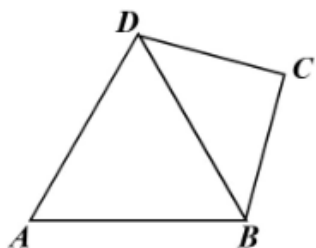
(1) 证明： $PO \perp$ 平面 ABC 。

(2) 若点 M 在棱 BC 上，且 $MC = 2MB$ ，求点 C 到平面 POM 的距离。



【答案可以翻开对应的金考卷】

③ 筝形

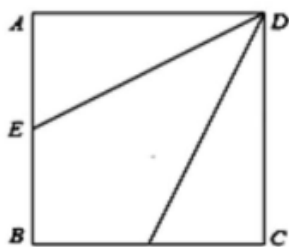


【曾几何时的某某题，基于课本】

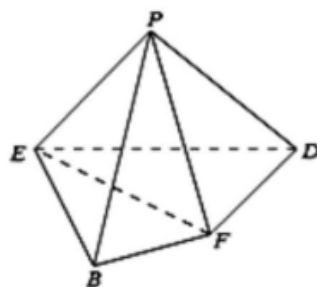
如图，边长为4的正方形 $ABCD$ 中，点 E, F 分别是 AB, BC 上的点，将 $\triangle AED$ 和 $\triangle DCF$ 折起，使 A, C 两点重合于 P 。

(1) 求证： $PD \perp EF$ ；

(2) 当 $BE = BF = \frac{1}{4}BC$ 时，求四棱锥 $P - BEDF$ 的体积。



【so easy】



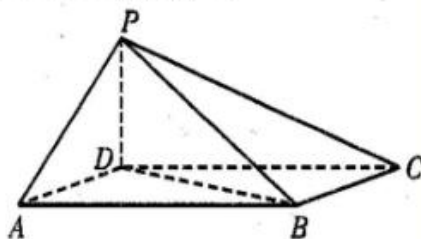
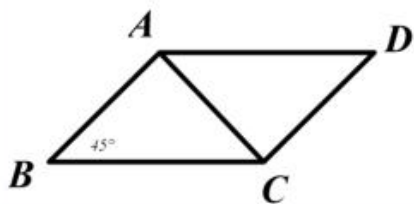
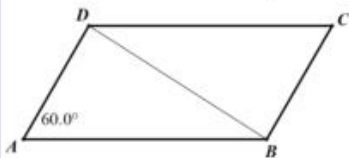
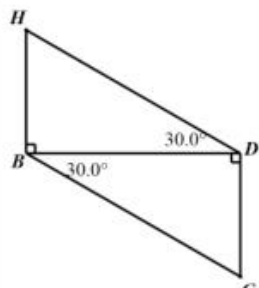
④ 含30/60/45度的平行四边形

【2011年全国卷文科18题】

如图，在四棱锥 $P-ABCD$ 中，底面 $ABCD$ 为平行四边形， $\angle DAB = 60^\circ, AB = 2AD, PD \perp$ 底面 $ABCD$ 。

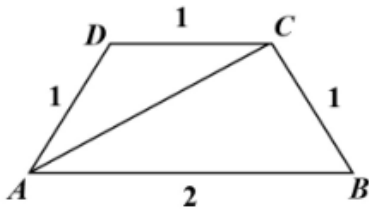
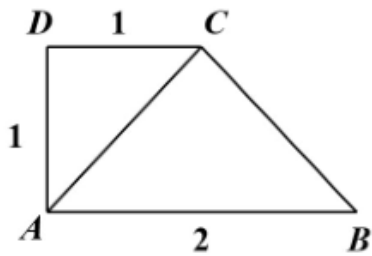
(1) 证明： $PA \perp BD$ ；

(2) 设 $PD = AD = 1$ ，求棱锥 $D-PBC$ 的高。



【答案可以翻开对应的金考卷】

⑤ 梯形



【2017年广州一模】

如图1, 在直角梯形 $ABCD$ 中, $AD \parallel BC$, $AB \perp BC$, $BD \perp DC$, 点 E 是 BC 边的中点, 将 $\triangle ABD$ 沿 BD 折起, 使平面 $ABD \perp$ 平面 BCD , 连接 AE , AC , DE , 得到如图2所示的几何体。

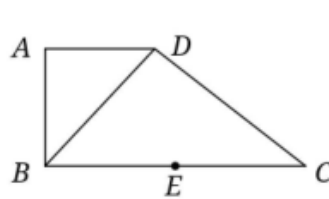
(1) 求证: $AB \perp$ 平面 ADC ;

图1

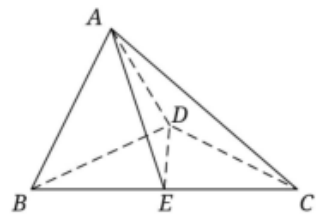
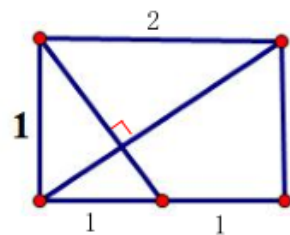
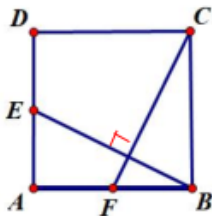
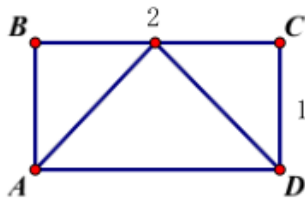


图2

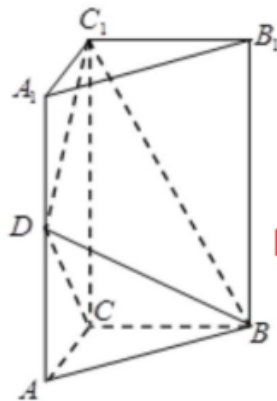
【so easy】

⑤ 矩形



【2012年全国卷理科19题】

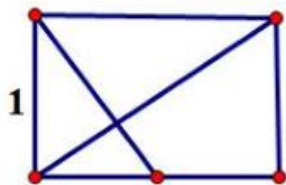
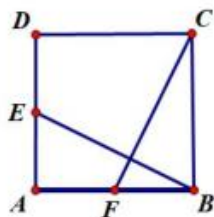
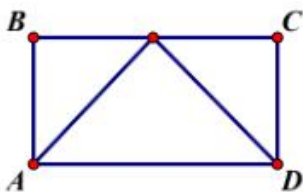
如图, 直三棱柱 $ABC-A_1B_1C_1$ 中, $AC = BC = \frac{1}{2}AA_1$, D 是棱 AA_1 的中点, $DC_1 \perp BD$



【答案可以翻开对应的金考卷】

(I) 证明: $DC_1 \perp BC$;(II) 求二面角 A_1-BD-C_1 的大小.

⑤ 矩形

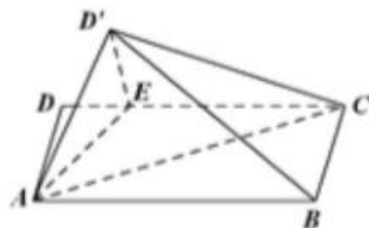


【2017年佛山一模文数】

8

如图,

矩形ABCD中, $AB = 4$,
 $AD = 2$, E在DC边上,且
 $DE = 1$,将 $\triangle ADE$ 沿A

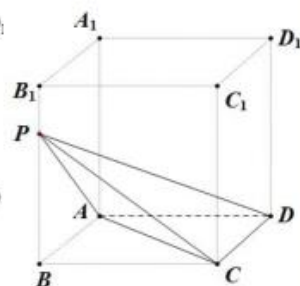
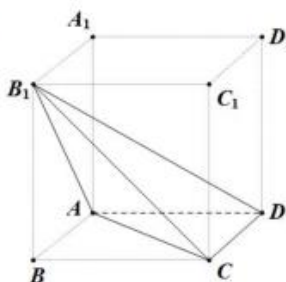
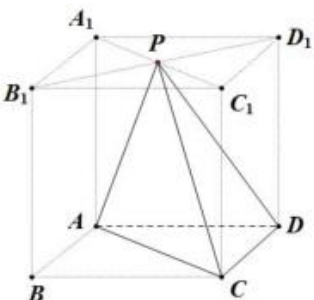
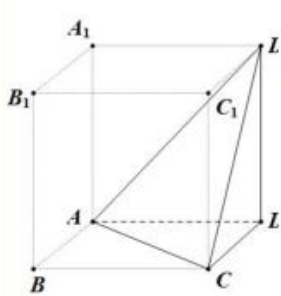
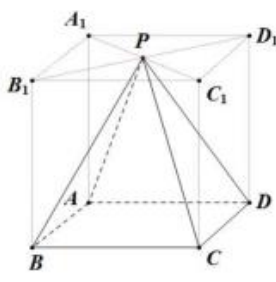
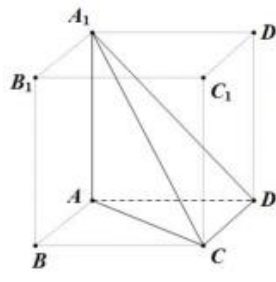
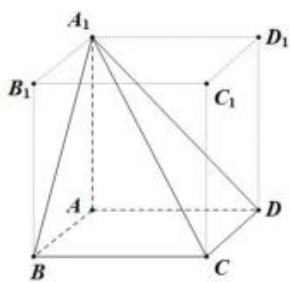
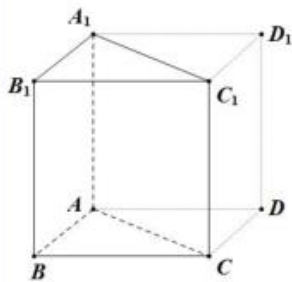


E折到 $\triangle AD'E$ 的位置,使得平面 $AD'E \perp$ 平面A
 BCE.

(I) 求证: $AE \perp BD'$;(II) 求三棱锥 $A - BCD'$ 的体积.

【这道题明天还会再提一下】

以下图形是否熟悉？



① 长方体应用——判断证明

【专题透析P44页3】

3. (2019 年全国 II 卷, 文 T7) 设 α, β 为两个平面, 则 $\alpha // \beta$ 的充要条件是().

- A. α 内有无数条直线与 β 平行
 B. α 内有两条相交直线与 β 平行
 C. α, β 平行于同一条直线
 D. α, β 垂直于同一平面

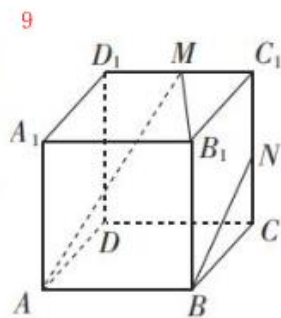
B

① 长方体应用——判断证明

【专题透析P44页4】

4. (2019 年全国 III 卷, 文 T8 改编) 如图, 在正方体 $ABCD-A_1B_1C_1D_1$ 中, M, N 分别为棱 C_1D_1, C_1C 的中点, 有以下四个结论:

- ① 直线 AM 与 CC_1 是相交直线;
 ② 直线 AM 与 BN 是平行直线;
 ③ 直线 BN 与 MB_1 是异面直线;
 ④ 直线 AM 与 DD_1 是异面直线.



③④

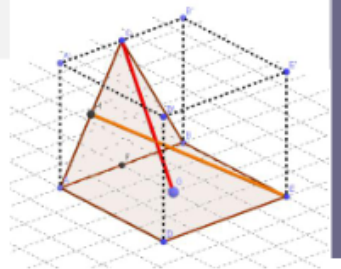
其中正确的结论的序号为_____.

3d

1 专题一：模型化——立体模型

① 长方体应用一——判断证明

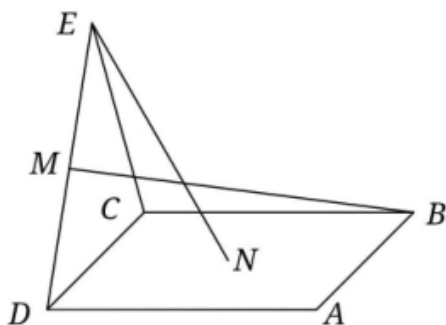
【2019年III卷第9题】



如图，点 N 为正方形 $ABCD$ 的中心， $\triangle ECD$ 为等边三角形，平面 $ECD \perp$ 平面 $ABCD$ ， M 是线段 ED 的中点，则（ ）。

- A: $BM = EN$ ，且直线 C, EN 是相交直线
- B: $BM \neq EN$ ，且直线 C, EN 是相交直线
- C: $BM = EN$ ，且直线 C, EN 是异面直线
- D: $BM \neq EN$ ，且直线 C, EN 是异面直线

10



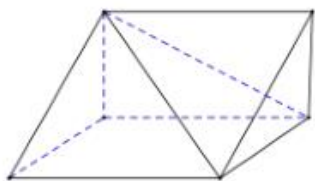
B

3d

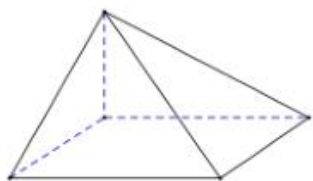
1 专题一：模型化——立体模型

4

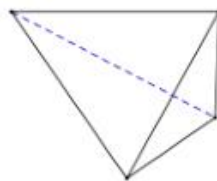
① 长方体应用二——切成子物体



三棱柱：堑堵



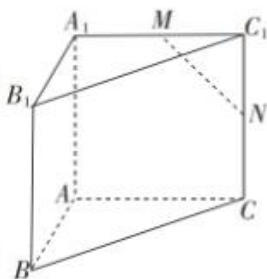
四棱锥：阳马



三棱锥：鳖臑

5. (2018年全国II卷,文T9改编)

在直三棱柱 $ABC-A_1B_1C_1$ 中,若 $AB=AC=AA_1=1, AB \perp AC$, M,N 分别为 A_1C_1, CC_1 的中点,则异面直线 MN 与 B_1C_1 所成的角为().



【专题透析P44页5】

11

- A. 90°
- B. 60°
- C. 45°
- D. 30°

B

① 长方体应用二——切成子物体

【2019年II卷16题】 中国有悠久的金石文化，印信是金石文化的代表之一。印信的形状多为长方体、正方体或圆柱体，但南北朝时期的官员独孤信的印信形状是“半正多面体”（图1）。半正多面体是由两种或两种以上的正多边形围成的多面体。半正多面体体现了数学的对称美。图2是一个棱数为48的半正多面体，它的所有顶点都在同一个正方体的表面上，且此正方体的棱长为1，则该半正多面体共有 26 个面，其棱长为 $\sqrt{2}-1$ 。（本题第一空2分，第二空3分）

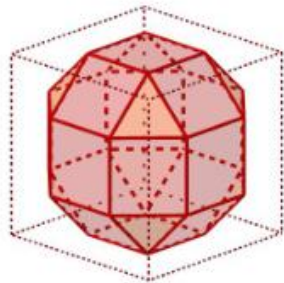


图1

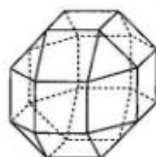


图2

12

3d

① 长方体应用四——外接球

【2016年佛山二模】 已知三棱锥 $P-ABC$ 的四个顶点在球 O 的球面上， $PA=PB=PC$ ， $\triangle ABC$ 是边长为2的正三角形， E, F 分别是 PA, AB 的中点， $\angle CEF=90^\circ$ ，则球 O 的体积为 () **D**

A. $8\sqrt{6}\pi$

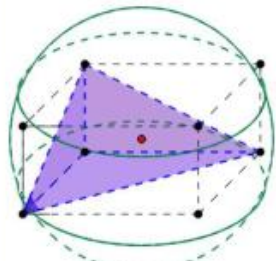
B. $4\sqrt{6}\pi$

C. $2\sqrt{6}\pi$

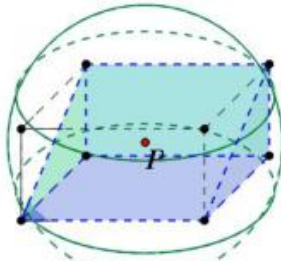
D. $\sqrt{6}\pi$

13

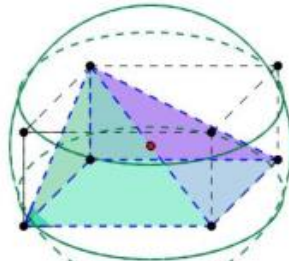
① 长方体应用四——外接球



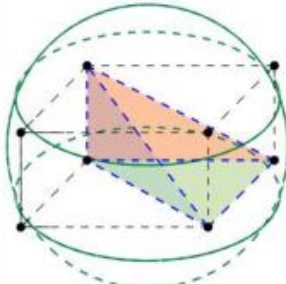
墙角



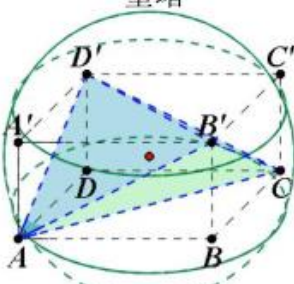
堑堵



阳马



鳖臑



对棱相等四面体

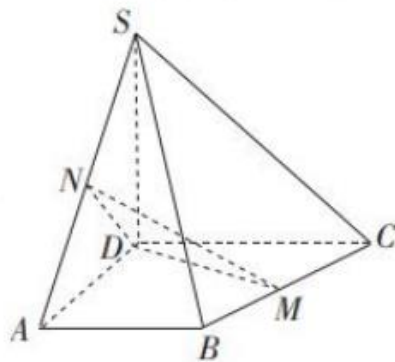
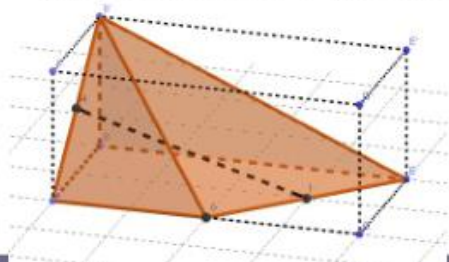
② 阳马、墙角

【《专题透析》P44第1题】

1. (2019 年全国 I 卷, 文 T19 改编) 如图, 四棱锥 $S-ABCD$ 中, $SD \perp$ 平面 $ABCD$, $AB \parallel CD$, $AD \perp CD$, $SD=CD$, $AB=AD$, $CD=2AD$, M 是 BC 中点, N 是 SA 中点.

(1) 求证: $MN \parallel$ 平面 SDC .

(2) 求点 A 到平面 MDN 的距离.



1

专题一：模型化——立体模型

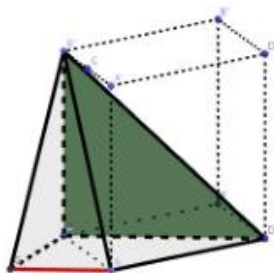
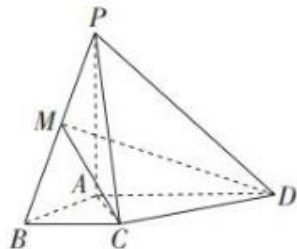
12

③ 鳖臑 【《专题透析》P45第2题】

2. (2018年全国I卷,文T18改编)如图,在四棱锥 $P-ABCD$ 中,已知 $PA \perp$ 平面 $ABCD$, $\triangle ABC$ 为等边三角形, $PA=2AB=2$, $AC \perp CD$, $\tan \angle DPC = \frac{\sqrt{15}}{5}$.

(1)证明: $BC \parallel$ 平面 PAD .

(2)若 M 为 PB 上一点,且 $V_{MPCD} = \frac{\sqrt{3}}{18}$,试判断点 M 的位置.



15

3d

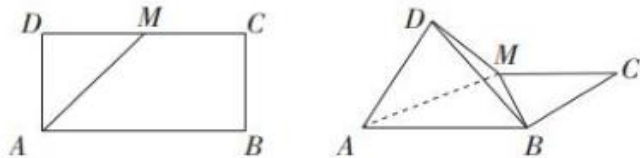
1

专题一：模型化——立体模型

13

③ 鳖臑 【《专题透析》P45第3题】

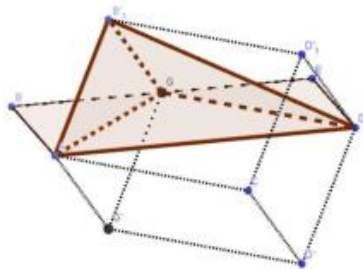
3. (2019年全国III卷,文T19改编)如图,在矩形 $ABCD$ 中, $AB=2BC=2$,点 M 为 DC 的中点,将 $\triangle ADM$ 沿 AM 折起,使得平面 $\triangle ADM \perp$ 平面 $ABCM$.



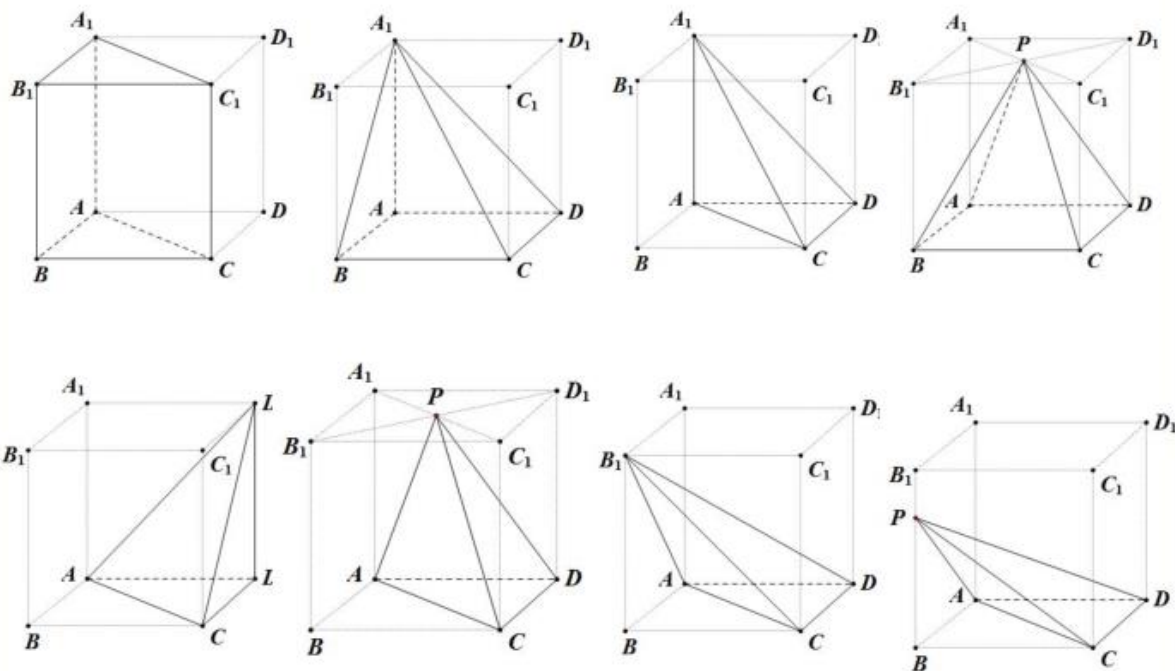
(1)求证: $AD \perp BM$.

(2)求点 C 到平面 BDM 的距离.

16



立方体及其子物体渗透到了高考的方方面面



[1] 考点分析

[2] 必记必背

[3] 平面模型

- ① 三角形 ② 菱形 ③ 筝形 ④ 梯形
⑤ 矩形

[4] 立体模型

- ① 长方体的应用—证明和判断，
三视图，外接圆
② 阳马 嵌堵
③ 鳖臑

【1】认真重做课件中的高考题（大题玩第一问）

【2】完成好《专题透析》P46-47内容

4.2 Transcript of general interview after the second lesson in H.III

The fourth interview with Huang was made in the morning of 3th March 2020, after the observation of the two distance online lessons given by Huang on 19~20th February, 2020. The interview was conducted via WeChat (a Chinese instant communication software) and it lasted 1 hour and 30 minutes.

The interview was recorded in audio format, with the teacher or the researcher sharing some photos from time to time. The audio was transcribed in Chinese with the transcript being integrated with the photos. Then the whole transcript was translated into English by the researcher. Below presents the complete English version of the interview transcript.

R: OK, I remember you said you had spent lots of time on the online courses. Can you elaborate on it?

HE: I mean the online courses really took lots of time because I was afraid of making any mistake during the class. As no student could interact with me, I would get stuck there if I made any mistake. So I must at least spend some time on it, like a demonstration lesson, and rehearse on it. It is really time-consuming. During a normal class, my students will respond and tell me if I make a mistake. The class will go on smoothly after communication with the students. But I have to spend considerable time on it if I don't find my mistake and continue

my class. So it is ...

R: How can you find your own mistake during a rehearsal?

HE: Nothing special, I just try to walk through it and try to find if things go on smoothly without any problem. But I have to spend more time and energies on preparing for the lesson. During a normal class, we have to write on the blackboard. But there isn't any blackboard during an online course. Some teachers don't have the necessary equipment and possibly have to make PowerPoint presentations and it is even more troublesome to type out those words in a slide.

HE: I just feel Tencent Class isn't that useful as you imagine. It can basically satisfy our needs but we still need other tools. So it is very troublesome.

R: What do you use to check the attendance?

HE: We do it directly via WeChat group and I use Wenjuanxing (Questionnaire Star) to check attendance. We made a questionnaire in Wenjuanxing and sent it to the group for all students to sign in.

R: You have a WeChat group for your class?

HE: Yeah, we have it under control by establishing one WeChat group of each of the two classes.

R: OK, how do you feel towards online teaching? What is your attitude? What benefits or weaknesses does it have?

HE: It certainly has its weaknesses, i.e. it is based on the self-discipline of students. If the students are self-disciplined, it will work well. But we have some backward students. For instance, only 410 or so students of all the 430-plus art students attend my class each time. Where are the remaining 20 students? I mean it is hard to supervise all of them effectively. But we can during a normal class. The students may not adapt to it well in the beginning although things are better now. It doesn't affect our teaching if we are familiar with it. For instance, when we are talking about those mathematics exercises, I will write down directly and the impacts are nominal.

R: Yes. Do you think online teaching is a big challenge or not?

HE: It is okay for me actually. As a teacher, I must keep updated with the Internet and I must certainly know about it. If I am still a teacher of blackboard and chalk, I will always remain on the paper and close my door to the Internet era, right?

R: What new possibilities do you think it brings?

HE: Wow, it has generated substantial impacts on online education and teaching in just two months. Like Xueersi, they have many online courses and many of them are chargeable. As you can see, many teachers have flocked in because they can make money. They basically record their lessons and upload them onto the Internet. So it becomes very profitable. Moreover, their contents are highly commercial and therefore influential.

R; How about their impacts on your teaching?

HE: To me, I can conveniently upload and display my teaching fruits on the Internet.

R: As you said previously, didn't you feel the work pressure was slightly lower for lesson preparation?

HE: It is smaller comparatively. We had to prepare lessons every day previously but we only focus on the contents we are in charge. So the contents will have a better quality and the pressure is certainly reduced as we take turns in the teaching.

R: For instance, another teacher will preside over the review of function next. Will he be in charge of the general framework?

HE: Yeah.

R: And then you have division of work among all of you?

HE: Yes.

R: OK. I think it is convenient. Next, please fill in a form for me. It is about some of the features and resources used for different teaching work. It seems you mentioned some other applets like Homework Register other than Tencent Class. How did you come to know these applets?

HE: Some teachers found these during work. Some head teachers found them even earlier as they had to summarize some information. If the applet proposed by a head teacher is recognized by others, all the teachers of our grade will be requested to use it.

R: OK, what do you mean when you talked about the website of Dongni.

HE: Our school has always used Dongni which is a platform for computerized exam paper marking. The weekly exam papers of our senior grade 3 are uploaded to Dongni where they are automatically divided up and electronically marked. Multiple choice and cloze tests are normally subject to computerized marking. Other tests will be shown on the website so that they can be marked on a computer and displayed on a cell phone. Basically, each school has chosen one platform. Dongni isn't a very mature website but it is relatively cheap. That is why we have chosen it.

R: Who is supposed to upload the students' exam papers?

HE: The students scan their exam papers themselves. Do you mean epidemic or non-epidemic days?

R: Just the weekly test, e.g. the online teaching recently.

HE: It is impossible recently. I mean during normal days, e.g. a normal class, the teacher will collect all the exam papers and have them scanned one by one. But it is impossible now.

R: You can't get in touch with the students face to face, right?

HE: Yes, the students can't upload now. The students only need to tell me their score. Dongni only marks the cloze test. The students are supposed to complete the multiple choice and cloze tests and the system will mark the test automatically.

R: What kind of multiple choice and cloze tests?

HE: The multiple choice and cloze tests which are uploaded onto Dongni.

R: Oh, then the student can see the result?

HE: It is like the questionnaire we normally fill.

R: Is it something like Wenjuanxing?

HE: Actually, it is very much like Wenjuanxiang.

R: Oh, then it will be distributed to the student for filling.

HE: They have an account each and they will log in, complete the multiple choice and cloze tests one by one and submit the paper to see the test results. It is something like Subject 1 and Subject 4 in your driver's license test.

R: Oh, what kind of score statistics will be available then?

HE: Yes, we can check it in the background.

R: What results are available? For instance, will it display the names or just the number of students who choose a specific answer for a multiple choice question?

HE: You can check who has made the wrong choice and the number and percentage of students making the wrong choice.

R: How about cloze test? Will it summarize the frequency of words?

HE: Cloze tests are normally marked by a teacher. They can't be marked by a machine. There are statistics after marking.

R: OK, you mark the exam manually. You previously mentioned interaction with students. Does it primarily refer to messages on Tencent class?

HE: Yes, it is message. We didn't enable it in the beginning as we were worried about possible chats, something like absent-mindedness in class. Later on, some people recommended enabling it as it was also enabled for English and Chinese classes. So we enabled it and it proved to be okay because the students would ask questions whenever they needed clarification. So we could make supplementary explanations in subsequent classes.

R: Will you answer the questions on a real-time basis? Like the student say that I don't understand this one. Will you stop to answer it then?

HE: Impossible. Only one or two people have queries out of more than 400 people. It is impossible to answer the questions real-time.

R: When will you answer it, after class?

HE: Yes, I will check the messages after class and I will make some supplementary explanations if many people ask the same question. But no supplementary explanation is made if only a specific student has a query. And some of them is not really having problems, they just like to cut in the class that way. In this case, the student who has a problem can ask others about it or ask me after class.

R: When it comes to asking a question privately, you teach more than 400 students and will they come to their teacher for the answer after class or will you also explain it to them one by one?

HE: They have to talk to their teacher.

R: So you only have to respond to the students of your class. It seems that you always ask your students to prepare for subject analysis and make their notebooks ready before class. Are these all the tools that the students need? I mean the computer or cell phone necessary for live streaming?

HE: Basically enough. It is preferable that they can write as the class goes on because some information passes quickly. The students can better understand it if they can note down what they hear. But we basically don't use other tools. It is enough for them to have just one cell phone to watch the video.

R: The students basically stay alone at home. Do they need to form a group?

HE: It is pretty troublesome. It is troublesome for us to contact with those students now. I may send them a message and get a reply in the afternoon or evening as they won't read it until then. It is hard to reach them. Those groups or group study isn't reliable. A class is sometimes divided up into several groups and a group leader is appointed. Ridiculous. Not even the teacher can manage them well. How can a student manage other students who stay away from each other at home? Impossible! It just sounds a good idea but isn't at all.

R: So will you give the students some feedbacks via the WeChat group during your online class?

HE: I will check if any student complaints about absence of audio signals during my course. Previously, a message box popped up in the computer but I didn't notice it during the class. But my students noticed it because they had been doing exercises one minute ago and the message box popped up suddenly. So they talked about it in the group and notified me about it.

R: Actually, the message board of Tencent class also enables it, doesn't it?

HE: Yes, it will. But it won't remind me. It will just keep sending a new message but won't alert me at all, as what they do on WeChat public account.

R: I see. OK. Tencent also has a feature of question card, doesn't it? Have you used it?

HE: Question card, what kind of card is it?

R: For instance, during screen sharing, a question card will appear in the toolbar at the lower left corner. Click it and you can create a single-choice or multi-choice question.

HE: I haven't tried it. Is it a new feature?

R: I noticed this feature in Tencent's help manual, i.e. a prompt for a single-choice question. A few options will be provided to the students to make a choice. An answer box will pop up, something like this.

HE: Actually, you can check the teaching of Senior Grade 1 or 2 to know about our exercise and review mode. I will allocate works to the students one day in advance and my task is to explain them the second day. I mean there is basically limited time for the students to do exercises in class. For instance, the feature of question card is more reliable for Senior Grade 1 and 2 as they are studying new lessons in each class. A new lesson requires explanations and some accompanying exercises which have to be finished in class. So the teacher will use this feature more by asking the students to finish questions one by one. Thereafter, statistics will be made to see how many people offer the correct or the wrong answer and then the

teacher can make a proper judgment.

R: OK.

HE: I won't elaborate if all the students answer it correctly. If many students get the wrong answer, I will make further explanations. This is more suitable for a new lesson than review. We directly explain and seldom have time for exercises in the latter case.

R: OK. What other resources are needed for the review of solid geometry?

HE: Solid geometry? Resource?

R: Tools, like this.

HE: There is basically no other new tool for subsequent classes because the contents are generally the same and don't require new tools.

R: Will you use GGB model and the like from time to time?

HE: We will use it for contents that are hard to comprehend from time to time. After explanation, I may show this model to help with their understanding. Actually, the students would give me the same feedbacks. If I directly show them this tool, they will ask you a question in the end: I don't have this tool during an exam when I find it hard to answer it. It is something like giving them a calculator. They can use a calculator well but they will complain: how can I calculate without this during an exam? It is just an aid. After I explain a question completely, I may tell them about this tool if they still can't understand it.

R: Do you meet with some constraints on using the GeoGebra files online?

Huang: No, there are no specific constraints. The (GeoGebra) courseware are simple. I usually prepare them before the lesson and that wouldn't take me much time. Then in the lesson, I just display the dynamic models to provide a perceptive support; there is not complex usages

R: OK, I noticed you would show the graphic models and then the stereo models before a specific question. For instance, how do you create those graphs and graphic models?

HE: I basically used Geometry Sketchpad to make those drawings and then paste them into my Word or PowerPoint files. I tried to use GGB before, but it is very troublesome to take a screenshot or copy-paste some objects. From Geometry Sketchpad the copy-paste is much easier...especially the 2D figure, since they are all about lines, are very convenient to draw in Geometry Sketchpad.

R: It is easier to make a copy with the Geometer's Sketchpad, isn't it?

HE: Particularly planar graphs because it only comprises lines. It is easy to draw it with the Geometer's Sketchpad.

GGB offers better control only with a 3D graph. It enables better zooming and dynamic features but it doesn't offer an advantage when it comes to the creation of teaching graphs.

R: For instance, I noticed you had created auxiliary lines basically with your mouse. Didn't you have a sketchpad then? Or did you have this tool later on?

HE: I have a sketchpad. But WPS doesn't support sketchpad quite accurately. I recognized it had a very poor accuracy as it couldn't be shown if the density of click was too high. So I had no choice but to use the mouse and then I realized Office was a better tool. I mean PowerPoint have a higher accuracy. So I started to use Sketchpad and it felt much more comfortable.

R: Do you think GGB brings convenience or inconvenience to online teaching?

HE: GGB brings convenience to online teaching as it quickens up when I use my mouse for operation. But it brings troubles if I use it in the school. We have a computer on the blackboard but it is still troublesome because I have to use my hand to click. In particular, touch screen operations are very inconvenient sometimes.

HE: It is like the creation of a graph. The subsequent operations are inconvenient.

R: I wonder what role it plays in the online teaching of solid geometry to students and the development of their logic reasoning. What values do you think it contributes?

HE: Do you mean the most important value to me?

R: I mean the solid geometry graphs, e.g. the solid geometry graphs that allow students to have a direct feeling and enable them directly to draw the auxiliary lines and have pure logic reasoning. How do you think about their relations?

HE: I think it's better for students to accumulate some fixed patterns, and accomplish the proof tasks on that basis. If they only rely on deductive reasoning, from the first step till the last one, that would be very painful. Many students don't know where to start... So one of the best way is that you give them some common patterns, like the 2D patterns here. The perpendicular relationships often questioned in GAOKAO examination will be contained in which patterns, and what patterns contain congruent relationships. I summarize all these for them. Later when they encounter tasks, with the inspiration of from the patterns, they will soon see some direction for solving the tasks

R: OK. You talked about concerted lesson preparation later. Do you still rely primarily on WeChat group conversation for online teaching and research?

HE: Yes. We can't see each other but still need to communicate. There is no other choice but WeChat.

R: How about document sharing?

R: For instance, you have to allocate tasks and then ...

HE: We will certainly share some useful data with all.

R: Will you have group discussion and online communications and then prepare lessons?

HE: Yes, exactly. One person prepares all the contents and then submits them to the group for discussion. As the speaker, he needs to introduce the contents and process flows of lesson preparation and the precautions to all others who will then provide their opinions thereon, including recommended additions, deletions and modifications.

R: Do you usually have a videoconference or do you just type in the texts during a discussion?

HE: An audio conference is enough.

R: Audio message?

HE: Not message. It is WeChat group chat, like a telephone conversation.

R: Normally, the lesson preparing plan can be basically determined after a conference.

HE: Yes, as the speaker, as I did during my previous return home, I certainly have determined everything and reported the contents to the lesson preparing team leader before the conference and the class. Necessary changes must have been made and approved by the team leader before I disclose them at the conference. Otherwise, there won't be enough time to discuss on them and make a decision during the conference.

R: You will have another meeting with the lesson preparing team leader beforehand.

HE: No meeting is required. But he will tell me the requirements clearly and I will follow and submit the final results to him until he is satisfied with the results before the meeting is held.

R: OK. Tencent Class enables playback. Will you also watch the video lessons of other teachers and provide your feedbacks too?

HE: We will. We are all present at her lesson.

R: Will you have discussions? Or any group discussion later?

HE: If any problem is found, we will have a discussion. But no big problem will occur under most circumstances.

R: Do you all have the chance to listen to the lessons of other teachers?

HE: You may go and listen but you won't have time. It is nothing more than leisure time by going there. Only teachers like us without considerable teaching experiences are required to listen to other teachers' classes, like homework that must be done. Not many teachers go and listen to others' lessons unless a school event is involved or the teacher has a public course to teach.

R: One more question on GGB! What weaknesses do you think GGB has in online teaching or what improvements need to be made?

HE: Improvements...

R: For instance, you may make some gestures during prior classes by which you can give the students greater room of imagination. Are you restricted to do the same now?

HE: We have enough tools now and so I don't feel great restrictions here. If we really need to use them, we will prepare them before the class. What I need to do is just turning the model left and right and show it to all students. For three graphs, I only need to show the main view, the left view and the top view, and excessive use is unnecessary. It is only necessary to show it directly. So we don't find great inconvenience here.

R: OK. Did you encounter difficulties while integrating these new tools?

HE: No great difficulty indeed. Maybe the teachers at an old age will encounter some troubles. For instance, they need to write on a board during live streaming or they aren't familiar with computer screen projection.

R: 恩,

R: Yeah.

HE: Yes, they use the tablet and the stylus but encounter some troubles in computer screen projection. But it is easy when you become familiar with it basically one to two classes later.

R: If you are the one who is most familiar with it in your team, will you train others or share some experiences with them?

HE: Actually, we are all new hands. I used Windows Sketch Pad to make a blackboard writing yesterday and it worked well although it was just a try on my part. I didn't talk about it to other group members in the beginning. I only used it for my classes and I found it really

worked effectively. Later on, they started to use it on a trial basis. Anyway, everybody has his own way of display. For instance, one teacher prefers writing on a tablet and it is okay. But I probably prefer a PowerPoint slide or a sketch pad because I feel more comfortable with it. Some teachers love to make comments in a PDF file and that is okay too because it works effectively.

R: Oh, do you mean Windows Sketch Pad is also a tool to draw geographic graphs?

HE: No, it is just ordinary drawing software by which primary school students can make a drawing. It only has some basic features, including adding some lines. You can primarily use it to write down something.

R: Is it convenient to make comments?

HE: No, it is just a white background on which you can write, like a blackboard.

R: Oh, OK, it works as a blackboard to you.

HE: Or it is like a piece of paper on which I can write something.

R: OK, oh, for instance, will you intentionally accumulate some strategies for online teaching. Many such strategies are available on the Internet now because some teachers share their experiences online.

HE: Some of the strategies they share are good. Anyway, it is okay when you become familiar with it. Some people directly display their practical operations, something like live streaming. It is a good idea. Just have a blackboard at home and record your operations like a public course via Tencent class. But we are not motivated to do the same as you need to pay attention to your personal image. I still prefer writing it directly.

R: Yes. It seems you seldom show up personally.

HE: Yes, basically, I don't turn on the camera.

R: Finally, do you still have additional time?

HE: It is okay with me.

R: Okay. When it comes to the contents of the two classes of solid geometry, do you still remember them? Shall I help you look back on them? Do you firstly have some key points of examination in history? Have you summarized such key points of historic examination yourself?

HE: It is very easy to make a summary. Just find all the questions in the past ten years and check them carefully to find the key points of examination each year.

R: Is this a job finished by another teacher of your team or yourself?

HE: I did it myself, because I had the questions in the past ten years. I checked all of them and summarized the key points each year.

R: Is this subject analysis taken as the primary reference whatever contents you are reviewing?

R: Yes, OK. Have you summarized these models, including those subjects of solid geometry, according to your understanding of solid geometry?

HE: Oh, are you talking about how I deal with the six subjects?

R: Yes.

HE: I must certainly consult leader of the lesson preparing team as he will have his own ideas. I will tell him my ideas. For instance, he may tell me that eight periods will be allocated to me and also the arrangements I have to make. For instance, I must teach the students on calculation; establish a subject on point, line and distance and a subject on three views; and focus on modeling. He may tell me the key points and I will make the arrangement and provide details on each key point. I need to determine of level of modeling and the types of models that I must summarize. Of course, you may find some reference materials which are certainly available through so many years of review.

R: Do you mean these key points rely on your experiences?

HE: Yes, in particular, the lesson preparing team leader plays an important role here. He has to tell me the contents I need to teach, the key points of the college entrance examination and the direction of teaching. I will then summarize in that direction.

R: OK. What is the general teaching goal of this class and the series of reviews and preparatory efforts?

HE: General teaching goal.

R: Or the two review classes.

HE: What are my purposes?

R: Yes.

HE: My primary purpose is to summarize the disorderly questions and tell the students how the question makers have designed them. For instance, I believe the students know how to solve the questions of modeling as I teach in two periods. They certainly know how to work

out the questions after checking the answers. Let's take many folding questions as an example. I don't know if you still remember it. There is a rectangle with a length to width ratio of 1:2. Divide it up into four parts of the same size and connect it to a vertical plane and fold it up. The model is already there for this kind of questions, isn't it? If any change is made, For example in this task, they take a rectangle with the ratio of width and length being 1:2, then take the quadratic point of the side of length and fold the rectangle up. What If I change it to a rectangle of $1:\sqrt{2}$ or $1:\sqrt{3}$. Actually, students have dealt with every kind of rectangle in tasks, and what I need to do now, is to put them together, so that they could see all the tasks are of the same class and think about a task from the basic geometric structure involved therein. You tell them the essence of the task, that will make them clearer.

R: Yes. I see that triangular and rectangular pyramids are models that you repeatedly talked about previously in your class.

HE: That is only part of it. We talked about it in the previous round of review. It frequently appears in major and minor questions alike, e.g. circumsphere. We got a teaching plan of circumsphere then and it was based on these models then. So the review of circumsphere and the review of point to plane distance are isolated. Now I want to tell him that these subjects have something in common and I would summarize them. Actually, the second round of review, unlike the first round, doesn't have to start from the beginning and go through it completely again. It is unnecessary. What is most important is to make a general summary of it.

R: OK, did you give a review lesson like this before?

HE: I have given review lessons like this. This is the third time for me to teach Senior Grade 3 students this year although my previous class is a science class.

R: Is there any change when it comes to an art class or is there any historic experience that can be preserved?

HE: Space rectangular coordinates is a compulsory subject for science class but unnecessary for us. So some contents are omitted. But there aren't big changes except the deleted parts.

R: I think some questions are even more difficult although space coordinates are deleted.

HE: Not necessarily, because the requirements aren't so high. The difficulty of science lies in the solution of dihedral angle and line-plane angle. They just use space coordinates directly. I won't test on dihedral angle but will test on line-plane angle. So the analytic method is enough basically.

R: What are the difficulties that an art student faces? Just talk about these subjects, i.e. the three views, section, volume, point to plane distance...

HE: A major breakthrough for them is calculation and they always make mistakes. The second one is difficulty in finding the path of proof and the graph. These are the two major difficult points.

R: Are science students more talented in calculation and proof like this?

HE: Yes, our science students have a mean score of 9 to 10 in 12 points of solid geometry questions. They only make mistakes in some calculations and most students have no problems. Our art students basically can get a score of 8 to 9 points, somewhat better than before actually. Anyway, the solid geometry questions are placed at the first two or three questions and it isn't so difficult.

R: Function is the last one, right? OK, I just hope to see your models, including planar models and solid geometry models. I notice that you give a GGB image with respect to the identification of the truncated cone. I have sent it to WeChat (Figure 1). Can you share your views with me?

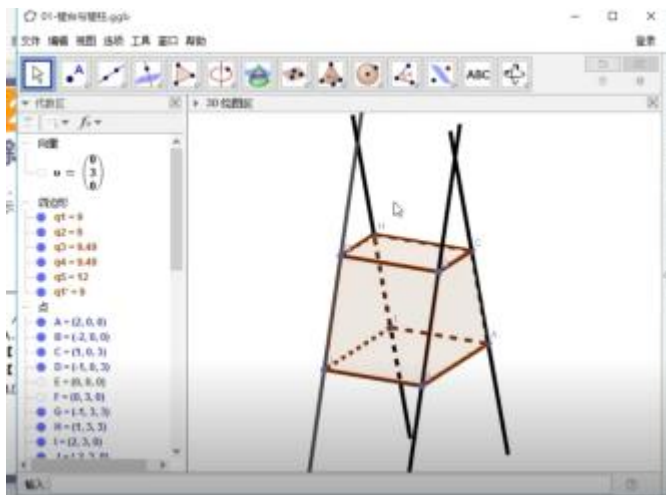


Figure 1

HE: They all know about column, pyramid, platform and sphere although some terms may be strange to them. For instance, right prism. Some people are ignorant of it and don't know that vertical conditions are applicable. I will just talk about the definition of right prism, regular pyramid and regular prism and then they have to find the contents in the notes of the corresponding round of review. Many people also ask about platform frequently. In three views, he resumed one graph I had taught but he didn't recognize it. He introduced it into the calculation formula of platform volume. I then explained to him that such a thing wasn't a platform. A platform should be part of a pyramid. So I just introduced the basic concepts of column, pyramid, platform and sphere to them. You have to look back if you aren't familiar with it. But just pass if you are familiar.

R: It is something like this one that looks like a platform but isn't. Does it derive from the previous subject?

HE: Yes, it is an example on the textbook. Compulsory Course 2 includes such an example.

R: Oh, was it requested to calculate the volume then?

HE: The students were asked to tell what it was. We also talked about a question on the textbook then and during first review again.

R: I see. How did you make this graph in the GGB courseware? Was it troublesome?

HE: Not troublesome. You can make it in just one to two minutes.

R: Point coordinates? Directly?

HE: You may use point coordinates and you may also use alternation. You draw a trapezoid and then translate the trapezoid in one direction according to one vector. Just link up those side edges after the translation.

HE: Yes, that is how it is drawn. Just draw a plane first and then translate it according to one vector. After translation...

R: Yes, I see. OK. I noticed a model of rectangle later. There is one graph showing many vertical structures in it. I sent one graph, from a rectangle of 1:2 (Figure 2) to a rectangle of $1: \sqrt{a}$ and then the a-section point of the side of length, . How did you come across such an idea of generalization?

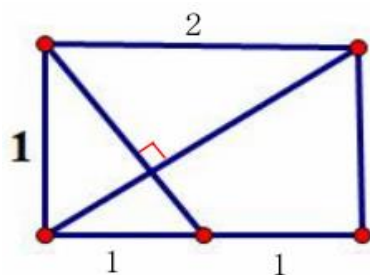


Figure 2

HE: It certainly isn't my idea. Instead, the lesson preparing team leader told me during review of science class. It was usually used during our daily teaching.

R: Oh.

HE: This is an idea left by the question setters and then taken by us as a good example for teaching.

R: OK. I also noticed that you had done a great deal of 3D dynamic models. I wonder if you noticed it or not. Look at this multiple-choice task in GAOKAO (Figure 3), you want to justify the two line segments, they are really intersecting and equal.

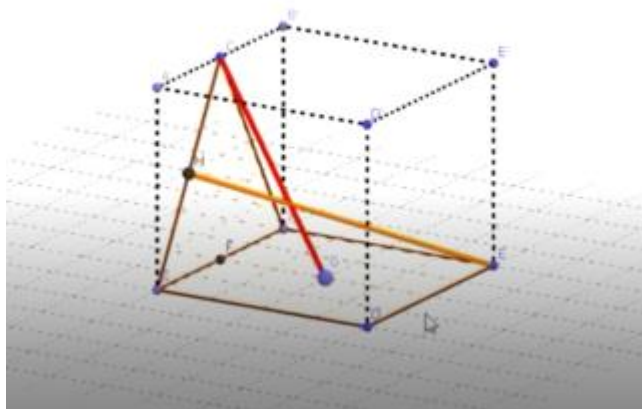


Figure 3

HE: So what I want to tell them here? There is a triangle face perpendicular to a rectangle face, and once you get two perpendicular planes, you can put them in a cuboid pattern, then the quantitative relationship and the relative positions are obvious...

R: Yeah.

HE: Of course, it may not be very proper. According to my personal understanding, it is a vertical relation on two sides. It is a triangle that runs vertical to a rectangle. For such a model with vertical relations on two sides, it is very easy to identify some quantitative relations in a cuboid. I mean it is an easy exercise for a science student.

R:

HE: Not recent years. I only told him that it could be used to create vertical relations between a line and a plane, something like height.

R: Is it also very convenient for a science student not to use a cuboid structure?

HE: No. He will know where to start it when he knows a cuboid structure.

R: Yes, what is your purpose of showing this GGB dynamic model?

HE: I just want to show it has a cuboid in here.

R: To make it convenient for graphing?

HE: To show it and tell him that there is a cuboid here.

R: Ok. I noticed that you had many GGB in your folder actually. But some about three views haven't been fully played, right?

HE: Yes, because I found time wasn't enough. So I didn't display them.

R: How about the student's reaction then? I also felt a little hard when I saw three views then actually.

HE: Not really. Basically they can work out those prism questions. Do you know which one is beyond them? It is the one that is a square when seen from three directions. They can't work it out. It looks very much like a triangular pyramid in three directions and it is normally beyond them. So we designed the projection

of a rectangular pyramid which looks very much alike in three directions, i.e. one triangle, two triangles and one square. One inclined line in the middle isn't displayed. So I drew it out first and then displayed one GGB model for them.

R: Did they come to you for it later?

HE: Yes, some people still couldn't understand it.

R: How did you reply to them?

HE: I could only make a proposal by telling them to take out the solid geometry and then draw its three views as an exercise. After the exercise, you will know why such a cube appears in the three views.

R: Oh, ask them to draw it again based on the original solid geometry.

HE: Yes, exactly. Actually, it must be done this way. You just give him much first, like drawing. You give him many such models and ask him to draw the three views before a test. Just provide the three views and ask them to reproduce the original ones. In present teaching practices, the three views are directly provided, which is very unfavorable indeed, right? But this is what they are supposed to do for senior grade 2. You shall do it when you talk about solid geometry to senior grade 2 students. Ask them to practice on these solids first. They are supposed to do the same even during junior high school days.

R: Is the role of GGB to display it directly in the end?

HE: Yes, it is displayed more directly. Some people may still find it hard to comprehend with just a graph. I can go deeper with it, right?

HE: I just give you a real model to check more carefully, right?

R: Will you share these GGB files with the students?

HE: I shared with them. I didn't share with them what I had showed them. I gave a new courseware to the students and asked them to watch it after class. I created snapshots of those models and sent the new files to the students.

R: Oh, do you mean GGB model?

HE: Exactly, I didn't put it in the courseware during my lesson. But I retreated the features of it in the files given him after class.

R: I see. Can the students use it well if GGB is directly given to them?

HE: They don't know how to use it. How can they open it?

R: Open? Didn't they learn to use this software?

HE: No. The new teaching materials aren't available now. They may not know how to use it after the new teaching materials are available in the future. Some students still remained ignorant of the Geometer's Sketchpad even years after it had been introduced.

R: 嗯

R: Er.

HE: Yes, there isn't any special training on it.

R: Maybe. The ideal course and the practical course.

HE: Yes, the textbook had specific requirement on learning calculator. Science calculators were supposed to be provided to the students for use. In the early years of my career, I used to use it as a senior high school student. It is not part of the college entrance exam some years later and it is useless to teach it then. How can the students use it if they haven't learned it? The students can't even use a calculator today, e.g. they don't know C8 for 9.

R: Yes, indeed.

HE: Although it is just an aid, the teacher constructs the models and shows to the students. The students can't create the models themselves because they don't have the tools in hand. It may be possible if they can use it and learn to use some mathematic tools in the computer class in the future. But they have nothing in hand at the mathematics class. One of our teachers used to teach differential coefficient and its origin and introduce the relations of differential coefficient and tangent line. He gathered all students on the computer room. It is only possible for a demonstration lesson. How can we do it without a public course? So many people, how the computer room...

R: Exactly, impossible. It would be better if computer lessons are provided for the students as part of the mathematics class.

HE: The course designers are very idealistic in many aspects but we won't teach it during our practical teaching unless the hardware conditions are very good, regardless of the school.

R: Yes. Hardware investment is required or the like anyway.

HE: It will be ignored if you have to guarantee the results of teaching.

R: OK. I also noticed you had produced a model of triangular pyramid. I send it to you, do you see this (Figure 4)?

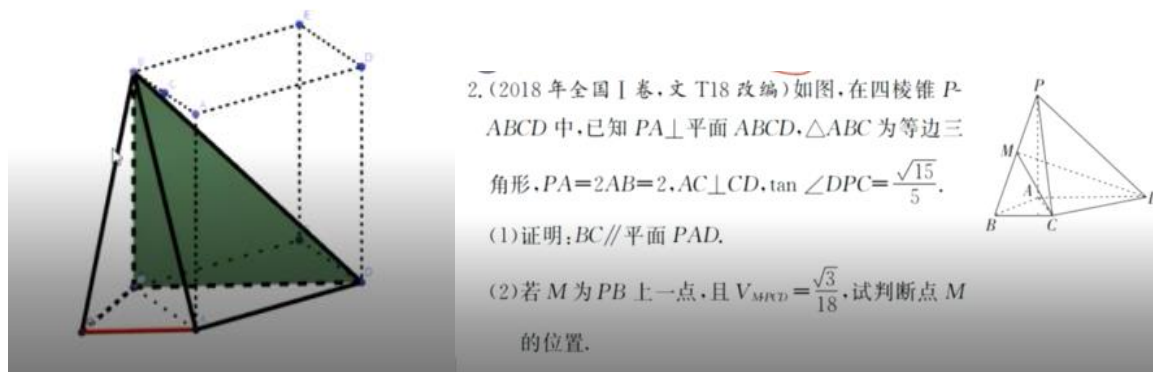


Figure 4

HE: Yes, I do.

R: It seems you expected them to see the graphs in college entrance questions. Actually, they hide a structure of triangular pyramid in them. I hope to know your ideas then. It seems to me that it won't help to work out the question greatly.

HE: Yes, sometimes the pattern is too complicated for them to remember, as the coordinator of the teaching research group told me last time: too many patterns will increase the burden of memory of students, if they cannot apply the patterns effectively to solve the tasks, it is better not to introduce the patterns at all. So here I firstly explain the general solution to the task, making them completely clear about every step in the deductive reasoning, and then I refer to the pattern, just to help them better understand the essence of the task figure. It is similar to figures in previous tasks – the same pattern in different orientations. If I was the question designer and if I had to create an open question for the student of senior grade 1 or 2, you will do the same. Then cut a cube without an auxiliary line; cut a cuboid into a rectangular pyramid and add some triangles aside, e.g. the model as previously mentioned; add one 30° and 60° right triangle or a right-angled isosceles triangle at the bottom surface and create a very special geometry. Just teaching them these things will be more useful than talking about one particular question. Actually, it will be more helpful if you teach them those common questions. Just tell them the nature of this question. As the question designer, how did you think about it? Just tell him things like this clearly.

R: It is going to give them a deeper understanding?

HE: Actually, many students with a strong base can do it too. Just forget this. How many questions have you worked out in the first round of review? They can do it themselves. But it will be clearer if you summarize for them.

R: What role does GGB play here?

HE: It has direct displays. It is going to take half a day for manual drawing. It is very convenient to display it this way, just projection. I wonder if you know about this 3D graph. The previous team leader, I mean the teaching researcher of Nanhai District used to say something really impressive. He introduced their ways of designing a question. Just turn this model to an angle where nobody recognizes it. Then it is a graph by which a question is designed. Everybody recognizes a rectangular pyramid whose apex faces upward. But if I put it upside down and has its bottom surface facing upward, nobody will recognize it. So this is a graph by which he designs a test.

R: It seems the base is always there regardless of all the changes.

HE: Many students are curious about it. Just kick the prism so that its bottom faces to the side, like the platform.

R: Put the bottom face of the quadrangular prism on both sides and kick it over.

R: You used green color to highlight the plane of a triangle. What is your purpose?

HE: It is just for the convenience of oral explanation, because I found the letters very small, when I rehearsed for the distance online lessons, I found it difficult to indicate these objects in GeoGebra clearly, I cannot directly point at them and it is slow to read the letters. For example, plane ABC, students still need to search where is A, where is B, what a messy. If you directly refer by color, students will find them quickly

R: Is this an improvement you made during a trial class?

HE: I made it myself. I must perform this exercise before a class. It is very hard for me to explain it clearly before exercise. It is very slow to read out the letters, e.g. plane ABC, and then the students have to search for it, which one is A and which one is B. It is in a mess. It will be much quicker if it is highlighted in another color.

R: Was the tempo of your class adjusted after the rehearsal?

HE: I basically tried it twice myself before class.

R: Tried twice. What major improvements did you make then? Just a general introduction.

HE: Major improvements in subject screening; some subjects were excluded and deleted because time was limited; for instance, I would remind the students of some questions that I found hard to work out. I would tell them these questions would be ignored and asked them to review them after class. I would work on these questions the next day.

R: Yes, I saw one question like this. I noticed you introduced two GGB relating to editing. But you didn't include any further rectangular pyramid

HE: I made it myself. But I recognized time was limited and only seven to eight minutes were left and we still had two and three questions to go. So I directly ignored it.

R: Oh.

HE: Yes. But it was included in the file I distributed to the students later.

I produced a snapshot and had it included.

R: OK, do you think it is even harder to see a triangular pyramid?

HE: Yes. They basically know a rectangular pyramid.

R: OK. You had the first two online classes thereafter. Is it the first time for you to give an online class on geometry?

HE: I had one class on array. It is just one full week for arrays. Five people and one class by each person.

R: Array comes first.

HE: Yes, it is a new hand in the second time.

R: For instance, what feedbacks or experiences did you get after the first class?

HE: The students didn't comment much on it. I asked if they had understood it and they said it was okay. So I got nothing about it. Then I checked the previous class on array and it was satisfactory. The students may understand it more quickly if I write less on the blackboard. So I intentionally slowed down a little bit.

R: Do you mean the students responded less than what they would do during a normal class?

HE: Yes, certainly. The talkative students would ask a question directly during a normal class. He would directly ask the question and he was the only one in the class not to understand it. But I had to spend time explaining it to him exclusively.

R: Will you stop and explain it to specific students during a normal class?

HE: Yes, because they won't give up.

HE: They will keep asking you questions and you have to stop and explain it.

R: That is really interesting.

HE: So the class won't be so boring and the teacher won't take the class as a monodrama because some students would interact with you. I won't be afraid even if I make a mistake. Sometimes, I even make a mistake purposefully to check if the students are listening carefully.

R: Oh, yes.

HE: It will be very embarrassing if you find a mistake a long time or five minutes after you start an online lecture.

R: Not many students will remind you of it.

HE: Yes, so online teaching is more like a performance.

R: Oh, okay. That is basically the end of my interview.