



HAL
open science

The development of the concern for tightness in the salt cavern industries, of accurate tightness test techniques and of the concept of Mechanical Integrity Tes

Arnaud Réveillère

► To cite this version:

Arnaud Réveillère. The development of the concern for tightness in the salt cavern industries, of accurate tightness test techniques and of the concept of Mechanical Integrity Tes. Earth Sciences. Sorbonne Université, 2021. English. NNT : 2021SORUS564 . tel-04043152

HAL Id: tel-04043152

<https://theses.hal.science/tel-04043152>

Submitted on 23 Mar 2023

HAL is a multi-disciplinary open access archive for the deposit and dissemination of scientific research documents, whether they are published or not. The documents may come from teaching and research institutions in France or abroad, or from public or private research centers.

L'archive ouverte pluridisciplinaire **HAL**, est destinée au dépôt et à la diffusion de documents scientifiques de niveau recherche, publiés ou non, émanant des établissements d'enseignement et de recherche français ou étrangers, des laboratoires publics ou privés.



Ecole Doctorale 398: Géosciences, ressources naturelles et environnement

The development of the concern for tightness in the salt cavern industries, of accurate tightness test techniques and of the concept of Mechanical Integrity Test

Thèse pour obtenir le grade de Docteur
par

Arnaud Réveillère

Présentée et défendue publiquement le 6 décembre 2021 à Paris

Membres du jury:

Valérie Plagnes, Professeur Sorbonne Université, Référente VAE HDR
Pierre Bérest, Professeur Ecole Polytechnique, Référent VAE HDR
France Uebersfeld, Responsable VAE Sorbonne Université, Accompagnatrice VAE
Loïc Labrousse, Professeur Sorbonne Université, Président du jury
Roselyne Friedenberg, Ingénieur SU-FSI, Examinatrice
Philippe Cosenza, Professeur Université de Poitiers, Rapporteur
Amade Pouya, Professeur Ecole des Ponts Paris Tech, Rapporteur
Benoit Brouard, Directeur et fondateur de Brouard Consulting, Examineur
Grégoire Hévin, Expert Senior EISE Geosciences & solution mining Storengy, Examineur

Remerciements

Mes remerciements vont en premier lieu à Pierre Bérest qui m'a fait l'honneur de m'accompagner et de me conseiller avec bienveillance et patience tout au long de ce projet doctoral, depuis une première discussion en 2016 à Galveston jusqu'à la constitution de ce dossier aujourd'hui.

Je remercie les membres de mon jury de thèse pour leur participation et l'intérêt qu'ils manifestent pour mon travail. Je remercie en particulier mes rapporteurs Philippe Cosenza et Amade Pouya, ainsi que mes examinateurs Benoit Brouard et Grégoire Hévin pour les nombreux échanges fructueux que nous avons pu avoir, notamment au sein de la communauté informelle du SMRI. Je remercie l'équipe de l'ED398 de Sorbonne Université, notamment Loïc Labrousse son directeur et Valérie Plagnes mon accompagnatrice scientifique qui ont toujours manifesté un soutien manifeste à ma démarche. Je remercie aussi le Pôle Reprise d'étude et Validation des Acquis de l'Expérience, dont Mme Uebersfeld, pour son accompagnement tout au long de cette VAE.

Je tiens également à remercier plus largement l'ensemble des personnes avec qui j'ai travaillé au BRGM et à celles qui travaillent aujourd'hui à Geostock : chercheurs, ingénieurs, secrétaires, membres des services généraux. A chacun d'eux je suis redevable de m'avoir permis d'acquérir les expériences dont ce dossier est une synthèse.

Mes remerciements vont également à tous ceux qui m'ont formé en tant qu'étudiant et salarié. Je pense notamment à mon professeur de mathématiques en 1^{ère} année de classe préparatoire M. Philibert qui m'a durablement marqué sans que je n'aie jamais saisi l'occasion de le lui dire ; à Pierre Bérest pour le modèle qu'il est dans la clarté de ses exposés, sa recherche indéfectible de la compréhension des phénomènes, et pour ses conseils précieux jusque dans ce dossier de VAE. Je pense plus largement à tous les enseignants, collègues, ou confrères dans le petit monde du stockage souterrain qui m'ont formé ou inspiré, et que je n'ai pas toujours su remercier à la hauteur de ce qu'ils m'apportaient.

Enfin, ce dossier de synthèse de VAE doctorale ayant été un travail réalisé sur mon temps personnel, je tiens avant tout à remercier ma femme, Marion, pour son soutien constant et sans faille pour ce projet. Je lui dédie ce travail ainsi qu'à nos filles Léonie et Brune.

Table of content

1.	Introduction.....	6
2.	Development of the concern for tightness in the salt cavern industries.....	6
2.1.	Introduction.....	6
2.2.	Brief history of the brine production by solution mining.....	7
2.2.1.	Early days of salt production	7
2.2.2.	Examples of salt production in some selected brine field cases.....	12
2.2.3.	Tightness of the cavities left in the ground from the early brine production fields	18
2.3.	Brief history of storage in salt caverns	19
2.3.1.	Development of the use of salt caverns for storage	19
2.3.2.	Current status of the salt caverns storage industry	20
2.3.3.	Leakage incidents in the history of the storage salt cavern industry.....	21
2.4.	The requirement to test the tightness of salt cavern wells	22
2.4.1.	The requirement for testing the “Mechanical Integrity” of injection wells.....	22
2.4.2.	The status of tightness test requirements outside of the USA	24
2.4.3.	Are Tightness test techniques and requirements similar for brine production and storage caverns?.....	25
3.	Development of the Mechanical Integrity Test techniques.....	26
3.1.	Introduction to the main types of MITs	26
3.2.	Introduction to the main interpretation methods.....	29
3.2.1.	Hydraulic test interpretation.....	29
3.2.2.	In situ volume balance.....	29
3.2.3.	In situ mass balance	31
3.2.4.	Pressure Observation Test	31
3.2.5.	Pressure Differential Observation Test	34
3.2.6.	In-situ compensation.....	34
3.2.7.	Above ground balance method	35
3.2.8.	Summary of the interpretation methods used for the various types of MITs	35
3.3.	Introduction to the selection of a test pressure	39
3.4.	Literature-based review of the development of MIT techniques	41
3.5.	Current practice of the MITs (tightness tests) in the industry	46

4.	The development of the test accuracies standards and acceptance criterion in the nitrogen/brine MIT	48
4.1.	Progressive introduction of the Minimum Detectable Leak Rate (MDLR) as the acceptability criterion	48
4.1.1.	Pressure-based acceptance criteria for hydraulic tests	48
4.1.2.	Early attempts to refer to a Maximum Acceptable Leak Rate (MALR)	49
4.1.3.	A balance between what is achievable and what is desirable: the introduction of the Minimum Detectable Leak Rate (MDLR) reference value	50
4.2.	Origin of the thresholds values for MDLR	51
4.2.1.	Volume-based Minimum Detectable Leak Rate thresholds	51
4.2.2.	The mass-based Minimum Detectable Leak Rate (MDLR) threshold	52
4.3.	Comparison with other industries' tightness test accuracy requirements	53
4.3.1.	Underground Storage Tanks	53
4.3.2.	Natural gas transportation pipelines	55
4.3.3.	Comparison of accuracy threshold with other techniques	55
4.4.	What are 1000 bbl/year or 50 kg/d-accurate tests able to detect?	56
4.4.1.	What leakpath are MIT able to detect?	56
4.4.2.	What would nitrogen-brine MITs be able to detect, would they apply to other industries ?	58
5.	Comparison of accuracies between the main MIT interpretation methods	63
5.1.	Methodology	63
5.1.1.	Sources of uncertainties	63
5.1.2.	Cavern properties for a comparison purpose	63
5.2.	Hydraulic test interpretation	64
5.2.1.	Formulation of a Calculated Leak Rate (CLR)	64
5.2.2.	Minimum Detectable Leak Rate (MDLR) of the Hydraulic test interpretation	65
5.2.3.	Typical Application	66
5.3.	Pressure Observation Test (POT)	67
5.3.1.	Formulation of a Calculated Leak Rate (CLR)	67
5.3.2.	Minimum Detectable Leak Rate (MDLR)	67
5.3.3.	Typical Application	68
5.4.	In-situ mass balance interpretation of a gas cavern MIT	69
5.4.1.	Formulation of a Calculated Leak Rate (CLR)	69
5.4.2.	Minimum Detectable Leak Rate (MDLR)	70
5.4.3.	Typical Application	72
5.5.	In-situ Mass Balance interpretation of a Nitrogen-Brine MIT	73
5.5.1.	Formulation of a Calculated Leak Rate (CLR)	73

5.5.2.	Minimum Detectable Leak Rate (MDLR)	74
5.5.3.	Typical Application	75
5.5.4.	Comparison of the 1st order and Monte Carlo methods to propagate uncertainties..	76
5.6.	In-situ volume balance of a Nitrogen-Brine MIT or Liquid-Liquid Interface test	77
5.6.1.	Formulation of a Calculated Leak Rate (CLR)	78
5.6.2.	Minimum Detectable Leak Rate (MDLR) of the In-situ volume balance	78
5.6.3.	Typical Application	78
5.7.	Pressure Difference Observation Test in a N2-brine MIT	79
5.7.1.	Assumption of uniform gas density in the well	79
5.7.2.	Formulation of a Calculated Leak Rate (CLR)	80
6.	Conclusion	81
7.	References	85

1. Introduction

Salt caverns have singular properties when compared to alternative underground storage options (depleted fields, mined caverns): they are tight from an engineering point of view and that tightness can be accurately tested.

In the global industry of salt production by solution mining and of underground storage in salt caverns, “Mechanical Integrity Test” is the most commonly used terminology to designate tightness tests of the salt caverns. In 2019, the Solution Mining Research Institute, the leading research and educational organization in the salt cavern industry, gathered 300 people in New Orleans, USA, and, six months later, 150 in Berlin, for a 7-hour class entitled “*Mechanical Integrity Testing (MIT) and Techniques in Gas and Liquids Storage Caverns*”. Choosing this naming rather than “Tightness testing” or “Leak test” could suggest that “Mechanical Integrity Test” answers to a precise definition, or is a standardized test. Actually, it is not, as explained hereafter, even if one type of test, the nitrogen/brine MIT, has emerged as the most common practice today. The present report summarizes the development of this technique over the history of the salt cavern industry, by analyzing when and how did the question of tightness emerge in the long history of solution mining (Part 1), which tightest test techniques have been applied (part 2), how standards of tightness tests accuracies emerged (Part 3) and how accurate are the main tightness tests interpretation methods (Part 4).

2. Development of the concern for tightness in the salt cavern industries

2.1. Introduction

Salt cavern creation through solution mining in geological deposits of salt is originally a salt production technique. Salt production is a very old human activity. It has been the only way of preserving food for long, making it central to human activity. As the writer and journalist Mark Kurlanski (2002) summarized, “*until about 100 years ago, when modern geology revealed its prevalence, salt was one of the world’s most sought after commodity. A substance so valuable that it served as currency, salt has influenced the establishment of trade route and cities, provoked and financed wars, secured empires and inspired revolutions*”. Salt was used as a levee to raise taxes in China (First introduction was in 300 BC), England, France (“Gabelle” has been in place from mid-14th century to 1946, with only brief lapses and revisions) or India (the 1930 “Salt March” led by Gandhi against the British salt monopoly and taxes was a major development on the non-violent civil disobedience in colonial India). Legacy of this period lies in city names (starting with “Salins” in France¹ or “Salz” in Austria or Germany, ending in “wich” in England) and in the etymology of common words such as “salary” (or “salaire” in French, “salario” in Spanish) that comes from a ration of salt paid to Roman Empire soldiers. This importance of salt essentially dates from times when underground salt production had not been industrialized yet. Today, it is a highly effective industrial process: at a salt mine, the price of bulk rock salt is in the order of \$50 per ton², the same order of magnitude than the cost of bulk construction sand at the quarry. Salt in brine is even cheaper. It is sometimes disposed in the sea or salt lakes³ when the main reason for solution mining is not salt production anymore, but excavating a cavern for storage.

¹ 37 French cities have “Salin” in their name in France today. From public.opendatasoft.com, visited on 10/01/2021.

² At the American Rock Salt Mine, NY, USA. Personal visit in 2018.

³ Personal experienced in at least 5 recent solution mining projects over the past 9 years

Today, ca. 2000 of the caverns solution mined in salt deposits are also used for storing liquid or gaseous products. The concern, technical capability and requirement of testing the tightness of these salt caverns have progressively emerged over the long history of this industry.

2.2. Brief history of the brine production by solution mining

2.2.1. Early days of salt production

Use of surface-available salt: coastal salt and salt springs

Underground mining of salt in Austria and Romania may have begun in the New Stone Age (Thorns, 2000). However, the history of the salt production for human activity, summarized by Hocquet (1993) and Hocquet (2000), shows that it was only at the end of the 18th and during the 19th century that salt production became a truly industrial activity in Western Europe. Between the 13th and the 17th centuries, French Atlantic coast sea farmers provided $\frac{3}{4}$ of their country's salt supply, and shipped salt to Ireland, southern England, Belgium and the Netherlands. In continental or North-Western Europe areas, salt was supplied by salt springs: when natural groundwater come into contact with the top of a salt formation it leads to dissolution of the salt rock, or very fast sub-surface erosion since salt is very soluble and thus increases the salt concentration of the groundwater, that can result in salt springs.

However, underground salt was discovered and mined in Cheshire around 1780, and improvement of the river transport network around Liverpool in the 18th century enabled Cheshire to conquer the monopoly of salt production in the United Kingdom. A century later in France, the transport revolution also contributed to change the production of salt drastically and pulled up rock salt and the Lorraine brineworks to the top position in less than half a century: northern France was supplied with salt from Lorraine after ca. 1860. In Europe, geological exploration, modernization of transport networks (canals, railroads), and more generally the industrial revolution over the 18th and 19th centuries led to the progressive switch of salt production from coastal salt ponds or natural salty water springs to industrial production of underground salt. The development of the underground salt production made salt abundant, turning a precious commodity into an ordinary one⁴.

Underground salt: salt works, pits and wild brining

Uses of salt that was not immediately available at the surface started with mining works (remains of the mining activity in the New Stone age can be found near Salzburg in Austria) and the enlargement or deepening of the brine outlets, and ultimately pumping of salt springs (remains of a roman period brine well were found in Upwich, Cheshire, UK⁵). No water was injected underground. Pumping of the brine led to groundwater flow to the roof of the salt formation, increasing the natural dissolution processed at the rock head.

⁴ Although, not fully. In France, the distinction is made between mines and quarries based on a list of concessionable ("concessible") extracted materials. This list of material for which mining regulation applies is normally based on strategic or precious character of the substance, and does include salt. Maybe, as supposed by P. Bérest, because salt production raises technical questions that make it of interest under the mining regulation framework.

⁵ "There was a wood-lined well a probable brine lifting structure that may have incorporated some sort of counterbalanced bucket mechanism" (Cooper, 2002)



Figure 1: Manually operated bucket elevator brine pump. From Crotagino and Wilke (2014)

As developed for instance by Bérest et al. (2005) and Crotagino and Wilke (2014), to satisfy the increasing demand for salt, wells were drilled to penetrate the declining water table, and also with the aim of exploiting the higher salt concentrations typically found in deeper groundwater horizons (Figure 1). Production rates increased dramatically with the development of motor-driven brine pumps, the technology to drill deep wells into the salt formations themselves, and the availability of coal to produce the salt from the brine. Wells were drilled tens of meters into the salt formation and equipped with a unique tube which, in most cases, was not cemented to the ground (Figure 4, left). Groundwater with low salt content flowed down through the uncemented annulus between the rock and the production well or entered the dissolution zone at the salt roof (brine aquifer) through discontinuities, either natural or induced by salt extraction. It was pumped back to the surface, resulting in uncontrolled formation of cavities without any salt roof (Figure 2).

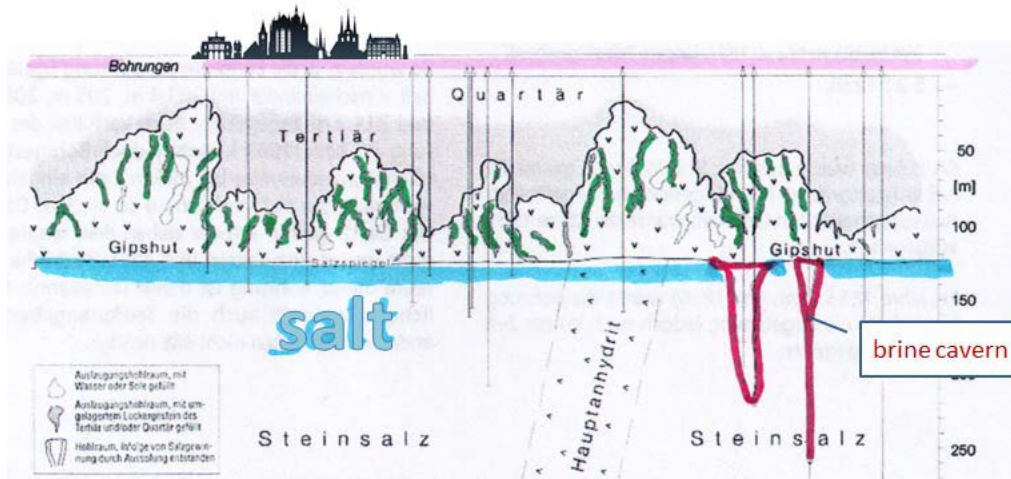

Figure 2: Section of a salt dome with 2 caverns without salt roof (in red contour) due to uncontrolled wild brining. From Crostogino and Wilke (2014)

Underground salt: first room and pillar mines and bastard brining

Dry mines in bedded salt formations often used the room-and-pillar method. Bérest and al., 2005 mention that “extraction ratios were then quite high, often more than 80% at a 200-m depth, which was too high and frequently led to overburden collapse, or to partial roof failure often followed by mine flooding.” Figure 3 painting illustrates the high extraction ratio of a mine. Brine production from flooded salt mines was also a production process, Cooper (2002) referring to “bastard brining” to illustrate the technique of pumping the brine from the flooded mines, as practiced in Cheshire, UK.

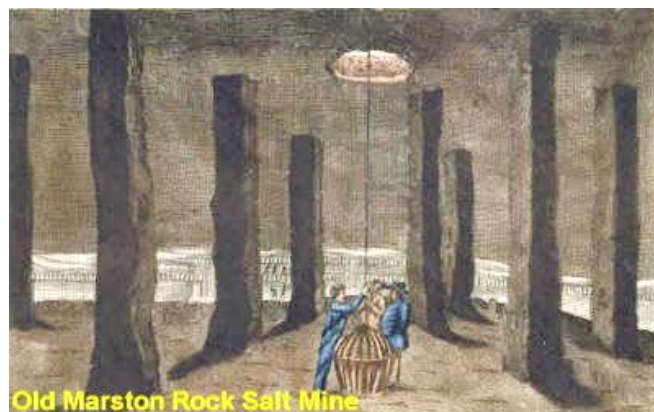

Figure 3. Painting of the Old Marston Rock salt mine in Cheshire, UK showing the very high extraction ratio and very thin pillars. From Crostogino and Wilke, 2014.

Underground salt: cavern connection

To increase the extraction ratio and get a more saturated brine when solution mining, coalescence of neighbouring caverns was deliberately managed. Some wells could be used as injection wells, and other wells could be specialized as brine withdrawal wells, making water flow through a cavern of a large volume. Caverns were initially connected by solution mining, after individual caverns growth made them reach one to another resulting in underground galleries (an example of it is the brine production at Windsor, Canada). The hydraulic fracturing technique was then introduced and enabled to connect the wells right after they were spud. According to Bays (1962a), hydraulic fracturing to

connect the wells right after they were spud was introduced in North America in 1955 by his consulting company and rapidly developed. By connecting wells at the base of a salt deposit in bedded salt, hydraulic fracturing also enabled to mine this lower salt section and increase the recovery rate of salt, while using only a small number of distant wells, creating a strong economic incentive for brine producers. The application of hydraulic fracture pressure at circa the lithostatic pressure required the salt mining industry to install casings, and cement them to the rock formation, to ensure effective pressure sealing. Prior to it, casings and cement jobs were essentially used when drilling demanded it to e.g. prevent water influx or mud loss, and the uncemented annulus was often used for the downwards flow of unsaturated water (“wild brining”).

Controlled brine production

Crotogino and Wilke (2014) recall that controlled brine extraction is an invention implemented at the beginning of the 20th century. They characterize it by *“the drilling of a well to a position far below the top of the salt, the injection of fresh water through the cased wellbore, and the simultaneous displacement of the resulting brine to the surface. The overall aim is to construct a salt cavern with long-term stability.”* They summarize the differences in the following table.

Table 1: comparison of wild and controlled brining (or solution mining) by Crotogino and Wilke (2014)

	Wild brining	Controlled brining (solution mining)
Salt mining	at or close to top salt	at a safe distance from top salt
Brine production controlled by	brine pumping	fresh water injection
Salt dissolution leads to	dissolution of salt layer at top salt, equally distributed or concentrated in channels	development of caverns

In controlled brine production, or solution mining, the salt production is controlled by the water injection. This implies that the cavern is reasonably tight, otherwise the water injection would be partly lost (see e.g. Tully valley case).and would not enable a good control of the brine production.

The introduction of new techniques then progressively gave brine producers more tools to ensure that the cavern left in the ground by the brine production can be tight and stable. Most notable advances are the introduction of the techniques developed by the oil and gas industry for the cementation of the well, the introduction of nitrogen or oil blanket to prevent from leaching the top of the cavern, the introduction of sonar survey enabling to monitor the growth of the cavern, and the introduction of rules for cavern design and solution mining follow-up supported by empirical experience and/or modelling tools for assessing cavern stability and controlling the leaching process.

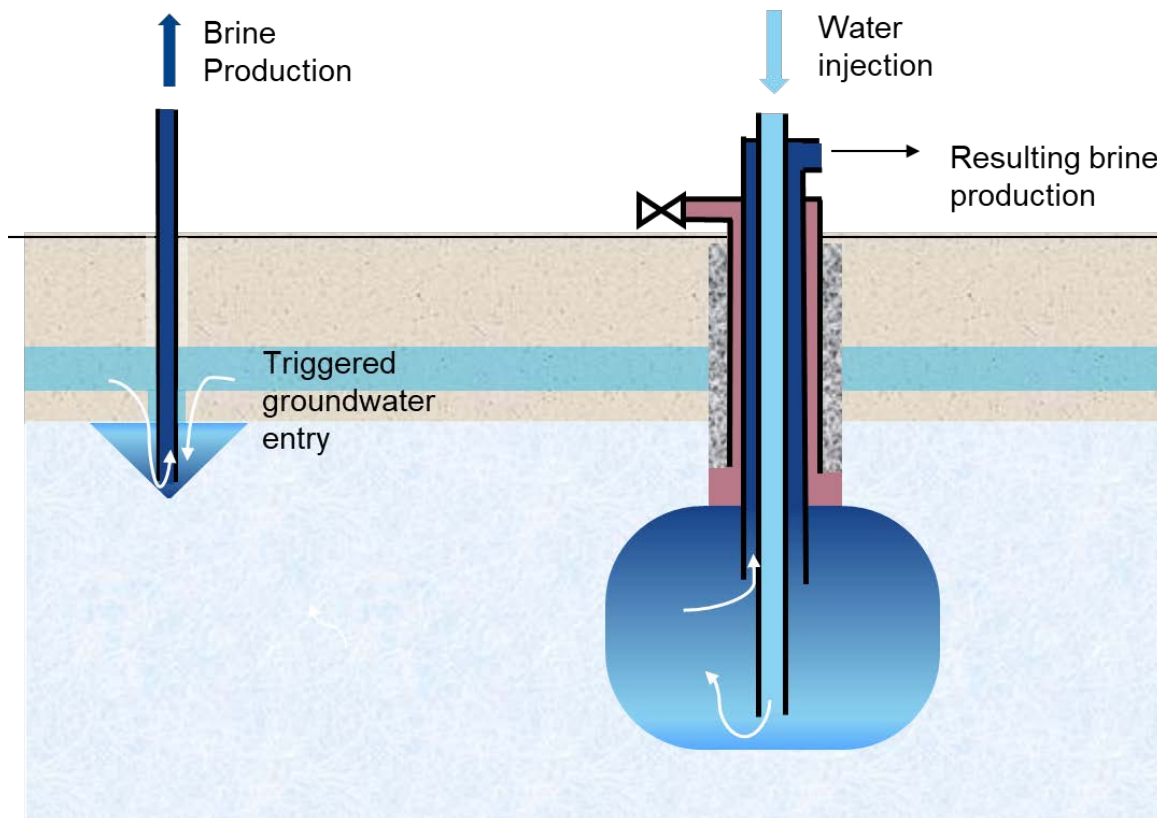

Figure 4: Left: early leaching through « Wild brining », leaching process is controlled by brine pumping out. It triggers a groundwater flow into the cavern. Right: modern solution mining, with a cemented well down to the salt formation, a blanket fluid preventing the leaching to rise above it. The leaching process is controlled by water injection. Here direct leaching is depicted; water being injected through the inner string at the bottom of the cavern. Reverse leaching with water injection in the annulus is possible too.

It is however difficult to generalize the evolution of the leaching techniques over time. Nicot (2009) has proposed a very interesting analysis of the oil and gas wells in Texas (USA), listing the progressive technical improvements that have been introduced over time to enable long term integrity. The age the wells were spud and the age they were abandoned are used to follow the technical improvements progressively added such as well centralizers (1930s), caliper logs (1940s), or cement tagging. Using age as the main metric of technical improvement assumes a homogeneous practice at a given time, which was relevant for the Oil and Gas industry in Texas due the regulatory drive (role of the Railroad Commission of Texas), the diffusion of good practices among the industry through the American Petroleum Industry (API) Standards, and also the size of the industry (“~ 1 100 000” O&G wells drilled in Texas alone, likely 2 orders of magnitude higher than the solution mining industry globally). Presenting evolution of techniques in the solution mining industry based on the age of the wells does not seem feasible at a global scale. It can be done per site specific, as presented in this report for 2 examples that both started in the 18th century and lasted for a century: Preesall (UK) and Tully Valley (USA). But dates for introducing new techniques are generally specific to one site, and techniques are still today relatively site-specific. For instance, the solution mining production in Vauvert (France) today is still using hydraulic fracturing to connect the wells, does not use sonar measurements nor a blanket system.

2.2.2. Examples of salt production in some selected brine field cases

Cheshire salt production, UK.

Cheshire, UK, has seen a very old human use of its salt spring (documented in pre-Roman ages), and has also seen the start of the industrial production of underground salt. The history of the production is summarized in Cooper (2002) as follows:

“The original method of getting the salt was to tap into the natural brine springs, a technique that satisfied the Roman and Medieval salt industries. In the 16th to 18th Centuries the demand for salt became much greater and wells were sunk on the sites of the brine springs to tap into the deeper more concentrated and more reliably available brine. From the late 16th Century reciprocating pumps were developed to draw up the brine.

From the 18th Century onwards, boreholes with pumps were developed and the extraction of even deeper brine became possible. The technique was to tap into the natural underground brine runs that mainly existed at the interface of the rock salt and the overlying deposits and collapsed materials. This method of uncontrolled brine extraction was referred to as “wild” brining. [...] this uncontrolled way to abstract brine that caused the enlargement of the natural brine runs and resulted in widespread subsidence for considerable distances from the extraction points. The large-scale abstraction of brine in this way enhanced the development of the natural salt karst into an unnatural form.

In the late 19th and early 20th Centuries the salt deposits were worked mainly by two methods: conventional mining and wild brine solution mining. Most of the conventional mining was in shallow “pillar and stall” mines with networks of tunnels commonly separated by narrow salt pillars. In many places the salt was also worked by pillar and stall mining based on very large extraction rates and very small pillars for support. Many of these mines were fairly near to the wet rock head areas and flooding was a common hazard. Not wishing to waste valuable salt, many of the flooded salt mines were also pumped for brine, a technique referred to as “bastard” brining. This produced catastrophic mine collapse inducing surface subsidence on such an enormous and unprecedented scale that it destroyed whole areas of towns and factories. Around Northwich and Middlewich, the resulting subsidence was catastrophic and widespread.” As shown on Figure 5.



Figure 5: Damage at Castle street, Northwich, 1894, following “bastard brining”.

The following illustration from Cooper (2002) shows the various techniques for brine and salt extraction using the wet rockhead area and then the dry salt body in Cheshire, UK. It gathers on one site most of the evolution of the brine production techniques. From the left to the right, it shows:

- Natural brine springs or “wiches”
- Wild brine extraction: brine extraction through a well drilled to the salt, while fresh water flowed down to the top of the salt through the uncemented annulus
- Shallow mining: construction of salt mines near top salt, usually applying very high extraction ratio and implying high risks of flooding
- Bastard brining: pumping of the brine from the shallow mines after they were flooded
- Modern salt mining: dry mining with maintaining adequate salt thickness between the top of the salt and the underground works
- Controlled brine extraction, or solution mining : injection of water through a leaching string, production of brine through the annulus outside this string (in “direct leaching” mode, the opposite is possible as well and is called “reverse leaching”). The well is cemented down below the salt top, and a blanket fluid is used to hinder leaching the top of the salt.

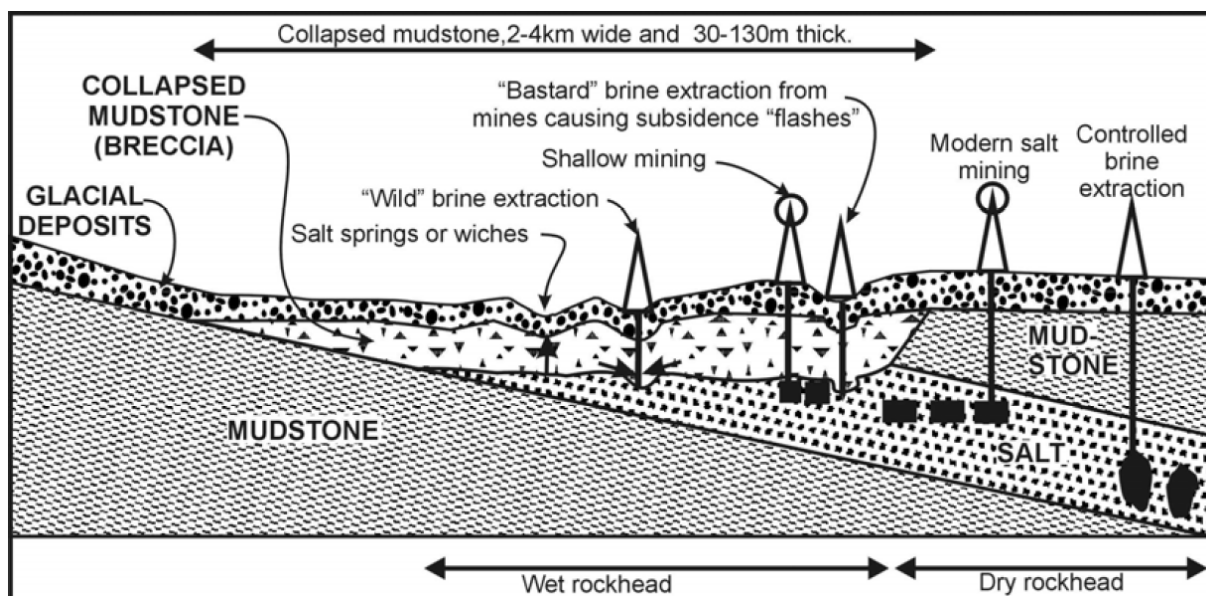

Figure 6: Cross-section through a typical Cheshire Triassic salt area showing past and present brine production techniques. From Cooper (2002)

Example of the salt production in Tully Valley brinefield, USA.

Sanford (1996) offers an interesting and educational summary of this solution mining historical case. Operations in Tully Valley, near Syracuse, New York, USA, started in 1888. By 1900, the operator was facing a decrease in produced brine pressure, and Sanford (1996) mentions a 1926 study stating that “40 to 60 % of the injected water was lost to “underground leakage”.” Water injection was reduced for cost saving reasons, and “starting in about 1930, casings were removed from some wells, allowing aquifer water to flow down though wellbores and dissolve salt, initiating a process that led to long time wild brining.”

The Tully valley solution mining is therefore quite unique from a tightness point of view: after having had, from 1888 to 1925, up to 40 to 60% of the injected water not recovered in the produced brine, it has on the opposite deliberately used wild brining techniques from the 1950s to 1986, producing brine without injecting water and relying on groundwater flow into the caverns. Referring to an internal report of the operator, Briggs and Sanford (2002) mention a salt extraction ratio of 64% to 75%, much

higher than what is practiced in modern solution mining fields, and what is required to ensure stability of the field.

We should also note that Tully Valley has also been the place where several inventive techniques have been implemented for the first time, in the objective of maximizing salt recovery:

- “roof padding”, which was a first version of the modern standard practice of using a blanket system to prevent from leaching the top of the salt. It was introduced by Edward N. Trump in Tully Valley in 1929. In the Trump plan, air is forced down with the water and forms a protective blanket between the salt above and the water, forcing solution of the salt to advance radially from the base of the well along the floor of the salt bed, and enabling to recover more salt. Air was mixed within the water injection, and must have been largely coming out with the brine, which was not an issue since an air lift system was also implemented to pump the brine. This is a 1st air blanket system, but was still quite far from the current practice of a static blanket fluid in a dedicated annulus (Figure 4, right).
- horizontal caverns creation by coalescing close wells drilled in 1928 and 1929. This has been implemented as a second option, after having done engineering studies for solution mining from horizontal tunnels that would have been drilled from a shaft (in some ways an early version of a horizontal well).

However, despite these innovations, the high extraction ratio and the uncontrolled nature of the salt production in Tully Valley resulted in significant and damaging subsidence, sinkholes, and groundwater impacts. Seven sinkholes were formed between 1949 and 1980. Subsidence monitoring stations installed between 1959 and 1980 have recorded a land surface significant subsidence, as much as 30 ft (10 m), that stopped after the end of the brine production (Figure 7). Hackett et al. (2009) report includes recent pictures, of the cracks, still visible today at the surface.

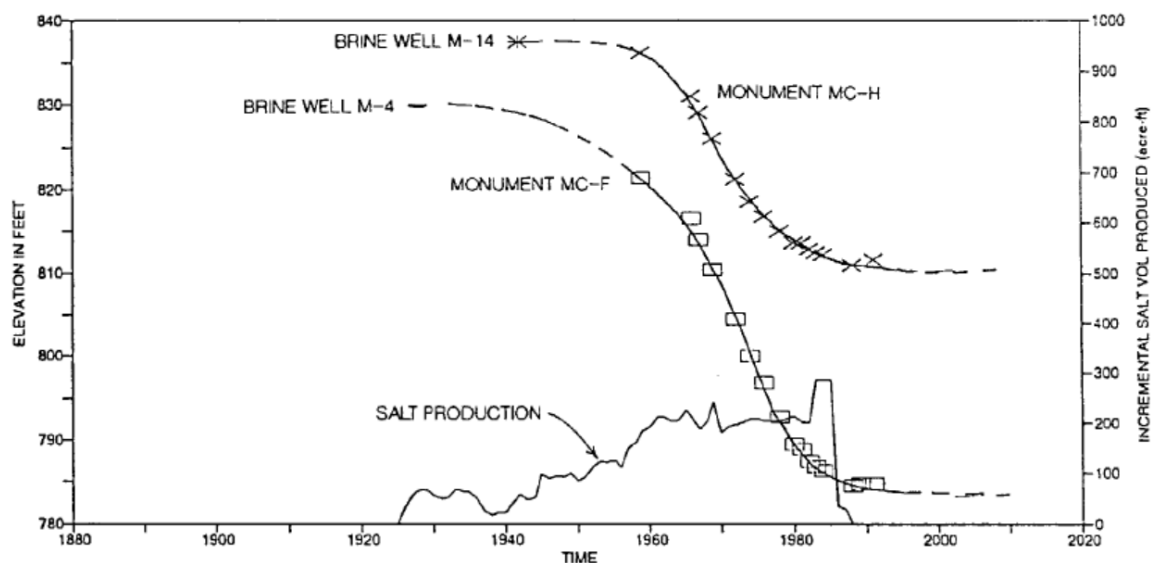

Figure 7: Subsidence salt production on the Tully Valley brinefield. Details can be found in Walker et al., 1993, from which this figure is taken.

During the century-long life of the brine field, 167 wells were drilled and 1.4 billion ft³ (40 million m³) of salt were removed. The solution mining of this site is however not representative of the solution mining at the time: Stanford (1996) also notes that 5 (other) solution mining facilities were active in New York, including three that have begun operation since the late 19th century as well, without similar damages or catastrophic subsidence.

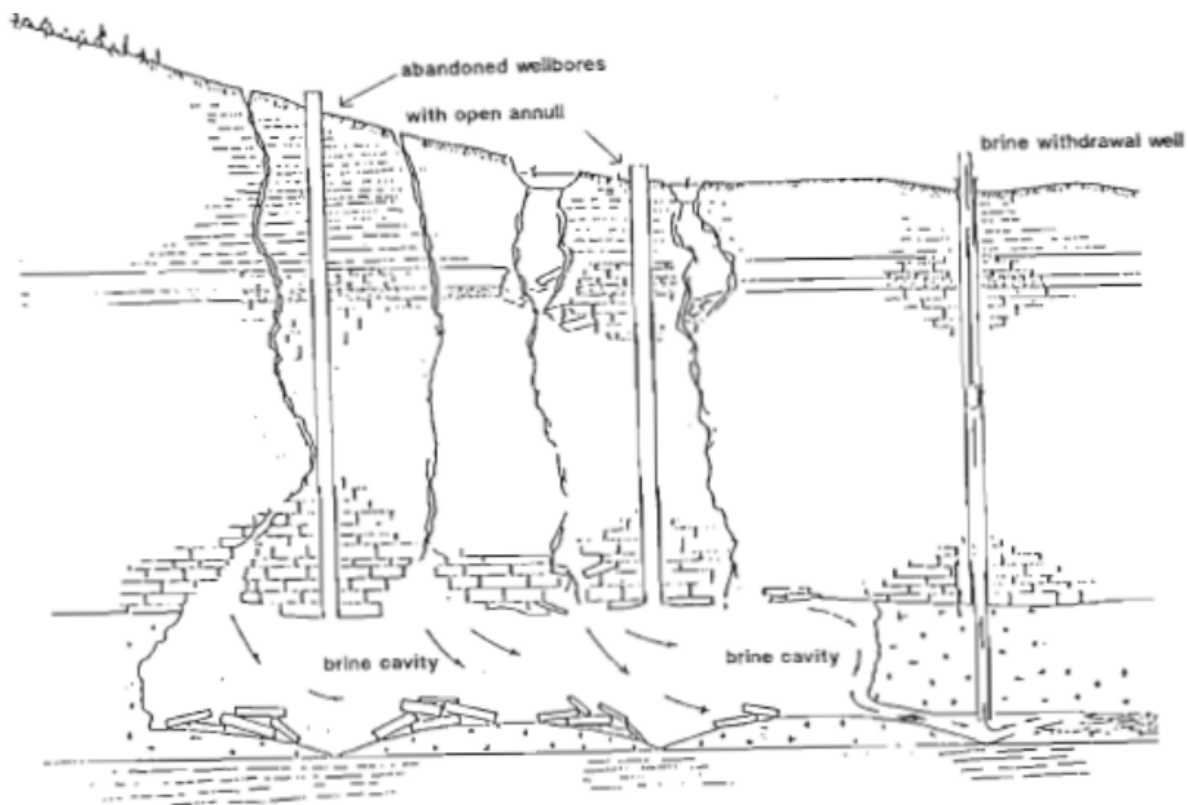

Figure 8 : schematic illustration of the Wild brining mining method applied at Tully valley. Brine cavity is recharged by groundwater through a flow in intentionally open wellbores (after the casings have been pulled out), as well as fracture associated with subsidence. Brine is probably produced using air lift. From Stanford (1996).

Example of the salt production at Belvedere di Spinello, Italy

Since 1970, salt has been solution mined at the Belvedere di Spinello brine field, in the South of Italy. According to Guarascio (1994), a multiple wells brining method was adopted in the initial development stage, from 1970 to 1986. In this method, hydrofracturing is first applied by injecting fresh water at 20 MPa, connecting one well to another. The wells being drilled down to a depth of 600 m (according to an interpretation of Fig. 2 of Gisotti, 1991), it means a downhole pressure of 26 MPa, and a pressure gradient of 0.43 MPa/m, much higher than the lithostatic pressure and than the fracturation gradient. The author reports that *"brine sometimes showed up unexpectedly at the ground surface in the pre-86 operations of multiple wells, especially during attempts to connect wells by hydro-fracking"*. Single-wells method began in 1986. Besides the fact that this multiple-wells brining method repeatedly caused surface subsidence and sinkholes in the 1980s and 1990s (as reported e.g. by Gisotti, 1991), brine occurrence at the surface during the hydraulic fracturing stage shows the absence of tightness of the solution mining wells.

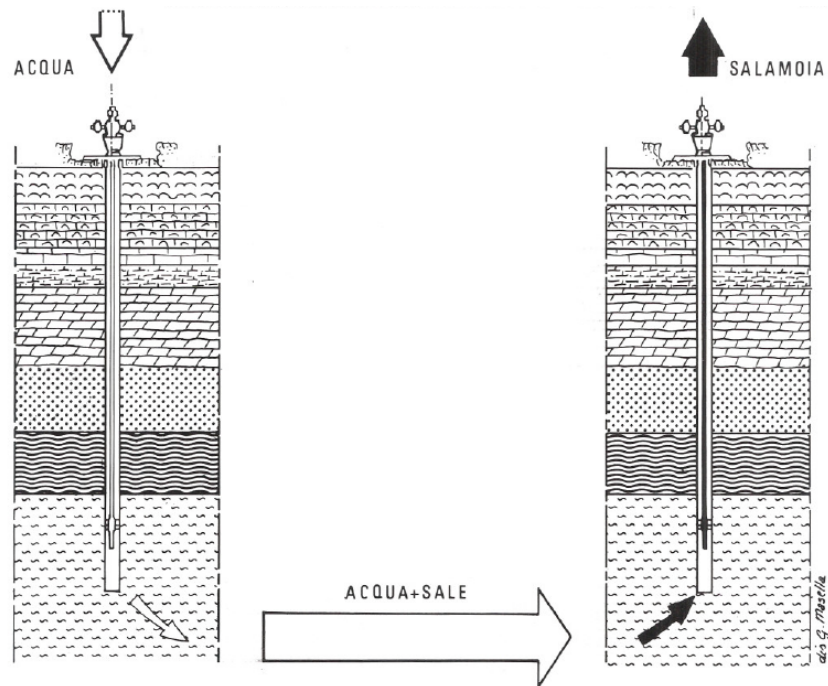

Figure 9. Schematic of the multiple wells brining method used from 1970 to 1986 at Belvedere di Spinello. From Gisotti, 1992.

Example of the salt production at Vauvert, France

Salt production has started in 1973 at the Parrapon concession near Vauvert in France. The salt formation is found between depths of 1900 and 3000 m. It is one of the deepest solution mining site in the world, likely the 2nd deepest one after Frisia in the Netherlands. The solution mining is described by Duquesnoy et al., 2013 as follows:

“salt is dissolved by circulating fresh water through fracture zones between an injection well and a production well (doublet) mutually connected by hydraulic fracturing. Periodically, the flow in the wells is reversed to avoid salt crystallization inside one of the wells. A roof blanket capable of limiting fast cavern growth in upward direction is not applied.

During the salt dissolution process casing joints are broken and insoluble rock sections, mainly containing anhydrite and clay stone, create a pile of crumbled blocs and particles falling at the bottom of the cavern. This debris forms a permeable sump, the pores of which are filled with practically immobile saturated brine. Above the sump the cavern gradually creeps upwards and contains a certain (limited) amount of freely movable brine. Solution mining without roof blankets creates cylindrical cavities of about 40 m in diameter and at least 500 m high. After definite brine production stop the caverns are left with the top section partially filled with freely movable brine. »

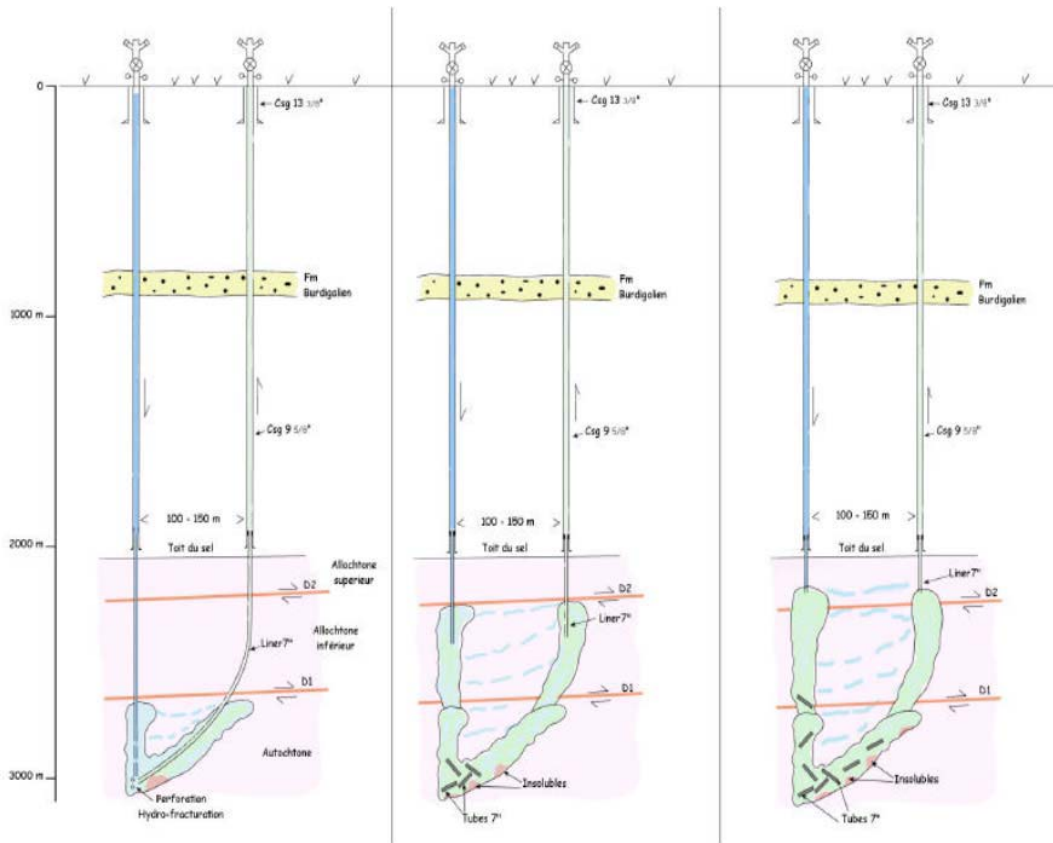

Figure 10: Schematic cross section of subsequent phases of salt leaching in Vauvert, France, by means of a doublet. Water injected in the well on the left circulated through cracks in the salt, dissolving it, and is produced by the well on the right. From Duquesnoy et al., 2013.

The solution mining done in Vauvert today therefore does not use some of the techniques seen as major improvements to the control of solution mining, such as avoiding hydraulic fracturing to connect the wells, using an inert blanket to prevent the rise of the leaching, or conducting sonar surveys to monitor the shape and growth of the leached cavity. On these aspects the leaching is similar to the techniques applied in Tully Valley a century ago. But, contrarily to Tully Valley, it does not use “Wild brining” nor uncased/uncemented wellbores. And a major difference is the depth of the salt that is mined (370 to 430 m in Tully Valley, 1900 to 3000 m in Vauvert), which mitigates the risks associated with surface subsidence and sinkhole creation.

This example shows that despite the efforts to standardize this solution mining industry, notably by SMRI through its bi-annual Conferences, Technical Classes and Research Reports, it is still an industry with many site-specific technical approaches, largely historical. This might be especially true for salt production, an industry that cannot afford the same design refinement, construction costs and monitoring equipment the storage industry does. Local experience and historical practice still have a strong influence.

Example of the salt production at Preesall, UK

Salt in the area near Preesall was first discovered by accident in 1872, during an exploration program looking for iron ore. Salt was mined by dry and wet mining, and by solution mining through wells. As summarized by Hough et al. (2011), following the salt discovery, “an exploration shaft was sunk, and brining commenced via this and subsequent brine wells, principally located immediately north and

south of the Preesall mine, which opened in 1894 in the shallower, eastern part of the brinefield.[...] Despite efforts to the contrary including pumping and the sinking of additional shafts, brine entered the mine through the roof in 1920, possibly sourced from the original exploration shaft. The mine eventually closed in 1930, due in part to the dissolution of pillars within the mine. Part of the mine subsequently collapsed in 1934, with a 5 acre area eventually subsiding and flooding with the formation of a surface subsidence pond.” After the collapse, brining of the mine continued in 1941 with 7 wells being drilled in the upper parts of the mine, and one brine production well in a deeper part, associated with WWII war effort. Besides this dry and “bastard” mining of salt mine, Sofregaz 1998 reports that “by 1890, attempts were made to extract natural brine at rock head. By 1893 forced wells were drilled, and extraction of the salt continued by this method until air blanket control was introduced in 1960.”

Monitoring in this solution mining field was poor: *“Until 1940 when a seismic method of cavity surveying was introduced, there was no means of knowing anything about the shape of the “forced wells”. The volume was known from the weight of salt extracted, and the rise of the roof into the marl was deduced from the hooking of the casing and tubing and also dipping of the cavity floor. Cavities often connected together without warning but this in itself did not prevent continued operation.”* (Sofregaz, 1998)

The seismic survey of 1940, combined with data from hooking of casings and dipping of cavity floors, showed that while a number of cavities has exposed marl roofs, others had developed a more or less spherical shape within the salt.

Full air blanket control was introduced in 1960 with cavity development proceeding with cavities of 80 meters diameter and 110 meter spacing and a salt cover being left above the roof of the caverns. The review of historical cases of man-induced sinkholes over salt formations shows that most of them happened over caverns that did not left such salt cover at the top of the salt formation

2.2.3. Tightness of the cavities left in the ground from the early brine production fields
Leaching first started where it was the easiest: groundwater was used to leach the top of the geological layer of salt (“wild brining”). This produced low salinity brine, created heavy subsidence and frequent sinkholes at the surface, and only enabled to mine the top of the salt layer. To prevent the risk of sinkhole creation and increase both the extraction ratio and the salinity of the produced brine, salt producers started drilling deeper in the salt. They also introduced a blanket fluid to limit depth up to which the leaching took place, enabling to extract more salt from the bottom of the formation and to produce higher salinity brine by connecting adjacent caverns. When the leaching was stopped prior to reaching the top of the salt, the remaining salt beam at the top could help preventing sinkhole creation. In addition, the cementation of the wells down to the salt formation developed, partly as it was needed for hydraulic fracturing that enabled the rapid production of saturated brine through a limited number of wells.

All these efforts to get more saturated brine, more rapidly, and to increase the salt extraction ratio while preventing sinkhole creation at the surface therefore led the brine extraction industry to leave caverns fully lying within the salt formation and connected to the surface with a well entirely cemented down to it. Caverns that could be tight: the only access to them was the wellhead.

The brine production industry therefore transitioned from wild bring technique and leaching of the top of the salt, for which tightness was usually not possible as a groundwater influx was required (in the extreme case of Tully Valley brine field 40% to 60 % of the injected water was lost to “underground leakage” from 1888 to 1925, and the field was then operated without water injection, relying on

groundwater), to the production of caverns that could be tight in principle. Although, it was not a main objective and was not always done. It is for instance reported in Belvedere di Spinello (where the hydraulic fracking used to connect new wells in the 1970s to mid-1980s sometimes created brine outflows at the surface). But the brine production through the creation of potentially tight caverns will become a standard for many brine production sites.

2.3. Brief history of storage in salt caverns

2.3.1. Development of the use of salt caverns for storage

As shown in the history presented above, the salt production industry came out to create cavities filled with brine within the salt formation itself (and not at the top of it) and connected to the surface through a cemented well. The use of the cavity left when the salt is gone has started about 8 decades ago. The first storages were done by converting wells that had been solution mined without particular consideration to their subsequent use for storage. Storage caverns have then rapidly been built on purpose, whether the brine extracted to produce the desired underground cavity was used or not.

The oldest public reference to underground storage in salt caverns is a Canadian patent application of June 30, 1944 (Pattinson, 1944). The application covers both gases and liquids. It is interesting to note that the listed advantages are still the ones claimed today: *“the danger from fire and explosion is practically eliminated”* through the absence of oxygen, the fact that gas *“may be delivered to users at faster and more uniform rates”* than if storage would have been done in depleted fields, and the *“substantially impervious cavity in a natural rock salt”*. Moreover, caverns were then developed for extracting salt, and were seen as free: *“the formation of the cavity is a self-liquidating expense through the recovery of the salt”*.

Thoms and Gehle (2000) propose a “Brief history of salt cavern use”, from which most of the dates exposed hereafter are :

- Early 1940s: 1st liquid storage by converting of cavern mined for brine production (Canada, during WWII). The first oil storage cavern was commissioned in 1969 in France.
- 1950s: LPG and light hydrocarbon storages spread in North America and Europe
- 1950s: 1st crude oil storage in UK, following the “Suez Crisis”.
- 1959: Disposal of alkali waste from local soda ash plant in Holford brinefield, in the UK. Organic residues generated off site were deposited as well in special designated caverns.
- 1961: 1st natural gas storage by converting a cavern mined for brine production in Michigan, USA. It might had been done earlier in Kansas, USA, or UK before. The first caverns engineered for gas storage were built in 1963 in Canada, 1970 in the USA, 1970 in France or 1971 in Germany
- 1973: 1st storage of Hydrogen in UK
- 1978: 1st storage of compressed Air Energy Storage (CAES), in Germany
- 1990s: 1st storage of Helium in Russia

From this history of storage salt caverns, we note that for both liquid and gaseous products, it started in North America, followed by Europe a decade later. We also note that for first liquid hydrocarbon storage in Canada in the 1940s, waste disposal cavern in the UK in 1959, and gas storage in the USA in 1961, the storage was based on the conversion of a brine production cavern that had not been built

for a storage or disposal purpose. For gas and liquid storages as well as for waste disposal, caverns engineered purposely for storage or disposal only followed.

Why has storage not started before is hard to tell. A hypothesis would be that a State reason was necessary to initiate the use of these salt caverns that had been created and left unused for decades by the salt production companies. To support this, we note that strategic reasons have been key to trigger creating the first storages, at least for oil storage that led the way: WWII is behind the first storage in Canada, while in Europe the aftermath of the Suez 1956 crisis have resulted in the first storage in UK (in the late 1950s) and France (in the late 1960s). Storage to cope for fluctuating demand (typically for natural gas) or to provide a logistical buffer (typically for LPG) has followed.

2.3.2. Current status of the salt caverns storage industry

There is no exhaustive, global census of the salt cavern sites based on mandatory declaration. However, in their “Update of SMRI’s Compilation of Worldwide Salt Deposits and Salt Cavern Fields”, Horvath et al. (2018) have surveyed for the SMRI a large part of the industry, and besides the improvement of previous compilations of salt deposits, they have included a list of solution mining or salt cavern storage sites. Under some conservative hypotheses⁶, it enables to deduce table 2 summarizing the current status of the salt cavern storage industry:

Table 2: number of storage salt cavern per stored product and per region

Stored product \ Number of:	Other regions		USA and Canada		Global	
	caverns	sites	caverns	sites	caverns	sites
LPG	20	8	860	56	880	64
Natural gas	511	57	186	36	697	93
Liquid hydrocarbon	172	16	233	24	405	40
Waste	1	1	7	3	8	4
Helium	7	2			7	2
Hydrogen	3	1	3	3	6	4
Nitrogen	3	2			3	2
Compressed air	2	1	1	1	3	2
Total	719	88	1289	123	2008	211

We also note that Horvath et al. (2018) statistics are not fully complete or up to date. When the update was known without further research, it was applied. For instance, there a CAES cavern was considered in the USA instead of 0 (Mac Intosh, operating since 1991), and the 4 caverns listed under LPG storage for the Carresse site in France were not (only 3 were propane filled, and anyhow the site was abandoned in 2015). The above-given numbers should therefore not be considered as precise numbers, but rather as the best publicly available effort to compile the storage salt caverns globally.

⁶ Main hypotheses used for compiling the table, and remarks:

- LPG includes butane, propane, but also ethylene, propylene and natural gas liquids
- When several products are stored in a given site without mention of the split of the caverns in terms of number of caverns from a given product, the split is made proportionally.
- When the number of caverns was only known in an approximate manner, the lower bound was taken (e.g. 10 caverns when « 10-11 » or « >10 » was mentioned).
- Only operating cavities are considered. Caverns under construction or abandoned are not.
- Some sites are active but the number of caverns is not indicated. Only the minimum, 1 cavern, is considered

Horvath et al. have provided their results per country, but only the USA and Canada have been distinguished from the rest of the world caverns, as it is interesting to see the 98% of the LPG caverns are located in these 2 countries. This shows that the petrochemical industry in the USA heavily relies on LPG caverns, which is more limited elsewhere.

We also note that in terms of number of storage caverns, the development of the storage industry is relatively limited outside Europe and North America. Various factors might be behind this fact, one being that some continents, notably Asia or Africa, have fewer favorable geological settings for developing storage salt caverns.

2.3.3. Leakage incidents in the history of the storage salt cavern industry

Réveillère et al. (2017) have done, under the support of SMRI, an extensive compilation of 21 past incidents in storage salt caverns whose description can be supported by public information. Loss of tightness of the access well in a dozen storage sites was further analyzed in Bérest et al. (2018). This is to be compared to the ca. 2000 storage caverns operated worldwide.

The oldest incident reported in these works dates from 1973. It is a leakage from a LPG storage cavern in Elk city, Oklahoma, USA. In February 23, 1973, a landowner discovered huge rocks that had seemingly erupted from his smooth pasture land (Figure 11). It took until March 9 to relate this to the propane storage cavern located 700-m away, after gas sampling in the soil revealed a propane content that could not have been natural. Right after, the storage operator of that cavern, Shell, tested the tightness of the cavern at halmostatic pressure (i.e., a gradient of 0.012 MPa/m) as follows. The brine string of the storage was connected to a surface standpipe and the operator tracked the level of the brine. *“A drop of 75 inches was observed in the standpipe over a 13-hour period, indicating a total loss of about 30 gallons of liquid per day, presumably propane”* (Fay, 1973). At the time of the incident, the conclusion was that it was the leakage that could have allowed sufficient buildup of propane over time to lift the rocks as observed. Réveillère et al. (2017) suggest that the pressure drop observed in the standpipe could also have been created by a 0.05 K/day temperature change, i.e. a 0.027 °C temperature decrease in the cavern during the 13-hour long test. Which cannot be dismissed.

In this case, the leakage was evidenced by its impacts at the surface. A tightness test was not much needed but was done, but through a hydraulic test that can hardly be conclusive, as presented in section 4.1.

Tightness tests aim to deliver the opposite: an accurate assessment of whether there is a leakage prior to any evident surface or groundwater impact, enabling mitigation measures to be taken.

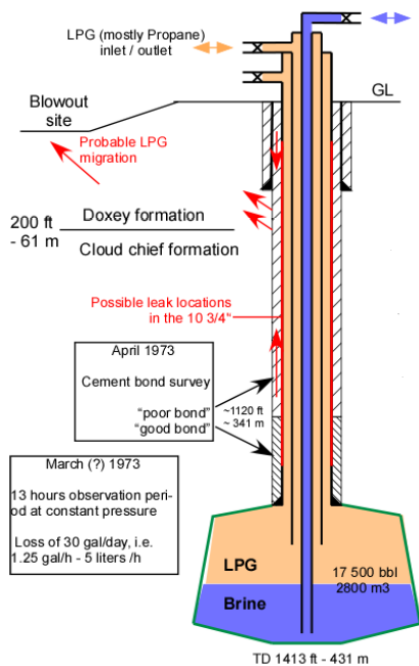

Figure 11 : Elk city blow out. Schematic of the leakage scenario (in red) and summary of the post-incident investigations (left, from Réveillère et al., 2018) and of the results of the LPG blow out – without ignitio - at the surface (right, from Fay, 1973)

2.4. The requirement to test the tightness of salt cavern wells

2.4.1. The requirement for testing the “Mechanical Integrity” of injection wells

After the use of salt caverns for storage was one to two decades old, Bays (1962b) gave relatively extensive technical guidelines for the creation of caverns specifically designed for storage. It included conducting a hydraulic pressure test of the well itself and *a priori* of the casing shoe area once the well is spud and prior to the leaching start: “*pressure test of the casing string is usually desirable before any drilling out is done. This is best done hydraulically and can simultaneously be used to test the final casing head and fittings, if these are installed.*”. The Elk City hydraulic test, in 1973, is the oldest public reference found of a hydraulic test applied to an entire salt cavern, but it is done to investigate after a leakage, and not in prevention of it, and consists in a non-accurate hydraulic test (cf. section 4.1). In the USA, posterior references, such as Van Fossan (1983), mention the practice of hydraulic testing as a standard practice, which is still the case 10 years later as shown by the responses to an industry-large questionnaire (cf. Appendices of Crotonino, 1995). In France in the 70s and 80s, first storages, whether oil or gas, had the ambition to conduct more sophisticated and accurate tightness tests than hydraulic tests. As exposed by Dubois (1982), tests very close to a Pressure Observation Test (POT) were conducted by Geostock for the first liquid underground storage of Géosel (storage operation started in 1969). And as described by ATG, 1985 (and also summarized in Bérest, 2007), tests based on a method close to an above ground balance method were conducted on the first natural gas storage caverns developed by Gaz de France (now Storengy) in Tersanne (a site started in 1970). From these examples of practices in the USA and France during the first decades of the storage cavern industry, it is unclear whether these tightness tests of storage salt caverns were a regulatory requirement or a good practice, and how generalized they were. The standardization and generalization came soon after with the concept, and obligation in the USA, of “Mechanical Integrity Tests” (MIT).

The terminology of « Mechanical Integrity Test » of salt cavern wells was coined in the United States, deriving from a US Federal requirement imposing to test the mechanical integrity of injection wells. It has been the most decisive event that prompted technical developments and a wide industrial deployment of very accurate tightness test of salt caverns wells. Even if not substantially originating from the salt cavern industry. In 1974, the Safe Drinking Water Act (Public Law 93-523) was enacted, and required the US Environmental Protection Agency (EPA) to promulgate minimum requirements for State programs which prevent endangerment of underground sources of drinking water by injection wells. This statutory mandate formed the basis for the Underground Injection control (UIC) Program⁷. As stated in Brasier (1990), who worked for the EPA, *“EPA considers mechanical integrity testing (MIT) one of the cornerstones of the UIC program.”* That regulation has introduced the concept of "Mechanical Integrity" Tests (MITs) of wells. The context that has led to this regulation helps understanding the goals and requirements of this MIT.

In its general information about injection wells, the UIC⁸ mentions the *“widespread use of injection wells began in the 1930s to dispose of brine generated during oil production”*, and that in the 1950s *“chemical companies began injecting industrial wastes into deep wells”*. As chemical manufacturing increased, so did the use of deep injection, which led to first legislations and first incidents. McCurdy (2011) delineates the first US state regulations in the 1950s, the first earthquake attributed to a deep injection well and the first case of potential contamination of a drinking water aquifer in the 1960s. It is in this context that, in the 1970s, the Safe Drinking Water Act gave the Environmental Protection Agency's (EPA) the authority to control underground injection, and required EPA to develop minimum federal requirements and UIC program, covering systems used for injection of hazardous materials through cased borehole penetrating usable water aquifers. This regulation defined 5 well classes at the time (6 nowadays, the sixth being CO₂ injection wells for geological sequestration), including the brine production wells (within Class III wells, along with sulfur, uranium or copper solution mining wells) and storage cavern wells (within Class II wells, along with other injection wells related to the Oil & Gas industry: brine disposal, enhanced oil recovery). According to Van Fossan (1983), *“the Act appears to have originally been oriented toward injection wells disposing of hazardous wastes into non-usable water aquifers, and then was expanded to cover all injection wells, including salt cavern wells.”* We note that the oil and gas exploration or production wells, in which a fluid is not injected into the underground from the surface, are not subject to this regulation.

The Act imposes testing the "mechanical integrity" of the wells every 5 years. *“Mechanical integrity is defined as the absence of significant leaks in the casing, tubing, or packer (40 CFR Section 146.8(a)(1)), and the absence of significant fluid movement into a USDW through vertical channels adjacent to the injection wellbore (40 CFR Section 146.8(a)(2))”*. The former is commonly known as internal mechanical integrity and the later as external mechanical integrity (hence the fact that MITs are sometimes called External Well Mechanical Integrity Tests or EWMIT). This fluid movement can occur either from the injection zone or from other zones or aquifers: *“fluid movement external to a well's casing has, in general, been termed significant if fluid (either injection related or non-injection related) migrates into a USDW or out of the permitted injection interval.”* CH2M Hill (1995).

Testing the "Mechanical Integrity" as defined by the SWDA is therefore not exactly a tightness test of an underground storage:

- In a literal reading of the UIC definition, the mechanical Integrity applies to the well, not the cavern. This interpretation is confirmed by Crotofino 1995 who mentions *“The US regulations for salt*

⁷ <https://www.epa.gov/uic>, visited on 05/02/2020

⁸ https://www.epa.gov/uic/general-information-about-injection-wells#well_def visited on 05/02/2020

caverns refer exclusively to the tightness of the last cemented casing and its cementation, but not the cavern.” However, in practice, accurately proving that a salt cavern underground storage is tight essentially comes down to accurately proving that the well is tight. Fluid migration through pure salt takes place, it is a process called “brine permeation” when brine is the fluid migrating, but it happens at a exceedingly low rate (cf. estimations in Bérest et al., 2001). Salt is frequently called “technically tight” in the salt cavern industry, and is explored by the oil and gas industry because it has proved being a sufficiently tight caprock to trap oil or gas for millions of years. Moreover, such migration is homogeneous in a large volume of salt, which does not expose to the same consequences as a localized leak along a well does. However, rare cases of leakage through the cavern walls have been gathered in Réveillère et al. (2021, Chapter 7 “hydraulic connection”): Clovelly cavern 14 at the Louisiana Offshore Oil Port -LOOP-, where the breaches coincides with an anomalous zone toward the adjacent flank of the salt dome; Centana 1 and Gladys 2 caverns, likely related to the presence of a very soluble non-salt layer; and Mont Belvieu 2E and 16E, related to an anomalous zone. We also note that some tightness tests applied to a whole cavern volume, such as “Gas-Filled Cavern MITs” (Skaug, 2019), are named “Mechanical Integrity Tests”. These 3 cases are related to anomalous geological zones

- In a literal reading of the UIC, testing the “mechanical integrity” is not exactly testing the tightness. It means testing that there is no significant movement of fluid - originating from the cavern or not- reaching a drinking water aquifer. As Van Fossan 1983 states *“Generally speaking, the term “proving the mechanical integrity” of the system is considered by State Agencies to relate solely to the integrity of the final casing string and its cementation. Any fluid escaping the confines of this segment of the system is considered to move directly into the aquifer containing the USDW to an unacceptable degree regardless of how small that quantity might be.*” We may see both practical (proving than there is no external leak is in most cases the most practical way of proving than there is no leakage from a well to a drinking water aquifer) and conservative reasons behind the fact than the proof of the mechanical integrity falls into a proof of the tightness.

The protection of US drinking water therefore led to a legislation imposing testing the external “mechanical integrity” of the wells in the 1970s, and initiated the development of “Mechanical Integrity Tests”, now a widespread terminology used worldwide throughout the salt cavern industry, with sometimes varying meaning or concepts behind it. We hereafter consider its current meaning, which is testing the tightness of the salt/cement and cement/casing bonds at the last cemented casing shoe. Internal Mechanical Integrity Test, such as packer tests, is left out of the scope of the “Mechanical Integrity Test”.

Last, we have to mention that the UIC has evolved since its creation in the 1970s: it has continued producing technical memoranda, or guidance documents, maintained in a complete list⁹. Moreover, US States may establish Primacy under the Act provided they promulgate and enforce rules and regulations that are more stringent than the Federal one, defined in the Act. UIC Programs are therefore either EPA regulated, or state regulated, with UIC programs operated by the state. Ratigan (2019) shows that the large majority of US States have now established such rules, and even prescribed acceptable techniques.

2.4.2. The status of tightness test requirements outside of the USA

In Canada, Canadian Standards Association has published CSA Standard Z341, Storage of Hydrocarbons in Underground Formations, which also covers cavern mechanical integrity tests. The Canadian

⁹ <https://www.epa.gov/uic/uic-technical-and-program-guidance> visited on January 3, 2020.

standards stipulates confirmation of the external well mechanical integrity in the completed cavern via an interface test with e.g. nitrogen; no Minimum Detectable Leak Rate (MDLR) is defined. The test must be repeated after five years and thereafter at longer time periods. The situation is therefore very similar to what is applied in the USA.

In contrast to North America, there is currently no uniform set of regulations governing salt caverns in Europe, thus integrity tests are still carried out in different ways.

In Germany, according to Bernhardt, 2019, tightness of storage wells is a regulatory obligation: *“Before the beginning and after the completion of the solution mining process an integrity test must be carried out to prove the tightness in the area between the last cemented casing and the geological formation. [sec.41 §3 cl. 1 BVOT]”*

In France, each application for a new storage well has to include a detailed test procedure proposal. The applicant has to take into account current engineering and state of the art practices. This leads to a variety of testing techniques. For instance, all natural gas cavern are operated by Storengy, whose procedure is described in Hévin (2019): tests are done using diesel-oil LLI prior to leaching start and to gas conversion. When testing liquid storage caverns, Geostock performs nitrogen-brine MIT before leaching (at the maximum operating pressure during leaching, plus a margin) and a diesel-brine LLI test prior to the conversion into storage (at the maximum operating pressure during storage, plus a margin).

In the UK, as described in Bernhardt (2019), no law sets out explicit prescriptive technical requirements regarding underground well barrier systems (e.g. integrity tests). However, an applicant for a new well will be assessed against *“Good practice”*. The situation is therefore quite similar to the French one. When designing, and conducting MITs in the UK, Geostock applied Nitrogen/brine MITs with in-situ mass balance interpretations.

During the last decade, Geostock has also been designing, supervising and interpreting MITs in a handful of other countries, where regulation usually does not impose precise technical requirements. The approach has been essentially similar to the above-described for France or the UK: generally, a test procedure is proposed and has to be approved by a regulating authority and/or the client. Geostock proposed nitrogen/brine MITs, or diesel-brine MITs when the cavern is to be operated for storing liquids, and interpret the test through an in situ mass balance method as described in Réveillère, 2019. This is derived from Crotofino, 1995, proposed standard, except that mass balance are done rather than volume balance.

2.4.3. Are Tightness test techniques and requirements similar for brine production and storage caverns?

From a technical standpoint, we note that most brine production wells now use blanket systems to control the leaching, and most use diesel oil as the blanket fluid (cf. schematic of modern solution mining on Figure 4). In these wells, diesel oil being in contact with the cemented casing shoe, and with the cement/salt and cement/casing interfaces during solution mining, the tightness is necessary to ensure that diesel-oil will not leak. Van Fossan (1983), one of the main and first authors describing Nitrogen-Brine MITs when working for the brine production company Texas Brine, was for instance concerned by *“the volume of pad material escaping”*. However, the quantity at play, circa 10 m³, is 3 to 5 orders of magnitudes lower than the quantity of stored fluid in an oil storage cavern.

From a regulatory point of view, in the USA the UIC regulation applies to both storage wells (within Class II) and salt production wells (within Class III). However, as mentioned by Crotofino (1995), *“North*

American companies differentiate between two basic testing principles, depending upon whether a well is considered a class II or class III well according to EPA regulations:

- *Class II wells: storage cavern wells (require quantitative verification e.g. by interface tests)*
- *Class III wells: brine production wells (require qualitative verification on the basis of well logs, e.g. temperature logs)."*

The frequent use of a diesel oil blanket during leaching, and the similarity between a solution mining well and a storage well could suggest that similar tightness tests are applied. In theory they can, in practice they often do not. For instance, we note that SMRI has proposed 3 Technical Classes focused on MITs, with the inclusion of brine production wells only explicitly in the scope of the first one:

- "Mechanical Integrity Testing of Brine Production and Storage Caverns", in 1998
- "Gas Storage Mechanical Integrity, Testing and Procedures" in 2007
- "Mechanical Integrity Testing (MIT) and Techniques in Gas and Liquids Storage Caverns" in 2019

SMRI has also produced 4 Research Reports focusing on the Mechanical Integrity Tests, 2 being dedicated to storage wells, 1 to brine production, and 2 encompassing both:

- Crotonino, 1995, focuses on storage wells
- CH2MHill, 1995, focuses on brine production wells, but includes a presentation of nitrogen/brine MIT
- Nelson and Van Sambeek, 2003, addresses MIT of gas-filled caverns, a subset of the storage caverns
- Van Sambeek et al., 2005, entitled "Improvements in MITs for solution-mined caverns used for mineral production or liquid product storage", addresses both.

In the next sections, the present work will focus on the storage wells as, in this case, MITs are a generalized industrial practice. Although the techniques that are developed are applicable to brine production wells too.

3. Development of the Mechanical Integrity Test techniques

3.1. Introduction to the main types of MITs

Mechanical Integrity Test methods for solution-mined salt cavern have been well established in several publications, as exposed in §2.2. The testing methods are most often classified by the test medium, the main two MIT types being:

- **The nitrogen/brine MIT**, when a small part of the cavern is filled with nitrogen. Other gases may have been used instead in exceptional cases, or are considered: gases that were or will be stored in the cavern, such as hydrogen (Bérest et al., 2021)
- **Liquid-Liquid interface MIT (LL MIT)**, when a small part of the cavern is filled with a liquid hydrocarbon. Diesel oil is usually used, but the stored liquid or liquefied hydrocarbon can also be used.

Tightness test with the whole cavern entirely filled with the test fluid also are possible. These types of MIT are usually named:

- **Hydraulic Test**, when the cavern is entirely filled with brine.
- **Gas MIT** when the cavern is entirely filled with natural gas
- **Long duration tests**, when the liquid storage cavern is nearly entirely filled of the liquid hydrocarbon stored product

This classification based on the type of test fluid may be the most common, but it is not fully homogeneous throughout the industry, and tests are sometimes named by the test interpretation

method applied to them. In this work, we propose to distinguish types of tests (characterized by the test medium, cf. table 3), and the test interpretation method (presented in section 2.2). In the literature, the distinction is not always explicit. We note that:

- the **nitrogen/brine MIT**, is also known as Nitrogen In-Situ Mass Balance method in Europe. It can also be named Nitrogen Leak Test (NLT) or Nitrogen Interface Test (NIT). “MIT” also refer to it as it is the most common test method.
- **Liquid-Liquid interface MIT** (LL MIT) is also known as a Fluid Leak Test (FLT) or Liquid Interface Test (LIT), or diesel In-Situ Mass Balance. LL MIT methods include the Pressure Observation Test (POT) or Pressure Difference Observation (PDO) test.

Table3: Types of MITs per type of test fluid

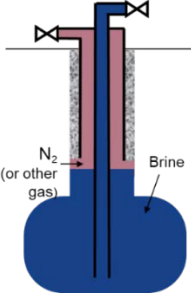
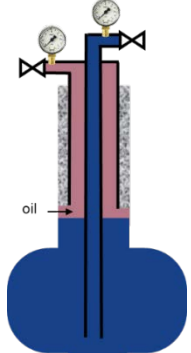
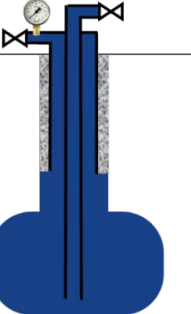
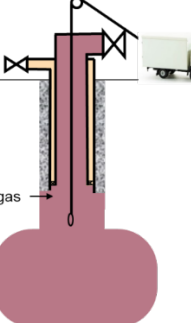
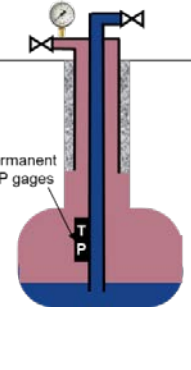
Most used name and description	Schematic of the cavern	Main interpretation methods (*: also used to name the test)
<p>Nitrogen/brine MIT</p> <p>Injection of nitrogen to form a gas column in the annular space, down to below the last cemented casing. The central string remains filled with brine, and is generally used to pressurize the cavern up to the test pressure. The test duration is generally 24, 48 or 72 hours.</p>		<ul style="list-style-type: none"> - In-situ volume balance - In-situ mass balance - Pressure Observation Test* - Pressure Differential Observation Test* - In-situ compensation*
<p>The Liquid-Liquid Interface (LLI) tests</p> <p>Injection of a liquid hydrocarbon to form a column in the annular space down to below the last cemented casing. The central string remains filled with brine, and is usually used to pressurize the cavern up to the test pressure. Most of the time in North America, the storage product is used. The test duration is generally 24, 48 or 72 hours.</p>		<ul style="list-style-type: none"> - In-situ volume balance - In-situ mass balance - Pressure Observation Test* - Pressure Differential Observation Test* - Above ground balance method*
<p>Hydraulic test</p> <p>It is the standard tightness test for surface tanks. It has been the first tightness evaluation method applied, in a widespread way according to Van Fossan (1983) or Crotogino (1995)</p>		<ul style="list-style-type: none"> - Hydraulic test interpretation - Pressure Observation Test*
<p>Gas cavern MIT</p> <p>Pressure is increased to the test pressure by gas injection in a cavern already in gas storage operation. Two pressure and temperature logs, generally separated by 24, 48 or 72 hours, enable to do a mass balance of the gas in the cavern. This method is essentially used in the USA, where several States require MITs every 5 years even on gas caverns</p>		<ul style="list-style-type: none"> - In-situ mass balance
<p>Long duration tests</p> <p>These tests (usually not called "MIT") are done on a cavern in liquid storage operation. The cavern is rose to its test pressure by brine or product injection, and is usually nearly filled with the stored product. The test is based on long term analysis of wellhead and downhole the pressure and temperature measurement. Tests usually last several months.</p>		<p>There are specific but no global practice to interpret these tests. Interpretation is different than other tests as additional effects, such as cavern creep, should be considered. It is not detailed in this work.</p>

For nitrogen/brine MITs, other gases could be used and would be about equally good from a test accuracy point of view. Nitrogen is the most common gas used for MITs since the beginning thanks to other advantages: it is one of the cheapest industrial gases, and, as already noticed by Heitmann (1987) *"it is safe to handle, does not react with most stored products, is readily available in most locations, has known physical*

3.2. Introduction to the main interpretation methods

The major benefit of salt caverns is that their tightness can be tested. Test interpretation relies on a fail / pass criterion based on measured pressure, volume or mass changes of a test fluid in the storage. This fluid either is in the whole cavern, or is in a small portion of it that covers most possible leakpath.

The following table summarizes the test interpretation methods practiced in the salt cavern industry.

Tests aim at measuring a pressure decay or leak rate, called Calculated Leak Rate (CLR) which relies on a difference between two volumes (for a volumetric leak rate) or mass (for a mass leak rate) measurements, divided by the time in between these two measurements:

- In a pressure interpretation, pressure is measured at least twice
- In a volume interpretation, volume is measured twice, or alternatively a volume change is estimated based on a pressure measurement and a compressibility of the test fluid. Thermal equilibrium has to be reached
- a mass interpretation requires measuring a volume of test fluid and its density (derived from a temperature log and a wellhead pressure measurement)

Continuous measurements are also possible.

3.2.1. Hydraulic test interpretation

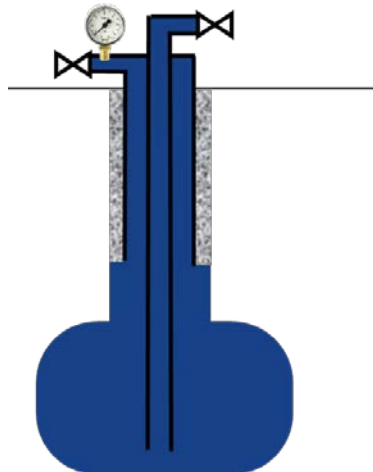

Figure 12. Cavern and main monitoring required during an hydraulic test interpretation

The test interpretation consists in pressurizing the cavern and observing the pressure evolution. Assuming that everything else is stable, a pressure decay is interpreted as a leak.

3.2.2. In situ volume balance

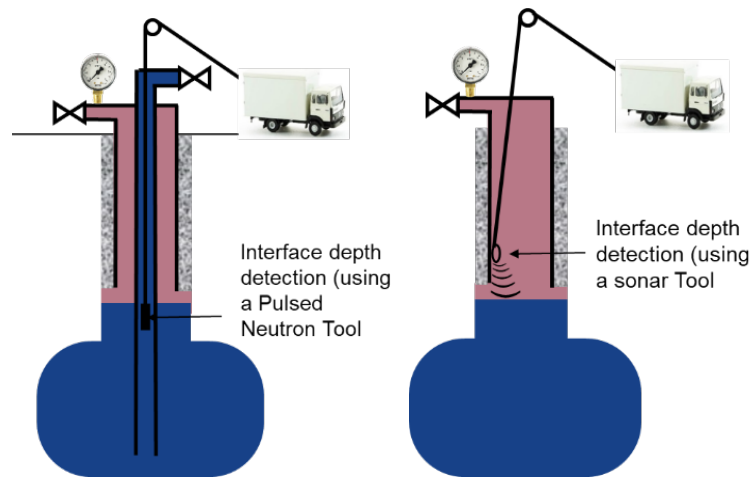

Figure 13. Cavern and main monitoring required during an in-situ volume balance. On the left, the interface depth detection between the test fluid and the brine is done through a PNT run, whereas on the right it is done using a permanently clamped sonar tool

The interpretation is done by measuring the interface depth based on a downhole measurement.

The balance of volumes occupied by the test fluid (nitrogen, or liquid hydrocarbon) is deduced from the cross sectional area (“section”) at the interface depth (usually measured prior to the test through a caliper log, sometimes through a sonar acquisition) and the measurement of the interface depth change.

Downhole techniques to measure the interface depth are depicted on Figure 13, and listed hereafter:

- The main logging technique used to measure the interface depth is a Pulsed Neutron Tool (PNT), emitting neutrons and detecting gamma rays, which enables to detect changes in the environment at the tool depth between brine and a gas or a liquid hydrocarbon.
- using a sonar tool, for instance the “SoMIT” tool from the company SOCON clamped on the well
- using transducers attached to the outer wall of the inner brine string.

The volume difference divided by the test duration gives the Calculated Leak Rate (CLR), expressed in m^3 or bbl of test fluid per day or year. When assuming a constant density, the CLR can be expressed in kg of test fluid per day, which is for instance done by Crotagino (1995). But this method is still essentially an in situ volume balance, up to a constant multiplier (the assumed constant density).

3.2.3. In situ mass balance

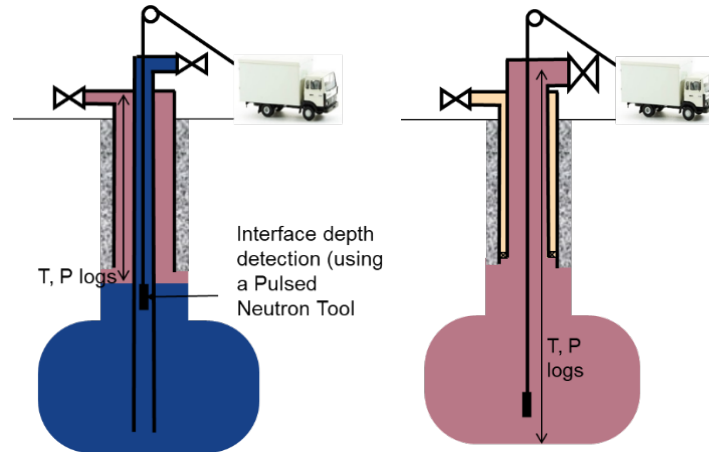

Figure 14. Cavern and main monitoring equipment required during an in situ mass balance. Wireline runs are needed to measure a temperature log along the test fluid, and deduce the density of the test fluid. On the left, only the top portion of the well is filled with the test fluid (gas – usually nitrogen – or liquid hydrocarbon) down to an interface, whose depth also has to be measured during the run. On the right, in the gas cavern MIT, the test fluid is the stored gas.

This is a slight variation of the in situ volume balance. The interface depth measurements enable to determine the volume occupied by the nitrogen, while the temperature logs enable to estimate the density along the well. Combining both enables to calculate the mass balance, even with unstable thermal conditions.

For nitrogen-brine type of MITs, it is done by Geostock, but *a priori* relatively rare in the industry, many relying on in-situ volume balance. When the thermal equilibrium is reached, there is no difference.

For Gas-MIT, it is the only interpretation method that is used. In that cases, the volume of test fluid is very large (the whole cavern), but is constant between the two mass measurements of the mass balance.

3.2.4. Pressure Observation Test

The Pressure Observation Test interpretation consists in the following two steps:

- measuring the cavern compressibility by recording pressure changes and volume injection during a pressurization of the cavern.
- observing the wellhead brine and liquid hydrocarbon pressures of the cavern over the test period. This pressure change is then converted into a leak rate by multiplying it to the cavern compressibility.

The calculated leak rate (CLR) is obtained by multiplying the pressure decay rate (in psi/day or MPa/day) as it is observed at the wellhead by the cavern compressibility (in bbl/psi or m³/MPa). Cavern compressibility, which is proportional to cavern volume, can be measured when liquid is injected in the cavern to build up cavern pressure at the beginning of the test. The method is usually used for large span cavern without a neck, typically for the caverns found in the thin Hutchinson bedded salt formation in Kansas (Thiel, 1993).

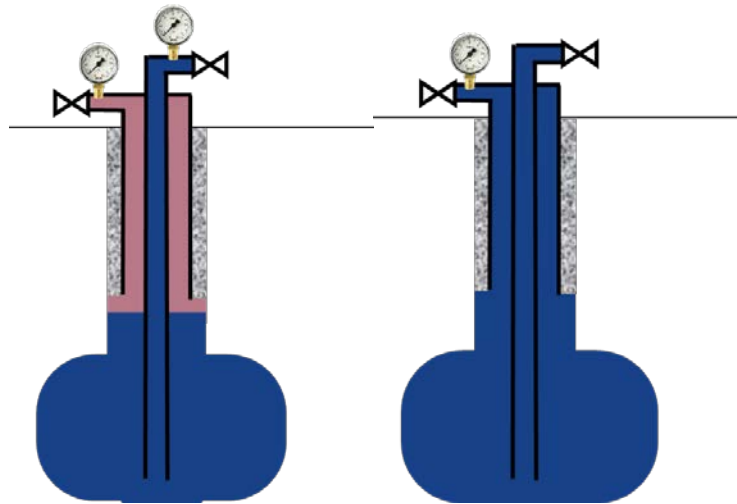

Figure 15. Cavern and main monitoring equipment during a POT. In the most referenced cases, POT is done with an oil-brine interface lowered down to below the casing shoe. But it could also be done with a cavern fully filled with brine, or with nitrogen instead of oil.

An example of the measurements by Thiel and Russel (2004) is presented in the Figure 15.

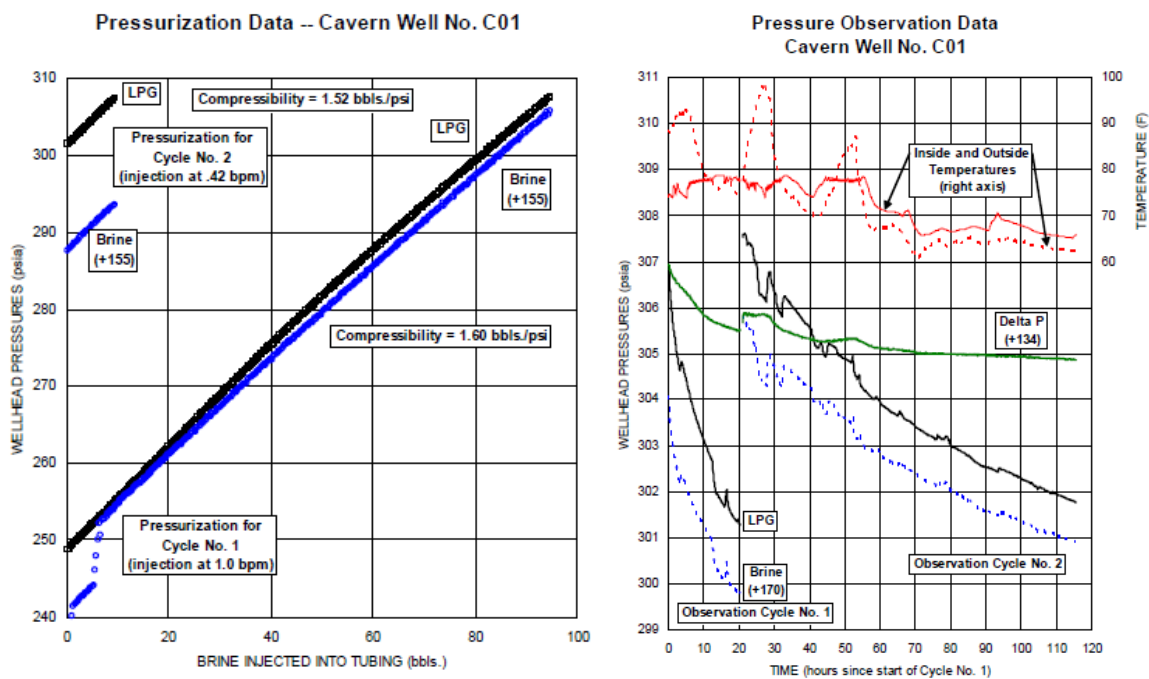

Figure 15. Left: the cavern compressibility is measured during the pressurisation¹⁰ Right: Pressure decay during the test¹¹. From Thiel and Russel, 2004.

¹⁰ the plotted brine pressures were increased by 155 psi so they could be plotted on the same scale as LPG pressure.

¹¹ Two different curves are plotted associated with two observation cycles, separated by a re-pressurisation of the cavern after 20h of test.

The main advantages of this interpretation method is that the cross section at the interface depth does not have to be known. For a given volume, the method is equally accurate for a large span cavern (typical in Kansas), or for a cavern with a narrow neck.

Having two fluids and an interface is not needed for this interpretation Pressure Observation Test interpretation. It is justified by Thiel (1993) by the lower viscosity of nitrogen that would give more chances to observe a leakage: *“a brine full pressure test is not considered valid. The theory is that at least the casing and casing shoe area (the top of the open hole) should be in contact with a fluid less viscous than brine to more accurately simulate normal operating conditions. The casing and casing shoe areas are the most likely leak paths and it is conceivable that a cemented annulus that is relatively impermeable to brine could be considerably more permeable to a hydrocarbon liquid (or gas).”* It also enables observing the two pressures, as parallel curves indicate an absence of leak. This judgment in a POT is qualitative (Figure 17), a Pressure Differential Method is needed to quantitatively assess a leak from surface pressure measurement.

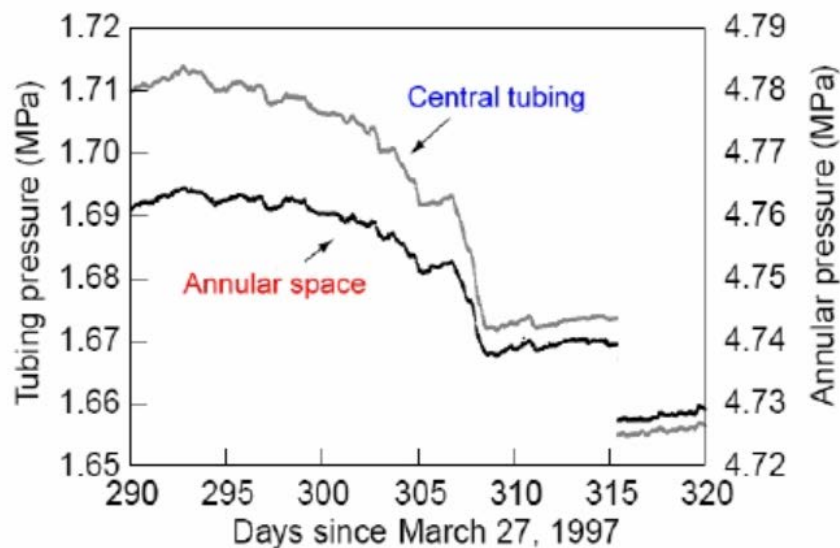

Figure 17. Annular Space and Tubing Pressure During a Well Leak. The two curves are parallel before Day 293 (no leak) and after Day 315 (leak repaired). Not in between, due to a surface leak at the wellhead. From Van Sambeek et al. (2005)

3.2.5. Pressure Differential Observation Test

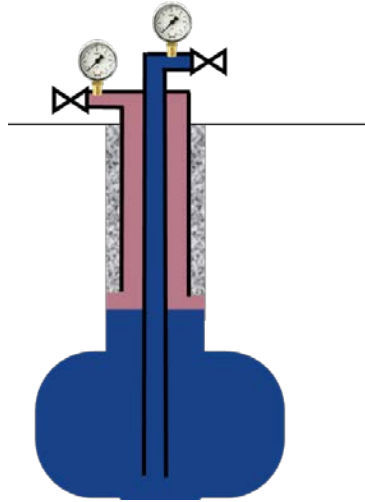

Figure 19. Cavern and main monitoring equipment during a PDO.

Pressure Differential Observation Test (PDO) is also based only on pressure measurements at the wellhead. The pressure differential between the brine and nitrogen wellhead pressures can be used to estimate the interface displacement. The method could therefore be considered a “in situ volume balance” as it is one, even without a direct measurement of the interface depth.

3.2.6. In-situ compensation

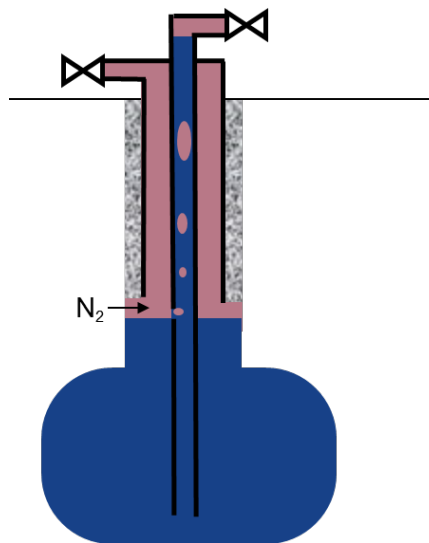

Figure 20. Cavern and main monitoring equipment during a nitrogen-brine MIT interpreted by an in-situ compensation method.

For In-situ compensation interpretations, a dedicated tubing is run into the well, equipped with a weep hole positioned slightly below the last cemented casing shoe. Nitrogen is injected in the annulus as in any type of interpretation of nitrogen/brine MIT.

Instead of measuring the interface depth change, the volume of nitrogen possibly lost by leakage is compensated by injecting more nitrogen until the original interface depth at the weep-hole is reached again. Which is observed by collecting the nitrogen at the top of the inner string.

The interest of this method is that, contrarily to the other in-situ balance method (including the PDO), it makes use of a stable interface. Knowing the section of the borehole around the interface depth is not needed as the interface does not move, and it can be applied in large sections of the borehole or cavern without impacting the test accuracy.

This method was developed and implemented by the German company UGS, a subsidiary of Geostock.

3.2.7. Above ground balance method

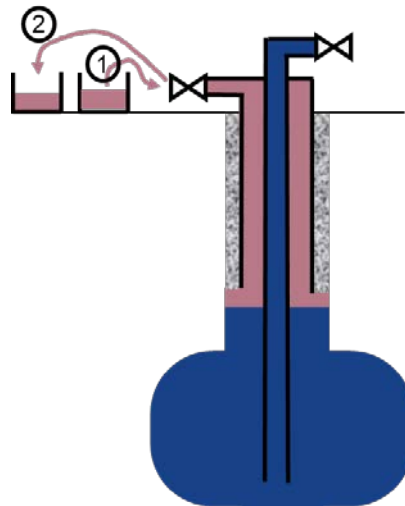

Figure 20. Cavern and main monitoring equipment during a Liquid-Liquide Interface MIT interpreted by an above-ground balance method.

In this method, the test medium, usually a liquid hydrocarbon, is injected into the well down to below the last cemented casing shoe, where it remains over the test duration and is then released and collected. At ground level, the injected and recovered test medium volumes are measured as accurately as possible: the volume difference of the test medium, corresponds to the volume potentially lost down in the well.

The two main drawbacks of this method are that the test fluid can be trapped in the cavern and not be recovered, although not being a leak either and that when the cavern has already been in operation, stored product can be released from a trap and mix with the test fluid. This questions the ability to interpret the measurement as leak rates. Advantages of the method is that interpretation is not impacted by non-equilibrated downhole conditions during the test, and that virtually no information on the cavern (sonars, well completion diameters, etc) is needed.

This method has essentially been used in Poland.

3.2.8. Summary of the interpretation methods used for the various types of MITs

The major benefit of salt caverns is that they can be tested for tightness. Test interpretation relies on a fail / pass criterion based on measured pressure, volume or mass changes of a test fluid in the storage. This fluid either is in the whole cavern or is in a small portion of it that covers most possible leak paths.

The following table summarizes the test practiced in the salt cavern industry according to the test type (which test fluid, and whether it occupies the whole cavern or only a small portion of it) interpretation and methods that is used.

All MITs aim at measuring a leak rate, often named Calculated Leak Rate (CLR) which relies on a difference between two volumes (for a volumetric leak rate) or mass (for a mass leak rate) measurements, divided by the time in between these two measurements.

The following tables propose a summary of the types of tightness tests and the interpretation that are applied to them in the current or past industry practice. The interpretation methods contoured in bold will be further developed in section 4.

Table 4 present tightness test types with the whole cavern filled with the test medium (brine, gas or oil), or nearly all of it.

Table 5 presents tightness tests (or MITs) using a test fluid from the surface down to an interface between that test fluid and brine, testing the well and the borehole section of interest only. These techniques benefit from the fact that salt caverns present a remarkable advantage (when compared to depleted reservoirs): borehole tightness can be tested and conclusion drawn for the entire cavern, as the borehole opens in a closed “container” (the cavern itself), which is almost perfectly tight.

Table 4: main types of salt cavern tightness tests when the test fluid occupies the whole cavern (or nearly all of it), per type of test fluid and per interpretation method. Formulations of the Calculated Leak Rate (CLR) and of the Minimum Detectable Leak Rate (MDLR) are exposed in Section 4 for bold boxes cases.

Test type per test fluid	Practiced test interpretation methods. Based on a difference of:		
	Test fluid Pressures	Test fluid volumes	Test fluid masses
<p>Brine in the whole cavern</p> 	<p>Hydraulic test</p>  <p>Standard in the case of tightness tests on surface tanks. A priori not practiced as a test.</p>	<p>Pressure Observation Tests (POT)</p>  <p>A priori not practiced as a test; the POT is rather done with a test fluid interface.</p>	<p>Not practiced</p>
<p>Gas in the whole cavern</p> 	<p>Not practiced as a test (normal monitoring, at cavern pressure)</p>	<p>Not practiced</p>	<p>In-situ mass balance</p>  <p>Practiced in North America</p>
<p>Oil in most of the cavern</p> 	<p>Not practiced as a test (normal monitoring, at cavern pressure)</p>	<p>Not practiced</p>	<p>Long duration test</p>  <p>Practiced e.g. in France</p>

Table 5: main types of salt cavern tightness tests, or MITs, when the test fluid occupies a small volume relatively to the cavern volume, per type of test fluid and per interpretation method. Formulations of the Calculated Leak Rate (CLR) and of the Minimum Detectable Leak Rate (MDLR) are exposed in Section 4 for bold boxes cases.

MIT type per test fluid:	Practiced test interpretation methods. Based on a difference of:		
	Test fluid Pressures	Test fluid volumes	Test fluid masses
<p>Nitrogen/brine MIT</p> 	<p>Not practiced as a test</p> <p>(observed to ensure cavern stabilization prior to the test)</p>	<p>In-situ volume balance</p>  <p>Main MIT practice.</p>	<p>In-situ mass balance</p>  <p>Other main practice, e.g. by Geostock</p>
		<p>Pressure Observation Test (POT)</p>  <p>Practiced for flat roof case</p>	<p>In-situ compensation</p>  <p>Practiced by one company (UGS)</p>
		<p>Pressure Differential Observation test (PDO)</p>  <p>Practiced by some, e.g. Brouard Consulting</p>	

MIT type per test fluid:	Practiced test interpretation methods. Based on a difference of:		
	Test fluid Pressures	Test fluid volumes	Test fluid masses
Liquid-Liquid Interface test (LLI) 	<p>Not practiced as a test</p> <p>(observed to ensure cavern stabilization prior to the test)</p>	In-situ volume balance  <p>Interface depth detection (using a Pulsed Neutron Tool)</p> <p>Main practice for LLI, using the stored product (caverns in operation in North America)</p>	In-situ mass balance  <p>Interface depth detection (using a Pulsed Neutron Tool)</p> <p>T, P logs</p> <p>Other main practiced, e.g. by Geostock</p>
		Pressure Observation Test (POT)  <p>Practiced for flat roof cases</p>	Above ground balance  <p>Practiced in Poland</p>
		Pressure Differential Observation test (PDO)  <p>Practiced by some, e.g. Brouard Consulting</p>	

3.3. Introduction to the selection of a test pressure

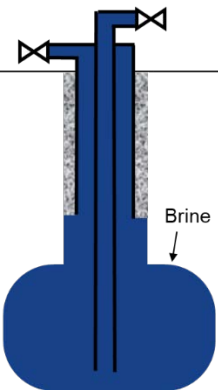
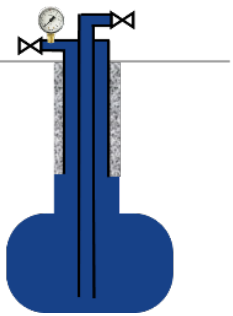
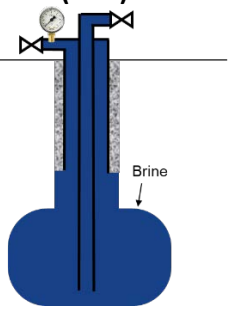
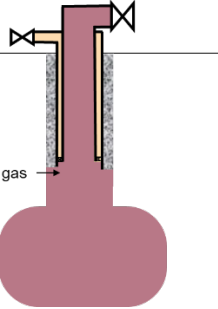
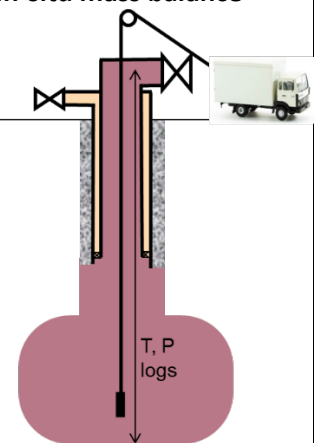
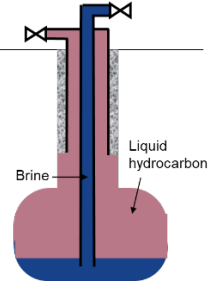
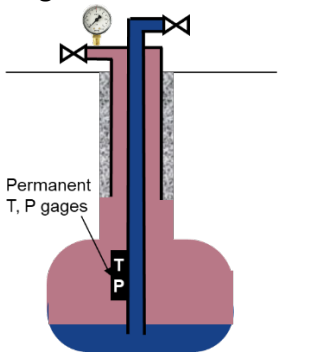
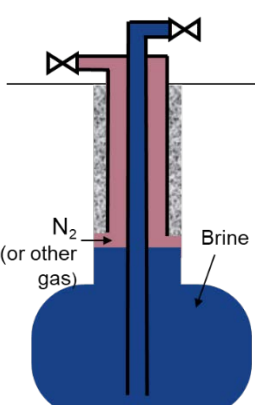
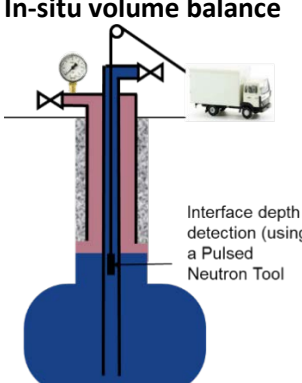
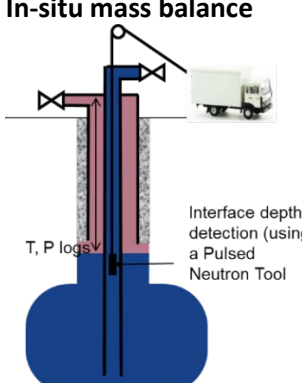
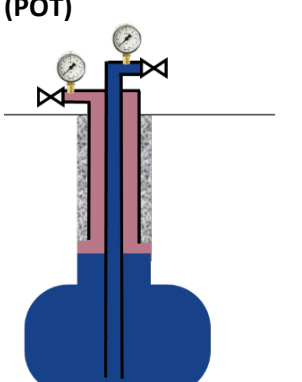
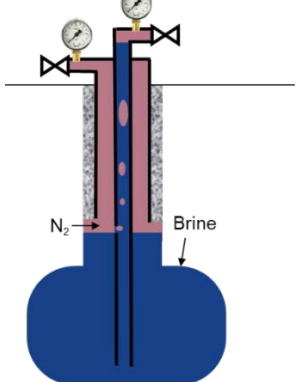
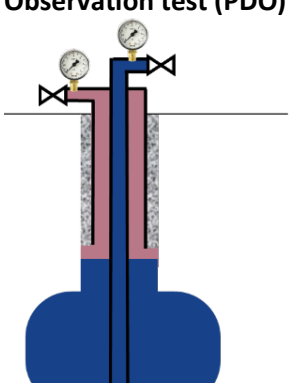
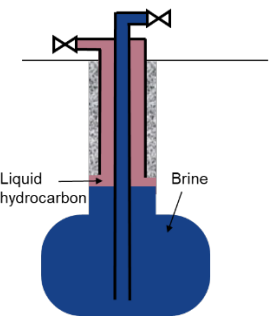
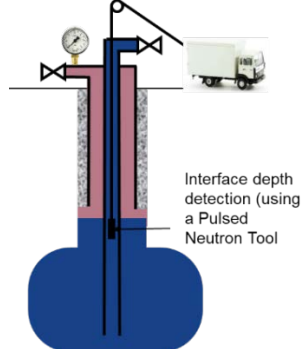
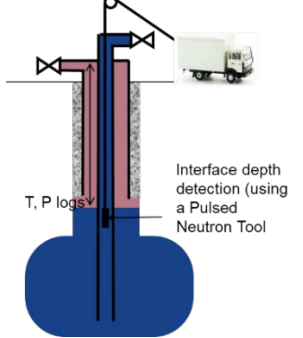
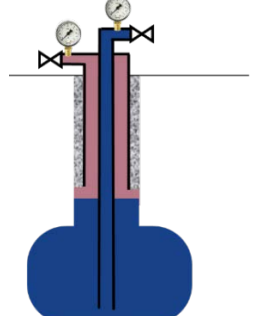
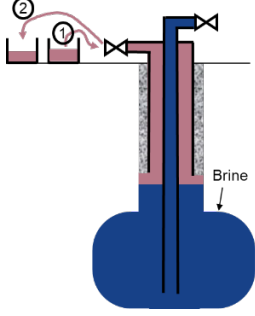
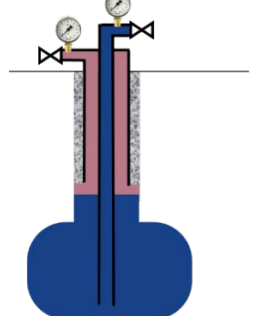
The test pressure must be equal to (as practiced in Carrico according to Quintanilha de Menezes et al., 2001) or larger than the Maximum Operating Pressure. In one of the first technical guidelines for storage salt caverns, Bays (1962b) proposes that *“The pressure test of the casing should be carried to a pressure above the probable operating or storage pressures that may be involved in the cavity*

operation, with a suitable margin of safety.”; Dubois (1982) for the first tightness test performed in Manosque (France), or Thiel (1993) in the USA, mention testing at 110% of the Maximum Operating Pressure. The balance has to be found between not risking to be harmful for future cavern and well integrity, and having additional confidence on the cavern tightness at maximum operating pressure.

The choice of the Maximum Operating Pressure itself is detailed by Bérest et al. (2000) and summarized hereafter. The tensile strength of salt is small, and cavern pressure must be kept lower than geostatic pressure or, more precisely, lower than the least compressive stress at the cavern wall. (Figure 21). The redistribution of stresses in the rock mass, due to the visco-plastic nature of rock salt, must be taken into account. In practice, the empirical approach for setting the maximum operating pressure, and therefore the testing pressure, is exposed as follows by Bérest et al. (2020) : “(1) estimating the weight of the overburden at cavern-shoe depth using density logs (density-based vertical stress), assuming that it equals the vertical stress, and (2) selecting a maximum admissible pressure that is a fraction (80–85%) of the vertical stress.” The Maximum Operating Pressure (and then the Testing Pressure) is therefore essentially chosen for not being harmful to the salt, but include a 15–20% margin of safety to take into account factors such as geological anomalies, imperfectly known physical or mechanical processes (secondary stresses), and possible cement weaknesses.”

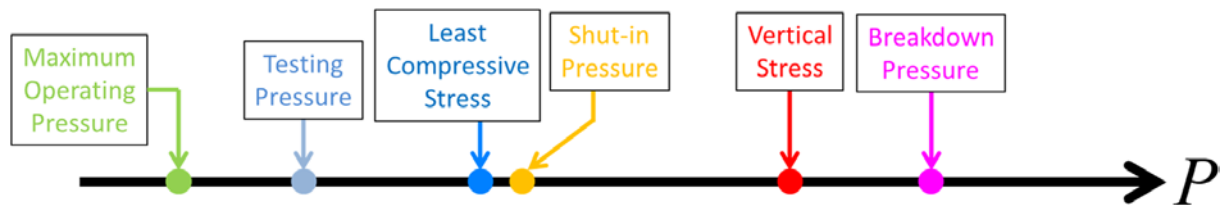

Figure 21: The testing pressure is selected above (or equal to) the Maximum Operating Pressure, and significantly smaller than the least compressive stress. From Bérest et al., 2020.

Hundreds of natural gas caverns have been operated worldwide for decades. Only a small number of leakages are reported (Réveillère et al., 2017). The rationale for setting maximum operating (and test) pressure is to prevent from opening a leak path:

- From the salt rock formation. Some hydraulic connections between adjacent caverns have been documented (Réveillère et al., 2021), and are analysed in Bérest et al. (2020) who note that “these connections originated in geological anomalies rather than in the creation of a fracture.”.
- from the well. The identified leakage mechanisms that involve a leak coming from the well originate in a welding flaw (suspected in the Magnolia case), a drilling issue (milling of the cemented casing happened during re-opening of an abandoned well in the Hutchinson case), a leaking connection (it happened in the Teutchenenthal case), or dome movements (suspected at Clute). Storage pressure played a critical role as a driving force of the leakage once a leakpath was open, but its role for creating a leak path in the well is not obvious in the cases reviewed by Réveillère et al. (2017) and Bérest et al. (2018).

We should also note that, interestingly and conversely, the minimum pressure played a role in opening leakpath in several cases. Due to the viscoplastic behaviour of salt and the fact that in a storage cavern pressure is below the initial geostatic pressure, cavern tends to close and this can overstretch the cemented casing. It has played a role in the leaks created by overstretching of the well in Epe, Eminence, and Boling cases presented in Réveillère et al. (2017) and Bérest et al. (2018).

Last, testing the cementation of the well, especially the salt/cement and cement/casing bonds at the casing shoe, is particularly the objective of Mechanical Integrity Tests (MIT) prior to start leaching (usually done at the maximum pressure during leaching) and prior to commissioning the storage cavern (at cavern Maximum Operating Pressure, or slightly above). Among the 12 leakage cases described in Bérest et al. (2018), none is documented as a leak at the salt/cement or cement/casing bonds. One reason may be that such leak would at the casing shoe would lead the well to fail the MIT. In such case, various techniques allow identification of the weak zones of the cement column and repair of the well before performing a second tightness test (see, for instance, McLeod et al., 2011 or Manceau et al., 2014).

3.4. Literature-based review of the development of MIT techniques

The Underground Injection Control Program left the technical testing options open, and more complex tightness tests were designed following the implementation of the USDW: *“the Act requires that such wells be proven to have “mechanical integrity”, but neither specifies parameters which constitute it nor the type or adequacy of proof required to demonstrate that it exists.”* (Van Fossan, 1983). Several techniques have soon been introduced. The literature that addresses the development of tightness testing is abundant, especially in the Proceedings of the SMRI Technical Conferences, where the question has been heavily discussed. This is summarized hereafter, continuing a literature review already started in Van Sambeek et al., 2005. The articles summarized in italic are quoted from this reference without substantial modification.

Dubois (1982) from Geostock exposes the tightness tests applied in the future oil storage of Manosque, France. The test relies on the in situ measurement of the cavern compressibility and of the cavern heating rate over time, and of the lab measurement of the brine cavern brine thermal expansion coefficient. These are used to fit a mathematical model of the cavern during the test period. The test is done by maintaining pressure over a quite long duration (15 days for the test exposed on figure 9 or the article). This test is therefore an extension of a Pressure Observation Tests, as thermal expansion is considered in addition to the compressibility. Dubois mentions a Minimum Detectable Leak Rate of $1 \text{ m}^3/\text{d}$ (2 300 bbl/y) in a $100\,000 \text{ m}^3$ cavern.

Goin (1983) from Sandia National Laboratory aims at deriving equivalent leak rates of the stored products (liquid or liquefied hydrocarbons) from leak rates measured through tests using nitrogen. His proposition is notably based on the viscosity differences between these products.

Van Fossan (1983) presents the basis of the nitrogen-brine Interface MIT, or at least the “NITRAC” proprietary procedure by Texas Brine to conduct them. We note Van Fossan addresses both solution mining (class III wells) and hydrocarbon storage wells (class II wells), putting the blanket fluid or the stored product under the same consideration. Van Fossan also mentions the established use of POT: *“Hydrostatic tests of open-ended cased boreholes and solution caverns have been universally used for many years, and material balances in brine wells (product loss experience in storage caverns) has demonstrated that if there is as little as + 10 psig change in the applied brine test pressure during a continuous 24-hour period, no loss of material will occur from the system.”* He suggests that this should however be replaced by nitrogen / brine MIT, unless the state requires to test the whole cavern and not only the well. Van Fossan and Whepley (1985) is very close to the above, with recommendations on how to conduct the test made more explicit through the attachment of the NITRAC Patent. It also enables for the correction of the pressure change during the test.

The ATG Manual (1985) describes an Above-Ground Liquid Balance Test performed before the first natural-gas injection in a leached-out cavern. A light hydrocarbon is injected in the annular space to a depth of 15 m below the last cemented casing shoe. Test duration is 4–5 days. The hydrocarbon mass is measured accurately at ground level before injection and again after withdrawal. The pass/fail criterion is a hydrocarbon loss rate smaller than 250 liters per day [91 m³/y or 570 bbl/y]. The test pressure is 110 percent of the maximum operating gas pressure.

Heitmann (1987), from PB-KBB, details the nitrogen-brine interface MIT procedure. Inject N₂ while logging, down to the required depth. Wait 1 day. Then initial interface, and “24 or more hours” latter, final one. Heitmann also wants to convert the results of the nitrogen test to the product volume stored using the results of Goin, 1983.

Vrakas (1988) discusses the cavern integrity program used by the U.S. Strategic Petroleum Reserve (SPR). This program includes 2 phases: a “Hydrostatic Testing” (i.e., Pressure Observation Tests) with caverns filled partly with oil and a nitrogen/brine interface MIT (“Nitrogen Interface” testing).

Diamond (1989) proposed the Water-Brine Interface pressure differential method which originally was designed to test multiple-well caverns operated for brine production. The cavern is filled with brine and wells are shut in. Soft water is injected in one well to fill all but the bottom 50 ft; the remaining wells remain brine filled. Any upward displacement of the water/brine interface results in a pressure drop at the wellhead, which is compared to the pressure evolution in a reference brine-filled well. The same method can be used in a single well equipped with a brine-filled central string, which plays the role of the reference well: soft water is injected in the annular space to create the brine-water interface.

Brasier (1990), from the EPA, presented the MIT requirements of his Agency, and supported the water-brine interface method proposed by Diamond (1989), while advocating against Pressure Observation Tests (POT), named “gallery test”, as “a massive leak would have to be present in order to detect any pressure decrease”, that, in addition needs to be distinguished from temperature and salt dissolution effects.

Thiel (1993) describes two test methods applied by his company, Phillips Petroleum Co., that owned and operated 57 solution mined cavern wells:

- the nitrogen / brine MIT, called “Nitrogen Leak Test”, for which a method to acquire a caliper of the neck of the cavern, a requirement for conducting interface-based MITs, is proposed. The cavern compressibility is first measured by interpreting the pressure difference when lowering a nitrogen blanket in the well annulus: *“the incremental increase in brine pressure is simply multiplied by the compressibility ratio to obtain the volume of test fluid injected into that interval”*
- the Pressure Observation Test (POT), named “Precision Pressure Observation Method”, as for bedded salt caverns, they *“had to consider that some had relatively broad, flat, roofs immediately below the production casing”*. A hydrocarbon cap is established in the cavern; the pressure evolution, as observed at ground level, is then converted into a leak rate by multiplying the pressure drop rate and the cavern compressibility.

In 1993, the SMRI started funding two research projects in the aim of standardizing the MIT techniques. The choice of ordering two reports is explained by Crotogino (1995) as North American companies differentiated between two basic testing principles, depending upon whether a well is considered a class II or class III well according to EPA regulations, which led to:

- Crotogino (1995) report, focused on Class II wells: storage cavern wells. Quantitative verification, such as nitrogen/brine interface tests, are developed
- CH2MHill (1995) report, focused on Class III wells: brine production wells. Qualitative verification on the basis of e.g. well logs are accepted

Crotogino (1995) is a major standardization effort. It summarizes 3 of the applied techniques: the nitrogen/brine interface MIT (called "*In-Situ Balance Method*"), the In-Situ Compensation Method (called as such), and the Above-Ground Balance Method. In addition, he proposes a reference value for the Minimum Detectable Leak Rate, or MDLR (resolution of the testing method), and proposes for the first time to use a different value for the Maximum Allowable Leak Rate, or MALR. These MDLR and MALR are mass leak rates.

CHM2Hill (1995) is a manual with a quite large scope, reviewing cement evaluation methods (CBL, calipers, CET, USIT, PET, SBT), temperature, oxygen activation or noise logging. It also considered nitrogen/brine MIT (called "Nitrogen Leak Test"), and proposed a volume-based interpretation of it: the "average leak rate" is obtained by multiplying the borehole section by the interface rise speed. Without considering thermal effects.

Bérest et al. (1995) point out that during nitrogen/brine interface MITs (simply called "MIT"), multiplying the annular cross section by the interface rise leads to a clear misinterpretation. Other phenomena have to be accounted for, essentially the temperature changes in the test fluid. It is the introduction of the concept of "real" and "apparent" leak rates.

Bérest et al. (2001) bring 3 significant improvements to the MITs:

- They expose further the need for distinction of three types of leak rates: apparent, corrected and actual leaks. The apparent leak results from a "naïve" interpretation of the observed pressure decrease (for POT) or interface rise (for nitrogen/brine interface tests). The corrected leak is obtained by accounting for quantifiable factors contributing to pressure or interface changes.
- They propose a novel method, the Pressure Differential Observation Test (PDO), based on the analysis of the evolution of the difference between the annular-space pressure and the central-string pressure, which is somehow an improvement of the method proposed by Diamond et al. (1989), with a liquid hydrocarbon replacing fresh water. They propose a mathematical formulation of the PDO interpretation, and suggest that with a pressure sensor accuracy of 1 kPa, the resulting accuracy on interface displacement is 20 cm, which is similar to a logging-tool accuracy
- They expose the results of what has probably been the first attempt to validate the nitrogen/brine MIT (called "Nitrogen Leak Test"): the simulation of artificial leaks by withdrawing calibrated amounts of brine or nitrogen in the EZ53 cavern at Etrez (Ain, France), and the assessment of the test under both the pressure differential method and the logging one, demonstrating the ability of both methods to provide a good estimation of the leaks (or, in that case, withdrawals).

Remizov et al. (2000) recommend that cavern wells be tested 28–45 days after leaching is completed. Several methods can be used. The pass/fail criteria they propose are (a) the leak rate must be smaller than 20–27 liters per day (when testing with liquid) or 50 kg per day (when testing with gas), and (b) the pressure drop rate (during a Pressure Observation Test) must become constant and be less than 0.05 percent (of test pressure) per hour. The Pressure Observation Test interpretation takes into account the following influential factors: additional dissolution, cavern convergence, changes in brine and test fluid temperatures, and transient creep. Transient creep is deemed to be effective for only 1–

2 days after pressure build-up. According to Remizov et al., cavern compressibility during depressurization is 2–20 percent smaller than when measured during pressurization. Formulas establishing a correspondence between the wellhead pressure drop rate and leakage rate are proposed.

Branka et al. (2002) describe an MIT performed in Gora Underground Cavern Oil and Fuel Storage (Poland). The Above-Ground Balance Method was used to avoid "... complicated and expensive installation and survey." The authors state that testing a liquid-storage cavern using a liquid test fluid (rather than a gas) seems reasonable. The procedure basically consists of injecting the test liquid ("blanket oil") down the central-tubing to the level of a weep-hole, which is located below the last cemented casing shoe. Both the injected volume and the overflowed volume are measured carefully, taking temperature and pressure changes into account. Test pressures equal to 105 percent of the maximum operating pressure are recommended. The pressurized well is kept idle for 10 days, at which time, the test liquid is again injected to reach overflow. Volumes are measured carefully, and the "lost" volume is computed. Observed leak rates are in the range of 3.7–29.2 kg/day (of blanket oil); the larger leak rate applying to newly created wells.

Edler et al. (2003) describe use of the In-Situ Compensation Method. Before leaching, or when leaching is completed, the well is equipped with a central gas-tight string to below the last cemented casing. A 1-cm-diameter hole is located at the lower end of this central string. A gas (nitrogen or air) column is injected to below the last cemented casing. When the gas-brine interface reaches the hole (overflow), gas rises in the string and wellhead pressure increases. After several hours, gas is injected again until the brine/gas interface reaches the hole located in the central string. The amount of gas leaked between the two injections is computed via a spreadsheet that allows temperature and pressure variations with depth, as well as changes in central volume composition, to be taken into account. The accuracy of the method is discussed.

Nelson and Van Sambeek (2003) present the results of a questionnaire sent to US gas storage operators, suggesting that two methods are essentially used to perform MITs in gas-filled storage caverns: the gas cavern MIT (called "mass balance test") and the POT (called "pressure test"). The authors develop an extensive list of MIT techniques applicable to gas filled caverns. Within the internal MIT techniques, they distinguish the methods that are designed to evaluate the condition of the casing (e.g. ultrasonic logs) and methods that attempt to determine the presence of a leak within the wellbore (T log, Neutron log, spinner, radioactive tracers, noise logs). They also review gas inventory verification techniques and External MITs (gas cavern MIT and POT). They assess the accuracy of the gas cavern MIT to 0.5% to 1% of the stored gas volume, or 0.2 to 0.3% per day for a 3-day test. Which is much larger than liquid compressibility, resulting in poor accuracy of any pressure observation method. Novel MIT techniques are also explored.

Thiel and Russel (2004) proposed the Pressure Observation Test (POT) method, which is a liquid-liquid method. Whereas the standard Nitrogen Interface Test (NIT) can be used conveniently when the tested cavern has a narrow and consistent neck, a situation often met in domal caverns; in the bedded-salt caverns whose thickness is small, the caverns tend to be shallow and small with no neck. For bedded-salt caverns, the authors strongly suggest using the POT method, which is based on accurate measurement of wellhead pressures in a pressurized liquid-filled cavern. The cavern remains filled with brine, except for a small hydrocarbon cap that is injected in the annular space to establish the brine/hydrocarbon interface below the last cemented casing. Advantage is taken of the end of the pressure buildup phase to measure cavern compressibility. After a stabilization period, the wellhead pressure decay rate (accounting for ground temperature variations) is divided by cavern compressibility to get the leak rate, which must be smaller than 1,000 bbls/year. If this criterion is not met, a second

observation cycle is performed. Real-life examples are discussed, as are the advantages of the two methods (POT and nitrogen/brine MIT).

Van Sambeek et al. (2005) report written for SMRI is largely a continuation of the Liquid-Liquid interface test presented in Bérest et al. (2001). The authors had proposed in 2001 a Pressure Differential Observation Test (PDO), in which the interface depth is deduced from the observation of the differential pressure between a central brine string and an annular pressure, and had introduced concepts of “apparent” leak (directly deduced from the observed pressure decrease), “corrected” leak, obtained by accounting for quantifiable factors contributing to pressure changes and “actual” leak. This 2005 SMRI report details all relevant physical phenomena that have to be corrected and give mathematical equations to correct them: salt creep, liquid temperature changes (brine or product warming or cooling), micropermeation, additional salt dissolution, and transient creep.

Bérest et al. (2007) is also related to the identification and correction of physical phenomena to enable correcting an “apparent leak” into an “corrected leak”. It is in some ways a continuation of the Van Sambeek et al. (2005) report, focusing on the influence that “reverse” transient creep can have on the interpretation of the tests. This phenomenon is illustrated through a field test done on the EZ53 cavern.

Skaug et al. (2011) provide an interesting brief history of the N₂-brine MITs, and insist on the necessity of waiting for thermal stabilization of the well prior to conducting the test, as the warming of the cool nitrogen could otherwise hide possible leaks. The authors also give the acceptancy criteria of the test as practiced in the USA: to pass, the test design must have a MDLR lower than 1000 bbls/yr, and then a calculated leak rate lower than the MDLR. The resolution of the interface tool is the only element considered in the MDLR, and the test duration must be 24h, but it typically selected such that the MDLR is lower than 1000 bbls/yr.

Olesko et al. (2012) propose a liquid-liquid interface test based on PDO, using the stored product as the test fluid. The density of the test fluid and of the brine are assumed to be constant. The test duration is set to have a test accuracy that is less than “an acceptable level (for example, 1 000 bbls/yr)”.

Schulte and Lampe, 2013, propose an interpretation of Liquid-Liquid MIT based on PDO, using differential pressures of LPG and brine to track the interface. In order to account for density changes due to thermal expansion and fluid compressibility, the authors use initial and final temperature logging in order to correct the initial and final density, instead of assuming a constant density.

Colcombet et al. (2013) describe a “long term tightness test” applied to the oil storage caverns of Manosque, in France. The test is conducted without emptying the caverns, and is essentially derived from the Pressure Differential Observation Test. It still differs, as a downhole temperature gage is used, and as it lasts five and a half months. The following phenomena are taken into account for, in order to correct out their influence: salt creep (transient and steady state), thermal expansion of fluid in cavern, additional dissolution generated by pressure and temperature changes, compressibility dependence on pressure and temperature, and intrinsic permeability of salt. The test resolution is estimated at 100 m³/yr.

Meinecke et al. (2013) present a nitrogen-brine MIT (called as such) where the interface depth is measured by a sonar tool clamped at the bottom of a string, which enables an interface depth measurement with an accuracy of 1 cm. The authors state that “The maximum measuring error of the MIT should be within limits of ± 50 litres per day” and, using this sonar measurement technique on a well, propose a test with an estimated 25.8 l/d measuring error.

Lampe and Ratigan (2014) discuss the influence of transient disequilibrium in the vertical distribution of temperature in the brine wellbore during nitrogen/brine MIT (called as such). They show how the CLR can vary dramatically from the actual leak rate when insufficient time is allowed for thermal stabilization following nitrogen injection, which is especially true for large diameters boreholes that require more time for reaching a thermal equilibrium

Manivannan et al. (2015) describe a liquid-liquid interface test measured by a PDO (called “Pressure Differential method”). The effects of cavern pressure and wellbore transient temperature are modelled in order to correct them in the Interface depth estimation, and in the calculated leak rate. The field application of the method on an oil/brine interface MIT enables an accuracy in the interface depth detection of a few centimeters.

3.5. Current practice of the MITs (tightness tests) in the industry

The above exposed literature review is essentially based on four SMRI published reports and on many Proceedings of SMRI Technical Conferences. Aside these conferences, SMRI proposes “Technical Classes” whose goal is that experienced people from the academia or industry teach the state of the art to young professionals. In 2019, it was dedicated to “Mechanical Integrity Testing (MIT) and Techniques in Gas and Liquids Storage Caverns”. Analyzing which techniques were considered is an indication of those practiced by many of the most active companies in this industry. The techniques mentioned are summarized in the table hereafter, quoting the terminology under which they were called.

Table 6: Tightness test techniques mentioned, and name under which they were mentioned, during the 2019 SMRI Technical Class. For in-situ balance interpretation methods, which one is used may be unclear

Author	Company (country)	Nitrogen/brine MIT			LLI					Cavern Gas MIT
		In-situ balance	In-situ mass balance	In-situ compensation	In-situ volume balance	In-situ Mass balance	Pressure Differential Observation (PDO)	Pressure Observation Test (POT)	Above ground balance method	In-situ mass balance
Bauer	SSO (USA)	"MIT"								
Abdel-Haq	UGS (Germany)	"Conventional MIT"								
Hévin	Storengy (France)					"Test before gas filling (MIT)"				
Jordan & Bush	Longquist (USA)	"Nitrogen / Brine Interface Test - NIT"		"In-situ Compensation Method"	"Liquid / Liquid Interface Test", logging technique		"Liquid / Liquid Interface Test", Pressure Differential technique	"Pressure Observation Test"	"Above Ground Volume Balance"	"Cavern Gas Tightness Tests"
Lampe	WSP (USA)	"Nitrogen-Brine MIT"								
Perk & Schneider	Deep (Germany)		"MIT" / "In-situ Mass Balance"							
Ratigan	Ratigan consulting (USA)	"N2-brine"								
Révillère	Geostock (France)		"N2 Mass-balance MIT"							
Skaug	WSP (USA)									« Gas-Filled Cavern MITs »
Bérest & Brouard	X-LMS – Brouard Consulting (France)	"Simplest interpretation of a Nitrogen Leak Test"						"Simplest interpretation of a Liquid-Liquid Interface Test"		

All presenters were not asked to teach the same lesson, which largely explains why e.g. Jordan and Bush (2019) cover all techniques, whereas most other teachers do not. However, we note the preeminence of the nitrogen/brine MIT.

The most widespread technique now in use is the nitrogen/brine MIT. The Liquid-Liquid Interface MIT is used essentially measuring the interface with a PNT log. Both tests are therefore relatively similar, besides the fact that they use a different test fluid. Liquid-Liquid interface MIT are interesting for the following reasons:

- they imply lower surface pressures. Wellheads are not always rated to withstand surface pressure required by Nitrogen / Brine MIT
- Lower cost, especially if the stored hydrocarbon is used as the test fluid

The Nitrogen / Brine MIT has the following advantages:

- The low viscosity of the gas enables a higher sensitivity to leaks
- The thermal expansion and compressibility are lower than for liquid hydrocarbons, making the test more robust than liquid-liquid interface tests when the test interpretation is an in situ volume balance method. When temperature logs are used in a mass-balance interpretation, this is not true anymore
- acceptance criterion is volume-based (typical in North America). When temperature logs, mass conversions are used, and mass-based acceptance criteria are used (typical in Europe), the advantage is questionable.

Pressure Observation Tests (POT) also are used. When the caverns have no neck, the interface-based tests (nitrogen/brine or LLI) can hardly deliver a good accuracy, and POT are sometimes used, as they are independent of this parameter.

In the USA, most states impose operators to conduct an MIT every 5 years, which is not the case in Europe, where MITs are essentially done for new caverns in two circumstances of the cavern life

- After drilling and prior to starting leaching the well (at the maximum leaching pressure)
- After the leaching is done, and prior to starting the cavern conversion into a storage

This has implications, notably the fact that gas operators conduct Gas Caverns MITs in the USA, whereas European operators essentially rely on other well integrity measures.

4. The development of the test accuracies standards and acceptance criterion in the nitrogen/brine MIT

4.1. Progressive introduction of the Minimum Detectable Leak Rate (MDLR) as the acceptability criterion

4.1.1. Pressure-based acceptance criteria for hydraulic tests

Prior to the Nitrogen-Brine MIT implementation, the industry practice was to conduct hydraulic tests, pressurizing the whole cavern and monitoring the pressure decay, applying the following

interpretation criterion: *“cavern will be considered “tight” if the pressure decay is less than ten psi in a 24 hour period”* (Van Fossan and Wheeply, 1985).

It was still true 10 years later. After having sent to cavern engineering and operating companies a questionnaire, Crotagino (1995) summarizes 44 feedbacks to gather their practices for tightness testing. On the evaluation criteria of the tests, he notes that *“approximately half of the questionnaires returned, named the pressure loss as the evaluation criterion. This criterion, which is the standard in the case of tightness tests on surface tanks, is still very widespread, in particular in the USA, and is even prescribed by the authorities in some states. The state of Mississippi for example defines a permissible pressure drop of 10 psi/day (0.7 bar/day).”*

These first hydraulic tests, and their pressure-decay based acceptance criteria, are similar to what is practiced for testing the tightness of surface tanks, or of wellbores in the drilling industry, and is probably derived from it. However, if hydraulic test of a wellbore (“Formation Integrity Test” - FIT) or a surface tank may be satisfying, it is not for a cavern: salt caverns have shown they can act similarly to a barometer or thermometer, the well playing the same role as the thin capillary on which the small pressure, thermal and even tidal or atmospheric pressure effects, applied to a relatively large volume, can be detected by pressure measurements at the wellhead (see e.g. *“why MIT can be wrong”* in Brouard and Bérest, 2019). Based on the measurement of the pressure decay of a test fluid occupying the whole cavern, one cannot distinguish a leakage from these other effects, most notably from those proportional to the volume they apply to such as thermal expansion of cavern brine.

A pressure decay of e.g. 10 psi/day (0.7 bar/day) maximum pressure variation at the wellhead can detect large leakages, as shown in Section 5.2. But today, it is essentially used as an indication of the cavern approaching equilibrium (i.e. that these other effects, and most notably brine thermal expansion, are small), and should be used as such rather than as a cavern tightness criterion.

4.1.2. Early attempts to refer to a Maximum Acceptable Leak Rate (MALR)

Soon after the MIT requirement emerged in the USA, the invention of the nitrogen/brine MIT enabled to accurately test the cavern down to the salt/cement and cement/casing interfaces just below the last cemented casing shoe. In the thermometer or barometer analogy, it would consist in testing the capillary itself, and only it. But this includes the area where leakpath is most likely to be found. Focusing on this limited volume enabled to access to accurate tests and has been a tremendous progress. The question of what acceptance criterion should be used came along.

Van Fossan (1983) introduces the nitrogen / brine MIT as a technique able to answer the US EPA regulation whose primary and initial objective is to prevent the pollution of USDWA by the stored product. The accuracy of the test, expressed in volume of nitrogen per year, is therefore converted into an equivalent volume of oil per year by applying a ratio of 30 on the results obtained with nitrogen: *“The nitrogen test has an ultrasensitive detection capability since gaseous phase nitrogen, at test pressures, would escape in far greater quantities from the system than would pad material or stored product. [...] it would seem very conservative to set the ratio as 30 volumes of nitrogen to 1 of diesel fuel oil and vary the ratio for other products proportionally to their relative viscosities.”*

Assuming the "allowable variance volume" of nitrogen (at bottom hole conditions) was set at 2,000 bbl/yr, Van Fossan (1983) tries to assess this impact: *“the volume of pad material “escaping” would be only 66.7 bbl/yr. When this is viewed in the context of the billions of barrels of water in an underground drinking water source, it would have a completely insignificant impact on the water quality.”*

Interestingly, we note that oldest nitrogen / brine MIT references introduce viscosity-based equivalence ratios to convert leak rates obtained with nitrogen to equivalent leak rate with the stored product: Goin, 1983, Van Fossan 1983, Van Fossan and Wheepley 1985, Vrakas,1988, or Crotofino, 1995. The reason for it is not always explicit, but we can reasonably think that it is the idea that the leak rate measured in m³ or kg of nitrogen, will have to be related to the possible impact after reaching the aquifer, measured in quantity of the stored product.

After 1995, there is no reference to the assessment of the impacts in the public MIT literature reviewed in Section 3.4., and even references to the conversion factors, and of the MALR, are soon missing too.

4.1.3. A balance between what is achievable and what is desirable: the introduction of the Minimum Detectable Leak Rate (MDLR) reference value

Van Fossan (1983) also defends a balance between what is practically achievable on the field and what is desirable from a groundwater protection point of view (the MALR). His interpretation of the test is based on the ability to detect an interface change: *“The mechanical integrity of the final cemented casing string and its cementation might be proved by demonstrating that the protective blanket/brine interface remains at a constant elevation below the casing seat. Since there are variations between individual interface logging tools and in different wireline truck odometers, a variance of ± 2 to 3 feet between subsequent interface surveys must be considered. [...] If there is no detectable shift between the two interfaces, it can be assumed that no protective pad material has escaped through either the casing or casing seat, and mechanical integrity is proven.”*

So even if he is justifying the test acceptance based on what can be acceptable for aquifers, in practice the test acceptance is based on the fact the possible leakage cannot be distinguished from the accuracy of the test. This idea is behind the notion of “Minimum Detectable Leak Rate” (MDLR), a wording that is first introduced in a public document of the salt cavern industry by Van Fossan and Wheepley (1985).

This idea is further developed by Crotofino, 1995, who proposes a numerical value for this MDLR reference, and a one distinct from the MALR. This report has had a major influence on the methodology that is followed in Europe, at least for some companies such as Geostock or DEEP.KBB. Crotofino’s objective is *“primarily to verify tightness and not to determine a leak rate. Bearing in mind that 100 % tightness is not verifiable [...] it is necessary to differentiate between a theoretical leak rate which is within and one which is outside the maximum possible error (equivalent to the minimum detectable leak rate (MDLR) of the test method”*.

The question then is *“to what extent this theoretical leak rate is tolerable ?”*, which has to be determined based on a pre-defined evaluation criteria, the MALR. *“Normally, in measuring technology, the permissible value is first defined, and then based on this, the necessary accuracy of the method is defined. In order to be able to determine a sensible limiting value, it is necessary to ensure that the value for the accuracy is at least a factor of 3 below the criterion itself.”* However, it is found *“not realistically possible to draw up a generally valid limiting value for leakrates or an MALR based on firm scientific considerations”*. Crotofino therefore uses a pragmatic approach, somehow similar to what Van Fossan did. As setting MALR based on risk-analysis considerations is not feasible, *“It was thus necessary to “put the cart before the horse” : the MDLR is defined first, and the MALR taken as three times this figure.*

Van Fossan (1983) and Crotofino (1995) therefore distinguished the MDLR from the MALR, and base the acceptance criteria on a reference MDLR, which enables to be more stringent than what would be based on MALR set in a conservative way. After 1995, there are only rare references in the public

literature to the assessment of the impacts or the MALR. The quantitative acceptance criteria are referring to standard practices of minimum MDLR that the test should be able to achieve.

The second generation of MIT developers, including the one practicing it today, probably still have in mind what is desirable from a groundwater protection point of view, but also the practical impossibility to establish a quantitative Maximum Acceptable Leak Rate criteria. And they have the track record of several decades of salt cavern testing with an accuracy, or MDLR, below the reference MDLR values of 1000 bbl/y (in North America) or 50 kg/d (in Europe), and can refer to the limited history of leakages incidents from the salt cavern storage industry. That track record could weight more in the balance and be *de facto* accepted as the fail/pass criterion, while impact-related assessments of the MALR are still hardly achievable.

Skaug et al. 2011 from PB (now WSP) summarize the acceptance criteria generally in place in North America:

“Generally, the test results must satisfy the following criteria to be considered a successful test:

- *The MDLR must be 1,000 bbls/yr or less.*
- *The [Calculated Leak Rate] CLR must be less than the MDLR.*
- *Test conditions (pressure, wellbore temperature, and interface location) should have the characteristics of a well that displays mechanical integrity.”*

In Europe, Geostock also uses a similar approach: the MIT is designed to have an accuracy, or MDLR, lower than a threshold value (50 kg/d of nitrogen), and the well passes if the Calculated Leak Rate is below this MDLR.

After four decades of experience in Nitrogen-Brine MITs, hundreds of which are being done every year currently, the track record of these tests together with the analysis of past leakage incidents (see e.g. Réveillère et al., 2017; Bérest et al., 2018) have probably demonstrated the relevance of the MIT tests and their acceptance criteria based on reference historical Minimum Detectable Leak Rates (typically, 50 kg/d or 1000 bbl/y of nitrogen at casing shoe temperature and pressure conditions).

4.2. Origin of the thresholds values for MDLR

4.2.1. Volume-based Minimum Detectable Leak Rate thresholds

Van Fossan (1983) does not propose a minimum accuracy threshold, but mentions a MDLR of 2000 bbl/y or nitrogen (or 66.7 bbl/y of oil) at bottom hole conditions, and notes that *“In many brine wells the borehole interval is very small in volume, and the “minimum detectable” nitrogen would be much less--perhaps as low as 100 bbl/yr of nitrogen”*

Vrakas (1988) discusses the testing plan developed by Sandia National Laboratory in 1984 to comply with DOE, Louisiana and Texas regulation, and its application on SPR caverns. Results of 9 wells are presented. Vrakas suggests a fail/pass criterion based on the calculated oil leak rate of 100 bbl/y, converted from the calculated nitrogen leak rate by using a factor 10. Uncertainty is not discussed, but Vrakas suggests that during a Nitrogen/ brine MIT, the optimum test duration is 0.65 day per square foot of cross-sectional area of the borehole (at interface depth), which implicitly means that larger open holes need longer tests to get a homogeneous accuracy among all tests. During this duration, a 100 bbl/y leak corresponds to the observation of the interface rise by 1 ft.

Thiel (1993) is often cited for the reference it mentions in terms of MDLR threshold it states: **“160 m3/year (1000 bbls/yr) test resolution has become somewhat of a standard”**. This 1000 bbls/y (160

m³/y) test resolution is still mentioned today in most North American test applications, and in many recent North American technical publications: Bauer (2019), Jordan, (2019), Ratigan (2019), Skaug et al. (2011), Olesko et al. (2012). Thiel (1993) is sometimes referred to for it, even if he was himself already mentioning he was using a standard.

Crotogino (1995) gives a tentative explanation of the 1000 bbls/yr threshold: *“On the SPR project, technical tightness is given when the leak rate is smaller than or equal to 100 bbl/yr. The requirement of 100 bbl/yr of oil equivalent was then accepted by some operators in the USA. Whereby, in the case of high pressure caverns the value was raised by a factor of 10 to 1000 bbl/yr. This is due to the fact that a leak flow volume of a gas under otherwise equal conditions is larger than that of a liquid by approximately this factor due to its lower viscosity”*

In Europe, some companies may also use volume-base criterion. Historical criterion from the company history itself can also be used, which is for instance what is presented by Hévin (2019) for Storengy: the criterion is *“~10 to 12 liter/day”* for LLI tests prior to the leaching, and *“~250 liter/day”* prior for the LLI prior to the cavern conversion. The threshold value of 250 liter/day (570 bbls/yr), half the American standard of 1000 bbl/year, is likely to be historical: it can already be found in the French manual by ATG (1985) as the threshold value of future gas caverns, tested at that time with a test best classified as an above-ground mass balance method.

Last, we note that in North America some companies do a mass-balance (using Temperature log information to account for thermal effects) but convert the result back to an equivalent volume rate to match a volume-based MDLR.

4.2.2. The mass-based Minimum Detectable Leak Rate (MDLR) threshold

Crotogino (1995) proposes using maximum design MDLR of 50 kg/day. This MDLR threshold figure is based on a typical cavern (whose dimensions are indicated on Figure 22), and considering one source of uncertainty, the interface depth measurement from a PNT tool. This measurement uncertainty (estimated at +/- 10 cm) is propagated to find an uncertainty in the measure volume of 37 kg¹². Assuming the test lasts 1 day and rounding this value, Crotogino (1995) proposes the value of 50 kg/day. We also note that in his SMRI-funded work, he must have collected feedback from the industry and regulators prior to proposing this value.

¹² Although, re-doing this computation leads to 30 kg when taking 2*0.1 m for the PNT tool accuracy

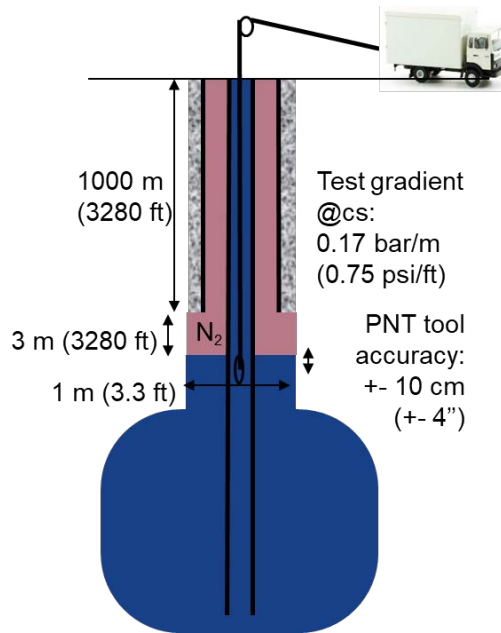

Figure 22: Cavern case that is the basis for proposing a maximum MDLR of 50kg/day in Crostogino (1995)

This acceptance criteria used by Geostock and a priori most other European companies, whereas the volumetric value of 1000 bbl/y is used by North American companies. The main difference is that using a mass flow rate rather than a volume flow rate criterion ease in-situ mass balance interpretation of tests with non-stable temperatures (although this was not mentioned by Crostogino, 1995).

4.3. Comparison with other industries' tightness test accuracy requirements

4.3.1. Underground Storage Tanks

Underground Storage Tank can notably be used to store hydrocarbons for refuelling stations (Figure 23). Tightness test of the tank is used following a repair, or if routine monthly tank leak detection results indicate a failing result.



Figure 23: Illustration of an underground storage tank and possible monitoring and testing equipment for volumetric tightness tests (such as gages in the tank) or for other, external types of assessment (vapor monitoring well, groundwater well) from Veeder-root, a global supplier of tank gaging systems¹³.

According to Minnesota Pollution Control Agency (2019), tightness tests are divided into two broad categories: “volumetric” and “non-volumetric”.

Volumetric tests operate by applying a slight pressure to the tank and then carefully measuring pressure and temperature for estimating any change in volume over time. Depending upon the method, volumetric tests require either partially full or overfilled tanks. A temperature measurement is made to correct thermal effects, similarly to what is done when doing an in-situ mass balance in salt cavern MITs.

Non-volumetric tests use other principles and methods to determine a leak instead of measuring the volume. For instance, one method puts a slight vacuum on the tank and then uses acoustic sensors to listen for the sound of water bubbling into the tank. This cannot be applied to salt cavern tests, since a minimum pressure has to be maintained for stability reasons. Another method places a chemical marker into the product in the tank and checks for its presence outside the tank. If the tank is leaking, the chemical marker, a volatile liquid, will be detected outside the tank. This is relatively similar to radioactive tracing test that can be applied on some wells, such as injection wells or abandoned wells within the area of review of an injection well, but it is not significantly used for salt cavern wells.

According to Minnesota Pollution Control Agency (2019), the performance standard for the tightness test requires a leak to be detectable at 0.1 gallon per hour (9 liter/d) with 95% confidence. In the USA, the National Work Group On Leak Detection Evaluations¹⁴ publishes online a list of third party evaluations of various vendors’ leak detection methods or equipment’s. For instance, from the evaluation sheet of Franklin Fuel System or Leighton O’Brien, volumetric tank tightness test methods with a “minimum detectable leak rate” (the terminology is the same as in salt caverns MITs) of 0.1

¹³ From <https://www.veeder.com>, visited on 07/04/2020

¹⁴ <http://nwgldc.org/>, visited on 07/04/2021

gallon per hour (9 liter/d) is proposed for tanks up to 2 000 gallons (76 m³). This threshold value for tests accuracies, or MDLR, is given for a number of tests vendors in the National Work Group On Leak Detection Evaluations list.

4.3.2. Natural gas transportation pipelines

Pressure testing is the practice of subjecting pipeline systems to pressure above operating pressure to confirm its integrity. It is presented by Kiefner, 2001 as a universally known and accepted means of demonstrating the fitness for service. Pressure testing may occur before the pipe is put into service or on pipelines in operation, called “revalidation” test.

The testing process on a new pipeline is presented in video by Atlantic Coast Pipeline, an American company that used to plan to build a new natural gas pipeline¹⁵. Dedicated test caps are placed to isolate a pipe segment, a foam plug and then water are injected, enabling to have the whole pipe section in water. The hydraulic pressure is then increased above max operating pressure for 8 hours or more to confirm the pipeline integrity. “if any inconsistencies are detected, the pipeline is uncovered and replaced or repaired, then re-tested”.

The testing process on an operating pipeline is presented in a video by the US TSO SoCalGas¹⁶. Compared to new pipelines, additional operations are required: pipelines must be removed from service (which cannot be afforded in some cases), the line must be isolated and the gas left inside the pipeline vented. Excavation is done at both ends of the segment to expose the pipeline, which is cut and short sections are removed to place test caps. The process is then similar to above-described for new pipelines. “After holding the increased pressure for 8 hours or more, the test is complete. If there is a leak, it is repaired or replaced”. The pipe must be cleaned from water using air, and then from air using nitrogen, before being reinstalled and put back into service.

We note similarities with salt caverns in the practice. Notably, hydraulic testing of pipelines is performed to expose defective materials that have missed prior detection and serve as a final validation of the integrity of the constructed system. Visual and weld inspections are possible before.

Unfortunately, no quantitative acceptance criteria could be found for tightness tests of natural gas transmission pipelines. However, in the vendors evaluation list from the list published by the National Work Group On Leak Detection Evaluations¹⁴, Hansa Consult of North America LLC for instance propose a test for liquid hydrocarbon pipelines of diameters of 6” or above. They mention an EPA annual test leak detection rate not to exceed of 1.0 gallon per hour for pipe sections between 75000 and 100000 gallons (i.e. a 15 to 20 km long section for a 6” pipe).

4.3.3. Comparison of accuracy threshold with other techniques

Pressure vessels or tanks such as pipelines, plumbing, gas cylinders, boilers and fuel tanks can usually be tested for strength and leaks using hydraulic tests. The test involves filling the vessel or pipe system with a liquid, usually water, which may be dyed to aid in visual leak detection, and pressurization of the vessel to the specified test pressure. Tightness can be tested by visual inspection and/or observing

¹⁵ Cf. youtube videos <https://www.youtube.com/watch?v=xJsLeEs2Xys>, visited on 07/04/2021

¹⁶ Cf. youtube videos <https://www.youtube.com/watch?v=IRFWeTRAcCU>, visited on 07/04/2021

whether there is a pressure loss, and correction based on temperature measurements can be made to account for thermal effects.

For salt caverns, visual leak detection is not possible (except for leaks at the wellhead), and the very large volume make pressure-decay based analysis of the test little accurate (cf. Section 5.2.). Only few other industrial sectors also imply storage of product without having the possibility to visually inspect whether there is a leak outside of the storage. Underground storage tanks and pipelines are two of them, and tightness test methods and acceptance limits have been presented above.

For both, acceptance criteria are expressed in absolute terms, as an absolute leak rate threshold rather than as a fraction of the stored product. Only considering a given impact, we can understand that the absolute leak rate is a criterion: should 150 kg/day of hydrocarbon reach an aquifer, the fact that it comes from a 500 000 m³ or a 75 m³ reservoir does not make a difference. But a holistic approach should consider that more smaller storages would be needed to meet a given storage demand. Having more accurate tests by having smaller storages is not a solution as more of these would be needed: the ratio of the accuracy of the tightness test to a typical volume of such storage is a relevant indicator of the tightness of a storage in a holistic approach. The following table shows that the tightness tests acceptance criteria used for salt caverns, when taken relatively to the stored volume, are 2 to 3 order of magnitudes better than the state of the art for underground tank storage or pipeline sections

Table 7: tightness test acceptance thresholds for several underground storage types.

Storage type	Tightness test accuracy thresholds			Typical volume			Acceptance threshold relative to typical storage volume ratio
	gal/h	bbbl/y	liter/d	Gal	Bbl	m ³	%-vol loss per year
Underground tank storage	0,1	21	9	20 000	475	75	4%
Pipeline section	1	209	91	100 000	2 500	375	9%
Storage salt cavern	4,8	1000	435	130 000 000	300 000	500 000	0,03%
	0,6	115	50				0,004%

4.4. What are 1000 bbl/year or 50 kg/d-accurate tests able to detect?

4.4.1. What leakpath are MIT able to detect?

MITs are particularly targeting the detection of leakage through the well cementation at the casing shoe area. To model the leakage through the cemented annulus, we consider that the migration would occur through a microannulus, typically at the formation/cement or cement/casing bonds, rather than through the cement matrix itself and apply a cubic law to model the vertical flow. This approach is similar to what Vernoux and Manceau (2017) have done (Figure 24).

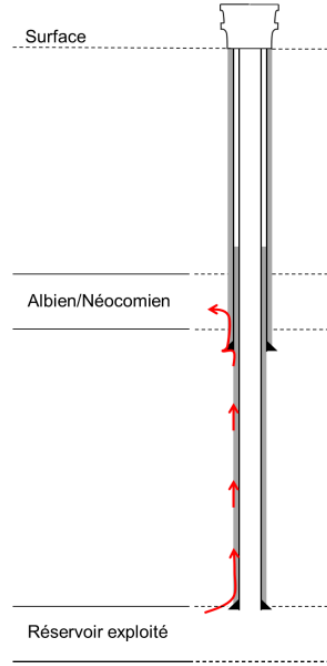

Figure 24: Microannulus leakage scenario considered in Vernoux and Manceau (2017)

From a flow modelling perspective, because microannuli are considered discrete, fracture-like flaws, they can be described in terms of their aperture, similar to how rock fractures are characterized (Stormont et al., 2018). The hydraulic aperture (e) is the spacing between smooth-walled parallel plates that produces the equivalent steady-state flow as the microannulus. The hydraulic aperture of a microannulus that corresponds to the effective permeability (k_{eff}) of a wellbore system can be approximated by the so-called cubic law:

$$k_{eff} \cdot A_{eff} = \frac{e^3 \cdot w}{12}$$

Where A_{eff} is the wellbore annular effective area and w is the length the hydraulic aperture, that can be approximated to the circumference of the casing assuming the microannulus is at the casing/cement bond.

We consider that the microannulus is connecting a salt cavern to a fresh water aquifer. To be conservative, we consider a single phase flow of the test fluid through it and neglect the fact that the microannulus is probably initially filled with water that will provide a capillary barrier prior to gas or oil flowing through it. The vertical Darcy single phase equation is:

$$Q_L = \frac{k_{eff} \cdot A_{eff}}{\mu} (P_- - P_+ - \rho g(z_- - z_+))$$

Where Q_L is the volumetric leak rate, μ is the test fluid viscosity, P_- is the pressure below the microannulus (at the cavern casing shoe, at depth z_-) and P_+ is the pressure above it (in the aquifer at depth z_+), ρ is the average test fluid density.

Hence the leak rate is

$$Q_L = \frac{e^3 \cdot w}{12 \cdot \mu} (P_- - P_+ - \rho g(z_- - z_+))$$

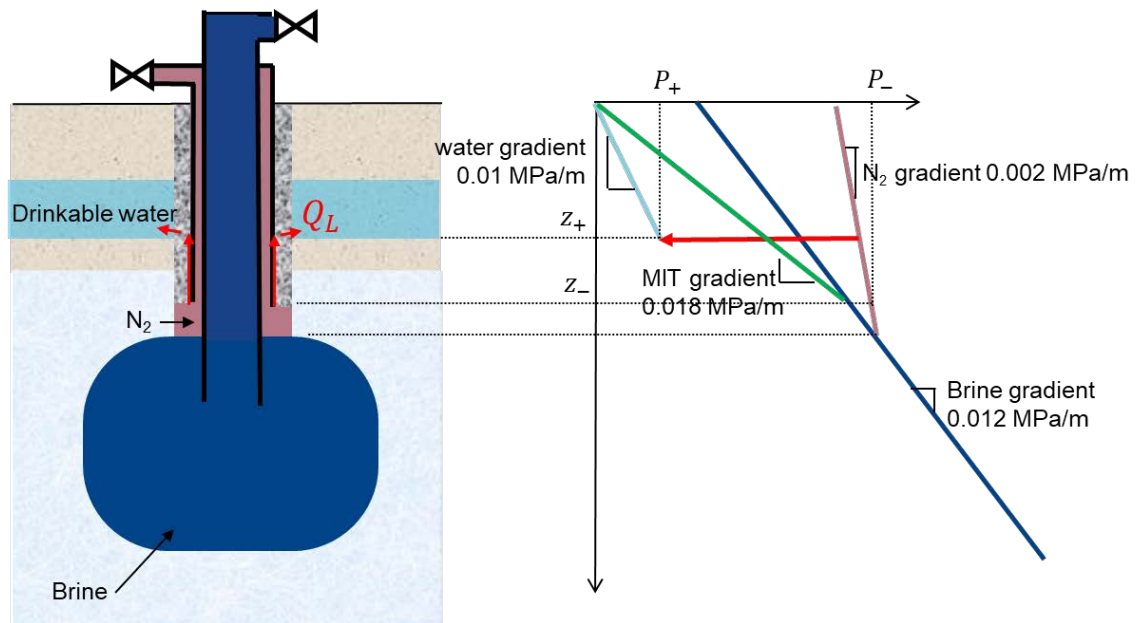

Figure 25: pressure profiles in the cavern and surrounding groundwater, and MIT test pressure gradient (in green). The microannulus leakpath is represented in red in the left diagram, and the driving force of it by the red arrow in the right figure.

Vernoux and Manceau (2017) consider that the detection limit of the microannulus aperture by CBL logs is $e = 50 \mu m$. Above it, it can be detected by CBL logs.

We consider a salt cavern tested at $P_- = 18 MPa$ at its casing shoe ($z_- = 1000 m$ depth), a fresh water aquifer at a pressure $P_+ = 5 MPa$ pressure at a depth $z_+ = 500 m$, a microannulus of aperture $e = 50 \mu m$ and a 13-3/8" last cemented casing ($w = 1.1 m$). At $27^\circ C$ and these pressures, the average nitrogen viscosity is $\mu = 2 \cdot 10^{-5} Pa \cdot s$ and its density is $\rho = 90 kg/m^3$.

This gives a nitrogen leak rate $Q_L = 1.2 m^3/d = 2800 bbl/y$, or 110 kg/d.

Such a microannulus could remain unnoticed by CBL logs, but such a leak flow would be detectable by MIT tests designed and implemented with respect to the MDLR references values, whether it is 1000 bbl/y or 50 kg/d.

This result shows the tremendous progress made by introducing the Nitrogen/brine MITs: it enables to expose defective materials that can have been missed by prior detection and serve as a final validation of the integrity of the well.

4.4.2. What would nitrogen-brine MITs be able to detect, would they apply to other industries ?

MIT requires having a tight open hole below the last cemented casing shoe to have the test fluid in contact of the casing shoe, and is particularly applicable to salt caverns. It is tempting to imagine what would be possible to detect, in other subsurface industries, with a tightness test equivalent to the nitrogen – brine MIT.

In France, the Paris basin is the largest sedimentary basin and it hosts the largest urban area (Paris agglomeration) and a very productive agricultural region (Beauce, where most of the French crops are produced), making the protection of fresh groundwater resources particularly sensitive. It has also known relatively important oil and gas production relatively to what has been produced in France, and

is largely used for deep geothermal wells and natural gas storage. Drinkable water resources are managed by French state agencies which ordered BRGM to:

- analyse the conditions of the cementation of deep wells and their evolution over time
- analyse the risk of contamination of 2 fresh water aquifers (Albien and Néocomien) by salty geothermal water, oil and gas from production fields, or stored natural gas.
- based on it, give order of magnitudes of potential impact of a leak to 2 water aquifers (Albien and Néocomien).

This resulted in an ambitious report by Vernoux and Manceau (2017). To provide orders of magnitude of a potential impact, they introduced leakage scenarios. They identified three such scenarios, including a leakage through a defective cemented annulus (Figure 24), which is precisely what MITs are testing in the salt caverns industry. One other scenario is only applicable to geothermal injection wells (and corresponds to a historical incident of this industry), and the third one is for plugged and abandoned wells, which is not relevant for salt cavern wells in operation.

Vernoux and Manceau (2017)'s work is notably remarkable on the data collation side, as the authors:

- gathered information from 29 oil production fields, among 50 discovered in this Paris Basin, totalizing more than 2000 wells.
- extracted from the “Dogger” database¹⁷ information on 142 deep geothermal wells
- but missed to collect data from the 10 natural gas storage sites (aquifer or depleted field) wells

Information extracted included not only the location of the wells (cf. Figure 26) or their characteristics, but also the piezometric levels of the reservoirs or aquifers, source or receiver of a possible leakage.

¹⁷ “Dogger” is the age of the sedimentary layer targeted by most geothermal wells in the Paris basin, and is here the name of a database set up to store all data on heat extraction from the aquifer to supply district heating networks in the Paris region. <https://www.brgm.fr/en/reference-completed-project/geothermal-database-dogger-aquifer-paris-basin>

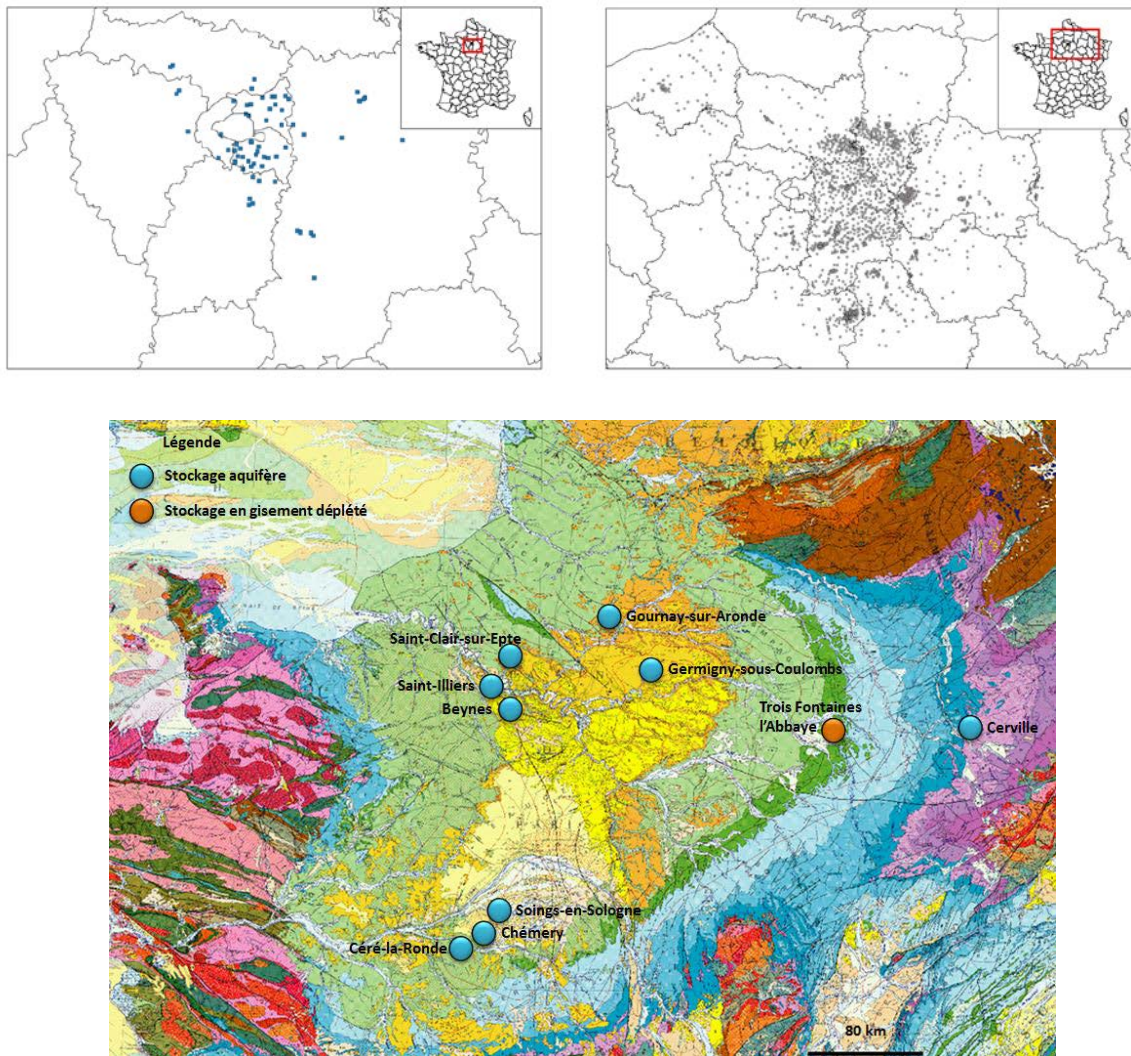

Figure 26: Geothermal wells (top left), oil and gas wells (top right) and natural gas storage sites (bottom) in the Paris basin. From Vernoux and Manceau (2017)

Vernoux and Manceau (2017) then applied a semi-analytical model of leakage from a reservoir, through a vertical porous column and up to an aquifer to quantify possible flow rate that could reach the Albian aquifer, a drinking water aquifer. This led to a rare result: the quantitative estimation of a leak rate for the 1000s of collated wells, would one of the hypothetical leakpath be true. Results are presented on Figure 27 for the mircoannulus leak case, with oil reservoir at their pre-exploitation pressure.

A MIT designed according to the standards of the salt cavern industry would enable a Minimum Detectable Leak Rate (MDLR) of 1000 bbl/y, or 160 m³/y of nitrogen. As exposed in Section 4.1., the early MIT references were used to convert leak rates measured with nitrogen tests to equivalent leak rates of the stored product. Only considering the difference of viscosities is not enough to estimate conversion of flow rates, since the density also plays a role in a vertical flow. Goin (1982) from Sandia National Laboratories investigated the question. According to him, this conversion can only be done roughly, since it depends on a variety of unknown factors, such as the flow regime, or the geometry of the leakpath. Goin, in results recalled in Crotagino (1995), proposes applying a conversion factor of 3 for water or brine, and of 10 for crude oil (although viscosity range of crude oils can be extremely large)

compared to a field test leak rate measured with nitrogen. Applying these factors, a nitrogen-brine MIT with a MDLR of 1000 bbl/year (160 m³/y) would be able to detect a leak rate of 53 m³/y of water or brine, and of 16 m³/y of crude oil. In Figure 27, these rough estimations of what could be detected through a nitrogen MIT are compared to the distribution of leak rates obtained by Vernoux and Manceau when assuming that the wells of the Paris Basin have a microannulus.

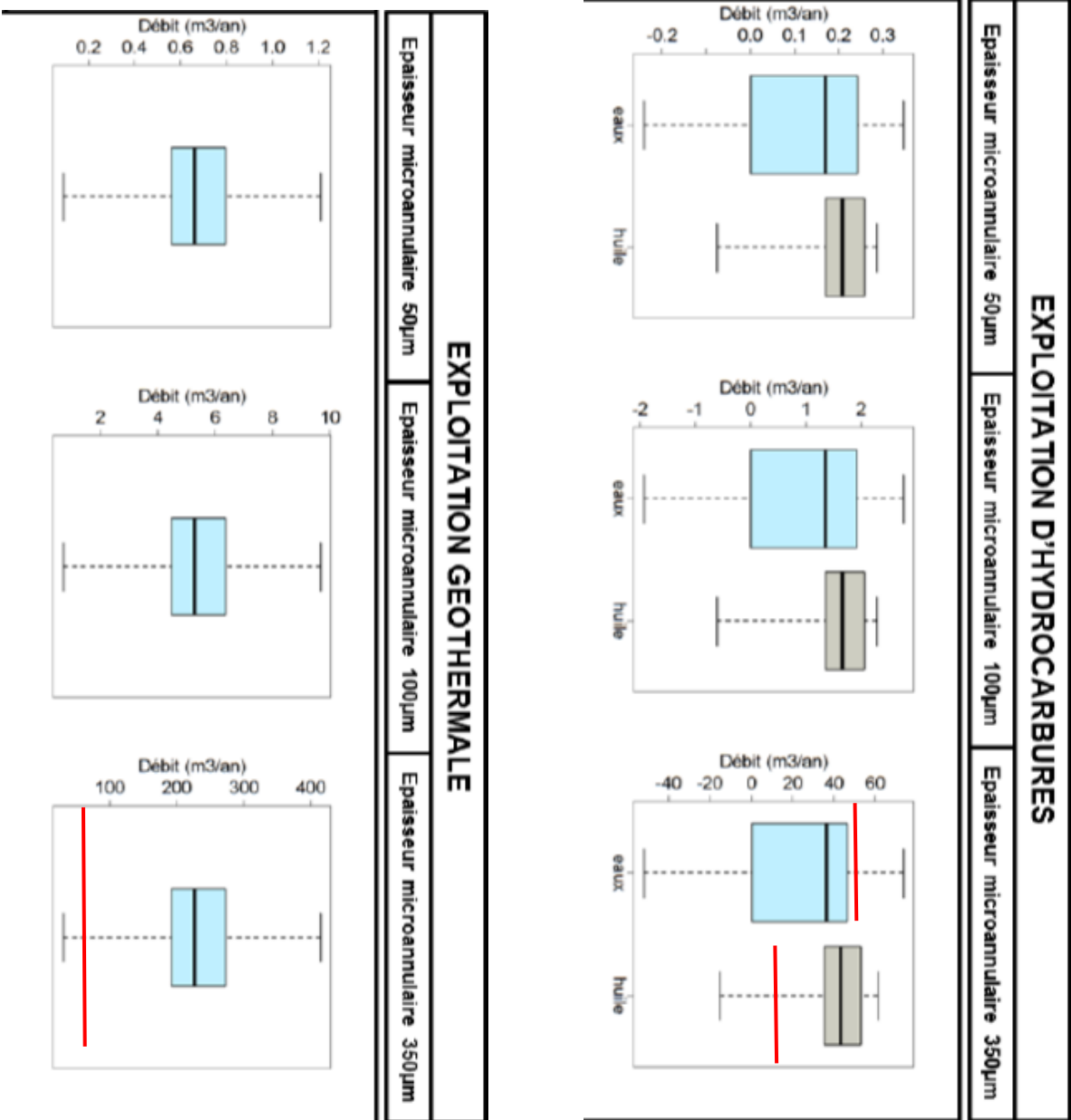

Figure 27: Extracted results from Vernoux and Manceau (2017) of hypothetical leak rate of the circa hundred deep geothermal wells (left) and of the few thousands of oil production wells (right) reaching the Albian aquifer. When assuming that a microannulus of 50, 100 or 350 micron aperture exists on these wells, in a purely theoretical exercise. The vertical red line are rough estimations of the Minimum Detectable Leak Rates that nitrogen-brine salt caverns MITs would enable to detect (another theoretical exercise).

This rough analysis, which has to be taken cautiously, suggests that MITs would only be able to detect few leakage cases from geothermal or oil production activities, and most cases of oil leakage from oil production fields when assuming a leakpath through a large microannulus (350 μm aperture). In the above Section 4.4.1., the MIT was able to detect a leakpath of aperture lower than 50 μm . This must be largely explained by a contrast in the driving force, the pressure difference required to move fluid from the oil or geothermal field up to the drinking water aquifer, which is proportional to the difference between the reservoir pressure and the drinking water aquifer pressure, and therefore on the flow rate value for a given leakpath. Section 4.4.1. case had a large driving force (difference between a test pressure at a gradient of 0.018 MPa/m and a drinking water aquifer at a gradient of 0.01 MPa/m), whereas the cases exposed in Vernoux and Manceau had very little driving forces (initial reservoir pressure must have been close to the drinking water gradient of 0.01 MPa/m). In other words, not surprisingly, the smaller the driving force and leak rates, the more difficult the leak detection is. But the potential contamination in such conditions are smaller too.

This idea is close to the Concept of Area of Review applicable in the USA: the wells that have to be reviewed for tightness are those into the Area of Review, a zone where driving forces can lead to the pollution of a drinking water aquifers should there be a connection.

5. Comparison of accuracies between the main MIT interpretation methods

5.1. Methodology

5.1.1. Sources of uncertainties

Excepting the hydrostatic test measuring a pressure decay, all test aims at measuring a leak rate, called Calculated Leak Rate (CLR), based on several measurements. Each measurement has its own uncertainty due to the measurement limitation (e.g., instrument precision), or the fact that the measurement is not exactly what is in the model (e.g. measurement of the temperature in the brine string rather than in the nitrogen annulus). Moreover, test interpretation methods rely on assumptions that may not be exact during the field test, creating errors due to limitations of the models to match the field test conditions (e.g. the assumption of thermal equilibrium for most of the test interpretation methods).

To account for the measurement uncertainties, for any measurement X , we introduce (cf. Figure 28):

- systematic errors ϵ_X . It has a reduced influence on the CLR that relies on a balance. It is typically the result of a poor calibration of instruments, or model bias
- random errors, $\epsilon_{\Delta X}$, typically a result of the precision of the measuring instrument (pressure or temperature gages, PNT and caliper logs).

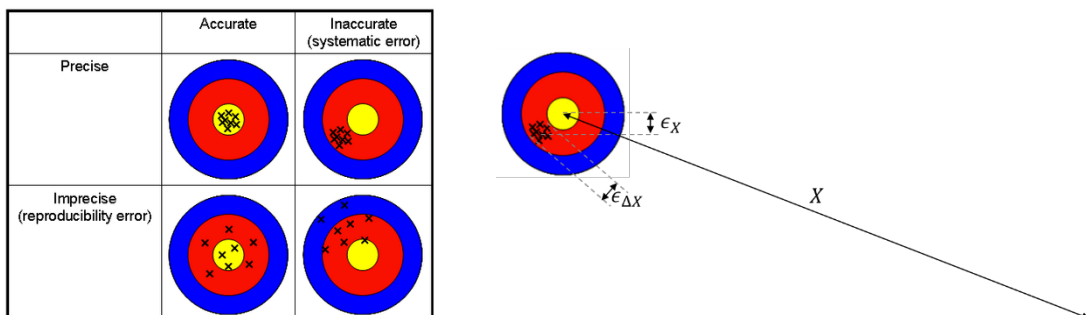

Figure 28. Proposed distinction between systematic errors (ϵ_X , accurate/inaccurate) and random errors ($\epsilon_{\Delta X}$, precise/imprecise).

The error due to the limitation of test interpretation methods are harder to identify. In some cases, they can be considered explicitly (see an example on Sections 5.2. and 5.3.), but in most cases expert judgement should be used to adapt the measurement errors, including more than the sensors accuracy into it.

5.1.2. Cavern properties for a comparison purpose

For a comparison between different test interpretation methods, we consider the following cavern parameters:

Table 8: Cavern parameters considered for tightness tests accuracy comparison in Section 5

Parameter	Value	Remark
Cavern volume	$V = 500\,000\ m^3$	
Brine thermal expansion	$\alpha = 0.00047\ K^{-1}$	Value for NaCl-saturated brine at 300 K
Brine cavern compressibility factor	$\beta = 4\ 10^{-4}\ MPa^{-1}$	Cf details herebelow.
Pressure change during the test	$\Delta P = 0.06\ MPa$	It corresponds to 0.2 bar/day for a 3-days test, which is typical from Geostock MIT experience
Cavern test pressure	$P = 17\ MPa$	Same as Crotogino (1995) case, for the sake of comparison. It corresponds to a casing shoe at 1000 m depth, tested at a maximum test pressure of 0.17 bar/m at the casing shoe
Gas or brine temperature when OD cavern	$T = 300\ K$	Same as Crotogino (1995) case, for the sake of comparison.
Gas constant	$r = 298\ J/kgK$	For nitrogen. Same as Crotogino (1995) case, for the sake of comparison.

The compressibility factor of a brine cavern β is the sum of:

- the adiabatic compressibility of brine, $\beta = 2.7\ 10^{-4}\ MPa^{-1}$,
- the compressibility of the cavern (the elastic “box” that contains brine), β_c . It depends on the shape of the cavern (the least compressible shape is a sphere), and on the elastic properties of the rock salt (Young’s modulus and Poisson’s ratio). As detailed on Bérest (1999)
- the effect of additional dissolution

Notably due to the compressibility of the cavern itself (the “box” that contains brine), the compressibility can vary. Bérest et al. (1999) mention that the typical brine cavern compressibility is 4 to 5 $10^{-4}\ MPa^{-1}$. We consider a cavern compressibility of $\beta = 4\ 10^{-4}\ MPa^{-1}$

5.2. Hydraulic test interpretation

5.2.1. Formulation of a Calculated Leak Rate (CLR)

We consider the cavern presented on Figure 29, and assume that its volume V (which equals the brine or test fluid volume) has been measured by sonar. During the test, only the wellhead pressure measurement P is needed for the interpretation.

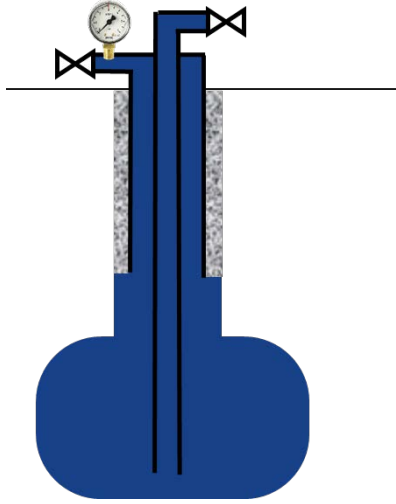

Figure 29. Cavern and monitoring used during a hydraulic test and during a Pressure Observation Test (POT)

The volumetric Calculated Leak Rate (CLR) is deduced from the brine volume balance ΔV between the initial state at t_i final state at $t_f = t_i + \Delta t$:

$$CLR = \frac{V(t_f) - V(t_i)}{\Delta t} = \frac{\Delta V}{\Delta t}$$

The volume balance between the final and initial states, i.e. the apparent leak, is:

$$\Delta V = V(t_f) - V(t_i) = \alpha V \Delta T - \beta V \Delta P$$

With α the isobaric thermal expansion coefficient, β the isothermal compressibility factor, ΔT the temperature change and ΔP the pressure change.

In a hydraulic test interpretation, temperature change is not measured and has to be assumed null ($\Delta T = 0$). We consider the cavern presented on Figure 29, whose volume V (also the brine or test fluid volume) has been measured by sonar. During the test, only the wellhead pressure measurement P is needed for the interpretation. Any pressure drop is interpreted as a leak:

$$CLR = -\beta V \frac{\Delta P}{\Delta t}$$

5.2.2. Minimum Detectable Leak Rate (MDLR) of the Hydraulic test interpretation

Supposing that each measured quantity X has an uncertainty ϵ_X , the resulting uncertainty in the volume balance $\epsilon_{\Delta V}$ can be derived from :

$$\Delta V + \epsilon_{\Delta V} = (\alpha + \epsilon_\alpha) \cdot (V + \epsilon_V) \cdot \Delta T - (\beta + \epsilon_\beta)(V + \epsilon_V) \cdot (\Delta P + \epsilon_{\Delta P})$$

We note the uncertainty related to the temperature is not based on a measurement error (there is no temperature measurement), but on the fact that this temperature T is not measured but is assumed constant (assumption of $\Delta T = 0$). The uncertainty on the volume balance therefore is:

$$\epsilon_{\Delta V} = \alpha V \Delta T - \beta \cdot V \cdot \epsilon_{\Delta P} - V \cdot \Delta P \cdot \epsilon_\beta + \beta \cdot \Delta P \cdot \epsilon_V$$

In a conservative approach, we assume that each source of uncertainty contributes to the final uncertainty in the most unfavourable way. It leads to applying absolute values to each of the terms in the final sum. The uncertainty over the volume balance is:

$$\begin{aligned} \epsilon_{\Delta V} = & |\Delta T \cdot \alpha \cdot V| \quad \text{Uncertainty due to the model hypothesis of a thermal equilibrium.} \\ & + |\epsilon_{\Delta P} \cdot \beta \cdot V| \quad \text{Uncertainty due to the pressure measurement (gages)} \\ & + |\epsilon_{\beta} \cdot V \cdot \Delta P| \quad \text{Uncertainty due to the cavern compressibility factor estimation} \\ & + |\epsilon_V \cdot \beta \cdot \Delta P| \quad \text{Uncertainty due to the measurement of the cavern volume} \end{aligned}$$

5.2.3. Typical Application

The propagation of source uncertainties lead to the following:

Source uncertainty			Propagated uncertainty on:		
Parameter	Value	Remark	In-situ volume balance $\epsilon_{\Delta V} (m^3)$	Over a 3-days test $\epsilon_{CLR} = \frac{\epsilon_{\Delta V}}{\Delta t}$ (m^3/d)	(bbl/y)
Temperature equilibrium hypothesis	$\Delta T = 0.05 \text{ } ^\circ C$	Assumption of temperature variation during the test	11,8	3,9	8 998
Pressure measurement	$\epsilon_{\Delta P} = 0.01 \text{ MPa}$	Pressure gages random accuracies can be better than this. But here it also accounts from model limitations	2,0	0,7	1 532
Compressibility factor	$\epsilon_{\beta} = 0.4 \cdot 10^{-4} \text{ MPa}$	Essentially due to the cavern part of the compressibility	12,0	4,0	9 189
Volume	$\epsilon_V = 25 \text{ } 000 \text{ } m^3$	Cavern volume measured by sonar (5% of the volume)	0,6	0,2	425
TOTAL			26	8,8	20 178

On this example, we see that the MDLR is way above the 1000 bbl/y threshold value generally accepted. It can typically be nearly 10 times higher than the MDLR threshold value due to the Thermal equilibrium hypothesis, or due to the fact that the compressibility factor is poorly known when not measured.

A hydraulic test interpretation does not match the current standards for MITs, it should rather be seen as an indicator of the cavern stabilization.

5.3. Pressure Observation Test (POT)

5.3.1. Formulation of a Calculated Leak Rate (CLR)

It is similar to the hydraulic test (Figure 29), the main difference being that, prior to the test, the cavern compressibility βV has to be measured, whereas the cavern volume V does not need to. During the test, it is similar.

The cavern compressibility βV is estimated as follows: during a brine injection of a volume V_{inj} , the pressure rise P_{rise} has been measured, which enables to determine the cavern compressibility, $\beta V = \frac{V_{inj}}{P_{rise}}$. This could also have been done during a brine withdrawal. No sonar measurement of the cavern and test fluid volume V is needed as an input parameter.

The volumetric Calculated Leak Rate (CLR) is deduced from the brine volume balance ΔV between the initial state at t_i final state at $t_f = t_i + \Delta t$:

$$CLR = \frac{V(t_f) - V(t_i)}{\Delta t} = \frac{\Delta V}{\Delta t}$$

The volume balance between the final and initial states, i.e. the apparent leak, is:

$$\Delta V = V(t_f) - V(t_i) = \alpha V \Delta T - \beta V \Delta P$$

With α the isobaric thermal expansion coefficient, β the isothermal compressibility, ΔT the temperature change and ΔP the pressure change.

In a Pressure Observation Test, temperature change is not measured and has to be assumed null ($\Delta T = 0$). We consider the cavern presented on Figure 29, whose compressibility βV has been measured prior to the test. During the test, only the wellhead pressure measurement P is needed for the interpretation. Any pressure drop is interpreted as a leak:

$$CLR = -\beta V \frac{\Delta P}{\Delta t}$$

We note that the POT may use a nitrogen/brine interface, but this does not impact the formulation of the CLR, as detailed in Section 2.2.4.

5.3.2. Minimum Detectable Leak Rate (MDLR)

Supposing that each measured quantity X has an uncertainty ϵ_X , the resulting uncertainty in the volume balance $\epsilon_{\Delta V}$ can be derived from :

$$\Delta V + \epsilon_{\Delta V} = (\alpha + \epsilon_\alpha) \cdot (V + \epsilon_V) \cdot \Delta T - (\beta V + \epsilon_{\beta V}) \cdot (\Delta P + \epsilon_{\Delta P})$$

Similarly to the Hydraulic test, the uncertainty related to the temperature is not based on a measurement error (there is no temperature measurement), but on the fact that this temperature T is assumed constant (assumption of $\Delta T = 0$). The uncertainty on the volume balance therefore is:

$$\epsilon_{\Delta V} = \alpha V \Delta T - \beta V \cdot \epsilon_{\Delta P} - \Delta P \cdot \epsilon_{\beta V}$$

In a conservative approach, we assume that each source of uncertainty contributes to the final uncertainty in the most unfavourable way. It leads to applying absolute values to each of the terms in the final sum. The uncertainty over the volume balance is:

$$\begin{aligned} \epsilon_{\Delta V} &= |\Delta T \cdot \alpha \cdot V| && \text{Uncertainty due to the model hypothesis of a thermal equilibrium.} \\ &+ |\epsilon_{\Delta P} \cdot \beta V| && \text{Uncertainty due to the pressure measurement (gages)} \\ &+ |\epsilon_{\beta V} \cdot \Delta P| && \text{Uncertainty due to the measurement of the cavern compressibility} \end{aligned}$$

5.3.3. Typical Application

During the in-situ measurement of the cavern compressibility βV , the volume of brine injected V_{inj} can be precisely known, assuming it is measured on a tank (rather than that using a flowmeter), for instance a 20' container (surface of 10 m²), accuracy of the level measurement of 5 mm, it leads to an accuracy of the injected volume of $\epsilon_{V_{inj}} = 0.05 \text{ m}^3$ (50 liters). Supposing that each measured quantity X has an uncertainty ϵ_X , the resulting uncertainty in the cavern compressibility is:

$$\begin{aligned} V_{inj} + \epsilon_{V_{inj}} &= (\beta V + \epsilon_{\beta V})(P_{inj} + \epsilon_{P_{inj}}) \\ \epsilon_{V_{inj}} &= \beta V \epsilon_{P_{inj}} + P_{inj} \epsilon_{\beta V} \\ \epsilon_{\beta V} &= \frac{\epsilon_{V_{inj}} - \beta V \epsilon_{P_{inj}}}{P_{inj}} \end{aligned}$$

Considering that the compressibility is measured over a pressurization $P_{inj} = 2 \text{ MPa}$, a pressure gage accuracy of $\epsilon_{P_{inj}} = 0.01 \text{ MPa}$, we have $\epsilon_{\beta V} = 1.0 \text{ m}^3/\text{MPa}$

The propagation of source uncertainties leads to the following:

Source uncertainty			Propagated uncertainty		
Parameter	Value	Remark	In-situ volume balance $\epsilon_{\Delta V} (\text{m}^3)$	Over a 3-days test $\epsilon_{CLR} = \frac{\epsilon_{\Delta V}}{\Delta t}$ (m^3/d) (bbl/y)	
Temperature equilibrium hypothesis	$\Delta T = 0.05 \text{ }^\circ\text{C}$	Assumption of temperature variation during the test	11,7	3,92	8 998
Pressure measurement	$\epsilon_{\Delta P} = 0.01 \text{ bar}$	Pressure gages random accuracies can be better than this. But here it also accounts from model limitations	2,0	0,67	1 532
Cavern Compressibility	$\epsilon_{\beta V} = 1.0 \text{ m}^3/\text{MPa}$	As above detailed	0,06	0,02	47
		TOTAL	13,8	4,6	10 577

With these source uncertainty hypotheses and this case application, the MDLR is way above the 1000 bbl/y threshold value generally accepted. It can typically be nearly 10 times higher than the MDLR threshold value due to the thermal equilibrium hypothesis. But the uncertainty related to the cavern compressibility is now very small. Thermal stabilization in the cavern may be achieved and make this influence negligible (although this can hardly be verified), and the pressure measurement model uncertainties can be minimized to reduce $\epsilon_{\Delta P}$. For instance, in the CLR formulation, a wellhead pressure measurement is applied to the mass of brine essentially downhole. It is fine when the weight of the hydrostatic column of brine is constant, but it may not be the case:

- If, for instance, weather conditions change significantly during the test duration (typically 3 days), leading to a difference in temperature and density on the first meters below ground. It can be mitigated by having initial and final test at the same hour within a day (this is usually chosen as such), and by measuring the atmospheric temperature and pressure to enable for correction.
- If, the thermal stabilization after the pressurization is not long enough. Brine has to be injected to rise the cavern pressure to the test pressure. If not at thermal equilibrium, the temperature of the column of brine will change towards it during the test. This can be mitigated by waiting for a sufficiently long time between the end of the pressurization and the test period.

5.4. In-situ mass balance interpretation of a gas cavern MIT

5.4.1. Formulation of a Calculated Leak Rate (CLR)

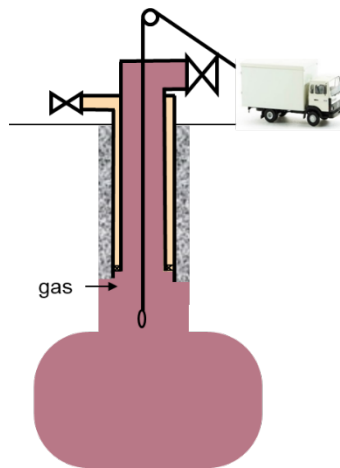

Figure 30. Cavern and monitoring used during an in-situ mass balance interpretation of a gas cavern MIT

The cavern sonar must be acquired prior to the test in order to measure the section of the cavern at each depth $S(z)$, and the gas composition must be known in order to calculate the gas compressibility factor Z . The gas cavern MIT itself consists in an initial temperature and pressure log at t_i and a final one at $t_f = t_i + \Delta t$, with a test duration Δt of generally 24, 48 or 72 hours. Each log, in a cavern full of gas, enables to estimate the mass of gas m in the cavern.

$$\text{CLR} = \frac{m(t_f) - m(t_i)}{\Delta t} = \frac{\Delta m}{\Delta t}$$

Combining the 2 gives the measure of the mass of the nitrogen in the well at that time.

$$m(t) = \int_{z=0}^{z=TD} \rho(z, t) S(z) dz$$

$$m(t) = \int_{z=0}^{z=TD} \frac{P(z, t)}{r \cdot Z(P, T) \cdot T(z, t)} S(z) dz$$

Hence

$$CLR = \frac{1}{r \cdot \Delta t} \int_{z=0}^{z=TD} \left(\frac{P(z, t_f)}{Z(P, T) \cdot T(z, t_f)} - \frac{P(z, t_i)}{Z(P, T) \cdot T(z, t_i)} \right) S(z) dz$$

5.4.2. Minimum Detectable Leak Rate (MDLR)

For uncertainty calculation, we use average values of the temperature T and pressure P. For the sake of simplicity, we also assume that Z is constant over time:

$$m(t) = \frac{P(t) \cdot V}{Z \cdot r \cdot T(t)}$$

P and T are functions of time. The Calculated Lead Rate in such conditions is the derivative of m with respect to time.

$$m'(t) = \frac{V}{Z \cdot r} \cdot \frac{P'(t) \cdot T(t) - P(t) \cdot T'(t)}{T(t)^2}$$

$$m'(t) = \frac{V}{Z \cdot r} \cdot \left(\frac{P'(t)}{T(t)} - \frac{P \cdot T'(t)}{T(t)^2} \right)$$

To simplify the writing in the following, we write for all variable $X(t)$, $\Delta X = X(t + \Delta t) - X(t)$ and $X = X(t)$.

$$\Delta m = \frac{V}{Z \cdot r} \cdot \left(\frac{\Delta P}{T} - \frac{P \cdot \Delta T}{T^2} \right)$$

Supposing that each measured quantity X has an uncertainty ϵ_X , the resulting uncertainty in the mass balance $\epsilon_{\Delta m}$ can be derived from:

$$\Delta m + \epsilon_{\Delta m} = \frac{V + \epsilon_V}{(Z + \epsilon_Z) \cdot r} \cdot \left(\frac{\Delta P + \epsilon_{\Delta P}}{T + \epsilon_T} - \frac{(P + \epsilon_P) \cdot (\Delta T + \epsilon_{\Delta T})}{(T + \epsilon_T)^2} \right)$$

These uncertainties are supposed to be small compared to X, ($\epsilon_X \ll X, \epsilon_{\Delta X} \ll X$), this can be developed in $O(\epsilon_X)$, neglecting products of uncertainties. This basically means that we neglect ϵ_X and $\epsilon_{\Delta X}$ when they are compared to X.

$$\begin{aligned} \Delta m + \epsilon_{\Delta m} &= \frac{1}{Z \cdot r} \left(1 - \frac{\epsilon_Z}{Z}\right) \cdot \left(\frac{V \cdot \Delta P + V \cdot \epsilon_{\Delta P} + \Delta P \cdot \epsilon_V}{T} \left(1 - \frac{\epsilon_T}{T}\right) - \frac{PV\Delta T + PV\epsilon_{\Delta T} + P\Delta T\epsilon_V + V\Delta T\epsilon_P}{T^2} \left(1 - \frac{\epsilon_T}{T}\right)^2 \right) \\ \Delta m + \epsilon_{\Delta m} &= \frac{1}{Z \cdot r} \left(1 - \frac{\epsilon_Z}{Z}\right) \left(\frac{V \cdot \Delta P + V \cdot \epsilon_{\Delta P} + \Delta P \cdot \epsilon_V}{T} \left(1 - \frac{\epsilon_T}{T}\right) - \frac{P \cdot V \cdot \Delta T + P \cdot V \cdot \epsilon_{\Delta T} + P \cdot \Delta T \cdot \epsilon_V + V \cdot \Delta T \cdot \epsilon_P}{T^2} \cdot \left(1 - 2 \frac{\epsilon_T}{T}\right) \right) \\ \Delta m + \epsilon_{\Delta m} &= \frac{1}{Z \cdot r} \left(1 - \frac{\epsilon_Z}{Z}\right) \left(\frac{V \cdot \Delta P + V \cdot \epsilon_{\Delta P} + \Delta P \cdot \epsilon_V}{T} - \frac{V \cdot \Delta P \cdot \epsilon_T}{T^2} - \frac{P \cdot V \cdot \Delta T + P \cdot V \cdot \epsilon_{\Delta T} + P \cdot \Delta T \cdot \epsilon_V + V \cdot \Delta T \cdot \epsilon_P}{T^2} + 2 \frac{P \cdot V \cdot \Delta T \cdot \epsilon_T}{T^3} \right) \\ \Delta m + \epsilon_{\Delta m} &= \frac{1}{Z \cdot r} \left(\frac{V \cdot \Delta P + V \cdot \epsilon_{\Delta P} + \Delta P \cdot \epsilon_V}{T} - \frac{V \cdot \Delta P \cdot \epsilon_T}{T^2} - \frac{P \cdot V \cdot \Delta T + P \cdot V \cdot \epsilon_{\Delta T} + P \cdot \Delta T \cdot \epsilon_V + V \cdot \Delta T \cdot \epsilon_P}{T^2} + 2 \frac{P \cdot V \cdot \Delta T \cdot \epsilon_T}{T^3} \right) \\ &\quad - \frac{\epsilon_Z}{Z^2 \cdot R} \left(\frac{P \cdot \Delta V}{T} + \frac{V \cdot \Delta P}{T} - \frac{P \cdot V \cdot \Delta T}{T^2} \right) \end{aligned}$$

Which leads to :

$$\begin{aligned} \epsilon_{\Delta m} &= \frac{1}{Z \cdot r} \left(\frac{V \cdot \epsilon_{\Delta P} + \Delta P \cdot \epsilon_V}{T} - \frac{V \cdot \Delta P \cdot \epsilon_T}{T^2} - \frac{P \cdot V \cdot \epsilon_{\Delta T} + P \cdot \Delta T \cdot \epsilon_V + V \cdot \Delta T \cdot \epsilon_P}{T^2} + 2 \frac{P \cdot V \cdot \Delta T \cdot \epsilon_T}{T^3} \right) - \frac{\epsilon_Z}{Z^2 \cdot R} \left(\frac{V \cdot \Delta P}{T} - \frac{P \cdot V \cdot \Delta T}{T^2} \right) \end{aligned}$$

$$\begin{aligned} \epsilon_{\Delta m} &= \epsilon_V \cdot \frac{1}{Z \cdot r \cdot T} \left(\Delta P - P \cdot \frac{\Delta T}{T} \right) \\ &\quad - \epsilon_P \cdot \frac{V}{Z \cdot r \cdot T} \frac{\Delta T}{T} + \epsilon_{\Delta P} \cdot \frac{V}{Z \cdot r \cdot T} \\ &\quad + \epsilon_T \cdot \frac{1}{Z \cdot r \cdot T^2} \left(2 \cdot P \cdot V \cdot \frac{\Delta T}{T} - V \cdot \Delta P \right) + \epsilon_{\Delta T} \cdot \frac{-P \cdot V}{Z \cdot r \cdot T^2} \\ &\quad + \epsilon_Z \cdot \frac{-1}{Z^2 \cdot r \cdot T} \left(V \cdot \Delta P - P \cdot V \cdot \frac{\Delta T}{T} \right) \end{aligned}$$

In a conservative approach, we assume that each source of uncertainty contributes to the final uncertainty in the most unfavourable way. It leads to applying absolute values to each of the terms in the final sum. The uncertainty over the mass balance is:

$$\epsilon_{\Delta m} = \left| \epsilon_V \cdot \frac{1}{Z \cdot r \cdot T} \cdot \left(\Delta P - P \cdot \frac{\Delta T}{T} \right) \right|$$

$$\begin{aligned}
& + \left| \epsilon_P \cdot \frac{V}{Z \cdot r \cdot T} \cdot \frac{\Delta T}{T} \right| + \left| \epsilon_{\Delta P} \cdot \frac{V}{Z \cdot r \cdot T} \right| \\
& + \left| \epsilon_T \cdot \frac{1}{Z \cdot r \cdot T^2} \cdot \left(2 \cdot P \cdot V \cdot \frac{\Delta T}{T} - V \cdot \Delta P \right) \right| + \left| \epsilon_{\Delta T} \cdot \frac{P \cdot V}{Z \cdot r \cdot T^2} \right| \\
& + \left| \epsilon_Z \cdot \frac{1}{Z^2 \cdot r \cdot T} \cdot \left(V \cdot \Delta P - P \cdot V \cdot \frac{\Delta T}{T} \right) \right|
\end{aligned}$$

We note that in the case of stable cavern, $\Delta P = \Delta T = 0$, we have a much simpler solution:

$$\epsilon_{\Delta m} = \left| \epsilon_{\Delta P} \cdot \frac{V}{Z \cdot r \cdot T} \right|$$

It is precisely the formulation we had for the POT, the liquid compressibility being replaced by the $\frac{1}{Z \cdot r \cdot T}$, which acts as a compressibility in the Perfect Gaz law.

Note that ΔT is not considered as a model limitation uncertainty here, as temperature is measured.

5.4.3. Typical Application

The propagation of source uncertainties leads to the following:

Source uncertainty			Resulting uncertainty on:		
Parameter	Value	Remark	In-situ mass balance kg	$\epsilon_{\Delta m}$ %inventory	Over a 3-day long test (kg/d) $\epsilon_{CLR} = \frac{\epsilon_{\Delta m}}{\Delta t}$
Volume	$\epsilon_V = 25\,000\,m^3$	Cavern volume measured by sonar (5% of the volume)	8354	0,01%	2785
Pressure systematic error	$\epsilon_P = 0.1\,MPa$	e.g. gage calibration	0,0	0,00%	0,0
Pressure random error	$\epsilon_{\Delta P} = 0.001\,MPa$	Lower than POT or CLR as there is less model limitation in a mass balance	0,0	0,00%	0,0
Temperature systematic error	$\epsilon_T = 3\,^{\circ}C$	Model limitation (measurement along the vertical axis only), gage calibration	176	0,00%	59
Temperature random error	$\epsilon_{\Delta T} = 0.5\,^{\circ}C$	T acquisition during a log	149494	0,16%	49831
Compressibility factor	$Z = 1\%$	Gas composition, moisture...	1576	0,00%	525
		TOTAL	159600	0,17%	53200

On this example, we see that the MDLR is 2 orders of magnitude over the 50 kg/d MDLR threshold. It is nearly entirely due to random error of the temperature log (assumption on the input uncertainty of 0.5°C).

The result of this application, an accuracy of 0.17% of the total gas inventory, is below what Nelson and Van Sambeek (2003) found (from 0.44% to 1.2% depending on the case) in a similar exercise but choosing larger source uncertainties.

5.5. In-situ Mass Balance interpretation of a Nitrogen-Brine MIT

5.5.1. Formulation of a Calculated Leak Rate (CLR)

This test interpretation is very similar to the gas MIT interpretation. But when the volume in which the test fluid is constant and large for the gas MIT (the cavern volume V), it varies and is small for the nitrogen-brine MIT: it occupies the annulus down to the interface at depth h , that can move upwards or downwards.

Figure 31. Cavern and monitoring used during an in-situ mass balance interpretation of a nitrogen-brine MIT

The cavern neck caliper must be acquired prior to the test in order to measure the section at each depth $S(z)$ down to below the nitrogen/brine interface level. Nitrogen is usually brought as liquid nitrogen, and so is totally pure, the compressibility factor Z of pure nitrogen can be considered. The gas cavern MIT itself consists in an initial temperature log and nitrogen/brine interface depth measurement at t_i and a final one at $t_f = t_i + \Delta t$, with a test duration Δt of generally 24, 48 or 72 hours. Each log, in a cavern full of gas, enables to estimate the mass of gas m in the cavern.

$$CLR = \frac{m(t_f) - m(t_i)}{\Delta t} = \frac{\Delta m}{\Delta t}$$

Combining the 2 gives the measure of the mass of the nitrogen in the well at that time.

$$m(t) = \int_{z=0}^{z=h(t)} \rho(z, t) S(z) dz$$

$$m(t) = \int_{z=0}^{z=h(t)} \frac{P(z, t)}{r \cdot Z(P, T) \cdot T(z, t)} S(z) dz$$

Hence :

$$\text{CLR} = \frac{1}{r \cdot \Delta t} \left(\int_{z=0}^{z=h(t_f)} \frac{P(z, t_f)}{Z(P, T) \cdot T(z, t_f)} S(z) dz - \int_{z=0}^{z=h(t_i)} \frac{P(z, t_i)}{Z(P, T) \cdot T(z, t_i)} S(z) dz \right)$$

5.5.2. Minimum Detectable Leak Rate (MDLR)

For uncertainty calculation, we use average values of the temperature T and pressure P. For the sake of simplicity, we also assume that Z is constant over time. At a given time t, the mass of nitrogen in the well is:

$$m(t) = \frac{P(t) \cdot V(t)}{Z \cdot r \cdot T(t)}$$

With P and T average pressure and temperature of the nitrogen, and V(t) the volume it occupies. For the sake of simplicity, we also assume that Z is constant over time: The Calculated Lead Rate in such conditions is the derivative of m with respect to time.

$$m'(t) = \frac{1}{Z \cdot r} \left(\frac{P(t) \cdot V'(t)}{T(t)} + \frac{V(t) \cdot P'(t)}{T(t)} - \frac{P(t) \cdot V(t) \cdot T'(t)}{T(t)^2} \right)$$

Gas volume variation happens only through the variation of the interface depth h. Considering that the borehole has a section S at the interface depth, we can write: $V'(t) = S \cdot h'(t)$ ¹⁸

$$m'(t) = \frac{1}{Z \cdot r} \left(\frac{P(t) \cdot S \cdot h'(t)}{T(t)} + \frac{V(t) \cdot P'(t)}{T(t)} - \frac{P(t) \cdot V(t) \cdot T'(t)}{T(t)^2} \right)$$

To simplify the writing in the following, we write for all variable $X(t)$, $\Delta X = X(t + \Delta t) - X(t)$ and $X = X(t)$.

$$\Delta m = \frac{1}{Z \cdot r} \left(\frac{P \cdot S \cdot \Delta h}{T} + \frac{V \cdot \Delta P}{T} - \frac{P \cdot V \cdot \Delta T}{T^2} \right)$$

Supposing that each measured quantity X has an uncertainty ϵ_X , the resulting uncertainty in the mass balance $\epsilon_{\Delta m}$ can be derived from:

$$\Delta m + \epsilon_{\Delta m} = \frac{1}{(Z + \epsilon_Z) \cdot r} \left(\frac{(P + \epsilon_P) S (\Delta h + \epsilon_{\Delta h})}{T + \epsilon_T} + \frac{(V + \epsilon_V) (\Delta P + \epsilon_{\Delta P})}{T + \epsilon_T} - \frac{(P + \epsilon_P) (V + \epsilon_V) (\Delta T + \epsilon_{\Delta T})}{(T + \epsilon_T)^2} \right)$$

¹⁸ In practice, this hypothesis is not necessary. We can do without it, using the real caliper data instead of a constant section S around the interface depth. It is used here to simplify the formulation

These uncertainties are supposed to be small compared to X , ($\epsilon_X \ll X, \epsilon_{\Delta X} \ll X$), this can be developed in $O(\epsilon_X)$, neglecting products of uncertainties. This basically means that we neglect ϵ_X and $\epsilon_{\Delta X}$ when they are compared to X .

This leads to :

$$\begin{aligned} \Delta m + \epsilon_{\Delta m} = & \frac{1}{Z \cdot r} \left(\frac{P \cdot S \cdot \Delta h + P \cdot \epsilon_{\Delta V} + S \cdot \Delta h \cdot \epsilon_P}{T} - \frac{P \cdot S \cdot \Delta h \cdot \epsilon_T}{T^2} \right. \\ & + \frac{V \cdot \Delta P + V \cdot \epsilon_{\Delta P} + \Delta P \cdot \epsilon_V}{T} - \frac{V \cdot \Delta P \cdot \epsilon_T}{T^2} \\ & \left. - \frac{P \cdot V \cdot \Delta T + P \cdot V \cdot \epsilon_{\Delta T} + P \cdot \Delta T \cdot \epsilon_V + V \cdot \Delta T \cdot \epsilon_P}{T^2} + 2 \frac{P \cdot V \cdot \Delta T \cdot \epsilon_T}{T^3} \right) \\ & - \frac{\epsilon_Z}{Z^2 \cdot r} \left(\frac{P \cdot S \cdot \Delta h}{T} + \frac{V \cdot \Delta P}{T} - \frac{P \cdot V \cdot \Delta T}{T^2} \right) \end{aligned}$$

And then :

$$\begin{aligned} \epsilon_{\Delta m} = & \epsilon_V \cdot \frac{1}{Z \cdot r \cdot T} \left(\Delta P - P \cdot \frac{\Delta T}{T} \right) + \epsilon_{\Delta h} \cdot \frac{S \cdot P}{Z \cdot r \cdot T} \\ & + \epsilon_P \cdot \frac{1}{Z \cdot r \cdot T} \left(S \cdot \Delta h - V \cdot \frac{\Delta T}{T} \right) + \epsilon_{\Delta P} \cdot \frac{V}{Z \cdot r \cdot T} \\ & + \epsilon_T \cdot \frac{1}{Z \cdot r \cdot T^2} \left(2 \cdot P \cdot V \cdot \frac{\Delta T}{T} - P \cdot S \cdot \Delta h - V \cdot \Delta P \right) + \epsilon_{\Delta T} \cdot \frac{-P \cdot V}{Z \cdot r \cdot T^2} \\ & + \epsilon_Z \cdot \frac{-1}{Z^2 \cdot r \cdot T} \left(P \cdot S \cdot \Delta h + V \cdot \Delta P - P \cdot V \cdot \frac{\Delta T}{T} \right) \end{aligned}$$

In a conservative approach, we assume that each source of uncertainty contributes to the final uncertainty in the most unfavorable way. It leads to applying absolute values to each of the terms in the final sum. The uncertainty over the mass balance is:

$$\begin{aligned} \epsilon_{\Delta m} = & \left| \epsilon_V \cdot \frac{1}{Z \cdot r \cdot T} \cdot \left(\Delta P - P \cdot \frac{\Delta T}{T} \right) \right| + \left| \epsilon_{\Delta h} \cdot \frac{S \cdot P}{Z \cdot r \cdot T} \right| \\ & + \left| \epsilon_P \cdot \frac{1}{Z \cdot r \cdot T} \cdot \left(S \cdot \Delta h - V \cdot \frac{\Delta T}{T} \right) \right| + \left| \epsilon_{\Delta P} \cdot \frac{V}{Z \cdot r \cdot T} \right| \\ & + \left| \epsilon_T \cdot \frac{1}{Z \cdot r \cdot T^2} \cdot \left(2 \cdot P \cdot V \cdot \frac{\Delta T}{T} - P \cdot S \cdot \Delta h - V \cdot \Delta P \right) \right| + \left| \epsilon_{\Delta T} \cdot \frac{P \cdot V}{Z \cdot r \cdot T^2} \right| \\ & + \left| \epsilon_Z \cdot \frac{1}{Z^2 \cdot r \cdot T} \cdot \left(P \cdot S \cdot \Delta h + V \cdot \Delta P - P \cdot V \cdot \frac{\Delta T}{T} \right) \right| \end{aligned}$$

5.5.3. Typical Application

For the sake of comparison with Crotagino (1995), we consider the same well completion: a 9-5/8" casing down to 1000 m, a 4-1/2" brine string and a 1 m diameter open hole. The interface is 3 m below the last cemented casing shoe.

The section of the test fluid volume at the interface depth is $S = 0.78 \text{ m}^2$.

The systematic error on the volume of nitrogen ϵ_V may come from an inaccuracy in the cased section (0.5% of the 1000 m), in the open hole (20% of the 3 m section measured by a caliper) and of the interface depth (PNT accuracy ϵ_h applied the section of 0.78m). It leads to an error $\epsilon_V = 5m^3$

The propagation of source uncertainties leads to the following:

Source uncertainty			Resulting uncertainty on:	
Parameter	Value	Remark	In-situ mass balance $\epsilon_{\Delta m}$ kg	Over a 3-day long test (kg/d) $\epsilon_{CLR} = \frac{\epsilon_{\Delta m}}{\Delta t}$
Volume	$\epsilon_V = 5 m^3$	Cf above	2	0,6
Interface depth random error	$\epsilon_{\Delta h} = 0.1 m$	PNT log accuracy. Most commonly found value.	13,9	4,6
Pressure systematic error	$\epsilon_P = 0.1 MPa$	e.g. gage calibration	0,0	0,0
Pressure random error	$\epsilon_{\Delta P} = 0.001 MPa$	Lower than POT or CLR as there is less model limitation in a mass balance	0,0	0,0
Temperature systematic error	$\epsilon_T = 3 ^\circ C$	Model limitation (measurement along the vertical axis only), gage calibration	0,2	0,1
Temperature random error	$\epsilon_{\Delta T} = 0.5 ^\circ C$	T acquisition during a log	9,5	3,2
Compressibility factor	$Z = 1\%$	Pure gas, but possible moisture	0,2	0,1
		TOTAL	26	9

5.5.4. Comparison of the 1st order and Monte Carlo methods to propagate uncertainties Réveillère (2019) have presented and compared different methods to propagate MIT source uncertainties. It has notably presented the result of a comparison of 10 nitrogen/brine MIT conducted by Geostock on future storage salt caverns and interpreted using the in-situ mass balance method:

- when uncertainties are propagated using the 1st order method (as presented in the present report)
- when uncertainties are propagated using a Monte Carlo approach, with 5000 random draws taken on the each of the source uncertainties and applied to the CLR formulation.

The result shows it does not lead to any significant difference in the MDLR. This validates the use of a 1st order approach in the present work. It is an approximation and may be more complex to set up, but that enables to identify explicitly the influence of each of the parameters.

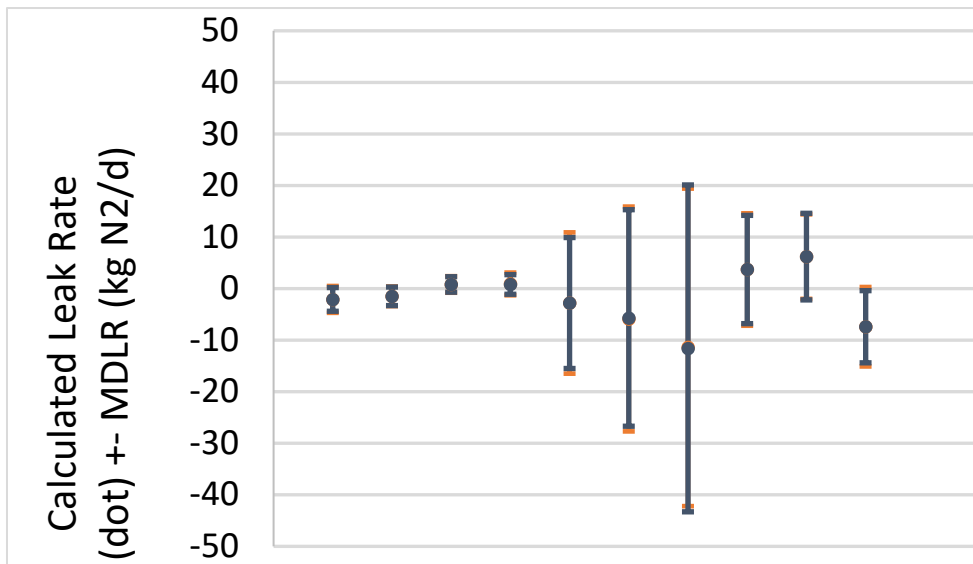

Figure 32. Calculated Leak Rate (dot) +/- the MDLR (line) for 10 Nitrogen-Brine MITs interpreted by Geostock using the in-situ mass balance method. Two uncertainty propagation methods are used: 1st order (orange) and Monte Carlo (blue). From Réveillère (2019).

Note that the same result is found on 4 Liquid-Liquid MITs, as presented in the figure below.

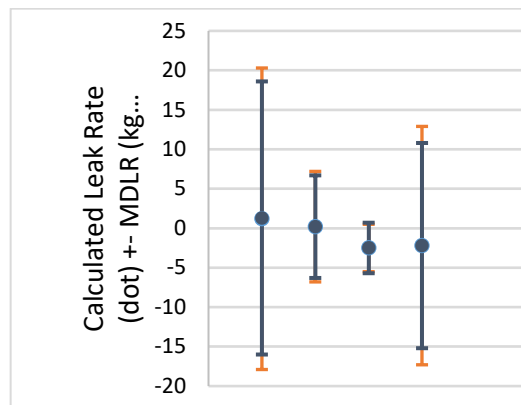

Figure 33. Calculated Leak Rate (dot) +/- the MDLR (line) for 10 diesel Liquid-Liquid MITs interpreted by Geostock using the in-situ mass balance method. Two uncertainty propagation methods are used: 1st order (orange) and Monte Carlo (blue).

5.6. In-situ volume balance of a Nitrogen-Brine MIT or Liquid-Liquid Interface test

An in-situ volume balance assumes a constant density of the test fluid. Whether it is a gas (nitrogen) or a liquid (LPG, diesel oil) does not make a difference. Prior to the test, the caliber of the borehole around the interface depth has to be known. During the test, the main monitoring required for the in-situ volume balance is two interface depth measurements (Figure 33).

Figure 33. Cavern and monitoring used during an in-situ volume balance interpretation of a nitrogen-brine MIT or Liquid-Liquid interface test

5.6.1. Formulation of a Calculated Leak Rate (CLR)

The volumetric Calculated Leak Rate (CLR) is deduced from the brine volume balance ΔV between the initial state at t_i final state at $t_f = t_i + \Delta t$:

$$CLR = \frac{V(t_f) - V(t_i)}{\Delta t} = \frac{\Delta V}{\Delta t}$$

We assume that the test fluid volume variation happens only through the variation of the interface depth h . Considering that the borehole has a section S at the interface depth, we can write $\Delta V = S \cdot \Delta h$ and:

$$CLR = S \frac{\Delta h}{\Delta t}$$

5.6.2. Minimum Detectable Leak Rate (MDLR) of the In-situ volume balance

Supposing that the random error of the measurement h has an uncertainty $\epsilon_{\Delta h}$, the resulting uncertainty in the volume balance $\epsilon_{\Delta V}$ can be derived from:

$$\epsilon_{\Delta V} = S \cdot \epsilon_{\Delta h}$$

5.6.3. Typical Application

The propagation of source uncertainty leads to the following:

Source uncertainty			Resulting uncertainty on:	
Parameter	Value	Remark	In-situ volume balance $\epsilon_{\Delta V}$ kg	Over a 3-day long test (kg/d) $\epsilon_{CLR} = \frac{\epsilon_{\Delta m}}{\Delta t}$
Volume	$\epsilon_V = 5 \text{ m}^3$	Cf above	2	0,6
Interface depth random error	$\epsilon_{\Delta h} = 0.1 \text{ m}$	PNT log accuracy. Most commonly found value.	13,9	4,6

5.7. Pressure Difference Observation Test in a N2-brine MIT

We consider the cavern presented on Figure 34. During the test, only the wellhead brine and test fluid (usually nitrogen or diesel) pressure measurement are needed for the interpretation.

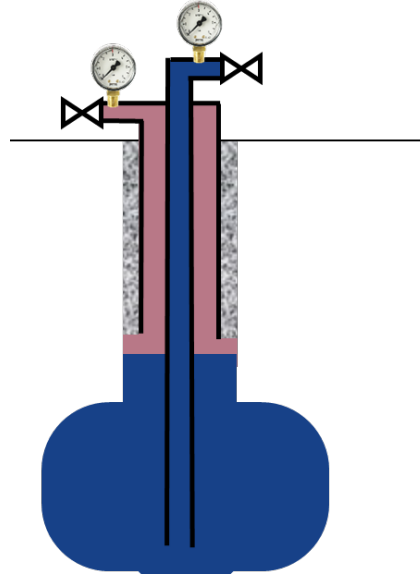

Figure 34. Cavern and monitoring used during a Pressure Difference Observation Test (PDO)

5.7.1. Assumption of uniform gas density in the well

The formulation of a Calculated Leak Rate in a relatively simple analytical formulation implies assuming a uniform gas density. We recall hereafter the justification proposed in Bérest et al. (2021) to explain why is this assumption acceptable.

The gas state equation is:

$$P_g(z) = \rho_g(z)ZrT(z)$$

The three variables are functions of depth (z , oriented downward) and when derived, this leads to:

$$P'_g(z) = \rho'_g(z)ZrT(z) + \rho_g(z)ZrT'(z)$$

The gas compressibility factor Z is assumed constant here, in order to simplify the formulations.

In the gas column, the hydrostatic equation is:

$$P'(z) = \rho_g(z)g$$

When the nitrogen test fluid is at thermal equilibrium with the surrounding rocks, the vertical distribution of the temperature in the gas column is the geothermal gradient:

$$T'(z) = G_{geo}$$

Hence:

$$\rho_g(z)g = \rho'_g(z)rT(z) + \rho_g(z)rG_{geo}$$

$$\frac{\rho'_g(z)}{\rho_g(z)} = \frac{1}{T(z)} \left(\frac{g}{r} - G_{geo} \right)$$

For nitrogen, $r = 290 \text{ J/kg}\cdot\text{C}$, and $g/r = 0.034 \text{ C/m}$ and for hydrogen, $r = 4120 \text{ J/kg}\cdot\text{C}$, and $g/r = 0.024 \text{ C/m}$. The average geothermal gradient is $G_{geo} = 0.02 \text{ C/m}$ in salt and 0.03 C/m in the overburden, which includes most of the column of test fluid.

At $T = 300\text{K}$ and considering a geothermal gradient of 0.025 C/m , $\rho'_g/\rho_g = 3 \cdot 10^{-5}/m$ for nitrogen and $\rho'_g/\rho_g = 3 \cdot 10^{-6}/m$ for hydrogen. For a 1000 m deep cavern, the error made when assuming the density is uniform is respectively 3% or 0.3%.

5.7.2. Formulation of a Calculated Leak Rate (CLR)

In the gas annular, gas pressure is time dependent. The hydrostatic equilibrium is:

$$P_g(z, t) = P_g^{wh}(t) + \rho_g(t)gz$$

With $\rho_g(t)$ the average nitrogen density along the well at time t . It is assumed constant uniform along the well, as detailed in the above section.

In the brine column:

$$P_b(z, t) = P_b^{wh}(t) + \rho_b(t)gz$$

With $\rho_b(t)$ the average brine density along the well at time t .

The mass of gas is estimated as follows:

$$m_g(t) = \rho_g(t)V_g(t)$$

The derivative with respect to time is equals the gas leak rate.

$$m'_g(t) = \rho_g(t)S h'(t) + V_g \cdot \rho'_g(t)$$

Assuming thermal equilibrium is reached, the perfect gas law in the gas annulus is:

$$P'_{g,wh}(t) = \rho'_g(t)rT$$

Hence the gas mass leak rate is

$$m'_g(t) = \rho_g(t)S h'(t) + \frac{V_g}{rT} P'_{g,wh}(t)$$

For brine, similarly:

$$m_b(t) = \rho_b V_b(t)$$

By derivating this expression and introducing the compressibility

$$\beta = \frac{-1}{V} \frac{\partial V}{\partial P} = \frac{1}{\rho} \frac{\partial \rho}{\partial P}$$

We have:

$$m'_b(t) = \rho_b S h'(t) + V_b(t) \rho_b \beta_b P'_{b,wh}(t)$$

Finally, gas and brine pressures are equal at interface depth:

$$P'_{g,wh}(t) + \rho_g g h'(t) = P'_{b,wh}(t) + \rho_b g h'(t)$$

$$h'(t) = \frac{P'_{g,wh}(t) - P'_{b,wh}(t)}{g(\rho_b - \rho_g)}$$

This can be introduced in the above equations. The gas mass flow rate is:

$$m'_g(t) = \rho_g S \frac{P'_{g,wh}(t) - P'_{b,wh}(t)}{g(\rho_b - \rho_g)} + \frac{V_g}{rT} P'_{g,wh}(t)$$

$$m'_b(t) = \rho_b S \frac{P'_{g,wh}(t) - P'_{b,wh}(t)}{g(\rho_b - \rho_g)} + \beta_b \rho_b V_b P'_{b,wh}(t)$$

In an MIT situation, variables are only measured at two given times t_1 and $t_2 = t_1 + \Delta t$. To simplify the writing in the following, we write for all variable $X(t)$: $X = X(t_1)$ and $\Delta X = X(t + \Delta t) - X(t)$. The in-situ mass balance is:

$$\Delta m_g = \rho_g S \frac{\Delta P_{g,wh} - \Delta P_{b,wh}}{g(\rho_b - \rho_g)} + \frac{V_g}{rT} \Delta P_{g,wh}$$

$$\Delta m_b = \rho_b S \frac{\Delta P_{g,wh} - \Delta P_{b,wh}}{g(\rho_b - \rho_g)} + \beta_b \rho_b V_b \Delta P_{b,wh}$$

I personally lack field experience using this pressure differential method. With such experience, the assessment of the source uncertainties should be possible and a similar estimation of the Minimum Detectable Leak Rate (MDLR) could be done.

6. Conclusion

The present work started from several impressions and questions found over a professional experience as an engineer at Geostock, notably conducting tightness tests of future storage salt caverns:

- that the ability to test accurately the tightness of salt cavern is a unique feature, and is a substantial benefit when compared to alternative storage options underground or above ground;
- that using “Mechanical Integrity Test” or “MIT” to name it instead of “tightness tests”, or “leak tests”, is a little bit odd and must be a historical heritage;
- that as MITs is a quite specific naming often used by itself, it should be self-sufficient and refer to a specific practice among the industry. But from my professional experience reviewing other companies’ tests, or getting industry feedback from SMRI conferences and proceedings, I realized that it is not;

- That although MITs are sometimes named through the test fluid that is used, there still is a number of interpretation methods that can be applied. How would these methods compare to each other was unclear.

The main answers to these questions found through this work are as follows.

Salt caverns started being produced as a lagniappe of the salt production. When industrial production of underground salt started 3 centuries ago, tightness or stability of the caverns were not an objective or were rarely achieved. Leaching first started where it was the easiest: groundwater was used to leach the top of the geological layer of salt (“wild brining”). This produced low salinity brine, created heavy subsidence and frequent sinkholes at the surface, and only enabled to mine the top of the salt layer. To prevent the risk of sinkhole creation and increase both the extraction ratio and the salinity of the produced brine, salt producers started drilling deeper in the salt and develop cavern with long term stability. To frack and recover saturated brine faster, the wells started being cemented down to the casing shoe. This led to a situation of stable and tight caverns being left over by the brine production industry in after the beginning of the 20th century.

First oil and gas storage were former brine production caverns, not designed for storage, converted generally under tense geopolitical times (WWII for the 1st oil storage in Canada, the oil crisis following the Suez crisis for the 1st British and French caverns). The first tightness tests were hydraulic tests in North America, which is similar to what is done in pipeline, surface tanks or drilling industries, and is rough and rather simple: the brine cavern is pressurized at or slightly above its maximum operating pressure, and the pressure decay is interpreted as a leak. But the huge volume of the caverns make it inaccurate and poorly satisfying, since the influence of effect proportional to the volume (thermal expansion) blur the identification of a small leak. We note that in France, where salt cavern storage started several decades after North America, the first oil and then gas storage caverns were tested with test methods more accurate than a hydraulic one.

However, it is the US Federal requirement to test the « Mechanical Integrity » of injection wells that prompted technical developments and a wide industrial deployment of very accurate tightness test. Even if not substantially originating from the salt cavern industry, it applied to it and prompted technical developments. Most notably the decisive invention of the nitrogen/brine MIT. The regulation in the United States and probably the numerous discussions about it at the Solution Mining Research Institute (SMRI) international conferences led to a wide and global industrial deployment of very accurate tightness test of salt caverns wells.

The question of the acceptance criteria of these tests came along. First attempts were to relate a fail/pass criteria to impacts on groundwater (concept of Maximum Acceptable Leak Rate, MALR). It did not prove practical, as the occurrence of leak paths below ground are practically unpredictable, and would anyhow be case-specific, which prevents from setting an industry standard. The alternative approach is to base the test acceptance on the fact that a possible leakage cannot be distinguished from the accuracy of the test (concept of Minimum Detectable Leak Rate, MDLR) while setting stringent but achievable limits to the MDLR that must be met on the field. It is what is practiced today: MIT developers probably still have in mind what is desirable from a groundwater protection point of view, but also the practical impossibility to establish a quantitative MALR. And they can refer to the track record of several decades of salt cavern testing with an accuracy (MDLR) below the reference MDLR values of 1000 bbl/y (in North America) or 50 kg/d (in Europe), and to the limited history of leakages incidents from the salt cavern storage industry, especially when recent (post 2000) caverns are concerned. That track records can now weight more in the balance and be *de facto* accepted as the acceptance criterion, while impact-related assessments of the MALR are still hardly achievable.

These criteria are typically 2 orders of magnitude more stringent than the criteria applied in the underground storage tanks or pipelines industries, when expressed relatively to the quantity of stored product. With such high accuracies, MITs can typically be able to detect microannulus of 50 μm aperture at the casing/cement bond, one that could be missed by a CBL log analysis. The accuracies reached by the interface-based MITs in the salt cavern industry are a tremendous progress: it enables to expose defective materials that can have missed prior detection and serve as a final validation of the integrity of the well. In case of failed MIT, it enables to repair the well prior to start storing product.

Various types tests and interpretation methods enable deriving a Calculated Leak Rate (CLR) from measurements made on the cavern at its maximum operating pressure or slightly above it. Test types are usually distinguished by the test fluid. When the test fluid occupies the whole cavern (or almost it), it can be gas, brine or liquid hydrocarbon. But best accuracies are reached only when a small volume of test fluid is used, from the surface down to a few meters below the last cemented casing shoe. This enables to have the test fluid in contact with the main possible leakpath (most notably the salt/cement and cement/casing bonds) but only a small quantity of test fluid (typically 3 to 5 orders of magnitude less than the whole cavern volume), which enables reaching such stringent test accuracy requirements. The remaining part of the cavern is not directly tested, and cannot be precisely due to its volume. It however benefits from the tightness properties of rock salt (exceedingly small intrinsic permeability of salt, from 10^{-22} to 10^{-19} m^2). And even during in the handful known cases of leakage through the cavern walls themselves, due to anomalous geological zones, MITs have in several occasions enabled to detect a leakage through qualitative interpretations.

Last, even for one single test type, several interpretation methods can apply. For instance, for the nitrogen/brine interface MIT which is the most frequently applied type of test, the main interpretation methods practiced today are:

- the Pressure Observation Test that only relies on surface pressure measurement. Its main advantage is not requiring logging to be performed, and to test the whole cavern (making it just as good for a cavern without a neck). However, the fact that it applies to the whole cavern volume also makes it moderately accurate: the 150 kg/d or 1000 bbl/y thresholds can hardly be matched. It also assumes a perfect thermal equilibrium
- the in-situ volume balance. The test relies on two PNT logs to measure the nitrogen/brine interface depth, and therefore the nitrogen volume. From which a leak rate can be deduced. It is the most widespread interpretation method. It assumes a perfect thermal equilibrium, and is very good when this condition is met.
- Pressure Differential Observation Test. It relies on surface pressure measurements only as well, but basically uses pressures differences to estimate the interface depth (without using a logging tool). Its main advantage is the avoidance of using a logging tool. As temperature is not measured, thermal equilibrium is assumed as well.
- the in-situ mass balance. It is similar to the volume balance, but in addition to it, temperature is measured as well during PNT logs and used to build density profiles, and deduce nitrogen masses. Would the temperature be stable during the test, it is equivalent to the volume balance method. But it also enables accurate interpretations when thermal equilibrium is not reached, as temperature is measured and thermal effects accounted for.

Quantitative comparison of these interpretation methods is not absolute, but specific to the cavern geometry (POT is not influenced by the absence of a cavern neck contrarily to the 3 others), to the test

conditions (if the cavern is not well stabilized prior to the test, only the in-situ mass balance accounts for changing temperature in the nitrogen annulus), and to the implementation plan of the test (waiting time and stability of the cavern prior to the test period, duration of the test, accuracy of the gages or logging tools) and also to quality of the field implementation and supervision (checking that there is no surface leak, that the sonar, caliper or PNT logging meets the best practices for a reliable measurement, have a correct depth correction...). For one typical case under several hypotheses, it is found that the in-situ mass balance interpretation provides better results than the in-situ volume interpretation (since the temperature change was considered, it would be equal otherwise) and that the Pressure Observation Test.

The salt production industry therefore developed techniques to produce stable and tight salt caverns at the beginning of the 20th century. These caverns started being used for hydrocarbon storage half a century later. In the 1980s the hydrocarbon storage industry developed the nitrogen / brine MIT, a very accurate technique to test the tightness of the salt caverns. Today, this experience and knowledge gained doing MITs is a solid ground to consider large scale storage of very mobile gases such as hydrogen, whose projects are burgeoning throughout the world.

7. References

Note: pages references are not mentioned for proceedings of SMRI technical conferences or classes, or Symposium of salt, as the articles are available individually on the SMRI website www.solutionmining.org. Similarly, pages are not mentioned for the 2019 and 2020 articles published in the Oil & Gas Science and Technology journal as for these years, it has published one volume per year with articles individually available online at <https://ogst.ifpenergiesnouvelles.fr/>

Abdel Haq, A., 2019. *Mechanical Integrity Tests for Oil Caverns. Principles and Case Study of Testing for Leak Detection*. Proc. SMRI Technical Classes, Spring (New Orleans) and Fall (Berlin).

ATG Manual, 1985. *Gas transport and distribution handbook (Manuel pour le transport et la distribution du gaz. Titre XIII, Stockages Souterrains de Gaz)* (in French).

Bauer, T., 2019. *Case History – Liquid Storage Cavern MIT with Large Diameter Wellbore*. Proc. SMRI Technical Classes, Spring (New Orleans) and Fall (Berlin).

Bays, 1962a. *Significant uncertainties in current salt solution extraction operations*. Proc. SMRI Technical Conference, Cleveland, Ohio, USA.

Bays, 1962b. *Use of salt solution cavities for underground storage*. Proc. SMRI Technical Conference, Cleveland, Ohio, USA.

Bérest, P., Brouard, B., and Durup, G., 1995. *Some comments on the MIT test*. Proc. Spring SMRI Technical Conference, San Antonio, Texas, USA.

Bérest P., Bergues J., Brouard B., 1999. *Review of static and dynamic compressibility issues relating to deep underground salt caverns*, Int. J. Rock Mech. Min. Sci. 36, 1031–1049.

Bérest, P., Brouard, B., and Durup, G., 2001. *Tightness Tests in Salt-Cavern Wells*. Oil & Gas Science and Technology, Vol.56 (2001), n°5, 451-469.

Bérest, P., Diamond, B., Duquesnoy, A., Durup, G., Feuga, B., Lhoff, L., 2005. *Salt and brine production methods in France: main conclusions of the international group of experts (IEG) commissioned by the French regulatory authorities*. Proc. Post-Mining 2005 Conference, Nancy, France.

Bérest, P., 2007. *Possibilities and limitations of MITs in Boreholes and Gas-filled caverns*. Proc. SMRI Technical Class, Halifax, Canada.

Bérest, P., Brouard, B., 2019. *Possibilities and Limitations of MITs in Boreholes and Gas-Filled Caverns*. Proc. SMRI Technical Classes, Spring (New Orleans) and Fall (Berlin).

Bérest, P., Réveillère, A., Evans, D., Stöwer, M., 2019. *Review and analysis of historical leakages from storage salt caverns wells*. Oil Gas Sci. Technol. Vol. 74 (2019), n° 27.

Bérest, P., Brouard, B., Karimi-Jafari, M., Réveillère, A., 2020. *Maximum admissible pressure in salt caverns used for brine production and hydrocarbon storage*. Oil & Gas Science and Technology, Vol. 75 (2020), n°76.

Bérest, P., Brouard, B., Hévin, G., Réveillère, A., 2021. *Tightness of salt caverns used for hydrogen storage*. Proc. SMRI Spring Virtual Technical Conference

Bernardt, H., 2019. *Technical and Legal Regulations for Integrity Tests for Underground Gas Storage in Selected European Countries*. Proc. SMRI Technical Classes, Spring (New Orleans) and Fall (Berlin).

- Brasier, F.M., 1990. *Assuring the integrity of solution mining operations*. Proc. SMRI Fall Technical Conference, Paris, France.
- Briggs, P., Sanford, K., 2000. *The Ups and Downs of Post-Closure Subsidence Monitoring at the Tully Valley Brine Field, New York*. Proc. SMRI Spring Technical Conference, Albany, New York, USA.
- CH2MHILL Inc., 1995. *Technical manual for external well mechanical integrity testing Class-III salt solution mining wells*. SMRI Research Report No. 94-0003-S.
- Colcombet, B., Nguyen, H. D., 2013. *Well Integrity Management At the Géosel Manosque Storage Facility*. Proc. Fall 2013 SMRI Fall Technical Conference, Avignon, France.
- Cooper, A.H., 2002. Halite karst geohazards (natural and man-made) in the United Kingdom. *Environmental Geology* (2002) 42:505–512.
- Crotogino, F., 1995. *External well mechanical integrity testing/performance, data evaluation and assessment*. SMRI Research Report 95-0001-S.
- Crotogino, F., Wilke, F., 2014. *Selected Examples of Sinkhole Formation Induced by Wild and Bastard Brining*. Proc. SMRI Fall Technical Class, Groningen, Netherlands.
- Diamond, H.W., 1989. *The water-brine interface method, An alternative Mechanical Integrity Test for salt solution mining wells*. Proc. SMRI Fall Technical Conference, San Antonio, Texas, USA.
- Dubois, D., 1982. *Tests for tightness/containment in a cavity leached in salt*. Proc. SMRI Fall Technical Conference, Manchester, UK.
- Gisotti, G., 1992. *Problemi geo-ambientali inerenti la miniera di salgemma di Belvedere Spinello (Catanzaro). Un nuovo caso di subsidenza in Italia*. Mem. Descr. Carta Geol. d'It. XLII, pp. 283 – 306. (in Italian).
- Goin, K.L., 1983. *A Plan for Certification and Related Activities for Department of Energy-SPR Oil Caverns*, SAND83-2005, Sandia National Laboratories, Albuquerque, New Mexico, USA.
- Guarascio, M., Fernandez, G., Thoms, R.L., 1994. *Updated evaluation of sinkhole potential at the Belvedere Spinello Brinefield*. SMRI Fall Technical Conference, Hanover, Germany.
- Hackett, W.R., Gleason, G.C., Kappel, W.M., 2009. *Land-Surface Subsidence and Open Bedrock Fractures in the Tully Valley, Onondaga County, New York*. USGS Open-File Report 2009-1188.
- Heitman, N.A., 1987. *Experience with cavern integrity testing using nitrogen gas*. Proc. SMRI Spring Technical Conference, Tulsa, Oklahoma, USA.
- Hévin, G., 2019. *Cavern / Well Testing Methods at Storengy*. Proc. SMRI Technical Classes, Spring (New Orleans) and Fall (Berlin).
- Hocquet, J.-C., 1993. *Salt and Capitalism in Western Europe (XVIIIth-XIXth Centuries)*. Proc. 7th Symposium on Salt, Vol. II, p. 437-444.
- Hocquet, J.-C., 2000. *Long-Term Baysalt History Structural Changes in Salt Winning and Production in Western Europe*. Proc. 8th Symposium on Salt, vol. II, p. 1103-1111.
- Horvath, P.L., Mirau, S., Schneider, G.S., Weiler, C., Bödeker, J., Ratigan, J., 2018. *Update of SMRI's. Compilation of Worldwide Salt Deposits and Salt Cavern Fields* – SMRI Research Report U2015-2.

Hough, E., Evans, D.J., Williamson, P., 2011. *A geological reappraisal of the Preesall Saltfield, Lancashire, United Kingdom: recognizing geological factors relevant to gas storage*. Proc. SMRI Fall Technical Conference, York, UK.

Jordan, P., 2019. *Basic Procedures for Borehole (Gas or Liquid Over Brine) MIT's, Pressure Observation Tests and Cavern Gas Tightness Tests*. Proc. SMRI Technical Classes, Spring (New Orleans) and Fall (Berlin).

Kiefner, J.F., 2001. *Role of hydrostatic testing in pipeline integrity assessment*. Proc. Northeast Pipeline Integrity Workshop, Albany, New York, USA, June 12.

Kunstman, A, Poborska-Mlynarska, K., Urbanczyk, K., 2007. *Solution Mining in Salt Deposits*. AGH University of Science and Technology Press, Krakow.

Lampe, B., 2019. *How Heat Transfer Can Influence MIT Results*. Proc. SMRI Technical Classes, Spring (New Orleans) and Fall (Berlin).

Lampe, B., Ratigan, J., 2014. *Pitfalls of a Nitrogen-Brine interface Mechanical Integrity Test*. Proc. SMRI Spring Technical Conference, San Antonio, Texas, USA.

Manceau, J.-C., Hatzignatiou, D.G., de Lary, L. Jensen, N.B., Réveillère, A., 2014. *Mitigation and remediation technologies and practices in case of undesired migration of CO₂ from a geological storage unit—Current status*. Int. J. of Greenhouse Gas Control 22 (2014) 272–290.

Minnesota Pollution Control Agency, 2019. *Tightness testing for underground storage tanks*. Report t-u3-21.

McCurdy, R., 2011. *Underground Injection Wells For Produced Water Disposal*. Presentation available at : https://www.epa.gov/sites/production/files/documents/21_McCurdy_-_UIC_Disposal_508.pdf on 30/04/2021.

Meinecke, I., Walter, M., Olaf Kruck, O., 2013. *A hydraulic Mechanical Integrity Test of an oil cavern using the SoMIT method*. Proc. SMRI Fall Technical Conference, Avignon, France.

Nelson, P.E., Van Sambeek, L., 2003. *State-of-The-Art Review and New Techniques for Mechanical Integrity Tests of (Gas-Filled) Natural Gas Storage Caverns*. SMRI Research Report 2003-2.

Pattinson, R.L., 1944. *Method of storing gases or liquids*. Patent application in Canada June 30, 1944. In the USA June 29, 1945. Patented on Mar. 18, 1952.

Quintanilha de Menezes J.E., Guerreiro V.N., Lúcio J.M., 2001. *Natural gas underground storage at Carriço in Portugal*. Proc. SMRI Fall Technical Conference, Albuquerque, New Mexico, USA.

Ratigan, J., 2019. *Technical and Regulatory Requirements for Integrity Tests in North America*. Proc. SMRI Technical Classes, Spring (New Orleans) and Fall (Berlin).

Réveillère, A., 2019. *Dealing with MIT Uncertainties*. Proc. SMRI Technical Classes, Spring (New Orleans) and Fall (Berlin).

Réveillère, A., Bérest, P., Evans, D.J., Stöwer, M., Chabannes, C., Koopmans, T., Bolt, R., 2017. *Past Salt Caverns Incidents Database Part 1: Leakage, Overfilling and Blow-out*. SMRI Research Report RR2017-2.

- Réveillère, A., Bérest, P., Jeronimo, R., 2021. *Past Salt Caverns Incidents Database Part 2: Structural Integrity - Sinkholes, Major Block Falls, Roof Falls, Casing Overstretch, Hydraulic Connections and Unexpectedly Fast Creep*. SMRI Research Report RR2021-3, in prep.
- Sanford, K.F., 1996. *Solution Salt Mining in New York, with Emphasis on Operational, Regulatory and Plugging Innovations in the Tully Valley Brine Field*. Proc. SMRI Fall Technical Conference.
- Schulte, B., Lampe, B., Welsh, I., 2013. *A Liquid-Liquid Mechanical Integrity Test Analysis That Implements a Fluid Equation of State*. Proc. SMRI Fall Technical Conference, Avignon, France.
- Skaug, N., 2019 *Case Histories - Gas-Filled Cavern MITs, North America*. Proc. SMRI Technical Classes, Spring (New Orleans) and Fall (Berlin).
- Skaug, N., Ratigan, J., Lampe, B., 2011. *A Critical Look at the Nitrogen/Brine Interface Mechanical Integrity Test*. Proc. SMRI Fall Technical Conference, York, UK.
- Sofregaz, 1998. *Relationship between Overbrining and Subsidence Report of Phase 1 : Desktop Study of Existing Data Development of a Preliminary Model*. SMRI Research Project Report No. 98-1-SMRI.
- Stormont, J.C., Garcia Fernandez, S., Taha, M.R., Matteo, E.N., 2018. *Gas flow through cement-casing microannuli under varying stress conditions*. Geomechanics for Energy and the Environment. Vol. 13, March 2018, 1-13.
- Thiel, W.R., Russel, J.M., 2004. *Pressure Observation Testing Solution Mined Underground Storage Caverns in Kansas*. Proc. SMRI Spring Technical Conference, Wichita, Poland.
- Thomas, R.L., Gehle, R.M., 2000. *A brief history of salt cavern use*. Proc. 18th world salt symposium.
- Van Fossan, N.E., 1983. *The characterization of mechanical integrity for cased boreholes entering solution caverns*. Proc. Sixth International Symposium on Salt, Vol. II: The Salt Institute; 1983:111-120.
- Van Fossan, N.E., Whelply, F.V., 1985. *Nitrogen as a testing medium for proving the mechanical integrity of wells*. Proc. SMRI Fall Technical Conference, Houston, Texas, USA.
- Van Sambeek, L.L., Bérest, P., Brouard, B., 2005. *Improvements in Mechanical Integrity Tests for solution-mined caverns used for mineral production or liquid-product storage*. SMRI Research Project Report 2005-1, 2005.
- Vernoux J.-F., Manceau J.-C., 2017. *Risques de pollution des nappes de l'Albien et du Néocomien par les forages profonds du bassin parisien*. Final report BRGM/RP-66820-FR (in French)
- Vrakas, J., 1988. *Cavern integrity testing on the SPR program*. Proc. SMRI Spring Technical Conference, Mobile, Alabama, USA.
- Walker, S.E., Mahoney, R.J., 1993. *Interpreting and projecting long-term environmental conditions in a shallow brine field*. Proc. SMRI Spring Technical Conference, Syracuse, New York, USA.