



HAL
open science

Control of partial differential Equations in the presence of saturated actuators and perturbations

Suha Shreim

► **To cite this version:**

Suha Shreim. Control of partial differential Equations in the presence of saturated actuators and perturbations. Automatic. Université Grenoble Alpes [2020-..], 2022. English. NNT : 2022GRALT110 . tel-04051708

HAL Id: tel-04051708

<https://theses.hal.science/tel-04051708v1>

Submitted on 30 Mar 2023

HAL is a multi-disciplinary open access archive for the deposit and dissemination of scientific research documents, whether they are published or not. The documents may come from teaching and research institutions in France or abroad, or from public or private research centers.

L'archive ouverte pluridisciplinaire **HAL**, est destinée au dépôt et à la diffusion de documents scientifiques de niveau recherche, publiés ou non, émanant des établissements d'enseignement et de recherche français ou étrangers, des laboratoires publics ou privés.

THÈSE

Pour obtenir le grade de

DOCTEUR DE L'UNIVERSITÉ GRENOBLE ALPES

École doctorale : EEATS - Electronique, Electrotechnique, Automatique, Traitement du Signal (EEATS)

Spécialité : Automatique - Productique

Unité de recherche : Grenoble Images Parole Signal Automatique

Contrôle des équations différentielles partielles en présence d'actionneurs saturés et de perturbations.

Control of partial differential Equations in the presence of saturated actuators and perturbations.

Présentée par :

Suha SHREIM

Direction de thèse :

Christophe PRIEUR

Directeur de Recherche CNRS, Université Grenoble Alpes

Directeur de thèse

Francesco FERRANTE

Maitre de Conférences, GINP

Co-directeur de thèse

Rapporteurs :

Angelo ALESSANDRI

PROFESSEUR, Università Degli Studi di Genova

Sophie TARBOURIECH

DIRECTEUR DE RECHERCHE, CNRS DELEGATION OCCITANIE OUEST

Thèse soutenue publiquement le **16 décembre 2022**, devant le jury composé de :

Christophe PRIEUR

DIRECTEUR DE RECHERCHE, CNRS DELEGATION ALPES

Directeur de thèse

Angelo ALESSANDRI

PROFESSEUR, Università Degli Studi di Genova

Rapporteur

Sophie TARBOURIECH

DIRECTEUR DE RECHERCHE, CNRS DELEGATION OCCITANIE OUEST

Rapporteuse

Hugo LHACHEMI

MAITRE DE CONFERENCES, CENTRALESUPELEC

Examineur

Gildas BESANCON

PROFESSEUR DES UNIVERSITES, GRENOBLE INP

Président

Cristofaro ANDREA

PROFESSEUR ASSOCIE, Univ. degli Studi di Roma La Sapienza

Examineur

Invités :

Francesco Ferrante

MAITRE DE CONFERENCES, University of Perugia



GRENOBLE ALPES UNIVERSITY

DOCTORAL THESIS

Control of Partial Differential
Equations in the Presence of Saturated
Actuators and Perturbations

Author:

Suha SHREIM

Supervisors:

Christophe PRIEUR
Francesco FERRANTE

*A thesis submitted in fulfillment of the requirements
for the degree of PhD*

in the

Infinite Dimensional Dynamics Team
Automatique et Diagnostic (PAD) Department of Gipsa-lab

March 16, 2023

*To children of war and poverty, who will never have the
privilege to explore what their minds can do...*

*“The conscious purpose of
science is control of Nature;
its unconscious effect is
disruption and chaos.”*

WILLIAM IRWIN THOMPSON

GRENOBLE ALPES UNIVERSITY

Abstract

Automatique et Diagnostic (PAD) Department of Gipsa-lab

PhD

Control of Partial Differential Equations in the Presence of Saturated Actuators and Perturbations

by Suha SHREIM

The thesis investigates control problems for two types of partial differential equations. The first interest is the study of state-feedback boundary control design for one-dimensional hyperbolic systems with an in-domain disturbance and a saturation limitation imposed on the control law. Nonlinear semigroup theory is used to prove well-posedness of the system and prove the existence and uniqueness of mild solution pairs to the abstract system. Sufficient conditions in the form of dissipation inequalities are derived to establish global exponential stability for the origin of the closed-loop system and input-to-state stability properties with respect to in-domain disturbances. The control design problem is then recast as an optimization problem over linear matrix inequality constraints. Numerical analysis are carried out to validate the effectiveness of the proposed control design.

The second interest is the study of the input-output stability (IOS) of a reaction-diffusion equation with Dirichlet boundary output which admits a finite number of unstable poles and is considered open-loop unstable. A finite-dimensional linear time-invariant control system is designed to achieve global exponential input-output stability. The control design problem consists of deriving sufficient conditions in the form of linear matrix inequalities using Lyapunov methods and control synthesis algorithm. Numerical simulations are presented to illustrate the efficiency of our approach.

The third interest is the study of the local exponential input-output stability (IOS) of a reaction-diffusion equation with finite unstable poles using saturated distributed control and anti-windup compensators. It is the first work to deal with anti-windup design on distributed parameter systems. Lyapunov functions and sufficient conditions are used to estimate the regions of attraction and stability gains. Numerical simulations are presented to illustrate the efficiency of our approach and to highlight the positive role an anti-windup compensator plays in counteracting the negative impacts that saturating actuators have on performance levels and regions of attraction.

Resumé

La thèse étudie les problèmes de contrôle pour deux types d'équations aux dérivées partielles. Le premier intérêt est l'étude de la conception d'un contrôle limite par retour d'état pour des systèmes hyperboliques unidimensionnels avec une perturbation dans le domaine et une limitation de saturation imposée à la loi de contrôle. La théorie des semigroupes non linéaires est utilisée pour prouver que le système est bien posé et pour prouver l'existence et l'unicité de paires de solutions douces au système abstrait. Des conditions suffisantes sous la forme d'inégalités de dissipation sont dérivées pour établir la stabilité exponentielle globale pour l'origine du système. La stabilité exponentielle globale pour l'origine du système en boucle fermée et des propriétés de stabilité d'entrée à l'état en ce qui concerne les perturbations dans le domaine. Le problème de conception de la commande est alors refondu en un problème d'optimisation sur des contraintes d'inégalités matricielles linéaires. Des analyses numériques sont effectuées pour valider l'efficacité de la conception de contrôle proposée. L'efficacité de la conception de contrôle proposée.

Le deuxième intérêt est l'étude de la stabilité entrée-sortie (IOS) d'une équation de réaction-diffusion avec sortie de frontière de Dirichlet qui admet un nombre fini de pôles instables et est considérée comme instable en boucle ouverte. Un système de contrôle linéaire invariant dans le temps à dimension finie est conçu pour atteindre une stabilité globale exponentielle de l'entrée-sortie. Le problème de conception de la commande consiste à dériver des conditions suffisantes sous la forme d'inégalités matricielles linéaires en utilisant les méthodes de Lyapunov et l'algorithme de synthèse de contrôle. Des simulations numériques sont présentées pour illustrer l'efficacité de notre approche.

Le troisième intérêt est l'étude de la stabilité locale exponentielle entrée-sortie (IOS) d'une équation de réaction-diffusion avec des pôles instables finis en utilisant un contrôle distribué saturé et des compensateurs anti-windup. Il s'agit du premier travail traitant de la conception anti-windup sur des systèmes à paramètres distribués. Les fonctions de Lyapunov et les conditions suffisantes sont utilisées pour estimer les régions d'attraction et les gains de stabilité. Des simulations numériques sont présentées pour illustrer l'efficacité de notre approche et pour mettre en évidence le rôle positif que joue un compensateur anti-windup en contrebalançant les impacts négatifs que les actionneurs saturants ont sur les niveaux de performance et les régions d'attraction.

Acknowledgements

Four years ago, I was fortunate enough to be accepted into an internship at Gipsa-lab at Université Grenoble Alpes. I remember being a little scared when I first read the title of the internship program: "Saturated Control Design for Hyperbolic systems". It seemed like a tough topic charged with mathematical complexities. I was right. However, I was particularly searching for a theoretical and challenging topic for my research internship in order to build a solid basis for a PhD in control theory. Even though the journey to writing this thesis and graduating was not as simple as I had first anticipated, the destination was worth the ride. A ride that would have been much burdensome and grueling have it not been for so many people to count; I will, however, try to thank most of them.

I start, of course, by thanking my supervisors (in no particular order) Christophe Prieur and Francesco Ferrante. Before becoming my supervisors, they were my professors at my Masters program where their first impressions were that of dedicated and caring educators. That impression was only solidified later on with much more endearing qualities. They were equally supportive and helpful throughout the thesis, providing me with expert guidance along with the perfect independence to advance my research and push my mental limits. I am forever grateful to hit the jackpot of thesis supervisors and I credit all my future academic accomplishments to you both.

I would also like to express gratitude to all my friends and colleagues. From outside the lab, I thank my friends Hala Sanbouskani, Marwa Safa, Stephanie El-Zahlanieh, Jana Awad, Dana Kanso, Yara Diab., Nour Chahrour, Ali Oussairan, Mohammad Nasr, Mohammad Baydoun. You have been a huge support system and I am grateful to have so many trustworthy people in my life who I can count on when life gets tough. I also thank my colleagues at Gipsa-lab who were always there to share the ups and downs of the PhD life.

The deepest thanks goes to my family. I would not have reached this point without my lovely fiancé who helped me in every way possible to remain strong, motivated and sane enough to successfully complete my thesis. I thank my mother, Widad Mazraani, my twin sister, Malak Shriem, and my little brother, Walid Shriem for being my compass when I was lost and my strength when I was weak. Being away from you was the most difficult part about the past three years, more difficult than all the PDE problems I had to solve, but you were also the reason my ambitions were set real high to try and make you proud. Finally, I dedicate this thesis to my late father whose spirit never left my side when I was most lonely. Your and Mom's sacrifices is what made this possible.

Contents

Abstract	v
Nomenclature and Acronyms	xvii
1 Introduction and Problem Motivation	1
1.1 Saturated Control	1
1.2 Boundary vs In-domain Control	3
1.3 Background View on Lyapunov Stability Analysis	4
1.4 Hyperbolic Systems	5
1.4.1 Examples of Transport Equations	6
1.4.2 Problem Statement and Motivation for the Stabilization of Hyperbolic Equations	7
1.4.2.1 Exponential Stability in Open Loop	8
1.4.2.2 Exponential Stability of the Closed-Loop System with Unsaturated Control Law	10
1.4.2.3 Linear Matrix Inequalities	11
1.5 Parabolic Systems	11
1.5.1 Reaction-Diffusion Systems	12
1.5.2 Input-Output Feedback Control Problem	13
1.6 Outline of the thesis	14
1.6.1 Chapter 2: Design of Saturated Boundary Control for Hyperbolic systems with in-domain disturbances	14
1.6.2 Chapter 3: Output Feedback Control of a Reaction-Diffusion Equation with In-domain Disturbances	15
1.6.3 Chapter 4: Saturated Control Design for a Reaction-Diffusion Equation with Anti-windup Compensator	16
1.6.4 Chapter 5: Conclusion and Perspectives	16
2 Design of Saturated Boundary control for Hyperbolic Systems with in-domain Disturbances	19
2.1 Problem Statement	19
2.1.1 Problem setup	19
2.1.2 Notion of the Solutions to the Closed-loop System	20
2.2 Well-posedness of the Closed-Loop System	21
2.3 Stability Analysis and Control Design	25
2.3.1 Sufficient Conditions	25
2.3.2 Quadratic Conditions	27
2.3.3 Control Design	28
2.4 Numerical Analysis	29
2.4.1 Application on a Scalar System	29
2.4.2 Numerical Example	31
2.5 Conclusion	32

3	Output Feedback Control of a Reaction-Diffusion Equation with In-domain Disturbances	39
3.1	General Properties of a Sturm-Liouville Operator	39
3.2	Problem Statement	40
3.2.1	Existence and Uniqueness of Classical Solution to the Cauchy Problem.	41
3.2.2	Spectral Reduction of the Reaction-Diffusion System	41
3.3	General Set-Up for the Output-Feedback Control Problem	42
3.4	Input-Output Stability Results	43
3.4.1	Sufficient conditions	43
3.4.2	Construction of the functional V	45
3.5	Control Synthesis	48
3.5.1	Control Design Algorithm	49
3.6	Numerical Analysis	50
3.7	Conclusion	50
4	Saturated Control and Anti-windup Design for a Reaction-Diffusion Equation with In-domain disturbances	53
4.1	Problem Statement	53
4.1.1	Existence and Uniqueness of Strong Solution Pairs to the Cauchy Problem.	54
4.1.2	Partition of the System into Stable and Unstable parts	54
4.2	General Set-Up for the Output-Feedback Control Problem	56
4.2.1	Local Stabilization and Estimation of the region of attraction for the Finite-dimensional Truncation System	57
4.2.1.1	Input-Output Stability Analysis for the Finite-dimensional System	58
4.2.2	Local Stabilization and Estimation of the region of attraction for the Overall Infinite-Dimensional System	60
4.2.2.1	Input-Output Lyapunov Stability Analysis for the Overall System with Saturated Control	61
4.2.2.1.1	Sufficient Conditions	61
4.2.2.1.2	Construction of the Functional V_c	62
4.2.3	Control Synthesis and Optimization Problems	65
4.2.3.1	Derivation of Linear Matrix Inequalities	65
4.2.3.2	Optimization Problems	67
4.3	General Set-Up for the Anti-Windup Compensator Synthesis	68
4.3.1	Local Stabilization and Estimation of the region of attraction for the Finite-Dimensional Truncation System with Anti-Windup Compensator	70
4.3.1.1	Input-Output Stability Analysis for the Finite-dimensional System	70
4.3.2	Local Stabilization and Estimation of the region of attraction for the Overall Infinite-Dimensional System with Anti-Windup compensator	70
4.3.2.1	Input-Output Lyapunov Stability Analysis for the Overall System with Saturated Control and Anti-windup compensator	71
4.3.2.1.1	Sufficient Conditions	71
4.3.2.1.2	Construction of the functional V_a	71
4.3.3	Control Synthesis and Optimization Problems	73

4.3.3.1	Derivation of Linear Matrix Inequalities	73
4.3.3.2	Optimization Problems	74
4.4	Numerical Simulation	75
4.5	Conclusion	83
5	Conclusion and Perspectives	87
5.1	Main Contributions and Perspectives for Hyperbolic Systems	87
5.1.1	Perspectives	88
5.2	Main Contributions and Perspectives for Parabolic Systems	88
5.2.1	Unconstrained Control Problem	88
5.2.2	Constrained Control Problem	88
5.2.3	Perspectives	89

List of Figures

1.1	General saturation function	2
1.2	Symmetric saturation function	3
1.3	Control of heat exchanger	4
1.4	Axially moving string under a right boundary control force. [53]	5
1.5	Lateral view of a pool of an open channel with constant bottom slope and rectangular cross section. [10]	6
1.6	Transmission line connecting a power supply to a resistive load R_L	7
1.7	Time evolution of the \mathcal{L}_2 -norm of the state $X(t, z)$ for $a = 0.1$ (in blue solid line), $a = 0.5$ (in red dashed line), and $a = 0.9$ (in green circle-line)	9
1.8	Time evolution of the \mathcal{L}_2 -norm of the state $X(t, z)$ for $a = 1.1$	10
1.9	Diffusion of particles in water.	12
1.10	One-dimensional heat conduction of a rod with a boundary heat source.	13
1.11	\mathcal{H}^1 -norm of the state $x(t, z)$ for an unstable open-loop heat equation.	14
2.1	Feasible Region of the pair (K, T) for $H = 0.5$	30
2.2	Feasible Region of the pair (K, T) for $H = 0.99$	31
2.3	Feasible (diamond) pairs (μ, α)	32
2.4	Time-evolution of the spatial norm \mathcal{L}^2 of $X(t, \cdot)$ in closed-loop (solid-line) and open-loop (dashed-line)	33
2.5	Time-evolution of $\sigma(K_1 X_1(t, 1))$ (solid-line) and $\sigma(K_2 X_2(t, 1))$ (dashed-line) with respect to time	33
2.6	Time-evolution of the spatial norm \mathcal{L}^2 of $X(t, \cdot)$ in closed-loop (solid-line) and open-loop (dashed-line) for saturation level 0.15.	34
2.7	Time-evolution of $\sigma(K_1 X_1(t, 1))$ (solid-line) and $\sigma(K_2 X_2(t, 1))$ (dashed-line) with respect to time for saturation level 0.15.	34
2.8	Time-evolution of the left (solid-line) vs. right (dashed-line)-hand side of dissipation inequality (35)	35
3.1	Closed-loop system.	42
3.2	Time and space-evolution of the state $x(t, z)$	51
3.3	Time and space-evolution of the state $x(t, z)$	51
3.4	Time and-evolution of the output $y(t)$	52
3.5	Output $y(t)$ for $N = 3$ (red) and $N = 5$ (blue)	52
4.1	Closed-loop system $(\mathcal{P}, \mathcal{K}_c)$ with saturation limitation.	56
4.2	Closed-loop system $(\mathcal{P}, \mathcal{K}_c, \mathcal{K}_a)$ with anti-windup compensator.	69
4.3	Time evolution of the \mathcal{H}^1 - norm of the state w in the case without anti-windup.	76
4.4	Time evolution of the \mathcal{H}_c^1 -norm of the state ζ_c in the case without anti-windup.	76
4.5	Time evolution of the output y in the case without anti-windup.	77
4.6	Time evolution of the saturated control signal u (in blue) vs. the unsaturated control signal $Y_c(t)$ (in red) in the case without anti-windup.	77

4.7	Output decay for increasing dimension N of the control system.	78
4.8	Time evolution of the \mathcal{H}^1 - norm of the state $w(t, \cdot)$ in the case with anti-windup.	80
4.9	Time evolution of the \mathcal{H}_a^1 - norm of the state $\zeta_a(t, \cdot)$ in the case with anti-windup.	80
4.10	Time evolution of the output $y(t)$ in the case without anti-windup. . .	81
4.11	Time evolution of the saturated control signal $u(t)$ and unsaturated control signal $Y_c(t)$ (coincide) in the case anti-windup.	81
4.12	Output $y(t)$ with no anti-windup.	82
4.13	Output $y(t)$ with anti-windup.	83
4.14	Control input $u(t)$ with anti-windup.	84
4.15	Output $y(t)$ for different dimensions of controller.	84
4.16	$u(t)$ and $Y_c(t)$ for $N = 3$	85
4.17	$u(t)$ and $Y_c(t)$ for $N = 6$	85

Nomenclature and Acronyms

In this thesis, we only consider Lebesgue measurable functions

Variables

z	line space
t	time
x	scalar state
X	vector state
d	disturbance signal
u	control signal
X_c	control state
X_{aw}	anti-windup state
y	system output
σ	saturation function
ϕ	dead-zone nonlinearity

Symbols and Notations

$\mathbb{R}_{>0}$	set of positive real scalars
$\mathbb{R}_{\geq 0}$	set of non-negative real scalars
\mathbb{R}	set of $n \times m$ real matrices
\mathbb{S}_p^n	set of $n \times n$ symmetric positive definite matrices
\mathbb{D}_p^n	set of $n \times n$ diagonal positive definite matrices
x_t	partial derivative of x with respect to time
x_z	partial derivative of x with respect to space
I	identity matrix

For a matrix $A \in \mathbb{R}^{n \times m}$:

A^\top	transpose of A
$\ A\ $	2-induced matrix-norm of A
$A \geq 0$	symmetric positive semidefinite matrix
$A \leq 0$	symmetric negative semidefinite matrix
$A > 0$	symmetric positive definite matrix
$A < 0$	symmetric negative definite matrix
$ A $	Euclidean norm (for $m = 1$)
$\lambda_{\min}(A)$	minimum eigenvalue of A
$\lambda_{\max}(A)$	maximum eigenvalue of A
*	symmetric block in a symmetric matrix A
•	don't-care term

For U, V normed linear spaces:

$\mathcal{L}(U, V)$ space of all bounded linear operators from U to V

For an open set $U \subset \mathbb{R}$ and a normed space $V \subset \mathbb{R}^n$ and $f : U \rightarrow V$:

$\mathcal{L}^p(U, V)$	set of functions f that are locally absolutely continuous to the order p on U
$\frac{d}{dz}f$	weak derivative of f
$\mathcal{H}^1(U, V)$	the set $\{f \in \mathcal{L}^2(U, V), \frac{d}{dz}f \in \mathcal{L}^2(U, V)\}$
$\mathcal{C}^0(U, V)$	set of functions f that are continuous
$\mathcal{C}^1(U, V)$	set of functions f that are continuously differentiable
$\mathcal{C}^2(U, V)$	set of functions f that are continuously differentiable and their derivatives are continuously differential
$\mathcal{C}_c^\infty(U, V)$	the set of smooth compactly supported functions $f : U \mapsto V$
$\mathcal{C}^{1,1}(U, V)$	the set of Lipschitz continuous functions $f : U \mapsto V$
$W^{p,k}(U, V)$	subset of functions $f \in \mathcal{L}^p(U, V)$ such that f and its weak derivatives up to order k have a finite \mathcal{L}^p -norm
$\mathcal{H}^p(U, V)$	$W^{p,2}(U, V)$
$\ f\ _{\mathcal{L}^2(U)} = (\int_U \ f\ ^2 dz)^{\frac{1}{2}}$	\mathcal{L}^2 -norm of function f on $U \subset \mathbb{R}$
$\ f\ _{\mathcal{H}^1(U)} = (\int_U \ f\ ^2 + \ f_z\ ^2 dz)^{\frac{1}{2}}$	\mathcal{H}^1 -norm of function f on $U \subset \mathbb{R}$
$\langle u, v \rangle$	inner product of $u, v \in V$

Abbreviations

PDE	Partial differential equation
ODE	Ordinary differential equation
LTI	Linear time-invariant
LMI	Linear matrix inequality
sup	supremum
inf	infimum

Chapter 1

Introduction and Problem Motivation

Partial differential equations (PDEs) are mathematical expressions which are found to be of great importance in the modeling of many physical systems that are described simultaneously via spatial and temporal variables. Light propagation in optic fibers, blood flow in the vessels, plasma in laser, liquid metals in cooling systems, road traffic, acoustic waves, and electromagnetic waves are all examples of systems modeled via PDEs that can be seen in civil, nuclear, mechanical, quantum, and chemical engineering (see [10] and [39] for more examples). Thus, the importance of studying the stability properties and control design of physical systems modeled via PDEs is growing more and more in the community of automatic control. In fact, what renders this topic challenging is the infinite-dimensional nature of the application. In this thesis, we study three stability and control problems for hyperbolic and parabolic systems in the presence of nonlinear controllers and perturbations.

1.1 Saturated Control

Control engineering is an engineering discipline that studies the problem of regulating system behavior via some control devices. Those devices are usually electromechanical actuators, proportional valves, electric circuits, power amplifiers, pumps, heaters, and so on. These control inputs that are introduced to the modeled system as a form of force, torque, thrust, stroke, voltage, etc are almost always limited in magnitude. Those limitations, or constraints, are referred to as saturation. Saturation is a magnitude limit that is present in practically all control systems due to physical or safety constraints that may restrict the system performance. However, if control engineers fail to take into consideration this limit when modeling the system, the closed-loop system is most likely to perform poorly and dangerously in terms of steady-state error, oscillation, global stability and region of stability. In sensitive applications such as nuclear power station or aircraft transport, neglecting control saturation leads to disasters in a similar manner that a rain-saturated soil land leads to a deathly flood. Thus, to protect against equipment malfunction, ensure a satisfactory system behavior, guarantee safety regulations and provide better engineering choices for the actuator capacities from an early stage, the study of saturated control systems is necessary and constitutes a very attractive topic for researchers.

The main challenge when studying stability of saturated control systems is the nonlinearity that appears in modeling the saturation function. Even though, in this thesis, we focus on systems described by linear partial differential equations, the saturated control input transforms the problem from linear to nonlinear control system. Mathematically, for a control input $u \in \mathbb{R}$, the saturation can be modeled using a

general piece-wise function $\sigma(u)$ given by

$$\sigma(u) := \begin{cases} u & \text{if } u_{\min} \leq u \leq u_{\max} \\ \sigma(u) = u_{\max} & \text{if } u \geq u_{\max} \\ \sigma(u) = u_{\min} & \text{if } u \leq u_{\min} \end{cases} \quad (1.1)$$

where u_{\min} is the lower saturation limit and u_{\max} is the upper saturation limit. FIGURE 1.1 shows the general saturation function in (1.1). In this thesis, we will use a

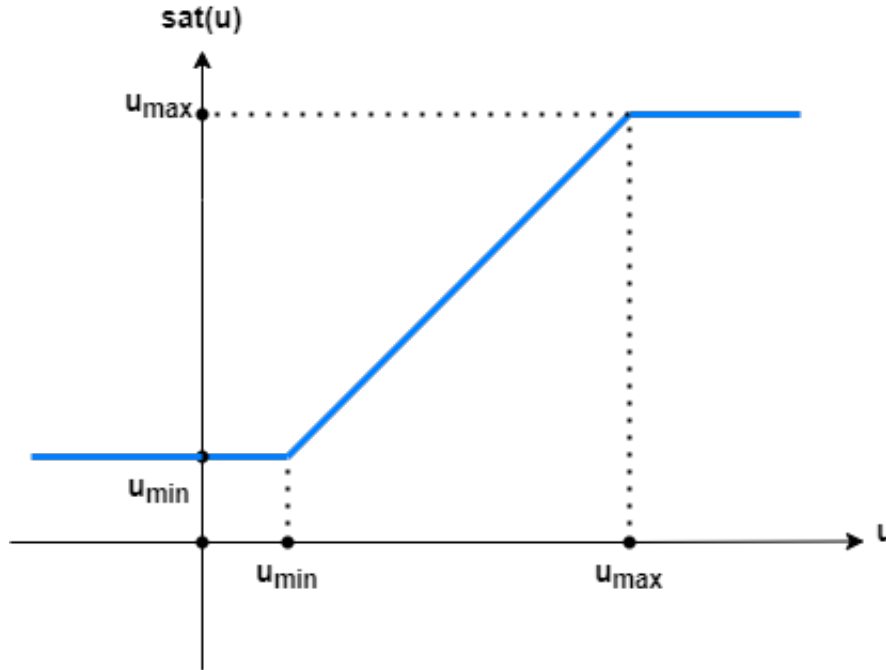

FIGURE 1.1: General saturation function

symmetric saturation function given as:

$$\sigma(u) := \min(|u|, u_0)\text{sign}(u) \quad (1.2)$$

where u_0 is the saturation limit. The graph of the symmetric saturation function in (1.2) is shown in FIGURE 1.2. Researchers have been studying several methods to tackle saturation problems in closed-loop systems as we can see in [72], [80] or [67]. Some examples of extensions of those works are presented in [63] and [48]. Stability analysis of PDEs in the presence of saturation has been studied in the math community [30], [2], but it is still an open research area, especially from an automatic control viewpoint [79], [34]. To the best of our knowledge, the particular problem of designing a boundary controller under the effect of saturation, to stabilize hyperbolic systems, has not been studied in previous works and will be presented as the first control problem in Chapter 2. Furthermore, we design a saturated boundary controller for a parabolic system in Chapter 4. As we have seen in [59], a natural approach to study the stability problem is to combine both Lyapunov theory and cone-bounded sector conditions (see more about sector conditions in [38], [72], [16]).

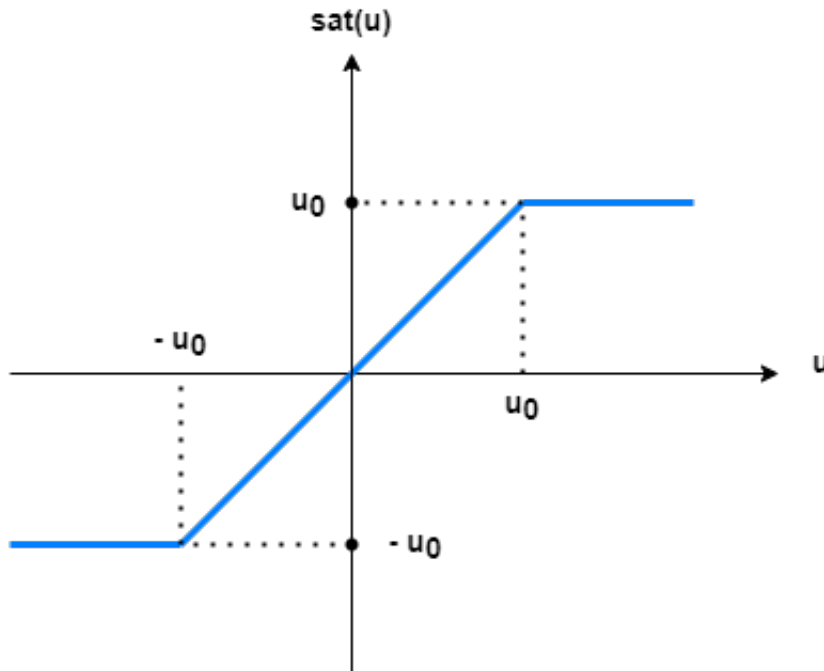

FIGURE 1.2: Symmetric saturation function

1.2 Boundary vs In-domain Control

There are mainly two approaches for controlling a system governed by a partial differential equation: distributed, or in-domain, control and boundary control. Distributed or "in-domain" control is a configuration in which controllers or actuators are located inside the domain or throughout the domain. This method is usually impractical and in some cases impossible due to the inaccessibility to the interior part of the system. For example, it is less intrusive to place a heat source at the walls of a heat exchanger rather than inside it (see FIGURE 1.3). On the other hand, boundary controllers or actuators are exclusively placed at the boundary of the domain or at given isolated points. In a one-dimensional domain, this translates to placing the control input at the start of the domain and/or at the end. Imagine for example the vibration of a string by a rocking movement at one or both ends (see FIGURE 1.4). In another application, the flow of water through pipes are controlled through the placement of water pumps at the source of the water tank and a control valve at the exit. This type of control placement becomes essential for sensitive and high risk applications, such as magnetic control for Tokamak plasma for example, to avoid any intrusive operations directed towards the fusion process taking place inside the domain of the reactor. Thus, modeling the boundary conditions that governs the relationship between the system input and outputs, enables us to control the output through a boundary input and it is widely used in the context of PDEs. Thus, we can find a lot of research conducted on the topic of boundary control [39]. In particular, different control strategies, from Lyapunov stability and stabilization methods [10], [74], to backstepping control [61], [39] and frequency domain approaches [44] have been applied on PDEs. Unfortunately, the nature of the boundary control systems renders the control problem hard because the input and output operators of the abstract linear time invariant (LTI) model are unbounded operators. The mathematical difficulties generated in those applications makes the subject of boundary control for PDEs difficult.

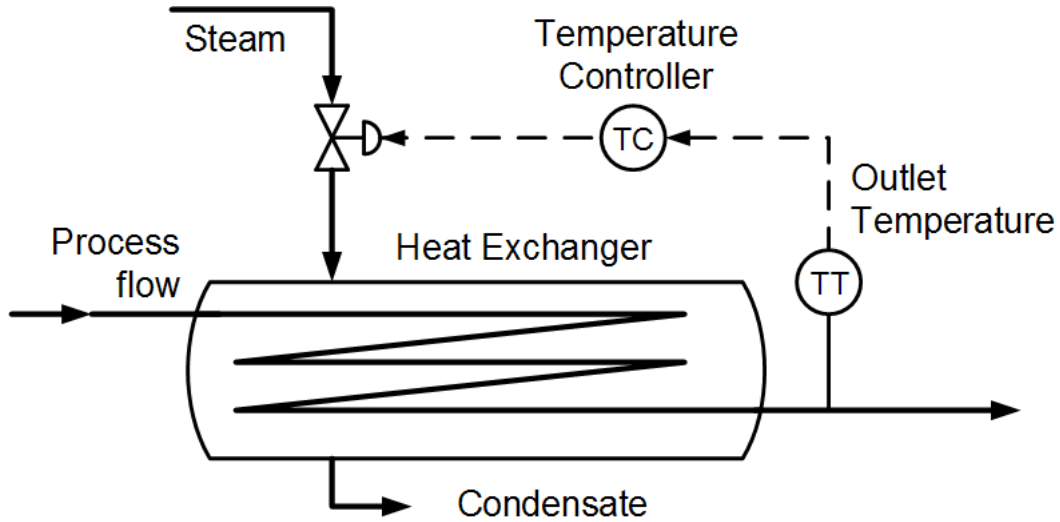

FIGURE 1.3: Control of heat exchanger

1.3 Background View on Lyapunov Stability Analysis

Throughout this thesis, we will study the stability of PDE models using Lyapunov theory as a stability tool. Let us first recall the definition of exponential stability as classically presented in [38, Page 40] for an ordinary differential equation, given by:

$$\dot{X} = AX \quad (1.3)$$

with $X \in \mathbb{R}^n$, a given matrix $A \in \mathbb{R}^{n \times n}$ and $n \in \mathbb{N}^*$. System (1.3) is said to be exponentially stable at the equilibrium $X = 0$ if there exist $k, \alpha > 0$ such that any solution X to (1.3) satisfies

$$\|X(t)\| \leq ke^{-\alpha t} \|X(0)\| \quad \forall t \geq 0, \quad (1.4)$$

where $\|\cdot\|$ denotes the appropriate Euclidean norm. This stability is said to be global if (1.4) holds for any initial state $X(0)$ and local when the initial state is bounded. One way to test this stability is using the method of Lyapunov stability which states that system (1.3) is exponentially stable if and only if for any positive definite matrix $Q \in \mathbb{S}_p^n$, there exist $P \in \mathbb{S}_p^n$ such that the following holds

$$PA + A^\top P = -Q \quad (1.5)$$

The previous equality leads to defining a positive definite Lyapunov function

$$V(X) = X^\top PX \quad \forall X \in \mathbb{R}^n$$

such that its derivative along the solutions to (1.3), given by

$$\dot{V}(X) = -X^\top QX$$

is negative definite. The goal behind this method is to find P such that equation (1.5) holds. This method can be extended to the infinite-dimensional case by rewriting the PDE (for example) as an abstract model:

$$\dot{X} = \mathcal{A}X \quad (1.6)$$

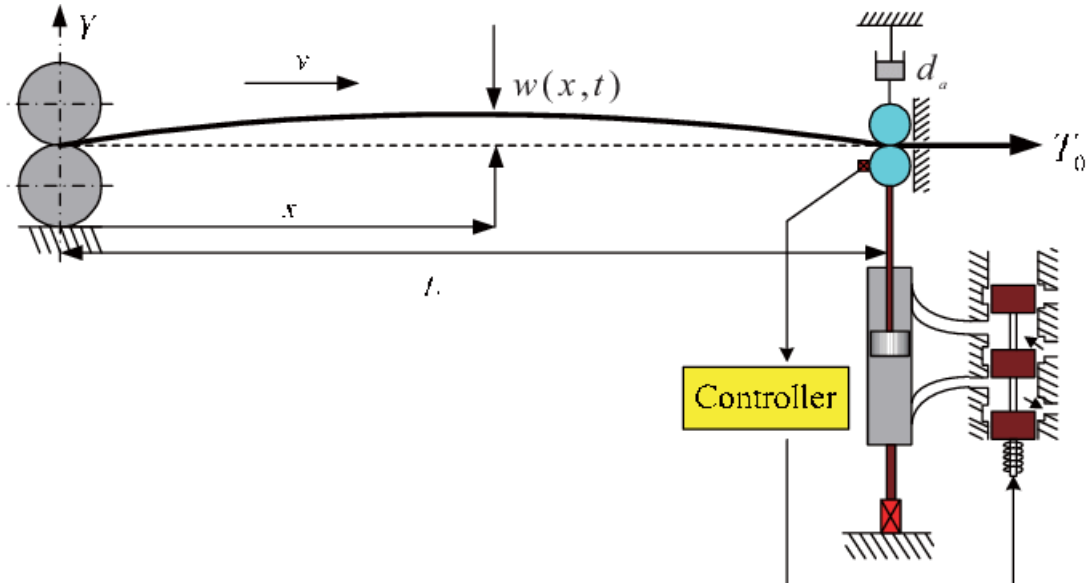

FIGURE 1.4: Axially moving string under a right boundary control force. [53]

where X is defined on a functional space and the unbounded linear operator \mathcal{A} is defined on that space.

1.4 Hyperbolic Systems

Hyperbolic equations are partial differential equations that find application in fluid dynamics, aerodynamics, the theory of elasticity, optics, electromagnetic waves, the road traffic, propagation of age-dependent epidemics, chromatography and the general theory of relativity. By definition, an n^{th} -order hyperbolic partial differential equation in a neighborhood A has a well-posed Cauchy problem in the same neighborhood for the first $n - 1$ derivatives. Although the dynamics of most applications exist in three dimensional, it is some times practical and useful to express the system dynamics in one-dimension and neglect the rest. Perhaps the most popular hyperbolic equation is the wave equation, known as the equation of vibration of a string and is often applied in elasticity, aerodynamics, acoustics, and electrodynamics. Let us consider that $u(t, z)$ is the state that represents the position of a vibrating string at time t and position $z \in (0, l)$ where l is the length of the string. Then, the wave dynamics are expressed by

$$x_{tt}(t, z) - cx_{zz}(t, z) = 0 \quad c > 0$$

where c can be the ratio of the tension or the linear density. To determine the motion of the string, the initial value problem is solved with a known and sufficiently smooth initial position and initial velocity:

$$x(0, z) = f(x), \quad x_z(0, z) = g(z)$$

A perturbation of the initial (or boundary) value of a hyperbolic equation is not felt by all points in the domain simultaneously but rather in a "wave-like" manner. We can solve the initial value problem using the method of characteristics. In this thesis we are mainly interested in homogeneous first order, one-dimensional hyperbolic

equations. In particular, we study the following transport equation

$$X_t(t, z) + \Lambda X_z(t, z) = 0, \quad t \in \mathbb{R}_{\geq 0}, \quad z \in [0, L] \quad (1.7)$$

where t and z are the two independent variables, time and space, respectively, and $X : [0, +\infty) \times [0, l] \rightarrow \mathbb{R}^n$ is the vector of state variables of dimension n . The term $\Lambda \in \mathbb{D}^{n \times n}$ corresponds to a matrix of real, constant eigenvalues or the characteristic velocities denoted:

$$\lambda_1, \lambda_2, \dots, \lambda_n.$$

We also assume that those eigenvalues positive.

1.4.1 Examples of Transport Equations

Transport systems are a specific type of hyperbolic equations that are widely used to describe the flow of fluids in open or closed channels, the transport of electrical energy and other physical systems. These systems undergo a time variation in one or more of its states along a bounded space domain and balanced by its rate of flow per unit length (flux) throughout this domain and its production or consumption inside the domain ([10], page 11). Take for instance the Saint-Venant equations, which describes the propagation of shallow water in open channels where the horizontal scale is much bigger than the vertical (see FIGURE 1.5). The flow can be given by a system of two nonlinear hyperbolic equations [71]:

$$\begin{aligned} H_t + (HV)_z &= 0 \\ V_t + (V^2/2 + gH)_z + (CV^2/H - gS_b) &= 0 \end{aligned} \quad (1.8)$$

where $H(t, z)$ is the water depth, $V(t, z)$ is the horizontal water velocity, S_b is the constant slope, g is the gravity acceleration and C is a constant friction coefficient. Another example is shown in FIGURE 1.6 of the telegrapher equations which describe

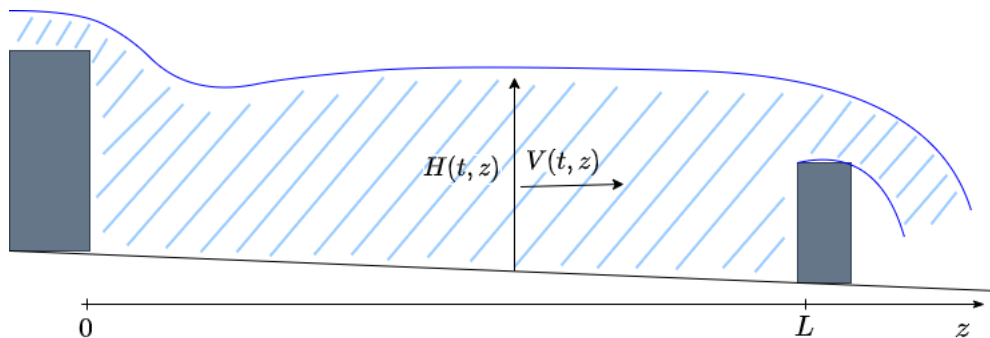

FIGURE 1.5: Lateral view of a pool of an open channel with constant bottom slope and rectangular cross section. [10]

the propagation of current and voltage along electrical transmission lines see ([10], page 18).

$$\begin{aligned} (L_l I)_t + V_z + R_l I &= 0 \\ (C_l V)_t + I_z + G_l V &= 0. \end{aligned} \quad (1.9)$$

where I is the current, V is the voltage, L_l is the line self inductance per unit length, C_l is the line capacitance per unit length and R_l is the resistance per unit length.

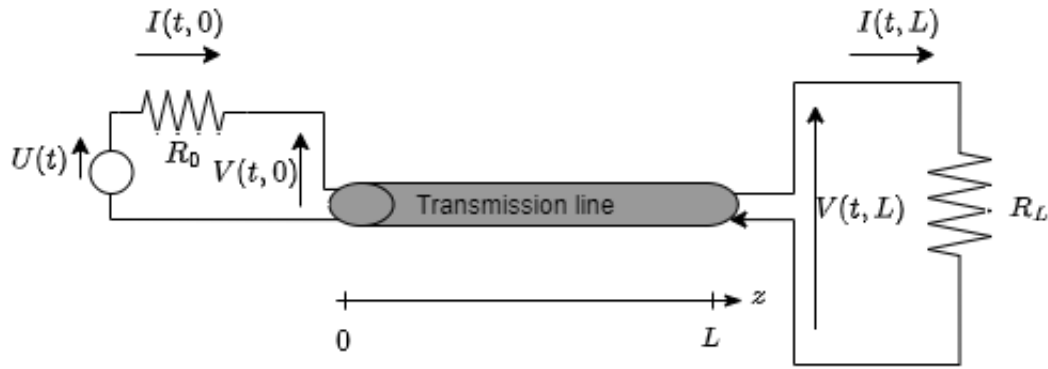

FIGURE 1.6: Transmission line connecting a power supply to a resistive load R_L .

We notice that the dynamics of these types of systems are represented by one dimensional equations instead of three dimensional ones. The reason behind this is that the dominant dynamics of the system occur mostly in one direction or coordinate, so it is simpler and efficient to neglect the evolution occurring on the other two axes.

Controlling hyperbolic systems, like any other type of system, means that we have to ensure stability of the steady state. The main focus is on designing a controller to achieve exponential stability over a one-dimensional real line interval. To define exponential stability, we may refer to the Lyapunov definition which states that if we start from any initial condition, the origin of the system converges to the steady state exponentially fast. This is translated to mathematically expressing the energy of the system by an \mathcal{L}^p -norm and deriving sufficient conditions for which the time-evolution of this norm decreases exponentially. This process is challenging and not straightforward, especially when dealing with nonlinear systems because the well-posedness is not guaranteed. The choice of the type of the norm might be ambiguous and we should often conduct several stability analysis to determine the best one.

1.4.2 Problem Statement and Motivation for the Stabilization of Hyperbolic Equations

Let \mathbb{D}_p^n be the set of real diagonal positive definite matrices of dimension n . Let n be the number of the states of the system and m be the number of control inputs. Consider the one-dimensional linear hyperbolic system of the form:

$$X_t(t, z) + \Lambda X_z(t, z) = 0 \quad (1.10)$$

where $z \mapsto X(\cdot, z) \in \mathbb{R}^n$ is the state, $\Lambda \in \mathbb{D}_p^n$, $t \in \mathbb{R}_{\geq 0}$ and $z \in (0, 1)$ are the two independent variables, respectively, time and space. The linear boundary condition of this system is given by the following expression:

$$X(t, 0) = HX(t, 1) + Bu(t) \quad \forall t \in \mathbb{R}_{\geq 0} \quad (1.11)$$

where $H \in \mathbb{R}^{n \times n}$ and $B \in \mathbb{R}^m$ are given. In this section, we present the results already discussed and stated in [10, Page 86]. In particular, we compare the stability analysis of (1.10), (1.11) in open ($u = 0$) and closed loop. Then, we present the same stability analysis with a saturation at the boundary control. Let us first give the following definition which will be later used.

Definition 1.1 *let M be a symmetric positive definite matrix. A matrix A is said to be Schur with respect to M if:*

$$A^\top M A - M \leq 0$$

◇

1.4.2.1 Exponential Stability in Open Loop

Let $P \in \mathbb{D}_p^n, \mu \in \mathbb{R}_{>0}$. Consider the Lyapunov functional candidate V given by:

$$V(X) = \int_0^1 e^{-\mu z} X^\top P X dz \quad (1.12)$$

The formal computation of the time derivative of the Lyapunov function along the solutions to (1.10) yields:

$$\dot{V}(X) = \int_0^1 e^{-\mu z} (X_t^\top P X + X^\top P X_t) dz = - \int_0^1 e^{-\mu z} (X_z^\top \Lambda P X + X^\top P \Lambda X_z) dz$$

Since P and Λ are two diagonal matrices, we have $P\Lambda = \Lambda P$. Then, using integration by parts, we have

$$\begin{aligned} \dot{V}(X) &= - \int_0^1 e^{-\mu z} (X^\top P \Lambda X)_z dz = -e^{-\mu z} X^\top P \Lambda X \Big|_0^1 - \mu \int_0^1 e^{-\mu z} X^\top P \Lambda X dz \\ &= X^\top(t, 0) P \Lambda X(t, 0) - e^{-\mu} X^\top(t, 1) P \Lambda X(t, 1) - \mu \int_0^1 e^{-\mu z} X^\top P \Lambda X dz \end{aligned}$$

Using the boundary condition (1.11), we obtain:

$$\dot{V}(X) = X^\top(t, 1) (H^\top P \Lambda H) X(t, 1) - e^{-\mu} X^\top(t, 1) P \Lambda X(t, 1) - \mu \int_0^1 e^{-\mu z} X^\top P \Lambda X dz \quad (1.13)$$

Since Λ is constant and known, we can upper-bound the integral part of (1.13) by replacing the matrix Λ with its minimum eigenvalue $\lambda_{\min}(\Lambda) > 0$. Thus, we obtain the following expression of the time derivative of the Lyapunov functional.

$$\dot{V}(X) \leq X^\top(t, 1) (H^\top P \Lambda H - e^{-\mu} P \Lambda) X(t, 1) - \mu \lambda_{\min}(\Lambda) \int_0^1 X^\top P \Lambda X dz \quad (1.14)$$

Thus, we conclude the final inequality:

$$\dot{V}(X) \leq -\mu \lambda_{\min}(\Lambda) V + X^\top(t, 1) (H^\top P \Lambda H - e^{-\mu} P \Lambda) X(t, 1) \quad (1.15)$$

The term $\mu \lambda_{\min}(\Lambda)$ is positive which means that if the expression $H^\top P \Lambda H - e^{-\mu} P \Lambda$ is negative semi-definite, then global exponential stability will be guaranteed.

According to Definition 1.1, since $e^{-\mu} \leq 1$ and $P\Lambda$ is symmetric positive definite, in the case where H is a Schur matrix with respect to $P\Lambda$, we can write:

$$\dot{V}(X) \leq -\mu \lambda_{\min}(\Lambda) V.$$

Thus, the open-loop system (1.10) is globally exponentially stable if H is Schur with respect to $P\Lambda$. For $n = 2$ and suppose that the initial condition is given by

$$X_0(z) = \begin{pmatrix} \cos 4\pi z - 1 \\ \cos 2\pi z - 1 \end{pmatrix}$$

and H is given by

$$H = a \begin{pmatrix} 1 & 0 \\ 0 & 1 \end{pmatrix}$$

where a is an arbitrary constant. FIGURE 1.7 shows the time evolution of the \mathcal{L}_2 -norm of the state $X(t, z)$ depending on the values of a , which corresponds to the eigenvalues of H . We notice that the stability performance weakens as a increases. FIGURE 1.8 shows that this norm diverges once $a > 1$. However, in many cases, we do not

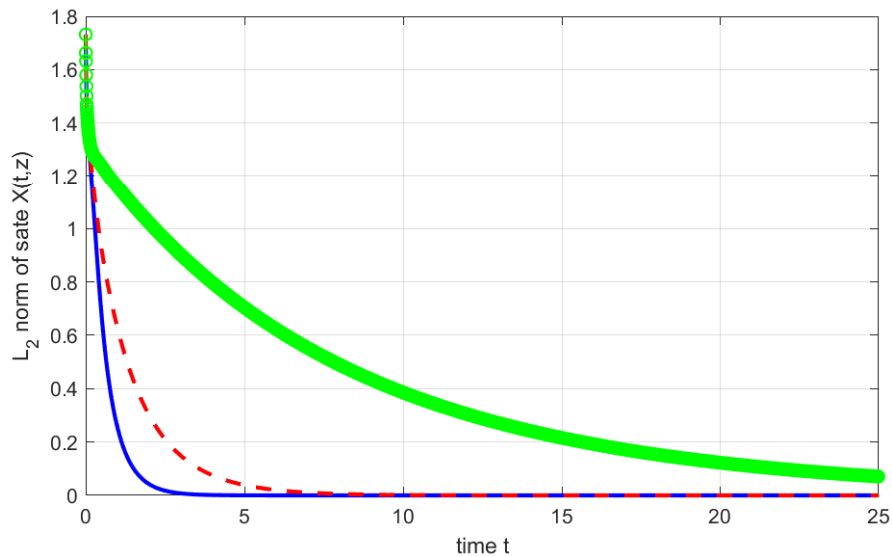

FIGURE 1.7: Time evolution of the \mathcal{L}_2 -norm of the state $X(t, z)$ for $a = 0.1$ (in blue solid line), $a = 0.5$ (in red dashed line), and $a = 0.9$ (in green circle-line)

have this condition. Therefore, in the case where the system is unstable, we have to introduce a controller in order to stabilize our system and relax our constraints.

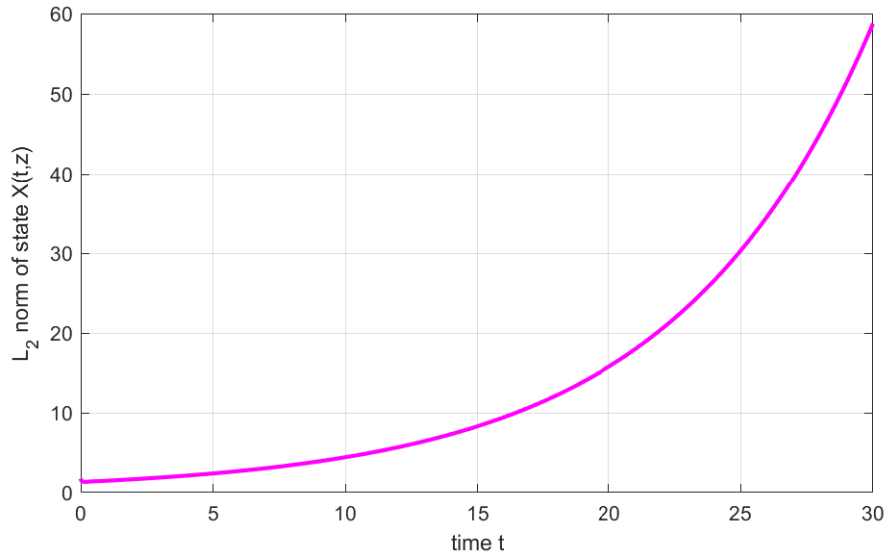

FIGURE 1.8: Time evolution of the \mathcal{L}_2 -norm of the state $X(t, z)$ for $a = 1.1$

1.4.2.2 Exponential Stability of the Closed-Loop System with Unsaturated Control Law

We now implement a linear, static controller depending on the boundary value of the state $X(t, 1)$. The controller is unsaturated so this section will serve as a reference to our upcoming work and we will compare it with the open-loop system to see the efficiency of the boundary controller.

Consider the same system given in Section 1.4.2. We assume that the plant is controlled at the boundary $z = 0$ using a static control law $t \mapsto u(t) = KX(t, 1)$ with $K \in \mathbb{R}^{m \times n}$. Consider the given initial condition $X_0 : [0, 1] \rightarrow \mathbb{R}^n$. We also assume that the boundary point $X(\cdot, 1)$ is the only measurable point. We have the following closed-loop plant:

$$\begin{aligned} X_t(t, z) + \Lambda X_z(t, z) &= 0 & \forall (t, z) \in \mathbb{R}_{>0} \times (0, 1) \\ X(t, 0) &= HX(t, 1) + BKX(t, 1) & \forall t \in \mathbb{R}_{\geq 0} \\ X(0, z) &= X_0(z) & \forall z \in (0, 1) \end{aligned} \quad (1.16)$$

The goal here is to design K such that the closed-loop system (1.16) is globally exponentially stable.

We will consider the same Lyapunov function in (1.12). The formal computation of the time derivative of the Lyapunov functional along the solutions to (1.16) yields:

$$\dot{V}(X) = X^\top(t, 0)P\Lambda X(t, 0) - e^{-\mu}X^\top(t, 1)P\Lambda X(t, 1) - \mu \int_0^1 e^{-\mu z} X^\top P\Lambda X dz$$

Then, we have:

$$\begin{aligned} \dot{V}(X) &= X^\top(t, 1)[(H + BK)^\top P\Lambda(H + BK) - e^{-\mu}P\Lambda]X(t, 1) \\ &\quad - \mu \int_0^1 e^{-\mu z} X^\top P\Lambda X dz \end{aligned}$$

Similarly as in Section 1.4.2.1, we obtain the following inequality

$$\dot{V} \leq -\mu\lambda_{\min}(\Lambda)V + X^\top(t, 1)MX(t, 1) \quad (1.17)$$

where

$$M = (H + BK)^\top P \Lambda (H + BK) - e^{-\mu} P \Lambda \quad (1.18)$$

To prove that the origin of the closed-loop system is globally exponentially stable, we need to design K such that M is negative semidefinite matrix. Unfortunately, M is nonlinear in the terms P and K which renders the problem inconvenient from a numerical standpoint. The next step is to reformulate the stability problem as a linear matrix inequality.

1.4.2.3 Linear Matrix Inequalities

Linear matrix inequalities, or LMIs, are inequalities that involve matrix variables with linear terms and usually exhibit convex regions of feasibility. It is a critical tool in control theory that we will be using extensively throughout the thesis to formulate and solve our stability conditions. Usually, we may try to apply the Schur Complement lemma which transforms nonlinear inequalities into LMIs [81]. We recall the definition of Schur Complement lemma from [81, Page 34]

Definition 1.2 For $n, m > 0$, let $Q \in \mathbf{S}^n$, $R \in \mathbf{S}^m$ and $S \in \mathbb{R}^{n \times m}$. The following equivalency holds:

$$\begin{bmatrix} Q & S \\ S^\top & R \end{bmatrix} < 0 \iff \begin{matrix} Q < 0 \\ R - S^\top Q^{-1} S < 0 \end{matrix}$$

◇

Using Definition 1.2, the following holds for (1.18):

$$\begin{cases} [(H + BK)^\top P \Lambda (H + BK) - e^{-\mu} P \Lambda] < 0 \\ P > 0 \end{cases} \iff \begin{bmatrix} -P \Lambda & H + BK \\ H^\top + K^\top B^\top & -e^{-\mu} P \Lambda \end{bmatrix} < 0 \quad (1.19)$$

The nonlinearity due to the term $e^{-\mu}$ is dealt with by performing a line search on μ . Thus, we obtain a linear matrix inequality in terms of P and K which can be solved numerically.

By observing (1.19), we can conclude that global exponential stability of the origin of the closed-loop system (1.16) holds, if K is chosen such that the term $H + BK$ is Schur. We conclude that the Lyapunov approach provides a sufficient condition for global exponential stability regardless of the value of H and for any initial condition.

In Chapter 2, we design a boundary controller under the effect of saturation that renders the open-loop-stable hyperbolic system globally exponentially stable and guarantee input-to-state stability with respect to some in-domain disturbances. Unfortunately, using the \mathcal{L}^2 Lyapunov function, it seems that the stability problem for local exponential stability is still an unanswered challenging task.

1.5 Parabolic Systems

Parabolic equations are partial differential equations which are widely used to mathematically describe the diffusion phenomena seen in heat conduction, population dynamics, electromagnetic waves and so on [40] [68] [42]. In particular, it models the fluctuations in the density of materials undergoing movement generally from higher concentration region to a lower one. This phenomena emerges to be of utmost importance due to its presence in the fields of chemistry, physics, biology, economics,

sociology and finance [50], [49], [29]. Whether we are studying the progressive heating of a slab, particles dissolving in a solvent, or pricing values, this gradient change is modeled by parabolic systems. Those systems are represented by the following

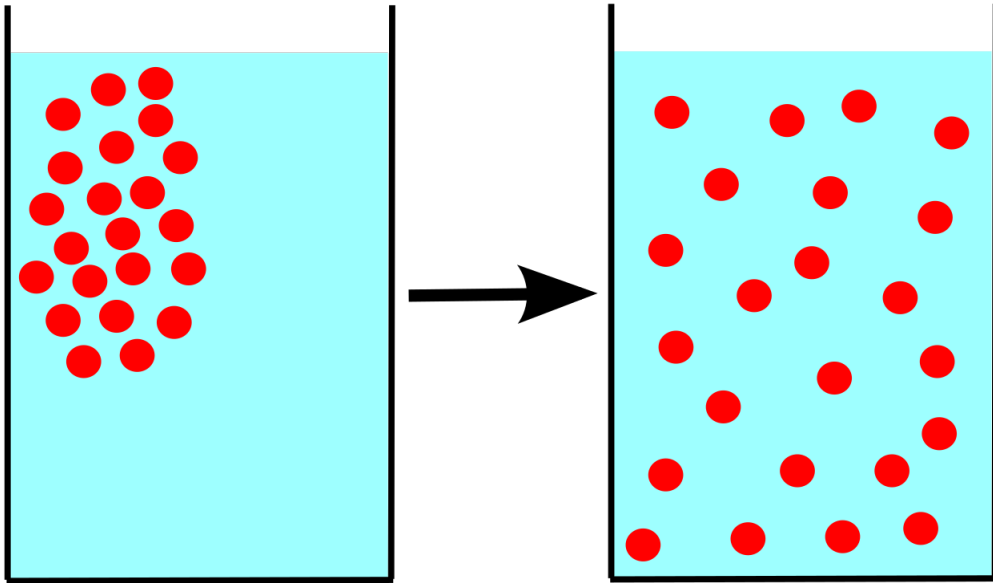

FIGURE 1.9: Diffusion of particles in water.

equation:

$$w_t(t, z) = (\mathbf{D}(w(t, z))_z w(t, z))_z \quad (1.20)$$

where $w(t, z)$ is the density of the diffusing material through space z and time t and \mathbf{D} denotes the diffusion coefficient. Considering the diffusion coefficient is a constant d independent of the density u , then we obtain Fick's second law or the heat equation in one-dimension (see FIGURE 1.10):

$$w_t(t, r) = dw_{zz}(t, z) \quad (1.21)$$

The spatial operators that governs most parabolic equations usually admit a finite number of slow, dominant eigenvalues and an infinite number of stable fast complement ones [28]. Thus, in the usual context of control of parabolic PDEs, a spectral reduction approximates the system by a finite-dimensional ordinary differential equation (see for example [4], [60], [43], [23]). Then, the ODE is used to design a finite-dimensional controller. This is also called the Galerkin method for solving a PDE [35].

1.5.1 Reaction-Diffusion Systems

In chemistry, the process in which chemical substances react together and spread out over a common region is mathematically described by reaction-diffusion equations [70], [9]. This concept can also be applied in other scientific domains such as ecology [36], physics [56], biology [27], population dynamics [50], Turing pattern formation [8] and neural networks [41]. Recent applications on the spread of epidemics and viral diseases have captured universal interest for its application on the Covid-19 epidemic [47], [46], [11], [15]. In this thesis, we are interested in the control and stabilization theory of such systems. This topic has been a challenging problem for control scientists and it has witnessed some major contributions using delayed

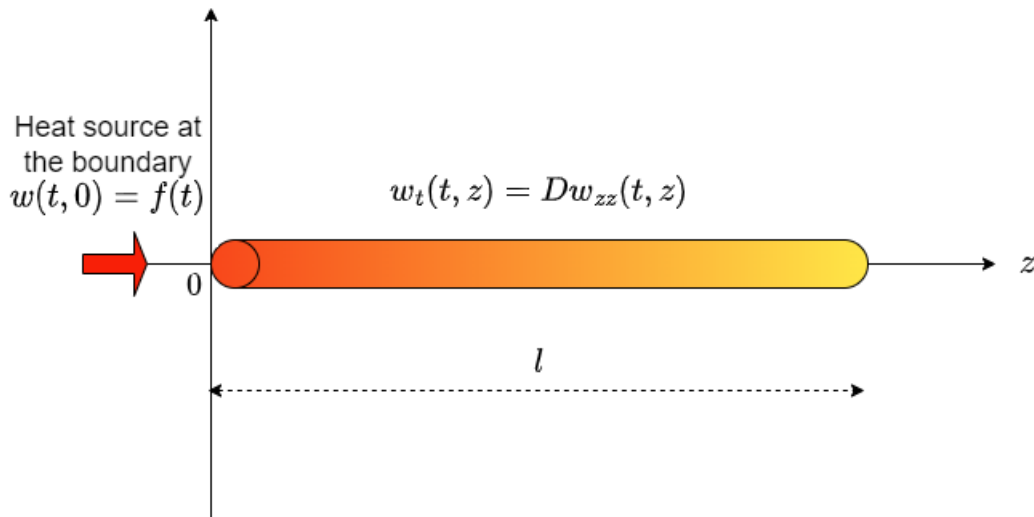

FIGURE 1.10: One-dimensional heat conduction of a rod with a boundary heat source.

boundary control methods [31] [43], and backstepping control [39], [17]. Let us introduce the simple, one-dimensional reaction-diffusion equation with Dirichlet boundary condition on the space $z \in (0, l)$ with $l > 0$:

$$\begin{aligned} x_t(t, z) &= x_{zz}(t, z) + qx(t, z) \\ x(t, 0) &= 0 \quad x(t, l) = 0 \\ x_z(t, 1) &= x_0(z) \end{aligned} \tag{1.22}$$

where q is an arbitrary constant. When system (1.22) is in open-loop ($u(t) = 0$), Lyapunov stability analysis conducted on the spectral projection of the PDE reveals that the plant is unstable due to the presence of the term $qx(z, t)$ with the number of unstable eigenvalues dependent on how large is q . For an initial condition given by $x_0(z) = z^2$, FIGURE 1.11 shows the unstable evolution of the \mathcal{H}^1 -norm of the state $x(t, z)$ through time. Thus, an adequate controller needs to be designed to stabilize system (1.22). In this work, we use the method of input-output feedback control that will be further discussed.

1.5.2 Input-Output Feedback Control Problem

One of the most important problems in control theory is global stabilization by means of output-feedback control. While the problem of the input-output stability (IOS) property with respect to domain or boundary disturbances has been widely investigated in the general context of finite-dimensional linear time-invariant (LTI) control systems and is considered classical, its extension to distributed parameter systems is a challenge and is still an open problem. Recently, several works on the IOS property extension to PDEs [77], [20] and output-feedback control extensions to PDEs [76], [18], [78], [82] have been published.

From a practical point of view, there is an emphasized interest in designing finite-dimensional feedback control for infinite-dimensional DPS mainly because the controllers must be implemented by online digital computers with finite memory-access time and finite wordlength. In past work, finite-dimensional approximations of an infinite-dimensional system was obtained to design controllers on those so-called

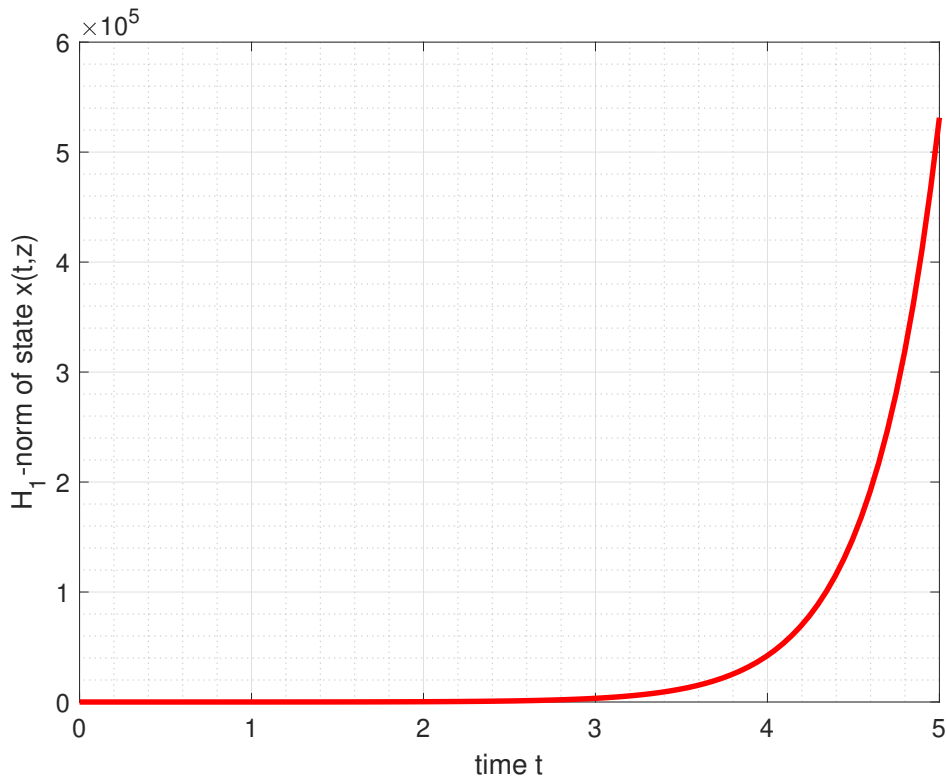

FIGURE 1.11: \mathcal{H}^1 -norm of the state $x(t, z)$ for an unstable open-loop heat equation.

reduced-order models [5], [58], [54]. However, we cannot theoretically guarantee the stability of the closed-loop system consisting of the actual DPS and the reduced order controller. In contrast, the controller synthesis here is considered with respect to a closed-loop system consisting of the infinite-dimensional system and the finite-dimensional control system. In particular, we propose, for the first time, an output feedback control design procedure to achieve the input-output stability (IOS) of a reaction-diffusion system by means of a finite-dimensional, LTI control system.

1.6 Outline of the thesis

We now give an overview of the next four chapters presented in this thesis:

1.6.1 Chapter 2: Design of Saturated Boundary Control for Hyperbolic systems with in-domain disturbances

In Chapter 2, we focus on systems of one-dimensional conservation laws modeled as a system of linear hyperbolic PDEs and study this class of hyperbolic systems in the presence of nonlinear control laws [65] as well as an in-domain exogenous disturbance [25]. We consider a classical saturation function and we present a systematic approach to design static boundary controllers to ensure closed-loop exponential stability and robustness with quantifiable margins with respect to in-domain energy bounded disturbances. To achieve this goal, we first prove the existence and uniqueness of solution to our closed-loop system. Then, we prove global exponential stability

by using a sector condition and a suitable Lyapunov functional. The proposed conditions are embedded into a convex optimization setup to enable the design of a controller minimizing the effect of the disturbance on the closed-loop system.

The chapter is organized as follows. Section 2.1 illustrates the problem we solve and defines the notion of solution we use. Section 2.2 tackles the well-posedness of the closed-loop system using properties of non-accretive operators. Section 2.3 is dedicated to Lyapunov analysis and provides the sufficient conditions for stability. Furthermore, it presents the control design problem in the sense of an optimization problem, which gives an optimal control gain. Section 2.4 validates the effectiveness of the proposed design algorithm through a numerical example.

1.6.2 Chapter 3: Output Feedback Control of a Reaction-Diffusion Equation with In-domain Disturbances

In Chapter 3, the considered reaction-diffusion plant, which is unstable, is modeled by a Sturm-Liouville operator as classically introduced in the context of parabolic partial differential equation (see [55]). We focus on a boundary control input along with a Dirichlet boundary measurement and regulated output. This configuration is interesting from a practical engineering perspective. This renders our problem more challenging since it requires to deal with unbounded control operators. Furthermore, the disturbance is in-domain. The proposed control design strategy is based on performing Lyapunov stability analysis on a closed-loop system consisting of the partitioned reaction-diffusion equation and an output-feedback finite-dimension LTI control system. It is important to note that when Dirichlet boundary conditions are considered for the control input and to-be-regulated output respectively, the solutions need to be sufficiently regular. However, our conditions do not need further regularity than the one required by the existence results of classical solutions. The main result of this chapter is a set of matrix inequalities, which constitutes sufficient conditions for the input-output stability of the reaction-diffusion plant with respect to in-domain disturbances. We use a predefined change of variable to linearize the matrix inequalities and propose an algorithm to compute the control gain matrices. Finally, we use numerical examples to assess the feasibility of the sufficient conditions as a function of the order of the finite-dimensional controller.

The chapter is organized as follows. Section 3.1 presents the general properties of the Sturm-Liouville operator. Section 3.2 introduces the reaction-diffusion plant with Dirichlet measurement and Dirichlet regulated output. The spectral reduction of the given plant is then partitioned into a stable finite-dimensional system and an unstable infinite-dimensional system. Section 3.3 presents the general framework for the output-feedback control problem by means of a finite-dimensional LTI control system. The problem of input-output stability is explicitly stated. In Section 3.4, the Lyapunov stability analysis is studied to derive sufficient conditions in the form of matrix inequalities. Section 3.5 proposes a method to transform the results into linear matrix inequalities and an optimization problem to minimize the effect of the IOS gain on the dissipation inequality of the output. In Section 3.6, we propose a numerical example that illustrates the efficiency and validity of our results.

1.6.3 Chapter 4: Saturated Control Design for a Reaction-Diffusion Equation with Anti-windup Compensator

In Chapter 4, we reconsider the same reaction-diffusion PDE presented in Chapter 3. We study the stabilizability problem of the unstable infinite-dimensional equation in the presence of in-domain disturbances using a distributed saturated control. The general framework for the design of the control law is based on \mathcal{H}^1 Lyapunov stability analysis of the closed-loop system composed by the reaction-diffusion plant and a dynamic control plant where the output of the control plant is plugged into a saturation function. Obviously, the saturation constraint leads to loss of the global stability property derived in the previous chapter.

The first result is the design of a saturated output feedback dynamic controller which locally exponentially stabilizes the unstable reaction-diffusion equation and evaluation of the region of attraction for the closed-loop system. We also provide input-output stability properties with respect to the in-domain disturbances. The sufficient conditions needed for the estimation of the region of attraction and output decay rates are derived in the form of linear matrix inequalities using Lyapunov techniques.

The second result is the design of an anti-windup compensator, which is introduced into the closed-loop system and evaluation of a new region of attraction for the local exponential stability of the origin of the new system. This addition is done to compensate for the negative impacts on the region of attraction and stability gains caused by the saturation limitation. We note that this is the first work dealing with anti-windup design on distributed parameter system.

The chapter is divided as follows: Section 4.1 presents the reaction-diffusion equation with the distributed controller, defines the saturation function, and provides the spectral decomposition of the PDE into an unstable finite and stable infinite-dimensional systems. Section 4.2 presents the closed-loop system layout with the dynamic output feedback control system. An estimation of the region of attraction for the finite closed-loop system is provided and used to conclude that of the overall infinite-dimensional system. Sufficient conditions for the problem of input-output local exponential stability are derived. Lyapunov functions are used to come up with the sufficient conditions as quadratic conditions. A control synthesis method is proposed to transform the quadratic conditions into linear matrix inequalities which can be exploited numerically. Finally, optimization problems are formulated to find optimal region of attraction and optimal performance levels. Section 4.3 introduces the anti-windup compensator to enhance the system behavior in closed-loop. Assuming the control parameters are given from the previous section, we repeat all the steps done in the previously to derive the appropriate Anti-windup parameters that renders the closed-loop system locally exponentially stable. The numerical results in Section 4.4 validates the stability properties found and illustrates the efficiency of the anti-windup approach in terms of enhancing the performance levels and enlarging the region of attraction. Section 4.5 presents some concluding remarks.

1.6.4 Chapter 5: Conclusion and Perspectives

Chapter 5 offers a resume to the work done in this thesis and a general conclusion for each chapter. Furthermore, it opens horizon and perspectives for possible extensions and future research on the subject of control of partial differential equations.

List of Publications

- Design of Saturated Boundary Control for Hyperbolic Systems, IFAC World Congress 2020 [65].
- Design of Saturated Boundary Control for Hyperbolic Systems with In-domain Disturbances, Automatica 2022 [66].
- Input-Output Stability of a Reaction Diffusion Equation with In-domain Disturbances, CDC 2022.

Chapter 2

Design of Saturated Boundary control for Hyperbolic Systems with in-domain Disturbances

Studies on the well-posedness of infinite-dimensional systems in the presence of nonlinearities have been presented in [7] [75], and [6] based on semigroup theory. In [32], the authors make use of infinite-dimensional linear systems theory to rewrite a linear PDE and interconnect it with a static nonlinearity. Only few papers study the well-posedness of hyperbolic PDEs in the presence of saturated boundary nonlinearity. More specifically, [59] considers the wave equation, whereas [22] analyses the stability of BV solutions.

The aim of this chapter is to provide a boundary feedback control design for 1D hyperbolic systems with an in-domain disturbance and a boundary feedback controller under the effect of actuator saturation. Nonlinear semigroup theory is used to prove well-posedness of mild solution pairs to the closed-loop system. Sufficient conditions in the form of dissipation functional inequalities are derived to establish global stability for the closed-loop system and \mathcal{L}^2 -stability in presence of in-domain disturbances. The control design problem is then recast as an optimization problem over linear matrix inequality constraints. Numerical results are shown to validate the effectiveness of the proposed control design. This chapter has been partially presented at IFAC World Congress 2020 [65] and appeared in *Automatica* as a journal paper in 2022 [66].

2.1 Problem Statement

2.1.1 Problem setup

We consider the boundary feedback control of the following n linear 1-D hyperbolic PDEs formally written as:

$$\begin{aligned} X_t(t, z) + \Lambda X_z(t, z) &= Nd(t, z) \quad \forall (t, z) \in \mathbb{R}_{\geq 0} \times (0, 1) \\ X(t, 0) &= HX(t, 1) + B\sigma(u(t)) \quad \forall t \in \mathbb{R}_{\geq 0} \\ X(0, z) &= X_0(z) \quad \forall z \in (0, 1) \end{aligned} \tag{2.1}$$

where $t \in \mathbb{R}_{\geq 0}$ and $z \in (0, 1)$ are the two independent variables, respectively, time and space, $z \mapsto X(\cdot, z) \in \mathbb{R}^n$ is the state, and $z \mapsto d(\cdot, z) \in \mathbb{R}^q$ is an exogenous in-domain disturbance. We assume also that the matrices $\Lambda \in \mathbb{D}_p^n$, $H \in \mathbb{R}^{n \times n}$, $B \in \mathbb{R}^{n \times m}$ and $N \in \mathbb{R}^{n \times q}$ are given and that the state $X(\cdot, z)$ is measurable only at the boundary point $z = 1$. Specifically, the measurable output of the system reads as $y = X(\cdot, 1)$.

Let $u := KX(\cdot, 1)$ where $K \in \mathbb{R}^{m \times n}$ is the control gain to be designed and the function $u \mapsto \sigma(u)$ is the symmetric decentralized saturation function with saturation levels $\bar{u}_1, \bar{u}_2, \dots, \bar{u}_m \in \mathbb{R}_{>0}$, whose components for each $u \in \mathbb{R}^m$ are defined as:

$$\sigma(u)_i = \sigma(u_i) := \min(|u_i|, \bar{u}_i) \text{sign}(u_i) \quad i = 1, 2, \dots, m \quad (2.2)$$

Our goal is to design the gain K to induce closed-loop stability with quantifiable convergence rate and robustness margins with respect to the exogenous input d . For convenience, we define the function $u \mapsto \phi(u)$ which is the symmetric decentralized dead-zone nonlinearity function given by the following expression (see [72, Page 40]):

$$\phi(u_i) := \sigma(u_i) - u_i \quad (2.3)$$

where $\phi : \mathbb{R}^m \rightarrow \mathbb{R}^m$. By setting $H_{cl} := H + BK$, the closed-loop system turns into:

$$\begin{aligned} X_t(t, z) + \Lambda X_z(t, z) &= Nd(t, z) & \forall (t, z) \in \mathbb{R}_{>0} \times (0, 1) \\ X(t, 0) &= H_{cl}X(t, 1) + B\phi(KX(t, 1)) & \forall t \in \mathbb{R}_{\geq 0} \\ X(0, z) &= X_0(z) & \forall z \in (0, 1) \end{aligned} \quad (2.4)$$

2.1.2 Notion of the Solutions to the Closed-loop System

Before conducting the Lyapunov stability analysis to design a stabilizing control gain, one must first check if the Cauchy problem (2.4) is well-posed. In other words, one must prove that the solution X to (2.4) exists, is unique, and depends continuously on the initial value X_0 satisfying the compatibility conditions. As classically done in [19] and [57], we reformulate the closed-loop system (2.4) as an abstract Cauchy problem.

Consider now the following operators defined, respectively, on the Hilbert spaces $\mathcal{L}^2(0, 1; \mathbb{R}^n)$ and $\mathcal{L}^2(0, 1; \mathbb{R}^q)$ equipped with their respective standard inner products:

$$\begin{aligned} \mathcal{A} : \mathcal{D}(\mathcal{A}) &\rightarrow \mathcal{L}^2(0, 1; \mathbb{R}^n) \\ X &\mapsto -\Lambda X_z(z) \\ \mathcal{N} : \mathcal{L}^2(0, 1; \mathbb{R}^q) &\rightarrow \mathcal{L}^2(0, 1; \mathbb{R}^n) \\ d &\mapsto Nd \end{aligned} \quad (2.5)$$

where

$$\mathcal{D}(\mathcal{A}) := \{X \in \mathcal{H}^1(0, 1; \mathbb{R}^n); X(0) = H_{cl}X(1) + B\phi(KX(1))\}$$

Then, the closed-loop dynamics can be formally written as the following abstract system with state $X \in \mathcal{L}^2(0, 1; \mathbb{R}^n)$ and exogenous input $d \in \mathcal{L}^2(0, 1; \mathbb{R}^q)$

$$\dot{X} = \mathcal{A}X + \mathcal{N}d \quad (2.6)$$

If \mathcal{A} is linear ($\phi(KX(t)) = 0$), we can use the Lumer-Philips Theorem [57, Page 14] to prove that \mathcal{A} is an infinitesimal generator of a C^0 -semigroup of contractions on $\mathcal{L}^2(0, 1; \mathbb{R}^n)$ by proving that \mathcal{A} is dissipative and that there exists $\lambda_0 > 0$ such that the range of $(\lambda_0 I + \mathcal{A})$ is equal to the state-space $\mathcal{L}^2(0, 1; \mathbb{R})$. Referring to [57, Page 109, Theorem 2.9], one can deduce the existence and uniqueness of a classical solution by imposing $d \in \mathcal{C}^1([0, T]; \mathcal{L}^2(0, 1; \mathbb{R}))$.

Unfortunately, due to the presence of saturation limitation at the boundary condition, the Cauchy problem is considered nonlinear (or semi-linear) and we are forced to deal with less regular notion of solution. In particular, as in [7], we focus on mild solution pairs to (2.1). We recall the definition of a mild solution pair to (2.6) introduced in [7, Definition 4.3, Page 120]:

Definition 2.1 A mild solution pair for the system (2.6), with the initial condition $X(0, z) = X_0$ is a pair (X, d) satisfying the following: functions $X \in \mathcal{C}^1(\text{dom}X; \mathcal{L}^2(0, 1; \mathbb{R}^n))$ and $d \in \mathcal{L}^1(\text{dom}d, \mathcal{L}^2(0, 1; \mathbb{R}^q))$ where ¹ $\text{dom}X = \text{dom}d$ is an interval of $\mathbb{R}_{\geq 0}$ including zero. In addition, for each $\epsilon > 0$, there exists an ϵ -approximate solution² ζ of the abstract system

$$\dot{X} = \mathcal{A}X + \mathcal{N}d$$

such that the following holds

$$\|X(t) - \zeta(t)\| \leq \epsilon$$

for all $t \in \text{dom}X$. \diamond

In what follows, we use the shorthand notation \mathcal{L}_i^2 instead of $\mathcal{L}^2(0, 1; \mathbb{R}^i)$ for simplification purposes.

Now, we state the problem we solve in this chapter:

Problem 2.1 Given $H \in \mathbb{R}^{n \times n}$, $B \in \mathbb{R}^{n \times m}$, $N \in \mathbb{R}^{n \times q}$, and $\Lambda \in \mathbb{D}_p^n$. Design K such that for some $\kappa, \omega, \gamma \in \mathbb{R}_{>0}$ and for each mild solution pair (X, d) to (2.6) one has, for all $t \in \text{dom}X$:

$$\|X(t)\|_{\mathcal{L}_n^2} \leq \kappa e^{-\omega t} \|X_0\|_{\mathcal{L}_n^2} + \gamma \sqrt{\int_0^t \|d(\theta)\|_{\mathcal{L}_q^2}^2 d\theta} \quad (2.7)$$

\diamond

Inequality (2.7) corresponds to a classical input-to-state-stability (ISS) bound for the abstract closed-loop system (2.6). Sufficient conditions to ensure ISS for infinite-dimensional systems are given in [37] and [51]. The main contribution of this paper is to perform an optimal design of the control design of the control gain K in order to minimize the ISS gain γ . In Section 2.3, we provide sufficient conditions to get an explicit estimate of the ISS gain γ .

2.2 Well-posedness of the Closed-Loop System

In this section, we state the well-posedness of the closed-loop system (2.6). Let us start by defining the notion of non-accretive operator inspired by [7, Definition 3.1, Page 97]:

Definition 2.2 An operator \mathcal{A} from $\mathcal{D}(\mathcal{A})$ to $\mathcal{L}^2(0, 1; \mathbb{R}^n)$ is said to be non-accretive with respect to an inner product $\langle \cdot, \cdot \rangle$ if for every pair $(X_1, X_2) \in \mathcal{D}(\mathcal{A}) \times \mathcal{D}(\mathcal{A})$, the following inequality holds:

$$\langle \mathcal{A}X_1 - \mathcal{A}X_2, X_1 - X_2 \rangle \leq 0 \quad (2.8)$$

\diamond

Inspired by [10, Appendix A, Page 224], let us introduce the following inner product on $\mathcal{L}^2(0, 1; \mathbb{R}^n)$:

$$\langle X_1, X_2 \rangle_\mu := \int_0^1 e^{\mu z} X_1^\top X_2 dz \quad (2.9)$$

where $\mu > 0$ will be selected later. It is noted that this inner product is equivalent to the standard inner product in \mathcal{L}^2 since the function $z \mapsto e^{\mu z}$ is bounded from below and above on $[0, 1]$. We now use the previous definition to apply it on a suitable operator which will be vital in proving the uniqueness and existence of mild solution pairs to (2.6).

Proposition 2.1 There exist $\mu > 0$ and $\rho \in \mathbb{R}$ such that the operator $\mathcal{A} + \rho I$ is non-accretive (with respect to the scalar product $\langle \cdot, \cdot \rangle_\mu$). \diamond

Proof. Let $X_1, X_2 \in \mathcal{D}(\mathcal{A})$, $\tilde{X} = X_1 - X_2 \in \mathcal{D}(\mathcal{A})$ and $\tilde{\phi} = \phi(KX_1(1)) - \phi(KX_2(1)) \in \mathbb{R}^m$. Let us prove (2.8) for the operator $\mathcal{A} + \rho I$ for a suitable choice of μ . First we can write the following:

$$\langle (\mathcal{A} + \rho I)\tilde{X}, \tilde{X} \rangle_\mu = \langle \mathcal{A}\tilde{X}, \tilde{X} \rangle_\mu + \rho \langle \tilde{X}, \tilde{X} \rangle_\mu$$

¹ $\text{dom}d$ and $\text{dom}X$ can be either $[0, T]$ or $[0, \infty)$.

²The definition of ϵ -approximate solution is found in 2.4

where

$$\langle \mathcal{A}\tilde{X}, \tilde{X} \rangle_\mu = - \int_0^1 e^{\mu z} \tilde{X}^\top \Lambda \tilde{X}_z dz$$

Using an integration by parts, we have:

$$\langle \mathcal{A}\tilde{X}, \tilde{X} \rangle_\mu = -\frac{1}{2} e^{\mu z} \tilde{X}^\top \Lambda \tilde{X} \Big|_0^1 + \frac{1}{2} \mu \int_0^1 e^{\mu z} \tilde{X}^\top \Lambda \tilde{X} dz$$

Thanks to the boundary condition in (2.4), we have:

$$\langle \mathcal{A}\tilde{X}, \tilde{X} \rangle_\mu = -\frac{1}{2} \left(e^\mu \tilde{X}(1)^\top \Lambda \tilde{X}(1) - (H_{cl} \tilde{X}(1) + B\tilde{\phi})^\top \Lambda (H_{cl} \tilde{X}(1) + B\tilde{\phi}) \right) + \frac{1}{2} \mu \langle \tilde{X}, \tilde{X} \rangle_\mu \quad (2.10)$$

We can rewrite the previous equation as:

$$\langle \mathcal{A}\tilde{X}, \tilde{X} \rangle_\mu = \frac{1}{2} \mathcal{X}^\top \begin{pmatrix} H_{cl}^\top \Lambda H_{cl} - e^\mu \Lambda & H_{cl}^\top \Lambda B \\ * & B^\top \Lambda B \end{pmatrix} \mathcal{X} + \frac{1}{2} \mu \langle \tilde{X}, \tilde{X} \rangle_\mu \quad (2.11)$$

where $\mathcal{X} := \begin{pmatrix} \tilde{X}(1) \\ \tilde{\phi} \end{pmatrix}$. Hence, recalling that ϕ is 1-Lipschitz continuous³, one has:

$$\mathcal{X}^\top \begin{pmatrix} -K^\top K & 0 \\ * & I \end{pmatrix} \mathcal{X} \leq 0$$

which by using, (2.11) gives:

$$\langle \mathcal{A}\tilde{X}, \tilde{X} \rangle_\mu \leq \frac{1}{2} \mathcal{X}^\top \begin{pmatrix} H_{cl}^\top \Lambda H_{cl} - e^\mu \Lambda + \tau K^\top K & H_{cl}^\top \Lambda B \\ * & B^\top \Lambda B - \tau I \end{pmatrix} \mathcal{X} + \frac{1}{2} \mu \langle \tilde{X}, \tilde{X} \rangle_\mu \quad (2.12)$$

for any $\tau > 0$. Pick τ such that $B^\top \Lambda B - \tau I \leq -I$. Thus, we can write

$$\langle \mathcal{A}\tilde{X}, \tilde{X} \rangle_\mu \leq \frac{1}{2} \mathcal{X}^\top \begin{pmatrix} H_{cl}^\top \Lambda H_{cl} - e^\mu \Lambda + \tau K^\top K & H_{cl}^\top \Lambda B \\ * & -I \end{pmatrix} \mathcal{X} + \frac{1}{2} \mu \langle \tilde{X}, \tilde{X} \rangle_\mu \quad (2.13)$$

Now, consider the following matrix:

$$\Omega := \begin{pmatrix} H_{cl}^\top \Lambda H_{cl} - e^\mu \Lambda + \tau K^\top K & H_{cl}^\top \Lambda B \\ * & -I \end{pmatrix}$$

From the Schur-complement lemma (see [81, Page 34, Theorem 1.12]), one has that $\Omega < 0$ if and only if the following conditions hold

$$\begin{aligned} H_{cl}^\top \Lambda H_{cl} - e^\mu \Lambda + \tau K^\top K &< 0 \\ -I - (B^\top \Lambda H_{cl})(H_{cl}^\top \Lambda H_{cl} - e^\mu \Lambda + \tau K^\top K)^{-1}(H_{cl}^\top \Lambda B) &< 0 \end{aligned} \quad (2.14)$$

Pick μ such that:

$$\mu > \ln \left(\left\| H_{cl}^\top \Lambda H_{cl} \Lambda^{-1} + \tau K^\top K \Lambda^{-1} + \left\| H_{cl}^\top \Lambda B \right\|^2 \Lambda^{-1} \right\| \right) \quad (2.15)$$

Thus, both conditions of (2.14) hold and $\Omega < 0$. Finally, choose $\rho < -\frac{1}{2}\mu$ and thus, (2.8) holds and the proof is concluded. \square

Following the work of [7, Page 97], we now prove that the non-accretive operator $\mathcal{A} + \rho I$ enjoys the following property:

Proposition 2.2 *There exists $\rho \in \mathbb{R}$ such that for all $\lambda > 0$, the following range property holds*

$$\text{Ran}(I + \lambda(\mathcal{A} + \rho I)) = \mathcal{L}^2(0, 1; \mathbb{R}^n) \quad (2.16)$$

³This follows from the fact ϕ is continuous and piecewise linear with a slope bounded by 1.

where Ran stands for the range. \diamond

Proof. We know that

$$\text{Ran}(I + \lambda(\mathcal{A} + \rho I)) \subset \mathcal{L}^2(0, 1; \mathbb{R}^n)$$

Let us prove that

$$\text{Ran}(I + \lambda(\mathcal{A} + \rho I)) \supset \mathcal{L}^2(0, 1; \mathbb{R}^n) \quad (2.17)$$

Pick any $f \in \mathcal{L}^2(0, 1; \mathbb{R}^n)$, we show that there exists $X \in \mathcal{D}(\mathcal{A})$ such that

$$(I + \lambda(\mathcal{A} + \rho I))X = f$$

The above statement is equivalent to checking the existence of solution to the following boundary value problem:

$$\begin{aligned} I_\rho X(z) - \lambda \Lambda X_z(z) &= f(z) & \forall z \in (0, 1) \\ X(0) &= H_{cl}X(1) + B\phi(KX(1)) \end{aligned} \quad (2.18)$$

where $I_\rho := (1 + \lambda\rho)I$. The solution for the first line of (2.18) is given by:

$$X(z) = e^{\frac{1}{\lambda}\Lambda^{-1}I_\rho z}X(0) - \int_0^z e^{\frac{1}{\lambda}\Lambda^{-1}I_\rho(z-s)}\frac{1}{\lambda}\Lambda^{-1}f(s)ds \quad \forall z \in (0, 1) \quad (2.19)$$

In particular, one has:

$$X(1) = e^{\frac{1}{\lambda}\Lambda^{-1}I_\rho}X(0) - \int_0^1 e^{\frac{1}{\lambda}\Lambda^{-1}I_\rho(1-s)}\frac{1}{\lambda}\Lambda^{-1}f(s)ds =: g_\lambda(X(0))$$

Then, the boundary condition is rewritten as:

$$X(0) = H_{cl}g_\lambda(X(0)) + B\phi(Kg_\lambda(X(0))) \quad (2.20)$$

Therefore, (2.18) has a solution if and only if there exists $X(0)$ satisfying (2.20). Let us introduce the following map:

$$\begin{aligned} \mathcal{T}: \mathbb{R}^n &\rightarrow \mathbb{R}^n \\ c &\mapsto H_{cl}g_\lambda(c) + B\phi(Kg_\lambda(c)) \end{aligned} \quad (2.21)$$

Now, we show that this is the case by using Banach fixed point theorem [13, Page 138] to \mathcal{T} . In order to show that \mathcal{T} is a contraction, let us first write that

$$g_\lambda(c_1) - g_\lambda(c_2) = e^{\frac{1}{\lambda}\Lambda^{-1}I_\rho}(c_1 - c_2) \quad \forall c_1, c_2 \in \mathbb{R}^n \quad (2.22)$$

Since ϕ is a 1-Lipschitz continuous function, it follows that for all $c_1, c_2 \in \mathbb{R}^n$:

$$|\phi(Kg_\lambda(c_1)) - \phi(Kg_\lambda(c_2))| \leq |K(g_\lambda(c_1) - g_\lambda(c_2))|$$

which, using (2.22), gives:

$$|\phi(Kg_\lambda(c_1)) - \phi(Kg_\lambda(c_2))| \leq |K(e^{\frac{1}{\lambda}\Lambda^{-1}I_\rho}(c_1 - c_2))| \quad (2.23)$$

Using (2.21), (2.22), and (2.23), we get:

$$\begin{aligned} |\mathcal{T}(c_1) - \mathcal{T}(c_2)| &= |H_{cl}g_\lambda(c_1) + B\phi(Kg_\lambda(c_1)) - H_{cl}g_\lambda(c_2) - B\phi(Kg_\lambda(c_2))| \\ &\leq |H_{cl}(g_\lambda(c_1) - g_\lambda(c_2))| + |B(\phi(Kg_\lambda(c_1)) - \phi(Kg_\lambda(c_2)))| \\ &\leq |H_{cl}(e^{\frac{1}{\lambda}\Lambda^{-1}I_\rho}(c_1 - c_2))| + |BK(e^{\frac{1}{\lambda}\Lambda^{-1}I_\rho}(c_1 - c_2))| \\ &\leq \left(\|H_{cl}e^{\frac{1}{\lambda}\Lambda^{-1}I_\rho}\| + \|BK e^{\frac{1}{\lambda}\Lambda^{-1}I_\rho}\| \right) |c_1 - c_2| \end{aligned}$$

Let $\alpha = \left\| H_{cl} e^{\frac{1}{\lambda} \Lambda^{-1} I_\rho} \right\| + \left\| BK e^{\frac{1}{\lambda} \Lambda^{-1} I_\rho} \right\|$. We have:

$$\alpha \leq (\|H_{cl}\| + \|BK\|) \left\| e^{\frac{1}{\lambda} \Lambda^{-1} I_\rho} \right\| \leq e^{\frac{\lambda \rho}{\lambda_{\max}(\Lambda) \lambda}} (\|H_{cl}\| + \|BK\|) \quad (2.24)$$

where $\lambda_{\max}(\Lambda)$ is the largest eigenvalue of the matrix Λ . Pick $\rho \in \mathbb{R}$ small enough, such that $e^{\frac{\rho}{\lambda_{\max}(\Lambda)}} (\|H_{cl}\| + \|BK\|) < 1$. Then, we have that $0 < \alpha < 1$. The proof is concluded \square

The main result of this section is presented in the following theorem where we show that the system is well-posed.

Theorem 2.1 *For every initial state $X_0 \in \mathcal{L}^2(0, 1; \mathbb{R}^n)$, $d \in \mathcal{L}^1(\text{dom}d; \mathcal{L}^2(0, 1; \mathbb{R}^q))$, the closed-loop system (2.4) admits a unique mild solution pair $(X, d) \in \mathcal{C}^1(\text{dom}X; \mathcal{L}^2(0, 1; \mathbb{R}^n)) \times \mathcal{L}^1(\text{dom}d; \mathcal{L}^2(0, 1; \mathbb{R}^q))$ such that $X(0, z) = X_0$.* \diamond

Proof. The choice of $X_0 \in \mathcal{L}_\mu^2(0, 1; \mathbb{R}^n)$ is equivalent to $X_0 \in \mathcal{L}^2(0, 1; \mathbb{R}^n)$ where \mathcal{L}_μ^2 is defined by the norm induced by the scalar product in (2.9). By means of Propositions 2.1 and 2.2, the operator $\mathcal{A} + \rho I$ is m -non-accretive and thus, the Cauchy problem (2.4) has a unique mild solution pair, (see [3, Theorem A.26, Page 286] and [7, Page 97]). \square

Definition 2.3 *In [7, Page 127], a strong solution pair to (2.6) is defined as a pair $(X, d) \in (W^{1,1}(\text{dom}X; \mathcal{L}^2(0, 1; \mathbb{R}^n)) \cap \mathcal{C}^1(\text{dom}X; \mathcal{L}^2(0, 1; \mathbb{R}^n))) \times \mathcal{L}^1(\text{dom}d; \mathcal{L}^2(0, 1; \mathbb{R}^q))$ such that*

$$\begin{aligned} \frac{dX}{dt}(t) + \mathcal{A}X(t) &= \mathcal{N}d(t) & t \in \text{dom}X, \\ X(z, 0) &= X_0 \end{aligned}$$

where $X_0 \in \mathcal{L}^2(0, 1; \mathbb{R}^n)$ and with $\text{dom}X = \text{dom}d$. \diamond

In the remaining part of this section, we restrict the focus on the perturbation $d \in \mathcal{L}^2(\text{dom}d; \mathcal{L}^2(0, 1; \mathbb{R}^q))$ which is instrumental for the derivation of stability results of Section 2.3. The following proposition is crucial for the stability analysis Section 4.1, in which the mild solution pair (X, d) can be approximated point-wise via a sequence of strong solution pairs (2.6).

Proposition 2.3 *Let (X, d) be a mild solution pair to (2.6) and $t \in \text{dom}X$. There exists a sequence of strong solution pair $\{(X^k, d^k)\}_{k \in \mathbb{N}}$ such that:*

$$X^k(t) \xrightarrow[k \rightarrow \infty]{\mathcal{L}^2(0,1;\mathbb{R}^n)} X(t) \quad (2.25)$$

$$d^k \xrightarrow[k \rightarrow \infty]{\mathcal{L}^2(0,t;\mathcal{L}^2(0,1;\mathbb{R}^q))} d \quad (2.26)$$

with $\text{dom}X^k =]0, t]$ and for all $k \in \mathbb{N}$. \diamond

Proof. Let $(X, d) \in \mathcal{L}^2(0, t; \mathcal{L}^2(0, 1; \mathbb{R}^n)) \times \mathcal{L}^2(0, t; \mathcal{L}^2(0, 1; \mathbb{R}^q))$ be a mild solution pair to (2.6). Pick $\{d^k\}_{k \in \mathbb{N}} \subset \mathcal{C}_c^\infty(0, t; \mathcal{L}^2(0, 1; \mathbb{R}^q))$ such that, one has:

$$d^k \xrightarrow[k \rightarrow \infty]{\mathcal{L}^2(0,t;\mathcal{L}^2(0,1;\mathbb{R}^q))} d \quad (2.27)$$

Since $\mathcal{D}(\mathcal{A})$ is dense in $\mathcal{L}^2(0, 1; \mathbb{R}^n)$, then there exists a sequence $\{X_0^k\}_{k \in \mathbb{N}} \subset \mathcal{D}(\mathcal{A})$ such that

$$X_0^k \xrightarrow[k \rightarrow \infty]{\mathcal{L}^2(0,1;\mathbb{R}^n)} X_0 \quad (2.28)$$

We know that a strong solution pair to (2.4) is also a mild solution pair. Moreover, \mathcal{A} is ρ -non-accretive, $X_0 \in \mathcal{D}(\mathcal{A})$, and since $(X, d), \{(X^k, d^k)\}_{k \in \mathbb{N}}$ are mild solutions to (2.4). Therefore, from [7, Theorem 4.1, Page 130], it holds:

$$\left\| X(t) - X^k(t) \right\|_{\mathcal{L}_n^2} = e^{\rho t} \left\| X_0 - X_0^k \right\|_{\mathcal{L}_n^2} + \int_0^t e^{\rho(t-\tau)} [X(\tau) - X^k(\tau), d(\tau) - d^k(\tau)]_s d\tau$$

where for functions x, y in real Banach spaces, $[\cdot, \cdot]_s$ is the directional derivative of the function $x \rightarrow \|x\|$ in the direction y , defined by

$$[x, y]_s := \lim_{\lambda \rightarrow 0} \frac{\|x + \lambda y\| - \|x\|}{\lambda}$$

Using [7, Proposition 3.7, (iv)], one has

$$-\|d(\tau) - d^k(\tau)\|_{\mathcal{L}_q^2} \leq [X(\tau) - X^k(\tau), d(\tau) - d^k(\tau)]_s \leq \|d(\tau) - d^k(\tau)\|_{\mathcal{L}_q^2} \quad (2.29)$$

Then using the previous statement, one has:

$$\|X(t) - X^k(t)\|_{\mathcal{L}_n^2} \leq e^{\rho t} \|X_0 - X_0^k\|_{\mathcal{L}_n^2} + \int_0^t e^{\rho(t-\tau)} \|d(\tau) - d^k(\tau)\|_{\mathcal{L}_q^2} d\tau \quad (2.30)$$

Since the term $\|d(\tau) - d^k(\tau)\|_{\mathcal{L}_q^2}$ is convergent as we can see in (2.27)-(2.28), we have:

$$\lim_{k \rightarrow \infty} \int_0^t e^{\rho(t-\tau)} \|d(\tau) - d^k(\tau)\|_{\mathcal{L}_q^2} d\tau \leq \int_0^t e^{\rho(t-\tau)} \lim_{k \rightarrow \infty} \|d(\tau) - d^k(\tau)\|_{\mathcal{L}_q^2} d\tau \quad (2.31)$$

So taking the limit as $k \rightarrow \infty$ in (2.30), one has:

$$\begin{aligned} \lim_{k \rightarrow \infty} \|X(t) - X^k(t)\|_{\mathcal{L}_n^2} &\leq e^{\rho t} \lim_{k \rightarrow \infty} \|X_0 - X_0^k\|_{\mathcal{L}_n^2} \\ &\quad + \int_0^t e^{\rho(t-\tau)} \lim_{k \rightarrow \infty} \|d(\tau) - d^k(\tau)\|_{\mathcal{L}_q^2} d\tau \end{aligned} \quad (2.32)$$

Thus, from (2.27), (2.28), (2.31) and (2.32), we can infer that

$$\lim_{k \rightarrow \infty} X^k(t) \stackrel{\mathcal{L}^2(0,1;\mathbb{R}^n)}{=} X(t) \quad (2.33)$$

and the proof is concluded. \square

2.3 Stability Analysis and Control Design

This section contains results on the \mathcal{L}^2 -stability analysis to achieve closed-loop exponential stability. This is done first by proposing sufficient conditions and then constructing a Lyapunov functional to derive those sufficient conditions in the form of functional inequalities.

2.3.1 Sufficient Conditions

The following section presents the sufficient conditions for the solution to Problem 2.1 using a dissipation inequality. This is done by proving the following proposition:

Proposition 2.4 *Assume that there exists a Fréchet differentiable functional $V : \mathcal{L}^2(0, 1; \mathbb{R}^n) \rightarrow \mathbb{R}_{\geq 0}$ and $c_1, c_2, c_3, \chi \in \mathbb{R}_{>0}$ such that for each $d \in \mathcal{L}^2(0, 1; \mathbb{R}^q)$ and $\zeta \in \mathcal{D}(\mathcal{A})$.*

$$c_1 \|\zeta\|_{\mathcal{L}_n^2}^2 \leq V(\zeta) \leq c_2 \|\zeta\|_{\mathcal{L}_n^2}^2 \quad (2.34)$$

$$DV(\zeta)(\mathcal{A}\zeta + \mathcal{N}d) \leq -c_3 V(\zeta) + \chi^2 \|d\|_{\mathcal{L}_q^2}^2 \quad (2.35)$$

Let (X, d) be a mild solution pair to (2.6). Then, for all $t \in \text{dom}X$, one has:

$$\|X(t)\|_{\mathcal{L}_n^2} \leq e^{-\frac{c_3}{2}t} \left(\frac{c_2}{c_1}\right)^{\frac{1}{2}} \|X_0\|_{\mathcal{L}_n^2} + \frac{\chi}{\sqrt{c_1}} \sqrt{\int_0^t \|d(\theta)\|_{\mathcal{L}_q^2}^2 d\theta} \quad (2.36)$$

\diamond

Proof. First we show that the above results hold for all strong solution pairs to (2.6). More precisely, we consider solution pair $\text{dom}X \ni t \mapsto (X(t), d(t))$ to (2.6) and assume that $X(0) \in \mathcal{D}(\mathcal{A})$, $d \in \mathcal{L}^1(\text{dom}d; \mathcal{L}^2(0, 1; \mathbb{R}^q))$. Then, since, as shown in the proof of Proposition 2.1, \mathcal{A} is ρ -non-accretive, one has that (X, d) is a strong solution pair (this is proved in [7, Theorem 4.14]). More precisely, one has that $X \in \mathcal{C}^1(\text{dom}X, \mathcal{L}^2(0, 1; \mathbb{R}^n))$, and for all $t \in \text{dom}X$:

$$\dot{X}(t) = \mathcal{A}X(t) + \mathcal{N}d(t) \quad (2.37)$$

where $X(t) \in \mathcal{D}(\mathcal{A})$. Now, consider the following function:

$$\begin{aligned} \mathcal{W} : \text{dom}X &\rightarrow \mathbb{R} \\ t &\mapsto (V \circ X)(t) \end{aligned} \quad (2.38)$$

Then, since $V : \mathcal{L}^2(0, 1; \mathbb{R}^n) \rightarrow \mathbb{R}_{\geq 0}$ is Fréchet differentiable everywhere and $X : \text{dom}X \rightarrow \mathcal{L}^2(0, 1; \mathbb{R}^n)$ is differentiable almost everywhere, it follows that for almost all $t \in \text{dom}X$:

$$\dot{\mathcal{W}}(t) = DV(X)\dot{X}(t)$$

which thanks to (2.37) yields for almost all $t \geq 0$

$$\dot{\mathcal{W}}(t) = DV(X)(\mathcal{A}X(t) + \mathcal{N}d(t))$$

Thus, using (2.35) one gets for almost all $t \in \text{dom}X$

$$\dot{\mathcal{W}}(t) \leq -c_3\mathcal{W}(t) + \chi^2 \|d(t)\|_{\mathcal{L}_q^2}^2$$

Therefore, since \mathcal{W} is continuous on $\text{dom}X$, from the comparison principle (see Definition 2.6) we have that:

$$\mathcal{W}(t) \leq e^{-c_3 t} \mathcal{W}(0) + \chi^2 \int_0^t e^{-c_3(t-\theta)} \|d(\theta)\|_{\mathcal{L}_q^2}^2 d\theta$$

At this stage, notice that for all $t \in \text{dom}X$, one has:

$$\int_0^t e^{-c_3(t-\theta)} \|d(\theta)\|_{\mathcal{L}_q^2}^2 d\theta \leq \int_0^t \|d(\theta)\|_{\mathcal{L}_q^2}^2 d\theta$$

which allows one to conclude that for all $t \in \text{dom}X$

$$\mathcal{W}(t) \leq e^{-c_3 t} \mathcal{W}(0) + \chi^2 \int_0^t \|d(\theta)\|_{\mathcal{L}_q^2}^2 d\theta$$

Finally by using (2.34), it follows that for almost all $t \in \text{dom}X$

$$\|X(t)\|_{\mathcal{L}_n^2} \leq e^{-\frac{c_3}{2}t} \sqrt{\frac{c_2}{c_1}} \|X_0\|_{\mathcal{L}_n^2} + \frac{\chi}{\sqrt{c_1}} \sqrt{\int_0^t \|d(\theta)\|_{\mathcal{L}_q^2}^2 d\theta} \quad (2.39)$$

Now we conclude the proof by showing that the above bound holds also for mild solution pairs to (2.6). Let (X, d) be any solution pair. By applying Proposition 3, there exists a sequence of strong solution pairs $\{(X^k, d^k)\}_{k \in \mathbb{N}}$ such that (2.25) and (2.26) hold. Then, for all $k \in \mathbb{N}$, thanks to (2.39), one has for all $t \in \text{dom}X$

$$\|X^k(t)\|_{\mathcal{L}_n^2} \leq e^{-\frac{c_3}{2}t} \sqrt{\frac{c_2}{c_1}} \|X_0^k\|_{\mathcal{L}_n^2} + \frac{\chi}{\sqrt{c_1}} \sqrt{\int_0^t \|d^k(\theta)\|_{\mathcal{L}_q^2}^2 d\theta}$$

Taking the limit for $k \rightarrow \infty$, due to (2.25)-(2.26), one has for all $t \in \text{dom}X$

$$\|X(t)\|_{\mathcal{L}_n^2} \leq e^{-\frac{c_3}{2}t} \sqrt{\frac{c_2}{c_1}} \|X_0\|_{\mathcal{L}_n^2} + \frac{\chi}{\sqrt{c_1}} \sqrt{\int_0^t \|d(\theta)\|_{\mathcal{L}_q^2}^2 d\theta}$$

This concludes the proof. \square

Remark 2.1 Proposition 4 provides sufficient conditions for input-to-state stability for the closed-loop system in the form of a functional inequality. This provides an elegant generalization to abstract dynamical systems of the well-known ISS dissipation inequality for finite-dimensional nonlinear systems; see, e.g [69]. It is interesting to observe that the gradient of V is replaced in (2.35) by the Fréchet derivative. \circ

2.3.2 Quadratic Conditions

Let us define the following global sector condition which will be useful in the upcoming Lyapunov analysis computations.

Lemma 2.1 [72, Page 41] For all $\nu \in \mathbb{R}^m$, the nonlinearity $\phi(\nu)$ satisfies the following inequality:

$$\phi(\nu)^\top T(\phi(\nu) + \nu) \leq 0 \quad (2.40)$$

for any diagonal matrix $T \in \mathbb{D}_p^m$. \diamond

The following theorem provides sufficient conditions in the form of matrix inequalities under which Problem 2.1 admits a feasible solution.

Theorem 2.2 If there exist $P \in \mathbb{D}_p^n$, $T \in \mathbb{D}_p^m$, $\mu, \chi, \alpha \in \mathbb{R}_{>0}$, and $\Gamma \in \mathbb{S}_p^n$ such that the following hold:

$$\begin{pmatrix} H_{cl}^\top P \Lambda H_{cl} - e^{-\mu} P \Lambda & H_{cl}^\top P \Lambda B - K^\top T \\ * & B^\top P \Lambda B - 2T \end{pmatrix} \leq 0 \quad (2.41)$$

$$\begin{pmatrix} \Gamma & PN \\ * & \chi^2 I \end{pmatrix} \geq 0 \quad (2.42)$$

$$P(\alpha I - \mu \Lambda) + \Gamma \leq 0 \quad (2.43)$$

Then, K solves Problem 2.1 and in particular (2.7) holds with

$$\omega = \frac{\alpha}{2}, \quad \kappa = \sqrt{\frac{\lambda_{\max}(P)}{\lambda_{\min}(P)}} e^{\frac{\mu}{2}}, \quad \gamma = \frac{\chi}{\lambda_{\min}(P)} e^{\frac{\mu}{2}} \quad (2.44)$$

\diamond

Proof. Similarly as in [10], consider the following Lyapunov functional

$$\begin{aligned} V : \mathcal{L}^2(0, 1; \mathbb{R}^n) &\rightarrow \mathbb{R} \\ X &\mapsto \int_0^1 e^{-\mu z} \langle X(z), PX(z) \rangle_{\mathbb{R}^n} dz \end{aligned} \quad (2.45)$$

with the same μ defined in (2.9) and observe that for each $X \in \mathcal{L}^2(0, 1; \mathbb{R}^n)$, one has

$$c_1 \|X\|_{\mathcal{L}_n^2}^2 \leq V(X) \leq c_2 \|X\|_{\mathcal{L}_n^2}^2 \quad (2.46)$$

where $c_1 := e^{-\mu} \lambda_{\min}(P)$ and $c_2 := \lambda_{\max}(P)$ are strictly positive. As done in [26], for each $X \in \mathcal{D}(\mathcal{A})$, $d \in \mathcal{L}^2(0, 1; \mathbb{R}^q)$ one has

$$DV(X)(\mathcal{A}X + \mathcal{N}d) = \int_0^1 e^{-\mu z} \left(-2X_z(z)^\top \Lambda PX(z) + 2d(z)^\top N^\top PX(z) \right) dz$$

Since $P, \Lambda \in \mathbb{D}_p^n$, one has that

$$\int_0^1 -2e^{-\mu z} X_z(z)^\top \Lambda PX(z) dz = - \int_0^1 e^{-\mu z} \frac{d}{dz} \left(X(z)^\top P \Lambda X(z) \right) dz$$

Using integration by parts, the following holds

$$DV(X)(\mathcal{A}X + \mathcal{N}d) = -e^{-\mu z} X(z)^\top P \Lambda X(z) \Big|_0^1 - \mu \int_0^1 e^{-\mu z} X(z)^\top P \Lambda X(z) dz + \int_0^1 2e^{-\mu z} d(z)^\top N^\top PX(z) dz$$

Since $X \in \mathcal{D}(\mathcal{A})$, one gets

$$\begin{aligned} DV(X)(\mathcal{A}X + \mathcal{N}d) = & \mathcal{X}^\top \begin{pmatrix} H_{cl}^\top P \Lambda H_{cl} - e^{-\mu} P \Lambda & H_{cl}^\top P \Lambda B \\ * & B^\top P \Lambda B \end{pmatrix} \mathcal{X} \\ & + \int_0^1 e^{-\mu z} \begin{pmatrix} X(z) \\ d(z) \end{pmatrix}^\top \begin{pmatrix} -\mu P \Lambda & P N \\ * & 0 \end{pmatrix} \begin{pmatrix} X(z) \\ d(z) \end{pmatrix} dz \end{aligned}$$

where $\mathcal{X} := \begin{pmatrix} X(1) \\ \phi(KX(1)) \end{pmatrix}$. Similarly as in [65], after we introduce the global sector condition found in (2.40) one has

$$\begin{aligned} DV(X)(\mathcal{A}X + \mathcal{N}d) \leq & \mathcal{X}^\top \begin{pmatrix} H_{cl}^\top P \Lambda H_{cl} - e^{-\mu} P \Lambda & H_{cl}^\top P \Lambda B - K^\top T \\ * & B^\top P \Lambda B - 2T \end{pmatrix} \mathcal{X} \\ & + \int_0^1 e^{-\mu z} \begin{pmatrix} X(z) \\ d(z) \end{pmatrix}^\top \begin{pmatrix} -\mu P \Lambda & P N \\ * & 0 \end{pmatrix} \begin{pmatrix} X(z) \\ d(z) \end{pmatrix} dz \end{aligned}$$

where $T \in \mathbb{D}_p^m$. From (2.42) one has

$$\begin{aligned} DV(X)(\mathcal{A}X + \mathcal{N}d) \leq & \mathcal{X}^\top \begin{pmatrix} H_{cl}^\top P \Lambda H_{cl} - e^{-\mu} P \Lambda & H_{cl}^\top P \Lambda B - K^\top T \\ * & B^\top P \Lambda B - 2T \end{pmatrix} \mathcal{X} \\ & + \int_0^1 e^{-\mu z} \begin{pmatrix} X(z) \\ d(z) \end{pmatrix}^\top \begin{pmatrix} -\mu P \Lambda + \Gamma & 0 \\ * & \chi^2 I \end{pmatrix} \begin{pmatrix} X(z) \\ d(z) \end{pmatrix} dz \end{aligned}$$

Finally, using (2.41) and (2.43) we have

$$DV(X)(\mathcal{A}X + \mathcal{N}d) \leq -\alpha V(X) + \chi^2 \|d\|_{\mathcal{L}_q^2}^2 \quad (2.47)$$

which reads as (2.35). Hence, the proof is concluded. \square

Remark 2.2 We emphasize that the result presented in Theorem 2.2 is global. However, the feasibility of (2.34) is not always guaranteed. This is commonly seen in the literature of saturated control (see [72, Chapter 3]). \circ

2.3.3 Control Design

Theorem 2.2 enables to recast the solution to Problem 2.1 as the feasibility problem of some matrix inequalities, i.e. (2.41)-(2.42)-(2.43). However, those conditions are nonlinear in the variables P, K, χ, μ and α . As such, Theorem 2.2 cannot be used directly to get a numerically tractable solution to Problem 2.1. The result given next, provides sufficient conditions in a form that is more advantageous from a numerical standpoint.

Corollary 2.1 *If there exist $Q \in \mathbb{D}_p^n, S \in \mathbb{D}_p^m, \hat{\Gamma} \in \mathbb{S}_p^n, \mu, \alpha \in \mathbb{R}_{>0}$ and $W \in \mathbb{R}^{m \times n}$ such that*

$$\begin{pmatrix} -Q\Lambda^{-1} & HQ + BW & BS \\ * & -e^{-\mu}\Lambda Q & -W^\top \\ * & * & -2S \end{pmatrix} \leq 0 \quad (2.48)$$

$$\begin{pmatrix} \hat{\Gamma} & N \\ * & I \end{pmatrix} \geq 0 \quad (2.49)$$

$$Q(\alpha I - \mu\Lambda) + \hat{\Gamma} \leq 0 \quad (2.50)$$

Then, $K = WQ^{-1}$ solves Problem 2.1. In particular, (2.7) holds with ω and κ defined as in (2.44) and

$$\gamma = \sqrt{\lambda_{\max}(Q)} e^{\frac{\mu}{2}} \quad (2.51)$$

\diamond

Proof. Applying the Schur complement lemma to (2.41) gives

$$\begin{pmatrix} -\Lambda^{-1}P & PH + PBK & PB \\ * & -e^{-\mu}P\Lambda & -K^\top T \\ * & * & -2T \end{pmatrix} \leq 0$$

which is equivalent to

$$\begin{pmatrix} P^{-1} & 0 & 0 \\ * & P^{-1} & 0 \\ * & * & T^{-1} \end{pmatrix}^\top \begin{pmatrix} -\Lambda^{-1}P & PH + PBK & PB \\ * & -e^{-\mu}P\Lambda & -K^\top T \\ * & * & -2T \end{pmatrix} \begin{pmatrix} P^{-1} & 0 & 0 \\ * & P^{-1} & 0 \\ * & * & T^{-1} \end{pmatrix} \leq 0$$

which gives

$$\begin{pmatrix} -P^{-1}\Lambda^{-1} & HP^{-1} + BKP^{-1} & BT^{-1} \\ * & -e^{-\mu}\Lambda P^{-1} & -P^{-1}K^\top \\ * & * & -2T^{-1} \end{pmatrix} \leq 0$$

Then, by setting $P^{-1} = Q$, $T^{-1} = S$ and $W = KP^{-1}$, we have that the previous inequality is equivalent to (2.48). In [26, Corollary 1], it is shown that (2.42) and (2.43) are respectively equivalent to the linear inequalities (2.49) and (2.50) with $P^{-1} = Q$, $\hat{\Gamma} = Q\Gamma Q$, and $\chi = 1$. \square

Remark 2.3 *It can be easily shown that the conditions in Corollary 2.1 are actually equivalent to those in Theorem 2.2 in terms of feasibility. As such, Corollary 2.1 does not introduce any additional conservatism.* \circ

In the formulation of Problem 2.1, no specific requirements on the scalar γ are considered. On the other hand, it is obvious that to minimize the effect of the exogenous input d on the closed-loop system, the controller gain K should be designed so that (2.7) holds with a minimal γ . This goal can be achieved by considering the following optimization problem

$$\begin{aligned} & \inf_{Q, W, \mu, \alpha, c} c \\ \text{s.t: } & (2.48), (2.49), (2.50), Q \in \mathbb{D}_p^{n_p}, \mu > 0, \alpha > 0, Q - cI \leq 0. \end{aligned} \quad (2.52)$$

It can be seen through equation (2.51) that the variable γ is directly proportional to the square root of the maximum eigen value of matrix Q . Therefore, minimizing c is equivalent to minimizing $\lambda_{\max}(Q)$. One can note that (2.48), (2.49) and (2.50) are nonlinear in the decision variables μ and α . In fact, we select the scalars μ and α via a grid search. In other words, we set μ and α as arrays of appropriate values and resolution, and then running the code to generate a 3-dimensional diagram representing the feasible regions of the solution with respect to the pair (μ, α) .

2.4 Numerical Analysis

2.4.1 Application on a Scalar System

In this section we consider that $n = m = 1$. In other words, the hyperbolic system is scalar. We will also assume that there are no disturbances ($d = 0$) and that the matrix B is just the identity matrix as our focus will be on the effect of the value of the matrix H on the region of stability of the system. Thus we have the following closed-loop system:

$$\begin{aligned} X_t(t, z) + \Lambda X_z(t, z) &= 0 & \forall (t, z) \in \mathbb{R}_{\geq 0} \times (0, 1) \\ X(t, 0) &= (H + K)X(t, 1) + \phi(KX(t, 1)) & \forall t \in \mathbb{R}_{\geq 0} \\ X(0, z) &= X_0(z) & \forall z \in (0, 1) \end{aligned} \quad (2.53)$$

where $\Lambda, H, K \in \mathbb{R}$. Let $P, T \in \mathbb{R}$, then the sufficient conditions for global exponential stability given by (2.41), (2.42), (2.43) can be expressed through a single LMI (knowing that

$d = 0$):

$$M_s = \begin{pmatrix} (H + K)^2 P\Lambda - P\Lambda & (H + K)P\Lambda - KT \\ * & P\Lambda - 2T \end{pmatrix} \leq 0 \quad (2.54)$$

Since $M_s \in \mathbb{R}^2$, then $M_s \leq 0$ if and only if the determinant $\det(M_s) \geq 0$ and the trace $\text{trace}(M_s) \leq 0$. We now derive the expression of the determinant and trace of M_s and deduct the conditions of H under which global stability is guaranteed. For simplicity of the calculation, consider $\mu = 0$. However, due to the continuity with respect to μ , we know that if inequality (2.41) holds for $\mu = 0$, then there exist ϵ such that inequality also holds for $\mu \in (0, \epsilon)$.

Corollary 2.2 Inequality (2.54) admits a feasible solution if and only if $-1 < H < 1$. \diamond

Proof. The determinant of matrix M_s is given by:

$$\det(M_s) = -2T(H^2 P\Lambda - P\Lambda) - (P\Lambda + KT)^2 - 2P\Lambda KT(H + 1) \quad (2.55)$$

and the trace is given by

$$\text{trace}(M_s) = (H + K)^2 P\Lambda - 2T \quad (2.56)$$

We use a numerical solver to show the variation of the region of stability. First we consider that K and T are variables and we select several values for H and then find the region (K, T) under which both conditions (2.55) and (2.56) are satisfied. We notice that once $|H| \geq 1$, there are no feasible solution for K and T . We also observe that as $|H|$ approaches zero, the region of feasible (K, T) increases. This is showcased in a comparison between FIGURE 2.1 where $H = 0.5$ and FIGURE 2.2 where $H = 0.99$. \square

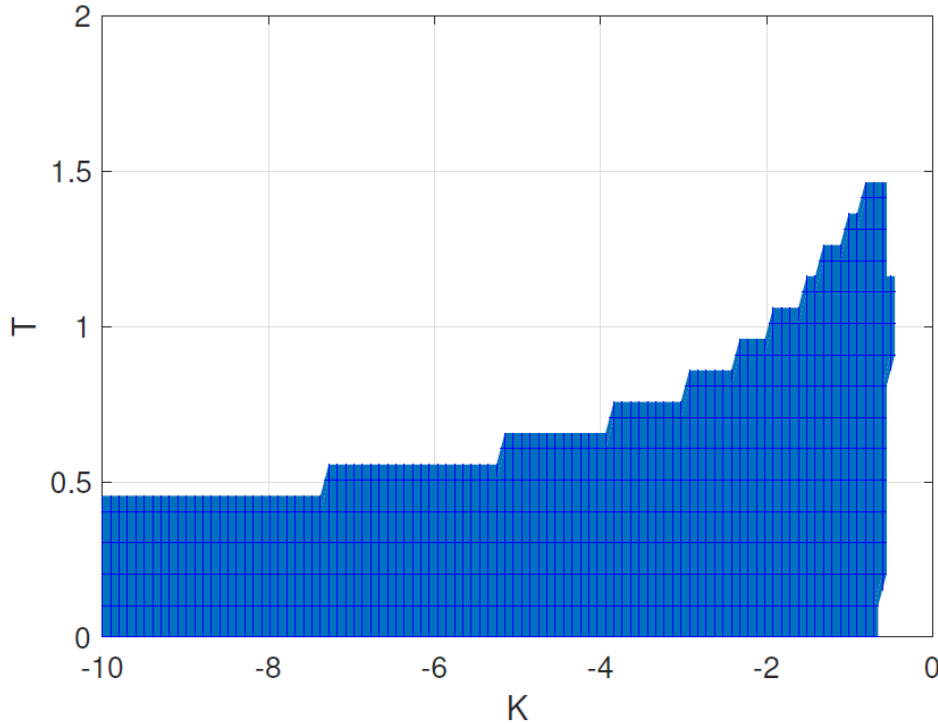
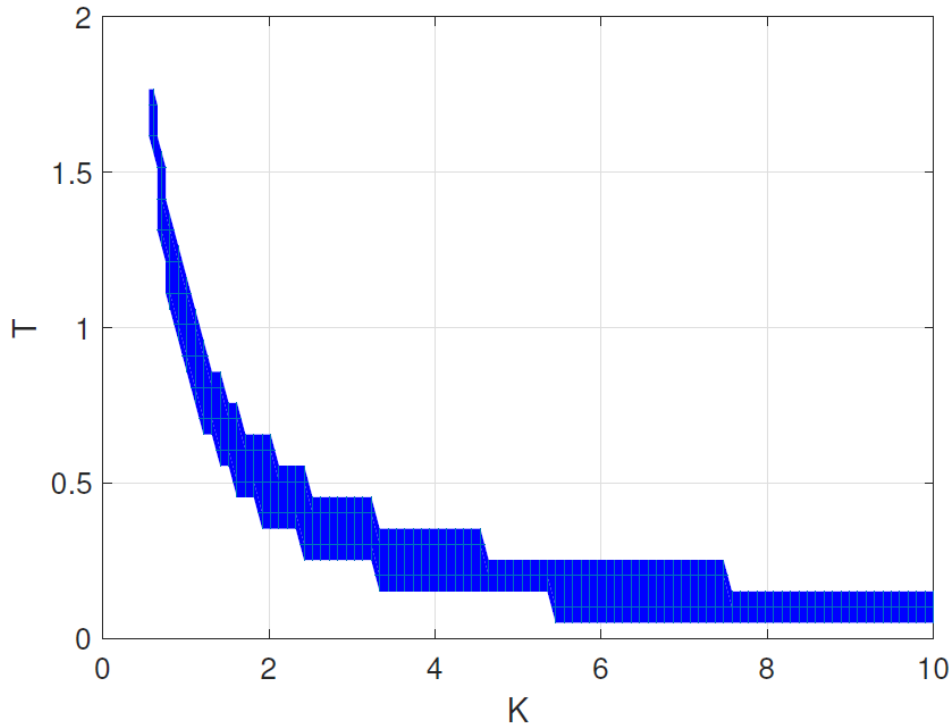

FIGURE 2.1: Feasible Region of the pair (K, T) for $H = 0.5$.

FIGURE 2.2: Feasible Region of the pair (K, T) for $H = 0.99$.

2.4.2 Numerical Example

To solve initial-boundary value problem for (2.4), numerical integration of hyperbolic PDEs is performed via the use of the Lax-Friedrichs (Shampine's two-step variant) scheme implemented in MATLAB by Shampine [64]. YALMIP package in MATLAB is used to solve the LMIs [45]. Consider the example presented in [65] modified to account for the presence of in-domain disturbances. Specifically, we consider the following system for all $(t, z) \in \mathbb{R}_{\geq 0} \times (0, 1)$:

$$\begin{aligned} X_t(t, z) + \begin{pmatrix} 1 & 0 \\ 0 & \sqrt{2} \end{pmatrix} X_z(t, z) &= \begin{pmatrix} 1 \\ 1 \end{pmatrix} d(t, z) \\ X(t, 0) &= \begin{pmatrix} 0.25 & 0 \\ -1 & 0.25 \end{pmatrix} X(t, 1) + \begin{pmatrix} 1 & 0 \\ 0 & 1 \end{pmatrix} u(t) \quad \forall t \in \mathbb{R}_{\geq 0} \end{aligned} \quad (2.57)$$

We consider the solution to Problem 2.1 obtained by solving (2.52), via a line search on the scalars α and μ . FIGURE 2.3 represents the set of feasible values of (2.52) of the pair (μ, α) . As in [26], we have that the feasible values of μ decreases as α increases. Then, as seen in the figure, we choose $\mu = 1$, $\alpha = 0.5$ in order to guarantee a feasible solution to our problem. For this example, the solution to (2.52) yields:

$$Q = \begin{pmatrix} 12.5 & 0 \\ 0 & 82 \end{pmatrix}, \Gamma = \begin{pmatrix} 4.07 & 0.2 \\ 0.19 & 36.3 \end{pmatrix}, K = \begin{pmatrix} -0.24 & 0 \\ 0.33 & -0.08 \end{pmatrix}$$

Consider the following disturbance defined over $t \in [0, 25]$:

$$(t, z) \mapsto d(t, z) := 5 \begin{pmatrix} \sin(zt) \\ \cos(zt) \end{pmatrix} \quad (2.58)$$

the initial condition:

$$(0, 1) \ni z \mapsto X_0(z) = \begin{pmatrix} \cos(4\pi z) - 1 \\ \cos(2\pi z) - 1 \end{pmatrix}$$

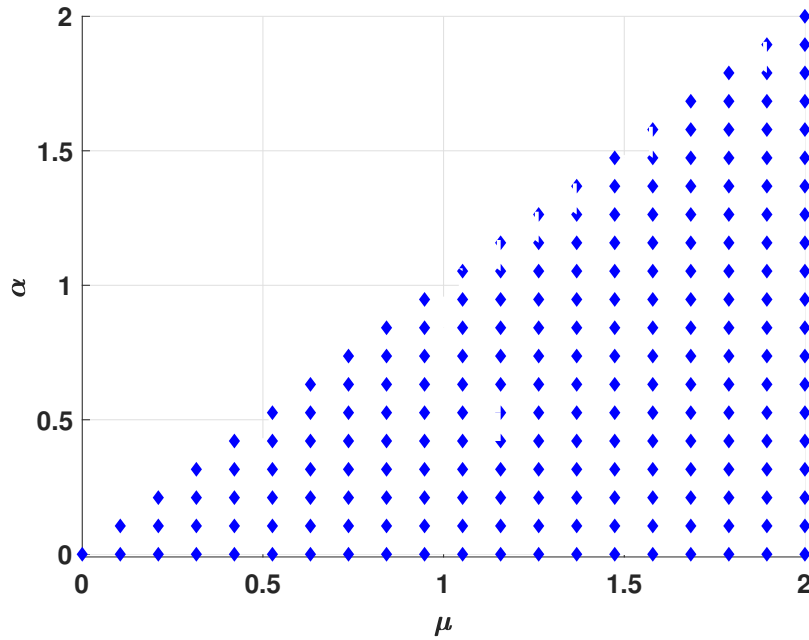

FIGURE 2.3: Feasible (diamond) pairs (μ, α)

and the saturation level $u_{\max_1} = \begin{pmatrix} 0.3 \\ 0.3 \end{pmatrix}$. In FIGURE 2.4, we report the evolution of the \mathcal{L}^2 -norm of the closed-loop system state compared to that of the open-loop ($K = 0$) in response to the disturbance (2.58). As expected, the gain K designed via the proposed sufficient conditions provides better disturbance reduction and convergence rate than that in the open-loop case.

Consider again the same system (2.57) with a larger initial condition:

$$(0, 1) \ni z \mapsto X_0(z) = 3 * \begin{pmatrix} \cos(4\pi z) - 1 \\ \cos(2\pi z) - 1 \end{pmatrix}$$

and a lower (more constraining) saturation level: $u_{\max_2} = \begin{pmatrix} 0.15 \\ 0.15 \end{pmatrix}$. The same numerical simulation is carried out and FIGURE 2.6 shows that the state norm manages to stabilize successfully. FIGURE 2.7 shows the added saturation instances that appears with this case and validates the good performance level of our control design. Finally, FIGURE 2.8 shows the same time evolution of the \mathcal{L}^2 - spatial norm of the closed-loop state $X(t)$ in comparison with that of the right-hand side of the dissipation inequality (2.36)

$$e^{-\frac{c_3}{2}t} \left(\frac{c_2}{c_1} \right)^{\frac{1}{2}} \|X_0\|_{\mathcal{L}_n^2} + \frac{\chi}{\sqrt{c_1}} \sqrt{\int_0^t \|d(\theta)\|_{\mathcal{L}_q^2}^2 d\theta}$$

Looking at the plot, the formal computation is consistent with the stability result.

Remark 2.4 In FIGURE 2.5 and FIGURE 2.7, one can see the saturation levels of under which our controller perform. Thus, those results are in fact reflecting the behavior of this stabilizing design for the controller acting on the hyperbolic system (2.1). \circ

2.5 Conclusion

Well-posedness and the global exponential stability of a class of 1D hyperbolic equations have been studied. The PDE under consideration was the result of a perturbed hyperbolic system in the presence of an in-domain exogenous disturbance connected in a feedback loop with a

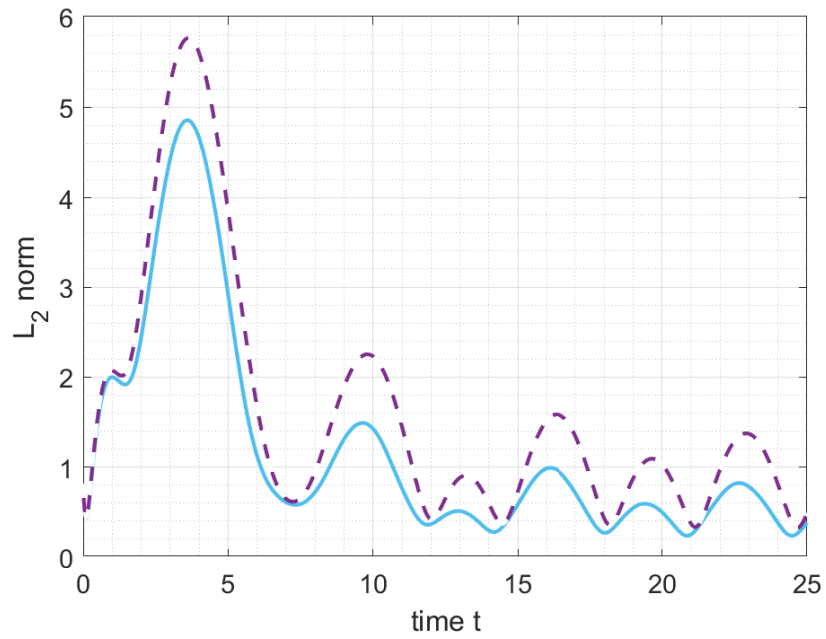

FIGURE 2.4: Time-evolution of the spatial norm \mathcal{L}^2 of $X(t, \cdot)$ in closed-loop (solid-line) and open-loop (dashed-line)

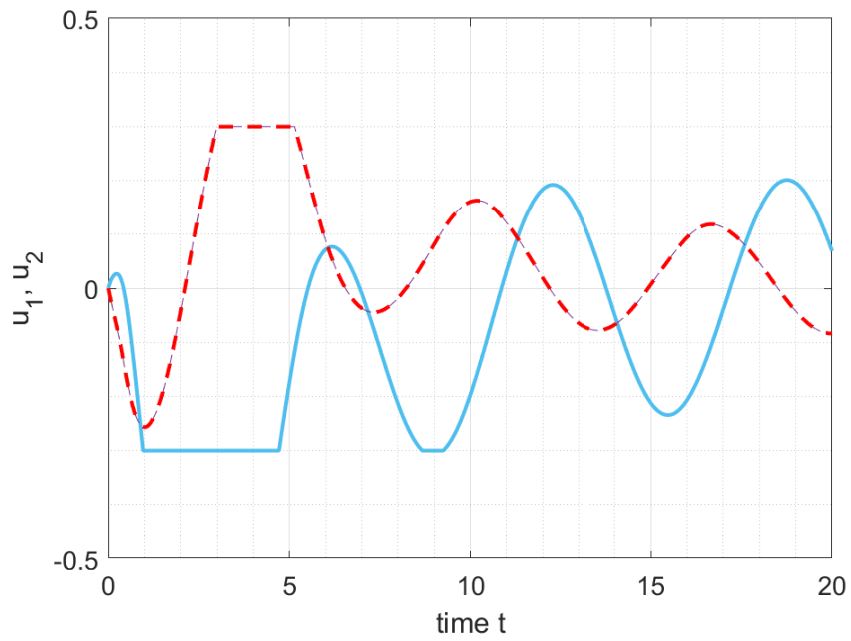

FIGURE 2.5: Time-evolution of $\sigma(K_1 X_1(t, 1))$ (solid-line) and $\sigma(K_2 X_2(t, 1))$ (dashed-line) with respect to time

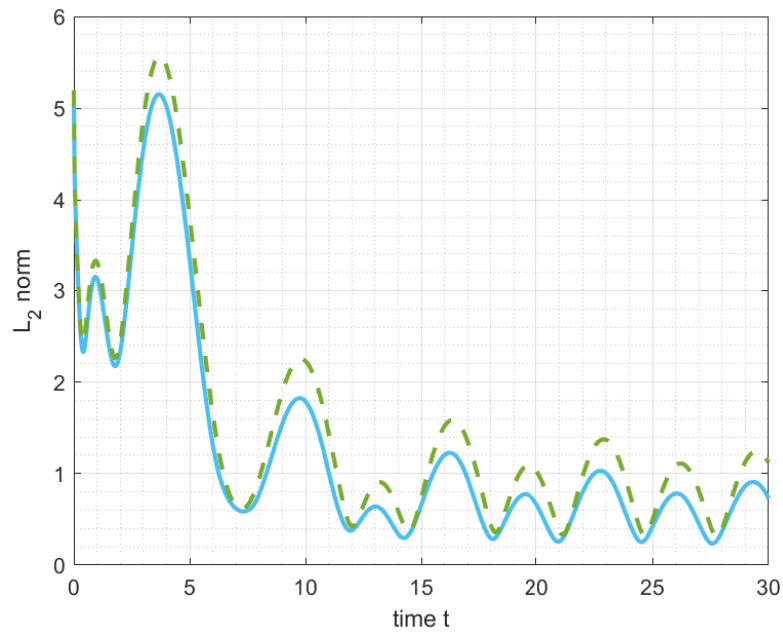

FIGURE 2.6: Time-evolution of the spatial norm \mathcal{L}^2 of $X(t, \cdot)$ in closed-loop (solid-line) and open-loop (dashed-line) for saturation level 0.15.

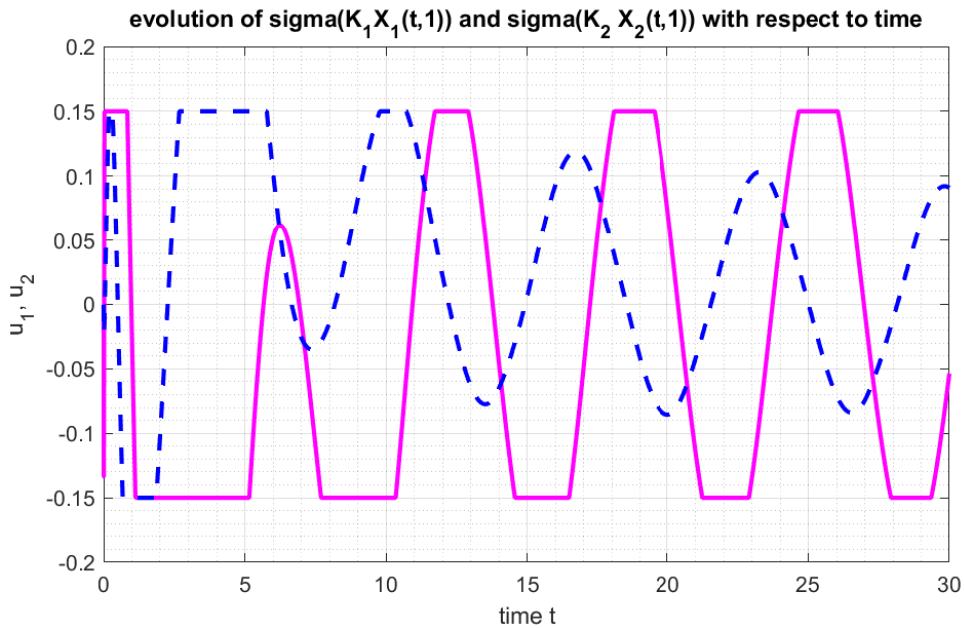

FIGURE 2.7: Time-evolution of $\sigma(K_1 X_1(t, 1))$ (solid-line) and $\sigma(K_2 X_2(t, 1))$ (dashed-line) with respect to time for saturation level 0.15.

saturated nonlinear control law. The controller acted on the boundary condition. The well-posedness was investigated under the techniques of nonlinear semi-group theory proving the existence and uniqueness of a mild solution pair. Then, the approximation of this solution to a strong solution pair was established. Furthermore, sufficient conditions for the exponential stability have been derived in the form of linear matrix inequalities using Lyapunov theory for infinite-dimensional systems. Semi-definite programming tools were used to design the

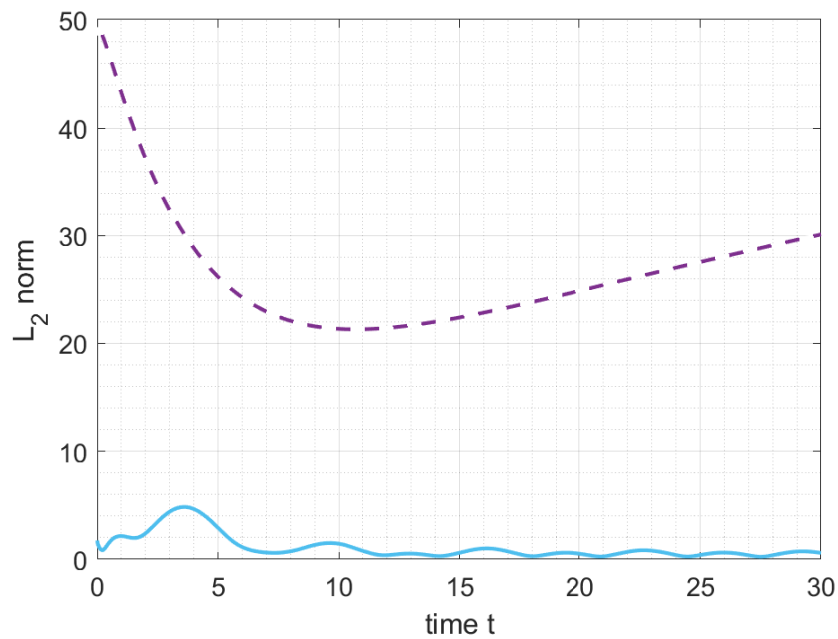

FIGURE 2.8: Time-evolution of the left (solid-line) vs. right (dashed-line)-hand side of dissipation inequality (35)

controller to minimize the effect of the disturbance and boundary nonlinearity on the \mathcal{L}^2 -norm of the state. Numerical simulations were used to illustrate the effectiveness of the proposed control design strategy in an example.

In the next chapter, we tackle another control problem of an infinite-dimensional system in the presence of in-domain disturbances. In particular, we present the input-output stability of a reaction-diffusion plant that admits a finite number of unstable poles using a finite-dimensional controller.

Auxiliary Results for Chapter 2

The ϵ -approximate solution to the abstract system 2.6 is given in the following definition found in [7, Definition 4.2, Page 129].

Definition 2.4 Let $d \in \mathcal{L}^1(0, T, \mathcal{L}^2(0, 1; \mathbb{R}^q))$. Consider the partition on the time interval $[0, t_N]$ given by $0 \leq t_1 \leq \dots \leq t_N$ and a finite sequence $\{d^k\}_{k=1}^N \subset \mathcal{L}^2(0, 1; \mathbb{R}^q)$ such that

$$t_k - t_{k-1} < \epsilon \quad k = 1, \dots, N, \quad T - \epsilon < t_N \leq T,$$

and

$$\sum_{k=1}^N \int_{t_{k-1}}^{t_k} \|f(s) - f_i\| ds < \epsilon.$$

An ϵ -discretization solution to the abstract Cauchy problem 2.6 is a piecewise constant function $\zeta : [0, t_N] \rightarrow \mathcal{L}^2(0, 1; \mathbb{R}^n)$ whose values ζ_k on $(t_{k-1}, t_k]$ satisfy the finite difference equation

$$\frac{\zeta_k - \zeta_{k-1}}{t_k - t_{k-1}} + \mathcal{A}\zeta_k \ni \mathcal{N}d_k \quad k = 1, \dots, N.$$

The function $\zeta = \{\zeta_k\}_{k=1}^N$ is called an ϵ -approximate solution to the abstract Cauchy Problem 2.6 if it further satisfies:

$$\|\zeta(0) - X_0\| \leq \epsilon.$$

◇

Definition 2.5 Let Y_1 and Y_2 be linear normed spaces, U be an open subset of Y_1 , $f : U \rightarrow Y_2$, and $x \in U$. We say that f is Fréchet differentiable at x if there exists $L \in \mathcal{L}(Y_1, Y_2)$ such that

$$\lim_{h \rightarrow 0} \frac{\|f(x+h) - f(x) - Lh\|_{Y_2}}{\|h\|_{Y_1}} = 0 \quad (2.59)$$

In particular, L is the Fréchet derivative of f at x and is denoted by $Df(x)$. When $Y_1 = \mathbb{R}$, we denote $\dot{f}(x) = \lim_{h \rightarrow 0} \frac{f(x+h) - f(x)}{h}$. ◇

Lemma 2.2 Let $\Phi \in \mathcal{C}^0(0, 1; \mathbb{R})$, $P \in \mathbb{D}_p^n$ and $\mathcal{L}^2(0, 1; \mathbb{R}^n)$ be endowed with its standard inner product. Consider the following functional

$$\begin{aligned} V : \mathcal{L}^2(0, 1; \mathbb{R}^n) &\rightarrow \mathbb{R} \\ X &\mapsto V(X) := \int_0^1 \Phi(z) \langle PX(z), X(z) \rangle dz \end{aligned}$$

Then, V is Fréchet differentiable on $\mathcal{L}^2(0, 1; \mathbb{R}^n)$ and in particular, for each $X, h \in \mathcal{L}^2(0, 1; \mathbb{R}^n)$

$$DV(X)h = 2 \langle \Phi PX, h \rangle_{\mathcal{L}_n^2}$$

◇

Proof. For any $X, h \in \mathcal{L}^2(0, 1; \mathbb{R}^n)$, one has

$$\begin{aligned} V(X+h) - V(X) &= \int_0^1 \Phi(z) (\langle h(z), Ph(z) \rangle_{\mathbb{R}^n} + 2 \langle X(z), Ph(z) \rangle_{\mathbb{R}^n}) dz \\ &\leq \lambda_{\max}(P) \|\Phi\|_{\infty} \|h\|^2 + 2 \langle \Phi PX, h \rangle_{\mathcal{L}_n^2} \end{aligned}$$

Thus, it follows that

$$\lim_{\|h\|_{\mathcal{L}_n^2} \rightarrow 0} \frac{|V(X+h) - V(X) - 2 \langle X, \Phi Ph \rangle_{\mathcal{L}_n^2}|}{\|h\|_{\mathcal{L}_n^2}} = 0$$

This concludes the proof. □

The following definition of the Comparison Lemma is found in [38, Page 102].

Definition 2.6 Consider the following differential equation

$$\dot{Y}(t) = f(t, Y), \quad Y(0) = Y_0$$

where f is continuous and locally Lipschitz in Y on $\text{dom}Y$ and for all $Y \in J \subset \mathbb{R}$. Let $W(t)$ be a continuous function whose Fréchet differential $DV(W(t))\dot{W} \leq f(t, W(t))$ with $W(0) \leq Y_0$ and $Y(t) \in J$ on $\text{dom}Y$. Then, we have on $\text{dom}Y$ that

$$W(t) \leq Y(t).$$

where $\text{dom}Y$ is the interval of time on which Y is defined. ◇

Chapter 3

Output Feedback Control of a Reaction-Diffusion Equation with In-domain Disturbances

The input-output stability (IOS) of a reaction-diffusion equation by means of a finite-dimensional linear time-invariant control system is studied. The reaction-diffusion plant admits a finite number of unstable poles and is open-loop unstable. The infinite-dimensional plant is put in feedback with a dynamic controller to achieve output stability via a Dirichlet boundary measurement and regulated output. The control design problem consists of deriving sufficient conditions in the form of matrix inequalities which allows us to show that the order of the finite-dimensional controller can be selected large enough to achieve IOS even when the control design is not optimal. This work has been presented to and accepted by the CDC 2022.

3.1 General Properties of a Sturm-Liouville Operator

A Sturm-Liouville differential equation is given by a second ordered ordinary differential equation:

$$-\frac{d}{dz} \left[p(z) \frac{df}{dz} \right] + q(z)f = \lambda f \quad (3.1)$$

where $p(x) > 0$ and for $z \in (0, 1)$. The differential equation (3.1) is essentially an eigenvalue problem since λ is not specified. Consider the mixed Dirichlet-Neumann boundary conditions

$$\begin{aligned} af(0) + bf'(0) &= 0 \\ bf(1) + af'(1) &= 0 \end{aligned} \quad (3.2)$$

where a, b are real constants. Let the Sturm-Liouville operator $\mathbb{A} : \mathcal{D}(\mathbb{A}) \subset \mathcal{L}^2(0, 1) \rightarrow \mathcal{L}^2(0, 1)$ be defined by

$$\mathbb{A}f = -(pf')' + qf$$

Let $p \in \mathcal{C}^1([0, 1])$ and $q \in \mathcal{C}^0([0, 1])$ with $p, q > 0$. In [12, Chapter 11], the authors solve the Sturm-Liouville boundary value problem. In the particular case where $a = 0, b = 1$ (Neumann boundary conditions), the normalized boundary value problem is given by:

$$\begin{aligned} p\Phi'' + q\lambda\Phi &= 0 \\ \Phi'(0) = 0, \quad \Phi(1) &= 0 \end{aligned} \quad (3.3)$$

The eigenvalues $\lambda_n, n \geq 1$ of \mathbb{A} are simple, non-negative, and form an increasing sequence with $\lambda_n \rightarrow +\infty$ as $n \rightarrow +\infty$. Moreover the associated unit eigenvectors $\Phi_n \in \mathcal{L}^2(0, 1)$ form an orthonormal basis. The computation of the normalized eigenfunctions and eigenvalues for problem 3.3 is straight forward and is given in [12, Chapter 11, Problem 11.2.2] by:

$$\Phi_n(z) = \sqrt{2} \cos\left(\left(n - \frac{1}{2}\right)\pi z\right) \quad (3.4)$$

$$\lambda_n = (n - \frac{1}{2})^2 \pi^2 p + q \quad (3.5)$$

We also have

$$\mathcal{D}(\mathbb{A}) = \{f \in \mathcal{H}^2(0, 1; \mathbb{R}) : \sum_{n \geq 1} |\lambda_n|^2 |\langle f, \Phi_n \rangle|^2 < +\infty\}$$

and

$$\mathbb{A}f = \sum_{n \geq 1} \lambda_n \langle f, \Phi_n \rangle \Phi_n.$$

Let $p_*, p^*, q^*, q_* \in \mathbb{R}$ be such that $0 < p_* \leq p(z) \leq p^*$ and $0 < q_* \leq q(z) \leq q^*$ for all $z \in (0, 1)$, then it holds (see e.g [55]):

$$0 \leq \pi^2 (n-1)^2 p_* + q_* \leq \lambda_n \leq \pi^2 n^2 p^* + q^* \quad (3.6)$$

for all $n \geq 1$. Finally, one can check that for all $f \in \mathcal{D}(\mathbb{A})$

$$\langle \mathbb{A}f, f \rangle = \sum_{n \geq 1} \lambda_n \langle f, \Phi_n \rangle^2 = \int_0^1 p(x) f'(x)^2 + q(x) f(x)^2 dx. \quad (3.7)$$

Moreover, for any $f \in \mathcal{D}(\mathbb{A})$, we have

$$f(x) = \sum_{n \geq 1} \langle f, \Phi_n \rangle \Phi_n(x)$$

and

$$f'(x) = \sum_{n \geq 1} \langle f, \Phi_n \rangle \Phi_n'(x).$$

In [21], [33], one can find a proof that the Sturm-Liouville operator \mathbb{A} is an infinitesimal generator of a C_0 -semigroup contraction on Hilbert spaces.

3.2 Problem Statement

We consider the stabilization problem of a one-dimensional linear reaction-diffusion system with Dirichlet boundary condition by means of a boundary control input $u \in \mathbb{R}$ $t \geq 0$ and $z \in (0, 1)$:

$$\begin{aligned} x_t(t, z) &= (p(z)x_z(t, z))_z + (q_c - q)x(t, z) + m(z)d(t) \\ x_z(t, 0) &= 0, \quad x(t, 1) = u(t) \\ x(0, z) &= x_0(z) \\ y(t) &= x(t, 0) \end{aligned} \quad (3.8)$$

where $p \in \mathcal{C}^1([0, 1])$. Here $q_c \in \mathbb{R}$ is a constant, $u(t) \in \mathbb{R}$ is the control input, $y \in \mathbb{R}$ is a boundary measurement and the to-be-regulated output, $x(t, \cdot) \in \mathcal{L}^2(0, 1; \mathbb{R})$ is the state, $x_0 \in \mathcal{L}^2(0, 1; \mathbb{R})$ is the initial condition and $d \in \mathbb{R}$ is the disturbance with $m \in \mathcal{C}^0([0, 1])$. The objective is to design a finite-dimensional controller to achieve input-output stability (IOS) with respect to the in-domain disturbance.

As classically done in the context of boundary control systems (see [19, Page 481]), for sufficiently smooth inputs, it is possible to reformulate boundary control problems on an extended state space in such a way that we obtain the associated system of the abstract inhomogeneous Cauchy problem on $\mathcal{L}^2(0, 1; \mathbb{R})$:

$$\dot{w}(t) = \mathbb{A}w(t) + f(t)$$

where $f \in \mathcal{C}^2([0, T]; \mathbb{R})$. We are able to transform the boundary control system (3.8) into an in-domain controlled equivalent system by introducing the change of variable

$$w(t, z) := x(t, z) - z^2 u(t). \quad (3.9)$$

For which we have

$$\begin{aligned} w_t(t, z) &= (p(z)w_z(t, z))_z + (q_c - q(z))w(t, z) + a(z)u(t) + b(z)\dot{u}(t) + m(z)d(t) \\ w_z(t, 0) &= 0, \quad w(t, 1) = 0 \\ y(t) &= w(t, 0) \end{aligned} \quad (3.10)$$

with $a, b \in \mathcal{L}^2(0, 1; \mathbb{R})$ defined by $a(z) = 2p(z) + 2xp'(z) + (q_c - q(z))z^2$, and $b(z) = -z^2$. In addition, $w_0(z) = x_0(z) - z^2u(0)$. Considering that $v(t) = \dot{u}(t)$ is an auxiliary command input, we obtain the abstract Cauchy problem

$$\begin{aligned} \dot{w}(t) &= -\mathbb{A}w(t) + q_cw(t) + au(t) + bv(t) + md(t) \\ \dot{u}(t) &= v(t) \end{aligned} \quad (3.11)$$

with $\mathcal{D}(\mathbb{A}) := \{f \in \mathcal{H}^2(0, 1; \mathbb{R}) : f'(0) = f(1) = 0\}$.

3.2.1 Existence and Uniqueness of Classical Solution to the Cauchy Problem.

Consider the definition of a classical solution pair to the inhomogeneous abstract Cauchy problem found in [19, Page 189].

Definition 3.1 *The functions $(w(t), d(t))$ is a classical solution pair of (3.11) on $\text{dom}w$ if $w(t) \in \mathcal{C}^1(\text{dom}w; \mathcal{L}^2(0, 1; \mathbb{R})) \in \mathcal{D}(\mathbb{A})$ and $d(t) \in \mathcal{C}^1(\text{dom}d; \mathbb{R})$ for $\text{dom}w = \text{dom}d$, the time interval $\mathbb{R}_{\geq 0}$ and $(w(t), d(t))$ satisfies (3.11) for all $0 \leq t \leq T$. \diamond*

Proposition 3.1 *Assume $m \in \mathcal{L}^2(0, 1; \mathbb{R})$, $d(t) \in \mathcal{C}^1([0, T]; \mathbb{R})$ and $w_0 \in \mathcal{D}(\mathbb{A})$. Then, (3.11) has a unique classical solution pair $(w(t), d(t))$.*

Proof. According to [21], [33], the Sturm-Liouville operator \mathbb{A} is an infinitesimal generator of a C_0 -semigroup contraction on Hilbert spaces. In addition, functions $a(z), b(z), m(z) \in \mathcal{L}^2(0, 1; \mathbb{R})$. Thus, the abstract inhomogeneous Cauchy problem (3.11) has a unique classical solution pair for $w_0 \in \mathcal{D}(\mathbb{A})$ and $d(t) \in \mathcal{C}^1(\text{dom}d; \mathbb{R})$ (see [19, Theorem 5.1.3, Page 189]). Finally, referring to [19, Theorem 10.1.4, Page 481], for $x_0(z) = w_0(z) + z^2u(0) \in \mathcal{D}(\mathbb{A})$, the Cauchy problem (3.8) has a unique classical solution pair. \square

3.2.2 Spectral Reduction of the Reaction-Diffusion System

We introduce the coefficients of projection $w_n = \langle w(\cdot), \Phi_n \rangle$, $a_n = \langle a, \Phi_n \rangle$, $b_n = \langle b, \Phi_n \rangle$ and $m_n = \langle m, \Phi_n \rangle$. We have $w(t) \in \mathcal{D}(\mathbb{A})$ for all $t \geq 0$ and for $n \geq 1$

$$\begin{aligned} \dot{w}_n(t) &= (-\lambda_n + q_c)w_n(t) + a_nu(t) + b_nv(t) + m_nd(t), \\ \dot{u}(t) &= v(t), \\ y(t) &= \sum_{i \geq 1} \Phi_i(0)w_i(t). \end{aligned} \quad (3.12)$$

Let $N_0 \geq 1$ and $\delta > 0$ be given such that $-\lambda_n + q_c < -\delta < 0$ for all $n \geq N_0 + 1$. We now introduce an arbitrary integer $N \geq N_0$ which will be further constrained later. We design an output feedback controller that will act on and modify the first N modes of the plant. First, we introduce the following vectors:

$$\begin{aligned} W^N(t) &:= (w_1(t) \dots w_N(t))^{\top}; \\ A_u &:= (a_1 \dots a_N)^{\top}; \\ B_1 &:= (b_1 \dots b_N)^{\top}; \\ B_2 &:= (m_1 \dots m_N)^{\top}. \end{aligned}$$

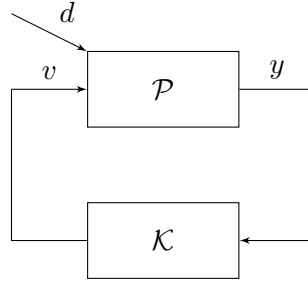

FIGURE 3.1: Closed-loop system.

$$A_0 := \begin{pmatrix} -\lambda_1 + q_c & 0 & \cdots & 0 \\ 0 & -\lambda_2 + q_c & \ddots & \vdots \\ \vdots & \ddots & \ddots & 0 \\ 0 & \cdots & 0 & -\lambda_N + q_c \end{pmatrix}$$

and, we focus on the following finite-dimension truncation of (3.12) which will be later used in the stability analysis:

$$\begin{aligned} \dot{W}^N(t) &= A_0 W^N(t) + A_u u(t) + B_1 v(t) + B_2 d(t) \\ \dot{u}(t) &= v(t). \end{aligned} \quad (3.13)$$

Our objective is to design a finite-dimensional linear time invariant control system that renders the closed-loop system (3.12) exponentially stable in the \mathcal{H}_1 -norm while achieving a quadratic performance specification on the controlled system. This controller serves to achieve IOS for the infinite-dimensional system (3.8) with respect to the disturbance d . The general framework of such a controller is given in the next section.

3.3 General Set-Up for the Output-Feedback Control Problem

In this section, we present the general framework of the control problem using output measurement feedback. This is presented in FIGURE 3.1 which conveys the problem of a feedback interconnection of a plant \mathcal{P} given by (3.11) and controller \mathcal{K} with inputs d , u and regulated output y .

We suppose that plant (3.12) is controlled by the following dynamic output feedback controller \mathcal{K} given below:

$$\mathcal{K} : \begin{pmatrix} \dot{X}_c \\ v \end{pmatrix} = \begin{pmatrix} A_c & B_c \\ C_c & D_c \end{pmatrix} \begin{pmatrix} X_c \\ y \end{pmatrix} \quad (3.14)$$

where $A_c \in \mathbb{R}^{(N+1) \times (N+1)}$, $B_c \in \mathbb{R}^{(N+1)}$, $C_c \in \mathbb{R}^{1 \times (N+1)}$ and $D_c \in \mathbb{R}$ are to be designed, with N being the dimension of W^N . Let

$$\begin{aligned} C &:= [\Phi_1(0) \dots \Phi_N(0)]^\top \\ \tilde{y} &:= \sum_{i \geq N+1} \Phi_i(0) w_i. \end{aligned}$$

Then, the closed-loop system dynamics $(\mathcal{P}, \mathcal{K})$ can be formally written as follows:

$$\begin{cases} \begin{pmatrix} \dot{W}^N(t) \\ \dot{u}(t) \\ \dot{X}_c(t) \end{pmatrix} = \begin{pmatrix} A_0 + B_1 D_c C & A_u & B_1 C_c \\ D_c C & 0 & C_c \\ B_c C & 0 & A_c \end{pmatrix} \begin{pmatrix} W^N(t) \\ u(t) \\ X_c(t) \end{pmatrix} + \begin{pmatrix} B_1 D_c \\ D_c \\ B_c \end{pmatrix} \tilde{y}(t) + \begin{pmatrix} B_2 \\ 0 \\ 0 \end{pmatrix} d(t) \\ \dot{w}_n(t) = (-\lambda_n + q_c)w_n + b_n D_c C W^N(t) + a_n u(t) + b_n C_c X_c(t) + b_n D_c \tilde{y}(t) + m_n d(t) \quad n \geq N+1 \\ y(t) = C W^N(t) + \tilde{y} \end{cases} \quad (3.15)$$

From now on, we denote $\zeta := (w, u, X_c)$ and for all $\zeta \in \mathcal{D}(\mathbf{A}) \times \mathbb{R} \times \mathbb{R}^{N+1}$, we define the following norm:

$$\|\zeta\|_{\mathcal{H}_n^1} := \sqrt{\|w\|_{\mathcal{H}^1}^2 + u^2 + X_c^\top X_c}. \quad (3.16)$$

We will refer to this norm as the \mathcal{H}_n^1 -norm.

We are now able to formally state the problem we solve in this chapter.

Problem 3.2 *Given $p \in \mathcal{C}^1([0, 1])$, $q \in \mathcal{C}^0([0, 1])$ with $p, q > 0$ and $q_c \in \mathbb{R}$. Design the control parameters $\begin{pmatrix} A_c & B_c \\ C_c & D_c \end{pmatrix}$ such that the following properties hold for the closed-loop system (3.11) with (3.14):*

- the origin of the closed-loop system is zero-input globally exponentially stable;
- for some (solution independent) $\rho, \psi, v > 0$, for each classical solution pair (ζ, d) to the closed-loop system, the bound:

$$|y(t)| \leq \psi e^{-vt} \|\zeta(0)\|_{\mathcal{H}_n^1} + \rho \sqrt{\int_0^t d(\theta)^2 d\theta} \quad (3.17)$$

holds for all $t \geq 0$.

Inequality (3.17) corresponds to an input-output stability (IOS) bound for the closed-loop system (3.8) with (3.14). The main contribution of this chapter is to design an optimal controller \mathcal{K} in order to minimize the effect of the gain ρ . In Section 3.4, we provide an explicit estimate of the IOS gain ρ .

3.4 Input-Output Stability Results

In this section we provide sufficient for the solution to Problem 3.2. First, we propose sufficient conditions for \mathcal{H}_n^1 stability and then construct a Lyapunov functional to derive the sufficient conditions in the form of quadratic inequalities.

3.4.1 Sufficient conditions

The following section presents sufficient conditions for the solution to Problem 3.2. The result relies on a dissipation inequality. This is done by proving the following proposition:

Proposition 3.3 *Assume there exist a Fréchet differentiable functional $V : \mathcal{H}^1(0, 1; \mathbb{R}) \times \mathbb{R} \times \mathbb{R}^{N+1} \rightarrow \mathbb{R}_{\geq 0}$ and $c_1, c_2, c_3, \chi \in \mathbb{R}_{>0}$ such that for each $d \in \mathbb{R}$ and $\zeta \in \mathcal{D}(\mathbf{A}) \times \mathbb{R} \times \mathbb{R}^{N+1}$*

$$c_1 \|\zeta\|_{\mathcal{H}_n^1}^2 \leq V(\zeta) \leq c_2 \|\zeta\|_{\mathcal{H}_n^1}^2, \quad (3.18)$$

$$DV(\zeta)\dot{\zeta} \leq -c_3 V(\zeta) + \chi^2 d^2. \quad (3.19)$$

Then, the origin of the closed-loop system (3.15) is zero-input globally exponentially stable and (3.17) holds with

$$\begin{aligned} \psi &= \sqrt{\frac{2c_2}{c_1}}, & v &= \frac{c_3}{2}, \\ \rho &= \sqrt{2} \frac{\chi}{\sqrt{c_1}}. \end{aligned} \quad (3.20)$$

Proof. First we consider a classical solution pair $(\zeta(t), d(t))$, i.e, $\zeta \in \mathcal{D}(\mathbf{A}) \times \mathbb{R} \times \mathbb{R}^{N+1}$ and $d \in \mathbb{R}$ for all $t \in \text{dom}\zeta$ where $\text{dom}\zeta$ is an interval of $\mathbb{R}_{\geq 0}$ including zero. Now, consider the following function:

$$\begin{aligned} \mathcal{W} : \text{dom}\zeta &\rightarrow \mathbb{R} \\ t &\mapsto (V \circ \zeta)(t) \end{aligned} \quad (3.21)$$

Then, since $V : \mathcal{H}^1(0, 1; \mathbb{R}) \times \mathbb{R} \times \mathbb{R}^{N+1} \rightarrow \mathbb{R}_{\geq 0}$ is Fréchet differentiable everywhere and $\zeta : \text{dom}\zeta \rightarrow \mathcal{H}^1(0, 1; \mathbb{R}) \times \mathbb{R} \times \mathbb{R}^{N+1}$ is differentiable everywhere, it follows that for all $t \geq 0$:

$$\dot{\mathcal{W}}(t) = DV(\zeta)\dot{\zeta}(t).$$

Thus we have for all $t \in \text{dom}\zeta$

$$\dot{\mathcal{W}}(t) = DV(\zeta) \begin{pmatrix} -\mathbf{A}w(t, \cdot) + q_c w(t, \cdot) + au(t) \\ +bv(t) + md(t) \\ v(t) \\ A_c X_c(t) + B_c y(t) \end{pmatrix}$$

Using (3.19), one gets, for all $t \in \text{dom}\zeta$,

$$\dot{\mathcal{W}}(t) \leq -c_3 \mathcal{W}(t) + \chi^2 d(t)^2.$$

Therefore, since \mathcal{W} is continuous on $\text{dom}\zeta$, from comparison lemma, we have:

$$\mathcal{W}(t) \leq e^{-c_3 t} \mathcal{W}(0) + \chi^2 \int_0^t e^{-c_3(t-\theta)} d(\theta)^2 d\theta, \quad \forall t \in \text{dom}\zeta.$$

This bound, thanks to (2.34), ensures that the origin of the closed-loop system is globally exponentially stable with respect to the norm defined in (3.16) when $d = 0$. At this stage, notice that for all $t \in \text{dom}\zeta$, one has:

$$\int_0^t e^{-c_3(t-\theta)} d(\theta)^2 d\theta \leq \int_0^t d(\theta)^2 d\theta$$

which allows one to conclude that for all $t \in \text{dom}\zeta$

$$\mathcal{W}(t) \leq e^{-c_3 t} \mathcal{W}(0) + \chi^2 \int_0^t d(\theta)^2 d\theta.$$

Finally by using (3.18), it follows that for all $t \in \text{dom}\zeta$

$$\|\zeta(t)\|_{\mathcal{H}_n^1} \leq e^{-\frac{c_3}{2}t} \sqrt{\frac{c_2}{c_1}} \|\zeta(0)\|_{\mathcal{H}_n^1} + \frac{\chi}{\sqrt{c_1}} \sqrt{\int_0^t d(\theta)^2 d\theta}. \quad (3.22)$$

Using the inequality $(a+b)^2 \leq 2a^2 + 2b^2$ for all $a, b \in \mathbb{R}$, we have

$$\|\zeta(t)\|_{\mathcal{H}_n^1}^2 \leq 2\frac{c_2}{c_1} e^{-c_3 t} \|\zeta(0)\|_{\mathcal{H}_n^1}^2 + \frac{\chi^2}{c_1} \int_0^t d(\theta)^2 d\theta. \quad (3.23)$$

Since $y(t) = w(t, 0)$, and we know that since $w(t, 1) = 0$, we have

$$y(t)^2 = \left(\int_0^1 w_x(t, s) ds \right)^2 \leq \int_0^1 w_x^2(t, s) ds \leq \|w(t)\|_{\mathcal{H}^1}^2 \quad (3.24)$$

Then, since

$$\|w(t)\|_{\mathcal{H}^1}^2 \leq \|\zeta\|_{\mathcal{H}_n^1}^2$$

using (3.24) and (3.23), we get

$$y(t)^2 \leq 2 \frac{c_2}{c_1} e^{-c_3 t} \|\zeta(0)\|_{\mathcal{H}_n^1}^2 + \frac{\chi^2}{c_1} \int_0^t d(\theta)^2 d\theta. \quad (3.25)$$

Since the terms $\sqrt{\frac{c_2}{c_1}} e^{-\frac{c_3}{2} t} \|\zeta(0)\|_{\mathcal{H}_n^1} > 0$ and $\frac{\chi}{\sqrt{c_1}} \sqrt{\int_0^t d(\theta)^2 d\theta} > 0$, we can deduce the final inequality:

$$\|\zeta(t)\|_{\mathcal{H}_n^1} \leq \sqrt{2} e^{-\frac{c_3}{2} t} \sqrt{\frac{c_2}{c_1}} \|\zeta(0)\|_{\mathcal{H}_n^1} + \sqrt{2} \frac{\chi}{\sqrt{c_1}} \sqrt{\int_0^t d(\theta)^2 d\theta}. \quad (3.26)$$

This concludes the proof. \square

Remark 3.4 Inequality (3.22) in the proof corresponds to a classical input-to-state stability (ISS) bound for the closed-loop system (3.15) with respect to the disturbance d . The ISS asymptotic gain is equal to the IOS gain $\rho = \sqrt{2} \frac{\chi}{\sqrt{c_1}}$ given in (3.20) to-be-minimized [69].

3.4.2 Construction of the functional V

Proposition 3.3 provides sufficient conditions for input-output stability (IOS) for the closed-loop system in the form of functional inequality. In this section we provide a specific structure for the functional V in Proposition 3.3, which allows one to cast the solution of Problem 3.2 in the solution to some matrix inequalities.

We define the following matrices which will be necessary for the proof of the next theorem.

$$\begin{aligned} A_1 &:= \begin{pmatrix} A_0 + B_1 D_c C & A_u & B_1 C_c \\ D_c C & 0 & C_c \\ B_c C & 0 & A_c \end{pmatrix}, \\ B_{11} &:= \begin{pmatrix} B_1 D_c \\ D_c \\ B_c \end{pmatrix}, \quad B_{12} := \begin{pmatrix} B_2 \\ 0 \\ 0 \end{pmatrix}, \\ A_2 &:= \begin{pmatrix} 4D_c^2 C^\top C & 0 & 0 \\ * & \alpha \|a\|_{\mathcal{L}^2}^2 & 0 \\ * & * & 2\alpha \|b\|_{\mathcal{L}^2}^2 C_c^\top C_c \end{pmatrix}. \end{aligned} \quad (3.27)$$

We also define the constant $M_\Phi = \sum_{n \geq N+1} \frac{\Phi_n(0)^2}{\lambda_n}$ which is finite when $p \in \mathcal{C}^2([0, 1])$ since $\Phi_n(0) = O(1)$ as $n \rightarrow +\infty$ (see [55]) and (3.6) holds.

Theorem 3.5 Assume that $p \in \mathcal{C}^2([0, 1])$. Suppose there exist $P \in \mathbb{S}_p^{2N+2}$, $A_c \in \mathbb{R}^{N+1 \times N+1}$, $B_c \in \mathbb{R}^{N+1}$, $C_c \in \mathbb{R}^{1 \times N+1}$, $D_c \in \mathbb{R}$ and $\alpha, \beta, \chi, \eta, \gamma \in \mathbb{R}_{>0}$ such that:

$$\Theta = \begin{pmatrix} A_3 & P B_{12} & P B_{11} \\ * & \alpha \|m\|_{\mathcal{L}^2}^2 - \chi^2 & 0 \\ * & * & 2\alpha \|b\|_{\mathcal{L}^2}^2 D_c^2 - \beta \end{pmatrix} \leq 0 \quad (3.28)$$

where $A_3 := A_1^\top P + P A_1 + A_2 + 2\eta P$.

Select N sufficiently large such that for all $n \geq N + 1$

$$\Gamma_n := \lambda_n \left(-\lambda_n + q_c + \eta + \frac{3}{\alpha} + \frac{\beta}{2\gamma} M_\Phi \right) \leq 0. \quad (3.29)$$

Then, the parameters A_c, B_c, C_c, D_c solve Problem 3.2. In particular (3.17) holds with:

$$\rho = \frac{\sqrt{2}\chi}{\sqrt{\min\{\lambda_{\min}(P), \gamma p^*, \gamma q^*\}}} . \quad (3.30)$$

Proof. Let $P \in \mathbb{S}_p^{2N+2}$, $\gamma > 0$, and $X_1 := (W^N, u, X_c)$. Consider the following Fréchet differentiable Lyapunov functional:

$$V: \mathcal{D}(\mathbb{A}) \times \mathbb{R} \times \mathbb{R}^{N+1} \rightarrow \mathbb{R}$$

$$\begin{pmatrix} w \\ u \\ X_c \end{pmatrix} \mapsto X_1^\top P X_1 + \gamma \sum_{n \geq N+1} \lambda_n \langle w, \Phi_n \rangle^2. \quad (3.31)$$

The first term corresponds to the dynamics of the truncated model (3.13) and the control model (3.14) while the second term, which is related to the \mathcal{H}^1 -norm of the PDE trajectories as depicted in 3.30, is used to handle the modes w_n for $n \geq N+1$. We have $c_1 := \min\{\lambda_{\min}(P), \gamma p_*, \gamma q_*\}$ and $c_2 := \max\{\lambda_{\max}(P), \gamma p^*, \gamma q^*\}$ are strictly positive. Consider the first term of the functional V :

$$V_1(X_1) := X_1^\top P X_1 \quad (3.32)$$

and the closed-loop system (3.15). Then,

$$DV_1(X_1)\dot{X}_1 = X_1^\top (A_1^\top P + P A_1) X_1 + \tilde{y}^\top B_{11}^\top P X_1 + d^\top B_{21}^\top P X_1 + X_1^\top P B_{11} \tilde{y} + X_1^\top P B_{12} d. \quad (3.33)$$

We obtain the computation of the time derivative of V_1 along the solution pair to (3.12) and (3.13):

$$DV_1(X_1)\dot{X}_1 = \begin{pmatrix} X_1 \\ d \\ \tilde{y} \end{pmatrix}^\top \Omega_1 \begin{pmatrix} X_1 \\ d \\ \tilde{y} \end{pmatrix} \quad (3.34)$$

where the matrix Ω_1 is given by:

$$\Omega_1 = \begin{pmatrix} A_1^\top P + P A_1 & P B_{12} & P B_{11} \\ * & 0 & 0 \\ * & * & 0 \end{pmatrix}.$$

Now, consider $V_2(w) := \gamma \sum_{n \geq N+1} \lambda_n \langle w, \Phi_n \rangle^2$ with $\gamma > 0$. The time derivative of V_2 along the solution pair to (3.12), (3.13) yields:

$$DV_2(w)\dot{w} = 2\gamma \sum_{n \geq N+1} \lambda_n ((-\lambda_n + q_c) w_n^2 + a_n u w_n + b_n v w_n + m_n d w_n). \quad (3.35)$$

Thus, knowing that $V = V_1 + V_2$, we conclude the following expression:

$$DV(X_1, w) \begin{pmatrix} \dot{X}_1 \\ \dot{w} \end{pmatrix} + 2\eta V = \begin{pmatrix} X_1 \\ d \\ \tilde{y} \end{pmatrix}^\top \Omega_2 \begin{pmatrix} X_1 \\ d \\ \tilde{y} \end{pmatrix} + 2\gamma \sum_{n \geq N+1} \lambda_n [(-\lambda_n + q_c + \eta) w_n^2 + a_n u w_n + b_n v w_n + m_n d w_n] \quad (3.36)$$

and $\Omega_2 = \Omega_1 + \begin{pmatrix} 2\eta P & 0 & 0 \\ * & 0 & 0 \\ * & * & 0 \end{pmatrix}$. Using Young's inequality, we have:

$$2 \sum_{n \geq N+1} \lambda_n a_n w_n u \leq \frac{1}{\alpha} \sum_{n \geq N+1} \lambda_n^2 w_n^2 + \alpha \|a\|_{\mathcal{L}^2}^2 u^2$$

$$2 \sum_{n \geq N+1} \lambda_n b_n w_n v \leq \frac{1}{\alpha} \sum_{n \geq N+1} \lambda_n^2 w_n^2 + \alpha \|b\|_{\mathcal{L}^2}^2 v^2$$

$$2 \sum_{n \geq N+1} \lambda_n m_n w_n d \leq \frac{1}{\alpha} \sum_{n \geq N+1} \lambda_n^2 w_n^2 + \alpha \|m\|_{\mathcal{L}^2}^2 d^2$$

for any $\alpha > 0$. Recall that $v = C_c X_c + D_c(CW^N + \tilde{y})$. We have the following inequality:

$$\begin{aligned} v^2 &\leq 2(X_c C_c^\top C_c X_c) + 2D_c^2(CW^N + \tilde{y})^2 \\ &\leq 2(X_c C_c^\top C_c X_c) + 4D_c^2(CW^{N^\top} C^\top CW^N) + 4D_c^2 \tilde{y}^2 \end{aligned} \quad (3.37)$$

Hence, using (3.37), (3.36) is bounded by:

$$\begin{aligned} DV(X_1, w) \begin{pmatrix} \dot{X}_1 \\ \dot{w} \end{pmatrix} + 2\eta V &\leq \begin{pmatrix} X_1 \\ d \\ \tilde{y} \end{pmatrix}^\top \Omega_3 \begin{pmatrix} X_1 \\ d \\ \tilde{y} \end{pmatrix} \\ + 2\gamma \sum_{n \geq N+1} \lambda_n \left(-\lambda_n + q_c + \eta + \frac{3}{\alpha}\right) w_n^2 & \end{aligned} \quad (3.38)$$

and Ω_3 is given by:

$$\Omega_3 = \begin{pmatrix} A_1^\top P + PA_1 + A_2 & PB_{12} & PB_{11} \\ * & \alpha \|m\|_{\mathcal{L}^2}^2 & 0 \\ * & * & 4\alpha \|b\|_{\mathcal{L}^2}^2 D_c^2 \end{pmatrix}$$

where

$$A_2 = \begin{pmatrix} 4D_c^2 C^\top C & 0 & 0 \\ * & \alpha \|a\|_{\mathcal{L}^2}^2 & 0 \\ * & * & 2\alpha \|b\|_{\mathcal{L}^2}^2 C_c^\top C_c \end{pmatrix}.$$

Knowing that

$$\tilde{y}^2 = \left(\sum_{i \geq N+1} \Phi_i(0) w_i \right)^2$$

and $M_\Phi = \sum_{i \geq N+1} \frac{\Phi_i(0)^2}{\lambda_i}$ is finite and $\sum_{i \geq N+1} \lambda_i w_i^2$ is finite due to (3.7), we use the generalization of the Cauchy-Schwarz inequality [14] to obtain the following

$$\tilde{y}^2 \leq \sum_{i \geq N+1} \frac{\Phi_i(0)^2}{\lambda_i} \sum_{i \geq N+1} \lambda_i w_i^2$$

Hence, for any $\beta > 0$,

$$\beta M_\Phi \sum_{i \geq N+1} \lambda_i w_i^2 - \beta \tilde{y}^2 \geq 0 \quad (3.39)$$

Combining (3.38) and (3.39), we obtain

$$\begin{aligned} DV(X_1, w) \begin{pmatrix} \dot{X}_1 \\ \dot{w} \end{pmatrix} + 2\eta V &\leq \begin{pmatrix} X_1 \\ d \\ \tilde{y} \end{pmatrix}^\top \Omega_4 \begin{pmatrix} X_1 \\ d \\ \tilde{y} \end{pmatrix} \\ + 2\gamma \sum_{n \geq N+1} \lambda_n \left(-\lambda_n + q_c + \eta + \frac{3}{\alpha} + \frac{\beta}{2\gamma} M_\Phi\right) w_n^2 & \end{aligned} \quad (3.40)$$

where Ω_4 is given by:

$$\Omega_4 = \begin{pmatrix} A_1^\top P + PA_1 + A_2 & PB_{12} & PB_{11} \\ * & \alpha \|m\|_{\mathcal{L}^2}^2 & 0 \\ * & * & 2\alpha \|b\|_{\mathcal{L}^2}^2 D_c^2 - \beta \end{pmatrix}$$

and A_2 is given in (3.27).

The latter implies that, for all $d \in \mathbb{R}$, $(w, u, X_c) \in \mathcal{D}(\mathbb{A}) \times \mathbb{R} \times \mathbb{R}^{N+1}$, we have

$$DV(X_1, w) \begin{pmatrix} \dot{X}_1 \\ \dot{w} \end{pmatrix} - \chi^2 d^\top d \leq -2\eta V(X_1, w) + \begin{pmatrix} X_1 \\ d \\ \tilde{y} \end{pmatrix}^\top \Theta \begin{pmatrix} X_1 \\ d \\ \tilde{y} \end{pmatrix} + 2\gamma \sum_{n \geq N+1} \Gamma_n w_n^2 \quad (3.41)$$

where $\Theta = \Omega_4 - \begin{pmatrix} 0 & 0 & 0 \\ * & \chi^2 I & 0 \\ * & * & 0 \end{pmatrix}$. At this stage, notice that (3.28), (3.29) state that $\Theta \leq 0$ and $\Gamma_n \leq 0$ for sufficiently large N ; therefore, (3.41) implies that

$$DV(X_1, w) \begin{pmatrix} \dot{X}_1 \\ \dot{w} \end{pmatrix} \leq -2\eta V(X_1, w) + \chi^2 d^\top d$$

The previous equation reads as (3.19) and the proof is complete. \square

Notice that the sufficient condition (3.28) is a nonlinear matrix inequality in the decision variables P, A_c, B_c, C_c , and D_c . Therefore (3.28) is hard to exploit from a numerical standpoint for the design of the controller. To overcome this drawback, next we provide sufficient conditions in the form of linear matrix inequalities. To achieve this, we adapt the approach introduced in [62] for the design of dynamical output feedback controllers. This is the objective of the upcoming section.

3.5 Control Synthesis

To simplify our approach and avoid nonlinearities in what follows, we enforce $D_c = 0$. This is not restrictive and leads to strictly proper controllers that can be more appealing in practice.

Let $X, Y \in \mathbb{S}_p^{N+1}$ and $U, V \in \mathbb{R}^{(N+1) \times (N+1)}$ be nonsingular matrices such that $YX + VU^\top = I$. Let $\mathcal{Y} = \begin{pmatrix} Y & I \\ V^\top & 0 \end{pmatrix}$ and $P = \begin{pmatrix} X & U \\ U^\top & \bullet \end{pmatrix}$ where “ \bullet ” denotes “don’t care” symmetric positive definite matrix. Under the considered assumptions \mathcal{Y} is nonsingular and a simple congruence transformation shows that

$$\Theta \leq 0 \iff \Sigma \leq 0$$

with

$$\Sigma := \begin{pmatrix} \mathcal{Y}^\top A_3 \mathcal{Y} & \mathcal{Y}^\top P B_{12} & \mathcal{Y}^\top P B_{11} \\ * & \alpha \|m\|_{\mathcal{L}^2}^2 - \chi^2 & 0 \\ * & * & -\beta \end{pmatrix}$$

We define the following matrices:

$$\hat{A} := \begin{pmatrix} A_0 & A_u \\ 0 & 0 \end{pmatrix}, \hat{B}_1 := \begin{pmatrix} B_1 \\ 1 \end{pmatrix}, \\ \hat{B}_2 := \begin{pmatrix} B_2 \\ 0 \end{pmatrix}, \hat{C} := (C \ 0).$$

At this stage, as in [62], we consider the following invertible change of variables:

$$\begin{pmatrix} K & L \\ M & 0 \end{pmatrix} = \begin{pmatrix} X \hat{A} Y & 0 \\ 0 & 0 \end{pmatrix} + \begin{pmatrix} U & X \hat{B}_1 \\ 0 & I \end{pmatrix} \begin{pmatrix} A_c & B_c \\ C_c & 0 \end{pmatrix} \begin{pmatrix} V^\top & 0 \\ \hat{C} Y & I \end{pmatrix} \quad (3.42)$$

This transforms the old variables (P, A_c, B_c, C_c) into the new variables $\nu = (X, Y, K, L, M)$. Using the change of variable (3.42), applying the Schur complement lemma [81] and by following [62], one can show that $\Sigma \leq 0$ is equivalent to the following linear matrix inequalities:

$$X(\nu) > 0 \quad (3.43)$$

and

$$\begin{pmatrix} A(\nu)^\top + A(\nu) & B_1(\nu) & B_2(\nu)^\top & C(\nu) \\ * & \alpha \|m\|_{\mathcal{L}^2}^2 - \chi^2 & 0 & 0 \\ * & * & -\beta & 0 \\ * & * & * & -S^{-1} \end{pmatrix} \leq 0 \quad (3.44)$$

where

$$\begin{aligned} X(\nu) &= \begin{pmatrix} Y & I \\ I & X \end{pmatrix}, \\ A(\nu) &= \begin{pmatrix} \hat{A}Y + \hat{B}_1M & \hat{A} \\ K & X\hat{A} + L\hat{C} \end{pmatrix}, \\ B_1(\nu) &= \begin{pmatrix} 0 \\ L \end{pmatrix}, \quad B_2(\nu) = \begin{pmatrix} \hat{B}_2 \\ X\hat{B}_2 \end{pmatrix}, \\ C(\nu) &= \begin{pmatrix} Y \begin{pmatrix} 0 \\ I \end{pmatrix} & VC_c^\top \\ \begin{pmatrix} 0 \\ I \end{pmatrix} & 0 \end{pmatrix}, \quad S = \begin{pmatrix} \alpha \|a\|_{\mathcal{L}^2}^2 & 0 \\ * & 2\alpha \|b\|_{\mathcal{L}^2}^2 \end{pmatrix}. \end{aligned}$$

If conditions (3.43), (3.44) are feasible for certain K, L, M , one can use equation (3.42) to deduce the values of A_c, B_c, C_c that satisfy condition (3.28).

In the formulation of Problem 3.2, no specific requirements on the scalar ρ are considered. On the other hand, it is obvious that to minimize the effect of the disturbance d on the closed-loop system, the control parameters should be designed so that (3.17) holds with a minimal ρ . This goal can be achieved by choosing $\gamma = \beta$, $\alpha = 3$ and considering the following optimization problem

$$\begin{aligned} &\sup_{P,c} c \\ \text{s.t.} & \text{ (3.43), (3.44) hold } P \in \mathfrak{S}_p^{2N+2}, P - cI > 0. \end{aligned} \quad (3.45)$$

The optimization problem (3.45) is equivalent to finding a maximal c such that

$$\mathcal{Y}^\top (P - cI) \mathcal{Y} > 0$$

We apply the Schur complement lemma [81] on the latter nonlinear inequality to obtain the equivalent condition:

$$\begin{pmatrix} \frac{1}{c}I & Y & V \\ * & Y & I \\ * & * & X \end{pmatrix} > 0 \quad (3.46)$$

which is linear in $\mu = \frac{1}{c}$. Problem (2.52) can now be seen as designing minimal μ such that (3.46) holds.

3.5.1 Control Design Algorithm

We present the following algorithm to design the dynamic output feedback controller given in (3.14).

Input: Specify the values of the system parameters $p(z)$, $q(z)$ and q_c .

Step 1: Calculate the value of N_0 , the minimum value of n for which $-\lambda_n + q_c < 0$.

Step 2: Calculate the value of $N \geq N_0$, the minimum value of n for which (3.29) holds. This N exists due to the fact that λ_n is positive definite and increasing. This will be the dimension of the dynamic controller.

Step3: Use a numerical solver to find a feasible solution X, Y, K, L, M, N, c under which (3.43), (3.44), (3.45) hold.

Step4: Derive the control parameters A_c, B_c, C_c, D_c using (3.42).

Output: The designed control parameters are given by A_c, B_c, C_c, D_c and ρ given by (3.30) is computed.

In the next section, we use a numerical example to showcase our method.

3.6 Numerical Analysis

In this section, we use the YALMIP package in MATLAB to solve linear matrix inequalities. We illustrate the result of this chapter using a modal approximation that captures the 50 dominant modes of the reaction-diffusion plant with an in-domain disturbance given by:

$$d(t) = 0.1 \sin(2t)$$

We set $p = 1$, $q = 1$, $m = 1$, and $q_c = 4$ for which the open-loop plant is unstable. We select $\delta = 0$, and we obtain that $N_0 = 1$ and $N = 2$, which is the minimum n for which (3.29) holds. We choose the dimension of W^N to be $N = 3$. The following control matrices renders (3.43), (3.44) and (3.45) feasible.

$$\begin{aligned} A_c &= \begin{pmatrix} -15.24 & 11.9 & -6.47 & 14.62 \\ -4.84 & -24.87 & -25.51 & -2.25 \\ 145.35 & -73.53 & -126.97 & -49.13 \\ -36.28 & -3.48 & -5.86 & -14.43 \end{pmatrix} \\ B_c &= \begin{pmatrix} 5.46 \\ 0.32 \\ -29.98 \\ 0.66 \end{pmatrix} \\ C_c &= (6.91 \quad -0.45 \quad -0.57 \quad 8.8) \quad D_c = 0 \end{aligned} \tag{3.47}$$

We solve inequality (3.28) for the designed control parameters $\{A_c, B_c, C_c, D_c\}$ and notice that we do in fact have a feasible solution. The initial condition of the reaction-diffusion system described by (3.8) is $x_0(z) = x^2$. We simulate the closed-loop system (3.15) for the first 50 modes. Thus, we can deduce the time-evolution of the state $x(z, t)$ in closed-loop system and it is depicted in FIGURE 3.2 which showcases a convergence to a neighborhood of the origin as predicted in Theorem 3.5 and one can observe the effect of the disturbance at steady state. Similarly, FIGURE 3.3 shows the time and space evolution of the state $w(t, z)$. Finally, FIGURE 3.4 demonstrates the decay in the output $y(t)$ verifying the dissipation inequality in Proposition 3.3 with $\rho = 1.8$.

3.7 Conclusion

The design of a finite-dimensional linear time-invariant (LTI) control system is proposed in order to achieve the input-output stability (IOS) of a reaction-diffusion equation with a Dirichlet regulated output and in-domain disturbance. Sufficient conditions in the form of matrix inequalities are derived to solve the control design problem. Control Synthesis method proposed by [62] is applied to the nonlinear matrix inequality to derive a suitable LMI. A control design algorithm is proposed to provide a solution to the sufficient conditions. Finally, a numerical example is presented to showcase the effectiveness and validity of our method.

In the next chapter, we investigate the problem of saturated distributed control of a reaction diffusion equation to achieve local exponential stability results. We also design an anti-windup compensator to enhance the system behavior under constrained controller.

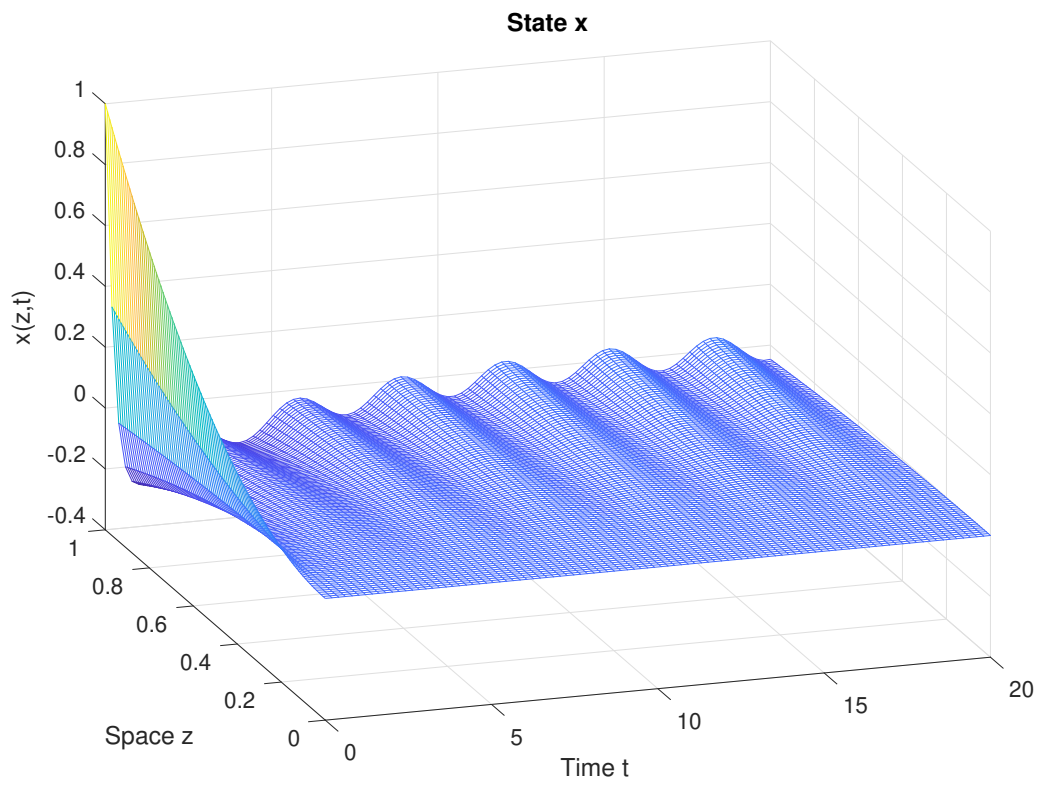
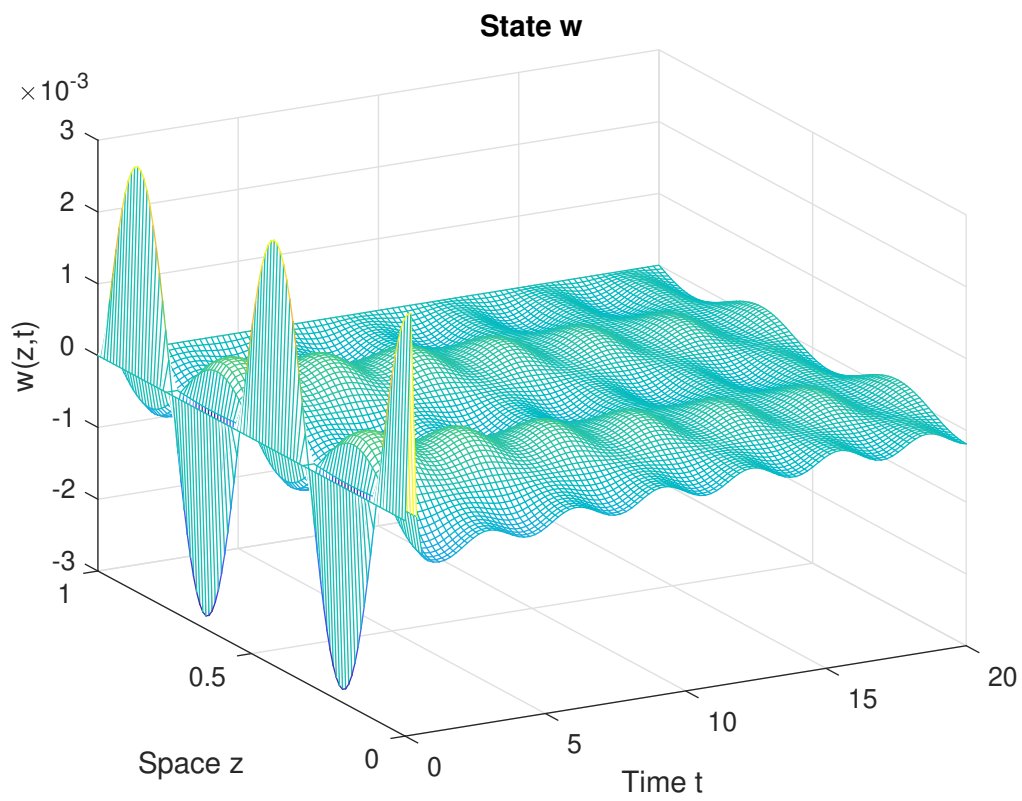
FIGURE 3.2: Time and space-evolution of the state $x(t, z)$ FIGURE 3.3: Time and space-evolution of the state $x(t, z)$

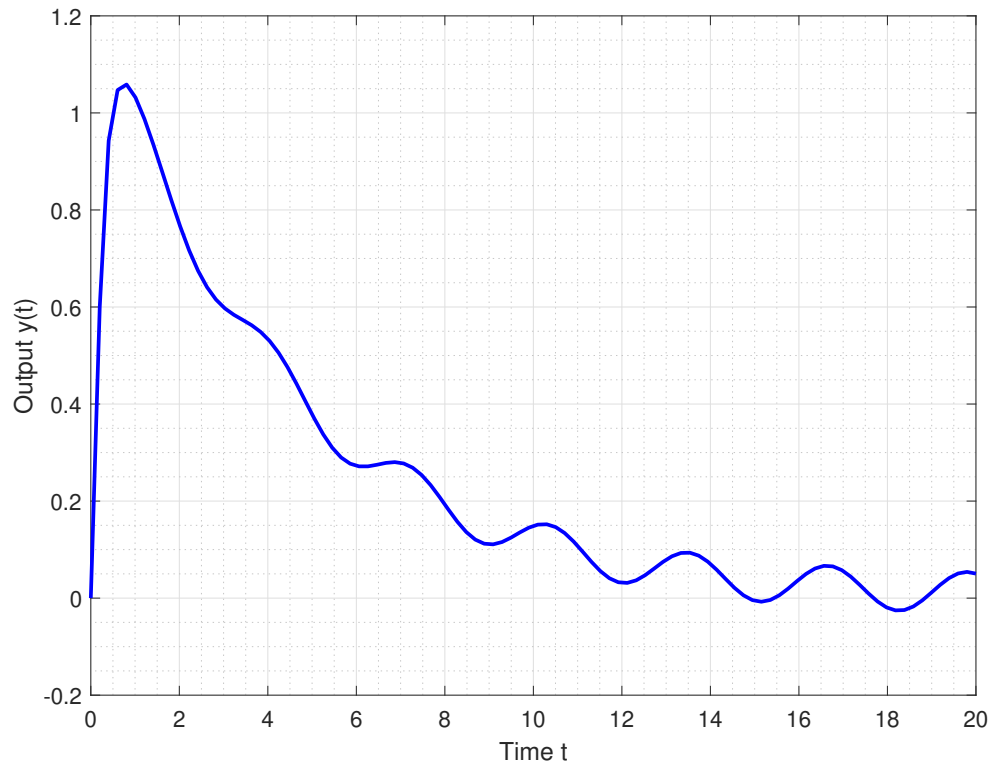
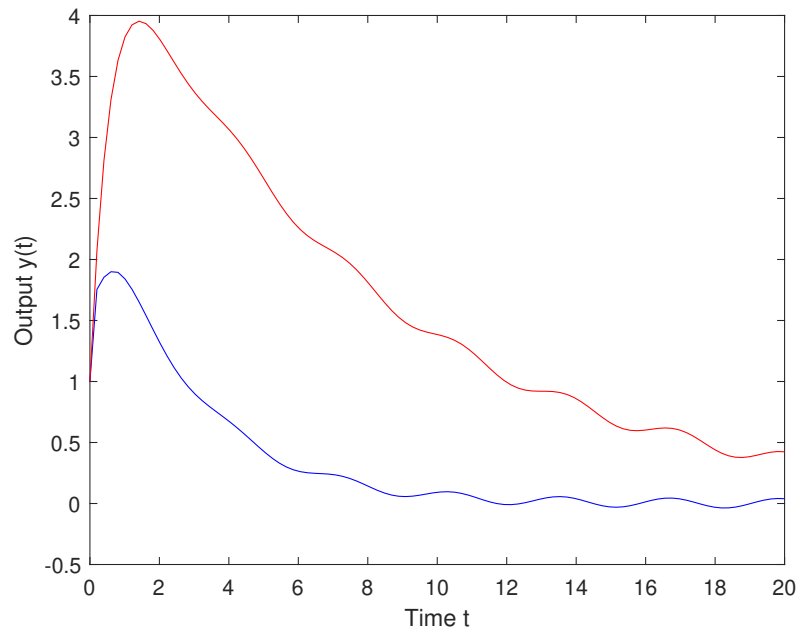
FIGURE 3.4: Time and-evolution of the output $y(t)$ FIGURE 3.5: Output $y(t)$ for $N = 3$ (red) and $N = 5$ (blue)

Chapter 4

Saturated Control and Anti-windup Design for a Reaction-Diffusion Equation with In-domain disturbances

We design a saturated dynamic output feedback control law which locally stabilizes a linear reaction-diffusion equation with in-domain disturbance. As in the previous chapter, the reaction-diffusion plant admits finite unstable poles. This chapter is divided into two parts. The first part, found in Section 4.2, studies the input-output stabilization problem of the infinite-dimensional system in closed loop with the finite-dimensional saturated control system. The second part, found in Section 4.3, studies the input-output stabilization problem of the infinite-dimensional system in closed loop with the saturated control system and an anti-windup compensator. With the control system parameters designed and known thanks to the studies done in the first part, we design an anti-windup compensator which locally stabilizes the partial differential equation under consideration to ensure better performance levels and bigger regions of stability. Using Lyapunov methods, dead-zone nonlinearities and associated sector conditions, we tackle two main issues for each part. The first is estimating the region of attraction for the closed-loop systems given in terms of linear matrix inequalities when the in-domain exogenous signal is considered to be null. The second is evaluating the performance level of each system by estimating the IOS gain when the in-domain exogenous signal is different than zero and is energy-bounded. In the process of achieving those two goals, two optimization problems for the two control problems in question are presented which allow the optimization of the regions of stability and the stability gains. Finally, the efficiency of the proposed methods is illustrated using numerical simulations which clearly demonstrates the benefits of the anti-windup compensator in a saturated control problem.

4.1 Problem Statement

We consider the stabilizability problem of a one-dimensional linear reaction-diffusion equation by means of a distributed control input $u \in \mathbb{R}$. The system model is given for all $t \geq 0$ and for $z \in (0, 1)$:

$$\begin{aligned} w_t(t, z) &= (p(z)w_z(t, z))_z + (q_c - q(z))w(t, z) + b(z)u(t) + m(z)d(t) \\ w_z(t, 0) &= w(t, 1) = 0 \\ y(t) &= w(t, 0). \end{aligned} \tag{4.1}$$

We assume that the state-space of this system is $\mathcal{L}_2(0, 1; \mathbb{R})$ and $p \in \mathcal{C}^2([0, 1]; \mathbb{R})$, $q \in \mathcal{C}^0([0, 1]; \mathbb{R})$, $q_c \in \mathbb{R}$ and $b, m \in \mathcal{L}^2(0, 1; \mathbb{R})$. Suppose that the input controller $u(t)$ is a nonlinear saturated controller subject to symmetric magnitude limitation \bar{u}_l such that:

$$-\bar{u}_l \leq u \leq \bar{u}_l, \quad \bar{u}_l > 0. \tag{4.2}$$

We can express the controller $u(t)$ by the saturation nonlinearity defined by:

$$u := \sigma(v) = \min(|u|, \bar{u}_l) \text{sign}(u)$$

where the input signal v is given by the output of the control system dynamics which will be defined later.

4.1.1 Existence and Uniqueness of Strong Solution Pairs to the Cauchy Problem.

Recall the Sturm-Liouville operator defined in Chapter 3:

$$\begin{aligned} \mathbb{A} : \mathcal{D}(\mathbb{A}) &\rightarrow \mathcal{L}^2(0, 1; \mathbb{R}) \\ w &\mapsto -(p(z)w_z)_z + qw(z) \end{aligned} \quad (4.3)$$

where the domain of the operator \mathbb{A} is given by $\mathcal{D}(\mathbb{A}) := \{f \in \mathcal{H}^2(0, 1; \mathbb{R}) : f'(0) = f(1) = 0\}$. Then, abstract Cauchy problem is given by:

$$w_t(t) = -\mathbb{A}w(t) + q_cw(t) + bu(t) + md(t) \quad (4.4)$$

Proposition 4.1 *Assume $b, m \in \mathcal{L}^2(0, 1; \mathbb{R})$, and $w_0 \in \mathcal{L}^2(0, 1; \mathbb{R})$. Then, (4.4) has a unique mild solution pair $(w(t), d(t)) \in \mathcal{C}^1(\text{dom}w; \mathcal{L}^2(0, 1; \mathbb{R})) \times \mathcal{L}^1(\text{dom}d; \mathbb{R})$ where $\text{dom}d = \text{dom}w$ is a time interval of $\mathbb{R}_{\geq 0}$.*

Proof. Since $\sigma(v(t))$ is 1-Lipschitz continuous on $\text{dom}w$, then, according to [57, Definition 2.3, Page 106], there exists a unique mild solution pair $(w(t), d(t)) \in \mathcal{C}^1(\text{dom}w; \mathcal{L}^2(0, 1; \mathbb{R})) \times \mathcal{L}^1(\text{dom}d; \mathbb{R})$ of the inhomogeneous Cauchy problem (4.4). \square

By imposing further constraints on d , we can obtain strong solution pairs to the Cauchy problem which will be useful later in the Lyapunov analysis. Strong solutions are similar to classical solutions used in the previous chapter (see Definition 3.1). The following definition of a strong solution pair of (4.4) is found in [57, Definition 2.8, Page 109].

Definition 4.1 *A function w which is differentiable almost everywhere on $\text{dom}w$ such that $\dot{w} \in \mathcal{L}^1(\text{dom}w; \mathcal{L}^2(0, 1; \mathbb{R}))$ is called a strong solution of the abstract Cauchy problem (4.4) if $w(0) = w_0$ and $\dot{w}(t) = \mathbb{A}w(t) + q_cw(t) + bu(t) + md(t)$ almost everywhere on $\text{dom}w$. \diamond*

Proposition 4.2 *Assume $b, m \in \mathcal{L}^2(0, 1; \mathbb{R})$, $w_0 \in \mathcal{D}(\mathbb{A})$, and d is Lipschitz continuous on $\text{dom}d$. Then, (4.4) has a unique strong solution pair $(w(t), d(t)) \in \mathcal{C}^1(\text{dom}w; \mathcal{L}^2(0, 1; \mathbb{R})) \times \mathcal{C}^{1,1}(\text{dom}d; \mathbb{R})$ where $\text{dom}d = \text{dom}w$ is an interval of $\mathbb{R}_{\geq 0}$.*

Proof. Since the state space $\mathcal{L}^2(0, 1; \mathbb{R})$ is a reflexive Banach space, and $\sigma(v(t))$ is 1-Lipschitz continuous on $\text{dom}w$, then, according to [57, Corollary 2.11, Page 109], for every $w_0 \in \mathcal{D}(\mathbb{A})$, the abstract Cauchy problem (4.4) has a unique strong solution pair (w, d) on $\text{dom}w$. \square

4.1.2 Partition of the System into Stable and Unstable parts

As seen in Section 3.1, \mathbb{A} consists of isolated increasing eigenvalues with finite multiplicity given in (3.5). Now, introduce the coefficients of projection $w_n = \langle w(\cdot), \Phi_n \rangle$, $b_n = \langle b, \Phi_n \rangle$ and $m_n = \langle m, \Phi_n \rangle$ for $n \in \mathbb{N}^*$. We have for all $w(t, \cdot) \in \mathcal{D}(\mathbb{A})$ and for all $t \geq 0$ and for $n \in \mathbb{N}^*$:

$$\begin{aligned} \dot{w}_n(t) &= (-\lambda_n + q_c)w_n(t) + b_nu(t) + m_nd(t), \\ y(t) &= \sum_{i \geq 1} \Phi_i(0)w_i(t). \end{aligned} \quad (4.5)$$

Let L_N and H_N be the subspaces of $\mathcal{L}^2(0, 1; \mathbb{R})$ and $\mathcal{H}^1(0, 1; \mathbb{R})$ spanned by $(\Phi_j(\cdot))_{j=1}^N$ respectively. Let L_N^\perp and H_N^\perp be the orthogonal complement of L_N and H_N in $\mathcal{L}^2(0, 1; \mathbb{R})$

and $\mathcal{H}^1(0, 1; \mathbb{R})$ respectively. Let $\iota : \mathbb{R}^n \rightarrow H_N$ be the isomorphism defined by $\iota(\Phi^j) = \Phi_j(\cdot)$, where $(\Phi^j)_{j=1, \dots, N}$ is an orthonormal basis of \mathbb{R}^N . We will use the isometric representation of $\mathcal{L}^2(0, 1; \mathbb{R})$ as $\ell^2(\mathbb{N}^*, \mathbb{R})$ and $\mathcal{H}^1(0, 1; \mathbb{R})$ as $h^1(\mathbb{N}^*, \mathbb{R})$ obtained by the isomorphism induced by $\Phi_j(\cdot) \mapsto \Phi^j$, where

$$\ell^2(\mathbb{N}^*, \mathbb{R}) := \{(w_n)_{n \in \mathbb{N}^*} \in \mathbb{R}^{\mathbb{N}^*} : \sum_{n=1}^{\infty} |w_n|^2 < \infty\},$$

and

$$h^1(\mathbb{N}^*, \mathbb{R}) := \{(w_n)_{n \in \mathbb{N}^*} \in \mathbb{R}^{\mathbb{N}^*} : \sum_{n=1}^{\infty} \lambda_n |w_n|^2 < \infty\}$$

where $\Phi^j, j \in \mathbb{N}^*$ are the standard basis vectors in $\ell^2(\mathbb{N}^*, \mathbb{R})$ and $h^1(\mathbb{N}^*, \mathbb{R})$ and we use the standard norm on those spaces. We also denote the decomposition Let " \oplus " be the orthogonal sum of subspaces. $\ell^2(\mathbb{N}^*, \mathbb{R}) = \mathbb{R}^N \oplus \ell_{j \geq N+1}^2$ corresponding to the decomposition $\mathcal{L}^2(0, 1; \mathbb{R}) = L_N \oplus L_N^\perp$ where $\ell_{j \geq N+1}^2$ is the set of sequences in $\ell^2(\mathbb{N}^*, \mathbb{R})$ which are zeros in the first N entries. Similary, $h^1(\mathbb{N}^*, \mathbb{R}) = \mathbb{R}^N \oplus h_{j \geq N+1}^1$ corresponds to $\mathcal{H}^1(0, 1; \mathbb{R}) = H_N \oplus H_N^\perp$.

Let $N_0 \geq 1$ and $\delta > 0$ be given such that $-\lambda_n + q_c < -\delta < 0$ for all $n \geq N_0 + 1$. We now introduce an arbitrary integer $N \geq N_0$ which will be further constrained later. We design an output feedback controller that will act on and modify the first N modes of the plant. First, we introduce the following vectors:

$$\begin{aligned} W^N(t) &:= (w_1(t) \dots w_N(t))^\top, \\ B_1 &:= (b_1 \dots b_N)^\top, \\ B_2 &:= (m_1 \dots m_N)^\top, \\ A_0 &:= \begin{pmatrix} -\lambda_1 + q_c & 0 & \dots & 0 \\ 0 & -\lambda_2 + q_c & \ddots & \vdots \\ \vdots & \ddots & \ddots & 0 \\ 0 & \dots & 0 & -\lambda_N + q_c \end{pmatrix}, \end{aligned}$$

and we focus on the following unstable finite-dimension truncation of (4.5):

$$\dot{W}^N(t) = A_0 W^N(t) + B_1 u(t) + B_2 d(t). \quad (4.6)$$

Assumption 4.1 *The pair (A_0, B_1) is controllable.* \diamond

Assumption 4.2 *Consider that the Lipschitz continuous exogenous disturbance $d(t)$ is energy bounded such that it belongs to the following set of functions:*

$$\mathcal{S} = \{d : [0, \infty) \rightarrow \mathbb{R}; \int_0^\infty d(s)^2 ds \leq \xi^{-1}\}$$

for some $\xi > 0$. The energy of $d(t)$ is now said to be bounded by ξ^{-1} . \diamond

Our first objective is to design a finite-dimensional linear time-invariant control system under the effect of saturation that renders the origin of the closed-loop system (4.5) locally exponentially stable in the \mathcal{H}_1 -norm while achieving a quadratic performance specification on the controlled system. The second objective is to introduce an anti-windup compensator to the system that allows for better system performance and larger region of attraction. The general framework of the dynamic control law is given in the next section.

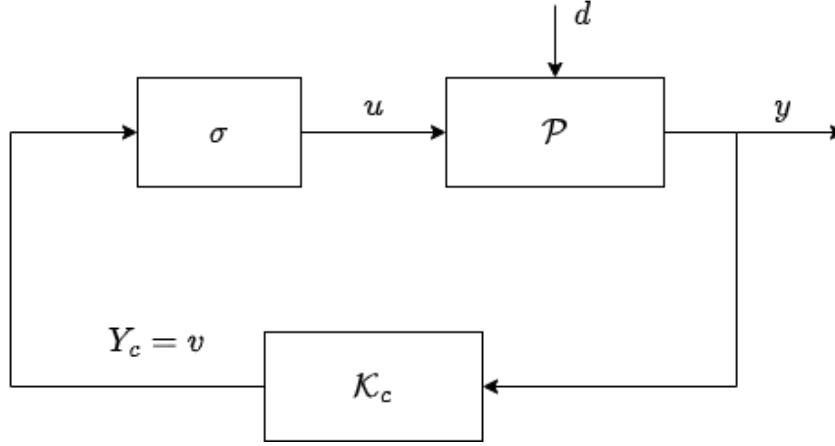

FIGURE 4.1: Closed-loop system $(\mathcal{P}, \mathcal{K}_c)$ with saturation limitation.

4.2 General Set-Up for the Output-Feedback Control Problem

Given $N \geq N_0$, consider the following state space representation for the continuous-time linear plant \mathcal{P} :

$$\begin{aligned} \dot{W}^N(t) &= A_0 W^N(t) + B_1 \sigma(v(t)) + B_2 d(t), \\ \dot{w}_n(t) &= (-\lambda_n + q_c) w_n(t) + b_n \sigma(v(t)) + m_n d(t) \quad n \geq N + 1, \\ y &= \sum_{i \geq 1} \Phi_i(0) w_i(t). \end{aligned} \quad (4.7)$$

We assume the following LTI dynamic output feedback controller \mathcal{K}_c :

$$\begin{aligned} \dot{X}_c(t) &= A_c X_c(t) + B_c y(t) \\ Y_c(t) &= C_c X_c(t) \end{aligned} \quad (4.8)$$

where $X_c \in \mathbb{R}^N$ is the state of the controller and $A_c \in \mathbb{R}^{N \times N}$, $B_c \in \mathbb{R}^N$ and $C_c \in \mathbb{R}^{1 \times N}$ are to be designed, with N being the dimension of W^N . The dead-zone nonlinearity is denoted by

$$\phi(v) := \sigma(v) - v$$

and let

$$\begin{aligned} C &:= (\Phi_1(0) \dots \Phi_N(0))^\top \\ \tilde{y} &:= \sum_{i \geq N+1} \Phi_i(0) w_i, \end{aligned}$$

The general closed-loop system between (4.1) and (4.8) is given by:

$$\begin{cases} \dot{w}(t) = \mathbb{A} w(t) + q_c w(t) + b \sigma(Y_c(t)) + b u(t) + m d(t) \\ y(t) = w(t, 0) \\ \dot{X}_c(t) = A_c X_c(t) + B_c y(t) \\ Y_c(t) = C_c X_c(t). \end{cases} \quad (4.9)$$

Let $\zeta_c = \begin{pmatrix} w \\ X_c \end{pmatrix} \in \mathcal{D}(\mathbb{A}) \times \mathbb{R}^N$, and the \mathcal{H}_c^1 -norm is defined by

$$\|\zeta_c\|_{\mathcal{H}_c^1} := \sqrt{\|w\|_{\mathcal{H}^1}^2 + X_c^\top X_c} \quad (4.10)$$

The projected closed-loop dynamics $(\mathcal{P}, \mathcal{K}_c)$ of the plant (4.7) with the output feedback control (4.8) (as seen in FIGURE 4.1) can be formerly written as:

$$\begin{cases} \begin{pmatrix} \dot{W}^N(t) \\ \dot{X}_c(t) \end{pmatrix} = \begin{pmatrix} A_0 & B_1 C_c \\ B_c C & A_c \end{pmatrix} \begin{pmatrix} W^N(t) \\ X_c(t) \end{pmatrix} + \begin{pmatrix} B_1 \\ 0 \end{pmatrix} \phi(Y_c(t)) + \begin{pmatrix} B_2 \\ 0 \end{pmatrix} d(t) + \begin{pmatrix} 0 \\ B_c \end{pmatrix} \tilde{y}(t) \\ \dot{w}_n(t) = (-\lambda_n + q_c)w_n(t) + b_n C_c X_c(t) + b_n \phi(Y_c(t)) + m_n d(t) \quad n \geq N+1 \\ Y_c(t) = \begin{pmatrix} 0 & C_c & 0 \end{pmatrix} \begin{pmatrix} W^N(t) \\ X_c(t) \end{pmatrix} \\ y(t) = \begin{pmatrix} C & 0 & 0 \end{pmatrix} \begin{pmatrix} W^N(t) \\ X_c(t) \end{pmatrix} + \tilde{y} \end{cases} \quad (4.11)$$

Inspired by the work done in [52], we prove that the exponential input-output stability of the infinite-dimensional closed-loop system (4.11) boils down to studying the exponential input-output stability of the unstable finite-dimensional system in closed loop with the defined control plant. In the next section, we define the finite-dimensional closed-loop system and then present the local exponential stability analysis which will help us later in Section 4.2.2. We are now able to formally state the first problem we solve in this chapter.

Problem 4.3 *Given $p \in \mathcal{C}^2([0, 1])$, $q \in \mathcal{C}^0([0, 1])$ with $p, q > 0$ and $q_c \in \mathbb{R}$. Design the control parameters $\begin{pmatrix} A_c & B_c \\ C_c & 0 \end{pmatrix}$ such that the following properties hold for the closed-loop system (4.9):*

- the origin of the closed-loop system is zero-input locally exponentially stable with region of attraction \mathcal{R}_c ,
- for some (solution independent) $\psi_c, v_c, \rho_c > 0$, for each strong solution pair (ζ_c, d) to the closed-loop system, the bound:

$$|y(t)| \leq \psi_c e^{-v_c t} \|\zeta_c(0)\|_{\mathcal{H}_c^1} + \rho_c \sqrt{\int_0^t d(\theta)^2 d\theta} \quad (4.12)$$

holds for all $t \in \mathbb{R}_{\geq 0}$.

Inequality (4.12) corresponds to an input-output stability (IOS) bound for the closed-loop system (4.11). The first contribution of this chapter is to design an optimal controller \mathcal{K}_c in order to minimize the effect of the gain ρ_c for $d \neq 0$ and maximize the region of attraction \mathcal{R}_c for $d = 0$. In Section 4.2.2.1, we provide an explicit estimate of the IOS gain ρ_c and the region of attraction \mathcal{R}_c .

4.2.1 Local Stabilization and Estimation of the region of attraction for the Finite-dimensional Truncation System

Consider the closed-loop system of (4.6) with (4.8):

$$\begin{cases} \begin{pmatrix} \dot{W}^N(t) \\ \dot{X}_c(t) \end{pmatrix} = \begin{pmatrix} A_0 & B_1 C_c \\ B_c C & A_c \end{pmatrix} \begin{pmatrix} W^N(t) \\ X_c(t) \end{pmatrix} + \begin{pmatrix} B_1 \\ 0 \end{pmatrix} \phi(Y_c(t)) + \begin{pmatrix} B_2 \\ 0 \end{pmatrix} d(t) \\ Y_c(t) = \begin{pmatrix} 0 & C_c \end{pmatrix} \begin{pmatrix} W^N(t) \\ X_c(t) \end{pmatrix} \end{cases} \quad (4.13)$$

The goal of this section is to evaluate the region of attraction for the zero-input exponential stability of finite-dimensional unstable system (4.13) in order to later find the region of attraction for the zero-input exponential stability of the whole system (4.11).

Definition 4.2 *Assume A_c, B_c, C_c are chosen such that (4.13) is zero-input exponentially stable. The set $\mathcal{E}(P_{fc}, 1)$ is said to be a region of attraction if*

- $0 \in \text{int}\mathcal{E}(P_{fc}, 1)$,

- for any $(W^N(0), X_c(0)) \in \mathcal{E}(P_{fc}, 1)$, the corresponding solution of (4.13) satisfies $(W^N(t), X_c(t)) \rightarrow 0$ as $t \rightarrow \infty$,
- for any $(W^N(0), X_c(0)) \in \mathcal{E}(P_{fc}, 1)$, it holds that $(W^N(t), X_c(t)) \in \mathcal{E}(P_{fc}, 1)$ for all $t \geq 0$ (forward invariant property).

The maximal region of attraction, or the domain of stability, is the largest set with the above properties satisfied. It is also uniquely defined. \diamond

As classically done in the subject of local exponential stability using saturated control, the system states are constrained into a polyhedral set with the help of quadratic Lyapunov functions. Usually, the Lyapunov function defines the state domain as an ellipsoidal level set defined below.

Definition 4.3 Consider the finite state $X \in \mathbb{R}^m$, $m \in \mathbb{N}^*$ belonging to an ellipsoidal level set domain. Then, X belongs the following set

$$\mathcal{E}(R, \kappa) := \{X \in \mathbb{R}^m : X^\top R X \leq \kappa^{-1}\} \quad (4.14)$$

for some $\kappa > 0$ and $R \in \mathbb{S}_p^m$. \diamond

In the next proposition, we prove that the region of attraction for the local exponential stability of the origin of (4.13) is given by an ellipsoidal domain.

4.2.1.1 Input-Output Stability Analysis for the Finite-dimensional System

In this section, we use the quadratic Lyapunov function in order to solve the local exponential stability analysis problem with respect to the energy-bounded exogenous input d for system (4.13). Let us define the generalized sector condition found in [72, Page 43] which will be later used in the calculations of the Lyapunov stability conditions.

Lemma 4.1 For all $v_1, v_2 \in \mathbb{R}$ such that $-\bar{u}_l \leq v_1 - v_2 \leq \bar{u}_l$, the nonlinearity $\phi(v_1)$ satisfies the following inequality:

$$\phi(v_1)T(\phi(v_1) + v_2) \leq 0 \quad (4.15)$$

for any $T \in \mathbb{R}_{>0}$. \diamond

We define the following matrices which will be used in the proof of the next proposition.

$$\begin{aligned} A_{11} &:= \begin{pmatrix} A_0 & B_1 C_c \\ B_c C & A_c \end{pmatrix}, & B_{11} &:= \begin{pmatrix} B_1 \\ 0 \end{pmatrix}, \\ B_{12} &:= \begin{pmatrix} B_2 \\ 0 \end{pmatrix}, & X_{fc} &:= \begin{pmatrix} W^N \\ X_c \end{pmatrix}, \\ \mathbb{K} &:= \begin{pmatrix} 0 & C_c \end{pmatrix}. \end{aligned} \quad (4.16)$$

The following proposition is an already published result in [72, Page 137]

Proposition 4.4 Suppose there exist $P_{fc} \in \mathbb{S}_p^{2N}$, $T_{fc} \in \mathbb{R}_{>0}$, $\mathbf{G} \in \mathbb{R}^{1 \times 2N}$, $A_c \in \mathbb{R}^{N \times N}$, $B_c \in \mathbb{R}^N$, $C_c \in \mathbb{R}^{1 \times N}$ and $\tau_1, \tau_2, \mu \in \mathbb{R}_{>0}$ such that:

$$\begin{pmatrix} A_{11}^\top P_{fc} + P_{fc} A_{11} + \tau_1 P_{fc} & P_{fc} B_{11} - \mathbf{G}^\top T_{fc} & P_{fc} B_{12} \\ * & -2T_{fc} & 0 \\ * & * & -\tau_2 \end{pmatrix} \leq 0 \quad (4.17)$$

$$\begin{pmatrix} P_{fc} & \mathbf{K}^\top - \mathbf{G}^\top \\ * & \bar{u}_l^2 \end{pmatrix} \geq 0 \quad (4.18)$$

$$-\tau_2 \xi + \tau_1 \leq \mu \quad (4.19)$$

Then, we have the following:

- for $d = 0$, the ellipsoid $\mathcal{E}(P_{fc}, 1)$ is a region of attraction for the local exponential stability of the origin of the saturated system (4.13).
- for any $d \in \mathcal{S}$ and $X_{fc}(0) \in \mathcal{E}(P_{fc}, 1)$, the trajectories of the saturated system (4.13) do not leave the ellipsoid $\mathcal{E}(P_{fc}, 1)$.

Proof. Let $P_{fc} \in \mathbb{S}_p^{2N}$ and consider the quadratic Lyapunov function defined as

$$V_f = X_{fc}^\top P_{fc} X_{fc} \quad (4.20)$$

Following the procedure done in [72, Chapter 3], we want to prove that $\dot{V}_f \leq \mu V_f$ for $\mu < 0$ along the trajectories of the saturated system (4.13) for any X_{fc} such that $X_{fc}^\top P_{fc} X_{fc} < 1$ and for any $d \in \mathcal{S}$. This translates to proving the following inequalities:

$$\dot{V}_f(X_{fc}) + \tau_1 X_{fc}^\top P_{fc} X_{fc} - \tau_2 d^2 < 0 \quad (4.21)$$

$$-\tau_1 + \tau_2 \xi^{-1} \leq \mu \quad (4.22)$$

The informal computation of the derivative of V_f along the trajectories of the saturated finite system (4.13) gives:

$$\begin{aligned} \dot{V}_f(X_{fc}) &= X_{fc}^\top (A_{11}^\top P_{fc} + P_{fc} A_{11}) X_{fc} + \phi B_{11}^\top P_{fc} X_{fc} + d^\top B_{21}^\top P_{fc} X_{fc} + X_{fc}^\top P_{fc} B_{11} \phi \\ &\quad + X_{fc}^\top P_{fc} B_{12} d \end{aligned} \quad (4.23)$$

where A_{11} , B_{11} and B_{12} are defined in (4.16). We rewrite (4.23) as:

$$\dot{V}_f(X_{fc}) = \begin{pmatrix} X_{fc} \\ \phi \\ d \end{pmatrix}^\top \begin{pmatrix} A_{11}^\top P_{fc} + P_{fc} A_{11} & P_{fc} B_{11} & P_{fc} B_{12} \\ * & 0 & 0 \\ * & * & 0 \end{pmatrix} \begin{pmatrix} X_{fc} \\ \phi \\ d \end{pmatrix} \quad (4.24)$$

We have that

$$\phi(Y_c) = \phi(\mathbb{K}X_{fc})$$

and let $\mathbf{G} = (G_1 \ G_2) \in \mathbb{R}^{1 \times 2N}$. We can apply Lemma 4.1 by choosing $v_1 = \mathbb{K}X_{fc}$ and $v_2 = \mathbf{G}X_{fc}$ for any $X_{fc} \in \mathcal{G} := \{X_{fc} \in \mathbb{R}^{2N}; |\mathbb{K}X_{fc} - \mathbf{G}X_{fc}| \leq \bar{u}_l\}$ which is satisfied if (4.18) is satisfied. Thus the dead-zone nonlinearity $\phi(\mathbb{K}X_{fc})$ satisfies:

$$\phi(\mathbb{K}X_{fc})^\top T_{fc}(\phi(\mathbb{K}X_{fc}) + \mathbf{G}X_{fc}) \leq 0$$

Then, we have the following inequality

$$\dot{V}_f(X_{fc}) - \tau_2 d^\top d + \tau_1 V_f(X_{fc}) \leq \dot{V}_f(X_{fc}) - \tau_2 d^\top d + \tau_1 V_f(X_{fc}) - 2\phi T_{fc}(\phi(\mathbb{K}Y) + \mathbf{G}Y). \quad (4.25)$$

Thus, we obtain

$$\begin{aligned} \dot{V}_f(X_{fc}) - \tau_2 d^\top d + \tau_1 V_f(X_{fc}) &\leq \\ \begin{pmatrix} X_{fc} \\ \phi \\ d \end{pmatrix}^\top &\begin{pmatrix} A_{11}^\top P_{fc} + P_{fc} A_{11} + \tau_1 P_{fc} & P_{fc} B_{11} - \mathbf{G}^\top T & P_{fc} B_{12} \\ * & -2T & 0 \\ * & * & -\tau_2 \end{pmatrix} \begin{pmatrix} X_{fc} \\ \phi \\ d \end{pmatrix} \end{aligned} \quad (4.26)$$

Thus, if (4.17) is satisfied, the previous inequality implies

$$\dot{V}_f(X_{fc}) - \tau_2 d^\top d + \tau_1 V_f(X_{fc}) \leq 0 \quad (4.27)$$

and the proof is concluded. \square

4.2.2 Local Stabilization and Estimation of the region of attraction for the Overall Infinite-Dimensional System

We prove in the next proposition that the region of attraction for the asymptotic stability of the overall system (4.11) depends mainly on the knowledge of the region of attraction $\mathcal{E}(P_{fc}, 1)$ given by Proposition 4.4.

Proposition 4.5 *Assume A_c, B_c, C_c are chosen such that the origin of the finite-dimensional system (4.13) is zero-input locally exponentially stable with region of attraction $\mathcal{E}(P_{fc}, 1)$ given in Proposition 4.4. Then:*

- the origin of system (4.11) is zero-input locally exponentially stable with region of attraction $\mathcal{E}(P_{fc}, 1) \times \mathfrak{h}_{j \geq N+1}^1$.
- the origin of system (4.9) is zero-input locally exponentially stable with region of attraction $H_N^1 \times \iota(\mathcal{E}(P_{fc}, 1))$.
- for any $d \in \mathcal{S}$ and $\zeta_c(0) \in H_N^1 \times \iota(\mathcal{E}(P_{fc}, 1))$, the trajectories of the saturated system (4.11) do not leave the region \mathcal{R}_c .
- There exist three positive values M, a and ρ_1 such that for any initial condition $w(0, \cdot) \in \text{int}(H_N^1 \times \iota(\mathcal{E}(P_{fc}, 1)))$, the following IOS inequality holds.

$$|y(t)| \leq M e^{-at} \|\zeta_c(t, 0)\|_{\mathcal{H}_c^1} + \rho_1 \sqrt{\int_0^t d(\theta)^2 d\theta}. \quad (4.28)$$

Proof. Since we prove that the origin of (4.13) is zero-input locally exponentially stable with region of attraction $\mathcal{E}(P_{fc}, 1)$, it follows from Proposition 4.4 and inequality (4.27) that for any $X_{fc}(0) \in \text{int}\mathcal{E}(P_{fc}, 1)$ (or a compact subset of $\text{int}\mathcal{E}(P_{fc}, 1)$), the following holds

$$|X_{fc}(t)| \leq \sqrt{\frac{\lambda_{\max}(P_{fc})}{\lambda_{\min}(P_{fc})}} e^{-\frac{\tau_1 t}{2}} |X_{fc}(0)| + \sqrt{\frac{\tau_2}{\lambda_{\min}(P_{fc})}} \sqrt{\int_0^t d(\theta)^2 d\theta}, \quad t \geq 0.$$

Let $M_1 = \sqrt{\frac{\lambda_{\max}(P_{fc})}{\lambda_{\min}(P_{fc})}}$, $a_1 = \frac{\tau_1}{2}$ and $M_2 = \sqrt{\frac{\tau_2}{\lambda_{\min}(P_{fc})}}$. From equation (4.7), we derive that for $j \geq N + 1$, for any $t \geq 0$, for any $(w_{N+1}(0), w_{N+2}(0), \dots) \in \mathfrak{h}_{j \geq N+1}^1$ and $d \in \mathcal{S}$:

$$w_j(t) = e^{(-\lambda_j + q_c)t} w_j(0) + b_j \int_0^t e^{(-\lambda_j + q_c)(t-\theta)} \sigma(\mathbb{K} X_{fc}(\theta)) d\theta + m_j \int_0^t e^{(-\lambda_j + q_c)(t-\theta)} d(\theta) d\theta$$

Since the saturation function σ is 1-Lipschitz continuous, it holds that

$$|\sigma(\mathbb{K} X_{fc})| \leq |\mathbb{K} X_{fc}| \leq \|\mathbb{K}\| |X_{fc}|.$$

Thus, exploiting Assumption 4.2 and Proposition 4.5, we obtain for all $j \geq N + 1$ and for all $t \geq 0$ the following

$$\begin{aligned} |w_j(t)| &\leq e^{-a_{2j}t} |w_j(0)| + |b_j| \|\mathbb{K}\| \int_0^t e^{-a_{2j}(t-\theta)} |X_{fc}(\theta)| d\theta + |m_j| \int_0^t e^{-a_{2j}(t-\theta)} |d(\theta)| d\theta \\ &\leq e^{-a_{2j}t} |w_j(0)| + M_1 |b_j| \|\mathbb{K}\| \int_0^t e^{-a_{2j}(t-\theta) - a_1\theta} |X_{fc}(0)| d\theta \\ &\quad + M_2 |b_j| \|\mathbb{K}\| \int_0^t (e^{-a_{2j}(t-\theta)} \sqrt{\int_0^t d(\theta)^2 d\theta}) d\theta + |m_j| \sqrt{\int_0^t d(\theta)^2 d\theta} \\ &\leq e^{-a_{2j}t} |w_j(0)| + \frac{M_1 |b_j| \|\mathbb{K}\|}{a_{2j} - a_1} (e^{-a_1 t} - e^{-a_{2j}t}) |X_{fc}(0)| + (|m_j| + M_2 |b_j| \|\mathbb{K}\| t) \sqrt{\xi^{-1}}. \end{aligned}$$

where $a_{2j} = \lambda_j - q_c$. Using the inequality $(a + b)^2 \leq 2a^2 + 2b^2$ for any $a, b \in \mathbb{R}$, and the square summability of $|w_j(0)|$, $|b_j|$ and $|m_j|$, it follows that $\sum_{j=N+1}^{\infty} |w_j(t)|^2$ decays exponentially

with respect to the input-to-state stability gain. Hence, if the origin of (4.13) is zero-input exponentially stable with region of attraction $\mathcal{E}(P_{fc}, 1)$, then the origin of the overall system (4.11) is zero-input asymptotically stable with region of attraction

$$\mathcal{E}(P_{fc}, 1) \times \mathfrak{h}_{j \geq N+1}^1.$$

At this point, system (4.11) is seen as a cascade interconnection of a locally exponentially stable system and an ISS system. For a ζ_c in a closed, bounded subset of $\text{int}(\iota(H_N^\perp \times \mathcal{E}(P_{fc}, 1)))$, the previous computations yield:

$$\|\zeta_c(t)\|_{H_c^1} \leq M e^{-at} \|\zeta_c(0)\| + \rho_1 \sqrt{\int_0^t d(\theta)^2 d\theta}$$

for suitable constants M, a and ρ_1 . Since $y(t) = w(t, 0)$ and $w(t, 1) = 0$, we have

$$y(t)^2 = \left(\int_0^1 w_x(t, s) ds \right)^2 \leq \int_0^1 w_x^2(t, s) ds \leq \|w(t)\|_{\mathcal{H}^1}^2 \leq \|\zeta_c\|_{\mathcal{H}_c^1}^2. \quad (4.29)$$

Thus, we can obtain (4.28), and the proof is concluded. \square

Remark 4.1 *If we are exclusively looking to prove input-to-state stability, the region of attraction is relaxed. In particular, the region of attraction for the asymptotic stability of (4.11) becomes $\mathcal{E}(P_{fc}, 1) \times \ell_{(j \geq N+1)}^2$ and that of (4.9) becomes $L_n^\perp \times \iota(\mathcal{E}(P_{fc}, 1))$. See [52] for more results on ISS stability.* \circ

In the next section, we propose a second Lyapunov method to derive sufficient conditions for local exponential stability of the origin of the infinite-dimensional closed-loop system.

4.2.2.1 Input-Output Lyapunov Stability Analysis for the Overall System with Saturated Control

In this section we perform Lyapunov stability analysis on the infinite-dimensional system to design a solution to Problem 4.3. First, we propose sufficient conditions for \mathcal{H}_c^1 -stability and then construct a Lyapunov functional to derive the sufficient conditions in the form of quadratic inequalities.

4.2.2.1.1 Sufficient Conditions

The following section presents sufficient conditions for the solution to Problem 4.3. The result relies on a dissipation inequality. This is done by proving the following proposition:

Proposition 4.6 *Assume there exist a Fréchet differentiable functional $V: \mathcal{H}^1(0, 1; \mathbb{R}) \times \mathbb{R}^N \rightarrow \mathbb{R}_{\geq 0}$ and $c_1, c_2, c_3, \chi \in \mathbb{R}_{>0}$ such that for each $d \in \mathcal{S}$ and $\zeta_c \in \mathcal{R}_c \subset \mathcal{D}(\mathbb{A})$, a sublevel set of V , such that:*

$$c_1 \|\zeta_c\|_{\mathcal{H}_c^1}^2 \leq V(\zeta_c) \leq c_2 \|\zeta_c\|_{\mathcal{H}_c^1}^2, \quad (4.30)$$

$$DV(\zeta_c)\zeta_c \leq -c_3 V(\zeta_c) + \chi^2 d^2. \quad (4.31)$$

Then, the origin of the closed-loop system (4.9) is zero-input locally exponentially stable with region of attraction \mathcal{R} and (4.12) holds with

$$\rho_c = \frac{\chi}{\sqrt{c_1}} \quad (4.32)$$

Proof. First we consider a strong solution pair $(\zeta_c(t), d(t))$; i.e. $\zeta_c \in \mathcal{R}_c$ and $d \in \mathcal{S} \cap \mathcal{C}^{1,1}(\text{dom}d; \mathbb{R})$ for all $t \in \text{dom}\zeta_c$ where $\text{dom}\zeta_c$ is an interval of $\mathbb{R}_{\geq 0}$ including zero. Now, consider the following function:

$$\mathcal{W}: \text{dom}\zeta_c \rightarrow \mathbb{R} \\ t \mapsto (V \circ \zeta_c)(t) \quad (4.33)$$

Then, since $V : \mathcal{H}^1(0, 1; \mathbb{R}) \times \mathbb{R}^N \rightarrow \mathbb{R}_{\geq 0}$ is Fréchet differentiable everywhere and $\zeta_c : \text{dom}\zeta_c \rightarrow \mathcal{H}^1(0, 1; \mathbb{R}) \times \mathbb{R}^N$ is differentiable almost everywhere, it follows that for almost all $t \geq 0$:

$$\dot{\mathcal{W}}(t) = DV(\zeta_c)\dot{\zeta}_c(t).$$

Thus we have for almost all $t \in \text{dom}\zeta_c$

$$\dot{\mathcal{W}}(t) = DV(\zeta_c) \begin{pmatrix} -\mathbf{A}w(t, \cdot) + q_c w(t, \cdot) + bu(t) + md(t) \\ A_c X_c(t) + B_c y(t) \end{pmatrix}$$

Using (4.31), one gets, for all $t \in \text{dom}\zeta_c$,

$$\dot{\mathcal{W}}(t) \leq -c_3 \mathcal{W}(t) + \chi d(t)^2.$$

Therefore, since \mathcal{W} is continuous on $\text{dom}\zeta_c$, from comparison lemma [38, Page 102], we have:

$$\mathcal{W}(t) \leq e^{-c_3 t} \mathcal{W}(0) + \chi^2 \int_0^t e^{-c_3(t-\theta)} d(\theta)^2 d\theta, \quad \forall t \in \text{dom}\zeta_c.$$

This bound, thanks to (4.30), ensures that the origin of the closed-loop system is locally exponentially stable with respect to the \mathcal{H}_c^1 -norm and with a region of attraction \mathcal{R} when $d = 0$. At this stage, notice that for all $t \in \text{dom}\zeta_c$, one has:

$$\int_0^t e^{-c_3(t-\theta)} d(\theta)^2 d\theta \leq \int_0^t d(\theta)^2 d\theta$$

which allows one to conclude that for all $t \in \text{dom}\zeta_c$

$$\mathcal{W}(t) \leq e^{-c_3 t} \mathcal{W}(0) + \chi^2 \int_0^t d(\theta)^2 d\theta.$$

Finally by using (4.30), it follows that for all $t \in \text{dom}\zeta_c$

$$\|\zeta_c(t)\|_{\mathcal{H}_c^1} \leq e^{-\frac{c_3}{2}t} \sqrt{\frac{c_2}{c_1}} \|\zeta_c(0)\|_{\mathcal{H}_c^1} + \frac{\chi}{\sqrt{c_1}} \sqrt{\int_0^t d(\theta)^2 d\theta}. \quad (4.34)$$

Since $y(t) = w(t, 0)$ and $w(t, 1) = 0$, we have

$$y(t)^2 = \left(\int_0^1 w_x(t, s) ds \right)^2 \leq \int_0^1 w_x^2(t, s) ds \leq \|w(t)\|_{\mathcal{H}^1}^2. \quad (4.35)$$

Then, since

$$\|w(t)\|_{\mathcal{H}^1}^2 \leq \|\zeta_c\|_{\mathcal{H}_c^1}^2$$

using (4.34) and (4.35), we get

$$|y(t)| \leq e^{-\frac{c_3}{2}t} \sqrt{\frac{2c_2}{c_1}} \|\zeta_c(0)\|_{\mathcal{H}_c^1} + \sqrt{2} \frac{\chi}{\sqrt{c_1}} \sqrt{\int_0^t d(\theta)^2 d\theta}, \quad (4.36)$$

which reads as (4.12). This concludes the proof. \square

4.2.2.1.2 Construction of the Functional V_c

Next, we define the following matrices which will be used for the proof of the next theorem:

$$\begin{aligned} B_{13} &= \begin{pmatrix} 0 \\ B_c \end{pmatrix}, \\ A_{12} &= \begin{pmatrix} 0 & 0 \\ 0 & \alpha_1 \|b\|^2 C_c^\top C_c \end{pmatrix} \end{aligned} \quad (4.37)$$

Let the constant $M_\phi = \sum_{n \geq N+1} \frac{\Phi_n(0)^2}{\lambda_n}$ which is finite when $p \in \mathcal{C}^2([0, 1])$ since $\Phi_n(0) = O(1)$ as $n \rightarrow +\infty$ (see [55]) and (3.6) holds.

Theorem 4.7 *Suppose there exist $P \in \mathbb{S}_p^{2N}, T \in \mathbb{R}_{>0}, \mathbf{G} \in \mathbb{R}^{1 \times 2N}, A_c \in \mathbb{R}^{N \times N}, B_c \in \mathbb{R}^N, C_c \in \mathbb{R}^{1 \times N}$ and $\alpha_1, \beta_1, \gamma, \mu \in \mathbb{R}_{>0}$ such that:*

$$\begin{pmatrix} A_{11}^\top P + PA_{11} + A_{12} + \tau_1 P & PB_{11} - \mathbf{G}^\top T & PB_{12} & PB_{13} \\ * & \alpha_1 \|b\|_{\mathcal{L}^2}^2 - 2T & 0 & 0 \\ * & * & \alpha_1 \|m\|_{\mathcal{L}^2}^2 - \tau_2 & 0 \\ * & * & * & -\beta_1 \end{pmatrix} \leq 0 \quad (4.38)$$

$$\begin{pmatrix} P & \mathbf{K}^\top - \mathbf{G}^\top \\ * & \bar{u}_l^2 \end{pmatrix} \geq 0 \quad (4.39)$$

$$-\tau_2 \xi^{-1} + \tau_1 < \mu \quad (4.40)$$

Select N sufficiently large such that for all $n \geq N + 1$

$$\lambda_n \left(-\lambda_n + q_c + \tau_1 + \frac{3}{\alpha_1} + \frac{\beta_1}{2\gamma} M_\phi \right) \leq 0. \quad (4.41)$$

Then, the parameters A_c, B_c, C_c solve Problem 4.3. In particular (4.12) holds with:

$$\rho = \frac{\sqrt{2\tau_2}}{\sqrt{\min\{\lambda_{\min}(P), \gamma p^*, \gamma q^*\}}} . \quad (4.42)$$

and the region of attraction \mathcal{R}_c is given by $H_N^\perp \times \iota(\mathcal{E}(P, 1))$.

Proof. Let $P \in \mathbb{S}_p^{2N}, \gamma > 0$, and $X_{fc} := (W^N, X_c)$. Consider the following Fréchet differentiable Lyapunov functional:

$$\begin{aligned} V: \mathcal{H}^1(0, 1; \mathbb{R}) \times \mathbb{R}^N &\rightarrow \mathbb{R} \\ \begin{pmatrix} w \\ X_c \end{pmatrix} &\mapsto X_{fc}^\top P X_{fc} + \gamma \sum_{n \geq N+1} \lambda_n \langle w, \Phi_n \rangle^2. \end{aligned} \quad (4.43)$$

The first term corresponds to the dynamics of the truncated model and the control model while the second term, which is related to the \mathcal{H}^1 -norm of the PDE trajectories, is used to handle the modes w_n for $n \geq N$. We have that (4.30) holds for $c_1 := \min\{\lambda_{\min}(P), \gamma p^*, \gamma q^*\}$ and $c_2 := \max\{\lambda_{\max}(P), \gamma p^*, \gamma q^*\}$ are strictly positive. Consider the first term of the functional V :

$$V_1(X_{fc}) := X_{fc}^\top P X_{fc} \quad (4.44)$$

For the finite-dimensional part of the Lyapunov functional, the stability analysis is similar to the proof of Proposition 4.4. We have

$$\begin{aligned} DV_1(X_{fc})\dot{X}_{fc} &= X_{fc}^\top (A_{11}^\top P + PA_{11}) X_{fc} + \phi B_{11}^\top P X_{fc} + X_{fc}^\top P B_{11} \phi \\ &\quad + d^\top B_{12}^\top P X_{fc} + \tilde{y}^\top B_{13}^\top P X_{fc} + X_{fc}^\top P B_{12} d + X_{fc}^\top P B_{13} \tilde{y} \end{aligned} \quad (4.45)$$

where A_{11}, B_{11}, B_{12} are defined in (4.16) and B_{13} is defined in (4.37). We obtain the computation of the time derivative of V_1 along the system trajectories:

$$DV_1(X_{fc})\dot{X}_{fc} = \begin{pmatrix} X_{fc} \\ \phi \\ d \\ \tilde{y} \end{pmatrix}^\top \begin{pmatrix} A_{11}^\top P + PA_{11} & PB_{11} & PB_{12} & PB_{13} \\ * & 0 & 0 & 0 \\ * & * & 0 & 0 \\ * & * & * & 0 \end{pmatrix} \begin{pmatrix} X_{fc} \\ \phi \\ d \\ \tilde{y} \end{pmatrix} \quad (4.46)$$

As done for the proof of Proposition 4.4, let $\mathbf{G} = (G_1 \ G_2) \in \mathbb{R}^{1 \times 2N}$. We can apply Lemma 4.1 by choosing $v_1 = \mathbf{K}X_{fc}$ and $v_2 = \mathbf{G}X_{fc}$ for any $X_{fc} \in \mathcal{G} = \{X_{fc} \in \mathbb{R}^{2N}; |\mathbf{K}X_{fc} - \mathbf{G}X_{fc}| \leq \bar{u}_l\}$ which is guaranteed by the satisfaction of condition (4.39). Thus, the dead-zone

nonlinearity $\phi(\mathbb{K}X_{fc})$ satisfies:

$$\phi(\mathbb{K}X_{fc})^\top T(\phi(\mathbb{K}X_{fc}) + \mathbf{G}X_{fc}) \leq 0$$

Then, we have the following inequality

$$DV_1(X_{fc})\dot{X}_{fc} - \tau_2 d^\top d \leq DV_1(X_{fc})\dot{X}_{fc} - \tau_2 d^\top d - 2\phi T_{fc}(\phi(\mathbb{K}Y) + \mathbf{G}Y). \quad (4.47)$$

Thus, we obtain

$$DV_1(X_{fc})\dot{X}_{fc} \leq \begin{pmatrix} X_{fc} \\ \phi \\ d \\ \tilde{y} \end{pmatrix}^\top \begin{pmatrix} A_{11}^\top P + PA_{11} & PB_{11} - \mathbf{G}^\top T & PB_{12} & PB_{13} \\ * & -2T & 0 & 0 \\ * & * & -\tau_2 & 0 \\ * & * & * & 0 \end{pmatrix} \begin{pmatrix} X_{fc} \\ \phi \\ d \\ \tilde{y} \end{pmatrix} \quad (4.48)$$

Now, consider $V_2(w) := \gamma \sum_{n \geq N+1} \lambda_n \langle w, \Phi_n \rangle$ with $\gamma > 0$. The time derivative of V_2 along the system trajectories (4.11) yields:

$$DV_2(w)\dot{w} = 2\gamma \sum_{n \geq N+1} \lambda_n ((-\lambda_n + q_c)w_n^2 + b_n \sigma(Y_c)w_n + m_n dw_n). \quad (4.49)$$

Thus, knowing that $V = V_1 + V_2$, we conclude the following expression:

$$\begin{aligned} & DV(w, X_c) \begin{pmatrix} \dot{w} \\ \dot{X}_c \end{pmatrix} + \tau_1 V(w, X_c) = \\ & \begin{pmatrix} X_{fc} \\ \phi \\ d \\ \tilde{y} \end{pmatrix}^\top \begin{pmatrix} A_{11}^\top P + PA_{11} + \tau_1 P & PB_{11} - G_1^\top T & PB_{12} & PB_{13} \\ * & -2T & 0 & 0 \\ * & * & -\tau_2 & 0 \\ * & * & * & 0 \end{pmatrix} \begin{pmatrix} X_{fc} \\ \phi \\ d \\ \tilde{y} \end{pmatrix} \\ & + 2\gamma \sum_{n \geq N+1} \lambda_n [(-\lambda_n + q_c + \tau_1)w_n^2 + b_n \mathbb{K}X_{fc}w_n + b_n \phi(\mathbb{K}X_{fc})w_n + m_n dw_n] \end{aligned} \quad (4.50)$$

Using Young's inequality, we have:

$$\begin{aligned} 2 \sum_{n \geq N+1} \lambda_n b_n w_n \mathbb{K}X_{fc} &\leq \frac{1}{\alpha_1} \sum_{n \geq N+1} \lambda_n^2 w_n^2 + \alpha_1 \|b\|_{\mathcal{L}^2}^2 X_{fc}^\top \mathbb{K}^\top \mathbb{K}X_{fc} \\ 2 \sum_{n \geq N+1} \lambda_n b_n w_n \phi &\leq \frac{1}{\alpha_1} \sum_{n \geq N+1} \lambda_n^2 w_n^2 + \alpha_1 \|b\|_{\mathcal{L}^2}^2 \phi^2 \\ 2 \sum_{n \geq N+1} \lambda_n m_n w_n d &\leq \frac{1}{\alpha_1} \sum_{n \geq N+1} \lambda_n^2 w_n^2 + \alpha_1 \|m\|_{\mathcal{L}^2}^2 d^2 \end{aligned}$$

for any $\alpha_1 > 0$. We have that $\mathbb{K}^\top \mathbb{K} = \begin{pmatrix} 0 & 0 \\ 0 & C_c^\top C_c \end{pmatrix}$. Furthermore, knowing that

$$\tilde{y}^2 = \left(\sum_{i \geq N+1} \Phi_i(0)w_i \right)^2$$

and $M_\Phi = \sum_{i \geq N+1} \frac{\Phi_i(0)^2}{\lambda_i}$ is finite and $\sum_{i \geq N+1} \lambda_i w_i^2$ is finite due to (3.7), we use the generalization of the Cauchy-Schwarz inequality [14] to obtain the following

$$\tilde{y}^2 \leq \sum_{i \geq N+1} \frac{\Phi_i(0)^2}{\lambda_i} \sum_{i \geq N+1} \lambda_i w_i^2$$

Hence, for any $\beta_1 > 0$,

$$\beta_1 M_\Phi \sum_{i \geq N+1} \lambda_i w_i^2 - \beta_1 \tilde{y}^2 \geq 0 \quad (4.51)$$

Combining (4.50) with Young's inequality and (4.51), we obtain

$$\begin{aligned} DV(w, X_c) \begin{pmatrix} \dot{w} \\ \dot{X}_c \end{pmatrix} + \tau_1 V(w, X_c) - \tau_2 d^\top d \leq \begin{pmatrix} X_{fc} \\ d \\ \tilde{y} \end{pmatrix}^\top \Theta_c \begin{pmatrix} X_{fc} \\ d \\ \tilde{y} \end{pmatrix} \\ + 2\gamma \sum_{n \geq N+1} \lambda_n \left(-\lambda_n + q_c + \tau_1 + \frac{3}{\alpha_1} + \frac{\beta_1}{2\gamma} M_\Phi \right) w_n^2 \end{aligned} \quad (4.52)$$

there has been a change in the formula here where Θ_c is given by:

$$\Theta_c = \begin{pmatrix} A_{11}^\top P + PA_{11} + \alpha_1 \|b\|_{\mathcal{L}^2}^2 \mathbb{K}^\top \mathbb{K} + \tau_1 P & PB_{11} - \mathbf{G}^\top T & PB_{12} & PB_{13} \\ * & \alpha_1 \|b\|_{\mathcal{L}^2}^2 - 2T & 0 & 0 \\ * & * & \alpha_1 \|m\|_{\mathcal{L}^2}^2 - \tau_2 & 0 \\ * & * & * & -\beta_1 \end{pmatrix}$$

If the conditions (4.38) and (4.41) are satisfied, then (4.31) holds for ρ_c given in (4.32). In addition, if conditions (4.38), (4.39), (4.40), (4.41) are satisfied the origin of closed-loop system (4.11) is zero-input locally exponentially stable with region of attraction $\mathcal{E}(P, 1) \times \mathcal{h}_{j \geq N+1}^1$, and consequently, the origin of (4.1) in feedback with (4.8) is zero-input locally exponentially stable with region of attraction $H_N^\perp \times \iota(\mathcal{E}(P, 1))$. \square

Remark 4.2 *In the case where the control input Y_c is not constrained ($\phi(Y_c) = 0$), the origin of the closed-loop system (4.11) is said to be zero-input globally exponentially stable. If the open-loop system is stable, and the previous inequalities hold for $\mathbb{K} = \mathbf{G}$ which provide conditions for global exponential stability.* \circ

4.2.3 Control Synthesis and Optimization Problems

The quadratic conditions derived in Theorem 4.7 constitute sufficient conditions used to solve Problem 4.3. We notice that the matrix Θ_c in the inequality (4.38) is nonlinear with respect to $P, A_c, B_c, C_c, \mathbf{G}$ and T . Thus, as done in the previous chapter, we propose a linearization method [62], [72] that allows us to exploit the quadratic condition from a numerical standpoint and therefore derive the values of the control parameters that solve Problem 4.3.

4.2.3.1 Derivation of Linear Matrix Inequalities

Let $S = T^{-1}$ and let $X, Y \in \mathbb{S}_p^N$ and $U, V \in \mathbb{R}^{(N \times N)}$ be nonsingular matrices such that $YX + VU^\top = I$. Let $\mathcal{Y} = \begin{pmatrix} Y & I \\ V^\top & 0 \end{pmatrix}$ and $P = \begin{pmatrix} X & U \\ U^\top & \bullet \end{pmatrix}$ where “ \bullet ” denotes “don't care” symmetric positive definite matrix. Under the considered assumptions \mathcal{Y} is nonsingular and a simple congruence transformation gives:

$$\begin{pmatrix} \mathcal{Y} & 0 & 0 & 0 \\ * & S & 0 & 0 \\ * & * & I & 0 \\ * & * & * & I \end{pmatrix}^\top \Theta_c \begin{pmatrix} \mathcal{Y} & 0 & 0 & 0 \\ * & S & 0 & 0 \\ * & * & I & 0 \\ * & * & * & I \end{pmatrix} < 0$$

implies that

$$\begin{pmatrix} \mathcal{Y}^\top (A_{11}^\top P + PA_{11} + A_{12} + \tau_1 P) \mathcal{Y} & \mathcal{Y}^\top PB_{11}S - \mathcal{Y}^\top \mathbf{G}^\top & \mathcal{Y}^\top PB_{12} & \mathcal{Y}^\top PB_{13} \\ * & \alpha_1 \|b\|_{\mathcal{L}^2}^2 S^2 - 2S & 0 & 0 \\ * & * & \alpha_1 \|m\|_{\mathcal{L}^2}^2 - \tau_2 & 0 \\ * & * & * & -\beta_1 \end{pmatrix} < 0 \quad (4.53)$$

We consider the following change of variable [62]:

$$\begin{pmatrix} K & L \\ M & 0 \end{pmatrix} = \begin{pmatrix} XA_0Y & 0 \\ 0 & 0 \end{pmatrix} + \begin{pmatrix} U & XB_1 \\ 0 & I \end{pmatrix} \begin{pmatrix} A_c & B_c \\ C_c & 0 \end{pmatrix} \begin{pmatrix} V^\top & 0 \\ CY & I \end{pmatrix} \quad (4.54)$$

This transforms the old variables (P, A_c, B_c, C_c) into the new variables $\nu = (X, Y, K, L, M)$. Using the change of variable (4.54), it follows that:

$$\begin{aligned} \mathcal{Y}^\top (A_{11}^\top P + PA_{11}) \mathcal{Y} &= A(\nu)^\top + A(\nu); \\ A(\nu) &:= \begin{pmatrix} A_0Y + B_1M & A_0 \\ K & XA_0 + LC \end{pmatrix} \\ X(\nu) &:= \mathcal{Y}^\top P \mathcal{Y} = \begin{pmatrix} Y & I \\ I & X \end{pmatrix}; \\ B_1(\nu) &:= \mathcal{Y}^\top PB_{11}S = \begin{pmatrix} B_1S \\ XB_1S \end{pmatrix}; \\ B_2(\nu) &:= \mathcal{Y}^\top PB_{12} = \begin{pmatrix} B_2 \\ XB_2 \end{pmatrix}; \\ B_3(\nu) &:= \mathcal{Y}^\top PB_{13} = \begin{pmatrix} 0 \\ L \end{pmatrix}; \\ \mathbf{Z}(\nu) &:= \mathcal{Y}^\top \mathbf{G}^\top = \begin{pmatrix} YG_1^\top + VG_2^\top \\ G_1 \end{pmatrix} =: \begin{pmatrix} Z_1^\top \\ Z_2^\top \end{pmatrix}. \end{aligned}$$

We can rewrite $\mathcal{Y}^\top A_{12} \mathcal{Y}$ as $\Pi_1^\top \tilde{A}_{12} \Pi_1$ where

$$\tilde{A}_{12} = \alpha \|b\|_{\mathcal{L}^2}, \quad \Pi_1 = \begin{pmatrix} M^\top \\ 0 \end{pmatrix}.$$

Thus, inequality (4.53) implies

$$\begin{pmatrix} A(\nu)^\top + A(\nu) + \Pi_1^\top \tilde{A}_{12} \Pi_1 + \tau_1 X(\nu) & B_1(\nu) - \mathbf{Z}(\nu) & B_2(\nu) & B_3(\nu) \\ * & \alpha_1 \|b\|_{\mathcal{L}^2}^2 S^2 - 2S & 0 & 0 \\ * & * & \alpha_1 \|m\|_{\mathcal{L}^2}^2 - \tau_2 & 0 \\ * & * & * & -\beta_1 \end{pmatrix} < 0. \quad (4.55)$$

Applying the Schur complement lemma [81] on (4.55), we say that (4.55) holds if

$$X(\nu) > 0 \quad (4.56)$$

and

$$\begin{pmatrix} A(\nu)^\top + A(\nu) + \tau_1 X(\nu) & B_1(\nu) - \mathbf{Z}(\nu)^\top & B_2(\nu) & B_3(\nu) & \Pi_1 \\ * & -2S & 0 & 0 & S \\ * & * & \alpha_1 \|m\|_{\mathcal{L}^2}^2 - \tau_2 & 0 & 0 \\ * & * & * & -\beta_1 & 0 \\ * & * & * & * & -\tilde{A}_{12}^{-1} \end{pmatrix} < 0. \quad (4.57)$$

Finally, multiplying (4.39) by \mathcal{Y}^\top on the left and \mathcal{Y} on the right, we obtain the following linear matrix inequality written in the new variables (4.54):

$$\begin{pmatrix} X & I & M^\top - Z_1^\top \\ I & Y & -Z_2^\top \\ * & * & \bar{u}_l^2 \end{pmatrix} \geq 0 \quad (4.58)$$

Notice that the matrix in (4.57) is nonlinear in the terms X, Y, τ_1 and S . The nonlinear terms $\tau_1 X, \tau_1 Y$ are considered linear if we fix τ_1 by performing a line search on $\tau_1 \in \mathbb{R}_{\geq 0}$. In addition, we fix α_1 by performing a line search on $\mathbb{R}_{>0}$ and therefore the last diagonal element is now linear. Looking at (4.41), it is obvious that α_1 needs to be chosen sufficiently large to satisfy the inequality. The last inconvenient nonlinearity is dealt with in [72] by adding a static anti-windup input $E_c \phi(Y_c)$ to the control dynamics such that only the matrix B_{11} is modified and becomes

$$\bar{B}_{11} = \begin{pmatrix} B_1 \\ E_c \end{pmatrix}.$$

Therefore, the matrix $B_1(\nu)$ is replaced by:

$$\bar{B}_1(\nu) = \begin{pmatrix} B_1 S \\ X B_1 S + U E_c S \end{pmatrix} =: \begin{pmatrix} B_1 S \\ Q \end{pmatrix}$$

In conclusion, if there exist $X, Y \in \mathbb{S}_p^N, K \in \mathbb{R}^{N \times N}, L \in \mathbb{R}^N, M^{1 \times N}, Z_1 \in \mathbb{R}^{1 \times N}, Z_2 \in \mathbb{R}^{1 \times N}, Q \in \mathbb{R}^N$ and $\beta_1, \gamma, \tau_2 \in \mathbb{R}_{>0}$ such that (4.56), (4.57) (modified), (4.58), (4.41) hold, then the solution (A_c, B_c, C_c) to Problem 4.3 is derived using the change of variable in (4.54).

Obviously, the same change of variable can be used to transform (4.17), (4.18) into linear matrix inequalities as done in [72]. Following that method, since S here is scalar, we can perform a line search on S and avoid the addition of a static anti-windup term. However, this might not give feasible solutions to the exponential stability of the infinite-dimensional system since S here is constrained due to the second diagonal element in (4.55).

4.2.3.2 Optimization Problems

In the formulation of Problem 4.3, no specific requirements on the scalar ρ_c or on the size of the region of attraction are considered. For $d \neq 0$, it is obvious that to minimize the effect of the disturbance d on the closed-loop system, the control parameters should be designed so that (4.12) holds with a minimal ρ_c . This goal can be achieved by fixing τ_1 , and considering the following optimization problem

$$\begin{aligned} & \sup_{P, r_1} r_1 \\ \text{s.t: } & (4.57), (4.56), (4.58), (4.41) \text{ hold } P \in \mathbb{S}_p^{2N}, P - r_1 I > 0. \end{aligned} \quad (4.59)$$

The optimization problem (4.59) is equivalent to finding a maximal r_1 such that

$$\mathcal{Y}^\top (P - r_1 I) \mathcal{Y} > 0$$

We apply the Schur complement lemma [81] on the latter nonlinear inequality to obtain the equivalent condition:

$$\begin{pmatrix} \frac{1}{r_1} I & Y & V \\ * & Y & I \\ * & * & X \end{pmatrix} < 0 \quad (4.60)$$

which is linear in $\mu_1 = \frac{1}{r_1}$. Problem (4.59) can now be seen as designing minimal μ_1 such that (4.60) holds along with (4.57), (4.56), (4.58).

On the other hand, for $d = 0$, to maximize the region of attraction, the control parameters should be designed so that \mathcal{R}_c is maximal which implies that $\mathcal{E}(P_{fc}, 1)$ should be maximal.

This goal can be achieved by fixing α_1 , choosing $\gamma = \beta_1$ and considering the following optimization problem

$$\begin{aligned} & \inf_{P, r_2} r_2 \\ \text{s.t. } & (4.57), (4.56), (4.58), (4.41) \text{ hold } P \in \mathbb{S}_p^{2N}, P - r_2 I < 0. \end{aligned} \quad (4.61)$$

In the next section, we consider the design problem of an anti-windup compensator that helps achieve better performance levels for the input-output stability and enlarges the region of attraction evaluated in this section.

4.3 General Set-Up for the Anti-Windup Compensator Synthesis

We introduce an anti-windup compensator to the overall system such that the output of the anti-windup plant is plugged into the dynamics of the control state X_c . Thus, we add an input v_x to system (4.8) for the anti-windup purposes:

$$\begin{aligned} \dot{X}_c &= A_c X_c + B_c y + v_x \\ Y_c &= C_c X_c. \end{aligned} \quad (4.62)$$

The extra input v_x is given in the following simplified direct anti-windup system \mathcal{K}_a presented in [72, Chapter 7] called the direct linear anti-windup design:

$$\begin{aligned} \dot{X}_{aw} &= A_{aw} x_{aw} + B_{aw} (\sigma(Y_c) - Y_c) \\ v_x &= C_{aw} X_{aw} + D_{aw} (\sigma(Y_c) - Y_c). \end{aligned} \quad (4.63)$$

where $X_{aw} \in \mathbb{R}^{2N}$ is the anti-windup state such that the dimension of the anti-windup state X_{aw} is the same as that of X_{fc} and the output of the anti-windup plant Y_{aw} is injected into the dynamics of the controller state ($Y_{aw} = v_x$). The goal is to design suitable anti-windup parameters $A_{aw} \in \mathbb{R}^{2N \times 2N}$, $B_{aw} \in \mathbb{R}^{2N}$, $C_{aw} \in \mathbb{R}^{N \times 2N}$ and $D_{aw} \in \mathbb{R}^N$ so that the origin of system (4.1) in closed loop with (4.62), (4.63) achieves input-output stability

with smaller IOS gain and larger region of attraction. Let $\zeta_a = \begin{pmatrix} w \\ X_c \\ X_{aw} \end{pmatrix}$ such that for all $\zeta_a \in \mathcal{D}(\mathcal{A}) \times \mathbb{R}^N \times \mathbb{R}^{2N}$, the \mathcal{H}_a^1 -norm is defined by

$$\|\zeta_a\|_{\mathcal{H}_a^1} := \sqrt{\|w\|_{\mathcal{H}^1}^2 + X_c^\top X_c + X_{aw}^\top X_{aw}} \quad (4.64)$$

The configuration of the closed-loop dynamics of (4.7), (4.62) and (4.63) can be seen in FIGURE 4.2 and is formerly written as $(\mathcal{P}, \mathcal{K}_c, \mathcal{K}_a)$:

$$\left\{ \begin{aligned} \begin{pmatrix} \dot{W}^N(t) \\ \dot{X}_c(t) \\ \dot{X}_{aw}(t) \end{pmatrix} &= \begin{pmatrix} A_0 & B_1 C_c & 0 \\ B_c C & A_c & C_{aw} \\ 0 & 0 & A_{aw} \\ 0 & b_n C_c & 0 \end{pmatrix} \begin{pmatrix} W^N(t) \\ X_c(t) \\ X_{aw}(t) \end{pmatrix} + \begin{pmatrix} B_1 \\ D_{aw} \\ B_{aw} \end{pmatrix} \phi(Y_c(t)) \\ &+ \begin{pmatrix} B_2 \\ 0 \\ 0 \end{pmatrix} d(t) + \begin{pmatrix} 0 \\ B_c \\ 0 \end{pmatrix} \tilde{y}(t) \\ \dot{w}_n(t) &= (-\lambda_n + q_c) w_n(t) + b_n C_c X_c(t) + b_n \phi(Y_c(t)) + m_n d(t) \quad n \geq N + 1 \\ Y_c(t) &= C_c X_c(t) \\ y(t) &= C W^N(t) + \tilde{y} \end{aligned} \right. \quad (4.65)$$

There are two main issues to tackle in system (4.65) with the anti-windup compensator. The first issue is in the case when $d = 0$ where the goal is to enlarge the region of attraction of the resulting closed-loop system. The second issue is in the case when the energy bounded

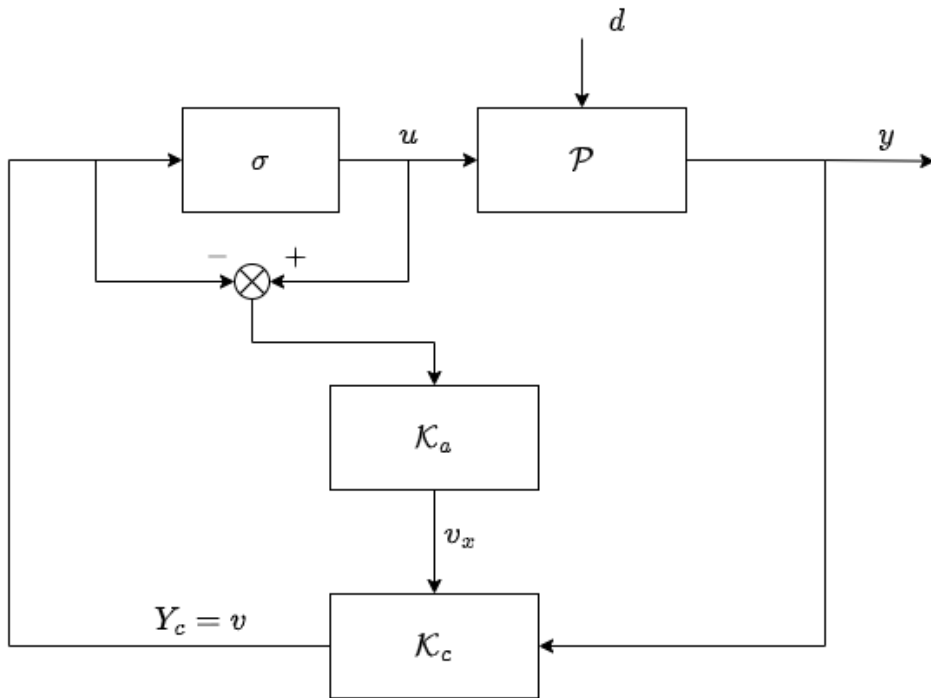

FIGURE 4.2: Closed-loop system $(\mathcal{P}, \mathcal{K}_c, \mathcal{K}_a)$ with anti-windup compensator.

exogenous signal $d \neq 0$ where the goal is to enhance the performance level regarding the input-output stability property discussed before. Mainly, we aim to minimize the IOS gain obtained before as ρ_c . Following the steps done in Section 4.2, we start by estimating the region of attraction and IOS gain for the origin of the finite-dimensional closed-loop system in order to conclude that of the infinite-dimensional system.

We are now able to formally state the second problem we solve in this chapter.

Problem 4.8 Given $p \in \mathcal{C}^2([0, 1])$, $q \in \mathcal{C}^0([0, 1])$ with $p, q > 0$ and $q_c \in \mathbb{R}$. Given the control parameters $\begin{pmatrix} A_c & B_c \\ C_c & 0 \end{pmatrix}$ that solves Problem 4.3. Design the anti-windup parameters $A_{aw}, B_{aw}, C_{aw}, D_{aw}$ such that the following properties hold for system (4.1) in closed loop with (4.62) and (4.63):

- the origin of the closed-loop system is zero-input locally exponentially stable with region of attraction \mathcal{R}_a ,
- for some (solution independent) $\psi_a, v_a, \rho_a > 0$, for each strong solution pair (ζ_a, d) to the closed-loop system, the bound:

$$|y(t)| \leq \psi_a e^{-v_a t} \|\zeta_a(0)\|_{\mathcal{H}_a^1} + \rho_a \sqrt{\int_0^t d(\theta)^2 d\theta} \quad (4.66)$$

holds for all $t \in \mathbb{R}_{\geq 0}$.

Inequality (4.66) corresponds to an input-output stability (IOS) bound for the closed-loop system (4.67). The second contribution of this chapter is to design an anti-windup system \mathcal{K}_a in order to further minimize the effect of the gain ρ_a for $d \neq 0$ and further maximize the region of attraction \mathcal{R}_a for $d = 0$. In the next section, we provide an explicit estimate of the IOS gain ρ_a and the region of attraction \mathcal{R}_a .

4.3.1 Local Stabilization and Estimation of the region of attraction for the Finite-Dimensional Truncation System with Anti-Windup Compensator

Consider the closed-loop finite-dimensional system of (4.6) with output feedback control (4.62) and anti-windup compensator (4.63) such that the first input for the control system (4.62) is now known and given by $y = Y^N = CW^N$. Let the finite state be $X_{fa} := \begin{pmatrix} W^N \\ X_c \\ X_{aw} \end{pmatrix}$. Then, the closed-loop is given as follows:

$$\begin{aligned} \dot{X}_{fa}(t) &= A_{21}X_{fa}(t) + B_{21}\phi(Y_c(t)) + B_{22}d(t) \\ Y_c(t) &= \mathbb{K}_a X_{fa}(t) \end{aligned} \quad \forall t \geq 0 \quad (4.67)$$

where

$$\begin{aligned} A_{21} &= \begin{pmatrix} A_0 & B_1 C_c & 0 \\ B_c C & A_c & C_{aw} \\ 0 & 0 & A_{aw} \end{pmatrix} & B_{21} &= \begin{pmatrix} B_1 \\ D_{aw} \\ B_{aw} \end{pmatrix} \\ B_{22} &= \begin{pmatrix} B_2 \\ 0 \\ 0 \end{pmatrix} & \mathbb{K}_a &= (0 \quad C_c \quad 0). \end{aligned} \quad (4.68)$$

The goal of this section is to evaluate the region of attraction for the zero-input exponential stability of the origin of finite-dimensional unstable system (4.67) in order to later find the region of attraction for the zero-input exponential stability of the origin of the whole infinite-dimensional system (4.65).

4.3.1.1 Input-Output Stability Analysis for the Finite-dimensional System

The next proposition is an already published result in [72, Chapter 7, Page 294].

Proposition 4.9 *Suppose there exist $P_{fa} \in \mathbb{S}_p^{4N}$, $T \in \mathbb{R}_{>0}$, $\mathbf{G}_a \in \mathbb{R}^{1 \times 4N}$, $A_{aw} \in \mathbb{R}^{2N \times 2N}$, $B_{aw} \in \mathbb{R}^{2N}$, $C_{aw} \in \mathbb{R}^{N \times 2N}$, $D_{aw} \in \mathbb{R}^N$ and $\tau_3, \tau_4, \mu \in \mathbb{R}_{>0}$ such that:*

$$\begin{pmatrix} A_{21}^\top P_{fa} + P_{fa} A_{21} + \tau_3 P_{fa} & P_{fa} B_{21} - \mathbf{G}_a^\top T & P_{fa} B_{22} \\ * & -2T & 0 \\ * & * & -\tau_4 \end{pmatrix} \leq 0 \quad (4.69)$$

$$\begin{pmatrix} P_{fa} & \mathbb{K}_a^\top - \mathbf{G}_a^\top \\ * & \bar{u}_l^2 \end{pmatrix} \geq 0 \quad (4.70)$$

$$-\tau_4 \xi^{-1} + \tau_3 < \mu \quad (4.71)$$

Then, we have the following:

- for $d = 0$, the ellipsoid $\mathcal{E}(P_{fa}, 1)$ is a region of attraction for the local exponential stability of the origin of the saturated system (4.13).
- for any $d \in \mathcal{S}$ and $X_{fa}(0) \in \mathcal{E}(P_{fa}, 1)$, the trajectories of the saturated system (4.13) do not leave the ellipsoid $\mathcal{E}(P_{fa}, 1)$.

Proof. We follow the same proof provided for Proposition 4.4 □

4.3.2 Local Stabilization and Estimation of the region of attraction for the Overall Infinite-Dimensional System with Anti-Windup compensator

As done in Section 4.2, we prove that the region of attraction of the infinite-dimensional equation in closed loop with the control dynamics and the anti-windup compensator boils

down to the estimation of the region of attraction for the finite unstable system (4.67). This is guaranteed in the next proposition.

Proposition 4.10 *Assume $A_{aw}, B_{aw}, C_{aw}, D_{aw}$ are chosen such that the the origin of finite-dimensional system (4.67) is zero-input locally exponentially stable with region of attraction $\mathcal{E}(P_{fc}, 1)$ given in Proposition 4.12. Then:*

- *the origin of system (4.65) is zero-input locally asymptotically stable with region of attraction $\mathcal{E}(P_{fa}, 1) \times \mathfrak{h}_{j \geq N+1}^1$,*
- *the origin of system (4.1) with feedback (4.62) and (4.63) is zero-input locally asymptotically stable with region of attraction $H_N^\perp \times \iota(\mathcal{E}(P_{fa}, 1))$,*
- *for any $d \in \mathcal{S}$ and $\zeta_a(0) \in H_N^\perp \times \iota(\mathcal{E}(P_{fa}, 1))$, the trajectories of the saturated system (4.11) do not leave the region.*

Proof. We follow the same proof provided for Proposition 4.5. □

We propose a second Lyapunov method to solve Problem 4.8.

4.3.2.1 Input-Output Lyapunov Stability Analysis for the Overall System with Saturated Control and Anti-windup compensator

4.3.2.1.1 Sufficient Conditions

The following section presents sufficient conditions for the solution to Problem 4.8. The result relies on an exponential dissipation inequality. This is done by proving the following proposition:

Proposition 4.11 *Assume there exist a Fréchet differentiable functional $V: \mathcal{H}^1(0, 1; \mathbb{R}) \times \mathbb{R}^N \times \mathbb{R}^{2N} \rightarrow \mathbb{R}_{\geq 0}$ and $c_1, c_2, c_3, \chi \in \mathbb{R}_{>0}$ such that for each $d \in \mathcal{S}$ and $\zeta_a \in \mathcal{R}_a \subset \mathcal{D}(\mathbf{A})$, a sublevel set of V , then the following hold:*

$$c_1 \|\zeta_a\|_{\mathcal{H}_a^1}^2 \leq V(\zeta_a) \leq c_2 \|\zeta_a\|_{\mathcal{H}_a^1}^2, \quad (4.72)$$

$$DV(\zeta_a)\dot{\zeta}_a \leq -c_3 V(\zeta_a) + \chi^2 d^2. \quad (4.73)$$

Then, the origin of the closed-loop system (4.67) is zero-input locally exponentially stable with region of attraction \mathcal{R}_a and (4.66) holds with

$$\rho_a = \frac{\chi}{\sqrt{c_1}} \quad (4.74)$$

Proof. We follow the proof provided for Proposition 4.6. □

4.3.2.1.2 Construction of the functional V_a

The next theorem provides the sufficient conditions for local exponential stability under the form of quadratic matrix inequalities. Let

$$B_{23} = \begin{pmatrix} 0 \\ B_c \\ 0 \end{pmatrix}$$

$$A_{22} = \begin{pmatrix} 0 & 0 & 0 \\ 0 & \alpha_2 \|b\|^2 C_c^\top C_c & 0 \\ 0 & 0 & 0 \end{pmatrix}$$

Theorem 4.12 Suppose there exist $P_a \in \mathbb{S}_p^{4N}$, $T_a \in \mathbb{R}_{>0}$, $\mathbf{G}_a \in \mathbb{R}^{1 \times 4N}$, $A_{aw} \in \mathbb{R}^{2N \times 2N}$, $B_{aw} \in \mathbb{R}^{2N}$, $C_{aw} \in \mathbb{R}^{1 \times 2N}$ and $\alpha_2, \beta_2, \gamma, \mu \in \mathbb{R}_{>0}$ such that:

$$\begin{pmatrix} A_{21}^\top P_a + P_a A_{21} + \tau_3 P_a + A_{22} & P_a B_{21} - \mathbf{G}_a^\top T_a & P_a B_{22} & P_a B_{23} \\ * & \alpha_2 \|b\|_{\mathcal{L}^2}^2 - 2T_a & 0 & 0 \\ * & * & \alpha_2 \|m\|_{\mathcal{L}^2}^2 - \tau_4 & 0 \\ * & * & * & -\beta_2 \end{pmatrix} \leq 0 \quad (4.75)$$

$$\begin{pmatrix} P_a & \mathbb{K}_a^\top - \mathbf{G}_a^\top \\ * & \bar{u}_l^2 \end{pmatrix} \geq 0 \quad (4.76)$$

$$-\tau_4 \xi^{-1} + \tau_3 < \mu \quad (4.77)$$

Select N sufficiently large such that for all $n \geq N + 1$

$$\Gamma_n := \lambda_n \left(-\lambda_n + q_c + \tau_3 + \frac{3}{\alpha_2} + \frac{\beta_2}{2\gamma} M_\phi \right) \leq 0. \quad (4.78)$$

Then, the parameters $A_{aw}, B_{aw}, C_{aw}, D_{aw}$ solve Problem 4.8. In particular, (4.66) holds with:

$$\rho_a = \frac{\sqrt{2\tau_4}}{\sqrt{\min\{\lambda_{\min}(P_a), \gamma p^*, \gamma q^*\}}} . \quad (4.79)$$

The region of attraction \mathcal{R}_a is given by $H_N^\perp \times \iota(\mathcal{E}(P_a, 1))$.

Proof. Consider $P \in \mathbb{S}_p^{4N}$, $\gamma > 0$, and $X_{fa} := (W^N, u, X_c)$. Consider the following Fréchet differentiable Lyapunov functional:

$$V_a: \mathcal{H}^1(0, 1; \mathbb{R}) \times \mathbb{R}^N \times \mathbb{R}^{2N} \rightarrow \mathbb{R} \\ \begin{pmatrix} w \\ X_c \\ X_{aw} \end{pmatrix} \mapsto X_{fa}^\top P_a X_{fa} + \gamma \sum_{n \geq N+1} \lambda_n \langle w, \Phi_n \rangle^2. \quad (4.80)$$

The first term corresponds to the dynamics of the truncated model (4.6), the control model (4.62) and the anti-windup model (4.63), while the second term, which is related to the \mathcal{H}^1 -norm of the PDE trajectories, is used to handle the modes w_n for $n \geq N$. Condition (4.72) holds for $c_1 := \min\{\lambda_{\min}(P_a), \gamma p^*, \gamma q^*\}$ and $c_2 := \max\{\lambda_{\max}(P_a), \gamma p^*, \gamma q^*\}$ which are strictly positive. Consider the first term of the functional V_a :

$$V_1(X_{fa}) := X_{fa}^\top P_a X_{fa} \quad (4.81)$$

Derive the Lyapunov functional $V_1(X_{fa})$ along the trajectories of the closed-loop system (4.65). Then, we obtain

$$DV_1(X_{fa})\dot{X}_{fa} = X_{fa}^\top (A_{21}^\top P_a + P_a A_{21}) X_{fa} + \phi^\top B_{21}^\top P_a X_{fa} + d^\top B_{22}^\top P_a X_{fa} + X_{fa}^\top P_a B_{21} \phi + X_{fa}^\top P_a B_{22} d \\ + \tilde{y}^\top B_{23}^\top P_a X_{fa} + X_{fa}^\top P_a B_{23} \tilde{y}. \quad (4.82)$$

We obtain the computation of the time derivative of V_1 along the solution to (4.7):

$$DV_1(X_{fa})\dot{X}_{fa} = \begin{pmatrix} X_{fa} \\ d \\ \tilde{y} \\ \phi \end{pmatrix}^\top \begin{pmatrix} A_{21}^\top P_a + P_a A_{21} & P_a B_{21} & P_a B_{22} & P_a B_{23} \\ * & 0 & 0 & 0 \\ * & * & 0 & 0 \\ * & * & * & 0 \end{pmatrix} \begin{pmatrix} X_{fa} \\ d \\ \tilde{y} \\ \phi \end{pmatrix}. \quad (4.83)$$

Let $\mathbf{G}_a = (G_3 \ G_4) \in \mathbb{R}^{2N} \times \mathbb{R}^{2N}$. We can apply lemma 4.1 by choosing $v_1 = \mathbb{K}_a X_{fa}$ and $v_2 = \mathbf{G}_a X_{fa}$ for any $X_{fa} \in \mathcal{G}_a = \{X_{fa} \in \mathbb{R}^{4N}; |\mathbb{K}_a X_{fa} - \mathbf{G}_a X_{fa}| \leq \bar{u}_l\}$ which is guaranteed by the satisfaction of condition (4.76). Thus, the dead-zone nonlinearity $\phi(\mathbb{K}_a X_{fa})$ satisfies:

$$\phi(\mathbb{K}_a X_{fa})^\top T(\phi(\mathbb{K}_a X_{fa}) + \mathbf{G}_a X_{fa}) \leq 0$$

Then, we have the following inequality

$$DV_1(X_{fa})\dot{X}_{fa} - \tau_4 d^\top d \leq DV_1(X_{fa})\dot{X}_{fa} - \tau_4 d^\top d - 2\phi T(\phi(\mathbb{K}_a X_{fa}) + \mathbf{G}_a X_{fa}). \quad (4.84)$$

The rest of the proof mimics the proof of Theorem (4.7). Thus, we obtain that Fréchet differential of the Lyapunov functional (4.80) satisfies the following inequality:

$$\begin{aligned} DV(X_{fa}, w) \begin{pmatrix} \dot{X}_{fa} \\ \dot{w} \end{pmatrix} + \tau_3 V(X_{fa}, w) - \tau_4 d^\top d &\leq \begin{pmatrix} X_{fa} \\ d \\ \tilde{y} \end{pmatrix}^\top \Theta_a \begin{pmatrix} X_{fa} \\ d \\ \tilde{y} \end{pmatrix} \\ + 2\gamma \sum_{n \geq N+1} \lambda_n \left(-\lambda_n + q_c + \tau_3 + \frac{3}{\alpha_2} + \frac{\beta_2}{2\gamma} M_\Phi \right) w_n^2 & \end{aligned} \quad (4.85)$$

where Θ_a is given by the matrix in (4.75). If the conditions (4.75) and (4.78) are satisfied, then (4.31) holds. In addition, if conditions (4.75), (4.77), (4.77), (4.78) are satisfied, the origin of the system (4.1) in closed loop with (4.62) and (4.63) is zero-input locally exponentially stable with region of attraction $H_N^\perp \times \iota(\mathcal{E}(P_a, 1))$. \square

4.3.3 Control Synthesis and Optimization Problems

The quadratic conditions derived in Theorem 4.12 constitute sufficient conditions used to solve Problem 4.8. We notice that the matrix Θ_a in the inequality (4.75) is nonlinear with respect to $P_a, A_{aw}, B_{aw}, C_{aw}, \mathbf{G}_a$ and T_a . Thus, we repeat the same procedure done in Section 4.2.3 to transform the quadratic conditions found in Theorem 4.12 into linear matrix inequalities that can be exploited numerically in order to calculate the anti-windup parameters.

4.3.3.1 Derivation of Linear Matrix Inequalities

Let $S_a = T_a^{-1}$ and let $X_a \in \mathbb{S}_p^{2N}, Y_a \in \mathbb{S}_p^{2N}$ and $U_a, V_a \in \mathbb{R}^{(2N \times 2N)}$ be nonsingular matrices such that $Y_a X_a + V_a U_a^\top = I$. Let $\mathcal{Y}_a = \begin{pmatrix} Y_a & I \\ V_a^\top & 0 \end{pmatrix}$ and $P_a = \begin{pmatrix} X_a & U_a \\ U_a^\top & \bullet \end{pmatrix}$. Under the considered assumptions \mathcal{Y}_a is nonsingular and a simple congruence transformation gives:

$$\begin{pmatrix} \mathcal{Y}_a & 0 & 0 & 0 \\ * & S_a & 0 & 0 \\ * & * & I & 0 \\ * & * & * & I \end{pmatrix}^\top \Theta_a \begin{pmatrix} \mathcal{Y}_a & 0 & 0 & 0 \\ * & S_a & 0 & 0 \\ * & * & I & 0 \\ * & * & * & I \end{pmatrix} < 0$$

implies that

$$\begin{pmatrix} \mathcal{Y}_a^\top (A_{21}^\top P_a + P_a A_{21} + A_{22} + \tau_3 P_a) \mathcal{Y}_a & \mathcal{Y}_a^\top P_a B_{21} S - \mathcal{Y}_a^\top \mathbf{G}_a^\top & \mathcal{Y}_a^\top P_a B_{22} & \mathcal{Y}_a^\top P_a B_{23} \\ * & \alpha_2 \|b\|_{\mathcal{L}^2}^2 S_a^2 - 2S_a & 0 & 0 \\ * & * & \alpha_2 \|m\|_{\mathcal{L}^2}^2 - \tau_4 & 0 \\ * & * & * & -\beta_2 \end{pmatrix} < 0 \quad (4.86)$$

Consider the following change of variable [62]:

$$\begin{pmatrix} K_a & L_a \\ M_a & E_a \end{pmatrix} = \begin{pmatrix} X_a A_{11} Y_a & 0 \\ 0 & 0 \end{pmatrix} + \begin{pmatrix} U_a & X_a \bar{B} \\ 0 & I \end{pmatrix} \begin{pmatrix} A_{aw} & B_{aw} \\ C_{aw} & D_{aw} \end{pmatrix} \begin{pmatrix} V_a^\top & 0 \\ 0 & I \end{pmatrix} \quad (4.87)$$

where $\bar{B} = \begin{pmatrix} 0 \\ I \end{pmatrix}$. In other words:

$$\begin{aligned} K_a &= X A_{11} Y + U A_{aw} V^\top + X \bar{B} C_{aw} V^\top; \\ L_a &= U_a B_{aw} + X_a \bar{B} D_{aw}; \\ M_a &= C_{aw} V^\top; \\ E_a &= D_{aw}. \end{aligned}$$

This transforms the old variables $(P_a, A_{aw}, B_{aw}, C_{aw}, D_{aw})$ into the new variables $\nu = (X_a, Y_a, K_a, L_a, M_a, E)$. Using the change of variable (4.87), it follows that:

$$\begin{aligned} \mathcal{Y}_a^\top (A_{21}^\top P_a + P_a A_{21}) \mathcal{Y}_a &= \hat{A}(\nu)^\top + \hat{A}(\nu); \\ \hat{A}(\nu) &:= \begin{pmatrix} A_{11} Y_a + \bar{B} M_a & A_{11} \\ K_a & X_a A_{11} \end{pmatrix}; \\ \hat{X}(\nu) &:= \mathcal{Y}_a^\top P_a \mathcal{Y}_a = \begin{pmatrix} Y_a & I \\ I & X_a \end{pmatrix}; \\ \hat{B}_1(\nu) &:= \mathcal{Y}_a^\top P_a B_{21} S_a = \begin{pmatrix} \bar{B} D_{aw} \\ X \bar{B} D_{aw} + U_a B_{aw} \end{pmatrix} S_a = \begin{pmatrix} \bar{B} E_a S_a \\ L_a S_a \end{pmatrix} =: \begin{pmatrix} \bar{B} Q_1 \\ Q_2 \end{pmatrix}; \\ \hat{B}_2(\nu) &:= \mathcal{Y}_a^\top P_a B_{22} = \begin{pmatrix} B_{12} \\ X_a B_{12} \end{pmatrix}; \\ \hat{B}_3(\nu) &:= \mathcal{Y}_a^\top P_a B_{23} = \begin{pmatrix} B_{13} \\ X_a B_{13} \end{pmatrix}; \\ \mathbf{Z}(\nu) &:= \mathcal{Y}_a^\top \mathbf{G}_a^\top = \begin{pmatrix} Y G_3^\top + V G_4^\top \\ G_3^\top \end{pmatrix} =: \begin{pmatrix} Z_3 \\ Z_4 \end{pmatrix}. \end{aligned}$$

Thus, inequality (4.86) implies

$$\hat{X}(\nu) > 0 \quad (4.88)$$

and

$$\begin{pmatrix} \hat{A}(\nu)^\top + \hat{A}(\nu) + A_{22} + \tau_3 X(\nu) & \hat{B}_1(\nu) - \mathbf{Z}(\nu) & \hat{B}_2(\nu) & \hat{B}_3(\nu) & 0 \\ & -2S & 0 & 0 & S \\ * & * & \alpha_2 \|m\|_{\mathcal{L}^2}^2 - \tau_4 & 0 & 0 \\ * & * & * & -\beta_2 & 0 \\ * & * & * & * & -\tilde{A}_{12}^{-1} \end{pmatrix} < 0. \quad (4.89)$$

Finally, multiplying (4.76) by \mathcal{Y}_a^\top on the left and \mathcal{Y}_a on the right, we obtain the following linear matrix inequality written in the new variables (4.87):

$$\begin{pmatrix} X & I & Y C_2^\top - Z_3 \\ I & Y & C_2^\top - Z_4^\top \\ * & * & \tilde{u}_1^2 \end{pmatrix} \leq 0 \quad (4.90)$$

where $C_2 = (0 \ C_c)$. Notice here also that the matrix in (4.89) is nonlinear in the terms $X_a, Y_a, \tau_3, \tilde{A}_{12}^{-1}$. As done previously, the nonlinear terms $\tau_3 X_a, \tau_3 Y_a$ and \tilde{A}_{12}^{-1} are considered linear if τ_3 and α_2 are fixed by performing a line search on $\tau_3, \alpha_2 \in \mathbb{R}_{\geq 0}$.

In conclusion, if there exist $X_a, Y_a \in \mathbb{S}_p^{2N}, K_a \in \mathbb{R}^{2N \times 2N}, L_a \in \mathbb{R}^{2N}, M_a^{N \times 2N}, E_a \in \mathbb{R}^N, Z_1 \in \mathbb{R}^{1 \times 2N}, Z_2 \in \mathbb{R}^{1 \times 2N}$ and $\beta_2, \gamma \in \mathbb{R}$ such that (4.88), (4.89), (4.90), (4.77), (4.78) hold, then the solution $(A_{aw}, B_{aw}, C_{aw}, D_{aw})$ to Problem 4.8 is derived using the change of variable in (4.87).

4.3.3.2 Optimization Problems

As done for Section 4.2.3.2, the minimization problem of the effect of the external perturbations on system (4.1) in closed loop with (4.62) and (4.63) boils down to solving the following convex optimization problem:

$$\begin{aligned} &\inf_{P_a, \mu_2} \quad \mu_2 \\ \text{s.t: } & (4.89), (4.88), (4.90), (4.78) \text{ hold } \begin{pmatrix} \mu_2 I & Y_a & V_a \\ * & Y_a & I \\ * & * & X_a \end{pmatrix} < 0 \end{aligned} \quad (4.91)$$

On the other hand, for $d = 0$, the maximization problem of the size of the region of attraction for the local exponential stability of the origin of (4.1) in closed loop with (4.62) and (4.63)

boils down to solving the following convex optimization problem:

$$\begin{aligned} & \inf_{P_a, r_3} r_3 \\ \text{s.t: } & (4.89), (4.88), (4.90), (4.78) \text{ hold } P_a - rI < 0 \end{aligned} \quad (4.92)$$

4.4 Numerical Simulation

In this section, we use the YALMIP package in MATLAB to solve the linear matrix inequalities (4.41), (4.56), (4.57), (4.58) and derive a feasible solution to Problem 4.3. The simulation of the closed loop system without anti-windup (4.11) is presented to graphically display the time evolution of the \mathcal{H}^1 -norm of the state $w(t, z)$ and the norm of the output $y(t)$ in order to validate the ISS and IOS properties proven in this chapter.

Consider (4.1) with $b(z) = m(z) = p(z) = q(z) = 1$ in closed loop with (4.8). We illustrate the result of Section 4.2 using a modal approximation that captures the 50 dominant modes of the reaction-diffusion plant with an in-domain disturbance given by:

$$d(t) = 0.1 \sin(2t)$$

The saturation limit $\bar{u}_l = 2$. Choose $q_c = 4$ such that the open-loop plant is unstable with $N_0 = 1$ and select the dimension of the finite-dimensional controller $N = 3$. Fix $\alpha_1 = \alpha_2 = 1$. The following control matrices renders (4.41), (4.56), (4.57), (4.58) feasible with optimization goal (4.60).

$$\begin{aligned} A_c &= \begin{pmatrix} -29 & -26 & -33 \\ -4 & -29 & 27 \\ 80 & 83 & -70 \end{pmatrix} \\ B_c &= \begin{pmatrix} -17 \\ -3 \\ 51 \end{pmatrix} \\ C_c &= (5.7 \quad 3.6 \quad -1.35) \end{aligned} \quad (4.93)$$

The initial condition of the reaction-diffusion system described by (4.1) is $w_0(z) = x^2$. For $d \neq 0$, the time-evolution of the states $\|w(z, t)\|_{\mathcal{H}^1}$ and $\|\zeta_c\|_{\mathcal{H}_c^1}$ are depicted in FIGURE 4.3 and FIGURE 4.4 which showcases a convergence to a neighborhood of the origin as predicted in Proposition 4.6 and one can observe the effect of the disturbance at steady state. FIGURE 4.5 demonstrates the decay in the output $y(t)$ verifying the dissipation inequality describing the input-output stability property in Proposition 4.6 with $\rho_c = 3.9$. Finally, FIGURE 4.6 shows the time evolution of the control input $u(t)$ (in blue) under the effect of saturation limitation in comparison with the unsaturated signal $Y_c(t)$ (in red).

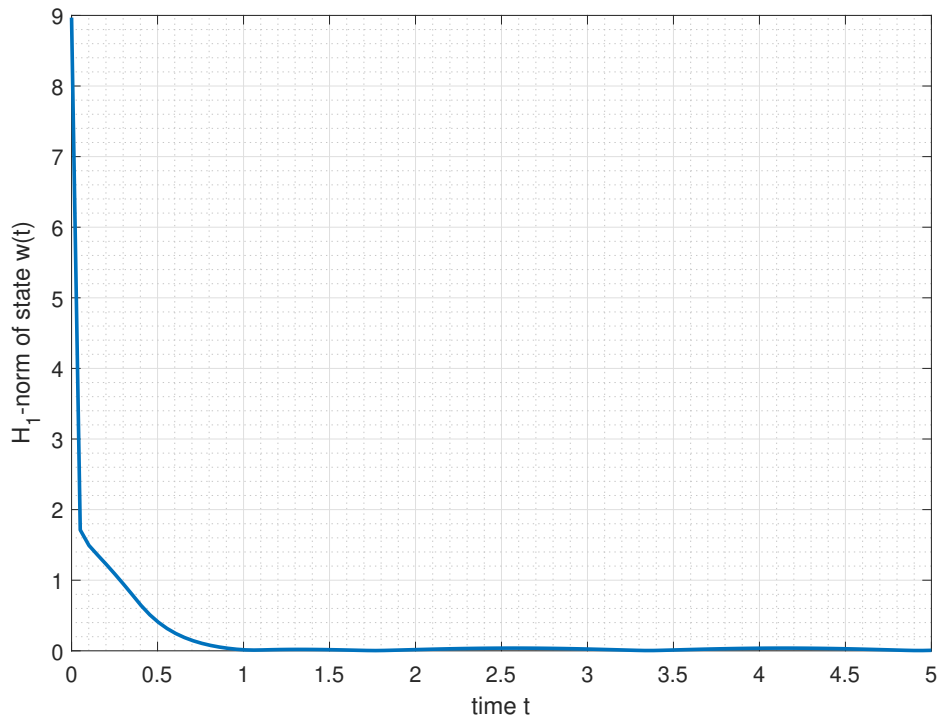

FIGURE 4.3: Time evolution of the \mathcal{H}^1 - norm of the state w in the case without anti-windup.

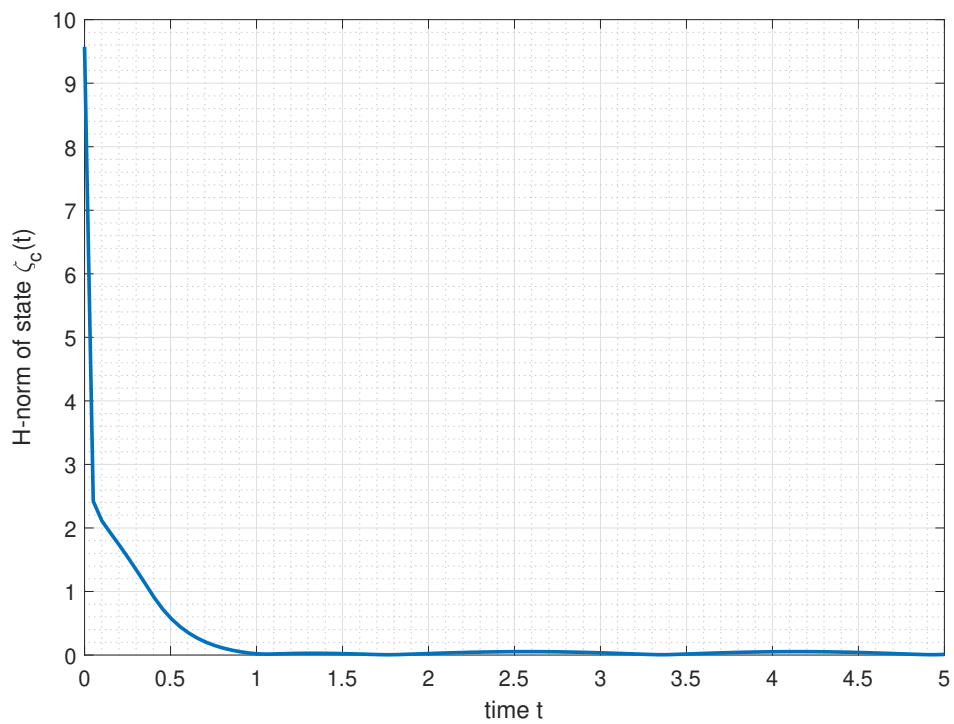

FIGURE 4.4: Time evolution of the \mathcal{H}_c^1 -norm of the state ζ_c in the case without anti-windup.

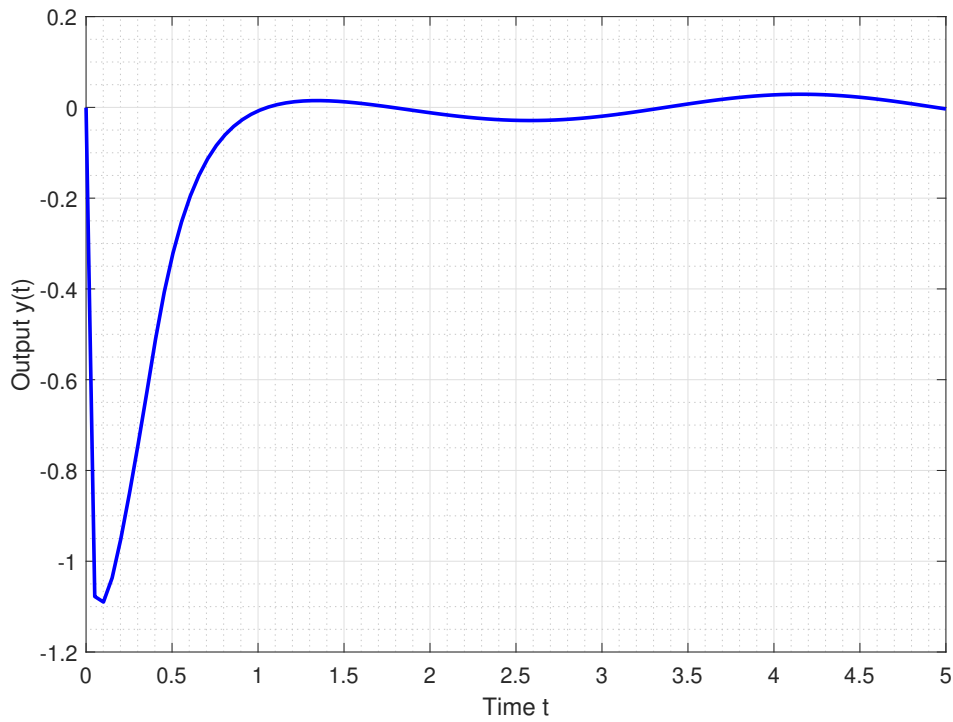

FIGURE 4.5: Time evolution of the output y in the case without anti-windup.

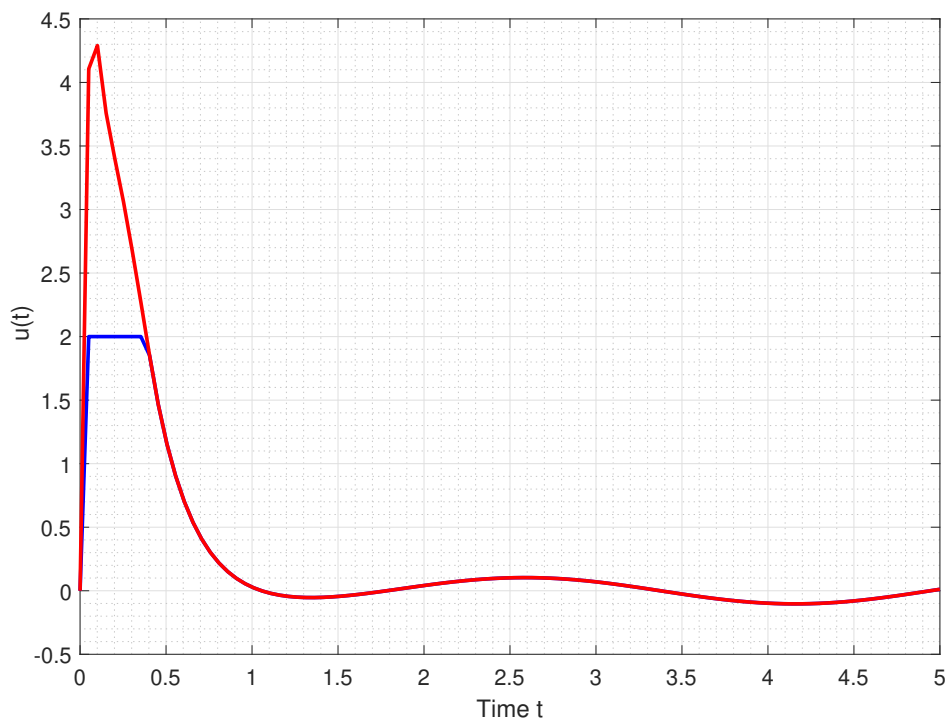

FIGURE 4.6: Time evolution of the saturated control signal u (in blue) vs. the unsaturated control signal $Y_c(t)$ (in red) in the case without anti-windup.

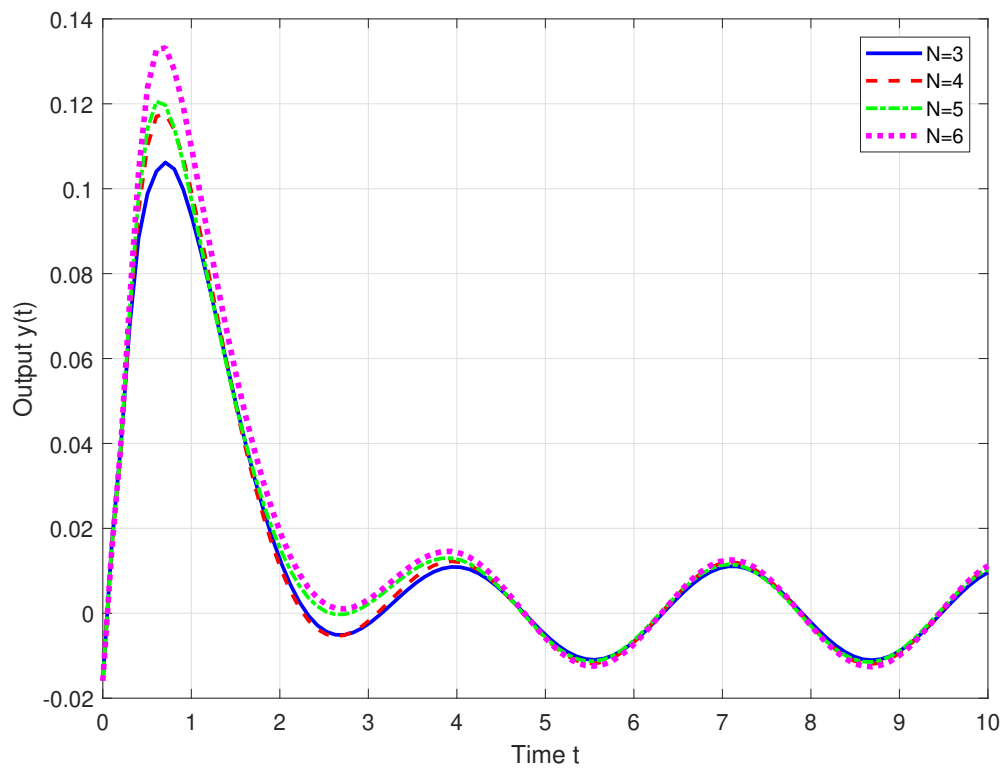

FIGURE 4.7: Output decay for increasing dimension N of the control system.

Now that (A_c, B_c, C_c) are computed, the anti-windup parameters are derived such that (4.78), (4.88), (4.89), (4.90) are satisfied with with optimization goal (4.91):

$$\begin{aligned}
 A_{aw} &= \begin{pmatrix} 0.53 & 0.01 & -0.18 & 5.17 & 3.32 & -1.37 \\ -0.02 & -22 & 5.05 & -1.87 & -1.2 & 0.83 \\ -0.25 & 1.36 & -149 & 1.65 & 1.12 & 1.34 \\ -7.42 & 9.23 & -24 & -1.4 & -24.6 & -33.65 \\ -0.38 & 18.1 & -24.7 & 24.4 & -1.5 & 29 \\ 4.8 & 6.5 & -0.35 & 34 & -27 & -4.6 \end{pmatrix} \\
 B_{aw} &= \begin{pmatrix} -81 \\ -14 \\ 34 \\ -195 \\ -123 \\ 0.46 \end{pmatrix} \\
 C_{aw} &= \begin{pmatrix} -18 & -34 & -12 & -28 & -2 & 0.68 \\ -4 & -23 & 15 & -29 & 0.25 & 1 \\ 67 & 72 & 161 & 46 & 112 & -72 \end{pmatrix} \\
 D_{aw} &= \begin{pmatrix} 197 \\ 124 \\ -49 \end{pmatrix}
 \end{aligned} \tag{4.94}$$

For the same initial conditions and saturation limit, the time-evolution of the states $\|w\|_{\mathcal{H}_1}$ and $\|\zeta_a\|_{\mathcal{H}_c^1}$ are depicted in FIGURE 4.8 and FIGURE 4.9 which showcases a convergence to a neighborhood of the origin as predicted in Proposition 4.11 and one can observe the effect of the disturbance at steady state. FIGURE 4.10 demonstrates the decay in the output $y(t)$ verifying the dissipation inequality describing the input-output stability property in Proposition 4.11 with $\rho_a = 1.3$. Finally, FIGURE 4.6 shows the time evolution of the control input $u(t)$ coinciding with the unsaturated signal $Y_c(t)$ (in red).

One can obviously see a better performance level for the Input-output stability gain after the anti-windup compensator to the closed-loop system when comparing FIGURE 4.5 with FIGURE 4.10. This is validated also by:

$$\rho_a < \rho_c.$$

For $d = 0$, we re-do the simulations for the optimization goals (4.61) and (4.92) respectively. The numerical results gives:

$$\lambda_{\max}(P) = 30 > \lambda_{\max}(P_a) = 25$$

Thus, the region of attraction for the local exponential stability of the origin of the closed-loop system without anti-windup is smaller than that with anti-windup.

Therefore, the addition of the dynamic anti-windup clearly benefits the system requirements in terms of performance level and region of attraction.

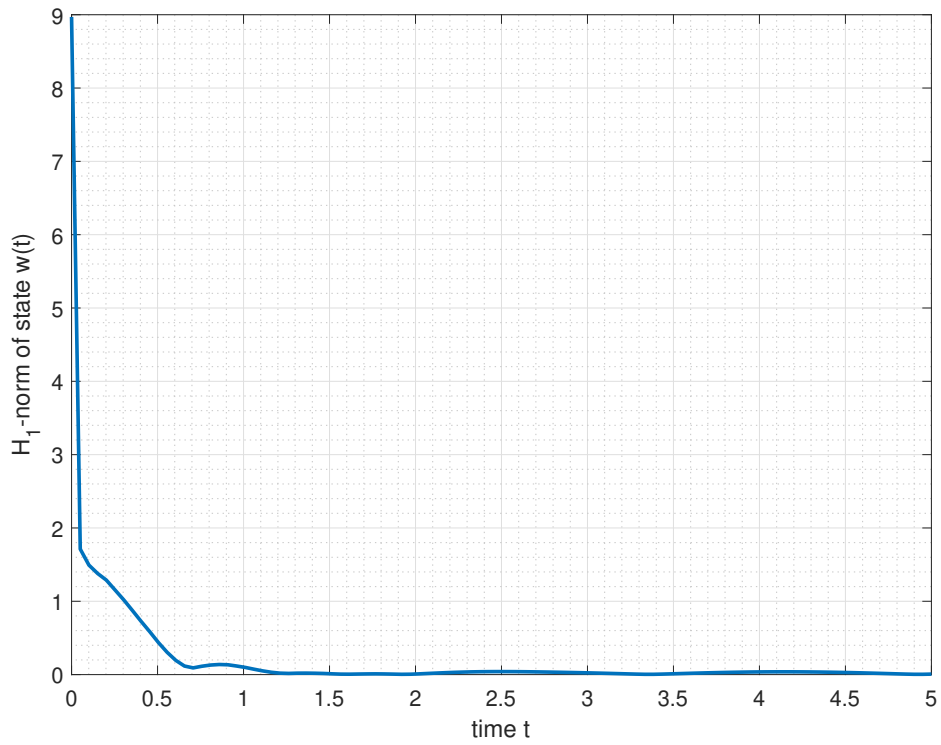

FIGURE 4.8: Time evolution of the \mathcal{H}^1 - norm of the state $w(t, \cdot)$ in the case with anti-windup.

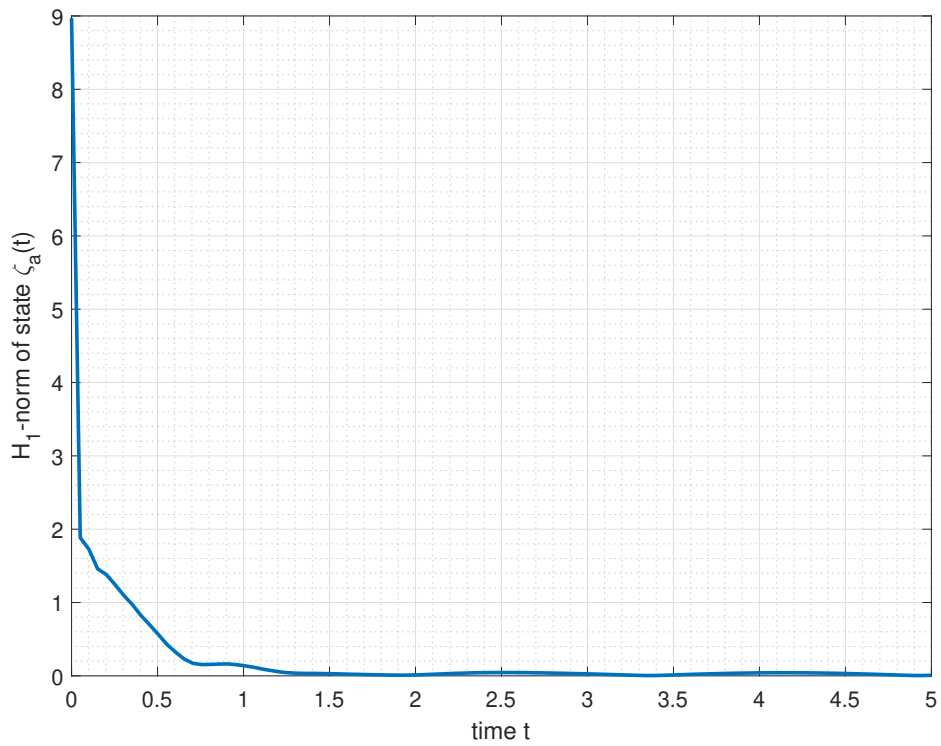

FIGURE 4.9: Time evolution of the \mathcal{H}_a^1 - norm of the state $\zeta_a(t, \cdot)$ in the case with anti-windup.

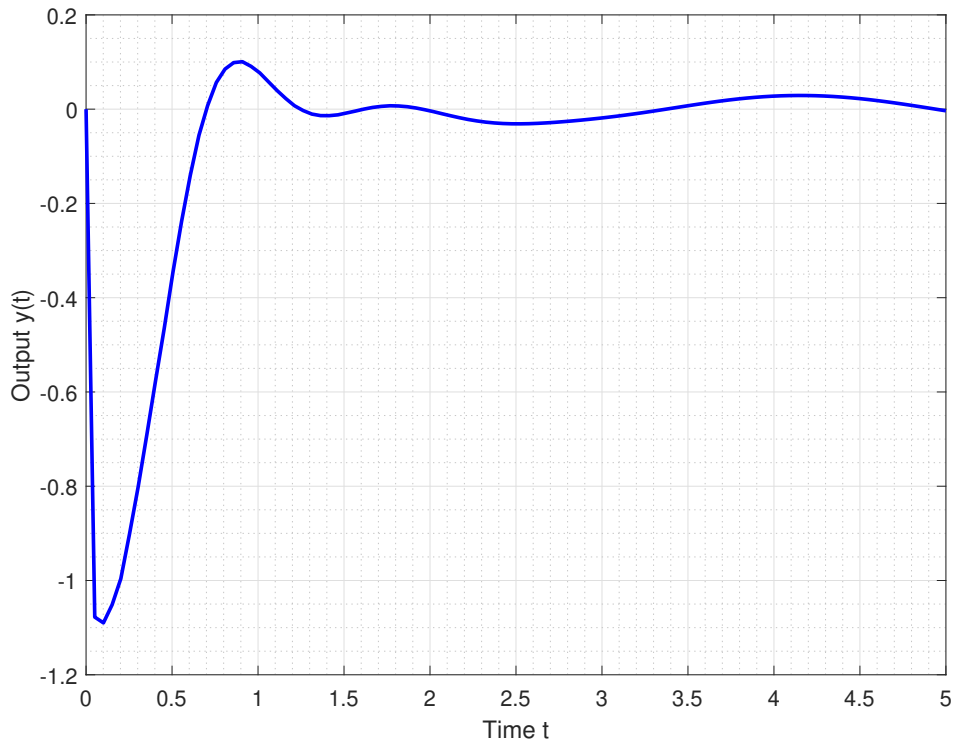

FIGURE 4.10: Time evolution of the output $y(t)$ in the case without anti-windup.

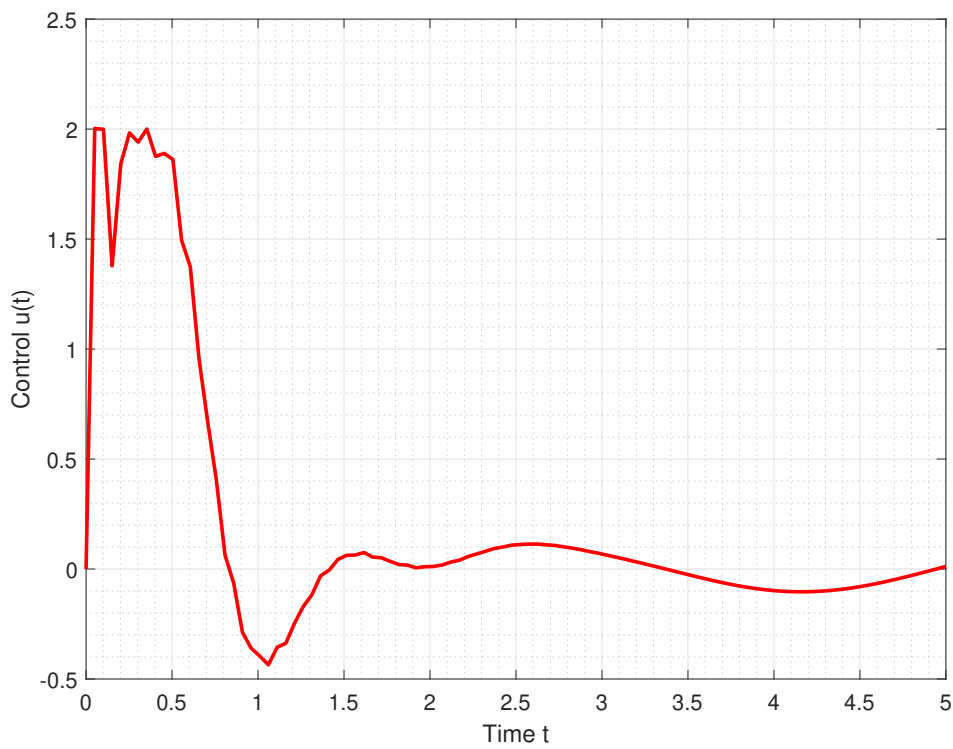

FIGURE 4.11: Time evolution of the saturated control signal $u(t)$ and unsaturated control signal $Y_c(t)$ (coincide) in the case anti-windup.

Consider now another example where $N = 3$, $\bar{u}_l = 1$ and the initial condition $w_0(z) = 4(\cos(z) + 1)$. FIGURE 4.12 shows that the output $y(t)$ diverges when there is no anti-windup compensator. FIGURE 4.13 shows a converging output $y(t)$ when anti-windup is considered with control input $u(t)$ given in FIGURE 4.14. This further illustrates the importance of using such configuration when we have saturation limitations.

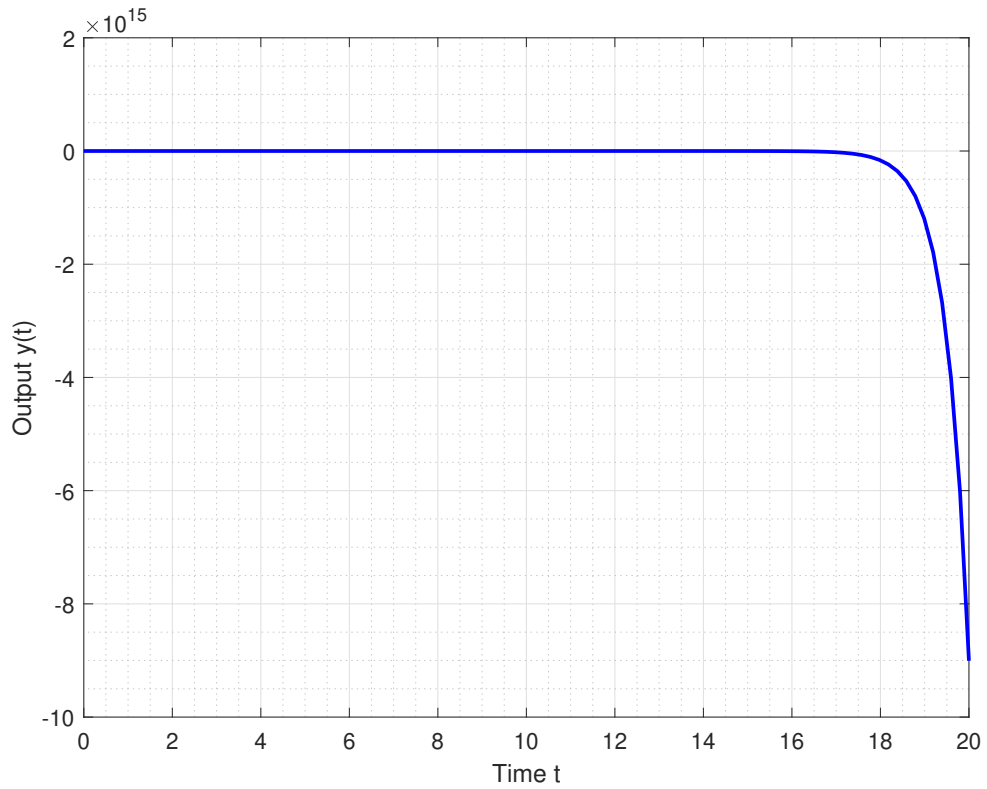
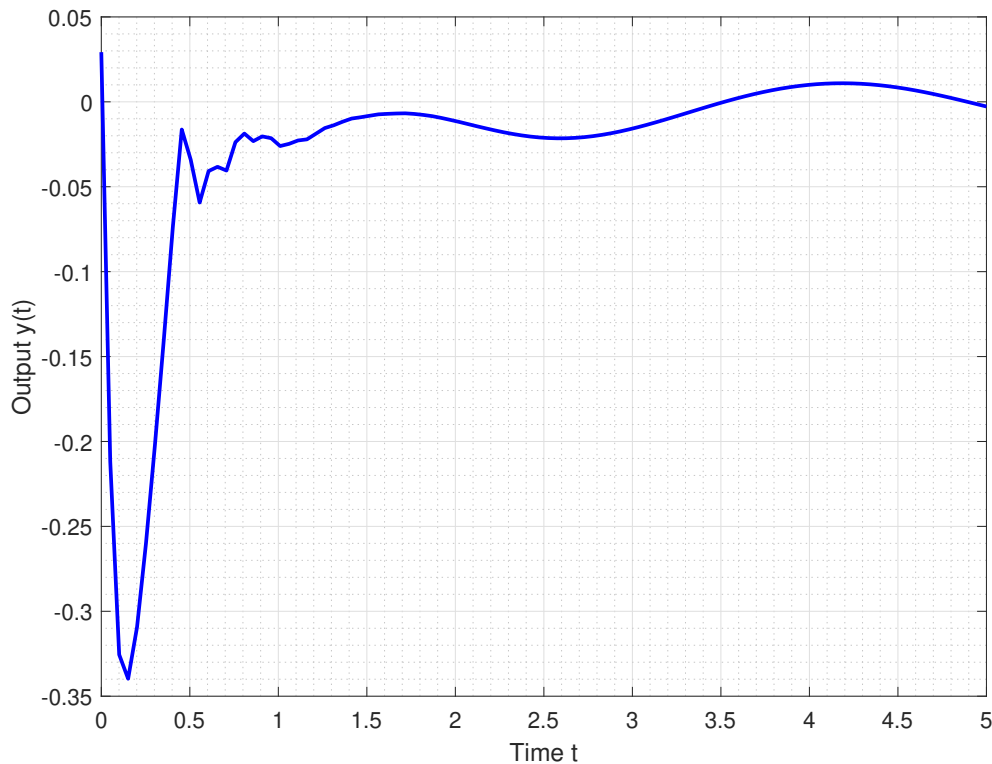

FIGURE 4.12: Output $y(t)$ with no anti-windup.

FIGURES 4.15, 4.16, 4.17 shows the different output and control responses for different dimensions of controllers.

FIGURE 4.13: Output $y(t)$ with anti-windup.

4.5 Conclusion

In this chapter, the stabilization problem of a linear unstable reaction-diffusion equation has been studied using Lyapunov stability theory. The control input is under saturation limitation and an output feedback dynamic control system has been introduced to drive the origin of the closed-loop system into local exponential stability. The region of attraction of the closed-loop infinite-dimensional system has been evaluated by proving that it basically depends on the region of attraction of the finite-dimensional system consisting of the finite unstable truncation model in closed loop with the output feedback control dynamics. Sufficient conditions in the form of linear matrix inequalities have been found for the design of the appropriate control parameters.

After the control parameters were designed and given, an anti-windup compensator has been added to the closed-loop system in order to improve the performance level of the overall system. The stability analysis is done again to derive the new sufficient conditions and region of attraction for the local exponential stability of the origin of the new closed-loop system.

The efficiency and interest in the anti-windup approach have been illustrated in numerical results which clearly shows the decrease in the input-output stability gain and the increase in the size of the region of attraction after introducing an anti-windup compensator.

In the next chapter, we present a summary for the whole thesis and offer some perspective for future research extensions.

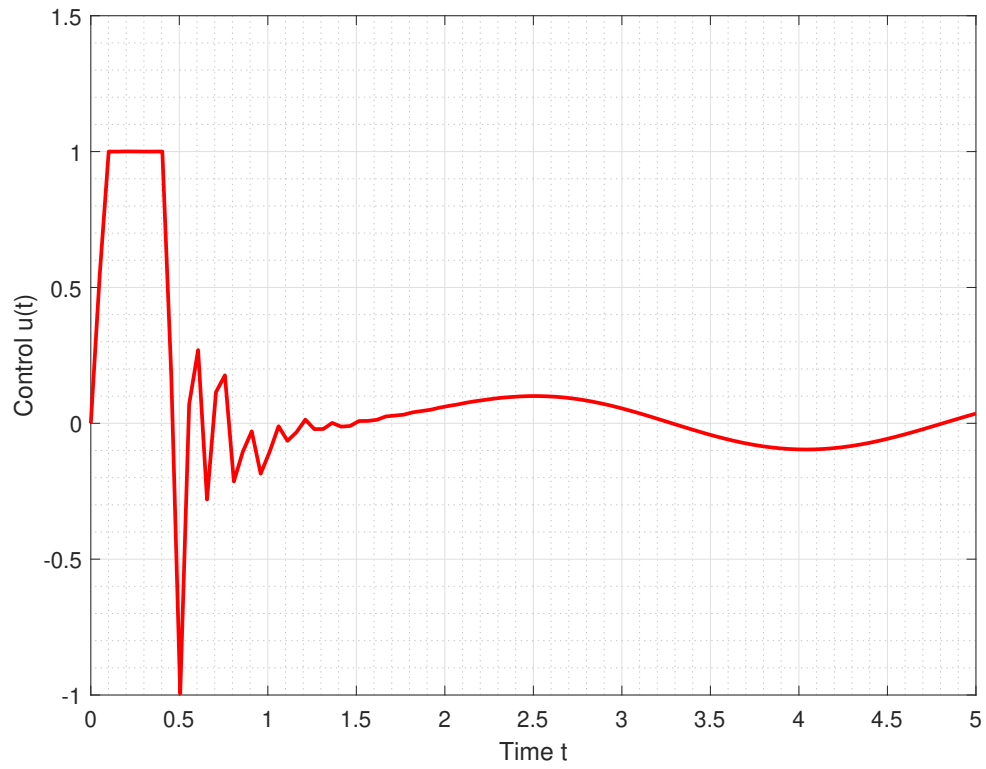

FIGURE 4.14: Control input $u(t)$ with anti-windup.

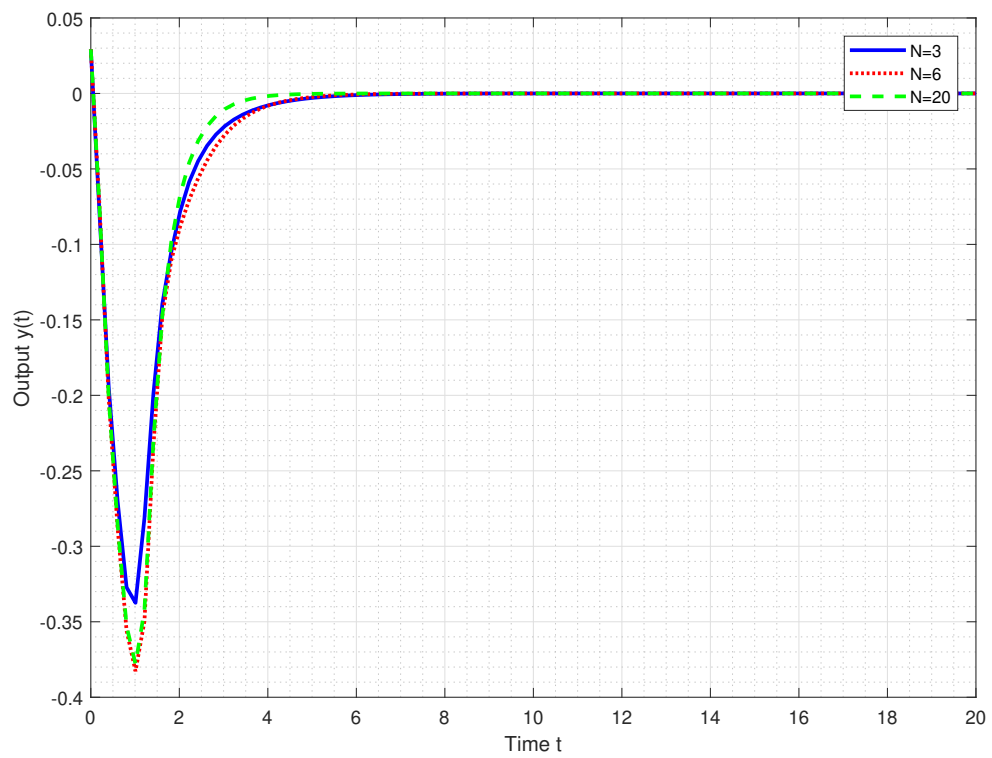
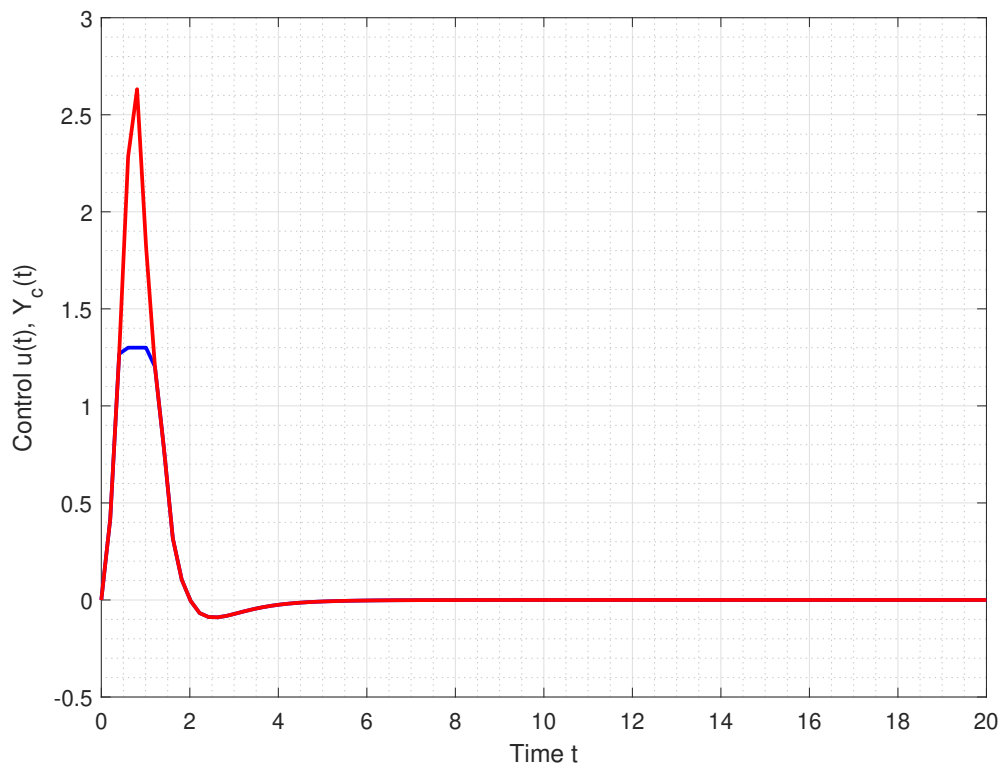
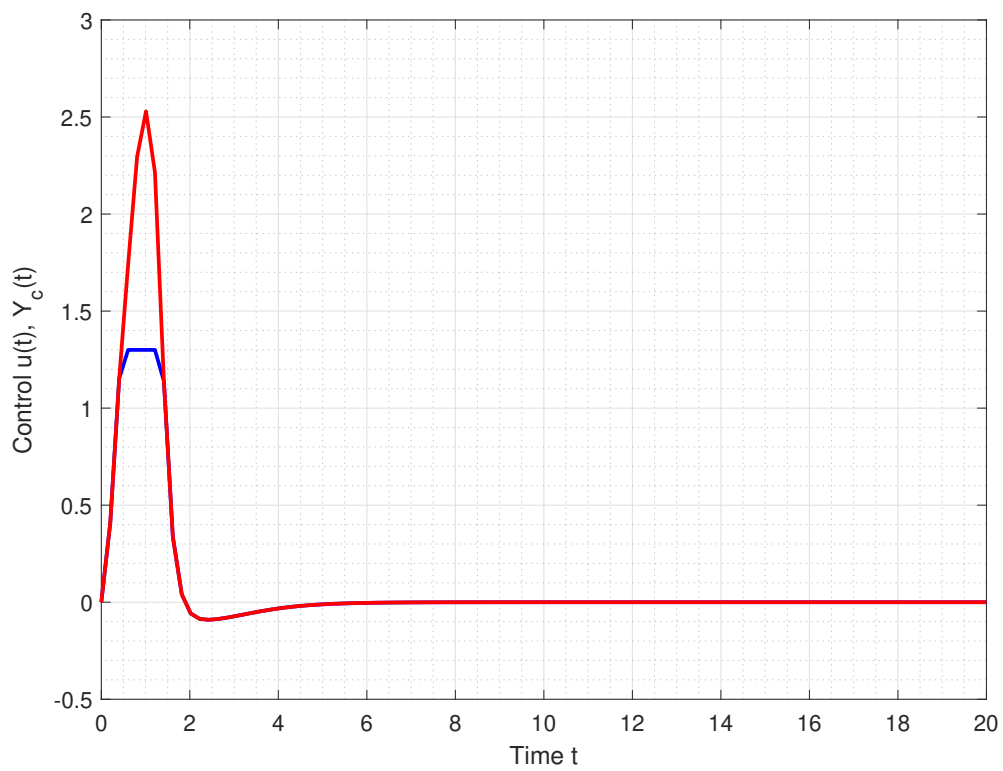

FIGURE 4.15: Output $y(t)$ for different dimensions of controller.

FIGURE 4.16: $u(t)$ and $Y_c(t)$ for $N = 3$ FIGURE 4.17: $u(t)$ and $Y_c(t)$ for $N = 6$

Chapter 5

Conclusion and Perspectives

The thesis investigated the stabilization and control design problems of partial differential equations using control signals that might be subjected to saturation constraints. The various problems we solved are: well-posedness Cauchy problem, boundary control design, distributed control design, and anti-windup design problems; all in the context of infinite dimensional systems. The main tools used to solve those problems are nonlinear semigroup theories, Lyapunov stability theory and linear matrix inequality techniques. The applications of the presented approaches are interesting from a practical and theoretical point of views.

In all chapters, we have tackled issues related to ensuring system stability (either input-to state stability or input-output stability) using state feedback or output feedback control laws. The magnitude constraints imposed on the boundary and distributed controls under the form of saturation functions led to stability problems. In particular, saturated control not only restricts the initial conditions of the system state into being close to zero but also threatens the well-posedness of the boundary value problem. We used nonlinear semigroup theories to prove the existence and uniqueness of solutions to the partial differential equation with the nonlinear saturation function at the boundary. We have used Lyapunov methods to ensure exponential decay of the energy of the system over time. We have used both \mathcal{L}^2 and \mathcal{H}^1 Lyapunov functional to mathematically provide sufficient conditions for the exponential decay of the system state or of the regulated output. In this thesis, when we talk about global stability results, either the system is open-loop stable or the control is not constrained. For local stability results, we used local sector conditions and Lyapunov functions to derive the appropriate region of attraction for the stability of the system. Finally, for all the systems studied, we presented ISS or IOS stability gains with respect to the in-domain disturbances. In what follows, we summarize the problems solved in each chapter and provide future insight and perspectives to the topics presented.

5.1 Main Contributions and Perspectives for Hyperbolic Systems

The first chapter solves two problems. We focused on the study of an open-loop stable one-dimensional transport equation with a saturation at the boundary and perturbation in the domain.

The first problem is proving that the boundary value problem is well-posed. We proved that the unbounded operator that governs the system is non-accretive and that its range is equal to the space on which the state is defined. By using the general theory of nonlinear m -accretive operators in Banach spaces, we deduced the existence of mild solution pairs to the Cauchy problem. The second challenge solved was proving that the mild solution pair can be approximated by a sequence of strong solution pairs in order to be able to carry out the Lyapunov stability analysis.

At this point we were able to solve the second problem in this chapter. The sufficient conditions for the global exponential stability of the origin of the system were derived using Lyapunov stability theory. This analysis revealed an input-to-state stability bound to the closed-loop state. By the help of the global sector condition, an \mathcal{L}^2 Lyapunov functional, and Schur complement lemma, the sufficient conditions were rewritten under the form of

linear matrix inequalities, which led to numerically affordable tests. Finally, an optimization problem was solved in order to reduce the effect of the disturbance on the ISS property.

For the numerical analysis, we presented an application on a scalar system of the transport equation. We prove that the satisfaction of the sufficient conditions, which were derived with an \mathcal{L}^2 Lyapunov function, requires the open-loop stability property. Finally, some numerical simulations were carried out to illustrate the efficiency and interest of our approach and display the input-to-state stability result.

5.1.1 Perspectives

Chapter 2 opens the horizon for some interesting questions. In particular, one can extend the research towards other classes of Lyapunov functions, as those considered in [1] and to compare the consequent constraints with those present in Theorem 2.2. One can also consider the extension of this application to the design of an observer and an anti-windup compensator. Another interesting extension is introducing uncertainties in the domain or boundary and design a control strategy with robust properties. Finally, one can consider other class of nonlinearity such as backlash operator as considered in [73].

5.2 Main Contributions and Perspectives for Parabolic Systems

5.2.1 Unconstrained Control Problem

The third chapter solves the output feedback boundary control problem for a reaction-diffusion equation with Dirichlet boundary conditions to achieve input-output stability results globally. In this chapter, the control input was not saturated. The main interest was considering an open-loop unstable plant. In particular, the system in question admitted a finite number of unstable poles, which is not usually considered in the literature of controlling reaction diffusion equations (where marginal stability holds for open-loop systems). In addition, the system was assumed to be affected by an in-domain disturbance. Through a standard change of variable, the system was transformed into a homogeneous parabolic partial differential equation. The proposed control design strategy was based on a partition of the overall system into a unstable finite ODE system and an stable infinite-dimensional system using eigenfunction projections. Then, the partitioned systems were put in closed loop with a finite-dimensional linear time-invariant control plant whose output is plugged into the boundary of the system. Using Lyapunov stability methods, sufficient conditions in the form of matrix inequalities for input-output stability of the reaction-diffusion plant with respect to in-domain disturbances, were derived. Using an appropriate change of variable, we provided LMIs and an appropriate algorithm to effectively choose the dimension of the controller and to design the control parameters required to solve the problem defined. A numerical example was presented to illustrate the effectiveness of our approach and to highlight the strategic choice of the dimension of the controller.

5.2.2 Constrained Control Problem

The first problem that was solved in Chapter 4 was the stabilization problem of a linear unstable reaction-diffusion equation using a saturated distributed control. As done in the previous chapter, coefficients of projections were used to rewrite the system into a finite unstable part and an infinite stable part. The control input signal was given by the output feedback dynamic control system which was designed to achieve closed-loop local exponential stability of the origin. The region of attraction of the closed-loop infinite dimensional system has been evaluated by proving that it mainly depends on the region of attraction of the projected finite dimensional system in closed loop with the output feedback control dynamics. Using Lyapunov stability theory, sufficient conditions in the form of matrix inequalities have been presented for local exponential input-output stability of the origin of the closed-loop system.

The second problem we solved in this chapter, was the design of an anti-windup compensator for the infinite dimensional system, which was the first time done in the context of distributed parameter systems. The intention behind this addition was to maintain the previous local stability properties and enhance the performance levels as well as enlarge the region of attraction of the closed-loop system. Stability analysis was carried out to derive new sufficient conditions and an estimate of the region of attraction for local exponential stability of the origin of the new closed-loop system.

The efficiency and interest in the anti-windup approach have been illustrated in numerical results, which clearly show the decrease in the input-output stability gain and the increase in the size of the region of attraction after introducing an anti-windup compensator. It also highlights the strategic choice of the order of the finite dimensional controller and that of the anti-windup to deal with the suboptimal control design issues.

5.2.3 Perspectives

It would be interesting to consider other classes of Lyapunov functions than the ones considered in this study and to compare the associated regions of attractions and stability gains. It also opens extension to saturated boundary control design for the local input-to-state stability problem. In addition, the observer design problem for the reaction diffusion system with distributed saturated control is a possible future research topic. Finally, one can study the problem of limited information control as considered in [24], for example.

Bibliography

- [1] Mohamadreza Ahmadi, Giorgio Valmorbida, and Antonis Papachristodoulou. Dissipation inequalities for the analysis of a class of pdes. *Automatica*, 66:163–171, 2016.
- [2] Fatiha Alabau-Boussouira. On some recent advances on stabilization for hyperbolic equations. *Control of partial differential equations*, pages 1–100, 2012.
- [3] Fuensanta Andreu-Vaillo, Vicent Caselles, and José M Mazón. *Parabolic quasilinear equations minimizing linear growth functionals*, volume 223. Springer Science & Business Media, 2004.
- [4] Mark J Balas. Feedback control of linear diffusion processes. *International Journal of Control*, 29(3):523–534, 1979.
- [5] Mark J Balas. Finite-dimensional control of distributed parameter systems by galerkin approximation of infinite dimensional controllers. *Journal of mathematical analysis and applications*, 114(1):17–36, 1986.
- [6] Viorel Barbu. *Nonlinear semigroups and differential equations in Banach spaces*. Springer, 1976.
- [7] Viorel Barbu. *Nonlinear differential equations of monotone types in Banach spaces*. Springer Science & Business Media, 2010.
- [8] Blake Barker, Soyeun Jung, and Kevin Zumbrun. Turing patterns in parabolic systems of conservation laws and numerically observed stability of periodic waves. *Physica D: Nonlinear Phenomena*, 367:11–18, 2018.
- [9] G Barles, C Georgelin, and PE Souganidis. Front propagation for reaction–diffusion equations arising in combustion theory. *Asymptotic Analysis*, 14(3):277–292, 1997.
- [10] Georges Bastin and Jean-Michel Coron. *Stability and boundary stabilization of 1-d hyperbolic systems*, volume 88. Springer, 2016.
- [11] Mostafa Bendahmane and Michel Langlais. A reaction-diffusion system with cross-diffusion modeling the spread of an epidemic disease. *Journal of Evolution Equations*, 10(4):883–904, 2010.
- [12] William E Boyce, Richard C DiPrima, and Douglas B Meade. *Elementary differential equations and boundary value problems*. John Wiley & Sons, 2021.
- [13] Haim Brezis. *Functional analysis, Sobolev spaces and partial differential equations*. Springer Science & Business Media, 2010.
- [14] DK Callebaut. Generalization of the cauchy-schwarz inequality. *Journal of mathematical analysis and applications*, 12(3):491–494, 1965.
- [15] V Capasso and Lucia Maddalena. Convergence to equilibrium states for a reaction-diffusion system modelling the spatial spread of a class of bacterial and viral diseases. *Journal of Mathematical Biology*, 13(2):173–184, 1981.
- [16] Eugênio B Castelan, Sophie Tarbouriech, and Isabelle Queinnec. Control design for a class of nonlinear continuous-time systems. *Automatica*, 44(8):2034–2039, 2008.
- [17] Juan Chen, Baotong Cui, and YangQuan Chen. Backstepping-based boundary control design for a fractional reaction diffusion system with a space-dependent diffusion coefficient. *ISA transactions*, 80:203–211, 2018.

- [18] Panagiotis D Christofides and James Baker. Robust output feedback control of quasi-linear parabolic pde systems. *Systems & Control Letters*, 36(5):307–316, 1999.
- [19] Ruth Curtain and Hans Zwart. *Introduction to infinite-dimensional systems theory: a state-space approach*, volume 71. Springer Nature, 2020.
- [20] Ruth F Curtain. Equivalence of input-output stability and exponential stability for infinite-dimensional systems. *Mathematical systems theory*, 21(1):19–48, 1988.
- [21] Cédric Delattre, Denis Dochain, and Joseph Winkin. Sturm-liouville systems are riesz-spectral systems. *International Journal of Applied Mathematics and Computer Science*, 13(4):481–484, 2003.
- [22] Mathias Dus, Francesco Ferrante, and Christophe Prieur. On \mathcal{L}^∞ stabilization of diagonal semilinear hyperbolic systems by saturated boundary control. *ESAIM: Control, Optimisation and Calculus of Variations*, 26:23, 2020.
- [23] Nael H El-Farra, Antonios Armaou, and Panagiotis D Christofides. Analysis and control of parabolic pde systems with input constraints. *Automatica*, 39(4):715–725, 2003.
- [24] Francesco Ferrante, Frédéric Gouaisbaut, Ricardo G Sanfelice, and Sophie Tarbouriech. State estimation of linear systems in the presence of sporadic measurements. *Automatica*, 73:101–109, 2016.
- [25] Francesco Ferrante and Christophe Prieur. Boundary control design for conservation laws in the presence of measurement disturbances. *Mathematics of Control, Signals, and Systems*, 33:49–77, 2020.
- [26] Francesco Ferrante and Christophe Prieur. Boundary control design for linear 1-d balance laws in the presence of in-domain disturbances. In *proceedings of the 2019 18th European Control Conference (ECC)*, pages 2412–2417, Napoli, Italy, 2020.
- [27] SC Ferreira Jr, ML Martins, and MJ Vilela. Reaction-diffusion model for the growth of avascular tumor. *Physical Review E*, 65(2):021907, 2002.
- [28] MENAHEM FRIEDMAN and YAAKOV YAVIN. On the random rotational motion of a ship with a two position automatic pilot. *INTERNATIONAL JOURNAL OF SYSTEMS SCIENCE*, 7(4):425–434, 1976.
- [29] FR Guarguaglini and R Natalini. Global existence and uniqueness of solutions for multi-dimensional weakly parabolic systems arising in chemistry and biology. *Communications on Pure & Applied Analysis*, 6(1):287, 2007.
- [30] Alain Haraux. *Nonlinear vibrations and the wave equation*. Springer, 2018.
- [31] Tomoaki Hashimoto and Miroslav Krstic. Stabilization of reaction diffusion equations with state delay using boundary control input. *IEEE Transactions on Automatic Control*, 61(12):4041–4047, 2016.
- [32] Anthony Hastir, Federico Califano, and Hans Zwart. Well-posedness of infinite-dimensional linear systems with nonlinear feedback. *Systems & Control Letters*, 128:19–25, 2019.
- [33] Anthony Hastir, Judicaël Mohet, and Joseph J Winkin. Sturm-liouville systems on a class of hilbert spaces. *arXiv preprint arXiv:2207.09802*, 2022.
- [34] Birgit Jacob, Felix L Schwenninger, and Lukas A Vorberg. Remarks on input-to-state stability of collocated systems with saturated feedback. *Mathematics of Control, Signals, and Systems*, 32(3):293–307, 2020.
- [35] Simon Jones and Mathias Legrand. The wavelet-galerkin method for solving pde’s with spatially dependent variables. In *19th International Congress on Sound and Vibration (ICSV19)*, 2012.
- [36] Yuki Kaneko and Yoshio Yamada. A free boundary problem for a reaction-diffusion equation appearing in ecology. *Advances in Mathematical Sciences and Applications*, 21(2):467, 2011.

- [37] Iasson Karafyllis and Miroslav Krstic. *Input-to-state stability for PDEs*. Springer, 2019.
- [38] H. Khalil. *Nonlinear Systems*. Pearson Education. Prentice Hall, 2002.
- [39] Miroslav Krstic and Andrey Smyshlyaev. *Boundary control of PDEs: A course on backstepping designs*, volume 16. SIAM, 2008.
- [40] Ding Lee, Allan D Pierce, and Er-Chang Shang. Parabolic equation development in the twentieth century. *Journal of Computational Acoustics*, 8(04):527–637, 2000.
- [41] Yanfang Lei and Junmin Li. Robust adaptive neural networks control for a class of time-delay parabolic systems with nonlinear periodic time-varying parameter. *Journal of the Franklin Institute*, 2022.
- [42] Mireille Levy. *Parabolic equation methods for electromagnetic wave propagation*. Number 45. IET, 2000.
- [43] Hugo Lhachemi, Christophe Prieur, and Emmanuel Trélat. Pi regulation of a reaction–diffusion equation with delayed boundary control. *IEEE Transactions on Automatic Control*, 66(4):1573–1587, 2020.
- [44] Xavier Litrico and Vincent Fromion. *Modeling and control of hydrosystems*. Springer Science & Business Media, 2009.
- [45] Johan Lofberg. YALMIP: A toolbox for modeling and optimization in matlab. In *proceedings of the 2004 IEEE international conference on robotics and automation (IEEE Cat. No. 04CH37508)*, pages 284–289, 2004.
- [46] Latifa Ait Mahiout, Nikolai Bessonov, Bogdan Kazmierczak, Georges Sadaka, and Vitaly Volpert. Infection spreading in cell culture as a reaction-diffusion wave. *ESAIM: Mathematical Modelling and Numerical Analysis*, 56(3):791–814, 2022.
- [47] Youcef Mammeri. A reaction-diffusion system to better comprehend the unlockdown: Application of seir-type model with diffusion to the spatial spread of covid-19 in france. *Computational and Mathematical Biophysics*, 8(1):102–113, 2020.
- [48] Swann Marx, Vincent Andrieu, and Christophe Prieur. Cone-bounded feedback laws for m-dissipative operators on hilbert spaces. *Mathematics of Control, Signals, and Systems*, 29(4):1–32, 2017.
- [49] Ana-Maria Matache, Christoph Schwab, and Thomas P Wihler. Fast numerical solution of parabolic integrodifferential equations with applications in finance. *SIAM Journal on Scientific Computing*, 27(2):369–393, 2005.
- [50] Johan A Metz and Odo Diekmann. *The dynamics of physiologically structured populations*, volume 68. Springer, 2014.
- [51] Andrii Mironchenko and Christophe Prieur. Input-to-state stability of infinite-dimensional systems: recent results and open questions. *SIAM Review*, 62(3):529–614, 2020.
- [52] Andrii Mironchenko, Christophe Prieur, and Fabian Wirth. Local stabilization of an unstable parabolic equation via saturated controls. *IEEE Transactions on Automatic Control*, 66(5):2162–2176, 2020.
- [53] Quang Hieu Ngo, Quoc Chi Nguyen, and Keum-Shik Hong. Adaptive boundary control of an axially moving string under the effect of boundary disturbance. pages 304 – 309, 09 2009.
- [54] Mark R Opmeer, Fred W Wubs, and Simon van Mourik. Model reduction for controller design for infinite-dimensional systems: theory and an example. In *Proceedings of the 44th IEEE Conference on Decision and Control*, pages 2469–2474, Seville, Spain, 2005.
- [55] Yury Orlov. On general properties of eigenvalues and eigenfunctions of a sturm–liouville operator: comments on “ISS with respect to boundary disturbances for 1-d parabolic PDEs”. *IEEE Transactions on Automatic Control*, 62(11):5970–5973, 2017.

- [56] Andrew G Osborne and Mark R Deinert. Stability instability and hopf bifurcation in fission waves. *Cell Reports Physical Science*, 2(10):100588, 2021.
- [57] Amnon Pazy. *Semigroups of linear operators and applications to partial differential equations*, volume 44. Springer Science & Business Media, 2012.
- [58] Sebastian Peitz and Stefan Klus. Koopman operator-based model reduction for switched-system control of PDEs. *Automatica*, 106:184–191, 2019.
- [59] Christophe Prieur, Sophie Tarbouriech, and João Manoel Gomes da Silva Jr. Wave equation with cone-bounded control laws. *IEEE Transactions on Automatic Control*, 61(11):3452–3463, 2016.
- [60] W HARMON RAY. Advanced process control, 1982.
- [61] David L Russell. Controllability and stabilizability theory for linear partial differential equations: recent progress and open questions. *SIAM Review*, 20(4):639–739, 1978.
- [62] Carsten Scherer, Pascal Gahinet, and Mahmoud Chilali. Multiobjective output-feedback control via lmi optimization. *IEEE Transactions on automatic control*, 42(7):896–911, 1997.
- [63] Thomas I Seidman and Houshi Li. A note on stabilization with saturating feedback. *Discrete & Continuous Dynamical Systems-A*, 7(2):319, 2001.
- [64] Lawrence F Shampine. Solving hyperbolic pdes in matlab. *Applied Numerical Analysis & Computational Mathematics*, 2(3):346–358, 2005.
- [65] Suha Shreim, Francesco Ferrante, and Christophe Prieur. Design of saturated boundary control for hyperbolic systems. In *proceedings of the IFAC World Congress*, Berlin, Germany, 2020.
- [66] Suha Shreim, Francesco Ferrante, and Christophe Prieur. Design of saturated boundary control for hyperbolic systems with in-domain disturbances. *Automatica*, 142:110346, 2022.
- [67] Marshall Slemrod. Feedback stabilization of a linear control system in hilbert space with an a priori bounded control. *Mathematics of Control, Signals and Systems*, 2(3):265–285, 1989.
- [68] Andrey Smyshlyaev and Miroslav Krstic. *Adaptive control of parabolic PDEs*. Princeton University Press, 2010.
- [69] Eduardo D Sontag. Input to state stability: Basic concepts and results. In *Nonlinear and optimal control theory*, pages 163–220. Springer, 2008.
- [70] Ivar Stakgold. Reaction-diffusion problems in chemical engineering. *Nonlinear diffusion problems*, pages 119–152, 1986.
- [71] Theodor Strelkoff. Numerical solution of saint-venant equations. *Journal of the Hydraulics division*, 96(1):223–252, 1970.
- [72] Sophie Tarbouriech, Germain Garcia, João Manoel Gomes da Silva Jr, and Isabelle Queinnec. *Stability and stabilization of linear systems with saturating actuators*. Springer Science & Business Media, 2011.
- [73] Sophie Tarbouriech, Isabelle Queinnec, and Christophe Prieur. Nonstandard use of anti-windup loop for systems with input backlash. *IFAC Journal of Systems and Control*, 6:33–42, 2018.
- [74] Ngoc-Tu Trinh, Vincent Andrieu, and Cheng-Zhong Xu. Design of integral controllers for nonlinear systems governed by scalar hyperbolic partial differential equations. *IEEE Transactions on Automatic Control*, 62(9):4527–4536, 2017.
- [75] Marius Tucsnak and George Weiss. *Observation and control for operator semigroups*. Springer Science & Business Media, 2009.

-
- [76] Ji Wang and Miroslav Krstic. Output-feedback control of an extended class of sandwiched hyperbolic pde-ode systems. *IEEE Transactions on Automatic Control*, 66(6):2588–2603, 2021.
- [77] George Weiss and Richard Rebarber. Optimizability and estimatability for infinite-dimensional linear systems. *SIAM Journal on Control and Optimization*, 39(4):1204–1232, 2000.
- [78] Huai-Ning Wu and Jun-Wei Wang. Static output feedback control via pde boundary and ode measurements in linear cascaded ode–beam systems. *Automatica*, 50(11):2787–2798, 2014.
- [79] Cheng-Zhong Xu and Gen Qi Xu. Saturated boundary feedback stabilization of a linear wave equation. *SIAM Journal on Control and Optimization*, 57(1):290–309, 2019.
- [80] Luca Zaccarian and Andrew R Teel. *Modern anti-windup synthesis: control augmentation for actuator saturation*, volume 36. Princeton University Press, 2011.
- [81] Fuzhen Zhang. *The Schur complement and its applications*, volume 4. Springer Science & Business Media, 2006.
- [82] Yang Zhu, Miroslav Krstic, and Hongye Su. Adaptive output feedback control for uncertain linear time-delay systems. *IEEE Transactions on Automatic Control*, 62(2):545–560, 2016.