



**HAL**  
open science

# Going Toward Low Waste External Walls of Residential Buildings in XXI Century in Bosnia and Herzegovina

Renata Asceric Androšević

► **To cite this version:**

Renata Asceric Androšević. Going Toward Low Waste External Walls of Residential Buildings in XXI Century in Bosnia and Herzegovina. Art and art history. Université Paris-Est; 190456396, 2022. English. NNT: 2022PESC1005 . tel-04066009

**HAL Id: tel-04066009**

**<https://theses.hal.science/tel-04066009>**

Submitted on 12 Apr 2023

**HAL** is a multi-disciplinary open access archive for the deposit and dissemination of scientific research documents, whether they are published or not. The documents may come from teaching and research institutions in France or abroad, or from public or private research centers.

L'archive ouverte pluridisciplinaire **HAL**, est destinée au dépôt et à la diffusion de documents scientifiques de niveau recherche, publiés ou non, émanant des établissements d'enseignement et de recherche français ou étrangers, des laboratoires publics ou privés.

## THÈSE

préparée au sein du laboratoire Géométrie Structure Architecture  
de l'École nationale supérieure d'architecture Paris-Malaquais

présentée pour l'obtention du diplôme de  
DOCTEUR DE L'UNIVERSITÉ PARIS-EST  
École doctorale : Ville, Transports et Territoires  
Spécialité : Architecture

Thèse présentée par:  
**Renata Androšević**

Intitulée

**Vers les systèmes constructifs à faible production de déchets:  
L'enveloppe des bâtiments résidentiels du XXIème siècle  
en Bosnie-Herzégovine**

**/ Going Toward Low Waste External Walls of Residential  
Buildings in XXI Century in Bosnia and Herzegovina /**

Soutenue le 31 mai 2022 devant le jury composé de :

Prof. Dr. Niels de Temmerman, président du Jury  
Prof. Dr. Antonella Mastroianni, rapportrice  
Prof. Dr. Maja Roso Popovac, rapportrice  
Dr. Katherine Adams, examinatrice  
Dr. Adelaïde Feraille, examinatrice

Prof. Dr. Maurizio Brocato, directeur de thèse  
Prof. Dr. Elma Durmišević, co-encadrant



## **VERS LES SYSTÈMES CONSTRUCTIFS À FAIBLE PRODUCTION DE DÉCHETS – L'ENVELOPPE DES BÂTIMENTS RÉSIDENTIELS DU XXIÈME SIÈCLE EN BOSNIE-HERZÉGOVINE**

### Récapitulatif (Français)

Cette recherche est inspirée par des projets visionnaires visant à trouver une manière de créer un environnement construit qui aura un petit impact sur la nature et tous les êtres humains. Cela aidera tous les participants, lors du processus de la prise de décision, à prendre la meilleure option en choisissant le matériel/matériau, la technologie de construction et le système constructif, qui auront le moindre impact négatif sur l'environnement, en tenant compte de toutes les données nécessaires.

En analysant les méthodes et les outils existants avec leurs avantages et leurs défauts, les recherches essaient de trouver une manière pour surmonter les obstacles identifiés.

Les méthodologies existantes montrent l'importance de la prévision de l'impact sur l'environnement et peuvent montrer les différences entre les systèmes comparés, mais il leur manque la quantification des données.

Approche proposée sa base sur une symbiose des méthodologies et des outils existants.

La nouvelle méthode inclut l'évaluation du système de construction (y compris la comparaison et la classification) et la quantification de l'impact sur l'environnement. Cela fournit une image claire de l'impact du système choisi et facilite la prise de décision.

A la fin du processus, l'on voit clair ce que l'on pourrait et devrait changer et améliorer pour aboutir à un meilleur résultat.

Cette nouvelle méthode fourni la comparaison, l'évaluation et la quantification de la production des déchets de construction et contribue à la diminution de l'impact négatif sur l'environnement.

Mots-clés :

Impact de la construction sur l'environnement, bâtiment avec peu de déchets, potentiel de réutilisation, cycle de vie d'un bâtiment, architecture circulaire.

# GOING TOWARD LOW WASTE EXTERNAL WALLS OF RESIDENTAL BUILDINGS IN XXI CENTURY IN BOSNIA AND HERZEGOVINA

## Summary (English)

This research is inspired by the visionary projects which are trying to find the way to create built environment with low impact on the nature and all living creatures, especially human beings. It will help decision making process for all stakeholders to choose the best option when considering the materials, building technologies and building systems, which will have the lowest negative environmental impact, providing all necessary data.

Analysing the existing methods and tools with their barriers and opportunities, the research attempts to find the way to overcome observed obstacles.

Existing methodologies point out the importance of environmental impact predictions and they can show the differences between compared systems. Existing tools give precise numerical data of environmental impact.

The approach proposed here shows that symbiosis of methodologies and tools can give the result that reaches the goal – to achieve low or no waste building construction.

The new method includes building system evaluation (with comparison and ranking) and quantification of environmental impact. This provides a picture of the chosen system's impact and facilitates decision making. At the end of the process, it is evidently clear what could and should be changed and upgraded in order to have better performance and lower impact.

This new method provides comparison, evaluation and quantification in terms of generation of the construction waste and contributes in lowering negative environmental impact.

### **Key words in English:**

Building environmental impact, low waste building, reuse potential, building life-cycle, circular architecture.

# Contents

<b>Summary (English)</b> .....	4
1. INTRODUCTION.....	9
Summary (English) .....	9
1. INTRODUCTION.....	10
Récapitulatif (Français) .....	10
<b>1. INTRODUCTION</b> .....	12
1.1. ORGANIZATION OF THE WORK.....	15
1.2. METHODOLOGY USED.....	18
1.3.    DEFINING THE PROBLEM - ENVIRONMENTAL IMPACT OF BUILT STRUCTURES.....	22
1.4. FINAL GOAL – LOW OR NO WASTE BUILDINGS .....	27
1.5. SPECIFIC GOALS – MAKE THE LOW WASTE BUILDING DESIGN DECISION MAKING PROCESS EASIER .....	31
2. OVERVIEW OF THE CORPUS THEORIES.....	33
Summary (English) .....	33
2.    APERÇU DES THEORIES (Récapitulatif Français) .....	34
<b>2. OVERVIEW OF THE CORPUS THEORIES</b> .....	35
2.1. CIRCULAR BUILDINGS.....	39
2.2. IMPACT ASSESSMENTS – IDENTIFY OPORTUNITIES AND BARRIERS IN THE FIELD OF CIRCULAR BUILDING PRINCIPLES .....	46
2.2.1. Equation of Environmental Impact .....	51
3. FIRST ANALYSES .....	52
3.    PREMIERES ANALYSES.....	53
(Récapitulatif Français) .....	53
<b>3. FIRST ANALYSES</b> .....	54
3.1. TESTING EXISTING METHOD ON CHOOSEN CASE STUDIES .....	58
4. RESIDENTIAL BUILDINGS IN XXI CENTURY IN BOSNIA AND HERZEGOVINA.....	63
4.    BATIMENTS RESIDENTIELS AU XXie SIECLE EN BOSNIE-HERZEGOVINE (Récapitulatif Français) 64	
<b>4. RESIDENTIAL BUILDINGS IN XXI CENTURY IN BOSNIA AND HERZEGOVINA</b> .....	65
4.1. RESIDENTIAL BUILDINGS’ EXTERNAL WALLS STILL IN PRODUCTION IN XXI CENTURY IN BIH	69
4.2. WOODEN WALLS IN BIH.....	71
4.2.1. Transformable wooden wall in BIH.....	78
4.3. RESIDENTIAL BUILDINGS’ EXTERNAL WALLS IN BIH DISCUSSIONS AND CONCLUSIONS .....	90
5. THEORY - EXISTING METHODS AND TOOLS .....	94

Summary (English) .....	94
5. THEORIE – METHODES ET OUTILS EXISTANTS .....	95
(Récapitulatif Français) .....	95
<b>5. THEORY - EXISTING METHODS AND TOOLS .....</b>	<b>96</b>
5.1. BIM - Building Information Modelling with Material Database.....	99
5.2. Reversible Building Design with Transformation and Reuse Potential Method and Tool....	110
5.3. Life Cycle Assessment (LCA) Approach and Tool .....	120
6. TOOLS TO APPLY THE THEORY .....	128
Summary (English) .....	128
6. OUTILS POUR METTRE EN PLACE UNE THEORIE.....	129
(Récapitulatif Français) .....	129
<b>6. TOOLS TO APPLY THE THEORY .....</b>	<b>130</b>
6.1. EXISTING METHODS AND APPLICATION .....	131
6.1.1. Reuse Potential (Method Durmišević) Application.....	132
6.2. EXISTING TOOLS AND APPLICATION .....	144
6.2.1. LCA – Life Cycle Assessment Application using OneClickLCA software .....	148
6.2.2. LCA – Life Cycle Assessment Application using OpenLCA software.....	159
7. LOWERING ENVIRONMENTAL IMPACT IN TERMS OF CONSTRUCTION WASTE – THE NEW METHODOLOGY .....	168
Summary (English) .....	168
7. DIMINUTION DE L’IMPACT SUR L’ENVIRONNEMENT EN TERMES DES DECHETS DE CONSTRUCTION - NOUVELLE METHODOLOGIE.....	169
(Récapitulatif Français) .....	169
<b>7. LOWERING ENVIRONMENTAL IMPACT IN TERMS OF CONSTRUCTION WASTE – THE NEW METHODOLOGY.....</b>	<b>170</b>
7.1. IMPROVEMENTS FOR THE EXISTING METHODS AND TOOLS .....	173
7.2. Construction Waste Elimination (CWE) Protocol.....	178
8. CWE PROTOCOL APPLICATION .....	191
Summary (English) .....	191
8. MISE EN PLACE DU PROTOCOLE CWE.....	192
(Récapitulatif Français) .....	192
<b>8. CWE PROTOCOL APPLICATION .....</b>	<b>193</b>
8.1. EXTERNAL WALL OF THE GDC.....	193
9. DISCUSSION AND CONCLUSIONS.....	222
Summary (English) .....	222
9. DISCUSSION ET CONCLUSIONS .....	223

(Récapitulatif Français) .....	223
<b>9. DISCUSSION AND CONCLUSIONS</b> .....	224
9.1. WHAT IS ACHIEVED - The Construction Waste and its Environmental Impact.....	224
9.2. WHAT IS ACHIEVED - Discussions and Conclusions After the Case Study Testing.....	229
9.3. RECCOMENDATIONS FOR FURTHER RESEARCH – What is Left to be Done .....	236
9.4. RECCOMENDATIONS FOR FURTHER RESEARCH – What are the Next Steps .....	240
<b>REFERENCES</b> .....	241
<b>LIST OF FIGURES AND TABLES</b> .....	258
LIST OF FIGURES .....	258
LIST OF TABLES .....	265
<b>ACKNOWLEDGEMENTS</b> .....	266



***“Learning is experience. Everything else is just information.”***

Albert Einstein

# 1. INTRODUCTION

## Summary (English)

Environmental impact generated a considerable recent research interest. However, absence in correlation between the theory and practice in this area is evident. There is an urgent need to establish the good practice in the construction and building industry.

The System Improvement Process (SIP) *methodology has been chosen as a good approach* for this research thesis and the procedure will be as follows:

1. Problem Definition – Environmental impact of built structures;
2. Analysis – root cause: huge expansion of built structures and its negative impact on the environment.

Identified sub-problem which needs to be solved is construction waste and the focus will be on it. In order to lower pollution, this research will describe, examine and suggest the solution for the problem of construction waste.

3. Solution Convergence – making the low or no waste buildings.

There remains a need for creating an efficient method that can ease decision process in designing low waste buildings. After establishing the new method, the tool and protocol for that purpose will follow.

4. Implementation – method testing through case studies.

For the purpose of this study, a building will be decomposed into systems which will be tested separately to identify the method and tool that give the best result.

# 1. INTRODUCTION

## Récapitulatif (Français)

L'impact sur l'environnement a récemment généré un grand intérêt de recherche. Cependant, l'absence de corrélation entre la théorie et la pratique est évidente dans ce domaine. La mise en place d'une bonne pratique dans le domaine de la construction est une question d'urgence.

La méthodologie d'amélioration continue (The System Improvement Process - SIP) est choisie en tant que bonne approche pour cette étude de recherche, et la procédure sera la suivante :

1. Définition du problème – Impact des structures bâties sur l'environnement.
2. Analyse de la cause principale – Grande augmentation du nombre des structures bâties et leur impact négatif sur l'environnement.

Un sous-problème identifié devant être résolu sont les déchets de construction et c'est la raison pour laquelle ce sera le centre de l'étude. Dans le but de diminuer la pollution, cette recherche va décrire, examiner et proposer une solution du problème des déchets de construction.

3. Convergence de la solution – Construction des bâtiments produisant peu ou pas de déchets de construction. Persiste la nécessité pour la création d'une méthode efficace pouvant faciliter le processus de la prise de décision liée à la conception des bâtiments produisant peu de déchets. Ce qui suit après la mise en place de la nouvelle méthode, ce sont les outils et le protocole nécessaires à cette fin.
4. Mise en œuvre – Tester la méthode à travers les études de cas.

Pour les besoins de cette étude, le bâtiment sera décomposé en systèmes qui seront testés séparément pour tester quelle méthode et quel outil aboutissent au meilleur résultat.

## Plan de la thèse de doctorat:

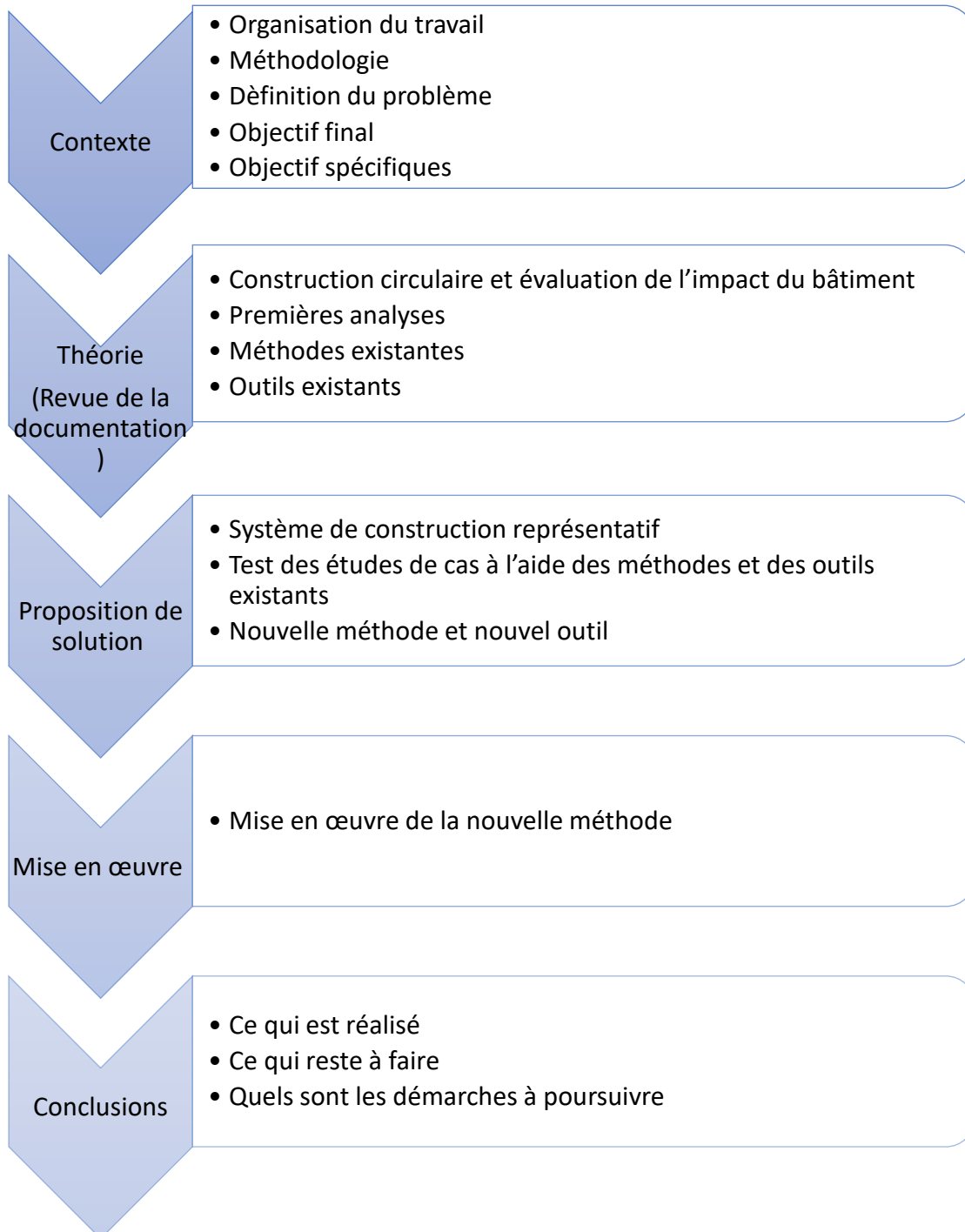

## 1. INTRODUCTION

The environmental impact generated considerable recent research interest. However, absence in correlation between the theory and practice in this area is evident. There is an urgent need to establish the good practice in the construction and building industry.

The human population is growing and, in accordance to that, the needs for the built structures are increasing. The construction and building industry successfully follow this change. However, this process should be done according to the “green building” principles and protocols, which are to be defined soon.

As one of the most densely populated cities, Hong Kong is the best example of what the world will be like if the population continues to grow exponentially. (Figure 1)



Figure 1. Yichang building Hong Kong. Source: <https://www.dreamstime.com>

The use of virgin materials, water and energy is increasing. Many reports state that the construction industry is producing more than a third of a total waste and total CO<sub>2</sub> emissions and uses more than the half of all natural resources (EEA 2001, Eurostat 2001, EIB 2015, McCormick 2016).

A current problem that construction industry has to deal with is built structures' negative environmental impact. This impact manifest in many aspects:

- climate change,

- water, soil and air pollution,
- resource depletion,
- extinction of a wildlife etc.

Considering the global environmental pollution and the impact that the construction industry has in that area, it is the time to find the way to lower the negative effect of built structures on the planet.

Some ideas and proposals how to save the planet from the negative impact are attracting widespread interest, but in practice, there is always a matter of immediate profit. Even though the systematic and holistic approach is the best, to lower the negative impact, it is good to start with lowering the impact for at least one category. To lower the water and soil pollution, it would be necessary to lower the waste. It will be a really good start to achieve better performance of building structures in terms of a land use for construction waste and soil, water and air waste pollution.

Construction waste is identified as a problem of 21<sup>st</sup> century and this research will go one step forward in solving this issue.

This thesis goal is to find the right methodology that will help building and construction industry to change the view and help them decide what approach to apply when building a new building structures that will be environmentally friendly and make less or no waste in every life-cycle, which means very low negative environmental impact.

The desirable objective of the research is to contribute to the design and implementation of more sustainable and reusable buildings and building systems to lower the building waste, as one of the problems in total building environmental impact.

A rulebook can be made according to the conclusions after the method application. The tools that show how to increase the potential for reuse of systems can be established on this basis. In particular, it is envisaged that these rules can serve as a guide and will be applied in design and construction of new buildings in Bosnia and Herzegovina (BIH) and in other countries around the world.

This research will show the benefits of the new approach showing what can be done in the future of the building practice. The results of this work may help to extend the functional lifespan of buildings and its systems, components and materials. This would mean that the stakeholders can predict and reduce the amount of resources consumed by construction industry and generate less waste in the construction, maintenance and demolition of buildings. All these will help developing the circular building industry and economy.

In addition to the existing, the new method is going to be the recipe for the tool that will make decision process easier even in the design phase, in terms of the construction waste during building use, maintenance and at the end of the building's life and life of its parts. The method can integrate with Decision Support System (DSS) and Building Information Modelling (BIM) to facilitate the determinations, decision-making process and courses of further actions, thanks to the computerized programs.

In summary, the research will show the new approach to the construction waste prevention (not construction waste management!) and point out the following:

- what are the measures that should be taken into account to prevent negative environmental impact of construction industry and built structures in the field of construction waste;
- methods and tools that can help decision making process when designing the future built structures to be less harmful to the environment;
- what can be done to ease application of the method and tools and make it available to the stakeholders. (Figure 2)

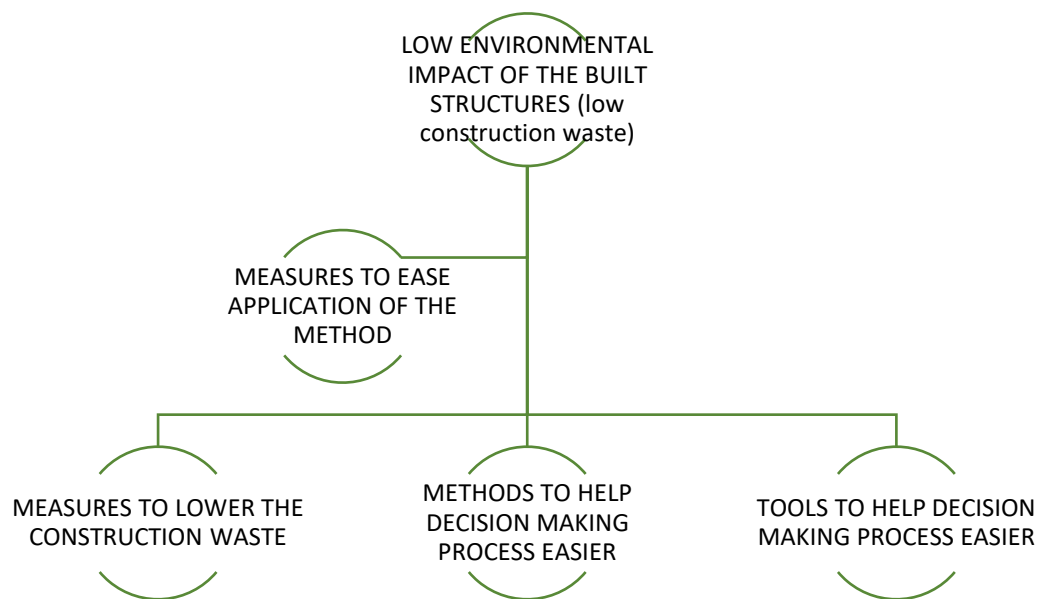

Figure 2. How to accomplish low environmental impact of the built structures in terms of the construction waste.

## 1.1. ORGANIZATION OF THE WORK

This research is done following the scientific methodology. This thesis starts with the problem identification, the approach and methodology definition and the final and specific goals of the research.

A literature review of the existing theories helps identifying opportunities and barriers in the circular building practices.

In the first analyses, some Case studies were tested with the existing reuse potential method (Durmišević 2006). The author of this thesis was involved as an architect and coordinator for a Pilot project in the EU HORIZON 2020 project Buildings as Material Banks (BAMB) and applied the method to some case studies within this project. After analyses and testing, many new answers and questions opened up.

As the building is a very complex system, the approach that has been used in this research was to choose one representative building system to apply the methods and tools and then to adapt the method for other building systems and the whole building.

Other existing methods that are helpful in this area, have been analysed and tested on some case studies. Beside the *reuse potential* method (RP) of Durmišević 2006, the complete approach of *reversible building design* (RDB) by Durmišević 2019 and the *life cycle assessment* (LCA) methods and tools will be studied and applied to chosen Case studies.

Besides description and application of existing methods to the chosen case studies, building project efficient methodology will be proposed. The methodology will be followed from the building design through the whole process of building construction and each life-cycle of the building. The method will point out the positive and negative details of each examined system and establish a basis for relevant data to draw conclusions.

The methodology will be tested on the same case studies that were tested with the existing methods and tools to show the advantages of the new proposed methodology. Considering the final goal, the best solution will be presented.

This research thesis is organized as follows in the Figure 3.



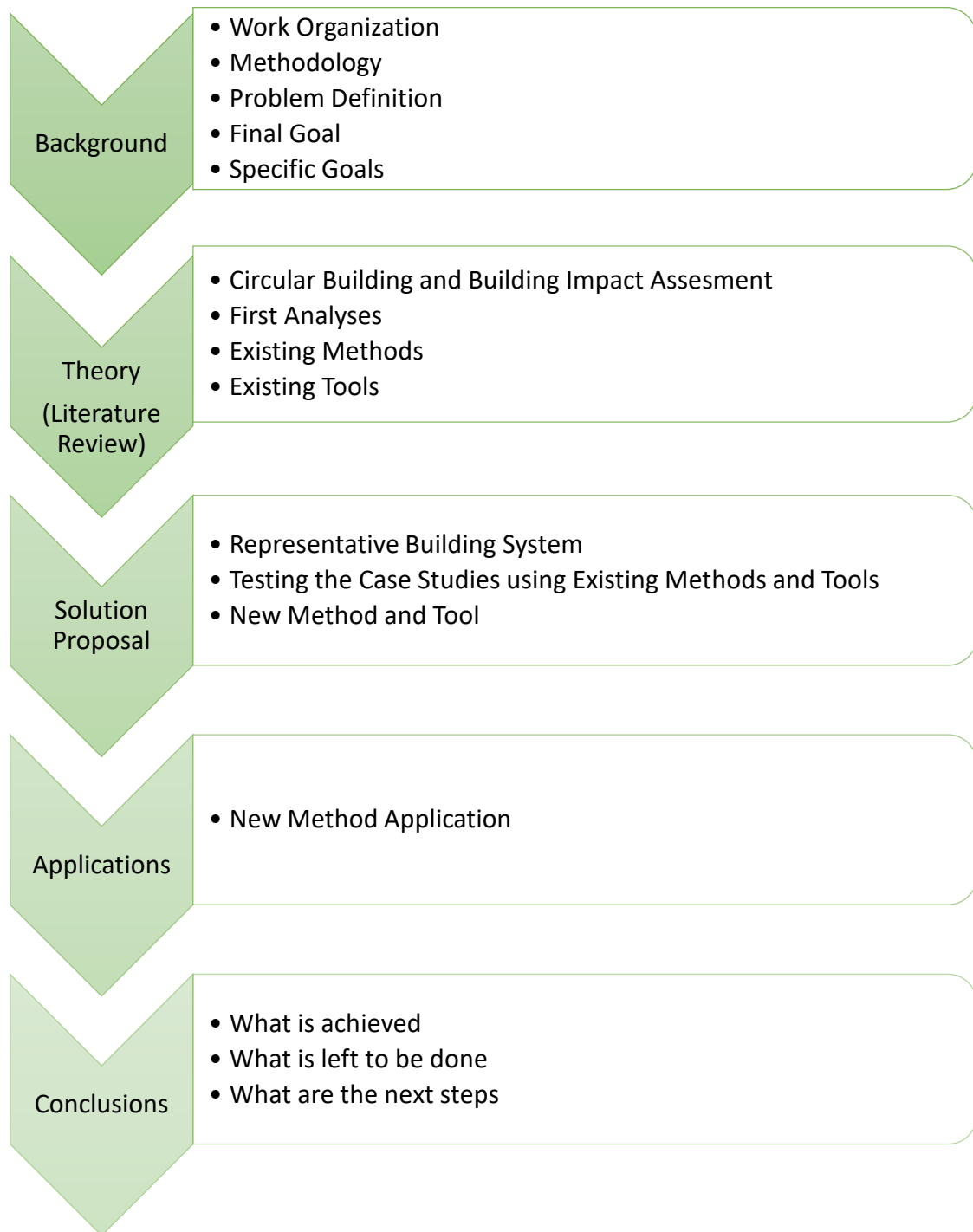

Figure 3. Research thesis work plan.

***“We cannot solve our problems with the same thinking  
we used when we created them.”***

Albert Einstein

## 1.2. METHODOLOGY USED

Some guidance regarding the methodology was needed when looking for the solution of the problem of the environmental pollution.

During the research, different methods contributed to achieving the final goal. The following three groups of research methods were used:

- Theory,
- Models,
- Numerical methods and tools.

As for the theory, the inductive method of development of existing theories and methods and tools was applied.

Comparative method was used for models and numerical methods were used to test these methods and tools. The results were analysed and compared with the purpose of finding the optimal new method and tool which would help to achieve the goal.

Even though the built structures are the ones that are impacting the environment, maybe the solution is not necessary in the construction industry. All fields have to cooperate to achieve what is necessary and accomplish the success. Building industry has to implement some ideas not only from civil engineering and architecture, but also from other fields such as social sciences, economy, production industry and product design, psychology, chemistry etc.

*The System Improvement Process (SIP)* methodology has been chosen as a good approach. (Table 1)

This theory is very young and used mostly for social sciences, but it is time to test it in the field of environmental science and building practice and try to solve the incurred loss.

“SIP is a comprehensive process for solving difficult large-scale social problems. The process first defines the problem to solve. The one big problem is then decomposed into smaller and hence easier to solve sub-problems. Each sub-problem is then analysed using root cause analysis and the five sub steps of analysis. Process output is not policy recommendation but a solved problem, since the SIP includes implementation. Policy managers use SIP and thus are treated as an integral part of the process. All problems are solved by use of mental models of the problem. SIP provides a high-level mental model of a problem in the form of the SIP matrix.” (Harich 2016)

1. Problem Definition		The System Improvement Process matrix		
Sub-problems: A. B. C.		A. How to Overcome Change Resistance	B. How to Achieve Proper Coupling	C. How to Avoid Excessive Model Drift
<b>2. Analysis with five sub-steps</b>  Spend about 80% of the time here.	A	Find the immediate cause of the sub-problem symptoms in terms of the system's dominant feedback loops.		
	B	Find the intermediate causes, low average points and superficial (symptomatic) solutions.		
	C	Find the root causes of the intermediate causes.		
	D	Find the feedback loops that should be dominant to resolve the root causes.		
	E	Find the high leverage points to make those loops dominant.		
<b>3. Solution Convergence</b>		Converge on solution elements to push on HLPs, with testing.		
<b>4. Implementation</b>		Implement solution elements that pass testing.		
<b>Continuous Process Improvement – The Foundation of the entire process</b>				

Table 1. System Improvement Process, adapted from Harich 2016

“Definitions of the root cause, root cause analysis, and process driven problem solving:

A. Root cause analysis.

B. Feedback loop modelling of key aspects of the analysis.

C. Decomposition of a one big problem into smaller sub-problems, starting with the three standard sub-problems and adding more as needed.

D. Analysis of each sub-problem using social force diagrams and related definitions...  
What needs to be done at the project level, what has been done, and how it's been done are always shown by the matrix...

A root cause is the deepest cause in a causal chain that can be resolved. “Resolved” means that system's feedback loop structure is changed so that a root cause force no longer exists or is acceptably low. To be more exact, a root cause is that portion of a system's feedback loop structure that, using the checklist below, explains why the system's behaviour produces the problematic symptoms.

Process driven problem solving is the use of a formal process as your main approach to solving problems. The three steps of process driven problem solving are:

1. Identify the problem.

2. Choose or develop a suitable process for solving this type of problem.

3. Execute the process, which must include continuous improvement.” (Harich 2016)

Similar to the Universal Problem-Solving Process, “The Four Main Steps of System Improvement Process Matrix:

1. Problem definition
2. Analysis,
3. Solution Convergence,
4. Implementation.” (Harich 2016)

If the suggested SIP matrix is followed for this research, the procedure will be as follows:

1. Problem Definition – Environmental impact of built structures;
2. Analysis – root cause: huge expansion of built structures and its negative impact on the environment. The big problem has been separated into sub-problems:
  - usage of resources (water, energy and other virgin materials),
  - impact on wellbeing (impact on natural ecosystems and human health),
  - pollution (producing harmful gases and waste).

Solving one of the sub-problems will lower the total negative impact and some conclusions can help in solving the other two sub-problems. Identified sub-problem which needs to be solved is construction waste and the focus will be on it. In order to lower pollution, this research will describe, examine and suggest the solution for the problem of construction waste.

3. Solution Convergence – making the low or no waste buildings;

According to the above, the huge environmental impact of the construction industry and built structures should be directed to be less harmful. There remains a need for creating an efficient method that can ease decision process in designing low waste buildings. After establishing the new method, the tool and protocol for that purpose will follow.

4. Implementation – method testing through case studies.

To make a low or no waste building, for the purpose of this study, a building will be decomposed into systems which will be tested separately to test which method and tool give the best result. Continuous improvement will be done in terms of finding a way to apply the successful method that worked for one building system to other building systems and finally to the whole building.

***“If you think that the economy is more important than  
the environment (and health),  
try holding your breath while counting your money.”***

Mc Pherson Guy

### 1.3. DEFINING THE PROBLEM - ENVIRONMENTAL IMPACT OF BUILT STRUCTURES

As already mentioned, an expansion of construction industry and overproduction of built structures in 21<sup>st</sup> century is evident. The industry is trying to make more profits in this sector and to fulfil the enormous needs of consumers who are buying more buildings than they need. The construction industry is responsible for one third of the total global energy consumption and the associated emissions. (Ness et al. 2015) The construction industry is also the largest consumer of natural resources. (Iacovidou & Purnell 2016)

Built structures and their huge growth have a big impact on the environment, changing ecosystems and directly influencing the health and wellbeing of all living creatures on the Earth. It is estimated that the built environment demands approximately 40% of all materials extracted from nature. (Cheshire 2016).

There are institutions like World Health Organisation (WHO) and Building Council which finance projects and studies that are raising awareness about environmental impact of built structures in terms of using resources, impact to the users and pollution. The studies are about the health and wellbeing of the consumers and users of the built structures. Considering the available data, research of the data shows that the biggest investments are in projects connected with the renewable energy sources, water protection and air pollution. Some of these investments are made by Energy Sector Management Assistance Program (ESMAP), World Bank Group (WBG), European Commission (EC), European Investment Bank (EIB), Global Energy Efficiency and Renewable Energy (GEEREF), ING Group and many other big companies.

“Construction research that aims to contribute to a more sustainable built environment is still mostly concerned with energy consumption and carbon emission issues (Hossain & Ng 2018, Pomponi & Moncaster 2016). Recent studies include, for example, an analysis of the embodied energy use of China’s construction industry through a multi-regional input-output model (Hong et al. 2016) or a case study approach to evaluate and assess the energy efficiency of buildings (De Lieto Vollaro et al. 2015). Although important, research that focuses only on energy tends to overlook other environmental impacts associated with mining and processing of raw materials, such as scarcity or the impact on biodiversity of mining or drilling operations (Cheshire 2016). To secure that actual recovering of building objects for reuse (or not) achieves environmental impacts of circular economy and works towards sustainability, many of their advocates accordingly argue that more research is needed into closing material loops on a building level (Leising et al. 2018, Pomponi & Moncaster 2017).” (van den Berg 2019)

Much study in recent years are trying to form the parameters and establish the framework of the ultimate “green building”. Although, the right strategy to assess the building and evaluate its sustainability has still not been defined. Economic point of view is maybe one of the most obvious criteria, but certainly not the most important.

All mentioned research data are showing that the construction industry has to change according to the Sustainable Development Goals (SDGs) that are adopted by world leaders in September 2015 at an historic UN Summit came on force on January 1<sup>st</sup> 2016. (Figure 4)



Figure 4. Sustainable Development Goals (M. Mabkhot 2021)

Establishing these SDG, stakeholders have some big expectations. “Over the next fifteen years, with these new Goals that universally apply to all, countries will mobilize efforts to end all forms of poverty, fight inequalities and tackle climate change, while ensuring that no one is left behind.” (UN 2016)

Following these goals, construction industry can contribute the most in area of Sustainable cities and communities (SDG 11), developing the sustainable Industry, innovation and infrastructure (SDG 9) with Responsible consumption and production (SDG 12), to provide Affordable and clean energy (SDG 7) and Clean water and sanitation (SDG 6). All this will have a huge impact in terms of Climate protection action (SDG 13) and contribute to Good health and well-being (SDG 3) on Life on land (SDG 15) and Life below water (SDG 14). It is very important to cooperate with other stakeholders and achieve Partnership for the goals (SDG 17) for better final results.

How World Green Building Council applies the SDG to the green buildings is explained and shown in Figure 5.





Figure 5. How World Green Building Council applies the SDG to the green buildings. Source: <https://www.worldgbc.org/news-media/green-building-improving-lives-billions-helping-achieve-un-sustainable-development-goals>

The results of survey of investment priorities in many different firms is shown in (Figure 6). Public investment priorities like construction, infrastructure, manufacturing and services have been compared. The construction is always present and very often a big investment. Construction has high scores in prof. training and higher education and transport. Growing share of construction in other investment priorities is very high. The highest share is in social housing.

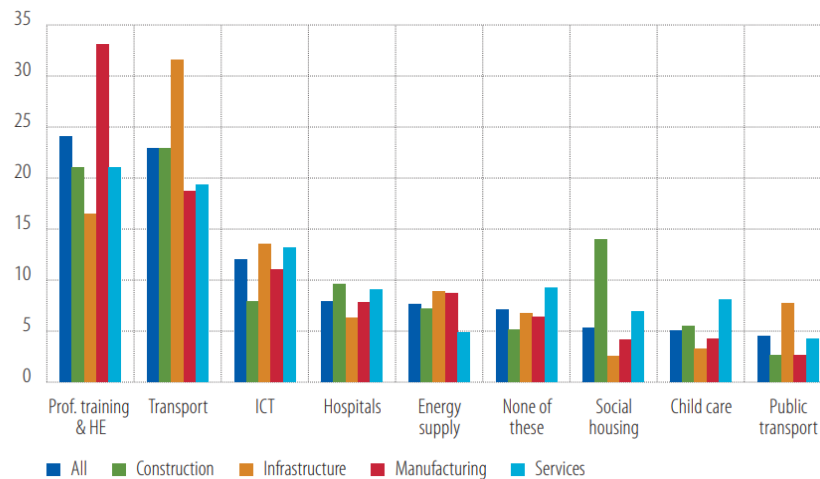

Source: EIBIS2017.  
Note: Base: All firms. ICT = information and communication technologies. HE = Higher education.

Figure 6. Public Investment Priorities. Source: EIB Investment report 2017/2018

It is necessary to plan the future construction investments very carefully. If we want to achieve sustainable construction, with low negative impact on the environment, it will require a lot of advance planning and very complex decision-making processes.

Kylili et al. 2016 underline the evident problem, which is “the lack of a sustainable building standardized basis, which will be established on a set of relevant well-defined

performance indicators.” According to Kylili et al. 2016 the solution lies in “the work of research initiatives and innovative research projects” .

European Investment Bank (EIB) made a report about residential investments in the European Union (EU). “Investors are more likely to invest in new buildings if the price of existing dwellings exceeds the cost of new building or the replacement cost.” (EIB 2017)

Recently, the awareness of the construction waste is in focus, among which is the *Construction Demolition Waste (CDW)*, which is considered as really serious problem, as its quantities are growing rapidly. “Based on volume, Construction and Demolition (C&D) waste is the largest waste stream in the EU. That's why the EC is introducing a new protocol on construction and demolition waste. Recycling and re-using of C&D waste is the answer. Proper management of C&D waste and recycled materials – including the correct handling of hazardous waste - can have major benefits in terms of sustainability and the quality of life.” (EU 2018)

European construction and demolition waste comprises 820 million tons per year, which is equivalent to around 46% of the total amount of waste generated. (Gálvez-Martos et al. 2018).

“Its overall aim is to increase confidence in the C&D waste management process and the trust in the quality of C&D recycled materials. This will be achieved by:

- Improved waste identification, source separation and collection;
- Improved waste logistics;
- Improved waste processing;
- Quality management;
- Appropriate policy and framework conditions.” (EC 2018)

“Construction and demolition activities generate one of the heaviest and most voluminous waste streams worldwide, of which the majority ends up in landfills (Llatas 2011)” (van den Berg 2019)

Literature research of the reports confirms that the impact of built structures in every aspect is really big and immediate action should be done in terms of the construction waste.

Focus of this research will be construction waste in terms of its prevention, and not in terms of construction waste management after building demolition.

The main problem which this research will try to solve is:

- **increasing quantities of the construction waste.**

***“Can you actually put a price on wellbeing,  
or rather on the absence of it?”***

Feifer 2011

#### 1.4. FINAL GOAL – LOW OR NO WASTE BUILDINGS

Considering the above mentioned results of the different research and surveys, the environmental impact of built structures is very big in terms of construction waste production. The total negative environmental impact will be lower when the construction demolition waste is properly treated. Even better solution is to plan ahead, predict and avoid the construction waste in the beginning of the building design. The new way of thinking is the future for the low negative environmental impact construction industry.

Thus, the focus and final goal of this research will be to find the way to lower the construction waste, or better - *how to avoid making the waste at the very beginning*. Some suggestions are already here, but there are many that are not stated yet or missing the right way of implementation.

Agenda 21 states that “Cyclic processes must replace linear ones to create sustainable development”, but there should be more specific protocols to follow to achieve sustainable development in construction industry.

According to the European Environment Agency (EEA), “quantity of waste is defined as an indicator of material efficiency of society; it represents an enormous loss of resources in the form of materials and energy. Excessive quantities can result from inefficient production processes, poor durability of goods, excessive consumption patterns, but also due to short term and inadequate design.” (EEA 2001)

“The planning of building industry waste management begins in the design phase, as the waste prevention is the preferred option, and reuse, recycling, and other types of recovery are a second option according to European Commission. (EC 2008).” (Androšević et al. 2019) (Figure 7)

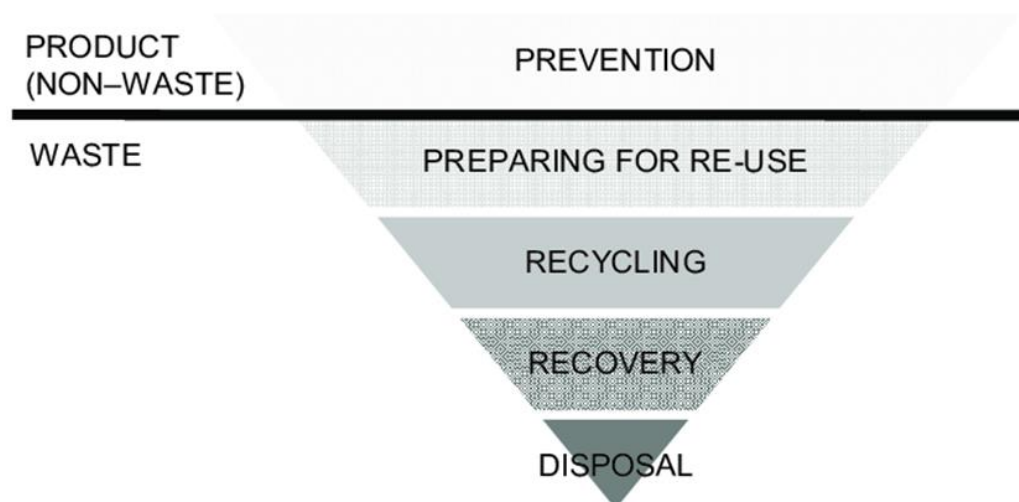

Figure 7. Building industry waste management. Source: Directive 2008/98/EC 2008

Numerous public and private bodies are developing construction and demolition waste protocols and establishing the measures to solve the problem of the huge amount of waste that ends in landfills. That disposed material is making a lot of damage to the existed ecosystems, filling the land that can be used for other purposes (for example agriculture, green parks or production industry). In the meantime, new buildings are built and there is a need to establish construction waste prevention, too.

This means that *a new concept of the building* should be accepted. Technical development provides use of the new technologies in the construction industry, which can be used wisely.

Some projects provided proposals what should be done to prevent the construction waste. One of them is the EC project called Building as Material Banks (BAMB) which established building protocols like Reversible Building Design and made the Material Passports database to track the materials which are built into buildings, increase the transformation and reuse potential of the building parts and prevent the construction waste.

“Increased value equals less waste, and that is what BAMB is creating – ways to maintain and increase the value of building materials... Instead of being to-be waste, buildings will function as banks of valuable materials, building materials and building systems – conserving material value and functionality, so materials and building components can be reused, and thus decreasing the need for primary resource mining.” (BAMB 2016)

Beside direct involvement in construction waste management, there are some movements and “green” and “circular” oriented projects which contribute with their ideas, conclusions, projects and research results.

“The Ellen MacArthur Foundation (EMF) was launched in 2010 to accelerate the transition to a circular economy. Since its creation, the charity has emerged as a global thought leader, establishing the circular economy on the agenda of decision makers across business, government, and academia... Growth Within: A circular economy vision a competitive Europe” (Ellen MacArthur Foundation 2015)

EPEA Braungart et al. 2016 suggested a new way to look at the buildings and design “a building like a tree”, incorporating in it all benefits that the tree gives to the environment and living creatures. (Figure 8)



Figure 8. A building like tree. Source: Cradle to Cradle Manifesto presented at 15th Biennale di Venezia EPEA Braungart et al. 2016

“Based on a study performed by Bio Intelligence et al. 2011, the composition of C&D waste (excluded excavation material) for most studied EU member states is composed of concrete and masonry (ranging from 40% to 84%), asphalt (ranging from 4% to 26%) and other mineral waste (2% to 9%); for some analysed North-Eastern European countries such as Finland and Estonia, metal (up to 40%) and wood (up to 41%).” (BAMB 2016)

“In other European countries, such as Bosnia and Herzegovina (BIH), C&D waste recovery and recycling is far from being a well-established practice, because the national waste management system is still based on disposing waste in regional sanitary landfills. Recently, BIH passed a legal framework on waste management introducing the obligation to develop waste management plans for the purpose of building construction, reconstruction and demolition.” (Durmišević et al. 2016).

“Despite the many (policy) efforts to reduce and prevent it, C&D waste still puts a lot of pressure on the way we (re)use and try to protect our scarcely available material and spatial resources. The situation will become even more complex, due to upcoming composite waste fractions such as thermal insulation (e.g. contaminating stony debris) and coatings (e.g. fixed to glass fractions) – used on a regular basis from the 1970s and installed in practically all new buildings due to energy performance regulations.

Selective demolition and sorting of these upcoming waste fractions is in the majority of demolition cases seen as technically and/or financially unfeasible. (EMIS 2016, OVAM 2012).” (BAMB 2016)

A growing interest in this area produces numerous reports that are reaching the same conclusion. Some countries are implementing the construction and demolition waste protocols, but the expansion of building and construction industry forces us to develop the sustainable building protocols in early phase, as soon as possible.

Even though many strategies are supporting sustainability and green buildings, there are not many stakeholders that are accepting the suggested protocols. Most contemporary buildings and their parts are still designed to be built-in very quickly, but with small or no possibility to be disassembled in order to be repaired, replaced or removed. That complicates the possible recovery or reuse of any part of the building system.

The environmental impact of built structures in terms of the construction waste production should be prevented in the design phase and the possibility of easy disassembling should be taken into account. It should be “Design for change” in every aspect and phase of construction process.

There is a need to react very quickly and *establish building and construction regulations*, in terms of *preventing the total waste*, which consists of the building construction waste, building maintenance waste and construction demolition waste. (Figure 9)

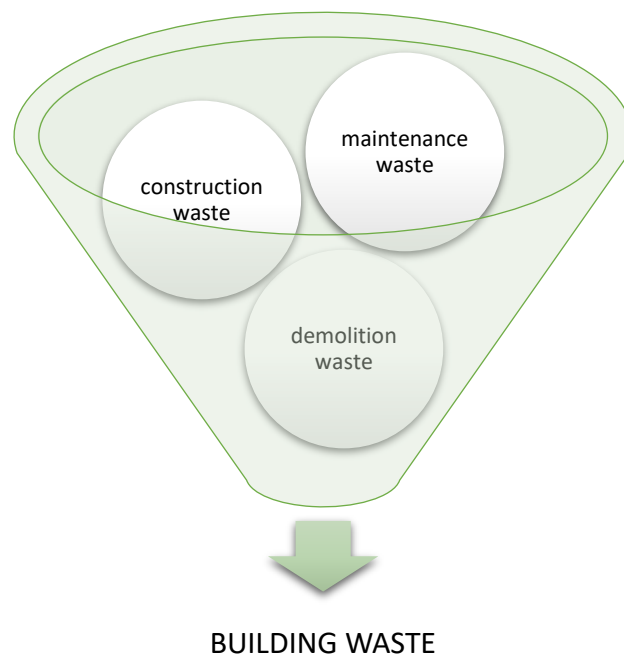

Figure 9. What is exactly a total building waste?

## 1.5. SPECIFIC GOALS – MAKE THE LOW WASTE BUILDING DESIGN DECISION MAKING PROCESS EASIER

Even though the integral approach is the best, the small steps in every area will help to improve the total score in attempt to achieve the sustainable construction with benefits for the earth and its inhabitants.

Considering all mentioned above, the important task and the focus should be to help stakeholders to know how to:

- prevent the construction waste in every stage of the project, starting from the design phase,
- predict the possible scenarios,
- propose or choose the best possible design and technical solution for the built structure and its parts.

Decision making process can be easier if construction stakeholders have:

- methods,
- systems/tools,
- protocols.

That will help them to decide at the early beginning of the process of building planning and design.

This research will analyse the existing methods and test them on some case studies to see the final data and information which can be used further. In addition to this, the new method, developed according to the previous conclusions, will be developed, in order to have a low waste building. The method will help designers and other stakeholders to accomplish the good design of the building and its parts in order to lower the amount of the waste in each stage of the project, and total quantity of the construction waste of the building and its parts. Methodology would be helpful in the decision-making process, to choose the best scenario for building and its parts when the first life-cycle of the building is finished.

The purpose of this research is to describe and examine the direct dependencies of the indicators that cause most environmental impact of the built structures, in an attempt to lower the final total impact if the main factors have been eliminated. Further research will contribute to finding the main indicators for building impact in terms of construction waste, as this is indicated as the ongoing problem that needs quick solution. It is not a simple solution and equation, as the possibilities and scenarios are very various.



***“All buildings are predictions. All predictions are wrong.”***

Brand 1994

## 2. OVERVIEW OF THE CORPUS THEORIES

### Summary (English)

If we use more virgin materials without planning to use them again, the quantity of construction waste is increasing every moment. The environmental impact of construction is two-fold:

- we impoverish the nature by taking the virgin materials,
- the material finishes as a waste at landfills and occupies the land on Earth we could use for better purposes when the life cycle of the product is over.

It is obvious that we have to develop a society that instead of “take-make-dispose” considers “take already used - make something we need – use further for something else”. In this case, the support of designers and engineers is needed to make products that will be able to adapt to the new purposes and have another life and purpose.

There are two points of view of the phases in each project:

- Linear and
- Circular.

For many years, common concept of thinking in the construction industry was that the building exists from the beginning to an end. The “end” in industry means putting the product to the waste bin and landfill, at the end of its primary use. After the mass production, the waste quantities have started to rise enormously, and it was a time to activate the alarm and do something about that. It is a “linear” way of thinking and it is starting to have huge consequences.

The other way of thinking was introduced recently and it was first mentioned in economy, starting with the principles and term “circular” economy. The industry is making the preparations to adapt its way of thinking processes in that direction.

Considering all mentioned above, construction industry and its stakeholders should adapt the circular economy principles and create sustainable circular building practice, as soon as possible. This circularity has to start in the early beginning, when process of planning is starting and to apply all circularity principles during the process of building planning, designing, building, maintenance and use (in the first life cycle) and predicting the sustainable scenarios for the next building life-cycles.

## 2. APERÇU DES THEORIES (Récapitulatif Français)

Il est évident que nous devons développer une société qui ne réfléchit pas de la manière « prends-produis-met à côté », mais de la manière « prends ce qui est déjà utilisé – produis quelque chose dont nous avons besoin - continue à s'en servir pour produire quelque chose d'autre. » Dans ce cas, l'appui du designer et de l'ingénieur ne devrait pas manquer pour que l'on puisse créer des produits qui pourront s'adapter à un nouvel usage et avoir une nouvelle vie et un nouvel objectif.

Il existe deux points de vue concernant les phases dans chaque projet, et ce sont:

- Linéaire et
- Circulaire.

Pendant de nombreuses années, le concept de la pensée commune dans l'industrie de la construction a été que le bâtiment existe du début à la fin. Dans l'industrie, «la fin» signifie l'élimination du produit dans la poubelle pour les déchets et la mise en décharge, après son usage principal. Après la production de masse, des quantités des déchets ont commencé à augmenter énormément, et l'heure est arrivée de faire activer l'alarme et d'agir sur cette question. Ce mode de pensée «linéaire» commence à avoir des conséquences énormes.

Une autre manière de penser est introduite récemment et elle est mentionnée pour la première fois dans le domaine de l'économie, partant du principe et de la notion de l'économie «circulaire». L'industrie s'apprête à orienter sa manière de penser vers cette direction.

En prenant en considération tout ce qui est cité ci-dessus, l'industrie de construction et ses parties prenantes devraient le plus tôt possible adapter les principes de l'économie circulaire et créer la pratique durable de la construction circulaire. Cette circularité doit commencer au moment où commence le processus de la planification et mettre en place tous les principes de la circularité lors du processus de la planification, de l'étude d'un projet, de la construction, de la maintenance et de l'usage (lors du premier cycle de vie) et de la prévision des scénarios durables pour les cycles de vie du bâtiment à venir.

## 2. OVERVIEW OF THE CORPUS THEORIES

The human impact on the environment was detected long ago and the impact has been growing exponentially since the industrial revolution, but the measures to slow down the negative impact are unable to follow the growth of the impact. There are some existing theories and methods for measuring environmental impact, as well as the theories and methods to lower it. Some knowledge from the other fields can also be applied to the built structures and help the construction industry to decrease its negative influence on the environment. A research in the field of economy has an important influence on the construction industry, as it calculates the costs (money gains and losses) of being irresponsible to the environment, producing the waste and having a big negative impact on the only planet we can live on.

Graedel & Allenby 1996 put the state of development in relation with the use of the resources. This graph can be still used in the 21<sup>st</sup> century, as the influence on the environment is going in the same way they have predicted. (Figure 10)

There is an urgent need to do as much as possible in the field - “immediate action”, in the way that we don’t lose the resources (as they are limited), but to use them in a smarter way and lower the need for virgin materials.

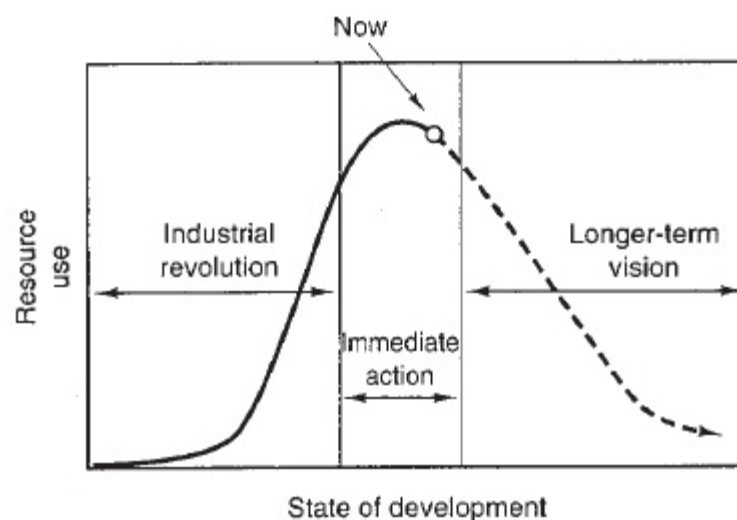

Figure 10. Diagram of the relationship between the state of the technological development of society and its influence on the environment and use of resources (Graedel & Allenby 1999).

The period of industrial revolution (left side of the diagram) shows enormous growth of the use of resources. The population state development is still in the second part of “immediate action” and fighting for lowering virgin material needs in different ways. The right part of the diagram “longer-term vision”, a dashed line which is certain to happen, will depend on us and whether we will use less or we will have resource scarcity.

Considering the construction waste, if we use more virgin materials without planning to use them again, the quantity of waste is increasing every moment. The environmental impact of construction is two-fold:

- we impoverish the nature by taking the virgin materials,
- the material finishes as a waste at landfills and occupies the land on Earth we could use for better purposes when the life cycle of the product is over.

It is obvious that we have to develop a society that instead of “take-make-dispose” (Figure 11) considers “take already used - make something we need – use further for something else”. (Figure 12) In this case, the support of designers and engineers is needed to make products that will be able to adapt to the new purposes and have another life , without downgrading.



Figure 11. Traditional concept “take-make-dispose” with the waste at the landfill.



Figure 12. New concept “take– make - use again” that forms a loop.

Terminology used in accordance with the proposals in field of design are “eco design”, “green design”, “design for the environment”, “sustainable design” and it always goes with the new ways to deliver less damage to the environment and the society. (Roy 2006)

The circular economy is defined as an “industrial system that is restorative or regenerative by intention and design.” (Ellen MacArthur Foundation 2013).

McDonough & Braungart 2002 recognized two cycles for resource loops:

- „technical cycle” (closed loop in which materials that are inorganic or synthetics can stay in continued use without losing their properties or value) and
- “biological cycle” (organic materials or nutrients that can return back to the system or decompose without causing harm to the environment and provide a source of food).

In addition to that, circular design needs to consider the business model that a product is being designed for. Some loops involve a business maintaining the economic value of assets throughout their life-cycle and others involve the adoption of resources that can be reintegrated into nature or fed into other supply chains. (McDonough & Braungart 2002)

Go et al. 2015 define “Design for X” which provides directional criteria on designing for multiple generation life-cycles and it is defined as a “combination of eco-design strategies including Design for Environment and Design for Remanufacture, which leads to other design strategies such as Design for Upgrade, Design for Assembly, Design for Disassembly, Design for Modularity, Design for Maintainability and Design for Reliability. This multiple life-cycles design thinking will pave the way for a more sustainable design and development of future products.” (Figure 13)

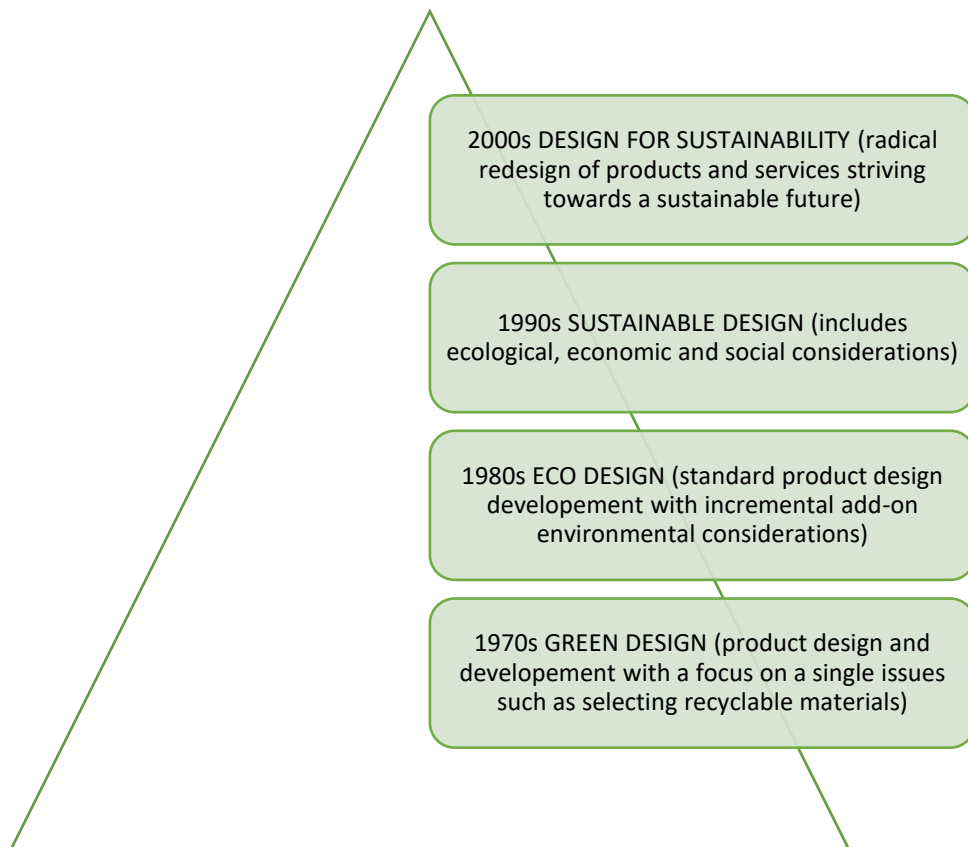

Figure 13. Historical evolution of environmental philosophies applied to design. Adapted Moreno 2016.

**“There is too much making and not enough designing.”**

Ezio Manzini

## 2.1. CIRCULAR BUILDINGS

There are two points of view of the phases in each project:

- Linear and
- Circular.

For many years, common concept of thinking in the construction industry was that the building exists from the beginning to an end. The “end” in industry means putting the product to the waste bin and landfill, at the end of its primary use. After the mass production, the waste quantities have started to rise enormously, and it was a time to activate the alarm and do something about that. It is a “linear” way of thinking and it is starting to have huge consequences.

The other way of thinking was introduced recently and it was first mentioned in economy, starting with the principles and term “circular” economy. The industry is making the preparations to adapt its way of thinking processes in that direction.

Although this is often simply “depicted as a combination of reduce, reuse and recycle activities” (Kirchherr, Reike & Hekkert 2017), its three principles are more fundamental. These principles have been translated into four – alternative – value propositions. (Ellen MacArthur Foundation 2013)

Cheshire 2016 applied these principles to the buildings:

- “minimizing material usage (refurbishing rather than demolishing and rebuilding);
- maximizing the number of consecutive cycles (refurbishing, adapting and refitting longer);
- diversifying reuse across industries (replacing virgin materials with waste from other industries);
- avoiding contaminated materials (keeping materials pure and allowing them to be reused, recycled or composted at the end-of-life).”

“Other industry specific issues are related to the large quantities of salvaged items, the lack of standards, codes and guidelines and the uniqueness of buildings (Hosseini et al. 2014, Hosseini et al. 2015, Iacovidou & Purnell, 2016). Examples of organizational issues include extra time and efforts in sorting, transporting and recovering processes (Mahpour 2018) and the higher associated labour costs (Coelho & De Brito 2013b). Another stream of literature aims to guide the transition to a circular economy through traditional quantitative instruments (e.g., Life Cycle Analyses) (Merli, Preziosi &



Acampora 2018). The systematic analysis of best (management) practices lacks behind though. (Leising, Quist & Bocken 2018).” (Van den Berg 2019)

“The concept of a circular economy has recently gained traction as it suggests that economic development and profitability is possible without an ever-growing pressure on the environment.” (Ghisellini et al. 2016; Kalmykova et al. 2018)

The outline of the circular economy is showed in (Figure 14). It explains the whole process and should be followed in order to achieve the required result and have benefits for the future generations.

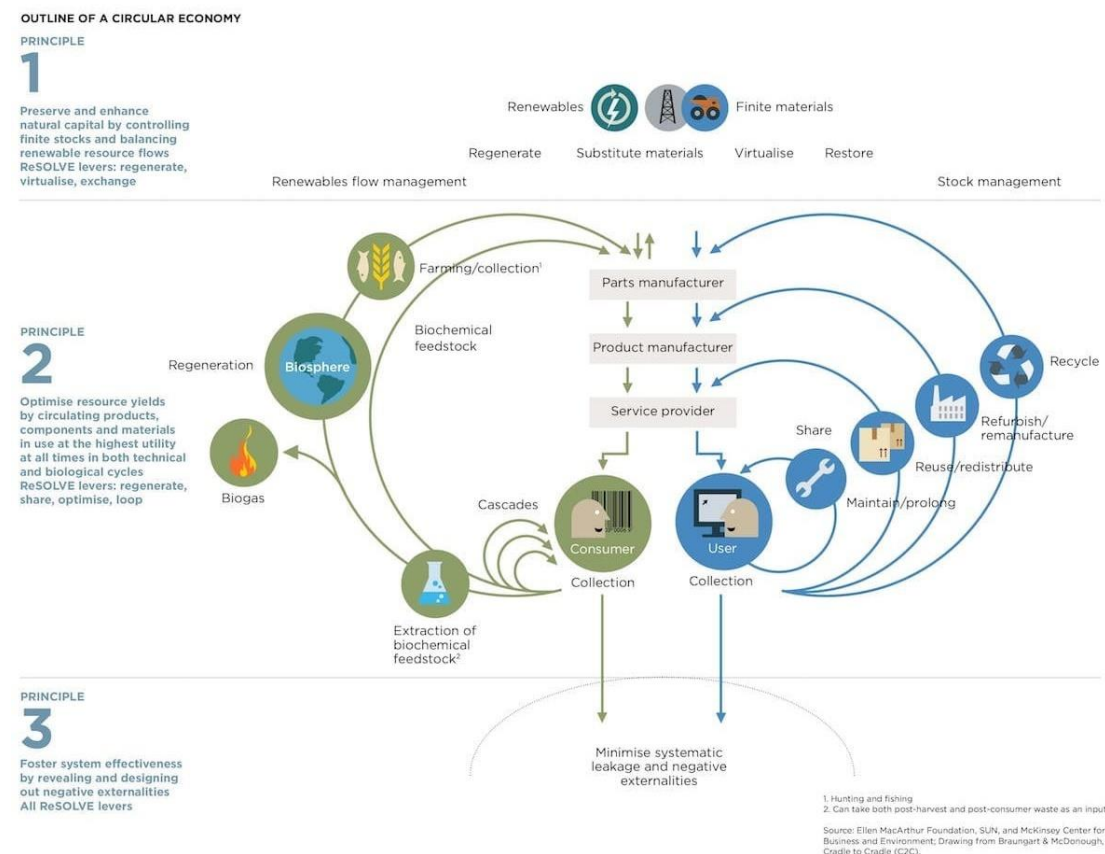

Figure 14. The outline of the circular economy of Ellen MacArthur Foundation (source: <https://www.ellenmacarthurfoundation.org/circular-economy/concept/infographic>)

Ellen MacArthur Foundation 2013 explained circular economy as “an industrial system that is restorative or regenerative by intention and design”. “It replaces the end-of-life concept with restoration, shifts towards the use of renewable energy, eliminates the use of toxic chemicals, which impair reuse and return to the biosphere, and aims for the elimination of waste through the superior design of materials, products, systems and business models”. (Ellen MacArthur Foundation 2013).

Some of them can be just taken and be adapted to hold the value of the building and its parts. The circular economy model shows potential savings on the use of material, labour, and embedded value. (Ellen MacArthur Foundation 2013).

“Interesting approach is the way of circularity. It’s called:

- the ‘power of the inner circle’ refers to minimizing comparative material usage vis-à-vis the linear production system. The tighter the circle, i.e., the less a product has to be changed in reuse, refurbishment and remanufacturing and the faster it returns to use, the higher the potential savings on the shares of material, labour, energy, and capital embedded in the product and on the associated rucksack of externalities (such as greenhouse gas (GHG) emissions, water, toxicity).
- The ‘power of circling longer’ refers to maximizing the number of consecutive cycles (be it reuse, remanufacturing, or recycling) and/or the time in each cycle.
- The ‘power of cascaded use’ refers to diversifying reuse across the value chain, as when cotton clothing is reused first as second-hand apparel, then crosses to the furniture industry as fibre-fill in upholstery, and the fibre-fill is later reused in stone wool insulation for construction—in each case substituting for an inflow of virgin materials into the economy—before the cotton fibres are safely returned to the biosphere.
- The ‘power of pure circles’, finally, lies in the fact that uncontaminated material streams increase collection and redistribution efficiency while maintaining quality, particularly of technical materials, which, in turn, extends product longevity and thus increases material productivity.” (Ellen MacArthur Foundation 2013).

“Recycling is reprocessing recovered objects with a manufacturing process and making them into a (component for a) final object again (Kibert 2016).” Even though much policy is oriented towards recycling (Allwood et al. 2011), the strategy is less preferable because it typically reduces the object’s quality, potential for future uses and economic value – also called down-cycling (Chini 2007)” (Van den Berg 2019)

In Europe, there are some countries who have a strategy to pass from linear to circular economy, like Netherland. (Figure 15)

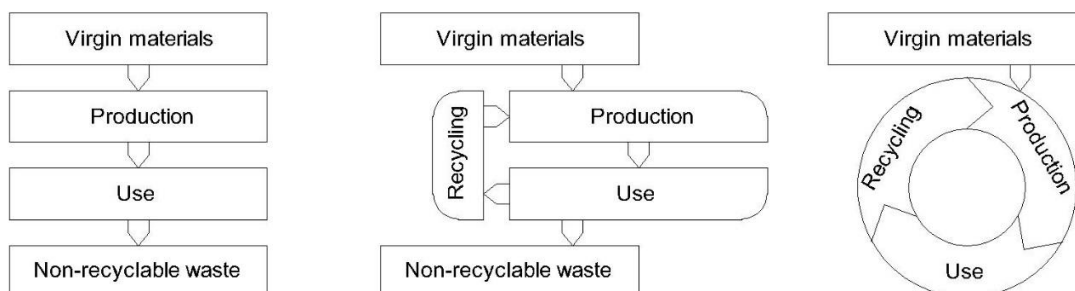

Figure 15. Differences between the linear (left), reuse (centre) and circular economy (right). (adapted from Dutch Government-wide program 2015)

National Waste Management Plans in Belgium, the Netherlands and UK as well as Dutch national program “The Netherlands circular in 2015” encourage sustainable/reversible construction in various ways:

- encourage renovation over new construction,
- encourage industries to develop circular processes and financial models,
- encourage manufacturers to develop take back systems for their materials,
- encourage the design of buildings that can adapt to changing functions and inhabitants,
- encourage selection and use of materials that are more sustainable, use less resources, and are easier to reuse,
- promote alternatives to building materials and products that contain hazardous materials,
- Support selective demolition, and stimulate the development of a social economy for selective dismantling.

A report of the Dutch Ministry of Environment and Infrastructure in 2015 proposes to “pre-finance the demolition of structures and the reuse of materials and construction elements (by disposal fee), as is already the case for cars”. (Durmišević et al. 2019)

“However, currently repurposing is not common practice and most end-of-use options of buildings lead to partly or complete demolition (i.e. the building as a demolition liability).” (Debacker & Manshoven 2016)

According to these data, the end of life should not be the demolition and waste on the landfill. The building fragments should have the possibility to be a part of something else and have another life-cycle and another one and another one.

“Implementation of such an approach is intended to accomplish the evolution of manufacturing from linear to semi-cyclic, and finally to cyclic processes, by understanding the interplay of process and material flows and by optimising the set of considerations involved.” (Durmišević 2006).

The linear (Figure 16) and the circular (Figure 17) perspective of building phases can be represented visually and help to understand the importance of the circularity.

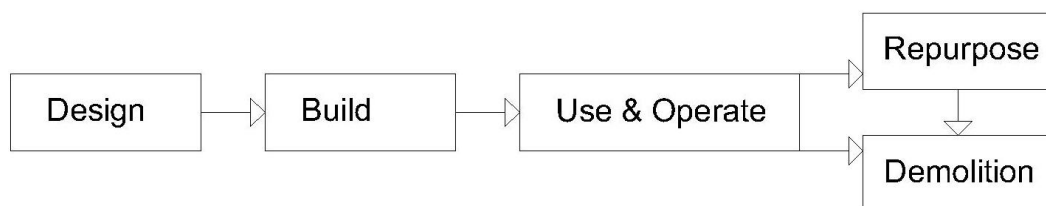

Figure 16. Building phases from a linear perspective. Adapted Peters et al. 2016

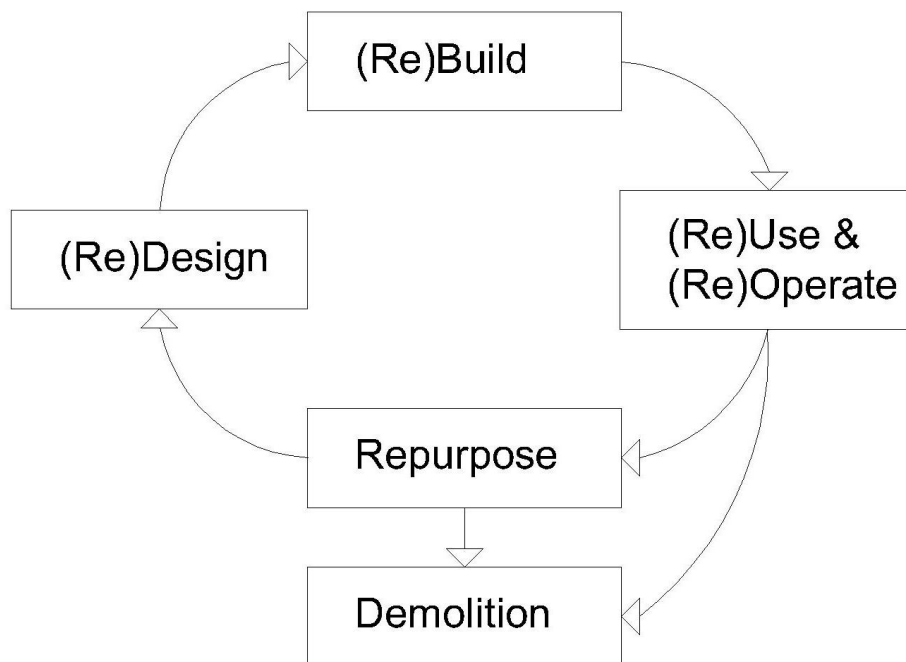

Figure 17. Phases from Building a circular perspective. Adapted Peters et al. 2016

A construction project passes through many phases. BAMB 2016 “analysis distinguishes four main building phases:

- Design: the phase where all the financing, designing, planning is specified.
- Building: the phase where the building or infrastructure is realized.
- Use & Operate: the phase where residents/ users/ occupants, etc. are using the building and the building is operated to maintain the service levels required by the occupants.
- Repurpose & demolition: the phase where transformation is planned, and products and materials are extracted.” (BAMB 2016)

Androšević et al. 2019 came to the similar conclusion that the building process is going through:

- “programming and design phase,
- realization / production / construction phase,
- use and maintenance phase,
- transformation and reuse phase,
- deconstruction / demolition phase (eventually)”. (Figure 18)

“In the final mentioned phase, term “demolition” should be considered as deconstruction or disassembly of the building parts when building life cycle is over, with the goal to bring back all parts to the construction phase again, if possible.” (Androšević et al. 2019)

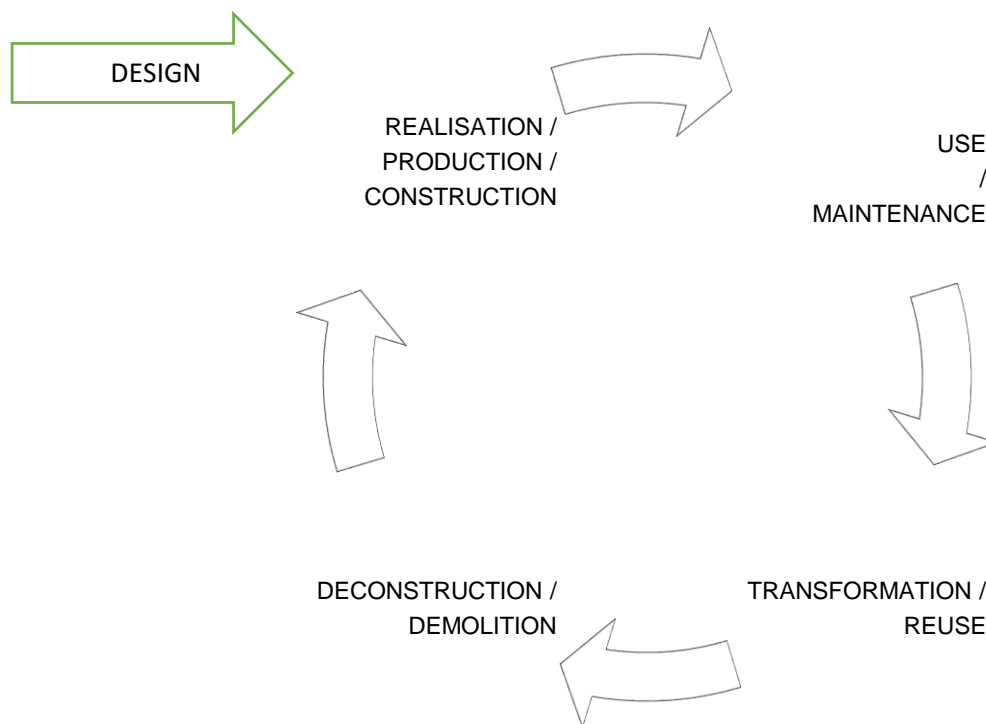

Figure 18. Phases in life cycle of the building project and the building itself. Source: Androšević et al. 2019

Construction industry has to follow up this “circular” model as soon as possible, because of the huge negative environmental impact of the built structures.

The conclusion of the BAMB survey: “if end-of-life issues would be taken into account during the design and construction phases, this would also facilitate the reuse of components, that are often worth much more than their constituent materials. In order to foster circularity in the building sector, connections between all phases in the value chain are necessary in order to support communication and information transfer across the whole of the value chain/network.” (Debacker & Manshoven 2016)

Sharp & Hobbs 2019 are promoting “the shift to a circular building sector, thereby reducing waste, retaining value for materials in the system and slowing down the use of resources to a rate that meets the capacity of the planet. “

Van den Berg & Durmišević 2017 have defined a term “reversible building”, as “a type of building that is specifically designed to enable transformations, disassembly and reuse of building elements”. The form of the building can be changed through “eliminating, adding, relocating or substituting parts”. They point out the importance of the disassembly and reuse in the whole process, with the aim to close the loop of material usage and to achieve upgrading rather than downgrading/down-cycling of building materials.

The term “circular economy,” is defined by the Ellen MacArthur Foundation 2013 as “an industrial system that is restorative or regenerative by intention and design.” The “circular construction” can follow the same definition and implement it in the practice.

“The expression “buildings as material banks” (Debacker & Manshoven 2016) can describe this “circular construction” where resources can be reduced, and materials can be reused until the end of their technical life-cycle and after that period, simply recycled and brought back in the loop again.

Beurskens 2021 defined the circular building design as a “design approach to create buildings that have the capacity to accommodate changing demands by taking into account all life cycle stages, to minimise resource input by narrowing resource flows, retain a high embodied value through design for disassembly, reparation and refurbishment and extend product life by slowing resource flows, utilise recyclable materials to enable closing resource flows, and eliminate leaking resource flows by continuously forming an incentive for future reuse”.

The advantages of the circular solutions are evident, as there are case studies in the construction sector that prove the circular methodology. Even though, there are many obstacles on the way. As Kozminska 2019 say “these developments happen despite multiple infrastructural, planning, legal, social, environmental and economic challenges which appear in a non-standard and iterative design and construction process.”

“The architects are working with construction waste, or they design for further reuse despite limited access to related knowledge, data, and information.” (Kozminska 2019) Kozminska 2019 states that stakeholders (mostly architects) must educate themselves, source materials and experiment with them, consult architectural solutions with experts, participate in collaborative processes, learn from the engineers, contractors, demolition companies, or local artisans, despite non-supporting environment and a lot of challenges. “They look beyond tested solutions and question standard practices. The emerging role of the architect, who participates in the circular design process, requires extended knowledge to negotiate between often contradicting circumstances without compromising the quality of created sustainable architecture.” (Kozminska 2019)

Considering all mentioned above, construction industry and its stakeholders should adapt the circular economy principles and create sustainable circular building practice, as soon as possible. This circularity has to start in the early beginning, when process of planning is starting and to apply all circularity principles during the process of building planning, designing, building, maintenance and use (in the first life cycle) and predicting the sustainable scenarios for the next building life-cycles.

## 2.2. IMPACT ASSESSMENTS – IDENTIFY OPORTUNITIES AND BARRIERS IN THE FIELD OF CIRCULAR BUILDING PRINCIPLES

Even though, some decades ago, design researchers have been exploring how a building's design can be optimized to allow adaptations and transformations on one hand and the recovery of objects for reuse on the other hand (Crowther 1999; Durmišević 2006), there are very small number of applications in construction industry.

Guidelines come out of these principles include (Crowther 1999, Durmišević 2006; Guy, Shell & Esherick 2006):

- the use of reversible building connections;
- allowing their accessibility,
- minimizing the number of connections.

These are good theoretical models which propose "circular" principles from economy to be implemented in construction industry with good value prediction, but the construction industry is really behind with the building protocols based on this strategy and of course, practice and implementation are at really low level.

"The main strategy to close material loops for buildings at the end of their useful life is reuse. The waste hierarchy (also called Lansink's Ladder) indicates an order of preference for the latter part of an object's life-cycle: prevention, minimization, reuse, recycling, energy recovery and disposal." (Parto et al. 2007).

Several studies have been looking for obstacles and mapping barriers why the transition towards circular construction practices is going so slow. Gorgolewski 2008 points out that the lack of coordinated construction supply chains, for example, limits a consistent alternative, circular pathways for building projects and supply of reusable building components. (Gorgolewski 2008)

Circular economy develops circular principles and establishes them faster than the construction industry. In practice, some production industries are adopting the easy disassembly principles, like car production industries, so the parts with shorter service life can be easily changed and repaired. However, in other industries, this practice is not accepted yet.

An easy assembly is required in construction industry, but unfortunately, there are no requirements for this. Building parts have different life expectancy, but "it is quite normal for parts with short durability to be fixed in permanently." (Durmišević 2006)

“Mahpour 2018, for example, used quantitative surveys to rank potential barriers in moving towards more circular construction and demolition waste management practices. One of the conclusions here is that “sorting, transporting, and recovering processes” are among the most important barriers, which is a generic insight that does not explain how or why certain objects may or may not be recovered. Other studies have similarly identified critical success factors for recovery (Akinade et al. 2017), factors impacting demolition waste generation (Chen & Lu 2017), benefits and constraints of deconstruction (Iacovidou & Purnell 2016), and drivers and/or barriers for reverse logistics in construction – sometimes substantiated with (some) empirical data (Chileshe, Rameezdeen, & Hosseini 2016; Chileshe et al. 2018) and sometimes limited to existing literature (Hosseini et al. 2014; Hosseini et al. 2015). Aiming for more in-depth insights, Gorgolewski 2008 alternatively used case studies to reveal “some challenges” for designers working with recovered building objects, like complexities due to the timing and availability of materials and the lack of a coordinated supply chain. An important shared insight from these studies is that object recovery is not only challenging because of project-specific uncertainties but also because of the socio-technical organization of the (selective) demolition process.” (van den Berg 2019)

During examination of the responsible demolition contractor’s recovery decisions Van den Berg 2019 “derived a proposition strongly grounded in the data: a building object will be recovered for reuse only when the demolition contractor:

- identifies an economic demand for the object;
- distinguishes appropriate routines to disassemble it; and
- can control the performance until integration in a new building.”

Tukker & Tischner 2006 found out that “transformation from product-orientation towards service-provider in many ways supports reaching the objectives of the circular economy”. Their research show that companies should be motivated “to extend product lifetime by repairing and remanufacturing, and by more efficient use of resources, and perceive their customers as users rather than buyers”.

Du Plessis et al. 2002 proposed the clear strategy for sustainable development for developing countries, where all stakeholders have to cooperate and to:

- “create a capable and viable local construction sector,
- ensure that the sector is able to respond to the demands sustainable development places on its activities.”

Du Plessis et al. 2002 identified “three types of interdependent and multi-dimensional sustainability enablers:

- technological,



- institutional,
- enablers related to value systems (both how things are valued and the social, spiritual or moral values that guide decisions)."

Also, Du Plessis et al. 2006 divide technology enablers into three areas, so each of them can be separately upgraded, if needed. These areas are:

- "Hard technology related to equipment and materials, industrial processes, and physical infrastructure solutions.
- Soft technology such as systems, mental models and those tools (ICT-based or otherwise) that support decision making, monitoring and evaluation.
- Knowledge and information (e.g. databases, benchmarks, guidelines and manuals, handbooks, indigenous knowledge systems)." (Du Plessis 2006)

Du Plessis 2016 underlined that "the past twenty years have seen an explosion in research publications and case studies that all contain useful knowledge" and "there are thousands of case studies of buildings that used one or more sustainable building strategies" and the solution will be "creating a knowledge sharing platform".

"Collecting and sharing these on a publically accessible, collaboratively developed and populated platform will increase the impact of research, and assist in further theory and tool development". (Du Plessis 2016)

Positive benefits are visible when this great idea make the knowledge share very easy. On this platform all Building Information Model (BIM) data, Life Cycle Assessment (LCA) data of the good known and new materials that are tested as a "green" solution, can be available to the stakeholders. Thus, this platform has to be well organized and user adapted. Theoretically, it is a wonderful idea which is looking for an implementation. Many platforms are developing in XXI century, but still haven't form one complete platform with database that will be used by many tools and worldwide.

"Advanced technologies such as smart sensors, smart materials and smart meters supports the development of high-performing buildings and cities that can function more effectively in current and future scenarios of constrained resources" (Buckman et al. 2014)

Even though the information databases are developing, BIM modelling is possible as a tool for making decision process easier, there are very little steps ahead in terms of really circular building practices. Summing it up, the key factors that are barriers for circular building practice are:

- Producers do not see the profit in changing the production process;

- Buildings are designed as static structures, without or with very little flexibility and ability to transform and adapt in functional, technical and physical way;
- Missing protocols for circular building;
- Missing circular building strategies and support (public and private);
- Missing methods and tools to help circular building implementation.

This kind approach “to building design has the potential to accomplish benefits such as:

A. Environmental benefits:

- Improvement of air and water quality
- Reduction in waste streams
- Conservation and restoration of natural resources
- Enhancement and protection of biodiversity and ecosystems

B. Economic benefits:

- Reduction in operating costs
- Creation, expansion, and shaping of markets for green product and services
- Improvement in occupant productivity
- Optimisation of life-cycle economic performance

C. Social benefits:

- Enhancement of occupant comfort and health
- Heightening of aesthetic qualities
- Minimizing the strain on local infrastructure
- Improvement of overall quality of life “(Durmišević 2006)

Taking this into consideration, we can reach a conclusion of what is necessary for good circular building practice (Figure 19)

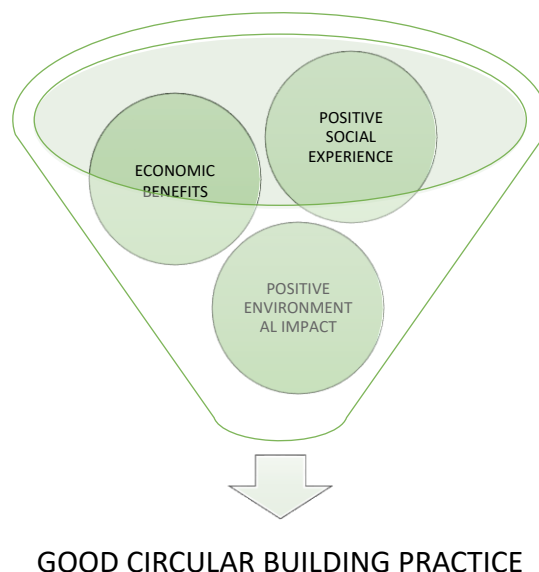

Figure 19. Good circular building practice.

There are many opportunities in this area and hopefully, the industry will recognize them. There is the urgent need to announce the circular building protocols as obligatory. Early adopters will profit in near future. Following these principles and protocols will surely help the environment to heal and be healthy for the future generations.

Akadiri et al. 2012 presented a conceptual framework aimed at implementing sustainability in the building industry. The proposed framework based on the sustainable triple bottom line principle, includes resource conservation, cost efficiency and design for human adaptation, with hope that this knowledge will facilitate the sustainability of building industry. (Figure 20)

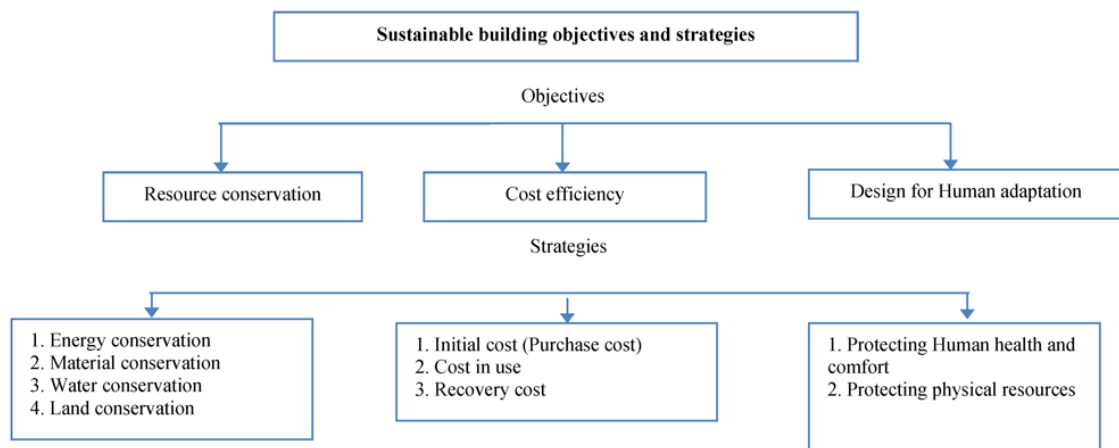

Figure 20. Framework for implementing sustainability in building construction. (Akadiri et al. 2012)

“It can be deduced that, even with a severely damaged building, the repair and retrofit work incurs a lower economic and environmental impact than that of the total replacement with a new construction.” (Alba-Rodríguez et al. 2017)

### 2.2.1. Equation of Environmental Impact

Review of literature led to some interesting observations and attempts to define environmental impact mathematically – to put variables in equation. The formula that describes the impact of human activities on the environment is **I = PAT**, or more precisely:

$$I = P \times A \times T$$

Where is:

I - Human impact on the environment,

P – Population,

A – Affluence (average consumption of each person) and

T – Technology.

The equation was developed thanks to the scientists Ehrlich, Holdren and Commoner and published. (Ehrlich & Holdren 1971, Commoner 1972.)

The I=PAT equation has been criticized for being too simplistic. The assumption in formula is that P, A, and T are independent of each other. Chertow 2001 analysed IPAT equation and its variants.

But, there could be at least seven interdependencies between P, A, and T. Alcott 2010 rewrite the equation as  $I = f(P, A, T)$

Speth 2012 was doing the MIT research where he defined the factors that influence the environmental impact in this equation:

**Environmental impact =**

**size of population x (GDP/person) x (environmental impact/per unit of capita GDP)**

GDP is gross domestic product (a measure of industrial and economic activity/consumption)

“The total environmental pressure is proportional to size of the population, its level of prosperity and the environmental effectiveness per unit of prosperity” (Speth 2012)

This equation can be adapted and used for environmental impact of built structures. Although, we already know that the negative impact of built structures is increasing every year.

### 3. FIRST ANALYSES

#### Summary (English)

During the involvement in the project Building as Material Banks, as one of the HORIZON 2020 projects, financed by the European Commission, the author of this thesis was able to be in the stream of the research and to underline and prove the necessity of going towards circular building.

The approach that has been used in this research starts with analysing the existing method and testing it on some case studies.

Case studies are selected on the basis of:

- use of the new building technology (with the accent on easy assembly and disassembly),
- place of design (BiH),
- territory in which it was built (BiH).

For the purpose of this research, the following buildings were studied and analysed:

- building designed in BiH and built in Switzerland,
- wooden structure Pixel, designed and built in BiH,
- building Green Design Center, designed and built in BiH.

These examples confirm that the reuse potential can be measured using the method Durmišević 2006 and that the conclusion about the reusability for the tested system can be made. To achieve the goal of complete view of the environmental impact of the building and its parts, the intention is to incorporate this method with the other methods.

### 3. PREMIERES ANALYSES

#### (Récapitulatif Français)

Lors de l'implication dans le projet de *Building as Material Banks*, l'un des projets du programme Horizon 2020, financé par l'Union européenne, l'auteur de cette thèse a pu être au courant des recherches actuelles et de cette manière mettre l'accent sur la nécessité d'avancer vers la construction circulaire et prouver celle-là.

L'approche qui a été utilisée lors de cette recherche commence par l'analyse de la méthode existante et par les essais sur certaines études de cas.

Les études de cas sont choisies sur la base de :

- Utilisation de la nouvelle technologie de la construction (en mettant l'accent sur le montage et le démontage aisés),
- Lieu de la conception (Bosnie-Herzégovine),
- Territoire sur lequel elles ont été construites (Bosnie-Herzégovine).

Pour les besoins de cette recherche, ont été étudiées et analysées les constructions suivantes :

- Bâtiment conçu en Bosnie-Herzégovine et construit en Suisse,
- Construction en bois *Pixel*, conçue et construite en Bosnie-Herzégovine,
- Bâtiment de Green Design Center, conçu et construit en Bosnie-Herzégovine.

Ces exemples confirment que le potentiel de la réutilisation peut être mesuré par la méthode de Durmišević 2006 et que l'on peut en tirer une conclusion sur la réutilisation pour le système éprouvé. Afin d'atteindre l'objectif visant à obtenir une vue complète de l'impact du bâtiment ainsi que de ses parties sur l'environnement, l'intention c'est d'intégrer cette méthode à d'autres méthodes.

### 3. FIRST ANALYSES

During the involvement in the project Building as Material Banks, as one of the HORIZON 2020 projects, financed by European Commission, the author of this thesis was able to be in the stream of the research and to underline and prove the necessity of going towards circular building.

The approach that have been used in this research starts with analysing the existing method and testing it on some case studies. The survey shows that there are many designers, architects, civil engineers and other construction industry stakeholders that are aware of the sustainable and circular building and construction, but they have a little chance to apply the knowledge in their own country, Bosnia and Herzegovina (BiH). The reasons are different, and some of them are explained in this research.

Case studies are selected on the basis of:

- use the new building technology (with the accent of easy assembly and disassembly),
- place of design (BiH),
- territory built (BiH).

For the purpose of this research, next buildings were studied and analysed:

- building designed in BiH and built in Switzerland,
- wooden structure Pixel, designed and built in BiH,
- building Green Design Center, designed and built in BiH.

The first chosen case study was the one residential two storey building, which was designed to be A+ class, with easy assembly and mostly made of wood. The building design was done in architectural bureau Normal d.o.o in Bosnia and Herzegovina, but built in 2014, in Safenwill, Switzerland. (Figure 21) Each floor of the building is made of four totally prefabricated units brought on site and put together. Every unit is finished in production and has all necessary elements including installations inside. After the unit positioning, the installations were connected between units and the building can be used.

Three more buildings with the same concept were built in Europe. As an excellent example of the prefabricated building, this project was worthwhile to be tested using the method by Durmišević, explained in Durmišević 2006. The reuse potential was tested on the Building level (Figure 26) and on the Unit level (Figure 27, Figure 28). Total reuse potential according to indicators is presented on the diagram in Figure 29.

More details about reuse potential analyses are in Appendix Figures 1a to 21b.



Figure 21. Easy assembly building in Safenwil. (source: photo archive Normal architects and <https://normal.ba/en/projektii/safenwil/>)

The other project that attracted attention was the small wooden structure called Pixel. It is an exhibition wooden box which was exhibited in 2015 in Mostar. After the exhibition, it was disassembled and put in the storage. It was designed as expo platform. The International Design Studio 2017 revived the Pixel elements/parts and gave it the new possible purposes. (Figure 22)

The Pixel is a very interesting structure designed to be assembled and disassembled many times for expo and it was also a good case study to analyse reuse potential with method Durmišević 2006. (Figure 29)

More details about reuse potential analyses are in Appendix Figures 22a to 30a.



Figure 22. Picture of the Pixel in the exhibition in Mostar 2015 (left) and exploded 3D model of the wooden structure (right)

The third case study, that generated considerable recent research interest, was the Green Design Center (GDC) building in Mostar. (Figure 23)





Figure 23. 3D visualization of the GDC innovation park in Mostar (source: [www.bamb2020.eu](http://www.bamb2020.eu))

GDC has been founded by Sarajevo Green Design Foundation in 2012 and became EU BAMB demonstration project in South East Europe in 2018. GDC will be a transformable dynamic structure which will change function and organization on yearly bases.

Green Design Centre is envisioned as a regional green laboratory that will be showcasing principles of circular buildings and green solutions.

“GDC Ambition:

- -development and showcasing of innovative circular/green building concepts;
- -create an interaction platform and meeting space between the inhabitancy, innovation and creativity
- -bring innovation closer to the people by means of interactive ICT platform;
- -bring knowledge institutions, schools, designers and production industry together;
- -promote research that will inform decision makers on assessing, evaluating the performance circular building;
- -new meeting and expo place that will have educational, entertainment, and innovation agenda.” (Durmišević 2019)

This kind of “design for disassembly” principle is shown on the 3D exploded module. (Figure 24)

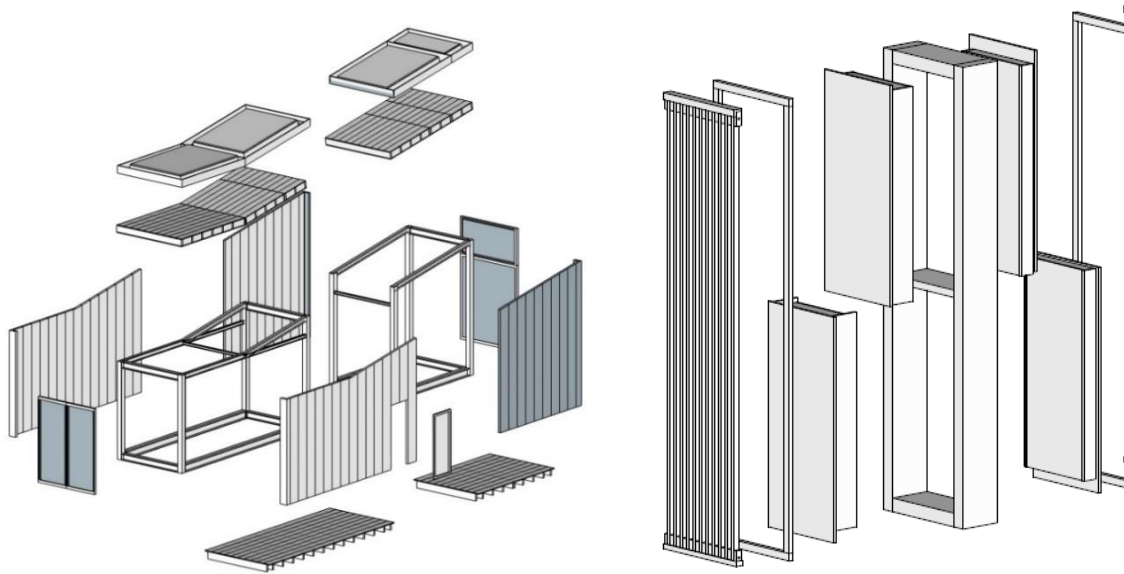

Figure 24. 3D exploded module GDC Mostar and 3D exploded wooden wall, Durmišević & Androšević. Source: BAMB pilot project

The façade of the GDC is designed to be easy to assemble and disassemble and thanks to that, also transformable with the possibility to adapt to a few new scenarios. (Figure 25)

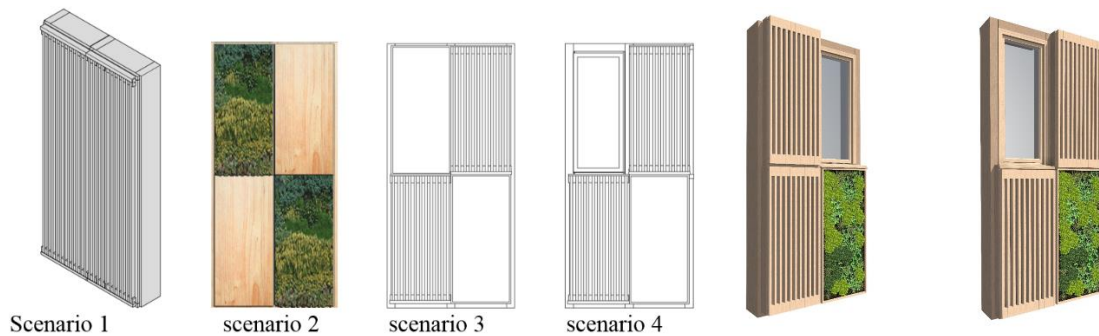

Figure 25. Possible scenarios for the GDC wall. Source: BAMB pilot project

This building was designed to be A+, transformable and with high reuse potential. Reuse potential analyses of the floor, roof and wall were done during the design phase to be sure that the reuse potential of these GDC parts is really high, as predicted. The reuse potential was calculated and described in Chapter 3.1. in this research, using method Durmišević 2006 for the roof (Figure 30) and for the floor (Figure 31)

More details about reuse potential roof and floor of GDC analyses are in Appendix Figures 31a to 47a.

### 3.1. TESTING EXISTING METHOD ON CHOSEN CASE STUDIES

The method Durmišević 2006 was used to demonstrate the differences between three selected case studies, described in the previous Chapter 3 in this research, in term of reuse potential, considering 7 of 8 indicators and their values. Reuse potential range is from 0,1 to 0,9. Bigger number means better performance and potential for reuse.

The analyses of the building in Safenwil in Switzerland confirmed that the reuse potential on building level was really high, as building is designed to be easily assembled from totally prefabricated units on site. Average reuse potential at the building level is 0,76. (Figure 26)

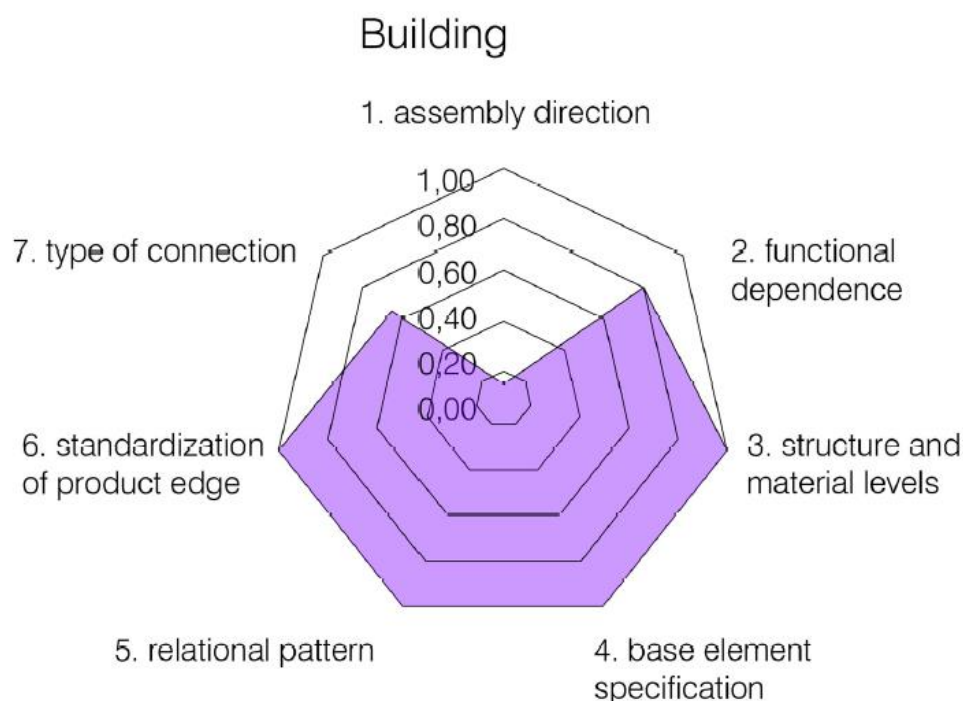

Figure 26. Reuse potential of the building in Safenwil at the building level using method Durmišević 2006

The reuse potential at unit level gives different results for enclosure, infill, load bearing and service. Total average reuse potential for the enclosure is 0,71, for the infill is 0,49 (Figure 27), for the load bearing is 0,71 and for the service is 0,57. (Figure 28) The average reuse potential more than 0,6 is a really good result, showing high possibility for reuse. Despite good average reuse potential for enclosure and load bearing, some parts in these systems are difficult to reach in case that they have to be removed or replaced during the maintenance or any transformation. Some indicators, like assembly direction and base element specification, which have very important role for successful disassembly, have very low values.

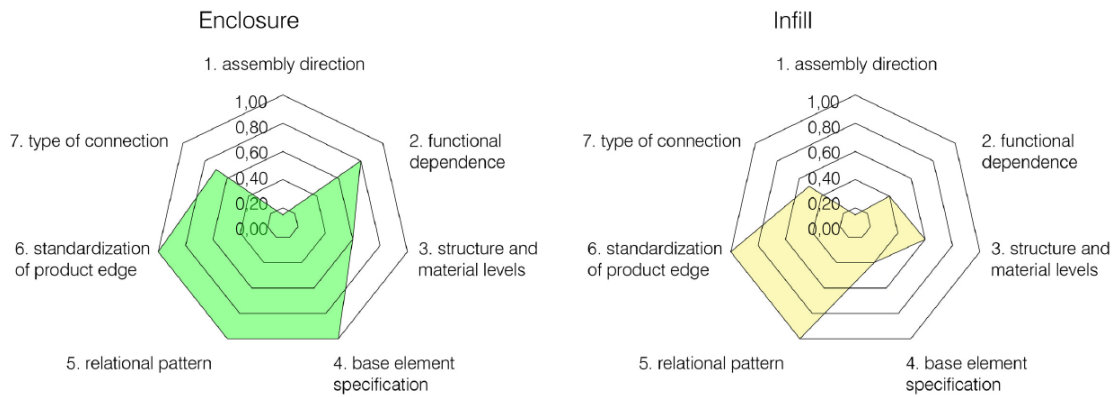

Figure 27. Reuse potential of the building in Safenwil for Enclosure and Infill using method Durmišević 2006

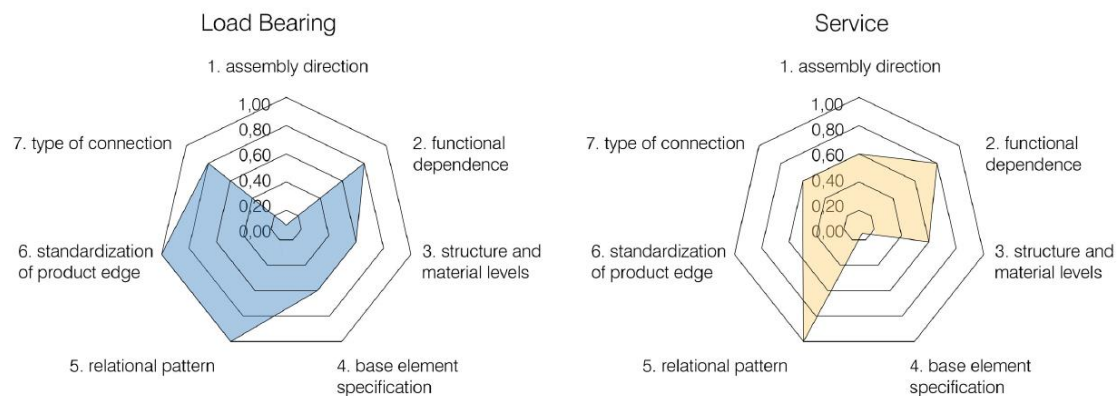

Figure 28. Reuse potential of the building in Safenwil for Loadbearing and Service using method Durmišević 2006

More details about reuse potential analyses for the Safenwil building are in Appendix Figures 1a to 21b.

Regarding reuse potential of the wooden cube called Pixel, the average reuse potential is 0,78. (Figure 29) That result is really good, according to the method analyses. When validate the calculated result in practice, there might be a slightly different conclusion. Even though, the result shows high reuse potential and indicators demonstrate high disassembly and assembly possibilities, the number of assemblies will be limited, because the connections between the wooden elements will damage the wood with each transformation. If it is reassembled 5 to 10 times, the damage in wood could be serious and there will be a requirement for some new parts to complete the structure again.

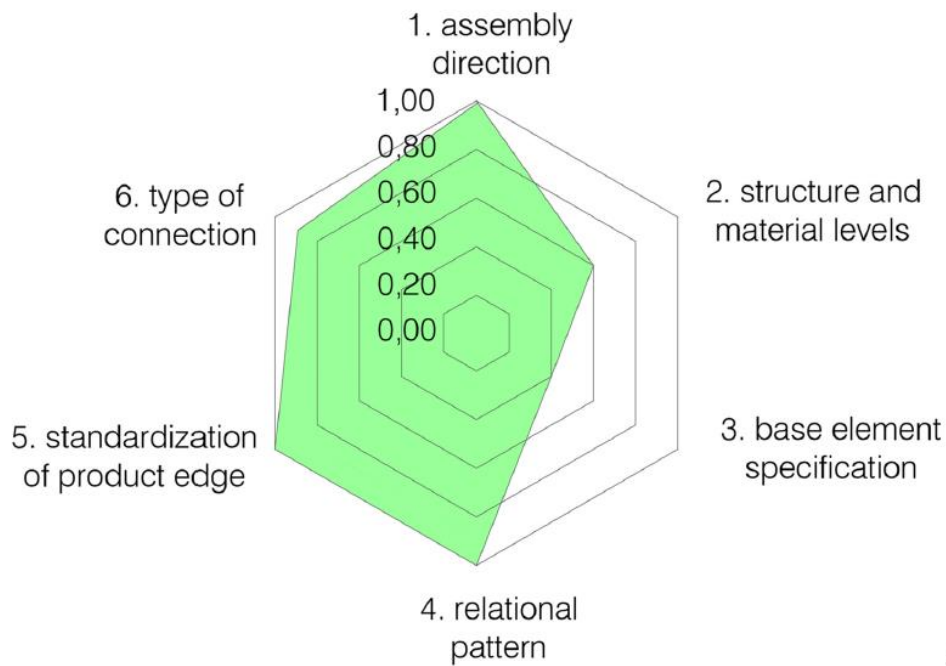

Figure 29. Reuse potential of Pixel using method Durmišević 2006

More details about reuse potential analyses for the Pixel are in Appendix Figures 22a to 30a.

In order to investigate the reuse potential of the Green Design Centre building in Mostar, first calculations were done for its roof and floor. The roof has been designed to have high reusability potential and its average reuse potential is 0,77. (Figure 30)

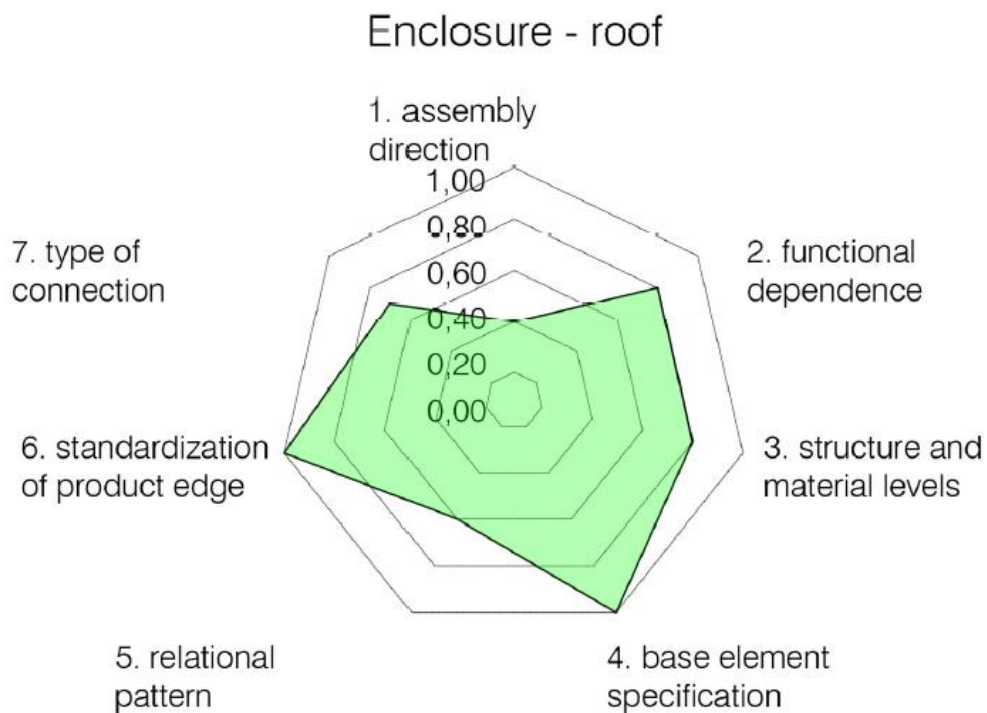

Figure 30. Reuse potential of the GDC roof using method Durmišević 2006

The GDC floor is a new structure and consists of the layers on the existing reinforced concrete slab. The average reuse potential of the floor is 0,65. (Figure 31)

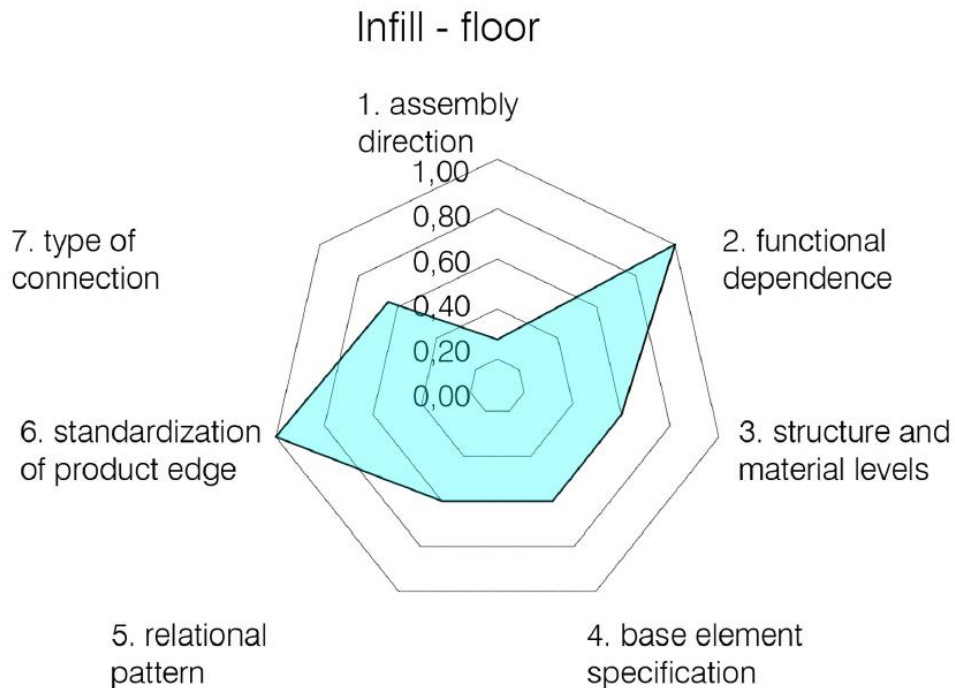

Figure 31. Reuse potential of the GDC floor using method Durmišević 2006

More details about reuse potential analyses for the floor and roof of the Green Design Centre are in Appendix Figures 31a to 47a.

The Green Design Centre building in Mostar is designed to have high transformation and reuse potential. The Green Design Centre is an excellent example of a transformable building with:

- high assembly and disassembly possibilities,
- reusable parts (systems, components, elements and materials),
- energy efficient external wall. (Figure 32)

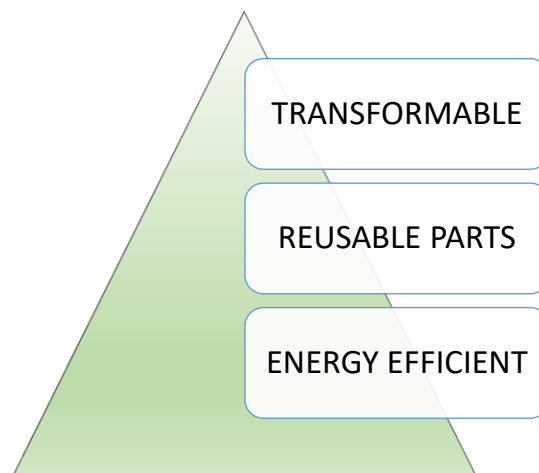

Figure 32. Green Design Centre building in Mostar is presented as a triangle and its advantages, which should be required in all future buildings

These examples confirm that the reuse potential can be measured using method Durmišević 2006 and the conclusion about the reusability for the tested system can be made. To achieve the goal of complete view of the environmental impact of the building and its parts, the intention is to incorporate this method with the other methods.

The attempt of the transformable building was in order to accomplish the same transformability in the building industry as it exists in the product design industry. For example, one compact system can be made from 3 separate systems, and adding 3 more, it becomes the complex system composed from 6. This modularity already exists, but not the reversible process to get separate parts again. Construction and building industry has to think about the reversible process of deconstruction and disassembling in order to prevent parts to become waste. Image below (Figure 33) shows that process of building can be in both direction – from assembly to disassembly and reverse for all separate parts. This should be the guiding idea when designing a product or a building, because it will help in the process of avoiding waste.

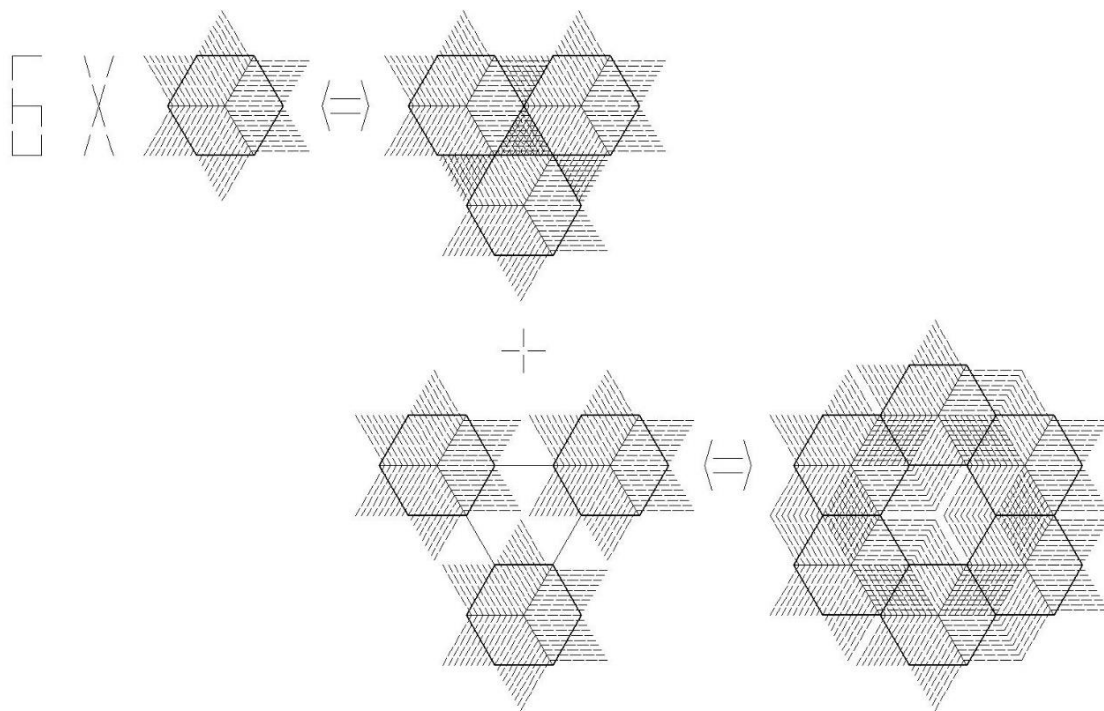

Figure 33. Modularity and transformability (possible assembly and disassembly) in the production and building industry in order to avoid waste.

## 4. RESIDENTIAL BUILDINGS IN XXI CENTURY IN BOSNIA AND HERZEGOVINA

### Summary (English)

Residential buildings in BIH are still built in the same way as in the XX century with reinforced concrete structure and external walls made of reinforced concrete or bricks with better thermal insulation (comparing to the old ones) to fulfil the more demanding energy efficiency standards.

The Energy Performance Improvement Project showed the way of energy performance improvement for existing building envelopes. The Project funds cover the costs to upgrade some collective houses' envelopes. But Single-family and terraced houses which account for as much as 97.36% of the entire stock in BIH (Arnautovic-Aksic et al. 2016), are still losing energy for heating during winter and using a lot of energy for cooling the house during hot summer.

The wooden wall and roof systems in BIH have been forgotten and abandoned in practice, despite all their advantages. Some producers saw their benefit in producing prefabricated wooden systems and houses in BIH at the end of XX and at the beginning of XXI century. Analysing characteristics of systems used, data from manufacturers and users experience, there is conclusion that these wooden systems are:

- energy efficient,
- easy for assembly,
- affordable.

The only example of a wall with easy assembly and easy disassembly is the reversible building façade with reversible connections, that have been designed by E. Durmišević 4D architects and made in Bosnia and Herzegovina productions for the Green Design Center (GDC) building in Mostar in BIH. As already mentioned, this building was built as one of the pilot project buildings for the project Buildings as Material Banks (BAMB), an EU HORIZON 2020 project, financed by EU Commission.

This GDC wall, as a type of the wall that enables easy assembly and disassembly, will be tested further in this research in terms of transformation, reuse potential and construction waste, using different methods.



#### 4. BATIMENTS RESIDENTIELS AU XXI<sup>e</sup> SIECLE EN BOSNIE-HERZEGOVINE (Récapitulatif Français)

Les bâtiments résidentiels en Bosnie-Herzégovine sont toujours construits de la même façon qu'au XX<sup>e</sup> siècle avec une structure en béton renforcé et des murs extérieurs en béton renforcé ou en briques, mais avec une meilleure isolation thermique (en comparaison avec les anciennes), afin de satisfaire des normes plus exigeantes de l'efficacité énergétique. Le projet de l'amélioration de la performance énergétique a montré la manière de l'amélioration de la performance énergétique pour les enveloppes des bâtiments existantes.

Les fonds du Projet couvrent les coûts de l'amélioration des performances de certains bâtiments résidentiels. Cependant, les maisons individuelles détachées sur parcelle, pas de mitoyenneté et les maisons individuelles mitoyennes sur un ou deux côtés qui représentent jusqu'à 97,36 de l'intégralité du stock en Bosnie-Herzégovine (Arnautović-Akšić et autres, 2016), perdent toujours de l'énergie pour le chauffage pendant l'hiver et consomment beaucoup d'énergie pour le refroidissement de la maison pendant l'été.

Les murs en bois et les systèmes de toiture en Bosnie-Herzégovine sont oubliés et abandonnés dans la pratique, en dépit de tous leurs avantages. Certains producteurs ont vu un avantage de la production des systèmes et des maisons en bois préfabriqués en Bosnie-Herzégovine à la fin du XX<sup>e</sup> siècle et au début du XXI<sup>e</sup> siècle. En analysant les caractéristiques des systèmes utilisés, les données des fabricants et les expériences des utilisateurs, l'on parvient à la conclusion que ces systèmes en bois sont :

- Efficaces du point de vue énergétique,
- Simples pour le montage,
- Economiques.

Le seul exemple du mur avec un montage aisé, ainsi qu'avec un démontage aisé est la façade du bâtiment réversible avec des connexions réversibles, qui a été conçue par E. Durmišević (architectes 4D) et créée en tant que production de Bosnie-Herzégovine, pour le bâtiment *Green Design Center (GDC)* à Mostar, en Bosnie-Herzégovine. Comme nous l'avons déjà mentionné, ce bâtiment a été construit comme un des projets pilotes pour le projet *Building as Material Banks (BAMB)*, le projet du programme Horizon 2020, financé par la Commission européenne.

Le mur de GDC, en tant que type de mur qui rend possible un montage et un démontage aisés, sera, par des méthodes différentes, soumis à des contrôles complémentaires lors de cette recherche en termes de transformation, de potentiel de la réutilisation et de déchets de construction.

## 4. RESIDENTIAL BUILDINGS IN XXI CENTURY IN BOSNIA AND HERZEGOVINA

Building technology of the residential buildings in Bosnia and Herzegovina (BIH) in XXI century continues to be the same as the building technology in XX century. There are two types of single-family housing and four types of collective housing in six time periods “based on the analysis of a historical aspect of the most important architectural and urban characteristics, as well as by overview of regulations” in BIH, according to Arnautovic-Aksic et al. 2016. The following periodization of typology of residential buildings in BIH was defined (Arnautovic-Aksic et al. 2016):

- period before 1919,
- period from 1919 to 1945,
- period from 1945 to 1960,
- period from 1971 to 1980,
- period from 1981 to 1991,
- period from 1992 to 2014.

The residential buildings made after the war in BIH (after 1994) are the most important for this research. These buildings have to be analysed and future buildings which will be built need to be made properly as they will stay for another century and will be used by future generations.

As Arnautovic-Aksic et al. 2016 say, “The post-war construction is characterised by reconstruction of a damaged buildings and construction of a great number of new buildings for family and collective housing... Residential buildings were constructed in accordance with valid regulations and only by the end of the period and due to increase of awareness on the significance of construction of energy efficient buildings the investors who built buildings, started installing thermal insulation of greater thickness than required.”

In some European countries, many buildings are changing its function every 5 to maximum 20 years and if the building is not designed for transformation, it is going to be destroyed and create a construction waste. A new building is constructed in the place of the old one to satisfy and fulfil new purpose and if a new function is not predicted, a new building will have the same destiny as the previous one.

In BIH settlements, it is not a widespread practice to change the function of a residential building and those buildings keep their purpose for almost a century or more. The ground floor is usually for public use as a store, market or office and an interior change are happening very often, but the upper residential floors usually keep their purpose.

The existing buildings for collective housing have upper floors with flats. These apartments are used by owners or they are rented, but they are mostly used for family life. It is very rare to use them as an office, but even then, the construction system stays unchanged, and transformation is happening only at the interior design level.

According to Arnautovic-Aksic et al. 2016 “By processing the collected data, experts of the Agency for Statistics came up with the total number of residential buildings and individual shares in percentage for each level – BIH / FBiH / RS. The results of the aforementioned quantitative analysis show that individual housing is the predominant form of housing in BIH / FBiH / RS since this building category, which includes single-family and terraced houses, accounts for as much as 97.63% of the entire stock in BIH.”

Most individual houses in BIH have a garage/storage at the ground floor, family living unit at the first floor (or ground floor) and one or two additional floors corresponding to the number of the children the family has. Each child (male child mostly) should get one whole floor with a flat to accommodate his own future family. These houses are built mostly with reinforced concrete structure and bricks or prefabricated concrete blocks between structural elements. Investor's/owner's presumption is to build a house which will last for one or two future generations. This idea has its roots in the period when only rich families could have a house which could accommodate 2 or 3 generations with luxury of space. Each generation had to have its own flat. However, the situation has been changed. Children don't stay at the same house with their parents, even though they have their own flats and they do not come back with their new families. This happened during and after the war in BIH. Many young people have gone abroad and settled in another country. Some of them have found a job and stayed in another town after the war. Inevitably, new generation has a different concept of a living, which considers life away from parents. The big houses are now half empty and in less than 50 years, they will be construction waste. Although, the times are changed, the mind-set of a big house for two or three generations remains and these houses are still built in the same way even in XXI century. (Androšević & Androšević 2021)

If these houses are made in a transformable way, the owner who made two additional floors could disassemble them and sell separately components, elements or materials and retrieve the invested money. The technical life of some materials in the building parts is longer than their use life. These parts could preserve their value if the building system was designed to be easily dismantled and used for another building. It would be useful to consider this concept of a building and presume a few new scenarios when designing a building for individual house. Private investors should be informed about all possibilities by designers, constructors and other stakeholders involved in the process of a building design and building construction.

There is another type of the house that is made in the XXI century in BIH, when considering the building structure material and the way of construction. The industry in BIH has recognized the chance to start production of the houses with quick and easy montage which can be built in a short time with affordable price, without reducing comfort. The advantages of these houses are still not recognized by investors in BIH, but these good characteristics are favoured in the western and northern European countries, where BIH producers export these prefabricated wooden house systems.

Both residential building types (for collective and individual living) remain for a long time with the same function with little reparations. The only difference between collective housing and individual housing is that apartments in the collective housing usually stay inhabited, but most of the space in individual housing remains empty. This phenomenon should require more attention and analyses.

If we speak about longevity of the residential buildings and their parts, different durability rates of building components by Durmišević 2006 can also be used as right assumptions and data for residential buildings in BIH. (Figure 34):

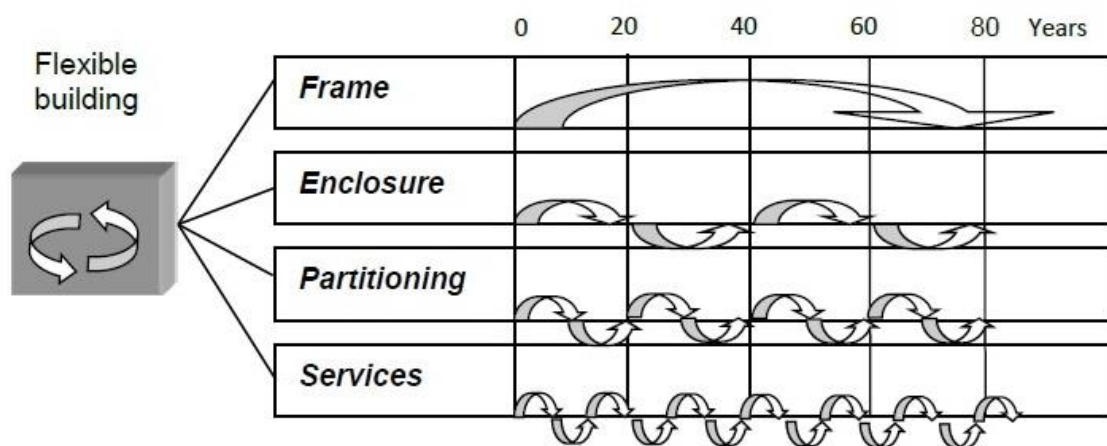

Figure 34. Different durability rates of building components by Durmišević 2006

Data analysis and assumptions point out that the main goal for the new building system proposal has to be enclosure. For every type of the residential building, the most reparations are done on the façade and roof.

Final layers of a building's enclosure are changed, adapted and upgraded in a period shorter than 20 years. Services and partitioning are changed more frequently, but the change and upgrading can be done in sequences and more or less easily in the existing building systems. Enclosure requires more effort when it comes to the reparation, upgrade or a bigger change. Like the human skin which is "the largest organ in the human body" (Swann 2010), the external wall with the roof is the biggest protective system for the building. Although it looks in many ways simple, the enclosure system is made of a lot of different materials in terms of the quality and quantity. In case of

demolition, an enclosure system produces a lot of waste if these materials cannot be easily separated to be used smartly – separated and reused or recycled with low environmental impact.

Like our body depends on the skin protection, energy efficiency of a building depends on the energy performance of the envelope. Energy losses of a building are presented in the Figure 35.

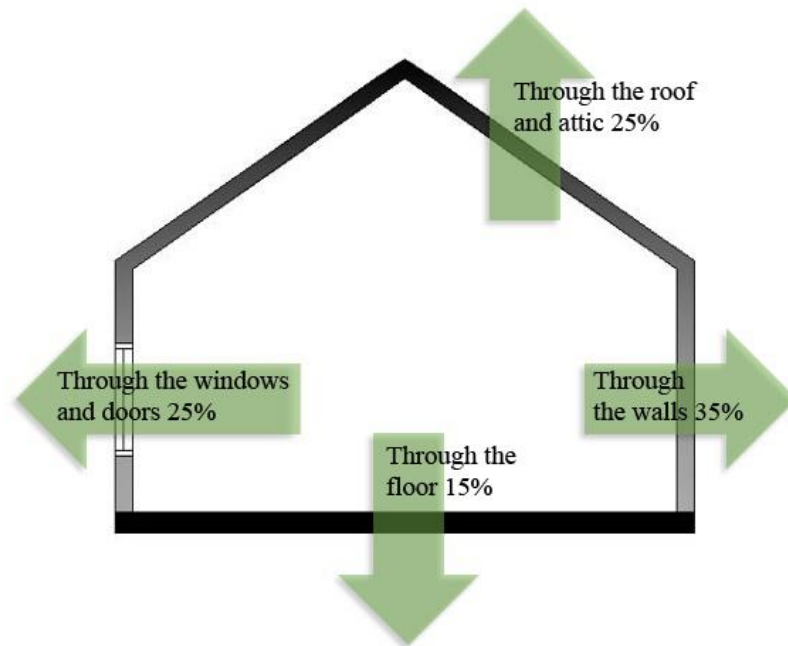

Figure 35. Main sources in energy losses through the external envelope of an average home adapted Souza 2019.

#### 4.1. RESIDENTIAL BUILDINGS' EXTERNAL WALLS STILL IN PRODUCTION IN XXI CENTURY IN BIH

Representative external walls are marked for all mentioned types of residential buildings in BIH, by Arnautovic-Aksic et al. 2016. For single-family houses in BIH built after the war in BIH walls are made of 29cm hollow clay bricks, with 5cm thermal insulation layer in the contact façade system. (Arnautovic-Aksic et al. 2016) (Figure 36)



Figure 36. Energy performance improvement for external wall of residential buildings for single-family houses in BIH made at the end of XX and beginning of the XXI century (Arnautovic-Aksic et al. 2016)

Representative external walls of residential buildings for multi-family houses in BIH built after the war in BIH are made of 20cm reinforced concrete and façade in form of Hard-Pressed Laminate (HPL) and plaster. (Arnautovic-Aksic et al. 2016) (Figure 37)



Figure 37. Energy performance improvement for external wall of residential buildings for multi-family houses in BIH made at the end of XX and beginning of the XXI century (Arnautovic-Aksic et al. 2016)

Representative external walls of residential buildings for apartment buildings in urban blocks in BIH built after the war in BIH are massive made of 25cm reinforced concrete or made of porous concrete blocks, wrapped in different thermal insulation façade system and finished with plaster. (Arnautovic-Aksic et al. 2016) (Figure 38)



Figure 38. Energy performance improvement for external wall of residential buildings for apartment buildings in urban blocks in BIH made at the end of XX and beginning of the XXI century (Arnautovic-Aksic et al. 2016)

Representative external walls of residential buildings for apartment blocks in BIH built after the war in BIH are made of 19cm clay thermo-blocks or 20cm reinforced concrete with 5cm thermal insulation layer typical of that period of twenty years, and 10cm thermal insulation since year 2010. (Arnautovic-Aksic et al. 2016) (Figure 39)



Figure 39. Energy performance improvement for external wall of residential buildings for apartment blocks in BIH made at the end of XX and beginning of the XXI century (Arnautovic-Aksic et al. 2016)

For all mentioned existing types of the wall in BIH, the group of authors have proposed energy performance improvement measures, among which is external wall improvement with additional 10cm or 20cm thermal insulation layer with 1cm façade plaster. (Figure 36, Figure 37, Figure 38, Figure 39 middle and right picture)

The Energy Performance Improvement Project showed the way of energy performance improvement for existing building envelopes. The Project funds cover the costs to upgrade some collective houses' envelopes. But Single-family and terraced houses which account for as much as 97.36% of the entire stock in BIH (Arnautovic-Aksic et al. 2016), are still losing energy for heating during winter and using a lot of energy for cooling the house during hot summer. Eventually, this project demonstrated investors that they can upgrade the existing envelope. Some new investors are putting additional 10-20cm of thermal insulation on the new buildings. This solves energy consumption, but not the durability or total environmental impact (per ex. how long these solutions will last and what kind of materials should be used to minimize total environmental impact). Usually, these residential buildings in BIH will last at least next 50 years in the state they are now, with occasional envelope surface repair. The mentioned study for energy efficiency should to be continued and upgraded with the research of environmental impact causing the different choice of isolating materials. Future work should consider the predictions of the frequencies of the future envelope reparations.

There is another problem that should require future attention and solution - the mentioned inhabited individual residential houses (or some of their spaces), as written and explained at the beginning of this chapter.

## 4.2. WOODEN WALLS IN BIH

BIH is a country very rich with wood and the old settlements were made mostly from wood and stone. As the individual houses are majority in BIH, these houses and their envelopes will be examined more carefully. There are three types of old traditional wooden walls of house in BIH (Hadrović 2017). (Figure 40, Figure 41, Figure 42)

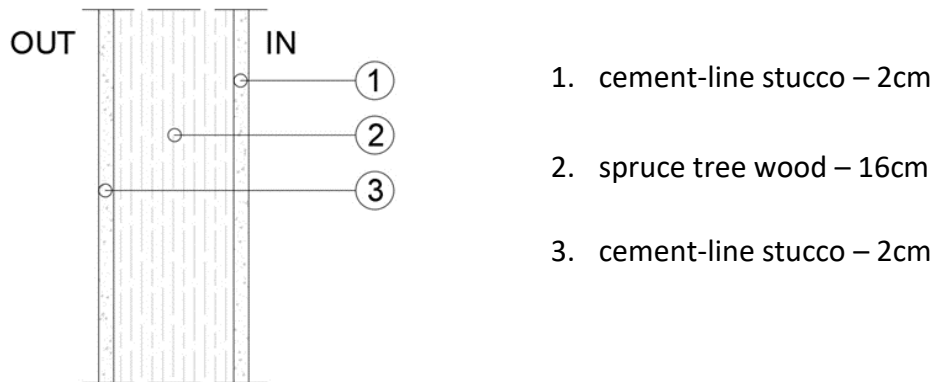

Figure 40. Bondruk wall type 1. (adapted Hadrović 2017)

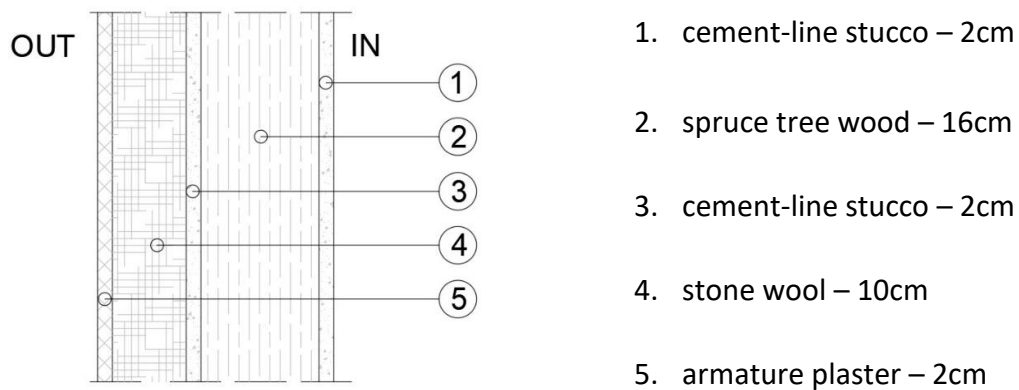

Figure 41. Bondruk wall type 2. (adapted Hadrović 2017)

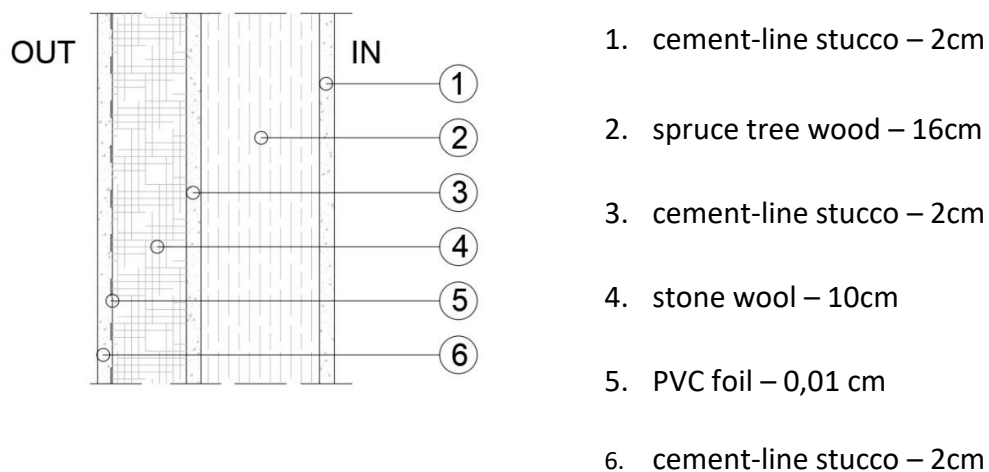

Figure 42. Bondruk wall with wood filling, type 3. (adapted Hadrović 2017)



In modern times, before and now after the war in BIH, production of prefabricated wooden walls is inspired with traditional wooden walls in BIH. There are some papers proving the advantages of wooden prefabricated houses.

Husetic and Beganovic 2017 demonstrated an example of prefabricated wooden wall. (Figure 43)

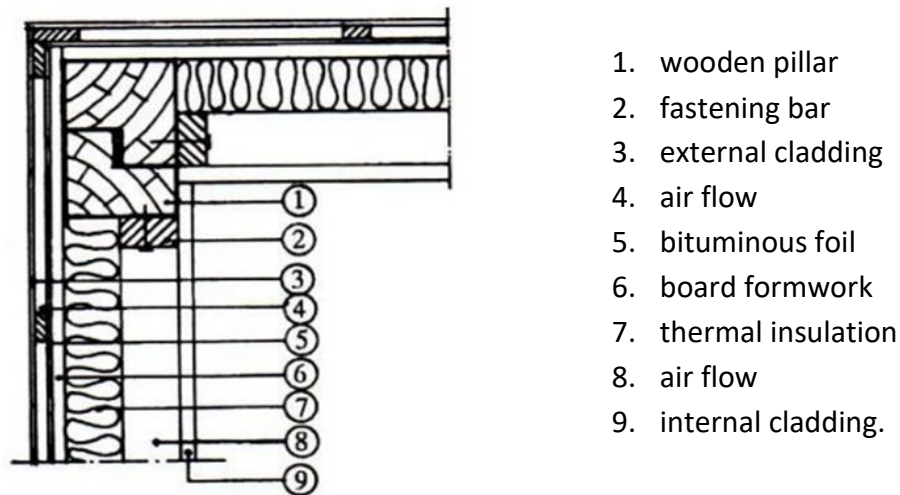

Figure 43. Example of prefabricated wooden wall. (Husetic & Beganovic 2017)

Husetic & Beganovic 2017 underline many advantages of wood construction over classic construction, among which are:

- quick installation (short construction time) - because most of the elements are prepared in factories and brought to the construction site;
- quick time to move in - 30-60 days;
- construction is possible at any time of the year;
- the dimensions of the elements are not determined by any modules;
- material is obtained from nature and minimal energy is required for its processing and fabrication of elements;
- the wood stores CO<sub>2</sub> in itself, thus reducing the greenhouse effect;
- wooden structure increases the usable surface of the building itself by about 10% due to the difference in wall thickness;
- construction behaves well in a fire, and it has greater earthquake resistance;
- greater overall comfort for users.

These wooden wall and roof systems in BIH have been forgotten and abandoned in practice, despite all advantages. Some producers saw their benefit in producing prefabricated wooden systems and houses in BIH at the end of XX and at the beginning of XXI century. Many of them are exporting, but there will more and more investors in

BIH who will decide to build a wooden prefabricated house, when they see the positive examples from abroad.

Some of the producers in BIH gave the external wall detail available to the users. One of them is company Steco centar doo, Bjeljina, which external wall details are shown below. (Figure 44, Figure 45, Figure 46) Source: <https://www.stecocentar.com>

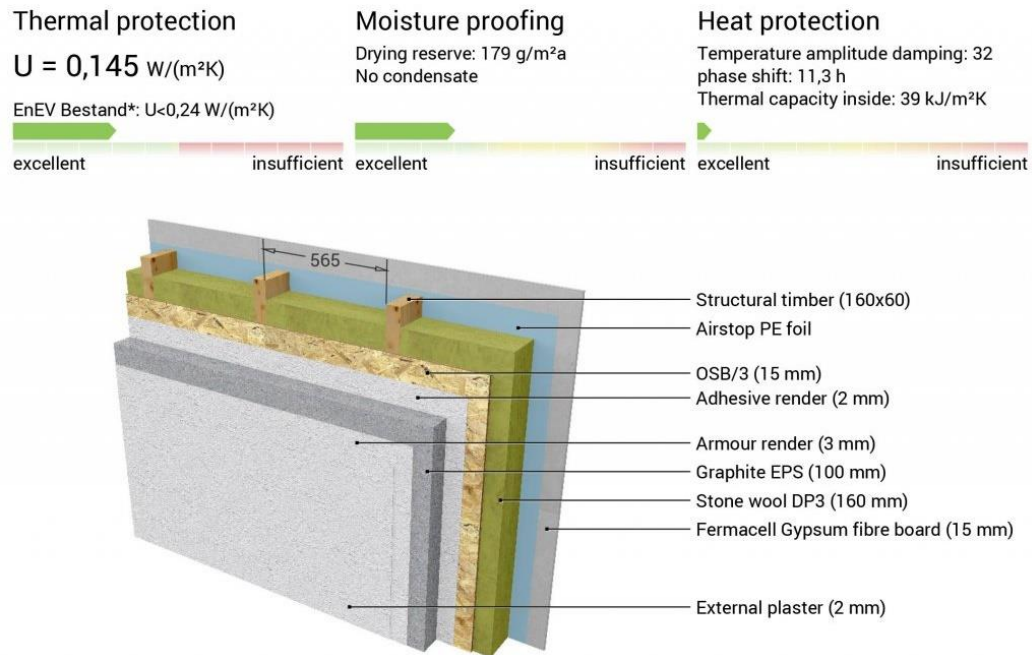

Figure 44. Steco centar external wall detail first example with thermal and heat protection values and moisture proofing.

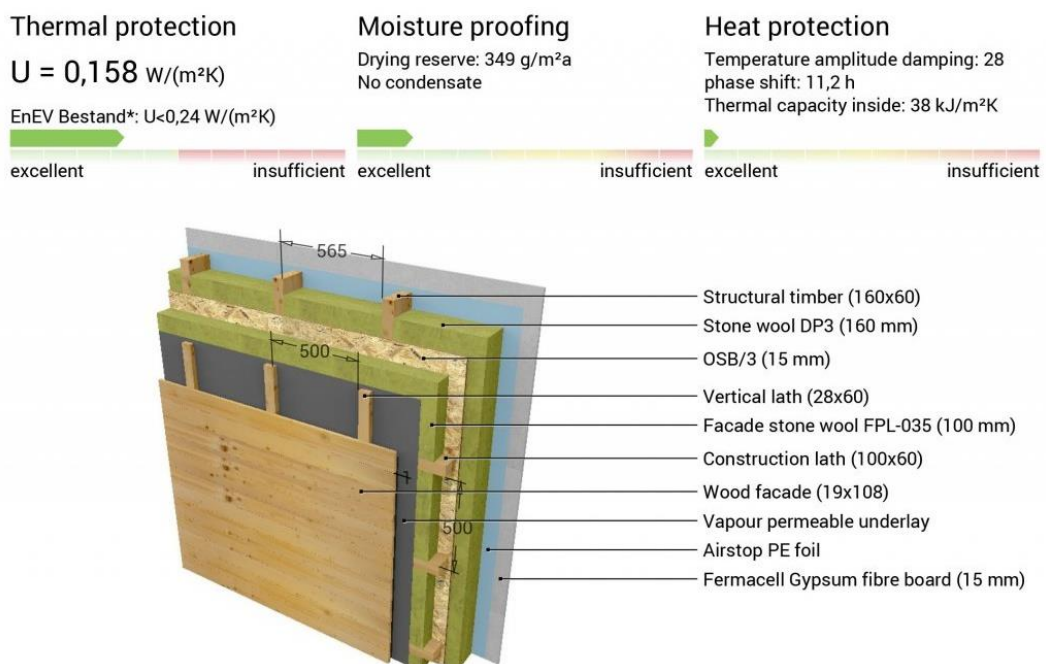

Figure 45. Steco centar external wall detail second example with thermal and heat protection values and moisture proofing.

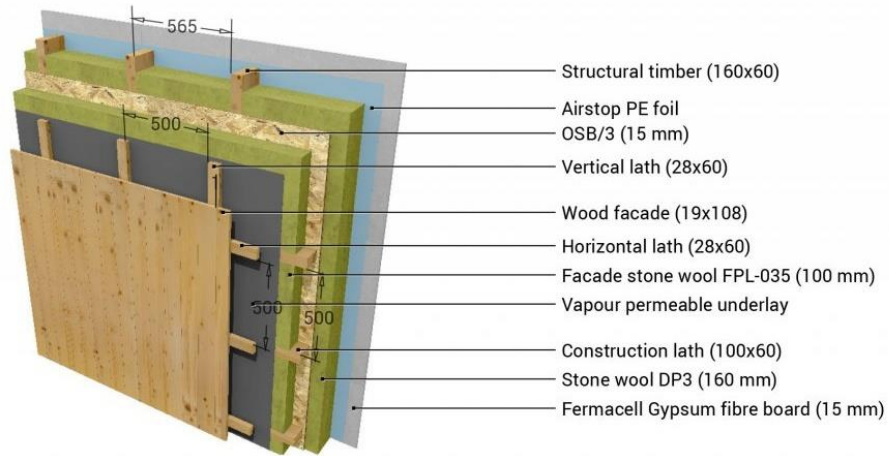

Figure 46. Steco centar external wall detail second example (thermal and heat protection values and moisture proofing are as same as the wall in Figure 45)

Details of external walls of Savox doo Milici. (Figure 47, Figure 48, Figure 49, Figure 50)  
 Source: <https://www.savox.ba/>

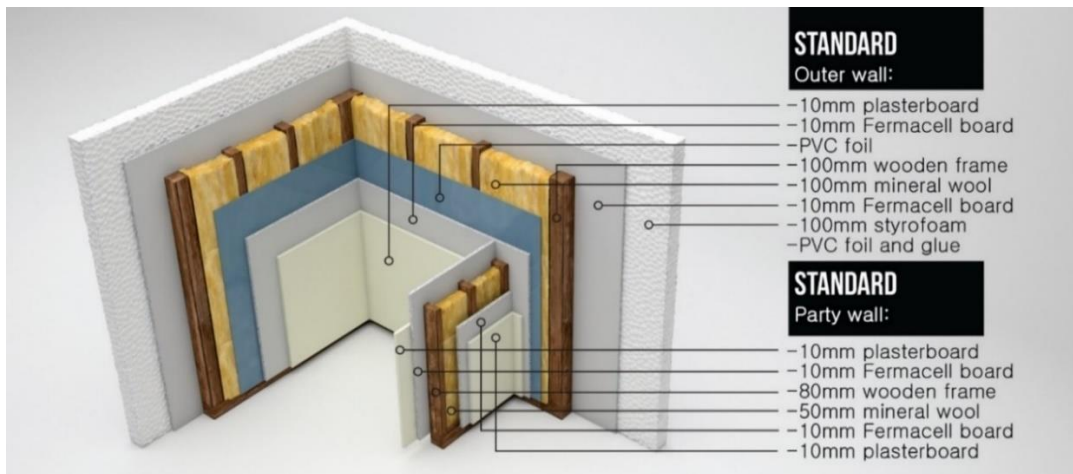

Figure 47. Savox standard external and partition wall

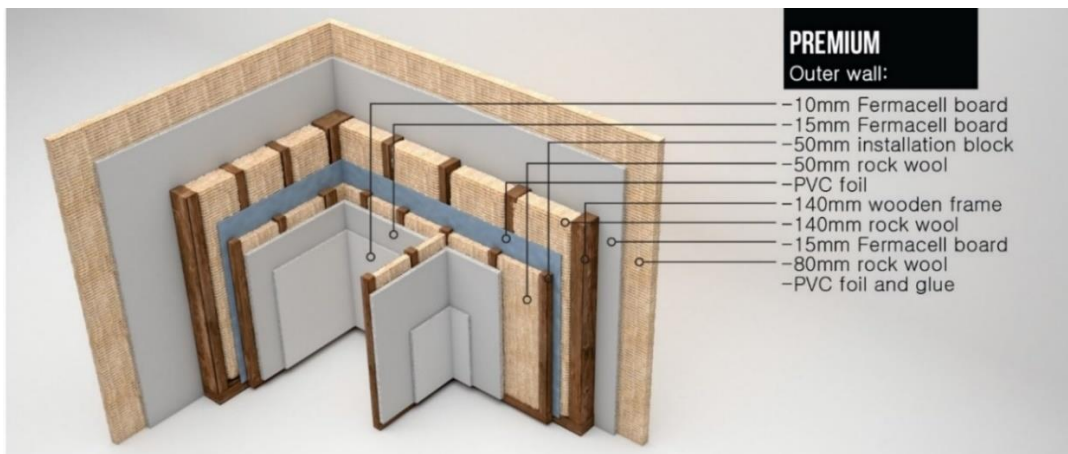

Figure 48. Savox premium external and partition wall

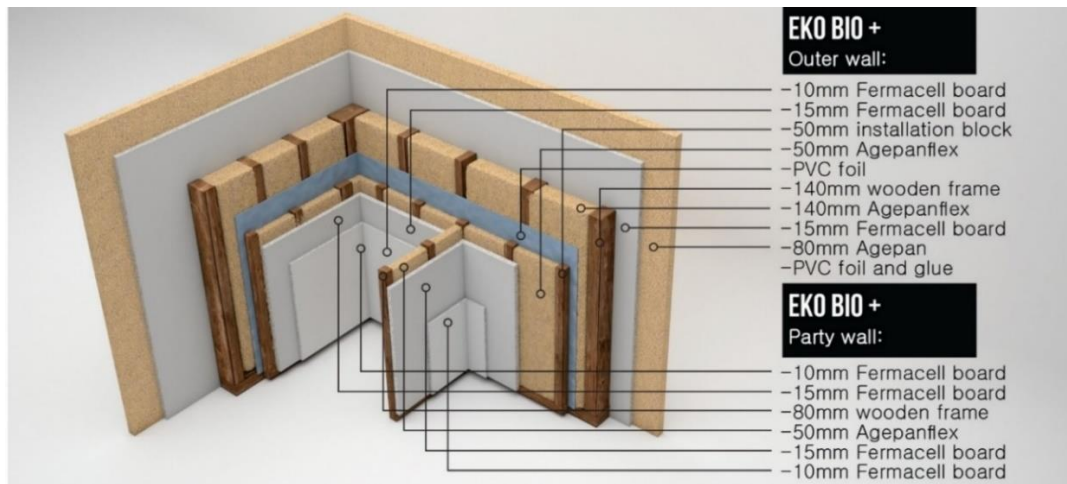

Figure 49. Savox eko bio+ external wall

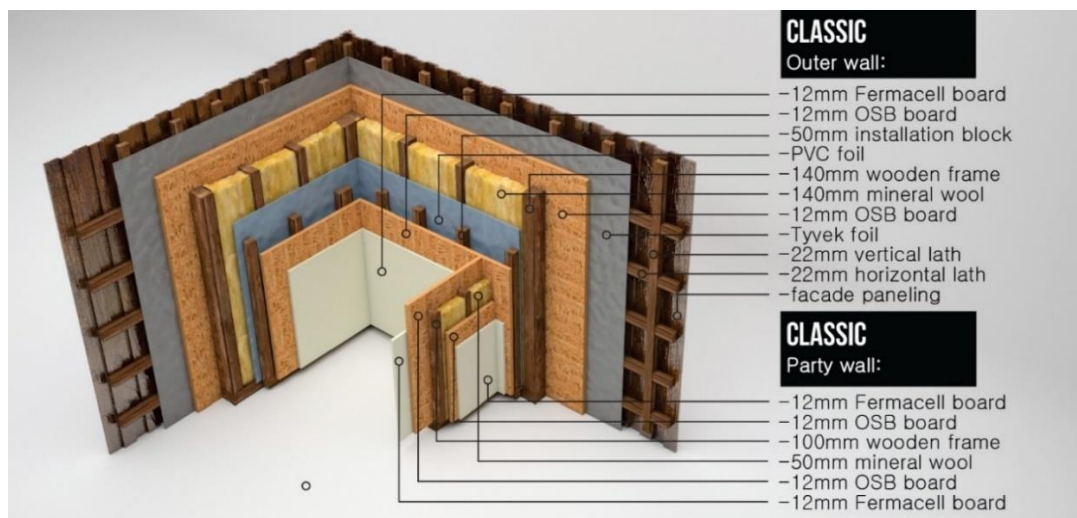

Figure 50. Savox Classic external and partition wall

Details of external walls of Krivaja – TMK doo, Zavidovici. (Figure 51, Figure 52, Figure 53)  
Source: <http://www.krivajahomes.com>



Figure 51. Prefabricated walls in production (Photo taken during the factory visit 2019, by Androšević)

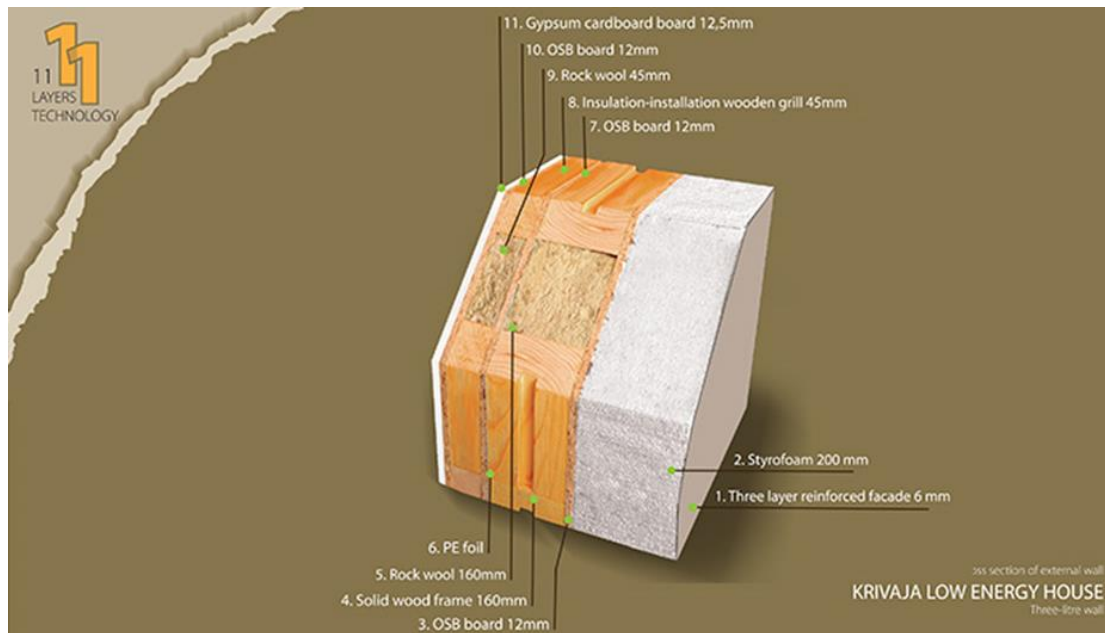

Figure 52. Krivaja 11 layers' low energy house wall.



Figure 53. Prefabricated walls in the production (Photo taken during the factory visit 2019, by Androšević)

Many prefabricated houses are declared energy efficient and, according to the data provided by mentioned producing companies, they are using between 15 to 50 kWh/m<sup>2</sup>. Analysing characteristics of systems used, data from manufacturers and users experience, there is conclusion that these wooden systems are:

- energy efficient,
- easy for assembly,
- affordable.

Wall panels are prefabricated in the production and transported and assembled on the site. Unfortunately, when it comes to disassembly, there is no offered solution. Once assembled, a prefabricated wooden house cannot be easily disassembled or cannot be transformed or moved at all. Producers don't even consider option of disassembly or changing parts during the maintenance, according to the statements of producers' representatives. Clients /investors/ are not well informed and educated properly to ask for this kind of support from the producer and producers don't offer it.

“Major refurbishments of the post-war housing in the Netherlands and Bosnia and Herzegovina involve upgrade and replacements of the façade. If the function of the building changes, the requirement for more or less light, privacy, natural ventilation etc. will change as well. Accordingly, the esthetical requirements for the façade are also changing in relation to its use. Most of the façade systems developed so far for high energy performance (energy positive buildings) are very fixed and do not accommodate easy adaptations. As a result, transformation is linked to demolition, waste creation and purchase of new material...” (Brussels Environment et al. 2018)

There has to be an option to have a system which can be easy dismantled too. Every stakeholder should take advantage of transformability. In product design, this option is preferable, but in construction industry it is still not in practice. The reasons are following:

- there are no demands from the investors and users, or
- the price will be higher for a system like that, or
- the landfill cost is still very low, or
- it is a forgotten practice?

This phenomenon should be investigated further.

#### 4.2.1. Transformable wooden wall in BIH

The only example of a wall with easy assembly and easy disassembly is the reversible building façade with reversible connections, that have been designed by E. Durmišević 4D architects and made in Bosnia and Herzegovina productions for the Green Design Center (GDC) building in Mostar in BIH. As already mentioned, this building was built as one of the pilot project buildings for the project Buildings as Material Banks (BAMB), an EU HORIZON 2020 project, financed by EU Commission.

This wall can be studied, adapted and applied to the residential buildings. As a pilot project coordinator and a Project Steering Group (PSG) member in the mentioned project Building as Material Banks, the author of this thesis has been doing analyses of the reversibility of old and new structures which will be implemented in the pilot project in Mostar, under the supervision of professor Dr Elma Durmišević, team leader and architect from 4D architects, the founder of the Green Design Center.

The wood production and assembly of two façade panels in a real scale has been made possible by companies within Wooden Cluster in Herzegovina and University of Mostar, which did energy performance analyses.

“The aim of prototype wall was to prove that it is possible to develop reversible/transformable façade system with high energy performance and yet with high transformation and reuse potential of its constituent parts. The system needed to show that with design of reversible transformable façade system it is possible to upgrade the system or change its functionality without destroying its elements and components.” (Brussels Environment et al. 2018)

The first analyses were done and the report is in the Chapter 3 in this research. The roof and the floor of the GDC have a good average reuse potential, but it is always possible to make improvements. The proposed external wall system should have better performance.

The author of this thesis was involved in the entire process of creating the new wall system prototype, which has high reuse potential and transformability.

“The objectives of the GDC is to develop concepts that will reduce construction waste for 60% and reduce raw material use for 50%.” (Brussels Environment et al. 2018)

The goal was to provide a quick and possible disassembly of all the system parts. It should be possible to perform assembly and disassembly many times with different scenarios. That goal was achieved through adding elements which are “intermediary”

(Durmišević 2006) between the other elements. The structural elements remain undamaged, thanks to that new added element. (Figure 54)

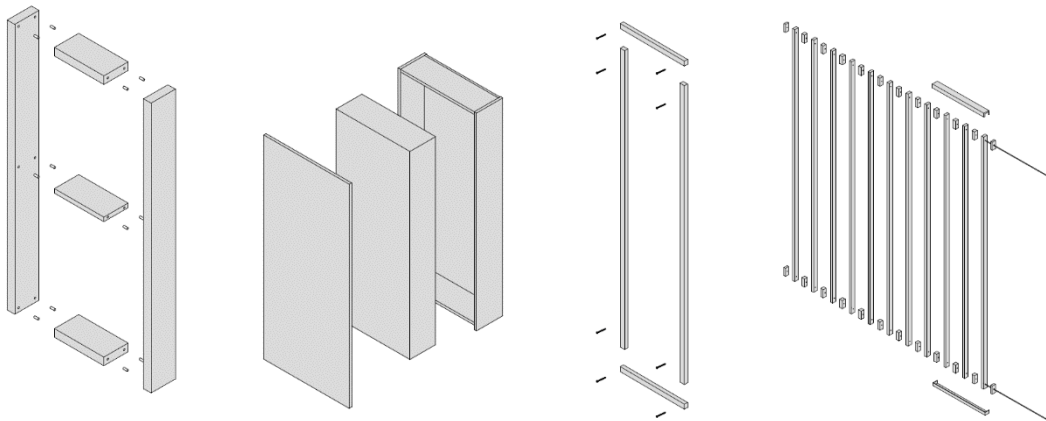

Figure 54. External Wall GDC which is easy to assemble and disassemble. Source: BAMB pilot project, 4D architects

(1) main frame of the system (2) insulation box (3) intermediary (4) finishing of the system

This external wall system consists of the core/base element - the frame of the system made of laminated wood (Figure 54 left) and two modular insulation boxes assembled from the front (Figure 54 middle) and two modular insulation boxes assembled from the back side of the system (Figure 54 middle). The middle element, called “intermediary” connects the wooden frame system with façade finishing. It provides a possibility to put on the new façade many times without damaging the wooden frame.

Beside presented and improved transformability and reusability potential, close attention was paid to the energy efficiency of this transformable wall. There is an assumption that these building structures with high transformability potential are not favourable when it comes to energy efficiency. This theory was rejected and proved wrong in this case study. The heat transfer coefficient was calculated for the central part of the wall of the GDC and for the wooden pillar corners. The results pointed out that the building envelope has lower heat transfer than required by law, which means that the building is energy efficient.

The energy efficiency calculation was done by professor at University of Mostar, dr Dragan Katić, graduated civil engineer. According to his report, maximum value of the heat transfer coefficient in the external wall required by law for Mostar region at that time was 0,60 W/m<sup>2</sup>K. Calculated value for the external wall panel is 0,12 W/m<sup>2</sup>K and in the place where there is a wooden pillar, the value is 0,38 W/m<sup>2</sup>K. The calculated heat transfer coefficient satisfies the standard for energy efficiency, even in the case of maximum allowed in the region, where the rules are more strict - for example in Croatia, where the maximal value is 0,45 W/m<sup>2</sup>K. Thanks to this calculation, high energy efficiency is confirmed for transformable wooden GDC wall.



“The façade system is 3,3 m high, 0,95 m wide and 0,4 m thick. Insulation properties of the façade module are in compliance with energy label A+.” (Brussels Environment et al. 2018)

Figure 55 illustrates assembly sequences of the façade module through four general assembly steps:

- the frame,
- insulation boxes,
- middle element and
- finishing panel.

The frame, insulation boxes and finishing are prefabricated and can be assembled as independent clusters of the façade.

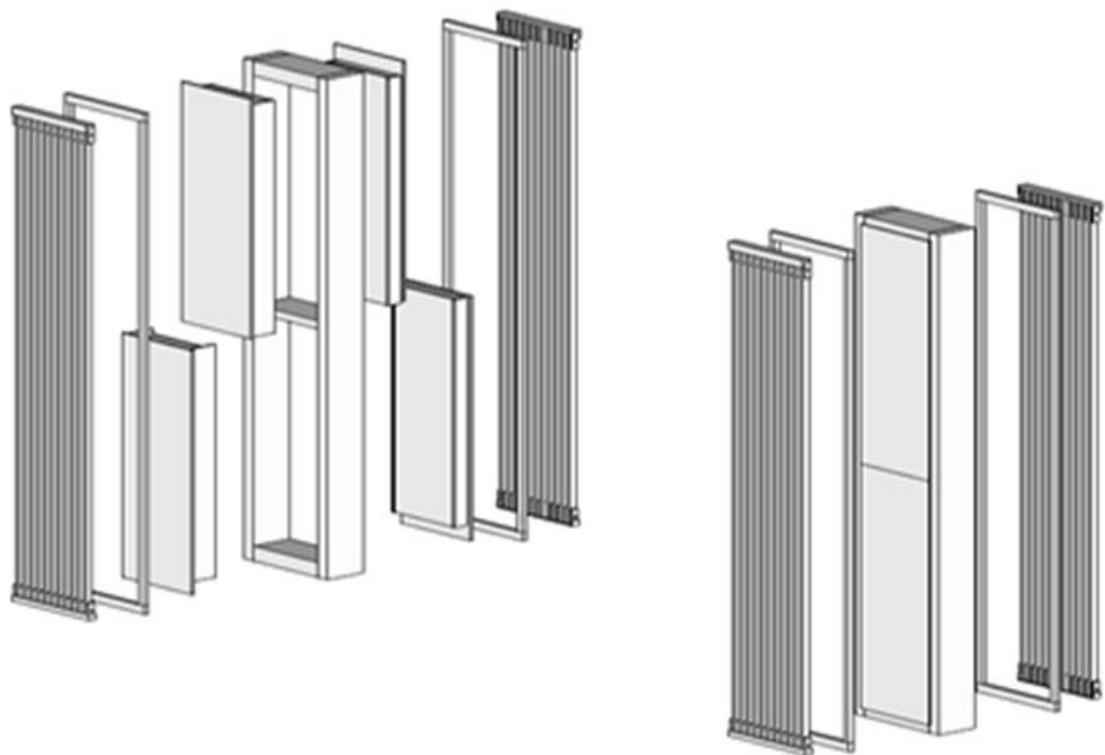

*Figure 55. Assembly sequences of the GDC façade wall. The assembly and disassembly can be done with separate elements and materials or with materials and elements forming clusters*

*Figure 56, Figure 57, Figure 58, Figure 59, Figure 60, Figure 61, Figure 62, Figure 63, Figure 64, Figure 65 illustrate detailed design plans of prototyping GDC wall sections and views of the reversible modular façade system for the GDC with technical details.*

Panel Front View  
R 1:10

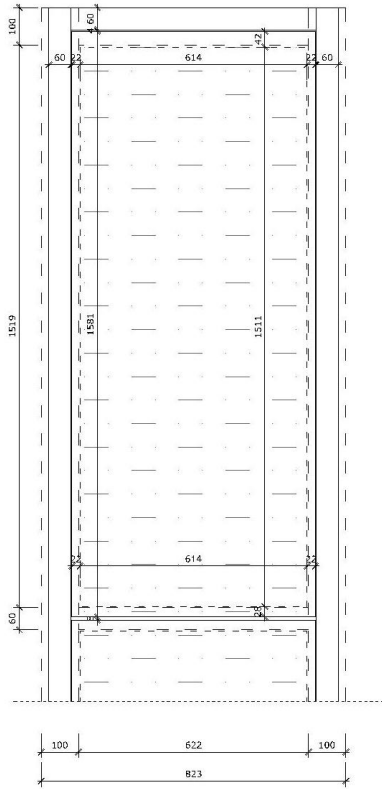

Vertical Section  
R 1:10

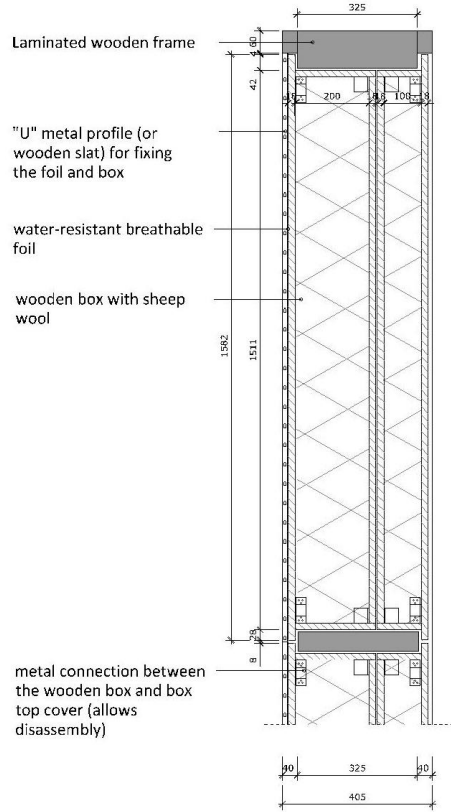
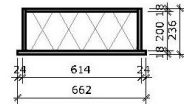
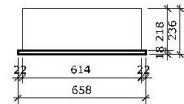

Figure 56. Section through the assembly of insulation boxes of GDC façade wall. (source: 4D architects)

Horizontal Section  
R 1:20



Top View  
R 1:20



Horizontal Section  
R 1:20

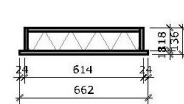

Top View  
R 1:20

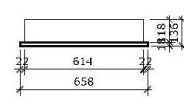

Front View  
R 1:20

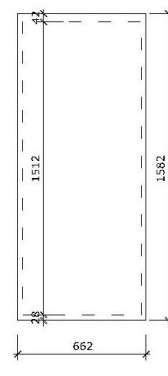

Side View  
R 1:20

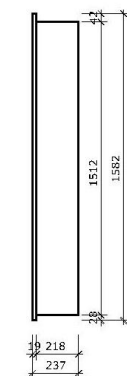

Vertical Section  
R 1:20

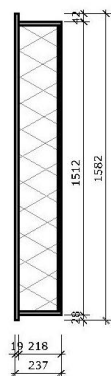

Front View  
R 1:20

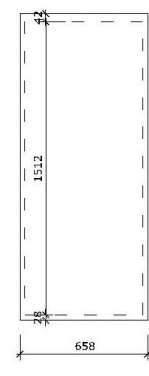

Side View  
R 1:20

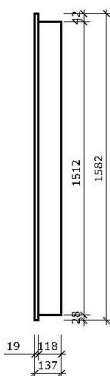

Vertical View  
R 1:20

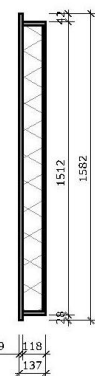

Figure 57. GDC wall system parts: wooden boxes. (source: 4D architects)

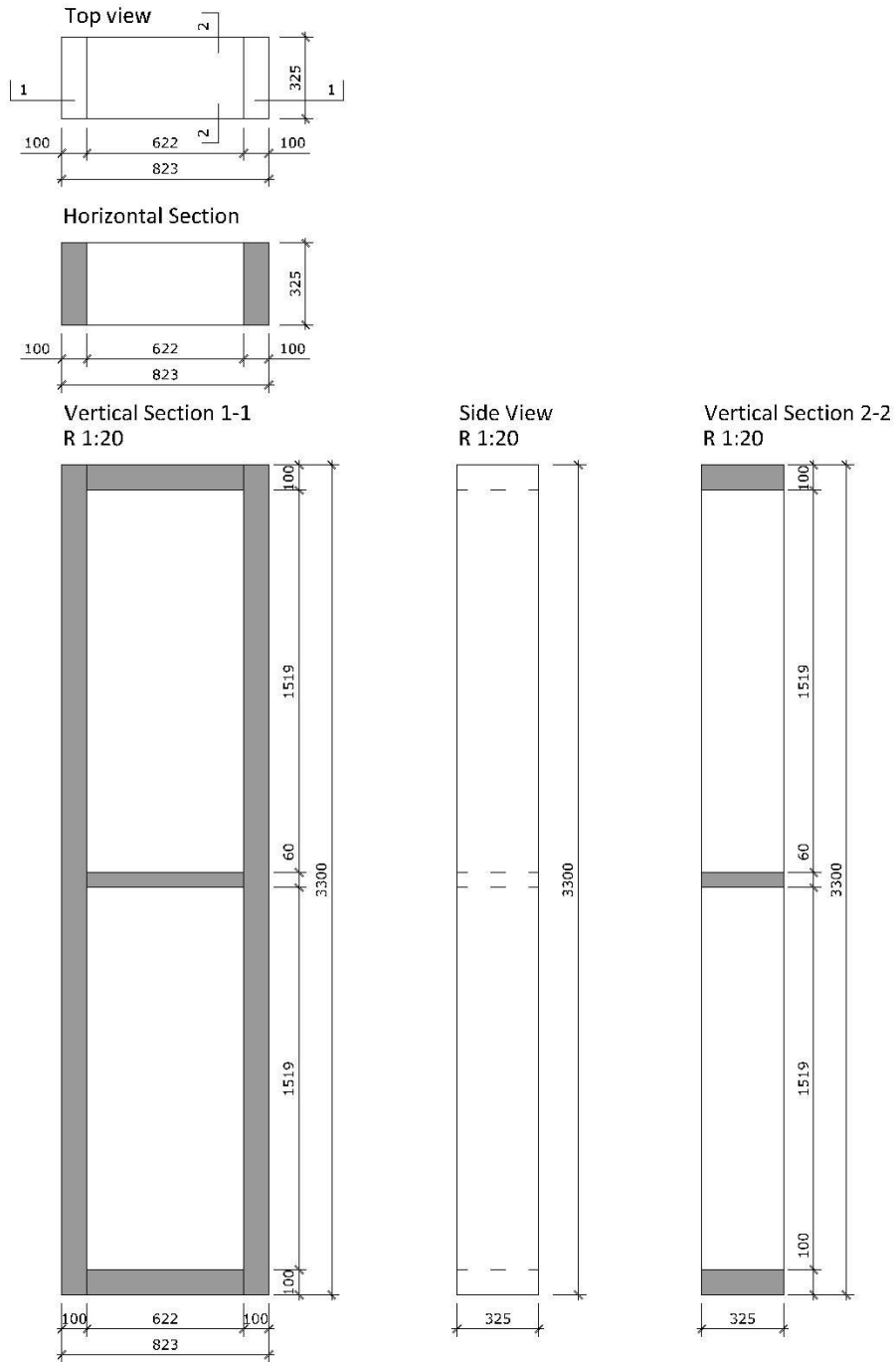

Figure 58. GDC wall system – views and sections of wooden frame. (source: 4D architects)

Detail plan of the GDC wall: front and side view, horizontal and vertical section is shown in Figure 59.

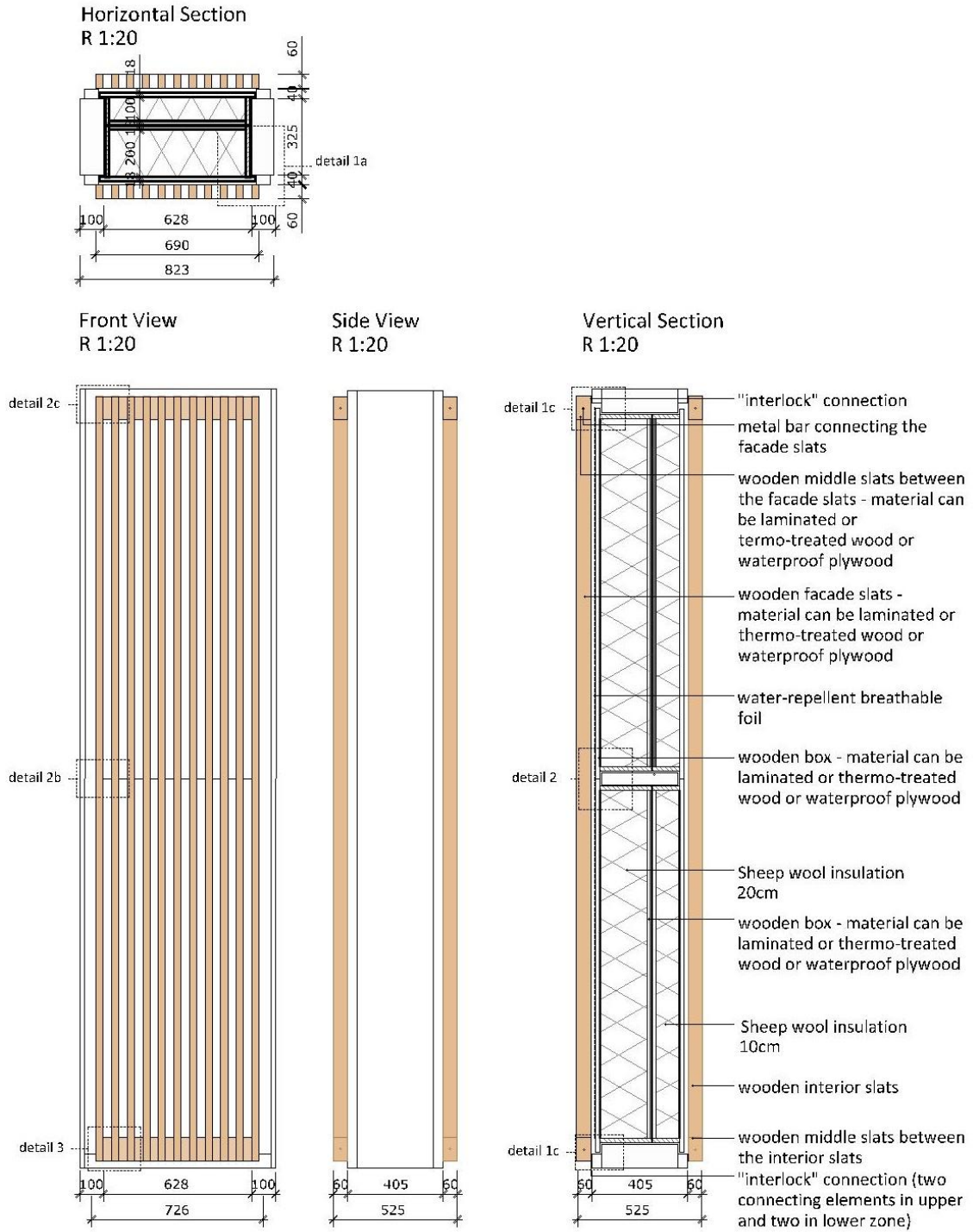
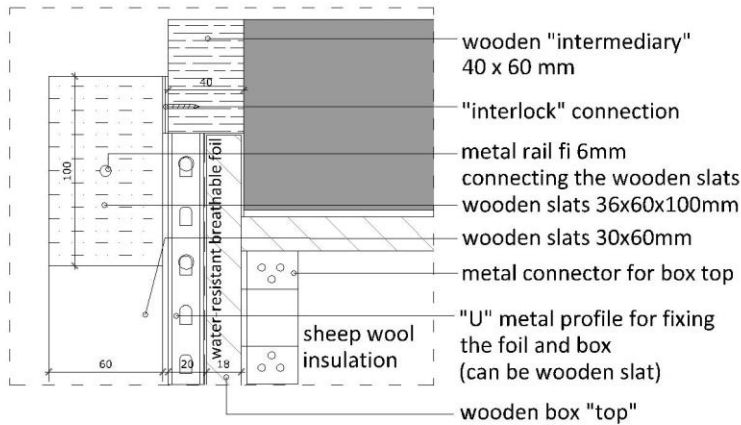

Figure 59. One module of the GDC façade wall (front and side view, horizontal and vertical section)

Detail 1b - Section 1-1  
R 1:2



Detail 1c - Section 1-1  
R 1:2

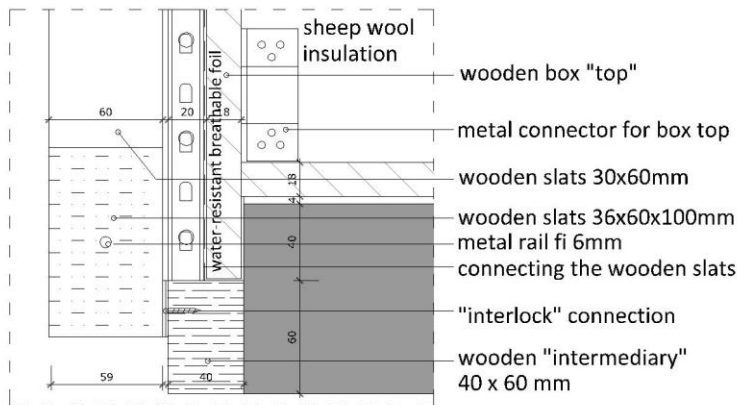

Figure 60. Details and sections of the GDC external wall finishing (detail of wooden slats facade). (source: 4D architects).

2D exploded detail  
wooden box top and hanging the facade R 1:2

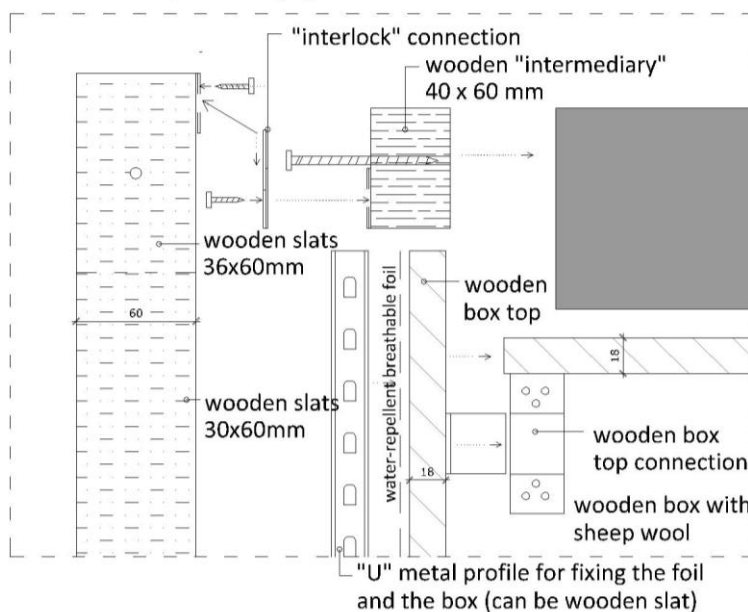

Figure 61. 2D exploded detail of the wooden box top and hanging façade slats panel. (source: 4D architects).

Detail 2 - Section  
R 1:2

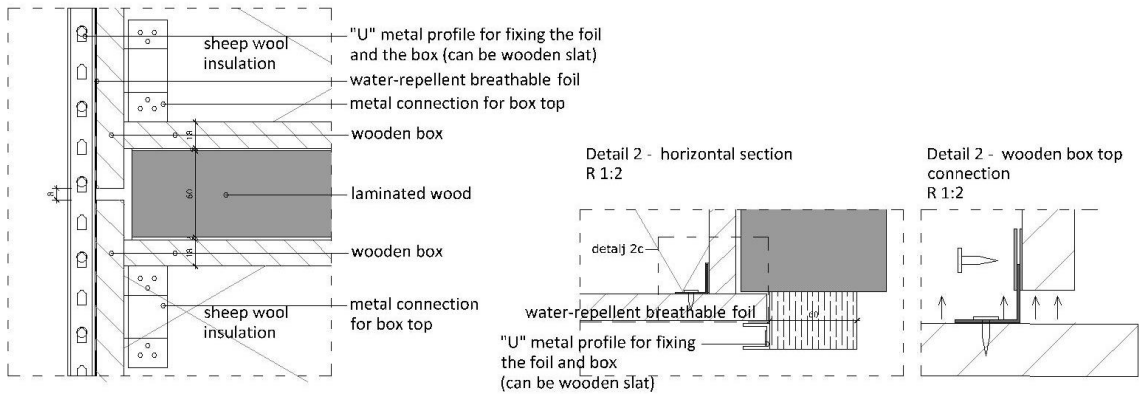
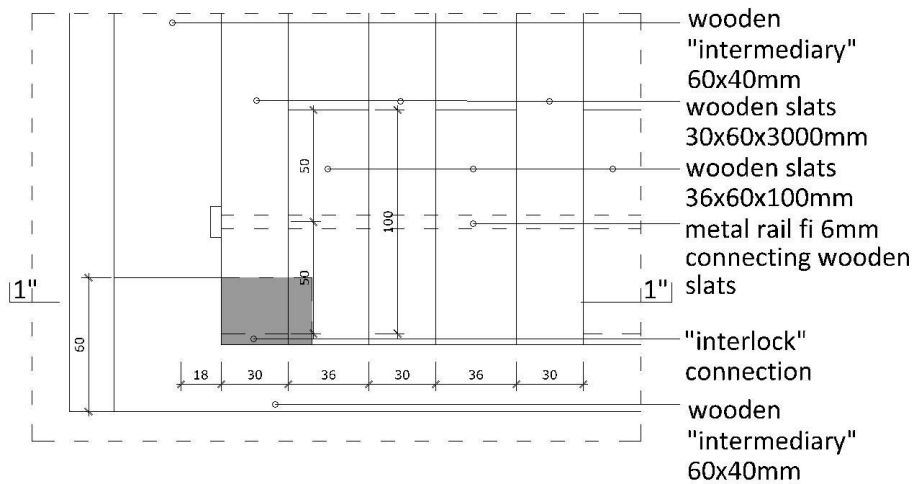

Figure 62. Details and sections of the GDC external wall boxes. (source: 4D architects).

Detail 3 - View  
R 1:2



Detail 3 - Horizontal Section 1"-1"  
R 1:2

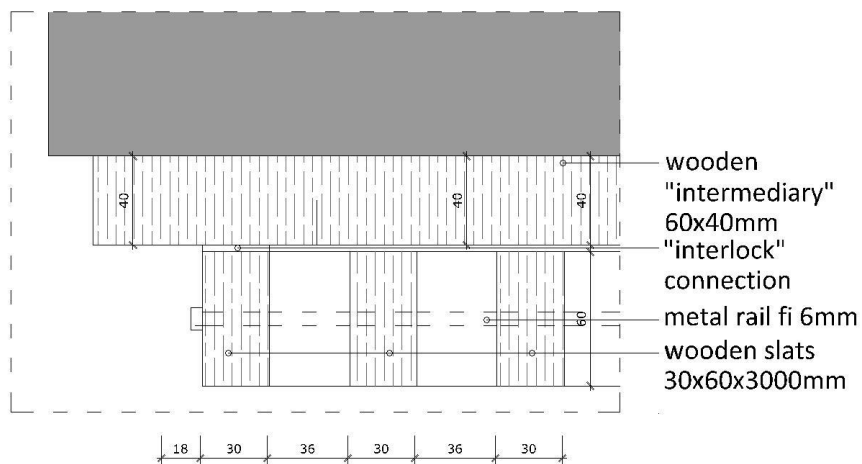

Figure 63. Details and sections of the GDC external wall finishing (wooden slats facade). (source: 4D architects).

Slats wall assembly R 1:10

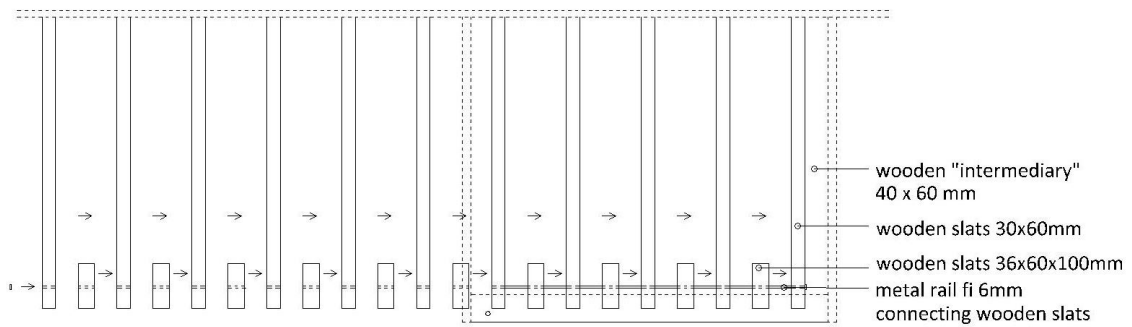
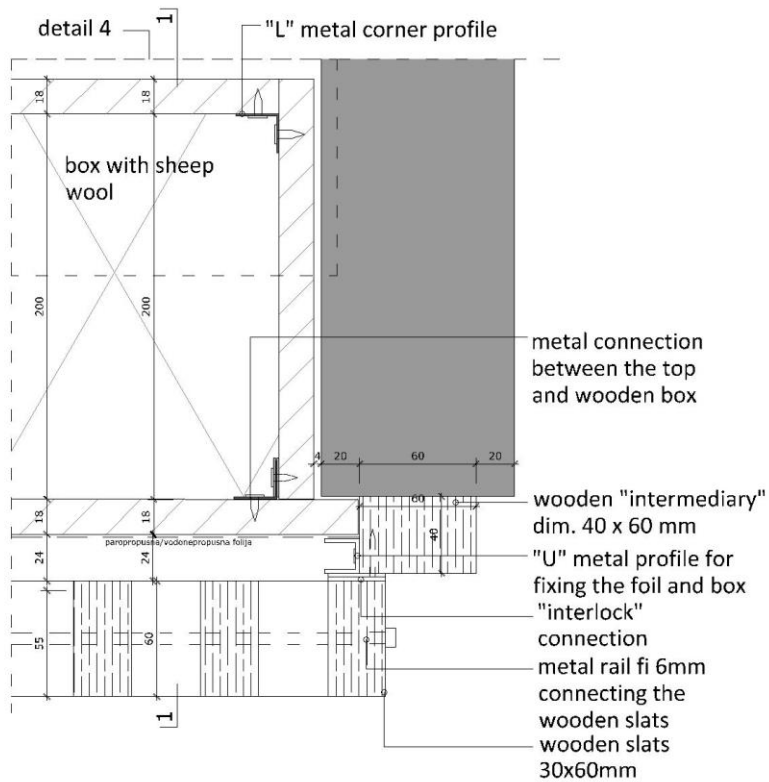

Figure 64. Wooden slats facade assembly in production or on site. (source: 4D architects).

Detail 1a -  
Horizontal Section R 1:2



Detalj 4 - 2D exploded detail wooden box with sheep wool  
R 1:2

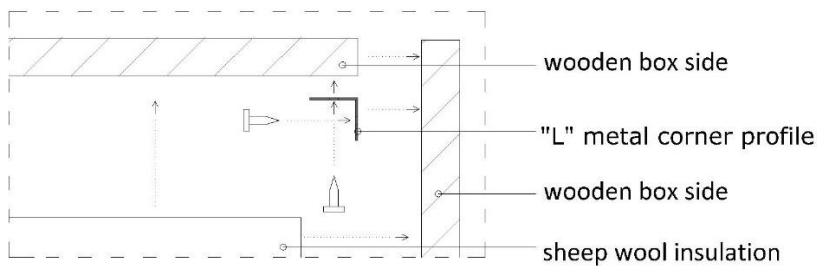

Figure 65. Horizontal section through wooden box and wooden slats facade (above) and 2d exploded detail of the wooden box with sheep wool (down). (source: 4D architects).

All these details presented above, show the composition and relations between the materials, elements and components of the wall. It was really hard to find the right connecting materials and connections between materials and elements while designing this wall. There are many prefabricated easy assembly and disassembly connectors in the production industry, but there are almost no connecting devices in the construction industry to satisfy these requirements and be resistant to different weather conditions.

Two prototypes of this GDC transformable wall have been made in two different productions and author of this thesis was monitoring and coordinating the whole process of assembly and disassembly. One and the first prototype was made in Sarajevo by company Edi Co. d.o.o. and the other was made in synergy of wood producers from “Wooden cluster Herzegovina”. The whole process of production and assembly was precisely monitored, to be sure that all details are made as designed and envisioned by professor Durmišević Elma, and to be sure that the main idea of transformable structure is respected. The pictures from the production in Sarajevo are shown below. (Figure 66, Figure 67, Figure 68)



Figure 66. Pictures during the production of the GDC wall prototype. From left to right: 1.all parts cut to measure, 2. Making wooden wall structure, 3. wooden box filled with natural sheep wool, 4. Wooden wall structure. (photo Androšević)



Figure 67. Pictures during the production of the GDC wall prototype. From left to right: 1. Wooden box with connection triangle and magnet for the top, 2. Wooden box completed, 3. Fixing foil and the box with wooden slats connected with the intermediary wooden slats. (photo Androšević)





Figure 68. GDC wall prototype finished. (photo Androšević)

Members of the Wooden cluster association in Herzegovina (“Drvni klaster Hercegovina”) were doing their best to produce all parts for the GDC wall in different carpentry production halls, which will be put together and assembled. The process of organizing the production of the parts was done by professor Valerija Kopilas, professor in the Mostar University. The assembly was monitored by her and the author of this thesis, to ensure that the original design and principles for the prototype (envisioned by professor Durmišević Elma) will be applied. The pictures from the production in Herzegovina are shown below. (Figure 69, Figure 70, Figure 71)



Figure 69. Picture of the GDC wall prototype made in Herzegovina. Picture left – wooden parts cut and ready to be laminated, middle – wooden slats assembly, right – wooden structure/frame. (photo Androšević)



Figure 70. Pictures of the GDC wall prototype made in Herzegovina. Picture left - Wooden box assembly, middle and right – Wooden box with sheep wool. (photo Androšević)



Figure 71. Pictures of the GDC wall prototype made in Herzegovina. Picture left – inserting wooden boxes in the wooden frame, middle – fixing water vapor permeable membrane with Alu L shaped profile and right – wall prototype finished. (photo Androšević)

GDC wall prototype in Herzegovina has been done with slightly different details and connections. Both walls were assembled and disassembled by two workers to show the possibility of assembly and disassembly on site, in case of changing some parts or transformation. This modular piece of the wall is designed in the way to provide easy manipulation on site, if necessary. Its transformable concept has been proved in the production hall, unlike other “recently developed façade products, which are available on the market for passive housing, which use a lot of chemical connections for making of fixed elements. If a user wants any additional transformation or material change, it will not be possible to do so without a lot of waste and changing of the whole wall panel.” (Androšević et al. 2019)

The existing connections from product design industry are usually not foreseen to be exposed to outer weather conditions, but some of these were tested in the wall prototype.

This GDC wall, as a type of the wall that enables easy assembly and disassembly, will be tested further in this research in terms of transformation, reuse potential and construction waste, using different methods.

#### 4.3. RESIDENTIAL BUILDINGS' EXTERNAL WALLS IN BIH DISCUSSIONS AND CONCLUSIONS

The research about the residential building's external walls in BIH leads to a conclusion that awareness about wood advantage has to be spread with positive examples. Many researchers confirm that wood is a more environmentally friendly material.

“Not only energy but also structural concepts have been compared, mainly renewable (wood) versus non-renewable materials (masonry, concrete, steel) in the context of low-energy dwellings. Most research assigns better results to wooden structures (Cole & Kernan 1996, Gerlla et al. 2007, Mithraratne & Vale 2004). Wood is easier to manipulate and CO2 neutral, while production of steel and concrete induces more burdens due to production and processing and has a higher embodied energy. However, the use of timber frames is limited to buildings up to three floors (Cole & Kernan 1996). Only the research of Marceau & Van Geem 2006 came to opposite conclusions, with a preference for concrete structures, mainly because of the higher land use of wood.” (Buyle 2013)

Guy et al. 2006 explained “Light Wood-Framed Residential Structures” and the principles of their DfD (“design for deconstruction”), summarizing more than nine residential structures that have been deconstructed by the Centre for Construction and Environment. As wood has considerably more value in reuse than in recycling, it was mostly hand deconstruction. The only problem he saw was “that damage weakens the building and reduces the value of the recoverable materials”. They also suggest “ease of disassembly (by using screws and bolts for instance) for replacement and repair of components and sub-components.” (Guy et al. 2006) Conclusion was that “on a fundamental level wood is a highly preferable material in design for deconstruction since it is flexible for both reuse and recycling, a “natural” material, and can be readily connected using interstitial connecting devices such as bolts... They figured out that it will be simple with simultaneous creation of a deconstruction plan along with the construction plan and labelling of components for their constituent materials”. (Guy et al. 2006)

The prototype of the case study wall of GDC confirms Guy et al. 2006 proposal and conclusion. The carefully predesigned connections between wooden elements, as “intermediary”, the middle element, can preserve the parts for future multiple reuse.

Residential buildings for collective housing in BIH are still built in the same way as in the XX century with reinforced concrete structure and external walls made of reinforced concrete or bricks with better thermal insulation (comparing to the old ones) to fulfil the more demanding energy efficiency standards. The collective housing units are keeping their purpose and the same function for almost a century after being built,

without big structural transformations. The technology used for these buildings is satisfying the needs of users in the present time (XXI century) and this continues. Residential buildings will be used as is for the next one or two generations. The only necessity will be to have possible transformation of the final layers of the walls which are exposed to weather and human impact (due to well-worn material, use and maintenance) and need to be changed or replaced because the material is weathered.

Although in essence similar to collective housing, residential buildings for individual family housing, which are majority in BiH, need improvements. Many of them are built as same as the buildings in XX century, using the expensive technology with reinforced concrete structure with reinforced or brick external walls covered with some thermal insulation and plaster as a final layer. The main problem is the size of these new buildings, which are dimensioned for one or two families more (future families of the owner's children). Usually, these two additional floors stay empty and cannot be "unbuilt". Most of the houses stay unfinished. Façade stays without its final layers because of the money deficit for proper insulation. As previously mentioned, the children usually build their home somewhere else and the space in the house intended to be used by them, stays empty. Another problem is the lack of proper insulation on the façade, and thus the energy efficiency is very low. These houses can be called "one eyed" houses, as in the winter night only one window has a light. (Androšević & Androšević 2021) All inhabitants are gathered in one room (with a heating) and the rest of the house is in dark and it is extremely cold.

Very rare example is the one where a family decides to buy a wooden house which is more affordable, more energy efficient and can be made using a system that can be easily disassembled. The mind-set of the owners/investors cannot be changed overnight and for them the only "real house" is the one made from the concrete and bricks (people still think about a fairy tale with three pigs and their houses).

Even though the wood is available and affordable material, the stakeholders usually don't recommend it or use it in building a house in BiH. These solid concrete houses are not suitable for change or any transformation and when not inhabited, they become construction waste. Their materials cannot be used again as the disassembly is not possible.

Considering all mentioned above, some solution can be proposed and compromise can be done. The ground floor and the first floor can be made traditionally with reinforced concrete structure and next one or two floors can be made with prefabricated wooden systems. These systems can be easy assembled and can be upgraded to be easy to dismantle. In case when a child doesn't come back to the family house and lives with his/her own family in near future, the house owner could disassemble the uninhabited floor and sell the system to someone else. In this case, there would be investment

return. In case that there is a need for additional floor, the roof could be disassembled and additional floor could be added easily. This hybrid concept can be acceptable in terms of many aspects:

- Mind-set of the investor would be satisfied,
- More affordable solution,
- Quicker assembly and move in,
- Investment value could be returned...

Schematic visual of the proposed hybrid house structure where ground floor and first floor are made traditionally without possibility of transformation and with solid reinforced concrete structure and bricks and first and second floor are made with wooden prefabricated structure systems and with the wooden prefabricated roof on top. (Figure 72) (Androšević & Androšević 2021)

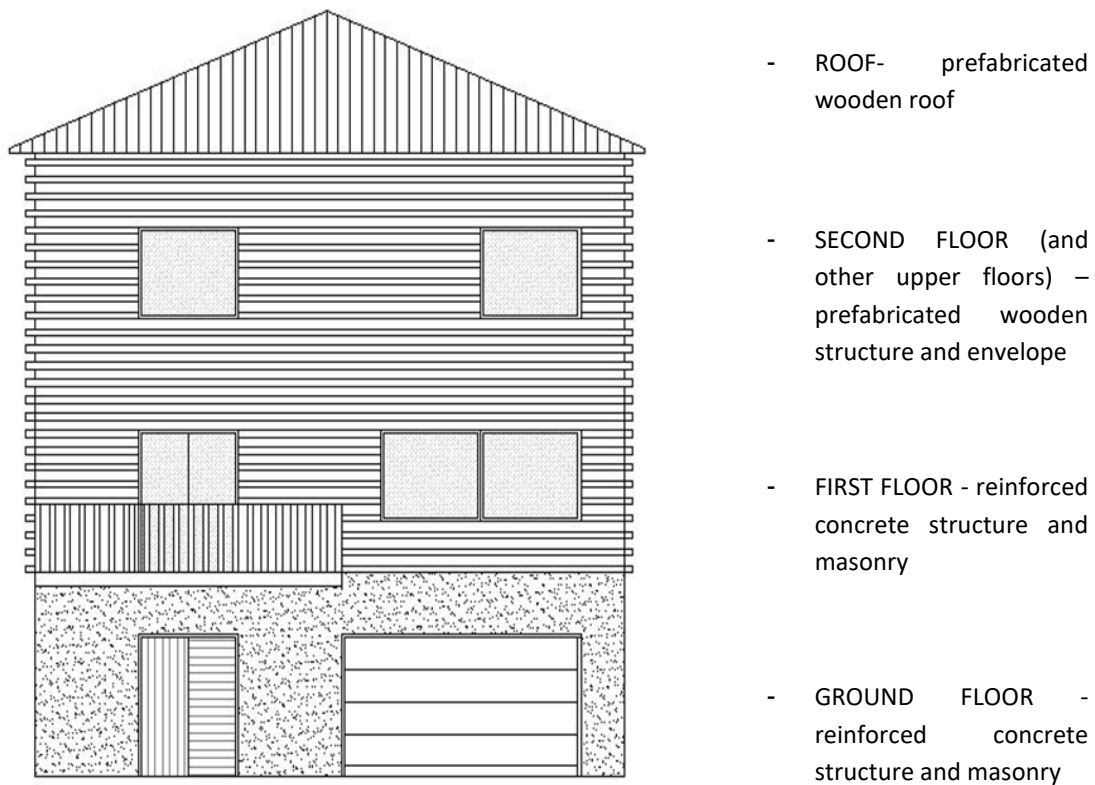

Figure 72. Schematic visual of the proposed hybrid house structure. Androšević & Androšević 2021

For this hybrid house, the second half should be transformable. The producers of the energy efficient wooden houses also have to consider the easy disassembly and fully apply the principles of the circular building construction in XXI century. If this concept becomes “real time action”, then the wooden parts won’t be losing their value through time and would not become waste after the first life cycle of the house.

***When the circular way of thinking becomes circular way of building?***

## 5. THEORY - EXISTING METHODS AND TOOLS

### Summary (English)

In the process of decision making, considering specific contextual aspect of this study, following databases, methods and tools are chosen for measuring and predicting the environmental impact of built structures and can help in the process of predicting the construction waste:

- a. Building materials databases - helpful to track the origin and composition of substances/materials in a product/system.
- b. Building Information Modelling (BIM) which can use the material databases - helpful to show the composition of materials in the system and their relations.
- c. Reversible building design (RBD) protocols which include:
  - method and tool for measuring the Reuse potential (RP) of a building and its parts;
  - method and tool for measuring the Transformation Capacity (TC) of the building and its parts.
- d. methods and tools for analysing and measuring the impact:
  - Life Cycle Assessment (LCA),
  - Life Cycle Inventory (LCI),
  - Life Cycle Impact Assessment (LCIA),
  - Life Cycle Costs (LCC).

All these databases, methods and tools will be studied and investigated separately in order to find the best solution to help in the decision-making process in the building industry in the field of environmental impact and construction waste.

## 5. THEORIE – METHODES ET OUTILS EXISTANTS

### (Récapitulatif Français)

Dans le processus de la prise de décision, vu l'aspect spécifique du contexte de cette étude, les bases des données, les méthodes et les outils de mesure et de prévision de l'impact des structures bâties sur l'environnement, pouvant aider dans le processus de la prévision des déchets de construction :

- a) Bases des données des matériaux de construction – utiles pour suivre l'origine et la composition des matériaux dans le produit/le système.
- b) Modélisation des informations du bâtiment (BIM) pouvant se servir des bases des données des matériaux – utile pour montrer la composition des matériaux dans le système et leurs relations réciproques.
- c) Reversible building design (RBD) protocols - Protocoles de conceptions de bâtiments réversibles incluant ;
  - Méthode et outil de mesure du potentiel de la réutilisation (RP) du bâtiment et de ses parties ;
  - Méthode et outil de mesure de la capacité de transformation (TC) du bâtiment et de ses parties.
- d) Méthodes et outils d'analyse et de mesure de l'impact :
  - L'analyse du cycle de vie (ACV)
  - L'inventaire de cycle de vie (ICV)
  - L'évaluation des impacts du cycle de vie (EICV)
  - Le coût du cycle de vie (CCV).

Toutes ces bases des données, toutes ces méthodes et tous ces outils seront étudiés et examinés séparément afin d'aboutir à la meilleure solution pour l'aide dans le processus de la prise de décision dans l'industrie de la construction dans le domaine de l'impact sur l'environnement et des déchets de construction.



## 5. THEORY - EXISTING METHODS AND TOOLS

Literature review (in Chapters 1 and 2 in this Research) concluded that the circular way of thinking when designing products and buildings is the best way for healthy future on Earth. Circular economy established not just environmental, but also financial benefits. Some industries are starting to follow the circular principles, but in the construction industry, the early adopters and practitioners are very rare. The main reason is the need for adaptation of the whole system (building technology and all stakeholders) to this kind of thinking and forcing the implementation of circular building design, production and building product installation.

In production industry, the *Design for Disassembly* (DfD) principles introduced by Crowther 1999 have not taken its full acceptance until today, even though they are well defined. Materials hidden in the existing buildings are considered as attractive alternatives to raw ones according to Koutamanis et al. 2018, but there are a lot of problems in extracting them in practice.

*Adaptive reuse* approach is the theory that requires attention. This concept considers that, a building, which is no longer in use, represents a potential “material” for new project, and it was described well by Chusid 1993 and called “urban ore”. When the basic structure and covering materials are left and just the function of the building is changed, then we can have the best result called “adaptive reuse”. This looks like a really practical solution, but as a concept. Some structural elements usually do not have the right span for the new purpose or the additional adaptations and refurbishing costs more. It happens usually when a building is not designed for any transformation. There should be “clear economic, environmental and social benefits that can make this option attractive to developers.” (Langston 2012) As already stated, adaptive reuse for the existing buildings is limited. It is well defined and proposed for some existing case studies. Uncontrary, it is very interesting as a concept to think about. Adaptive reuse can be considered when we are planning the new building, in the early stage. It is necessary to plan ahead and design the building for the adaptive reuse in its second life-cycle. The designer has to predict the future scenario, possible transformations and uses. This is very difficult because one or two decades can bring a totally different point of view and a lot of changes in the user preferences. Anyway it is worth a try.

Considering the construction waste, there are a lot of different *construction demolition waste* (CDW) protocols in many of the European countries. European Commission (EC) update very often Waste and Construction Demolition Waste protocols and recommendations. (EC 2018) Some countries like Netherlands, Germany and Denmark have already achieved the total mass flow of recovered waste of more than 80% of the total waste generation. (Eurostat 2017) Some countries have achieved this remarkable result, but total environmental impact is a little bit lower in terms of virgin materials use and construction demolition waste quantities. Other countries are unable to follow

these positive examples for many reasons. CDW protocols and management are developing and spreading positive results.

In the meantime, building industry continues to build in the same way it built from the start of the industrial revolution, without paying attention to the:

- quantities of virgin materials,
- non-renewable and embodied energy,
- construction residue left behind when the construction process is finished,
- waste which will be created after the first life cycle of the building.

In the future we will have to follow CDW protocols each time the building changes its parts or finishes its life-cycle. This is a step forward to protect the living creatures from the bad existing buildings' environmental impact, but the permanent solution is in the different approach.

In order to find the solution to this problem, it would be better to prevent the construction waste and make the plan for less expensive and less complicated procedures of CDW, which just a few countries can follow at this time. It is the time to make protocols to prevent the construction waste at the beginning of the building process. The construction industry is missing the recommendations, protocols and laws for *waste prevention* (preferred option for EIB 2015), which should be developed along the CDW management, regulations and protocols. This research will take advantage of the existing methods in order to prevent the waste in the design phase of the building, and to help build future buildings included in circular building system, producing no or very little waste.

Cambier, Galle & De Temmerman 2020 conducted the study that “resulted in eight subcategories of tools each having its specific added value during different design stages: Design principles tools, Material flow analysis tools, Life cycle assessment tools, Material and product labels, Reused material platforms, Material passport tools, Life cycle cost tools and Knowledge sharing platforms.” Insights and recommendations demonstrated in the mentioned study contributed to narrow the key design support tools for this research.

In the process of decision making, considering specific contextual aspect of this study, following databases, methods and tools are chosen for measuring and predicting the environmental impact of built structures and can help in the process of predicting the construction waste:

- a. Building materials databases - helpful to track the origin and composition of substances/materials in a product/system;
- b. Building Information Modelling (BIM) which can use the material databases - helpful to show the composition of materials in the system and their relations.
- c. Reversible building design (RBD) protocols which include:

- method and tool for measuring the Reuse potential (RP) of a building and its parts;
- method and tool for measuring the Transformation Capacity (TC) of the building and its parts;
- d. methods and tools for analysing and measuring the impact:
  - Life Cycle Assessment (LCA),
  - Life Cycle Inventory (LCI),
  - Life Cycle Impact Assessment (LCIA),
  - Life Cycle Costs (LCC).

All these methods and tools have been developing in the last few decades and have had huge progress in the field of presenting the difference between chosen solutions and help in the decision-making process at almost every stage of the project. Inevitably, considerable effort should be made to make a reliable tool which would be able to calculate and most of all, predict the future impact of a building (or its parts) during its use and maintenance phase and after the first building life-cycle. Majority of tools analyse the impact in the first life-cycle. The proposal of procedures after the first life-cycle are missing. As already mentioned, the future scenarios are very unpredictable, but it doesn't mean that predictions can't be done. We should broaden our perspectives and view of the future to lower the unwanted contingencies.

Even though it is recommended to have the tool "all in one", different stakeholders are interested in different impact calculation. Some different options should be considered for the next groups of stakeholders:

- project designers (architecture / product design / consultancy company);
- building constructors (building parts producer / construction / demolition company);
- building investors (private or public).

Previously mentioned databases, methods and tools will be studied and investigated separately in order to find the best solution to help in the decision-making process in the building industry in the field of environmental impact and construction waste.

## 5.1. BIM - Building Information Modelling with Material Database

With the technology development, computers started to be more than just a typing machine to write and a pen to draw lines. Many different databases and programs are helping users to complete projects with important data. The potential of computing can be used within its full capacity in the construction industry. All data for the building can be stored in one project, used and tested not just before, but also after the building is built. This kind of support for all stakeholders is called Building Information Modelling (BIM).

The idea of the digitalisation in the construction industry was created in the late XX century. Eastman 1975 suggests “The use of computers instead of drawings in building design”, and predicts that the Building Design System (BDS) will become significant to the degree that its design responds to the projected user’s needs. He imagined and described the System (BDS), which included ideas of parametric design, deriving drawings from a model, a “single integrated database for visual and quantitative analyses”. Eastman 1975 has said that the “Contractors of large projects may find this representation advantageous for scheduling and materials ordering”. He was the one of the visionaries and early adopters or even the first person who saw the future of the building industry in the computer design.

“In the 1980s and 1990s, building automation allowed real estate and facility management teams to visualize their buildings’ key performance indexes through dashboards (static, historical and aggregated, and did not provide actionable insight). They could tell us which buildings produced most waste, but not why, or what to do about it.” (IBM 2016)

Later on, in the XXI century, many researchers and organizations tried to define the BIM and the benefits that it can bring to the construction industry. (National Building Specifications (NBS) 2012) define it as follows: “The BIM is a project as well as a process simulation. It is a digital representation of physical and functional characteristics of a facility. The planning and realization of the BIM are very similar to the planning and realization of an actual construction project”

“The simulation process actually parallels the construction process, which makes the BIM such an effective tool. Development of the BIM happens through the shared knowledge of architecture, engineering, and construction (AEC) team which makes it a reliable resource for information. BIM proves to be a reliable basis for decisions during a project’s life-cycle, from concept initialization to its demolition.” (NBS 2012).

“BIM is a technology that can generate and manage all the information required during the life cycle of a building, from design to demolition... Based on this matching integration, the estimates of DW by type were calculated by applying the weight/unit

volume factors and the rates of DW volume change.” (Kim et al. 2017) This research shows that even in the year 2017, BIM has been used as a tool “from the design to the demolition” and not for the other life-cycles. Potential demolition waste can be the resource for another project and should be observed like one. BIM model should not be limited for only one life-cycle, as many researchers are proposing.

NBS researchers and many others after 2012 (Kim et al. 2017) also predicted the potential of the BIM, but the traditional concept of thinking that the building and its parts have only one life cycle, like the statement “from concept/design to its demolition”, still stays the same. The other life-cycle(s) of the building parts is(are) undefined. Later, the life of the building parts after the building first life-cycle was considered, but still not well defined.

Benefits and numerous possibilities of the BIM modelling have been seen from the start, but BIM advantages generated considerable recent research interest in the XXI century. Succar 2009 and Eastman et al. 2011 saw the multiple possibilities of these representations, called the BIM models. They saw that, with these tools, the buildings can be produced, communicated and analysed over different life-cycle stages. The BIM is having a great role in the management of projects (Bryde et al. 2013). The BIM is starting to be “ideal of having a complete, coherent, true digital representation of buildings” (Turk 2016).

BIM is considered as one of the spatial and data communication concepts, which is commonly used in architecture, engineering, and construction (AEC) industry and can be systematically and efficiently integrated with identification and data acquisition technologies. (NIST 2012)

“BIM includes associated benefits of visualization, built-in intelligent objects of a building model such as spatial data (3D), unstructured data (text), and structured data such as spreadsheets and databases. BIM models not only provide data pertaining to the building geometry but they allow the calculation of volumes and related energy based on the characteristics and orientation of a building.” (Jalaei & Jrade 2014)

UK BIM Task Group 2013 has considered the BIM as one of the most promising innovations in the modern era of the architecture, engineering, and construction (AEC) industry. “BIM is essentially value creating collaboration through the entire life-cycle of an asset, underpinned by the creation, collation and exchange of shared 3D models and intelligent, structured data attached to them.” (UK BIM Task Group 2013)

“Within this third digitalisation wave, the extensive growth of data has been put forward. It is accordingly of crucial importance that the instruments using these data are user-friendly, in order to translate the huge amount of data into ready-to-use information by decision-makers.” (Brussels Environment et al. 2016)

“The BIM helps owners visualize the spatial organization of a building and understand the sequence of construction activities and the project duration.” (Eastman et al. 2008)

Considering all earlier researches, BIM should be used at the very beginning, when the building is designed, because the BIM model gives multiple possibilities and necessary information to all stakeholders:

- For the *designer and engineer*, the computer model gives an opportunity to plan, design and see the building in its entirety with its parts and from a lot of perspectives (plan and section with visible materials, 3D model). BIM modelling provide the possibility to work on the same model and upgrade it with different functions to many different stakeholders (designers and engineers).
- For the *constructors*, the planned materials, their position and quantities are important. BIM software provides information in one place about all necessary materials, components, elements and systems so constructors can order and buy them from suppliers in required quality and quantity and build them in the building.
- For the *investor*, the first data are important, so that the total estimated price of the project can be formed (e.g. bill of quantities), the design can be presented, viewed and approved. For him, the cost and the look are equally important and both can be seen when using the BIM tools. Any change in design and material can demonstrate the change of the final cost accordingly, thanks to the software matrices and correlations/dependences between the drawing, building parts and material quantities.

Material database has to be included in BIM depository. The importance is visible in a case when a building is finished and inhabited and requires a proper maintenance. If the parts are documented, it would be easier to detect the failure and make repair or change. Many existing buildings have been digitalized, and some new ones are starting with a digital database and model. That good practice should be continued and used more when planning new structures. The BIM database can help construction industry to achieve “circular building” and use the parts of the building as the parts for the other building (or product/system) and give them “another life” and purpose after the first life-cycle of a building.

When we are speaking about buildings, their digitalization can go to the next level. BIM can be upgraded in terms to make the buildings “smart and cognitive”. (IBM 2016)

“From the beginning of this millennium, smart buildings made their entrance, making it possible to link sensor specific information with analytical tools to create actionable insights at the room and asset-specific level.” (IBM 2016)

IBM believes in cognitive buildings, and explained them in its white paper "Embracing the Internet of Things (IoT) in the new era of cognitive buildings". These buildings (besides automated and smart building), represent autonomously integrating IoT devices with learning system using user behaviour to optimise building performance. (Figure 73) These cognitive buildings will have the ability to:

- provide insights;
- learn, reason with purpose and interact naturally with humans and
- act and deploy changes to building operations. (IBM 2016)

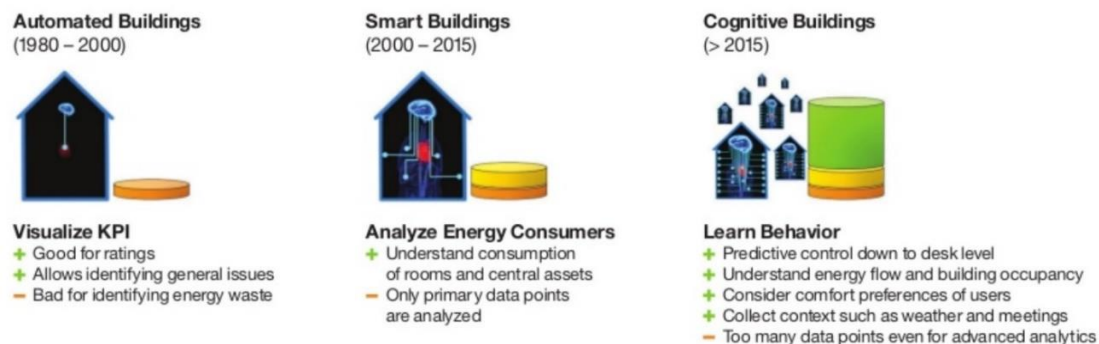

Figure 73. IBM's Cognitive Buildings Maturity Framework Source: "Embracing the Internet of Things in new era of cognitive buildings" (IBM 2016)

The buildings are still Automated Buildings in 2020, even though the Cognitive Buildings should be the buildings built in XXI century, after 2015, according to IBM predictions. The suggestion to have buildings which learn behaviour is a really good, but futuristic, as these cognitive buildings are still rare in the period since 2015 to 2020. This area is still not well elaborated and should be further developed and applied in practice. The practice shows that the building is as "smart" as the building's designer/creator. Cognitive buildings are the ones that will exist in the far future (even though the predictions and expectations were different).

Improvement to his approach and system can be with building materials and building systems data in terms of mapping the parts that the building is built of and their connections and interactions. This will be the start of the "smart system" for the future that will not produce the construction waste, and accordingly will have lower environmental impact.

As for the database of the materials and building parts, there are some existing and developed material databases, which can be used while developing building model:

- Environmental Product Description (EPD) database;
- Materials Passport database;
- Eco invent material database...

Other databases are available, but not mentioned, as they are irrelevant for this research, because they use the data in different format and are not compatible with the chosen tools.

Succar & Kassem 2015 detected “the technological, cultural, and legal barriers” for developing BIM. But despite them, BIM is “a database that embeds, displays, and calculates graphical/tangible and non-graphical/intangible information, ensuring the connection of information and data to the related objects”. (Succar & Kassem 2015) They saw that BIM provides “a reliable basis for decisions during the whole building life cycle, especially because, serving as a shared resource for information, it encourages communication, collaboration, and cooperation across the broad spectrum of disciplines and stakeholders involved in the process”.

“BIM has to be advanced from a database that evolves over the building life cycle in terms of quality and quantity to a life cycle database that properly progresses over time from its inception onward.” (Dalla Valle et al. 2020)

Dalla Valle et al. 2020 saw the transition of BIM into a building life cycle database as the integration of the life cycle information content into the model showing:

- different degrees of depth (detail),
- stability (development),
- reliability (approval).

“The improvement during the process of the set of intangible information attached to the tangible BIM objects:

- it provides additional specifications on the selected technological elements, not limiting them to the construction phase but involving their entire life cycle.
- it reveals and traces the set of criteria adopted during the decision-making of the whole building process, expanding the typical performance and aesthetic parameters with the connected life cycle information to make aware decisions, avoid shifting problems and gain a long-term perspective...
- it allows the overall monitoring of the process and the verification of its optimization, since the declared life cycle information and data stand for the thresholds not to be exceeded in the subsequent process phases.
- the data collection framework helps to build sector practitioners to comply with sustainability goals and towards LCT, calling for a life cycle information flow through a sharing of roles and responsibility.” (Dalla Valle et al. 2020)

Dalla Valle et al. 2020 concluded that, “if on one hand, this organizational setup represents a point of strength, not overburdening design competences in their assignments, on the other, it constitutes a point of weakness, since it involves a wide range of competencies that must be trained and successfully managed to account for life cycle information in practice.”

After 2010, much research has been focused on BIM possibilities in the sustainable building construction. In these researches the BIM contributes and has important role in the process of reduction of the building construction waste. Even though, “the use of



(digital) information to achieve closed-loop material flows is understudied.” (Van den Berg 2019)

There are some projects that take advantage of BIM, which is facilitating the process of reducing the construction waste. BIM is attracting widespread interest in this field and software developers upgrade the tools according to the suggestions in the area of the environmental protection.

“The BIM-based design validation, which involves clash detection and design review, could reduce the rate of design errors and rework, thereby reducing the amount of construction waste on site by 15%.” (Won et al. 2016). Multiple researches have been carried out on the design system based on the BIM and other management methods in order to reduce waste (Hamidi et al. 2014 and Won et al. 2016) and developed a database for the materials originated from the building demolition through the BIM. In addition, Hamidi et al. 2014 proposed a waste management system after demolition using the BIM. Cheng & Ma 2013 used the BIM concept to estimate demolition waste and disposal charging fee in addition to arrange trucks for waste collection system. Jrade & Jalaei 2013 described a methodology emphasizing the integration of the BIM, Management Information Systems and the LCA that can be used to implement sustainable design for proposed buildings at their conceptual stage all the while taking into consideration their Environmental Impacts. Won et al. 2017 proposed their BIM-based approaches to efficient construction waste management and minimization, including how the limitations in C&D waste management and minimization processes and technologies can be addressed by implementing the BIM in the AEC projects, which should be involved, and that information should be generated and exchanged between project participants through in-depth literature review. Liu et al. 2015 represented the first attempt to develop a design decision making framework in improving construction waste minimization performance through the BIM...

Despite the advantages, BIM was not frequently used in building design nor for construction waste management. Jalaei et al. 2019 found out in one questionnaire that only 28 out of 50 responding architects had used the BIM for sustainable building design.

Research results of Jalaei et al. 2019 “showed that there is an agreement on the potential use of the BIM for construction waste management during design stages, including BIM-aided coordination to reduce conflicts between disciplines, reduce rework, clash detection for error reduction, enhance communication and integration, increase the ability to quantify and test numerous design options of varying waste reduction performance and to improve the quality of knowledge for construction waste management decision making. However, there is a complete absence of investigation on the development and review of tools and methodologies that use BIM to support the construction waste management decision making during design. In spite of the appropriate results obtained from the aforementioned researches, the focus was on the management of C&D waste rather than the reduction of the main factors contributing to its creation.”

According to Warszawski 1999, there are various design rules for enhancing deconstruction, which have to be followed. These approaches help to increase the building flexibility and to separate building components. The most remarkable points are as follows: implementation of materials with high durability (Tingley & Davison 2012), the potential of reusing materials (Guy & Ciaramboli 2008), utilizing bolts in joints in lieu of welding (Chini & Balachandran 2002), avoiding toxic materials (Tingley & Davison 2012), and using prefabricated materials (Jaillon et al. 2009). Guy et al. 2008 discovered that the small number of materials and joint locations have more potential for deconstruction. Furthermore, Akinade et al. 2015 state that development should be according to the building deconstruction assessment system (DAS-BIM) in order to represent a benchmark for building deconstruction at the design stage.

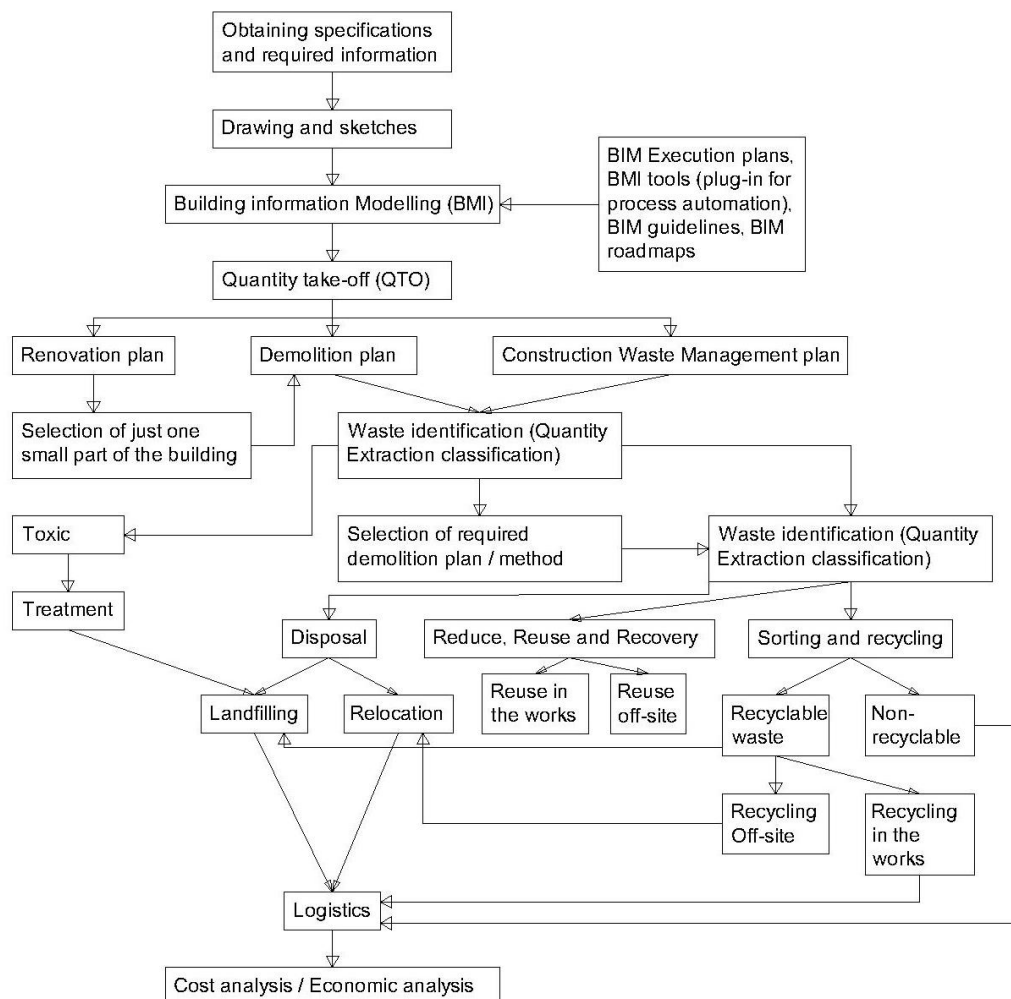

Figure 74. Proposed theoretical framework for the BIM based CDW management (adapted Gupta et al. 2020)

Gupta et al. 2020 proposed theoretical framework for the BIM based CDW management. (Figure 74) They followed logical path from obtaining specifications and required information through the Renovation, Demolition and Demolition Waste Management Plan to the final Cost analysis. This plan looks feasible, but it requires competency of all stakeholders in its implementation. The expert should follow up and monitor the process, which creates additional costs during the process. If all these steps could be done by the tool, this process will be done more quickly, will be simpler and

less expensive. The whole process should be defined with parameters and transferred into the computer language and then it would fulfil its purpose.

Some of the researchers suggested the symbiosis of two tools. This approach has a lot of potential to succeed. For example, Seyis 2020 suggested that “building information modelling (BIM) and life-cycle assessments (LCAs) could be integrated to quantify and alleviate the environmental effects of buildings while simplifying and optimizing data acquisition.” He identifies and classifies a total of 21 advantages and 7 disadvantages associated with BIM-based LCAs.

The advantages were grouped into four categories:

- decision making,
- material selection,
- sustainability performance, and
- waste reduction.

The disadvantages were grouped into two categories:

- standardization,
- data processing.

Jalaei & Jrade 2014 suggested “an integrated methodology that links BIM and energy analysis tools with green building certification systems. This methodology will be applied at the early design stage of a project’s life. It will help designers measure and identify potential loss or gain of energy for different design alternatives and calculate the potential LEED points they may accumulate and gain and accordingly select the best one... Furthermore, integrating BIM with Life Cycle Assessment (LCA) tools at that stage would help designers select components and materials that have lower embodied energy.”

This idea of combination of two tools is a really good idea and actually feasible. We must not stream towards one ultimate tool to help us solve the problem. Sometimes, the mix of the right tools and methods gives the best results. Many researchers saw the benefit of combining the BIM model with LCA methodology and interface. This combination will enable better view to sustainability, circular building and less negative impact of construction industry.

Jalaei et al. 2019 suggest “to use an integrated BIM-LCA interface to estimate and calculate EIs of the wastes, which are generated from design clashes and enable design team to modify design and to select optimal types of materials from early design stages of building projects.” LEED 2013 also states that “integrating the BIM with the LCA tools in the conceptual stage can help designers select components and materials that have lower EIs. This will promote sustainable development practices by recognizing the projects that implement strategies for better environmental and health performance.”

According to Kubba 2012 and Becerik-Gerber & Rice 2010, the development of a schematic model is superior to the generation of a detailed building model, allowing the designer to:

- make a more accurate assessment of the proposed scheme,
- evaluate whether it meets the functional and sustainable requirements set out by the owner and
- increase project performance and overall quality.

Digitalization can speed up the process in case when the building design is developed with software. Hollberg et al. 2020 made review of many researchers that have developed their own workflows to connect an LCA database with a BIM software, for example linking Autodesk Revit (Stadel et al. 2011), ArchiCAD (Crippa et al. 2018), SimaPro or Excel (Soust-Verdaguer et al. 2018) and the visual programming plug-in Dynamo for Autodesk Revit is also used to link the BIM model with the LCA database. (Shadram et al. 2016, Tsikos & Negendahl 2017, Bueno et al. 2018, Röck et al. 2018)

The research of Poon et al. 2004 aims to focus on the concept of “minimization at source” to reduce the amount of waste generated indeed to avoid situations where waste is generated. In order to reduce C&D waste, an integrated design technique is required because a large amount of waste can be generated due to the inappropriate design and unpredictable changes at the site.

A successful BIM platform has to have good and adaptable tools, which are able to follow processes (connected with material databases), recognize behaviours and predict scenarios. (Figure 75) and then, this platform will be an excellent base in the system for predicting environmental impact of a built structure.



Figure 75. Necessary for a successful BIM Platform.

Undoubtedly, BIM modelling with material database is the one to be considered in further research and to be a part of the symbiotic methods for predicting the building environmental impact and construction waste reduction. This digital model is the base with all necessary information. Database with BIM model can be combined with other methods and tools to give the right picture of the situation. The best characteristic of this type of the model is that it is:

- visually clear,
- easy to use,

- easy to read information,
- easy accessible,
- open and available to all stakeholders,
- adaptable (allows modifications),
- predictable...

The importance of this kind of thinking and presenting is inevitable.

After the literature survey of Building Information Modelling, many advantages of BIM use in the construction industry are evident. For the circular construction industry and sustainable building practice, BIM connected with material database is very useful, but just as a technical database that gives information about building parts. If we want that these information show the environmental impact, the connection of BIM and another methods and tools is necessary. Combining the tools and methods has very good results, according to many researchers, mentioned above.

Recent research points out that the main remark for BIM application is that it is not connected with other methods in the early design phase of the building, so it cannot help decision making process in order to prevent bad environmental impact. Connecting BIM with material data base helps a bit to decrease the use of hazardous materials. Symbiosis and interference with other methods and tools are more than welcome to achieve better view and results.

Potential benefits of the usage of the material database and BIM in the building sustainability can be seen when sustainability principles, methods and tools apply in every phase of the building life, especially in the phase of the building design. BIM is perceived as a huge start in the process of decision making when designing a building with low environmental impact. It can be helpful and tested in the case of predicting the building waste, one of the factors influencing total environmental impact score.

**“Building is a structure that has a roof and walls and stands more or less permanently in one place”**

Egenhofer 2002.

## 5.2. Reversible Building Design with Transformation and Reuse Potential Method and Tool

The definition of the building as more or less permanent structure is stated in the law in the countries all around the world and makes a real obstacle for the building progress in the way of transformability. Evidently, building transformability and adaptability to new terms and conditions is a key for lowering the construction waste, therefore including all building parts in a circular construction.

As already explained, BAMB pilot project Green Design Center in Mostar was imagined as transformable building. It is designed to be transformable on yearly basis and it encounters on the problem to get the building/construction permit. However, the transformable building is not defined by Law on Physical Planning and Utilization of Land at the Level of the Federation of Bosnia and Herzegovina. By the Law, if the building wants to change its shape and configuration during the time, it is considered as an extension or even reconstruction. These works require administrative procedure to get a new spatial consent and construction permit. The administrative procedure is time demanding and expensive, so this should be avoided. The solution of this potential problem for the future buildings can be the definition of the *transformable building*, so the building can be registered as such structure. Some researchers are explaining and developing the models of transformable buildings, but it will be a long process to incorporate these theories and suggestions into the law.

From “urban ore” (Chusid 1993) through “design for disassembly” (Crowther 1999), the idea of the transformable building structures (Durmišević 2006) is finally going into the realisation to accomplish circular building practice, if it follows the principles and protocols of Reversible Building Design. (Durmišević 2019)

Reversible and transformable building is the key for the future and should be taken into the consideration when designing the new building. Durmišević 2006 is originator of the new methodology that provides guidance of how to recognize and predict the potential of reuse and establish the framework for transformability of the building and its parts. The principles of the reuse potential and this methodology was applied on some Case studies in the Chapter 3 in this theses. Some more explanations about the used methodology are presented in this chapter.

“Reversible Building is seen as a backbone of circular building and circular economy in construction... A perception which sees a building not as a finished static product, but as an ever-evolving structure which keeps up with the time, new technological developments and user requirements.” (Durmišević 2019)

Reversible Building Design research led by experts in EU project Horizon 2020 in project Buildings as Material Banks has identified “fundamental system error embodied in the

building design and linked the Construction Demolition Waste directly to the design error.” (Durmišević 2016)

According to Durmišević 2006 conviction held by many is that buildings last longer when made of more durable materials. But everyday demolition practice that results in material and energy losses disproves that statements, because:

- due to the frequent functional changes the ‘use life cycle’ of materials is often shorter than the ‘technical life cycle’ of materials;
- materials are often integrated into a fixed assembly; the replaceability of one element means the demolition of others;
- the end of the life cycle of buildings is associated with demolition and waste generation...

During the survey of the techniques and criteria for reuse potential (RP) and analysis of the best data and indicators overview, “reuse” is something really often mentioned in the literature, but not strictly defined in construction industry and building design.

“The ultimate durability and circularity of buildings is not only related to the durability of their materials but more importantly to the way that the materials are put together... Exchangeability of parts is defined predominantly by technical and physical design domains that deal with hierarchical order of elements within structures, and with connections between elements.” (Durmišević 2019)

Considering that, Durmišević 2006 provides a preliminary design framework for high disassembly potential of building structures, which results in a high Transformation Capacity (TC) and Reuse Potential (RP).

“This means that design should guarantee multiple reuse options of the building, its systems, products, components and materials and provide incentives to retain or increase building value through reuse, repair, reconfiguration or remanufacturing.” (Durmišević 2019)

The key indicators for reversible building design are shown in the Figure 76 and Figure 77.

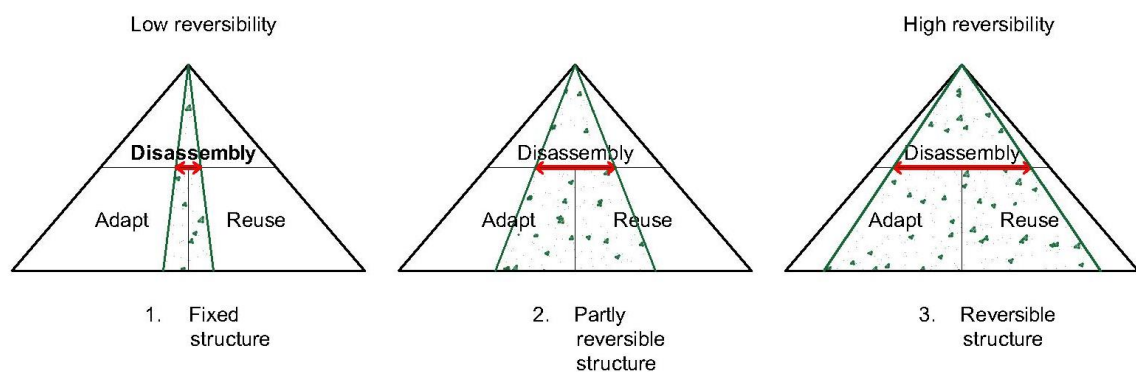

Figure 76. Key indicators forming a nucleus of reversible building design tools and protocol – adaptability, reuse and disassembly (adapted Durmišević 2019)



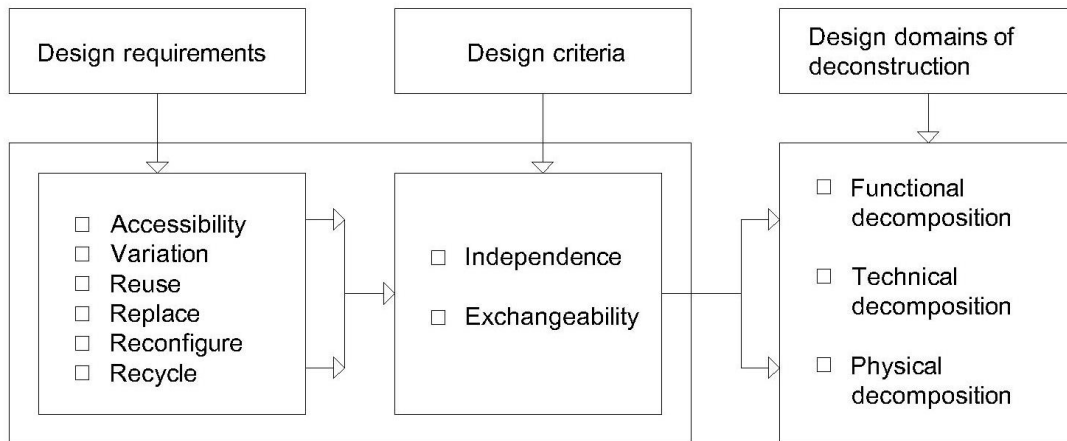

Figure 77. Two key indicators of reversibility of building structure are independence and exchangeability of building systems/components. (adapted Durmišević 2019)

“Traditionally companies were competing in their bids based on three competitive factors:

- costs,
- quality,
- time.

Then, more environmental focus in the 90’s led to emissions, biodiversity and resources. And going further to optimization of a broader holistic scope considering social equity and cultural issues, economic constraints, and environmental quality, which is shaping circular economy.” (Durmišević 2019) (Figure 78)

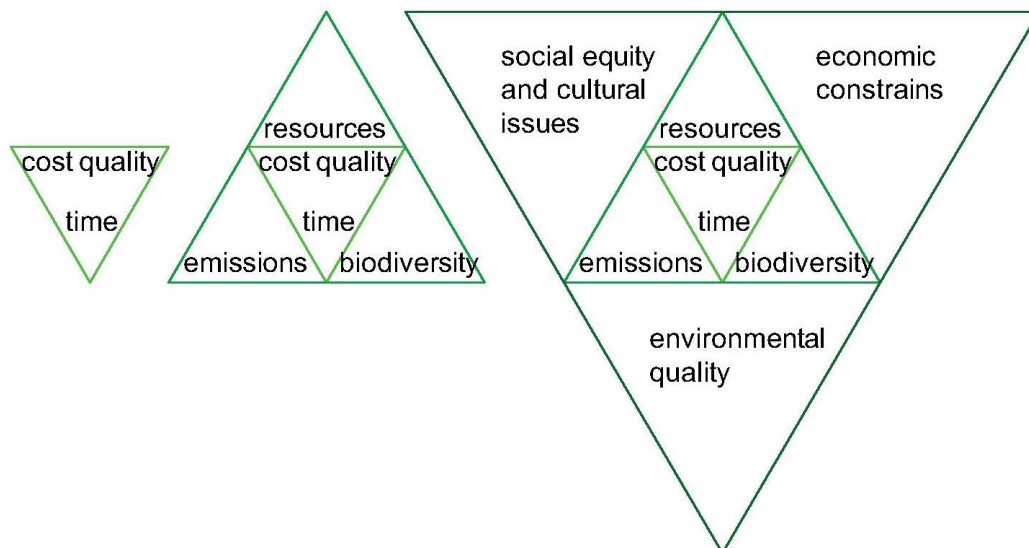

Figure 78. Transition of design focus from traditional factors in the past (left), through new paradigm (middle) and global context (right) (adapted Durmišević 2019)

Durmišević 2019 established the Reversible Building Design (RBD) protocol defined through 5 major steps:

1. Defining project objectives (identify long-term strategies);
2. Setting up Design Ecosystem for design of reversible / circular building (set up decision making processes during design and construction phases so that building materials and services will have defined second life at the end of the construction phase);
3. Design Brief (require delivery of final design accompanied with instructions for recovery of each product and number of recovery steps);
4. Design Process with three essential steps within each decision-making loop:
  - Analysis (indicate what the design is to accomplish)
  - Synthesis (formulation of a system that meets objectives and constraints – to reach the best reversible solution),
  - Evaluation (evaluation of reversible design solutions);
5. Multi Criteria Design Matrix (MCDM) – made in order to communicate the difference between desired performance of the building which has been set up at the start of the project and design solutions being presented and discussed during each design phase. (Durmišević 2019)

Reversible building design is an excellent design approach to achieve a circularity in the construction and building industry, in order to lower environmental impact of built structures. Reversible building design protocol can be the one to follow if we want to eliminate construction waste in the design phase.

As author Durmišević 2019 mentioned, there are two pillars of the building reversibility Figure 79:

- a) Spatial reversibility, addressing transformation on building level and
- b) Technical reversibility, which covers:
  - structural,
  - material dimension of reversibility.

„Integral view on Reversibility of buildings can be created by understating both:

a) spatial aspects of reversibility of buildings which affect the transformation capacity on building level to accommodate different functions and to be modified without demolishing part of the building and creating waist and

b) technical aspects of reversibility of building structure and product structures which affect reuse potential of building elements and transformation potential of building systems and components. “(Durmišević 2019)

Reversible building design guidelines are the ones to follow if we want to predict the construction/building waste, and lower total environmental impact of the building.

According to Durmišević 2019, 4 key design criteria defining spatial reversibility and 8 key design criteria defining technical reversibility have been identified as follows.

- a) Spatial reversibility (in preliminary design phase) Figure 79:
- dimension (building level),
  - position of core elements,
  - building level disassembly,
  - capacity of the core.



Figure 79. Design aspects of spatial reversibility. (adapted Durmišević 2019)

- b) Technical reversibility in technical and definitive design phase (reuse potential measuring indicators Durmišević 2006 and Durmišević 2019):

1. functional decomposition Figure 80, Figure 81;
2. systematization and clustering Figure 82;
3. hierarchical relations between elements Figure 83;
4. base element specification, Figure 84, Figure 85;
5. interface geometry Figure 86, Figure 87;
6. assembly sequences Figure 88, Figure 89;
7. type of the connections Figure 90 **Error! Reference source not found.**, Figure 91;
8. life cycle co-ordination in assembly/disassembly. Figure 92. (Durmišević 2019)

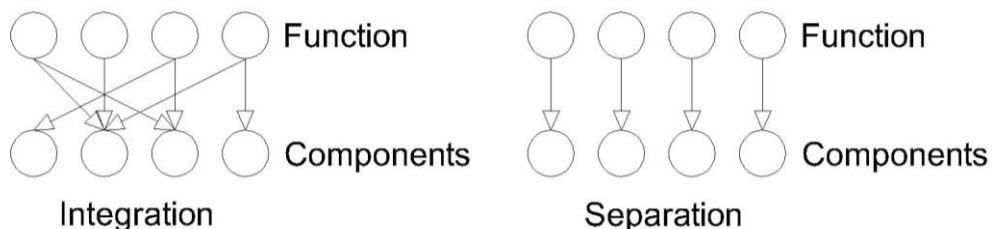

Figure 80. 1<sup>st</sup> Indicator - functional decomposition – models of possible separation of four main building functions (supporting, enclosing, servicing, and partitioning), which can be further subdivided into subsections (subsystems). (Durmišević 2006)

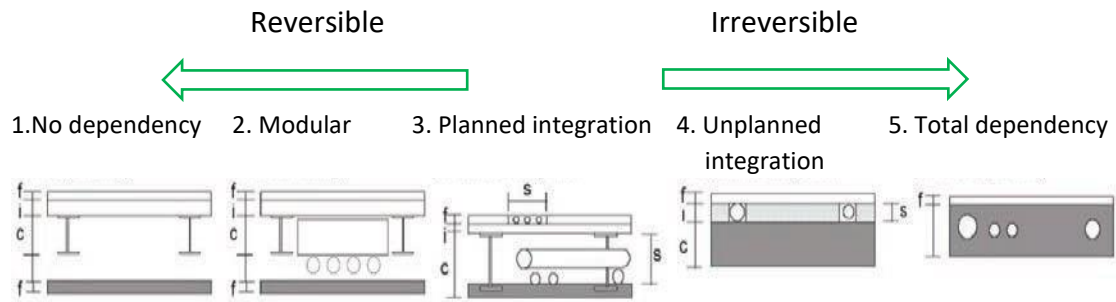

Figure 81. 1<sup>st</sup> Indicator - Schematic representation of five types of integration, the letters in the figure represent the following functions: (c) structure, (f) finish, (s) servicing and (i) insulation. (Durmišević 2006)

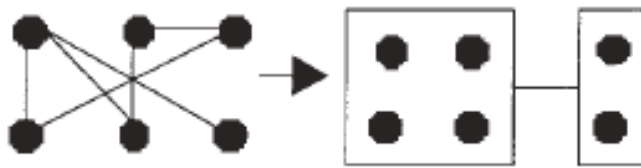
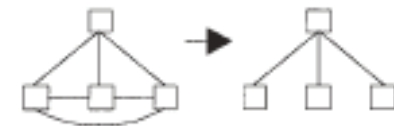

Figure 82. 2<sup>nd</sup> Indicator - systematization and clustering - the aim of reversible building design is a bigger level of assembly as possible (component/module/system level).. (Durmišević 2006)



closed assembly	layered assembly	stuck assembly	table assembly	open assembly	shared assembly
<p>■ - elements materials</p>			<p>○ - components</p>		

Figure 83. 3<sup>rd</sup> Indicator - relational patterns - pattern type and position of relations. (Durmišević 2006)

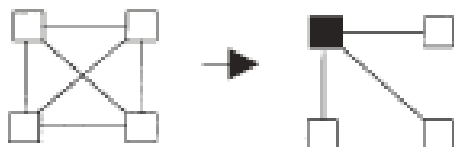

Figure 84. 4<sup>th</sup> Indicator - base element specification. (Durmišević 2006)

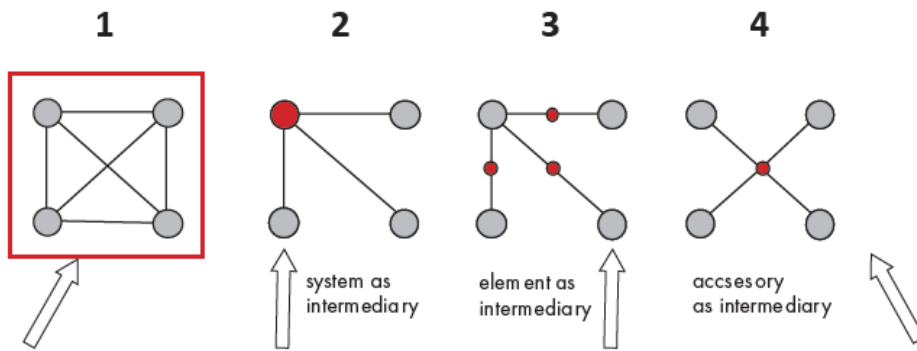

Figure 85. 4<sup>th</sup> Indicator - base element specification examples. (Durmišević 2006)

- the whole building with its exterior walls, interior walls are a base (1)
- loadbearing structure as a base element (building level) (2)
- a frame within a system as a base (system level) (3)
- intermediary connection which connects multiple elements as a base (element level) (4)



Figure 86. 5<sup>th</sup> Indicator - geometry of the product edge. (Durmišević 2006)

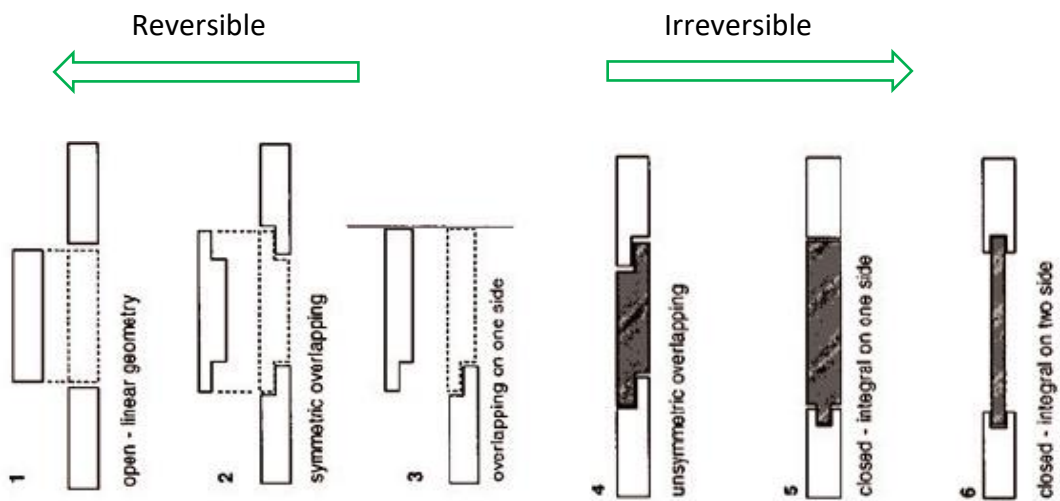

Figure 87. 5<sup>th</sup> Indicator - overview of basic geometries of product edge. (Durmišević 2006)



Figure 88. 6<sup>th</sup> Indicator - assembly sequences. (Durmišević 2006)

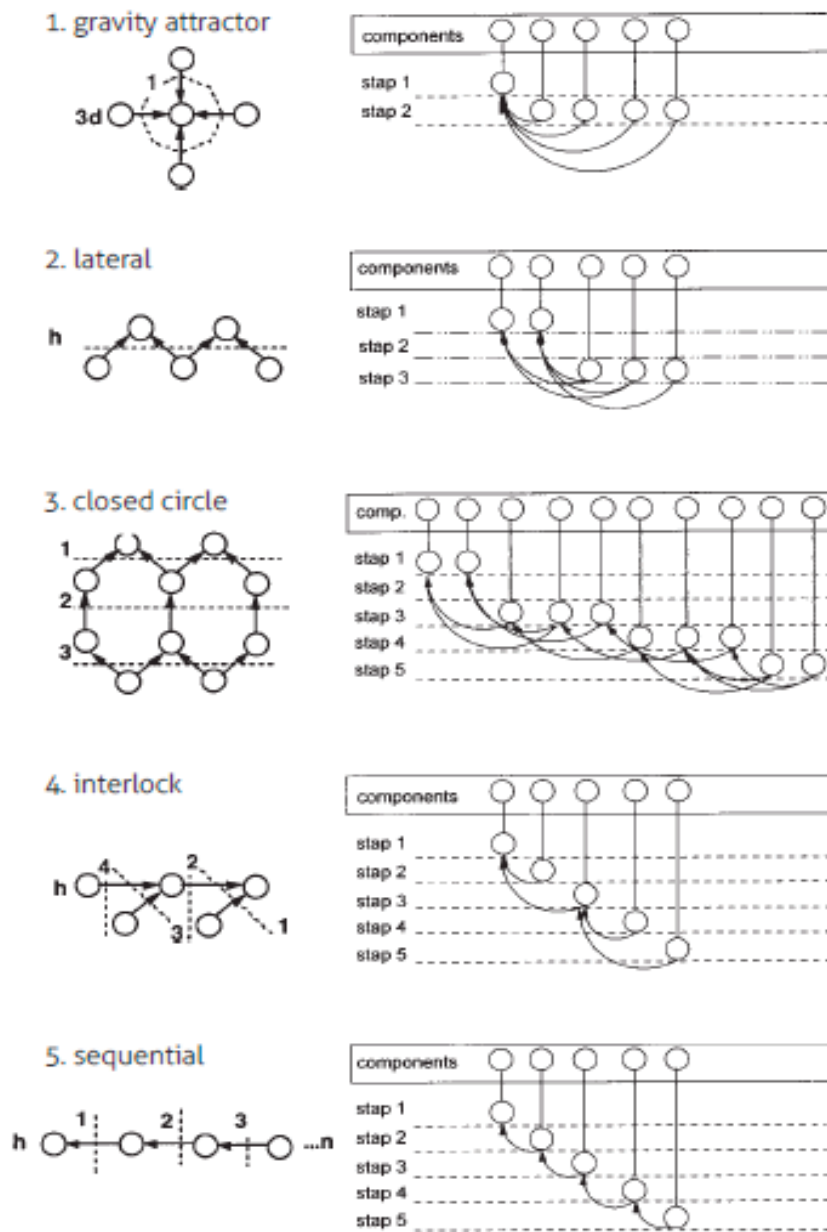

Figure 89. 6<sup>th</sup> Indicator - 5 types of assembly sequences. (Durmišević 2006)

↑ Irreversible	Adhesive material connection		<b>I Direct chemical connection</b> two elements are permanently fixed (no reuse no recycling)
	Direct with connecting devices		<b>II Indirect connection with irreversible chemical connection</b> two elements are permanently connected with third chemical substance which cannot be easily removed or disassembled
			<b>III Indirect connection with reversible chemical connection</b> two elements are connected with other chemical connections which can be removed or disassembled
↓ Reversible	Inaccessible interlock		<b>IV Direct insert connection</b> two elements are connected by insertion of fixing accessory inside elements
	Interlock		<b>V Direct connection with mechanical fixing devices</b> two elements are connected accessory which can be replaces. If one element has to be removed than ehole connection needs to be dismantled.
			<b>VI Indirect connection via dependent third component</b> two elements /components are repaired with third element, but they have dependence in assembly.
	Intermediary		<b>VII Direct connection between two pre-made components</b> two elements are connected by element geometry forming interlock connection
	Gravity		<b>VIII Indirect connection transitional / intermediary connection</b> assitional intermediary connection devise takes care that disassembly of the one element does not damage or afect other.
			<b>IX Gravity connections</b> two elements are connected only by gravity fource

Figure 90. 7<sup>th</sup> Indicator and Ranking the connection types form reversible to irreversible. (adapted Durmišević 2006, Durmišević 2018)



Figure 91. 7<sup>th</sup> Indicator- Types of connections. (Durmišević 2006)

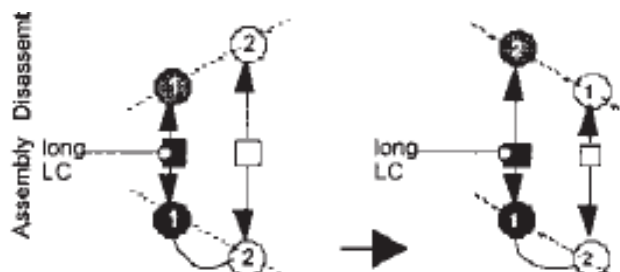

Figure 92. 8<sup>th</sup> Indicator - life cycle coordination - elements, which have a long life-cycle and greater dependencies in assembly, should be assembled first and disassembled last. (Durmišević 2006)

A reversibility profile of a building / system / component structure can be developed when analysing the mentioned eight design aspects and their sub aspects, which gives

a first indication of possible improvements of the design in order to provide higher structural reversibility. (Durmišević 2019)

Even though, the spatial reversibility is very important when it comes to changing the building function, *when measuring the building waste, the focus should be on technical reversibility*. Technical reversibility covers all stages of a building in its life-cycles and it is more frequent. Very important advantage of the technical reversibility is that it can be tested and calculated for separate building systems, not only for the whole building.

The eight reuse potential measuring indicators can be used separately, but the holistic approach is the best. The best result showing a complete image of reuse of a building and its systems is achieved if all 8 indicators are used as criteria for reuse potential evaluation. (Durmišević 2006, Durmišević 2019)

Durmišević method with its reuse potential measuring method provides guidelines and assesses capacity of a building structure to be transformed and disassembled without damaging building elements.

As it is not possible to experiment on each site, it is important to imagine methods to recover things and have them processed for future reparation or reuse. Analysis will show which tool and method should be implemented in the common practice, so it can lead to life cycle environmental savings. The eight criteria for high disassembly and consequently reuse potential from model Durmišević 2006 and Durmišević 2019 for numeric evaluation, are used for testing of the case studies in the Chapter 3 and Chapter 6 of this research. This method is definitely a start in developing the Method for measuring the waste potential of a building system.

Reversible building design protocols can help lower the environmental impact in total, and directly lower the construction waste. There is quite a close link between the reuse potential of building systems, components, elements and materials and construction waste. If reuse potential is high, then the construction waste is low and vice versa. Low construction waste leads to low environmental impact of a building or its parts in every aspect. This Durmišević 2006 method shows a numerical value that represents potential reuse of the building parts. For the purpose of this research, it is considered as a starting point in the final method that helps decision making in terms of the potential construction waste.



### 5.3. Life Cycle Assessment (LCA) Approach and Tool

“In developing countries however, the average standard of living is far lower than in developed countries and in many cases basic human needs are not being met. The emphasis here, it is argued, should therefore be on development that aims to address these basic needs while avoiding negative environmental impacts.” (Gibberd 2002)

Life Cycle Assessment (LCA) is generated considerable recent research interest when speaking about sustainability and environmental impact.

There remains a need for some LCA definitions, like this one:

“Life Cycle Assessment (LCA) is a method for assessing potential environmental impacts associated with products and services over their life cycle.” (ISO 14040 2006)

“At present, life cycle assessment LCA is the most efficient evaluation method for environmental impacts caused by materials. LCA is a tool to estimate and analyse the resource consumption, energy and environmental contamination of materials in their life cycles. Since it can process a tremendous amount of data, it is hardly necessary to carry out the data processing by hand. The full analysis has to be performed on computers, and related databases have been established. Many American and European countries have established their own evaluation systems, and have established legislation to promote the environmental conservation.” (Jincheng 2001)

“Life cycle assessment (LCA) is defined as decision making method for buildings from "cradle to grave", but according to EIB 2015 and its research the construction industry makes huge amounts of waste, the building industry has to change this way of thinking to the concept "cradle to cradle". The waste should be prevented in the design phase and the LCA should help a lot in this stage.” (Androšević et al. 2019)

Many LCA tools and software solutions have been developed and are still developing to help stakeholders' assessment. Tools play important role in the decision process when it comes to the building construction. They are following the existing laws and standards in order to give certificates to the producers, so that they can have proof that they have chosen sustainable solutions with low environmental impact.

Development of the tool should address to different needs of different stakeholders, the same as BIM modelling. Specific users require specific data adapted for their adoption.

LCA methodology and idea has its roots in the middle of XX century. According to the history review of the LCA by Guinee et al. 2011 and Buyle 2013, the first studies on environmental impacts date to the 1960s and 1970s, focusing on the evaluation or comparison of consumer goods, with only a small contribution to the use phase. In the

beginning of the 1980s, life cycle thinking appears in the construction sector with a study of Bekker 1982, with focus on the use of (renewable) resources. These early researches applied diverging methods, approaches, terminologies and results. Buyle 2013 explained the LCA approach path from the beginning, through period of standardization (1990s) until the 21<sup>st</sup> century, when life cycle thinking got the importance in predicting the environmental impact and LCA tools are got approved as guides and the important tool for designers in decision making process to choose eco-friendly products and materials.

Islam et al. 2014 and Fava 2006 claim that the LCA has been used in the building sector since 1990.

Finnveden et al. 2005 paper gives an overview of the current situation of Life cycle assessment (LCA) in the construction industry, both of regulatory developments and academic case studies until year 2005...But he concluded that besides energy consumption, other aspects also affect the sustainability of buildings. New tools' concept covers ecological, economic and social aspects."

"LCA is merely a model and simplification of reality, so assumptions have to be made that can generate uncertainties on different levels: model, scenario and parameter uncertainties." (Buyle et al. 2012)

Buyle et al. 2013 mention that LCA is still a powerful and science-based tool to evaluate the environmental impacts, despite some limitation of the LCA technique. They underline the application of LCA mainly "on controlling energy consumption", but "new fields of action emerge like for example controlling and reducing water consumption and paying more attention to smart design". They also suggested the "internalization, so the environmental effects would be reflected in market prices." (Buyle et al. 2013)

"The approaches to calculate environmental impacts can be subdivided into two types, attributional and consequential LCA. Attributional LCA is defined by its focus on describing the environmentally relevant flows within the chosen temporal window, while consequential LCA aims to describe how environmentally relevant flows will change in response to possible decisions." (Buyle et al. 2013 quoted Curran et al. 2005, Finnveden et al. 2009)

Many researchers saw LCA like useful tool for the whole construction process and tested it in their researches. It is a step forward in the construction industry to follow up all phases in the project, not just the final stage for achieving the certificate.

"With the increasing concern of the building environmental impacts, governmental regulation and people own consciousness have shown rising interest in buildings protocols and methods for sustainability certification. Life cycle assessment (LCA) represents a useful tool for designers, companies and building owners in every phase of the construction process." (Sonetti & Lombardi 2020)

A wide range of environmental classification and building rating systems (according to environmental impact of building materials) based on life cycle assessment (LCA) have been developed in many countries. Some of them are Environmental Impact Assessment (EIA), System of Economic and Environmental Accounting (SEEA), Environmental Auditing, Material Flow Analysis (MFA), etc. For construction industry, there are some methods that are developed and calculate the building impact providing certificate, like Green Star, BREEAM and LEED.

“There are also some more localized systems such as CASBEE in Japan, Green Mark in Singapore, DGNB in Germany and the Estidama Pearl rating system in the United Arab Emirates.” (Du Plessis 2016)

According to Jincheng & Tianmin 1997, LCA has three functions:

- a service for consumers,
- product comparisons and
- green label and product stratagem.

There should be LCA data for three different groups of stakeholders:

- For the designer and engineer, the LCA model can give an opportunity to plan, design and see the environmental impact of all building materials, elements, components and systems and have a possibility to compare different options. LCA tool should help the designer to make the decision and choose the best possible combination of parts for the future building.
- For the constructors, the planned materials, their position and quantities are important. These data are provided by BIM software, but LCA can compare the environmental impact of different alternatives and provide certificates for building according to the calculation.
- For the investor, the total environmental impact will be interesting as an information, but estimated price of the project is his bigger concern. LCA provides certificates to rank between the options. These certificates can be a ticket for some governmental grant or tax relief, and be helpful for the investor to make the final choice and decision.

Many research in recent years has been focused on finding out why this well-developed LCA system is not so much in use.

“Today, even in developed countries, performing life-cycle assessment (LCA) is still a challenging and complex process, mixed with the possibility of significant errors—namely due to unreliable input data derived from unrepresentative sampling... Even performing the most common types of LCA (E-LCA) is still difficult, time-consuming and sometimes results in unreliable estimates; because the LCA requires precise, up-to-date complex input information that varies from time-to-time, place-to-place, and case-to-case.” (Shahabian et al. 2020)

Ruschi Mendes Saade et al. 2020 recommend LCA:

- “in order to measure the interaction of the building stock with the environment,
- to identify the load balance between all stages of a building's service period,
- to provide an overview of the environmental performance of the studied object (considering all flows exchanged between the analysed product/system and the environment),
- to help support circularity between different product systems,
- because the LCA method has evolved in past years and increasingly incorporates approaches allowing for more realistic outcomes, such as following a dynamic or consequential modelling approach, or considering complex carbon cycle modelling,
- because consequential LCA aims to measure the environmental consequences of changes.”

Ruschi Mendes Saade et al. 2020 found out that LCA “has been widely applied to the construction sector, and increasingly used as a decision making support throughout all levels of the built environment: material [Knoeri et al. 2013, Zabalza Bribian et al. 2011], systems [Guggemos & Horvath 2005], whole buildings [Blengini & Carlo 2010, Veerbeek & Hens 2010] and neighbourhoods.”

Ekvall & Weidema 2004 notice that LCA can show how environmentally relevant input and output flows of a given product system change in response to possible changes in the life cycle.

“One could conclude that the complex systems that a building is composed of are peculiar enough to deny qualitative assumptions.” (Ruschi Mendes Saade et al. 2020)

“LCAs provide a holistic approach of product environmental impacts, since the methodology accounts for the whole LC of the product or service. It is interesting to obtain such an overall view of the life cycle to identify the major sources of environmental impact. Furthermore, the implementation of LCA can support designers, engineers, and decision makers in their work, by providing an analytical environmental evaluation. LCA is capable of analysing products and processes based on their function instead of on their specific physical characteristics. Consequently, products that are inherently different, can still be compared when they fulfil a similar function.” (Dossche et al. 2017)

LCA tools are developed in accordance with the ISO standards and regulations. According to ISO 14040, 2006:

- LCA considers the entire life cycle of product, from raw material extraction and acquisition, through energy and material production and manufacturing, to use and end of life treatment and final disposal.

- A potential environmental burden between life cycle stages or individual processes can be identified and possibly avoided.
- LCA addresses the potential environmental impacts of a product and service
- The depth of detail and time frame of an LCA may vary to a large extent, depending on the goal and scope definition
- There is no single method for conducting the LCA. Organizations have the flexibility to implement the LCA in accordance with the intended application and the requirements of the organization
- The LCA may use information gathered by other techniques (i.e. environmental impact analysis, risk assessment etc.) even though they are different technically

Literature research find out some limitations of the LCA:

- The LCA focuses on environmental dimension and does not analyze economic and social dimensions (Werner 2005; ISO 14040, 2006).
- The LCA is used as a tool within the decision support process and does not in itself encompass the whole decision-making procedure (Werner 2005)
- The LCA compresses the time dimension in the modelling phase as well as in the impact assessment phase and does not discount the future (Werner 2005)
- Weighing in the LCA varies from one place to another and this makes the LCA results to differ from one place to another
- The LCA phases, provide system-wide perspective of environmental and resources issues for one or more product system (ISO 14040, 2006).

Even though the LCA can have holistic approach, “usually these methods are characterized by evaluating a series of partial and aggregate features of construction, resulting in environmental ratings or sustainability scores. (Assefa et al. 2010).” (Castanheira & Braganca 2014)

Luckily, in the XXI century the construction industry has become more interested in these LCA methodology and saw some benefits in predicting the future environmental impact in many areas. LCA methodology can be connected and supplementary to the BIM tool. “However, BIM and LCA tools are currently not fully interoperable.” (Jalaei et al. 2019) They suggests the integrated model that will solve the gap between these tools. (Figure 93)

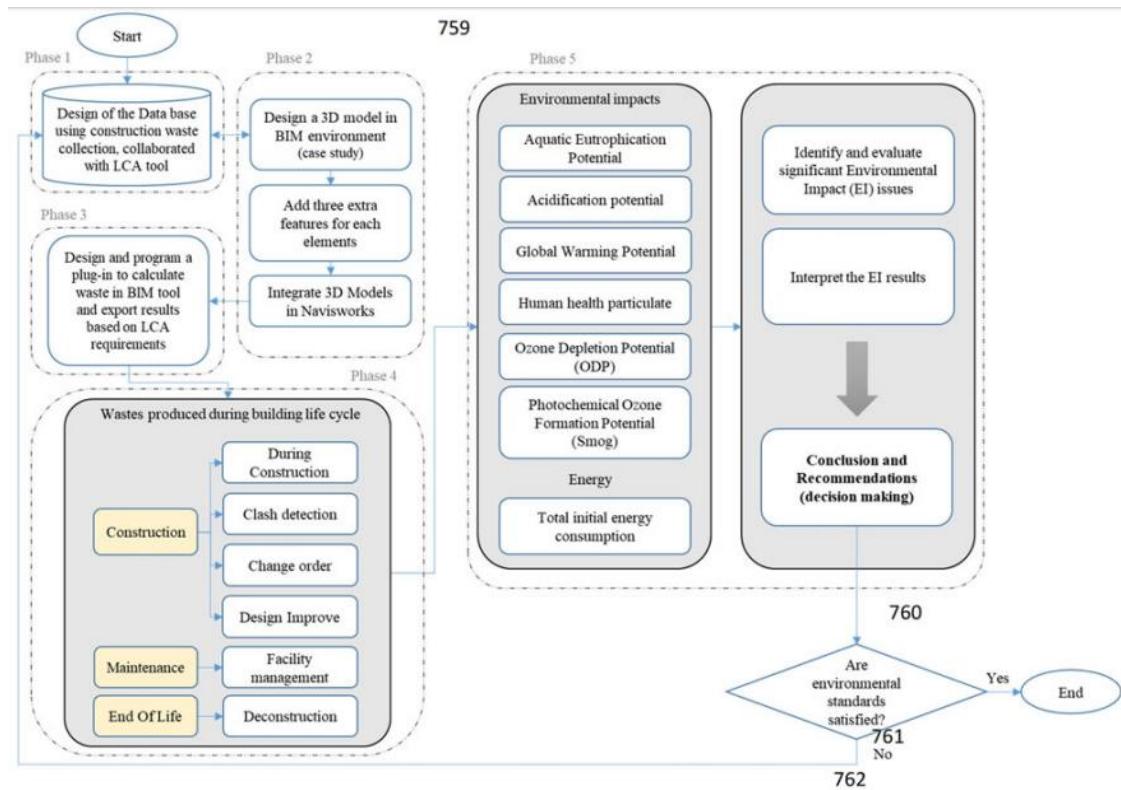

Figure 93. Different phases of the proposed integrated model. (Jalaei et al. 2019)

Josselme et al. 2020 provides a description of the current practice and context of use of Life-Cycle Performance Assessment, trying to increase usability of LCPA. They tried User-Centred Design approach following the ISO 9241 norm.

“The research findings highlight a decorrelation between:

- the high practitioner’s willingness to consider environmental constraints in their practice, and
- the low current use of the *LCPA* software.

This situation brings up socio-technological issues that should be addressed at the same time. From a sociological point of view, a first barrier is the absence of client’s incentives, a paradoxical situation in a European society where climate change is nowadays a daily discussion for everyone. A second sociological obstacle are the specificities between architects and engineers’ culture, language, and even work methodology whose discrepancies bear the risk of decreasing the integrated design efficiency.

From a technological point of view, the cost of use of the *LCPA* methods is the major issue. This creates the necessity to develop new techniques decreasing the input collection efforts while at the same time increasing the design support abilities in the specific context of early design stages, where projects have a very low detail level. To that end, new approaches should be investigated, such as exploration methods that, unlike assessment methods, are leveraged by design uncertainties.” Josselme et al. 2020

The benefits in using the LCA from the very beginning are evident for all stakeholders. In order to calculate environmental impact using the Life Cycle Analysis (LCA) method and tool, a fully defined building system is inevitable. This approach would be more helpful in proposing the options, so the decision making process can be easier.

The LCA can be used to see the value for the whole building through its life-cycles. There should be the comparison between possible systems and their impact, in order to decide which system is the best to choose. For example, the value of the existing building's envelope depends on many variables and the LCA can be used to define which existing protective layer is the best among the analysed ones. The LCA should be upgraded when it comes to the prediction for the future impact for the transformable building envelopes that will be constantly changing. LCA should be upgraded with the part where it comes to different possible scenarios for the building in the first and upcoming life-cycles of the building and its parts.

If the building project want to take the advantage of LCA, the analyses should be the common practice while designing the building, in the early phase, as later data are not useful if the choice was already made. In attempt to facilitate the use of LCA, the availability and affordability of the LCA methodology and software should be considered.

***Choose “the right tool for the right job!”***



## 6. TOOLS TO APPLY THE THEORY

### Summary (English)

This chapter of the research will present the analysis of the same case studies using different methods. At the beginning, reuse potential indicators (Durmišević 2006) will be applied to the case studies and then the LCA methods and its parameters to compare the results.

Analysis will show which tool and method should be implemented in the common practice, so that it can lead to the life cycle environmental savings and construction waste elimination.

The results after application of the reuse potential method Durmišević 2006 demonstrate whether the system and its parts are reusable or not and what is the level of reusability. If the reusability indicator is bigger, the quantity of waste is lower and vice versa, but the exact quantities of the waste and environmental impact is not presented in the final score value.

After application of the LCA principles and testing of the tools, the results showing the environmental impact are based only on quantities of materials used, but do not show if these materials can be separated and if it is possible to make most of their potential in the next transformation (even replacement during maintenance) or in the next life-cycle

## 6. OUTILS POUR METTRE EN PLACE UNE THEORIE

### (Récapitulatif Français)

Ce chapitre de recherche va présenter l'analyse des études de cas mentionnées en utilisant des méthodes différentes. Au début, aux études de cas vont être appliqués les indicateurs de la réutilisation (Durmišević 2006), et puis les méthodes de l'analyse du cycle de vie (ACV) ainsi que les paramètres pour la comparaison des résultats.

L'analyse va démontrer quel outil et quelle méthode doivent être mis en œuvre dans la pratique habituelle, pour finir par réduire l'impact négatif sur l'environnement dans chaque étape du cycle de vie et par éliminer des déchets de construction à la fin du cycle de vie.

Les résultats obtenus après la mise en œuvre de la méthode de la réutilisation potentielle (Durmišević 2006), démontrent si le système et ses parties peuvent être réutilisés ou non, ainsi que le niveau de la réutilisation. Si l'indicateur de la réutilisation est plus grand, la quantité des déchets est plus petite et vice versa, mais les quantités précises des déchets et l'impact sur l'environnement ne sont pas présentés dans le résultat final.

Après la mise en place du principe d'ACV et le contrôle des outils, les résultats démontrant l'impact sur l'environnement ne sont fondés que sur les quantités des matériaux utilisés, mais ne démontrent pas si ces matériaux peuvent être séparés et s'il est possible de se servir de leur potentiel lors de la transformation suivante (même remplacer lors de la maintenance) ou dans le cycle de vie suivant.

## 6. TOOLS TO APPLY THE THEORY

Before any early premise or conclusion can be made, it is necessary to do further testing of the existing methodologies in this field, so that the synthetic method /or methods/ for lowering the construction waste can be found. The methods depend of the systems analysed, to generate the best result. The methods and tools mentioned in the Chapter 5 of this research will be tested on some case studies in order to predict and lower construction waste and the upgrade will be suggested.

The BIM modelling with the database can be useful for project digitalization. But, material choice and quantities can be calculated by hand with the same accuracy. Material relations and connections can be defined better by hand, as the software does not require material connection data. Usually, material database used for the BIM model is not compatible with the LCA software, and thus the modelling is not an option for this research. It will be valuable in later database and software development, when the same material database can be used in all steps and in all required software.

For now, it is clear that the Reversible building design protocols have to be followed and that measuring the reuse potential of every case study should be done. There is quite a close link between the reuse potential of building systems, components, elements and materials and construction waste. It should also be going toward the method to evaluate the future project reuse potential, as the construction waste depends on the reuse potential of the building parts. But the main parameters should be defined in the process. It is also important to include the methodology of the Life Cycle Analyses in the prediction and calculation of the construction waste and its environmental impact. Thus, the LCA methodology will be applied to the mentioned case studies to see its potential to predict construction waste. The method should predict the environmental impact in each phase of the building life and in every building life-cycle.

This chapter of the research will present the analysis of the same case studies using different methods. At the beginning, reuse potential indicators (Durmišević 2006) will be applied to the case studies and then the LCA methods and its parameters to compare the results. The research will provide a conclusion which approach gives the best data and has the best final oversight of the data provided to the stakeholder, who should be able to have a clear picture of the chosen future scenario for the building and its consequences for the environment in the different time frame. Analysis will show which tool and method should be implemented in the common practice, so that it can lead to the life cycle environmental savings and construction waste elimination.

## 6.1. EXISTING METHODS AND APPLICATION

This research was focused on identifying the existing methods that can be useful in decision making when choosing the right building technology to achieve lower environmental impact. Next existing methods and tools demonstrated very good potential in this field (according to the previous researches) and will be tested on the chosen case studies:

- Durmišević 2006 reuse potential method, (method explained in the Chapter 5.2).
- LCA methodology (OneClick LCA and Open LCA tools). (method explained in the Chapter 5.2).

Durmišević reuse potential measuring method provide guidelines and assesses the capacity of a building structure to be transformed and disassembled without damaging building elements. (Durmišević 2006) To apply the method, the following information from the chosen case study should be provided:

- materials,
- techniques / building technology used.

Unfortunately, for the purpose of this research, it is not possible to do an experiment on each site. Thus, it is important to imagine methods to recover things and have them processed for future reparation or reuse.

It is possible to conclude that if the reuse potential is high, then the construction waste is low and vice versa. Low construction waste leads to low environmental impact of a building or its parts. For numeric evaluation, the reuse potential from model Durmišević 2006 will be applied to the chosen case studies.

Another method, Life Cycle Assessment, will be tested in two existing LCA software, which are commercially available and have the impact category "waste". These are OneClick LCA and Open LCA. The tool OneClick LCA has a trial version which is free and available for 14 days to test on some case studies. It uses the EPD (Environmental Product Description) database. The tool Open LCA is available for free and uses database Ecoinvent.

### 6.1.1. Reuse Potential (Method Durmišević) Application

In accordance to the previously conducted research, some reuse potential measuring indicators can be used separately, but performed testing of the criteria to analyse the reuse potential and evaluation of the existing and future projects (in this case just external walls of the building), pointed out that used criteria with 8 technical reversibility /reuse potential/ measuring and evaluating indicators Durmišević 2006 (explained in the Chapter 5.2 of this research) gave the expected result. These indicators are:

1. functional decomposition,
2. systematization and clustering,
3. hierarchical relations between elements,
4. base element specification,
5. interface geometry,
6. assembly sequences,
7. type of the connections,
8. life cycle co-ordination in assembly/disassembly.

Durmišević 2006 method is used as a base for development of a tool for reuse potential measuring. (developing in Netherlands). (Durmišević 2019)

The author of this thesis has been involved in the project Building as Material Banks (EU Horizon 2020 Project BAMB) from 2015 to 2019 year. Within that project, analyses of the reversibility of an old and a new building structures were conducted. These analyses should help stakeholders to choose the right model of the new building structure, but most important role was to implement them into the pilot project Green Design Center (GDC) in Mostar. The transformable envelope, roof and façade were in focus of the research. As the most exposed part of the building, the external wall was the one of the many systems specially designed and examined in terms of energy efficiency, transformability and reusability. The façade is the chosen system as a case study to test the quantity of the construction waste after transformations. The other systems can be designed in accordance with these results. Inevitably, “decreasing the waste from any part of the building will help reducing total waste during the building life-span.” (Androšević, Durmišević & Brocato 2019)

The requirements of the façade system were established at the beginning of the BAMB GDC project:

“Façade should follow transformations of the building without waste creation or without causing large financial or environmental impacts... This strategy aims to extend

functional life-span of external envelope of buildings and its components and materials, which would reduce the amount of consumed resources and generated waste during the life-span of the façade.” (Androšević, Durmišević & Brocato 2019)

In order to figure out the transformation possibilities, inspect data provided and envisioned, the analyses were performed using mentioned indicators and following the method Durmišević 2006.

In accordance to the Durmišević 2006 method, the reuse potential of the conventional (existing) façade system made of wood, developed for a passive house system, (Chapter 4, Figure 52) was compared to the prototype of the Green Design Centre (GDC) external wall system, addressing the issue of a reversible façade design. (Chapter 4, Figure 58).

Representative example of the existing façade system made of wood, for low-energy house in Bosnia and Herzegovina is the Krivaja’s external wall with 11 layers (Chapter 4, Figure 52):

1. Three-layer reinforced façade 6mm
2. Styrofoam 200 mm
3. OSB board 12 mm
4. Solid wood frame 160 mm
5. Rock wool 160 mm
6. PE foil
7. OSB board 12 mm
8. Insulation-installation wooden grill 45 mm
9. Rock wool 45 mm
10. OSB board 12 mm
11. Gypsum cardboard board 12,5 mm

Most of recently developed façade products, which are available on the market for low energy or passive housing are similar to this external wall example and use a lot of chemical connections when manufacturing fixed elements. The system is made for quick building assembly using the compact panels on site, but there is no possibility to disassemble panels themselves, on site or in production / factory /.

On the other hand, there are some ideas to develop modular transformable façade made of wood which will satisfy the needs of users and could be adapted for some other scenarios, if needed. The author of this thesis was involved in the whole process of creating the new wall system prototype, which has high reuse potential and transformability, besides energy efficiency. (Chapter 4 in this research)

“The reversible façade has been designed using design protocol for designing of low waste façade system for the future circular construction industry developed by

Durmišević 2017 as part of EU BAMB project... The goal was to include all parts of the enclosure system in circular low waste building industry and circular economy. In the case when the energy efficiency standards and requirements change, it will be necessary to have final layer of the wall which can be easily disassembled and removed without affecting surrounding elements, to allow the additional layers to be attached to the wall system and make it easy to assemble and put together again. This strategy aims to extend functional lifespan of the building external envelope and its components and materials, which would reduce the amount of consumed resources and generated waste during the construction, maintenance and demolition. The necessity for transformation possibilities of the façade is often shown, where elements and components of the façade system become objects of leasing and have the possibility to increase their value during their lifetime. (Good example is a pilot project at TU Delft developing a circular business model of leasing façade) ...” (Androšević, Durmišević & Brocato 2019)

“The study compared conventional façade system with reversible façade system and identified three transformation scenarios’ in order to be able to measure waste creation/saving from building façade upon transformations (when applying conventional and reversible façade system) Durmišević 2006. Different levels can be examined (element, component, system and building level). Each indicator for each level can be computed according to the tables by Durmišević 2006.” (Androšević, Durmišević & Brocato 2019) By doing the calculation of the construction waste during the transformation, it was possible to compare the selected systems mentioned above (traditional wooden wall (Chapter 4, Figure 52) and the GDC wall (Chapter 4, Figure 58)

GDC wall - quantities of materials to make one m<sup>2</sup> of the façade wall:

- Wood  $0,14 \text{ m}^3 \times 460\text{kg/m}^3 = 64,40\text{kg}$
- Sheep wool  $0,3 \text{ m}^3 \times 28,40\text{kg/m}^3 = 8,58\text{kg}$

Total material per one m<sup>2</sup> of façade = 73,00 kg

All these materials can be used and reused in other scenarios and in later transformations. This GDC wall system is designed for having a really high reuse potential.

“For the calculation of waste and material use, this assumption is based on the fact that during any construction and transformation process there is a risk that potential damage can occur due to a human failure or accident and a part needs to be repaired or replaced... In order to assess the waste during transformation processes, couple of transformation scenarios have been considered.” (Brussels Environment et al. 2018)

“Material stream analyses indicate that the system can perform transformations without creating waste in comparison with the existing passive façade system on the

market. This strategy aims to extend functional lifespan of external envelope of buildings and its components and materials, which would reduce the amount of consumed resources and generated waste during the lifespan of the façade.” (Androšević, Durmišević & Brocato 2019)

Several scenarios for transformations have been suggested to compare these two case studies of the wooden wall (GDC and traditional wall). Both walls have wall panels with dimension 160cm x 330cm and window dimension 75cm x 160cm. Assumption that the transformation will take place every 10 years, in the period of 50 years, was made. The amount of material used and associated waste has been calculated for traditional and the GDC reversible modular system.

For the transformation scenario, it has been considered that the existing window will not be necessary any more at the existing position and that the window will be replaced with the wall panel. The window itself will be placed again in the same building (new opening in different position in the building façade is needed, and the window can be relocated to this position). (Figure 94, Figure 95)



Figure 94. First position of the window (left) and second position of the window (right)





Figure 95. First position of the window (left), second position of the window (middle) and wall without the window (right)

In the first case study the façade is modular and the wall panel can be replaced with the mentioned window without any waste associated with the transformation process. The conclusion is that it will be possible to transform the façade and change the position of the windows and wall panels without any waste. The only cost will be the work of dismantling and assembling modular parts. The possibilities are various.

In the second case study - the traditional wooden wall, material streams are different. Cutting the window out is possible by cutting the foam which is fixing the window in its position. Furthermore, inserting the new opening in the wall is very demanding. Wooden wall can be cut through to insert the opening, but surrounding materials are damaged. At the same time, the part that has been cut will become waste and cannot be used as it is. In the best-case scenario, it can be recycled or down-cycled (due to use of chemical connections).

The waste quantities for the traditional wooden wall per m<sup>2</sup> façade:

- 3-layer reinforced façade  $0,006 \text{ m}^3 \times 29\text{kg}/\text{m}^3 = 0,17 \text{ kg}$
- Styrofoam  $0,2 \text{ m}^3 \times 50 \text{ kg}/\text{m}^3 = 10,00 \text{ kg}$
- PE foil  $1 \text{ m}^2$
- Rock wool  $0,205 \text{ m}^3 \times 45 \text{ kg}/\text{m}^3 = 9,22 \text{ kg}$
- OSB board  $0,036 \text{ m}^3 \times 450 \text{ kg}/\text{m}^3 = 16,20 \text{ kg}$
- Wood  $0,1 \text{ m}^3 \times 460 \text{ kg}/\text{m}^3 = 46,00 \text{ kg}$
- $1\text{m}^2$  of Gypsum cardboard board 12,2mm -  $1\text{m} \times 9,5\text{kg}/\text{m}^2 = 9,50 \text{ kg}$

Total material per one m<sup>2</sup> façade = 91,09 kg

Considering the way materials are put together in this wall, all materials calculated can be considered as construction and demolition waste. The same quantities are required for the 1m<sup>2</sup> to fill the hole of the window that is taken out.

The table and diagram in Figure 96 give an overview of materials used and waste generation during the transformations of the façade in the period of 50 years. The comparison is made for the performance of the conventional façade and the reversible GDC façade. It is evident that during the time and after each transformation, traditional wall requires additional investment similar to the initial one.

	kg 10	20	30	40	50	material use after after 5 years
GDC wall	73	80,3	87,6	94,9	102,2	103,3
traditional wall	91	182	273	364	455	455

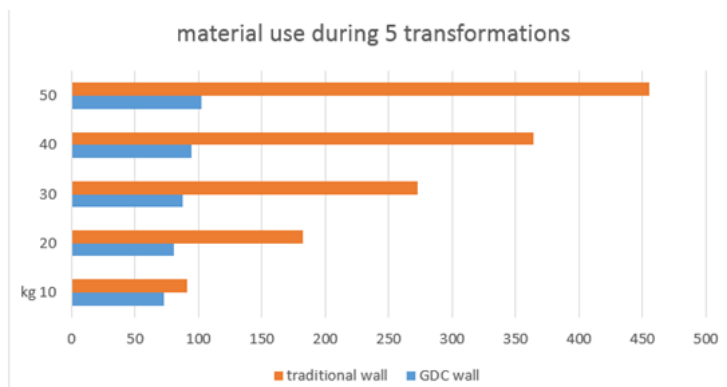

Figure 96. Diagram illustrating material use during 4 transformations of the façade according to above defined scenarios. (Brussels Environment et al. 2018)

The table and diagram in Figure 97 give an overview of construction and transformation costs of traditional and reversible GDC façade system per m<sup>2</sup>.

costs	year 10	20	30	40	50
GDC wall	700	910	1120	1330	1540
traditional	500	1010	1520	2030	2540

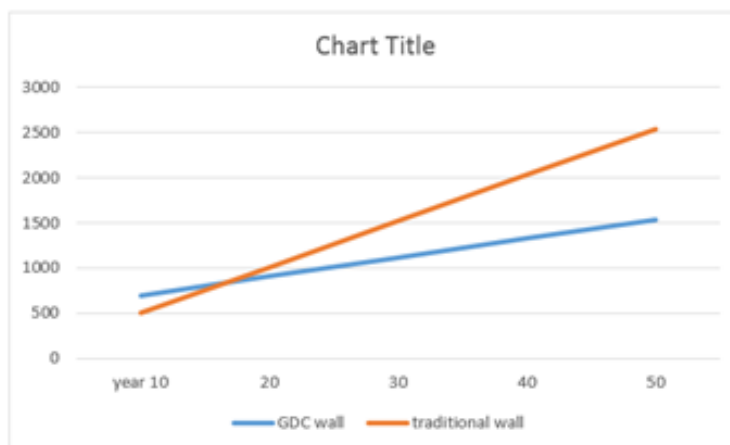

Figure 97. An overview of the construction and transformation costs of traditional and reversible GDC façade system per m<sup>2</sup>. (Brussels Environment et al. 2018)

“In the first case study the façade is modular and the wall panel can be replaced with the mentioned window without any waste associated with the transformation process. The conclusion is that it will be possible to transform the façade and change the position of the windows and wall panels without any waste. The only cost will be the work of dismantling and assembling modular parts... In this case, the enclosure system has been designed for reversibility illustrating circular building design, which enables circularity and reusability of system and its components, elements and materials during different transformation stages of the building façade.” (Androšević, Durmišević & Brocato 2019)

“One of the main objectives of the design and assembly of the prototype was to design connections between the elements in a way that parts of the structure which have longer use life-span (in this case the frame of the system) are not damaged or impacted by transformations. Second objective was to develop a system which will have capacity to transform its performance form delivering a closed insulated façade module to totally transparent or translucent modules or replacement of one of the insulation boxes by installation modules. Next to that the freedom of replacing the finishing of the system from wooden or aluminum façade, to green façade has to be possible. For above mentioned reasons, number of options have been studied with regards to intermediary between the frame and removable component and elements. Further to that, it has been studied how different functions that façade has, can be answered by independent parts of the façade system in order to allow for functional transformation of façade without demolishing parts. Third important objective of the prototype design was to design components and elements in a way that will not restrict their potential use in another context than this façade system. For that reason, the focus was on standardization and more universal geometry that will increase reuse potential of constituent parts of the system.” (Brussels Environment et al. 2018)

All these materials built in the GDC can be used and reused in other scenarios and in later transformations. This GDC wall system is designed to have a really high reuse potential in next 50 years, as demonstrated in Figure 96 and Figure 97.

“Then the method Durmišević 2006 for measuring reuse potential was applied to both case studies, to see the results. In this case, seven of eight indicators are used for measuring the reuse potential of reversible design for traditional wall and GDC wall in Mostar. The life cycle coordination indicator is not considered because there are no valid or reliable data of the technical life cycle of elements and materials used... During the design and development of prototype the design principles for reversible buildings have been used and reversibility of the GDC system and traditional systems have been evaluated in order to be able to compare the reversibility factor of the facade system with environmental impact. In this case with material use and waste reduction. This study has been valuable for the WP3 of the BAMB project (EU HORIZON 2020) and published in the paper...

According to the method, each of the reuse potential indicators are presented as a number  $R_p$  ranking [0,1]. From 0.1 - low reuse to 1.0 - high reuse. The results are divided into three categories:

- if  $R_p < 0.3$ , then this system will be characterized as irreversible and the end-of-life options of the materials and elements within the system are recycling/down cycling;
- if  $0.3 > R_p < 0.6$ , then its end-of-life options would be repair, direct reuse and remanufacturing;
- If  $R_p > 0.6$ , then besides direct reuse and repair of its parts, the system can be reconfigured and upgraded, and its dimensions adjusted to fit new requirement." (Durmišević 2018 presentation at "One Planet Event" in Brussel)

Following the methodology Durmišević 2006, carefully selected case study walls (conventional wooden and GDC wall) were compared in terms of reuse potential.

Scheme presented in Figure 98 illustrate the material composition (shown in the wall section) and evaluation of reversibility (shown at the diagram) of conventional low energy façade system. Each indicator is calculated separately. Looking at the diagram (Figure 98), it is visible that the existing façade system made of wood has low reuse potential, as most indicators have low score.

The reasons of the choices of the values of the indicators are the following:

1. The system is designed for quick assembly of compact panels on site, but does not allow assembly or separation /disassembly/ of its parts (score 0,1);
2. The functional dependence of this system is acceptable, as it is designed for planned interpretation for different solutions (score 0.8);
3. The structure and material level is really low, as the system consists of materials and elements which cannot be easily separated (score 0,2);
4. There is no base element in the system (score 0,1);
5. The relational pattern is vertical, which is good (score 1);
6. The geometry is half standardized (score 0,5);
7. The connections have a very bad score due to the use of many connection points (screws and nails) and chemical connections (adhesives) (score 0,2)." (Androšević, Durmišević & Brocato 2019)

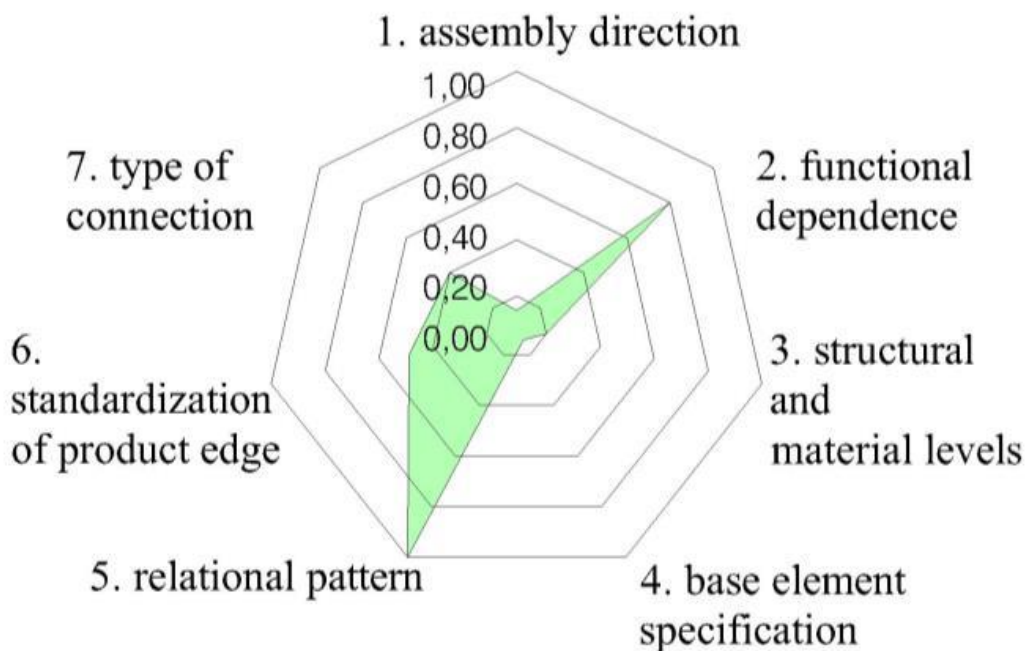
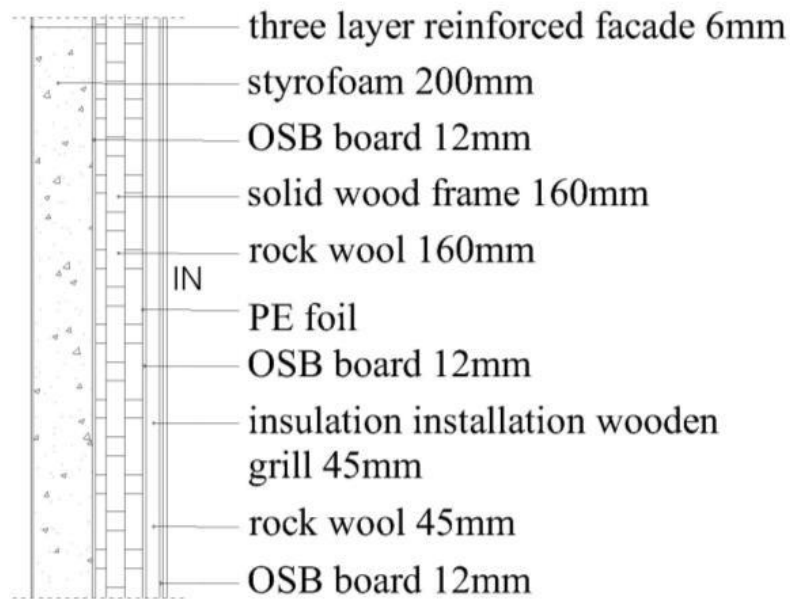

Figure 98. Reuse potential of the 11 layers wall. The section (up) and the overview of the main criteria of reversibility and the final score of the reuse potential of the 11 layers wall - existing façade system in wood (down) using method Durmišević. (Androšević, Durmišević & Brocato 2019)

“Looking at the diagram (Figure 99) it is visible that the GDC wall façade system in wood has high reuse potential, according to the high score of most indicators. The choices of the values of the indicators are the following:

1. The system is designed for easy disassembly of all its parts on all levels (components, elements and materials if necessary) (score 1);

2. The functional dependence of this system can be fully planned and enables modular zoning (score 1);
3. The structural and material level is high, as the system consists of elements and components (score 0,8);
4. There are the base element and the intermediary in the system (score 1);
5. The relational pattern is vertical, which is good (score 1);
6. The geometry is standardized and pre-made (score 1);
7. The average score for connection indicator is good, but some direct connections with additional fixing device have to be improved (score 0.87).” (Androšević, Durmišević & Brocato 2019)

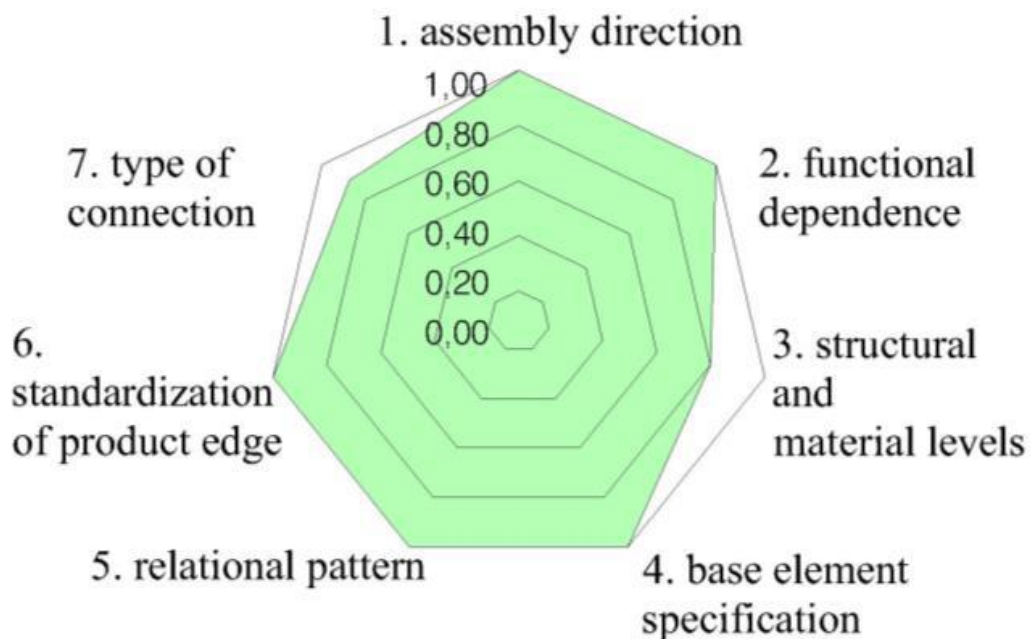
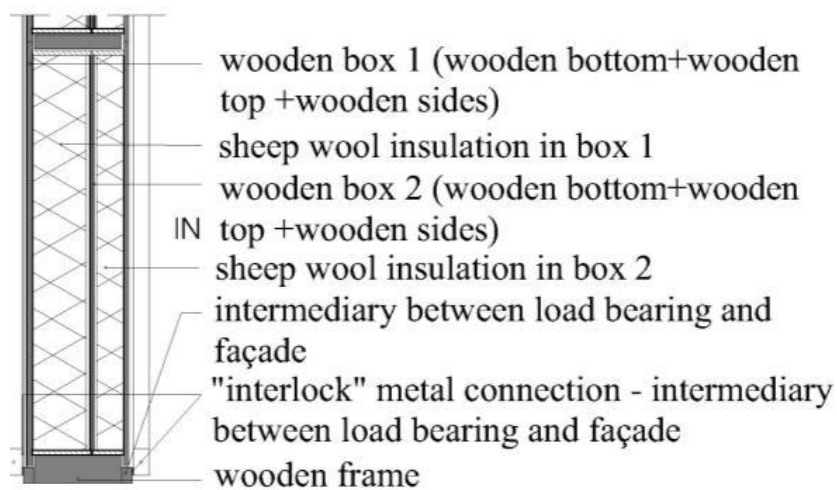

Figure 99. The section (left) and the overview of main criteria of reversibility and final score of the reuse potential of a GDC wall -developed façade system (right) using method Durmišević. (Androšević, Durmišević & Brocato 2019)

“Spider diagram gives an overview of the main criteria of reversibility which are directly linked to building design and its impact on reuse potential of elements and components within the system or building. These design criteria have direct relation to environmental and economic costs of the system.” (Brussels Environment et al. 2018)

More details about reuse potential analyses for the traditional 11 layers’ wooden wall and external wall of Green Design Centre are in Appendix Figures 48a to 58b.

Application of the method for evaluation of system reversibility per indicator (Figure 100 left) and total score per each case study (Figure 100 right) prove that the GDC wall has reversibility potential three times more than a traditional wall.

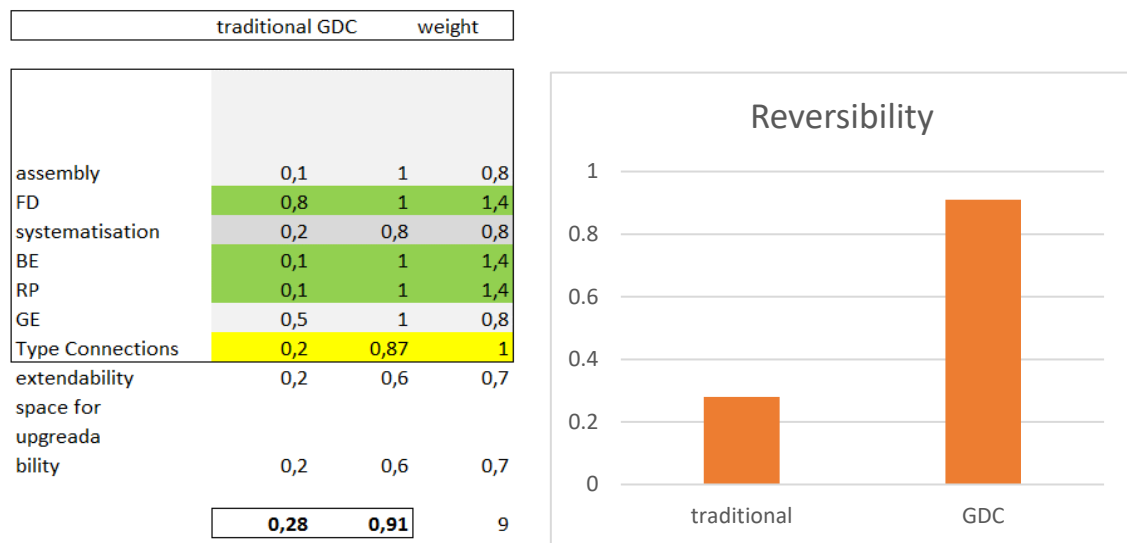

Figure 100. Evaluation of systems reversibility per indicator (left) and total score per type of system (right). (Brussels Environment et al. 2018)

In the article (Androšević, Durmišević & Brocato 2019) already published there is a good conclusion about the examined case studies and used methodology:

Some discussions and conclusions considering the two case study walls and their impact during time, were published already:

“As the results show (Figure 98), the first case study, existing wooden façade (Chapter 4, Figure 52) has low reuse potential, which means that it does not allow separation of components, elements and materials (to be reused or changed) or transformation of façade without waste creation.

The second case study (Chapter 4, Figure 58) the GDC façade prototype, is based on the observation that requirements for the use of buildings and façades of the building are changing very often. If the function of the building changes, the requirement for more or less: light, privacy, natural ventilation etc. will change as well. Furthermore, aesthetic requirement for the façade is also changing in relation to its use. The prototype of the

GDC reversible façade is designed to have high reuse potential (Figure 99) but can be improved. Indicator for the structure and material level can be high if the elements are clustered into prefabricated independent components.

The importance of the type of the connections in each façade system is noticeable. One of the main aims of the GDC façade design was to design connections between the elements, so that parts of the structure which have longer life span (in this case the frame of the system) are not damaged or impacted by transformations, but the upgrade can be done in order to achieve a maximum score.

Also, the components and elements have to be designed in a way that will not restrict their potential use in a context that is different than this façade system. For that reason, number of options have been studied regarding the intermediary between the frame and removable component and elements. After the survey of possibilities, it was found that the steel profile (the most appropriate solution) was not available in the area, and the team decided to look for a solution among wooden intermediaries. In this case, wooden intermediary would be fixed once to the main frame. Exchangeable elements would be fixed directly to the wooden intermediary. Assumption has been made that after five or six transformations, wooden intermediary would need to be replaced as it would have many drilled holes. This is a new approach to designing the connections in wood, as this is the way for extending the life cycle of the components in the system...

In addition, the freedom of replacing the finishing of the system with wooden, polycarbonate or aluminum façade into green façade has to be possible...

While trying to find the solutions that will allow easy assembly and disassembly of all parts of the system, some connections have been found in the furniture design industry that can be used for building/construction industry... Some of existing connections in furniture design were tested in the GDC wall prototype. The main problem is that many of these connecting elements are not made to be resistant to outside weather conditions and the additional protective layer needs to be considered." (Androšević, Durmišević & Brocato 2019)

The results after application the *Reuse potential calculation method* Durmišević 2006 to the case studies will be considered as a start in predicting the construction waste. The final results are the value - reuse potential indicator, showing if the tested case studies have a good potential for reuse or the potential to become construction / building waste. The final calculation shows the level of reusability.

After all these testing, there are conclusions if the system and its parts are reusable and what is the level of reusability. As mentioned, if the reusability indicator is bigger, the quantity of waste is lower and vice versa, but the exact quantities of the waste and environmental impact is not presented in the final score value.



## 6.2. EXISTING TOOLS AND APPLICATION

As described in Chapter 5.3, there are some tools that are commercially available to be used for calculating the environmental impact of the building projects and products. Most of the tools are made as user friendly, in order to be used by many stakeholders, and do not require special expertise.

Commercial LCA software (building oriented or general by alphabetic order) that were found in the literature, are following:

Athena (Canada), Arquimedes (Spain), BEES (USA), Bilan Produit ADEME (France), Carbon Footprint (UK), COCON (France), eToolLCD (Australia), Eco-bat (Switzerland), EcoCalculator (Canada), EcoEffect (Sweden), ECOSOFT (Austria), EIME (France), ELODIE (France), invest 2 (UK), EQUER (France), GaBi (Germany), GaBi-Build-IT (Germany), GreenCalc+ (The Netherlands), Klimagassregnskap (Norway), LEGEP (Germany), OneClickLCA (Finland), OpenLCA (Germany), SimaPro (The Netherlands), SBS (Germany), SULCA (Germany), TEAM (France), Umberto (Germany).

These software use different databases and methodology. European software that are using Eco-invent database are: eBalance, Quantis Suite, Team 5, Regis, OpenLCA. (source: <https://www.ecoinvent.org>)

It is challenging process to choose the best one in every aspect. Fava 2006 has done the comparison between the different LCA studies for residential buildings and tools. A lot of different LCA software were developed in different countries/regions. The data shows that the age, regional origin and accuracy of the inventory data affect the accuracy and validity of studies. (Islam 2015, Szalay 2007, Reap et al. 2008, Yellishetty et al. 2009). Choice of system boundary has a significant impact on outcomes of studies. Some studies include comprehensive life cycle phases associated with construction, use/operation, maintenance and end of life (Islam 2015). Some studies include an assessment of a partial product life cycle (i.e., cradle to gate) to evaluate environmental impacts. This involves resource extraction (cradle) to the factory gate. Some studies include an assessment of full life cycle from resource extraction (cradle) to end of life or disposal (grave) such as 'cradle to grave' (Islam 2015, Dixit et al. 2013).

Overall, the wide range of choices and assumptions made in different studies has very significant effects on the outcomes. Hence, when studies are compared, due regard for assumptions, building typology, scope, system boundary and climate must be given. (Islam 2015).

LCA tools are issuing the Certificates for some measured indicators, so that the stakeholders can have a proof of environmental impact of the project. Some countries and governments are giving some financial assistance to the projects which are “green” and less harmful to the environment, or demanding the proof of minimal environmental requirements.

Islam 2015 demonstrated for the construction phase that “LCA compiles an inventory of all relevant material inputs and their environmental releases. The relative contribution of construction depends mainly on the material or element level used in construction.” His LCA system boundaries are shown in the Figure 101

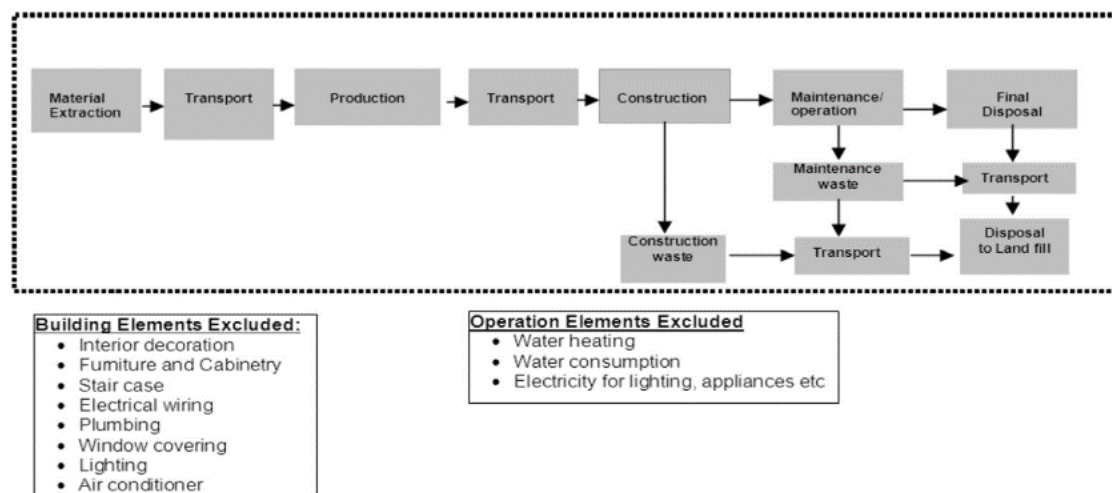

Figure 101. LCA system boundary (Islam 2015).

“The wide range of choices and assumptions made in different studies has very significant effects on outcomes, so due regard to building typology, scope, assumptions, system boundary and climate must be given when comparing LCA outcomes from different studies... Solid waste dominates at disposal phase, but stays same, no matter the lifespan, transportation distance or maintenance scenario, and it is not sensitive to assumptions in environmental impact categories.” (Islam 2015).

When it comes to the selection of the database, there are some recommendations in the literature.

“Thereby making it necessary to establish a state-of-the-art review for researchers in order to facilitate selection between a wide variety of databases available... A starting point in the selection of an LCA database for construction materials is provided... However, GaBi Database and Ecoinvent stand out for their integrity, usability and dedicated resources...” (Martinez-Rocamora 2016)

Islam et al. 2015 presented a summary table with some of the LCA software and databases around the world, declaring that Athena is the most suitable for its use in US and Canada, as Ecoinvent is for Europe and AusLCI for Australia.

Analysis of Asdrubali 2013 “includes all the life stages, from the production of the construction materials, to their transportation, assembling, lighting, appliances, cooling and heating, usages during the operating phase, to the end of life of all the materials and components”, using the LCA methodology and make the contribution for acceptance of the LCA “as a tool in the eco-friendly design of buildings, especially those buildings whose impact during the construction phase needs to be carefully checked”.

“As it can be seen, the LCA has become the most common way to quantify the (un)sustainability of buildings, but there is a general concern about the reliability of the LCA databases. In order to evaluate the current situation, a state-of-the-art review is presented in this paper, which may help users make a better-founded selection for the most suitable LCA database in accordance with their needs. Therefore, features and criteria for the evaluation of the LCA databases are presented, as well as a scoring system for their comparison.” (Martinez-Rocamora 2016) Features and criteria for the evaluation of the LCA databases are presented in Figure 102.

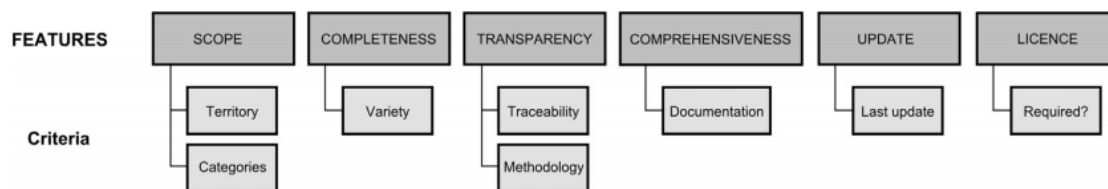

Figure 102. Features and criteria for the evaluation of the LCA databases. (Martinez-Rocamora 2016)

Martinez-Rocamora 2016 used a list of 40 LCA databases, and selected only those working with construction materials for their study:

European Commission's Institute for Environment and Sustainability provides a list of available LCA databases, and this has been taken as a starting point. (EC 2021)

“Ecoinvent was developed by the Swiss Centre for Life Cycle Inventories. Due to its consistency and transparency, it has been included in SimaPro 8, and it is also possible to use it with GaBi 5 and Umberto 5. A cradle-to-gate model is applied in most of the LCA studies, which are based on downloadable reports. <https://www.ecoinvent.org/>

In these reports, the methodology, flow charts, life cycle inventories, and literature references are presented. Access to 100 out of its 4000 processes is granted with the demo version of SimaPro. With a full paid licence, Ecoinvent is perfectly suited for construction purposes, since every category of construction materials is included and developed with a high variety of products. Users can also consult it online and download the data directly.” (Martinez-Rocamora 2016) (Figure 103)

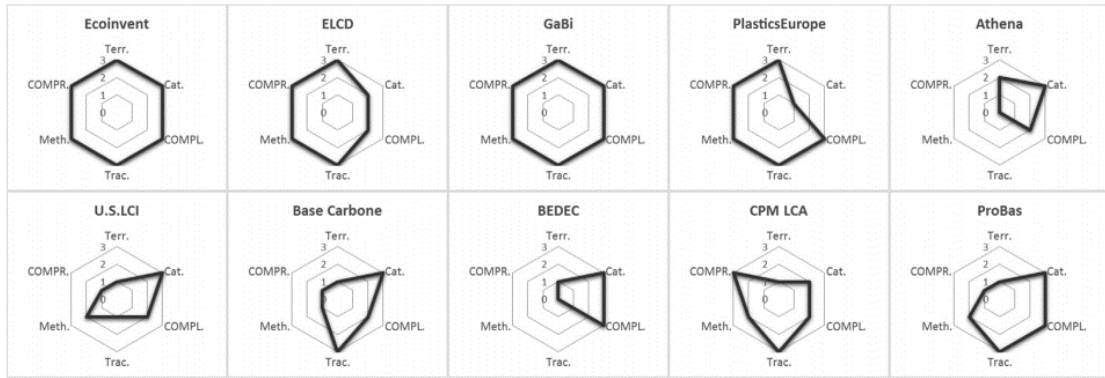

Figure 103. Spider chart for the comparison of the LCA databases. Legend: Terr=Territory, Cat=Categories, COMPL=Completeness, Trac= Traceability, Meth=Methodology outlining, COMPR=Comprehensiveness. (Martinez-Rocamora 2016)

“Ecoinvent and GaBi Database are identified as the most complete LCA databases according to the features defined for the study.” (Martinez-Rocamora 2016)

“An LCA database should contain two parts: one is the database of material properties; the other is the database of environmental impacts.” (Jincheng 2001)

“With these data, the direct and indirect energy consumption and environmental impacts are estimated.” (Ansah et al. 2019)

“According to Sezer et al. 2012, the existing methods of analysis of the environmental impact of buildings focus on the construction of new buildings. In these models, the variations in productivity, efficiency and short- and long-term consequences in the rehabilitation work are not covered: hence the need to create arises for the creation of a methodology for the quantification of resources and for the calculation of environmental impact that is applicable to rehabilitation.” (Alba-Rodriguez 2017)

“Considering the available literature and software based on the LCA, the LCA tools have brought much improvement in pushing the toxic and hazardous materials from the industry, giving the right data for the materials used and making the decision process easier.” (Androšević et al. 2019.)

Previous reviews and studies helped to identify the best database and the best software and tool to test the wall case studies and to evaluate the results. Selected tools are OneClickLCA and OpenLCA. OneClickLCA has free trial version and uses Environmental Product Description (EPD) database. EPD database has many materials available in pdf format, so every material/product can be separately checked. OpenLCA is a free tool and works with Ecoinvent database. Ecoinvent database has a good review, use in Europe and data of materials available in BiH region.

## 6.2.1. LCA – Life Cycle Assessment Application using OneClickLCA software

For the purpose of this research, it was decided to take advantage of the available free LCA tool, OneClickLCA. As already mentioned, the tool uses the EPD (Environmental Product Description) database. An option to test the tool for 14 days (free trial version) was helpful.

The tool is compliant with EN 15978, ISO 21931-1 and ISO 21929 standards and data requirements of ISO 14040 and EN 15804. Life cycle stages according to EN standards are shown in the Table 2.

Product Stage			Construction Process Stage		Use Stage							End-of-Life Stage			Benefits and loads beyond the system boundary			
Raw material supply	Transport	Manufacturing	Transport to building site	Installation into building	Use/application	Maintenance	Repair	Replacement	Refurbishment	Operational energy use	Operational water use	Deconstruction/demolition	Transport	Waste processing	Disposal	Reuse	Recovery	Recycling
A1	A2	A3	A4	A5	B1	B2	B3	B4	B5	B6	B7	C1	C2	C3	C4	D	D	D

Table 2. Life cycle stages according to EN standards (source: [www.oneclicklca.com](http://www.oneclicklca.com))

First analyses of the author of this thesis using this tool are explained and described in the paper Androšević et al. 2019.

The goal was to “show how the LCA can be used as a tool in the design phase to help decision process in the building design of one of the building systems and make that part circular and, if possible, without waste... Hence the design and building of external walls that produce less waste, is a huge step in construction waste management.” The paper describes “the main principles for designing the low waste wooden walls and gives some remarks on how to upgrade the software to be more helpful in the design phase of the wall systems.” (Androšević et al. 2019)

“The main focus will be materials used and what happens with them during the building exploitation stage and recommendations on what is possible when it becomes impossible to use them as they were intended (in the field of benefits and loads beyond the system boundary).” (Androšević et al. 2019)

“Two external composite wooden walls made in B&H are the two case studies, where the LCA tool is applied to help decision process. The first wall, prefabricated wooden wall for low energy houses (Chapter 4, Figure 52), is mostly used in the residential

buildings, but can also be used in other building types. The second GDC wall is used in the Green Design Center Building in Mostar Pilot Project (Chapter 4 in this research), whose final goal is to be used as an educational hub. Specific default conditions have been chosen in the OneClick LCA tool. In both cases, the assumed building areas are the same, as well as the transport distances (European, set as default in software), and the same transport vehicles. Both walls are designed for low energy buildings, so the assumption is that they will have the same energy consumption during the use stage. 1m<sup>2</sup> of the wall will be analyzed regarding use of materials and environmental impact. “(Androšević et al. 2019)

The functional unit is 100 m<sup>2</sup> of the external wall.

The trial version OneClick LCA tool “in compliance with BREEM International is used to measure the following environmental impact categories:

- Global warming (GWP)
- Acidification (AP)
- Eutrophication (EP)
- Nonhazardous waste disposed (NHWD) “ (Androšević et al. 2019)

“In the OneClick LCA simulation, comparing the two walls, the GDC wall 2 (Chapter 4, Figure 58) shows slightly less environmental impact than wall 1 (Chapter 4, Figure 52) in all categories, except quantity of non-hazardous construction waste (**Error! Reference source not found.**). The conclusion about used materials shows that the GDC walls are slightly better but the amount of non-hazardous waste is showing just a total weight in both cases.” (Androšević et al. 2019.)

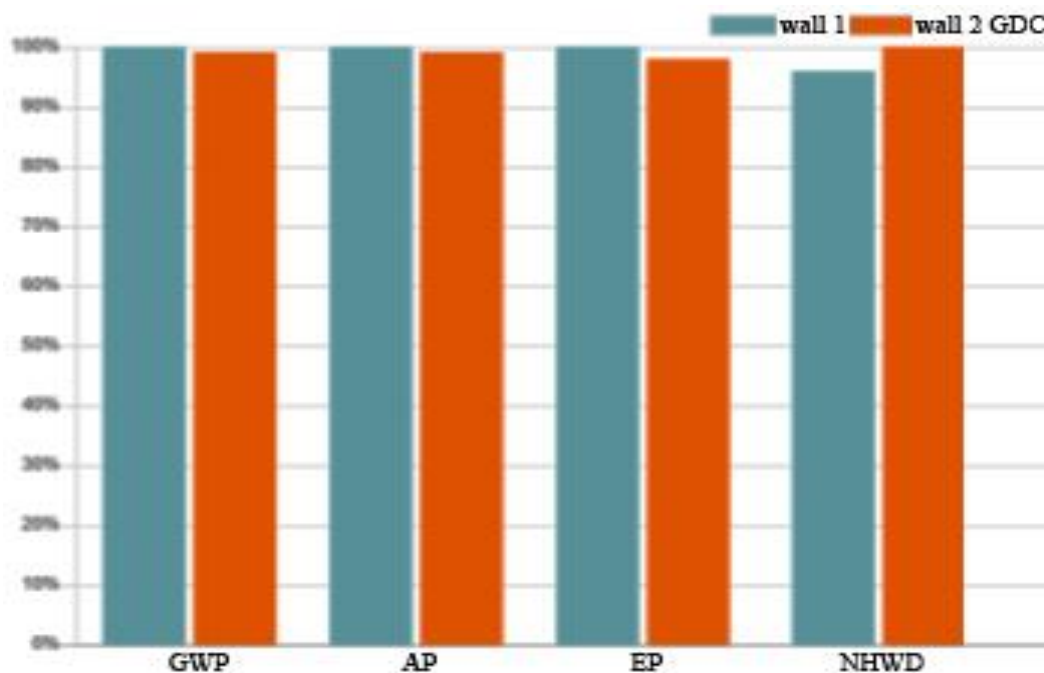

Figure 104. Results of environmental impact of two case study walls (Androšević et al. 2019.)

Results of non-hazardous waste, by stage, show that the difference is insignificant for the two different case study walls. (Figure 105)



Figure 105. Results of non-hazardous waste disposed, by stage, for the two case-study walls (Androšević et al. 2019.)

” In the first cycle of buildings system life, during the production and usage phase, the environmental impact seems almost the same for two walls, but when it comes to the concept of “cradle to cradle” and second cycle of life of building system and its elements, we have to be sure which system allows us to take out and store elements we can use again and which system does not. Also, the LCA should consider what the consequences and environmental impacts are for reusing the parts or for dumping the materials on a landfill.” (Androšević et al. 2019.)

“OneClick LCA software which we used helps users to find better choice of materials used, providing and using the EPD (environmental product declaration) with the purpose of lower environmental impact regarding their production in terms of ingredients used (environmentally friendly substances used), energy and water consumption during production and use. But, also in case that there are all environmentally friendly materials chosen and put together in one of the building systems – in this case the wall, where such wall can get the mentioned certificate (LEEDS, BREAM etc.), that doesn’t mean that there will be suggestions what to do with the calculated quantity of non-hazardous waste in the building.” (Androšević et al. 2019.)

The next way to see if the tool works is to test it on two almost identical walls and compare the results. The “functional unit” is 100 m<sup>2</sup> of the external wall. The same materials are built into the two case study external walls, but the connections between the chosen materials are not the same.

The chosen materials will be similar to the existing wall for low energy houses A+, already mentioned and tested before in this research (Krivaja 2018). This will be just a base to choose materials for the tested walls. The case study wall will be a composite of 10 main materials shown in Figure 106 and in the exploded 3d view. (Figure 107)

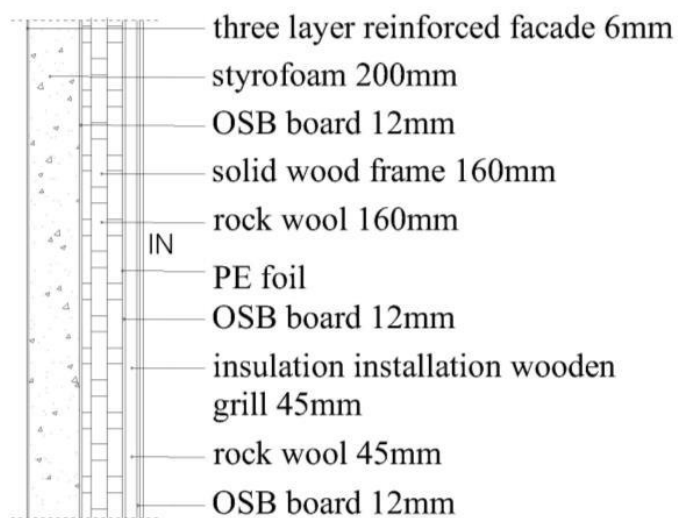

Figure 106. Section of the case study prefabricated wall for low energy house

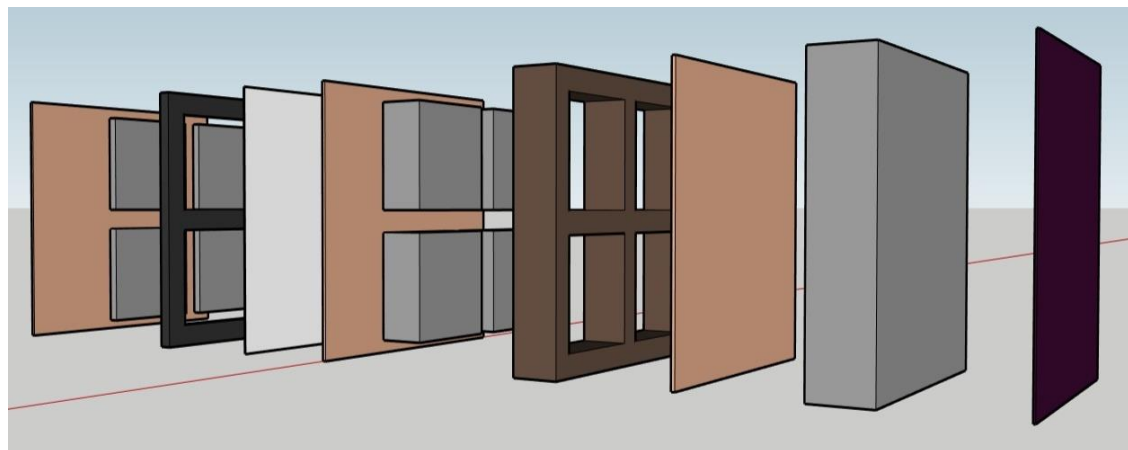

Figure 107. Case study wall exploded. Materials from left to right: OSB board 12mm, rock wool 45mm, insulation installation wooden grill 45mm, OSB board 12mm, PE foil, rock wool 160mm, solid wood frame 160mm, OSB board 12mm, Styrofoam 200mm, three-layer reinforced façade 6mm

The OneClick LCA analyses are done for the same wall, but with different connections and connection materials/devices.

Then, at least, two completely different scenarios regarding chosen connections can happen:



1. Scenario 1 – when stakeholder (designer, producer or construction company) chooses “glue-like” connections between materials;
2. Scenario 2 – when stakeholder (designer, producer or construction company) chooses “pin like” connections between materials.

There is an open question:

*Do these walls really have the same environmental impact when it comes to the construction waste during their life-cycles?*

1. *FIRST LIFE-CYCLE:*

- a) maintenance while in use during their first life-cycle, considering possibilities of changing damaged parts, then upgrading their performances by adding or changing some new parts inside (e.g., more TA insulation);
- b) disassembly possibilities in the case of a building or a building part transformation (these transformations can be considered as a second life-cycle in the calculation process);

2. *SECOND LIFE-CYCLE:*

- a) reuse possibilities for some parts of the system in the second life-cycle (when the first function is finished).

Testing was done with some adjustments in the already mentioned and tested Case study prefabricated wall for low energy houses.

Calculations in the tool were done for the case study wall in the first life-cycle.

1. *FIRST LIFE-CYCLE:*

Wooden wall for low energy houses with its materials in its first life-cycle is used as a case study wall (Figure 107) to demonstrate the differences in terms of the environmental impact between systems made of the same materials, but with different connections. Environmental impact was calculated for these scenarios of the same wall in the software OneClick LCA, free trial 14 days' version. Case study wall materials with environmental attributes and EN standards are shown in Table 3. (adapted from the table in the tool OneClick LCA)

Resource name	Country	Density	Year	Environment data source	Standard	EPD number / EPD program / Manufacturer	Product Category Rules (PCR) / notes about PCR	Technical specification	Upstream database / verification	Performance ranking
Dried timber, conifer	Norway	450.0	2015	Sawn dried timber of spruce or pine. Norwegian Wood Industry Federation.	EN 15804	NEPD 307 – 179 – EN / EPD Norge / Treindustrien	NPCR 015 rev.1 wood and wood based products for use in construction. 08 – 2013 / Biogenic CO2 separated		Ecoinvent / verified	12 / 69
EPS insulation	Norway / Sweden	16.0	2017	EPD lavlambda EPS 80 isolasjon EPS gruppen	EN 15804	NEPD 1236 – 244 – EN / EPD Norge / EPS gruppen	NPCR 12 rev.1. Insulation materials. Date 10.12.2012. / only with EN 15804	T 10-2400 mm 600 x 1200 mm. 0.031 W/m2K, 16 kg/m3	Ecoinvent / verified	168 / 289
Fibre cement façade panel	Germany	1300.0	2016	Oekobaudat 2017	EN 15804	- / Okobaudat/	EN 15804	10mm, 13 kg/m2, 1300 kg/m3	Gabi / verified	14 / 117
Oriented strand board (OSB) generic	Local	610.0	2018	OneClick LCA	EN 15804	- / OneClick LCA	EN 15804	9.5 – 28.5 mm, 610 kg/m3	Ecoinvent	5 / 8
PE foil	Germany		2016	Oekobaudat 2017	EN 15804	- / Okobaudat/	EN 15804	PE 1.2 kg/m2	Gabi / verified	107 / 250
Rock wool insulation panels, unfaced, generic	Local	50.0	2018	OneClick LCA	EN 15804	- / OneClick LCA	EN 15804	L = 0.0346 W/mK, 50 kg/m3 (aplikable for densities 25-50 kg/m3)	Ecoinvent	87 / 322

Table 3. Case study wall materials with environmental attributes and EN standards (adapted from the tool OneClick LCA)

Environmental impact in terms of non-hazardous waste was calculated for the:

- External wall 1 - which does not mention the connections between the materials,
- External wall 2 - where the connecting material is a glue (added as one material with estimated quantity),

- External wall 3 - where connecting material between layers are screws (added as a single material with estimated quantity).

The results for functional units of 100 m<sup>2</sup> of the external case study walls are calculated in the tool and demonstrated:

LCA for BREEM Int'l/ES/NOR/SE, Non-hazardous waste disposed, by categories shown in three figures where the exact amounts for each wall can be seen. (Figure 108, Figure 109, Figure 110)

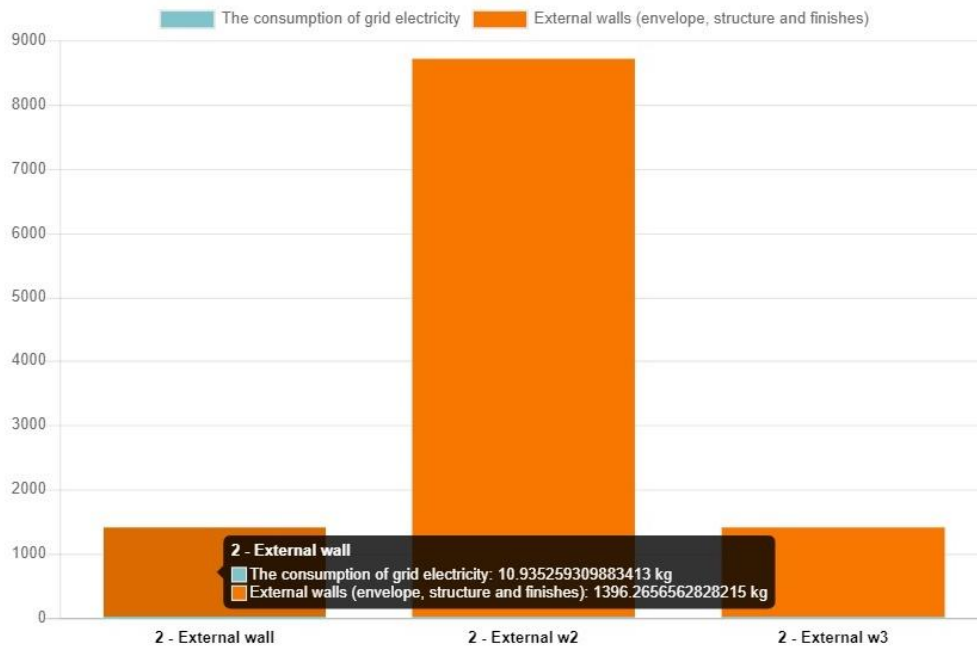

Figure 108. LCA for BREEM Int'l/ES/NOR/SE, Non-hazardous waste disposed, by category (data for the wall1)

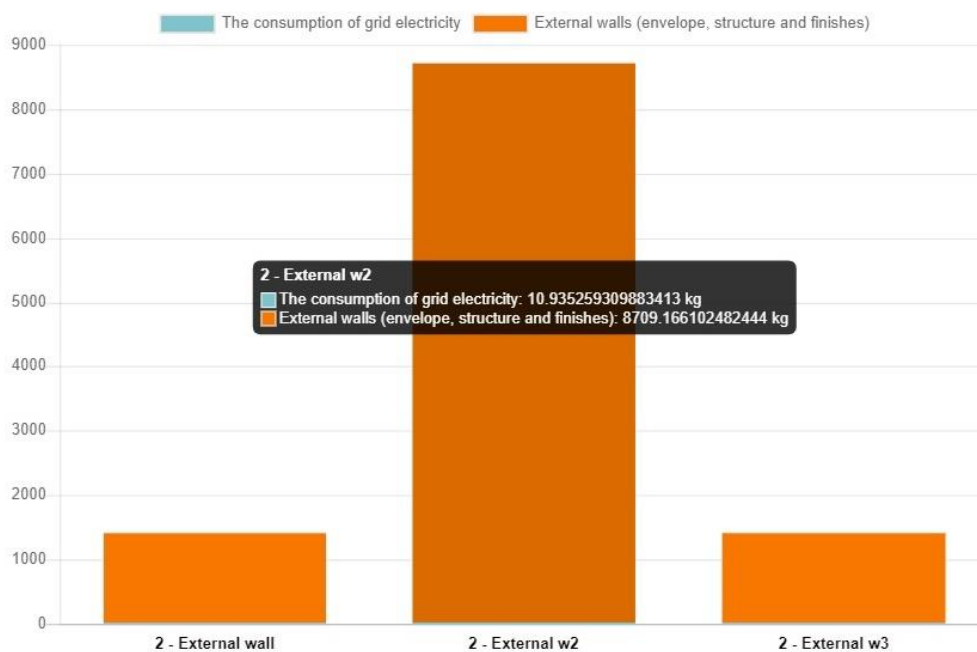

Figure 109. LCA for BREEM Int'l/ES/NOR/SE, Non-hazardous waste disposed, by category (data for the wall2)

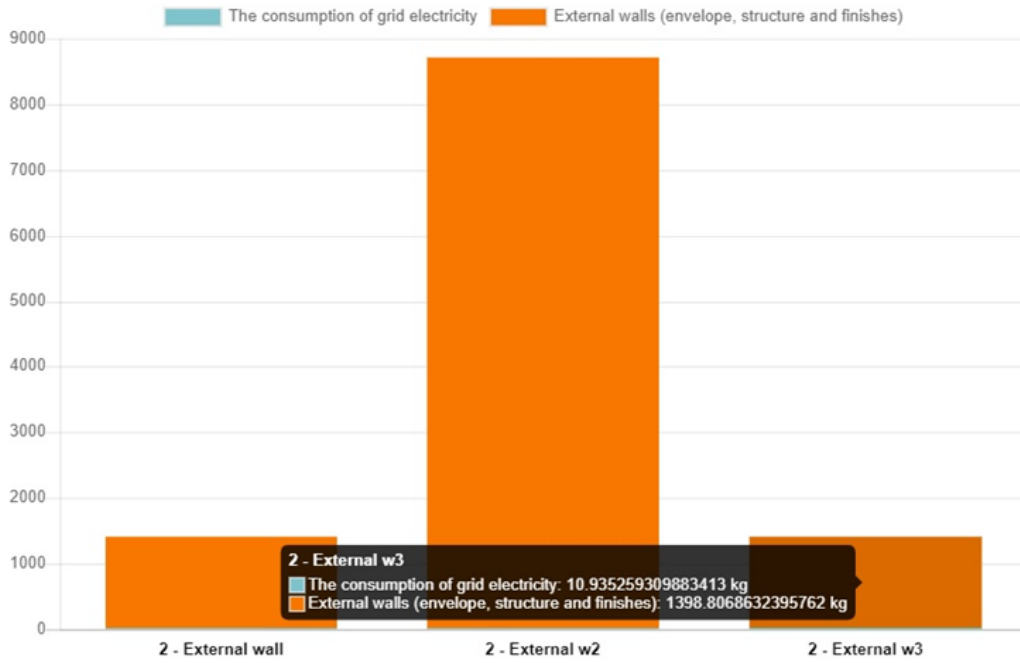

Figure 110. LCA for BREEM Int'l/ES/NOR/SE, Non-hazardous waste disposed, by category (data for the wall3)

LCA for BREEM Int'l/ES/NOR/SE, Non-hazardous waste disposed, by stage shown in three figures where the exact amounts for each wall can be seen. (Figure 111, Figure 112, Figure 113)

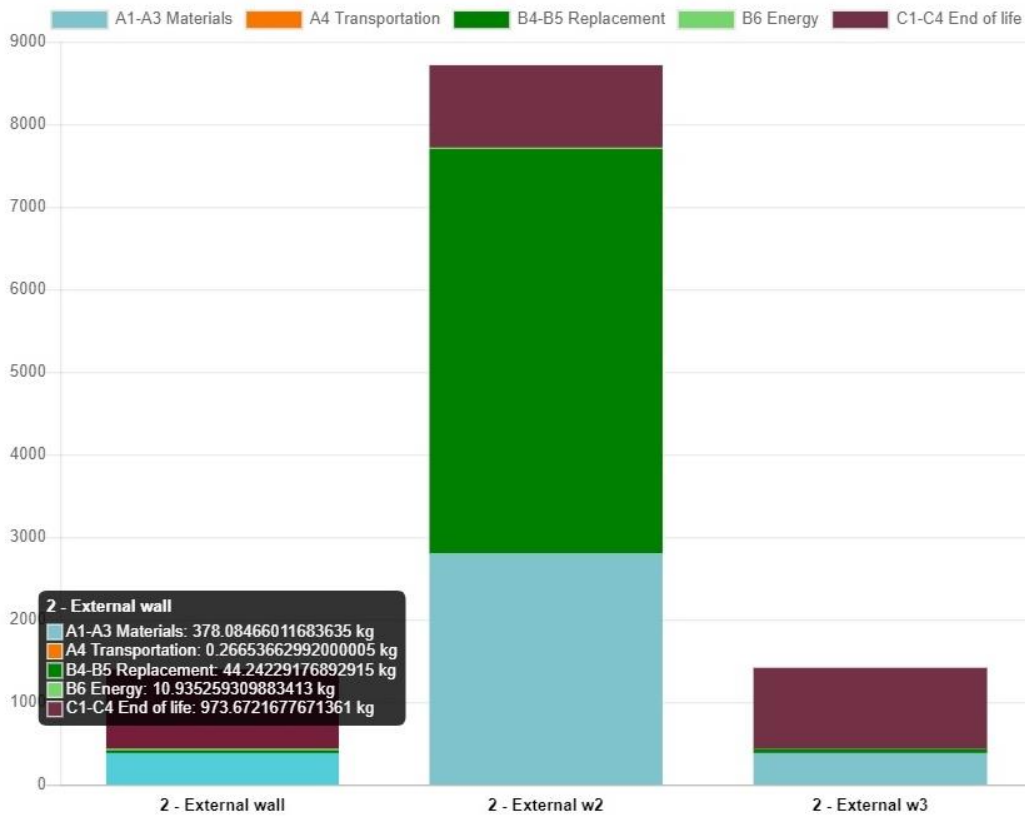

Figure 111. LCA for BREEM Int'l/ES/NOR/SE, Non-hazardous waste disposed, by stage (data for the wall1).

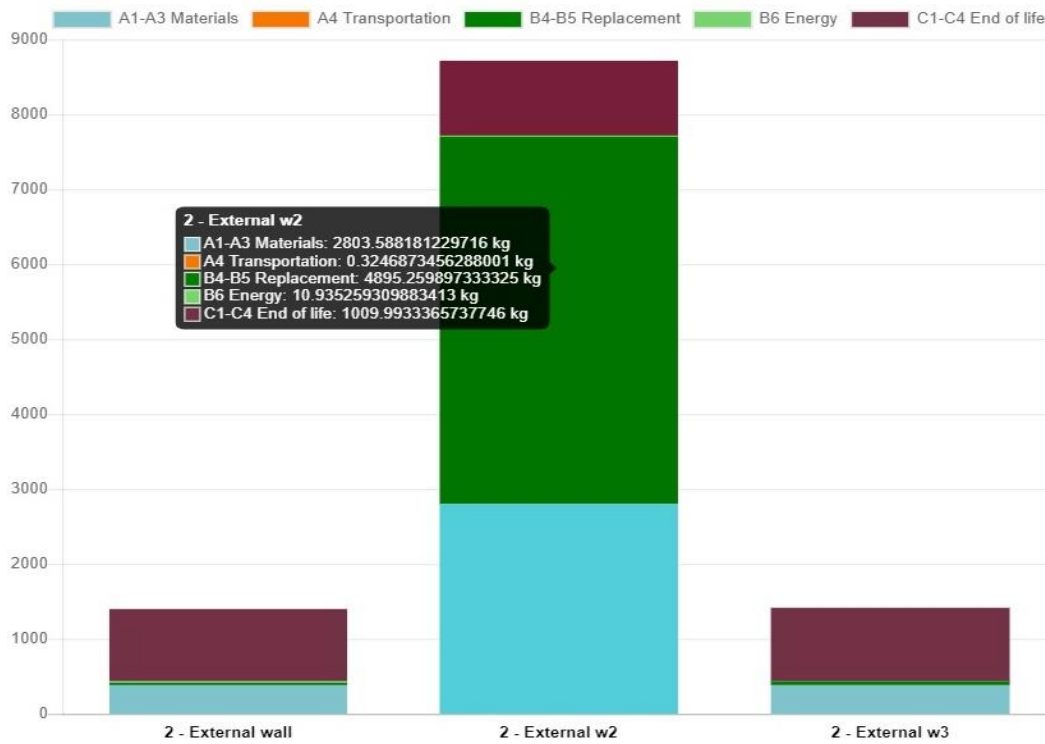

Figure 112. LCA for BREEM Int'l/ES/NOR/SE, Non-hazardous waste disposed, by stage (data for the wall2).

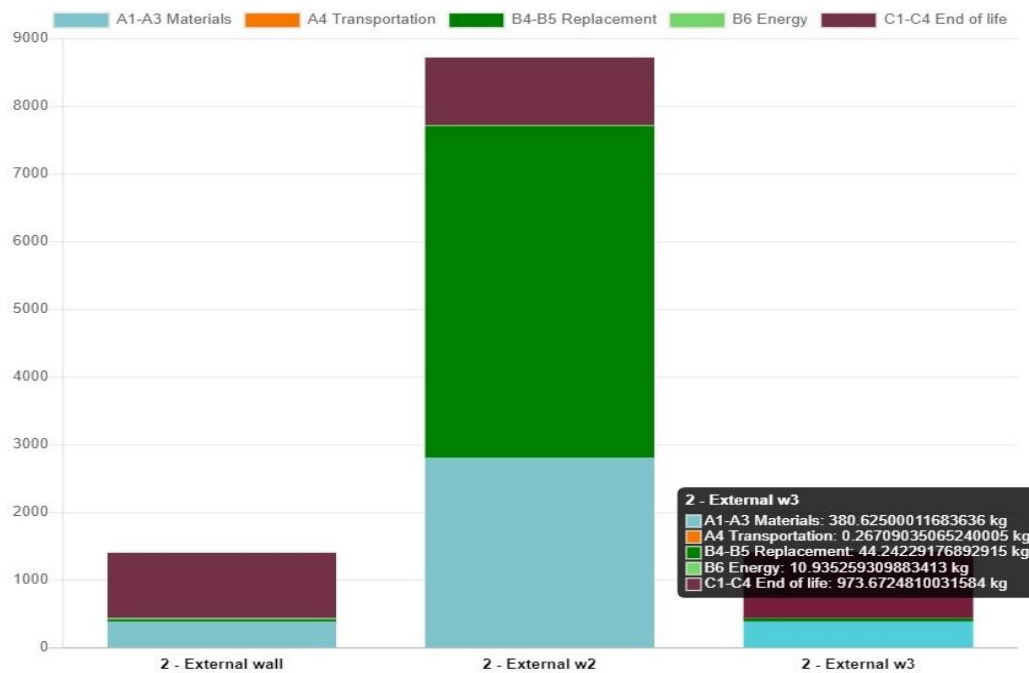

Figure 113. LCA for BREEM Int'l/ES/NOR/SE, Non-hazardous waste disposed, by stage (data for the wall3).

Element comparison, LCA for BREEM Int'l/ES/NOR/SE - Non-hazardous waste disposed, shown in 3 figures where the exact amounts for each wall can be seen. (Figure 114, Figure 115, Figure 116)

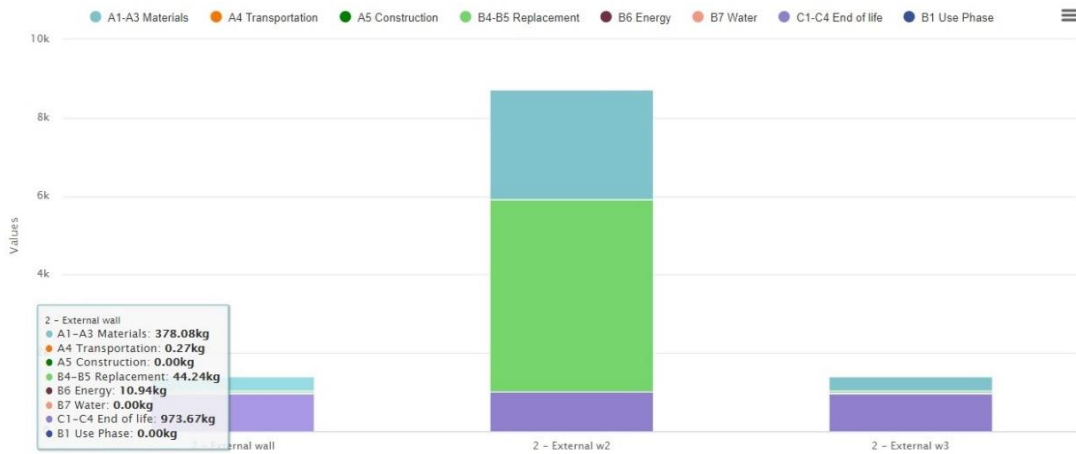

Figure 114. LCA for BREEM Int'l/ES/NOR/SE - Non-hazardous waste disposed (data for the wall1)

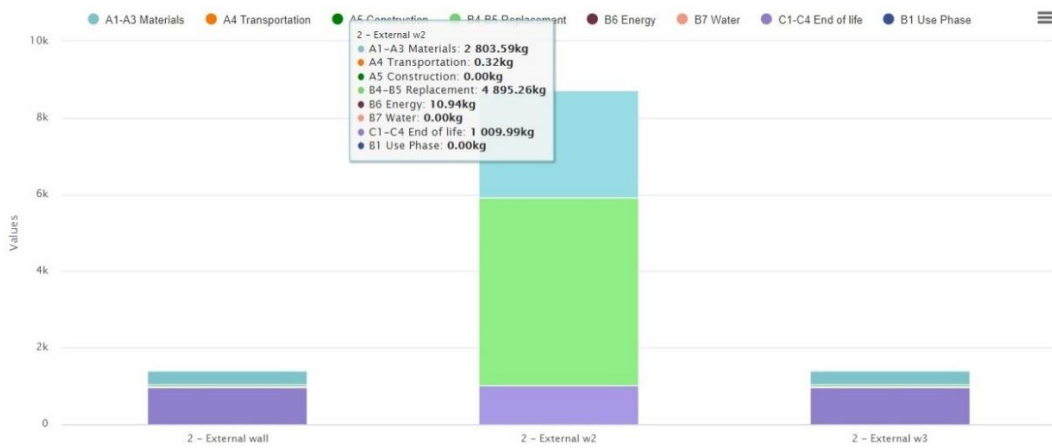

Figure 115. LCA for BREEM Int'l/ES/NOR/SE - Non-hazardous waste disposed (data for the wall2)

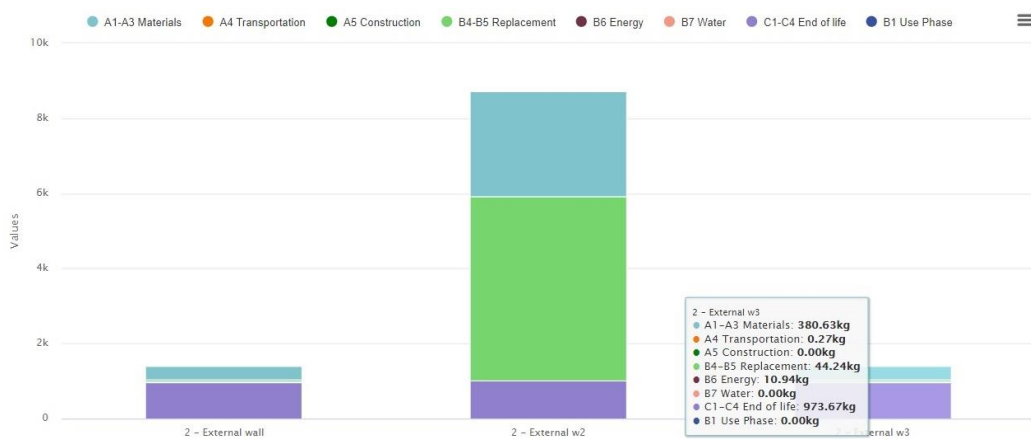

Figure 116. LCA for BREEM Int'l/ES/NOR/SE - Non-hazardous waste disposed (data for the wall3)

Results showing that the second wall has a huge impact, as the chosen connecting material, “glue” has a really bad performance in terms of the environmental impact. But, still, the difference between concepts is not visible.

According to the OneClick LCA program, the wall without visibly showed and mentioned connection materials can have the certificate if the main materials are environmentally friendly (in compliance with the used EPD database). Different results regarding environmental impact are shown if the connections are in the equation and cannot be disassembled. The connections should be included and mentioned in calculation for every case.

In this case, the LCA results are in favour of the metal connections, which, as material, have lower impact than glue. The other reasons cannot be concluded.

Let's presume that the connecting materials also have a really good score, according to the environmental impact. Then, both walls will have the possibility to receive the certificates for the first life-cycle as a proof that each system has low environmental impact scores and that is the point where the procedure ends nowadays in every basic LCA calculator used to acquire the certificate.

## 6.2.2. LCA – Life Cycle Assessment Application using OpenLCA software

The right software has to be chosen considering all previous reviews and analysing the other research experiences. Such software must be comprehensive, provide more data and work with the Ecoinvent database, considering literature survey and research results from other researchers. Thus, the Open LCA software was the next choice.

Environmental impact calculation (in terms of the construction waste) for the prefabricated 10 layers wall in Open LCA software considering all data gathered in previous steps.

In the Open LCA the differences between the similar wall systems with different connections should be shown. The functional unit is 100 m<sup>2</sup> of the external wall. In this case, we have three case studies with slight differences:

- First Case Study scenario for the first life-cycle (if a stakeholder wants to use the building system in a single life-cycle until the end of life of one of its parts):

Data for the Case study wall including materials and connections between them as materials with relevant database for each material and its environmental impact, (calculation of quantity of waste at the end of the first life-cycle).

- Second Case Study scenario for the first life-cycle (if a stakeholder wants to use the building system parts longer) and the second life-cycle:

Data for the Case study wall including materials and connections between them as materials with relevant database for each material and its environmental impact, adding the parameters (Conn values) to the connections regarding their possibility to be disassembled.

- Third Case Study scenario for the second life-cycle:

In the LCA programs for materials used in the second life-cycle the environmental impact for the production and use stages is considered to be 0, and only added impact categories are transport and energy used for disassembling and assembling again in another system. It means that the additional points should be given for the systems chosen to be used in the second life-cycle as well.

There are 3 Case studies which will be compared:

- Option 1 - Wall1 with all materials used, but without mentioning the connections and relations between them;
- Option 2 - Wall1 with glue-like connections;



- Option 3 - Wall1 with screw-like connections.

The environmental impact in the second life cycle is calculated considering possibilities to reuse the existing materials.

There are no connecting materials (as such) in the Ecoinvent\_34 databases, and no screws, so the steel is taken as a connecting material for the layers in this case study wall 1, and its mass (1kg) assumed for functional unit of 100m<sup>2</sup> area of the Wall1. (Figure 117)

Inputs/Outputs: Wall 1 prefabricated process with screw like conn

Flow	Category	Amount	Unit	Costs/Reven...	Uncertainty	Avoided wa...	Provider	Data quality...	Description
F <sub>2</sub> fleece, polyethylene	139:Manufacture of other...	96.00000	kg		none				
F <sub>2</sub> oriented strand board	162:Manufacture of prod...	1.20000	m <sup>3</sup>		none		P market f...		
F <sub>2</sub> oriented strand board	162:Manufacture of prod...	1.20000	m <sup>3</sup>		none		P market f...		
F <sub>2</sub> oriented strand board	162:Manufacture of prod...	1.20000	m <sup>3</sup>		none		P oriented ...		
F <sub>2</sub> polystyrene, general purpose	201:Manufacture of basic ...	1.00000	kg		none				
F <sub>2</sub> pulpwood, hardwood, measured ...	022:Logging/0220:Logging	8.00000	m <sup>3</sup>		none		P market f...		
F <sub>2</sub> pulpwood, hardwood, measured ...	022:Logging/0220:Logging	2.25000	m <sup>3</sup>		none				
F <sub>2</sub> steel, chromium steel 18/8	241:Manufacture of basic ...	1.00000	kg		none				
F <sub>2</sub> stone wool	239:Manufacture of non-...	49.50000	kg		none		P market f...		
F <sub>2</sub> stone wool	239:Manufacture of non-...	176.00000	kg		none		P market f...		

Figure 117. Print screen of Wall1 process with screw-like connections in the OpenLCA

The order and relation between materials in the wall is very important, but the program puts the materials in the alphabetical order. In the process, the OpenLCA software summarizes total quantity of two or more materials (model graph left) if there is the same material in the several places in the system. To avoid that in this process, the same material in two places is considered as it is from two different Providers (Figure 118 model graph right).

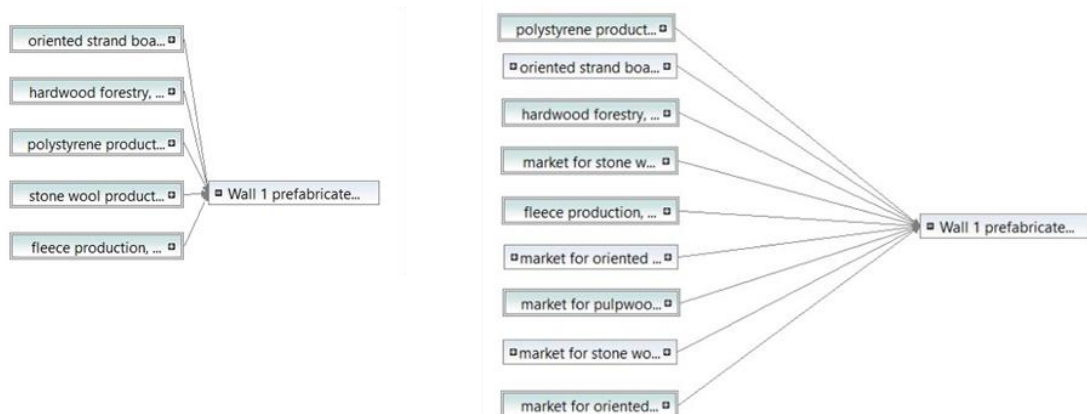

Figure 118. The model graphs for the same materials in the Case study prefabricated Wall1. Total quantity of material in the wall, even though it is in several positions in the wall - Model graph left. To avoid that, the same material is declared as being from a different Provider- model graph right.

The results for the first life cycle of the Case study for prefabricated Wall 1 without mentioning the connections between them are shown in the Figure 119, Figure 120, Figure 121.

After that, three Case studies (variants of this 10 layer wall) were compared in terms of Environmental impact in mentioned categories.

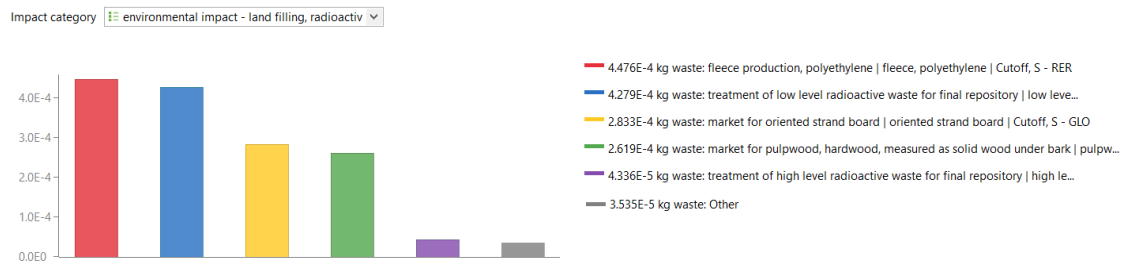

Figure 119. Case study prefabricated Wall 1 – 10 materials layers without mentioning the connections between them – Radioactive waste

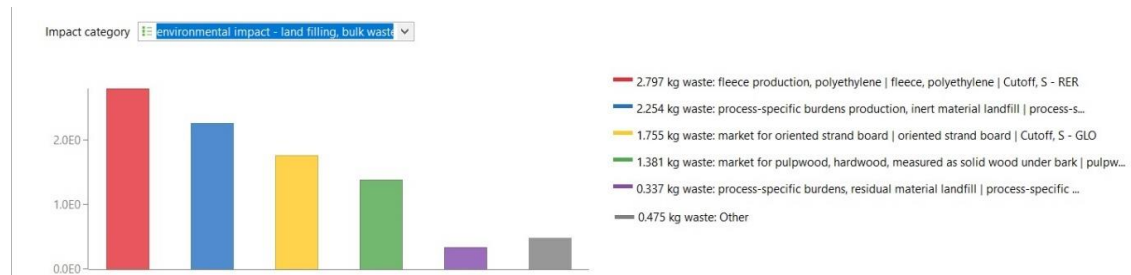

Figure 120. Case study prefabricated Wall 1 – 10 materials layers without mentioning the connections between them - Bulk waste

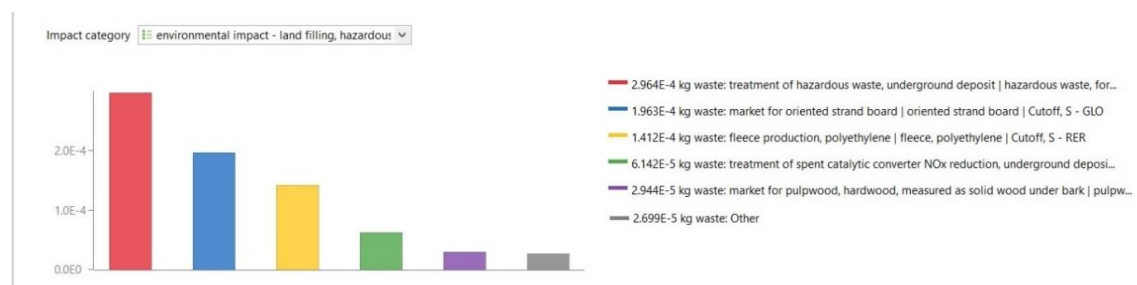

Figure 121. Case study prefabricated Wall 1 – 10 layers of materials without mentioning the connections between them - Hazardous waste

The table shows the LCA results of the project variants. Each selected LCIA category is displayed in the rows and the project variants in the columns. The unit is the unit of the LCIA category as defined in the LCIA method. Three Case studies (variants of this 10 layer wall) were compared in terms of Environmental impact in land filling.

Option1 - Wall1 with all materials used (but without mentioning the connections and relations between them);

Option2 - Wall1 with glue-like connections;

Option3 - Wall1 with screw-like connections. (Table 4)

Indicator	Option1	Option2	Option3	Unit
environmental impact - land filling, bulk waste	4.38543e+2	4.38726e+2	4.43990e+2	kg waste
environmental impact - land filling, hazardous waste	4.39307e-2	5.56401e-2	4.40657e-2	kg waste
environmental impact - land filling, radioactive waste	7.61657e-2	7.61846e-2	7.62711e-2	kg waste
environmental impact - land filling, slag and ashes	2.47328e+0	2.47654e+0	2.47458e+0	kg waste
resource consumption - renewable resources, wood	1.71254e+1	1.71254e+1	1.71256e+1	m3

Table 4. Case study prefabricated Wall 1 – 10 materials layers without mentioning the connections between them

Each category can be shown separately (Figure 122) or on the same chart (Figure 123).

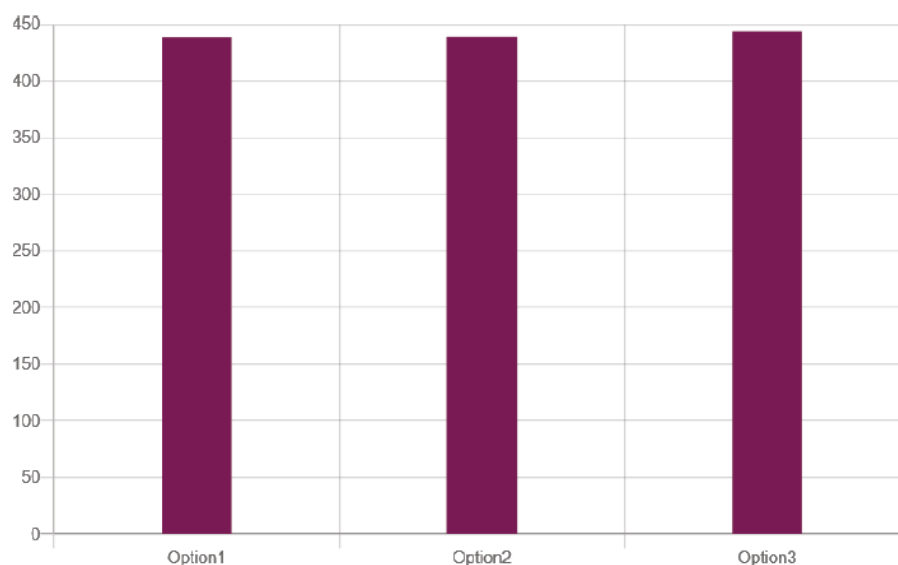

Figure 122. Three Case studies (variants of this 10 layer wall) were compared in terms of Environmental impact in land filling:

- Option1 - Wall1 with all materials used (but without mentioning the connections and relations between them);
- Option2 - Wall1 with glue-like connections;
- Option3 - Wall1 with screw-like connections. (chart from the OpenLCA tool)

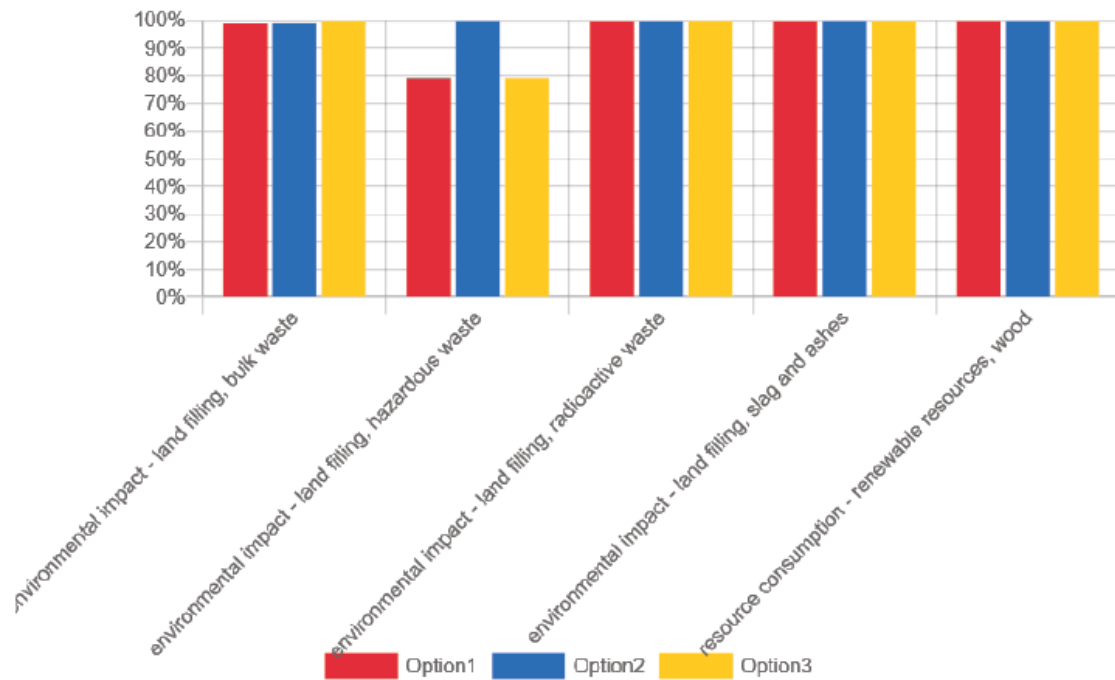

Figure 123. Relative indicator results of the three Case studies (variants of this 10 layer wall):

Option1 - Wall1 with all materials used (but without mentioning the connections and relations between them);  
 Option2 - Wall1 with glue-like connections;  
 Option3 - Wall1 with screw-like connections.

The Case study variants were compared in terms of Environmental impact in 5 categories. For each indicator, the maximum result is set to 100% and the results of other variants are displayed in relation to this result. (chart from the OpenLCA tool)

These data describe the environmental impact of materials in the first life-cycle without changing anything, and this can be valid for maximum 10 years after construction.

Huge difference in the results can be seen if there is going to be some repair, modification or transformation.

Because of that, there is another calculation for the second life-cycle of the same walls. In this case, two Case studies were considered:

- Wall1 with glue-like connections after the first and after the second life-cycle; (Table 5)
- Wall2 with screw-like connections after the first and after the second life-cycle. (Table 6)

Indicator	Option1	Option2	Unit
Environmental impact – land filling, bulk waste	4.38726 e+2	4.38726 e+2	Kg waste
Environmental impact – land filling, hazardous waste	5.56401 e-2	5.56401 e-2	Kg waste
Environmental impact – land filling, radioactive waste	7.61846 e-2	7.61846 e-2	Kg waste
Environmental impact – land filling, alg and ashes	2.47654 e+0	2.47654 e+0	Kg waste
Resource consumption – renewable resources, wood	1.71254 e+1	1.71254 e+1	m <sup>3</sup>

*Table 5. The table shows the LCIA results of the first life-cycle (Option 1) and the second life-cycle (Option 2) for a Wall1 with the glue-like connections. Each LCIA category is displayed in the rows and the project variants in the columns. The wall produces double environmental impact for two life-cycles, as the parts cannot be used in the second life-cycle. (adapted table from OpenLCA tool)*

Indicator	Option1	Option2	Unit
Environmental impact – land filling, bulk waste	4.38726 e+2	8.77452 e+2	Kg waste
Environmental impact – land filling, hazardous waste	5.56401 e-2	11.1280 e-2	Kg waste
Environmental impact – land filling, radioactive waste	7.61846 e-2	15.2369 e-2	Kg waste
Environmental impact – land filling, alg and ashes	2.47654 e+0	4.95307 e+0	Kg waste
Resource consumption – renewable resources, wood	1.71254 e+1	3.42508 e+1	m <sup>3</sup>

*Table 6. The table shows the LCIA results of the first life-cycle (Option 1) and the total amount after the second life-cycle (Option 2) for a Wall1 with the glue-like connections. Each LCIA category is displayed in the rows and the project variants in the columns. The wall produces double environmental impact for two life-cycles, as the parts cannot be used in the second life-cycle. (adapted from OpenLCA tool)*

For the first Case Study Wall with glue-like connections, the parameter used for glue-like connection has value 1, as the new materials are used for the second life-cycle. Thus, it means that in the second life-cycle the new materials have to be used to build a new wall. It means that, in this case, the second life-cycle is really the second wall built and at the end of process, the amount of waste is doubled. (Figure 124) This is obviously the same in all analysed categories.

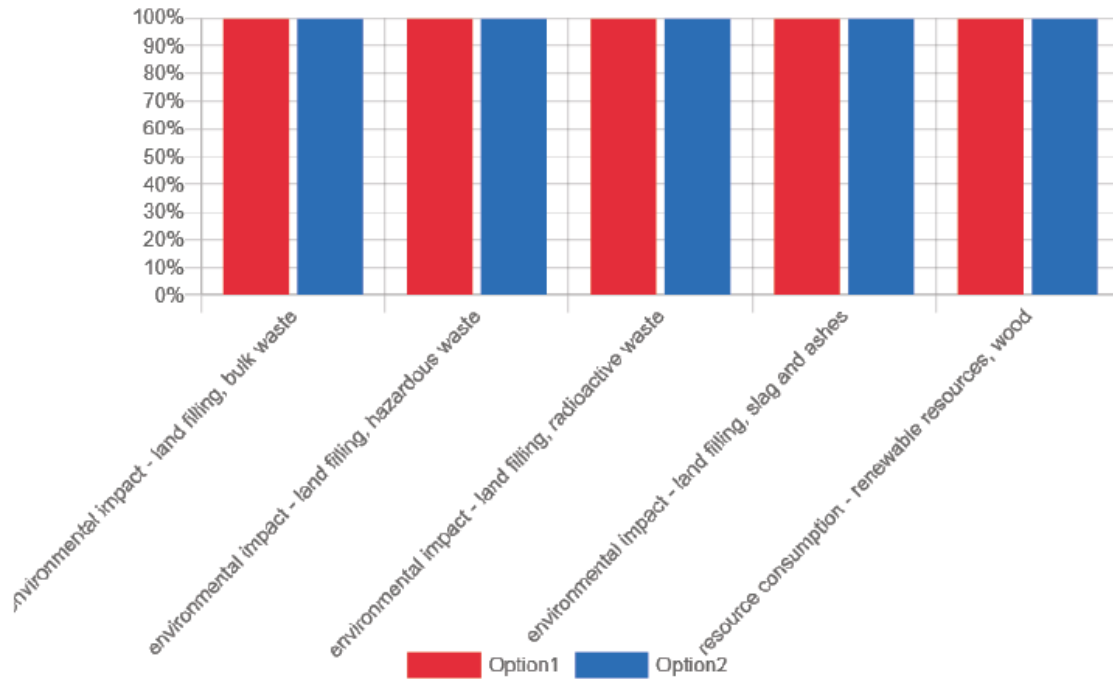

Figure 124. Relative indicator results of the respective project variants. For each indicator, the maximum result is set to 100% and the results of the other variants are displayed in relation to this result. We can see that Wall1 with the glue-like connections produces double environmental impact after second life-cycle (option 1 + option 2), as the parts cannot be used in the second life-cycle. Option 1 is the first life-cycle, option 2 is the second life-cycle of the wall1. (chart from OpenLCA tool)

The second Case study deals with Wall2 with screw-like connections after the first and after the second life-cycle. (Figure 125) The software Open LCA allows adjustments of parameters, which will be used to predict the resource usage in the second life-cycle. In the case where the disassembly is possible, the same materials are used in the second life-cycle and the usage of the new materials should be zero. The energy, transport costs and assembly of materials will be the same in the second scenario with the possibility of disassembly.

In this calculation, the parameter 0,1 was used as a worst case scenario, where maximum 10% of the material will be accidentally damaged due to the disassembly and assembly.

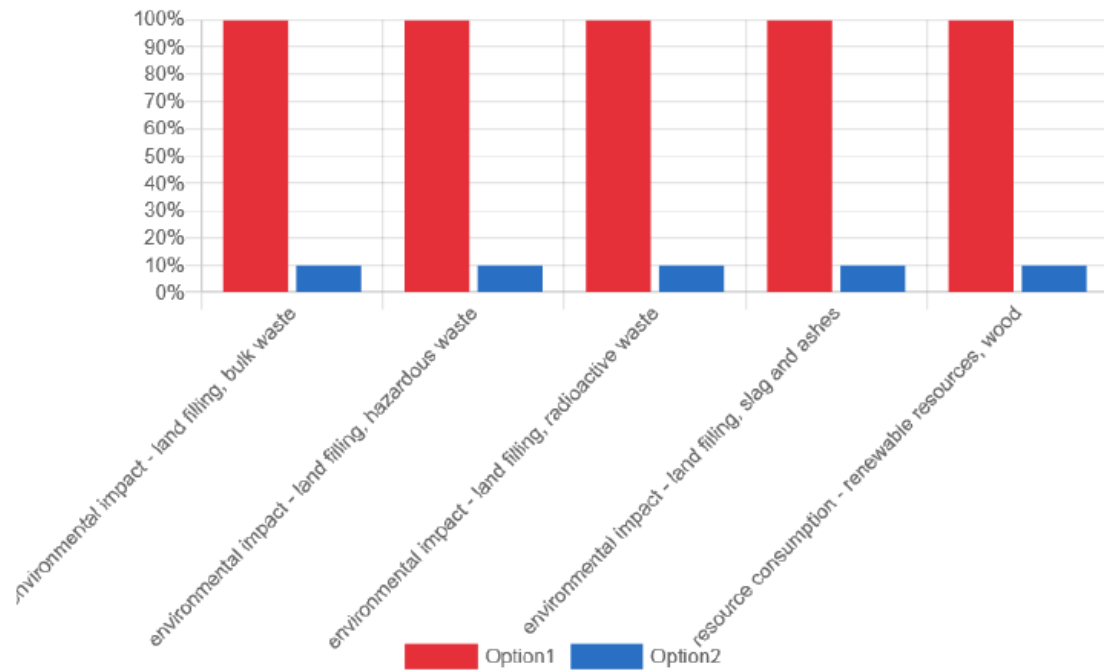

Figure 125. Relative indicator results of the respective project variants. For each indicator, the maximum result is set to 100% and the results of the other variants are displayed in relation to this result. We can see that in the second Case study, environmental impact of the Wall2 with screw-like connections is really low in the second life-cycle because almost all parts can be reused in the second life-cycle. Option 1 is the first life-cycle, option 2 is the second life-cycle of the wall2. (chart from OpenLCA tool)

After application of the LCA principles and testing of the tools, the results showing the environmental impact are based only on quantities of materials used, but do not show if these materials can be separated and if it is possible to make most of their potential in the next transformation (even replacement during maintenance) or in the next life-cycle. The processes from material production, transport and built-in phase are well elaborated and calculated, but after that phase, there are no proposals for possible scenarios. After the built-in phase, the assumptions for repair, reuse and recycle are not considering if the extraction of materials is possible and feasible. It is not in the analyses because the relation between materials and elements is not implied or in any way defined in defining / designing process. The result of the building environmental impact is not the simple quantity of materials used and their impact. It depends of the possibility to extract the used materials and use them again. It cannot be concluded, as the material and building parts relations are not defined in the process.

None of the tools tested is considering this matter or gives the possibility to add some scenarios during and after the first building life-cycle.

The suggested new method will be composed of methods that demonstrated a good results and overview that help stakeholders to make decisions regarding materials and systems they want to choose.

***Create “the right tool for the right job!”***



## 7. LOWERING ENVIRONMENTAL IMPACT IN TERMS OF CONSTRUCTION WASTE – THE NEW METHODOLOGY

### Summary (English)

In order to achieve high environmental performance, the new methodology has to provide a way of recognizing the opportunities and present integrated approach to the building industry stakeholders. Durmišević 2006 method and Open LCA software were adapted and incorporated in the new method and protocol, due to the positive results after testing. The missing areas in each method and tool can be fulfilled with other existing methods and tools. In essence, mentioned methods and tools synergy, together with some minor adjustments, can help to reach the goal of the research.

The new method will improve the possibility to make decision at the early design phases, following all project phases and providing the possibility to make intervention at any moment (product/building life phase) in order to improve the performance of the project, in terms of its environmental impact regarding the resource use/reuse. In addition to that, the important task of this research is to help stakeholders to predict future scenarios and what can be done after the first life-cycle is finished.

After the method and protocol is defined, the tool's digitalisation should follow, as digitalization is the process that helps method adoption and its application quicker. The method developed in this research will evolve in a tool that can be digitalised, as part of further development.

Based on inventory presented in previous chapters and gap analyses, the method proposed in this research results in creation of the Construction Waste Elimination (CWE) protocol. The CWE protocol should show the differences in potential waste and its environmental impact trough the life-cycle / life-cycles / of compared case studies in the process of building planning.

The new CWE protocol is envisioned as an instruction to follow in order to achieve low construction waste in each life-cycle. Construction and building related decisions will take advantage of this protocol, in order to prevent environmental impact in terms of the construction waste. The CWE protocol will be explained step by step, going through every phase of the building project.

## 7. DIMINUTION DE L'IMPACT SUR L'ENVIRONNEMENT EN TERMES DES DECHETS DE CONSTRUCTION - NOUVELLE METHODOLOGIE

(Récapitulatif Français)

Afin d'atteindre une haute performance en matière d'environnement, la nouvelle méthodologie doit assurer la manière de reconnaître des opportunités et présenter une approche intégrée à toutes les parties prenantes de l'industrie de construction. La méthode de Durmišević 2006 et le logiciel OpenLCA sont adaptés et intégrés à la nouvelle méthode et au nouveau protocole, grâce aux résultats positifs après le test. Les informations manquantes dans chaque méthode et chaque outil peuvent être complétés par d'autres méthodes et d'autres outils existants. En fait, les méthodes citées et la synergie des outils, avec de petites modifications, peuvent aider à atteindre l'objectif de la recherche. La nouvelle méthode va améliorer la possibilité de prendre la décision lors des premières phases de conception, en suivant toutes les phases du projet et en rendant possible l'intervention à tout moment (phase du cycle de vie du produit/bâtiment) visant à améliorer la performance du projet, en termes de son impact sur l'environnement et en ce qui concerne l'utilisation/la réutilisation des ressources. Ainsi, une des tâches importantes de cette recherche est d'aider les parties prenantes à prévoir les futurs scénarios et ce que l'on peut faire après que le premier cycle de vie est terminé.

Après avoir défini la méthode et le protocole, l'on procède à la numérisation des outils car la numérisation est un processus qui aide à adopter la méthode et sa mise en place plus large. La méthode élaborée lors de cette recherche va évoluer dans un outil pouvant être numérisé.

En s'appuyant sur la recherche présentée dans les chapitres précédents et sur les analyses des avantages et des défauts, la méthode proposée dans cette recherche aboutit à la création du Protocole des déchets de construction -Construction Waste Elimination (CWE). Le Protocole CWE devrait montrer les différences dans les déchets potentiels et leurs impacts sur l'environnement à travers le cycle de vie / les cycles de vie des études de cas comparées lors du processus de la planification du nouveau bâtiment.

Le nouveau Protocole CWE est conçu comme une consigne à suivre afin d'arriver à produire peu de déchets de construction dans chaque cycle de vie. Les décisions relatives à la construction tireront profit de ce protocole, afin de prévenir l'impact négatif sur l'environnement en termes des déchets de construction. Le Protocole CWE sera expliqué pas à pas, passant par chaque étape des déchets de construction.

## **7. LOWERING ENVIRONMENTAL IMPACT IN TERMS OF CONSTRUCTION WASTE – THE NEW METHODOLOGY**

This academic research has investigated the background theories, methods and tools providing a view on the environmental impact of buildings and building process. Next theories and methodologies, that deal with waste prevention in construction and its impact on the environment, were reviewed:

- Building Information Modelling (BIM) in Chapter 5.1. in this research,
- Reversible Building Design (RBD) in Chapter 5.2. in this research,
- Life – Cycle Assessment (LCA) in Chapter 5.3. in this research.

After the research survey, review, testing of methods and tools' application has been done on case studies in Chapter 6. The results of Case study testing have demonstrated potential and shortfalls of the existing methods and tools to provide integrated overview of reuse and its impact on the environment.

As carefully explained in Chapter 5.1. in this research, BIM is very useful tool in the field of building environmental impact, but this research won't be able to take advantage of it, as the tool is not connected in a proper way with the other methods and tools that are chosen to test the methodology. For the purpose of this research, all calculations were easily done by hand.

To validate and apply the methodology RBD, method Durmišević 2006 was chosen. It provided the way to show the reuse potential of the tested case study and compare their environmental impact and building waste, according to the data provided. (in Chapter 6 in this research)

In attempt to find the best tool to calculate LCA, two commercially available tools, OneClick LCA and Open LCA, were applied to each specific case study, (in Chapter 6 in this research) to provide a view on the environmental impact in terms of the building waste of the chosen case study building system.

As already mentioned in Chapter 6, these methods were applied to the external walls, the representative building systems of the buildings made in Bosnia and Herzegovina. The case studies were chosen very carefully, considering the best representatives of reversible and irreversible type of construction method. In attempt to accurately identify the strengths of method Durmišević 2006 for building waste prediction, method was precisely applied to chosen Case studies. After that, testing the same Case studies was carried out with available software OneClick LCA and Open LCA, using corresponding EPD and Ecoinvent material databases.

Durmišević 2006 method and Open LCA software were adapted and incorporated in the new method and protocol, due to the positive results after testing.

Improvements that this approach and methodology will bring, can be considered depending on the final value of the building system and its impact in terms of waste. As already mentioned, the value definition can be seen differently in specific areas, as follows: (Figure 126)

- environmental value,
- social value,
- economic / financial value...

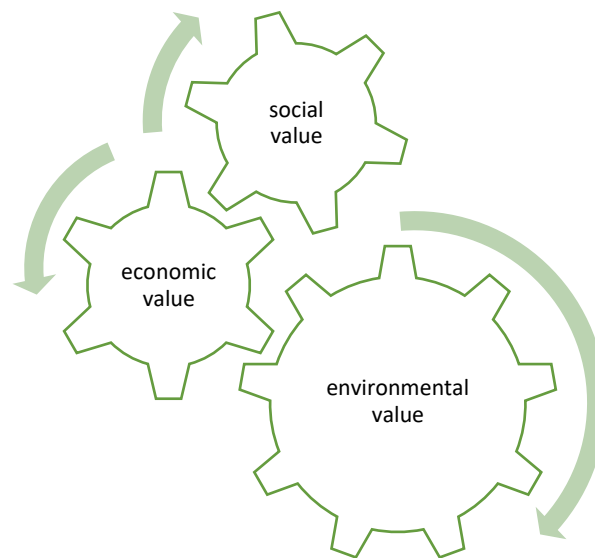

Figure 126. Value definition with focus on the environmental impact as a defined value that can help decision making process.

The impact in terms of the construction waste can be measured according to all these values. In this research the *environmental value* is in focus, because the values in the other areas will follow, if environmental value changes. When the construction industry stakeholders accomplish low environmental impact of the new building, then:

- Economic value of the systems will be preserved, as the parts can be reused and will not lose their value,
- Social value will be upgraded, as the land won't be polluted and fulfilled with waste. Spaces can be used for other purposes as social gatherings and green areas,
- Economic value will be predictable, as product will preserve its value during the whole time of use.

According to that goal, the environmental impact will be defined and measured and the systemic value will be considered accordingly.

Beurskens 2021 has made “cause-effect scheme identifying the main factors that influence the environmental impact benefit and the associated environmental benefits of reusing building materials”. In this analyses, the main factor criteria (that can influence the impact of the main factors) has been identified. Environmental impact benefits of deconstruction and reuse are evident (compared to a new production). Some of the very important benefits are:

- Less virgin resource consumption,
- Less waste generation,
- Lower environmental impact, carbon emissions, energy use and pollution to air, land and water.
- Lower pressure on nature due to reduction of loss of land to landfill sites, incineration facilities and virgin material extraction sites,
- More conservation of embodied energy and carbon,
- More resource productivity of building products.

In order to achieve high environmental performance, the new methodology has to provide a way of recognizing the opportunities and present integrated approach to the building industry stakeholders.

New method will improve the possibility to make decision format at the early design phases, following all project phases and providing the possibility to make intervention at any moment (product/building life phase) in order to improve the performance of the project, in terms of its environmental impact regarding the resource use/reuse. In addition to that, the important task of this research is to help stakeholders to predict future scenarios and what can be done after the first life-cycle is finished.

After the method and protocol is defined, the tool’s digitalisation should follow, as digitalization is the process that helps method adoption and its application quicker. Digitalisation can provide better overview of the building’s performance and its materials through all stages of building’s life as well as provide efficient communication and coordination between the stakeholders. The method developed in this research will evolve in a tool that can be digitalised, as part of further development.

## 7.1. IMPROVEMENTS FOR THE EXISTING METHODS AND TOOLS

After existing method and tools application (chapter 6 in this research), it is evident that every method or tool separately gives the result that shows which system has better performance in the tested area. Slightly disappointing is that the holistic approach, predicting future scenarios, some explanations and help in the decision making are missing. The main obstacle is that there is no interaction between the tested methods which would provide integrated view on the environmental impact of the building and the measures that can be taken in order to reduce the negative impact. Inevitably, future work will modify and upgrade methodology in this direction.

Noticeable deficit in the material databases is lack of connections and relations of building parts. Commercial BIM, which includes connecting materials and analyses the possibilities for assembly and disassembly, is still not available. Building project designer engineers are using BIM to make a building plan and present it to the investor. Construction stakeholders are using the BIM to have information about used materials, so they can calculate total quantities and estimated price and present it to the investors.

All stakeholders that are in the construction industry profit from BIM, but none of the BIM tools is totally exploited in order to give the possibility to make decision not only in terms of quantities and price, but also in terms of environmental protection possibilities. BIM should be upgraded in terms of sustainability. It can be upgraded with additional plug-in or compatibility software that will do the decision making proposals.

Thus, in this research, the BIM is not a tool that will be helpful in the process of finding the right method to lower the construction waste. Material specification and its quantities can be calculated by hand for every case study in this research.

Durmišević 2006 methodology provides building system evaluation. The reuse potential framework can be successfully established in accordance to it. Reuse potential indicators important to facilitate prediction of the construction waste were detected and will be incorporated in the new methodology. The environmental impact in terms of waste quantification is missing and it should be calculated additionally.

Open LCA software results provide quantification of the building environmental impact and waste as a simple value of the basic substances and their impact on air, soil and water. Minor deficit of the tool is that it doesn't offer evaluation and explanation, or even possible scenarios for another life-cycle. The results are very precise regarding quantities of polluting materials, but it is not complete when it comes to decision making. The tool doesn't suggest what should be corrected in case that the building impact is very big, or what could be done to lower the impact.

The missing areas in each method and tool can be fulfilled with other existing methods and tools. In essence, mentioned methods and tools synergy, together with some minor

adjustments, can help to reach the goal of the research. Some upgrades, such as methods and tools synergy, can offer a solution to lower negative environmental impact and solve the problem of construction waste. The main advantages and deficiencies of the mentioned methods and tools are shown in the Table 7.

	Method / tool	Helps to lower construction waste	Missing information	Suggested synthesis
1.	BIM tool	Connected with material database (info about used materials, their quantities and EI)	Missing connecting materials and relations between building parts.	With RBD tool and LCA tool
2.	RBD and RP method	Rp indicator shows level of reusability (Higher Rp = lower construction waste and vice versa)	Not connected with material database, missing quantities and total EI.	With material database, BIM and LCA
3.	LCA tool	Connected with material database and shows EI for each material and calculates total EI.	Missing material relations (how to separate materials to reuse them)	With BIM and RBD tool

Table 7. The advantages and deficiencies of the mentioned methods and tools.

As already mentioned, existing BIM tool was not connected with RBD tool or Open LCA tool. The project considering connecting the RBD methodology with BIM, adding plug-ins to achieve “Reversible BIM”, was elaborated in the paper Durmišević et al 2021. The framework of Digital Deconstruction (DDC) Platform was established during Interreg. NWE to the Digital Deconstruction project. Optimisation, integration of four DDC modules and testing the integrated platform on the real-life pilot cases will be done in the near future. (Durmišević et al. 2021)

There remains a need for an efficient method that can assist the decision making process when designing the new building with low environmental impact.

This method can be incorporated into a Tool (or integrated tools) that will make the decision-making process easier for the new building system in terms of lowering the quantities of construction waste and total environmental impact.

The Tool can be a hybrid consisting of the existing material / product database with the BIM, which is compatible with reuse potential tool (to calculate the building system reuse potential) and the LCA software to calculate environmental impact in every predicted scenario and for each life-cycle. (Figure 127)

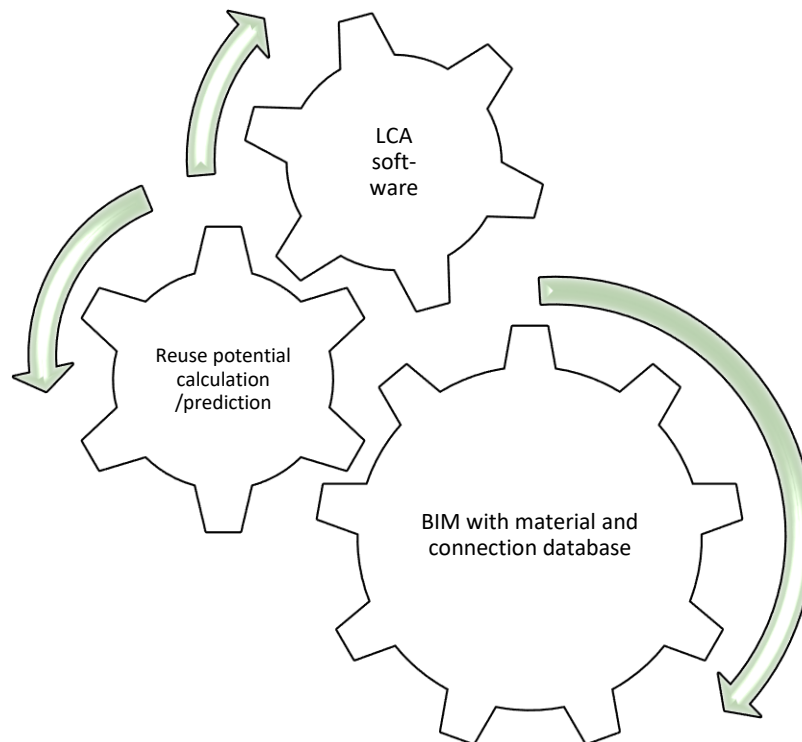

Figure 127. Tool assisting to lower the environmental impact of a building system especially in terms of construction waste.

In attempt to reach the goal of sustainability, the upgrading of the existing LCA software should be done with:

- database of connection materials,
- building parts relations,
- scenarios of possible transformations and upgrade in the first life-cycle,
- scenarios of possible transformations in the next life-cycles. (Figure 128)



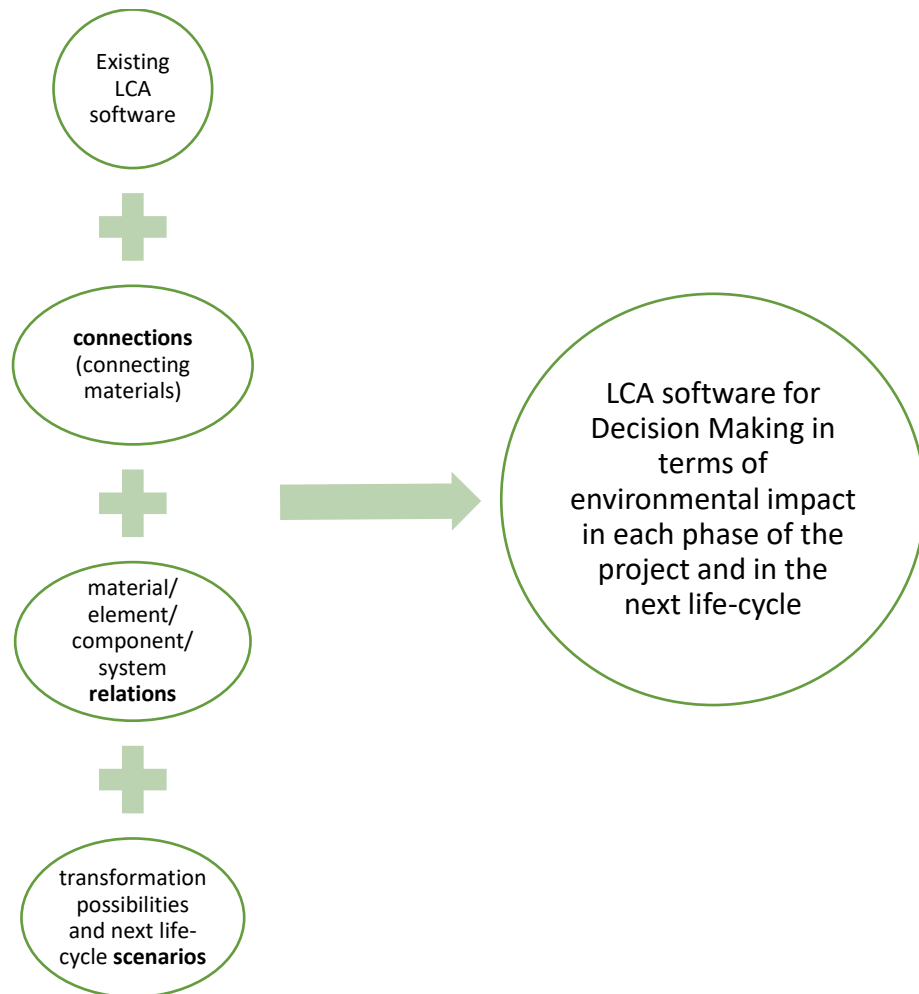

Figure 128. Suggested upgrade for the LCA software which would help in decision process regarding environmental impact of the future building.

In attempt to satisfy the requirements of the task, to have the *evaluation and quantification of the environmental impact* in terms of building waste, it is recognised that the combination of RBD and LCA methodology will be able to provide the clear picture of the building system impact in the first and the next life-cycle. It can easily provide comparison of analysed systems in terms of the potential building waste in every analysed life-cycle.

The new method has to:

- improve decision making process allowing design modification in early and late design stage,
- allow adding missing data in the material database and missing parameters,
- overcome obstacles regarding transparency of the whole procedure and data,
- integrate all project life-cycle phases to provide complete picture,
- provide real-life feedback regarding the environmental performance of technical life of the building during each life-cycle phase of the building,
- support stakeholders providing different reuse/end of life scenarios after the first use phase,

- validate designed system in order to determine the environmental impact and building waste,
- provide evaluation and quantification the building waste (and its potential environmental impact) at the end of each life-cycle.

The integrated method has to enable the synthesis of the following:

- Reversible Building Design Protocols and Reuse Potential method;
- Material Databases (with precise and detailed material data, material technical life expiry dates)
- Product and system databases containing relational patterns / with connection specification / between materials for products and systems, in addition to the material database;
- Bill of materials - BOM (calculated in the BIM or manually);
- Environmental impact calculations (e.g., LCA) for different building life-cycle scenarios.

This methodology and protocol will be tested on external walls Case studies and should be further tested on the other more complex systems and on the whole building.

## 7.2. Construction Waste Elimination (CWE) Protocol

The decision making procedure to improve the design of the building system regarding the construction waste and lower its environmental impact, should start with defining and predicting the time frame. Although the most of the buildings are assumed to last forever as imagined and designed by architects and designers, usually, there are two scenarios in practice:

1. Building will stay as it is and will be used for the predicted function at least 50 years or more;
2. Building will change its designed function and experience consequential transformation in the next 10 or 20 years.

In both cases, there will be a necessity to change some building systems in terms of maintenance, upgrade and repair.

Predicting optimal life expectancy for the system can be done statistically, considering the type of the building and country where the building is built, and the reference can also be the shortest lifetime of the one of its parts.

If there is the first scenario and the expected building lifetime is more than 50 years, there should be a possibility to change the systems whose life expectancy is shorter. Possible scenarios should be taken into account (during design) before it is too late.

When proposing / predicting potential use scenarios for a building in a requested time frame, possible timeline can be:

- a. Shorter than the expiry date of the material/part with the shortest technical lifetime,
  - b. The same as the expiry date of the material/part with the shortest technical lifetime,
  - c. Longer than the expiry date of the material/part with the shortest technical lifetime.
- 
- a. In the scenario where the life expectancy of a building life is predicted to be about 20 years, most of the building parts have longer technical life. The building parts should have high reuse potential. The building technology should allow reuse of these parts, which should be reachable easily. The advantage of this way of planning is lower quantities of construction waste when building life-cycle is over.
  - b. The second scenario is when a building life is the same as the expiry date of the material/part with the shortest technical lifetime. After the first life-cycle, the

building should be disassembled carefully and all building parts should be easily reached and reused. (except the part with expired lifetime). The expired part should be recycled.

- c. If the timeline of the building is longer than the expiry date of the material/part with the shortest technical lifetime, then that material/part must be carefully removed or upgraded (without damaging other parts) after its first life-cycle. It should be possible to add some new materials to the system, to continue its life in the building. In attempt to lower Construction Waste Elimination in the next life-cycle/transformation/, building technology has to enable removal of the old material and facilitate assembly of the new material. Maintenance of the building that was designed for upgrade (with the lowest quantity of the waste) during time is shown in the Figure 129.

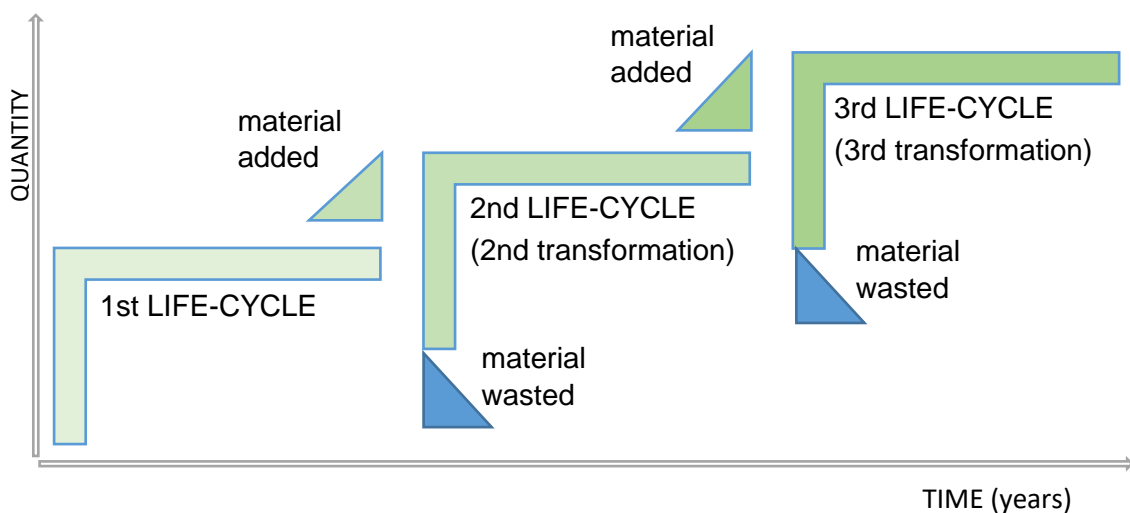

Figure 129. The process of creation of the construction waste and necessity for adding the new quantity of materials in the next life-cycle/transformation/ during time.

The systems inside the building with technical life expectancy of more than 50 or even 100 years should be determined. These building systems should be carefully designed and placed in the building in a way that ensure easy removal, in case that the building's life is shorter than the system's life or in case that some functional change happens and the upgrade should be made.

If we are speaking about only one of many building's system – an external wall, whose lifetime expectancy is approximately 20 years, then we have to consider the possible maintenance, upgrade and transformations during its lifetime.

It is important to predict possible scenarios for each building system (in this case the external wall). For each scenario, the reuse potential should be measured for parts and the whole system.

If the system is declared with “high reuse potential”, low construction waste creation with low environmental impact is expected. It means that there are possibilities to repair, reuse and upgrade the system and its parts (some of them separately, some of them in the system) within different transformations or maintenance purposes in the same life-cycle or for some other purpose in another life-cycle. As explained in chapters 5 and 6 in this research, in the system with Rp value higher than 0,6 (Durmišević 2019), many of its parts are not going to be just wasted and sent to a landfill. Unfortunately, this is not the only parameter that ensures low environmental impact. This makes a basic framework and gives directions to stakeholders when deciding what system to choose. Other variables should be investigated and included when decision regarding future construction waste creation must be made.

The system’s *value preservation during time* should be visible to stakeholders, as the time period in which this can be done. The number of transformations and upgrading should be predicted, even if this number is approximate. In the case of the external building wall, the maintenance works are very frequent, and external walls should be able to follow functional changes in the building and its surroundings. The walls should be designed for transformation and multiple use.

It is not the same when we are speaking about 10 years or 100s of years of lifetime and multiple life-cycles. Also, it depends on how many transformations have been done during the required time period. These carefully gathered data must be considered, analysed and calculated in the final score, so the best decision can be made. The holistic approach, uniting the existing methods and their results and conclusions, can give a clear picture of building’s and its parts’ sustainable possibilities to all building and construction industry stakeholders. All mentioned methodologies and tools should be integrated to contribute in decision to achieve low environmental impact. (Figure 130)

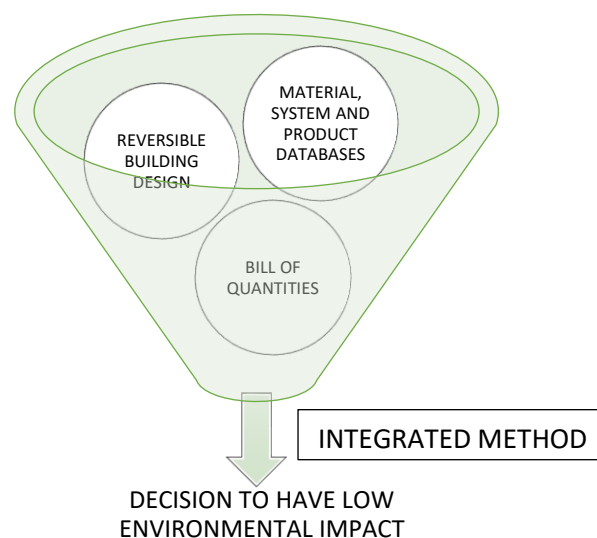

Figure 130. How to achieve low environmental impact?

Based on inventory presented in previous chapters and gap analyses, the method proposed in this research results in creation of Construction Waste Elimination (CWE) protocol. Beside the Construction Demolition Waste (CDW), where considering what to do with the potential and existing building waste (EC 2008 and EC 2018), it should be necessary to establish The Construction Waste Elimination (CWE) protocol.

CWE protocol should show the differences in potential waste and its environmental impact through the life-cycle / life-cycles / of compared case studies in the process of building planning. Average Conn value represents the part of the product that cannot be reused in another lifecycle and will be further explained as crucial factor in producing waste after the building's first life-cycle. (Table 8)

	1 <sup>st</sup> Life-cycle ‘		2 <sup>nd</sup> Life-cycle “	
	Average Conn value (Conn = 1-Rp)	Environmental Impact /EI/ per chosen category	Average Conn value (Conn = 1-Rp)	Environmental Impact /EI/ per chosen category
Case Study 1 (CS1)	Conn1’	EI1’	Conn1”	EI1”
Case Study 2 (CS1)	Conn2’	EI2’	Conn2”	EI2”

Table 8. CWE protocol shows the differences in potential waste and its environmental impact through the life-cycle / life-cycles / of compared case studies in the process of building planning. Conn value shows the part of the product that cannot be reused. Rp is Reuse potential calculated using Durmišević 2006 methodology.

This procedure can help preventing the construction waste and lowering environmental impact during maintenance and transformation phases of a building and its parts, too. The differences between case studies can be visible and better solution can be easily found and demonstrated.

The new CWE protocol is envisioned as an instruction to follow in order to achieve low construction waste in each life-cycle. As described in the Chapter 7.1. in this research, the methodology should be followed from the predesign phase through all other phases in the building project, to prevent the potential building waste and lower negative environmental impact.

In attempt to predict the scenarios, basic analyses and calculations at the early stage of the building project will provide a clear picture about possibility for disassembly (during maintenance) and transformation(s). If the predictions are good, then the designed building technology should ensure upgrade, extraction and reuse of systems, components, elements and materials and their involvement in the circular and

sustainable building industry. The integrated method will propose steps in each building phase. Building phases are explained in the chapter 2.1. in this research (Figure 18).

Construction and building related decisions will take advantage of this protocol, in order to prevent environmental impact in terms of the construction waste. CWE protocol will be explained step by step, going through every phase of the building project.

### PREDESIGN / DESIGN phase

Proposing and predicting scenarios for the building or its part in requested time-frame should be done in the predesign phase. Time-frame can be predefined by law regulations or by statistical data in a chosen region.

Stakeholder can develop a proposed scenario, but a computer can also make assumption and suggest the first time-frame (T1).

Survey and analyses for the new building, in terms of life expectancy, are as follows:

- statistically calculated first life-cycle expectancy, depending on the type of the building and the region where it will be built;
- optimal life expectancy for the building system(s), based on the shortest technical lifetime of one of its parts or expected first life-cycle duration.

Based on the data after the mentioned analyses, conclusion would be obtained after the predesign phase.

If the analyses for specific case study determine that the duration of the first life-cycle of the building is longer than 50 years and all its parts have the technical life and expected use life more than that, than the next steps for the whole building are not necessary to be followed, but it is advisable. This kind of the building is very rare. Even if, theoretically, it is possible to predict durability, in practice, each building has to have at least one huge reparation during the period of 50 years.

Even with the intention of longevity, the building parts need at least maintenance in 50 years' period. The focus can be on the system that needs to be changed due to the damages during use and maintenance, e.g., final layer /skin/ of the building which can be damaged during the use phase and needs reparation /special maintenance/ or change. To ensure durability and to take advantage from it, every building part needs a warranty for the period of 50 years, under certain conditions. From the experience and in practice, product warranties are much shorter. Producers have to adopt the practice to follow their product for a longer time period and take it back to repair or replace in

the warranty period. It will be a long way to achieve that practice, but it should be obligatory and supported by government (or NGO) for sustainable future.

Building parts should have the proof and warranty that they will last and be maintained for predicted time period, under certain conditions.

Stakeholders (designers, architects and engineers) usually define building design in the predesign and design phase. This step includes obligatory set of drawings, plans and calculations for building permit, defined by Spatial Planning and Building Law in each country. That building project includes all necessary plans, studies and projects defined by Law (beside obligatory application form).

In Federation of Bosnia and Herzegovina, Spatial Planning Low (“Zakon o prostornom uređenju”) of Sarajevo Canton, Official Gazette of Sarajevo Canton no. 24/2017 and 1/2018 (Article 97 - Main project), state that the application for the building permit should have next documents in the Main project:

- a) name and registration of the legal entity performing the design;
- b) signatures of the responsible designers for all parts of the project;
- c) project task certified by the investor;
- d) general and special conditions, standards, norms and regulations for the facility or project;
- e) technical description for all works with surface proof;
- f) bill of quantities and estimate of works, materials and equipment;
- g) architectural project;
- h) construction project;
- i) hydro installation project;
- j) electrical installation project;
- k) mechanical design;
- l) technological project;
- m) exterior design project;
- n) measures defined by the environmental permit, if it is the purpose of the building which is defined as an activity that may endanger the environment;
- o) study on geo-mechanical research of foundation bearing capacity;
- p) fire protection study;
- r) study of safety at work;
- s) and other contents in accordance with special regulations.”

Spatial Planning Low (“Zakon o prostornom uređenju”) of Sarajevo Canton, Official Gazette of Sarajevo Canton no. 24/2017 and 1/2018 (Article 97 - Main project) state:

“(7) For prefabricated parts of a building and equipment, which have a certificate or attestation of conformity or for which it has been proven in some other prescribed



manner that they have been manufactured according to the applicable standards, it is not necessary to prove it again in the main design. The above evidence as an attachment is an integral part of the project.

(8) The investor may start construction on the basis of the main or detailed design, on the basis of which the construction is inspected, the technical acceptance of buildings and the use permit is issued.”

Each building project has a huge environmental impact, therefore the environmental study has to be obligatory for all building projects, not only for the specific buildings which is defined “as an activity that may endanger the environment” by Gazette of Sarajevo Canton no. 24/2017 and 1/2018 (Article 97 - Main project). In attempt to lower the impact, this kind of study should become obligatory. This study will provide a way to track the building impact before, during and after its first life-cycle. This kind of study should be obligatory and provided by the government, to really enter into force. If this stays as non-obligatory and financed by the investor, it will be not implemented.

Beside projects for water, electricity and heating installation, energy efficiency project is obligatory in many European countries. That kind of study is more than necessary when stakeholders are planning a new building structure.

After PREDESIGN phase, which is considering the scenarios, specific calculations and necessary drawings required by Law, according to the new methodology, the construction phase cannot (should not) start before the next four steps in DESIGN phase:

- 1<sup>st</sup> step – material relations,
- 2<sup>nd</sup> step – reuse potential calculations,
- 3<sup>rd</sup> step – bill of materials which include connecting materials and their relations (upgrade for the initial bill of quantities required by Law),
- 4<sup>th</sup> step – environmental impact calculation.

#### 1<sup>st</sup> STEP in design phase – matrices with building material relation

With the intention to enable tracking the project from the beginning, the matrices with relations between the materials with defined connections should be developed alongside with the process of choosing the materials for the building system. (Figure 131)

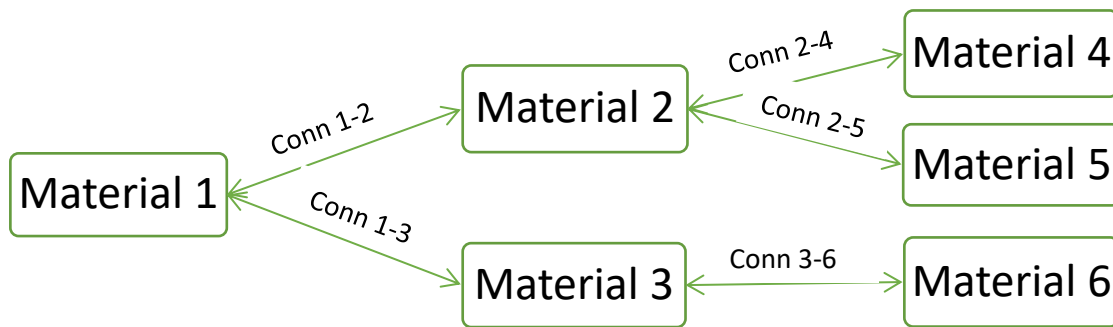

Figure 131. Materials in the building system and relations and connections (conn) between them.

Connection materials should be defined in material database with all attributes as other building materials. Connection itself should be described as material and in terms of disassembly possibilities. The net of relations between building parts shown in the Figure 131 should provide clear picture of relations and possibilities of assembly and disassembly.

### 2<sup>nd</sup> STEP in design phase – reuse potential calculation

By doing the calculation of the reuse potential (Rp) indicators (Durmišević 2006, 2019) that have substantial effect on the construction waste, stakeholders will be able to maximize the potential for transformations of the building.

Rp is ranking [0.1,1]. More info about Rp indicators is in the chapter 5.2. in this research. Three Rp indicators have been validated as very important for this research, in order to predict the construction waste after transformation. These Rp are:

- Relational dependences between parts of the system,
- Type of the connections,
- Assembly and disassembly possibilities.

Although Rp tool is in the development, indicators (Durmišević 2006, 2019) can be calculated by hand for the purpose of this research.

The average of calculated indicators' values can be ranked according to the model Durmišević 2018. The result can be classified in three reversibility categories. (Chapter 6.1.1. in this research)

If the final score of the building system is  $R_p < 0.3$ , then some upgrades should be done in its design, to achieve higher reversibility, in order to have lower environmental impact after building system modification during maintenance, transformation or in the next life-cycle. If this, 2<sup>nd</sup> step, is done in the *design phase*, there will be open possibility to do some modification in design, in an attempt to achieve circular building and

construction, therefore to preserve the value of each part of the building, as well as the value of the building itself.

Available previously conducted researches (Chapter 5 in this research) showed that the environmental analyses have no practical use when the calculations are done in the later building phases, after the building process has already started. Therefore, the reuse potential calculation has to be in the design phase.

### 3<sup>rd</sup> STEP in design phase – bill of materials

It is possible to calculate bill of materials by hand or using any BIM that is connected with material database. The bill of quantities is required by Spatial Planning Law (“Zakon o prostornom uređenju”) of Sarajevo Canton, Official Gazette of Sarajevo Canton no. 24/2017 and 1/2018 (Article 97 - Main project), but this kind of document needs some adjustments and upgrade in details.

The necessary modifications include:

- database of connections, which should be specified when calculate the quantities;
- calculation of quantities and description of materials which can be reused in the proposed time frame (dimensions already in the project, data for reusability options for each material or component should be already in the database) The data should be defined in correlation with network matrix and physical possibility for disassembly;
- calculation of quantities and description of materials that cannot be reused for the new purpose in the requested time frame and must be recycled (for materials with shorter life expectancy compared to the first building life-cycle and also for the parts that cannot be separated from the whole and cannot be used as a cluster for other purpose after the first life-cycle is over).

The total quantity of each building material and connecting material is easy to calculate by hand, as dimensions and details are already given in the project. Therefore, it is simple to calculate volume or weight for each material. If the project is designed in BIM, then the calculations will be done automatically. Preferably, existing BIM should have additional plug-ins and should be upgraded with material relations and environmental impact data for every material in database.

To obtain maximum use of the building part, it is recommended to have material database with “expiry date” for each material, so reusing building part in specific time-frame can be assumed.

#### 4<sup>th</sup> STEP - environmental impact calculation

In attempt to have the precise data with numerical values, environmental impact calculation will be performed in the LCA software, considering all input from the previous steps.

- a. The environmental impact in terms of construction waste quantities for the first building life-cycle (until the first transformation) for the whole building or for the part of the building, can be simply calculated using the LCA software and choosing the right methodology;
- b. The environmental impact for the second life-cycle of the building or its parts can be calculated taking into account reuse potential and connections between parts. These data are playing a big role in the total score. It is necessary to calculate the total environmental impact in terms of Construction Waste Elimination (CWE) in the second life-cycle. The total value depends on the relations between parts, and not just on the quantities of used materials and their individual impact.

As explained in the both LCA tools, One Click LCA and Open LCA, it is assumed that the impact of all materials (in production and use phase) is calculated in the first life-cycle and if used in the second life-cycle, their impact is calculated as 0.

The calculation and impact results do not present a complete lifecycle assessment (LCA) for the building and building system, as it doesn't show the impact of transport, energy and manufacturing on site and their impact. These categories and their quantities are comparable to the ones used during assembly at the first place. In this particular research, the LCA tool is used to calculate the building material impact on the environment and does not consider other impact categories.

Optionally /if not known/, all added materials and their impact, can be assumed to have maximum 10% of additional impact in the second life cycle. This assumption is based on the data from practice that the costs for the transport are approximately 10% of the cost of the goods.

There is necessity to introduce the *Conn x-y values* to underline distinction between the parts which can be disassembled and the ones which cannot. (Figure 132) *Conn values* are assigned to the connection types used between building parts or materials. Value depends of the disassembly possibilities of the connection.

Conn values are very important when the necessity for transformation arises. The disassembly can occur in the first life-cycle (maintenance phase – changing damaged or used parts, upgrading some elements etc.) or in another life-cycle.

If the Reuse potential connection indicator is maximal and equals 1, then the potential waste is minimal and will be nearly 0, as well as the value/coefficient Conn. If the Reuse potential connection indicator is minimal and has value 0,1, then the waste will be maximal and Conn coefficient value will be 0,9.

The Conn values can be explained depending on the type of the connection proposed by Durmišević 2006 (Figure 132), per ex.:

- Indirect connection with additional fixing device or middle element is the best solution for disassembly, because the connected parts can stay undamaged when separated. In this specific case, the connecting material can be broken, but materials that it connects could be preserved and undamaged, if designed wisely. Reuse potential connection indicator is determined and its value is maximal, therefore Rp is 1. If Rp has maximal, then Conn value, which represents waste after the disassembly, can be nearly 0.

According to that, the Conn value would be the waste material which cannot be reused after disassembly, and can be calculated for other connection types in Figure 132, according to the equation: **Conn = 1-Rp**







1. indirect connection with additional fixing device 1,0		1. Conn ~ 0
2. indirect connection via independent third element 0,8		2. Conn = 0,2
3. indirect connection via dependent third element 0,7		3. Conn = 0,3
4. direct connection with additional fixing device 0,6		4. Conn = 0,4
5. direct connection between two pre-made component 0,4		5. Conn = 0,6
6. indirect connection with third chemical material 0,2		6. Conn = 0,8
7. direct chemical connection 0,1		7. Conn = 0,9

Figure 132. Reuse potential ( $R_p$ ) indicators depending on the types of connections by Durmišević 2019 (left) and Conn values, which present the indicator for potential waste after disassembly, which are calculated in accordance to  $R_p$  values (right).

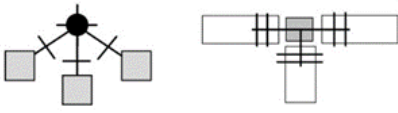
## REALISATION / PRODUCTION / CONSTRUCTION phase

When construction starts on the building site, there are, inevitably, a lot of materials and products that won't be used in the building, then packages that would remain on the building site as a waste. Precise building planning and calculation should prevent that waste.

Preparation and prefabrication in factory should be done according to a precise drawings and a bill of quantities (especially the bill of materials) to avoid massive quantities and leftovers of materials on the building site. Lower the quantity of package materials and enabling use of biodegradable materials will provide the way to achieve the low waste building site.

Materials, components, elements and even systems should be produced precisely and brought to site to be built in the new building. In that case, possibility of human error during assembly will be decreased, assembly would be quicker and of course, there will be no construction waste.

Even though the prefabricated building has a lot of advantages, many designers and architects are not satisfied with possibilities. Producers are not interested in prefabricating small amount of pieces for one specific building. Although in many ways prefabrication in building industry has a lot of benefits, prefabricated buildings are very rare in practice. The combination of prefabricated building and building on site would be preferred.

If some specific part has to be cut or make on the site, it will be a good practice to return the leftovers to the producer to use it, instead of use of virgin materials. Producers should promote the return of leftovers and return of product packages. It will help a lot to achieve circular building and lower the waste.

## USE / MAINTENANCE phase

It is advisable to take advantage of digitalization and do the mapping of all built-in materials when a building is finished. The forming / preparing database for materials used in the building (during the requested time period) is more than advisable. Each part should be enabled for traceability for future material tracking and harvesting, if necessary. If all predesign and design steps are carefully followed, then every part of the building is already in database, thus the maintenance would be easy and every reparation would be quickly and done with minimum cost.

Later building phases will take advantage of the complete database. It should contain following data for each building part:

- the date when it was built-in,
- its technical life duration,
- relational pattern in case of transformation or end of the building life-cycle.

### TRANSFORMATION phase

When it comes to the transformation, practically the same situation occurs as in the maintenance phase. If everything is predicted in the design phase, documented with precise data, the transformation can be done very easily and at low cost, as building parts are keeping their value during the time.

The necessity for database, where the reusable parts are stored, is identified. This kind of database, that includes data of the reusable building parts, will provide a way to achieve sustainable building. Importance of such database and the network of databases should be established in this phase. Establishing this kind of database will guarantee easy and sustainable transformation and:

- Environmental impact will be very low,
- Economic values would be preserved and
- Social value will be improved.

### DECONSTRUCTION / DEMOLITION phase

If previous steps are followed as described, deconstruction phase should be very easy and worthwhile. This phase should not be “demolition”, after which comes solving the problem of construction waste. Building technology should provide as much materials reuse as possible, to achieve less waste. It should be rather “deconstruction” instead of “demolition”.

Deconstruction can be done at the end of the first life-cycle or in the phase where some parts have to be changed. If all materials are easy accessible and disassembly predicted and previewed, stakeholders should be able to get the building parts for other building or other use in the case that the first life-cycle of the building is finished. If the deconstruction is done for the reason of maintenance, the disassembly should be easy, which means that change of the part and assembly should be very quick. If deconstruction is planned ahead, then all parts should be in the reuse database with all data, among which is the date of deconstruction and their availability. After that, the interested stakeholders could make reservation for the materials they need for their next building or project.

If the planning and information flow is done properly, all parts can be directly transported to the new building site instead of the warehouse.

## 8. CWE PROTOCOL APPLICATION

### Summary (English)

Application of the new methodology and the Construction Waste Elimination (CWE) protocol will be done on the same Case study on which existing methods were tested, to see the differences between the methods.



## 8. MISE EN PLACE DU PROTOCOLE CWE

(Récapitulatif Français)

La mise en place de la nouvelle méthodologie et du Protocole Élimination des déchets de construction - Construction Waste Elimination (CWE) sera faite dans la même étude de cas sur laquelle ont été testées des méthodes existantes, afin que l'on constate des différences entre les méthodes.

## 8. CWE PROTOCOL APPLICATION

Application of the new methodology and Construction Waste Elimination (CWE) protocol will be done on the same Case study that existing methods were tested, to see the differences between the methods.

### 8.1. EXTERNAL WALL OF THE GDC

Considering the methodology explained in the Chapter 7, environmental impact in terms of the construction waste for the previous case study of the Green Design Centre (GDC) wall can be measured. The GDC wall was predesigned to be transformable and with high reusability, and it is a proper example to test the Construction Waste Elimination protocol. The GDC wall with its materials is shown in the Figure 133.

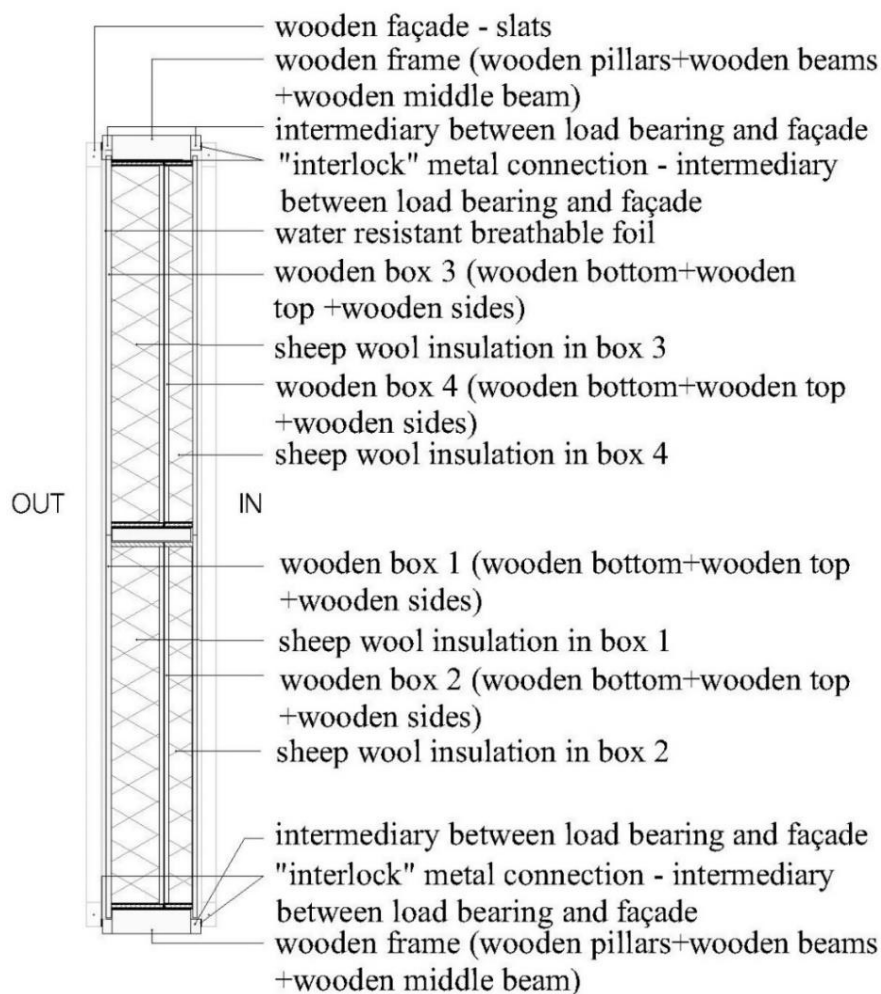

Figure 133. Vertical section of the GDC wall with its materials

## PREDESIGN PHASE:

### **Optimal life expectancy**

The stakeholder or computer assumption for this case study GDC wall was made according to:

- statistics for building lifetime (transformation) expectancies in the Case study country,
- predicted lifetime for materials used in the system (specify the material with the shortest lifetime).

Maximum likelihood estimates of life expectancy, as not given by producers, was calculated according to the available database of expected lifetime for each building material. The life expectancy for wood is shown in the Table 9. below and can be used for the prediction of longevity in this analyses.

	Type of the wood	Exposed to moisture open area – under the roof	In rooms with good protection from moisture	Completely submerged in water
1	Oak Chestnut Elm Acacia Hornbeam	60 - 120	Unlimited / more than 500 years	500 years and more
2	Ash Birch Maple	20 - 60	Unlimited / more than 500 years	50-100 years
3	Beech Planetree Poplar Lime-tree	30	Unlimited / more than 500 years	Less than 50 years
4	Larch Pine Spruce	100	Unlimited / more than 500 years	500 years and more

*Table 9. Wood longevity / durability by Campredon (Neidhart 2005)*

According to the upperTable 9, the pine tree wood can last at least 100 years outside in humid or protected area. The data for longevity of sheep wool point out the wool durability of 100 years, if properly ventilated. Thus, the prediction for the longevity of this case study GDC wall is approximately 100 years. The wall was designed to have a

good disassembly possibilities and each part can be reused separately during this time period, too. (in case that the building changes its concept or function and that change needs to be followed by structure and shape).

As previously envisioned, GDC building will be transformed every 10 years and the wall will change its position or position of its parts. It is possible to interchange building and wall parts within the same building, or reuse its parts for another building.

#### Proposing / predicting scenarios for the building in requested timeframe

Initially proposed scenario and first timeframe (T1) is 10 years, when the first building life-cycle is finished. It means that 5 transformations can take a place in the time-frame of 50 years.

Number of possible transformations with this kind of wall structure, with specially designed dismantling connections and “intermediary” (middle element) (Durmišević 2006), has been tested on the site during the project BAMB Horizon 2020. It is concluded that, after 5 to 10 transformations, the middle element has to be replaced. A producer could propose the reuse for the other elements, or recycling for each part, in the estimated timeframe. If not, the software should have the possibility to offer some suggestions. (if connected to the database with materials supply and demand). The database in accordance to the new technology possibilities regarding material reuse and recycling. should be provided and should be incorporated in the existing commercially available material / product database.

With the intention of reusing wood for the same purpose, GDC case study wall can take advantage of this methodology and lower the building waste in the next life-cycle. The exception are smaller pieces (damaged parts, if there are some) or connecting parts. The damaged pieces can be recycled and replaced with the new ones in the building.

In accordance with the explained precise planning and analyses, this Case study wall’s life-time would be at least 50 years with 5 transformations, which are planned ahead to use as much as possible parts and add only new parts if the new planned structure is bigger and cannot be “puzzle” from the existing ones. In attempt to reuse all parts in the new structure, for the sake of achieving zero waste, unused parts would be put in the reuse material database and incorporated in another project.

## DESIGN PHASE:

### 1<sup>st</sup> STEP:

#### The matrices with relations between the materials with defined connections

Relations and connection types used between materials (or building parts) have been defined at the beginning, when building materials were chosen. In the case study of the GDC wall, it is very important to know the relations between building parts. (Figure 134, Figure 135)

When the necessity for transformation comes, in the first life-cycle (maintenance phase – changing damaged or used parts, upgrading some elements etc.) or in another life-cycle, each building wall part can have a new role.

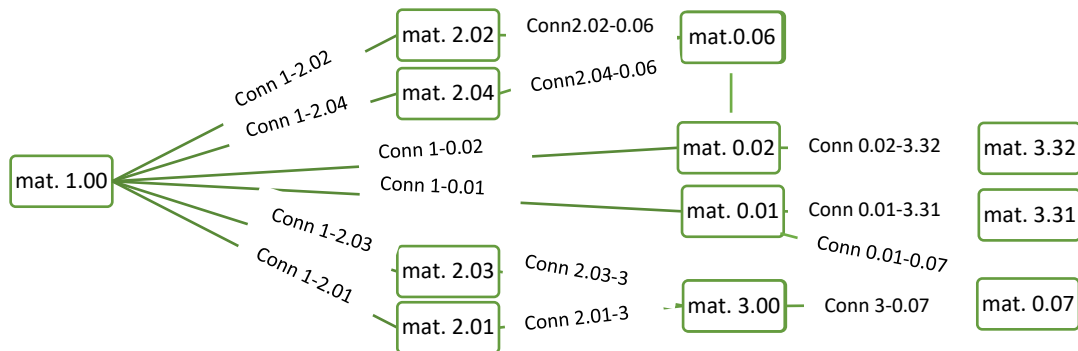

Figure 134. Matrices with relations and Connections values (Conn) between materials in the case study GDC wall.

#### Material codes:

<span style="border: 1px solid black; padding: 2px;">1.00 Wu, Fr</span>	wooden frame (wooden pillars 1.01 and 1.02 + wooden beams 1.11 and 1.12 + wooden middle beam 1.13 )	<span style="border: 1px solid black; padding: 2px;">3.01 Sh, Wu</span>	sheep wool insulation in box 1
<span style="border: 1px solid black; padding: 2px;">0.01 Wu, In</span>	intermediary between load bearing and facade •	<span style="border: 1px solid black; padding: 2px;">2.02 Wu, In</span>	wooden box 2 (wooden bottom 2.12 + wooden top 2.22 + wooden sides 2.33 and 2.34 )
<span style="border: 1px solid black; padding: 2px;">0.02 Wu, In</span>	intermediary between load bearing and interior finishing board •	<span style="border: 1px solid black; padding: 2px;">3.02 Sh, Wu</span>	sheep wool insulation in box 2
<span style="border: 1px solid black; padding: 2px;">0.03 Wu, Cu</span>	"interlock" metal connection - intermediary between load bearing and facade •	<span style="border: 1px solid black; padding: 2px;">3.32 Wu, Sl</span>	interior wooden slates board
<span style="border: 1px solid black; padding: 2px;">0.05 Wu, Cu</span>		<span style="border: 1px solid black; padding: 2px;">2.03 Wu, Br</span>	wooden box 3 (wooden bottom 2.13 + wooden top 2.23 + wooden sides 2.35 and 2.36 )
<span style="border: 1px solid black; padding: 2px;">0.04 Wu, Cu</span>	"interlock" metal connection - intermediary between load bearing and interior finishing board •	<span style="border: 1px solid black; padding: 2px;">3.03 Sh, Wu</span>	sheep wool insulation in box 3
<span style="border: 1px solid black; padding: 2px;">0.06 Wu, Cu</span>		<span style="border: 1px solid black; padding: 2px;">2.04 Wu, In</span>	wooden box 4 (wooden bottom 2.14 + wooden top 2.24 + wooden sides 2.37 and 2.38 )
<span style="border: 1px solid black; padding: 2px;">0.07 Wu, Fr</span>	"U" metal profile - connection for foil and box position fixing •	<span style="border: 1px solid black; padding: 2px;">3.02 Sh, Wu</span>	sheep wool insulation in box 2
<span style="border: 1px solid black; padding: 2px;">3.00 Br, Fo</span>	water resistant breathable foil	<span style="border: 1px solid black; padding: 2px;">3.31 Wu, Sl</span>	facade slates board
<span style="border: 1px solid black; padding: 2px;">2.01 Wu, Br</span>	wooden box 1 (wooden bottom 2.11 + wooden top 2.21 + wooden sides 2.31 and 2.32 )		

Figure 135. Material codes for matrices with relations and connections between materials in the case study GDC wall.

It is possible to do preliminary design in BIM (software for 3d modelling), then to take advantage of it and to have the material relations in 3d model presentation. Relational pattern schemes and connections between materials and components should be considered and marked when completing BIM model. (Figure 136)

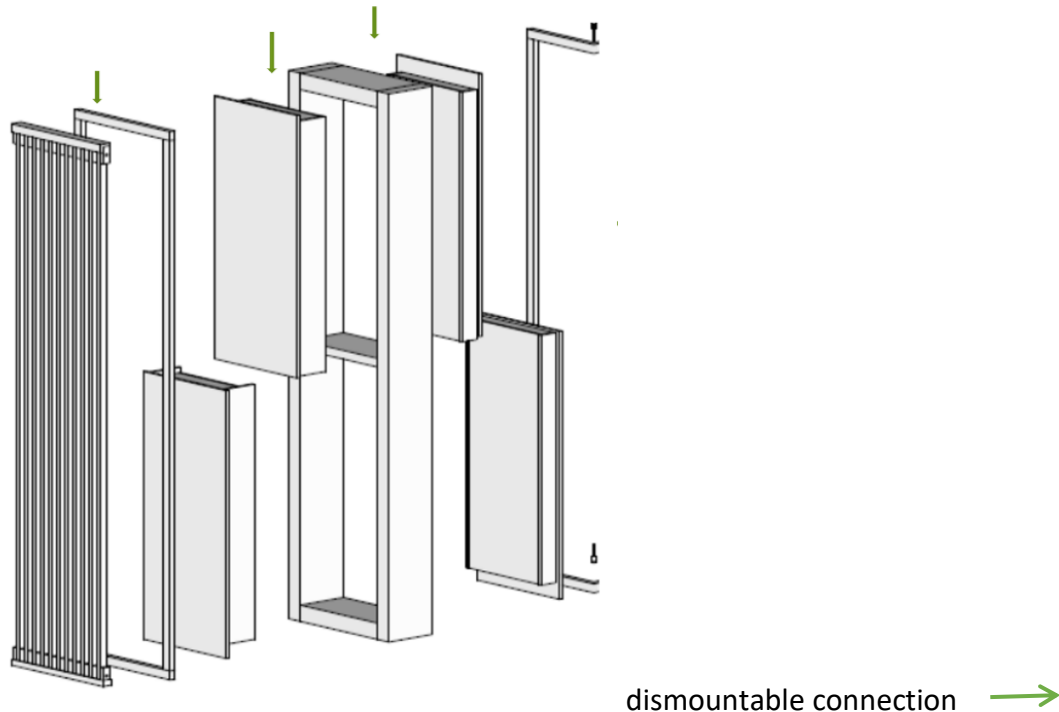

Figure 136. GDC wall materials and connections in the simple 3d model.

It is possible to identify or put defined connections and evaluate their disassembly possibilities in the reuse material database. The one way to avoid mistake in the process of choosing the connections, is the one where the connection possibilities are suggested by producers, so stakeholders (per ex. designers) can select the offered ones in the material database.

Except the advantage of the predesigned connections that provide easy disassembly, in the case of the GDC wall, there is also an “intermediary” (Durmišević 2006), which allows multiple assemblies and disassembles and do not damage the structure and other elements in the system. By doing the practice test (project BAMB, Horizon 200), it is concluded that the metal screw can be screwed and unscrewed approximately 5 times in the same place in the wooden middle element (in this particular case study), and then the position must be changed, or the piece of wood must be changed. According to that, it was possible to do the estimation that the intermediary element must be changed after 5 transformations. Therefore, intermediary (Durmišević 2006) should be replaced in approximately 50 years (transformation is happening every 10 years). The other parts can be reused more times and used much longer.

2<sup>nd</sup> STEP:

**Calculation of the Reuse potential indicators** that have substantial effect on the construction waste. (Durmišević 2006, 2019)

There are 5 indicators that are identified as the ones that have the influence on the building waste:

- relational pattern / dependences,
- type of connections,
- disassembly possibilities,
- assembly possibilities,
- assembly direction.

These indicators have been calculated separately for the case study GDC wall. Finally, the average value was considered for later calculations and conclusions. (Figure 137, Figure 138, Figure 139, Figure 140, Figure 141, Figure 142, Figure 143).

- **Relational dependences** between parts of the system are vertical (the best possible option) and have average value 1,0.

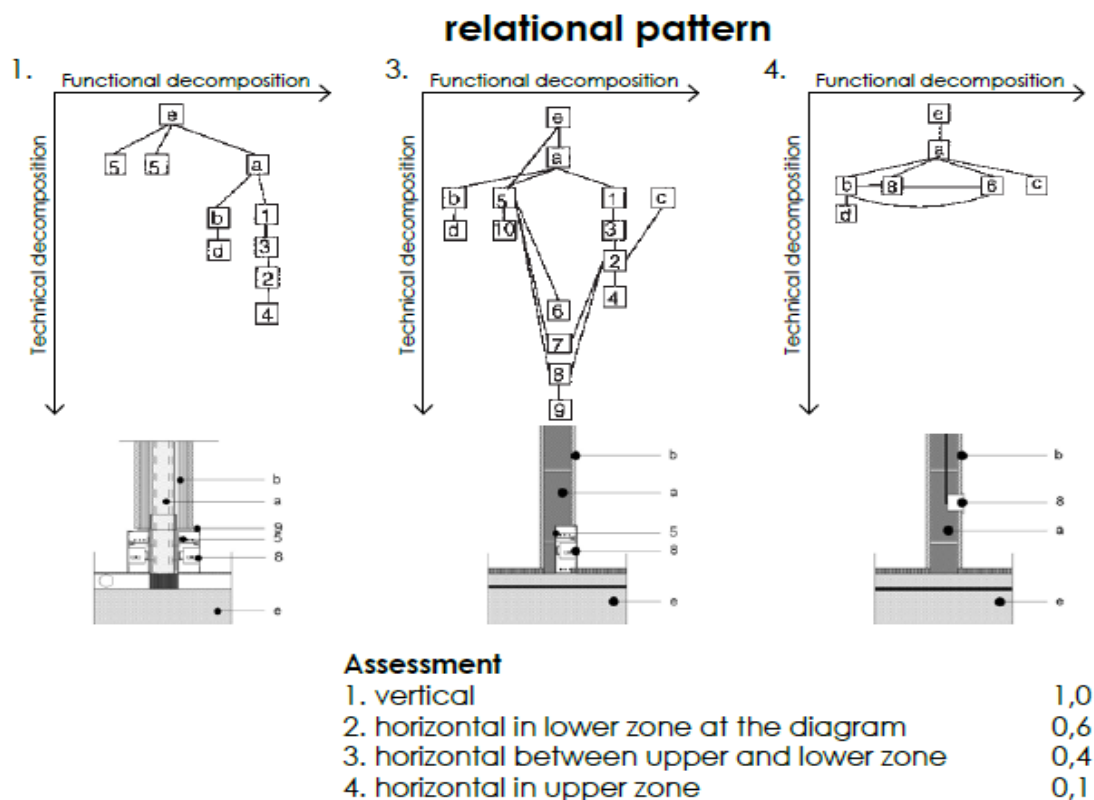
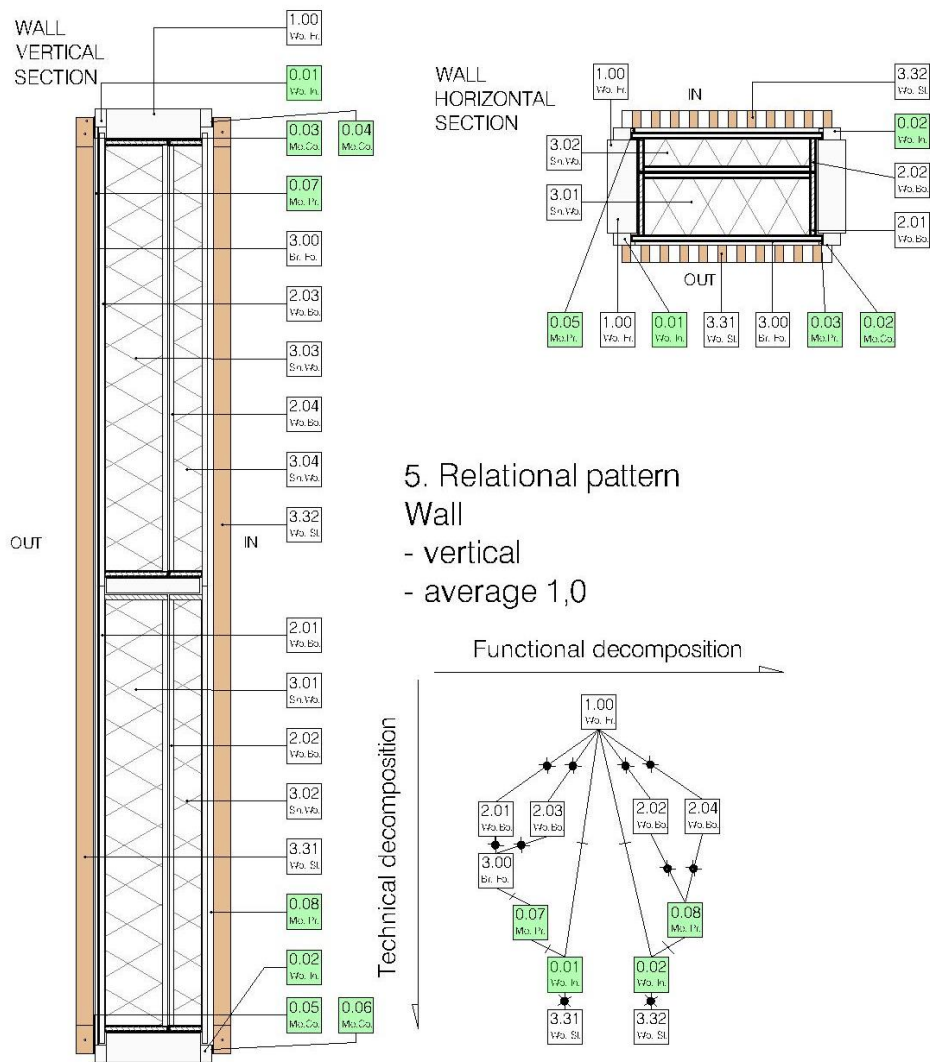

Figure 137. Assessment for relational pattern. (Durmišević 2006)



### 5. Relational pattern

#### Wall

- vertical
- average 1,0

Figure 138. Relational dependences between parts of the system

- **Type of the connections'** indicators were calculated and total average is 0,87.

#### Assessment

—	1. Indirect with additional fixing device	1,0
—	2. Indirect connection via independent third element	0,8
—	3. Indirect connection via dependent third element	0,7
—	4. Direct connection with additional fixing device	0,6
—	5. Direct connec. between two pre-made comp.	0,4
—	6. Indirect connection with third chemical material	0,2
—	7. Direct chemical connection	0,1

Figure 139. Assessment for type of connection. (Durmišević 2006)



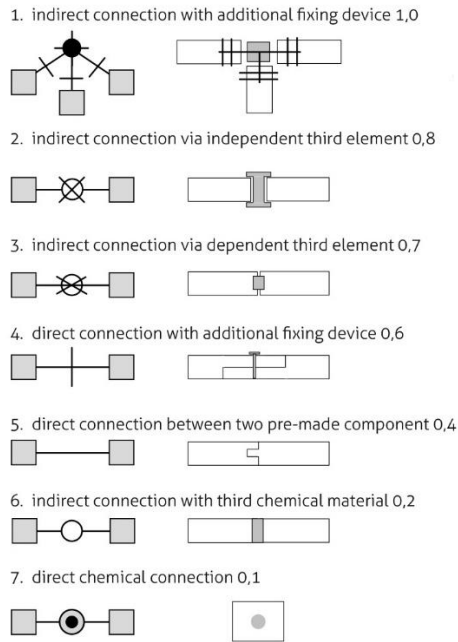

Figure 140. Assessment for type of connection with symbols.

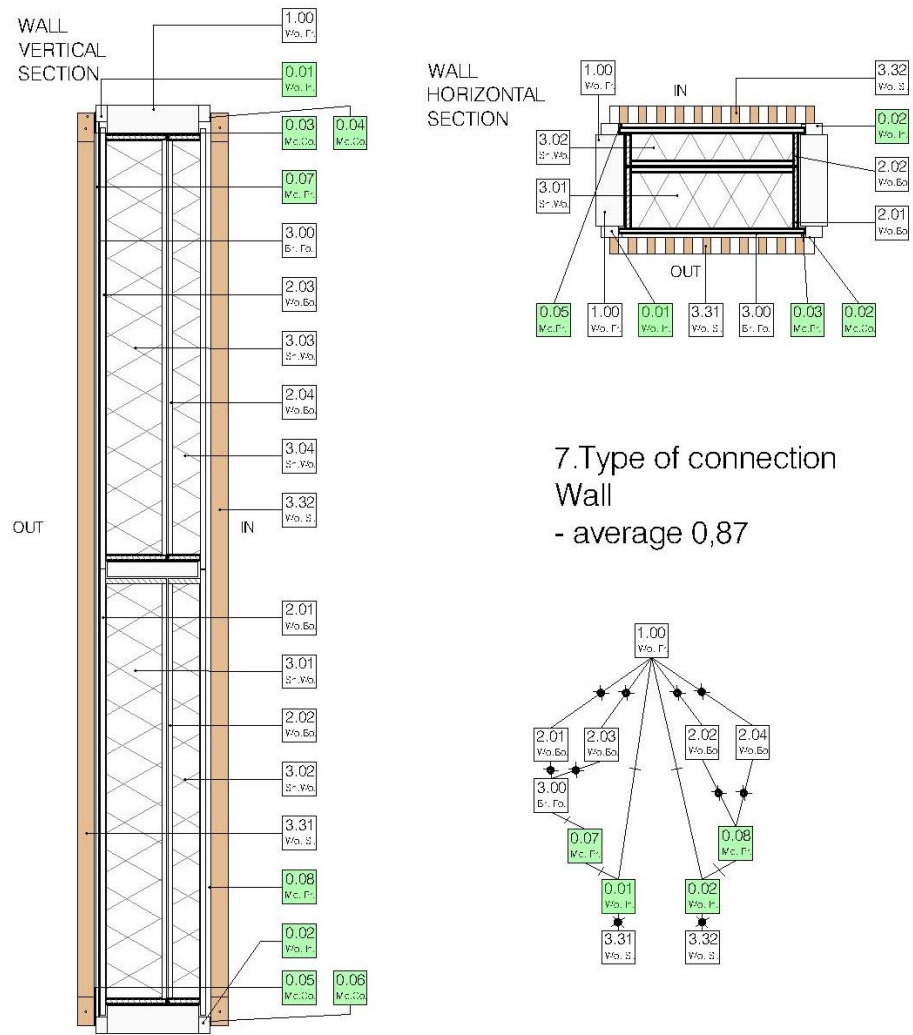

Figure 141. Type of the connections scheme and average value for type of connection calculation.

- **Disassembly possibilities** indicator has a value 1,0.
- **Assembly possibilities** indicator has a value 1,0.
- **Assembly direction** indicator has a value 1,0.

### Assessment

1. gravity attractor	1,0
2. parrallel	0,6
3. semi-parralel	0,4
4. sequential	0,1

## assembly direction

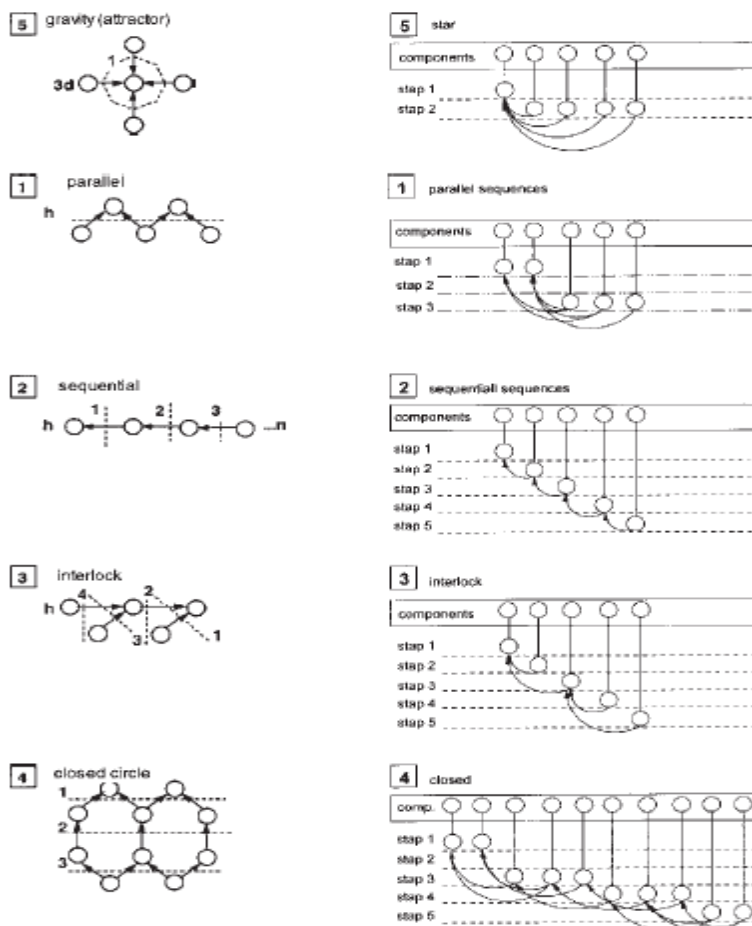

Figure 142. Assessment for assembly direction. (Durmišević 2006)

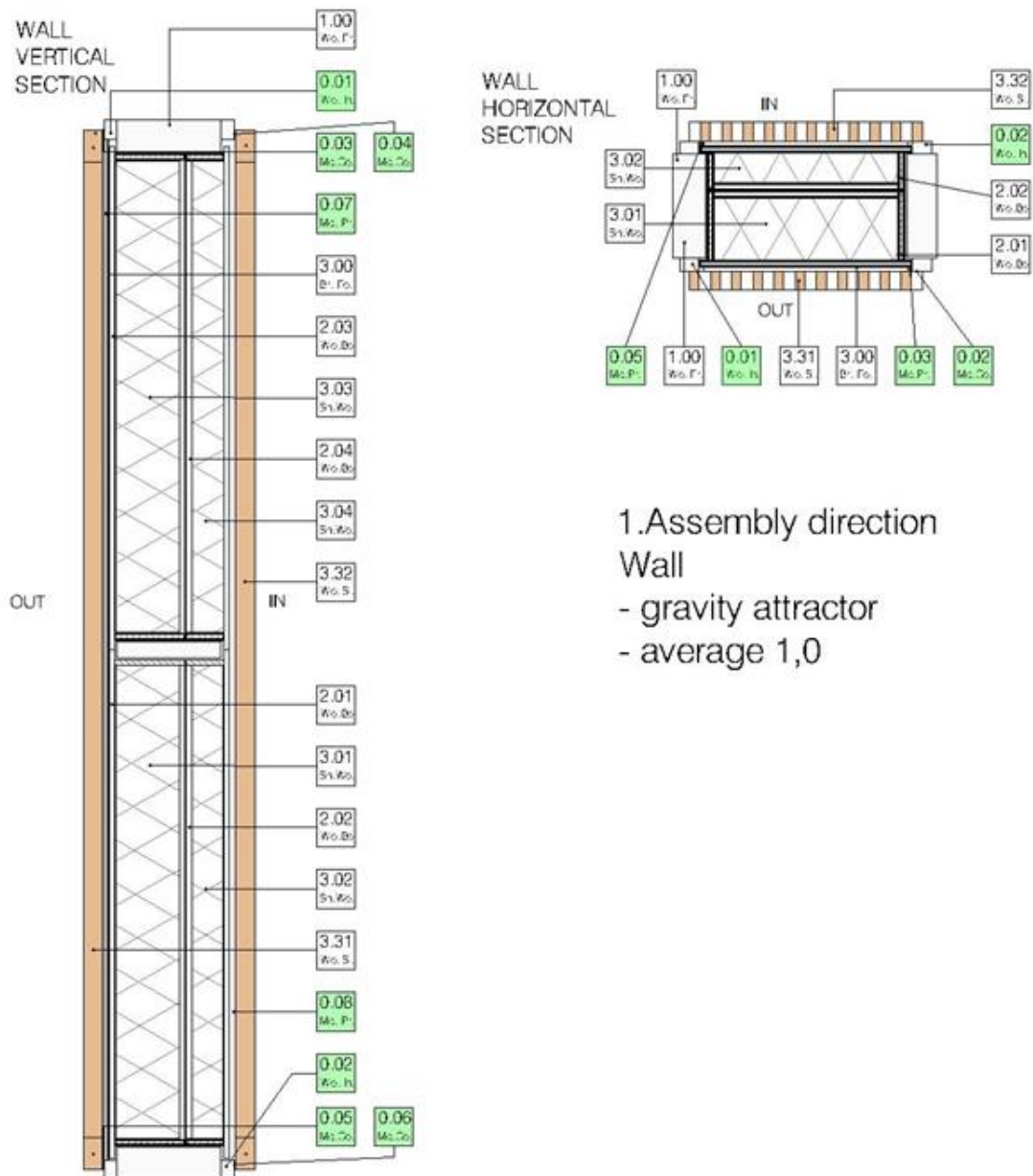

Figure 143. Assembly and disassembly possibilities of GDC wall.

Average reuse potential, considering calculated four Rp indicators that are influencing construction waste and environmental impact, in terms of waste is:

$$Rp = (1,0+0,87+1,0+1,0)/4 = 0.97$$

In tested case study wall, each indicator and the average score is  $Rp > 0.6$ . This value shows that the wall system has a very high reuse potential. (Chapter 6.1.1. in this research, Durmišević 2018)

After these Rp calculations, based on the final result, low environmental impact can be expected after the GDC wall modification during maintenance, transformation or in the next life-cycle.

Despite the obtained results and described high reuse potential, it is still unknown how big the impact is or how much waste will be produced.

### 3<sup>rd</sup> STEP:

**Calculating bill of materials** by hand or using any BIM software that is connected with material database.

If a 3d model is designed in BIM supported software, which is connected with material database, then the Material database must include database of connections beside the construction material database.

For the purpose of this research, the bill of materials was done by hand and calculated per 100m<sup>2</sup> of the GDC wall (functional unit).

Total volume of the 100m<sup>2</sup> of the GDC wall is 40 m<sup>3</sup> (wall width is 40 cm). In 100m<sup>2</sup> the volume of the wood is total 12,90 m<sup>3</sup> and the weight of the total sheep wool is 858,00 kg. The weight of the foil is approximately 1kg. These weights were calculated considering the specific mass per volume for each material. (Table 10.)

	Specific mass per volume	Volume of material per 100m <sup>2</sup> of the GDC wall	Weight of material per 100m <sup>2</sup> of the GDC wall
	(kg/ m <sup>3</sup> )	(m <sup>3</sup> )	(kg)
Wood	600,00	12,90	7.740,00
Sheep wool	30,00	28,60	858,00
PE foil	3,00	0,33	1,00

Table 10. The bill of materials done by hand and calculated per functional unit 100m<sup>2</sup> of the GDC wall.

Considering previous survey, mentioned materials can be reused in the next 50 years, if not physically damaged. If the system is transformed maximum 5 times in 50 years, then the wood used as “intermediary” can be considered as reusable in total predicted time frame. The intermediary is middle element, and its weight is 5,5 kg. This element will be replaced only after 5 transformations.

This GDC wall system does not contain parts with “expiry date” shorter than predicted time frame, or parts which will be wasted after the first life-cycle.

### 4<sup>th</sup> STEP:

**Environmental impact calculation in the LCA software** is considering all data gathered in the previous steps.

It is highly recommended that material database include database of connections beside the construction material database, with their attributes declaring their environmental impact (e.g., Environmental Product Description – EPD, Ecoinvent material database, material passport or similar database).

The LCA software will calculate the environmental impact.

a. The environmental impact in terms of construction waste quantities was calculated for the first building life-cycle (until the first transformation) for the GDC wall in two ways:

- (I) Calculation of the environmental impact of building materials with connection materials in total quantities;
- (II) Calculation of the environmental impact of building materials with connection materials calculated separately for each material layer and its impact.

The environmental impact calculated in the Oneclick LCA tool, for the first life-cycle, is considering only materials and it is not possible to conclude what will happen with these materials in the second life cycle. (these calculations have been precisely explained in the Chapter 6.2.1. of this research.)

In the other software, OpenLCA, the user can choose the one of many Impact assessment methods. The tool calculated environmental impact for the Case study GDCwall1 considering materials the wall is made of. The chosen database in the OpenLCA software is Ecoinvent v. 3.4 and EDIP methodology. The EDIP methodology gives the right data concerning environmental impact at the end of the process, considering the literature research conducted by the author of this thesis. (Figure 144)

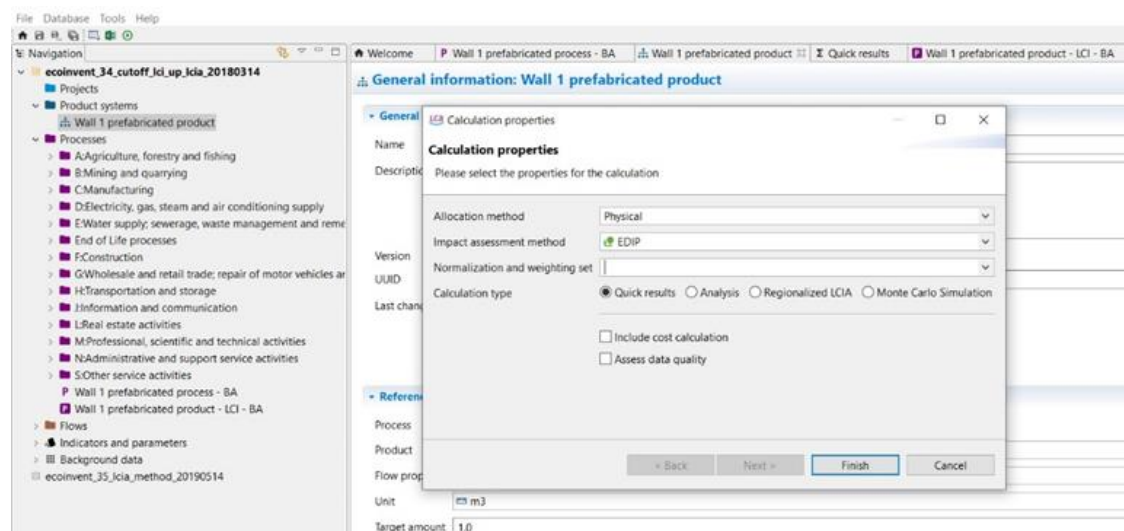

Figure 144. Chosen Ecoinvent v.3.4. database and the EDIP methodology in the Open LCA tool.

Regarding the land use and construction waste estimation, the best method is EDIP, as it has, among others, the following Impact categories:

- Land filling, bulk waste;
- Land filling, hazardous waste;
- Land filling, radioactive waste;
- Land filling, slag and ashes;
- Renewable resource, wood.

Some of the Ecoinvent v.3.4 LCIA methods are shown in the print screen of the tool. (Figure 145)

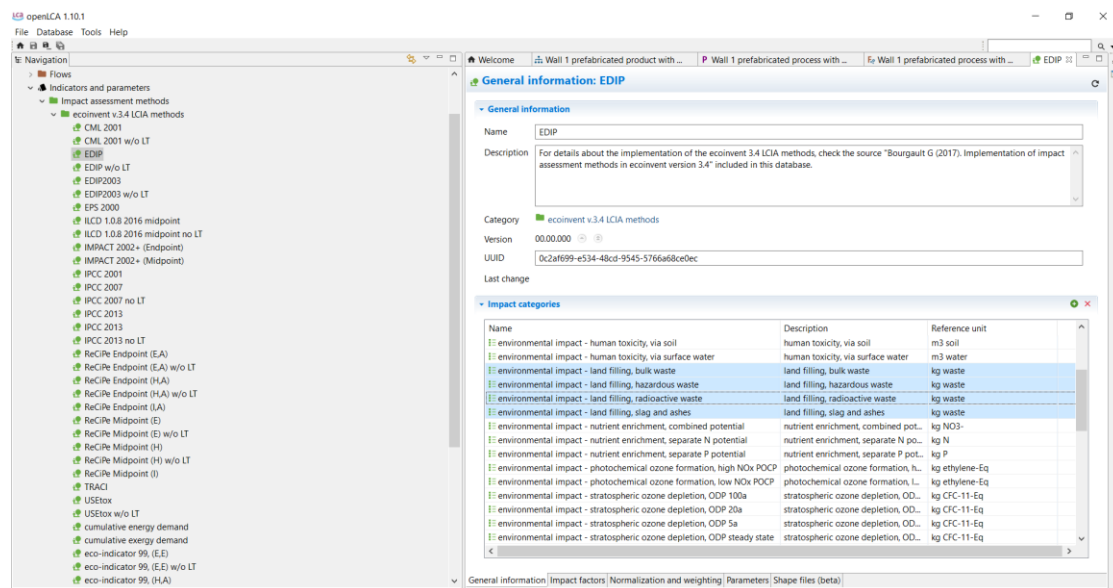

Figure 145. Some of the Ecoinvent v.3.4 LCIA impact categories are shown in the print screen of the tool with the accent on the used EDIP impact assessment method.

As previously confirmed, the calculation of the particular material quantity was made for 100m<sup>2</sup> of the GDC wall1. The chosen unit in the software is Volume (m<sup>3</sup>) for each material, but the software does not support m<sup>3</sup> for some materials and asks for quantity in kg. In this case, the material quantity was calculated according to the specific average mass per m<sup>3</sup> found in the Internet database Wikipedia. ([www.wikipedia.com](http://www.wikipedia.com))

- (1) The total amount of the wood, wool, metal connections and fleece was inserted in the tool and environmental impact of these materials was calculated. (Figure 146, Figure 147) There is no sheep wool insulation in the Ecoinvent v.3.4 material database, so the stone wool was chosen as a wall layer for this case study GDCwall1. The metal connections are in small quantities, but the steel impact was considered, too. Connections have very important role in transformation process, to allow easy assembly and disassembly, when necessary.

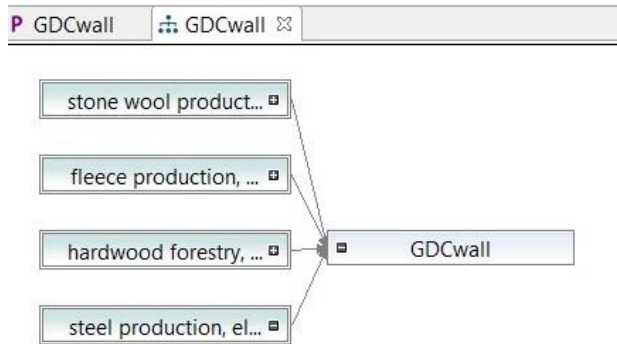

Figure 146. Materials (including metal connections) in the 100m<sup>2</sup> of the GDC wall1 inserted in the OpenLCA 1.10.1. tool, shown in Model graph.

Flow	Category	Amount	Unit	Costs/Revenu...	Uncertainty	Avoided waste	Provider	Data quality ...	Description
F <sub>1</sub> fleece, polyethylene	139Manufacture of other te...	1.00000	kg		none				
F <sub>2</sub> pulpwood, hardwood, measured as s...	022Logging/0220Logging	12.90000	m3		none				
F <sub>3</sub> steel, low-alloyed	241Manufacture of basic ir...	1.60000	kg		none				
F <sub>4</sub> stone wool	239Manufacture of non-me...	88.00000	kg		none				

Flow	Category	Amount	Unit	Costs/Revenu...	Uncertainty	Avoided pro...	Provider	Data quality ...	Description
F <sub>1</sub> GDCwall1		40.00000	m3		none				

Figure 147. Materials (including metal connections) in the 100m<sup>2</sup> of the GDC wall1 inserted in the OpenLCA 1.10.1. tool.

The environmental impact of these materials calculated in the OpenLCA 1.10.1. tool, concerning the mentioned impact categories (Figure 145), is shown in Figure 148, Figure 148, Figure 149, Figure 150, Figure 151, Figure 152. The impact categories were selected on the basis of impact in terms of building waste. The impact of the materials is shown in the Sankey diagram, where separate material contributions can be seen. (Figure 153)

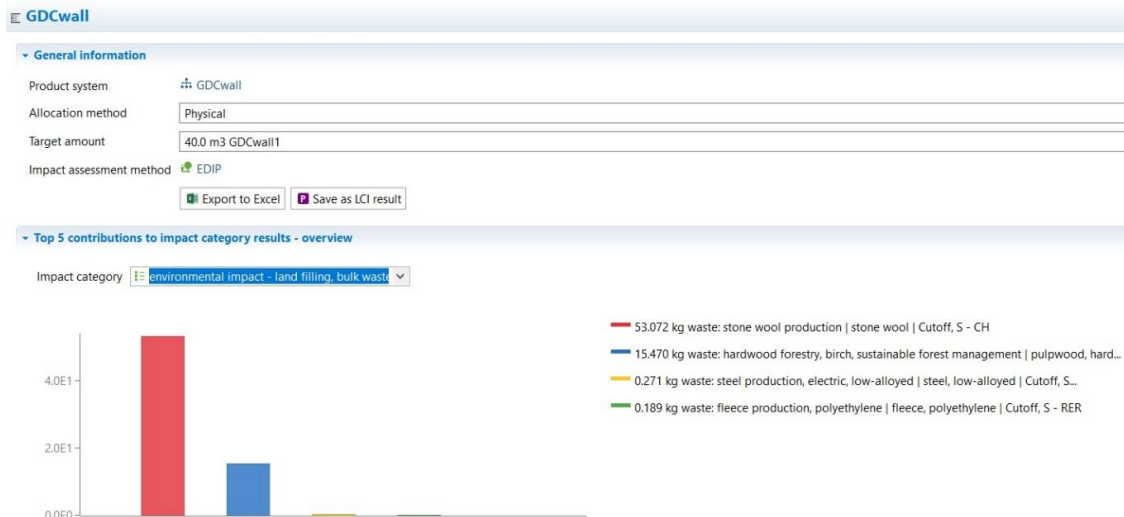

Figure 148. The environmental impact in terms of land filling – bulk waste, calculated in the OpenLCA 1.10.1. tool



Figure 149. The environmental impact in terms of land filling - hazardous waste, calculated in the OpenLCA 1.10.1. tool



Figure 150. The environmental impact in terms of land filling - radioactive waste, calculated in the OpenLCA 1.10.1. tool.



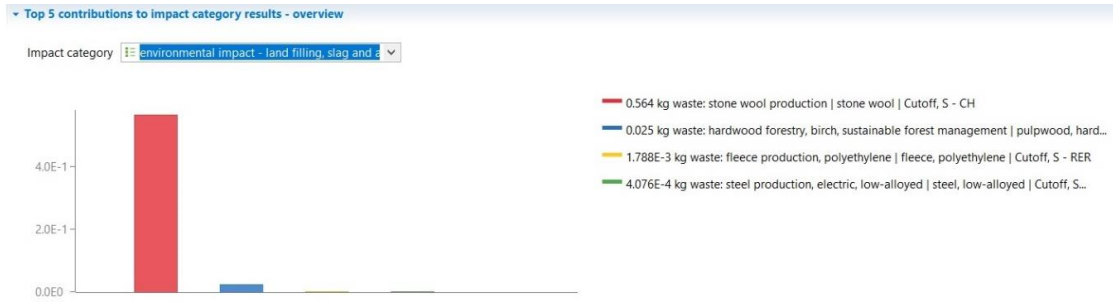

Figure 151. The environmental impact in terms of land filling – slag and ashes, calculated in the OpenLCA 1.10.1. tool.

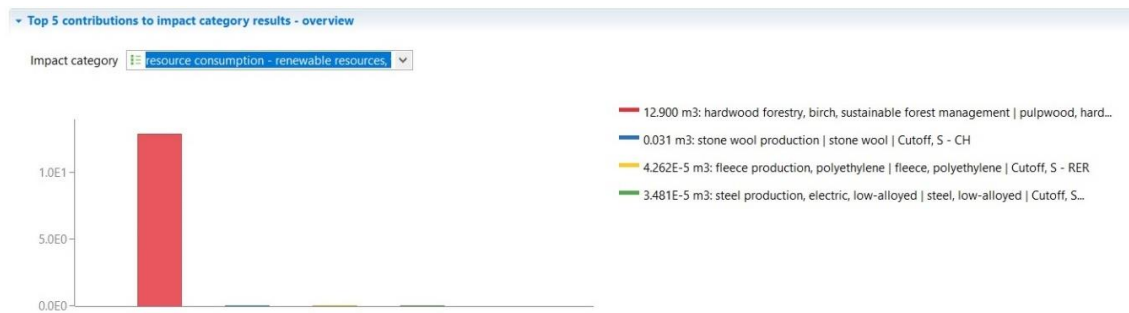

Figure 152. The environmental impact in terms of resource consumption - wood, calculated in the OpenLCA 1.10.1. tool.

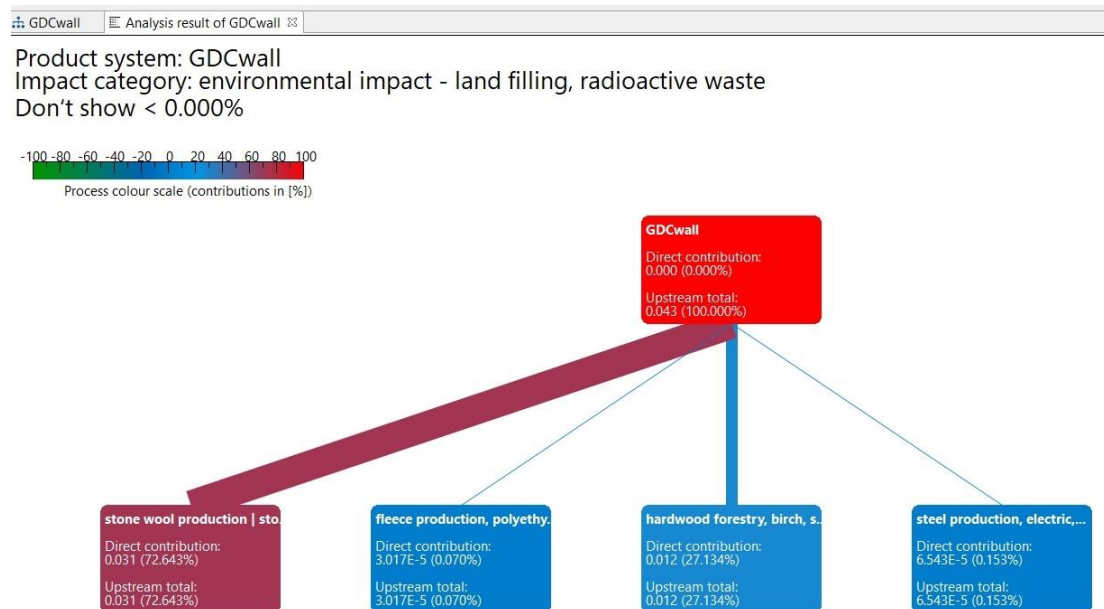

Figure 153. The impact of the materials can be shown in the Sankey diagram in the OpenLCA 1.10.1. tool, where separate material contribution can be seen.

Overview of the materials' input and output /environmental impact/ after first life-cycle are presented in the Table 11.

	Input		Output		
	Quantity		Reuse potential (RP) indicators average	Environmental Impact (EI) per category	
	Weight (kg)	Volume (m <sup>3</sup> )	(relational pattern + connection + assembly possibilities + assembly direction) / 4	EI land filling, bulk waste (kg)	EI resource consumption (m <sup>3</sup> )
Stone wool	858,00	28,60	0,97	53,072	0,031
Hardwood	7.740,00	12,90	0,97	15,470	12,90
Steel	1,6	0,34	0,97	0,271	3,481 E-5
PE foil	1	0,33	0,97	0,189	4,262 E-5

Table 11. Overview of the input and output data for used types of materials of case study GDC wall.

Tool results can show also basic material (chemical ingredients) inputs and outputs as emissions to air, water and soil. The tool allows some inventory results and added values can be estimated and calculated, so that the prices can be visible. The mentioned results are not significant for this research, so they will not be presented here.

The quantities of building materials of the GDC wall were inserted in the tool in the way to do the calculation for of each material in specific position. The tool organizes separate materials by alphabetic order after inserting them. This is not acceptable for this research because the material relations, order and dependence are very important for transformation possibilities. The material order, as a very important input, must be corrected in the tool. It is acceptable to calculate the same materials with the different position in the system as one material with its total quantity for the first life-cycle.

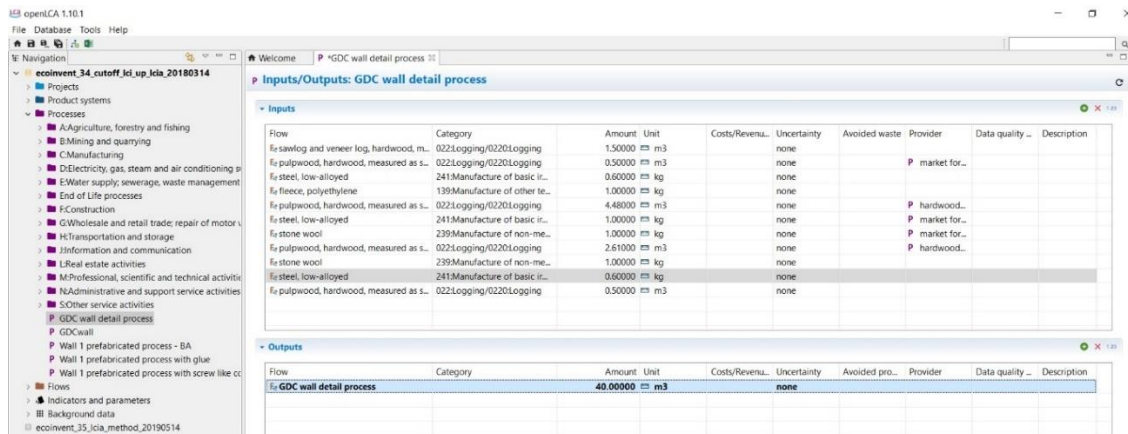

Figure 154. Materials (including metal connections) in the 100m<sup>2</sup> of the GDC wall1 inserted in the OpenLCA 1.10.1. tool.

- (II) Each material quantity (the wood, fleece and wool) were inserted in the tool, and the total metal connections quantity is added (as this quantity is very small). (Figure 154) The tool OpenLCA calculated environmental impact of these materials. As previously mentioned, there is no sheep wool insulation in the Ecoinvent v.3.4 material database, so the stone wool is calculated for this case

study GDC wall. Stone wool has almost the same density and the same role as sheep wool in the wall.

Materials (including metal connections) in the 100m<sup>2</sup> of the GDC wall inserted in the OpenLCA 1.10.1. tool are shown in the Model graph in Figure 155. The environmental impact of these materials calculated in the OpenLCA 1.10.1. tool, for the mentioned impact categories (Figure 145), is shown in Figure 156, Figure 157, Figure 158, Figure 159, Figure 160.

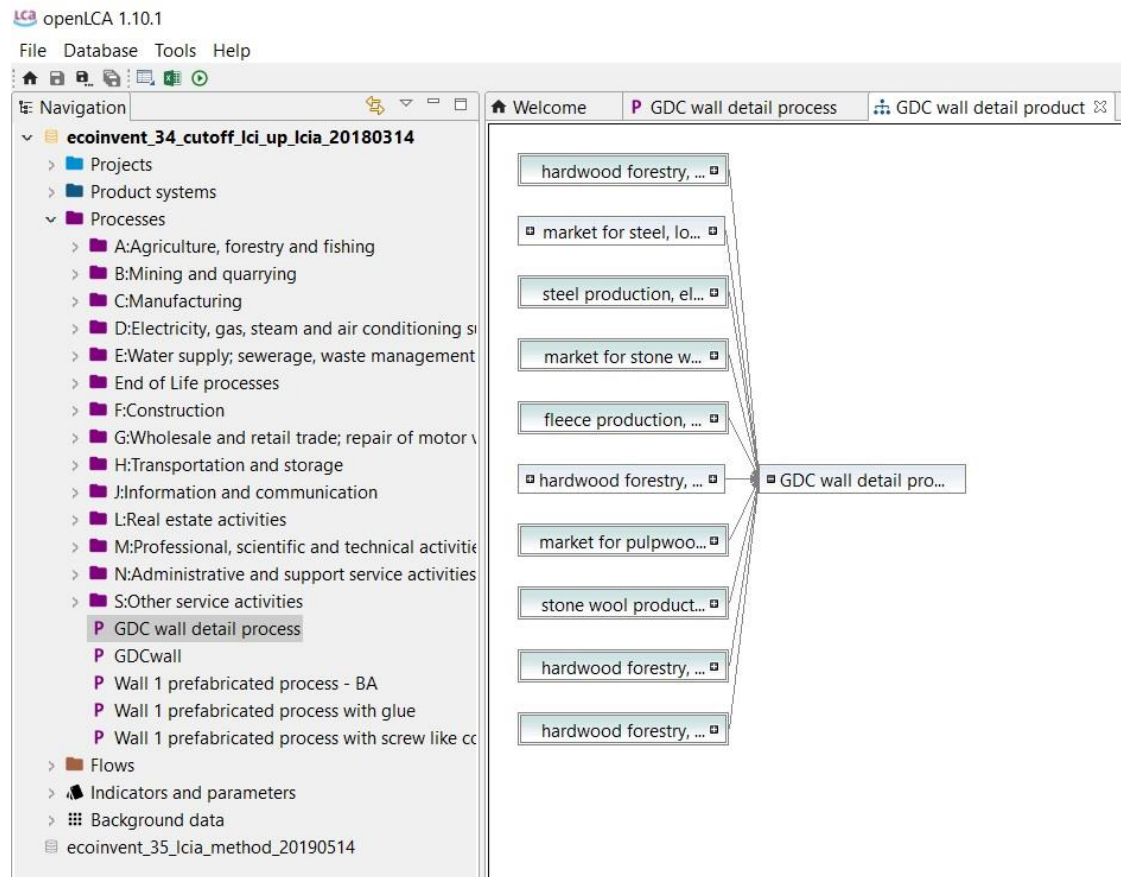

Figure 155. Materials (including metal connections) in the 100m<sup>2</sup> of the GDC wall inserted in the OpenLCA 1.10.1. tool showed in Model graph.

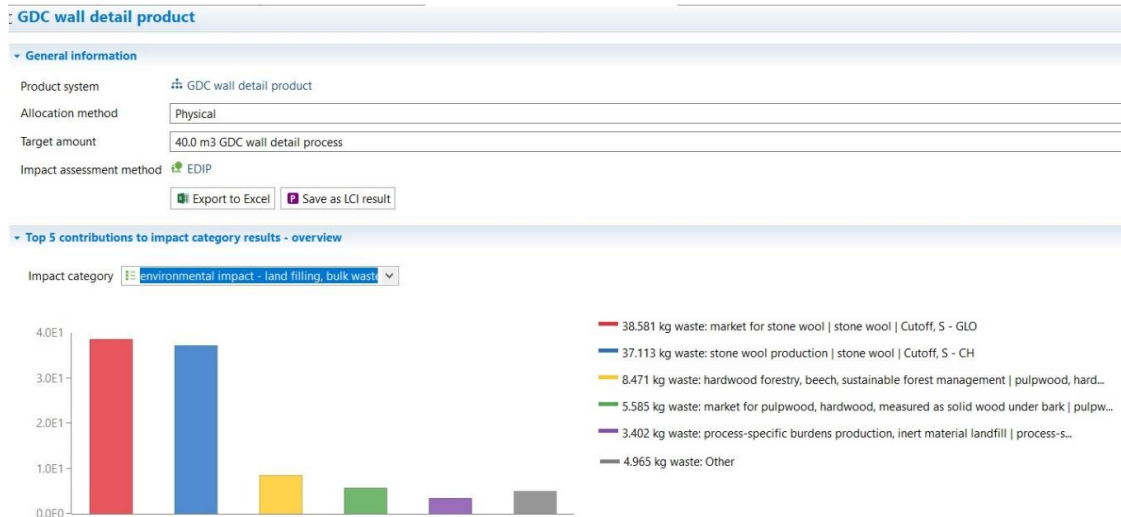

Figure 156. The environmental impact in terms of land filling – bulk waste, calculated in the OpenLCA 1.10.1. tool



Figure 157. The environmental impact in terms of land filling - hazardous waste, calculated in the OpenLCA 1.10.1. tool

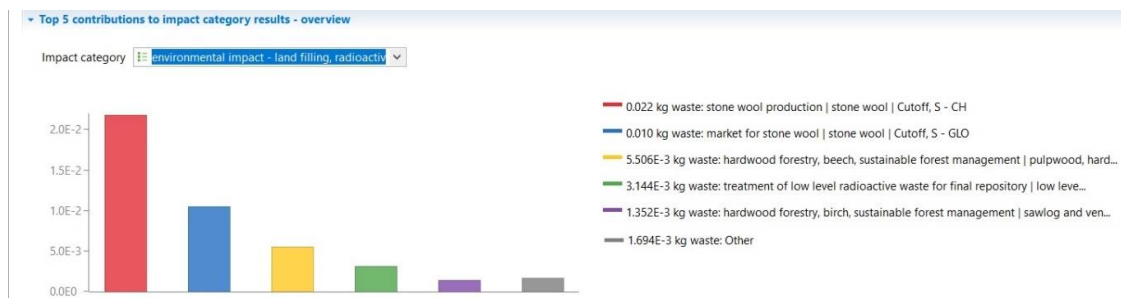

Figure 158. The environmental impact in terms of land filling - radioactive waste, calculated in the OpenLCA 1.10.1. tool.



Figure 159. The environmental impact in terms of land filling – slag and ashes, calculated in the OpenLCA 1.10.1. tool.

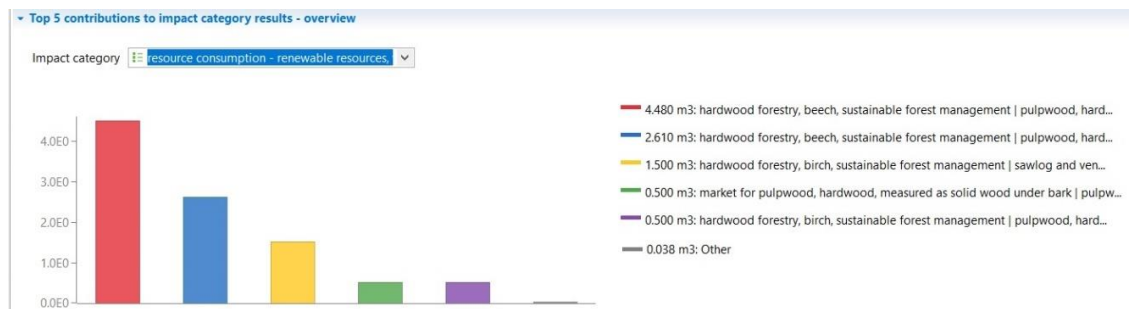

Figure 160. The environmental impact in terms of resource consumption - wood, calculated in the OpenLCA 1.10.1. tool.

- b. The second calculation of the environmental impact in terms of construction waste quantities was done for the second building life-cycle after the first transformation (10 years after the building is built) for the GDC wall.

The differences in the environmental impact in the second life cycle, depending on possibilities to dismantle in order to repair, recycle and reuse, can be determined in the OpenLCA software, where the parameters can be changed.

The GDC wall was designed in such a manner as to be transformable, so materials can be reused during transformation phases. The elements (and materials) can change its position, as the wall is modular and the connections between parts are easy to disassemble. Some elements might be damaged during the process in case of an accident, but the losses should not be severe.

Environmental impact calculation for the second life-cycle of the GDC wall in the LCA software depends on the possibility to fully use all parts of the wall. Defining Conn values is important part in this process. Conn values were assigned to the connection types used between materials in the GDC wall case study and depend on the disassembly possibilities of the connection. (more explanation in the Chapter 7.2 in this research) This input is very important to be considered in case when the transformation comes. Matrices with relations between materials with Conn values, which were assigned to the connection types used between materials in the GDC wall case study, are shown in matrices in Figure 161 and in the Table 12.

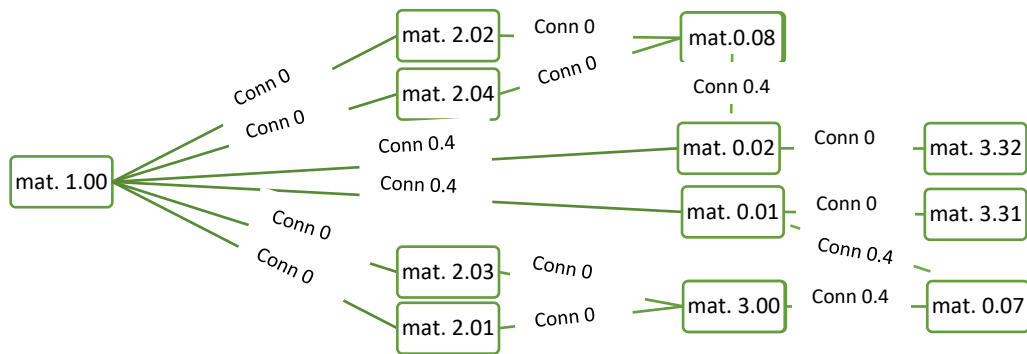

Figure 161. Matrices with relations between materials with Conn values, which are assigned to the connection types used between materials in the GDC wall case study. Material codes are in the Figure 135.

	Mat 1.00	Mat. 2.01	Mat. 2.02	Mat. 2.03	Mat. 2.04	Mat. 0.01	Mat. 0.02	Mat. 0.08	Mat. 0.07	Mat. 3.00	Mat. 3.31	Mat. 3.32
Mat. 1.00		Conn <b>0</b>	Conn <b>0</b>	Conn <b>0</b>	Conn <b>0</b>	Conn <b>0.4</b>	Conn <b>0.4</b>					
Mat. 2.01	Conn <b>0</b>									Conn <b>0</b>		
Mat. 2.02	Conn <b>0</b>							Conn <b>0</b>				
Mat. 2.03	Conn <b>0</b>									Conn <b>0</b>		
Mat. 2.04	Conn <b>0</b>							Conn <b>0</b>				
Mat. 0.01	Conn <b>0.4</b>								Conn <b>0.4</b>		Conn <b>0</b>	
Mat. 0.02	Conn <b>0.4</b>							Conn <b>0.4</b>				Conn <b>0</b>
Mat. 0.08			Conn <b>0</b>		Conn <b>0</b>		Conn <b>0.4</b>					
Mat. 0.07						Conn <b>0.4</b>				Conn <b>0.4</b>		
Mat. 3.00		Conn <b>0</b>		Conn <b>0</b>					Conn <b>0.4</b>			
Mat. 3.31						Conn <b>0</b>						
Mat. 3.32							Conn <b>0</b>					

Table 12. Table with relations between materials with Conn values, which are assigned to the connection types used between materials in the GDC wall case study.

Average value for Conn factor for GDC wall connections, in accordance with the matrices, is  $(0,4*5)/15 = 0,13$ .

Rp average considering connections is 0,87. Conn = 1-Rp = 0,13.

Rp average considering 4 Rp factors that have influence on the construction waste is 0,97 (calculated in previous step). In accordance with that Rp value, as previously described, value Conn is calculated: Conn = 1-Rp = 0,03

These GDC wall case study Conn values (from 0,03 to 0,13) can be in many ways similar to the value of indicative parameter of percentage of material that will be lost (damaged) and needed replacement in the second life-cycle (from 3% to 13%).

In accordance with the stated values, when the Rp (or Conn) values are assigned to the type of connections in the wall system, the result is showing the possible quantity (percentage) of the material waste in the next transformation. (Table 12)

The Conn values can be calculated for each part of the system. In the case of GDC wall, the Conn values are:

- 0 for wooden boxes and facade slats, as these elements are connected to the neighbour elements in a very loose manner, and disassembly will be easy.
- for the wooden 'intermediary' /mat 0.01/ Conn values are 0,4+0,4+0. The average Conn value is  $0.8 / 3 = 0.266$
- $0+0+0.4 = 0,4$  for the PE foil. The average conn value is  $0.4 / 3 = 0.133$

$0+0+0.4 = 0,4$  and  $0.4+0.4 = 0.8$  for connecting metal profiles. Total average is  $1.2 / 5 = 0.24$ . This value will be used for all metal parts in this wall.

The other 3 Rp indicators (relational patterns, assembly and disassembly possibilities) should be calculated as well, to get the range of the possible construction waste percentage in the next transformation.

In the LCA software tutorial, environmental impact calculated for the materials in the first life-cycle considers their environmental impact from "cradle to grave". The impact of the same materials will be zero in their second life-cycle. The only impact for the environment will be the energy used for disassembly / assembly and transport.

The LCA and environmental impact calculation for GDC wall in the second life-cycle was computed after the calculation of the GDC wall materials' environmental impact in the first life-cycle (calculated for 100m<sup>2</sup> of the wall - results shown from the Figure 154 to Figure 160). The calculated Conn values for each layer of material were inserted into OpenLCA software (Figure 162).

Parameters: GDC wall detail process

Global parameters

Input parameters

Name	Value	Uncertainty	Description
WI	0.266	none	conn Wooden intermediary
F	0.133	none	conn PE foil
M1	0.133	none	conn metal profiles
WB	0.0	none	conn wooden boxes
M2	0.4	none	conn metal profiles 2
M3	0.24	none	conn metal profiles 3
WS1	0.0	none	conn wooden slats 1
WS2	0.0	none	conn wooden slats 2
SW	0.0	none	conn stone wool

Figure 162. Conn values for each layer of the materials are inserted into OpenLCA software as parameters for that material.

After that, Conn values were added as a parameter in the quantity section for each material (Figure 163).

Inputs/Outputs: GDC wall detail process

Inputs

Flow	Category	Amount	Unit	Costs/Revenu...	Uncertainty	Avoided waste	Provider	Data quality ...	Description
Fl fleece, polyethylene	139:Manufacture of other te...	1.0 * F	kg		none				
Fl pulpwood, hardwood, measured as s...	022:Logging/0220:Logging	0.5 * WS1	m3		none		P market for...		
Fl pulpwood, hardwood, measured as s...	022:Logging/0220:Logging	2.61 * WB	m3		none		P hardwood...		
Fl pulpwood, hardwood, measured as s...	022:Logging/0220:Logging	0.5 * WS2	m3		none				
Fl pulpwood, hardwood, measured as s...	022:Logging/0220:Logging	4.48 * WB	m3		none		P hardwood...		
Fl sawlog and veneer log, hardwood, m...	022:Logging/0220:Logging	1.5 * WI	m3		none				
Fl steel, low-alloyed	241:Manufacture of basic ir...	0.6 * M1	kg		none				
Fl steel, low-alloyed	241:Manufacture of basic ir...	0.6 * M2	kg		none				
Fl steel, low-alloyed	241:Manufacture of basic ir...	1.0 * M3	kg		none		P market for...		
Fl stone wool	239:Manufacture of non-me...	600.0 * SW	kg		none				
Fl stone wool	239:Manufacture of non-me...	450.0 * SW	kg		none		P market for...		

Outputs

Flow	Category	Amount	Unit	Costs/Revenu...	Uncertainty	Avoided pro...	Provider	Data quality ...	Description
GDC wall detail process		40.00000	m3		none				

Figure 163. Conn values for each layer of material are inserted into OpenLCA software in the Quantities section.

After this conn value addition in the tool, the results are shown in the Figure 164 to the Figure 168.

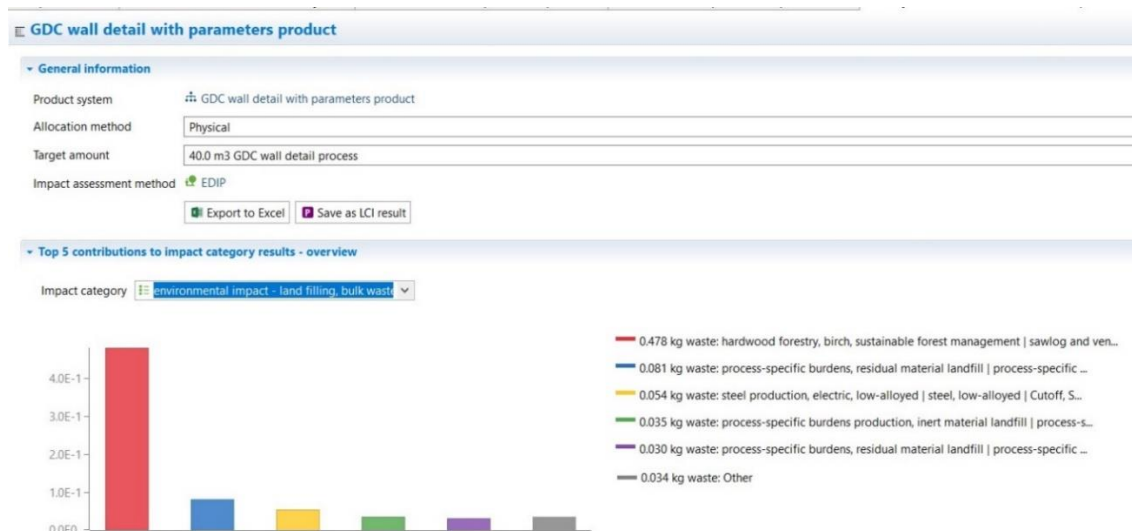

Figure 164. The environmental impact in terms of land filling – bulk waste, calculated in the OpenLCA 1.10.1. tool



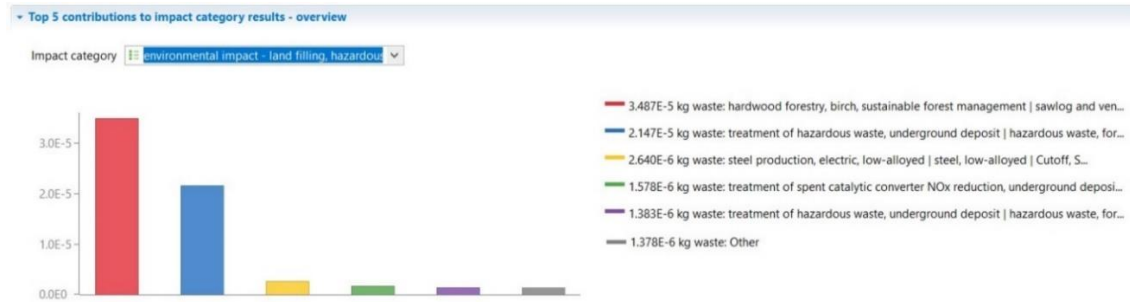

Figure 165. The environmental impact in terms of land filling - hazardous waste, calculated in the OpenLCA 1.10.1. tool



Figure 166. The environmental impact in terms of land filling - radioactive waste, calculated in the OpenLCA 1.10.1. tool.

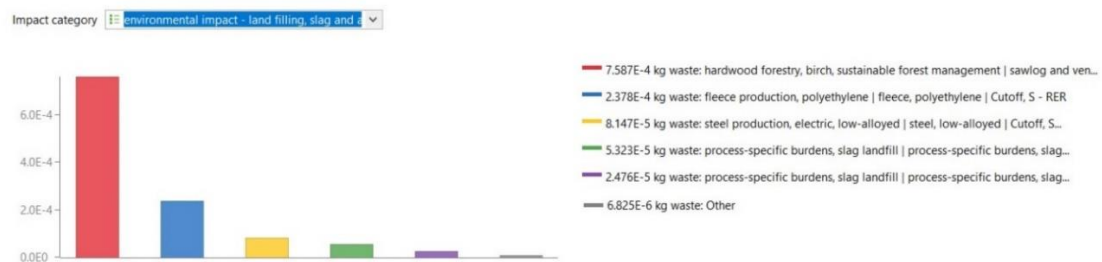

Figure 167. The environmental impact in terms of land filling - slag and ashes, calculated in the OpenLCA 1.10.1. tool.

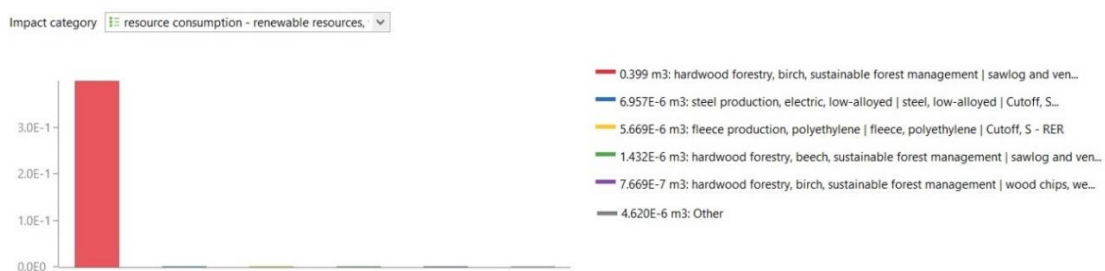

Figure 168. The environmental impact in terms of resource consumption - wood, calculated in the OpenLCA 1.10.1. tool.

Comparison of the quantities after the first and the second life-cycle can be done. In order to underline the impact of a material in the first life-cycle, the impact in the second life-cycle was calculated as value 0, in the case when that material can be fully reused in the second life-cycle. Some additional impact value was added thanks to Conn value definition, in case where a material cannot be reached to be used again undamaged and

when the relational pattern and connections play the role in the equation of the potential waste.

Figures from the Figure 169 to the Figure 173 demonstrate the impact in the first (Option 1) and the second (Option 2) life-cycle per selected indicator. The impact in the first life-cycle is shown in Option 1 and the impact in the second life-cycle is shown in Option 2 per all categories in the **Error! Reference source not found.**

Figure 169. The environmental impact in terms of land filling – bulk waste, calculated in the OpenLCA 1.10.1. tool.

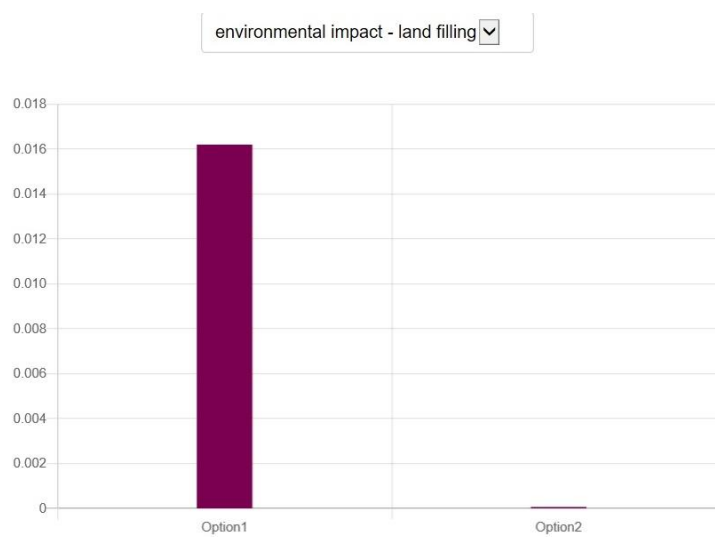

Figure 170. The environmental impact in terms of land filling - hazardous waste, calculated in the OpenLCA 1.10.1. tool.

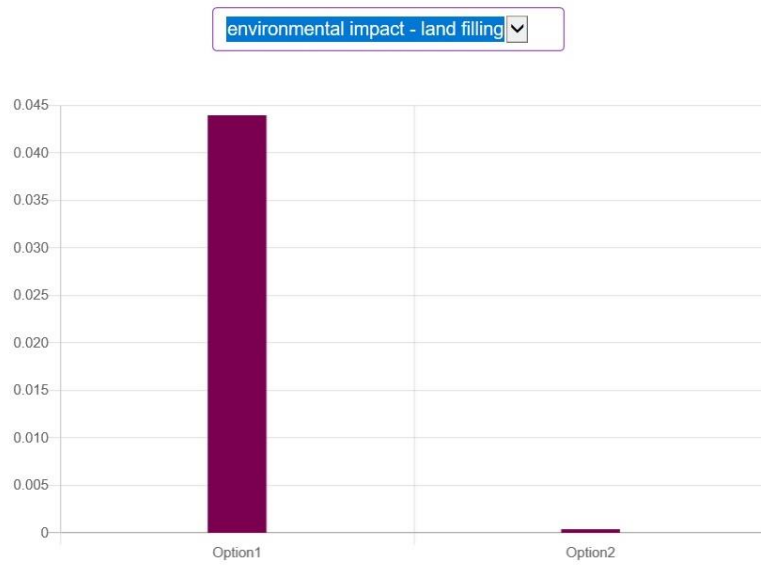

Figure 171. The environmental impact in terms of land filling - radioactive waste, calculated in the OpenLCA 1.10.1. tool.

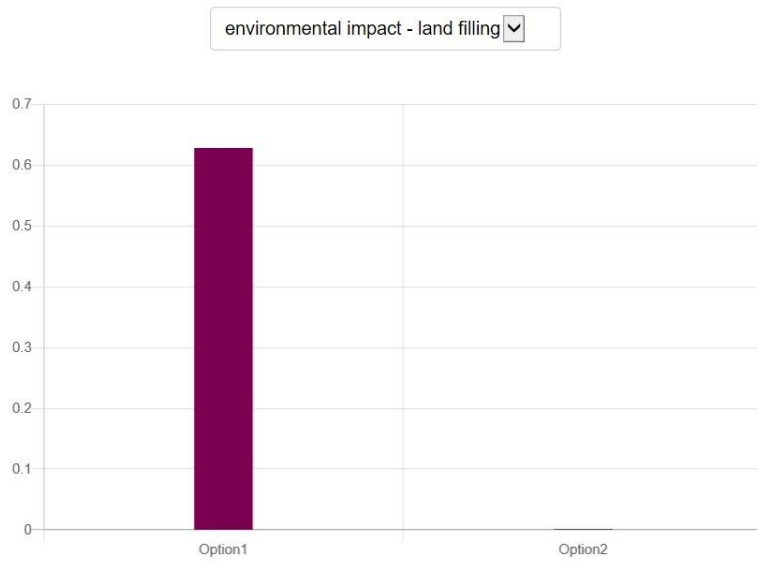

Figure 172. The environmental impact in terms of land filling – slag and ashes, calculated in the OpenLCA 1.10.1. tool.

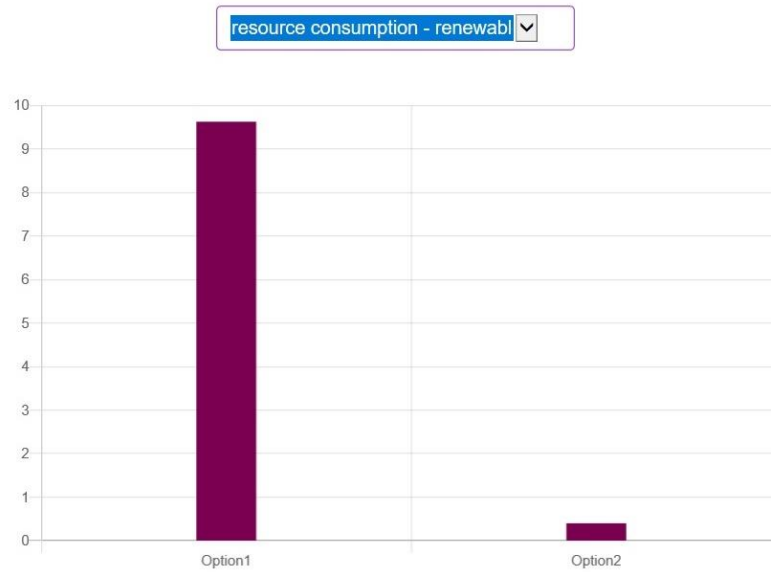

Figure 173. The environmental impact in terms of resource consumption - wood, calculated in the OpenLCA 1.10.1. tool.

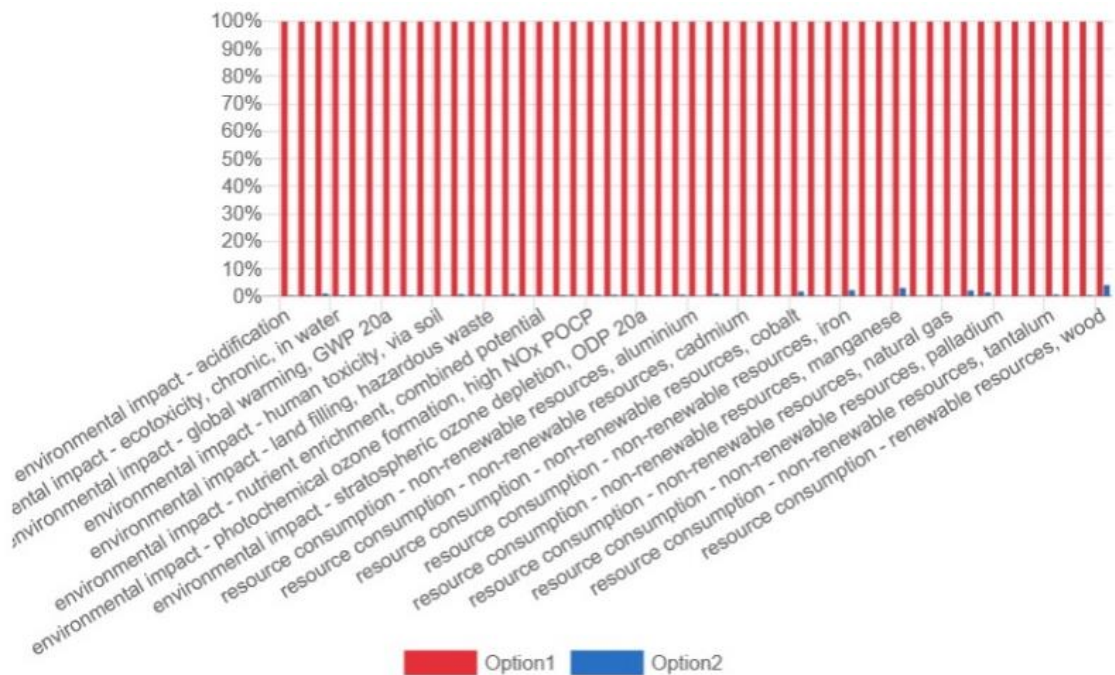

Figure 174. The chart shows relative indicator results of the environmental impact of the GDC wall in the first life-cycle (Option1) and second life-cycle (Option2), calculated and compared in the OpenLCA 1.10.1. tool. For each indicator, the maximum result is set to 100% and the results of the other variants are displayed in relation to this result.

### The REALISATION / PRODUCTION / CONSTRUCTION phase

GDC wall was completely made in the production hall, which means that there will be no leftovers on the construction site. Wall parts are modular and the combination can be done using connecting devices which allow easy assembly and disassembly of parts, in order to make a bigger wall as a puzzle.

It should be possible minimize the material leftovers in every case, not just in this particular case study. It means that stakeholders should make the precise design, preparation before production and calculation of bill of materials.

The packaging can be chosen wisely, to be made of as small quantity of material as possible and made of biodegradable material. If the production is nearby, the packaging can be made easy open-able and returned to the producer to use it again.

### **The USE / MAINTENANCE phase**

When the GDC case study wall was finished, all materials were mapped, and documented in the materials passport database (as a part of the EU Horizon 2020 BAMB project). Reuse materials database/log/ should be made for materials used in the wall (also relevant for the entire building). Traceability of built-in materials should be enabled. The codes of materials can be stored in the database, where the materials and parts are mapped to show their relations, beside their characteristics in the material database.

### **The TRANSFORMATION phase**

If everything was documented as suggested in the previous phase, the planned transformation would be easy. All parts are in the database and can be available for the next transformation. If some parts won't be used in the next transformation, they became available in the reuse database to be used for another project.

### **The DECONSTRUCTION / DEMOLITION phase**

The GDC building is previsionsed as transformable and ready for deconstruction. The demolition is out of question. During the deconstruction, when it takes place, only waste will be the broken parts, if there will be some. Parts which technical life-cycle is over will already have a repair or recycle plan to follow. Even the damaged parts can be further reused or recycled. GDC wall was mostly made of wood, which is eco-friendly material and will not have negative impact on the environment. Pieces of wood have multiple use. If metal connecting parts broke, they can be send into the repair or recycling process.

These assumptions and suggestions for specific parts can be proposed in the software (earlier envisioned by producers or designers), so the stakeholders can decide what to do in every case.

**“How to identify buildings for life-cycle extension?”**

**(Huuhka et al. 2021)**

## 9. DISCUSSION AND CONCLUSIONS

### Summary (English)

Besides dealing with the existing waste, the *construction waste prevention* is the most important issue in environmental protection when we are planning to build the new structures.

The *importance of the new environmental protocols* all over the world is evident.

This research thesis established:

- Comprehensive overview of the existing assessment methods and tools used for measuring the building environmental impact.
- Design framework for the building and building systems, components and elements which will have low environmental impact has been presented to gain a better understanding of the impact that a design solution has on the future possibilities for transformation and reuse.
- The Construction Waste Elimination (CWE) protocol, which gives exact picture of the analysed building or building product in terms of building waste and its impact.

Including the construction industry in circular building and economy will not be sacrificing the profit, just change the state of mind and following the new methodology, the CWE protocol and adequate planning. It will prevent large amounts of construction waste and negative environmental pollution.

## 9. DISCUSSION ET CONCLUSIONS

### (Récapitulatif Français)

Outre la gestion des déchets existants, la prévention des déchets de construction est la question la plus importante concernant la protection de l'environnement dans la phase de la planification de nouvelles constructions.

L'importance de nouveaux protocoles écologiques est évidente partout dans le monde.

Cette thèse de recherche comprend :

- Aperçu complet des méthodes d'évaluation et d'outils existants servant à mesurer l'impact du bâtiment sur l'environnement.
- Cadre de conception pour la construction des nouveaux bâtiments et des systèmes de construction, des composants et des éléments qui auront un petit impact sur l'environnement, pour comprendre mieux la conception architecturale et ses possibilités de la transformation et de la réutilisation.
- Protocole Elimination des déchets de construction - Construction Waste Elimination (CWE) fournissant une image précise du bâtiment ou du produit de bâtiment analysés en termes des déchets de construction et de leur impact sur l'environnement. Le fait que l'industrie de la construction est incorporée à la construction et à l'économie circulaires ne signifie pas que le profit sera sacrifié, mais que cela changera seulement l'état d'esprit suivant la nouvelle méthodologie, le Protocole CWE et la planification adéquate. De cette manière, de grandes quantités de déchets de construction, ainsi que l'impact négatif sur l'environnement seront prévenus.



## 9. DISCUSSION AND CONCLUSIONS

### 9.1. WHAT IS ACHIEVED - The Construction Waste and its Environmental Impact

A target set by the European Union by EC in 2008, was to recover 70% of construction and demolition waste by weight by 2020. (European Commission 2008) Positive initiatives and projects have been launched and are ongoing, some achieved results are encouraging, but there is still a long way to achieve this target in many European countries. For some developing countries, which are not in the EU, like Bosnia and Herzegovina (BiH), this goal is unreachable, even within the longer timeframe. Starting point, like projects for waste management, which are proposed as a guidance map, is already established in countries like BiH. Every project in favour of this matter is really important and creates a framework for further activities, but implementation and eventually, practice examples, would be more desirable.

Problem of the construction waste is not present only in Europe. It is a problem in the whole world. Obstacles for lowering the construction waste quantities have been detected in previous studies in many countries. As one of the main obstacle, Angulo 2005 mentions a lack of construction waste quantitative information, a key parameter for the development of policies aimed at waste reduction practices in Brazil. In many countries in Europe, there is the same problem – very little data of the construction waste qualities and quantities.

Building demolition and its waste disposal is usually happening on the local level, in a small community and there is not known database which can track the total waste in a single region or a country. If there is a database of construction waste, it will be easier to track the quantities, material disposal and enable next steps towards low building waste. It is hard to establish this kind of database at the end of the building life-cycle, as many stakeholders don't see it as a benefit for them directly. The database of materials and their relations in the design phase is crucial, as it provides insight into qualities and quantities of used materials and all stakeholders can benefit from it in each phase of the building life. According to that, the created database can be very valuable at the end of the building life-cycle in order to enable reuse of the building parts, as a first preferred option. (European Commission 2008)

The most generated Construction Demolition (C&D) wastes are considered as inert materials, which may not pose a threat similar to hazardous, municipal and solid wastes (Wang et al. 2014), but they require a great surface on the ground (landfill), that could be used for some other purpose. C&D waste could have a significant impact on the environment, including energy consumption and incremental greenhouse gas emissions, resource depletion, land deterioration and also environmental pollution.

(Mah et. al. 2016) The same problems with the waste are detected in BiH. There are illegal landfills throughout the country in BiH. These landfills have to be mapped and cleaned. Materials that are thrown away are not specified and could be hazardous materials that will damage the environment permanently. New law protocols in environmental protection and law enforcement should be developed and implemented, according to the mentioned.

Besides dealing with the existing waste, the *construction waste prevention* is the most important issue in environmental protection when we are planning to build the new structures.

The building, defined by Law on Physical Planning and Utilization of Land at the Level of the Federation of BiH, is “permanently connected to the ground, and consists of a building assembly and installed equipment, which together within the technological process together form a technological unit, as well as an independent facility permanently connected to the ground”. If the building changes its shape during the time, it is considered as extension. It means that every transformation requires administrative procedure for new spatial planning approval and construction permit. These law restrictions are obstacle for the new buildings, which should and could be transformable and follow the change in function, in accordance to the user needs. The Law should add new regulations, specify and define the *transformable building*. The future building structure has to allow change and transformation, in order to be included in circular construction and economy, which means that the building can:

- be able to change and upgrade its parts;
- accept and change parts with the other building;
- be easily disassembled and all its parts can be the parts in another building life-cycle;
- transform the shape during its life-cycles.

As already explained, the pilot project Green Design Center was facing the problem to get the building permit (in accordance to the Law in BiH), because it was designed to be transformable building and change its shape on the yearly basis. (Chapter 5 in this research). The Law should support and emphasize the building transformation, in order to allow the building parts to become the resource, not the waste.

This research thesis came to the conclusion that the reduction of construction waste generation is a complex process, usually a result of a combination of factors, and the process of lowering the building waste and its negative environmental impact can be successful when:

1. Construction companies adopt a new mind-set and change approaches.

The understanding of how and where waste is generated and the adoption of benchmarks can greatly contribute to disseminate this new culture. (Formoso et al. 2002). The construction approach cannot be changed overnight or by itself. New protocols should be implemented. The procedure should offer an understanding of benefits for each stakeholder group, the ones that are involved in the process of building new buildings (to prevent the waste) and the ones involved in the process of demolishing the old structures.

2. The quantification of waste generation is tracked.

It can contribute to controlling waste and provide a benchmark for reduction. However, it can be a difficult task because of the specific characteristics and the wide range of materials, construction system and design features used in different construction projects. (Formoso et al. 2002). For the new buildings, it should be mandatory to have a tracking log of each part (material/element/component/system) that is going to be built in. A producer should be responsible for the material marking, and constructor for its recording and tracking in the future. Material mapping can be simple done in the BIM model which would be matched with the final building state and helps during and after first building life-cycle.

3. Stakeholders select suitable construction methods, good trained workers and when enough attention is given to design supervision. (Scheer et al. 2007)

All these steps that are required from participants in the process should be supported by funded programs, so the stakeholders see their chance to improve the process without additional cost.

4. Using prefabricating building elements off-site in precast designs.

Design standardization is a pre-requisite criterion for precast operations and it is most suitable for the design of high-rise residential buildings. (Baldwin et al. 2009) Poon 2007 argues that recent studies have shown that about 10% of construction waste is generated from the cutting of building materials during the construction process. Saez et al. 2012 concluded that achieving optimal waste management is necessary to have the planning undertaken by construction companies. To take advantage of that planning, the good cooperation and coordination should be established between project designers (architects, civil engineers, consultants), construction stakeholders (material producers and construction contractors) and clients (private or public investors). The successful cooperation will result with precise project with well-defined materials (environmentally friendly) and specified dimensions of all elements (per ex. produced to precise measure in factory, to have less leftovers).

5. Decision makers start in a pro-active way with the objective to predict the amount of construction waste and to establish benchmark in order to reduce

waste generation. (Parisi Kern et al. 2015) Stakeholders start a wide practice of embedding waste reduction in briefing and contractual documents and designers' start to recognize and understand design waste origins, causes and sources. (Osmani 2013)

It is very important to include additional analyses and to follow the new protocols for environmental protection proposal with predicted scenarios in the new building project. In many countries stakeholders don't have enough data to properly plan the waste reduction. The real progress in this process will be the detailed documents with all necessary data for the building composition.

6. Designing out waste starts to be the main objective of architects and contractors in the context of sustainable construction. (Osmani 2013).

This is possible when materials/parts are mapped and available to be used separate as materials/parts (relations and connections should be in the way to enable decomposition).

7. Choosing the building system with the lowest quantity of the waste.

The comparison of the waste generated in high-rise buildings with three different construction methods was done by Lachimpad et al. 2012. They suggest that Industrialized Building System is the most efficient one, compared with Mixed System and the Conventional Construction. The study conducted by Wang et al. 2014 shows six critical production factors that influence waste generation: large-panel metal formworks; prefabricated components; fewer design modifications; modular design, investment on waste reduction and economic incentive.

Considering analyses in this research thesis, the best building system is the modular one, which is predesigned and anticipated to be dismantled without damaging its parts (with good internal relations of its parts and with connectors that ensure easy disassembly).

Besides modular design and prefabricated parts, the relations of the parts and connections should be added to this list, as that is very important factor that allows the transformation. The relations between parts of the system are crucial, considering the results of this study. For example, if we connect two prefabricated components with some sort of adhesive that doesn't allow their separation, then the reuse of the parts becomes impossible and some perfect modular prefabricated units become waste, as they cannot be reused ever again in its original role. Recycling is an option in this case, but the real waste reduction and the low negative environmental impact will be accomplished if the separation is possible.

Llatas 2011 proposes a model for quantifying construction waste in projects according to the European Waste List (EWL). It is based on two main variables:

- the amount of building / site-work elements and the building materials and components,
- the transformations that these building materials and their packaging experience throughout the construction process.

As main result, the model gives the quantity of the waste expected in each building / site-work element, as the addition of packaging waste, remains and soil coded, according to the EWL. (Llatas 2011)

“The selection of waste management and reuse methods and technologies is crucial if a selected system is to be sustainable under the present economic and social conditions.” (Androšević, Durmišević & Brocato 2019)

When we are speaking about a new building, the amount of the materials used can be estimated in the early phase, in building design, in the BIM model. The other waste on a building site can also be predicted and lowered by precise producer planning. All packaging can be reduced. Materials should be produced in required dimension or cut to measure in factory and leftovers can be returned in production process.

This end of the building first life cycle shouldn't be:

- simply demolition (preferably not the demolition at all),
- the transport of the construction waste to a landfill,
- proposing only recycling option for some materials.

“With new circular building design in mind, this study illustrates the importance of implementing reuse potential design protocols during design and evaluation phase in order to indicate what can be done in order to design reversible and sustainable building systems and how design solutions can be improved during the design process.” (Androšević, Durmišević & Brocato 2019)

## 9.2. WHAT IS ACHIEVED - Discussions and Conclusions After the Case Study Testing

Conducting the survey of the wooden walls in BiH (chapter 5 in this research), some remarks about existing building external wall systems and their construction waste production were already published:

“Most of the recently developed façade products available in the BiH market for passive housing, use many synthetic materials and have similar structural problems when it comes to transformation and reuse. Most of the façade systems developed so far for high energy performance (energy positive buildings) are fixed and do not accommodate easy adaptations. As a result, transformation is linked to demolition, waste creation and purchase of new materials... The connections have a big role for assembly and disassembly of a system and they are a very important factor regarding the waste creation... There are almost no reversible or easy connecting and disconnecting solutions in the construction industry. Construction industry was, and is developing towards easy assembly, but not easy disassembly solutions. Usually, there are no possibilities to separate its components, elements and materials in building systems...” (Androšević, Durmišević & Brocato 2019)

Additionally, it has been studied how different functions of the façade could be solved with independent parts of the façade system in order to allow for functional transformation of a façade without demolishing parts in it. (Androšević, Durmišević & Brocato 2019)

During the survey of available connections while designing and making the GDC façade module, the “intermediary” is introduced. It is a middle element, an interesting solution that allows easy assembly and disassembly of wood multiple times. (Brussels Environment et al. 2017)

Comparing the reuse potential of the mentioned two case study wooden walls, traditional wooden wall for low energy houses Figure 52 and transformable wooden wall of Green Design Centre Figure 58, early conclusions were the ones that would be proven right in the later research.

The case study analyses provide the evidence that “there is a close link between the reuse potential of building systems, components, elements and materials and construction waste. If reuse and transformation potential is high, then the construction waste is low and vice-versa. Low construction waste leads to low environmental impact of a building or its parts. In this case, the case studies of façade systems show the weak points in existing facades and the way to design a façade with high reuse and

transformation potential with low environmental impact and create very low amount of waste during its life-cycle.” (Androšević, Durmišević & Brocato 2019)

Further research and tested case studies in BiH confirmed these remarks from the first case study. The *importance of the new environmental protocols* all over the world is evident.

Comparison of the reuse potential of the two case study walls underlines the importance of environmental impact calculation in the early phase of the building project. The Reversible BIM tool (Durmišević et al. 2021) is developing while this research is going on, thus for the purpose of this research, reuse potential method Durmišević 2006 was applied manually to the case studies. Future work should be done in the direction of upgrading the material database:

- Adding data for the materials that are connections,
- Adding sustainable suggestions for relations between materials, systems and products.

It is evident that aside from the material database, which is needed in the first place where the materials for the building are chosen, there is a necessity to form a *built-in materials database*. The term “material database” should include all materials, elements, components or systems (with all details) with their possible relations predicted connections. The important upgrade to the construction product is information about possible connections that are allowed. A new “built-in” materials database should be placed together with the other building information documents. The case study walls are made of the same materials (same quantities, too), but connected with different types of connections. When the connecting materials are involved, the final result can be slightly different, even in the first life-cycle. If we include a scenario that enables reuse and if we calculate reuse potential for the future transformation in the second life-cycle, the environmental impact will be drastically different.

Working on this research was very demanding task, as the examples of circular buildings are rare in BiH. Experimenting and a lot of attempts were necessary to achieve the goal - finding the method which will be the most helpful to reduce the construction waste. Testing the wall, one of the most important building system, demonstrate that the method can help in building waste prediction.

In attempt to compare the results of tools OneClickLCA and OpenLCA, there was a small obstacle. It was hard to find essentially the same materials, as the tools use different material databases. Database EPD and Ecoinvent do not have exactly the same materials (used for the mentioned case studies) in their databases. For that reason, the LCA impact results for the construction materials analysed in the two mentioned software (OneClick LCA and OpenLCA) cannot be directly compared. Although in many ways similar, two

tested LCA software did not respond on the same way to the task. OneClick LCA tool was a slightly problematic, as it didn't accept any modifications according to the mentioned methodology. First calculations in the LCA tool OneClickLCA didn't give promising results in favour of finding a good approach for lowering the construction waste in later building life-cycles. The tool doesn't consider relations between materials used and don't require materials' connections' information. Total score of the impact calculated by OneClickLCA is simply the quantity of the used materials and there is no difference if there are different material connections. (chapter 6 in this research) These non-covered areas in the software would be solved if there were more interest in these analyses.

Another LCA software, OpenLCA, allows working with parameters which can be modified according to different factors defined with methodology described in the Chapter 7 in this research. In the Chapter 8 in this research, it is the tool used in the Construction Waste Elimination (CWE) protocol for construction waste reduction in the design phase and provide insight into the best future scenario for tested building system. This software illustrates the quantities of waste and its impact and can help in prediction of construction waste and decision-making process. OpenLCA software was tested on some case studies in the chapter 6 and 8 in this research. The suggested CWE protocol in the chapter 7 of this research predicts scenarios for a building and its systems and introduces parameters which are values depending on the relations between materials. Combining the methodology and applying the Conn values in the OpenLCA software, the final results are clear and confirm the theory. (Chapter 8 in this research). It is necessary to predict future scenarios and add numerical values to the final report, so stakeholders can have a clear picture what is possible to do and what is not.

Any software as good and user adaptable as OpenLCA can be used in the process of predicting the construction waste and its environmental impact, following the described CWE protocol in the Chapter 7 of this research. Thanks to this research, software engineers should adapt the LCA software with plug-ins that will help final users to calculate the waste in the next building life-cycle scenarios as well.

However, testing the same systems (made of the similar materials) as Case studies in the OneClick LCA and OpenLCA software (Chapter 6.2.1. in this research), brought some conclusions:

- The protocols for importance and transparency/visibility of connections in the products should be implemented in near future. The connection materials, connection possibilities and relations between building parts should be in focus.

For now, there are no known database of connection materials and products - declared as "connections", in order to do the LCA computation for all parts and components in the system and calculate the environmental impact.



- The methodology of the existing software does not consider any possible transformation and upgrade scenario during the first life-cycle or any possible material tracking after the first life-cycle. Suggested upgrade for the LCA software, which would help in decision process regarding environmental impact of the future building, is shown as a scheme in Figure 128.

LCA tools are not used much in practice as it is not obligatory and it is still a very expensive procedure (considering the software and the expert report).

Diaz & Antón 2014 and Hollberg & Ruth 2016 have found out why LCA tools are not used more often in practice. During the survey, they found out that “LCA means a high effort and therefore a high cost for sustainability certification. As a result, the LCA of buildings is commonly conducted at the end of the design process, when the necessary information is available, but it is too late to affect the decision-making process.”

Following earlier results from various researches, it is undeniable that the Life-cycle analyses have to be calculated in the design phase. Wittstock et al. 2009 said that this post-design evaluation through LCA is not sufficient on its own, as it does not improve the environmental performance of the design. Hollberg et al. 2020 confirmed the same conclusion as Bogenstätter 2000 “in order to minimize environmental impacts, an integration of the LCA into the architectural design process is needed, especially in the early design phases, as these have the highest influence.” The implementation of LCA in the beginning of the building project was suggested in this research, along with prediction the scenarios for the building and building system to prevent the mistakes in design that can be crucial for environmental impact. It is evident that this process has to be as simple as it can be and affordable or funded by governmental or non-governmental organization.

The testing of the LCA tools in this research demonstrated that LCA software should be included as advice/decision making tool in predesign and design phase in the process of the building design and implementation. It can be also used in other building phases, e.g., when a building is built and has to be evaluated. The final result or certificate will be used as a reminder what can be done with the parts of the building after one of its life-cycles.

After the literature review, case study testing and measuring/calculating and quantifying the waste, it was evident that there is a need to establish the Construction Waste Elimination (CWE) protocol, which is not the same as already defined Construction Demolition (C&D) Waste. Definition for *Construction and Demolition Waste* according to the EU Directive 2018/851 and EC 2008/98, is: “Waste generated by construction and demolition activities”, which means that it is simply an amount of materials created during the building construction and after demolition (usually measured when the building finishes its first life-cycle). *The Construction Waste*

*Elimination* protocol will prevent the waste in the early phase of the building design. If the system is planned well, the waste will be minimal and without negative environmental impact.

Considering the above, new construction/building protocol has to be considered as the requirement for the building permit. The set of documents in architectural building project must have a depository of all used materials/ elements/ components /systems in a building and their relations besides the set of drawings, calculations and other building technical information.

The Construction Waste is not just a simple quantity of the waste, for example weight (kg) or volume (m<sup>3</sup>) of all parts and materials included. It depends on:

- the characteristics of the used materials,
- material relations (connections),
- material condition after dismantling.
- of the maintenance and conditions during building parts lifetime,
- of the total time passed while in use.

*The Construction Waste* quality and quantity and its environmental impact depends on many factors which should be taken into account, as follows:

- Relational dependencies between parts of the system,
- Type of the connections,
- Assembly possibilities,
- Disassembly possibilities,  
(all four are defined by Durmišević 2006)
- Possibility of building transformations – calculated only for the whole building, and not necessarily for the building system,
- Quantity of the total materials used,
- Quantity of the materials/parts that can be reused (with expiry date),
- Quantity of the materials/parts that can be recycled (with zero or positive balance),
- Time frame for calculation (Predicted Timeline and Expected lifetime of the parts),
- Number of transformations.

It is important to compute the estimated time period for which the Construction Waste is calculated and predicted, as this factor is crucial for decision whenever the system satisfies the requested needs of users and the assigned functions in the requested time period.

In the future, Reversible BIM (Durmišević et al. 2021) should take a big role in the beginning of the architectural project, when the connection and synergy with other software and material database is achieved (in order to lower the environmental impact). Interconnection and compatibility of material database, BIM, RBD and LCA tool should be obligatory. Only in that case, the data and the final results can be clear and all current and future flaws can be corrected and negative environmental impact can be prevented.

This research thesis established:

- comprehensive overview of the existed assessment methods and tools for measuring the building environmental impact.
- design framework for the building and building systems, components and elements which will have low environmental impact has been presented to gain a better understanding of the impact that a design solution has on the future possibilities for transformation and reuse.
- the Construction Waste Elimination (CWE) protocol, which gives exact picture of the analysed building or building product in terms of building waste. The protocol provides evaluation and quantification of the factors that are affecting the future environmental impact of the compared case studies and enables explanation between the variance of one building's product compared to another. It gives an objective assessment for compared case studies and supports the circular building practice.

Through the analysis, testing methods and case studies, research strongly confirm that stakeholders can have a view of the environmental impact, not just in the first life-cycle, but also in the next ones. The best results will be achieved when possible scenarios are predicted in the design phase. The final results can show precisely the difference between tested case studies, and thus the stakeholders would be able decide on the best option. This research demonstrates that it is possible to lower the construction waste quantities, if we follow the proposed CWE protocol, which consists of steps that include combination of existing methods with some upgrades.

Limitations that the methodology is facing are following:

- Partially acceptance of prefabrication from stakeholders (mostly designers),
- Unreliable data from producers,
- Difficult validation of the available building product data.

This study “can open the eyes to the new building design approach and building design protocols, not only in BIH, but also in countries around the world. It should be further developed and tested in other building systems”. (Androšević, Durmišević & Brocato 2019)



### 9.3. RECOMMENDATIONS FOR FURTHER RESEARCH – What is Left to be Done

The definition of a building, like the definition of Egenhofer 2002: “Building is a structure that has a roof and walls and stands more or less permanently in one place”, should be extended with an information about the preservation or change of the building primary shape. The definition of a building should be adapted and upgraded according to the new discoveries that the transformable building is a building of the future:

*A building is a structure which will adapt itself in every aspect during time in order to satisfy the needs of its future users.* Building planning should consider and define future building transformations (even if it is a change in the building shape).

Considering all the above concluded after the literature research and the case study testing, the change in a way of thinking and acceptance of the suggested methodology will start when:

- building is defined as transformable structure (and not permanent!);
- environmental impact of a building is defined by law and low environmental impact of a building is obligatory for a building permit;
- low waste building becomes the investor’s main concern. (The change in building process could start when the cost of disposing waste/ transportation costs and landfill/ become so high that)

The next action items must be available and clearly defined:

- database of the building parts (materials, elements, components and systems) including their disposal and their condition and location;
- database of the connecting materials /parts/ with all data as material database;
- predicted scenarios for the building in the requested timeline;
- economic necessity to change just one small part of another building;
- reliable plan for dismantling the building or its parts;
- monitoring of the processes and all activities until the end of task;
- traceability of all the parts of the building.

There are still no studies found in the literature which apply the LCA or similar tools from the early stages in design and during the whole building process. To give actual feedback for designers and inform decision-makers, it is crucial to use the LCA in the predesign and design phase and its results should be available throughout all design phases, as confirmed also in the research of Meex et al. 2018 and Hollberg et al. 2020. They also found out that usually, LCA tools are employed for a model with a relatively high level of development (LOD) of LOD 300 or higher in later design stages, which doesn’t give desired results. This is just one of many studies that confirms that a building protocol

must include precise requirement to predict the environmental impact in the early design phase and take all measures to lower it as much as it is possible.

Fast progress and advancement in technology can help making the suggested method more available to the stakeholders, making the whole decision-making process easier and getting the accurate results cheaper and faster. It appears that the first step in implementation has to be adopting the measures on the governmental levels and giving some advantages to the early adopters.

Many scientists provide overviews and reviews of the possible digital improvements for the LCA analyses and tools. (Bueno & Fabricio 2018, Cavalliere 2018, Soust-Verdaguer et al. 2017) The conclusions and recommendations of Hollberg et al. 2020 are: “BIM can reduce the effort of calculating the embodied environmental impacts of buildings and therefore provides the potential to improve the environmental performance of buildings during the design stage... Three options to solve this general problem could be imagined:

- The design workflow is adapted to only work with predefined components. While this might be a suitable approach for industrialized building projects, designers might feel limited due to this approach for innovative projects or architectural competitions.
- The calculation of the embodied impact is adapted to use simplified approaches based on surface areas instead of volumetric models. This approach has proven to be beneficial in early design stages, but is slightly less accurate for certification of the as-built model.
- LCA tools learn from previous projects (machine learning) and automatically use typical assumptions for the placeholder materials in early design stages. This approach requires a large database of as-built BIM models with the required information for LCA that does not exist yet. In collaboration with researchers, sustainability certification institutes and commercial LCA tools such a database could be established and used in a long-term perspective.”

“The LCA analysis needs improvement and should include the component or system disassembly possibilities, so the users can really benefit from the final results /scores/ and get suggestions how to choose wisely to have longer and healthier building life. The possibility of material separation can be added as one of the factors in the whole process, and this can be monitored specifying the connections between a building and building system parts and suggesting the connections and disassembly possibilities in the design phase. Also, there should be environmental impact calculation for two case scenarios:

- storing and incorporating the parts in a new structure,
- dumping the parts of the system.” (Androšević et al. 2019)

Following the mentioned, LCA can enable transition from linear to circular economy, from “cradle to cradle” with the recommendations and decision making suggestions. (Androšević et al. 2019)

General Design Concepts - A list of design concepts and components for facilitating deconstruction of buildings is provided by Guy, Shell & Homsey 2006:

- All materials should be examined using a precautionary approach to eliminate possible toxicity or future regulatory constraints to their use and disposal.
- Fewer connectors and consolidation of the types and sizes of connectors will reduce the need for multiple tools and constant change from one tool to the next... Doubling and tripling the functions that a component provides will help “dematerialize” the building in general and reduce the problem of layering of materials...
- Separating long-lived components from short-lived components will facilitate adaptation and reduce the complexity of deconstruction, whereby types of materials could be removed one at a time, facilitating the collection process for recycling...
- The design for deconstruction aesthetic should be modelled as “high-tech” architecture aesthetic...
- Elimination of caulking and sealants and high-tolerances in the connections can be offset by the ease of removing components for repair and replacement, and designing in durability, using mechanical instead of chemical-based water protection.

“Design for deconstruction has much to learn from product design for disassembly. Buildings have much greater life cycles than consumer products and engage a larger number of actors over their lives than consumer products...Technology-oriented components of buildings will inherently make them more efficient to operate and therefore assist in maintaining their long term value.” (Guy, Shell & Homsey 2006)

Kozminska 2019 suggests changing design process and the role of the architect to establish lower environmental impact.

“In reality, business model innovation is quite often piecemeal or incremental, rather than transformational, fundamental, and system-wide. System wide innovations can only be realized in conjunction with related complementary innovations; in other words, these innovations are not autonomous. Thus, the introduction of a single innovation can result in a systemic innovation if it generates or requires changes in one or more areas of a system.” (Antikainen & Valkokari 2016)

Upgrading just one existing tool such as the LCA tool, can show the difference between the waste of the almost the same systems (at the first glance) in the Chapter 6 in this research. The upgrade of the LCA tool can be very simple and it involves:

- connecting materials database,
- conn values that show disassembly potential of chosen connections.

This change in methodology, in early building design phase, defined by Construction Waste Elimination (CWE) protocol in Chapter 7, can facilitate the procedure that the stakeholder can follow and digitalize the whole process. The software can be more helpful in decision-making process, in terms of proposing better solutions. This kind of protocol should be obligatory for every new building.

Following this procedure, the stakeholders could choose and decide:

- on materials which are environmentally less harmful;
- the right systems;
- the best relations between chosen materials, elements and components in the system, so the parts of the building could be changed if necessary in the maintenance phase or reused in the second life-cycle or transformation;
- the best possible scenario for the next building life-cycle.

The CWE protocols must provide guidelines to the optimal system or suggest better solution, if available.

Construction industry stakeholders should open their eyes and looking for solutions that will help circular building industry. In product design the transformable products with interchangeable parts are encouraged. Even the IT hardware industry started to think about the standardized parts for hardware (as chargers, plug-ins, batteries etc.). Modular building parts will be welcome in architecture design to achieve interchangeability between buildings and achieve transformability without waste. Construction industry stakeholders should consider total environmental benefits instead of immediately profit. They should sacrifice immediate enormous profit in favour of future long-term profit. This kind of methodical thinking would be bigger than the act of Nils Bohlin, Volvo engineer, who invented the V-type three-point safety belt in 1959 and give it for free to save the lives. It is remembered as “Volvo’s gift to the world.” (Bell D. 2019)

Including the construction industry in circular building and economy will not be sacrificing the profit, just change the state of mind and following the new methodology, CWE protocol and adequate planning. It will prevent big amounts of construction waste and negative environmental pollution.



#### 9.4. RECOMMENDATIONS FOR FURTHER RESEARCH – What are the Next Steps

The preliminary results after testing one building system, demonstrate feasibility of the methodology and CWE protocol. The next step after this research will be:

- Further research to test the methodology on other building systems and the whole building. Methodology should be upgraded according to the results after application to the more complex systems.
- Cooperation with software engineers with the goal to digitalize methodological framework and to fill the gaps. The compatible BIM (building information modelling), RP (reuse potential) and LCA (life-cycle analyses) software is vital in digitalization of the whole process. It can be “the implementation of Industrialised Building Systems (IBS), which has the potential of promoting sustainability deliverables.” (Yunus & Yang 2011) Digitalization of the building project is useful in every building stage, as digitalization ensures quicker results, easier track and flow of information and transparent data sharing for all stakeholders.
- Establishing the connection materials database is undeniable in the near future.
- Building environmental impact information dissemination to the stakeholders in the building industry, with protocols that will help them to transfer to new technological solutions that are more environmentally friendly.
- Informing the responsible for environmental protection about benefits of early predictions of environmental impact of building structures, so the new protocols and laws can be put in force.

When the mentioned changes in the database and software take place, it will be easy to make complex building systems and test them in the early design phase. This will make the process easier and available for all stakeholders. The stakeholder will get the recommendations for the system/building upgrade for better performance during the predicted transformations, modifications and in the next life-cycle in terms of the lower environmental impact and eventually, total cost of building including all building parts' life-cycles and their end of life.

There is still a long way to the methodology acceptance and its digitalization, as it requires the unique database of all building materials with specific details (per ex. possible transformable connectors) and scenarios for reuse in the next life-cycle. Eventually, stakeholders will overcome these obstacles, as soon as the methodology framework gets accepted.

## REFERENCES

1. Akadiri, P. O., Chinyio, E. A., & Olomolaiye, P. O. (2012). Design of a sustainable building: A conceptual framework for implementing sustainability in the building sector. *Buildings*, 2 (2), 126–152.
2. Akinade, O. O., Oyedele, L. O., Ajayi, S. O., Bilal, M., Alaka, H. A., Owolabi, H. A., ... & Kadiri, K. O. (2017). Design for Deconstruction (DfD): Critical success factors for diverting end-of-life waste from landfills. *Waste management*, 60, 3-13.
3. Akinade, O. O., Oyedele, L. O., Bilal, M., Ajayi, S. O., Owolabi, H. A., Alaka, H. A., & Bello, S. A. (2015). Waste minimisation through deconstruction: A BIM based Deconstructability Assessment Score (BIM-DAS). *Resources, Conservation and Recycling*, 105, 167-176.
4. Alba-Rodríguez, M. D., Martínez-Rocamora, A., González-Vallejo, P., Ferreira-Sánchez, A., & Marrero, M. (2017). Building rehabilitation versus demolition and new construction: Economic and environmental assessment. *Environmental Impact Assessment Review*, 66, 115-126. doi:10.1016/j.eiar.2017.06.002
5. Alcott, B. (2010). Impact caps: why population, affluence and technology strategies should be abandoned. *Journal of Cleaner Production*, 18(6), 552-560. doi:10.1016/j.jclepro.2009.08.001.
6. Allwood, J. M., Ashby, M. F., Gutowski, T. G., & Worrell, E. (2011). Material efficiency: A white paper. *Resources, Conservation and Recycling*, 55(3), 362-381.
7. Androšević, R., & Androšević, D. (2021). Designing the Future Residential Buildings with Low Environmental Impact-Case Study Buildings in Bosnia and Herzegovina. In *International Symposium on Innovative and Interdisciplinary Applications of Advanced Technologies*. In book: Advanced Technologies, Systems, and Applications VI (pp.735-743) Springer, Cham. doi:10.1007/978-3-030-90055-7\_59
8. Androšević, R., Brocato, M., Bijedic, D., & Rustempasic, N. (2019, September). Life Cycle Assessment as a Tool for Low Waste Building Systems, Case Study Building External Wall. In *IOP Conference Series: Materials Science and Engineering* (Vol. 603, No. 4, p. 042067). IOP Publishing. doi:10.1088/1757-899X/603/4/042067
9. Androšević, R., Durmišević, E., & Brocato, M. (2019). Measuring reuse potential and waste creation of wooden façades. In *IOP Conference Series: Earth and Environmental Science* (Vol. 225, No. 1, p. 012017). IOP Publishing. doi: 10.1088/1755-1315/225/1/012017
10. Angulo, S. C. (2005). *Caracterização de agregados de resíduos de construção e demolição reciclados e a influência de suas características no comportamento de concretos* (Doctoral dissertation, Universidade de São Paulo).
11. Ansah, M. K., Chen, X., Yang, H., Lu, L., & Lam, P. T. (2020). An integrated life cycle assessment of different façade systems for a typical residential building in Ghana. *Sustainable Cities and Society*, 53, 101974. doi:10.1016/j.scs.2019.101974

12. Antikainen, M., & Valkokari, K. (2016). A framework for sustainable circular business model innovation. *Technology Innovation Management Review*, 6(7).
13. Arnautović-Aksić, D., Burazor, M., Delalić, N., Gajić, D., Gvero, P., Kadrić, Dž., Kotur, M., Salihović, E., Todorović, D., Zagora, N. (2016). Typology of Residential Buildings in Bosnia and Herzegovina. published by GIZ, ISBN 978-9958-691-50-8, p 21, 100, 170, 202, 234
14. Asdrubali, F., Baldassarri, C., & Fthenakis, V. (2013). Life cycle analysis in the construction sector: Guiding the optimization of conventional Italian buildings. *Energy and Buildings*, 64, 73-89. ISSN: 0378-7788
15. Assefa, G., Glaumann, M., Malmqvist, T., & Eriksson, O. (2010). Quality versus impact: Comparing the environmental efficiency of building properties using the EcoEffect tool. *Building and Environment*, 45(5), 1095-1103. doi: 10.1016/j.buildenv.2009.10.001
16. Baldwin, A., Poon, C. S., Shen, L. Y., Austin, S., & Wong, I. (2009). Designing out waste in high-rise residential buildings: Analysis of precasting methods and traditional construction. *Renewable energy*, 34(9), 2067-2073.
17. Becerik-Gerber, B., & Rice, S. (2010). The perceived value of building information modeling in the US building industry. *Journal of Information Technology in Construction (ITcon)*, 15(15), 185-201.
18. Bekker, P. C. F. (1982). A life-cycle approach in building. *Building and Environment*, 17(1), 55-61.
19. Bell, D. (2019). "Volvo's Gift To The World, Modern Seat Belts Have Saved Millions Of Lives". <https://www.forbes.com/sites/douglasbell/2019/08/13/60-years-of-seatbelts-volvos-great-gift-to-the-world/?sh=44d2d3e422bc> (accessed July 2021)
20. Beurskens, P. R. (2021). The development of an evaluation method to support circular building design. Doctoral dissertation. doi: 10.3990/1.9789036552042
21. Beurskens, P.R. and Bakx, M.J.M. (2015). "Built-to-rebuild - the development of a framework for buildings according to the circular economy concept, which will be specified for the design of circular facades". Master thesis. <https://pure.tue.nl/ws/portalfiles/portal/46914599/801836-1.pdf>
22. Blengini, G. A., & Di Carlo, T. (2010). The changing role of life cycle phases, subsystems and materials in the LCA of low energy buildings. *Energy and buildings*, 42(6), 869-880. doi: 10.1016/j.enbuild.2009.12.009
23. Bogenstätter, U. (2000). Prediction and optimization of life-cycle costs in early design. *Building Research & Information*, 28(5-6), 376-386. doi: 10.1080/096132100418528
24. Bragança, L., Mateus, R., & Koukkari, H. (2010). Building sustainability assessment. *Sustainability*, 2(7). pp. 2010–2023. <https://doi.org/10.3390/su2072010>
25. Brand, S. (1995). *How buildings learn: What happens after they're built*. Penguin.

26. Brezet, H., van Hemel, C. (1997). *Ecodesign: A Promising Approach to Sustainable Production and Consumption*. UNEP and TU Delft: Paris, France, 1997.
27. Bribián, I. Z., Capilla, A. V., & Usón, A. A. (2011). Life cycle assessment of building materials: Comparative analysis of energy and environmental impacts and evaluation of the eco-efficiency improvement potential. *Building and environment*, 46(5), 1133-1140. doi: 10.1016/j.buildenv.2010.12.002
28. Brussels Environment (Groens, H., Capelle, T., Henrotay, C., Steinlage, M.) – authors of the report. UTwente (Durmišević, E., Beurskens, P.), EPEA (Mul, E.J.), SGDF (Androšević, R.), VUB (Paduart, A., Elden, S., Lanckriet, W., Poppe, J.) – authors of the pilot project studies. (2018). *D13 Prototyping and feedback report - Testing BAMB results through prototyping and pilot projects*. EU Horizon 2020 Project BAMB Work Package 4. <https://www.bamb2020.eu/wp-content/uploads/2018/10/20180425-BAMB-WP4-D13.pdf>
29. Brussels Environment (Groens, H., Henrotay, C., Steinlage, M.), UTwente (Durmišević, E., Beurskens, P.), ZUYD (Westerdijk, R.), EPEA (Mul, E.J.), SGDF (Androšević, R.), VUB (Paduart, A., Elden, S.), Drees&Summer (Brennerr, V., Mosle, P., Schneider, D., Ozer, M., Braun, F., Keppler, P.), TUM (Heinrich, M., Haberer, M., Lang, W.), VITO (Debacker, W., Vanassche, S., Wang, K.), BRE (Hobbs, G.) (2017). *D13 Feasibility report + feedback report. Testing BAMB results through prototyping and pilot projects*. EU Horizon 2020 Project BAMB. [https://www.bamb2020.eu/wp-content/uploads/2017/09/D12-feasibility-report-and-feedback-report\\_web.pdf](https://www.bamb2020.eu/wp-content/uploads/2017/09/D12-feasibility-report-and-feedback-report_web.pdf)
30. Bryde, D., Broquetas, M., & Volm, J. M. (2013). The project benefits of building information modelling (BIM). *International journal of project management*, 31(7), 971-980.
31. Buckman, A. H., Mayfield, M., & Beck, S. B. (2014). Smart and Sustainable Built Environment. *Environment*, 3(2), 92-109.
32. Bueno, C., & Fabricio, M. M. (2018). Comparative analysis between a complete LCA study and results from a BIM-LCA plug-in. *Automation in construction*, 90, 188-200. <https://doi.org/10.1016/j.autcon.2018.02.028>
33. Bueno, C., Pereira, L. M., & Fabricio, M. M. (2018). Life cycle assessment and environmental-based choices at the early design stages: an application using building information modelling. *Architectural Engineering and Design Management*, 14(5), 332-346. <https://doi.org/10.1080/17452007.2018.1458593>
34. Buyle, M., Audenaert, A., Braet, J. (2012). Life Cycle Assessment as a tool to improve sustainability of the Flemish residential construction sector: methodology for simplified designs. *Proceedings of the 8th IASME/WSEAS international conference on energy, environment, ecosystems and sustainable development (EEESD'12)*. Faro, Portugal.
35. Buyle, M., Braet, J., & Audenaert, A. (2013). Life cycle assessment in the construction sector: A review. *Renewable and sustainable energy reviews*, 26, 379-388. <https://doi.org/10.1016/j.rser.2013.05.001>

36. Cambier, C., Galle, W., & De Temmerman, N. (2020). Research and Development Directions for Design Support Tools for Circular Building. In O. Kapliński, & W. Bonenberg (Eds.), *Architecture and Engineering: The Challenges - Trends - Achievements* (pp. 165-184). MDPI AG. <https://doi.org/10.3390/books978-3-03943-750-4>
37. Castanheira, G., & Bragança, L. (2014). The evolution of the sustainability assessment tool: from buildings to the built environment. *The Scientific World Journal*, 2014. Article ID491791. <https://doi.org/10.1155/2014/491791>
38. Cavalliere, C., & BIM-led, L. C. A. (2018). feasibility of improving life cycle assessment through building information modelling during the building design process, Available at Politecnico di Bari. *Politecnico di Bari*. <https://iris.poliba.it/handle/11589/160002>
39. Chen, X., & Lu, W. (2017). Identifying factors influencing demolition waste generation in Hong Kong. *Journal of cleaner production*, 141, 799-811.
40. Chen, X., Yang, H., & Peng, J. (2019). Energy optimization of high-rise commercial buildings integrated with photovoltaic facades in urban context. *Energy*, 172, 1-17. <https://doi.org/10.1016/J.ENERGY.2019.01.112>
41. Cheng, J. C. P, Ma, L. Y. H, (2013). A BIM-based system for demolition and renovation waste estimation and planning. *Waste Management*. 33:1539–1551.
42. Chertow, M. (2001). *The IPAT Equation and Its Variants*. Changing Views of Technology and Environmental Impact.
43. Cheshire, D. (2019). *Building revolutions: Applying the circular economy to the built environment*. Routledge.
44. Chileshe, N., Rameezdeen, R., & Hosseini, M. R. (2016). Drivers for adopting reverse logistics in the construction industry: a qualitative study. *Engineering, Construction and Architectural Management*. 23(2), 134-157.
45. Chileshe, N., Rameezdeen, R., Hosseini, M. R., Martek, I., Li, H. X., & Panjehbashi-Aghdam, P. (2018). Factors driving the implementation of reverse logistics: A quantified model for the construction industry. *Waste management*, 79, 48-57.
46. Chini, A. R. (2007). General issues of construction materials recycling in USA. Proceedings of Sustainable construction, materials and practices: Challenges of the industry for the new millennium, Lisbon, 1, 848-855.
47. Chini, A. R., & Balachandran, S. (2002). Anticipating and responding to deconstruction through building design. *proceedings of Design for Deconstruction and Materials Reuse, CIB Publication*, 272, 175-185.
48. Coelho, A., & de Brito, J. (2011). Economic analysis of conventional versus selective demolition—A case study. *Resources, Conservation and Recycling*, 55(3), 382-392.
49. Coelho, A., & De Brito, J. (2012). Influence of construction and demolition waste management on the environmental impact of buildings. *Waste Management*, 32(3), 532-541.

50. Coelho, A., & De Brito, J. (2013a). Conventional demolition versus deconstruction techniques in managing construction and demolition waste (CDW). *Handbook of Recycled Concrete and Demolition Waste*. Woodhead Publishing pp. 141-185.
51. Coelho, A., & De Brito, J. (2013b). Economic viability analysis of a construction and demolition waste recycling plant in Portugal – part I: location, materials, technology and economic analysis. *Journal of Cleaner Production*, 39, 338-352.
52. Cole, R. J., & Kernan, P. C. (1996). Life-cycle energy use in office buildings. *Building and environment*, 31(4), 307-317.
53. Commoner B. (May 1972). A *Bulletin Dialogue: on "The Closing Circle" - Response*. Bulletin of the Atomic Scientists. 28 (5): 17, 42–56. doi:10.1080/00963402.1972.11457931.
54. Crippa, J., Boeing, L. C., Caparelli, A. P. A., de Mello Maron, M. D. R., Scheer, S., Araujo, A. M. F., & Bem, D. (2018). A BIM–LCA integration technique to embodied carbon estimation applied on wall systems in Brazil. *Built Environment Project and Asset Management* 8, 491–503. <https://doi.org/10.1108/BEPAM-10-2017-0093>
55. Crowther, P. (1999). Design for disassembly. *BDP environment design guide*.
56. Crowther, P. (2018). Re-valuing construction materials and components through design for disassembly. In *Unmaking waste in production and consumption: Towards the circular economy* (pp. 309-321). Emerald Publishing Limited.
57. Curran, M. A., Mann, M., & Norris, G. (2005). The international workshop on electricity data for life cycle inventories. *Journal of Cleaner Production*, 13(8), 853-862.
58. Dalla Valle, A., Campioli, A., & Lavagna, M. (2020). Life cycle BIM-oriented data collection: a framework for supporting practitioners. In *Digital Transformation of the Design, Construction and Management Processes of the Built Environment* (pp. 49-59). Springer, Cham. [https://doi.org/10.1007/978-3-030-33570-0\\_5](https://doi.org/10.1007/978-3-030-33570-0_5)
59. Debacker, W., & Manshoven, S. (2016). D1 Synthesis of the state-of-the-art. *Key Barriers and Opportunities for Material Passports and Reversible Design in the Current System (H2020 BAMB project)*. [https://www.bamb2020.eu/wp-content/uploads/2016/03/D1\\_Synthesis-report-on-State-of-the-art\\_20161129\\_FINAL.pdf](https://www.bamb2020.eu/wp-content/uploads/2016/03/D1_Synthesis-report-on-State-of-the-art_20161129_FINAL.pdf)
60. Díaz, J., & Antön, L. Á. (2014). Sustainable construction approach through integration of LCA and BIM tools. In *Computing in Civil and Building Engineering (2014)* (pp. 283-290). <https://doi.org/10.1061/9780784413616.053>
61. Dixit, M. K., Culp, C. H., & Fernández-Solís, J. L. (2013). System boundary for embodied energy in buildings: A conceptual model for definition. *Renewable and Sustainable Energy Reviews*, 21, 153-164.
62. Dossche, C., Boel, V., & De Corte, W. (2017). Use of life cycle assessments in the construction sector: critical review. *Procedia Engineering*, 171, 302-311. <https://doi.org/10.1016/j.proeng.2017.01.338>

63. Du Plessis C. (2016). CIB Research Roadmap Sustainable construction. *International Council for Research and Innovation in Building and Construction*.
64. Du Plessis, C. (2007). A strategic framework for sustainable construction in developing countries. *Construction management and economics*, 25(1), 67-76.
65. Du Plessis, C. (2002). Agenda 21 for sustainable construction in developing countries. *CSIR Report BOU E*, 204, 2-5.
66. Durmišević, E., Guerriero, A., Boje, C., Domange, B., & Bosch, G. (2021). Development of a conceptual digital deconstruction platform with integrated Reversible BIM to aid decision making and facilitate a circular economy. In *Proc. of the Joint Conference CIB W78-LDAC* (Vol. 2021, pp. 11-15).
67. Durmišević E. (2019) /in collaboration with De Laat P., Beurskens P., Van den Boogaart E., Balson K., Hobbs G., VUB and SGDF/. Deliverable D19 – Transformation Capacity Tool. EU Horizon 2020 Project BAMB
68. Durmišević, E. (2019). Circular economy in construction design strategies for reversible buildings. *The Netherlands: University of Twente*. ISBN 978-90-821-698-4-3
69. Durmišević, E. (2006). Transformable building structures: design for disassembly as a way to introduce sustainable engineering to building design & construction. Delft University of Technology, Delft.
70. Eastman C.M. (1975). The Use of Computers Instead of Drawings in Building Design. *AIA Journal vol.63*
71. Eastman, C. M., Eastman, C., Teicholz, P., Sacks, R., & Liston, K. (2011). *BIM handbook: A guide to building information modeling for owners, managers, designers, engineers and contractors*. John Wiley & Sons.
72. Ecoinvent <https://www.ecoinvent.org/> Accessed 2020
73. Egenhofer, M. J., & Mark, D. M. (Eds.). (2003). *Geographic Information Science: Second International Conference, GIScience 2002, Boulder, CO, USA, September 25-28, 2002. Proceedings*. (Vol. 2478). Springer. p. 110. ISBN 978-3-540-44253-0.
74. Ehrlich, P. R.; Holdren, J. P. (1971). *Impact of Population Growth*. Science. American Association for the Advancement of Science. 171 (3977): 1212–1217. doi:10.1126/science.171.3977.1212.
75. Ehrlich, P.R.; Holdren, J.P (1972). *A Bulletin Dialogue: on "The Closing Circle" - Critique*. Bulletin of the Atomic Scientists. 28 (5): 16, 18–27. doi:10.1080/00963402.1972.11457930.
76. Ekvall, T., Weidema, B. P. (2004). System boundaries and input data in consequential life cycle inventory analysis. *The international journal of life cycle assessment*, 9(3), 161-171. doi: 10.1007/BF02994190
77. EPEA Braungart et al. (2016). The 15<sup>th</sup> International Architecture Exhibition. Biennale Architettura, Venice, Italy

78. European Commission (EC) (2018). EU Construction and Demolition Waste Protocol and Guidelines, Available at: [http://ec.europa.eu/growth/content/eu-construction-and-demolition-waste-protocol-0\\_en](http://ec.europa.eu/growth/content/eu-construction-and-demolition-waste-protocol-0_en) (Accessed: 25 February 2021)
79. European Commission (EC). (2018). Final Implementation Report for Directive 2008/98/EC on Waste. Available at: [https://ec.europa.eu/environment/archives/waste/reporting/pdf/Final\\_Implementation\\_Report\\_2013\\_2015\\_WFD.pdf](https://ec.europa.eu/environment/archives/waste/reporting/pdf/Final_Implementation_Report_2013_2015_WFD.pdf) (Accessed: 15 February 2021)
80. European Commission (EC) (2021). List of LCA databases by the European Commission. Available at: <https://eplca.jrc.ec.europa.eu/ResourceDirectory/faces/databases/databaseList.xhtml> (Accessed: 10 February 2021)
81. European Commission (EC). (2012). 433 final Communication from the Commission to the European Parliament and the Council. Strategy for the sustainable competitiveness of the construction sector and its enterprises. Available at: [http://ec.europa.eu/growth/content/eu-construction-and-demolition-waste-protocol-0\\_en](http://ec.europa.eu/growth/content/eu-construction-and-demolition-waste-protocol-0_en) (Accessed: 15 February 2020)
82. European Commission (EC). (2008). Directive 2008/98/EC. *Waste Framework directive*. Brussels, Belgium.
83. European Commission (EC). (2015). List of LCA databases by the European Commission. Available at: <http://www.epa.gov/nrmrl/std/lca/resources.html#Software> (Accessed August 2015)
84. European Investment Bank (2017). *“Investment report 2017/2018 From recovery to sustainable growth”*. European Investment Bank 11/2017. doi:10.2867/38858. Available at: [https://www.eib.org/attachments/efs/economic\\_investment\\_report\\_2017\\_en.pdf](https://www.eib.org/attachments/efs/economic_investment_report_2017_en.pdf) (Accessed: October 2019)
85. Fava, J. A. (2006). Will the next 10 years be as productive in advancing life cycle approaches as the last 15 years?. *The International Journal of Life Cycle Assessment*, 11(1), 6-8. <https://doi.org/10.1065/lca2006.04.003>
86. Feifer, L. (2011). Sustainability indicators in buildings. Identifying key performance indicators. In: *27th international conference on passive and low energy architecture (PLEA). Architecture and sustainable development*. Proceedings vol. 1-786.
87. Finnveden, G., & Moberg, Å. (2005). Environmental systems analysis tools—an overview. *Journal of cleaner production*, 13(12), 1165-1173.
88. Finnveden, G., Hauschild, M. Z., Ekvall, T., Guinée, J., Heijungs, R., Hellweg, S., ... & Suh, S. (2009). Recent developments in life cycle assessment. *Journal of environmental management*, 91(1), 1-21.
89. Formoso, C. T., Soibelman, L., De Cesare, C., & Isatto, E. L. (2002). Material waste in building industry: main causes and prevention. *Journal of construction engineering and management*, 128(4), 316-325.



90. Gálvez-Martos, J. L., Styles, D., Schoenberger, H., & Zeschmar-Lahl, B. (2018). Construction and demolition waste best management practice in Europe. *Resources, Conservation and Recycling*, 136, 166-178.
91. Gerilla, G. P., Teknomo, K., & Hokao, K. (2007). An environmental assessment of wood and steel reinforced concrete housing construction. *Building and Environment*, 42(7), 2778-2784.
92. Ghisellini, P., Cialani, C., & Ulgiati, S. (2016). A review on circular economy: the expected transition to a balanced interplay of environmental and economic systems. *Journal of Cleaner production*, 114, 11-32.
93. Gibberd, J. (2002, May). The sustainable building assessment tool assessing how buildings can support sustainability in developing countries. In *Built Environment Professions Convention* (pp. 1-3). Produced by: Document Transformation Technologies. ISBN Number: 0-620-28854-X
94. Go, T. F., Wahab, D. A., & Hishamuddin, H. (2015). Multiple generation life-cycles for product sustainability: the way forward. *Journal of Cleaner Production*, 95, 16-29.
95. Gorgolewski, M. (2008). Designing with reused building components: some challenges. *Building Research & Information*, 36(2), 175-188.
96. Graedel, T. E., & Allenby, B. R. (1996). Design for environment. *Prentice Hall, Inc. UK*.
97. Guggemos, A. A., & Horvath, A. (2005). Comparison of environmental effects of steel-and concrete-framed buildings. *Journal of infrastructure systems*, 11(2), 93-101. doi: 10.1061/(ASCE)1076-0342 (2005)11:2(93)
98. Guinee, J. B., Heijungs, R., Huppes, G., Zamagni, A., Masoni, P., Buonamici, R., ... & Rydberg, T. (2011). Life cycle assessment: past, present, and future. *Environmental Science and Technology* 2011;45(1):90–6.
99. Gupta, S., Jha, K. N., & Vyas, G. (2020). Proposing building information modeling-based theoretical framework for construction and demolition waste management: strategies and tools. *International Journal of Construction Management*, 1-11. doi:10.1080/15623599.2020.1786908
100. Guy, B., & Ciarimboli, N. (2008). *DfD: Design for disassembly in the built environment: a guide to closed-loop design and building*. Hamer Center.
101. Guy, B., Shell, S., & Esherick, H. (2006). Design for deconstruction and materials reuse. *Proceedings of the CIB Task Group*, 39(4), 189-209.
102. Hadrović, A. (2017). Arhitektonsko kulturno-historijsko nasljeđe i energetska efikasnost. *Faculty of Architecture Sarajevo, Sarajevo, BIH*.
103. Hamidi, B., Bulbul, T., Pearce, A., & Thabet, W. (2014). Potential application of BIM in cost-benefit analysis of demolition waste management. In *Construction Research Congress 2014: Construction in a Global Network* (pp. 279-288).
104. Han, B., Wang, R., Yao, L., Liu, H., & Wang, Z. (2015). Life cycle assessment of ceramic façade material and its comparative analysis with three other common

- façade materials. *Journal of Cleaner Production*, 99, 86-93.  
<https://doi.org/10.1016/J.JCLEPRO.2015.03.032>
105. Hardin, B., & McCool, D. (2015). *BIM and construction management: proven tools, methods, and workflows*. John Wiley & Sons. ISBN 1118942760, 9781118942765.
  106. Harich, J. (2016). „Cutting through Complexity the Analytical Activist’s Guide to Solving the Complete Sustainability Problem with Root Cause Analysis”. Lulu Press Copyright © 2016 by Thwink.org
  107. Hollberg, A., & Ruth, J. (2016). LCA in architectural design—a parametric approach. *The International Journal of Life Cycle Assessment*, 21(7), 943-960.  
<https://doi.org/10.1007/s11367-016-1065-1>
  108. Hollberg, A., Genova, G., & Habert, G. (2020). Evaluation of BIM-based LCA results for building design. *Automation in Construction*, 109, 102972.  
<https://doi.org/10.1016/j.autcon.2019.102972>
  109. Hong, J., Shen, G. Q., Guo, S., Xue, F., & Zheng, W. (2016). Energy use embodied in China’ s construction industry: a multi-regional input–output analysis. *Renewable and sustainable energy reviews*, 53, 1303-1312.
  110. Hossain, M. U., & Ng, S. T. (2018). Critical consideration of buildings' environmental impact assessment towards adoption of circular economy: An analytical review. *Journal of Cleaner Production*, 205, 763-780.
  111. Hosseini, M. R., Chileshe, N., Rameezdeen, R., & Lehmann, S. (2014). Reverse logistics for the construction industry: Lessons from the manufacturing context. *International Journal of Construction Engineering and Management*. 3(3), 75-90.
  112. Hosseini, M. R., Rameezdeen, R., Chileshe, N., & Lehmann, S. (2015). Reverse logistics in the construction industry. *Waste Management & Research*, 33(6), 499-514.
  113. Husetic A. & Beganovic E. (2017). Prednosti izgradnje drvenih porodicnih kuca u BiH u odnosu na klasicnu gradnju. *11th International Scientific Conference on Production Engineering - Development and modernization of production*.
  114. Huuhka, S., Kolkwitz, M., Maubach-Howard, A., Kuchta, K., Abis, M., Bromisch, J., Giebelhausen, A., Small-Warner, K., Charlson, A., Andersen, R., Bjerregaard Jensen, L., Manelius, A-M., & Kjer Jeppesen, M. (2021). *How to identify buildings for life-cycle extension? Guide for case selection via the mapping of transformable neighbourhoods and buildings*. [https://download-files.wixmp.com/ugd/c49783\\_aa13aba124984243b8fcbf1b0e66096d.pdf?token=eYJ0eXAiOiJKV1QiLCJhbGciOiJIUzI1NiJ9.eyJpc3MiOiJ1cm46YXBwOmU2NjYzMGU3MTRmMDQ5MGFhZWExZjE0OWIzYjY5ZTMylwiwic3ViljoidXJuOmFwcDplNjY2MzBINzE0ZjA0OTBiHYWVhMwYxNDliM2I2OWUzMilslmF1ZCI6WyJ1cm46c2VydmJzTpmWxllmRvd25sb2FkIl0slmlhdCI6MTYyODA2MTgxOCwiZXhwIjoxNjI4MDk3ODI4LCJqdGkiOiJlZDQ4ZGZmYzBiHTYQlCjvYmoiOltbeyJwYXRoljoiL3VnZC9jNDk3ODNFyWExM2FiYTEyNDk4NDIOM2I4ZmNiZjFiMGU2NjA5NmQucGRmIn1dXX0.SDwu874R5Bny3Fo4](https://download-files.wixmp.com/ugd/c49783_aa13aba124984243b8fcbf1b0e66096d.pdf?token=eYJ0eXAiOiJKV1QiLCJhbGciOiJIUzI1NiJ9.eyJpc3MiOiJ1cm46YXBwOmU2NjYzMGU3MTRmMDQ5MGFhZWExZjE0OWIzYjY5ZTMylwiwic3ViljoidXJuOmFwcDplNjY2MzBINzE0ZjA0OTBiHYWVhMwYxNDliM2I2OWUzMilslmF1ZCI6WyJ1cm46c2VydmJzTpmWxllmRvd25sb2FkIl0slmlhdCI6MTYyODA2MTgxOCwiZXhwIjoxNjI4MDk3ODI4LCJqdGkiOiJlZDQ4ZGZmYzBiHTYQlCjvYmoiOltbeyJwYXRoljoiL3VnZC9jNDk3ODNFyWExM2FiYTEyNDk4NDIOM2I4ZmNiZjFiMGU2NjA5NmQucGRmIn1dXX0.SDwu874R5Bny3Fo4)

DJ1\_y9Q7S5Sroi2-

a15clhUY5ZI&filename=D5.1+Guide+for+case+selection\_disclaimer.pdf (accessed July 2021)

115. Iacovidou, E., & Purnell, P. (2016). Mining the physical infrastructure: Opportunities, barriers and interventions in promoting structural components reuse. *Science of the Total Environment*, 557, 791-807.
116. IBM Global Business Services, 2016
117. Islam, H., Jollands, M., & Setunge, S. (2015). Life cycle assessment and life cycle cost implication of residential buildings—A review. *Renewable and Sustainable Energy Reviews*, 42, 129-140. doi:10.1016/j.rser.2014.10.006
118. ISO 14044 (The International Standards Organisation). (2006). Environmental Management — Life Cycle Assessment — Requirements and Guidelines. *Geneva, Switzerland*.
119. ISO 14040 (The International Standards Organisation). (2006). Environmental Management - Life Cycle Assessment - Principles and Framework. International Standardization Organization. *Geneva Switzerland. 2006, p. 28*.
120. Jaillon, L., Poon, C. S., & Chiang, Y. H. (2009). Quantifying the waste reduction potential of using prefabrication in building construction in Hong Kong. *Waste management*, 29(1), 309-320.
121. Jalaei, F. (2015). *Integrate building information modeling (BIM) and sustainable design at the conceptual stage of building projects* (Doctoral dissertation, Université d'Ottawa/University of Ottawa).
122. Jalaei, F., & Jrade, A. (2014). Integrating Building Information Modeling (BIM) and Energy Analysis Tools with Green Building Certification System to Conceptually Design Sustainable Buildings. *Itcon*, 19, 494-519. <http://www.itcon.org/2014/29>
123. Jalaei, F., Zoghi, M., & Khoshand, A. (2019). Life cycle environmental impact assessment to manage and optimize construction waste using Building Information Modeling (BIM). *International Journal of Construction Management*, 1-18. doi:10.1080/15623599.2019.1583850
124. Jincheng, X., Weichang, H., Xinli, K., & Tianmin, W. (2001). Research and development of the object-oriented life cycle assessment database. *Materials & Design*, 22(2), 101-105. doi:10.1016/s0261-3069(00)00049-2.
125. Jrade, A., & Jalaei, F. (2013, December). Integrating building information modelling with sustainability to design building projects at the conceptual stage. In *Building Simulation* (Vol. 6, No. 4, pp. 429-444). Springer Berlin Heidelberg.
126. Jusselme, T., Rey, E., & Andersen, M. (2020). Surveying the environmental life-cycle performance assessments: Practice and context at early building design stages. *Sustainable Cities and Society*, 52, 101879. <https://doi.org/10.1016/j.scs.2019.101879>

127. Kalmykova, Y., Sadagopan, M., & Rosado, L. (2018). Circular economy—From review of theories and practices to development of implementation tools. *Resources, conservation and recycling*, *135*, 190-201.
128. Kern, A. P., Dias, M. F., Kulakowski, M. P., & Gomes, L. P. (2015). Waste generated in high-rise buildings construction: A quantification model based on statistical multiple regression. *Waste Management*, *39*, 35-44. doi:10.1016/j.wasman.2015.01.043.
129. Kibert, C. J. (2016). *Sustainable construction: green building design and delivery*. John Wiley & Sons.
130. Kim, Y. C., Hong, W. H., Park, J. W., & Cha, G. W. (2017). An estimation framework for building information modeling (BIM)-based demolition waste by type. *Waste Management & Research*, *35*(12), 1285-1295. <https://doi.org/10.1177/0734242X17736381>
131. Kirchherr, J., Reike, D., & Hekkert, M. (2017). Conceptualizing the circular economy: An analysis of 114 definitions. *Resources, conservation and recycling*, *127*, 221-232.
132. Knoeri, C., Sanyé-Mengual, E., & Althaus, H. J. (2013). Comparative LCA of recycled and conventional concrete for structural applications. *The international journal of life cycle assessment*, *18*(5), 909-918. doi: 10.1007/s11367-012-0544-2
133. Koutamanis, A., van Reijn, B., & van Bueren, E. (2018). Urban mining and buildings: A review of possibilities and limitations. *Resources, Conservation and Recycling*, *138*, 32-39.
134. Kovacic, I., Waltenbereger, L., & Gourelis, G. (2016). Tool for life cycle analysis of facade-systems for industrial buildings. *Journal of Cleaner Production*, *130*, 260-272.
135. Kozminska, U. (2019). Circular design: reused materials and the future reuse of building elements in architecture. Process, challenges and case studies. In *IOP Conference Series: Earth and Environmental Science* (Vol. 225, No. 1, p. 012033). IOP Publishing. <https://doi.org/10.1088/1755-1315/225/1/012033>
136. Kubba, S. (2012). *Handbook of green building design and construction: LEED, BREEAM, and Green Globes*. Butterworth-Heinemann.
137. Kylili, A., Fokaides, P. A., & Jimenez, P. A. L. (2016). Key Performance Indicators (KPIs) approach in buildings renovation for the sustainability of the built environment: A review. *Renewable and Sustainable Energy Reviews*, *56*, 906-915. <https://doi.org/10.1016/j.rser.2015.11.096>
138. Lachimpadi, S. K., Pereira, J. J., Taha, M. R., & Mokhtar, M. (2012). Construction waste minimisation comparing conventional and precast construction (Mixed System and IBS) methods in high-rise buildings: A Malaysia case study. *Resources, Conservation and Recycling*, *68*, 96-103.
139. Law on Physical Planning and Utilisation of Land at the Level of the Federation of Bosnia and Herzegovina (Official Gazette of the Federation BiH, no.

- 2/06, 72/07, 32/08, 4/10, 13/10 and 45/10)  
<https://www.aarhus.ba/~aarhus/images/docs/fbih/25%20Zakon%20o%20prostornom%20planiranju%20FBiH%20%2802-06%29.pdf>
140. LEED V.4 user guide, (2013). Available at: <http://www.cabrillo.edu/msoik/3/LEED%20v4%20guide.pdf> (Accessed: 20 Aug 2017)
  141. Leising, E., Quist, J., & Bocken, N. (2018). Circular Economy in the building sector: Three cases and a collaboration tool. *Journal of Cleaner production*, 176, 976-989.
  142. Liu, Z., Osmani, M., Demian, P., & Baldwin, A. (2015). A BIM-aided construction waste minimisation framework. *Automation in construction*, 59, 1-23. <https://doi.org/10.1016/j.autcon.2015.07.020>
  143. Llatas, C. (2011). A model for quantifying construction waste in projects according to the European waste list. *Waste management*, 31(6), 1261-1276.
  144. M. Mabkhot, M., Ferreira, P., Maffei, A., Podrżaj, P., Mądział, M., Antonelli, D., ... Lohse, N. (2021). Mapping Industry 4.0 Enabling Technologies into United Nations Sustainability Development Goals. *Sustainability*, 13(5), 2560. doi:10.3390/su13052560
  145. MacArthur, E. (2013). Towards the circular economy. *Journal of Industrial Ecology*, 2, 23-44. <https://www.ellenmacarthurfoundation.org/assets/downloads/publications/Ellen-MacArthur-Foundation-Towards-the-Circular-Economy-vol.1.pdf>
  146. Mah, C. M., Fujiwara, T., & Ho, C. S. (2016). Construction and demolition waste generation rates for high-rise buildings in Malaysia. *Waste Management & Research*, 34(12), 1224-1230.
  147. Mahpour, A. (2018). Prioritizing barriers to adopt circular economy in construction and demolition waste management. *Resources, Conservation and Recycling*, 134, 216-227.
  148. Marceau, M. L., & VanGeem, M. G. (2006). Comparison of the life cycle assessments of an insulating concrete form house and a wood frame house. *Journal of ASTM International*, 3(9), 1-11.
  149. Martínez-Rocamora, A., Solís-Guzmán, J., & Marrero, M. (2016). LCA databases focused on construction materials: A review. *Renewable and Sustainable Energy Reviews*, 58, 565-573. doi:10.1016/j.rser.2015.12.243
  150. McDonough, W., & Braungart, M. (2002). Remaking the way we make things: Cradle to cradle. *New York: North Point Press. ISBN, 1224942886*, 104.
  151. Meex, E., Hollberg, A., Knapen, E., Hildebrand, L., & Verbeeck, G. (2018). Requirements for applying LCA-based environmental impact assessment tools in the early stages of building design. *Building and Environment*, 133, 228-236. <https://doi.org/10.1016/j.buildenv.2018.02.016>

152. Merli, R., Preziosi, M., & Acampora, A. (2018). How do scholars approach the circular economy? A systematic literature review. *Journal of Cleaner Production*, 178, 703-722.
153. Mithraratne, N., & Vale, B. (2004). Life cycle analysis model for New Zealand houses. *Building and environment*, 39(4), 483-492.
154. Moreno, M., De los Rios, C., Rowe, Z., & Charnley, F. (2016). A conceptual framework for circular design. *Sustainability*, 8(9), 937. doi:10.3390/su8090937
155. NBS (National Building Specifications). (2012). "National BIM Report, Building Information Modeling." The National BIM Library.
156. Ness, D., Swift, J., Ranasinghe, D. C., Xing, K., & Soebarto, V. (2015). Smart steel: new paradigms for the reuse of steel enabled by digital tracking and modelling. *Journal of Cleaner Production*, 98, 292-303.
157. NIST. (2012). National Building Information Modelling Standard Version 2, 2005. US National Institute of Building Science, Washington, DC.
158. Osmani, M. (2011). Construction waste. In *Waste* (pp. 207-218). Academic Press.
159. Osmani, M. (2013, August). Design waste mapping: a project life cycle approach. In *Proceedings of the Institution of Civil Engineers-Waste and Resource Management* (Vol. 166, No. 3, pp. 114-127). ICE Publishing.
160. Osmani, M., Glass, J., & Price, A. D. (2008). Architects' perspectives on construction waste reduction by design. *Waste management*, 28(7), 1147-1158.
161. Parto, S., Loorbach, D., Lansink, A., & Kemp, R. (2007). Transitions and Institutional Change: The Case of the Dutch Waste Subsystem. Teoksessa: Industrial innovation and environmental regulation, toim. S. Parto–B. Herbert-Copley, 233–257.
162. Pektaş, Ş. T., & Pultar, M. (2006). Modelling detailed information flows in building design with the parameter-based design structure matrix. *Design Studies*, 27(1), 99-122. doi:10.1016/j.destud.2005.07.004
163. Peters M., Oseyran J. & Ribeiro A. (2016). BAMB Value Network, by Phase, within the framework of H2020 BAMB project (grant agreement No-642384). *Statistics Belgium. (2016), Afvalproductie*. <http://statbel.fgov.be/nl/statistieken/cijfers/leefmilieu/afval/productie/> (Acessed april 2016)
164. Pomponi, F., & Moncaster, A. (2016). Embodied carbon mitigation and reduction in the built environment–What does the evidence say?. *Journal of environmental management*, 181, 687-700.
165. Pomponi, F., & Moncaster, A. (2017). Circular economy for the built environment: A research framework. *Journal of cleaner production*, 143, 710-718.
166. Poon, C. S., Yu, A. T., & Jaillon, L. (2004). Reducing building waste at construction sites in Hong Kong. *Construction Management and Economics*, 22(5), 461-470.

167. Poon, C. S., Yu, T. W., & Ng, L. H. (2001). *A guide for managing and minimizing building and demolition waste*. Hong Kong: Department of Civil & Structural Engineering, Hong Kong Polytechnic University.
168. Poon, C.S. (2007). Reducing construction waste. *Waste management*, 27, 1715–1716.
169. Reap, J., Roman, F., Duncan, S., & Bras, B. (2008). A survey of unresolved problems in life cycle assessment. *The International Journal of Life Cycle Assessment*, 13(5), 374-388.
170. Röck, M., Hollberg, A., Habert, G., & Passer, A. (2018). LCA and BIM: Visualization of environmental potentials in building construction at early design stages. *Building and environment*, 140, 153-161. doi: 10.1016/j.buildenv.2018.05.006
171. Roy, R. (2006). Products: New Product Development and Sustainable Design. *The Open University: Milton Keynes, UK*.
172. Saade, M. R. M., Guest, G., & Amor, B. (2020). Comparative whole building LCAs: How far are our expectations from the documented evidence?. *Building and Environment*, 167, 106449. <https://doi.org/10.1016/j.buildenv.2019.106449>
173. Scheer, S., de Amorim, S. R. L., Santos, E. T., Ferreira, R. C., & Caron, A. M. (2007). The scenario and trends in the Brazilian IT construction applications experience. *Journal of Information Technology in Construction (ITcon)*, 12(13), 193-206.
174. Seyis, S. (2020). Mixed method review for integrating building information modeling and life-cycle assessments. *Building and Environment*, 173, 106703. doi:10.1016/j.buildenv.2020.106703
175. Sezer, A. A. (2012). Environmental assessment tools and efficiency in housing and office refurbishment. In *28th Annual Conference on Association of Researchers in Construction Management, ARCOM 2012; Edinburgh; United Kingdom; 3 September 2012 through 5 September 2012* (Vol. 2, pp. 1331-1341).
176. Shadram, F., Johansson, T. D., Lu, W., Schade, J., & Olofsson, T. (2016). An integrated BIM-based framework for minimizing embodied energy during building design. *Energy and Buildings*, 128, 592-604. <https://doi.org/10.1016/j.enbuild.2016.07.007>
177. Shahabian, A., Fadai, A., & Peruzzi, T. (2020). Future of Life-Cycle Assessment in a Smart and/or Sustainable World. In *Interdisciplinary Approaches to Public Policy and Sustainability* (pp. 177-207). IGI Global. doi: 10.4018/978-1-7998-0315-7.ch009
178. Sharp J. and Hobbs G. (BRE), Henrotay C. and Steinlage M. (Brussels environment), Debacker W. and De Regel S. (VITO), Sjorgen C. (2019). Framework for policies, regulations and standards. EU Horizon 2020 Project BAMB report. <https://www.bamb2020.eu/wp-content/uploads/2019/07/BAMB-Framework-for-Policies-Regulations-and-Standards-web.pdf>

179. Sonetti, G., & Lombardi, P. (2020). Multi-criteria decision analysis of a building element integrating energy use, environmental, economic and aesthetic parameters in its life cycle. In *Values and Functions for Future Cities* (pp. 463-477). Springer, Cham. [https://doi.org/10.1007/978-3-030-23786-8\\_26](https://doi.org/10.1007/978-3-030-23786-8_26)
180. Soust-Verdaguer, B., Llatas, C., & García-Martínez, A. (2017). Critical review of bim-based LCA method to buildings. *Energy and Buildings*, *136*, 110-120. <https://doi.org/10.1016/j.enbuild.2016.12.009>
181. Soust-Verdaguer, B., Llatas, C., García-Martínez, A., & Gómez de Cózar, J. C. (2018). BIM-based LCA method to analyze envelope alternatives of single-family houses: case study in Uruguay. *Journal of Architectural Engineering*, *24*(3), 05018002. [https://doi.org/10.1061/\(ASCE\)AE.1943-5568.0000303](https://doi.org/10.1061/(ASCE)AE.1943-5568.0000303)
182. Souza, E. (2019). Learn How to Avoid Energy Loss in Your Buildings. *ArchDaily*. ISSN 0719-8884. [www.archdaily.com/915546/learn-how-to-avoid-the-main-sources-of-energy-loss-in-your-home](http://www.archdaily.com/915546/learn-how-to-avoid-the-main-sources-of-energy-loss-in-your-home) (Accessed January 2021)
183. Stadel, A., Eboli, J., Ryberg, A., Mitchell, J., & Spatari, S. (2011). Intelligent sustainable design: Integration of carbon accounting and building information modeling. *Journal of professional issues in engineering education and practice*, *137*(2), 51-54. [https://doi.org/10.1061/\(ASCE\)EI.1943-5541.0000053](https://doi.org/10.1061/(ASCE)EI.1943-5541.0000053)
184. Succar, B. (2009). Building information modelling framework: A research and delivery foundation for industry stakeholders. *Automation in construction*, *18*(3), 357-375.
185. Succar, B., & Kassem, M. (2015). Macro-BIM adoption: Conceptual structures. *Automation in construction*, *57*, 64-79. <https://doi.org/10.1016/j.autcon.2015.04.018>
186. Swann, G. (2010). Editorial. *Journal of Visual Communication in Medicine*, *33*(4), 148-149. doi:10.3109/17453054.2010.525439
187. Szalay, Z. (2007). Life cycle environmental impacts of residential buildings. PhD thesis. Budapest University of Technology and Economics, Hungary.
188. Tingley, D. D., & Davison, B. (2012). Developing an LCA methodology to account for the environmental benefits of design for deconstruction. *Building and Environment*, *57*, 387-395.
189. Tsikos, M., & Negendahl, K. (2017). Sustainable design with respect to LCA using parametric design and BIM tools. In *World Sustainable Built Environment Conference 2017*.
190. Tukker, A., & Tischner, U. (2006). Product-services as a research field: past, present and future. Reflections from a decade of research. *Journal of cleaner production*, *14*(17), 1552-1556. <http://dx.doi.org/10.1016/j.jclepro.2006.01.022>
191. Turk, Ž. (2016). Ten questions concerning building information modelling. *Building and Environment*, *107*, 274-284.



192. Uher T.E. & Lawson W. (1998) Sustainable development in construction. *Faculty of the Built Environment, UNSW, Sydney, Australia.* [www.irbnet.de/daten/iconda/CIB8585.pdf](http://www.irbnet.de/daten/iconda/CIB8585.pdf)
193. UK BIM Task Group, 2013
194. van den Berg, M. C. (2019). Managing Circular Building Projects. PhD thesis. Enschede: University of Twente. <https://doi.org/10.3990/1.9789036547703>
195. van den Berg, M. C., & Durmišević, E. (2017, October). BIM uses for reversible building design. In *3rd International Green Design Conference 2017: Vital Cities and reversible Buildings for circular economy*. Sarajevo Green Design Foundation.
196. Verbeeck, G., & Hens, H. (2010). Life cycle inventory of buildings: A contribution analysis. *Building and Environment*, 45(4), doi: 964-967. 10.1016/j.buildenv.2009.10.012
197. Villoria Sáez, P., del Río Merino, M., & Porras-Amores, C. (2012). Estimation of construction and demolition waste volume generation in new residential buildings in Spain. *Waste Management & Research*, 30(2), 137-146.
198. Volk, R., Stengel, J., & Schultmann, F. (2014). Building Information Modeling (BIM) for existing buildings—Literature review and future needs. *Automation in construction*, 38, 109-127.
199. Vollaro, R. D. L., Guattari, C., Evangelisti, L., Battista, G., Carnielo, E., & Gori, P. (2015). Building energy performance analysis: A case study. *Energy and Buildings*, 87, 87-94.
200. Wang, J., Li, Z., & Tam, V. W. (2014). Critical factors in effective construction waste minimization at the design stage: a Shenzhen case study, China. *Resources, Conservation and Recycling*, 82, 1-7.
201. Warszawski, A. (1999). Industrialized and Automated Building Systems: E and FN Spoon.
202. Werner F. (2005) LCA as Method and its Modelling Characteristics. In: *Ambiguities in Decision-oriented Life Cycle Inventories. ECO-Efficiency in Industry and Science*, vol 17. Springer, Dordrecht. [https://doi.org/10.1007/1-4020-3254-4\\_2](https://doi.org/10.1007/1-4020-3254-4_2)
203. Wittstock, B., Albrecht, S., Colodel, C. M., & Lindner, J. P. (2009). Building from life-cycle perspective-life cycle assessment in construction industry. *BAUPHYSIK*, 31(1), 9-17.
204. Wittstock, B., Albrecht, S., Colodel, C.M., Lindner, J.P., Hauser, G., Sedlbauer, K. (2009), Gebäude aus Lebenszyklusperspektive – Ökobilanzen im Bauwesen (Buildings from a life cycle perspective – LCA in the building sector). Fraunhofer-Institut für Bauphysik. Holzkirchen. doi: 10.1002/bapi.200910003
205. Won, J., & Cheng, J. C. (2017). Identifying potential opportunities of building information modeling for construction and demolition waste management and minimization. *Automation in Construction*, 79, 3-18. <http://dx.doi.org/10.1016/j.autcon.2017.02.002>

206. Won, J., Cheng, J. C., & Lee, G. (2016). Quantification of construction waste prevented by BIM-based design validation: Case studies in South Korea. *Waste Management, 49*, 170-180.
207. Wong, J. K. W., & Zhou, J. (2015). Enhancing environmental sustainability over building life cycles through green BIM: A review. *Automation in Construction, 57*, 156-165.
208. Yellishetty, M., Ranjith, P. G., Tharumarajah, A., & BiHosale, S. (2009). Life cycle assessment in the minerals and metals sector: a critical review of selected issues and challenges. *The International Journal of Life Cycle Assessment, 14*(3), 257-267.
209. Yunus, R., & Yang, J. (2011). Sustainability criteria for industrialised building systems (IBS) in Malaysia. *Procedia Engineering, 14*, 1590-1598. doi:10.1016/j.proeng.2011.07.200

# LIST OF FIGURES AND TABLES

## LIST OF FIGURES

Figure 1. Yichang building Hong Kong. Source: <a href="https://www.dreamstime.com">https://www.dreamstime.com</a> .....	12
Figure 2. How to accomplish low environmental impact of the built structures in terms of the construction waste.....	14
Figure 3. Research thesis work plan. ....	16
Figure 4. Sustainable Development Goals (M. Mabkhot 2021).....	23
Figure 5. How World Green Building Council applies the SDG to the green buildings. Source:.....	24
Figure 6. Public Investment Priorities. Source: EIB Investment report 2017/2018 .....	24
Figure 7. Building industry waste management. Source: Directive 2008/98/EC 2008.....	27
Figure 8. A building like tree. Source: Cradle to Cradle Manifesto presented at 15th Biennale di Venezia EPEA Braungart et al. 2016.....	29
Figure 9. What is exactly a total building waste? .....	30
Figure 10. Diagram of the relationship between the state of the technological development of society and its influence on the environment and use of resources (Graedel & Allenby 1999). ....	35
Figure 11. Traditional concept “take-make-dispose” with the waste at the landfill.....	36
Figure 12. New concept “take– make - use again” that forms a loop.....	36
Figure 13. Historical evolution of environmental philosophies applied to design. Adapted Moreno 2016. ....	37
Figure 14. The outline of the circular economy of Ellen MacArthur Foundation (source: <a href="https://www.ellenmacarthurfoundation.org/circular-economy/concept/infographic">https://www.ellenmacarthurfoundation.org/circular-economy/concept/infographic</a> ).....	40
Figure 15. Differences between the linear (left), reuse (centre) and circular economy (right). (adapted from Dutch Government-wide program 2015) .....	41
Figure 16. Building phases from a linear perspective. Adapted Peters at al. 2016 .....	42
Figure 17. Phases from Building a circular perspective. Adapted Peters at al. 2016 .....	43
Figure 18. Phases in life cycle of the building project and the building itself. Source: Androšević et al. 2019.....	44
Figure 19. Good circular building practice.....	49
Figure 20. Framework for implementing sustainability in building construction. (Akadiri et al. 2012) .....	50
Figure 21. Easy assembly building in Safenwill. (source: photo archive Normal architects and <a href="https://normal.ba/en/projektii/safenwil/">https://normal.ba/en/projektii/safenwil/</a> ).....	55
Figure 22. Picture of the Pixel in the exhibition in Mostar 2015 (left) and exploded 3D model of the wooden structure (right).....	55
Figure 23. 3D visualization of the GDC innovation park in Mostar (source: <a href="http://www.bamb2020.eu">www.bamb2020.eu</a> )....	56
Figure 24. 3D exploded module GDC Mostar and 3D exploded wooden wall, Durmišević & Androšević. Source: BAMB pilot project.....	57
Figure 25. Possible scenarios for the GDC wall. Source: BAMB pilot project .....	57
Figure 26. Reuse potential of the building in Safenwil at the building level using method Durmišević 2006 .....	58
Figure 27. Reuse potential of the building in Safenwil for Enclosure and Infill using method Durmišević 2006 .....	59
Figure 28. Reuse potential of the building in Safenwil for Loadbearing and Service using method Durmišević 2006 .....	59
Figure 29. Reuse potential of Pixel using method Durmišević 2006 .....	60

Figure 30. Reuse potential of the GDC roof using method Durmišević 2006.....	60
Figure 31. Reuse potential of the GDC floor using method Durmišević 2006.....	61
Figure 32. Green Design Centre building in Mostar is presented as a triangle and its advantages, which should be required in all future buildings .....	61
Figure 33. Modularity and transformability (possible assembly and disassembly) in the production and building industry in order to avoid waste.....	62
Figure 34. Different durability rates of building components by Durmišević 2006.....	67
Figure 35. Main sources in energy losses through the external envelope of an average home adapted Souza 2019.....	68
Figure 36. Energy performance improvement for external wall of residential buildings for single-family houses in BIH made at the end of XX and beginning of the XXI century (Arnautovic-Aksic et al. 2016) .....	69
Figure 37. Energy performance improvement for external wall of residential buildings for multi-family houses in BIH made at the end of XX and beginning of the XXI century (Arnautovic-Aksic et al. 2016) .....	69
Figure 38. Energy performance improvement for external wall of residential buildings for apartment buildings in urban blocks in BIH made at the end of XX and beginning of the XXI century (Arnautovic-Aksic et al. 2016) .....	69
Figure 39. Energy performance improvement for external wall of residential buildings for apartment blocks in BIH made at the end of XX and beginning of the XXI century (Arnautovic-Aksic et al. 2016) .....	70
Figure 40. Bondruk wall type 1. (adapted Hadrović 2017) .....	71
Figure 41. Bondruk wall type 2. (adapted Hadrović 2017) .....	71
Figure 42. Bondruk wall with wood filling, type 3. (adapted Hadrović 2017) .....	71
Figure 43. Example of prefabricated wooden wall. (Husetic & Beganovic 2017).....	72
Figure 44. Steco centar external wall detail first example with thermal and heat protection values and moisture proofing. ....	73
Figure 45. Steco centar external wall detail second example with thermal and heat protection values and moisture proofing. ....	73
Figure 46. Steco centar external wall detail second example (thermal and heat protection values and moisture proofing are as same as the wall in Figure 45).....	74
Figure 47. Savox standard external and partition wall .....	74
Figure 48. Savox premium external and partition wall.....	74
Figure 49. Savox eko bio+ external wall.....	75
Figure 50. Savox Classic external and partition wall.....	75
Figure 51. Prefabricated walls in production (Photo taken during the factory visit 2019, by Androšević) .....	75
Figure 52. Krivaja 11 layers' low energy house wall. ....	76
Figure 53. Prefabricated walls in the production (Photo taken during the factory visit 2019, by Androšević) .....	76
Figure 54. External Wall GDC which is easy to assemble and disassemble. Source: BAMB pilot project, 4D architects.....	79
Figure 55. Assembly sequences of the GDC façade wall. The assembly and disassembly can be done with separate elements and materials or with materials and elements forming clusters.....	80
Figure 56. Section through the assembly of insulation boxes of GDC façade wall. (source: 4D architects) .....	81
Figure 57. GDC wall system parts: wooden boxes. (source: 4D architects).....	81
Figure 58. GDC wall system – views and sections of wooden frame. (source: 4D architects) .....	82

Figure 59. One module of the GDC façade wall (front and side view, horizontal and vertical section) .....	83
Figure 60. Details and sections of the GDC external wall finishing (detail of wooden slats facade). (source: 4D architects).....	84
Figure 61. 2D exploded detail of the wooden box top and hanging façade slats panel. (source: 4D architects).....	84
Figure 62. Details and sections of the GDC external wall boxes. (source: 4D architects).....	85
Figure 63. Details and sections of the GDC external wall finishing (detail of wooden slats facade). (source: 4D architects).....	85
Figure 64. Wooden slats facade assembly in production or on site. (source: 4D architects).....	86
Figure 65. Horizontal section through wooden box and wooden slats façade (above) and 2d exploded detail of the wooden box with sheep wool (down). (source: 4D architects).....	86
Figure 66. Pictures during the production of the GDC wall prototype. From left to right: 1.all parts cut to measure, 2. Making wooden wall structure, 3. wooden box filled with natural sheep wool, 4. Wooden wall structure. (photo Androšević) .....	87
Figure 67. Pictures during the production of the GDC wall prototype. From left to right: 1. Wooden box with connection triangle and magnet for the top, 2. Wooden box completed, 3. Fixing foil and the box with wooden slats connected with the intermediary wooden slats. (photo Androšević) ...	87
Figure 68. GDC wall prototype finished. (photo Androšević) .....	88
Figure 69. Picture of the GDC wall prototype made in Herzegovina. Picture left – wooden parts cut and ready to be laminated, middle – wooden slats assembly, right – wooden structure/frame. (photo Androšević) .....	88
Figure 70. Pictures of the GDC wall prototype made in Herzegovina. Picture left - Wooden box assembly, middle and right – Wooden box with sheep wool. (photo Androšević).....	89
Figure 71. Pictures of the GDC wall prototype made in Herzegovina. Picture left – inserting wooden boxes in the wooden frame, middle – fixing water vapor permeable membrane with Alu L shaped profile and right – wall prototype finished. (photo Androšević) .....	89
Figure 72. Schematic visual of the proposed hybrid house structure. Androšević & Androšević 2021 .....	92
Figure 73. IBM’s Cognitive Buildings Maturity Framework Source: “Embracing the Internet of Things in new era of cognitive buildings” (IBM 2016) .....	102
Figure 74. Proposed theoretical framework for the BIM based CDW management (adapted Gupta et al. 2020) .....	105
Figure 75. Necessary for a successful BIM Platform.....	107
Figure 76. Key indicators forming a nucleus of reversible building design tools and protocol – adaptability, reuse and disassembly (adapted Durmišević 2019) .....	111
Figure 77. Two key indicators of reversibility of building structure are independence and exchangeability of building systems/components. (adapted Durmišević 2019).....	112
Figure 78. Transition of design focus from traditional factors in the past (left), trough new paradigm (middle) and global context (right) (adapted Durmišević 2019) .....	112
Figure 79. Design aspects of spatial reversibility. (adapted Durmišević 2019) .....	114
Figure 80. 1 <sup>st</sup> Indicator - functional decomposition – models of possible separation of four main building functions (supporting, enclosing, servicing, and partitioning), which can be further subdivided into subsections (subsystems). (Durmišević 2006) .....	114
Figure 81. 1 <sup>st</sup> Indicator - Schematic representation of five types of integration, the letters in the figure represent the following functions: (c) structure, (f) finish, (s) servicing and (i) insulation. (Durmišević 2006) .....	115

Figure 82. 2 <sup>nd</sup> Indicator - systematization and clustering - the aim of reversible building design is a bigger level of assembly as possible (component/module/system level).. (Durmišević 2006).....	115
Figure 83. 3 <sup>rd</sup> Indicator - relational patterns - pattern type and position of relations. (Durmišević 2006) .....	115
Figure 84. 4 <sup>th</sup> Indicator - base element specification. (Durmišević 2006) .....	115
Figure 85. 4 <sup>th</sup> Indicator - base element specification examples. (Durmišević 2006) .....	116
Figure 86. 5 <sup>th</sup> Indicator - geometry of the product edge. (Durmišević 2006).....	116
Figure 87. 5 <sup>th</sup> Indicator - overview of basic geometries of product edge. (Durmišević 2006).....	116
Figure 88. 6 <sup>th</sup> Indicator - assembly sequences. (Durmišević 2006).....	116
Figure 89. 6 <sup>th</sup> Indicator - 5 types of assembly sequences. (Durmišević 2006) .....	117
Figure 90. 7 <sup>th</sup> Indicator and Ranking the connection types form reversible to irreversible. (Durmišević 2006) .....	118
Figure 91. 7 <sup>th</sup> Indicator- Types of connections. (Durmišević 2006) .....	118
Figure 92. 8 <sup>th</sup> Indicator - life cycle coordination - elements, which have a long life-cycle and greater dependencies in assembly, should be assembled first and disassembled last. (Durmišević 2006)	118
Figure 93. Different phases of the proposed integrated model. (Jalaei et al. 2019).....	125
Figure 94. First position of the window (left) and second position of the window (right).....	135
Figure 95. First position of the window (left), second position of the window (middle) and wall without the window (right).....	136
Figure 96. Diagram illustrating material use during 4 transformations of the façade according to above defined scenarios. (Brussels Environment et al. 2018).....	137
Figure 97. An overview of the construction and transformation costs of traditional and reversible GDC façade system per m2. (Brussels Environment et al. 2018).....	137
Figure 98. Reuse potential of the 11 layers wall. The section (up) and the overview of the main criteria of reversibility and the final score of the reuse potential of the 11 layers wall - existing façade system in wood (down) using method Durmišević. (Androšević, Durmišević & Brocato 2019) .....	140
Figure 99. The section (left) and the overview of main criteria of reversibility and final score of the reuse potential of a GDC wall -developed façade system (right) using method Durmišević. (Androšević, Durmišević & Brocato 2019) .....	141
Figure 100. Evaluation of systems reversibility per indicator (left) and total score per type of system (right). (Brussels Environment et al. 2018).....	142
Figure 101. LCA system boundary (Islam 2015).....	145
Figure 102. Features and criteria for the evaluation of the LCA databases. (Martinez-Rocamora 2016) .....	146
Figure 103. Spider chart for the comparison of the LCA databases. Legend: Terr=Territory, Cat=Categories, COMPL=Completeness, Trac= Traceability, Meth=Methodology outlining, COMPR=Comprehensiveness. (Martinez-Rocamora 2016) .....	147
Figure 104. Results of environmental impact of two case study walls (Androšević et al. 2019.) <b>Error! Bookmark not defined.</b>	
Figure 105. Results of non-hazardous waste disposed, by stage, for the two case-study walls (Androšević et al. 2019.) .....	150
Figure 106. Section of the case study prefabricated wall for low energy house.....	151
Figure 107. Case study wall exploded. Materials from left to right: .....	151
Figure 108. LCA for BREEM Int'l/ES/NOR/SE, Non-hazardous waste disposed, by category (data for the wall1) .....	154
Figure 109. LCA for BREEM Int'l/ES/NOR/SE, Non-hazardous waste disposed, by category (data for the wall2) .....	154

Figure 110. LCA for BREEM Int'l/ES/NOR/SE, Non-hazardous waste disposed, by category (data for the wall3) .....	155
Figure 111. LCA for BREEM Int'l/ES/NOR/SE, Non-hazardous waste disposed, by stage (data for the wall1).....	155
Figure 112. LCA for BREEM Int'l/ES/NOR/SE, Non-hazardous waste disposed, by stage (data for the wall2).....	156
Figure 113. LCA for BREEM Int'l/ES/NOR/SE, Non-hazardous waste disposed, by stage (data for the wall3).....	156
Figure 114. LCA for BREEM Int'l/ES/NOR/SE - Non-hazardous waste disposed (data for the wall1) .....	157
Figure 115. LCA for BREEM Int'l/ES/NOR/SE - Non-hazardous waste disposed (data for the wall2) .....	157
Figure 116. LCA for BREEM Int'l/ES/NOR/SE - Non-hazardous waste disposed (data for the wall3) .....	157
Figure 117. Print screen of Wall1 process with screw-like connections in the OpenLCA.....	160
Figure 118. The model graphs for the same materials in the Case study prefabricated Wall1. Total quantity of material in the wall, even though it is in several positions in the wall - Model graph left. To avoid that, the same material is declared as being from a different Provider– model graph right. ....	160
Figure 119. Case study prefabricated Wall 1 – 10 materials layers without mentioning the connections between them – Radioactive waste .....	161
Figure 120. Case study prefabricated Wall 1 – 10 materials layers without mentioning the connections between them - Bulk waste.....	161
Figure 121. Case study prefabricated Wall 1 – 10 layers of materials without mentioning the connections between them - Hazardous waste .....	161
Figure 122. Three Case studies (variants of this 10 layer wall) were compared in terms of Environmental impact in land filling: .....	162
Figure 123. Relative indicator results of the three Case studies (variants of this 10 layer wall):....	163
Figure 124. Relative indicator results of the respective project variants. For each indicator, the maximum result is set to 100% and the results of the other variants are displayed in relation to this result. We can see that Wall1 with the glue-like connections produces double environmental impact after second life-cycle (option 1 + option 2), as the parts cannot be used in the second life-cycle. Option 1 is the first life-cycle, option 2 is the second life-cycle of the wall1. (chart from OpenLCA tool) .....	165
Figure 125. Relative indicator results of the respective project variants. For each indicator, the maximum result is set to 100% and the results of the other variants are displayed in relation to this result. We can see that in the second Case study, environmental impact of the Wall2 with screw-like connections is really low in the second life-cycle because almost all parts can be reused in the second life-cycle. Option 1 is the first life-cycle, option 2 is the second life-cycle of the wall2. (chart from OpenLCA tool) .....	166
Figure 126. Value definition with focus on the environmental impact as a defined value that can help decision making process. ....	171
Figure 127. Tool assisting to lower the environmental impact of a building system especially in terms of construction waste. ....	175
Figure 128. Suggested upgrade for the LCA software which would help in decision process regarding environmental impact of the future building. ....	176
Figure 129. The process of creation of the construction waste and necessity for adding the new quantity of materials in the next life-cycle/transformation/ during time. ....	179

Figure 130. How to achieve low environmental impact? .....	180
Figure 131. Materials in the building system and relations and connections (conn) between them. ....	185
Figure 132. Reuse potential (Rp) indicators depending on the types of connections by Durmišević 2019 (left) and Conn values, which present the indicator for potential waste after disassembly, which are calculated in accordance to Rp values (right). ....	188
Figure 133. Vertical section of the GDC wall with its materials.....	193
Figure 134. Matrices with relations and Connections values (Conn) between materials in the case study GDC wall.....	196
Figure 135. Material codes for matrices with relations and connections between materials in the case study GDC wall. ....	196
Figure 136. GDC wall materials and connections in the simple 3d model. ....	197
Figure 137. Assessment for relational pattern. (Durmišević 2006) .....	198
Figure 138. Relational dependences between parts of the system .....	199
Figure 139. Assessment for type of connection. (Durmišević 2006) .....	199
Figure 140. Assessment for type of connection with symbols. ....	200
Figure 141. Type of the connections sheme and average value for type of connection calculation. ....	200
Figure 142. Assessment for assembly direction. (Durmišević 2006) .....	201
Figure 143. Assembly and disassembly possibilities of GDC wall. ....	202
Figure 144. Chosen Ecoinvent v.3.4. database and the EDIP methodology in the Open LCA tool. ....	204
Figure 145. Some of the Ecoinvent v.3.4 LCIA impact categories are shown in the print screen of the tool with the accent on the used EDIP impact assessment method.....	205
Figure 146. Materials (including metal connections) in the 100m2 of the GDC wall1 inserted in the OpenLCA 1.10.1. tool, shown in Model graph.....	206
Figure 147. Materials (including metal connections) in the 100m2 of the GDC wall1 inserted in the OpenLCA 1.10.1. tool.....	206
Figure 148. The environmental impact in terms of land filling – bulk waste, calculated in the OpenLCA 1.10.1. tool .....	207
Figure 149. The environmental impact in terms of land filling - hazardous waste, calculated in the OpenLCA 1.10.1. tool .....	207
Figure 150. The environmental impact in terms of land filling - radioactive waste, calculated in the OpenLCA 1.10.1. tool.....	207
Figure 151. The environmental impact in terms of land filling – slag and ashes, calculated in the OpenLCA 1.10.1. tool.....	208
Figure 152. The environmental impact in terms of resource consumption - wood, calculated in the OpenLCA 1.10.1. tool.....	208
Figure 153. The impact of the materials can be shown in the Sankey diagram in the OpenLCA 1.10.1. tool, where separate material contribution can be seen. ....	208
Figure 154. Materials (including metal connections) in the 100m2 of the GDC wall1 inserted in the OpenLCA 1.10.1. tool.....	209
Figure 155. Materials (including metal connections) in the 100m2 of the GDC wall inserted in the OpenLCA 1.10.1. tool showed in Model graph.....	210
Figure 156. The environmental impact in terms of land filling – bulk waste, calculated in the OpenLCA 1.10.1. tool .....	211
Figure 157. The environmental impact in terms of land filling - hazardous waste, calculated in the OpenLCA 1.10.1. tool .....	211



Figure 158. The environmental impact in terms of land filling - radioactive waste, calculated in the OpenLCA 1.10.1. tool. ....	211
Figure 159. The environmental impact in terms of land filling – slag and ashes, calculated in the OpenLCA 1.10.1. tool. ....	212
Figure 160. The environmental impact in terms of resource consumption - wood, calculated in the OpenLCA 1.10.1. tool. ....	212
Figure 161. Matrices with relations between materials with Conn values, which are assigned to the connection types used between materials in the GDC wall case study. Material codes are in the Figure 135. ....	213
Figure 162. Conn values for each layer of the materials are inserted into OpenLCA software as parameters for that material. ....	215
Figure 163. Conn values for each layer of material are inserted into OpenLCA software in the Quantities section. ....	215
Figure 164. The environmental impact in terms of land filling – bulk waste, calculated in the OpenLCA 1.10.1. tool. ....	215
Figure 165. The environmental impact in terms of land filling - hazardous waste, calculated in the OpenLCA 1.10.1. tool. ....	216
Figure 166. The environmental impact in terms of land filling - radioactive waste, calculated in the OpenLCA 1.10.1. tool. ....	216
Figure 167. The environmental impact in terms of land filling – slag and ashes, calculated in the OpenLCA 1.10.1. tool. ....	216
Figure 168. The environmental impact in terms of resource consumption - wood, calculated in the OpenLCA 1.10.1. tool. ....	216
Figure 169. The environmental impact in terms of land filling – bulk waste, calculated in the OpenLCA 1.10.1. tool. ....	217
Figure 170. The environmental impact in terms of land filling - hazardous waste, calculated in the OpenLCA 1.10.1. tool. ....	217
Figure 171. The environmental impact in terms of land filling - radioactive waste, calculated in the OpenLCA 1.10.1. tool. ....	218
Figure 172. The environmental impact in terms of land filling – slag and ashes, calculated in the OpenLCA 1.10.1. tool. ....	218
Figure 173. The environmental impact in terms of resource consumption - wood, calculated in the OpenLCA 1.10.1. tool. ....	219
Figure 174. The chart shows relative indicator results of the environmental impact of the GDC wall in the first life-cycle (Option1) and second life-cycle (Option2), calculated and compared in the OpenLCA 1.10.1. tool. For each indicator, the maximum result is set to 100% and the results of the other variants are displayed in relation to this result. ....	<b>Error! Bookmark not defined.</b>

## LIST OF TABLES

Table 1. System Improvement Process, adapted from Harich 2016 .....	19
Table 2. Life cycle stages according to EN standards (source: www.oneclicklca.com ) .....	148
Table 3. Case study wall materials with environmental attributes and EN standards (adapted from the tool OneClick LCA) .....	153
Table 4. Case study prefabricated Wall 1 – 10 materials layers without mentioning the connections between them.....	162
Table 5. The table shows the LCIA results of the first life-cycle (Option 1) and the second life-cycle (Option 2) for a Wall1 with the glue-like connections. Each LCIA category is displayed in the rows and the project variants in the columns. The wall produces double environmental impact for two life-cycles, as the parts cannot be used in the second life-cycle. (adapted table from OpenLCA tool) .....	164
Table 6. The table shows the LCIA results of the first life-cycle (Option 1) and the total amount after the second life-cycle (Option 2) for a Wall1 with the glue-like connections. Each LCIA category is displayed in the rows and the project variants in the columns. The wall produces double environmental impact for two life-cycles, as the parts cannot be used in the second life-cycle. (adapted from OpenLCA tool).....	164
Table 7. The advantages and deficiencies of the mentioned methods and tools. ....	174
Table 8. CWE protocol shows the differences in potential waste and its environmental impact trough the life-cycle / life-cycles / of compared case studies in the process of building planning. Conn value shows the part of the product that cannot be reused. Rp is Reuse potential calculated using Durmišević 2006 methodology.....	181
Table 9. Wood longevity / durability by Campredon (Neidhart 2005) .....	194
Table 10. The bill of materials done by hand and calculated per 100m <sup>2</sup> of the GDC wall. ....	203
Table 11. Overview of the input and output data for used types of materials of case study GDC wall.....	209
Table 12. Table with relations between materials with Conn values, which are assigned to the connection types used between materials in the GDC wall case study. ....	213

## ACKNOWLEDGEMENTS

This research and this valuable study wouldn't be possible without those who recognized the value of the research and directly or indirectly gave their support. I really appreciate that.

First of all, I would like to mention my sincere gratitude to the French Government and the French Embassy in BiH for giving me the scholarship and providing me the opportunity to study in France. My deepest thanks to the most helpful and the kindest person in the Campus France in Sarajevo, Željka Divković. Special mention for the Catherine Palpant from the French Embassy in Sarajevo and Vesselina Grozdeva from the Paris office of Campus France. Administrative part of the scholarship was easier thanks to their mutual guidance and support. I'm humbled and grateful to France for the opportunity to study, finish my PhD research and occasionally live and enjoy student life in Paris, the most beautiful town in Europe. Many thanks to all persons that work hard in this French scholarship program. This made such a difference in my life and I hope that the same program will help many other students in BiH and other countries.

I am thankful for all the help, motivation and support from my mentor professor Maurizio Brocato, who has accepted me to be his student and gave me the chance to study in Paris Est, the one of the best Universities in Paris and one of the best faculties of Architecture, ENSA Paris Malaquais (GSA Laboratory). Beside believing in me, I appreciate his guidance and critical thinking around this research project. I have to mention also his positive and practical thinking and organizing the seminars that provide me, among the other students, the opportunity to share the knowledge and meet the other experts in architecture. Thanks to Loïc Couton and Thierry Ciblac, who were always available as my CSI, I have fulfilled the necessary administrative files for enrolment at the Faculty and University, each year on time. I have to thank Denis Kindeur, Veronique le Veux, Caroline Gallez, Elsa Vivant, Nathalie Lourenco and many other persons that work at the University and the Faculty, that have helped me to complete complicated administrative procedure each year.

I give thanks to the amazing person, my mentor, professor Elma Durmišević. We have successfully cooperated on the EU project BAMB, when I have got the inspiration to continue my academic development and give my contribution in the field of environmental impact of the built structures. Her dedication to the projects was an inspiration for me and couldn't have pulled this off without her role model and support. She motivated me to continue when I was having a hard time. It's really admirable how she always sees projects though from conception to completion. I hope that I will justify her belief in me.

All the persons that were representatives of partner institutions in the EU project BAMB were the inspiration for my work, when I saw their dedication to the project. Their know-how gave me the necessary input and the idea for this research.

Many thanks to my colleagues, PhD students at GSA laboratory, for the hospitality, all explanations and sincere help.

Last, but not least, I would like to mention the support of my little family that believed in me and my idea. I would like to thank my lovely daughter Nea and my husband Damir for all the patience with me and all understanding when I needed time and space to work. I appreciate their companionship on all trips that I went and the time they spent with me, even when I was not in a good mood. Their love, kind words and presence warmed my heart and give me the strength to continue.

My deepest tanks to my parents, my mother and father, that supported me emotionally and financially through my whole education process at the Faculty of Architecture and helped me to become an architect. Unfortunately, my father didn't live enough to see me as a PhD, but I think that he will be proud of me as my mother is.

Thanks to my mother, father and sister in law, my cousins, colleagues and friends for having belief in me and my work.