



HAL
open science

Operations at the cultural interface: the implications of cultural matters in operations strategy

Camila Lee Park

► To cite this version:

Camila Lee Park. Operations at the cultural interface: the implications of cultural matters in operations strategy. Sociology. Université Panthéon-Sorbonne - Paris I, 2019. English. NNT: 2019PA01E064 . tel-04078333

HAL Id: tel-04078333

<https://theses.hal.science/tel-04078333v1>

Submitted on 23 Apr 2023

HAL is a multi-disciplinary open access archive for the deposit and dissemination of scientific research documents, whether they are published or not. The documents may come from teaching and research institutions in France or abroad, or from public or private research centers.

L'archive ouverte pluridisciplinaire **HAL**, est destinée au dépôt et à la diffusion de documents scientifiques de niveau recherche, publiés ou non, émanant des établissements d'enseignement et de recherche français ou étrangers, des laboratoires publics ou privés.

ESCP Europe

Ecole Doctorale de Management Panthéon-Sorbonne
ED 559

**OPERATIONS AT THE CULTURAL INTERFACE:
THE IMPLICATIONS OF CULTURAL MATTERS IN OPERATIONS STRATEGY**

THESE

En vue de l'obtention du
DOCTORAT ÈS SCIENCES DE GESTION

Par

« **Camila LEE PARK** »

Soutenance publique le « 8 Février 2019 »

JURY

Directeur de Recherche :

Mme. Valérie MOATTI
Professeur
ESCP Europe

Mme. Maral MURATBEKOVA-TOURON
Professeur
ESCP Europe

Rapporteurs :

Mme. Blandine AGERON
Professeur des Universités
Université Grenoble Alpes

Mme. Ulrike MAYRHOFER
Professeur des Universités
Université Nice Sophia Antipolis

Suffragants :

M. Pierre-Xavier MESCHI
Professeur des Universités
Aix-Marseille Université

M. José A. D. MACHUCA
Professor
Universidad de Sevilla



L'Université n'entend donner aucune approbation ou improbation aux opinions émises dans les thèses. Ces opinions doivent être considérées comme propres à leurs auteurs.

To my Husband, my support and best friend.

Acknowledgement

It is with immense gratefulness, and not without a certain longing already, that I reach the final stage of this doctorate. Entering Academia was not an easy decision to take nor path to walk through, but I am thankful for everything it has both charged me on and blessed me with to this point. Words could never measure up to the feelings that take us when accomplishing such a relevant milestone, therefore I leave this page with my gratitude to everyone that somehow took part on this journey.

To my husband, my partner in life, who transforms me into a better person everyday.

To our beautiful children – human and canine, who teach us happiness and strength.

To Professor Maral Muratbekova-Touron and Professor Valérie Moatti, who patiently supervised and guided me through this intense experience.

To ESCP Europe and to the École Doctorale de Management Panthéon-Sorbonne, which welcomed us and supported us to pursue our accomplishments.

To all Professors that we met along the way, and that made a significant difference in our training. Special gratefulness to Professor Valentina Carbone, Professor Aurélien Acquier, and Professor Hervé Laroche, who shared this story with us from the beginning. To Professor Jean-Phillippe Bouilloud, Professor Jean-François Lemoine, Professor Michael Haenlein, Professor Christophe Tibierge, Professor Elisabeth Tissier-Desbordes, Professor Luca Visconti, Professor Olivier Badot, Professor Alberta Di Giuli, all of which made such an impact on us, perhaps without even knowing it.

To Professor Ely L. Paiva and Professor José A.D. Machuca, whom I really look up to.

To Christine Rocque, the person that keeps the doctoral program working.

To the members of the jury.

To the staff that supports us at ESCP Europe.

To the ESCP Europe Foundation, which made our doctoral programs possible through its scholarship.

Operations at the Cultural Interface: The Implications of Cultural Matters in Operations Strategy

Abstract

The present dissertation explores the influence of cultural idiosyncrasies in the formulation and implementation of operations strategy. More specifically, through the consideration of distinct cultural factors argued to differ among human gatherings, the accommodation of operations is analyzed, in a way that the tensions between homogenization and flexibilization of productive practices and procedures shall be further addressed. Organized around three individual but complementary research articles, the dissertation explores then the relevance of aspects believed to be proper and – to some degree – segregational of national cultures, which shall be of particular interest to companies operating in foreign environments.

Within this perspective, the first article builds on four of Hofstede's national culture dimensions (i.e. power distance, individualism vs. collectivism, uncertainty avoidance, and long-term orientation vs. short-term) and on the High Performance Manufacturing (HPM) project's global database to assess the impact of the aspects of the Brazilian, Chinese, German, and South Korean cultures in the shaping of its companies' operations strategy. Relying on a confirmatory approach, results suggest that national cultures carry significant influences in firms' operations strategy processes. The second article further analyzes the influence of the Brazilian *jeitinho*, a cultural trait argued to be indigenous to Brazilian people and influent in the most diverse aspects of the functioning and organization of the Brazilian society, in business relationships. Within an exploratory qualitative approach, the assessment of semi-structured interviews conducted among Brazilian professionals suggest that supply chain relationships are indeed influenced by this cultural aspect, which may come to count with positive or negative

connotations. Such understanding is believed to be of value to companies currently operating in Brazil or to those that intend to do so as part of their internationalization strategies. Finally, the third article is centered around the peculiarities and distinctions that French filmmakers bring to their creations to extrapolate lessons that can be learned from an international buyer-supplier relationship perspective. In this direction, a discussion is built over the difficulties of cultural adaptation, as well as over the value of cultural preservation and originality. Within this main debate, propositions to a more successful adaptation to national cultures are offered, which shall be of particular usefulness to companies seeking to expand their operations in international and culturally diverse contexts.

Opérations à l'Interface Culturelle: Les Implications des Questions Culturelles dans la Stratégie des Operations

Résumé

Cette thèse explore l'influence des spécificités culturelles dans la formulation et la mise en œuvre de la stratégie des opérations. Plus spécifiquement, nous analysons de quelle manière les opérations sont adaptées pour répondre aux tensions entre homogénéisation et flexibilisation des pratiques et procédures de production à travers la prise en compte de différents facteurs culturels qui varient selon les contextes. Organisée autour de trois articles de recherche distincts mais complémentaires, la thèse explore la pertinence de dimensions considérées comme appropriées et – dans une certaine mesure – la ségrégation des cultures nationales pour des entreprises opérant dans des environnements internationaux.

Ainsi, le premier article s'appuie sur quatre dimensions culturelles de Hofstede (la distance hiérarchique, l'individualisme vs. le communautarisme, le contrôle de l'incertitude et l'orientation à long terme vs. court terme) et sur la base de données du projet global *High Performance Manufacturing* (HPM), pour évaluer l'impact des cultures brésilienne, chinoise, allemande, et sud-coréenne sur l'élaboration de la stratégie des opérations. A partir d'une approche confirmatoire, les résultats suggèrent que les cultures nationales exercent une influence significative sur les processus de la stratégie des opérations des entreprises. Le deuxième article analyse l'influence du *jeitinho* brésilien, un trait culturel considéré comme indigène au Brésil et influent sur les aspects les plus divers du fonctionnement et de l'organisation de la société brésilienne, dans les relations client-fournisseur. A l'aide d'une approche qualitative exploratoire, l'analyse des entretiens semi-structurés menés auprès de professionnels brésiliens suggère que les relations au sein de la « supply chain » sont

effectivement influencées par ce trait culturel, qui peut avoir une connotation positive ou négative. Cette mise en lumière peut intéresser les entreprises opérant actuellement au Brésil ou celles qui ont l'intention de le faire dans le futur dans le cadre de leurs stratégies d'internationalisation. Enfin, le troisième article part des particularités que les cinéastes français apportent à leurs créations pour les exporter, et extrapole ces enseignements dans le cadre des relations internationales acheteur-fournisseur. A partir de là, une discussion s'engage sur les difficultés d'adaptation culturelle, ainsi que sur la valeur de la préservation culturelle et de l'originalité. Dans ce débat principal, des propositions sont formulées pour permettre une adaptation plus réussie des relations client-fournisseur aux cultures nationales. Ces résultats devraient être particulièrement utile aux entreprises cherchant à étendre leurs activités à l'international et dans des contextes culturels variés.

Table of Contents

Part I – Research Context and Literature Review	1
Chapter 1. Introduction.....	2
Chapter 2. Literature Review.....	6
2.1. An Overview of Culture and Cultural Management	6
2.2. Critiques and Rebuttals on Cultural Perspectives.....	15
2.3. Behavioral Operations.....	19
2.4. Supply Chain Management in International Contexts	23
Chapter 3. Research Motivation	27
Chapter 4. Structure of the Dissertation	31
Chapter 5. Philosophy of Science.....	35
Chapter 6. Empirical Setting and Methods	41
6.1. Paper One: Survey-based Quantitative Research.....	41
6.1.1. <i>The High-Performance Manufacturing (HPM) Project</i>	41
6.1.2. <i>Countries Integrating the Analysis</i>	43
6.1.3. <i>Operations Strategy Constructs Operationalization and Measurement Instruments’ Refinement</i>	44
6.2. Paper Two: In-depth Interviews Qualitative Research	49
6.2.1. <i>Research Protocol</i>	49
6.2.2. <i>Data Collection</i>	54
6.2.3. <i>Data Analysis</i>	56
Part II - The Papers.....	62
Chapter 7. Paper One – How do National Cultures Impact the Operations Strategy Process?.....	63
7.1. Background to Paper One	63
7.2. Abstract	65
7.3. Introduction	67
7.4. Literature Review	69
7.4.1. <i>OS Process’ Enablers</i>	69
7.4.2. <i>OS Process Elements</i>	71
7.4.3. <i>OM and National Cultures</i>	74
7.4.4. <i>Hofstede and Cultural Classification</i>	75
7.5. Hypothesis Development.....	78

7.6.	Empirical Research and Method.....	86
7.6.1.	<i>Countries Analysed and National Culture</i>	86
7.6.2.	<i>Sample Data</i>	87
7.6.3.	<i>Measurement Models</i>	88
7.6.4.	<i>Hofstede's National Culture Indexes</i>	91
7.6.5.	<i>Data Treatment and Analysis</i>	92
7.7.	Results	94
7.8.	Discussion	98
7.9.	Conclusion.....	102
7.10.	Appendix: Manufacturing Strategy constructs.....	107
Chapter 8. Paper Two – The Duality of the Brazilian <i>jeitinho</i> : An Empirical Investigation and Conceptual Framework.....		108
8.1.	Background to Paper Two	108
8.2.	Abstract	110
8.3.	Introduction	112
8.4.	The Ethicality of <i>jeitinho</i> as an Indigenous Practice	115
8.4.1.	<i>Contrasting Perspectives on Indigenous Practices</i>	115
8.4.2.	<i>The Brazilian jeitinho</i>	118
8.4.3.	<i>Corruption</i>	120
8.5.	Method.....	122
8.5.1.	<i>Sample and Data Collection</i>	122
8.5.2.	<i>Data Analysis</i>	124
8.6.	Results	125
8.6.1.	<i>The Nature of Brazilian jeitinho and its social acceptance</i>	126
8.6.2.	<i>The Role of Brazilian jeitinho in Business</i>	128
8.7.	Discussion	130
8.8.	Practical and Theoretical Implications	139
8.9.	Conclusion.....	141
8.10.	Limitations and Future Research	143
Chapter 9. Paper Three – The Fifth Element of the Relational View: What Can French Filmmakers Teach Us on International Buyer-Supplier Relationships?		145
9.1.	Background to Paper Three.....	145
9.2.	Abstract	146
9.3.	Introduction	148
9.4.	Literature Review.....	150

ECOLE DOCTORALE DE MANAGEMENT PANTHÉON-SORBONNE

9.4.1.	<i>The Relational View</i>	150
9.4.2.	<i>Cultural Perspectives and Global Supply Chain Management</i>	153
9.5.	Theoretical Development.....	156
9.5.1.	<i>Lesson 1: Cultural Expectations</i>	156
9.5.2.	<i>Lesson 2: Transposition</i>	159
9.6.	Constructs, Propositions, and Conceptual Framework	162
9.6.1.	<i>Constructs</i>	162
9.6.2.	<i>Propositions and Conceptual Framework</i>	164
9.7.	Discussion	167
9.8.	Conclusion	170
9.9.	Limitations and Suggestions for Future Research	174
Part III – Final Considerations		176
Chapter 10. Conclusion		177
10.1.	General Discussion	178
10.2.	From Cultural Recognition to Cultural Management.....	182
10.3.	Contributions	184
10.4.	Practical Relevance.....	190
10.5.	Limitations and Extensions.....	194
References		199
Appendix A: Sample Interviews for the Second Paper		232
A.1.	Interview #1, Brazilian Portuguese	232
A.2.	Interview #1, English Translation	242
A.3.	Interview #2, Brazilian Portuguese	252
A.4.	Interview #2, English Translation	257
A.5.	Interview #3, Brazilian Portuguese	262
A.6.	Interview #3, English Translation	268
Appendix B: Published Articles		274

List of Charts

Chart 1: Kroeber and Kluckhohn's (1952) Groups of Culture Definitions and Examples	8
Chart 2: Baldwin, Faulkner, Hecht and Lindsley's (2006) Examples of Definitions of Culture Across Disciplines.....	10
Chart 3: Adler's (1983b) Six Types of Cross-Cultural Management Studies.....	15
Chart 4: Dissertation's Visual Synopsis.....	34
Chart 5: Articles' Positioning on Burrell and Morgan's (1979) Subjective-Objective Approaches.....	40
Chart 6: HPM's Manufacturing Strategy Scales and Article's Operations Strategy Constructs.....	45
Chart 7: Measurement Scales Initial Items for the Four Operations Strategy Constructs.....	46
Chart 8: Interview Protocol for the Second Paper (English).....	51
Chart 9: Interview Protocol for the Second Paper (Brazilian Portuguese).....	53
Chart 10: Extracts from Transcript Interview #1 (English Translation) and their Respective Generated Quotes	57
Chart 11: Extracts from Transcript Interview #2 (English Translation) and their Respective Generated Quotes	58
Chart 12: Extracts from Transcript Interview #3 (English Translation) and their Respective Generated Quotes	59
Chart 13: Illustrative Quotes Clusters	60
Chart 14: Hofstede's Independent National Culture Dimensions	78
Chart 15: Summary of Results and Hypotheses Confirmation	102
Chart 16: Determinants of Interorganizational Competitive Advantage in International Settings	166

List of Tables

Table 1: Descriptive Overview of HPM's 4th Round Participants by Country/Region and Industry ..	43
Table 2: Operations Strategy Constructs Unidimensionality Analysis, Reliability Analysis and Items' Standardized Factor Loadings	90
Table 3: Operations Strategy Constructs' Discriminant Validity Analysis.....	91
Table 4: Hofstede's National Culture Indexes and Levels for Selected Countries	92
Table 5: Results for OS Process Elements grouped by Countries, Industry and National Culture Dimension Index Levels.....	95
Table 6: Respondent and Company Profiles	123
Table 7: Brazilian jeitinho assessment dimension frequency in interviews.....	125
Table 8: Illustrative quotes for the nature of Brazilian jeitinho	126
Table 9: Illustrative quotes for the social acceptance of jeitinho	128
Table 10: Illustrative quotes for the applicability of jeitinho in business	129
Table 11: Illustrative quotes for creativity and corruption of the Brazilian jeitinho	135

List of Figures

Figure 1: Burrell and Morgan’s (1979) Scheme for Analysing Assumptions about the Nature of Social Science	37
Figure 2: Overview of HPM’s 4th Round Countries / Regions, Measurement Scales, and Respondents’ Area / Department	42
Figure 3: Final CFA Model and Factor Loadings for the Leadership for Cross-Functional Integration Construct	48
Figure 4: Final CFA Model and Factor Loadings for the Functional Integration Construct.....	48
Figure 5: Final CFA Model and Factor Loadings for the Manufacturing Strategy Linkage to Corporate Strategy Construct.....	48
Figure 6: Final CFA Model and Factor Loadings for the Formulation of Manufacturing Strategy Construct	49
Figure 7: The balance of Brazilian jeitinho.....	134
Figure 8: Proposed framework for the ethicality of the Brazilian jeitinho.....	139
Figure 9: Proposed Conceptual Framework for Cultural Adaptation as the Fifth Determinant of Relational Rents	166

Part I - Research Context and Literature Review

Chapter 1. Introduction

Along with their pursue of competitive advantage (Porter, 1985) and resources such as distinct assets (Aaker, 1989), information (Porter and Millar, 1985) and capabilities (Ray, Barney and Muhanna, 2004), firms' decision to internationalize might be reasoned by numerous and diverse factors (Morschett, Schramm-Klein and Zentes, 2015, Arregle, Miller, Hitt and Beamish, 2013). Harsh internal competition or even the exhaustion of the domestic market (Sigfusson and Harris, 2013) may threaten businesses' survival, pushing managers to search for fresh spaces abroad (Puig, González-Loureiro and Ghauri, 2014). The choice shall also be made in order to allow firms to expand their operations (Cuervo-Cazurra, Narula and Un, 2015) or in response/anticipation of competitors' moves (Fey, Nayak, Wu and Zhou, 2016). Such decisions generally regard the search for new markets (Ojala, 2015) or the control over the sources of specific inputs (Konijn and Tulder, 2015) and local resources (Casson, 2013), depending on each business' nature, needs or strategic inclinations, binding companies to revise their strategies in the corporate, business, and functional levels (Ageron, Gunasekaran and Spalanzani, 2012).

Whatever the reasons behind international arrangements, the contact with new cultural paradigms (Howard, 1990) would potentially force firms to interact with culturally distinct customers, suppliers, and employees. Beyond the number of actors itself, chances for successful connections could also be set to diminish, as the range of values (Roccas, Sagiv and Schwartz, 2002) and beliefs (Nurmi, 1993) of individuals or groups involved departs from one another. Such an economic immersion shall demand companies to rapidly adapt to their surroundings, in a way that the ones holding this sort of cross-cultural capability (Laughton and Ottewill, 2000) would hold competitive advantage in those markets. From this angle, the understanding

of different cultural environments and contexts on which companies may come to operate can be particularly profitable in the analysis of diverse strategic objectives.

Likewise, when it comes to the structuration of international supply chains, the search for foreign suppliers, third part manufacturers, or service providers can be rooted in the necessity firms have to seize more fleeting or short-term advantages, mainly in terms of strategic cost management (Monczka, Handfield, Giunipero and Patterson, 2015) and cost reduction initiatives (Pettersson and Segerstedt, 2013). That seems to be case of operations relocated to underdeveloped countries in industries such as electronics (Chan, Pun and Selden, 2013), auto parts (Shi, Shang, Liu and Zuo, 2014), and fashion (Turker and Altuntas, 2014), among others. Despite the apparent influence of cost efficiency concerns, alongside modern issues that affect the management of the arrangement between buyers and suppliers, such as supply chain responsiveness (Ferdows, Lewis and Machuca, 2004), robustness (Durach, Wieland and Machuca, 2014), and contamination (Fracarolli Nunes, 2018), for instance, it is possible that other factors may also, directly or indirectly, impact the internationalization of supply chains, especially on its capacity to lead to competitive advantage. Considering the interaction between companies of different countries, it could be argued that, among these factors, cultural distance (Morosini, Shane and Singh, 1998) represents relative materiality. As discussed by Shenkar (2001), the concept is extensively employed in international business studies, particularly relevant in the analysis of issues just as the expansion of foreign investment, the performance of foreign affiliates, and entry mode choices.

Within this reasoning, a further comprehension around the singularities and general characteristics of cultural patterns seems useful, as it may decisively impact the successful conduction of businesses, particularly within international contexts. Among other comprehensions, culture is defined as a “distinctly human means of adapting to circumstances

and transmitting this coping and knowledge to subsequent generations” (Moran, Abramson and Moran, 2014:11). Accordingly, through its capacity to offer people senses of who they are while belonging to groups, culture shall be a pungent conditioner of individual behavior, moral judgement, and, particularly relevant to our developments, productivity at work. From this perspective, the potential competitive advantage that might be sourced within the understanding of national cultures differences lay the ground for the present investigation’s overarching research question: *What are the implications of cultural matters in operations strategy?*

In the purpose to furnish supplementary understanding on this matter, the current dissertation is organized around three individual, yet commutual, articles. While the first addresses the influence of cultural dimensions in operations strategy process elements in four distinct countries (Brazil, China, Germany, and South Korea), the second focuses on an indigenous Brazilian cultural element (i.e. the Brazilian *jeitinho*) in the interaction between buyers and suppliers. Complementing the quantitative and qualitative approaches employed in the first and second investigations respectively, the third article offers a conceptual construction by proposing that cultural alignment is regarded under the lenses of the Relational View (Dyer and Singh, 1998). Within the context of international supply chains, the cultural fit between the partners’ involved in a buyer-supplier relationship would be therefore capable of generating relational rents, ultimately translated into competitive advantage.

In addition to this introduction, Part I carries a literature review on cultural management, the state of the field for behavioral operations and previous research encountered in supply chains within global contexts. The motivation of the research is presented, followed by the delimitation of the structure of the dissertation, along with a visual summary of its main components and contributions. The elements that integrate the philosophy of science, as well as the epistemology, ontology, and methods of choice are then discussed, and the empirical settings

and methods approached in the first two investigations are deepened, complementing the explanations presented in the respective articles. Next, Part II and its three subsequent chapters relate to the three articles that compose the study, each of which preambled by a brief background of their development and evolution. Finally, Part III presents the final considerations of the dissertation, including a summary of the contributions of the papers, the overall contributions of the study, its implications, limitations and future research extensions.

Chapter 2. Literature Review

This chapter is meant to raise the main literature references pertaining to the present work and its approached themes. For that reason, along with the debate around the definition of culture by different streams of knowledge, it pursues to acquaint its diverse conceptualizations and the main research issues on Cultural Management. Moreover, the particular critiques and rebuttals around cultural perspectives' studies are discussed, especially on what concerns the cultural frameworks adopted by the articles presented. The understanding of behavior outputs as a translation of national cultures is then offered as the main reasoning behind the field of Behavioral Operations. Furthermore, the setting of Supply Chain Management in international contexts lays the ground for the investigation of the impact of cultural patterns in companies' operations. Ultimately, as strategic choices and decision-making procedures are due to reflect human conduct to some extent, the study of the effects of cultural matters might be of value when it comes to competitive advantage generation and performance.

2.1. An Overview of Culture and Cultural Management

In face of the many understandings, and, by consequence, the complexity in delimiting the concept of culture, the consideration of the perspectives offered by assorted disciplines might be useful. Beyond possibly allowing for a clearer assessment of the distinctions in the concept's employment, the debate around these variate considerations shall add to the understanding of its origins, as well as of the dynamics of the semantics attributed to it. This sub-section covers thus the main developments and debates around the conceptualization of culture, so that the use of the construct throughout the present work may be more easily contextualized.

Because of its significant impact on numerous aspects of human conduct (McCort and Malhotra, 1993), defining culture has proved to be an extremely challenging mission. Authors such as Soares, Farhangmehr and Shoham (2007) highlight the complexity of the construct and lack of convergence for a joint meaning in cross-cultural literature, evidenced not only in the underdevelopment of its definition, but also in the argued contexts in which culture is manifested. Eliot (2010), for instance, exposes his understanding of fundamental conditions for cultural development as being related to an organic structure, therefore nurturing its hereditary diffusion; the necessity of geographical parameters to address its regionalities; and the simultaneous presence of universality and diversity of doctrines within religions. Baligh (1994), on the other hand, theorizes culture as being shaped by parts (e.g. family, society, government and politics, business and economics, religion, education) and components (i.e. truth, beliefs, values, logic, rules, action). Moreover, Buzzell (1968) and Usunier (1999) point to culture as being employed as a generic variable, comprehending anything that could not be empirically held or connected to a tangible or known factor.

Kroeber and Kluckhohn's (1952) seminal work around the concept is considered a "majestic", "historical and comparative compilation of definitions of culture" (Rosaldo, 2006:ix). Tracing the "interest in the distinctive life-ways of different peoples" back to "The Bible, Homer, Hippocrates, Herodotus" and "Chinese scholars from the Han dynasty" (Kroeber and Kluckhohn, 1952:3), the authors categorize the definitions of culture by the emphasis carried, evidencing their development through both convergence and divergence of conceptualizations. Six broad groups are presented – i.e. descriptive, historical, normative, psychological, structural, and genetic. Chart 1 below presents the six groups, their respective emphasis issues and illustrative examples of definitions pertaining to each one:

Chart 1: Kroeber and Kluckhohn's (1952) Groups of Culture Definitions and Examples

Group of Definitions	Emphasis	Examples of Definitions
Descriptive	"broad definitions with emphasis on enumeration of content" (pp.43)	<p>"Culture, or civilization (...) is that complex whole which includes knowledge, belief, art, law, morals, custom, and any other capabilities and habits acquired by man as a member of society" (Tylor, 1871:1)</p> <p>"(...) culture is essentially a construct that describes the total body of belief, behavior, knowledge, sanctions, values, and goals that mark the way of life of any people. (...) it comprises the things that people have, the things they do, and what they think" (Herskovits, 1948:629)</p>
Historical	"social heritage or tradition" (pp.47)	<p>"Culture comprises inherited artifacts, goods, technical processes, ideas, habits, and values" (Malinowski, 1931:621)</p> <p>"Culture includes everything that can be communicated from one generation to another. The culture of a people is their social heritage, a 'complex whole' which includes knowledge, belief, art, morals, law, techniques of tool fabrication and use, and method of communication" (Sutherland and Woodward, 1940:19)</p>
Normative	"rule or way" (pp.50)	<p>"The mode of life followed by the community or the tribe is regarded as a culture (...) the aggregate of standardized beliefs and procedures followed by the tribe" (Wissler, 1929:15,341).</p> <p>"Culture: the behavior patterns of all groups, called the 'way of life'" (Bennett and Tumin, 1949:209)</p>
	"ideals or values plus behavior" (pp.52)	<p>"Culture is the dissipation of surplus human energy in the exuberant exercise of the higher human faculties" (Carver, 1935:283)</p> <p>"(...) the material and social values of any group of people, whether savage or civilized (their institutions, customs, attitudes, behavior reactions)" (Thomas, 1937:8)</p>
Psychological	"adjustment" and "culture as a problem-solving device" (pp.55)	<p>"(...) the total equipment of technique, mechanical, mental, and moral, by use of which the people of a given period try to attain their ends (...) 'culture' consists of the means by which men promote their individual or social ends" (Small, 1905:344-345)</p> <p>"The sum of men's adjustments to their life conditions is their culture, or civilization" (Summer and Keller, 1927:46-47)</p> <p>"Culture, in the form of regulations governing human behavior, provides solutions to societal problems" (Ford, 1939:137)</p>
	"learning" (pp.58)	"(...) culture is the sociological term for learned behavior, behavior which in man is not given at birth, which is not determined by his germ cells as is the behavior of wasps or the social ants, but must be learned anew from grown people by each new generation" (Benedict, 1947:13)
	"habit" (pp.60)	"Forms of habitual behavior common to a group, community, or society. It is made of material and non-material traits" (Young, 1934:592)
Structural	"patterning or organization of culture" (pp.61)	<p>"Culture consists of patterned and functionally interrelated customs common to specifiable human beings composing specifiable social groups or categories" (Gillin, 1948:191)</p> <p>"Culture is the working and integrated summation of the non-instinctive activities of human beings. It is the functioning, patterned totality of group-accepted and -transmitted inventions, material and non-material" (Turney-High, 1949:9)</p>
Genetic	"culture as a product or artifact" (pp. 64)	"Culture is not any part of man or his inborn equipment. It is the sum total of all that man has produced: tools, symbols, most organizations, common activities, attitudes, and beliefs. It includes both physical products and immaterial products" (Folsom, 1931:476-477)

Source: Adapted from Kroeber and Kluckhohn (1952)

The typology above allowed for the authors to incorporate the different angles approached by each group and to propose their own definition of culture:

“Culture consists of patterns, explicit and implicit, of and for behavior acquired and transmitted by symbols, constituting the distinctive achievement of human groups, including their embodiments in artifacts; the essential core of culture consists of traditional (i.e. historically derived and selected) ideas and especially their attached values; culture systems may, on the one hand, be considered as products of action, on the other as conditioning elements of further action.” (Kroeber and Kluckhohn, 1952:181)

Extending on Kroeber and Kluckhohn’s (1952) endeavor, Baldwin, Faulkner, Hecht and Lindsley (2006) categorize and compile definitions of culture across disciplines in structural, functional, process, product, group membership, power/ideology. Chart 2 below presents examples of disciplines and definitions conferred by the authors:

Chart 2: Baldwin, Faulkner, Hecht and Lindsley’s (2006) Examples of Definitions of Culture Across Disciplines

Discipline	Examples of Definitions
Anthropology	<p>“the entire social heritage of a group, including material culture and external structures, learned actions, and mental representations of many kinds” (D’Andrade, 1995:212)</p> <p>“Culture - a body of symbols and meanings in play in a given society at a given time - operates largely as a pool of symbolic resources upon which people draw and over which people struggle, in the course of social and political differentiation and conflict (...) Every culture contains not just bundles of symbols, and not even just bundles of larger propositions about the universe (‘ideologies’), but also organized schemas for enacting (culturally typical) relations and situations.” (Ortner, 1990:59)</p> <p>“Culture lends significance to human experience by selecting from and organizing it. It refers broadly to the forms through which people make sense of their lives” (Rosaldo, 1989:26)</p>
Communication	<p>“an accumulated pattern of values, beliefs, and behaviors shared by an identifiable group of people with a common history and a verbal and nonverbal symbol system.” (Neuliep, 2003:15)</p> <p>“a socially constructed and historically transmitted pattern of symbols, meanings, premises and rules. (...) A cultural code of speaking, then, consists of a socially constructed and historically transmitted system of symbols and meaning pertaining to communication (...); beliefs about spoken actions (that a man who uses speech to discipline boys is not a real man); and rules for using speech (that a father should not interrupt his daughter at the dinner table).” (Philipsen, 1992:7–8)</p>
Philosophy	<p>“Culture comprises those aspects of human activity which are socially rather than genetically transmitted. Each social group is characterized by its own culture, which informs the thought and activity of its members in myriad ways, perceptible and imperceptible” (Routledge Encyclopedia of Philosophy, 1998:746)</p>
Psychology	<p>“1. The distinctive customs, manners, values, religious behavior, and other social and intellectual aspects of a society. 2. A shared pattern of attitudes, beliefs, self-definitions, role definitions, norms, and values that can be found in a geographic region among those who speak a particular language, or during a particular historic period.” (Corsini, 1999:243)</p> <p>“The complex whole that includes knowledge, belief, art, morals, law, custom, and any other capabilities and habits acquired by man as a member of society.” (Murphy, 1946:983)</p> <p>“The system of information that codes the manner in which the people in an organized group, society, or nation interact with their social and physical environment. (...) the frame of reference is the set of rules, regulations, mores and methods of interaction within the group. A key connotation is that culture pertains only to non-genetically given transmission; each member must learn the systems and the structures.” (Reber, 1995:177)</p>
Sociology	<p>“With ‘culture’ as a general term referring to all ways of thinking and doing of a social group, the term culture trait is used to denote a given set of group ways, such as raising maize.” (Bogardus, 1960:339)</p> <p>“refers to all the accepted and patterned ways of behavior of a given people. It is a body of common understandings. It is the sum total and the organization or arrangement of all the group’s ways of thinking, feeling, and acting. It also includes the physical manifestations of the group as exhibited in the objects they make - the clothing, shelter, tools, weapons, implements, utensils, and so on.” (Brown, 1963:3-4)</p> <p>“At the simplest level (...) culture is everything learned and shared by men. Culture is not simply a knowledge of the arts or the social graces; it is much more. It includes the profane as well as the sublime, the secular as well as the sacred.” (Cuzzort, 1969:255)</p>

Source: Adapted from Baldwin, Faulkner, Hecht and Lindsley (2006)

On business issues, the concept of culture is most usually portrayed on different proxies that attempt to translate the similarities and differences of a particular group. Nationality, as advocated by Hoover, Green and Saegert (1978), and furthermore by Steenkamp, Hofstede and Wedel (1999), is an example of such approximation, stemming the notion of national cultures, as the words culture, nation, and country are often utilized as synonyms (Sekaran, 1983). According to DiMaggio (1994), national culture has been unraveled by cultural sociologists as not only strongly influencing the population delimited by a determined country, but also its organizations and institutions. From this perspective, opposite from the approach that undertakes organizations as a source of culture – common to institutional economists (Biggart and Delbridge, 2004) –, business conformations, as well as economic ones, would be contemplated as culturally embedded, absorbing its characteristics and mechanisms. From a different angle, Lenartowicz and Roth (1999) offer a multi-method framework to validate cultural assessments that would not necessarily fit on national boundaries, arguing that cultural diversity can occur within countries also.

Some of the studies that contributed either theoretically or empirically to developing the literature around culture are discussed by Hofstede (2001). The author explains that, based on different points of assessment, different cultural dimensions were proposed. In the early 1950s, his review points to Aberle, Cohen, Davis, Levy and Sutton's (1950) valuation on functional prerequisites of societies, leading to cultural dimensions defined as adequate physical/social relationship with the environment, role differentiation (i.e. age, gender, hierarchy), communication, shared knowledge, beliefs and rules of logical thinking, and effective control of disruptive forms of behavior, for instance. Parsons and Shils (1951), on the other hand, looked at patterns of human action to delimit cultural dimensions around the contrast between affectivity and affective neutrality, self- and collectivity-orientation, universalism and particularism, ascription and achievement, and specificity and diffuseness, whereas Inkeles and

Levison (1954/1977) stood on standard analytic points to interpret culture in terms of relation to authority, conception of self, and primary dilemmas and ways of dealing with them.

Still according to Hofstede (2001), while Kluckhohn and Strodtbeck (1961) based their analysis on value orientations, proposing evaluation of human nature, relationship of man to the surrounding natural environment, orientation in time, orientation towards activities, and relationship among people as cultural dimensions, Naroll (1970) and Driver (1974) centered their judgement on the characteristics of institutions. Some of their offered cultural dimensions lies around weak to strong command of the environment, simple to complex organizations, responsible to exploitative elite behavior and vengeance to political function of war, for the first, and populational density, gross national product, and number of words present in language, for the later. Fiske (1992), in turn, offered an assessment based on the elementary forms of sociability, with dimensions such as communal sharing, authority ranking, and equality matching. Finally, Hofstede's model moves to offer his propositions around culture, based on basic problems encountered in societies. For the scholar, cultural dimensions can be understood through power distance, uncertainty avoidance, individualism *versus* collectivism, masculinity *versus* femininity, long-term *versus* short-term orientation, and indulgence *versus* restraint (Hofstede, 2001, Minkov, 2007). More recently, the author has advocated for the connection of his framework to a psychological approach within the "concepts of self and personality" (De Mooij and Hofstede, 2010:90), along with personality traits (Hofstede and McCrae, 2004), and the application of the dimensional model towards organizational culture (Hofstede, 2011).

Two particular conceptualizations are useful for understanding the approach of national culture undertaken in the present work:

“Culture refers to shared values and concepts among people who most often speak the same language and live in proximity to each other. These values and concepts are transmitted for generations, and they provide guidance for everyday behaviors (...) Great complexity can be added to this definition when analyses of cultural change, people’s selections among cultural elements, and individual differences are added. (...) Culture consists of ideals, values, and assumptions about life that people widely share and that guide specific behaviors. Yet these are invisible elements. Assumptions, values, and ideals are not immediately obvious. Instead, they are stored in people’s minds and consequently are hard for outsiders to see.” (Brislin, 2001:5, in: Baldwin, Faulkner, Hecht and Lindsley, 2006)

“1. The totality of learned behaviour transmitted from one generation to the next. 2. Behaviours having the highest probability of occurrence in a society. 3. Type of tradition in which symbols are transmitted from one generation to the next by social learning. 4. All that is socially transmitted in a society. 5. A way of life. 6. The non-cumulative part of a culture. See also civilization. 7. The nonutilitarian part of a culture. See also civilization. 8. An assemblage which recurs repeatedly (archaeol.)” (Reading, 1976:55, footnote numbers, citations, and emphases deleted, in: Baldwin, Faulkner, Hecht and Lindsley, 2006)

Research efforts that agree with the notions above have approached diverse managerial topics. The effects of culture have been analyzed on corporate social responsibility concerns (Halkos and Skouloudis, 2017), international joint venture survival and stability (Meschi and Riccio, 2007), integration processes on international mergers and acquisitions (Barmeyer and Mayrhofer, 2008), consumer research (Craig and Douglas, 2006), and service encounters (Stauss and Mang, 1999), among others. Human resource matters have also been addressed in contrast to culture, such as in labor issues (Tubadji, Moeller and Nijkamp, 2014), employee voice behavior (Park and Kim, 2016), the fit between leadership and both national and organizational cultures (Burns, Nieminen, Kotrba and Denison, 2014), work behavior (Steers and Sánchez-Rundle, 2017), and organizational diversity and inclusion (Stoermer, Bader and Froese, 2016). Entrepreneurship and innovation (Woodside, Bernal and Coduras, 2016) and entrepreneurship patterns (Valliere, 2017) have also been approached, as well as corporate governance convergence (Ntongho, 2016) and online management education (Lee, Becker and Nobre, 2012). The evolution and development of cross-cultural management as a field in both academia and practice (Philips and Sackmann, 2015) has also brought to discussion additional challenges faced by organizations in multiple cultures settings. Recent research on cultural management approached the difficulties in knowledge transfer throughout institutional and

cultural boundaries (Almeida, Grant and Phene, 2017), the spread of leadership in different cultures (Smith and Peterson, 2017), the implementation of sustainability practices related to cultural beliefs (Tata and Prasad, 2015), and conflict management within different cultures (Vollmer and Wolf, 2015), for instance. Intercultural communication (Romani and Claes, 2014) and individual perception on context and meaning (Dupuis, 2013) have been advocated as essential elements to be accounted for in what relates to cross-cultural management. Although often perceived as a one-way path, where organizations originated in one culture must adapt or understand the culture of its destination, a “reverse adaptation” of cultural traits (Luo, 2016:29) – in which both global companies and local talents may take learning from each other – has been argued to generate productive rents to companies.

“The culture concept”, as reported by Wright (2004:2), takes four different forms in organizational studies. The first two, more related to the objectives of this dissertation, concern national or ethnical cultures affairs for the management of global supply chains and diverse workforce, respectively. The third and fourth applications then involves the informal and formal assemblage of values, norms, attitudes and concepts that pertain to a determined set of workers or company. While still scant at the time, accounting for less than five percent of published organizational behavior studies in top American management journals (Adler, 1983a), Adler (1983b) offers a typology relying on six main perspectives of cross-cultural research within Management, as briefly summarized in Chart 3 below:

Chart 3: Adler’s (1983b) Six Types of Cross-Cultural Management Studies

Research	Studied Culture	Approach to Similarity and Difference	Approach to Universality	Study Type
Parochial	Single culture	Assumed similarity	Assumed	Domestic management
Ethno-centric	Second culture	Search for similarity	Questioned	Replication of domestic management studies in foreign cultures
Polycentric	In many cultures	Search for difference	Denied	Individual studies of organizations in specific foreign cultures
Comparative	Contrasting many cultures	Search for both	Emergent	Comparing organizations in multiple foreign cultures
Geocentric	International management	Search for similarity	Extended	Multinational organizations
Synergistic	Intercultural management	Similarities and differences as a resource	Created	Intercultural interaction within work settings

Source: Adapted from Adler (1983b)

While the main basis of the cultural perspectives adopted in this dissertation are better addressed in their respective articles, the shortcomings that are imbued with such approaches must be recognized. Given the controversial nature of the disputes they rise, critiques and rebuttals on both Hofstede’s (2001) model and the indigenous management approach are articulated next.

2.2. Critiques and Rebuttals on Cultural Perspectives

Along with the crescent trend of including cultural studies to the understanding of management subjects, the stream of critiques to this type of approach has also been proliferating in a comparable growing slide. D’Iribarne (2009:309), for instance, point to interpretative perspectives’ definition of culture as “shared meaning leading to common behaviour”, yet constantly confronting the notion of national cultures “whose key feature is pluralism in the conceptions of existence”. Lurie (2004) also notifies the exemption of the individual choices in cultural studies, to which behavior is attributed to the cultural or social influences of the

environment man pertains to, losing control over his own subjectivities. The standardization of cultures has been the object of critiques for research endeavors such as the GLOBE (Global Leadership and Organizational Behavior Effectiveness) project, aimed to analyze nine cultural dimensions that are theorized to impact leadership in comparing 61 countries (House, Javidan, Hanges and Dorfman, 2002).

Hofstede's (2001) framework, in particular, has received straightforward blows from the academic community. While Gernon and Wallace (1995:85) point to studies based on his cultural dimensions as "trapped by a paradigm myopia", Baskerville (2003), listing a number of studies that failed to reach similar results when replicating his proposals, argues for the lack of theorization, as well as anthropological and sociological foundations to the cultural indexes, although recognizing the increasing impact of such by analyzing the number of citations he carries. Emblematic to this scenario is the debate staged by McSweeney (2002a, 2002b) and Hofstede (2002) in the *Human Relations* journal, as the former scrutinizes the foundations and methods claimed by the latter, accusing the adoption of "fallacious assumptions" by an "evangelized entourage" (McSweeney, 2002a:112), to which Hofstede (2002) responds primarily by indicating points of his work that already addressed the raised issues. In his second edition of *Culture's Consequences*, the author acknowledges the critics he has received, presenting a section entitled "Support and Criticisms of the Approach Followed", in which he states:

"The disrespect I showed for academic borderlines in the first edition of *Culture's Consequences* paid off in a multidisciplinary readership. It also caused very mixed reviews – some enthusiastic (e.g. Eysenck, 1981; Sorge, 1983; Triandis, 1982), some irritated, some condescending, and some taking a tone of ridicule (e.g. Cooper, 1982; Roberts & Boyacigiller, 1984). I had made a paradigm shift in cross-cultural studies, and, as Kuhn (1970) has shown, paradigm shifts in any science meet with strong initial resistance." (Hofstede, 2001:73)

Moreover, Hofstede (2001) enlists five major currents of criticism his framework has encountered: the unsuitability of surveys for the measurement of cultural differences, the

assumption of nations as inappropriate units of analysis, the transmutability of national cultures from a sample of one company's subsidiaries, the elevated age of data extracted from IBM, and the insufficiency of four or five dimensions to account for cultural traits. The author rebuts by agreeing with most of the exposed critics. For him, surveys should not be the only instruments through which cultural differences are measured, additional dimensions need to be developed with conceptual and statistical independence from his proposed ones, and nations do not indeed represent the most reasonable unit of analysis, but are "usually the only kinds of units available for comparison, and they are better than nothing" (pp.73). As for the third and fourth issues, he argues that the measurement of cultural differences, and not national cultures, were the basis of his analysis, and therefore identifiable from "any set of functionally equivalent samples from national populations"; while his proposed model is meant to capture dimensions entrenched in societies for centuries on and stability between two subsequent collections was decisive in maintaining or discarding data.

Similar to the issues encountered in the standardizations made to culture, the indigenous management approach also implicates on a set of practices or beliefs that are common to a determined society, and is therefore understood as susceptible to the same kind of complaints. As pointed by Mardsen (2004) when analyzing the formal definition of 'indigenous' by *The Oxford English Dictionary* (i.e. "born or produced naturally in land or region; of, pertaining to, or intended for the natives", In: Mardsen, 2004:40), the problematic of conceptualization also applies for such term. He then identifies three variants for its employment, referring to 'indigenous peoples' – as the marginalized minorities of societies, such as "native Americans, Australian Aborigines, and Brazilian Indians" (pp.41); the process of 'indigenization of management' – as "the transfer of ownership, control, manpower and technology from foreigners or aliens, who formerly dominated the economy, to citizens of the newly independent states" (pp.42-43), in post-colonial nationalist movements; and, more broadly, 'insider'

knowledge and its utilization, following a trend on the “examination of the importance of the great cultural traditions of the East” (pp.43). Regardless of the use of the word, the delimitation of formal or informal frontiers is established, implicating in the assumption of a universality of costumes, beliefs and behavior. Banerjee and Linstead (2004) highlight the ongoing influence that colonialism still exerts even in the postcolonial date, making for a distorted perspective from indigenous managers.

Apart from the sensationalistic style that some critics embark on, shortcomings configure an underlying assumption of every research and must be recognized. This dissertation does not contend for a dogmatic or absolute approach of cultures, but rather confide on previously proposed models as potential alternatives for analyzing the impact of cultural issues on business matters, while acknowledging the multiplicity of existing frameworks and limitations that are incurred in each one of them. At the same time that one should not understand cultural frameworks as absolute legitimacies, to negate the presence of communalities between members of particular societies would exert an equal amount of blind fundamentalism fiercely denounced by cultural studies’ contestants. Scholars such as D’Iribarne (2009), for instance, corroborate with this rationale. By proposing an interpretative approach to national cultures, the afore mentioned opposition between the two notions is addressed by the author as an “apparent inadequacy” (pp.310), while, ultimately, similar traits may be found within a society’s boundaries, as concluded in the excerpt below:

“Does this mean that we do not find, in modern societies, anything that could be named ‘national culture’, meaning by that some sort of common mental universe? Actually, we have observed something of that kind, basing our work on observations made in the US and in France” (D’Iribarne, 2009:319).

Within this rationale, Tsui (2004) argues for both context-specific and context-embedded research to unravel particularities that are rooted in different cultural, political and institutional values and therefore contributing to global management knowledge. To the scholar, indigenous

research can move beyond the application of Western models to different societies, fulfilling the criteria of relevance and validity, and deepening the reflections on nature, limits and extensions of prevailing perspectives. Moreover, to achieve quality, it predicates “scientific studies of local phenomena using local language, local subjects, and locally meaningful constructs, with the aim to test or build theories that can explain and predict the specific phenomenon and related phenomena in the local social cultural context” (pp.501).

Under specific contexts, attitudes and activities performed by man may be understood as a direct derivative of the culture that surrounds them. The crossing point between the study of human behavior and Management has propagated into diverse areas such as Behavioral Finance and Behavioral Economics, for instance. The development of such intersection with Operations Management is addressed in the next section, aiming to delimit the state of the Behavioral Operations’ field as the environment in which the present study is settled.

2.3. Behavioral Operations

Along with the use of language, human behavior is perceived as the most evident manifestation of culture (Baligh,1994). Although recognizing the articulation between these elements on one hand, the author stresses the need for a clear delimitation of the hierarchy of substance so that, in analyzing the direction of the influence in the relation, one does not take the part for the whole. In this sense, the study of behavior would represent an arguably narrow view of culture, in a way that its examination could provide only partial or limited apprehensions around cultural patterns. In formulating his arguments, the author proposes that

“Discussions of cultures are invariably discussions of behavior. The Japanese speak indirectly (Harris and Moran 1987), the Greeks avoid taking risks (Hofstede 1980, 1991), the Brazilians avoid conflict (Amado and Vinagre Brasil 1991), and the Egyptians follow no traffic rules (Montville 1992). Culture is in the ultimate way of

doing things or a way of finding ways of doing things. But behavior is not random and directionless. It comes from somewhere, and concentrating on behavior gives one a shallow concept of what a culture is. Behavior, or action, is only one component of culture” (Baligh, 1994:16)

Nevertheless, albeit not fully representing cultural aspects in their totalities, the structured study of behavior may significantly contribute to investigations in that direction. Behaviorism – understood as the philosophy under the science of human behavior (Skinner, 2011) – seems to have provided useful insights to a range of disciplines. From the most straightforward ones just as Psychology (Rachlin, 1994) and Pedagogy (Berlak and Berlak, 1975), to fields at least partially rooted in robust quantitative examinations such as Economics (Lewin, 1996), behaviorism has been claimed to offer convenient perceptions not only around the comprehension of past human behavior, but also over its prediction in face of varying scenarios. Particularly within the Management scope, diverse topics have been studied through the behaviorist lenses of human action, notably in sub-fields such as behavioral finance (Olsen, 2010), customer relationship management (Vella, Caruana and Pitt, 2012), and behavioral branding (Kaufmann, Loureiro and Manarioti, 2016), among others.

In turn, on what concerns the Operations Management literature more specifically, behaviorist perspectives seem to have experienced a blooming application since the early 2000s. Coherently with the currents pointed above, the behaviorist agenda in OM is defined as the “study of potentially non-hyper-rational actors in operational contexts” (Croson, Schultz, Siemsen and Yeo, 2013:1). The delimitation was presented on the special issue on behavioral operations, featured in the *Journal of Operations Management* in 2013 by its guest-editors, what, considered the relevance of the publication to the field, denotes its acceptance as a factor to be seriously considered by its academic community. Related comprehensions are also offered by Sood and Sharma (2015:230), who outline “behavioural operations management” as the “study of interaction among behaviour as well as operations management”. As cited by the authors, illustrative of the matter would be specific situations around the ‘beer distribution

game' (Croson and Donohue, 2002) and the 'bullwhip effect' (Lee, Padmanabhan and Whang, 1997). In both cases, performance and ultimate outcomes are argued to yield a direct effect of participants' personal perspectives and backgrounds. Within a supply chain management angle, the objectives of the field are described by Katsikopoulos and Gigerenzer (2013:3) as "understanding the decision-making of managers and at using this understanding to generate interventions that improve the operation of the supply chain". Yet, the authors propose the assessment of heuristic decision making as more valuable than just a liability to companies' operations. In this way, it would be more properly depicted as a blind spot to be addressed, which, among other matters, would hold the potential to enhance operations. As pointed by Loch and Wu (2005:42), a "good first cut approximates when other information is insufficient".

Recent inquiries in this ground of research encompass the implications for integrating operations' models with cognitive and behavioral elements (Gino and Pisano, 2008), the relationship between organizational practices and supply chain employees' environmental behavior (Cantor, Morrow and Montabon, 2012), the degree of managerial commitment to sustainable supply chain endeavors (Gattiker, Carter, Huang and Tate, 2014), and the impact of behavioral factors as antecedents of collaboration in supply chains on its integration and performance (Tsanos and Zografos, 2016), among others. Mura, Lettieri, Radaelli and Spiller (2016) investigate the effect of knowledge sharing behavior in employees' innovative work conduct in the healthcare sector, while Prosman, Scholten and Power (2016) assess behavioral-based governance methods through the factors that might sway their effectiveness.

While Donohue and Siemsen (2011) provide insights from recent applications of behavioral issues in supply chain management, Kundu, Jain, Kumar and Chandra (2015) perform a state-of-the-art literature review through Latent Semantic Analysis, covering from 1934 to early 2013, to demonstrate the intense growth that the field has been experiencing throughout the

development of the supply chain management arena. According to the latter group, the intersection between these two disciplines have been portrayed in studies of upstream – in buyer-supplier relationships –, downstream – concerning distribution channels and customer segmentation, for instance –, and internal supply chain management – on what regards inter-department relationships. Supply chain management issues, specifically, have been in the spotlight of globalization’s consequences. Seppälä, Kenney and Ali-Yrkkö (2014:445), for instance, emphasize supply chain arrangements as being “central to understanding wealth creation and capture in an increasingly globalized production system”. As both upstream and downstream relationships turn to international waters in the search for competitiveness, “from a behavioral perspective, culture becomes important as a predictor and explaining factor of behavior in these settings” (Loch and Wu, 2007, in: Croson, Schultz, Siemsen and Yeo, 2013:4).

When analyzing the impact of behavioral issues on Operations, multi-cultural contexts usually offer a rich and contrasting scenario. The first article that composes this dissertation aims to provide a comparison between four distinct countries, with remarkably different socio-economic backgrounds, to understand to what extent operations strategy process elements may be influenced by cultural characteristics. The paper observes cultural effects on companies in an isolated manner, what is to say that the interaction between companies located in different countries was not the scope of the examination. In order to assess such issue, the second article seeks to deepen the understanding of cultural impacts by investigating a particular trait inside a particular country, but within a buyer-supplier relationship scenario from companies with diverse origins. The interviews opened a perspective of the Brazilian *jeitinho* as understood by Brazilian managers, therefore in a contextualized research, yet focusing on the interaction between the companies and counterparts from multiple nationalities. The third paper builds on this quest to extend the scenario to buyer-supplier interactions that happens in international fields. In the aim of providing a more thorough and integrated debate on the issue, the following

session is then devoted to the discussion of the literature on supply chain management within international contexts. Beyond that, the view of global outsourcing as an operations strategy decision is also approached, as its considerations may offer supplementary visions on the matter.

2.4. Supply Chain Management in International Contexts

Among those factors treated as essential for successful supply chain management, cross-functional integration is advertised as particularly significant (Lambert and Cooper, 2000). A major challenge in that task, as stressed by the authors, would be the determination of the means through which such integration shall be met, considered the arguable greater cultural homogeneity that must be observed in these situations, when compared to those expected in cross-country arrangements. The relation between buyers and suppliers of different cultural contexts may be argued to pose additional complexity to the solving of this puzzle. It is possible that, among other reasons, global supply chain management has received growing attention from both academics and practitioners, as the “effects of globalization have touched upon the complete range of organizational activities and processes associated with the flow of goods and services to end users” (Connelly, Ketchen and Hult, 2013:228). From this reasoning, it seems that, as globalization advanced, it would have forced the emergence of efforts objectifying the diminishment of the cultural incomprehension, at least in business’ connections. In this way, alongside companies’ search for new markets abroad, including partnerships in both upstream and downstream orientations, multi-nationality links are increasingly achieving several industries. In response to the rise of competitive pressures, the search for low-cost sources, for instance, have been handled by both small and large organizations (Ibrahim, Zailani and Tan, 2015).

Following the perception that “many of the rules of the past no longer apply as managers attempt to navigate cultural differences, geographic distances, language barriers, political uncertainty, currency exchanges, and multiple time zones in their supply chain” (pp.240), Connelly, Ketchen and Hult (2013) accuse globalization’s influence over the rational arrangement of buyers and suppliers, highlighting this global trend through the addressment of global supply chain management in a multiple theory approach. Accordingly, theoretical advancements issued from disparate yet complementing perspectives such as real options theory, internationalization theory, organization economics, resource dependence theory, social network theory and institutional theory would be advantageous in the treatment of global supply chain management issues. Within this reasoning, due to the creation of additional costs, or “liability of foreignness” (Hymer, 1976, in: Connelly, Ketchen and Hult, 2013), negotiations abroad firms’ countries may configure a competitive disadvantage to transnational arrangements. Such costs would be associated with geographical distance, unfamiliarity of local environment, and macro aspects (e.g. nationalism, infrastructure), among others. The importance of assessing the conjuncture involved in global supply chains represents the necessity to analyze all the factors which may come to influence this process, being culture one of such. Around this propensity, Prasad and Babbar (2000:211) note that “cultural effects of customs, languages, attitudes, motivation, social institutions, status symbols, and religious beliefs have all been documented in international operations literature”.

Classic to the Operations Strategy scenario is the broad comparison of American and Asian automobile manufacturers, for instance, in studies contrasting Japan and the U.S. (Dyer, 1996), supply chain relationship trust in the industry located in those two countries and Korea (Dyer and Chu, 2000, Dyer and Chu, 2011), or the junction of Toyota’s manufacturing knowledge when it comes to American suppliers (Dyer and Nobeoka, 2000). In that sense, Metters (2008) relies on an ethnographic approach to analyze the impact of cultural differences in offshoring

decisions, finding evidences for operational predicaments rooted in “culture clash”. In their literature review of business process management and culture, Brocke and Sinnl (2011) provide future research avenues depicted by the culture’s role on field. Trust in supply chain management was also examined by Liao, Sharkey, Ragu-Nathan and Vonderembse (2012), as they assess long-term strategic fit and autonomy as antecedents for the construct, while Ketkar, Kock, Parente and Verville (2012) conducted research on production processes of American and Brazilian manufacturers, suggesting that individualism negatively impacts suppliers’ involvement.

Beyond appraisals of operations located in different cultural venues, global supply chain management encompasses companies placed in multiple settings while pertaining to the same value chain. Research on this direction counsels the extension of operations and supply chain management concepts to accommodate their international configuration. Youngdahl and Loomba (2000), for instance, offer the expansion of the service-driven manufacturing notion to the global supply chain arena, arguing that the information flow in such delineations carry increased complexity, as “time, distance, language, and other factors come into play” (pp.335). Andersen and Skjoett-Larsen (2009) conducted a case study within IKEA’s South Asian offices to propose a conceptual framework for corporate social responsibility practices in global supply chains, while Mollenkopf, Stolze, Tate and Ueltschy (2010) investigate the literature on green and lean practices within the global setting, suggesting research opportunities within this agenda. The authors include the need for theoretically grounded approaches with integrated measurement models, the inclusion of multi-function perspectives and a systems’ attempt to generate strategic insights as gaps to be filled in the literature. Blackman, Holland and Westcott (2013) deepen the financial supply chain concept by studying Motorola’s global model, defending an integrated model that can lead to significant cost savings. Global supply chains also hold the potential to secure competitive advantage and value to organizations. Carlsson

(2017) promotes that companies prefer to source from multi-national companies rather than from local suppliers, as they perceive the former as carrying superior capabilities.

Consonant to this terrain are issues approached by international / global sourcing studies. The connection of elements such as cultural competitiveness (Hult, 2002) and human resources capabilities (Trent and Monczka, 2003), and the success of global sourcing are examples of the impact of behavioral matters on international strategies. Vachon (2009) applies Hofstede's (2001) national cultures dimensions to suggest that individualism and uncertainty avoidance implicate the sustainable practices anchored in international operations, as offshoring decisions, expansion of international production and global sourcing. Also from a sustainability perspective, Goebel, Reuter, Pibernik and Sichtmann (2012) analyze the ethical culture within organizations and its impact for supplier selection on global outsourcing decision when it comes to environmental and social criteria assessed by managers.

Far from intending to exhaust the subjects addressed, the present and the former sections are expected to have provided the basic understandings on the fields approached and demonstrate the relevance of cultural matters in Operations' related topics. Beyond these general considerations, more specific and detailed debates are provided within the theoretical discussion and literature reviews proper to each of the articles, further presented forward on the text. Meanwhile, the next chapter draws an overview of the dissertation, the organization of articles and a visual synopsis of the research questions and contributions.

Chapter 3. Research Motivation

Regardless of the approach to culture they might choose to pace on, scholars have been paying growing attention to the role it plays in the most diverse of Management disciplines, pointing also to other cultural factors as relevant matters when it comes to their impact in business concerns. Core differences between Western and Chinese managerial styles, for instance, have been assessed by Buttery and Leung (1998) in negotiation deals. Seock and Lin (2011) investigate the contrast between brand assessment and loyalty of consumers from Taiwan and the US, while cross-cultural differences with significant effects on managerial performance are analyzed by Neelankavil, Mathur and Zhang (2000). More recently, Johnson, Lenartowicz and Apud (2006) argue for a conceptual approach to cross-cultural competence in international contexts, defining it as being a result of personal attributes, personal skills and cultural knowledge, yet negatively impacted by institutional ethnocentrism and cultural distance. Plijter, Voordt and Rocco (2014) study national culture's function in workplace design and management, assessing multinational companies installed in three European nations. While Calza, Cannavale and Tutore (2016) display their findings on the consequences of national culture particularities on companies' proactivity on environmental issues, Kang, Lee and Yoo (2016) suggest that corporate social responsibility activities in the hospitality sector are influenced by national cultures traits.

Within the Operations Management landscape, studies have also explored the impact of cultural differences on various fields. Latest research on such direction can be illustrated by findings on the differences on quality management patterns, such as quality systems' implementation, training, tools and techniques, between companies established in the UK, Finland and Portugal (Mathews, Ueno, Kekäle, Repka, Pereira and Silva, 2001), whereas Naor, Goldstein, Linderman and Schroeder (2008) assess the relationship between quality

management practices, organizational cultures, and infrastructure. Vecchi and Brennan (2009) present the results from their 23-countries survey to suggest the influence of cultural dimensions in quality management practices, while Wiengarten, Fynes, Pagell and Búrca (2011) carry evidences that hint that the relationship between investments on manufacturing practices and manufacturing performance is moderated by national cultures dimensions, and Wiengarten, Gimenez, Fynes and Ferdows' (2015) study found that collectivism impacts the efficiency of lean procedures in a significantly manner. On a broader perspective, Pagell, Katz and Sheu (2005) set out to seek validation of national culture as an explanatory construct for decision-making processes in the international operations' context. Based on data collected by the Global Manufacturing Research Group (GMRG) on 778 industrial plants and on Hofstede's (1980a) cultural dimensions, the study points to national cultures as significantly explaining behavior on such decisions.

From the discussion garnished above, the fact of the matter remains that cultural idiosyncrasies may embody a strong source of threat if not appropriately addressed, especially when it comes to internationalized organizations and the intersection between two or more different settings. While growingly addressed within the Operations Management literature, the outcomings of the crossing between cultural perspectives and Operations Strategy has not yet been broadly comprehended and configures the central motivation of the present research. Pagell, Katz and Sheu (2005) delineate the relevance of considering national cultures within the discipline, while Sousa and Voss (2008) call for the need of recognizing contingency factors, among which lies culture, to better understand operational practices in organizations. Furthermore, Naor, Linderman and Schroeder (2010:194) highlight importance of the cultural and operational cross-point within the "era of transnational manufacturing", while "the world becomes flat and boundaries break down".

Also of high significance to the discussion, the concept of organizational culture, composed by the set of artifacts (i.e. “visible organizational structures and processes), values (i.e. “strategies, goals, philosophies”), and underlying assumptions (i.e. unconscious, taken for granted beliefs, habits of perception, thought and feeling”) within a determined organization (Schein, 1988:10) has been proposed to be a potential source of long-term competitive advantage to firms (Barney, 1986). Defined as the “pattern of basic assumptions that a given group has invented, discovered, or developed in learning to cope with its problems of external adaptation and internal integration” (Schein, 1984:3), it has been linked to operations strategies performance outcomes such as total quality practices (Prajogo and McDermott, 2005), and the adoption of supply chain management systems enabled through the internet (Liu, Ke, Wei, Gu and Chen, 2010), among others.

Within this landscape, the examination of the influence of cultural issues in Operations Strategy and in international supply chains from an international relationship setting perspective, influenced by cultural traits that are evidenced in behavioral patterns of the parties involved, as contended in the Literature Review chapter above, serves as the primary motivation of the current study. Because the focus of the present dissertation is to further understand the impact of human behavioral issues that arise from a socio-cultural background, rather than patterns that are derived from organizational formations, national cultures – rather than organizational ones – are the main basis for the analysis made in the ensemble of the three articles. Inner to this reaction, this dissertation reaches out to understand the cultural impacts from both an internal perspective, taking into account operational issues that occur within organizational boundaries, affected by companies’ country of origin, as further discussed in the first article; and an external viewpoint, while examining the crossing between two or more cultures when put into direct contact in a buyer-supplier relationship, as applied in articles two and three.

The next chapter presents the structure of this dissertation, organized around the central argument on the ability of companies to adjust their own strategy in order to accommodate particularities and singular behaviors of the targeted social group, nation or region as critical to the success or failure of international takes.

Chapter 4. Structure of the Dissertation

The present dissertation is configured of three main parts. This is the end of the first one, encompassing the introductory chapter, a delimitation of the literature review of cultural management and operations strategy, the state of the field in behavior operations, and supply chain management in international contexts, alongside the motivation that triggered this research. The structure of the dissertation is then presented, followed by the philosophical grounds that supports its development, as well as the chosen methods employed.

The second part is composed of three articles, and the overall composition was aimed to having one quantitative-oriented paper, a qualitative-oriented one, and a conceptual article. The first one, entitled “How do national cultures impact the operations strategy process?”, published at the *International Journal of Operations and Production Management*¹, presents a cross-national research including four countries with different industrialization histories and development backgrounds (i.e. Brazil, China, Germany, and South Korea). National cultures dimensions were hypothesized as influencing operations strategy process elements. Having results corroborated with a great part of the argued issues, this paper sheds some light into the relationship between culture and operations management. Additionally, sociological issues are discussed as a potential source of the differences encountered in operations strategy process elements.

Trailing insights presented on the discussion of the previous paper, the second paper, “The duality of the Brazilian *jeitinho*: An empirical investigation and conceptual framework”²,

¹ Lee Park, C. and Paiva, E.L. (2018). How do national cultures impact the operations strategy process? *International Journal of Operations and Production Management*, vol.38, n.10, pp.1937-1963.

² Lee Park, C., Fracarolli Nunes, M., Muratbekova-Touron, M. and Moatti, V. (2018). The duality of the Brazilian *jeitinho*: An empirical investigation and conceptual framework. *Critical Perspectives on International Business*, vol.14, n.4, pp.404-425.

featured at the *Critical Perspectives on International Business* journal, focuses on one of the previously studied countries and its cultural idiosyncrasies. It initially aimed to deepen the features that may influence relationships in a buyer-supplier context, exploring the indigenous management approach in order to understand the peculiarities of this specific culture that may influence its effects on operations management issues. Yet, from the literature review, the exploratory character of the study became evident as studies on the concept of the Brazilian *jeitinho* remain of low volume, and an urgency for better understanding the ambiguity around its ethicality emerged and was therefore pursued.

Finally, the third paper, “The fifth element of the Relational View: What can French filmmakers teach us on international buyer-supplier relationships?”, conceptualizes the impact of cultural differences on the generation of relational rents within buyer-supplier relationships, ultimately translating into interorganizational competitive advantage. It offers a theoretical construction for such relationships when located, for instance, in international contexts.

The rationale for having the articles organized in this fashion is to open the dissertation with a broader-scoped empirical investigation, which uncovered a cultural facet, particularly in Brazil, that could allow us to deepen the understanding of the cultural impact on operations management matters in the country. This issue was hence pursued by the second study, deepening the understanding around it in buyer-supplier relationships, and complementing the contributions achieved on the first. Finally, the third article would conceptually summarize such empirical findings, proposing a theorization of the effect of national cultures in operations management transnational contexts, comprehending opportunities for further empirical developments in future research. The presentation of the papers also coincides with the chronological order in which they were developed, and each of them are preceded by an

introductory text, clarifying its positioning and reporting any activities regarding their presentation and publication.

The third and last part of this dissertation concerns the concluding chapter. Contributions made by each of the three papers are summarized, followed by a discussion on theoretical and practical implications for the study. Limitations and future research suggestions are also approached. Chart 4 below presents a visual synopsis of the dissertation, encompassing the proposed research questions, employed method for the empirical papers, main results on each article and general contributions.

Chart 4: Dissertation’s Visual Synopsis

What are the implications of cultural matters in operations strategy?			
Article	<i>How do national cultures impact the operations strategy process?</i>	<i>The duality of the Brazilian jeitinho: An empirical investigation and conceptual framework</i>	<i>The fifth element of the Relational View: What can French filmmakers teach us on international buyer-supplier relationships?</i>
Research Question	To what extent are national cultures related to companies’ process of operations strategy?	What factors influence the perception of <i>jeitinho</i> around its ethicality among Brazilian professionals?	To what extent does cultural (dis)alignment impact the generation of relational rents in a buyer-supplier relationship?
Context	Cross-cultural study of plants within the machinery, electronics and transport equipment industries from eleven countries – High Performance Manufacturing (HPM) project	Buyer-supplier relationships with at least one side of the dyad based in Brazil	Inter-companies’ relationship in cross-cultural settings, specifically when inserted in international supply chains
Method (when applicable)	Perceptual survey data, Confirmatory Factor Analysis, Analysis of Variance	Semi-structured interviews, hierarchical coding	
Main Findings	Evidences suggest that national cultures impact the operations strategy process. Integrating leadership and implementation of manufacturing strategy are influenced by power distance, individualism vs. collectivism and uncertainty avoidance, while functional integration and formal manufacturing strategy are affected by individualism vs. collectivism and long-term orientation	Five dimensions for the assessment of the Brazilian <i>jeitinho</i> , classified as causes (personal benefit, assessed pertinence of rules and laws), context (seriousness of the issue, formality of relationships), and consequence (harm to third parties). Proposition of a formal definition for the Brazilian <i>jeitinho</i> as an indigenous practice and of its perception as a balancing pendulum.	Proposition of a theoretical framework for the effect of cultural traits on relational rents generated in inter-companies’ relationships.
Overall Contributions	<ul style="list-style-type: none"> ▪ Cultural characteristics have significant impact on Operations Strategy affairs; ▪ The understanding of cultural differences as a capability able to generate competitive advantage. 		

Chapter 5. Philosophy of Science

When it comes to Social Sciences, research methods have traditionally been transmuted into a conflicting debate between quantitative and qualitative streams (Smith and Heshusius, 1986, Bryman, 2007, Bernard, 2011). Although this separation might be representative of significant issues, one shall recognize that such binary classification may embody a reasonably restrict or, yet, limited thought around the possibilities lying in the scientific field. As Modern Science itself emerges from questionings of the dogmatic model in the fifteenth century in the denominated Scientific Revolution (Hall, 1954, Cohen, 1994, Shapin, 1996), researchers should be aware not to get caught into a purely tautological definition. Instead, they would profit from the understanding of such different phenomena that surrounds organizations and managerial practices. Whether reality does or does not exist as it is, or, in other words, if there can or cannot be a separation between object and meaning, then different people might carry different understandings.

In recent studies, authors have sponsored different stances of epistemological and ontological matters. Creswell (1998, 2003), for instance, conceives a multiple-model perspective for epistemological approaches, characterizing four major interpretations – post-positivism, derived from empirical observation, seeking to validate theories through empirical assessment; constructivism, which posits that research can generate theory through the comprehension of historical and social construction; pragmatism, driven by practices encountered in the “real world” and centered around the questioned problems; and advocacy, a change-oriented political participative approach. Alvesson and Sköldbberg (2000), in turn, discard the long running debacle between quantitative and qualitative methods, introducing the idea of reflective and reflexive research. Reflective research would be drawn upon interpretation and reflection, to the extent that empirical data is to be treated as being the result

of interpretation. It would be constituted of four different approaches: the empirically-oriented one, giving strength to the systematization of research and its techniques, represented by grounded theory, for instance; hermeneutics, with the understanding of research as interpretation; critical theory, which, according to the authors, arises the political and ideological nature of research; and postmodernism, preaching the separation between researcher and problem. Reflexive processes would then encompass the “researcher’s reflections influence (...) [to] change, shape and re-shape the study” (Mantzoukas, 2005:290). From another perspective, Prasad (2005) exposes four groups of post-positivism traditions, each of which supporting a series of epistemological approaches. In the interpretative tradition, the author encompasses symbolic interactionism, hermeneutic, dramaturgy, ethnomethodology and ethnography as epistemological methods; the critical tradition, on the other hand, would be based on historical materialism, critical theory, and the feminism movement; structuralism would be centered around the semi-optic approach; and post-traditions, such as post-modernism as a theory for society and culture, post-structuralism, as a philosophical movement defending multiplicity and differences, and post-colonialism, driven by the understanding of colonialism practices.

Burrell and Morgan’s (1979) effort on social paradigms is considered to be the most influential discussion on epistemological matters (Tsoukas and Knudsen, 2009), and is the one that fundamentals the epistemological and ontological cores of this dissertation. Based on their identification of the four main disputes around sociological issues – (i) the ontological debate, on reality being given or produced by the individual/collective mind; (ii) the epistemological debate, on understanding being a product of observation or experience; (iii) the human nature debate, on human action being shaped by the environment or the so-called “free-will”; and (iv) the methodological one, on understanding being better achieved through direct experience or the application of scientific methods –, the authors propose the analysis of subjective-objective

assumptions made on the nature of social sciences, as illustrated in Figure 1 below. The discussions around ontology, epistemology, human nature and methodology would then be situated within a subjectivist-objectivist dimension on what regards the approach on the nature of social science. Each debate would generate two opposite extremes, one pertaining to the subjectivist approach of social sciences, and the other to the objectivist one, with the choices on the four topics varying according to the position they hold.

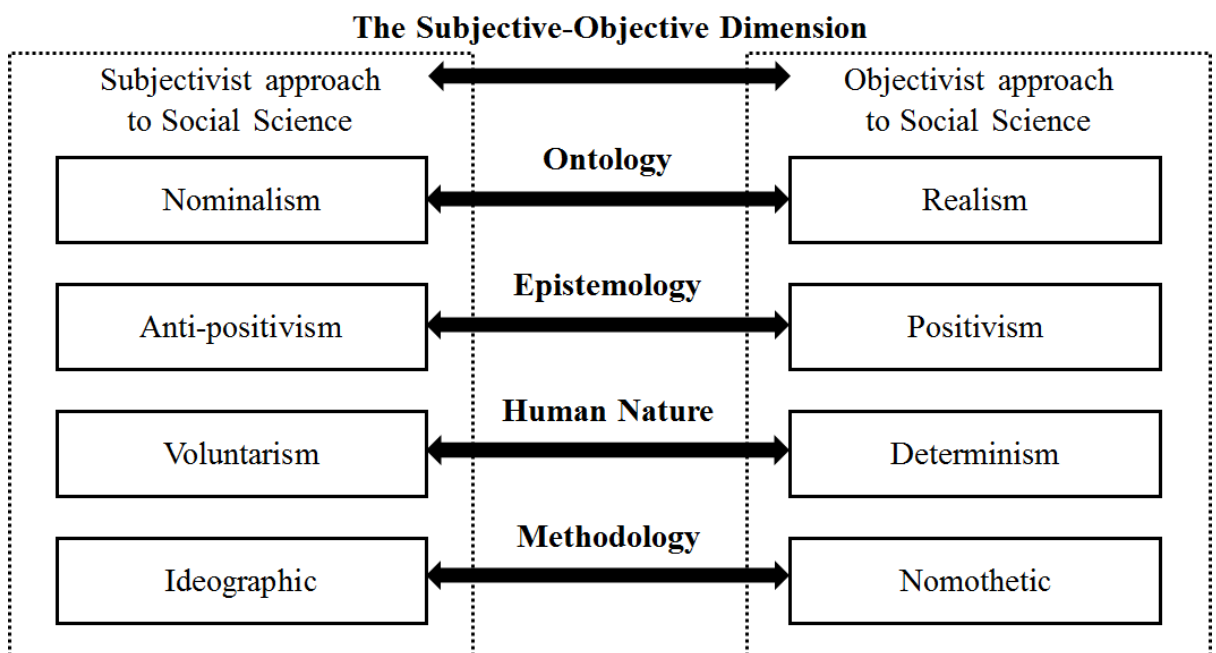

Figure 1: Burrell and Morgan’s (1979) Scheme for Analysing Assumptions about the Nature of Social Science

Source: Adapted from Burrell and Morgan (1979:3)

Central to the ontological debate would be the social universe that is encountered outside of individuals’ internal cognition, i.e. the external world. The nominalist position would assume reality as being structured by names which, in turn, represent artificial creations with the purpose of “describing, making sense of and negotiating the external world” (pp.4). On the opposite side of the dispute would be realism, positing that the external world would be constituted by “hard, tangible and relatively immutable structures” (pp.4). Reality would

therefore exist regardless of the individual's awareness or the use / lack of names attributed to describe it. The epistemological debate, in turn, exhibits the contrast between anti-positivism and positivism takes. Positivist epistemologies would be ones that utilize causal relationships and the identification of patterns to reach explanation and/or prediction. Governing the fields of natural sciences, positivism sees the progression of knowledge as being “essentially a cumulative process in which new insights are added to the existing stock of knowledge and false hypotheses eliminated” (pp.4). In other words, positivist scholars rely on the traditional concepts of verifiability and falsifiability mentioned previously in the text. Anti-positivists, on the other hand, would defend the social world as being fundamentally ruled by relativism. For them, the only way to understand it would be through the perspective of individuals who are inserted in the referred activities, thus rejecting the positivist notions of the external observer and objective knowledge.

The third debate highlighted by Burrell and Morgan (1979) concerns the human nature. From one side, determinism postulates man as being a product of the environment, meaning that the external world, or situations, determines and shapes human action. From the other side, voluntarism endorses man as free-willed autonomous creatures. Encompassing human activities and the relationship between man and the society that surrounds him, this discussion is endorsed by the authors as fundamental to theories developed under the social sciences domain, either for explicating one of the two referred positions, or for adopting a middle ground between them. According to the authors, the three debates detailed above carry inevitable impacts on the fourth one, on the methodological arguments. On this final one, the dissimilarities of the ideographic and the nomothetic approaches come to light. Ideographic theorists stand for researcher-subject proximity, meticulous exploration of its background and deep investigation of its history, while allowing for its own traits and nature to emerge. The nomothetic approach, extreme to the objectivist dimension, advocates for “the importance of

basing research upon systematic protocol and technique” (pp.6). Rigor in scientific conductions would be primordial to hypotheses testing investigations, along with data analysis through quantitative procedures. Proper to this approach are tools such as standardized research instruments, surveys and personality tests, for instance.

Rather than standing on contradictory positions, this dissertation searches for the complementarities that can be offered by adopting a mixed path on what concerns its approach to Social Science. On the ontological debate posed by Burrell and Morgan (1979), the perception of reality as a social construction approximates this application to a more nominalist view. The existence of reality itself as posed by the realism theorists is not negated, but the tangibility of its structures is questioned in a way that it could not shelter the concept of culture. Moreover, it is from individuals’ awareness and sense-making that cultural traditions, practices and beliefs are generated and perpetrated to the point of reflecting themselves into organizational conjunctions. Within the epistemological stance, a mixed conception of the understanding as being possibly produced by external observation and being dependent of individuals’ interpretation allocates the study under between the positivism and anti-positivism margins of research. While cultural studies rely on the standardization of behaviors to search for explanatory elements proper of positivistic approaches, individuals’ perception and relativism, as subsidized by anti-positivists theorists, is regarded as essential to the building of the social world, partially translated into the methods of research adopted in the second and third articles and sustained by the epistemological approach of the second one. The debate around human nature, in turn, bends the present investigation into the objectivist dimension. As discussed before, the study of cultural issues assumes a rather deterministic view of human behavior. According to this approach, cultural patterns would allow for the predictability of men’s actions, as they would be shaped by traditions, customs and traits inflicted in them by their respective culture.

Finally, the confounding traits of this study are also evidenced by the methodological approaches adopted in the subsequent empirical articles. While the first one reaches for a quantitative data analysis collected in systematic procedures, endorsing the testing and validation of the four recommended hypotheses, the second emphasizes the need for researchers' closeness to the studied issue. Without such researcher-subject proximity, the identification of the assessed cultural trait would be difficult to accomplish, as well as its provided definition based on respondents' perceptions on its main traits. Chart 5 below presents the assumptions undertaken by each of the three articles present in the dissertation on Burrell and Morgan's (1979) framework:

Chart 5: Articles' Positioning on Burrell and Morgan's (1979) Subjective-Objective Approaches

Article	<i>How do national cultures impact the operations strategy process?</i>	<i>The duality of the Brazilian jeitinho: An empirical investigation and conceptual framework</i>	<i>The fifth element of the Relational View: What can French filmmakers teach us on international buyer-supplier relationships?</i>
Ontological Approach	Nominalism	Nominalism	Nominalism
Epistemological Approach	Positivism	Relativism	Positivism
Human Nature's Approach	Deterministic	Deterministic	Deterministic
Methodological Approach (when applicable)	Nomothetic	Ideographic	-

Due to size limitations that are inherent to academic articles, they are only able to portrait a partial report on the methodological procedures adopted in empirical researches. For this reason, the next chapter provides a more outright view of the research processes employed for the second and the third articles of the dissertation, as well as of the empirical settings that served as the basis for such investigations.

Chapter 6. Empirical Setting and Methods

This chapter is dedicated to deepening the research methods adopted by the two empirical papers of the dissertation, as well as the contexts that surround such investigations. For the first article, the High-Performance Manufacturing (HPM) project and its database collaboration, as well as scales' development and procedures, which composed the basis of the empirical research conducted in the article, are further addressed below. Next, as in-depth interviews were conducted within a qualitative paradigm in the second empirical study, the applied research protocol, sampling and data collection, and data analysis procedures are then detailed.

6.1. Paper One: Survey-based Quantitative Research

6.1.1. *The High-Performance Manufacturing (HPM) Project*

Born in the mid-1990's as the World-Class Manufacturing (WCM) database, the High-Performance Manufacturing (HPM) project consists on a network of international scholars from Production and Operations that cooperate together. Specifically devised to the building of a broad database that allowed for the deepening of practices associated to world-class manufacturing (Flynn, Schroder and Flynn, 1999), the HPM project grants a comprehensive investigation on objective and perceptual data stemming from diverse topics such as quality management, adaptability, constrain management, lean management, new product development, and human resource management, among others. Currently in its fourth round, the project involves academics from 15 distinct countries and/or regions, and data was collected through multiple respondents per participant manufacturing plant, pertaining to the electronics, machinery, and transport equipment industries. Figure 2 below presents a descriptive overview of HPM's fourth round, including the participant countries, the measurement scales groups

covered by the research instrument, and the area or department to which respondents pertained to:

Country / Region	Measurement Scales	Area / Department
<ul style="list-style-type: none"> ▪ Brazil ▪ China ▪ Finland ▪ Germany ▪ Israel ▪ Italy ▪ Japan ▪ South Korea ▪ Spain ▪ Sweden ▪ Switzerland ▪ Taiwan ▪ United Kingdom ▪ United States ▪ Vietnam 	<ul style="list-style-type: none"> ▪ Adaptability ▪ Business Services ▪ Constraint Management ▪ Environment ▪ Human Resource Management ▪ Improvement ▪ Information System / Technology ▪ Lean / Just-in-Time ▪ Manufacturing Strategy ▪ New Product Development ▪ Performance ▪ Quality Management ▪ Supply Chain Management ▪ Sustainability ▪ Technology ▪ Total Productive Maintainance 	<ul style="list-style-type: none"> ▪ Upstream Supply Chain Management ▪ Downstream Supply Chain Management ▪ Environmental ▪ Human Resources ▪ Information Systems ▪ Plant Management ▪ Process Engineering ▪ Product Development ▪ Production Control ▪ Quality Management ▪ Supervision ▪ Accounting

Figure 2: Overview of HPM’s 4th Round Countries / Regions, Measurement Scales, and Respondents’ Area / Department

Source: HPM 4th Round

Each country has a designated leader for the project and, working together with a global coordinator, scales were developed from the project’s previous rounds, as well as from the incorporation of measurements derived from the literature. Instruments were developed in English, then translated and back-translated from each of the participant countries’ local language, ensuring that comparability of the questionnaires and collected data. Companies pertaining to the selected industries and withholding more than a hundred employees each were contacted. Such size delimitation allowed to gather a sample of manufacturing plants that carried the areas that were approached with the measurement scales. Because of the high complexity of the data collection, involving a minimum of twelve respondents per plant, participant companies were also based on country leaders’ networking and endeavors. Table 1 below displays an up-to-date portrait on the number of companies pertaining to each country / region, and industry, as well as the respective totals:

Table 1: Descriptive Overview of HPM’s 4th Round Participants by Country/Region and Industry

Country / Region	Industry			Total
	Machinery	Electronics	Transport Equipment	
Brazil	5	7	12	24
China	10	16	4	30
Finland	6	6	5	17
Germany	6	13	9	28
Israel	21	5	0	26
Italy	7	17	5	29
Japan	6	7	9	22
South Korea	8	5	13	26
Spain	8	7	10	25
Sweden	5	3	1	9
Switzerland	3	6	2	11
Taiwan	19	10	1	30
United Kingdom	4	5	4	13
United States	5	7	3	15
Vietnam	10	7	8	25
Total	123	121	86	330

Source: HPM 4th Round

6.1.2. Countries Integrating the Analysis

Our study aimed to understand the influence of national cultures traits in operations strategy process. With this purpose in mind, we set our goal to analyzing countries with different characteristics such as historic roots and industrialization processes as such developments would possibly have an important impact on their national cultures. Thus, the countries chosen to integrate the study – Brazil, China, Germany, and South Korea – bear outstanding differences between each other, both in their past history, and in their present day. Brazil and China are both emerging or developing countries, carrying recent industrialization processes. The social

aspect of their cultures differs significantly, even if thought as simplistically as in the contrast posed by Western and Eastern societies. Germany and South Korea, on the other hand, are developed countries in advanced stages of industrialization, with the first having had a more traditional process, and the latter, a recent one.

At the time of our research development, HPM's fourth round was undergoing the data collection phase. Therefore, the difference on the data found in the paper and in the updated one presented above is due to the further addition of three participant companies in the Brazilian sample after our analysis was ran (i.e. 105 manufacturing plants examined in the paper, versus 108 as previously displayed in Table 1).

6.1.3. Operations Strategy Constructs Operationalization and Measurement Instruments' Refinement

As mentioned before, scales were retrieved from the fourth round on the HPM project, which is composed by 13 manufacturing strategy multi-item scales. The operations strategy constructs examined in the study were developed from items pertaining to such instruments. Chart 6 below displays the HPM project's scales and codes that originated the Operations Strategy constructs adopted in the investigation, as well as scales' reliability measures from the project previous round, their initial number of items, and respondent from each participant plant.

Chart 6: HPM’s Manufacturing Strategy Scales and Article’s Operations Strategy Constructs

HPM Manufacturing Strategy Scale	Code	Cronbach’s Alpha Values for HPM Third Round	Operations Strategy Construct	Total Number of Items	Respondent
Leadership for Functional Integration	LDINT	.82	Leadership for Cross-Functional Integration	4	Supervision
Achievement of Functional Integration	INTEG	.79	Functional Integration	4	Plant Management
Integration between Functions	FUNCI	.81		8	Plant Management
Manufacturing-Business Strategy Linkage	LINKS	.76	Manufacturing Strategy Linkage to Corporate Strategy	6	Plant Management
Formulation of Manufacturing Strategy	MFGST	.80	Formulation of Manufacturing Strategy	4	Plant Management

Source: HPM 4th Round and elaborated by the author

The items pertaining to each HPM scale, their respective statement, and orientation are shown in Chart 7 below:

Chart 7: Measurement Scales Initial Items for the Four Operations Strategy Constructs

Item Code	Item Statement	Orientation
LDINTN01	Our top management emphasizes the importance of good inter-functional relationships.	Normally scaled
LDINTN02	Our managers do a good job of solving inter-functional conflicts.	Normally scaled
LDINTN03	We are encouraged to communicate well with different functions in this plant.	Normally scaled
LDINTN04	Our managers communicate effectively with managers in other functions.	Normally scaled
INTEGN01	The functions in our plant are well integrated.	Normally scaled
INTEGN02	Problems between functions are solved easily, in this plant.	Normally scaled
INTEGN03	Functional coordination works well in our plant.	Normally scaled
INTEGN04	Our business strategy is implemented without conflicts between functions.	Normally scaled
FUNCIN01	The functions in our plant work well together.	Normally scaled
FUNCIN02	The functions in our plant cooperate to solve conflicts between them, when they arise.	Normally scaled
FUNCIN04	Our plant's functions coordinate their activities.	Normally scaled
FUNCIN05	Our plant's functions work interactively with each other.	Normally scaled
FUNCIN06	The Marketing area knows a great deal about manufacturing in this plant.	Normally scaled
FUNCIN07	The Finance area knows a great deal about manufacturing in this plant.	Normally scaled
FUNCIN08	The Product Development area knows a great deal about manufacturing in this plant.	Normally scaled

FUNCIN09	The Human resource management area knows a great deal about manufacturing in this plant.	Normally scaled
LINKSN01	We have a manufacturing strategy that is actively pursued.	Normally scaled
LINKSN02	Our business strategy is translated into manufacturing terms.	Normally scaled
LINKSN03	Potential manufacturing investments are screened for consistency with our business strategy.	Normally scaled
LINKSN04	At our plant, manufacturing is kept in step with our business strategy.	Normally scaled
LINKSR05	Manufacturing management is not aware of our business strategy.	Reversed scaled
LINKSR06	Corporate decisions are often made without consideration of the manufacturing strategy.	Reversed scaled
MFGSTN01	Our plant has a formal manufacturing strategy process, which results in a written mission, goals and strategies.	Normally scaled
MFGSTN02	This plant has a manufacturing strategy, which is put into writing.	Normally scaled
MFGSTN03	Plant management routinely reviews and updates a long-range manufacturing strategy.	Normally scaled
MFGSTR04	The plant follows an informal manufacturing strategy, with no written strategy document.	Reversed scaled

Source: HPM 4th Round

After undergoing the missing data treatment exposed in the article ahead, each construct was assessed as an individual model through confirmatory factor analysis (CFA), with low scoring standardized factor loading items removed. Figures 3, 4, 5, and 6 below illustrate the graphical representation of the four final operations strategy models, further assessed for unidimensionality, reliability and discriminant validity as detailed in the article.

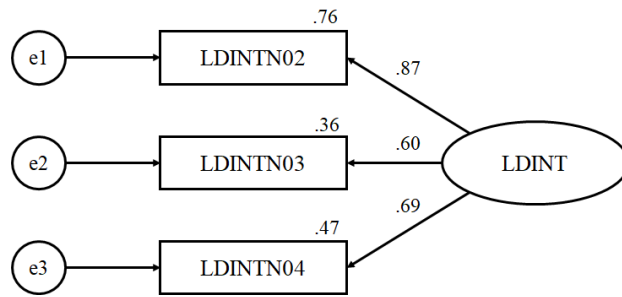

Figure 3: Final CFA Model and Factor Loadings for the Leadership for Cross-Functional Integration Construct

Source: Elaborated by the author

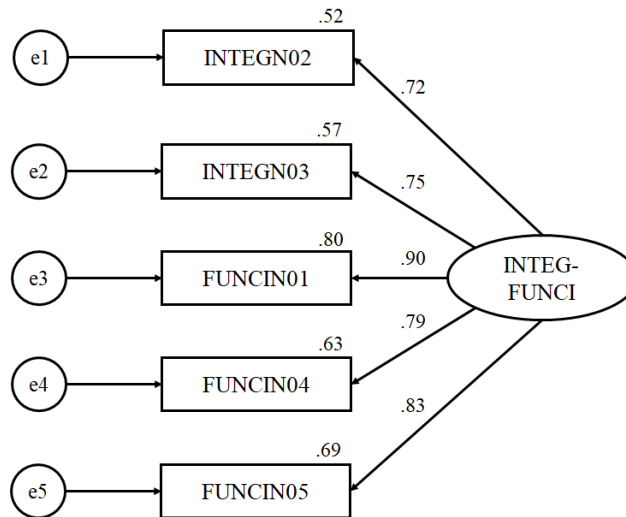

Figure 4: Final CFA Model and Factor Loadings for the Functional Integration Construct

Source: Elaborated by the author

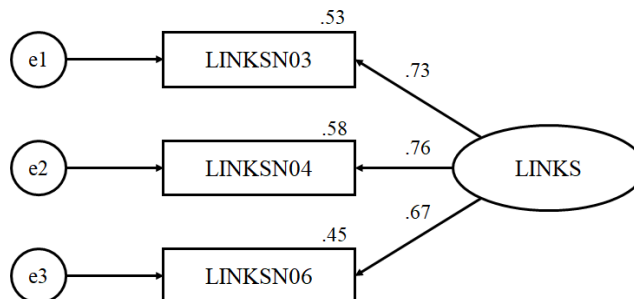

Figure 5: Final CFA Model and Factor Loadings for the Manufacturing Strategy Linkage to Corporate Strategy Construct

Source: Elaborated by the author

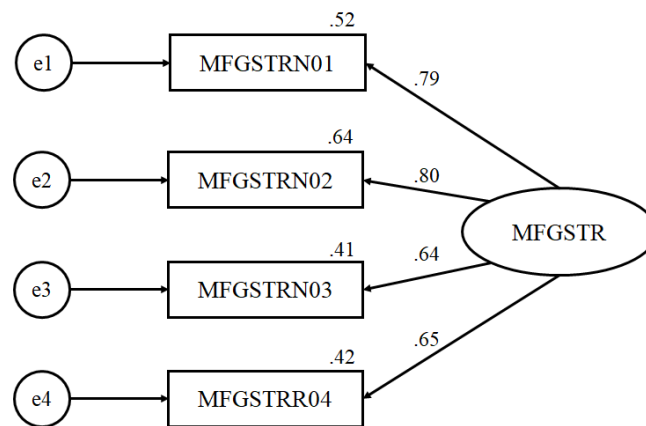

Figure 6: Final CFA Model and Factor Loadings for the Formulation of Manufacturing Strategy Construct

Source: Elaborated by the author

6.2. Paper Two: In-depth Interviews Qualitative Research

6.2.1. Research Protocol

Following extensive discussions and literature review on the Brazilian *jeitinho*, a research protocol with open-ended questions was developed to reflect the researchers' initial expectations on its possible implications on business matters. The protocol was originally build in English, then translated into Brazilian Portuguese, and back translated to ensure that accurate meaning was captured throughout the questions, along with refinement measures as discussed by the research team.

The introductory questions were designed to test if respondents would mention the Brazilian *jeitinho* spontaneously, by being asked if Brazilians would have a peculiar manner of dealing with business situations, and if such particular trait would have a denomination. The following questions were posed to assess the general definition of the Brazilian *jeitinho*, its applicability in business, its general assessment by respondents, the use of *jeitinho* in supply chain relationships, their perception of *jeitinho* in non-Brazilian contexts, the positive and negative

sides of *jeitinho*, and its origins. For supply chain relationship questions, participants would be exposed to similar questions that accounted for their position in their respective supply chains (i.e. buyer or supplier). Charts 8 and 9 below display the interview protocol developed in English, and its applied Brazilian-Portuguese version:

Chart 8: Interview Protocol for the Second Paper (English)

Objective / Assessment	Questions
Respondent Data	<ul style="list-style-type: none"> ▪ Gender; ▪ Age; ▪ Current job position; ▪ Years of experience before and in the company?
Company Data	<ul style="list-style-type: none"> ▪ Brazilian / multinational; ▪ Publicly traded / privately held; ▪ Small / medium / large; ▪ Industry and sector?
Introductory Questions	<ul style="list-style-type: none"> ▪ Do you think Brazilians have any special or unique way to deal with business questions / issues? How would that be? ▪ [If yes], Does this Brazilian way have a particular name? How would you call it?
General Definition of <i>jeitinho</i>	<ul style="list-style-type: none"> ▪ What do you understand by Brazilian <i>jeitinho</i>?
Applicability of <i>jeitinho</i> in Business	<ul style="list-style-type: none"> ▪ Can you give examples of <i>jeitinho</i> in business? ▪ Does <i>jeitinho</i> help business? If it does, how? ▪ Does <i>jeitinho</i> cause any problem for business? If it does, how? ▪ Is <i>jeitinho</i> indispensable for business? Why? ▪ Would you prefer to work in an environment completely free of <i>jeitinho</i>? Why?
General Assessment of <i>jeitinho</i>	<ul style="list-style-type: none"> ▪ In what kind of business situations is <i>jeitinho</i> expected? Why? ▪ In what kind of business situations is <i>jeitinho</i> acceptable? Why? ▪ In which business situations is <i>jeitinho</i> unacceptable? Why? ▪ Are there situations on which a person should be proud of using <i>jeitinho</i>? ▪ Are there situations on which a person should be ashamed of using <i>jeitinho</i>?
<i>Jeitinho</i> and Supply Chains	<ul style="list-style-type: none"> ▪ Does <i>jeitinho</i> improve the relationship between companies (buyers and suppliers)? How? <p>[Questions for Buyers:]</p> <ul style="list-style-type: none"> ▪ Is the capacity of using <i>jeitinho</i> an informal criterion for the choice of suppliers? How? ▪ Do suppliers use <i>jeitinho</i> to adapt their products / services to buyers' needs? How? ▪ Do suppliers use <i>jeitinho</i> to adapt payment conditions to buyers' needs? How? ▪ Do suppliers use <i>jeitinho</i> to adapt delivery conditions to buyers' needs? How? <p>[Questions for Suppliers:]</p> <ul style="list-style-type: none"> ▪ May <i>jeitinho</i> be useful in keeping or gaining new clients? How? ▪ Is it eventually necessary to use <i>jeitinho</i> to adapt products / services to buyers' needs? How?

	<ul style="list-style-type: none"> ▪ Is it eventually necessary to use <i>jeitinho</i> to adapt payment conditions to buyers' needs? How? ▪ Is it eventually necessary to use <i>jeitinho</i> to adapt delivery conditions to buyers' needs? How?
<i>Jeitinho</i> and non-Brazilians	<ul style="list-style-type: none"> ▪ Do you think <i>jeitinho</i> exists in other countries? How is it different? ▪ How do foreigners (in multinationals) deal with <i>jeitinho</i>?
<i>Jeitinho</i> as a Positive Point	<ul style="list-style-type: none"> ▪ May <i>jeitinho</i> be understood as a positive solution for business problems? Why? ▪ Does <i>jeitinho</i> add flexibility to the solution of business problems? How? ▪ Does <i>jeitinho</i> reduce time and cost of solutions of business problems? How?
<i>Jeitinho</i> as a Negative Point	<ul style="list-style-type: none"> ▪ Does <i>jeitinho</i> improve the relationship between companies and governments? How? ▪ Does <i>jeitinho</i> make it easier for companies to deal with bureaucracy? How? ▪ Who is most affected by <i>jeitinho</i>: Companies, the government, or individuals? Why? ▪ Are there risks of any sort in using <i>jeitinho</i>? What kind of risks? ▪ May the proposition of <i>jeitinho</i> be somehow offensive? Why?
Origins of <i>jeitinho</i>	<ul style="list-style-type: none"> ▪ Who or what is responsible for <i>jeitinho</i> (government, companies, Brazilian people)? Where does <i>jeitinho</i> come from?

Chart 9: Interview Protocol for the Second Paper (Brazilian Portuguese)

Objetivo / Avaliação	Questões
Dados do Respondente	<ul style="list-style-type: none"> ▪ Sexo; ▪ Idade; ▪ Cargo atual; ▪ Anos de experiência antes e na empresa?
Dados da Empresa	<ul style="list-style-type: none"> ▪ Brasileira / multinacional; ▪ Pública / privada; ▪ Pequena / média / grande; ▪ Indústria e setor?
Perguntas Introdutórias	<ul style="list-style-type: none"> ▪ Você acha que brasileiros possuem uma forma especial ou única de lidar com questões de negócios? Como seria? ▪ [Se sim], Esta forma brasileira possui um nome em particular? Como você a chamaria?
Definição Geral de <i>jeitinho</i>	<ul style="list-style-type: none"> ▪ O que você entende por <i>jeitinho</i> brasileiro?
Aplicabilidade de <i>jeitinho</i> em Negócios	<ul style="list-style-type: none"> ▪ Você pode fornecer exemplos do <i>jeitinho</i> nos negócios? ▪ O <i>jeitinho</i> ajuda nos negócios? Se sim, como? ▪ O <i>jeitinho</i> causa problemas nos negócios? Se sim, como? ▪ O <i>jeitinho</i> é indispensável para os negócios? Por quê? ▪ Você preferiria trabalhar em um ambiente completamente livre de <i>jeitinho</i>? Por quê?
Avaliação Geral de <i>jeitinho</i>	<ul style="list-style-type: none"> ▪ Em que tipos de situações de negócios o <i>jeitinho</i> é esperado? Por quê? ▪ Em que tipos de situações de negócios o <i>jeitinho</i> é aceitável? Por quê? ▪ Em que tipos de situações de negócios o <i>jeitinho</i> é inaceitável? Por quê? ▪ Existem situações em que uma pessoa deve se sentir orgulhosa de usar o <i>jeitinho</i>? ▪ Existem situações em que uma pessoa deve se sentir envergonhada de usar o <i>jeitinho</i>?
<i>Jeitinho</i> e Cadeias de Suprimentos	<ul style="list-style-type: none"> ▪ O <i>jeitinho</i> melhora o relacionamento entre empresas (compradores e fornecedores)? Como? <p>[Pergunta para Compradores:]</p> <ul style="list-style-type: none"> ▪ A capacidade de usar o <i>jeitinho</i> é um critério informal para a escolha de fornecedores? Como? ▪ Os fornecedores usam o <i>jeitinho</i> para adaptar seus produtos / serviços às necessidades dos compradores? Como? ▪ Os fornecedores usam o <i>jeitinho</i> para adaptar condições de pagamento às necessidades dos compradores? Como? ▪ Os fornecedores usam o <i>jeitinho</i> para adaptar condições de entrega às necessidades dos compradores? Como?

	<p>[Pergunta para Fornecedores:]</p> <ul style="list-style-type: none"> ▪ O jeitinho é útil em manter / conquistar novos clientes? Como? ▪ É eventualmente necessário usar o jeitinho para adaptar produtos / serviços às necessidades dos compradores? Como? ▪ É eventualmente necessário usar o jeitinho para adaptar condições de pagamento às necessidades dos compradores? Como? ▪ É eventualmente necessário usar o jeitinho para adaptar condições de entrega às necessidades dos compradores? Como?
<i>Jeitinho</i> e não-brasileiros	<ul style="list-style-type: none"> ▪ Você acha que o jeitinho existe em outros países? Quais seriam as diferenças? ▪ Como estrangeiros (em multinacionais) lidam com o jeitinho?
<i>Jeitinho</i> como um Ponto Positivo	<ul style="list-style-type: none"> ▪ O jeitinho pode ser entendido como uma solução positiva para problemas de negócios? Por quê? ▪ O jeitinho acrescenta flexibilidade para a solução de problemas de negócios? Como? ▪ O jeitinho reduz tempo e custo de soluções de problemas de negócios? Como?
<i>Jeitinho</i> como um Ponto Negativo	<ul style="list-style-type: none"> ▪ O jeitinho melhor o relacionamento entre empresas e governos? Como? ▪ O jeitinho torna mais fácil para empresas lidarem com a burocracia? Como? ▪ Quem é mais afetado pelo jeitinho: Empresas, o governo, ou indivíduos? Por quê? ▪ Existem riscos de algum tipo na utilização do jeitinho? Que tipos de riscos? ▪ A proposição do jeitinho pode ser de alguma forma ofensiva? Por quê?
Origens do <i>jeitinho</i>	<ul style="list-style-type: none"> ▪ Quem ou o quê é responsável pelo jeitinho (governo, empresas, povo brasileiro)? De onde vem o jeitinho?

6.2.2. Data Collection

Data collection was conducted with Brazilian respondents, located in Brazil or abroad, and interviews were carried on in Brazilian Portuguese either in person or by video-conference. Before participants and companies' profiling questions, every interviewee was guaranteed full anonymity and asked permission for the conversation to be recorded. Because the country has been undergoing major happenings involving corruption scandals that often relate the Brazilian *jeitinho* as playing an important role (Lee Park and Fracarolli Nunes, 2017), the topic of our study would touch sensitive points for respondents. Therefore, we chose to articulate our sample

with personal or professional connections of the two Brazilian authors, and each respondent were also asked for a contact that could be willing to participate in the research.

Such sampling procedure allowed respondents to feel more at ease when reacting to questions, as personal ties, direct or indirect, would configure a trustworthy environment. Nevertheless, the employment of both a convenience sample and snowball sampling technique could also represent a potential respondent profile bias due to a possible non-representativeness of the population or lack of validity (Landers and Behrend, 2015), as well as unknown biases (Hausman, Montgomery and Roth, 2002), and therefore shall be utilized prudently (Kam, Wilking and Zechmeister, 2007), prioritizing random sampling (Randall and Gibson, 1990). However, studies have demonstrated that, when a determined population is considered to be “hard-to-reach” (i.e. “population is small relative to the general population, geographically dispersed, and when population membership involves stigma or the group has networks that are difficult for outsiders to penetrate”, Heckathorn, 2012:355), chain-referral or snowballing sample might be applied (Bienarcki and Waldorf, 1981).

Furthermore, such approach is “well suited for a number of research purposes and is particularly applicable when the focus of study is on a sensitive matter, and thus requires the knowledge of insiders to locate people for the study” (Bienarcki and Waldorf, 1981:141), allied with “limited resources, time and workforce” to which researchers might be subject to, reinforcing the “need to use nonprobability sampling techniques” (Etikan, Musa and Alkassim, 2016:1). Studies may also benefit from higher “accessibility and response propensity” when it comes to restricted respondent samples that might yield in “highly accurate and consistent” information (Chen, Farh and MacMillan, 1993:1629). Highhouse and Gillespie (2010:261) also argue for the use of non-random samples in face of three questionings: i. if the research question treats “a specific and well-defined population of interest”; ii. if there is “a characteristic of the

convenience sample that may interact with the variables of interest in the study”; and iii. if “participant motivation” is “relevant” to the study. Our research touches the three proposed questions, as we set to investigate the perception of Brazilian professionals, where the belonging to the Brazilian culture and, specifically, the intense familiarity with the Brazilian *jeitinho* are essential characteristics for respondents, and motivation is enhanced by providing an entrustment environment.

Interviews’ recordings were then converted into transcripts by the two Brazilian researchers, and, while data analysis was conducted with data in its original language, Appendix A depicts sample transcript files from the first three interviewees in Brazilian Portuguese, and their English translation, respectively.

6.2.3. *Data Analysis*

Data analysis followed Miles, Huberman and Saldaña’s (2013) recommendation on two consecutive steps. For the first one, focused on reducing data volume, we extracted quotes from each interview transcript, thus organizing the data in a series of statements. Illustrative examples of such transformation are displayed in Charts 10, 11 and 12 below, with extracts from the three interviews depicted in Appendix A, and the respective quotes that were generated from them:

Chart 10: Extracts from Transcript Interview #1 (English Translation) and their Respective Generated Quotes

Extracts from Transcript Interview #1	Generated Quotes or Statements
<p>“I think that the Brazilian, one thing that mixes a little bit more is the personal relationship and not only the professional one. So in any business interaction here in Brazil, personal relationship also counts a lot. In the first moments of a conversation, of a negotiation, there is always that ice-breaking introduction of how the family is going, how was the weekend, talking about football, about some aspect of what is happening in society, and we do not go straight to the point. Do not go straight to the point. As well as I think that also in Brazil people are not very clear, they sometimes take deviations, or when they want to answer ‘no’, instead of them saying ‘no’, they say ‘I will think about it’, ‘I will check, we will talk again’, they are not direct and say ‘no’ right up front. Even when they are going to say ‘yes’ they always have to think. I think that the negotiation process, sales, purchasing here in Brazil takes a little bit longer because of that. People are less direct.”</p>	<p>“Brazilian, one thing that mixes a little bit more is the personal relationship and not only the professional one”</p> <p>“in any business interaction here in Brazil, personal relationship also counts a lot”</p> <p>“in Brazil people are not very clear, they sometimes take deviations”</p> <p>“the negotiation process, sales, purchasing here in Brazil takes a little bit longer because of that. People are less direct”</p>
<p>“I think, again, I think that it is not acceptable when it comes from bad faith, or from a stupidity, like, that the person did, from a stupidity that they created and that generated a whole problem and then you say ‘oh, no, it is fine, let’s...’, in these cases I think that or when it will harm a third party. Help this person with <i>jeitinho</i>, but I didn’t help the other, because this person knows I-don’t-know-who, then I think that you start to create a corporativist system that is not the least healthy.”</p>	<p>“I think that it is not acceptable when it comes from bad faith”</p> <p>“in these cases I think that or when it will harm a third party”</p>

Chart 11: Extracts from Transcript Interview #2 (English Translation) and their Respective Generated Quotes

Extracts from Transcript Interview #2	Generated Quotes or Statements
<p>“Generalizing, it is the famous <i>jeitinho</i>. The <i>jeitinho</i> is the famous ‘go, that it will work out’.”</p>	<p>“Generalizing, it is the famous <i>jeitinho</i>”</p> <p>“The <i>jeitinho</i> is the famous ‘go, that it will work out’”</p>
<p>“Without falling into the issue of merit, of character, it is knowing that, it is being used to a series of bureaucracies in which they search for alternative or non-traditional ways to reach the point that you demand. Which sometimes for other cultures is unthinkable.”</p>	<p>“[Brazilian <i>jeitinho</i>] is being used to a series of bureaucracies in which they search for alternative or non-traditional ways to reach the point that you demand”</p>
<p>“I cannot specify a punctual case, but it is known, for example, I think that mainly in negotiation, that Brazilians always like to negotiate everything. There is, I think, a lot of behaviors, there are culture in which you know how that culture negotiates. There is the American culture, that negotiates in one way, others in other way. Brazilians, they will want to negotiate everything, you don’t know exactly what, but they will want to find a way to get where they need to. And many times because they are not as prepared as the other ones, but they will try to find a way.”</p>	<p>“I think that mainly in negotiation”</p> <p>“[Brazilians] will want to find a way to get where they need to”</p>

Chart 12: Extracts from Transcript Interview #3 (English Translation) and their Respective Generated Quotes

Extracts from Transcript Interview #3	Generated Quotes or Statements
<p>“In general? I believe so, in the sense of... it is quite ample, quite open? I believe yes, because there is this thing of personal proximity that goes with business, that does not exist in other cultures.”</p>	<p>“there is this thing of personal proximity that goes with business, that does not exist in other cultures.”</p>
<p>“It is somewhat vague, but it is something of Brazilian <i>jeitinho</i>. Of the cordial man, I don’t know how to describe it.”</p>	<p>“Brazilian <i>jeitinho</i>. Of the cordial man”</p>
<p>“Well, don’t have a definitive answer to anything never, because there can always be an exception, it will depend on your relationship with the person that you work with, or on your business partner. There will always be a way to cheat something. And this is very much based on the relationship, on how serious the company is, on how much it will follow the rules, and in how controlled it is also, in the sense of... the size, the size sometimes allows the company to do different things, that it is not so much controlled by auditing, be it for issues of ISO standardization, for example. In this sense. I even mentioned the issue of the cordial man, because I also think it is... I would define this part of the cordial man as, to do business there has to be a personal connection, for instance, it is very strong the thing about a person introducing another one, indication for hiring is also very strong, I think that well stronger than in other cultures and I also think that without personal connection, it is very difficult to do business in Brazil and it is perceived as a strange thing. Something about the difficulty of saying ‘no’ also, that the Brazilian has.” (extracts from Interview #3, English translation)</p>	<p>“don’t have a definitive answer to anything never”</p> <p>“there can always be an exception”</p> <p>“it will depend on your relationship with the person that you work with, or on your business partner”</p> <p>“There will always be a way to cheat something”</p> <p>“this is very much based on the relationship”</p> <p>“how serious the company is, on how much it will follow the rules, and in how controlled it is also”</p> <p>“I would define this part of the cordial man as, to do business there has to be a personal connection, for instance, it is very strong the thing about a person introducing another one, indication for hiring is also very strong”</p> <p>“I think that well stronger than in other cultures”</p> <p>“without personal connection, it is very difficult to do business in Brazil and it is perceived as a strange thing”</p> <p>“Something about the difficulty of saying ‘no’ also, that the Brazilian has”</p>

Following the data compilation into quotes, the second stage on Miles, Huberman and Saldaña’s (2013) approach consists on the identification of patterns that may arise from the it. We adopted King’s (2004) prescribed hierarchical coding technique, thus clustering quotes carrying similar senses together. Chart 13 below represents the organization of the isolated quotes from the previous illustration into groups of similar meaning or subject:

Chart 13: Illustrative Quotes Clusters

Group / Cluster	Quotes	Meaning or Subject
1	<p>“Brazilian, one thing that mixes a little bit more is the personal relationship and not only the professional one” (Interview #1)</p> <p>“in any business interaction here in Brazil, personal relationship also counts a lot” (Interview #1)</p> <p>“there is this thing of personal proximity that goes with business, that does not exist in other cultures.” (Interview #3)</p> <p>“it will depend on your relationship with the person that you work with, or on your business partner” (Interview #3)</p> <p>“this is very much based on the relationship” (Interview #3)</p> <p>“I would define this part of the cordial man as, to do business there has to be a personal connection, for instance, it is very strong the thing about a person introducing another one, indication for hiring is also very strong” (Interview #3)</p> <p>“without personal connection, it is very difficult to do business in Brazil and it is perceived as a strange thing” (Interview #3)</p>	Personal relationship between two parties
2	<p>“in Brazil people are not very clear, they sometimes take deviations” (Interview #1)</p>	Deviations
3	<p>“the negotiation process, sales, purchasing here in Brazil takes a little bit longer because of that. People are less direct” (Interview #1)</p> <p>“I think that mainly in negotiation” (Interview #2)</p>	Negotiations
4	<p>“I think that it is not acceptable when it comes from bad faith” (Interview #1)</p>	Bad intention
5	<p>“in these cases I think that or when it will harm a third party” (Interview #1)</p>	Harm to third parties
6	<p>“Generalizing, it is the famous <i>jeitinho</i>” (Interview #2)</p> <p>“The <i>jeitinho</i> is the famous ‘go, that it will work out’” (Interview #2)</p> <p>“Brazilian <i>jeitinho</i>. Of the cordial man” (Interview #3)</p> <p>“I think that well stronger than in other cultures” (Interview #3)</p>	Definition of <i>jeitinho</i>
7	<p>“[Brazilian <i>jeitinho</i>] is being used to a series of bureaucracies in which they search for alternative or non-traditional ways to reach the point that you demand” (Interview #2)</p> <p>“[Brazilians] will want to find a way to get where they need to” (Interview #2)</p> <p>“There will always be a way to cheat something” (Interview #3)</p>	Alternative ways or cheating
8	<p>“don’t have a definitive answer to anything never” (Interview #3)</p> <p>“there can always be an exception” (Interview #3)</p>	Indefinability

9	“how serious the company is, on how much it will follow the rules, and in how controlled it is also” (Interview #3)	Assessed pertinence of rules and laws
10	“Something about the difficulty of saying ‘no’ also, that the Brazilian has” (Interview #3)	Difficulty of saying no

Once the clusters were formed, we proceeded to evaluate which topics most commonly emerged from the respondents’ interviews, reaching five clusters: harm to third parties, seriousness of the issue, formality of relationship, personal benefit, and assessed pertinence of rules and laws – the frequency on which each of these themes appeared in the interviews are displayed in the article ahead. Such dimensions thus represent a point of assessment that is made by our sample when evaluating the Brazilian *jeitinho* as either ethical or unethical, or, furthermore, as creativity or corruption, and are also represented in the conceptual framework that is proposed in our paper.

Following the contextualization of this study, Part II is dedicated to the presentation of the three articles that compose this dissertation, integrating Chapters 7, 8 and 9. A brief exposure of each of the papers’ background is also presented at the beginning of each chapter.

Part II - The Papers

Chapter 7. Paper One – How do National Cultures Impact the Operations Strategy Process?

7.1. Background to Paper One

The first paper of this dissertation, entitled “How do national cultures impact the operations strategy process?”, was also the first one to be developed. It derived from my Master thesis at Fundação Getulio Vargas – Escola de Administração de Empresas de São Paulo, obtained with distinction and given honorable mention at the GV Pesquisa Awards. It is co-authored with my Master thesis’ supervisor, Prof. Dr. Ely Laureano Paiva. An early version of this paper was presented at the 23rd European Operations Management Association (EurOMA) conference, held in Trondheim, Norway, in 2016, and was the source for participation at the 9th EurOMA Publishing Workshop in the days preceding the main event. The same version was also presented at the 5th World Conference on P&OM, in Havana, Cuba, in 2016, having had maximum score on the review, and in which it was awarded with the José A.D. Machuca P&OM World Conference Best Paper Award. It has then been invited for submission for the *International Journal of Operations and Production Management* special issue on the P&OM Havana conference, and, following two rounds of major revisions, the article was accepted for publication on December 12th, 2017. It follows, thus, IJOPM’s guidelines as for structured abstract and general organization.

This article aims to further understand the impact of national cultures dimensions in operations strategy process elements, and carries a quantitative-oriented approach to data collection and analysis. As my supervisor during the Master program, Dr. Paiva provided rich and helpful guidance in developing my thesis, specifically on what regards the choice of the research method and discussion points. He is also Brazil’s country leader for the High Performance Manufacturing (HPM) project, which allowed me access and use of its database.

After the defense, I was responsible for the version presented in both conferences, and also in preparing a first version of the full paper. Innumerable exchanges were made with Dr. Paiva to reaching the actual version, submitted to IJOPM. While a significant portion of the work was under my responsibility, Dr. Paiva contributed with deep reviews, valuable insights and inputs as for the hypothesis development and in editing issues, as well as on the strategy to tackle reviewers' suggestions.

“How do National Cultures Impact the Operations Strategy Process?”

Camila Lee Park

Ely Laureano Paiva

7.2. Abstract

Purpose – The purpose of this paper is to analyze the extent to which different patterns of cross-functional integration and the operations strategy (OS) process may be explained by national cultures differences.

Design/methodology/approach – Perceptual survey data from 105 manufacturing plants in four countries were used to validate the constructs and to test the hypotheses. The plants are located in two Western and two Eastern countries with different industrialization and development backgrounds (Brazil, China, Germany and South Korea). CFA validated the constructs, and ANOVA and t-tests evaluated the differences between levels of four Hofstede’s elements (i.e. power distance, individualism vs collectivism, uncertainty avoidance and long-term vs short-term orientation) on the OS process enablers (i.e. leadership for cross-functional integration and functional integration) and elements (i.e. manufacturing strategy linkage to corporate strategy and formulation of manufacturing strategy).

Findings – Results suggest that different OS and OM processes are present in different national cultures. Leadership for cross-functional integration and manufacturing strategy linkage to corporate strategy differ between levels of power distance, individualism vs collectivism and uncertainty avoidance. Functional integration and formulation of manufacturing strategy also present differences according to the degree of individualism vs collectivism and long-term orientation.

Originality/value – Results indicate that national culture is a key aspect for the OS process. Prior studies usually do not consider cultural aspects. Therefore, the OS process varies in different countries and contexts. Managers need to adjust their OS process when they are developing a global OS.

Key-words: Operations strategy, National culture, Hofstede's cultural dimensions

7.3. Introduction

Cross-cultural studies have been considered increasingly important for international management. When country idiosyncrasies are not properly recognized, they represent critical challenges to managers. One of the current questions for research still relies on how to manage network operations when plants are located in different countries. Other questions that have a considerable practical impact in operations management (OM) include internationalization, global supply chains, and international outsourcing, among others. These aspects involve a level of decisions that inevitably extend beyond ordinary managerial choices. The delimitation of eventual variances between countries, which is attributable to geographic, historical, sociological or any other national factor, highlights the importance of this matter, not only for managers but also for scholars.

In this sense, a further understanding of how businesses are impacted by country location (or the specific culture attached to them) is particularly useful for current and future OM research (Pagell, Katz and Sheu, 2005). Research exploring international issues usually focus on strategic issues of OM. One example was the study of Prasad, Babbar and Motwani (2001) that explored the differences in operations strategies in different markets. Rudberg and West (2008) proposed a theoretical model for coordinating international operations and manufacturing networks. Ahmad and Schroeder (2003) explored HRM practices on OM across countries and industries. There is, however, a lack of studies that integrate operations strategy (OS) and cultural aspects.

Some previous studies have associated cross-cultural aspects with the implementation of best quality management practices (Vecchi and Brennan, 2011) and supplier involvement (Ketkar, Kock, Parente and Verville, 2012). Also related to the buyer-supplier relationship, Liao, Sharkey, Ragu-Nathan and Vonderembse (2012) analyzed autonomy and long-term

strategic alignment as antecedents of trust in supply chain management. Other studies examined the classic comparison of automaker supplier relationships in the USA, Japan and Korea (Dyer and Chu, 2000, 2011), and specific case studies on Toyota's knowledge network with US suppliers (Dyer and Nobeoka, 2000). National cultures have also been found to influence the effect that manufacturing practices investments may have on operational performance (Wiengarten, Fynes, Pagell and Búrca, 2011).

There is still a lack of recognition of cultural aspects as a potential explanation for the patterns found in different operational processes in OM studies. There is a need for a further step to be taken towards understanding cultural impacts on OS. In order to fulfill this need, the present work will seek to answer the following research question:

RQ1. To what extent are national cultures related to companies' process of OS?

As a starting point, this research aims to empirically analyze the relationship between national cultures and OS. Based on the database of the fourth round of the high performance manufacturing (HPM) project and on Hofstede's cultural classification, the present study deepens the understanding of some of the issues and fills some of the gaps in OS literature related to cross-cultural issues.

The literature review section presents a discussion of the concepts of the OS process, formulation and implementation, as well as functional integration and leadership, along with previous studies on national cultures and OS. Hofstede's national cultural dimensions are introduced and discussed next, followed by the hypotheses development and description of the method used. The results are then discussed and their theoretical and practical implications and conclusions are presented. Finally, limitations and suggestions for future research are presented.

7.4. Literature Review

The present investigation draws from the conceptualization on enablers and elements of the OS process to understand the extent to which different patterns may be explained by cultural idiosyncrasies. In this sense, the constructs selected for this study (leadership for cross-functional integration, functional integration, manufacturing strategy linkage to corporate strategy and formulation of manufacturing strategy) have been presented since the seminal articles of Skinner (1969), Wheelwright (1984) and Hayes and Wheelwright (1985). These three studies emphasized on the rule of operations managers in the strategy formulation process, the need for integration between operations and other functional areas, like marketing, and the idea of alignment of operations decisions with business strategy. While leadership for cross-functional integration and functional integration are relevant for the success of OS as a communication development that needs to involve different functions within the organization, formulation of manufacturing strategy and manufacturing strategy linkage to corporate strategy are comprehended within the processual approach of OS discussed by Rytter, Boer and Koch (2007), relating to the formulation and implementation of OS, respectively.

7.4.1. OS Process' Enablers

Defined as “a process of interdepartmental interaction and collaboration in which multiple functions work together in a cooperative manner to arrive at mutually acceptable outcomes for their organization” (Frankel and Mollenkopf, 2015), the linkage between cross-functional integration and areas of related outcomes has been largely examined by the academic community. The relationship between manufacturing and marketing functional areas, for instance, has been posited to impact organizational performance (O’Leary-Kelly and Flores, 2002) and business outcomes (Hausman, Montgomery and Roth, 2002). Through the cumulative capabilities approach, Paiva (2010) assesses the integration between these two

functions suggesting that, along with managerial priorities, it is positively related to business performance. Research by Nakata and Im (2010), in turn, reveals cross-functional integration as a major contributor to the performance of new products, with the first being co-determined by internal (i.e. social cohesion and superordinate identity) and external (i.e. market-oriented reward programs, formalization of the planning process and managerial risk encouragement) factors. Cross-functional cooperation can also lead to new product development success in certain environments, such as those presenting high technological and market risks (Gemser and Leenders, 2011). Furthermore, internal integration has been argued to impact firms' profitability through process efficiency (Swink and Schoenherr, 2015).

Relating to cross-functional integration, Wheelwright (1984:79) asserts the "critical importance" of leadership "to the overall success and direction of the company." We go back to Skinner's (1969:145) argument – the need for what he calls the alignment of the manufacturing function with other strategic levels – made possible by the exercise of "innovative management." The author sets the tone for what we understand as leadership for cross-functional integration, demonstrated by the integrative-oriented role of upper management toward subordinates. In a procurement scenario, Trent (1996) highlights the critical impacts of leadership in cross-functional environments, as it nurtures collaboration and coordination in multi-boundary teams. Webber (2002) also reports the influence of leadership actions for establishing trust within cross-functional teams, with leadership individuals having "primary responsibility for team effectiveness" (Zaccaro and Klimoski, 2002:4). Current studies have highlighted the role of industrial directors in the corporate strategy formulation process, suggesting that the companies that have better operational results are those in which their directors are able to harmonize their attention between strategic focus and operational activities (De Meester, De Meyer and Grahovac, 2014; Kim, Sting and Loch, 2014). In a broader scope, leadership can be defined as "a process of social influence in which the leader

enlists the talents and efforts of other group members, [...] in order to accomplish the group's chosen task" (Chemers, 2003:5). Strategic leadership, in turn, has been linked to business ethics (Thomas, Schermerhorn Jr. and Dienhart, 2004), wealth creation (Rowe, 2001), and the capacity to learn and change (Boal and Hooijberg, 2000).

Functional integration, the second aspect, has lately been a trend topic both in academic literature as well as among practitioners. In several studies and business observations the need for clean flows of information and cooperation that are capable of connecting the diverse functions within organizations has been associated with the development of capabilities and with performance. Recent research explores the impact of cross-functional integration and performance (Foerstl, Hartmann, Wynstra, and Moser, 2013), their contribution to knowledge sharing practices or behavior (Ghobadi and D'Ambra, 2012) and the internal drivers that lead to integration success from a team's perspective (Daspit, Tillman, Boyd and Mckee, 2013), among others. We borrow from Paiva, Roth and Fensterseifer's (2008:117) definition of cross-functional integration orientation as "the ability of manufacturing to interact with other functional areas in order to improve a company's strategies and processes." The degree of integrative orientation and leadership affects not only the way work is done (i.e. operations), but also the basis on which it is planned (i.e. strategy). Hence, integrative leadership and functional integration are expected to be disturbed by differences within the dimensions of national cultures.

7.4.2. OS Process Elements

Since Leong, Snyder and Ward's (1990) proposed conceptual distinction between the manufacturing strategy process and content, OS literature has been evolving around these two fields. In their literature review on the POMS journal, Boyer, Swink and Rosenzweig (2005) identify process and content as the two broad areas approached by OS articles, although Barnes

(2001) point to the predominance of process in the field. Brown, Squire and Blackmon (2007) reinforce the importance of the two topics by indicating the adoption of both OS process and content by world-class manufacturing plants, while in low-performing ones such matters are not developed, whereas Schroeder, Anderson and Cleveland (1986) and Anderson, Schroeder and Cleveland (1991) propose “companion articles” to treat content and process issues in OS, respectively. As discussed by Rytter, Boer and Koch (2007:1094), process concerns “how to conduct OS formulation and implementation processes,” as where content refers to “how operations can create competitive advantage, by providing normative guidelines on what to include when formulating an OS.” Focusing on the first, the authors offer a comprehensive view on previous contributions to the OS process. According to them, among other studies, Menda and Dilts (1997) define the OS process as a “strategy formulation process, a technical-rational but also a consensus process to overcome functional barriers” (Rytter, Boer and Koch, 2007:1095), while to Riis, Dukovska-Popovska and Johansen (2006) the concept relates to a “vision development process with participation followed by implementation and learning. Also a communication process (dialogue) to overcome functional barriers,” where “other differences of viewpoint, facilitation, influence options and context can be important factors” (Rytter, Boer and Koch, 2007:1096). Complementing both notions, Rytter, Boer and Koch, 2007:1097) point to the OS process as “formulation and implementation” that is influenced not only by technical-rational factors, but also by political and socio-cultural aspects, the latter referring to “changes in actors’ knowledge, competencies, perceptions, communication patterns, logics, values, needs and interests.”

As for the third component of this study, the connection between manufacturing and corporate strategies has been largely approached in OS literature by enumerating several themes discussed within the manufacturing strategy (e.g. manufacturing capabilities, best practices, strategic decisions and performance) (Dangayach and Deshmukh, 2001). As OS is “expected

to specify competitive priorities and objectives for the operations function in alignment with the firm's overall business strategy" (Kim, Sting and Loch, 2014:463), the fit between manufacturing strategy to the general one is also suggested to have significant impact in performance and competitiveness (Thun, 2008). Practical relevance is also evident in the growing number of infrastructural manufacturing strategies, such as just-in-time, total quality management and statistical process control, among others, as these strategies are prescribed and implemented in the search for productivity and quality enhancement, as well as in cost reduction processes, with several studies surrounding these issues (e.g. Mellor, Hao and Zhang, 2014; Zatzick, Moliterno and Fang, 2012; Rho, Park and Yu, 2001). The manufacturing strategy linkage to corporate strategy may be defined as the extent to which the strategic planning of firms at the business level is complemented by the strategy established on the manufacturing function, ideally resulting in an alignment between strategic goals and manufacturing performance.

Finally, on what relates to the fourth construct, pioneering authors, such as Cohen and Lee (1985:153), argue that "the development of strategies directed towards improving the performance of manufacturing operations has recently become a critical component of the competitive strategy of many firms." Formulation of manufacturing strategy has been portrayed as a continuous process (Nielsen-Englyst, 2003), related to a better fit between improvement goals and action programs for competitive objectives (Acur, Gertsen, Sun, and Frick, 2003), which reflect the pattern of decisions that will be made over time, and the existence of formal or informal rules within this process, which are dependent on cultural idiosyncrasies (Miltenburg, 2005). Still accordingly, "when a formal manufacturing strategy exists, decisions follow a neat, logical pattern. When no strategy exists, the pattern is erratic and unpredictable" (p. 2). Taking a different approach to the subject, Gebauer (2009) assesses the extent to which service orientation (i.e. strategy formulation and implementation) is affected by managerial

attention, and Ocasio and Joseph's (2015) work brings an attention-based view to bear in order to link the micro and macro perspectives in the strategy formulation process. For these authors, strategy formulation is considered to be "a fluid and distributed process" and "a process of guided evolution" (p. 39), meaning that it builds on organizational attention at the business and corporate levels. Formulation of manufacturing strategy may be understood, then, as the precise definition and communication of the strategic priorities of firms with regard to their manufacturing function.

7.4.3. OM and National Cultures

Potential differences that may arise from cultural aspects have also been explored in the previous studies. From this landscape, behavioral issues might play an important role on manufacturing strategies' implementation, as "executives described the implementation process as one of gaining employee acceptance of the strategy through lower level involvement and teamwork" (Maruchek, Pannesi and Anderson, 1990:101). Schroeder and Flynn (2001), for instance, discuss that differences in how manufacturing strategy is implemented have been found according to the specific country analyzed. Such finding may suggest the influence of national cultures on this specific issue. The strategic decision process is also argued to be influenced by national cultures with different countries equally presenting different patterns on that regard (Bultjens and Noorderhaven, 1996). Corroborating with the idea, Rho, Park and Yu (2001) report significant differences between samples from USA and South Korea when comparing the outcomes of implementation of manufacturing strategies in terms of quality, cost and flexibility. Barnes (2002), in turn, offers a small plants' perspective around the manufacturing strategy building process, arguing that such process is strongly impacted by factors related to political, managerial and cultural matters.

Also in the global context, and because of its multi-countries nature, the HPM project derived studies that encompasses several different topics. Even though not directly considering the impact of cultural issues, examples of such cross-cultural research can be found in Bozarth, Warsing, Flynn and Flynn's (2009) proposed model for connecting supply chain complexity (i.e. upstream, internal manufacturing and downstream complexity) to manufacturing performance of the plant in negative relationships. Hallgren and Olhager (2009) empirically posit that lean and agile manufacturing are driven by different internal and external antecedents (i.e. competitive intensity of industry; differentiation strategy and competitive intensity of industry, respectively), as well as impact in different operational outcomes (i.e. quality, delivery, cost and flexibility). Paiva, Teixeira, Vieira and Finger (2014), on the other hand, investigate planning and trust in a supply chain management context, finding positive impacts in supply integration and operational performance. More specifically under the cultural assessment, Naor, Goldstein, Linderman and Schroeder (2008:671) state that "culture can provide insight into the context dependence of quality management practices." Cultural importance is also in the core of the authors' state of empirical proof on the impact of culture in manufacturing performance. In another study, three of these authors reinforce the effects of organizational over national cultures on manufacturing performance, claiming that organizations should develop "an internal organizational culture consistent with high performance manufacturing" (Naor, Linderman and Schroeder, 2010:194).

7.4.4. Hofstede and Cultural Classification

Geert Hofstede's (1980a, b, 1983, 1993, 1994, 2001) extensive studies on cultural classification and cross-cultural research are arguably few of the most impactful views on management practices across different cultural environments. Based on a survey of 72 national IBM subsidiaries, the author advocates that some management behaviors that are applicable in a

specific cultural environment might not actually be appropriate for another. Based on problems commonly identified in societies, four culture dimensions were originally presented: power distance, uncertainty avoidance, individualism vs collectivism, and masculinity vs femininity (Hofstede, 2001). Between the early 1990s and the end of the first decade of the current century, based on the research of Hofstede and Bond (1988) and Minkov (2007), two additional dimensions were added: long-term orientation and indulgence vs restraint. Indulgence vs restraint considers the difference between enjoying the life and strict social norms. Thus, it is more related to personal aspects than organizational ones. Masculinity vs femininity also has a closer approach to personal characteristics than to organizational processes. An additional constraint for this dimension is its multidimensional definition: masculinity (preference for achievement, heroism, assertiveness and material rewards for success) and femininity (cooperation, modesty, caring for the weak and quality of life), in the sense that they do not represent opposite poles, but rather distinct ones. The four dimensions that were explored in this study are present directly in the seminal OS studies.

Regarding power distance, Skinner (1969:142) mentioned that manufacturing managers were distant from the top management at that time, as “a technical point of view cut them off from the top management.” The four Hofstede’s dimensions are present in what Wheelwright (1984) identified as company’s philosophy or culture. First, power distance is mentioned by the author: “To be really effective, management must work toward the development of a culture – a set of ingrained attitudes – that helps to communicate its goals, plans, and policies to all employees.” On uncertainty avoidance, Wheelwright (1984:89) stated: “There tends to be a ‘company’ way of doing things. There is a sense of tradition and continuity within the firm.” Wheelwright (1984:89) also mentioned clearly aspects related to short- and long-term decision, when discussed the importance of corporate strategy and company’s culture (or philosophy): “[...] this balance tends to ensure a more appropriate trade-off between long-term and short-

term actions.” Finally, the author considers that company’s culture is a key aspect for a collective (individualism vs collectivism) development of OS: “[...] a strong philosophy can serve as the glue that makes strategy development an interactive process, with inputs and perspectives from all functions, and ensures consistency and integrity of the individual components” (p. 90).

As the other two dimensions are not directly present in the Wheelwright’s definition of company’s culture, they were not considered in this study. Similar to Wiengarten, Fynes, Pagell and Búrca’s (2011) approach, in which four national culture dimensions integrated their study, after assessing the basic problem approached by each one of them, the four dimensions selected to form part of this investigation were: power distance, uncertainty avoidance, individualism vs collectivism and long-term vs short-term orientation. Such dimensions are understood as being those that are more related to managerial processes and have a potential impact on elements of OS.

Chart 14 shows those four dimensions, the basic problem they deal with and their brief description.

Chart 14: Hofstede’s Independent National Culture Dimensions

Dimension	Basic Problem	Description
Power Distance	Human inequality	"The extent to which the less powerful members of institutions and organizations within a country expect and accept that power is distributed unequally." (pp.98)
Uncertainty Avoidance	Level of stress in unknown future	"The extent to which the members of a culture feel threatened by uncertain or unknown situations." (pp.161)
Individualism, as opposed to Collectivism	Integration of individuals	"Individualism stands for a society in which the ties between individuals are loose: Everyone is expected to look after him/herself and her/his immediate family only. Collectivism stands for a society in which people from birth onwards are integrated into strong, cohesive in-groups, which throughout people's lifetime continue to protect them in exchange for unquestioning loyalty." (pp.225)
Long-Term Orientation, as opposed to Short-Term Orientation	Choice of focus	"Long Term Orientation stands for the fostering of virtues oriented towards future rewards, in particular, perseverance and thrift. Its opposite pole, Short Term Orientation, stands for the fostering of virtues related to the past and present, in particular, respect for tradition, preservation of 'face' and fulfilling social obligations." (pp.359)

Source: Hofstede (2001)

7.5. Hypothesis Development

The first set of hypotheses refers to the power distance dimension and its relationship to the aspects related to the OS process. Hope (2004) sought to understand the influence of national culture in OM in the hotel industry, as represented by the adoption of “best practices.” She found that practices involving teamwork, empowerment and communication were largely affected by high levels of power distance between the staff. Chakrabarty (2009) argues that economies with a high power distance index are those in which wealth and opportunities are also available, but unequally distributed. At the same time, Nielsen and Nielsen (2011), also basing their analysis on Hofstede’s cultural classification, found that both international experience and the nationality diversity of top managers have impacts on strategic decision making. In their study of different leadership styles across six different countries (USA, Russia,

Germany, Georgia, Kazakhstan and Kyrgyzstan), Ardichvili and Kuchinke (2002) concluded that cultural differences indeed played a strong influence on the perceivable leadership style in each country. Other studies (e.g. Smith, Peterson and Schwartz, 2002; Dorfman, Howell, Hibino, Lee, Tate and Bautista, 1997) have also pointed out the prominence of power distance over all other cultural dimensions as far as its influence on leadership styles.

In the case of the OS process, we claim that leadership for cross-functional integration is present when the top management has intense influence on the other strategic levels, especially in allowing other hierarchical levels such as middle managers to participate on the companies' strategic initiatives (Slack and Lewis, 2011; Burgelman and Grove, 2007). Thus, a bottom-up orientation will be present when there is a clear integration among hierarchic levels and functions in the strategic decisions (Kim, Sting and Loch, 2014). Consequently, this orientation characterizes a lower power distance among the hierarchical levels. Other aspects related to OS are also expected to present a negative influence of power distance because integration is embedded in all of them. These aspects include functional integration, manufacturing strategy linkage to corporate strategy and formulation of manufacturing strategy.

As power distance relates to the perspective of the less powerful members and the extent to which they accept hierarchy in relationships ruled by fear and respect, we argue that in cultures with high power distance, it would be unnecessary to impose formal rules in order for them to be followed, as subordinates might feel more inclined or even obliged to accept them. On the other hand, greater power distance levels may negatively affect collaborative efforts, as power distance can hinder teamwork and communication attempts. This suggests that power distance levels may have a negative effect on leadership for cross-functional integration, functional integration, manufacturing strategy linkage to corporate strategy and formulation of manufacturing strategy.

The role of operations managers in the strategic process was highlighted by Skinner (1969) and Wheelwright (1984). Those authors stressed that a narrow technical view had isolated operations managers and decreased their influence on the strategic process during decades. Currently, authors like De Meester, De Meyer and Grahovac (2014) and Kim, Sting and Loch (2014) showed that the strategic process presents top-down and bottom-up processes simultaneously, and depends on the company's culture. For the first authors, "in high-performing companies the OE tends to spend less time on strategy making and more on other tasks as the operations function becomes a source of competitive advantage" (p. 412). These tasks include how to explore operational resources and how to integrate to other functional areas. Therefore, we may propose the first hypothesis:

H1a. Whether power distance differs; leadership for cross-functional integration differs.

Cross-functional integration is also present in the seminal works of Skinner (1969) and Wheelwright and Hayes (1985). Those authors showed that operations managers should be involved in the strategic process. According to Swink, Narasimhan and Wang (2007), when there is an integrated participation of the different functional areas in the business strategic process, operational and business performance are improved in different competitive criteria. Other authors like Malhotra and Sharma (2002) showed the importance of marketing and operations integration to improve business performance. Therefore, when different functional areas are more involved in the strategic process, we claim that there is a decrease of hierarchical distances and consequently of the power distance. Thus, we may propose the following two hypotheses:

H1b. Whether power distance differs, functional integration differs.

H1c. Whether power distance differs, manufacturing strategy linkage to business strategy differs.

For Kim, Sting and Loch (2014), decentralized organizations implement more action plans from middle or frontline managers than centralized ones. Similarly, Rytter, Boer and Koch (2007) showed the need to create a shared view of the manufacturing strategy to the middle management. It is worthy to mention Wheelwright (1984), who stressed the importance of the “company’s philosophy.” Company’s philosophy is oriented by how the company competes. This aspect is more linked to the culture and values than to formal and written plans. Therefore, we may address the following hypothesis:

H1d. Whether power distance differs, formulation of manufacturing strategy differs.

Hofstede and Bond (1988, p. 14) also stated that, over and above the power distance influence, leadership may also be influenced by the individualism dimension as, according to the authors, “both power distance and individualism affect the type of leadership most likely to be effective in a country.” In highly individualistic cultures, “employed persons [...] are expected to act rationally according to their own interest, and work should be organized in such a way that this self-interest and the employer’s interest coincide” (Hofstede, 2001, p. 235). Chen and West (2008, p. 259) propose a new scale for the individualism vs collectivism cultural dimension, and argue that individualism can be assessed in terms of “independence, competitiveness and uniqueness,” while collectivism can be defined as “considering of one’s decisions on others, sharing of positive outcomes and sharing of negative outcomes.”

By assessing supply chain integration, Zhao, Huo, Flynn and Yeung (2008) link the high level of collectivism culture to the Chinese normative relationship (i.e. “a mutual, ongoing relationship over an extended period of time which is based on mutual commitment and

sharing”; Ellram, 1991; in Zhao, Huo, Flynn and Yeung, 2008, p. 371), which is based mainly on trust. On the other hand, the opposite is an instrumental relationship commitment that is based on compliance (i.e. “when one party accepts the influence of another in hopes of receiving favorable reactions from the other party”; Zhao, Huo, Flynn and Yeung, 2008, p. 371). Power, Schoenherr and Samson (2010, p. 217) divided their sample, composed of cross-national plants, into individualistic and collectivist cultural sub-groups (i.e. industrialized western economies and emerging Asian economies), and found significant differences between their levels of investment in OM practices. The study found evidence of collective cultures being more emphatic on developing teamwork-based capabilities “where commitment to group goals are stronger.” Additionally, Ahmad and Schroeder (2003) showed that commitment mediates positively the relation between teams’ activities and performance. Thus, we argue that high individualism levels should have a negative effect on leadership for cross-functional integration. Therefore, we envisage the following hypothesis:

H2a. Whether individualism vs collectivism differs, leadership for cross-functional integration differs.

According to Wheelwright and Hayes (1985), most competitive companies seek to create a learning process based on collective actions among the functional areas. In the same way, Hayes and Upton (1998) showed that individual knowledge is not enough to build operational capabilities. According to them, companies “must be structured and shaped in a way that facilitates learning and change” (p. 18). Therefore, we address the following hypotheses:

H2b. Whether individualism vs collectivism differs, functional integration differs.

H2c. Whether individualism vs collectivism differs, manufacturing strategy linkage to business strategy differs.

Since Nonaka, Toyama and Nagata (2000), there is a clear understanding that capabilities are created mainly from tacit knowledge. Other authors like Paiva, Roth and Fensterseifer (2008) argue that manufacturing strategy is based on how companies explore their resources (knowledge, teams, equipment and functional areas) in order to create operational capabilities. Tan, Kannan and Narasimhan (2007) also stated that capabilities are based on the acquisition and dissemination of superior process knowledge. Thus, we claim that the OS process is related to collective efforts closely regarding the building of capabilities from tacit knowledge than the formalized and written strategic plans. We propose the following hypothesis:

H2d. Whether individualism vs collectivism differs, formulation of manufacturing strategy differs.

The two other dimensions (uncertainty avoidance and long-term orientation) are antecedents of manufacturing strategy formulation, since efforts to reduce ambiguity and establish long-term goals and objectives are ultimately related to how individuals perceive and manage risks. In that sense, prior studies have discussed the relationship between cultures with high scores in uncertainty avoidance and their aversion to risk (Baker and Carson, 2011). De Meester, De Meyer and Grahovac (2014) showed that uncertainty affects negatively the interactions between operations executives and other executives. Thus, we may address the next two hypotheses:

H3a. Whether uncertainty avoidance differs, cross-functional integration differs.

H3b. Whether uncertainty avoidance differs, functional integration differs.

Rytter, Boer and Koch (2007) also propose a five-stage process for lean and global manufacturing, with the last stage linked to global and advanced practices in manufacturing. Thus, anticipation of new technologies is a characteristic of the most competitive companies (Hayes and Wheelwright, 1985). Within a complementary view, Finger, Flynn and Paiva (2014)

also identified that this aspect influences positively operational performance. Thus, we may address the following hypothesis:

H3c. Whether uncertainty avoidance differs, manufacturing strategy linkage to corporate strategy differs.

Ayoun and Moreo (2008) found that different levels of uncertainty avoidance had little or no impact on business strategy development. On the other hand, Kull and Wacker's (2010:234) study on the GLOBE's project extension of Hofstede's cultural classification suggested that this dimension positively impacts quality management effectiveness, since "high uncertainty avoidance cultures are not uncomfortable with rules and process controls." Hence, it is reasonable to argue that low uncertainty avoidance levels should have a negative influence on formalized manufacturing strategy plans. We address the following hypothesis:

H3d. Whether uncertainty avoidance differs, formulation of manufacturing strategy differs.

Voss and Blackmon (1998:152) draw on data from 600 companies in 20 different countries to study how different attitudes in time orientation impact the strategic decisions of firms, specifically in Western and Japanese plants. The authors define corporate strategy as "the overall plan which defines how a company will create competitive advantage in the business in which it competes," with manufacturing strategy being a "functional level" of such strategy. While Japanese managers emphasize both short- and long-term practices and focus on prompt solutions and prevention issues, western organizations treat these two approaches within a trade-off model. Wang and Bansal (2012:1147) argue that new ventures are more inclined to short-term orientation and neglect the development of strategic resources or innovation, as "temporal orientation plays a critical role in decision making."

As discussed by Hofstede (2001), cultures with high long-term orientation index levels are related to lower immediacy. This aspect may lead to a less opportunistic behavior, as people would accept deferred gratification for their actions. Wheelwright (1984) in his seminal article on OS stated that leadership should create a company's philosophy, i.e. a long-term view for the strategic decisions in operations. In this article, the author follows a logic based on the formal strategic planning with the development of the corporate strategy to the operational processes. We argue, therefore, that higher level of long-term orientation is expected to influence positively leadership for cross-functional integration. We propose the following hypothesis:

H4a. Whether long-term orientation differs; leadership for cross-functional integration differs.

Seminal studies (Skinner, 1969; Hayes and Wheelwright, 1985) also indicate that the most competitive companies present a long-term view of their OS process with emphasis in cross-functional integration and learning processes. Thus, we may envisage the next hypothesis:

H4b. Whether long-term orientation differs; functional integration differs.

Rytter, Boer and Koch (2007) argued that the impact of OS in the long term is not easy to identify. At the same time, one of the key aspects of the OS process is to integrate manufacturing decisions to the corporate strategy along time. For Schroeder, Bates and Juntilla (2002), there is a link between long-term investments in manufacturing processes and competitive advantage. Thus, we may address the next hypothesis:

H4c. Whether long-term orientation differs, manufacturing strategy linkage to corporate strategy differs.

According to Gagnon (1999), the OS process has been developed in highly competitive environments in the last decades. For the authors, companies would have to forget the tradeoffs approach and focus on the leverage of the internal recourses. Thus, written and formalized plans such the ones proposed in the 1980s (Wheelwright, 1984) are not feasible for the speedy changes in the competitive environment. We propose the following hypothesis:

H4d. Whether long-term orientation differs, formulation of manufacturing strategy differs.

7.6. Empirical Research and Method

7.6.1. Countries Analysed and National Culture

It is worthy to question if the main aspects of the OS process are related to national culture. To fulfill the objective of this research, four countries were selected to integrate the analysis – Brazil, China, Germany, and South Korea. They are at different stages of industrialization and economic development, each of which also presenting singular characteristics regarding their respective national cultures. First, we may mention that Chinese *guanxi* builds a relational network based on reciprocity, loyalty and trust and influence the social relations in the business environment (Chen, Huang and Sternquist, 2011; Lee and Humphreys, 2007). On the other hand, Brazilian culture faces a continuous tension between European legacy and regional identity. Brazilian *jeitinho* is a way to deal with excessive bureaucracy and to resist to formal rules (Smith, Torres, Leong, Budhwar, Achoui and Lebedeva, 2012). The Korean *yongo*, in turn, also influences social relations in this country. *Yongo* refers to the different networks to which individuals belong (i.e. hometown relationships, school attendance, and family or blood ties), and configures exclusive trusting relationships (Horak and Klein, 2015). Finally, German management presents a long tradition with relations based on technical competence,

formalization and hands-on production management. At the same time, these aspects may decrease companies' flexibility (Glunk, Wilderom and Ogilvie, 1996).

7.6.2. Sample Data

Data were retrieved from the HPM project, previously called WCM (world-class manufacturing) database, which has been expanded since its beginning in the mid-1990s, as it seeks to articulate practices related to world-class manufacturing through the appliance and use of a proper and comprehensive database (Flynn, Schroeder and Flynn, 1999). By creating an international network for cooperation, HPM's fourth round currently involves researchers in production and operations from 11 countries and regions. Measurement instruments were translated into local languages and back-translated to ensure that each country would work with comparable questionnaires. The project aims to assess companies from the machinery, electronics and transport equipment sectors that have more than a hundred employees to ensure that each participating enterprise is of a size that supports the studied areas and practices; there is a minimum of 20 companies per country. Companies were chosen according to the selected industries and sampling relied on each country leaders' efforts and networking, thus generating a group of respondents with the necessary characteristics who were willing to participate in the project.

A total of 105 companies integrate the sample of the study. Germany was a pioneer in global industrialization and forms part of the group of developed countries; South Korea, although it has a recent industrialization history, is also considered to be a developed country today; and finally, both Brazil and China are representative of recent industrialization in countries considered to be emerging economies. Leadership for crossfunctional integration (LDINT), manufacturing strategy linkage to corporate strategy (LINKS) and formulation of manufacturing strategy (MFGSTR) measurements were drawn from individual scales of the

HPM project's database, originally carrying four, six and four items each, respectively, while functional integration was measured through items pertaining to two different scales, namely achievement for functional integration (INTEG) and integration between functions (FUNCI), initially totalizing 12 items. Missing data accounted for 248 out of the 2,808 items contained in the corresponding original scales (8.83 percent) of respondents from the four countries. Various techniques are advisable to dealing with missing values in a database, such as imputation, deletion and interpolation (Hair, Babin, Money and Samouel, 2003). Little's (1988) MCAR tests were carried out, not verifying complete randomness of the missing data. Although mean substitution has been argued to "produce biased parameter estimates, even with MCAR data" (Enders, 2010:55), and "if there are moderate to large amounts of missing data, simple imputation is likely to underestimate standard errors, distort correlations among variables, and produce incorrect p-values in statistical tests" (Kabacoff, 2011:371), mean substitution was selected since the amount of data missing in the sample is relatively low. Missing values were treated within each country's limits, so that the inputted mean would not capture potential differences between samples. Therefore, they were replaced with averages calculated for each item on the measurement scales per country.

7.6.3. Measurement Models

The measurement models for the OS constructs were tested for validity and reliability with confirmatory factor analysis (CFA). IBM® SPSS Statistics software was utilized both for construct refinement and empirical research. Similar to Menor and Roth's (2007) study, which conceptualized the New Service Development competence into five different constructs, the four elements of OS are here considered to be separate elements as a consequence of the sample size. Although relatively small, authors such as Wolf, Harrington, Clark and Miller (2013) have positioned their results against the "one size fits all" general rule for CFAs, defending the

variability of sample size requirements when it comes to applying the technique. The four different models, which were to be assessed individually, underwent their own refinement, validity and reliability test processes. Initially CFAs were run for the four OS construct models, two of which required item refinement before they became part of the final data analysis. Items with low standardized factor loadings (i.e. below 0.60 and 0.70 for constructs with a higher number of initial items) were dropped, being one from the LDINT scale with factor loading 0.40, seven from the INTEG-FUNCI scales with factor loadings 0.62, 0.60, 0.59, 0.43, 0.59, 0.63 and 0.53, and three from the LINKS measurements with factor loadings 0.66, 0.27 and 0.38. The MFGSTR scale remained with no items removed. Table 2 shows the robustness measurements and indexes for the four final leadership for crossfunctional integration (LDINT), functional integration (INTEG-FUNCI), manufacturing strategy linkage to corporate strategy (LINKS) and formulation of manufacturing strategy (MFGSTR) constructs, as well as the factor loadings for each item on the final constructs.

Table 2: Operations Strategy Constructs Unidimensionality Analysis, Reliability Analysis and Items' Standardized Factor Loadings

	LDINT	INTEG- FUNCI	LINKS	MFGSTR
Items	3	5	4	4
Average	3.89	3.90	3.80	3.82
Standard Deviation	0.56	0.55	0.68	0.69
χ^2 (p-value)	0.000(n.c.)	11.379(0.044)	0.000(n.c.)	5.548(0.062)
χ^2 /DF	n.c.	2.276	n.c.	2.774
CFI	1.000	0.979	1.000	0.974
GFI	1.000	0.955	1.000	0.973
NFI	1.000	0.964	1.000	0.961
Composite Reliability	0.745	0.898	0.749	0.813
Average Variance Ext.	0.53	0.64	0.51	0.52
Cronbach's Alpha	0.756	0.895	0.752	0.806
		INTEGN01(.72)		MFGSTRN01(.79)
	LDINTN02(.87)	INTEGN03(.75)	LINKSN03(.73)	MFGSTRN02(.80)
Item(Factor loading)	LDINTN03(.60)	FUNCIN01(.90)	LINKSN04(.76)	MFGSTRN03(.64)
	LDINTN04(.69)	FUNCIN04(.79)	LINKSR06(.67)	MFGSTRR04(.65)
		FUNCIN05(.83)		

Unidimensionality means that the items within a determined scale measure a single construct and were assessed by way of the overall fit of the absolute and comparative models, or incremental fit indexes. As expected, χ^2 values were not significant in the functional integration and formulation of manufacturing strategy scales (99 percent significance). The χ^2 per degrees of freedom ratio (χ^2 /df) reveals the relative efficiency of the model; under 5 is acceptable and under 2 is indicative of good fit. The two constructs gave acceptable ratios, while the other two (leadership for cross-functional integration and manufacturing strategy linkage to corporate strategy) were not assessed by χ^2 analysis because their probabilities and degrees of freedom could not be computed. Nevertheless, all four constructs presented good model fit, with incremental fit indexes – comparative fit index, goodness-of-fit index and normed fit index – exceeding the 0.95 threshold, also reinforcing the strong unidimensionality of the scales.

Composite reliability values for all constructs are above 0.70, indicating a very satisfactory result. Reliability was also assessed through the average variance extracted. All constructs demonstrated values above 0.50, meaning that a larger part of the variance is due to the operationalized items. Additionally, Cronbach’s α (Cronbach, 1951) presented values higher than 0.70 for the four constructs. Discriminant validity between OS constructs was assessed by comparing their average variance extracted with the squared correlation of every possible pair of constructs (Fornell and Larcker, 1981). Although correlations between each pair of constructs are statistically significant, Table 3 also shows that each individual extracted variance presented higher values than its shared variance with the other constructs, demonstrating that discriminant validity was present.

Table 3: Operations Strategy Constructs’ Discriminant Validity Analysis

	OS Element	LDINT	INTEG-FUNCI	LINKS	MFGSTR
Individual-shared Variances Matrix	LDINT	0.5310	0.0595	0.0240	0.0434
	INTEG-FUNCI		0.6407	0.3956	0.4238
	LINKS			0.5198	0.4199
	MFGSTR				0.5240
Correlations Matrix	LDINT	1.000	0.244	0.155	0.217
	INTEG-FUNCI	0.012	1.000	0.629	0.599
	LINKS	0.114	0.000	1.000	0.648
	MFGSTR	0.026	0.000	0.000	1.000

Notes:

For the Individual-shared Variances Matrix: Numbers in bold represent constructs’ individual variances, numbers above represent squared correlations of each pair of constructs’;

For the Correlations Matrix: Numbers above the diagonal line represent constructs’ correlations, numbers below the diagonal line represent correlations’ significance values

7.6.4. Hofstede’s National Culture Indexes

Hofstede’s Indexes for each of the national culture dimensions were based on the Value Survey Module 2013 Questionnaire (Hofstede and Minkov, 2013). The results are openly available for

academic studies. Each of the four dimensions is composed of four items, based on a five-point scale, generating indexes ranging from 0 to 100 and with data gathered from 110 countries (Hofstede and Minkov, 2013). National culture dimension index levels were created to assess their impact on OS elements, and each cultural index was classified as low, medium low, moderate high or high, according to the countries' scores (0-25, 26-50, 51-75 and 76-100, respectively). Table 4 displays the four assessed countries' national culture dimension indexes and attributed levels.

Table 4: Hofstede's National Culture Indexes and Levels for Selected Countries

Country	PDI*		IDV		UAI		LST	
	Index	Level	Index	Level	Index	Level	Index	Level
Brazil	69	Moderate High	38	Medium Low	76	High	44	Medium Low
China	80	High	20	Low	30	Medium Low	87	High
Germany	35	Medium Low	67	Moderate High	65	Moderate High	83	High
South Korea	60	Moderate High	18	Low	85	High	100	High

Source: <http://www.geerthofstede.edu> and elaborated by the authors

* Power distance index (PDI), individualism versus collectivism (IDV), uncertainty avoidance (UAI), and long-term orientation versus short-term (LST)

7.6.5. Data Treatment and Analysis

The aim of the study is to test for potential differences that may reside in OS process elements when cultural aspects are factored in. Because it relates to differences rather than causal relationships, analysis of variance (ANOVA) and t-tests were run to fulfill that goal. Five cultural groupings were formed. The first four, according to the country power distance index levels, individualism vs collectivism index levels and uncertainty avoidance index levels, formed part of the ANOVA factors, with which averages of the OS elements were to be compared. Differences for long-term orientation vs short-term index levels were tested through t-tests, since there were only two levels identified in the sample. In order to control for

differences between industries, an additional grouping was also configured by industry type (i.e. electronics, transport and machinery).

A previous assessment of the several assumptions necessary for defining the type of test and post hoc tests was made. For this stage, Anderson, Sweeney and Williams's (2010) three assumptions were considered: normal distribution of the response variable, homogeneity of variances, and independence of observations. For the first assumption, Q-Q graphs for the four variables were assessed, presenting distributions that were very approximately normal in every case. Next, Levene's tests defined if variances were homogeneous or heterogeneous between the different groups of factors. Two constructs, leadership for cross-functional integration and manufacturing strategy linkage to corporate strategy, resulted in homogeneous variances, according to their Levene's p-values, which were significant at the 99 percent confidence level. Thus, One-Way ANOVAs with Tukey's post hoc tests were performed. For the other two constructs, functional integration and formulation of manufacturing strategy, which did not present homogeneity in their variances at the same level of confidence, Welch's ANOVA and Games-Howell post hoc tests were conducted, because they do not require that the compared groups present the same standard deviations. Independent groups were created in each of the categories analyzed by country to test the third assumption. This resulted in four different groups: by power distance index levels, individualism vs collectivism index levels and uncertainty avoidance index levels, with three different levels each; and finally, by long-term orientation vs short-term index levels, for which there were two different levels of respondents.

Additionally, data were assessed to ensure continuous dependent variables. The HPM project surveys for the selected constructs were designed with respondents being asked to answer on a five-point Likert scale. While rather an ordinal scale, Likert measurements might be employed as a continuous one (Field, 2009), this being particularly true when it comes to the use of

parametric tests such as ANOVA, as, along with “other tests of central tendency are highly robust to things like skewness and non-normality” (Norman, 2010:629). Finally, each group’s boxplot was examined for significant outliers, as “analysis of variance methodologies can be sensitive to the presence of outliers” (Kabacoff, 2011:230). Although some outliers were detected, it was decided not to remove them from the data set, since this would lower the sample size.

On what concerns the analysis of results, several scholars have been advocating for a broader interpretation, rather than the extensive search for the “stars” that traditionally indicate accepted significance levels (Brodeur, Lé, Sangnier and Zylberberg, 2016), while “unwarranted faith is placed in the p-value as a breakpoint [...] between valuable and worthless results” (Bettis, Ethiraj, Gambardella, Helfat and Mitchell, 2016:259). Although we recognize that such pointer alerts for the fact that false positives may be erroneously inferred, ignoring “marginally insignificant coefficients” (Brodeur, Lé, Sangnier and Zylberberg, 2016:2) may also lead to a misinterpretation of the data. Thus, instead of adopting a “rigid p-value breakpoint” that might be considered “inconsistent with good science” (Bettis, Ethiraj, Gambardella, Helfat and Mitchell, 2016:259), results are interpreted considering also p-values that surround the generally adopted thresholds as possible indicators of statistical relevance.

7.7. Results

A total of 20 ANOVAs, 20 post hoc tests and four t-tests were run, with each OS element construct being assessed for the six distinct data groupings. The study showed that there are significant results that suggest the relationship between National Culture dimensions and the OS aspects that were studied. Results are summarized in Table 5.

Table 5: Results for OS Process Elements grouped by Countries, Industry and National Culture Dimension Index Levels

			Operations Strategy Element			
			Leadership for Cross-Functional Integration	Functional Integration	Manufacturing Strategy Linkage to Corporate Strategy	Formulation of Manufacturing Strategy
			Mean(S.D.)	Mean(S.D.)	Mean(S.D.)	Mean(S.D.)
Country	1-G	N=28	3.67(0.35)[2]	3.91(0.50)	4.06(0.47)	3.92(0.74)
	2-C	N=30	4.08(0.69)[1]	3.85(0.68)	3.70(0.87)	3.64(0.80)
	3-B	N=21	3.96(0.53)	4.16(0.42)[4]	3.92(0.59)	4.06(0.64)
	4-K	N=26	3.84(0.54)	3.71(0.48)[3]	3.83(0.42)	3.71(0.48)
	Statistics	P-value	0.041**	0.050**	0.180	0.128
		Z	2.855	2.698	1.663	1.936
	df (in; within)	3;101	3;101	3;101	3;101	
Industry	1-E	N=29	4.04(0.59)	3.71(0.66)	3.88(0.76)	3.95(0.62)
	2-M	N=41	3.82(0.57)	3.77(0.47)	3.84(0.62)	3.63(0.77)
	3-T	N=35	3.84(0.52)	3.87(0.55)	3.91(0.53)	3.91(0.62)
	Statistics	P-value	0.229	0.4962	0.917	0.1024
		F	1.497	0.706	0.087	2.331
		df (in; within)	2;102	2;102	2;102	2;102
Power Distance	1-L	N=0				
	2-ML (G)	N=28	3.67(0.35)[4]	3.91(0.50)	4.06(0.47)[4]	3.92(0.74)
	3-MH (B, K)	N=47	3.90(0.53)	3.91(0.51)	3.87(0.50)	3.87(0.58)
	4-H (C)	N=30	4.08(0.69)[2]	3.85(0.68)	3.70(0.87)[2]	3.64(0.80)
	Statistics	P-value	0.021**	0.888	0.094*	0.260
		Z	4.015	0.119	2.416	1.365
	df (in; within)	2;102	2;102	2;102	2;102	
Individualism vs. Collectivism	1-L (C, K)	N=56	3.97(0.63)[3]	3.78(0.59)[2]	3.76(0.70)	3.67(0.67)[2]
	2-ML (B)	N=21	3.96(0.53)	4.16(0.42)[1]	3.92(0.59)	4.06(0.64)[1]
	3-MH (G)	N=28	3.67(0.35)[1]	3.91(0.50)	4.06(0.47)	3.92(0.74)
	4-H	N=0				
	Statistics	P-value	0.061*	0.031**	0.117	0.062*
		Z	2.882	3.585	2.196	2.856
	df (in; within)	2;102	2;102	2;102	2;102	
Uncertainty Avoidance	1-L	N=0				
	2-ML (C)	N=30	4.08(0.69)[3]	3.85(0.68)	3.70(0.87)[3]	3.64(0.80)
	3-MH (G)	N=28	3.67(0.35)[2]	3.91(0.50)	4.06(0.47)[2]	3.92(0.74)
	4-H (B, K)	N=47	3.90(0.53)	3.91(0.51)	3.87(0.50)	3.87(0.58)
	Statistics	P-value	0.021**	0.888	0.094*	0.260
		Z	4.015	0.119	2.416	1.365
	df (in; within)	2;102	2;102	2;102	2;102	
Long-Term Orientation	1-L	N=0				
	2-ML (B)	N=21	3.96(0.53)	4.05(0.47)	3.92(0.59)	4.06(0.64)
	3-MH	N=0				
	4-H (C, G, K)	N=84	3.87(0.57)	3.72(0.56)	3.86(0.64)	3.75(0.70)
	Statistics	P-value	0.514	0.010**	0.737	0.062*
		t	0.656	2.722	0.337	1.934
	df	32.715	35.511	32.747	32.915	

Notes:

For Country identification, G=Germany, C=China, B=Brazil and K=South Korea

For Industry identification, E=Electronics, M=Machinery and T=Transport

For National Cultures Index levels, L=Low, ML=Medium-Low, MH=Moderate High and H=High

* p<0.10

** p<0.05

The numbers in parentheses are sample standard deviations.

The numbers in brackets indicate the group means from which this group is significantly different at the 0.10 significance level, as indicated by Tukey's or Games-Howell pairwise comparison test.

Among the four countries, there is a clear difference in leadership for cross-functional integration (LDINT) (ANOVA p-value = 0.041) between China and Germany (post hoc Tukey's test p-value = 0.029) and in functional integration (INTEG-FUNCI) (ANOVA p-value = 0.050) between Brazil and South Korea (post hoc Games-Howell's test p-value = 0.009). Manufacturing strategy linkage to corporate strategy (LINKS) and formulation of manufacturing strategy (MFGSTR) also present differences, but with significance around the acceptable level (ANOVA p-values = 0.180 and 0.128, respectively). Therefore, the first evidences suggest that when different levels of Hofstede's dimensions are identifiable, there are variations in the aspects related to the OS process. No significant differences were found between the three industries assessed, except for in formulation of manufacturing strategy (ANOVA p-value = 0.1024), yet with no particularly significant differences in the pairwise comparisons.

The second set of analyses had three different groups of power distance index levels (i.e. medium low, moderate high and high). For power distance, China presented a high level, while Brazil and South Korea presented moderate high levels. On the other hand, Germany has a medium low level. Strong evidence of differences between these groups suggest that leadership for cross-functional integration (ANOVA p-value = 0.021) and manufacturing strategy linkage to corporate strategy (ANOVA p-value = 0.094) are related to differences between medium low (Germany) and high (China) levels of power distance index (post hoc Tukey's test p-values = 0.015 and 0.076, respectively). Contrary to initial expectations, results point to a positive relationship between power distance and leadership for crossfunctional integration. This result may be considered as counterintuitive. The results also suggest that functional integration and formulation of manufacturing strategy do not differ among power distance levels (ANOVA p-

values = 0.888 and 0.260, respectively). ANOVA analysis for functional integration and formulation of manufacturing strategy did not present a statistically significant result. Therefore, H1a and H1c were confirmed.

Data presented three levels for the individualism vs collectivism dimension in the third set. In this case, Germany presented moderate high level of individualism vs collectivism. Brazil presented medium low level, and China and South Korea, low levels of individualism both (i.e. both have high level of collectivism). There are differences in leadership for cross-functional integration for the levels of individualism (ANOVA p-value = 0.061), as expected. Evidences are also present for differences in functional integration (ANOVA p-value = 0.031) and formulation of manufacturing strategy (ANOVA p-value = 0.062), but for both with a positive relationship, meaning that the higher individualism, the higher the functional integration and the formulation of manufacturing strategy. The results show that manufacturing strategy linkage to corporate strategy also differ (ANOVA p-value = 0.117) between low (China and South Korea) and moderate high (Germany) individualism vs collectivism levels (post hoc Games-Howell's test p-value = 0.102). Hence, H2a-H2d were confirmed.

The fourth set for uncertainty avoidance index levels aggregated the data in three different groups. In this case, Brazil and Korea presented high levels of uncertainty avoidance and Germany moderate high. In turn, China presented a medium low level. Similar to the power distance grouping, evidence suggests strong differences in leadership for cross-functional integration (ANOVA p-value = 0.021) and manufacturing strategy linkage to corporate strategy (ANOVA p-value = 0.094), both with significant differences between medium low (China) and moderate high (Germany) levels of uncertainty avoidance (post hoc Tukey's test p-values = 0.015 and 0.076). On the other hand, the results suggest that functional integration and

formulation of manufacturing strategy do not differ among the levels of this national culture dimension. Therefore, only H3a and H3c were confirmed.

The fifth and final set of analyses contained groups with medium low (Brazil) and high (China, Germany and South Korea) levels of long-term orientation vs short term, with clear evidences pointing to differences on functional integration (t-test p-value = 0.010) and formulation of manufacturing strategy (t-test p-value = 0.062) in negative relationships, having Brazil presented the highest values for both elements. This is also a counterintuitive result. Post hoc tests were not performed, since this set only had two groups that were being compared. For the other two elements of OS, leadership for cross-functional integration and manufacturing strategy linkage to corporate strategy, the results suggest that they do not differ between long-term orientation vs short-term index levels. Thus, H4b and H4d were confirmed.

7.8. Discussion

Several authors have attributed a great deal of importance to social networking and indigenous management concepts or approaches, stating that they are a fundamental basis for comprehending the development of managerial practices in emerging economies (e.g. Horak and Klein, 2015; Minbaeva and Muratbekova-Touron, 2013; Smith, Torres, Leong, Budhwar, Achoui and Lebedeva, 2012; Motta and Alcadipani, 1999). Such an understanding might also be helpful for explaining the main differences between China and Germany regarding OS. Guanxi has been portrayed in literature as a “pervasive relationship lubricant that helps to increase the efficiency and effectiveness of daily business operations” (Luo, Huang and Wang, 2011:140). At the same time, some authors characterize the Chinese leadership as a paternalistic leadership that combines authoritarianism, benevolence and moral leadership (Farh and Bor-

Shiuan, 2000). In this sense, even though China has high power distance index levels, its indigenous culture would favor relationships and networking, which may explain higher values of leadership for cross-functional integration in the country. On the other hand, Germany carries a higher level of uncertainty avoidance, which was expected to be reflected in lower levels of leadership for cross-functional integration.

There is also evidence that leadership for cross-functional integration differs between the levels of the individualism vs collectivism dimension, with distinctions between low (China and South Korea) and moderate high (Germany) IDV countries, demonstrating that a more collective culture can facilitate an integration-oriented leadership. Following the same logic argued above, China's guanxi practices reflect the country's high collectivism culture, which also nurtures integrating leadership efforts.

There are different levels of functional integration between Brazil and South Korea, as well as between countries with low and medium low individualism vs collectivism dimensions (i.e. China and South Korea; Brazil), but with opposite relationship when compared to the literature. Although Brazil, based on Hofstede's model, carries a more individualistic culture, it had higher levels of cross-functional integration when compared with China and South Korea. According to Holanda (1936), as a result of an historical process, Brazilians hold an "aversion to social ritualism" (p. 147, our translation), which is a possible explanation for the individualistic traits reported by Hofstede's studies. This social ritualism aversion may decrease the barriers between "rival" functional areas, such as operations and marketing, for instance. Thus, even though this was not an expected result, individualism may overcome functional constraints instead of strengthening them, maybe because individuals are "less" captives of functional or departments groups. In Germany, Brodbeck, Frese and Mansour (2002) showed that low compassion, low

self-protection, low team orientation, high autonomy, and high participation are not constraints for high performance.

The two groups of long-term orientation vs short-term index levels (medium low – Brazil, and high – Germany, China and South Korea) also resulted in statistically significant differences. Similar to the above analysis, it showed a negative relationship between long-term orientation and functional integration. Besides the cultural traits, Brazil is a country that faces cyclical economic instabilities. This aspect might be a possible explanation for Brazil's low long-term orientation score. The combination of short-term orientation perception and high functional integration would then be a mechanism by which Brazilian companies deal rapidly with external changes.

Third, manufacturing strategy linkage to corporate strategy carried significant differences among power distance (medium low and high, i.e. Germany and China) and uncertainty avoidance (medium low and moderate high, i.e. China and Germany) levels. For the individualism vs collectivism levels (low and moderate high, i.e. China and Germany), evidence for differences between the countries was present, while its relationship with long-term orientation vs short term could not be proved. These findings strengthen the idea on German companies first proposed by Simon (1992), and his then ground-breaking term, “hidden champions.” Hidden champions are midsized German companies, which had a low profile as far as regards media and consumer attention, but that had market leadership on a global scale (Simon, 1992, 1996, 2009). Such characteristics culminate in a narrow focus on a highly technical, expertise-demanding niche, meaning also that these companies concentrate all of their resources on maintaining the top position in their chosen sector. Germany's lower power distance and higher uncertainty avoidance could explain the adherence to strategies in the local

companies; in other words, they succeed in implementing the manufacturing strategy. In this sense, the latter may also advocate for the high performance levels of such firms.

Finally, moderate evidence of differences between the countries with low and medium low individualism vs collectivism levels (i.e. China and South Korea; Brazil) were found for formulation of manufacturing strategy. This could also be understood from the social networking perspective. As discussed above, China's *guanxi* relates to the exchange of favours or obligations within social networks, reflected in its low scores on the individualism vs collectivism index. The Korean *yongo*, in turn, refers to the different networks and configures exclusive trusting relationships (Horak and Klein, 2015). Although these concepts share similarities as well as differences, their contribution to collectivism is perceptible. Along with this trait, they are also reported to be more influential on people's behavior than formal rules and prescriptions, which would lend a better comprehension as to why these two countries scored lower on formulation of manufacturing strategy than the others.

Empirical evidence also points to relevant differences between the two groups of longterm orientation vs short-term levels (medium low – Brazil, and high – China, Germany and South Korea). Although Brazil has a less long-term oriented culture than the other three countries assessed, it scored higher on the formulation of manufacturing strategy scales. One possible explanation here is also related to the Brazilian aversion to social and formal rules. A formalized manufacturing strategy may be a way for Brazilian companies to strengthen internally their strategic goals. It could also be the case of assessing OS from different perspectives, as “alternative operations strategy” may be detected in organizations with difficulties in the execution of formal strategies (Jagoda, Kiridena and Lin, 2016:740). Chart 15 summarizes the results found.

Chart 15: Summary of Results and Hypotheses Confirmation

	Power Distance	Individualism Collectivism	Uncertainty Avoidance	Long Term Orientation
Leadership for Cross-Functional Integration	Significant	Significant	Significant	N.S.
Functional Integration	N.S.	Significant	N.S.	Significant
Manufacturing Strategy Linkage to Corporate Strategy	Significant	N.S.	Significant	N.S.
Formulation of Manufacturing Strategy	N.S.	Significant	N.S.	Significant
Hypotheses Confirmation per National Culture Dimension	<i>Partially confirmed</i>	<i>Confirmed</i>	<i>Partially confirmed</i>	<i>Partially confirmed</i>

Although comparisons between countries were expected to indicate more significant differences, each country also carries multiple national cultural dimensions. This might open the possibility of the combine impacts of the four assessed dimensions of culture on the aspects of the OS process to be annulled by each other, or at least compensated for. On what concerns differences between industries, it is also possible that the organizational culture present in such sectors may be largely influenced by national cultures traits, as there is reportedly a “logical connection between national and organizational culture via individual socialization and institutional forms” (Nelson and Gopalan, 2003:1116).

7.9. Conclusion

In addition to analyzing the extent to which national cultures explain the differences in diverse elements of the OS process, from a more generalist perspective this study aimed to achieve a more in-depth understanding of the relationship between these two apparently disconnected topics. In that sense, as discussed throughout the text, the relevance of the research relies on providing empirical evidence for filling some gaps around how national culture may impact on

the formulation, implementation and maintenance of OS. Such an effort was conducted by assessing the HPM project's fourth round data and Hofstede's cultural classification.

Moreover, we may state that the elements of the OS process differ for the levels of Hofstede's dimensions of national culture. All the analyzed elements of OS process (leadership for cross-functional integration, functional integration, manufacturing strategy linkage to corporate strategy and formalization of manufacturing strategy) present differences in at least two of the Hofstede's dimensions. Individualism vs collectivism is the dimension that displayed differences in all the elements of OS process. This is relevant because shows that internal group and teams are essential for the OS process. For example, China and Korea with a high presence of social networks present a low result for formulation of manufacturing strategy and higher results for leadership for cross-functional integration, as expected. On the other hand, more individualistic and formal processes are present in Germany, showing that there the OS process does not follow a "one size fits all" approach.

Nevertheless, some results were counterintuitive. Surprisingly, China with the highest power distance group also presented the higher result for leadership for cross-functional integration. Additionally, Brazil presented the lowest mean for long-term orientation and the highest mean for formulation of manufacturing strategy. Therefore, those results suggest again that the national culture is key for these two aspects of the OS process. China has a strong influence of its leadership approach on their social rules. On the other hand, Brazilian aversion to social rules may create a need for the manufacturing strategy formalization. These results suggest that a narrow and sometimes ethnocentric view is not enough for the OS process.

The assessment of OS from a cultural approach can shed new light on different choices and decisions, as global supply chains emerge as a model for competitiveness, leading to different cultures interacting in cooperative behavior to gain better performance and competitive

advantage. The empirical work highlights strong relationships between culture and OS, indicating their importance and contributing new perspectives both to theory and practice as far as regards the planning and implementation of strategic and operations management.

One contribution of this study relies on the fact that the results emphasize that culture has an identifiable impact on Operations. Major issues might find answers by assessing the motivations and patterns embedded in cultural characteristics. Since behavioral patterns might be understood to be the result of the social environments that individuals are embedded in (at least partially), some explanations of human actions were brought from the sociology literature. Social relations such as *guanxi* and *yongo* were brought into the discussions, along with historical backgrounds, thus offering additional and complementary views on how expectations and interactions between employees may influence their relationship with companies. Within this reasoning, Hofstede's national culture classifications were contextualized, helping to build the logic behind the general behaviors observed in each society analyzed, and more specifically looking at how they can affect the planning, implementation and results of OS.

As for practical implications, an understanding of the impact of national culture dynamics on OS can enlighten the formulation, implementation and maintenance processes of the latter. Managers involved in internationalization processes might encounter ways of dealing with different cultures if they understand their relevance when it comes to OS. Dealing with high power distance cultures such as the ones located in Asia, for instance, do not necessarily implicate on higher difficulties in functional integration as would intuitively expected. Instead, such companies may find significantly higher levels of integration between different functions in China and South Korea, as they are inserted in cultures that favor the collective identity. At the same time, China has consistently scored lower in formulation of manufacturing strategy for all the comparisons, calling for the need of managers to approach the matter from a different

perspective, possibly relying on alternative OS paths, as mentioned before. The study also contributes to the understanding that successful OS is conditional upon its adaptation to specific environments. By doing so, companies could explore the maximum potential of their strategies, thereby avoiding waste caused by any eventual lack of adherence between national and organizational cultures. This is particularly relevant to firms in global supply chains and/or strong internationalization processes, as a better understanding of the supply chain partners' social elements may lead to more efficient OM.

This study has its limitations. The HPM project, although very consolidated and known for its cross-cultural nature and multiple respondents within the plants involved, is based on a cross-sectional investigation. The observation of the longitudinal evolution of OS elements may clarify other issues that were not captured by this data collection. Because of the large extent of the project, respondent selection often relies on a convenience sample, which does not allow for a guarantee on its representativeness. The selection of four countries for the study also results in a relatively small sample size, allowing medium or large effects to be captured by the analysis, yet possibly ignoring smaller differences between the distinct groups as statistically significant.

Moreover, the scales utilized in this study reflect measurement models that were designed and implemented as part of the broader project, meaning that they may not be exactly suited to the purposes of this research. It is also centered on the plant as the basic unit of analysis, instead of the whole supply chain, and relies on respondent perceptions. Future research could encompass other sources of information (i.e. document research, open-ended interviews) to fill the gaps left by the survey technique and possibly involve other supply chain partners.

Additionally, our study presumes that Hofstede's dimension levels have intra-country homogeneity and inter-country heterogeneity, meaning that each plant would reflect its

country's cultural behavior. Future studies could also consider administering both cultural dimension and OM questionnaires, thereby confirming such behavior or capturing external influences that may emerge from cross-cultural transactions.

7.10. Appendix: Manufacturing Strategy constructs

Manufacturing Strategy Scales Items

Integrating Leadership

- Our top management emphasizes the importance of good inter-functional relationships
- Our managers do a good job of solving inter-functional conflicts
- We are encouraged to communicate well with different functions in this plant
- Our managers communicate effectively with managers in other functions

Functional Integration

- The functions in our plant are well integrated
- Functional coordination works well in our plant
- The functions in our plant work well together
- Our plant's functions coordinate their activities
- Our plant's functions work interactively with each other

Implementation of Manufacturing Strategy

- We have a manufacturing strategy that is actively pursued
- Potential manufacturing investments are screened for consistency with our business strategy
- At our plant, manufacturing is kept in step with our business strategy
- Corporate decisions are often made without consideration of the manufacturing strategy

Formal Manufacturing Strategy

- Our plant has a formal manufacturing strategy process, which results in a written mission, goals and strategies
 - This plant has a manufacturing strategy, which is put into writing
 - Plant management routinely reviews and updates a long-range manufacturing strategy
 - The plant follows an informal manufacturing strategy, with no written strategy document
-
-

^aHow often are the leadership tools and techniques listed below used in your plant? (1: never, 5: always)

Chapter 8. Paper Two – The Duality of the Brazilian *jeitinho*: An Empirical Investigation and Conceptual Framework

8.1. Background to Paper Two

The second paper, entitled “The duality of the Brazilian *jeitinho*: An empirical investigation and conceptual framework”, was developed in co-authorship with Mauro Fracarolli Nunes, and my PhD dissertation supervisors, Prof. Dr. Valérie Moatti and Prof. Dr. Maral Muratbekova-Touron. A previous version of this paper, then named “The duality of the Brazilian *jeitinho*: Balancing between creativity and corruption”, was presented at the 32nd European Group for Organizational Studies (EGOS) colloquium, hosted in Naples, Italy, in 2016. A further developed version has been submitted and accepted for presentation at the Academy of Management (AOM) meeting in 2017, held in Atlanta, Georgia, U.S, under the Sustainable Supply Chains theme session. After two rounds of revisions, one major and the second minor, the present version has been accepted for publication at the *Critical Perspectives on International Business* journal on April 22nd, 2018, and therefore follows its guidelines concerning structured abstract and article format.

This study draws on a qualitative-oriented approach and seeks to explore the interface between human behavior and operations management issues. My research interest in such crossing point is very strongly translated by the composition of my doctoral dissertation supervisors, and, as a superficially cultivated territory in my home country, it favored the choice of the Brazilian context. While the main share of the work was under my responsibility, the ideas for the project were jointly developed by the co-authors. Mauro played a fundamental role in the construction of the research protocol, and we worked together on the data collection and analysis. Moreover, Dr. Muratbekova-Touron made significant contributions on the

introduction and on the literature review on corruption, further re-allocated in the discussion session, and on perceiving the different levels of the dimensions which yielded in our proposed framework. Dr. Moatti added the most valuable insights throughout the development of the paper, especially on the discussion section, and was essential to strengthen the article.

“The Duality of the Brazilian *jeitinho*: An Empirical Investigation and Conceptual Framework”

Camila Lee Park

Mauro Fracarolli Nunes

Maral Muratbekova-Touron

Valérie Moatti

8.2. Abstract

Purpose – This paper aims to deepen the understanding of the impact of cultural and national idiosyncrasies on businesses. The authors concentrate on the cultural particularity of the Brazilian *jeitinho* to assess the ethicality of the concept in buyer–supplier relationships.

Design/methodology/approach – Semi-structured interviews were conducted with 28 Brazilian professionals working for both national and international companies, allowing for the analysis of the context in which the Brazilian *jeitinho* is perceived either as positive or negative in terms of ethics.

Findings – The authors propose five distinct dimensions (harm to third parties, seriousness of the issue, formality of relationships, personal benefit and assessed pertinence of rules and laws) to the assessment of Brazilian *jeitinho* as creativity, corruption or more nuanced classifications between them and offer a reviewed definition of the practice.

Practical Implications – The results of the study may offer new insights into the Brazilian business environment. Deeper comprehension of the contexts in which *jeitinho* is used and its different connotations may optimise the relations between foreign and Brazilian companies and between foreign and Brazilian professionals and employees.

Originality/value – Within the context of intensified international trade, global supply chains and geographically spread operations, an understanding of cultural and national idiosyncrasies may provide managers with a powerful tool to conduct their business more effectively. With the economic emergence of countries such as China, Russia and Brazil, local practices are also gaining increased importance as they seem to have a direct influence on management in these places and beyond.

Key-words: Creativity, International business, Corruption, Brazilian *jeitinho*, Indigenous management

Paper type: Research paper

8.3. Introduction

“Unfortunately in Brazil we have not been able to get rid of the so-called “jeitinho”. This is observed at every moment, in traffic jams or among those who violate Petrobras’ public patrimony” (Lisboa, 2015)

This opening quote, by Brazilian judge Newton Trisotto after denying jail release requests made by two of Petrobras’ former directors, refers to the corruption scheme that was uncovered in an operation by the country’s Federal Police. The local term *jeitinho* is derived from *jeito* (a way out, adroitness, dexterity, aptitude) and is used in its diminutive form to convey the sense of intimacy and endearment which reflects the emotional way in which Brazilians deal with all kinds of situations, even in business (Duarte, 2006). This practice made its way into the spotlight recently when events involving the country’s most prominent company pointed to *jeitinho* as the enabler of what is now being referred to as the biggest corruption scandal of all time, as Petrobras is being investigated on bribery charges involving several foreign companies (Leahy, 2015; Reuters, 2016; Russo, 2017).

Along with national cultures’ influences in diverse areas such as corporate governance practices (Daniel, Cieslewicz and Pourjalali, 2012), project management (Rees-Caldwell and Pinnington, 2013), customer loyalty (Zhang, Van Doorn and Leeflang, 2014) and earning management behaviour (Gray, Kang and Lin, 2015), indigenous management concepts such as the Brazilian *jeitinho* have been proven to be critical to understanding business practices, especially in emerging markets (Holtbrügge, 2013). Guanxi in China (Fu, Tsui and Dess, 2006; Lee and Humphreys, 2007; Chen, Huang and Sternquist, 2011; Jia, Rutherford and Lamming, 2016), blat (Ledeneva, 1998; McCarthy and Puffer, 2008) and more recently *svyazi* (Yakubovich, 2005) in Russia, *jeitinho* in Brazil (Page, 1995; Tanure and Duarte, 2005; Ardichvili, Jondle, Kowske, Cornachione, Li and Thakadipuram, 2012), *wasta* in the Middle East and North Africa (Khakhar and Rammal, 2013; Hawkins, Randall, Coyne and Baitalmal,

2014), jaan-pehchaan in India (McCarthy, Puffer, Dunlap and Jaeger, 2012; Puffer, McCarthy, Jaeger and Dunlap, 2013) or clanism (Minbaeva and Muratbekova-Touron, 2013) in Kazakhstan have been the subject of academic studies examining the impact of these informal institutions on business relations in those countries (McCarthy, Puffer, Dunlap and Jaeger, 2012). Although these studies recognise the existence of such concepts in handling business and assess them in terms of ethics, the general attitude of managers toward these culturally embedded phenomena is ambiguous, with a positive image often clashing with a negative perception of them as being corrupt practices.

In this context, insight into the different connotations of such indigenous practices may be particularly useful for management research. To provide additional evidence in this respect, we focus here on one of these indigenous practices: Brazilian *jeitinho*. It is defined as an informal problem-solving strategy in organisations (Duarte, 2006), a form of creative ingenuity to find quick, short-term solutions to problems (Smith, Torres, Leong, Budhward, Achouie and Lebedeva, 2012) or “a special way of managing obstacles to find a way out of bureaucracy” (Amado and Vinagre Brasil, 1991:48). The sense of closeness that Brazilians feel towards such practice is representative of its strong presence in their day-to-day lives and also reflects their attitudes in business matters. From a broader perspective, Brazil’s position as a strong emerging economy also confirms the importance of studying its managerial particularities.

Existing research shows a certain ambiguity towards the concept: while some scholars state that Brazilian people consider *jeitinho* as a way of using favours and thus see it as ethical (Duarte, 2006; McCarthy, Puffer, Dunlap and Jaeger, 2012), others argue that *jeitinho* can be viewed as corruption (Barbosa, 2006 cited in Smith, Torres, Leong, Budhward, Achouie and Lebedeva, 2012). Pearson (2015) illustrates this ambivalence as follows:

“[...] the *jeitinho* in its most innocuous form is considered a positive trait of Brazilian culture because it is an expression of resourcefulness and informality that is often traced back to the country’s mixed heritage and Iberian ancestry. However, the concept also extends to unethical behaviour such as queue-jumping and illegal practices such as parents bribing driving instructors so their children can pass their tests.” (Pearson, 2015).

The goal of this paper is therefore to analyse the perception of Brazilian *jeitinho* among practitioners in the country and to attempt to resolve the ambiguity surrounding this concept. More specifically, in light of the contexts in which the term is used, we aim to understand when and why *jeitinho* is perceived as an ethical or an unethical attitude towards business. In that sense, the objectives of the study may be translated into the following research question:

RQ1. What factors influence the perception of the ethicality of *jeitinho* among Brazilian professionals?

To answer this question, 28 interviews were conducted with professionals in buyer–supplier positions. Inter-organisational relationships have been shown to offer relevant settings for studying indigenous practices (Millington, Eberhardt and Wilkinson, 2006). In addition to providing supplementary elements to clarify the existing literature, the results show that *jeitinho* is generally perceived in two different and arguably opposed ways at one and the same time. While it is seen as a form of creativity serving to solve day-to-day problems, it may also be referred to as a synonym for corruption. Based on the analysis of the data, five dimensions emerged as the basis for the development of a theoretical model to differentiate between these two different facets.

Beyond this introduction, the paper is organised as follows. The literature review section provides a contextualised discussion on the various perceptions of indigenous practices and, more specifically, the existing literature on *jeitinho*. It also examines the literature on corruption to further analyse *jeitinho* in light of corruption classifications. Next, details of the empirical procedures used are presented in the method section. The results of the study are then presented,

followed by their discussion. Practical and theoretical implications are addressed, including the development of a theoretical model. Finally, the conclusions and limitations of the study are explored, as well as suggestions for future research.

8.4. The Ethicality of *jeitinho* as an Indigenous Practice

8.4.1. Contrasting Perspectives on Indigenous Practices

The term “indigenous” is used in the management literature in reference to what is native to or natural of a place, a country or a community. In general, cultures remaining outside the “European identity” (Long and Mills, 2008) are those laid within the concept of “other societies” (Banerjee and Linstead, 2004:222), while the study of local or regional practices, as opposed to the epistemic tradition of international business’ governing, remains urgent (Durepos, Prasad and Villanueva, 2016). Authors such as Crawley and Sinclair (2003:362), for instance, classify Aboriginal communities in Australia as “indigenous people” as, in reference to the later colonisation of the country, they represent what was native to those lands. Dia (1996:7), in his analysis of management in Africa, denominates as indigenous those “institutions born of traditional African culture”, in opposition to non-native institutions or those “transplanted from outside”. Jackson (2013:21) addresses the multitude of definitions for indigenous traits and adopts a political resistance perspective in his approach to the topic, critically indicating the marginalisation of “indigenous voices” in the “dominant global management literature”.

Having developed for centuries as fundamental connectors of societies, social practices and customs are unavoidably present in businesses (Redding and Witt, 2015). Ultimately, the application of indigenous practices in contexts that are different from those in which they have

traditionally been developed may generate interferences in their interpretations by western managers, as they may be commonly confused with, or simplified as, a form of local corruption (McCarthy and Puffer, 2008), as any assessment of these culturally embedded phenomena is influenced by the lenses through which they are analysed.

The ambiguity in the assessment of these practices is more evident when they are considered within a business context. For example, Smart and Hsu (2007:167) discuss the different connotations associated with *guanxi* in the literature, either in “positive functions for building trust” or having “strong links between *guanxi* practice and corruption”. Gu, Hung and Tse (2008) also uncover the practice in contradictory ways, highlighting its potential benefits and risks. Accordingly, *guanxi* may at the same time represent a core competence of corporations with direct effects on market performance and also engage firms in processes of reciprocal obligation and “collective blindness” (Gu, Hung and Tse, 2008:12), eventually placing governance structures in environments run through with bribery, corruption, obstacles to the rules of law and overdependence, among others. Dunfee and Warren (2001) criticise an instrumental evaluation of *guanxi* as a facilitator of business transactions in China as it does not take ethical issues into account. Proposing a normative assessment of *guanxi*, these scholars call attention to its problematic dimensions: it may reduce societal wealth, “benefits a few at the expense of many” (p. 200), may lead to the violation of fiduciary duties, may not be supported by “authentic norms of relevant communities” (p. 199) and may violate hypernorms, which are manifest universal principles (Dunfee and Warren, 2001). In the specific context of buyer–supplier relationships, *guanxi* represents an efficient mechanism to reduce transaction costs while also inducing illicit behaviour through bribery (Millington, Eberhardt and Wilkinson, 2006).

Similar views have been associated with other indigenous practices. *Blat*, for instance, is described as being obscured by the rhetoric of friendship, while actually working as a vector for bribery and corruption (Ledeneva, 1998). Both *blat*, originally a negative term, and *guanxi*, originally a neutral term, are blurred concepts (Michailova and Worm, 2003). Such networks may be viewed as positive personal relationships based on cooperation, mutual support and trust that can increase flexibility through gathering and disseminating information and relocating different types of resources in unpredictable and changing environments. However, they can also work on the basis of negative information that one party has about the other party and thus holding the other party hostage if the trust-based relationship is betrayed (Michailova and Worm, 2003). The negative connotation of these practices concerns possible abuses of political and economic power, increased corruption and a weakening of the development of an open-market economy (Michailova and Worm, 2003).

Affective (education-based, kinship and of regional origin) ties and networks in South Korea, known as *yongo*, contribute to the challenging and time-consuming trust-building process and thus increase collaboration and coordination efficiency and internal firm group cohesion (Horak, 2016). They also prevent free-riding through peer pressure, lowering the cost of monitoring and supervision and keeping transaction costs low (Horak, 2016). *Yongo* can also prevent information leaks to competitors as it implies a strong code of behaviour (Horak, 2016). However, it may lead to discrimination in the recruitment and selection process, distortion of fair competition and inefficient allocation of resources (Horak, 2016).

In Kazakhstan, *rushyldyq*, referred to as clanism in the political and management literature (Minbaeva and Muratbekova-Touron, 2013; Schatz, 2004), also has a twofold connotation: while some ethnic Kazakhs strongly support mutual assistance among kin, considering it to define Kazakhness, others believe it to be a menace to their unity as an ethnic group (Minbaeva

and Muratbekova-Touron, 2018). Non-titular citizens of Kazakhstan such as Russians, Uzbeks, Ukrainians, Koreans and others perceive clanism as corrupt.

In summary, scholars studying indigenous practices in different countries highlight the duality of perceptions of these practices that have both a positive connotation of networking, and thus development of trustful relationships, and a negative side of corruption (Dunfee and Warren, 2001 or Warren, Dunfee and Li, 2004 for *guanxi*; Horak, 2016 for *Yongo*; Hutchings and Weir, 2006 for *guanxi* and *wasta*; Ledeneva, 1998 for *blat*; Michailova and Worm, 2003 for *blat* and *guanxi*; Minbaeva and Muratbekova-Touron, 2018 for clanism). Thus, different scholars discuss the ethicality of indigenous practices or their “double-edged sword” (Warren, Dunfee and Li, 2004:355), depending on the lenses through which they are analysed, the context or their impact on management practices.

8.4.2. *The Brazilian jeitinho*

Building on the analysis of Barbosa (1992, cited in Duarte, 2006), Duarte (2006:511) lists the following characteristics of *jeitinho*:

It is used in response to an extraordinary, unforeseen situation; it involves a conscious act of breaking rules; it provides a short-term solution to a problem; it is normally self-serving but can be also altruistic; it requires certain “techniques” to foster *simpatia*(e.g. a smile and a gentle, pleading tone of voice); it can be used between strangers, but it works more effectively between people who know each other; and it is perceived by Brazilians as an important element of their cultural identity.

As previously discussed, Brazilian *jeitinho* is among the concepts viewed as indigenous as it is considered natural, inherent to and typical of Brazilian society. In that sense, by contrast to more mainstream environments, it would be strange to foreigners, endowing it with a certain exoticism. For that reason, a consideration of its historical and sociological origins may be helpful to define it. According to Amado and Vinagre Brasil (1991) and Duarte (2006), *jeitinho*

arose in reaction to the excessive formalism and rigid governmental bureaucracy inherited from the Portuguese colonial administration and which is still present today in Brazilian society.

Like other indigenous concepts, *jeitinho* has been the object of exterior analysis, which may have contributed to an unclear and foggy conceptualisation as regards the ethics behind it. While McCarthy, Puffer, Dunlap and Jaeger (2012) state that Brazilian managers consider *jeitinho* to be ethical, other scholars tend to be more nuanced. Inner to this view, *jeitinho* may be perceived as both a positive and a negative way to “get things done” (Barbosa, 2006, cited in Smith, Torres, Leong, Budhward, Achouie and Lebedeva, 2012; Duarte, 2006). *Dá um jeitinho pra mim* (literally “give a *jeitinho* for me”, or “find me a workaround”) is thus perceived as being similar to the use of favours and as a rather positive way of dealing with a difficult situation (Duarte, 2006) or a harmless problem solving strategy (Duarte, 2018). However, *jeitinho* can also be regarded as ruthless manipulation for personal advantage (Duarte, 2018). Barbosa (Barbosa, 2006, cited in Smith, Torres, Leong, Budhward, Achouie and Lebedeva, 2012) considers *dar um jeitinho* (to find a workaround) to be close to the notion of corruption.

The presence of such contrasting perceptions in the literature inherently calls for further investigation into Brazilian *jeitinho*. Beyond searching for a direct and conclusive definition of the term, the quest for a more developed understanding of the different factors leading to its distinct interpretations may be particularly fruitful. Additionally, analysis of the interaction between the different dimensions that may eventually come to impact its connotations can also contribute to our understanding of these complex constructs that have not yet been addressed in full.

8.4.3. *Corruption*

The word “corruption” has different meanings in different countries (Bardhan, 1997) and varies according to distinct ideological perspectives (Cloke, 2006). What is considered corrupt in one country may seem regular and ordinary in another. Exchanging gifts, for example, is perceived as the norm in business deals in some developing nations (Bardhan, 1997). A strong relationship has also been evidenced between corruption and national cultures’ traits (Gelbrich, Stedham and Gätke, 2016). Managers working in countries with high levels of regulation may consider arguably unethical mechanisms to reduce transaction costs as a source of competitive advantage (Cuervo-Cazurra, 2016) and thus not consider them as corruption. Defining the concept is therefore not easy and this makes it difficult to analyse. For example, Jain (2001:73) defines corruption as “acts in which the power of public office is used for personal gain in a manner that contravenes the rules of the game”. This definition implies that some actions, such as money laundering or fraud, are not considered as corruption because they do not use (i.e. abuse) public power. Levine (2005:723), on the other hand, delimits corruption as “an attack on norms of conduct in organizations”. Brown and Cloke (2011:119) also emphasise the “dualistic and derivative nature” of the literature around corruption, leading to a superficial understanding of the concept and its practice. We adopt the definition proposed by Cuervo-Cazurra (2016:36), who describes corruption of government officials in international business broadly as “the abuse of entrusted power for private gain”. This definition embraces corruption in different instances: government, firms, international organisations, and non-profit and non-governmental organisations.

There are numerous classifications of corruption. The most widely used distinction is between public and private corruption (Cuervo-Cazurra, 2016; Argandona, 2005). Public corruption involves the misuse of power in public office, i.e. when one of the parties is a public

official or politician (Argandona, 2005), whereas private corruption implies abuse of power by the manager of a company or organisation (Cuervo-Cazurra, 2016). Corruption can also be categorised as national (happening within the territory of a single country) versus international (involving parties from different countries); it can be grand (implicating large payments and sizeable effects) or petty (involving small gifts for facilitating payments, for example, also known as grease payments) (Cuervo-Cazurra, 2016); it can be political, bureaucratic or administrative; demand-driven (originating from the person who receives the payment) or supply-driven (originating from the person who pays); individualised (isolated) or systemic (permanent); centralised and organised versus decentralised and disorganised (Argandona, 2005). Corruption may be based on coercion (when one party dominates the other) or collusion (when there is a mutual agreement between parties) and on actual payment or on just the promise or hope of payment; and it can be predictable (when the desired results are assured) or arbitrary (Argandona, 2005). Cuervo-Cazurra (2016) also distinguishes between deviation-from-the-rules corruption and changing-the-rules corruption. Deviation-from-the-rules corruption involves payment to “ensure that current regulation is applied differently from its original intention, and corruption to change existing rules or laws, where the payment of the bribe is done to replace current rules with new ones” (Cuervo-Cazurra, 2016:37).

In light of these different classifications, the analysis of the definition of *jeitinho* (Duarte, 2006) suggests that it can be considered as corruption only if it is self-serving (and not altruistic). It can also be perceived as individualised (and not systemic) and a deviation from the rules (rather than changing the rules) because it is used in response to extraordinary or unforeseen situations and provides a short-term solution to the problem.

8.5. Method

8.5.1. *Sample and Data Collection*

Due to the relatively low level of maturity of this topic, our method is exploratory; semi-structured interviews were conducted with 28 Brazilian professionals involved in a buyer–supplier relationship within their companies. Such a setting allows us to understand indigenous business practices from the local point of view more deeply than the intracompany context where corporate policy prevails, and also in a different way from more commonly studied firm–state relationships (Millington, Eberhardt and Wilkinson, 2006). As evidenced by previous research (Lambert-Mogiliansky and Sonin, 2006; Millington, Eberhardt and Wilkinson, 2006), indigenous practices are particularly interesting and relevant when observed in inter-company relationships. Because companies’ internal compliance measures are often formulated in a centralised fashion and implemented across multiple units, buyer–supplier dyads represent an important context as, configured by the interface with external players, they are expected to be less influenced by organisations’ compliance policies. Given that *jeitinho* is a sensitive topic among Brazilians, respondents were chosen through the personal contacts of the first two authors. Interviews were conducted in Portuguese, under a full verbal anonymity agreement and were tape recorded. Interviews lasted between 21 and 67 min. Transcripts of the interviews were then generated from their recordings.

The average age and experience of interviewees was 34.00 and 12.17 years, respectively. Respondents included directors, managers, coordinators, analysts and one entrepreneur. Regarding the dyad position, the sample comprised 14 suppliers and 14 buyers. Out of the 28 companies, 27 had private capital – among which 9 were multinational organisations from the USA, Europe and Asia, 14 were Brazilian (i.e. both nationality and capital) and 4 were Brazilian with foreign capital – and the remaining company had mixed capital with government control.

Company sizes were distributed between 10 small, 7 medium and 11 large enterprises. Table 6 summarises the profiles of both the respondents and their companies.

Table 6: Respondent and Company Profiles

Respondent Profile					Company Profile		
#	Age	Gender	Position	Supply Chain Position	Nationality	Size	Industry/Sector
1	32	Male	Director	Supplier	Multi-national	Large	Publicity / Digital Media
2	30	Male	Director	Buyer	Brazilian / Foreign Capital	Medium	Communications
3	29	Male	Coordinator	Buyer	Multi-national	Large	Electronics / Manufacturing
4	33	Male	Analyst	Supplier	Brazilian	Small	Services / Consulting
5	31	Female	Director	Buyer	Brazilian	Small	Services / Accounting
6	32	Male	Coordinator	Buyer	Multi-national	Large	Electronics / Manufacturing
7	34	Female	Analyst	Buyer	Multi-national	Large	Electrics / Manufacturing
8	36	Male	Director	Supplier	Brazilian / Multi-national	Large	Mining / Transforming
9	39	Female	Analyst	Buyer	Multi-national	Large	Electrics / Manufacturing
10	31	Male	Manager	Supplier	Multi-national	Large	Services / Consulting
11	33	Male	Manager	Supplier	Brazilian	Medium	Services / Consulting
12	28	Male	Analyst	Buyer	Multi-national	Large	Electrics / Manufacturing
13	33	Male	Manager	Buyer	Multi-national	Large	Telecommunications
14	31	Female	Manager	Buyer	Multi-national	Medium	Electronics / Manufacturing
15	37	Female	Analyst	Supplier	Brazilian	Small	Food and Beverages
16	31	Male	Coordinator	Supplier	Brazilian	Small	Services / Consulting
17	51	Female	Owner	Supplier	Brazilian	Small	Pet Services
18	31	Male	Coordinator	Supplier	Brazilian	Medium	Financial Services
19	31	Male	Manager	Buyer	Brazilian	Small	Financial Services
20	40	Male	Coordinator	Buyer	Brazilian	Medium	Marketing and Advertising
21	36	Male	Director	Supplier	Brazilian	Small	Financial Services
22	30	Female	Manager	Supplier	Brazilian	Medium	Marketing and Advertising
23	32	Female	Director	Buyer	Brazilian	Large	Food and Beverages
24	31	Female	Coordinator	Supplier	Brazilian	Small	Mobile Banking
25	35	Male	Manager	Buyer	Brazilian / Foreign Capital	Medium	Financial Services
26	44	Female	Manager	Supplier	Brazilian	Small	Hotel and Catering
27	34	Female	Coordinator	Supplier	Multi-national	Large	Aviation
28	37	Male	Analyst	Buyer	Brazilian / Foreign Capital	Small	Mobile Banking

8.5.2. Data Analysis

The overall purpose of the interviews was to gain a better understanding of how these managers perceive *jeitinho* from their business experience. The introductory questions in the interviews aimed to check whether Brazilian *jeitinho* was mentioned spontaneously, which was the case in 15 of the 28 interviews. Interviewees were asked whether Brazilians have a particular way of doing business and, if so, they were asked to describe and name it. Whether it appeared spontaneously, they were then asked to explain their understanding of Brazilian *jeitinho*. Given the ambiguity surrounding the term, the subsequent investigation focussed on capturing different perceptions of *jeitinho*, aiming to clarify when it is perceived as a positive or a negative practice.

Transcripts were assessed independently by the two Brazilian researchers, following the two-stage approach recommended by Miles, Huberman and Saldaña (2013). Stage 1 dealt with the raw data, aiming to reduce the volume of information and to prepare for the following step in the process, consisting in identifying patterns in the data. The primary set of topics guided the interview protocol and was related to the definition of Brazilian *jeitinho*, its social acceptance and its applicability in business matters, addressed in the Section 8.6.

The interviews were then organised into series of quotes, and similar to the hierarchical coding technique (King, 2004:258), “groups of similar codes” were “clustered together”. Key issues were then isolated, and the topics with higher frequencies were defined for the study. Table 7 displays the five topics defined for the study that emerged from data analysis (harm to third parties, seriousness of the issue, formality of relationship, personal benefit and assessed pertinence of rules and laws) and their appearances in each of the interviews, as these were the dimensions used by the participants when assessing whether a given Brazilian *jeitinho* practice

is considered as creative or a sign of corruption. These dimensions then gave rise to our theoretical framework in Section 8.7. The findings for each set were then cross-tabulated, presented and discussed with the rest of the research team.

Table 7: Brazilian *jeitinho* assessment dimension frequency in interviews

#	Harm to third parties	Seriousness of the issue	Formality of relationships	Personal benefit	Assessed pertinence of rules and laws
1	√			√	
2					
3			√	√	√
4			√	√	√
5			√		√
6	√		√	√	√
7	√	√	√		√
8			√		√
9	√		√		√
10	√			√	√
11		√	√	√	√
12		√		√	√
13	√	√	√		√
14	√		√	√	√
15			√		√
16			√		√
17	√	√	√		√
18		√	√	√	√
19			√		√
20				√	√
21	√	√	√	√	√
22	√		√	√	
23			√	√	
24			√	√	√
25	√	√		√	√
26	√			√	
27	√			√	√
28		√			√

8.6. Results

The classification of the data led to the definition of two main groups of findings that emerged from the analysis. First, two contrasting perceptions of *jeitinho* are discussed, along with the

society’s assessment of *jeitinho* according to its different connotations. Second, the uses, applicability and role of *jeitinho* in business are explored.

8.6.1. *The Nature of Brazilian jeitinho and its social acceptance*

Analysis of the data shows that Brazilian *jeitinho* is usually perceived as any set of actions or behaviours intended to bypass established norms and rules. In that sense, it is perceived as occasionally being the only alternative to make something easier or even possible. The quotes in Table 8 illustrate this perception:

Table 8: Illustrative quotes for the nature of Brazilian *jeitinho*

Alternative	<p>“Brazilian <i>jeitinho</i> is to take advantage or try to solve something that a system, a rule would not allow.” (#1)</p> <p>“Brazilian <i>jeitinho</i> is to always try to find a way to make things happen, without following any process, doing it in an easier way.” (#7)</p> <p>“<i>Jeitinho</i> is to find alternatives to pre-determined rules.” (#22)</p>
Action to be proud of	<p>“<i>Jeitinho</i> is the art of improvising. To know the rules of the game and to be able to see opportunities in them is a talent.” (#2)</p> <p>“Brazilians are extremely creative in situations of scarcity, and that is a form of <i>jeitinho</i>.” (#22)</p> <p>“Brazilian <i>jeitinho</i> is creativity in solving problems, in the face of critical situations or in negotiation contexts.” (#25)</p>
Shameful behavior	<p>“(…) bribery, informal arrangements with public ministries” (#3)</p> <p>“For instance, if a buyer were to cheat on the weightings of the factors that are employed in a supplier selection process, in order to favour a determined company or contract.” (#14)</p> <p>“When you work with integrity and transparency in the negotiation, then the Brazilian <i>jeitinho</i> is completely disposable.” (#26)</p>

Within this reasoning, *jeitinho* is also perceived in two opposing and relatively clear-cut ways. On the one hand, it is often seen as a fair relaxation of the highly bureaucratic rules and norms. Inherently, its use is perceived as a personal ability that can allow individuals to accomplish tasks and solve problems despite difficulties arising from standardisation. *Jeitinho*

can also be perceived as a response to a deficiency in resources, with which Brazilians would then be able to cope by forging creative alternatives to the situation. In addition, the ability to remain on the margins of the rules is seen as relatively demanding and therefore reserved to those who boast a high level of knowledge of the standards and laws. From that point of view, the use of *jeitinho* is often reported as something to be proud of, as it demonstrates a high degree of brightness and creativity.

While it may be seen as a sort of harmless, productive and even welcome creativity in solving day-to-day problems, *jeitinho* is also constantly associated with a lack of respect for ethical principles. In its more negative uses, *jeitinho* is generally defined as a synonym for illicit practices or corruption, a dimension that comes out more frequently in discussions of the relations between two companies (e.g. buyers and suppliers) and between companies and governments. In these cases, *jeitinho* is frequently seen as shameful behaviour for those who take part in it.

Along with the contrasting perspectives of *jeitinho*, two different assessments were identified as to the acceptance of its use. Depending on the means applied and on the gravity of the expected consequences, *jeitinho* may be seen either as an acceptable valid practice or as an unacceptable breach of morality. Regarding the former, *jeitinho* is seen as acceptable when it is presumed not to be harmful to third parties, insofar as no major consequences are expected for society on account of these practices. This view would appear to be more closely associated with the perception of *jeitinho* as a form of creativity in solving problems, even if to make things work, “small” misdeeds are required along the way. The quotes in Table 9 embody this view.

Table 9: Illustrative quotes for the social acceptance of *jeitinho*

Ethical	<p>“<i>Jeitinho</i> is acceptable when it does not harm anybody.” (#1)</p> <p>“If it is understood as a way to create alternatives, I think that it [<i>jeitinho</i>] is legit and valid. If it does not cause trouble or harm to another person, there is no problem in using <i>jeitinho</i>.” (#10)</p> <p>“<i>Jeitinho</i> is acceptable when it is interpreted as flexibility. (...) When you are in competition with a foreign company, for instance, and you are in Brazil, you know the client, you know what he expects from the product or service. And you have the ability to make your delivery more flexible to meet the client’s demand.” (#18)</p>
Unethical	<p>“<i>Jeitinho</i> is unacceptable when you harm other people.” (#7)</p> <p>“<i>Jeitinho</i> is unacceptable where it involves economic abuse of power, or comes in the form of exchanging favours for things that are not legal.” (#11)</p> <p>“I once watched a company go bankrupt and a CEO get fired because he tried to use <i>jeitinho</i>, and the investors ended up withdrawing the money.” (#21)</p> <p>“From my previous experiences, in sales there is a lot of <i>jeitinho</i>, in terms of trickery and roguery. It only serves to ‘push’ a product to someone, regardless of its quality. Sellers just have to sell it, and they do not care if the client will end up making the right purchase or not.” (#26)</p>

On the other hand, *jeitinho* is perceived as unacceptable and undesirable when it is considered to be harmful, illegal or representing abuse of power. It may be linked to deceitful actions carried out with the objective of gaining personal benefits while harming the counterparty involved. Within this reasoning, the use of *jeitinho* is seen as one of the main causes of corruption.

8.6.2. *The Role of Brazilian jeitinho in Business*

Regarding the role and the use of *jeitinho* in business, it is perceived as recurrent in three distinct areas: as an alternative to restrictions and bureaucracy, as a facilitator in buyersupplier relationships, and as way of dealing with issues related to intra-organisational processes (see the illustrative quotes in Table 10).

Table 10: Illustrative quotes for the applicability of *jeitinho* in business

<p>Alternative to restrictions and bureaucracy</p>	<p>“[<i>Jeitinho</i>] not only facilitates, but also makes possible or viable projects that without <i>jeitinho</i> would be impossible to accomplish.” (#2)</p> <p>“In Brazil, unfortunately, if a company were to follow all the [legal governmental] protocols, it would waste a lot of time and money.” (#10)</p>
<p>Facilitator in buyer-supplier relationships</p>	<p>“Suppliers use <i>jeitinho</i> to adapt products and services all the time, in order to meet our demands.” (#2)</p> <p>“Sometimes I have to ask [my supplier] for something that was not defined in our contract. For the relationship’s sake and because of his will to get repeat business, he delivers.” (#3)</p> <p>“If you are friends with your client, then <i>jeitinho</i> improves the relationship.” (#16)</p> <p>“<i>Jeitinho</i> is an informal criterion for choosing between suppliers. I need suppliers that can solve my problems, and not those who bring more trouble. (...) And in the end, suppliers use <i>jeitinho</i> to deliver what their commercial team have promised.” (#25)</p>
<p>Dealing with inflexible intra-organizational norms</p>	<p>“<i>Jeitinho</i> has the function of stepping over rules, and highly bureaucratic companies have a lot of rules.” (#3)</p> <p>“When you have to meet some demand or make certain modifications to the system. There is the company’s protocol that takes about two days. But with <i>jeitinho</i>, you can reduce the timing to less than one day, for instance.” (#15)</p> <p>“Use of subterfuge means to cheat on a rule. Another example would be not formalizing employees’ contracts. (...) In some sectors (...), it is a very ingrained practice.” (#18)</p>

Concerning its role in dealing with restrictions and bureaucracy, *jeitinho* is seen as a response to the severe and prohibitive Brazilian legal environment. In this respect, it would seem to be viewed as an alternative way of coping with such restrictions to make business possible despite the high level of bureaucratisation of the country. In this sense, some of the bureaucratic impositions are even perceived as barriers to the viability of projects, to the extent that following them would imply in the non-accomplishment of the targeted results. Regarding the internal processes of companies, *jeitinho* is often quoted as a way of dealing with inflexible norms and rules. In that sense, it appears to represent a way of proceeding more permissively in matters of compliance.

When a business-to-business perspective is considered, *jeitinho* is quoted as a facilitator of the relationship between buyers and suppliers, most notably by making operational rules more flexible or by customising general practices for specific partners. These actions would seem to be used mainly to strengthen pre-existing relationships, with *jeitinho* described as being more successful when it comes to keeping clients than winning new ones. Here, the informal dimension of these relations seems to stand out, with *jeitinho* apparently being more easily employed when buyers and suppliers share a relationship that is closer to friendship. Unlike other indigenous practices that presuppose blood or background ties between the parties (i.e. clanism, *blat* and *yongo*), *jeitinho* is possible when those ties are weak as long as those involved share a certain friendship. Moreover, although there is not a clear distinction in the perception of *jeitinho* as ethical or unethical between buyers and suppliers, in terms of its mechanics in the context of buyer–supplier relationships, there is a clearer understanding as being performed by suppliers to satisfy their clients’ needs. When inquired about whether their suppliers made use of *jeitinho* to fulfil their expectations, 11 out of the 14 buyers responded affirmatively, adding that the ability to use *jeitinho* is an informal criterion in choosing among suppliers. On the other hand, with the exception of only one, the respondents that occupy positions on the supplier side of the relationship dyad stated that the use of *jeitinho* is necessary to meet their clients’ demands. Such results suggest that, regardless of their dyadic position, *jeitinho* is expected to be used to enhance the quality of the relationship and might be specifically considered as an important attribute when it comes to suppliers’ capabilities.

8.7. Discussion

On the basis of the results presented above, five main dimensions emerged for the assessment of *jeitinho* as a form of creativity or a form of corruption: harm to third parties; seriousness of

the issue; formality of relationships; personal benefit; and assessed pertinence of rules and laws. Each dimension is addressed in this section, providing the basis for our proposed definition of the Brazilian *jeitinho*.

Concerning the first dimension, when the use of *jeitinho* is not expected to have major consequences for third parties, it seems to benefit from a less negative connotation and is seen as an inoffensive practice. In line with the conclusions of Warren, Dunfee and Li (2004), who discussed the harmfulness and helpfulness of *guanxi* to individuals, business and the Chinese community, our study also considers “third parties” on three levels, including individuals, companies and society in general. In these cases, the bright side of *jeitinho* takes the form of an ethically valid alternative in dealing with difficulties in a creative way. On the other hand, once negative outcomes are expected for third parties, *jeitinho* is perceived as noxious and as a pernicious and unacceptable practice. In this latter perspective, the ethical validity of the practice is questioned, positioning it closer to corruption.

In terms of the seriousness of the issue, when *jeitinho* is used to resolve “small day-today” problems, it is generally perceived as a creative and valid method. Small problems can be solved through minor deviations from expected behaviour, and these deviations do not give rise to any major concerns. On the other hand, once issues of a more important nature are considered, the significance of the solutions offered by the use of *jeitinho* also seems to increase. A sense of proportionality to the seriousness of the issue is manifested, which tends to lead people to label the practice as somehow riskier, and thus, preferably avoidable. It seems that the use of *jeitinho* to deal with bigger issues turns the spotlight on the more fragile aspects of such practices and may expose those who make use of them to a moral judgment and to outright condemnation. Apparently, as a way of anticipating any such moral judgment, people seem to condemn the use of *jeitinho* for bigger issues themselves, generally linking it to corruption. Using the

classification of corruption as petty versus grand (Argandona, 2005), only grand corruption is seen as corruption: petty corruption (or grease payment) when associated with *jeitinho* is not considered as corruption by Brazilian practitioners.

As for the formality of relationships, the use of *jeitinho* may occur either individually or collectively. While the former is generally associated with personal responses to one-off situations, the latter commonly involves two separate actors in an exchange in which one has a problem and the other the means to offer a possible solution. Analysis of the data revealed that the closer two hypothetical parties are to being friends, the likelier it is that *jeitinho* will be proposed and happen, with the practice remaining within a sort of camaraderie or brotherhood between colleagues or friends. In these cases, it seems that the nature of the relationships spills over into the assessment of the practice, reducing any other considerations. People tend to perceive it as part of normal and healthy relations, endowing it with a sort of natural character. However, once the practice appears in relationships surrounded by a stronger sense of formality, the perception changes and *jeitinho* tends to be perceived as a transgressive practice. In this view, *jeitinho* requires an extra effort when it is not seen as a natural component of the relationships in question.

In the personal benefit dimension, the assessment of who may eventually benefit from the outcomes of *jeitinho* also seems to affect how people perceive it. When *jeitinho* is used altruistically (i.e. for the benefit of third parties), it tends to be perceived in a more positive light. The alternative solutions offered are generally welcome, as they are seen as representing a creative way of helping people and, ultimately, doing good to society. However, when people use *jeitinho* more selfishly in search for personal benefits, it tends to be associated with negative practices.

Finally, for the assessed pertinence of rules and law, analysis of the data revealed that when *jeitinho* is used as the only alternative to overcome a problem, it is seen as being valid. In these cases, rules and laws are not perceived as relevant or beneficial, but as inappropriate obstacles to be overcome. In these cases, once again, *jeitinho* is associated with a positive projection of creativity, as it ultimately allows a task to be accomplished in an alternative way. This conclusion is consistent with the definition of *jeitinho* as an informal problem-solving method to work around bureaucratic rules (Amado and Vinagre Brasil, 1991; Duarte, 2006).

According to the data, *jeitinho* is clearly associated with corruption when it concerns “changing rules”, but not when it deals with “deviation from the rules”, in reference to Cuervo-Cazurra’s (2016) distinction. “Deviation-from-the-rules” corruption is perceived as a positive side of *jeitinho*. However, once rules and laws are perceived as pertinent, the use of *jeitinho* to bypass them is often pointed to as being invalid and reprehensible. In these cases, the association of *jeitinho* with a clear and intentional disrespect for valuable and pertinent laws is closely linked with the practice of corruption.

Based on the discussion above, Figure 7 illustrates the balance of the Brazilian *jeitinho* between creativity and corruption, according to the five emerging dimensions, along with quotes illustrating these two extremes in Table 11.

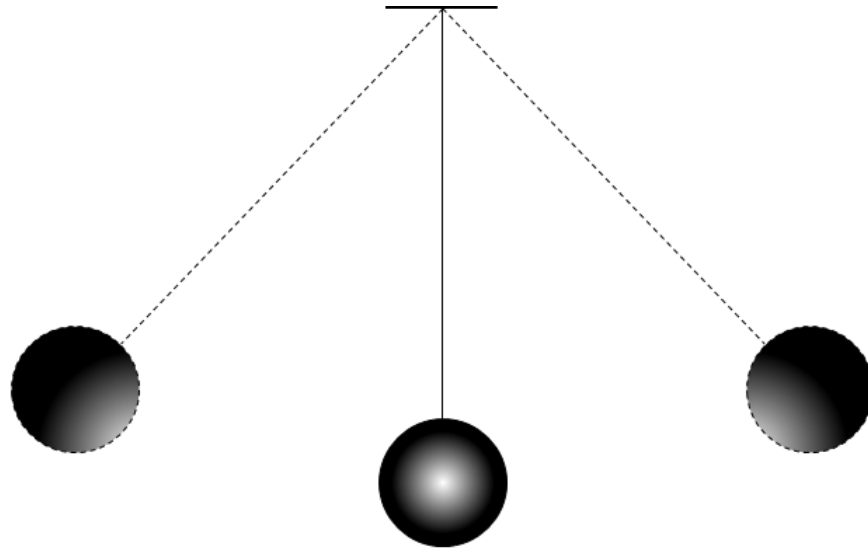

Creativity	Dimension	Corruption
No harm to third parties as a consequence of using <i>jeitinho</i>	Harm to third parties	Third parties harmed from the use of <i>jeitinho</i>
Smaller, lighter day-to-day issues	Seriousness of the issue	Serious issues
Informal relationship or situations, close to friendship	Formality of relationships	In environments of high formality/control
No personal benefit. Benefit to third parties sometimes acceptable	Personal benefit	Personal benefit as a motivator for the use of <i>jeitinho</i>
Low assessed pertinence and/or high malleability (i.e. bendable) of rules and laws	Assessed pertinence of rules and laws	High assessed pertinence and/or low malleability (i.e. breakable) of rules and laws

Figure 7: The balance of Brazilian *jeitinho*

Table 11: Illustrative quotes for creativity and corruption of the Brazilian *jeitinho*

Creativity / Ethical	Dimension	Corruption / Unethical
“A person could be proud of using <i>jeitinho</i> when this unnatural path did not impact any other stakeholder or peer.” (#6)	Harm to third parties	“ <i>Jeitinho</i> is unacceptable when there is loss (financial, sustainability, and so on) to any part of the system (company, customer, or supplier, for instance).” (#25)
“In less serious situations, you have to have <i>jeitinho</i> in order to resolve smaller issues, like in human relations, for instance.” (#21)	Seriousness of the issue	“If you think of more serious issues, the root of corruption in Brazil is closely linked to <i>jeitinho</i> in business”. (#18)
“Sometimes an informal conversation can make a difference when negotiating.” (#15)	Formality of relationships	“In situations of higher control and formality, there’s no place for <i>jeitinho</i> .” (#21)
“When you have to deal with issues that are outside your hierarchical scope in order to be able to work, then it is something to be proud of.” (#13)	Personal benefit	“[<i>Jeitinho</i>] is unacceptable when it involves personal benefits.” (#06)
“Brazil has a lot of taxes, a lot of rules. If you go ‘by the book’, you cannot succeed.” (#21)	Assessed pertinence of rules and laws	“For the country’s sake in terms of the future and business, we would be better off without <i>jeitinho</i> .” (#19)

We propose that the Brazilian *jeitinho* should be analysed from a critical viewpoint, not as an ethical or an unethical action but as a term embedded in semantic instability, meaning that its ethicality is able to range from positive to negative, or from creativity to corruption, depending on the dimensions it is assessed by. In this sense, the definition of theoretical extremes is not intended to delimit punctual situations or cases. Instead, it may be understood as a simplification of reality, delimiting the space within which the combination of different variables may fluctuate and result in a diverse set of combinations (Fracarolli Nunes and Lee Park, 2016). In a complex social phenomenon such as the Brazilian *jeitinho*, it is particularly probable that real circumstances will fall somewhere in the grey area between these two extremes of pure creativity or pure corruption. The following quotes illustrate observed cases that may be argued to fit this scenario in that it is not clear on which side the pendulum is:

“Brazil has a lot of taxes, a lot of rules. If you go “by the book”, you cannot succeed. I complain when someone gives a *jeitinho* with me, but I do that too sometimes. [...] Brazilians don’t know how to follow rules. To step outside of a pre-determined path is very natural for us.” (#21).

“In airports [*jeitinho*] is very common. In some cases, there are people who do not charge a “less affluent” passenger for exceeding the luggage weight, and then move this charge to other passengers who did not really use it.” (#27).

As portrayed in the examples above, the grey area of *jeitinho* tends to emerge in contexts of greater social complexity, where different dimensions are affected at the same time and to differing intensities. This contributes to the ambiguity in the assessment of the overall ethical outcome of the actions. In this perspective, the interpretation of each case in which *jeitinho* is used may vary considerably from one person to another, as it may be largely based on individual moral judgements and values. Depending on the dimension to which the individual is more sensitive, he or she may interpret *jeitinho* either positively or negatively, as a specific dimension (or set of dimensions) may be more or less important to their own personal judgement.

Creativity might be understood as a process inherent to social interactions (Byron, Madjar and Perry-Smith, 2015). Moreover, creativity is regarded as a “social cultural and contextually embedded phenomenon” (Fleith, 2011). *Jeitinho* may be seen as a creative way to avoid a highly bureaucratic Brazilian administration (Amado and Vinagre Brasil, 1991; Duarte, 2006). The use of *jeitinho* may provoke quite distinct reactions, as despite the fact that it may be seen as causing no direct harm to third parties and as being beneficial to the local community, it may also be seen as a way of gaining personal benefits, as politicians will benefit directly from it by being able to claim responsibility for building streets and schools.

“Even in large companies, you have to benefit public agents all the time. A company I previously worked at had to build streets and a school in order to gain access to a certain city, to be able to open a subsidiary there.” (#20).

In this case, dimensions are also being pushed in opposite directions. While the construction of roads and schools may be perceived as a good outcome for the local community, as a benefit

to third parties, positioning *jeitinho* on the creative side when such actions pertain to the public sphere, this may imply that the local government has the budgetary power to do so. The fact that it does not act on such and asks a private company to do so instead might mean that unethical practices are taking place (e.g. deviation of resources), clearly pushing *jeitinho* towards a form of corrupt behaviour. Adding to the complexity of the analyses, the same dimensions could also be interpreted in quite opposite ways. It might be argued that in this case, *jeitinho* has actually caused harm to third parties, as companies that may have strictly followed the rules may have been at disadvantage in a competitive situation even if they offered better terms. On the other hand, it might be argued that the benefits for society are greater than those for any individual politician, thereby countering the idea of personal benefit.

If other dimensions are also included in the discussion, the conclusions on this situation could become even cloudier. The seriousness of the issue may be seen as either low or high, depending on the lenses applied. One could say that it is not a serious situation as it does not depart much from common practices between players in the private and public sectors. On the other hand, it could be argued that this sort of behaviour encourages corruption at all levels and thus directly harms society by its perceived contempt for the norms and rules of a genuinely democratic state. Similar dual treatments may be applied to the other two dimensions. The relationship between members of a company and those of the public sector might be expected to be governed by the formalities set out by the law, while at the same time, this sort of relationship is based on interactions that are closer to friendship. Differentiation between these two distinct situations might be particularly difficult. In turn, the last dimension, the assessed pertinence of rules and laws, can be also dubious. In this case, it is possible that an outside observer might understand that, as the rules have not been strictly followed, they were not respected. However, rules may be interpreted as not having been actually breached,

but rather treated in a more flexible manner. In this case, this dimension may represent the best example of the difficulties surrounding the interpretation of *jeitinho*.

Considering the specificities of each situation, the same rationale could be used, as they all represent situations of potentially increased duality. In this respect, it could be argued that perceptions of *jeitinho* are not only influenced by the combination of different sets of dimensions but also by the countless sets of levels of sensitivity an external observer may have towards these dimensions. We therefore propose the following definition of the Brazilian *jeitinho* and a framework for its assessment (Figure 2):

The Brazilian *jeitinho* is the informal act of circumventing rules in order to achieve specific goals, balancing between the ethical frontiers of creativity and corruption. Its ethicality (corruption versus creative action) depends on the causes (personal benefits versus altruistic intentions and high versus low assessed pertinence of rules and laws) and the consequences (harm versus no harm to third parties) of using it, as well as the context in which it is employed (serious versus not so serious issue and informal versus formal relationships).

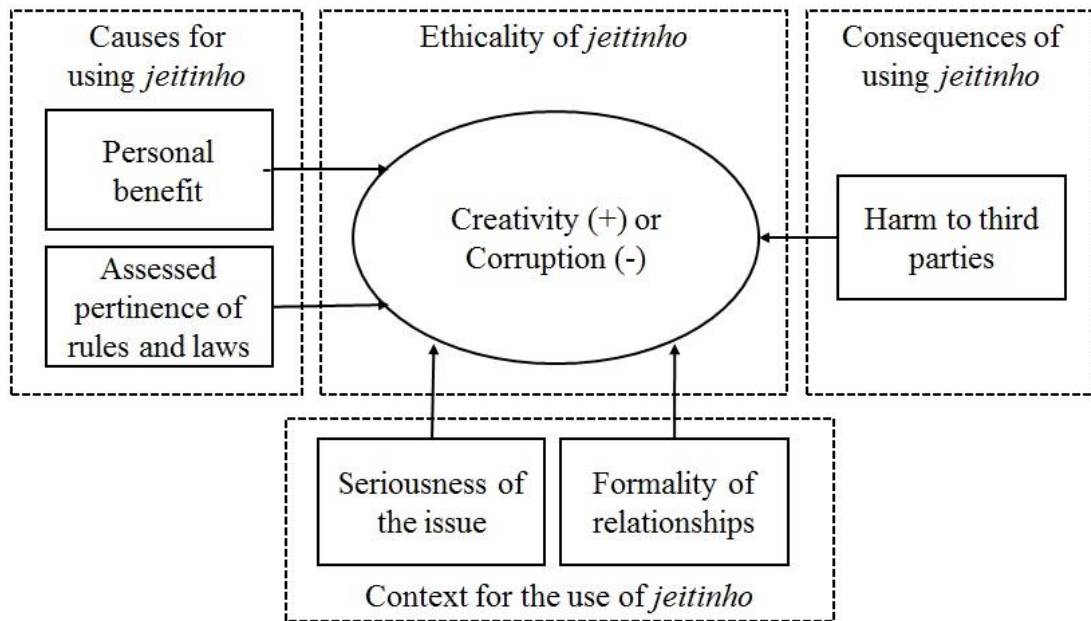

Figure 8: Proposed framework for the ethicality of the Brazilian *jeitinho*

The complexities arising from the interpretation of *jeitinho* are not surprising, however. In light of the discussions above, we would seem to be on fairly safe ground in asserting that assessments of this practice are highly dependent on a social construction of meanings (Barkin, 2009), which inherently qualifies it as being highly complex in terms of interpretation. Therefore, despite the propositions put forward by the study, providing a prescriptive formula for assessing *jeitinho* could prove to be far too ambitious. The main contribution of this paper may be seen as drawing attention to the possibility of distinct interpretations of the same social act being highly dependent on the complexities of its observers and its specific context. The practical and theoretical implications are discussed in the next section.

8.8. Practical and Theoretical Implications

From a practical perspective, the results of the study may offer new insights into the Brazilian business environment. In that regard, a deeper comprehension of the contexts in which *jeitinho*

is used and its different connotations may optimise the relations between foreign and Brazilian companies, as well as between foreign and Brazilian managers and employees. Anticipation of possible misunderstandings may lead to more harmonious relations between foreign and Brazilian actors, thereby minimising the issues of disconnected relations and bringing the benefits of adjusted and consonant business relationships. An integrated assessment of *jeitinho* in the contexts of other business issues may add to a richer and possibly more accurate understanding of the effects of social phenomena in strategic choices. The inclusion of a cultural dimension in international transactions shall be particularly useful, as, through a better understanding of the interaction between players from different countries or cultures, the flow of power in those relations may be better dealt with.

A similar rationale can be used in the design and management of global supply chains in which managers of multinational companies are necessarily in contact with international players. Hennart, Sheng and Pimenta (2015) also analyse how local industry characteristics may impact the choice of foreign investments in the country. In this sense, an extended view of Brazilian *jeitinho* is expected to offer foreigners a chance to develop more effective communication with Brazilian people and reduce misunderstandings in the conduct of business. Suppliers might use *jeitinho* to enhance their ability to meet customers' needs, while buyers may require suppliers to come up with creative or flexible solutions to their problems. Our study provides an ancillary contribution to the understudied field of the influence of culture on inter-company links (Ribbink and Grimm, 2014) and therefore furnishes guidance for improving buyer–supplier relationships in multicultural contexts where Brazilian businesses or managers are involved. Additionally, Brazilian practitioners may benefit from a deeper understanding of the mechanics of *jeitinho* in business relationships, especially when it comes to appraising its ethicality. The proposed framework may help them to better apply the positive and ethical facets of *jeitinho*, generating creative solutions or responses to the demands they face.

From a theoretical outlook, by highlighting the different aspects revolving around the diverse uses, interpretations and contextualisations of *jeitinho*, this study contributes to clarifying the existing literature, while providing the basis for future development, mainly on matters relating to the present ambiguity over indigenous practices. Additionally, in raising the discussion on cultural distance as a potential antecedent for comprehending social phenomena, the study offers valuable perceptions that may extend the assessment of indigenous management concepts in general. In line with recent research in other contexts (Dunfee and Warren, 2001; Gooderham, Nordhaug and Ringdal, 2006; Gu, Hung and Tse, 2008; Hawkins, Randall, Coyne and Baitalmal, 2014; Horak, 2016; Hutchings and Weir, 2006; Ledeneva, 1998; Michailova and Worm, 2003; Warren, Dunfee and Li, 2004), it reinforces and analyses the ambiguous character of indigenous practices, proposing a critical interpretation of the assessment of their ethicality. The focus of the investigation on the perception of Brazilian managers works as a control variable of the study, as it eliminates possible turbid perceptions arising from the eventual myopia or a vision influenced from outside. In this way, it confirms that *jeitinho* is not entirely linked to corruption. The study's approach may offer a theoretical basis for future research on *jeitinho*, as well on other indigenous management concepts.

8.9. Conclusion

The contributions of our study are fourfold. First, it fills an important gap in the literature regarding the dual perception of *jeitinho* among Brazilian managers and offers a critical perspective of Brazilian *jeitinho*. We do not merely propose a descriptive and instrumental depiction of *jeitinho*, we answer to the critical questions “is *jeitinho* perceived to be ethical” and “what factors influence the perception of the ethicality of *jeitinho*”. To the best of our knowledge, the duality of *jeitinho* has never been studied in detail: when and why this practice

is perceived as positive or negative. Our results suggest that Brazilian *jeitinho* is perceived in two opposing ways: either as a creative solution or as synonymous with corrupt and illicit practices. We propose a critical assessment of the ethicality of the practice, in which such duality is present simultaneously, i.e. individuals hold both perceptions and portray *jeitinho* as positive or negative depending on the context in which it is used. In both cases, the motivations for its use seem to relate to the possibility of making something possible or more efficient, regardless of the requirements of the formal procedures set down by norms, laws and rules. The results also indicate that *jeitinho* is used in a vast range of situations, from day-to-day issues to those encompassing the buyer–supplier relationship and interactions between companies and governments.

Second, in answer to our research question of what factors influence the perception of the ethicality of *jeitinho* among Brazilian professionals, we propose five dimensions through which Brazilian professionals assess *jeitinho* as either creative or corrupt behaviour: harm to third parties, seriousness of the issue, formality of relationships, personal benefit and assessed pertinence of rules and laws. Third, we take a step forward on the issue of perceptions and also study social acceptance of *jeitinho* among Brazilian practitioners. According to our data, the consequences of *jeitinho* are of substantial importance in its social assessment. If no major consequences are perceived, the use of *jeitinho* is considered to be a less significant breach and not worthy of exhaustive analysis or punishment. On the other hand, once negative outcomes result from its use (e.g. harm to third parties), it may be strongly disapproved of. This would appear consistent with the duality of the term. When positive, it can help resolve difficulties and problems, while when negative, it is seen as causing major damage to the Brazilian society.

Finally, we propose a categorisation of the role of *jeitinho* in business. When *jeitinho* is used as a solution to problems arising from bureaucracy, it is regarded as something positive, and

even as a personal skill of which people should be proud. In general, this assessment relates to the dimensions of *jeitinho* within the analysis of inter-organisational processes, such as compliance and internal rules of companies. Moreover, interfaces between companies, such as buyer–supplier relations, also seem to fall within this scope. In these relations, the data suggest that the presence of *jeitinho* is possibly influenced by the level of informality between the parties involved. The closer buyers and suppliers are to being friends, the more *jeitinho* may be used to resolve their common problems. In line with the discussions in the literature, *jeitinho* works more effectively between people who know each other (Duarte, 2006). Suppliers that have the ability to apply *jeitinho* to fulfil customers’ needs might hold an advantage over their competitors, as buyers may appreciate and even expect suppliers’ use of flexibility to meet their demands.

On the other hand, Brazilian *jeitinho* is often associated with its “dark side” when it is used between companies and their legal environments. The relationship between firms and governmental entities is perceived as a fertile field for the practice of corruption. Within this view, the term seems to be used as a code or euphemism for the practice of illicit exchanges of money and influence between the private and the public sectors.

8.10. Limitations and Future Research

Despite its notable contributions, our study reflects the immaturity of this research field and does have some limitations. Specifically, while our empirical results are interesting, they cannot be generalised due to the exploratory nature of our study and the small number of interviews. However, it offers fruitful ground for further analysis on larger samples and for a finer understanding of different perceptions of *jeitinho* according to respondent profiles and company

contexts. It would also be interesting to triangulate our results with perceptions among non-Brazilian managers doing business with Brazilian companies. We hope our future research will contribute to filling these gaps. These limitations aside, we believe that our study brings significant new insight into the duality of Brazilian *jeitinho*.

Regarding future research, progress on the explanations for the different functions and interpretations of national idiosyncrasies may represent a decisive and fundamental aspect for the future of indigenous management research. Empirical work could test, question, confirm or reinforce the theoretical model proposed. This could be particularly useful for extending the present research beyond *jeitinho*.

Chapter 9. Paper Three – The Fifth Element of the Relational View: What Can French Filmmakers Teach Us on International Buyer- Supplier Relationships?

9.1. Background to Paper Three

The third and final paper, entitled “The fifth element of the Relational View: What can French filmmakers teach us on international buyer-supplier relationships?”, was the last one to be written, and it was done in sole authorship. Originally intended for submission to a journal within the International Management field of study, the primary target of this paper is the *Global Strategy Journal*, as it may represent a potentially good fit in terms of aim and scope, and therefore guides the format requirements and specifications, such as the presentation of a plain language and a technical summary.

An early version of the paper was discussed during the *Avancement de thèse* procedure in June of 2017 at ESCP Europe, in which valuable insights and comments were provided, helping to better frame and strengthen it. Special thanks to Mauro Fracarolli Nunes, Prof. Dr. Valérie Moatti, Prof. Dr. Maral Muratbekova-Touron, and Prof. Dr. Aurélien Acquier for such insightful takes. It was also discussed with Dr. Blandine Ageron and Dr. Ulrike Mayrhofer, the referees of this dissertation in the pre-defense stage, allowing me to gather valuable insights to enhance its contributions, and for which I am very grateful for.

This study relies on a conceptual approach of the cultural issues that might influence the relationship between companies. Profiting from my previous and current work on the impact of cultural idiosyncrasies and differences on operations strategy, cultural alignment is proposed to impact the generation of competitive advantage on buyer-supplier configurations, offering a conceptual development to be applied in cross-cultural buyer-supplier relationships.

**“The Fifth Element of the Relational View: What Can French Filmmakers Teach Us
on International Buyer-Supplier Relationships?”**

Camila Lee Park

9.2. Abstract

Plain language summary –

This study aims to deepen the understanding of the impact of cultural differences in buyer-supplier relationships contextualized in international settings. Deriving two major lessons learned from successful French filmmakers that thrived in an American-dominated industry, the abilities to identify and meet cultural expectations and to socially navigate/overcome cultural differences are proposed to hold the capacity of generating competitive advantage through supply chain relationships. Managers enrolled in negotiations with partners pertaining to different cultural paradigms may better position their strategies when working in international supply chains contexts.

Technical summary –

This study proposes a conceptual reinterpretation of buyer-supplier relationships from a cultural perspective. Building on the Relational View and guided by lessons taught by French filmmakers that thrived in an American-dominated industry, the insertion of cultural alignment as a fifth dimension of determinants of relational rents is suggested, referring to the fit between dyadic partners when they belong to different cultural contexts. By approaching cultural alignment both analytically and systemically, the abilities to identify and meet cultural expectations and to socially transpose cultural differences are theorized to facilitate the generation of relational rents, thus contributing to competitive advantage. Such theoretical

extension opens an avenue for a multitude of theories that may encounter a better fit in cross-cultural interorganizational relationships and emphasizing the cultural perspectives' importance.

Key-words: Relational View, buyer-supplier relationship, cultural alignment, international business, intercultural management

9.3. Introduction

Intensively dominated by the American influence (Crane, 2014), the global entertainment industry has watched the rise of French filmmakers since the early 1970s (Langman, 2000). Names such as Luc Besson, the “most Hollywood of French filmmakers” (Wolf, 2007), figure among the major league players in the field, with worldwide blockbuster successes such as “Lucy” and “The Fifth Element”. Based between Paris and Beverly Hills, Besson’s connection to the American culture has been evident since his early adulthood. Attempting a spot on La Fémis, the prominent French film school, he pointed at Steven Spielberg, Martin Scorsese and Milos Forman as his most admired directors, to which he was immediately cut off for not belonging at the institution (Wolf, 2007).

While the interplay between French and American movies is still booming, the movement sometimes also implicates frustrated endeavors. When interviewed by Annette Insdorf – then an Associate Professor at Yale and Columbia – to The New York Times in 1985, the French film director, producer and writer Francis Veber comments:

“A remake requires a great writer. Failures can be explained by the fact that producers say, ‘If we have a precise model to work from, we can hire a second-rate author’. And of course there’s the fact that you’re going from one universe to another, like from cognac to... what’s that American whisky?... bourbon. (...) There has to be a transposition, and if you have a talented writer, he’ll take great liberties. For the first draft of the American ‘Les Comperes’, the writers stuck very close to my script – and the charm was dead”. (Veber, in: Insdorf, 1985)

Much like the struggles encountered in the filmmaking industry, international supply chain managers are faced with difficulties that stem from cultural differences. Inner to internationalization contexts, companies have spread their activities not only to geographically, but also culturally distant markets and societies (Sousa and Bradley, 2006; Kogut and Singh, 1988) in a way that, in many cases, these motions may represent a sudden and abrupt encounter of different and possibly antagonistic social identities (Boulu-Reshef, 2015). Yet within the

global markets arena, negotiations across supply chains may happen to take place in distinct cultural environments, each carrying its own idiosyncrasies. The need for the ‘transposition’ referred to by Francis Veber is also reflected into buyer-supplier transactions in global contexts – the mere application of a pre-determined model, or strategy, will possibly lead to a failed replication, instead of a successful and profitable relationship.

Beyond the historical need to export production surpluses (Baily and Bosworth, 2014), strategic issues such as the search for more competitive conditions in terms of cheaper work force (Sekliuckiene, 2013), tax incentives (Zhang, Wang, Wang and Zhao, 2015), and benefits from trade agreements (Campos, Axinn, Wang and Baeza, 2016), among others, have offered concrete incentives for many western multinationals to place their bets on far away countries. If, by one side, the accommodation of different social perspectives may be considerably costly to parties involved, eroding the profitability and the general performance of businesses (Furusawa and Brester, 2015), on the other, well-developed harmonization between cultures may lead to increased accomplishments, optimizing general management results (Luo, 2016; Clampit, Kedia, Fabian and Gaffney, 2015). Aiming to offer supplementary insights on the issue, the present study proposes a conceptual reinterpretation of buyer-supplier relationships under the lenses of the Relational View (Dyer and Singh, 1998). Through the assessment of its main theorizations, cultural management approaches are inserted in the discussion as an additional form to analyze the determinants of interorganizational competitive advantage.

Cultural perspectives have been increasingly addressed within the Management literature as a factor for the understanding of theories in local contexts. From this perspective, our research question surfaces: *To what extent does cultural (dis)alignment impact the generation of relational rents in a buyer-supplier relationship?* In addressing the issue, novel insights around the management of cross-cultural relationships are offered. The lack of cultural alignment in

dyadic relationships is argued to act as a direct influencer on the generation of relational rents. Within this reasoning, the sturdier the fit between such cultures, the more positive its expected impact would be on relational rents, and thus, ultimately, on generated competitive advantage. Such achievement is suggested to be met by a two-path advance that involves both systemic (i.e. social transposition) and analytic (i.e. meeting of cultural expectations) approaches of cultural management.

Next to this introduction, the study is organized as follows. The section ahead draws a literature review on the main features of the relational view, and on cultural management within the context of international supply chains. The fifth cultural element to the relational view is then presented, along with the theoretical development and conceptual framework, followed by the discussion of practical and theoretical implications, and conclusion.

9.4. Literature Review

9.4.1. The Relational View

In opposition to Porter's (1980) industry structure view, which suggests that firms' abnormal performance is the result of their enrollment in industries presenting favorable conditions, from a resource-based perspective (Barney, 1991; Rumelt, 1984; Wernerfelt, 1984; Penrose, 1959) superior performance is understood as a prior outcome of firms' heterogeneity against their competitors (Barney, 1991, in: Dyer and Singh, 1998). Competitive advantage would thus be a result of resources and capabilities, relating to tangible and intangible assets, controlled by the firm (Barney, Wright and Ketchen Jr., 2001), in a way it would be more likely to be achieved by companies capable to compile ones that are, at the same time, valuable, rare, onerous to copy and non-substitutable (Barney, 1991). Yet, although these approaches are argued to have made major contributions to the understanding of above-normal returns, it is also contended that both

of them disregard the potentiality for competitive advantage that rests on inter-firm associations or networks, as resources and capabilities postulated by them would be “housed within the firm” (Dyer and Singh, 1998:660).

Dyer and Singh’s (1998) relational view proposes the relationship between firms as a prominent unit of analysis within strategic management, with organizational alliances only generating competitive advantage in case they move relationships away from the attributes of market interactions. The authors identify four categories for the task, denominated as determinants of relational rents: (i) investments in relation-specific assets; (ii) substantial knowledge exchange; (iii) combining of complementary but scarce resource or capabilities; and (iv) more effective governance mechanism. Relational rents would then be those representing “supernormal profit jointly generated in an exchange relationship that cannot be generated by either firm in isolation and can only be created through the joint idiosyncratic contributions of the specific alliance partners” (pp.662). Still accordingly, each determinant of relational rent would be impacted by two facilitating sub-processes, represented by the duration of safeguards and the volume of interfirm transactions for the first determinant; partner-specific absorptive capacity and incentives to encourage transparency and discourage free riding to the second; the ability to identify and evaluate potential complementarities and the role of organizational complementarities to access benefits of strategic resource complementarity for the third; and, finally, the ability to employ self-enforcement rather than third-party enforcement governance mechanisms and the ability to employ informal vs. formal self-enforcement governance mechanisms for the fourth determinant.

Scholars have empirically set the relational view in supply chain contexts to the test. Recently, Chen, Preston and Xia (2013), for instance, assess a sample of U.S. hospitals and, among other findings, suggest that the impact of knowledge exchange on hospital supply chain

performance is in part mediated by hospital-supplier integration. Supply chain resilience has also been found to receive a positive effect when it comes to relational competences, more specifically on communication, cooperation and integration (Wieland and Wallenburg, 2013), while information sharing activities have been demonstrated to significantly improve performance by positively impacting communication openness between buyers and suppliers (Sanders, Autry and Gligor, 2011). From a Marketing angle, manufacturer-retailer relationships have also been suggested to positively impact supplier performance (Corsten and Kumar, 2005:91), where “suppliers achieve greater economic performance and develop their capabilities in collaborative [efficient consumer response] relationships”.

A concurrent stream of research has also built on Dyer and Singh’s (1998) seminal work to offer additions of the relational theory itself. Lavie (2006), from one side, advises the relaxation of the resource-based view’s proprietary conjecture to hypothesize on alliances’ shared resources. According to the author, when companies partner together, their network of relationships generate resources that are owned by multiple organizations, and that are capable of not only achieving competitive advantage, but to create value in a unilateral manner, hence either benefitting or hindering the firms pertaining to such complexes. Walker, Schotanus, Bakker and Harland (2013), on the other hand, look at the public sector to assess the perspective of the buyer-buyer relationship, configured by organizations set to jointly negotiate with suppliers, gaining more bargaining power and efficiency. The authors interviewed senior employees in purchasing activities to propose new dimensions of enablers and barriers to collaborative procurement.

To the extent of our knowledge, although cultural context has been argued to offer relevant impact on the generation of relational rents (e.g. Dyer and Nobeoka’s Toyota case, 2000), research has not been yet significantly dedicated to the consequences of relational rent

generation in international cross-cultural settings. Considering the relevance of the matter, committed efforts on that direction may substantially contribute to a further comprehension of the issue. If based in distinct origins, the relationship between buyers and respective suppliers might find in cultural differences obstacles that sway their ultimate outcomes. Within this panorama, the present study proposes that cultural traits may either approximate or segregate the involved parties. Just as the fifth element of Besson's plot, such cultural alignment would then configure an additional dimension of relational rents' determinants, also carrying its own facilitating sub-processes, therefore posing an indirect effect on the generation of relational rents. The next section presents a brief overview of the potential impact culture may exert on business, as well as diverse indigenous practices found in the literature, and their influence on global supply chains.

9.4.2. Cultural Perspectives and Global Supply Chain Management

The interaction between the two counterparts may be subject to differences arising from cultural values that affect the outcomes of the partnership. Within the International Business literature, such phenomenon is addressed as cultural distance, referring to the "extent to which different cultures are similar or different" (Shenkar, 2012:1), although the complexity around the concept of culture itself has generated a lack of consensus on the elements that it comprehends (Soares, Farhangmehr and Shoham, 2007). Studies dedicated to the issue are illustrated, for example, by Tihanyi, Griffith and Russell's (2005) meta-analytic work, indicating positive effects of cultural distance on multinational enterprises' performance and international diversification. Hutzschenreuter, Voll and Verbeke (2011), in turn, examine multinational organizations and their expansion patterns. The scholars suggest that added cultural distance (i.e. "expansion into new local contexts", pp.305) influence further international expansion in a negative manner in the short-term due to the augmentation of costs, but provides companies with access to new

resources and potentially new capability development in the long run, therefore also having a positive impact. Reus and Lamont (2009) also offer a “double-edged sword” perspective in which cultural distance carries both positive and negative impacts in international acquisitions. According to the authors, while it hinders communication and understandability of key capabilities, it also positively moderates the relationship between these two concepts and internal acquisition performance.

Moreover, such disparities may be raised as a sensitive point of negotiations. From an inter-organizational relationship landscape, the collaboration settled between organizations within a supply chain in the Operations Management literature represents a powerful example, as “there is ample evidence (...) that buyer-supplier relationships can provide a strategic source of efficiency and even competitive advantage if managed appropriately” (Zaheer, McEvily and Perrone, 1998:20). Within this scenario, classical studies have explored the comparison between Asian and Western practices in the automobile industry (Dyer, 1996, Dyer and Chu, 2000, Dyer and Chu, 2011, Dyer and Nobeoka, 2000), as others have portrayed the impact of cultural traits in different aspects of supply chain management such as trust (Liao, Sharkey, Ragu-Nathan and Vonderembse, 2012) and suppliers’ involvement (Ketkar, Kock, Parente and Verville, 2012).

As international and cross-culture management literatures nourish the growth of the application of anthropological logics, turning their attention to ‘other’ cultures and societies (Banerjee and Linstead, 2004), researchers have also demonstrated large interest in the study of emerging economies (Peng, Wang and Jiang, 2008). Colloquial practices such as social networking and indigenous management approaches thus gain momentum as essential to understand business development in such contexts (Holtbrügge, 2013). While Marsden (2004:40) defines indigenous management as the “elaboration of local strategies by local people

for the control and use of their own resources in the struggle for self-reliant development”, such definition may be applied not only to developing economies, but as a manner of explicating cultural idiosyncrasies as a whole. When located into international settings, the reliance on relationships might evidence cultural differences not only in inter-personal relations within companies, but also in those established between firms (Redding and Witt, 2015).

Indigenous practices, relating to regional or local conventions, proper to a determined community or country, have also gained attention on buyer-supplier relationship studies, with the majority of references dedicated to the Chinese *guanxi*. Research on that direction encompass the effect of *guanxi* as a relationship strengthener, smoothing differences that might be encountered in terms of ideas, opinions or even objectives, and therefore acting as a conflict reducer in outsourcing practices (Lee, Shin, Haney, Kang, Li and Ko, 2017), for instance. Similarly, Zhang and Zhang (2013) posit that *guanxi* helps reducing the intensity of intercompany conflicts by fostering the use of informal communication. Interpersonal connections in business-to-business markets (Dong, Ma and Zhou, 2017) are also approached. Studying the association between 300 Chinese plants and their respective suppliers, the authors suggest that *guanxi* mediates the influence of relationship marketing orientation and relational governance. Chen, Huang and Sternquist (2011) adopt a lifecycle approach to the buyer-supplier relationship, submitting that while *guanxi* negatively impacts commitment and social satisfaction from the perspective of buyers, the practice carries a positive effect on their economic satisfaction when the relation achieves its maintenance phase. The disagreement around the ethicality of some indigenous practices also poses challenges to inter-cultural relationship matters (Ardichvili, Jondle, Kowske, Cornachione, Li and Thakadipuram, 2012; Lee Park, Fracarolli Nunes, Muratbekova-Touron and Moatti, 2018) as, on one hand, a determined action might be usual to a certain culture, for instance; and on the other, the same

behavior might be deemed as corrupt to another cultural understanding (Lee Park and Fracarolli Nunes, 2018).

Although cultural distance may be argued to provide contextualization to a particular phenomenon, it may also be capable of enabling a more active role, therefore directly or indirectly impacting the outcomes of the relationship between multiple parties. The agreements firmed between buyer and supplier organizations within international contexts may offer a seamless outline for the search of cultural bearings on relational rents, as global negotiations are extended to numerous countries with different cultural characteristics. Building on Dyer and Singh's (1998) elaboration on the determinants of relational rents' role in generating competitive advantage within an inter-firm relationship, the main idea of the present theoretical development is to situate the relational view's preconized assumptions in international contexts. Guided by lessons from French filmmakers and their experience in thriving – or failing – in an American dominated industry, such panorama furnishes a strong and caricatured portrait of the distance between these two cultures, and the efforts made by the first to be able to permeate the business to the point of recognition. The theoretical argumentation leading to cultural alignment is also illustrated by quotes on buyer-supplier negotiation cases in international panoramas, collected through previous research on the issue, from the academic literature and from extracts from media channels.

9.5. Theoretical Development

9.5.1. Lesson 1: Cultural Expectations

Having successfully made several blockbusters in the Hollywood arena, Luc Besson has been framed as the “most widely received of French directors” (Rushfield, 2017). The filmmaker is aligned with the American culture to the point that he is regarded as “too American by French

critics” (Ivory, 2017), or even “considered the French equivalent of Steven Spielberg”, with a critic claiming that “Besson’s films are really just American films made in France” (Rotten Tomatoes, 2017). His production company Europacorp, located at the Parisian suburb, has been said to have “cracked the most important cinema market in the world” (Bintliff, 2009), referring to the Hollywood tradition. According to CEO Jean-Julien Baronnet, attention to the rise of emerging economies as an important consumer market is in the center of their strategy, focusing on “movies with cross-border appeal”, namely the ‘melting-pot movies’, as they are known in the company (Bintliff, 2009). In this sense, understanding different cultures and being able to deliver films that successfully align with audiences’ expectations is fundamental to these productions’ success.

Analogously, within the reality of supply chain links, partners’ expectations may be partially forged by cultural traits. Several scholars have advocated for the impact of cultural and behavioral issues on supply chain relationship outcomes. Buyers’ satisfaction, for instance, is referred by Graça, Barry and Doney (2015) as being significantly shaped by the “behavioral paradigm” in what relates to supplier’s performance. Villena, Revilla and Choi (2011), in turn, investigate how buyer-supplier relationships are impacted by both “bright” and “dark” sides of social capital. The authors suggest that, depending on the degree applied, structural, cognitive and relational developments of social capital may impact value creation within the relation either in a positive or a negative manner. From a socio-technical perspective on supplier integration, Kull, Ellis and Narasimhan (2013) conceptualize that a series of constrains may hinder the partnership’s success. According to the authors, as supplier integration projects shift technical centralities established between buyers and suppliers, they also pose a threat to social positions held by individuals inserted in one of the parties, causing constraints rooted in individuals’ behavior. These constrains might be translated by resisting attitudes such as sabotage, decrease in commitment or request’s bypasses, which compromises the achievement

of the joint goals, for instance. In this context, the study further contends that divergences on social values create “dysfunctional cultural diversity” (pp.73).

Simple attitudes carry the potential to create misunderstandings that might hinder successful developments. As noted by Niels Van Hove, then Manager of Integrated Business Planning at Don KRC in Australia:

“Generally, there are two ways that people in different cultures ask or respond to a question. For example, the American and Dutch cultures get directly to the point in asking as well as in answering a question. In other geographies (like Southern Europe, Asia, and Japan), people tend to circle around the point before asking or answering a question. One culture wants to get straight to the point but the other perceives that to be too direct, impersonal, and pushy. Such differences may stand in the way of making progress, thereby making the process less effective. The best way to work in such an environment is to keep in mind what is perceived to be best in the culture you are dealing with.” (Van Hove, 2013)

Within an international context, Cannon, Doney, Mullen and Petersen (2010) propose that culture carries a moderating effect when it comes to trust and performance in buyer-supplier relationships. While the authors suggest that cultural differences “warrant consideration in developing successful purchasing strategies” (pp.506), such misfit is also addressed by Ribbink and Grimm’s (2014) experimental study. Their results imply that negotiations held in dyads with similar cultural backgrounds accounted for higher joint profits than ones representing larger cultural differences. Bhaskaran and Gligorovska (2009) reinforces the idea. By surveying 376 chief executive officers in the food and trading industries, the authors find that behavior in transnational alliances is not only influenced by relational constructs (i.e. commitment, communication, co-operation, compatibility, dependence and trust), but also by national cultures. Moreover, national cultures’ proximity or distance is argued to have an impact on the degree of similarity that involved organizations hold on their beliefs and actions.

Specialized in corporate e-learning solutions, CommLab India (CommLab India, 2017) ponders on the impact of national cultures differences in supply chain partners. Reporting on a study they operated,

“In a survey conducted by CommLab India, covering 94 stakeholders from around 30 countries revealed that understanding culture was the KEY to developing relationships. Now in the supply chain there may be different departments working in different countries. All branches are interdependent. The success of managing the supply chain is dependent on the collaboration of all its partners and relationships they maintain. When the culture is not compatible, collaboration among the supply chain partners become a tedious process.” (Pakala, 2013).

The aggregated interpretation of these studies and illustrations might lead to the understanding that, while behavior grants significant impact on the performance of a buyer-supplier relationship, it is, in turn, largely shaped by the local culture a company is inserted in. Depending on the extent of cultural distance between two partners, the alliance can be hindered by cultural misunderstandings or shocks. Within the same rationale, the present theoretical development posits that the identification and meeting of cultural expectations might serve as a catalyst for negotiations, and therefore positively impacting the generation of relational rents.

9.5.2. Lesson 2: Transposition

Francis Veber, as quoted above, advocates for the transposition of French movies to fit the American culture. According to the director, successful adaptations would rise not from literal translations of the screenplays, but rather by the hands of a “talented writer” that will “take great liberties” (Veber, in: Insdorf, 1985). He or she would then be able to understand the cultural nuances of the American filmmaking tradition, and tailor the narrative of the motion picture appropriately. In the international buyer-supplier relationship context, the writer may be rendered as the professionals who are directly involved with the dyadic transactions. The understanding of the counterparts’ cultural traits would make for a better translation of the company’s strategic goals in the multi-cultural setting which might, in turn, lead to enhanced supplier integration.

Similar to the talented writer in successful transpositions posited by Veber, managers concerned in international supply chains play a crucial role on the outcomes of such processes. Smagalla (2004), for instance, narrates the discoveries made by scholars De Koster and

Shinohara when analyzing manufacturing plants located in Europe. While Japanese manufacturing practices have been praised for its high-quality and efficiency standards, the study found that “the Japanese logistics subsidiaries failed to deliver superior logistics support” (Smagalla, 2004). Moreover,

“The interviews also revealed that European managers did not fully understand the ultimate payoff of the Japanese service strategy. (...) The authors conclude that the Japanese subsidiaries would better adapt to Western business practices if they were to take into greater account the conditions (...) of the country where they are doing business. They suggest that (...) the parent companies should select Japanese managers for their Western subsidiaries primarily on the basis of their communication skills.” (Smagalla, 2004)

To enhance the relationship’s outcomes, companies may need to find a way to navigate through or even to overcome cultural traits that are not necessarily in line with what the organization is accustomed to on its day-to-day business routines. When dealing with a partner inserted in a different culture, the understanding of local practices can become quite useful. In a conceptual approach, Ivanova-Gongne (2015) posits that individuals inserted in interorganizational relationships will react in accordance to the extent of their knowledge of the partner’s culture and the criticality of a determined interaction event between them. Accordingly, the higher such knowledge or event criticality, the more they move away from what the author calls the ‘accessible cultural schemas’, to the point that one culture will be overshadowed by the other. In this scenario, either the individual in question works to persuade the counterpart to adopt their own cultural schemas, or they trust or depend on the partner enough to incorporate its cultural practices.

By delineating the different areas of study and main theoretical schools that dedicated to the topic, Ellegaard, Johansen and Drejer (2003) address the human factor of buyer-supplier relationships, encouraging the “human interface” as strongly influencing both their management and success. The authors portrait a comparison between the social and professional relations that employees inserted in an interfirm arrangement held both in the early

and late 1990s to illustrate the issue. In the first period, individuals were bound by solid social integration which, in turn, was translated into higher good willingness from both parties and acted as a reinforcer of the relationship between companies. However, the second period was marked by a drastic fall in such social integration, generating discordant relations with declining cultural fit, leading to mistrust and fading interest in one another. Still after the authors, the “customer employees need to manage according to the beliefs, culture, preferences and perceptions on the supplier employees” (pp.354).

In this scenario, *social capabilities* might lead the path to fortifying relationships to the point that cultural practices are either overpowered or more easily bypassed. Social bonding tactics have been approached by Wang, Wang, Jiang, Yang and Cui (2016) as being effective in fostering buyer-supplier relationships. The authors investigate the role of customization, information sharing and managerial ties on long-term collaboration between companies, uncovering relevant evidences to support their hypothesis for the second and third tactics. Clear communication strategies can also act as an important tool within the analytic approach. Accordingly, Paulraj, Lado and Chen (2008) offer the understanding of interfirm communication as improving the performance for both buyers’ and suppliers’ side of the dyad, and therefore acting as a “relational competency that may yield strategic advantages for supply chain partners” (pp.45).

Drawing from the discussions given above, this study proposes that companies may rely on individuals to either reinforce or weaken their relationships with buyers or suppliers. From an analytical view, local practices attributed to the partner’s culture or the company’s itself can be navigated through or overcome by holding strong interpersonal relationships that foster trust and commitment from both sides. Ultimately, this will lead to the softening of eventual cultural

misalignments, creating higher potential to generate relational rents through cultural alignment, knowledge-sharing routines and effective governance.

9.6. Constructs, Propositions, and Conceptual Framework

In face of the discussion above, four constructs are developed in the context of the present work: cultural identification, cultural meeting, cultural understanding, and social capabilities. The joint delimitation of these constructs and the debate of their interfaces corroborate the schematization of our conceptual framework, bringing together the two lessons learned from French filmmakers (i.e. cultural expectations and transposition) as the major building blocks of the fifth element of the relational view here proposed.

9.6.1. *Constructs*

Cultural identification – Commonly employed to express the idea of individuals or group believing to pertain to a given culture (e.g. Irving and Hudley, 2008), the concept of cultural identification may be useful to approach the outcomes of one's insertion in a cultural environment, whether through birth or immigration. Here, however, the idea of identification is employed to designate the perception of cultural traits in which companies intend to do business. In that way, the recognition of social codes, languages, religions, beliefs, costumes, as well as of any other collective agreement proper to a society would be crucial in the development of successful interactions. More specifically, the perception and recognition of cultural patterns would serve as the basis for the implementation of adequate strategies to accommodate business activities not only with suppliers, but also customers, governments, communities, competitors or any other group of stakeholders. Within this set, **cultural**

identification is here understood as the initial step in the building of cultural expectations, with the recognition of the collective moral and ethical values being particularly important.

Cultural meeting – Once cultural traits and characteristics have been identified, considerations over the best form to adjust or to cope with these aspects shall be made. Differently put, once the ‘dos and don’ts’ of a society are delimited, managers must architect their strategy in a way that the (un)expected behaviors are respected. The development and implementation of cultural strategies may then be at the core of the successful alignment with distinct collective logics, allowing companies to properly operate in such environments. In the case of the non-observation of these norms, companies may face severe retaliation from stakeholders, what may range from product boycotts until organized internet campaigns targeting their operations. In that way, the construct **cultural meeting** is here framed as the respect and adjustment of cultural norms, including all the actions and avoidances that allow the operations of a company to fit cultural expectations.

Cultural understanding – While the identification and meeting of cultural expectations may allow companies to operate in different cultural contexts, the comprehension of cultural environments may permit them to more properly organize social actions. Indeed, the expansion of the initial limitations of conformity may drive firms into a further integration within the culture in question, meaning that, beyond the respect to expectations, they may actually influence their surroundings. Considering that cultures may be, at some level, dynamic, this comprehension may turn companies in real agents of change. Within this reasoning, built on the conformity of cultural expectations, the construct **cultural understanding** is here employed as the further step leading to the integration of companies in new cultural environments. Differently from the initial step of cultural identification, cultural understanding would necessarily evolve the accusation (i.e. perception) of a distinct cultural context towards a more

embased comprehension of the main norms and codes expected to be respect within a given social group. Beyond allowing the avoidance, or, at least, the minimization of eventual disrespects to established social norms, a higher level of understanding is expected to allow the formulation of a proper strategy in light of the capabilities of the group entering that environment. From this angle, it could be considered as a previous step to the idea of cultural meeting discussed above, in a way that, the more efficient the understanding of a culture is, the higher the likelihood of cultural meeting.

Social capabilities – In turn, **social capabilities** are understood as the succesful combination of all the previous steps along with the presence of a well-developed organizational conscience. From this perspective, in order to transpose their operations into different cultures, the observation of (1) cultural identification, (2) cultural meeting, and (3) cultural understanding may demand the competence to perceive the nuances not only of the collective groups companies search to get inserted in, but also those of the organization itself. Along with an understanding of the national culture of its originary country, the company must also recognize the idiosyncrasies of its organizational culture so that the adaptation of its current operational schemes is softened when confronted to new social norms. In this sense, **social capabilities** relate to both the ability to properly discern the characteristics of foreign environments, but also to recognize the interior features that may allow or prevent the successful fit within a new culture.

9.6.2. Propositions and Conceptual Framework

As discussed, the present article proposes that, beyond the four determinants arranged by Dyer and Singh (1998), relational rents may be created by what is here delimited as cultural adaptations. It is also argued here that the capacity firms may have to fit a distinct culture is built over their relationship with cultural expectations and transposition. Within these two

concepts the constructs of cultural identification, cultural meeting, cultural understanding, and social capability were argued to form the basis of cultural adaptation, as pointed above. Based on the approach of Pagell and Wu (2009), this reasoning is here organized in the formulation of the following six propositions:

Proposition 1. The greater the identification of a distinct culture, the more successful shall be the meeting of cultural expectations.

Proposition 2. The greater the meeting of cultural expectations, the greater the chances of positive evaluations of conformity with social norms.

Proposition 3. The greater the identification and understanding of a distinct culture, the greater the capacity of a company to accommodate its national and organizational culture in it.

Proposition 4. The more social capabilities a company has, the greater the chances of successful transposition.

Proposition 5. The observation of cultural expectations and transposition may increase the chances of cultural adaptation.

Proposition 6. A successful cultural adaptation increases the chances of the creation of relational rents.

The consideration of these six propositions and the relationship between them leads to the formulation of the conceptual model of the study as shown in Figure 9 below. Next, chart 16 depicts Dyer and Singh's (1998) determinants of interorganizational competitive advantage, added by our fifth dimension, and their respective sub-processes:

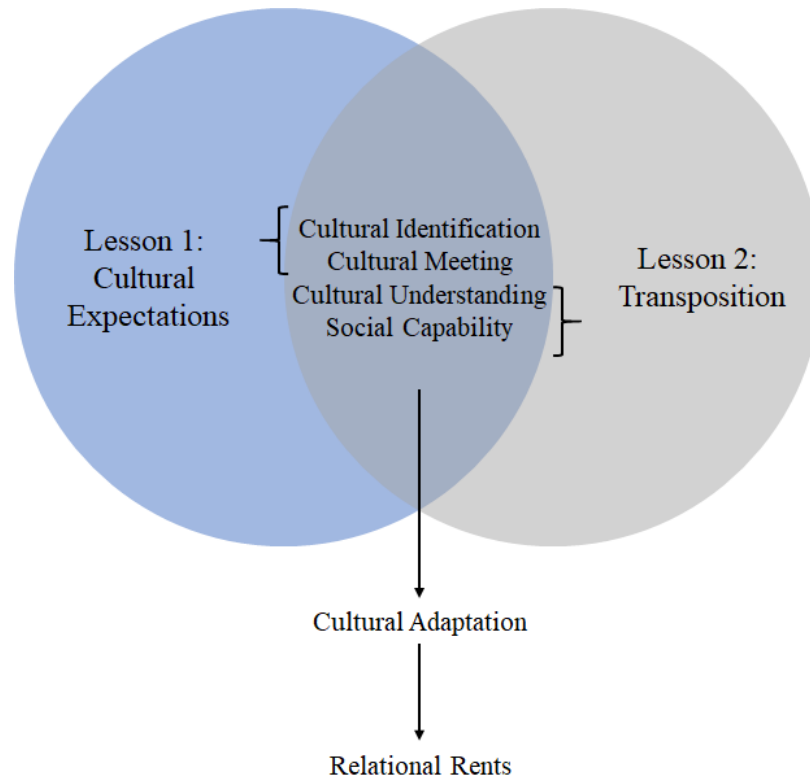

Figure 9: Proposed Conceptual Framework for Cultural Adaptation as the Fifth Determinant of Relational Rents

Chart 16: Determinants of Interorganizational Competitive Advantage in International Settings

Determinants of Relational Rent	Sub-process Facilitating Relational Rents
(1) Relation-specific assets	(1a) Duration of safeguards (1b) Volume of interfirm transactions
(2) Knowledge-sharing routines	(2a) Partner-specific absorptive capacity (2b) Incentives to encourage transparency and discourage free riding
(3) Complementary resources and capabilities	(3a) Ability to identify and evaluate potential complementarities (3b) Role of organizational complementarities to access benefits of strategic resource complementarity
(4) Effective governance	(4a) Ability to employ self-enforcement rather than third-party enforcement governance mechanisms (4b) Ability to employ informal vs. formal self-enforcement governance mechanisms
(5) Cultural adaptation	(5a) Ability to identify and meet cultural expectations (5b) Ability to socially transpose through local cultural practices

Adapted from Dyer and Singh (1998) and elaborated by the author

9.7. Discussion

As depicted in our conceptual model, different paths might lead organizations to reach cultural adaptation, influenced by the companies' perception of what the necessary degree of such fit should be, as well as by the initial cultural distance they encounter themselves in. This paper proposes a two-way systemic-analytical approach to achieve cultural alignment within a buyer-supplier relationship. From the analytical side, identifying and meeting both buyers' and suppliers' cultural expectations may play a fundamental role on assuring that the relationship will succeed on its goals. Among other things, these steps may enhance the quality of informational exchange in a way that the general performance of companies might be improved. Likewise, it is possible that such alignment collaborates to the development of trust among partners, facilitating exchanges and possibly diminishing transaction costs (Coase, 1937). That would be reflected, for instance, in the eventual elimination or simplification of more elaborated forms of contracts and other formal controls of future behaviors. The perception that cultural expectations are respected may hold an influence to the judgement of partners around the possible responses to stimulus from one another, which, beyond diminishing the direct cost of the relationship, would be also expected to save companies time, making them more dynamic and competitive.

Once companies realize that they belong or at least that they adequate, to a given set of informal rules and norms it may be argued that the range of distinct behaviors that are expected becomes more limited. Within this prospect, the notion of risk might be evoked as it would stand, among other denotations, as the variation of possible outcomes (Sitkin and Pablo, 1992). With the possible actions being more restricted, so are their variation, and thus lower the transaction risk will be. Analogously, the lower the risks of a transaction, the lower may be their

cost. That would represent one of the paths through which the observation of cultural norms would ultimately lead to the creation of relational rents.

Beyond the development of more efficient forms of exchange with partners, the meeting of cultural expectations may be also particularly important in preventing companies from facing resistance from stakeholders. As previously highlighted, in case consumers perceive fails in the respect to their cultural expectations, boycotts to products may emerge, potentially causing damage to the reputational capital of firms. In line with that, other groups of stakeholders may find themselves in the position to retaliate such fails. Governments, for instance, may be driven to impose social norms to companies operating within their cultural context, especially on what relates to the respect of corporate social responsibility principles. It may be relevant to note that the concepts of respect to human rights may vary from one culture to another, in a way that the practices of a company may be considered legal, moral, and ethical within a given cultural context and illegal, immoral and, unethical in another.

While the assessment of the legality of practices might be more direct – considering that operations are held in countries where laws are written and jurisprudence exists – the moral and ethical judgments of issues related to work conditions, modern slavery, preservation of endangered species, deforestation, and so on must be more rooted in the cultural values of a given country, or, in a micro level, in that of the local communities in which operations are held. Within this perspective, it seems that issues related to the social and environmental aspects of sustainable development are more critical as they pertain to a conjunct of values mostly developed and adopted in the Western countries and, moreover, are still relatively recent. Thus, the replacement of important portions of the operations of companies to low labor cost zones under the label of strategic outsourcing (Quinn and Hilmer, 1994) might be quite representative of cultural shocks that can emerge when cultural expectations are not respected. Not by chance,

several cases of abuses to workers have been disclosure in the factories which either belonged to western companies or supplied to them. While these companies typically respected the cultural expectations of their country of origin, they were somehow accepting their negligence in the other side of the world.

On the systemic perspective, in turn, the understanding of a foreign culture may increase the chances of adaptation, once, beyond the recognition of social norms and rules, the further comprehension of a cultural environment shall allow companies to actively work on the construction of environments which can be more favorable to their operations. Such capacity rests within the idea that, despite standing for a group of often unwritten agreements that support social cohesion, cultures are fluid and dynamic, in the sense that they may be expected to change during the course of time. It is possible that the main sources of changes are indeed the insertion of outsiders which, through the application of their own cultural background, end up offering reinterpretations of the generally accepted culture. Even if this accommodation may happen naturally, the understanding of a given culture may permit companies to rationally influence, and eventually modify it so that they may better serve their interests. Still, the development of social capabilities might also help attenuating cultural differences and fostering behavioral attitudes relating to trust and commitment from both parties. This goes back to the previous constructs discussed, as it represents the capacity to successfully engage in a new cultural environment. These considerations, along with the debate proposed in the previous sessions of the study, offer the basis to the comprehension that cultural adaptation shall be proposed as a fifth element of the relational view. This conclusion is explored in greater details in the following section.

9.8. Conclusion

Through the discussion of the relevance of cultural aspects and the influence they may play in the interaction between distinct business actors, the present article proposes an extension of Dyer and Singh's (1998) developments on the Relational View. More specifically, from the intersection of the literature on culture with that around the determinants of relational rents, the theoretical development is translated into the role of cultural alignment between organizations placed in a buyer-supplier relationship, particularly in those inserted in international contexts. In face of these considerations, guided by the lessons from French filmmakers in the American industry, illustrations drawn from practitioners were presented along with the theoretical argumentation, supporting the motion of a cultural dimension as an additional determinant of relational rent. The importance of interfirm links has been recognized as a powerful source of superior performance, as, from a strategic standpoint, "both the buyer and the supplier aim to leverage the relationship for gaining competitive advantage" (Tanskanen and Aminoff, 2015:128). As companies engage in dealings that encompass partners located in different cultures, the integration of and navigation through indigenous traits are theorized to act as sub-facilitators of relational rents, and therefore indirectly impacting the generation of competitive advantage from the relationship itself.

The present study proposes that, along with the afore mentioned four determinants of relational rent, a fifth dimension ought to be considered as impacting their generation, namely *cultural adaptation*, referring to the extent to which engaging companies can act to alleviate differences or emphasize similarities that arise from their respective national cultures. This course would, in turn, be facilitated by the two sub-processes here named cultural expectations (i.e. the ability to identify and meet cultural expectations), and transposition (i.e. the ability to socially transpose through local cultural practices). The complexity of the insertion of a cultural

component to the dyadic relationship analysis rests, however, on the diffuse influence that it exerts. In other words, the buyer-supplier cultural alignment would carry impacts not only to the generation of competitive advantage itself, but also on the other determinants of relational rents, implicating in cultural indirect effects on interorganizational rents. The study seeks them to explore these issues from practical examples, what must facilitate the absorption of its more abstract nature.

In the end of Francis Veber's interview, when Annette Insdorf questions as to why so many American remakes are inspired by his scripts, he pondered if either his subjects or himself were to be considered more international. Veber then adds, "Or maybe because my stories belong to the category of 'scripts of situation'. If the mechanics of the situation are precise, it can be adapted to the U.S., Japan or anywhere"; to which Insdorf reflects: "Perhaps this phenomenon means that what is assumed to be quintessentially French – a certain sophistication about sex, a stylishness in fashion and cuisine, a sense of irony – is not limited to one country". In a managerial context, cultural adaptation, in this sense, might take a fundamental part on adjusting expectations and actions towards international endeavors. Studies in this direction have highlighted the importance of cross-cultural competence, as integrated by personal attributes, skills, and cultural knowledge, while negatively moderated by cultural distance, and cultural intelligence, with cognitive, motivational, and behavioral components (Johnson, Lenartowicz and Apud, 2006), for instance.

Yet, the implementation of management techniques such as Just-in-Time, or more broadly as the lean synchronization approach, has proven to be difficult in cultural environments outside Japan. It seems that even companies such as Toyota – arguably one of the main birthplaces of these techniques – have not been capable to fully profit from them in culturally diverse environments. One must argue that the lack of an adequate cultural adaptation to new

environments has prevented the company to generate relational rents on its relationships with suppliers and customers. All in all, the transposition of a set of typically Japanese behaviors and practices that demand, among other things, a high sense of responsibility from employees, discipline, and a well-developed long-term orientation, may have demanded a greater period not only of recognition of the new cultural environments, but also in their molding, so that they could accommodate such characteristics. In that way, the lack of cultural adaptation, or, at least, its non-satisfactory reach, may have cost Japanese companies considerable advantages in relation to their competition with local players. Likewise, as previously discussed, the same difficulties of cultural adaptation must reason the several issues around inefficient CSR implementation in low-labor cost zones, which have fueled disrespect to human rights for Western standards.

In that way, within a buyer-supplier relationship context, rather than limited to negotiations within similar cultures, successful partnerships (i.e. capable of generating relational rents) may be built over being able to extract the precise mechanics that sustain successful relationships, and to adapt them to fit distinct cultures. Considering that modern supply chains are characterized by a multitude of players which are often geographically spread, cultural discrepancies must be particularly challenging for companies. The rapid adaptation to these different cultures can actually be crucial in the delivery of products and services to customers of the most distinct cultures, as well as in the employment of workers from equally distant origins.

The theoretical contributions that arise from this paper are then threefold. First, it offers an extension of the relational view by adding a cultural dimension to the generation of relational rents. Albeit considering the relationship between companies as its primarily unit of analysis, Dyer and Singh's (1998) theory and its proposed derivatives (e.g. Lavie, 2006; Walker,

Schotanus, Bakker and Harland, 2013) do not account for relationships contextualized in international settings, and therefore being subject to differences that may surface due to cultural issues. In that way, the present study may be useful as it explores generally neglected cultural matters which seem to be relevant in the creation of relational rents, particularly for companies inserted in international contexts. It must be argued that this theoretical contribution rests in bringing together mainstream operations management approaches and others more related to what may be understood as an anthropological point of view. From this reasoning, the discussions here presented must be seen as an advancement in the idea that companies are social actors embedded in complex social systems, in a way that a deeper comprehension of human environments cannot be absent from modern management. In this sense, the recognition of cultural adaptation as a key element in the creation of relational rents may call the attention of scholars to the human aspect of business who may possibly use this comprehension as a theoretical basis for the study of differentiated performance of firms, notably within supply chain contexts.

Second, from a broader perspective, the paper opens an avenue for the extension of a multitude of theories that may encounter a better fit in cross-cultural interorganizational relationships by considering potential cultural differences. Although the cultural distance concept and its effects on business have been largely investigated in several streams of literature, generating a significant flow of empirical studies in that matter, such phenomenon still lacks proper conceptualization. Through the proposition of a conceptual model, this study attempts to take an initial step on covering this gap. Indeed, the gathering and organization of the constructs here discussed inside a model that proposes a dynamic perspective of their interaction must also serve as an initial theoretical structure from which hypotheses around the order and the weight of each element may be drawn.

The third and final theoretical contribution lays in its emphasis around the importance of cultural characteristics as influencers of business. To the present date, several studies in the Supply Chain Management literature have been dedicated to the examination of *guanxi* in China as a major influencer of inter-firm negotiations. However, the existence of several cultural traits, represented by – but not limited to – indigenous practices, and the lasting importance of emerging countries on the global economic scenario, call for the attention to a need of research diversification. Although sharing similarities with the Chinese custom, they also raise several peculiarities that could carry significant impact on varied issues not only pertaining to the buyer-supplier relationship instance, but also to other arenas that may include global projection such as supplier development, internationalization strategies, consumer satisfaction, and so on.

From a practitioners' point of view, this study may be helpful in addressing international strategies in supply chain management. The understanding of distinct cultures and the impact of the differences it may arise is useful for managers enrolled in negotiations with partners from abroad their own cultural paradigm. When searching for business associates and alliances worldwide, companies might consider incorporating strategic tools that minimize the outcomes that can burst from eventual cultural distance. More specifically, this paper expects to shed a light onto the mechanisms by which companies may deal with partners' culture related practices when negotiating in international contexts. Despite its contributions, the study also presents limitations and possibilities for further investigations. These issues are addressed in the next session as follows.

9.9. Limitations and Suggestions for Future Research

Two main limitations and consequential fruitful avenues for future research are identified in the paper. Its primary restriction relies on the fact that it is conceptual in nature. While supported

by a thorough literature search, future studies may seek to empirically test the propositions by analyzing cross-cultural dyadic relationships. Additionally, a further understanding and refinement of the mechanisms employed to achieve cultural alignment may surface from such investigations, potentially breeding insights as to how to enhance value creation (i.e. the generation of competitive advantage) and capturing (i.e. the distribution of value) to both sides of the partnership. Moreover, the impact of cultural fit on such distribution in the short- and long-run of the relationship may play an important role on understanding the strengths and weaknesses in different international supply chain designs. The secondary shortcoming derives from the conceptualization of culture as a concentrated vector of human behavior. While the translation of cultural particularities as a focused aim is often adopted to facilitate their study, culture denotes a much more complex construct that is likely to achieve a rather diffuse impact, not only through direct effects on subjects' behavior, but also as a context in which relationships are submerged. The conceptual model could benefit from the observation of the effects cultural traits may exert on the previously conceptualized determinants of relational rent, making for a broader and more comprehensive framework.

Part III – Final Considerations

Chapter 10. Conclusion

As pointed by Erez and Earley (1993:3), despite seemingly simple, the question on “why were successful managerial and motivational techniques not found to be uniformly effective across cultural borders?” demands the consideration of a broad range of literature, theoretical models, and different methodologies. Beyond more immediate and directly related considerations over the impact of culture in the development of the operations strategies of companies, the research process of the present dissertation reaches out for the study of a wider disciplinary scope, which may substantially add to the understanding and interpretation of our results. This concluding chapter addresses then issues comprehended as valid and useful to the sedimentation of our analysis, particularly on what relates to the delimitation of the contexts in which culture must be critical for business development.

In that way, a discussion over the nature of culture as a collective manifestation of humans may also add to the assessment of the relevance of this study. The first part of the conclusion – entitled general discussion – develops thus the argument that culture is an inseparable part of human function within societies, and, as so, must not be neglected by any social science, among which Management is found. Following this more structural debate, contributions are discussed in view of their exchange with other social sciences, in a way that the three articles here proposed should be understood as composing more than a functionalist view of cultural management. In turn, the practical relevance of our outcomes is pointed, with the possible impacts of our findings to distinct management literatures being highlighted. Finally, limitations and suggestions for future research are presented.

10.1. General Discussion

Inside a more quantitative approach, the demonstration that different sets of operation strategies may be associated to national cultures is particularly relevant to the development of the dissertation's argument. As suggested by the evidences presented in the first article, the cultural dimensions proposed in Hofstede's work, here understood as proxies of the main characteristics of societies, represent influential factors in the shaping of companies' operations, in such way that distinct tactics and strategies are put in march in the adequation of foreign practices. These findings corroborate the existence of a tension between operational standardization and adaptation, as, while the first may allow firms to increase value generation by the employment of equal or similar procedures and practices in their global operations, the second demands the consideration of local idyssincrasies, leading to eventual flexibilizations. Considered the necessary investments, complexities, and consequently risks related to the development and maintenance of distinct production processes, these individualizations may erode operational (and financial) performance. On the other hand, as discussed in the second and, particularly, in the third article, fails in properly understanding and adapting operations may pose a potentially more damaging risk to companies.

From this angle, it may be argued that the current discussion departs from the traditional rationalism and objectivism commonly present in a relevant portion of the operations management literature, seeking to advance in the influences of the Sociology of the actors inside management. The appropriateness of culture to access such issues is not direct though. Differently from more universally or widely accepted concepts over the nature of men (i.e. those issued from the biological sciences, which focuses on the functioning of the individual human body), social investigations are often concerned with the complex and dynamic interaction between and within groups of individuals (e.g. Doise and Graham, 1978, Lewin,

1947). Even if disciplines such as Psychology and Microeconomics seem to be, in general, more oriented towards the analysis of personal emotions (e.g. Tangney and Fisher, 1995) and choices (e.g. Sen, 1979), investigations of human behavior are also largely influenced by the study of collective answers. Social scientists – particularly those carrying an anthropologic background –, have been long recognizing that the mechanics of social groups and the interaction between their members may lead to forms of cohesion that unify them around a system of values (e.g. Murphy, 1957). In that way, the comprehension of the motives and the mechanism that drive groups to live together and establish common agreements would form the basis of such analysis. Likewise, the social codes that keep individuals inside groups and add to their uniformity contribute to the recognition of the dynamics of collective interaction.

The reunion of people around a common code of behaviors and beliefs would serve their survival necessities in two basic ways: firstly, it would allow them to organize physical resistance and defense against external and potentially competing and threatening groups (Taylor, Klein, Lewis, Gruenewald, Gurung, and Updegraff, 2000). Secondly, and in a less direct manner, are the issues related to the preservation of the conscience, which, through the building of an artificial structure of collective pillars, shall prevent the individual from an eventual incapacity to recognize itself as a being, and thus as part of a real, material, and minimally predictable world. On that regard, Ewing (1990) points that:

“in all cultures people can be observed to project multiple, inconsistent self-representations that are context-dependent and may shift rapidly. At any particular moment a person usually experiences his or her articulated self as a symbolic, timeless whole, but this self may quickly be displaced by another, quite different ‘self’, which is based on a different definition of the situation. The person will often be unaware of these shifts and inconsistencies and may experience wholeness and continuity despite their presence.” (Ewing, 1990:251)

While the defensive aspect of the former may give origin to the most initial frames of protective tribalism, the latter may allow people to keep away from mental disorientations that might ultimately lead them to a disconnection with reality. In that way, the development of

culture would be intrinsically related to surviving strategies, either of physical and of psychic nature. This reasonings represent additional support to the propositions of the third article in which an accurate identification, meeting, and understanding of social codes are argued to be potencial antecedents of relational rents. In other words, the careful correspondence to social expectations would also work as a prevention to negative reactions, as, in case such need is ignored, the implementation of an operation that comes to be, in any direction, disrespectful to a given social norm may be interpreted as a threat to either the mental health or the survival of individuals and groups, respectively.

Incidentally, the idea of culture seems to differentiate or distinguish people according to their social interactions. It is not, however, a question of hierarchizing different groups in face of their costumes, nor of attesting that these cultural assemblages are immutable or inflexible during the course of time. Yet, when a static perspective is considered, it may be possible to distinguish forms of social agreements under which a group of people live. In this sense, the admission that cultures exist would imply the recognition that there is no system of absolute values accepted and adopted simultaneously by the entirety of mankind. Instead, the acknowledgement that different gatherings may produce equally different social agreements give them some level of distinction, being, perhaps, the overlap of values of geographically close groups the root of more generic forms of collective identity. From this angle, basically every manifestation of mutual or group logics that is transmitted from one generation to another would stand as a form of culture. Even though this view is present throught all the text, it is more directly applied in the third article, in which the capacity to properly recognize the distinctions of cultures is highlighted.

In that direction, Turner and Killian (1957) posit that sociologists place culture as the environment in which both individual and group behavior develop, while French sociologist

Emile Durkheim would classify culture as being comprised primarily of collective representations (Mestrovic, 2017). It is possible to discuss then cultures within the most distinct level of social interactions. Families, for instance, may develop their own idiosyncrasies and peculiarities, which, in the long run, must differentiate them from other families. As these singularities are sedimented and come to be not only understood and adopted, but also defended by those who feel part of this segregation, one shall argue that a culture is established. It seems that, within a familiar aspect, the adoption of differentiated values may occur since the basic nuclear family composed by parents and children, until the extended members, including grandparents, cousins, uncles, and other more distant components. The stronger the links shared by these people, the closer they would be to belong to the one cultural cell. The same seems to be true when the idea of belonging to a group is extended. It would be possible, for instance, to detect the culture of a community of people who live in a given area, and that has developed common standards. In this case, the idea of culture surpasses blood ties, in a way that virtually anyone inserted in an environment shall be part of a given culture, as long as the social norms are respected. Such view is relevant to the present discussion as it adds to the understanding of cultural aspects as an important part in the formation of individuals and groups. At the limit, the same logics may be stretched to the understanding of national cultures. All in all, the culture of a country must be understood as the conjunct of shared values guiding those who identify themselves with a given nationality, and agree to behave in what may be understood as the acceptable manner. Control mechanisms recognized in the creation and promulgation of laws are some of the structures over which the idea of national states shall be built. Moreover, the concept that these laws are overarching or universal (i.e. common to every citizen without distinction of social status) stand as a direct attack to regimes of privilege and may be seen as a fundamental concept in the organization of modern republican states. In that way, the segregation of who belongs to a given culture and those who do not would be mainly supported

by the observation, acceptance, and even the promulgation of a given range of social values. Despite the difficulties in the definition of the concept (Boyacigiller, Kleinberg, Phillips and Sackmann, 1996), from this angle, culture may be understood as any form of written or non-written social rule or accordance that, at some level, unify and differentiate a group of people from its surroundings.

10.2. From Cultural Recognition to Cultural Management

As discussed throughout the text and on each of the individual articles, the perception and understanding of these distinct conjuncts of social norms may lead to the creation of competitive advantage to companies. That would be translated in the idea that managers who are capable to perceive the singularities of a given culture have a better chance to operate within it. The clear recognition of the 'rules of the cultural game' may prevent social friction, possibly allowing companies to develop a smoother dynamic within distinct markets and with partners. In fact, the development of social capabilities would include not only the sheer identification and eventually the understanding of distinct cultural environments, but also the capacity to accommodate both the national and organization cultures of firms without disrespecting the local cultural codes. This arguably delicate balance between the preservation of an original culture and the respect to the culture of the environment may ultimately lead companies to profit from relational rents. As our results suggest, when operating abroad, companies should ideally invest in these aspects, so that processes of internationalization and development of partnerships with foreign partners are optimized.

In fact, the study of Economics – of which, along with Sociology and Psychology, Management may be considered a descendent (Dobbin and Baum, 2000) –, is argued to be

originated, among other things, in the analysis of the exchange of production surplus between different groups of producers in search to maximize the general utility (Henry, 2009). Specialization would then allow for the development of both the volume and the quality of outputs, what, through the logics of the exchange, would guarantee access to different ranges of products. Although the introduction of money and the creation of several business intermediates between producers and consumers may reduce the relevance of the good relationship between groups, it must be argued that the premises of rational behavior of the economic agents, also referred to as (un)bounded rationality (Shakun, 2001, Conlisk, 1996) must not be fully immune to the emotional and even instinctive aspects of human functioning. From this angle, the comprehension of the interaction between groups would boost the understanding of the discipline towards the emotional side of human conduct. In other words, from the consideration of cultural aspects, deviations from expected rational behaviors between agents must be better appreciated.

When brought to the Management discussion, similar views must be useful in the analysis of strategic outsourcing schemes (Quinn and Hilmer, 1994), for instance. Overall, the strategic choice of transferring non-core activities to third parties, and concentrating on those granting greater chances of success (i.e. here understood as a form of specialization), demand the development of relationships with new partners, not rarely from acutely different cultural environments. Trust, for instance, is argued to act as a “vital lubricant for relationships”, and also affected by cultural issues (Johnson and Cullen, 2017). In the perspective of Western companies, the overcome of such cultural challenges actually stood as a crucial step for the implementation of international operations in general (Sweeney and McFarlin, 2014), being, however, arguably more critical in the placement or transfer of non-neglectable portions of their operations to often distant low labor cost zones. The relationship with Chinese suppliers, for example, may have demanded a considerable effort in the comprehension of different visions,

expectations, and methods. Indeed, it must be argued that the capacity of managers of both sides to understand and adapt to each other has been a prominent aspect in the building of long-term relationships, which have largely shaped international business in the last decades. With the acceleration of the globalization of markets, and the geographic redistribution of production, the contact between different cultures gained prominence, and may have accounted for important shares of the relational rents and competitive advantages created and captured by firms involved in such operations. Along with the other situations discussed in the three articles of the dissertation, as well as throughout the text, these aspects closer related to the internationalization of business, and on the strategic decisions around the outsourcing of operations illustrate the relevance of cultural aspects in Management. Yet, these and other issues are further addressed in our subsection dedicated to the contributions and practical relevance of this study as follows.

10.3. Contributions

As discussed by Erez and Earley (1993), diverse business experiences presented significantly different results when applied in different contexts. Among these cases, the author points to the successful implementation of quality control circles in Japan, and their respective limited effectiveness in the United States (Lawler, 1986); the wide use of methods of individual performance appraisal in the United States, that presents poorer results when applied by American companies abroad; reward systems being accessed as both motivational and unacceptable in the United States and Israel respectively; among others. Considered these and other examples issued from business practices, from a macro perspective this dissertation shall be comprehended as an effort towards a better understanding of the effects that cultural aspects may have on business practices, and, more specifically, on those aspects related to Operations

Management. Building on this initial orientation, related, yet specific, research questions were elaborated and investigated in each of the three proposed articles. Considering then that these individual studies make up for a larger whole, it may be useful to further discuss them both in isolation, and in relation to their contributions to the broader objectives of the research. While the link between the research questions were treated on the specific session (Chapter 4), a parallel analysis must be performed around the dynamics of such results, so that the relevance of the individual outcomes in contributing to a major view may be more easily identified. In the aim of offering a more contextualized sense of the general advancements of the present dissertation, this discussion proposes then such considerations, primarily focusing on how each contribution may be gathered and viewed as forming a more robust structure.

By evidencing that cultural aspects are relevant to the implementation of Operations Strategy, the first article stresses the pertinence of behavioral factors in the conduction of businesses, particularly those held within different cultural contexts. Despite the difficulties in agreeing upon the nature and definition of culture (Boyacigiller, Kleinberg, Phillips and Sackmann, 1996), the application of objective cultural dimensions proposed by Hofstede (2001, 1994, 1993, 1983, 1980a, 1980b) allowed for a more direct measure of the impacts of these elements in the successful implementation of operational orientations. On that regard, it is argued in the article that, among other things, the respect and the adaptation to different cultures may ultimately lead companies to better perform in operational settings. In the context of the present dissertation, the article contributes as an initial confirmation of the inherent hypothesis that cultural elements may, in fact, not only influence the design and implementation of strategies related to the operation of companies, but also be a crucial element in the search and reach of competitive advantages. Moreover, the consideration of culturally distant environments such as those observed in Brazil, China, Germany, and South Korea add to the representativeness of our outcomes, as, to greater or lesser degree, they have all intensively

exchanged with foreign cultures, either in the internationalization of their companies, or by receiving multinational companies in their territory.

The second article of the dissertation, in turn, focuses on a particular aspect of the Brazilian culture, believed to directly influence the conduction of businesses in the country. The assessment of the positive and the negative interpretations of the Brazilian *jeitinho* highlights the complexities that foreign managers must be exposed to upon their interaction with Brazilian employees, peers, and partners. In this sense, the comprehension of the nuances of a typical cultural trait is argued to permit a more effective relationship, in a way that, not only the aspects related to the creativity of these traits are considered (i.e. positive aspects), but also those linked to the corruptive side (i.e. negative ones). In face of the increasing demand for business ethics, and the constant surveillance and debate of business conducts, a clearer perception of national idiosyncrasies must be relevant as companies search to expand their business abroad. Considering the potential that cases of corruption have to link firms to negative associations, they may ultimately compromise corporate images and reputations. The contributions of the paper may thus be argued to add to the assessment of the reputational risk possibly resulting from a misunderstanding of the Brazilian *jeitinho* and, more specifically, around its different connotations within business relationships. In this set, the study of cultural idiosyncrasies would not only improve the operational performance of firms, but also work as a mitigator factor in the protection of intangible resources (e.g. images, reputations, identities, brands).

The study of a Brazilian singularity may be also positive as it adds to the diversity of objects in the field. As discussed in the article, literature dedicated to cultural or indigenous management seems to be more focused on the characteristics of major economic players, such as China, South Korea, and India, among others, even though studies on other cultures have also been of interest. Despite the consideration of this literature does not lead to evidences of a

clear bias in the choice of these countries, it is possible that the apparent more common assessment of these contexts is mainly driven by their economic relevance. If that is the case, one must argue that the attraction of foreign practices – at least within business literature – shall be objective and run within a functionalist prospect, meaning that, instead of standing as a legitimate enthusiasm for cultures, their study would be appealing only if they hold the potential to either boost or prevent a profitable development of business relations. While, not surprisingly, within a Management perspective such motives must contribute to a more superficial comprehension of diverse cultural environments, in a way that, beyond the current state of things, issues such as the origins, causes, history, and even the future development of these diverse groups would be neglected, as this objective understanding may eventually hinder the debate and exchange with other disciplines (e.g. Sociology and Anthropology). This possible incompatibility must turn the study of indigenous practice in business relatively isolated, and potentially less structured than those constructed by the above-mentioned fields of study.

With such concern in mind, the discussions developed in the two first articles of the dissertation searched to base at least part of their arguments on studies of other social sciences. The discussion of a prominent work of the Brazilian sociological literature illustrates this concern. As pointed, Holanda's (1936) seminal book "Raízes do Brasil" (Roots of Brazil, our translation) explains Brazilian society as a result of a complex and dynamic process in which people from different origins and for the most different reasons met together in a (for some) foreign land, under severe technological and power imbalance. With the analysis of the characteristics of the Iberic people, and more specifically the Portuguese colonizers, the author debates the antecedents of the Brazilian idiosyncrasies. Moreover, by considering the characteristics of the other groups who originally came to form Brazilian people, such as Africans and local native Americans, the author advances in the comprehension of the dynamic

of different cultures that, although having mutually influenced each other and merged to some degree, are still perceivably distinct in the country. Despite the still detectable isolation of these groups in some areas, it must be also noted the considerable mix that followed the contact, which may have given birth to a Brazilian culture all alone that still dialogues and exchanges with its origins. As the author focuses on the interaction between distinct influences, he seems to evidence a causal relation of a continuous process, according to which the country's society would be the reflex of a cultural shock that was relatively original in the human history.

Brazilian society must be seen then, to some extent, as artificial, in the sense it was created and forged according to a logic of economic exploitation. Differently from European societies, which preceded the creation and consolidation of their National States, this natural process in Brazil was somehow inverted, with the Portuguese State actively working in the creation of a desired, or possible, society. Such process led to distortions in terms of the distribution of power and the use of bureaucracy, which are still firmly reflected in the way Brazilian people deal with issues such as creativity and corruption in business, both analyzed through the study of the Brazilian *jeitinho*.

By linking the empirical findings to such references, the articles are expected to enrich the debate beyond the functionalist view discussed above, in a way that, not only the opportunities of the present must be captured, but also those in the long-term. Beyond that, contributions are also expected to be of value to other social sciences, in the sense that the consideration of such antecedents through a Management perspective may hopefully serve as a source of dialogue and exchange between disciplines. Furthermore, the application of such findings in different relational contexts, not only that of competition between companies of different origins or of buyer-supplier relationships, but also in the insertion of multinational companies in foreign countries, for instance, dealing with local culture in what concerns customs, legal issues,

employee relations, and so on, might contribute to a better fit between organizations and cultures. This process should not be restricted to the pointed countries though, but also extended to cultures different from the ones studied in the present articles as well.

The central theoretical contribution relates to the expansion of the Relational View (Dyer and Singh, 1998), with the outcomes of the third paper being mainly built over a conceptual analysis of how cultural aspects could reinforce the creation and capture of relational rents. As discussed, the success of French filmmakers in translating and adapting the characteristics of French culture so that they may be more easily accepted and absorbed by other cultural settings offers valuable lessons to managers experiencing relatively similar situations. Also notable is the fact that the study builds on the actions and strategies adopted by citizens of a country regarded as an important cultural source of the Western civilization, in which its recognized philosophers has markedly influenced the development of arts, music, literature, fashion, among other forms of human expression. Adds to that the fact that France is a former colonial power, having extended its cultural traits to a wide range of geographically spread regions. Nevertheless, the transmission of French culture may perceivably expand much beyond its colonial possessions. In the context of the dissertation, the article contributes by investigating the perspectives of a predominant culture, what, considered the eventual Eurocentric view of anthropologic studies, must aggregate. It is possible, however, that such prominence in the cultural terrain works as a natural facilitator of cultural management, situation from which French managers – and not only filmmakers – may profit. Future research could contribute by applying similar approaches in relation to other cultures, prospect further discussed in the subsection dedicated to limitations and suggestions for future research.

From the Operations Management lenses, such argument reinforces that potential sources of competitive advantage in supply chains must reside within the better management of cultural

differences. As discussed through the text, these aspects are particularly relevant for global value chains, in which partners of the most distinct cultural origins must work together and ideally in partnership. From this angle, it can be argued that the alignment of cultural expectations is crucial for the evolution of direct market transactions, as well as to the development of long-term relationships. Particularly relevant to the development of trust, cultural comprehension and respect seem to stand as an actual structural condition for the formation and maintenance of successful supply chain and supply chain networks. These and other managerial implications are discussed in greater details in the following subsection, dedicated to the practical relevance of the study.

10.4. Practical Relevance

Given the objects of analysis and the general focus of the present investigation, the main practical contributions may rest within an Operations Management perspective, with results being of potential interest to the analysis of strategic processes such as the internationalization of operations and outsourcing decisions. The understanding of distinct cultural environments and the development of social capabilities must then facilitate the entrance of companies in new markets. Within an *a posteriori* approach, the consideration of the relevance of cultural aspects may be useful in the awareness of both successful and unsuccessful processes, in which either a company of a given cultural background enters another cultural context, or companies from distinct cultural origins come to develop a form of relationship. In this way, processes of de-verticalization, followed by the transfer of relevant portions of the production to low-labor cost zones, for example, may be reinterpreted through the lenses of cultural aspects.

This focus must be of value in the perception of the reasons why some countries and areas such as India, China, and East Asia, in general, were greatly favored to accommodate the production of Western companies, while others, which arguably also hold the potential to meet comparative advantages in relation to wages (e.g. African countries), were deprecated. Along with many other factors such as the presence or the level of physical infrastructure (e.g. roads, railways, ports, and airports), the investment capacity of the governments, the stability of the respective legal environments, the respect to international contracts and trade agreements, the civil cohesion in terms of both an absence of internal conflicts or the presence of an organized government (even if non-democratically elected), and the trust of international investors, it is possible that cultural aspects of these areas have come to play a significant role in their choices to stand as business partners of the West.

Findings presented in the three articles allow for future research to reinforce the hypothesis of the influence of cultural traits as potentially important aspects in the development of international commerce, and, more specifically, in the advancement and consolidation of the globalization of the production markets. Yet, while useful for recovering the reasons of such moves of the past, the consideration of cultural aspects must be also convenient in the analysis of future developments in that direction. Similarly, results shall also allow for the comprehension of the reasons supporting the non-successful implementation of major operational practices outside their original business contexts. Particularly, aspects related to the operational revolution implemented by Toyota in the period after the Second World War, which includes the implementation of strategies such as Just-in-Time, and, more broadly, of a Lean Synchronization approach, shall be explored within this perspective. It is possible, for instance, that, beyond aspects such as the then poor economic position of the country and the lack of natural resources – factors that must have simultaneously contributed to impossibility of building security stocks –, cultural dimensions translated into the high hierarchization (Adair,

Okumura and Brett, 2001), and the disseminated discipline (Wheelright, 1981) of Japanese employees, have strongly contributed to the implementation of such techniques. In that way, the absence of the cultural aspects may be at least partially responsible for the lack of such prosperous implementation in foreign contexts, such as in the United States, Latin America, or Europe. Again, this study adds to the possible comprehension of past enterprises in that direction through the cultural aspect, being also interesting to the understanding of future attempts.

Although our contributions are more concentrated around an Operations Management perspective, when it comes to the importance of cultural management, several disciplines must be affected. As pointed by Shenkar (2001:519), the construct of cultural distance, or “the extent to which different cultures are similar or different”, is widely employed in the field of International Business, in reference to issues such as investment expansion, choice of entry modes, and the performance of foreign investment. Beyond that, the author also refers to its use in most of business administration disciplines such as Marketing, Finance, and Accounting. Accordingly, among the reasons leading to such an extensive use would be the complex, intangible, and subtle nature of culture itself (Boyacigiller, Kleinberg, Phillips and Sackmann, 1996), phenomenon which the idea of cultural distance would search to set. In that way, from a pragmatic view, the evidence of our contributions must extend across Management as a whole, with the potential aggregations to assorted practices being ideally stressed.

For Marketing, for example, presented results must be valid as, although not focusing on dependent variables linked to dimensions of consumer behavior or attitude towards businesses, they may suggest that the perceptions of a class of stakeholders (i.e. employees) over cultural aspects shall possibly be expected to be also observed by another (i.e. consumers). Despite our results do not allow for such conclusion, the conjuncture seems reasonable if cultural influences

over different classes of stakeholders are considered more influent than their position in relation to a focal company. Differently put, it must be argued that distinct classes of stakeholders may converge in their perceptions over cultural aspects if they belong to a same culture. Further evidence on that direction is necessary, being this issue discussed in greater details as an opportunity for future development.

Nevertheless, in case this hypothesis holds true, companies must not neglect the cultural factors of the groups targeted to consume services and goods, as, beyond the loss of sales, the disrespect to cultural expectations may seriously damage corporate images and reputations. In this vein, cultural aspects must be considered since the conception of products until the forms and mechanisms employed in their advertisement and services after sales. If the values of a given community are not fully respected, retaliations must be expected, ranging from the boycott to a given product to the defamation of companies in both traditional and social medias. Within this set, once more the non-observation of cultural aspects may configure a sort of reputational risk to companies.

From a Finance point of view, companies must be attentive to the cultural expectations of its shareholders as, in the context of the globalization of financial markets, investors belong to the most distinct cultural background. Managers must then again assure that the practices of companies do not hurt the presumptions of those who ultimately fund it. Similar rationale must be extended to the relationship companies keeps with its creditors. The connection with financial institutions and investment banks issued from different cultural contexts may also demand the accommodation of cultural expectations so that the relationship must be developed without undesired and / or counterproductive barriers. One must argue that this sort of business-to-business relations among companies holding some extent of cultural distance (i.e. a source company and a financial institution) may be close to those of buyers and suppliers, which were

more centrally considered in the present work. In this sense, it is possible that the theoretical contributions around the preservation and extension of the possibilities to create and capture of relational rents, here proposed as the fifth element to be added to Dyer and Singh's (1998) Relational View, may also come to be useful in the relationships between companies and its creditors, notably financial institutions. Once more, our results do not allow more than the presumption of such relations, resting this investigation to be analyzed as a possibility to future development.

From the angle of Ethical Management, one must also consider the adjustment of firms to different cultural environments when it comes to their interfaces with governments, legislations, and political systems. Eventual discrepancies in that direction may lead firms to forms of adaptations, not always ethically or morally acceptable. The disclosure of cases of corruption involving multinational firms operating abroad illustrate the issue. In order to ensure the viability of their projects in corrupt environments, companies such as Rolls-Royce and Siemens, for example, have been pointed to operate complex bribery schemes with local authorities when operating abroad (Berghoff, 2018, Tovey, 2017). As previously discussed, in the context of a greater surveillance of the attitudes held by managers, and their nearly-free dissemination in social medias, misconducts of such nature may seriously compromise the reputational capital of firms. This aspect was particularly addressed as a negative outcome of the Brazilian *jeitinho* in the second article of the dissertation.

10.5. Limitations and Extensions

Despite the concern for academic rigor and all the efforts committed in the best conduction of the work, this research is not free of intrinsic limitations. Even if, globally, such restraints do not compromise the significance of results, action to eliminate, or at least minimize, their effects

must be constant, especially for the conduction of the investigations to come. In that way, the recognition of its limitations, allied with the proposition of alternatives, may represent valuable opportunities for a more complete comprehension of the subjects here approached.

A discussion around the nature of the data analyzed in the empirical investigations will act then as the starting point of such discussion. As pointed in the first article, the High Performance Manufacturing (HPM) project is built over the application of structured surveys with diverse levels of employees engaged in the operational processes of companies. As a result, a comprehensive database is compiled, allowing for different uses and applications, including, in some cases, the configuration of longitudinal analysis. While the use of such data is certainly valuable and permits the development of a wide set of investigations, it must be noted that its use implies in the analysis of a data which was not primarily collected for such purpose. The consideration of a standard result may thus lead to potential incongruities and lack of fit to the specific objectives of the research being conducted, factors that would be likely to be eliminated in case the collection instruments were to be design to specific fit the conducted research. From this perspective, the impossibility to adapt or to reformulate questions may be seen as a constraint and, as such, a potential limitation of the study. Moreover, the choice of Hofstede's findings to compose this set of analysis needs to be recognized as a static perspective on culture, which adds a limitation connected to the fact that globalization has been a changing process to societies involved – to the point that, what may have been defined as a determined culture in the past, might not necessarily hold true throughout time-passing. This would be attributed to cultures both incorporating and being incorporated by others, influenced by migration movements, and hence being ultimately subject to continuous change.

Within a qualitative approach, the second article concentrates on the application of semi-structure interviews, so that nuances and not evidently perceivable characteristics of the

indigenous practice in study could be captured. If, on the one hand, this method offered a considerably higher degree of flexibility in the adaptation of the questions to our goals, the non-utilization of structured scales (such as those used in article one) prevents the application of more sophisticated statistical methods. In fact, not only for the impossibility to develop a more objectivist view of our outcomes, but also for the own nature of the qualitative approach, evidences result from the interpretation of the researchers. Even if all the procedures to eliminate eventual bias were adopted, such investigations may be always subject to the pre-conceptions and prejudices of those analyzing data. Nevertheless, the fact that the articles make use of such different methodologies must be seen as a positive factor, as they must work as a complement of each other, and, thus, enhance the validity of the general results.

Beyond the limitations emerging from the methods employed and from the nature of the data used in our studies, opportunities for future development may be found in the extension of the unities of analysis, as currently such evidences are concentrated in specific groups of stakeholders. In the first study, for example, the data analyzed is sourced from surveys conducted with managers of manufacturing plants. Likewise, study two was conducted with professionals of either buyer or supplier positions of companies operating in Brazil. Despite the different hierarchical grades considered, all the respondents stand as employees. While this class of stakeholders may be traditionally consulted in Operations Management studies, the extension of such investigations to other categories such as investors, consumers, members of local communities, and of local governments, to name a few, would reinforce the validity of the outcomes in relation to other associated Management disciplines, such as Marketing, Finance, and Strategic Management, among others. Despite the presented empirical evidences strongly suggest that the effective management of cultural issues may indeed lead firms to create and capture relational rents (and ultimately reach competitive advantage), when it comes to the proposition of a similar logic in relation to other classes of stakeholders, the outcomes do

not allow for more than the proposition of hypotheses to be tested by future research. Studies deepening the effect of cultural accommodation in dimensions of consumer's behavior would be welcome, what would potentially offer valuable insights to Marketing scholars. Still, the attention to scales linking consumers' perceptions to attitudes towards businesses may help clarifying the impact of such cultural strategies, possibly adding to the comprehension of their effects. Particularly important must be the analysis concentrated on the cultural aspects' effects on dimensions linked to the intangible resources of companies, such as corporate images, identities, and reputations. Investigations considering how a cultural offense may affect the reputational capital of companies, for instance, shall be of interest. Furthermore, the potential positive outcomes that may arise from cross-cultural management also deserves attention (Stahl, Miska, Lee and De Luque, 2016) as its effects might not only extend to threats, but benefits as well.

On what relates to different methods to be explored, researchers could profit from the application of a range of different approaches. Nevertheless, the use of experiments may be argued to be particularly advantageous to the extension of the presented findings. Among the reasons supporting such view is the fact that experiments grant researchers with a high level of flexibility in both the design of the scenarios and on the scales to be tested. Not only different classes of stakeholders might be analyzed in a same experiment – potentially with the use of role-playing approaches –, but also a wide range of dimensions may come to be jointly assessed. Around the analysis of the reactions of investors, the application of the event study method shall be also valuable, as, through the measurement of stock prices variations, it allows for the delimitation of causal relations between an event and its consequences to the valuation of companies. In the context of this analysis, the method would be more likely to be successfully applied in the considerations of major events accounting for severe fails or misconducts related to cultural aspects. The detection of a causal relation between eventual issues of that nature and

the negative reactions of investors would reinforce the argument that cultural aspects are relevant, and, moreover, potentially a source of value creation (or destruction).

Results must also contribute to future research associating other disciplines linked to social studies, particularly Sociology and Anthropology. Regarding the former, it must be useful in the comprehension of how internationalization of companies modifies traditional relationships in distinct societies. The implementantation of thousands of factories in low-labor cost zones, which were previously dedicated to other economic activities such as cattle breeding and agriculture, may bear some resemblance with the early stages of the industrial revolution of the eighteenth century. The joint analysis of both business and sociological aspects of these periods may then help clarifying not only the last decades of the world economy, but also the impact of capitalism as a whole. From an anthropologic view point, the effects of such subtle changes in ancient cultures may be also relevant. Once more, the contextualized analysis linking business development and culture may lead to new propositions and examinations.

References

- Aaker, D.A. (1989). Managing assets and skills: The key to a sustainable competitive advantage. *California Management Review*, vol.31, n.2, pp.91-106.
- Aberle, D.G., Cohen, A.K., Davis, A.K., Levy, M.J. Jr. and Sutton, F.X. (1950). The functional prerequisites of a society. *Ethics*, vol.60, n.2, pp.100-111.
- Acur, N., Gertsen, F., Sun, H. and Frick, J. (2003). The formalisation of manufacturing strategy and its influence on the relationship between competitive objectives, improvement goals, and action plans. *International Journal of Operations & Production Management*, vol.23, n.10, pp.1114-1141.
- Adair, W.L., Okumura, T. and Brett, J.M. (2001). Negotiation behavior when cultures collide: the United States and Japan. *Journal of Applied Psychology*, vol.86, n.3, p.371-385.
- Adler, N.J. (1983a). Cross-cultural management research: The ostrich and the trend. *The Academy of Management Review*, vol.8, n.2, pp.226-232.
- Adler, N.J. (1983b). A typology of management studies involving culture. *Journal of International Business Studies*, vol.14, n.2, pp.29-47.
- Ageron, B., Gunasekaran, A. and Spalanzani, A. (2012). Sustainable supply management: An empirical study. *International Journal of Production Economics*, vol.140, n.1, pp.168-182.
- Ahmad, S. and Schroeder, R.G. (2003). The impact of human resource management practices on operational performance: Recognizing country and industry differences. *Journal of Operations Management*, vol.21, pp.19-43.
- Almeida, P., Grant, R. and Phene, A. (2017). Knowledge acquisition through alliances: Opportunities and challenges. In: M.J. Gannon and K.L. Newman (Eds.). *The Blackwell Handbook of Cross-Cultural Management*. Blackwell Publishers Ltd.
- Alvesson, M. and Sköldböck, K. (2000). *Reflexive Methodology. New Vistas for Qualitative Research*. London: Sage Publications.
- Amado, G. and Vinagre Brasil, H. (1991). Organizational behavior and cultural context: The Brazilian "jeitinho". *International Studies of Management and Organization*, vol.21, n.3, pp.38-6.
- Andersen, M. and Skjoett-Larsen, T. (2009). Corporate social responsibility in global supply chains. *Supply Chain Management: An International Journal*, vol.14, n.2, pp.75-86.
- Anderson, D.R., Sweeney, D.J. and Williams, T.A. (2010). *Essentials of Statistics for Business and Economics*. 6th Edition. Mason, OH: South Western.
- Anderson, J.C., Schroeder, R.G. and Cleveland, G. (1991). The process of manufacturing strategy: Some empirical observations and conclusions. *International Journal of Operations & Production Management*, vol.11, n.3, pp.86-110.

- Ardichvili, A., Jondle, D., Kowske, B., Cornachione, E., Li, J. and Thakadipuram, T. (2012). Ethical cultures in large business organizations in Brazil, Russia, India, and China. *Journal of Business Ethics*, vol.105, n.4, pp.415-428.
- Ardichvili, A. and Kuchinke, P.K. (2002). Leadership styles and cultural values among managers and subordinates: A comparative study of four countries of the former Soviet Union, Germany and the U.S. *Human Resource Development International*, vol.5, n.1, pp.99-117.
- Argandona, A. (2005). Corruption and companies. The use of facilitating payments. *Journal of Business Ethics*, vol.60, pp.251-264.
- Arregle, J.L., Miller, T.L., Hitt, M.A. and Beamish, P.W. (2013). Do regions matter? An integrated institutional and semiglobalization perspective on the internationalization of MNEs. *Strategic Management Journal*, vol.34, n.8, pp.910-934.
- Ayoun, B.M. and Moreo, P.J. (2008). The influence of the cultural dimension of uncertainty avoidance on business strategy development: A cross-national study of hotel managers. *International Journal of Hospitality Management*, vol.27, pp.65-75.
- Baily, M.N. and Bosworth, B.P. (2014). US manufacturing: Understanding its past and its potential future. *Journal of Economic Perspectives*, vol.28, n.1, pp.3-26.
- Baldwin, J.R., Faulkner, S.L., Hecht, M.L. and Lindsley, S.L. (2006)(Eds.). *Redefining Culture. Perspectives Across the Disciplines*. New Jersey and London: Lawrence Erlbaum Associates, Inc., Publishers.
- Baligh, H.H. (1994). Components of culture: Nature, interconnections, and relevance to the decisions on the organization structure. *Management Science*, vol.40, n.1, pp.14-27.
- Banerjee, S.B. and Linstead, S. (2004). Masking subversion: Neocolonial embeddedness in anthropological accounts of indigenous management. *Human Relations*, vol.57, n.2, pp.221-247.
- Barbosa, L. (1992). *O Jeitinho Brasileiro: a Arte de Ser Mais Igual do que os Outros*. Rio de Janeiro, Brazil: Editora Campos.
- Barbosa, L. (2006). *O Jeitinho Brasileiro: a Arte de Ser Mais Igual do que os Outros*. São Paulo, Brazil: Elsevier.
- Bardhan, P. (1997). Corruption and development: A review of issues. *Journal of Economic Literature*, vol.35, pp.1320-1346.
- Barkin, S. (2009). Realism, constructivism and international relations theory. *American Political Science Association*, Toronto Meeting Paper. Available at SSRN: <http://ssrn.com/abstract=1451682>
- Barmeyer, C. and Mayrhofer, U. (2008). The Contribution of intercultural management to the success of international mergers and acquisitions: An analysis of the EADS group. *International Business Review*, vol.17, pp.28-38.

- Barnes, D. (2001). Research methods for the empirical investigation of the process of formation of operations strategy. *International Journal of Operations & Production Management*, vol.21, n.8, pp.1076-1095.
- Barnes, D. (2002). The complexities of the manufacturing strategy formation process in practice. *Journal of Operations & Production Management*, vol.22, n.10, pp.1090-1111.
- Barney, J.B. (1986). Organizational culture: Can it be a source of sustained competitive advantage? *The Academy of Management Review*, vol.11, n.3, pp.656-665.
- Barney, J.B. (1991). Firm resources and sustained competitive advantage. *Journal of Management*, vol.17, n.1, pp.99-120.
- Barney, J., Wright, M. and Ketchen Jr., D.J. (2001). The resource-based view of the firm: Ten years after 1991. *Journal of Management*, vol.7, pp.625-641.
- Baskerville, R.F. (2003). Hofstede never studied culture. *Accounting, Organizations and Society*, vol.28, pp.1-14.
- Benedict, R. (1947). *Race, Science and Politics*. (Rev. ed.). New York.
- Bennett, J.W. and Tumin, M.M. (1949). *Social Life: Structure and Function*. New York.
- Berlak, A.C. and Berlak, H. (1975). *The Dilemmas of Schooling: An Application and Interpretation of GH Mead's Social Behaviorism*.
- Bernard, H.R. (2011). *Research Methods in Anthropology. Qualitative and Quantitative Approaches*. Fifth Edition. Plymouth, UK: AltaMira Press.
- Bettis, R.A., Ethiraj, S., Gambardella, A., Helfat, C. and Mitchell, W. (2016). Creating repeatable cumulative knowledge in Strategic Management: A call for a broad and deep conversation among authors, referees, and editors. *Strategic Management Journal*, vol.37, pp.257-261.
- Bhaskaran, S. and Gligorovska, E. (2009). Influence of national culture on trans-national alliance relationships. *Cross Cultural Management: An International Journal*, vol.16, n.1, pp.44-61.
- Bienarcki, P. and Waldorf, D. (1981). Snowball sampling. Problems and techniques of chain referral sampling. *Sociological Methods & Research*, vol.10, n.2, pp.141-163.
- Biggart, N.W. and Delbridge, R. (2004). Systems of exchange. *Academy Management Review*, vol.29, n.1, pp.28-49.
- Blackman, I.A., Holland, C.P. and Westcott, T. (2013). Motorola's global financial supply chain strategy. *Supply Chain Management: An International Journal*, vol.18, n.2, pp.132-147.
- Bintliff, E. (2009). "The French filmmaker who knows what audiences like". *Financial Times*, 14 August, available at <http://www.ft.com/cms/s/0/dc1ecbb6-8874-11de-82e4->

00144feabdc0.html?ft_site=falcon&desktop=true#axzz4oCLhkQtS (accessed 29 July 2017).

- Boal, K.B. and Hooijberg, R. (2000). Strategic leadership research: moving on. *The Leadership Quarterly*, vol.11, n.4, pp.515-549.
- Bogardus, E.S. (1960). *The Development of Social Thought*. 4th ed. New York: David McKay.
- Boulu-Reshef, B. (2015). Toward a personal identity argument to combine potentially conflicting social identities. *Review of Social Economy*, vol.73, n.1, pp.1-18.
- Boyacigiller, N., Kleinberg, M. and Phillips, M., Sackmann, S. (1996). Conceptualizing culture. In: B.J. Punnett and O. Shenkar. *Handbook for International Management Research*, MS: Blackwell.
- Boyer, K.K., Swink, M. and Rosenzweig, E.D. (2005). Operations strategy research in the POMS Journal. *Production and Operations Management*, vol.14, n.4, pp.442-449.
- Bozarth, C.C., Warsing, D.P., Flynn, B.B. and Flynn, E.J. (2009). The impact of supply chain complexity on manufacturing plant performance. *Journal of Operations Management*, vol.27, pp.78-93.
- Brislin, R.W. (2001). *Understanding Culture's Influence on Behavior* (2nd ed.). Ft. Worth: Harcourt.
- Brocke, J. and Sinnl, T. (2011). Culture in Business Process Management: A Literature Review. *Business Process Management Journal*, vol.17, n.2, pp.357-378.
- Brodbeck, F.C., Frese, M. and Mansour, J. (2002). Leadership made in Germany: Low on compassion, high on performance. *The Academy of Management Executive*, vol.16, n.1, pp.16-29.
- Brodeur, A., Lé, M., Sangnier, M. and Zylberberg, Y. (2016). Star Wars: The empirics strike back. *American Economic Journal: Applied Economics*, vol.8, n.1, pp.1-32.
- Brown, I.C. (1963). *Understanding Other Cultures*. Englewood Cliffs, NJ: Prentice-Hall.
- Brown, E. and Cloke, J. (2011). Critical perspectives on corruption: An overview. *Critical Perspectives on International Business*, vol.7, n.2, pp.116-124.
- Brown, S., Squire, B. and Blackmon, K. (2007). The contribution of manufacturing strategy involvement and alignment to world-class manufacturing performance. *International Journal of Operations & Production Management*, vol.27, n.3, pp.282-302.
- Bryman, A. (2007). Barriers to integrating quantitative and qualitative research. *Journal of Mixed Methods Research*, vol.1, n.1, pp.8-22.

- Builtjens, R.P.M. and Noorderhaven, N.G. (1996). *The Influence of National Culture on Strategic Decision Making: A Case Study of the Philippines*. Tilburg University and Institute for Research on Intercultural Cooperation.
- Burgelman, R.A. and Grove, A.S. (2007). Let chaos reign, then rein in chaos-repeatedly: Managing strategic dynamics for corporate longevity. *Strategic Management Journal*, vol.28, n.10, pp.965-979.
- Burrell, G. and Morgan, G. (1979). *Sociological Paradigms and Organizational Analysis*. London: Heinemann.
- Burns, G.N., Nieminen, L.R.G., Kotrba, L. and Denison, D. (2014). Leader-culture fit around the globe: Investigating fit as layered within organizations and national cultures. *Advances in Global Leadership*, vol.8, pp.67-92.
- Buttery, E.A. and Leung, T.K.P. (1998) The difference between Chinese and Western negotiations. *European Journal of Marketing*, vol.32, n.3/4, pp.374-389.
- Buzzell, R. (1968). Can you standardize multinational marketing? *Harvard Business Review*, Nov-Dec, vol.46, pp.102-113.
- Calza, F., Cannavale, C. and Tutore, I. (2016). The important effects of national culture on the environmental proactivity of firms. *Journal of Management Development*, vol.35, n.8, pp.1011-1030.
- Campos, L.A., Axinn, C., Wang, Y.J. and Baeza, M.A. (2016). The internationalization pattern of traditional Brazilian footwear manufacturers: A qualitative analysis. *International Journal of Entrepreneurship and Small Business*, vol.27, n.1, pp.71-83.
- Cannon, J.P., Doney, P.M., Mullen, M.R. and Petersen, K.J. (2010). Building long-term orientation in buyer-supplier relationships: The moderating role of culture. *Journal of Operations Management*, vol.28, pp.506-521.
- Cantor, D.E., Morrow, P.C. and Montabon, F. (2012). Engagement in environmental behaviors among supply chain management employees: An organizational support theoretical perspective. *Journal of Supply Chain Management*, vol.48, n.3, pp.33-51.
- Carver, T.N. (1935). *The Essential Factors of Social Evolution*. Cambridge.
- Carlsson, K. (2017). Sourcing from Multinational suppliers to overcome weak contracting institutions and gain supply chain capabilities. In: *Geography, Location, and Strategy*. *Advances in Strategic Management*, vol.36, pp.229-265.
- Casson, M. (2013). Economic analysis of international supply chains: An internalization perspective. *Journal of Supply Chain Management*, vol.49, n.2, pp.8-13.
- Chakrabarty, S. (2009). The influence of national culture and institutional voids on family ownership of large firms: A country level empirical study. *Journal of International Management*, vol.15, n.1, pp.32-45.

- Chan, J., Pun, N. and Selden, M. (2013). The politics of global production: Apple, Foxconn and China's new working class. *New Technology, Work and Employment*, vol.28, n.2, pp.100-115.
- Chemers, M.M. (2003). Leadership effectiveness: Functional, constructivist, and empirical perspectives. In: D. Van Knippenberg and M.A. Hogg (2003). *Leadership and power. Identity processes in groups and organizations*. London: Sage Publications.
- Chen, D.Q., Preston, D.S. and Xia, W. (2013). Enhancing hospital supply chain performance: A relational view and empirical test. *Journal of Operations Management*, vol.31, pp.391-408.
- Chen, M., Farh, J. and MacMillan, I.C. (1993). An exploration of the expertness of outside informants. *Academy of Management Journal*, vol.36, n.6, pp.1614-1632.
- Chen, Z., Huang, Y. and Sternquist, B. (2011). Guanxi practice and Chinese buyer–supplier relationships: The buyer’s perspective. *Industrial Marketing Management*, vol.40, n.4, pp.569–580.
- Clampit, J., Kedia, B., Fabian, F. and Gaffney, N. (2015). Offshoring satisfaction: The role of partnership credibility and cultural complementarity. *Journal of World Business*, vol.50, n.1, pp.79-93.
- Cloke, E.B.J. (2006). The critical business of corruption. *Critical Perspectives on International Business*, vol.2, n.4, pp.275-298.
- Coase, R.H. (1937). The nature of the firm. *Economica*, vol.4, n.16, pp.386-405.
- Cohen, H.F. (1994). *The Scientific Revolution. A Historiographical Inquiry*. Chicago and London: The University of Chicago Press.
- Cohen, M.A. and Lee, H.L. (1985). Manufacturing strategy. Concepts and methods. In: P.R. Kleindorfer (Ed). *The Management of Productivity and Technology in Manufacturing*. New York: Plenum Press.
- CommLab India (2017). “About us”. Available at <https://www.commlabindia.com/company/about-us.php> (accessed 29 July 2017).
- Connelly, B.L., Ketchen, D.J. and Hult, T.M. (2013). Global supply chain management: Toward a theoretically driven research agenda. *Global Strategy Journal*, vol.3, pp.227-243.
- Conlisk, J. (1996). Why bounded rationality? *Journal of Economic Literature*, vol.34, n.2, pp.669-700.
- Cooper, C.L. (1982). [Review of the book *Culture’s Consequences*, by G. Hofstede]. *Journal of Occupational Behaviour*, vol.3, n.2, pp.123. In: Hofstede, G. (2001) *Cultures Consequences. Comparing Values, Behaviors, Institutions, and Organizations across Nations*. 2nd Edition. London: Sage Publications, Inc.
- Corsini, R.J. (1999). *The Dictionary of Psychology*. Philadelphia, PA: Brunner/Mazel.

- Corsten, D. and Kumar, N. (2005). Do suppliers benefit from collaborative relationships with large retailers? An empirical investigation of efficient consumer response adoption. *Journal of Marketing*, vol.69, pp.80-94.
- Crane, D. (2014). Cultural globalization and the dominance of the American film industry: Cultural policies, national film industries, and transnational film. *International Journal of Cultural Policy*, vol.20, n.4, pp.365-382.
- Crawley, A. and Sinclair, A. (2003). Indigenous human resource practices in Australian mining companies: Towards an ethical model. *Journal of Business Ethics*, vol.45, n.4, pp.361-373.
- Creswell, J.W. (1998). *Qualitative Inquiry and Research Design – Choosing among Five Traditions*. London: Sage Publications.
- Creswell, J.W. (2003). *Research Design: Qualitative, Quantitative and Mixed Approaches*. California: Sage Publications.
- Cronbach, L.J. (1951). Coefficient alpha and the internal structure of tests. *Psychometrika*, vol.16, n.3, pp.297-334.
- Croson, R. and Donohue, K. (2002). Experimental economics and supply chain management. *Interfaces*, vol.32, pp.74-82.
- Croson, R., Schultz, K., Siemsen, E. and Yeo, M.L. (2013). Behavioral operations: The state of the field. *Journal of Operations Management*, vol.31, pp.1-5.
- Cuervo-Cazurra, A. (2016). Corruption in international business. *Journal of World Business*, vol.51, pp.35-49.
- Cuervo-Cazurra, A., Narula, R. and Un, C.A. (2015). Internationalization motives: Sell more, buy better, upgrade and escape. *The Multinational Business Review*, vol.23, n.1, pp.25-35.
- Cuzzort, R.P. (1969). *Humanity and Modern Sociological Thought*. New York: Holt, Rinehart and Winston.
- D’Andrade, R. (1995). *The Development of Cognitive Anthropology*. New York: Cambridge University.
- D’Iribarne, P. (2009). National cultures and organisations in search of a theory. An interpretative approach. *International Journal of Cross Cultural Management*, vol.9, n.3, pp.309-321.
- Dangayach, G.S. and Deshmukh, S.G. (2001). Manufacturing strategy: Literature review and some issues. *International Journal of Operations & Production Management*, vol.21, n.7, pp.884-932.
- Daniel, S.J., Cieslewicz, J.K. and Pourjalali, H. (2012). The impact of national economic culture and country-level institutional environment on corporate governance practices. *Management International Review*, vol.52, pp.365-394.

- Daspit, J., Tillman, C.J., Boyd, N.G. and Mckee, V. (2013). Cross-functional team effectiveness: An examination of internal team environment, shared leadership, and cohesion influences. *Team Performance Management: An International Journal*, vol.19, n.1/2, pp.34-56.
- De Meester, L., De Meyer, A. and Grahovac, J. (2014). The role of operations executives in strategy making. *Journal of Operations Management*, vol.32, n.7–8, pp.403-413.
- De Mooij, M. and Hofstede, G. (2010). The Hofstede model. Applications to global branding and advertising strategy and research. *International Journal of Advertising*, vol.29, n.1, pp.85-110.
- Dia, M. (1996). Africa's Management in the 1990s and Beyond. Reconciling Indigenous and Transplanted Institutions. Washington D.C.: *The World Bank*.
- DiMaggio, P. (1994). Culture and economy. In: N.S.R. Swedberg (Ed) *Handbook of Economic Sociology*. Princeton, NJ: Princeton University Press, pp.27-57.
- Dobbin, F. and Baum, J.A. (2000). Introduction: Economics meets sociology in strategic management. In: B. Silverman (Ed.). *Economics Meets Sociology in Strategic Management*, pp. 1-26. Bingley, UK: Emerald Group Publishing Limited.
- Doise, W. and Graham, D. (1978). *Groups and Individuals: Explanations in Social Psychology*. CUP Archive.
- Dong, W., Ma, Z. and Zhou, X. (2017). Relational governance in supplier-buyer relationships: The mediating effects of boundary spanners' interpersonal guanxi in China's B2B market. *Journal of Business Research*, vol.78, pp.322-340.
- Donohue, K. and Siemsen, E. (2011). Behavioral operations: Applications in supply chain management. *Wiley Encyclopedia of Operations Research and Management Science*.
- Dorfman, P.W., Howell, J.P., Hibino, S., Lee, J.K., Tate, U. and Bautista, A. (1997). Leadership in Western and Asian countries: Commonalities and differences in effective leadership processes across cultures. *The Leadership Quarterly*, vol.8, n.3, pp.233-274.
- Driver, H.E. (1973). Cross-cultural studies. In: J.J. Honigmann (Ed.). *Handbook of Social and Cultural Anthropology*, pp.327-367. Chicago: Rand McNally.
- Duarte, F. (2006). Exploring the interpersonal transaction of the Brazilian jeitinho in bureaucratic contexts. *Organization*, vol.13, n.4, pp.509-527.
- Duarte, F. (2018). Jeitinho, entry 1.2. In: A. Ledeneva (Ed.). *The Global Encyclopaedia of Informality*. London: UCL Press, vol.1.
- Dunfee, T.W. and Warren, D.E. (2001). Is guanxi ethical? A normative analysis of doing business in China. *Journal of Business Ethics*, vol.32, n.3, pp.191-204.

- Dupuis, J. (2013). New approaches in cross-cultural management research. The importance of context and meaning in the perception of management styles. *International Journal of Cross Cultural Management*, vol.14, n.1, pp.67-84.
- Durach, C.F., Wieland, A. and Machuca, J.A.D. (2014). Antecedents and dimensions of supply chain robustness: A systematic literature review. *International Journal of Physical Distribution & Logistics Management*, vol.45, n.1/2, pp.118-137.
- Durepos, G., Prasad, A. and Villanueva, C.E. (2016). How might we study international business to account for marginalized subjects? Turning to practice and situating knowledges. *Critical Perspectives on International Business*, vol.12, n.3, pp.306-314.
- Dyer, J.H. (1996). Specialized supplier networks as a source of competitive advantage: Evidence from the auto industry. *Strategic Management Journal*, vol.17, pp.271-291.
- Dyer, J.H. and Chu, W. (2000). The determinants of trust in supplier-automaker relationships in the U.S., Japan, and Korea. *Journal of International Business Studies*, vol.31, n.2, pp.259-285.
- Dyer, J.H. and Chu, W. (2011). The determinants of trust in supplier-automaker relationships in the U.S., Japan, and Korea: A retrospective. *Journal of International Business Studies*, vol.42, n.1, pp.1-7.
- Dyer, J.H. and Nobeoka, K. (2000). Creating and managing a high performance knowledge-sharing network: the Toyota case. *Strategic Management Journal*, vol.21, n.1, pp.345-367.
- Dyer, J.H. and Singh, H. (1998). The relational view: Cooperative strategy and sources of interorganizational competitive advantage. *Academy of Management Review*, vol.23, n.4, pp.660-679.
- Erez, M. and Earley, P.C. (1993). *Culture, Self-Identity, and Work*. New York and Oxford: Oxford University Press.
- Eliot, T.S. (2010). *Notes Towards the Definition of Culture*. Faber & Faber.
- Ellegaard, C., Johansen, J. and Drejer, A. (2003). Managing industrial buyer-supplier relations – The case for attractiveness. *Integrated Manufacturing Systems*, vol.14, n.4, pp.346-356.
- Enders, C.K. (2010). *Applied Missing Data Analysis*. New York, NY: The Guilford Press.
- Etikan, I., Musa, S.A. and Alkassim, R.S. (2016). Comparison of convenience sampling and purposive sampling. *American Journal of Theoretical and Applied Statistics*, vol.5, n.1, pp.1-4.
- Ewing, K.P. (1990). The illusion of wholeness: Culture, self and the experience of inconsistency. *Ethos*, vol.18, n.3, pp.251-278.
- Eysenck, H.J. (1981). The four dimensions [Review of the book *Culture's Consequences*, by G. Hofstede]. New Society. In: Hofstede, G. (2001) *Cultures Consequences. Comparing*

Values, Behaviors, Institutions, and Organizations across Nations. 2nd Edition. London: Sage Publications, Inc.

Farh, J. and Bor-Shiuan, C. (2000). A cultural analysis of paternalistic leadership in Chinese organizations. In: J.T. Li, A.S. Tsui and E. Weldon (Eds). *Management and organizations in the Chinese context*. Palgrave Macmillan UK, pp.84-127.

Ferdows, K., Lewis, M.A. and Machuca, J.A.D. (2004). Rapid-fire fulfillment. *Harvard Business Review*, vol.82, n.11, pp.104-117.

Fey, C.F., Nayak, A.K., Wu, C. and Zhou, A.J. (2016). Internationalization strategies of emerging market multinationals: A five M framework. *Journal of Leadership & Organizational Studies*, vol.23, n.2, pp.128-143.

Field, A. (2009). *Discovering Statistics Using R*. 3rd Edition. London: Sage Publications.

Finger, A.B., Flynn, B.B. and Paiva, E.L. (2014). Anticipation of new technologies: Supply chain antecedents and competitive performance. *International Journal of Operations & Production Management*, vol.34, n.6, pp.807-828.

Fiske, A.P. (1992). The 4 elementary forms of sociality: Framework for a unified theory of social relations. *Psychological Review*, vol.99., pp.689-723.

Fleith, D.S. (2011). Creativity in the Brazilian culture. *Online Readings in Psychology and Culture*, vol.4, n.3.

Flynn, B.B., Schroder, R.G. and Flynn, E.J. (1999). World Class Manufacturing: An investigation of Hayes and Wheelwright's foundation. *Journal of Operations Management*, v.17, pp.249-269.

Foerstl, K., Hartmann, E., Wynstra, F. and Moser, R. (2013). Cross-functional integration and functional coordination in purchasing and supply chain management: Antecedents and effects on purchasing and firm performance. *International Journal of Operations & Production Management*, vol.33, n.6, pp.689-721.

Folsom, J. (1931). *Social Psychology*. New York.

Ford, C.S. (1939). Society, culture, and the human organism. *Journal of General Psychology*, vol.20, pp.135-179.

Fornell, C. and Larcker, D.F. (1981). Evaluating structural equation models with unobservable variables and measurement error. *Journal of Marketing Research*, vol.18, n.1, pp.39-50.

Fracarolli Nunes, M. (2018). Supply chain contamination: An exploratory approach on the collateral effects of negative corporate events. *European Management Journal*, vol.36, n.4, pp.573-587.

Fracarolli Nunes, M. and Lee Park, C. (2016). Self-claimed sustainability: Building social and environmental reputations with words. *Sustainable Production and Consumption*, vol.11, pp.46-57.

- Frankel, R. and Mollenkopf, D.A. (2015). Cross-functional integration revisited: Exploring the conceptual elephant. *Journal of Business Logistics*, vol.36, n.1, pp.18-24.
- Fu, P.P., Tsui, A.S. and Dess, G.G. (2006). The dynamics of guanxi in Chinese high-tech firms: Implications for knowledge management and decision making. *Management International Review*, vol.46, pp.277-305.
- Furusawa, M. and Brewster, C. (2015). The bi-cultural option for global talent management: The Japanese/Brazilian nikkeijin example. *Journal of World Business*, vol.50, n.1, pp.113-143.
- Gagnon, S. (1999). Resource-based competition and the new operations strategy. *International Journal of Operations & Production Management*, vol.19, n.2, pp.125-138.
- Gattiker, T.F., Carter, C.R., Huang, X. and Tate, W.L. (2014). Managerial commitment to sustainable supply chain management projects. *Journal of Business Logistics*, vol.35, n.4, pp.318-337.
- Gebauer, H. (2009). An attention-based view on service orientation in the business strategy of manufacturing companies. *Journal of Managerial Psychology*, vol.24, n.1, pp.79-98.
- Gelbrich, K., Stedham, Y. and Gäthke, D. (2016). Cultural discrepancy and national corruption: Investigating the difference between cultural values and practices and its relationship to corrupt behavior. *Business Ethics Quarterly*, vol.26, n.2, pp.201-225.
- Gemser, G. and Leenders, M.A.A.M. (2011). Managing cross-functional cooperation for new product development success. *Long Range Planning*, vol.44, n.1, pp.26-41.
- Gernon, H. and Wallace, R.S.O. (1995). International accounting research: A review of its ecology, contending theories and methodologies. *Journal of Accounting Literature*, vol.14, pp.54-106.
- Ghobadi, S. and D'Ambra, J. (2012). Knowledge sharing in cross-functional teams: A cooperative model. *Journal of Knowledge Management*, vol.16, n.2, pp.285-301.
- Gillin, J.P. (1948). *The Ways of Men*. New York.
- Gino, F. and Pisano, G. (2008). Toward a theory of behavioral operations. *Manufacturing & Service Operations Management*, vol.10, n.4, pp.676-691.
- Glunk, U., Wilderom, C. and Ogilvie, R. (1996). Finding the key to German-style management. *International Studies of Management & Organization*, vol.26, n.3, pp.93-108.
- Gooderham, P., Nordhaug, O. and Ringdal, K. (2006). National embeddedness and calculative human resource management in US subsidiaries in Europe and Australia. *Human Relations*, vol.59, n.11, pp.1491-1513.
- Goebel, P., Reuter, C., Pibernik, R. and Sichtmann, C. (2012). The influence of ethical culture on supplier selection in the context of sustainable sourcing. *International Journal of Production Economics*, vol.140, pp.7-17.

- Graça, S.S., Barry, J.M. and Doney, P.M. (2015). Performance outcomes of behavioral attributes in buyer-supplier relationships. *Journal of Business & Industrial Marketing*, vol.30, n.7, pp.805-816.
- Gray, S.J., Kang, T. and Lin, Z. (2015). Earnings management in Europe post IFRS: Do cultural influences persist? *Management International Review*, vol.55, pp.827-856.
- Gu, F.F., Hung, K. and Tse, D.K. (2008). When does guanxi matter? Issues of capitalization and its dark sides. *Journal of Marketing*, vol.72, pp.12-28.
- Hair Jr., J.F., Babin, B., Money, A.H. and Samouel, P. (2003). *Essentials of Business Research Methods*. Hoboken, NJ: Wiley.
- Halkos, G. and Skouloudis, A. (2017). Revisiting the relationship between corporate social responsibility and national culture: A quantitative assessment. *Management Decision*, vol.55, n.3, pp.595-613.
- Hall, A.R. (1954). *The Scientific Revolution, 1500-1800: The Formation of the Modern Scientific Attitude*. Michigan: Longmans, Green and Company.
- Hallgren, M. and Olhager, J. (2009). Lean and agile manufacturing: External and internal drivers and performance outcomes. *International Journal of Operations & Production Management*, vol.29, n.10, pp.976-999.
- Harris, P.R. and Moran, R.J. (1987). *Managing Culture Differences*, 2nd edition. Houston, Texas: Gulf Publishing.
- Hausman, W.H., Montgomery, D.B. and Roth, A.V. (2002). Why should marketing and manufacturing work together? Some exploratory empirical results. *Journal of Operations Management*, vol.20, n.3, pp.241-257.
- Hawkins, T.G., Randall, W.S., Coyne, A.V. and Baitalmal, M.H. (2014). Sustainable integrity: How reverse auctions can benefit suppliers in emerging markets. *Supply Chain Management: An International Journal*, vol.19, n.2, pp.126-141.
- Hayes, R.H. and Wheelwright, S.C. (1985). *Restoring Our Competitive Edge: Competing through Manufacturing*. New York: Wiley.
- Heckathorn, D.D. (2012). Snowball versus respondent-driven sampling. *Sociological Methodology*, vol.41, n.1, pp.355-366.
- Hennart, J., Sheng, H.H. and Pimenta, G. (2015). Local complementary inputs as drivers of entry mode choices: The case of US investments in Brazil. *International Business Review*, vol.24, n.3, pp.466-475.
- Henry, G.M. (2009). *Histoire de la Pensée Economique*. Armand Colin.
- Herskovits, M.J. (1948). *Man and His Works*. New York.

- Highhouse, S. and Gillespie, J.Z. (2010). Do samples really matter that much? In: C.E. Lance and R.J. Vanderberg (Eds). *Statistical and Methodological Myths and Urban Legends: Doctrine, Verity and Fable in Organizational and Social Sciences*, pp.247-266. New York: Routledge.
- Hofstede, G. (1980). *Culture's Consequences*. London: Sage Publications. In: Baligh, H.H. (1994). Components of culture: Nature, interconnections, and relevance to the decisions on the organization structure. *Management Science*, vol.40, n.1, pp.14-27.
- Hofstede, G. (1980a). *Culture's Consequences: International Differences in Work-Related Values*. London: Sage Publications.
- Hofstede, G. (1980b). Motivation, leadership and organization: Do American theories apply abroad? *Organizational Dynamics*, vol.16, n.4, pp.42-63.
- Hofstede, G. (1983). The cultural reliability of organizational practices and theories. *Journal of International Business Studies*, vol.14, pp.75-89.
- Hofstede, G. (1991). *Culture and Organizations*. Maidenhead, England: McGraw-Hill Books Co. In: Baligh, H.H. (1994). Components of culture: Nature, interconnections, and relevance to the decisions on the organization structure. *Management Science*, vol.40, n.1, pp.14-27.
- Hofstede, G. (1993). Cultural constraints in management theories. *The Executive*, vol.7, n.1, pp.81-95.
- Hofstede, G. (1994). Management scientists are human. *Management Science*, vol.40, n.1, pp.4-13.
- Hofstede, G. (2001) *Cultures Consequences. Comparing Values, Behaviors, Institutions, and Organizations across Nations*. 2nd Edition. London: Sage Publications, Inc.
- Hofstede, G. (2002). Dimensions do not exist: A reply to Brendan McSweeney. *Human Relations*, vol.55, n.11, pp.1355-1361.
- Hofstede, G. (2011). Dimensionalizing cultures: The Hofstede model in context. *Online Readings in Psychology and Culture*, vol.2, n.1, pp.3-26.
- Hofstede, G. and Bond, M.H. (1988). The Confucius connection: From cultural roots to economic growth. *Organizational Dynamics*, vol.16, n.4, pp.4-21.
- Hofstede, G. and McCrae, R.R. (2004). Personality and culture revisited: Linking traits and dimensions of culture. *Cross-Cultural Research*, vol.38, n.1, pp.52-88.
- Hofstede, G. and Minkov, M. (2013). *Values survey module 2013 manual*. Available at: [http://www.geerthofstede.com/media/2186/Manual%20VSM20.202013\(2008\):202013](http://www.geerthofstede.com/media/2186/Manual%20VSM20.202013(2008):202013).
- Holanda, S.B. (1936). *Raízes do Brasil*. 26th Edition. São Paulo, SP: Companhia das Letras.
- Holtbrügge, D. (2013). Indigenous management research. *Management International Review*, vol.53, pp.1-11.

- Horak, S. (2016). Join in or opt out? A normative-ethical analysis of affective ties and networks in South Korea. *Academy of Management Proceedings*, vol.2016, n.1, doi: <https://doi.org/10.1007/s10551-016-3125-7>
- Horak, S. and Klein, A. (2015). Persistence of informal social networks in East Asia: Evidence from South Korea. *Asia Pacific Journal of Management*, vol.33, n.3, pp.673-694.
- Hoover, R., Green, R. and Saegert, J. (1978). A cross-national study of perceived risk. *Journal of Marketing*, July, pp.102-108.
- Hope, C. (2004). The impact of national culture on the transfer of “best practice operations management” in hotels in St. Lucia. *Tourism Management*, vol.25, pp.45-59.
- House, R., Javidan, M., Hanges, P. and Dorfman, P. (2002). Understanding cultures and implicit leadership theories across the globe: An introduction to project GLOBE. *Journal of World Business*, vol.37, pp.3-10.
- Howard, A. (1990). Cultural paradigms, history, and the search for identity in Oceania. In: J., Linnekin and L. Poyer (Eds) *Cultural Identity and Ethnicity in the Pacific*, pp.259-279.
- Hult, G.T.M. (2002). Cultural competitiveness in global sourcing. *Industrial Marketing Management*, vol.31, pp.25-34.
- Hutchings, K. and Weir, D. (2006). Understanding networking in China and the Arab world: Lessons for international managers. *Journal of European Industrial Training*, vol.30, n.4, pp.272-290.
- Hutzschenreuter, T., Voll, J.C. and Verbeke, A. (2011). The impact of added cultural distance and cultural diversity on international expansion patterns: A Penrosean perspective. *Journal of Management Studies*, vol.48, n.2, pp.305-329.
- Hymer, S.H. (1976). *The International Operations of National Firms*. Cambridge, MA: MIT Press.
- Ibrahim, H.W., Zailani, S. and Tan, K.C. (2015). A content analysis of global supply chain research. *Benchmarking: An International Journal*, vol.22, n.7, pp.1429-1462.
- Inkeles, A. and Levinson, D.J. (1954/1977). National character: The study of modal personality and sociocultural systems. In: A. Inkeles. *National Character: A Psycho-Social Perspective*. New Brunswick, NJ: Transaction (Original work published 1954).
- Insdorf, A. (1985). “French films, American style”. *The New York Times*, 28 July, available at <http://www.nytimes.com/1985/07/28/movies/french-films-american-style.html?pagewanted=all> (accessed 24 July 2017).
- Irving, M.A. and Hudley, C. (2008). Cultural identification and academic achievement among African American males. *Journal of Advanced Academics*, vol.19, n.4, pp.676-698.
- Ivanova-Gongne, M. (2015). Culture in business relationship interaction: An individual perspective. *Journal of Business & Industrial Marketing*, vol.30, n.5, pp.608-615.

- Ivory, J. (2017). "France in American film, America in French film". *American Center France*, available at <http://www.americancenterfrance.org/front/index.php?&lvlid=11&artid=91&pos=1&lang=en> (accessed 29 July 2017).
- Jackson, T. (2013). Reconstructing the indigenous in African management research. *Management International Review*, vol.53, pp.13-38.
- Jagoda, K., Kiridena, S. and Lin, X. (2016). Alternative operations strategy processes: Do they matter? *Production Planning & Control*, vol.27, n.9, pp.740-752.
- Jain, A.K. (2001). Corruption: A review. *Journal of Economic Surveys*, vol.15, n.1, pp.71-121.
- Jia, F., Rutherford, C. and Lamming, R. (2016). Cultural adaptation and socialisation between western buyers and Chinese suppliers: The formation of a hybrid culture. *International Business Review*, vol.25, n.6, pp.1246-1261.
- Johnson, J.P., Lenartowicz, T., and Apud, S. (2006). Cross-cultural competence in international business: Toward a definition and a model. *Journal of International Business Studies*, vol.37, n.4, pp.525-543.
- Johnson, J.L. and Cullen, J.B. (2017). Trust in cross-cultural relationships. In: M.J. Gannon and K.L. Newman (Eds.). *The Blackwell Handbook of Cross-Cultural Management*. Blackwell Publishers Ltd.
- Kabacoff, R.I. (2011). *R in Action. Data Analysis and Graphics with R*. Shelter Island, NY: Manning Publications.
- Kam, C.D., Wilking, J.R. and Zechmeister, E.J. (2007). Beyond the "narrow data base": Another convenience sample for experimental research. *Political Behavior*, vol.29, n.4, pp.415-440.
- Kang, K.H., Lee, S., and Yoo, C. (2016). The effect of national culture on corporate social responsibility in the hospitality industry. *International Journal of Contemporary Hospitality Management*, vol.28, n.8, pp.1728-1758.
- Katsikopoulos, K.VOL. and Gigerenzer, G. (2013). Behavioral operations management: A blind spot and a research program. *Journal of Supply Chain Management*, vol.49, n.1, pp.3-7.
- Kaufmann, H.R., Loureiro, S.M.C. and Manarioti, A. (2016). Exploring behavioural branding, brand love and brand co-creation. *Journal of Product & Brand Management*, vol.25, n.6, pp.516-526.
- Ketkar, S., Kock, N., Parente, R. and Verville, J. (2012) The impact of individualism on buyer-supplier relationship norms, trust and market performance: An analysis of data from Brazil and the U.S.A. *International Business Review*, vol.21, pp.782-793.
- Khakhar, P. and Rammal, H.G. (2013). Culture and business network: International business negotiations with Arab managers. *International Business Review*, vol.22, n.3, pp.578-590.

- Kim, Y., Sting, F. and Loch, C. (2014). Top-down, bottom-up, or both? Toward an integrative perspective on operations strategy formation. *Journal of Operations Management*, vol.32, n.7-8, pp.462-474.
- King, N. (2004). Using templates in the thematic analysis of text. In: C. Cassell and G. Symon (Eds.) *Essential Guide to Qualitative Methods in Organizational Research*. Sage Publications Ltd.
- Kluckhohn, F.R. and Strodtbeck, F.L. (1961). *Variations in Value Orientations*. Westport, CT: Greenwood.
- Kogut, B. and Singh, H. (1988). The effect of national culture on the choice of entry mode. *Journal of International Business Studies*, vol.19, n.3, pp.411-432.
- Konijn, P. and Tulder, R. (2015). Resources-for-infrastructure (R4I) swaps: A new model for successful internationalisation strategies of rising power firms? *Critical Perspectives on International Business*, vol.11, n.3/4, pp.259-284.
- Kroeber, A.L. and Kluckhohn, C. (1952). *Culture. A Critical Review of Concepts and Definitions*. Cambridge, Massachusetts: The Museum.
- Kuhn, T.S. (1970). *The Structure of Scientific Revolutions* (2nd ed.). Chicago: University of Chicago Press. In: Hofstede, G. (2001) *Cultures Consequences. Comparing Values, Behaviors, Institutions, and Organizations across Nations*. 2nd Edition. London: Sage Publications, Inc.
- Kull, T.J., Ellis, S.C. and Narasimhan, R. (2013). Reducing behavioral constraints to supplier integration: A socio-technical systems perspective. *Journal of Supply Chain Management*, vol.49, n.1, pp.64-86.
- Kull, T.J. and Wacker, J.G. (2010). Quality management effectiveness in Asia: The influence of culture. *Journal of Operations Management*, vol.28, n.3, pp.223-239.
- Kundu, A., Jain, VOL., Kumar, S. and Chandra, C. (2015). A journey from normative to behavioral operations in supply chain management: A review using latent semantic analysis. *Expert Systems with Applications*, vol.42, pp.796-809.
- Lambert, D.M. and Cooper, M.C. (2000). Issues in supply chain management. *Industrial Marketing Management*, vol.29, n.1, pp.65-83.
- Lambert-Mogiliansky, A. and Sonin, K. (2006). Collusive market sharing and corruption in procurement. *Journal of Economics and Management Strategy*, vol.15, n.4, pp.883-908.
- Landers, R.N. and Behrend, T.S. (2015). An inconvenient truth: Arbitrary distinctions between organizational, Mechanical Turk, and other convenience samples. *Industrial and Organizational Psychology*, vol.8, n.2, pp.142-164.
- Langman, L. (2000). *Destination Hollywood: The Influence of Europeans on American Filmmaking*. Jefferson, North Carolina: McFarland & Company, Inc., Publishers.

- Laughton, D. and Ottewill, R. (2000). Developing cross-cultural capability in undergraduate business education: Implications for the student experience. *Education+ Training*, vol.42, n.6, pp.378-386.
- Lavie, D. (2006). The competitive advantage of interconnected firms: An extension of the resource-based view. *Academy of Management Review*, vol.31, n.3, pp.638-658.
- Leahy, J. (2015). "Prosecutor in Petrobras scandal warns foreign companies". *The Financial Times*, 8 November, available at: www.ft.com/content/39964508-84d6-11e5-9dc0-186bb1146746?mhq5j=e6 (accessed 26 October 2017).
- Ledeneva, A.V. (1998). Russia's economy of favours: Blat, networking and informal exchange. Cambridge: Cambridge University Press. In: *Economic Systems – Journal of Economic Literature*, vol.37, n.1, pp.322-332.
- Lee, G., Shin, G., Haney, M.H., Kang, M., Li, S. and Ko, C. (2017). The impact of formal control and *guanxi* on task conflict in outsourcing relationships in China. *Industrial Marketing Management*, vol.62, pp.128-136.
- Lee, H.L., Padmanabhan, V. and Whang, S. (1997). Information distortion in a supply chain: The bullwhip effect. *Management Science*, vol.43, n.4, pp.546-558.
- Lee, J.W., Becker, K. and Nobre, H. (2012). Impact of culture on online management education. *Cross Cultural Management: an International Journal*, vol.19, n.3, pp.399-420.
- Lee, P.K.C. and Humphreys, P.K. (2007). The role of *guanxi* in supply management practices. *International Journal of Production Economics*, vol.106, pp.450-467.
- Lee Park, C. and Fracarolli Nunes, M. (2017). Cultural corruption: Lessons from the Petrobras scandal case. *4th Interdisciplinary Insights on Fraud and Corruption Conference*, I2FC, Porto, Portugal, November 25.
- Lee Park, C. and Fracarolli Nunes, M. (2018). Cultural corruption: Lessons from the Petrobras scandal case. *Proceedings of the Seventy-eighth Annual Meeting of the Academy of Management*, vol.2018, n.1. Doi: <https://doi.org/10.5465/AMBPP.2018.12345abstract>.
- Lee Park, C., Fracarolli Nunes, M., Muratbekova-Touron, M. and Moatti, V. (2018). The duality of the Brazilian *jeitinho*: An empirical investigation and conceptual framework. *Critical Perspectives on International Business*, vol.14, n.4, pp.404-425.
- Lee Park, C. and Paiva, E.L. (2018). How do national cultures impact the operations strategy process? *International Journal of Operations and Production Management*, vol.38, n.10, pp.1937-1963.
- Lenartowicz, T. and Roth, K. (1999). A framework for culture assessment. *Journal of International Business Studies*, vol.30, n.4, pp.781-798.
- Leong, G.K., Snyder, D.L. and Ward, P.T. (1990). Research in the process and content of manufacturing strategy. *Omega*, vol.18, n.2, pp.109-122.

- Levine, D.P. (2005). The corrupt organization. *Human Relations*, vol.58, n.6, pp.723-740.
- Lewin, K. (1947). Frontiers in group dynamics: Concept, method and reality in social science; social equilibria and social change. *Human Relations*, vol.1, n.1, pp.5-41.
- Lewin, S.B. (1996). Economics and psychology: Lessons for our own day from the early twentieth century. *Journal of Economic Literature*, vol.34, n.3, pp.1293-1323.
- Liao, K., Sharkey, T.W., Ragu-Nathan, T.S. and Vonderembse, M. (2012). Trust-driven joint operational activities to achieve mass customization: A culture perspective. *Benchmarking: An International Journal*, vol.19, n.4/5, pp.585-603.
- Lisboa, P. (2015). “STJ mantém ex-diretores da Petrobras Duque e Cervero presos”. *Folha de S. Paulo*, 18 August, available at: www1.folha.uol.com.br/poder/2015/08/1670301-stj-mantem-ex-diretorda-petrobras-renato-duque-presos.shtml (accessed 10 October 2017).
- Little, R.J.A. (1988). A test of missing completely at random for multivariate data with missing values. *Journal of the American Statistical Association*, vol.83, n.404, pp.1198-1202.
- Liu, H., Ke, W., Wei, K.K., Gu, J. and Chen, H. (2010). The role of institutional pressures and organizational culture in the firm’s intention to adopt internet-enabled supply chain management systems. *Journal of Operations Management*, vol.28, pp.372-384.
- Loch, C. and Wu, Y. (2007). Behavioral operations management: Foundations and trends in technology. *Information, and Operations Management*, vol.1, n.3, pp.121-232.
- Long, B.S. and Mills, A.J. (2008). Globalization, postcolonial theory, and organizational analysis. Lessons from the Rwanda genocide. *Critical Perspectives on International Business*, vol.4, n.4, pp.389-409.
- Luo, Y. (2016). Toward a reverse adaptation view in cross-cultural management. *Cross Cultural & Strategic Management*, vol.23, n.1, pp.29-41.
- Luo, Y., Huang, Y. and Wang, S.L. (2011). *Guanxi* and organizational performance: A meta-analysis. *Management and Organization Review*, vol.8, n.1, pp.139-172.
- Lurie, P. (2004). Cultural-studies criticism. In: C.A. Peek and R.W. Hamblin (Eds.). *The Companion to William Faulkner Studies*. Westport, CT: Greenwood Press.
- Malhotra, M.K. and Sharma, S. (2002). Spanning the continuum between marketing and operations. *Journal of Operations Management*, vol.20, n.3, pp.209-219.
- Malinowski, B. (1931). Culture. *Encyclopedia of the Social Sciences*, vol.4, pp.621-646.
- Mantzoukas, S. (2005). The inclusion of bias in reflective and reflexive research. A necessary prerequisite for securing validity. *Journal of Research in Nursing*, vol.10, n.3, pp.279-295.
- Mardsen, D. (2004). Indigenous management and the management of indigenous knowledge. In: S. Wright (Ed.). *Anthropology of Organizations*, pp.39-53. London and New York: Routledge.

- Maruchek, A., Pannesi, R. and Anderson, C. (1990). An exploratory study of the manufacturing strategy process in practice. *Journal of Operations Management*, vol.9, n.1, pp.101-123.
- Mathews, B.P., Ueno, A., Kekäle, T., Repka, M., Pereira, Z.L. and Silva, G. (2001). European quality management practices: The impact of national culture. *International Journal of Quality & Reliability Management*, vol.18, n.7, pp.692-707.
- McCarthy, D.J. and Puffer, S.M. (2008). Interpreting the ethicality of corporate governance decisions in Russia: Utilizing integrative social contracts theory to evaluate the relevance of agency theory norms. *Academy of Management Review*, vol.33, n.1, pp.11-31.
- McCarthy, D.J., Puffer, S.M., Dunlap, D.R. and Jaeger, A.M. (2012). A stakeholder approach to the ethicality of BRIC-firm managers' use of favors. *Journal of Business Ethics*, vol.109, n.1, pp.27-38.
- McCort, D. and Malhotra, N.K. (1993). Culture and consumer behavior: Toward an understanding of cross-cultural consumer behavior in international marketing. *Journal of International Consumer Marketing*, vol.6, n.2, pp.91-127.
- McSweeney, B. (2002a). Hofstede's model of national culture differences and their consequences: A triumph of faith – A failure of analysis. *Human Relations*, vol.55, n.1, pp.89-118.
- McSweeney, B. (2002b). The essentials of scholarship: A reply to Geert Hofstede. *Human Relations*, vol.55, n.11, pp.1363-1372.
- Mellor, S., Hao, L. and Zhang, D. (2014). Additive manufacturing: A framework for implementation. *International Journal of Production Economics*, vol.149, pp.194-201.
- Menda, R. and Dilts, D. (1997). The manufacturing strategy formulation process: Linking multifunctional viewpoints. *Journal of Operations Management*, vol.15, pp.223-241.
- Menor, L.J. and Roth, A. (2007). New service development competence in retail banking: Construct development and measurement validation. *Journal of Operations Management*, vol.25, pp.825-846.
- Meschi, P.X. and Riccio, E.L. (2007). Country risk, national cultural differences between partners and survival of international joint ventures in Brazil. *International Business Review*, vol.17, n.3, pp.250-266.
- Mestrovic, S. (2017). *Durkheim and Postmodern Culture*. Routledge.
- Metters, R. (2008). A case study of national culture and offshoring services. *International Journal of Operations & Production Management*, vol.28, n.8, pp.727-747.
- Michailova, S. and Worm, V. (2003). Personal networking in Russia and China: Blat and guanxi. *European Management Journal*, vol.21, n.4, pp.509-520.

- Miles, M.B., Huberman, A.M. and Saldaña, J. (2013). *Qualitative Data Analysis: A Methods Sourcebook*. Sage Publications Inc.
- Millington, A., Eberhardt, M. and Wilkinson, B. (2006). Guanxi and supplier search mechanisms in China. *Human Relations*, vol.59, n.4, pp.505-351.
- Miltenburg, J. (2005). *Manufacturing Strategy. How to Formulate and Implement a Winning Plan*. New York: Productivity Press.
- Minbaeva, D.B. and Muratbekova-Touron, M. (2013). Clanism. Definition and Implications for Human Resource Management. *Management International Review*, vol.53, pp.109-139.
- Minbaeva, D. and Muratbekova-Touron, M. (2018). Rushlydyq, entry 3.4. In: A. Ledeneva (Ed.); *The Global Encyclopaedia of Informality*. London: UCL press, vol.1.
- Minkov, M. (2007). *What Makes Us Different and Similar: A New Interpretation of The World Values Survey and Other Cross-Cultural Data*. Sofia, Bulgaria: Klasika I Stil.
- Mollenkopf, D., Stolze, H., Tate, W.L. and Ueltschy, M. (2010). Green, lean, and global supply chains. *International Journal of Physical Distribution & Logistics Management*, vol.40, n.1/2, pp.14-41.
- Monczka, R.M., Handfield, R.B., Giunipero, L.C. and Patterson, J.L. (2015). *Purchasing and Supply Chain Management*. Cengage Learning.
- Montville, L. (1992). “A seven-footer from Timbuktu”. *Sports Illustrated*, 76(6):80-95.
- Moran, R.T., Abramson, N.R. and Moran, S.V. (2014). *Managing Cultural Differences*. Routledge.
- Morosini, P., Shane, S. and Singh, H. (1998). National cultural distance and cross-border acquisition performance. *Journal of International Business Studies*, vol.29, n.1, pp.137-158.
- Morschett, D., Schramm-Klein, H. and Zentes, J. (2015). Motives for internationalisation. In: *Strategic International Management*, Springer Fachmedien Wiesbaden, pp.75-98.
- Motta, F.C.P. and Alcadipani, R. (1999). Jeitinho brasileiro, controle social e competição. *RAE – Revista de Administração de Empresas*, vol.39, n.1, pp.6-12.
- Mura, M., Lettieri, E., Radaelli, G. and Spiller, N. (2016). Behavioural operations in healthcare: A knowledge sharing perspective. *International Journal of Operations & Production Management*, vol.36, n.10, pp.1222-1246.
- Murphy, G. (1946). *Personality: A Biosocial Approach to Origins and Structure*. New York: Harper & Brothers.
- Murphy, R.F. (1957). Intergroup hostility and social cohesion. *American Anthropologist*, vol.59, n.6, pp.1018-1035.

- Nakata, C. and Im, S. (2010). Spurring cross-functional integration for higher new product performance: A group effectiveness perspective. *Journal of Product Innovation Management*, vol.27, n.4, pp.554-571.
- Naor, M., Goldstein, S.M., Linderman, K.W. and Schroeder, R.G. (2008). The role of culture as driver of quality management and performance: Infrastructure versus core quality practices. *Decision Sciences*, vol.39, n.4, pp.671-702.
- Naor, M., Linderman, K. and Schroeder, R. (2010). The globalization of operations in Eastern and Western countries: Unpacking the relationship between national and organizational culture and its impact on manufacturing performance. *Journal of Operations Management*, vol.28, n.3, pp.194-205.
- Naroll, R. (1970). What have we learned from cross-cultural surveys? *American Anthropologist*, vol.72, pp.1227-1288.
- Neelankavil, J.P., Mathur, A. and Zhang, Y. (2000). Determinants of managerial performance: A cross-cultural comparison of the perceptions of middle-level managers in four countries. *Journal of International Business*, vol.31, n.1, pp.121-140.
- Nelson, R.E. and Gopalan, S. (2003). Do organizational cultures replicate national cultures? Isomorphism, rejection and reciprocal opposition in the corporate values of three countries. *Organization Studies*, vol.24, n.7, pp.1115-1151.
- Neuliep, J.W. (2003). *Intercultural Communication: A Contextual Approach*. 2nd ed. Boston: Houghton Mifflin.
- Nielsen, B.B. and Nielsen, S. (2011). The role of top management team international orientation in international strategic decision-making: The choice of foreign entry mode. *Journal of World Business*, vol.46, pp.185-193.
- Nielsen-Englyst, L. (2003). Operations strategy formation – a continuous process. *Integrated Manufacturing Systems*, vol.14, n.8, pp.677-685.
- Nonaka, I., Toyama, R. and Nagata, A. (2000). A firm as a knowledge-creating entity: a new perspective on the theory of the firm. *Industrial and Corporate Change*, vol.9, n.1, pp.1-20.
- Norman, G. (2010). Likert scales, levels of measurement and the ‘laws’ of statistics. *Advances in Health Sciences Education*, vol.15, n.5, pp.625-632.
- Ntongho, R.A. (2016). Culture and corporate governance convergence. *International Journal of Law and Management*, vol.58, n.5, pp.523-544.
- Nurmi, J.E. (1993). Adolescent development in an age-graded context: The role of personal beliefs, goals, and strategies in the tackling of developmental tasks and standards. *International Journal of Behavioral Development*, vol.16, n.2, pp.169-189.
- O’Leary-Kelly, S.W. and Flores, B.E. (2002). The integration of manufacturing and marketing / sales decisions: Impact on organizational performance. *Journal of Operations Management*, vol.20, n.3, pp.221-240.

- Ocasio, W. and Joseph, J. (2015). An attention-based theory of strategy formulation: Linking micro- and macroperspectives in strategy processes. *Strategy Process – Advances in Strategic Management*, vol.22, pp.39-61.
- Ojala, A. (2015). Geographic, Cultural, and Psychic Distance to Foreign Markets in the Context of Small and New Ventures. *International Business Review*, vol.24, n.5, pp.825-835.
- Olsen, R.A. (2010). Toward a Theory of Behavioral Finance: Implications from the Natural Sciences. *Qualitative Research in Financial Markets*, vol.2, n.2, pp.100-128.
- Ortner, S.B. (1990). Patterns of history: Cultural schemas in the foundations of Sherpa religious institutions. In: E. Ohnuki-Tierney (Ed.), *Culture Through Time: Anthropological Approaches*. Stanford: Stanford University, pp.54-93.
- Page, J.A. (1995). *The Brazilians*. Reading: Addison-Wiley.
- Pagell, M., Katz, J.P. and Sheu, C. (2005). The Importance of National Culture in Operations Management Research. *International Journal of Operations & Production Management*, vol.25, n.4, pp.371-394.
- Pagell, M. and Wu, Z. (2009). Building a more complete theory of sustainable supply chain management using case studies of 10 exemplars. *Journal of Supply Chain Management*, vol.45, n.2, pp.37-56.
- Paiva, E.L. (2010). Manufacturing and marketing integration from a cumulative capabilities perspective. *International Journal of Production Economics*, vol.126, n.2, pp.379-386.
- Paiva, E.L., Roth, A. and Fensterseifer, J.E. (2008). Organizational knowledge and the manufacturing strategy process: A resource-based view analysis. *Journal of Operations Management*, vol.26, pp.115-132.
- Paiva, E.L., Teixeira, R., Vieira, L.M. and Finger, A.B. (2014). Supply chain planning and trust: Two sides of the same coin. *Industrial Management & Data Systems*, vol.114, n.3, pp.405-420.
- Pakala, S. (2013). “Effect of culture on supply chain management”, *Commlabindia*, 22 July, available at <http://blog.commlabindia.com/elearning-design/culture-supply-chain-management> (accessed 29 July 2017).
- Park, J. and Kim, D. (2016). Employee voice behavior across cultures: Examining cultural values and employee voice behaviors in Korea and the United States. In: *Employee Voice in Emerging Economies. Advances in Industrial and Labor Relations*, vol.23, pp.73-103.
- Parsons, T. and Shils, E.A. (1951). *Toward a General Theory of Action*. Cambridge, MA: Harvard University Press.
- Paulraj, A., Lado, A.A. and Chen, I.J. (2008). Inter-organizational communication as a relational competency: Antecedents and performance outcomes in collaborative buyer-supplier relationships. *Journal of Operations Management*, vol.26, pp.45-64.

- Pearson, S. (2015). "Petrobras shows corruption is now a high-stakes game in Brazil". *The Financial Times*, 15 April, available at <https://next.ft.com/content/2e2a58fede1811e48d1400144feab7de> (accessed 26 July).
- Peng, M.W., Wang, D.Y.L. and Jiang, Y. (2008). An institution-based view of international business strategy: A focus on emerging economies. *Journal of International Business Studies*, vol.39, n.5, pp.920-936.
- Penrose, E.T. (1959). *The Theory of the Growth of the Firm*. New York: John Wiley.
- Pettersson, A.I. and Segerstedt, A. (2013). Measuring supply chain cost. *International Journal of Production Economics*, vol.143, n.2, pp.357-363.
- Philipsen, G. (1992). *Speaking Culturally: Explorations in Social Communication*. Albany: State University of New York.
- Philips, M. and Sackmann, S. (2015). Cross-cultural management rising. In: N. Holden, S. Michailova and S. Tietze (Eds.). *The Routledge Companion to Cross-Cultural Management*. Oxton and New York: Routledge.
- Plijter, E.B., Voordt, T.J.M., and Rocco, R. (2014). Managing the workplace in a globalized world: The role of national culture in workplace management. *Facilities*, vol.32, n.13/14, pp.744-760.
- Porter, M.E. (1980). *Competitive Strategy*. New York: Free Press.
- Porter, M.E. (1985). *Competitive Advantage. Creating and Sustaining Superior Performance*. New York. Free Press.
- Porter, M.E. and Millar, V.E. (1985). *How Information Gives You Competitive Advantage*.
- Power, D., Schoenherr, T. and Samson, D. (2010). The cultural characteristic of individualism/collectivism: A comparative study of implications for investment in operations between emerging Asian and industrialized Western countries. *Journal of Operations Management*, vol.28, n.3, pp.206-222.
- Prajogo, D.I. and McDermott, C.M. (2005). The relationship between total quality management practices and organizational culture. *International Journal of Operations and Production Management*, vol.25, n.11, pp.1101-1122.
- Prasad, P. (2005). *Crafting Qualitative Research. Working in the Postpositivist Traditions*. London: ME Sharpe Inc.
- Prasad, S. and Babbar, S. (2000). International Operations Management Research. *Journal of Operations Management*, vol.18, pp.209-247.
- Prasad, S., Babbar, S. and Motwani, J. (2001). International operations strategy: Current efforts and future directions. *International Journal of Operations & Production Management*, vol.21, n.5/6, pp.645-665.

- Prosman, E., Scholten, K. and Power, D. (2016). Dealing with defaulting suppliers using behavioral based governance methods: An agency theory perspective. *Supply Chain Management: An International Journal*, vol.21, n.4, pp.499-511.
- Puffer, S.M., McCarthy, D.J., Jaeger, A.M. and Dunlap, D. (2013). The use of favors by emerging market managers: Facilitator or inhibitor of international expansion? *Asia Pacific Journal of Management*, vol.30, n.2, pp.327-249.
- Puig, F., González-Loureiro, M. and Ghauri, P.N. (2014). Internationalisation for survival: The case of new ventures. *Management International Review*, vol.54, n.5, pp.653-673.
- Quinn, J.B. and Hilmer, F.G. (1994). Strategic outsourcing. *MIT Sloan Management Review*, vol.35, n.4, pp.43-55.
- Rachlin, H. (1994). *Behavior and Mind: The Roots of Modern Psychology*. Oxford University Press.
- Randall, D.M. and Gibson, A.M. (1990). Methodology in business ethics research: A review and critical assessment. *Journal of Business Ethics*, vol.9, pp.457-471.
- Ray, G., Barney, J.B. and Muhanna, W.A. (2004). Capabilities, business processes, and competitive advantage: Choosing the Dependent variable in empirical tests of the resource-based view. *Strategic Management Journal*, vol.25, n.1, pp.23-37.
- Reber, A.S. (1995). *The Penguin Dictionary of Psychology*. London: Penguin.
- Redding, G. and Witt, M.A. (2015). Advancing indigenous management theory: Executive rationale as an institutional logic. *Management and Organization Review*, vol.11, n.2, pp.179-203.
- Rees-Caldwell, K. and Pinnington, A.H. (2013). National culture differences in project management: Comparing British and Arab project managers' perceptions of different planning areas. *International Journal of Project Management*, vol.31, n.2, pp.212-227.
- Reus, T.H. and Lamont, B.T. (2009). The double-edged sword of cultural distance in international acquisitions. *Journal of International Business Studies*, vol.40, pp.1298-1316.
- Reuters (2016). "Brazil seeks deals with 10 companies in Petrobras scandal". 14 January, available at: www.reuters.com/article/brazil-corruption-companies/brazil-seeks-deals-with-10-companiesin-petrobras-scandal-idUSL2N14X2EI20160114 (accessed 26 October 2017).
- Rho, B.H., Park, K. and Yu, Y.M. (2001). An international comparison of the effect of manufacturing strategy-implementation gap on business performance. *International Journal of Production Economics*, vol.70, n.1, pp.89-97.
- Ribbink, D. and Grimm, C.M. (2014). The impact of cultural differences on buyer-supplier negotiations: An experimental study. *Journal of Operations Management*, vol.32, pp.114-126.

- Riis, J.O., Dukovska-Popovska, I. and Johansen, J.J. (2006). Participation and dialogue in strategic manufacturing development. *Production Planning & Control*, vol.17, n.2, pp.176-188.
- Roberts, K.H. and Boyacigiller, N.A. (1984). Cross-national organizational research: The grasp of the blind men. In: B.M. Shaw and L.L. Cummings (Eds.). *Research in Organizational Behavior*, pp.423-475. In: Hofstede, G. (2001) *Cultures Consequences. Comparing Values, Behaviors, Institutions, and Organizations across Nations*. 2nd Edition. London: Sage Publications, Inc.
- Roccas, S., Sagiv, L., Schwartz, S.H. and Knafo, A. (2002). The big five personality factors and personal values. *Personality and Social Psychology Bulletin*, vol.28, n.6, pp.789-801.
- Romani, L. and Claes, M. (2014). Why critical intercultural communication studies are to be taken seriously in cross-cultural management research? *International Journal of Cross Cultural Management*, vol.14, n.1, pp.127-132.
- Rosaldo, M. (1989). *Culture and Truth: The Remaking of Social Analysis*. Boston: Beacon.
- Rosaldo, R.I. (2006). Foreword: Defining culture. In: J.R. Baldwin, S.L. Faulkner, M.L. Hecht and S.L. Lindsley (Eds.). *Redefining Culture. Perspectives Across the Disciplines*. New Jersey and London: Lawrence Erlbaum Associates, Inc., Publishers, pp.ix-xiv.
- Rotten Tomatoes (2017). “Luc Besson”, available at https://www.rottentomatoes.com/celebrity/luc_besson/ (accessed 29 July 2017).
- Routledge Encyclopedia of Philosophy*, (1998). Vol.2. London: Routledge.
- Rowe, W.G. (2001). Creating wealth in organizations: The role of strategic leadership. *Academy of Management Perspectives*, vol.15, n.1, pp.81-94.
- Rudberg, M. and West, B.M. (2008). Global operations strategy: Coordinating manufacturing networks. *Omega – The International Journal of Management Science*, vol.36, pp.91-106.
- Rumelt, R.P. (1984). Towards a strategic theory of the firm. In: R.B. Lamb (Ed.). *Competitive Strategic Management*, pp.556-571. Englewood Cliffs, NJ: Prentice-Hall.
- Rushfield, R. (2017). “The future of French cinema may be riding on Luc Besson’s *Valerian and the City of a Thousand Planets*”. *Vanity Fair*, 18 July, available at <http://www.vanityfair.com/hollywood/2017/07/luc-besson-valerian-and-the-city-of-a-thousand-planets-set> (accessed 29 July 2017).
- Russo, R. (2017). “Several foreign companies may be indicted over Petrobras corruption probe”. *Mlex Market Insight*, 9 May, available at: <https://mlexmarketinsight.com/insights-center/editorspicks/anti-bribery-and-corruption/latin-america/several-foreign-companies-may-be-indicted-over-petrobras-corruption-probe> (accessed 26 October).
- Rytter, N.G., Boer, H. and Koch, C. (2007). Conceptualizing operations strategy processes. *International Journal of Operations & Production Management*, vol.27, n.10, pp.1093-1114.

- Sanders, N.R., Autry, C.W. and Gligor, D.M. (2011). The impact of buyer firm information connectivity enablers on supplier firm performance: A relational view. *The International Journal of Logistics Management*, vol.22, n.2, pp.179-201.
- Schatz, E. (2004). *Modern Clan Politics: the Power of 'Blood', Kazakhstan and Beyond*. Seattle and London: University of Washington Press.
- Schein, E.H. (1984). Coming to a new awareness of organizational culture. *Sloan Management Review*, vol.25, n.2, pp.3-16.
- Schein, E.H. (1988). Organizational culture. *Sloan School of Management, MIT*. Working paper n.2088-88.
- Schroeder, R.G., Anderson, J.C. and Cleveland, G. (1986). The content of manufacturing strategy: An empirical study. *Journal of Operations Management*, vol.6, n.4, pp.405-415.
- Schroeder, R.G., Bates, K.A. and Juntilla, M.M. (2002). A resource-based view of manufacturing strategy and the relationship to manufacturing performance. *Strategic Management Journal*, vol.23, pp.105-117.
- Schroeder, R.G. and Flynn, B.B. (2001). *High Performance Manufacturing – Global Perspectives*. Danvers, MA: John Wiley & Sons, Inc.
- Sekaran, U. (1983). Methodological and theoretical issues and advancements in cross-cultural research. *Journal of International Business Studies*, vol.14, pp.61-73.
- Sekliuchiene, J. (2013). Lithuanian companies in emerging markets: Internationalization motives and barriers. *Economics and Management*, vol.28, n.1, pp.124-133.
- Seock, Y.K. and Lin, C. (2011). Cultural influence on loyalty tendency and evaluation in retail store attributes. An analysis of Taiwanese and American consumers. *International Journal of Retail & Distribution Management*, vol.39, n.2, pp.94-113.
- Sen, A. (1979). Personal utilities and public judgements: Or what's wrong with welfare economics. *The Economic Journal*, vol.89, n.35, pp.537-558.
- Seppälä, T., Kenney, M. and Ali-Yrkkö, J. (2014). Global supply chains and transfer pricing: Insights from a case study. *Supply Chain Management: An International Journal*, vol.19, n.4, pp.445-454.
- Sigfusson, T. and Harris, S. (2013). Domestic market context and international entrepreneurs' relationship portfolios. *International Business Review*, vol.22, n.1, pp.243-258.
- Shakun, M.F. (2001). Unbounded rationality. *Group Decision and Negotiation*, vol.10, n.2, pp.97-118.
- Shapin, S. (1996). *The Scientific Revolution*. Chicago and London: The University of Chicago Press.

- Shenkar, O. (2001). Cultural distance revisited: Towards a more rigorous conceptualization and measurement of cultural differences. *Journal of International Business Studies*, vol.32, n.3, pp.519-535.
- Shenkar, O. (2012). Cultural distance revisited: Towards a more rigorous conceptualization and measurement of cultural differences. *Journal of International Business Studies*, vol.43, n.1, pp.1-11.
- Shi, W., Shang, J., Liu, Z. and Zuo, X. (2014). Optimal design of the auto parts supply chain for JIT operations: Sequential bifurcation factor screening and multi-response surface methodology. *European Journal of Operational Research*, vol.236, n.2, pp.664-676.
- Simon, H. (1992). Lessons from Germany's midsize. *Harvard Business Review*, March-April, pp.115-123.
- Simon, H. (1996). You don't need to be German to be a "hidden champion". *Business Strategy Review*, vol.7, n.2, pp.1-13.
- Simon, H. (2009). *Hidden champions of the twenty-first century. Success strategies of unknown world market leaders*. New York, NY: Springer.
- Sitkin, S.B. and Pablo, A.L. (1992). Reconceptualizing the determinants of risk behavior. *Academy of Management Review*, vol.17, n.1, pp.9-38.
- Skinner, W. (1969). Manufacturing – missing link in corporate strategy. *Harvard Business Review*, vol.47, n.3, pp.5-14.
- Skinner, B.F. (2011). *About behaviorism*. Vintage.
- Slack, N. and Lewis, M. (2011). *Operations Strategy*. Harlow, England: Pearson Education Limited.
- Smagalla, D. (2004). "Supply-chain culture clash". *MIT Sloan Management Journal*, Research Highlight, 15 October, available at <http://sloanreview.mit.edu/article/supplychain-culture-clash/> (accessed 29 July 2017).
- Smart, A. and Hsu, C.L. (2007). Corruption or social capital? Tact and the performance of guanxi in market socialist China. In: M. Nuijten and G. Anders (Eds). *Corruption and the Secret of Law. A Legal Anthropological Perspective*. Hampshire: Ashgate, pp.167-190.
- Smith, J.K. and Heshusius, L. (1986). Closing down the conversation: The end of the quantitative-qualitative debate among educational inquirers. *Educational Researcher*, vol.15, n.1, pp.4-12.
- Smith, P.B. and Peterson, M.F. (2017). Cross-cultural leadership. In: M.J. Gannon and K.L. Newman (Eds.). *The Blackwell Handbook of Cross-Cultural Management*. Blackwell Publishers Ltd.

- Smith, P.B., Peterson, M.F. and Schwartz, S.H. (2002). Cultural values, sources of guidance and their relevance to managerial behavior: A 47-nation study. *Journal of Cross Cultural Psychology*, vol.33, n.2, pp.188-208.
- Smith, P.B., Torres, C., Leong, C.H., Budhwar, P., Achoui, M. and Lebedeva, N. (2012). Are indigenous approaches to achieving influence in business organizations distinctive? A comparative study of guanxi, wasta, jeitinho, svyazi and pulling strings. *The International Journal of Human Resource Management*, vol.23, n.2, pp.333-348.
- Soares, A.M., Farhangmehr, M. and Shoham, A. (2007). Hofstede's dimensions of culture in international marketing studies. *Journal of Business Research*, vol.60, pp.277-284.
- Sood, A. and Sharma, V. (2015). A study of behavioural perspective of operations. *Procedia – Social and Behavioral Sciences*, vol.189, pp.229-233. XVIII Annual International Conference of the Society of Operations Management (SOM-14).
- Sorge, A. (1983). [Review of the book *Culture's Consequences*, by G. Hofstede]. *Administrative Science Quarterly*, vol.28, pp.625-629. In: Hofstede, G. (2001) *Cultures Consequences. Comparing Values, Behaviors, Institutions, and Organizations across Nations*. 2nd Edition. London: Sage Publications, Inc.
- Sousa, C.M.P. and Bradley, F. (2006). Cultural distance and psychic distance: Two peas in a pod? *Journal of International Marketing*, vol.14, n.1, pp.49-70.
- Sousa, R. and Voss, C.A. (2008). Contingency research in operations management practices. *Journal of Operations Management*, vol.26, n.6, pp.697-713.
- Stahl, G.K., Miska, C., Lee, H. and De Luque, M.S. (2016). The upside of cultural differences: Towards a more balanced treatment of culture in cross-cultural management research. *Cross Cultural & Strategic Management*, vol.24, n.1, pp.2-12.
- Stauss, B. and Mang, P. (1999). "Culture shocks" in inter-cultural service encounters? *Journal of Services Marketing*, vol.13, n.4/5, pp.329-346.
- Steenkamp, J., Hofstede, F. and Wedel, M.A. (1999). A cross-national investigation into the individual and national cultural antecedents of consumer innovativeness. *Journal of Marketing*, vol.63, pp.55-69.
- Steers, R.M. and Sánchez-Rundle, C.J. (2017). Culture, motivation, and work behavior. In: M.J. Gannon and K.L. Newman (Eds.). *The Blackwell Handbook of Cross-Cultural Management*. Blackwell Publishers Ltd.
- Stoermer, S., Bader, A.K. and Froese, F.J. (2016). Culture matters: The influence of national culture on inclusion climate. *Cross Cultural & Strategic Management*, vol.23, n.2, pp.287-305.
- Summer, W.G. and Keller, A.G. (1927). *The Science of Society*. 4 vols. New Haven.
- Sutherland, R.L. and Woodward, J.L. (1940). *An Introduction to Sociology*. 2nd ed. Chicago.

- Sweeney, P.D. and McFarlin, D. (2014). *International Management: Strategic Opportunities & Cultural Challenges*. Routledge.
- Swink, M., Narasimhan, R. and Wang, C. (2007). Managing beyond the factory walls: Effects of four types of strategic integration on manufacturing plant performance. *Journal of Operations Management*, vol.25, n.1, pp.148-164.
- Swink, M. and Schoenherr, T. (2015). The effects of cross-functional integration on profitability, process efficiency, and asset productivity. *Journal of Business Logistics*, vol.36, n.1, pp.69-87.
- Tan, K.C., Kannan, V.R. and Narasimhan, R. (2007). The impact of operations capability on firm performance. *International Journal of Production Research*, vol.45, n.21, pp.5135-5156.
- Tangney, J.P.E. and Fischer, K.W. (1995). Self-conscious emotions: The psychology of shame, guilt, embarrassment, and pride. In *The idea for this volume grew out of 2 pivotal conferences. The 1st conference, on emotion and cognition in development, was held in Winter Park, CO, Sum 1985. The 2nd conference, on shame and other self-conscious emotions, was held in Asilomar, CA, Dec 1988*. Guilford Press.
- Tanskanen, K. and Aminoff, A. (2015). Buyer and supplier attractiveness in a strategic relationship – A dyadic multiple-case study. *Industrial Marketing Management*, vol.50, pp.128-141.
- Tanure, B. and Duarte, R.G. (2005). Leveraging competitiveness upon national cultural traits: The management of people in Brazilian companies. *International Journal of Human Resource Management*, vol.76, n.12, pp.2201-2217.
- Tata, J. and Prasad, S. (2015). National cultural values, sustainability beliefs, and organizational initiatives. *Cross Cultural Management*, vol.22, n.2, pp.278-296.
- Taylor, S.E., Klein, L.C., Lewis, B.P., Gruenewald, T.L., Gurung, R.A. and Updegraff, J.A. (2000). Biobehavioral responses to stress in females: Tend-and-befriend, not fight-or-flight. *Psychological Review*, vol.107, n.3, p.411-429.
- Thomas, W.I. (1937). *Primitive Behavior*. New York.
- Thomas, T., Schermerhorn Jr., J.R. and Dienhart, J.W. (2004). Strategic leadership of ethical behavior in business. *Academy of Management Perspectives*, vol.18, n.2, pp.56-66.
- Thun, J. (2008). Empirical analysis of manufacturing strategy implementation. *International Journal of Production Economics*, vol.113, pp.370-382.
- Tihanyi, L., Griffith, D.A. and Russell, C.J. (2005). The Effect of cultural distance on entry mode choice, international diversification, and MNE performance: A meta-analysis. *Journal of International Business Studies*, vol.36, pp.270-283.

- Tovey, A. (2017). "US prosecutors name five in Rolls-Royce corruption case". *The Telegraph*, 8 November, available at: <https://www.telegraph.co.uk/business/2017/11/08/us-prosecutors-name-five-rolls-royce-corruption-case/> (accessed 24 September 2018).
- Trent, R.J. (1996). Understanding and evaluating cross-functional sourcing team leadership. *International Journal of Purchasing and Materials Management*, vol.32, n.3, pp.29-36.
- Trent, R.J. and Monczka, R.M. (2003). International purchasing and global sourcing – What are the differences? *Journal of Supply Chain Management*, vol.39, n.3, pp.26-36.
- Triandis, H.C. (1982). [Review of the book *Culture's Consequences*, by G. Hofstede]. *Human Organization*, vol.41, pp.86-90. In: Hofstede, G. (2001) *Cultures Consequences. Comparing Values, Behaviors, Institutions, and Organizations across Nations*. 2nd Edition. London: Sage Publications, Inc.
- Tsanos, C.S. and Zografos, K.G. (2016). The effects of behavioural supply chain relationship antecedents on integration and performance. *Supply Chain Management: An International Journal*, vol.21, n.6, pp.678-693.
- Tsoukas, H. and Knudsen, C. (2009). Introduction: The need for meta-theoretical reflection in organization theory. In: C. Knudsen and H. Tsoukas (Eds.). *The Oxford Handbook of Organization Theory. Meta-Theoretical Perspectives*. Oxford University Press, pp.1-38.
- Tsui, A.S. (2004). Contributing to global management knowledge: A case for high quality indigenous research. *Asia Pacific Journal of Management*, vol.21, pp.491-513.
- Tubadji, A., Moeller, J. and Nijkamp, P. (2014). Introduction to cultural research approaches: Applications to culture and labour analysis. *International Journal of Manpower*, vol.35, n.1/2, pp.2-10.
- Turker, D. and Altuntas, C. (2014). Sustainable supply chain management in the fast fashion industry: An analysis of corporate reports. *European Management Journal*, vol.32, n.5, pp.837-849.
- Turney-High, H.H. (1949). *General Anthropology*. New York.
- Tylor, E.B. (1871). *Primitive Culture*. Boston.
- Usunier, J. (1999). Cultural aspects of international business negotiations. In: P. Ghauri and J. Usunier (Ed.) *International Business Negotiations*. Amsterdam: Pergamon, pp.91-118.
- Vachon, S. (2009). International operations and sustainable development: Should national culture matter? *Sustainable Development*, vol.18, n.6, pp.350-361.
- Valliere, D. (2017). Belief patterns of entrepreneurship: Exploring cross-cultural logics. *International Journal of Entrepreneurial Behavior & Research*, vol.23, n.2, pp.245-266.
- Van Hove, N. (2013). "Cultural differences need to be addressed in global S&OP". *Supply Chain Movement*, 20 March, available at <https://www.supplychainmovement.com/cultural-differences-need-to-be-addressed-in-global-sop/> (accessed 29 July 2017).

- Vecchi, A. and Brennan, L. (2009). Quality management: A cross-cultural perspective. *Cross Cultural Management: An International Journal*, vol.16, n.2, pp.149-164.
- Vecchi, A. and Brennan, L. (2011). Quality management: A cross-cultural perspective based on the GLOBE framework. *International Journal of Operations & Production Management*, vol.31, n.5, pp.527-553.
- Vella, J., Caruana, A. and Pitt, L.F. (2012). The effect of behavioural activation and inhibition on CRM adoption. *International Journal of Bank Marketing*, vol.30, n.1, pp.43-59.
- Villena, V.H., Revilla, E. and Choi, T.Y. (2011). The dark side of buyer-supplier relationships: A social capital perspective. *Journal of Operations Management*, vol.29, pp.561-576.
- Vollmer, A. and Wolf, P. (2015). Adaptation of conflict management styles during the encounter of cultures. Findings from a Russian-West European case study. *International Journal of Cross Cultural Management*, vol.15, n.2, pp.151-166.
- Voss, C. and Blackmon, K. (1998). Differences in manufacturing strategy decisions between Japanese and Western manufacturing plants: The role of strategic time orientation. *Journal of Operations Management*, vol.16, pp.147-158.
- Walker, H., Schotanus, F., Bakker, E. and Harland, C. (2013). Collaborative procurement: A relational view of buyer-buyer relationships. *Public Administration Review*, vol.73, n.4, pp.588-598.
- Wang, T. and Bansal, P. (2012). Social responsibility in new ventures: profiting from a long-term orientation. *Strategic Management Journal*, vol.33, pp.1135-1153.
- Wang, Y., Wang, N., Jiang, L., Yang, Z. and Cui, V. (2016). Managing relationships with power advantage buyers: The role of supplier initiated bonding tactics in long-term buyer-supplier collaborations. *Journal of Business Research*, vol.69, pp.5587-5596.
- Warren, D.E., Dunfee, T.W. and Li, N. (2004). Social exchange in China: the double-edged sword of guanxi. *Journal of Business Ethics*, vol.55, n.4, pp.355-372.
- Webber, S.S. (2002). Leadership and trust facilitating cross-functional team success. *Journal of Management Development*, vol.21, n.3, pp.201-214.
- Wernerfelt, B. (1984). A resource-based view of the firm. *Strategic Management Journal*, vol.5, n.2, pp.171-180.
- Wheelwright, S.C. (1981). Japan - where operations really are strategic. *Harvard Business Review*, pp.66-74.
- Wheelwright, S.C. (1984). Manufacturing strategy: Defining the missing link. *Strategic Management Journal*, vol.5, n.1, pp.77-91.
- Wheelwright, S.C. and Hayes, R.H. (1985). Competing through manufacturing. *Harvard Business Review*, vol.63, n.1, pp.99-109.

- Wieland, A. and Wallenburg, C.M. (2013). The influence of relational competencies on supply chain resilience: A relational view. *International Journal of Physical Distribution and Logistics Management*, vol.43, n.4, pp.300-320.
- Wiengarten, F., Fynes, B., Pagell, M. and Búrca, S. (2011). Exploring the impact of national culture on investments in manufacturing practices and performance: An empirical multi-country study. *International Journal of Operations & Production Management*, vol.31, n.5, pp.554-578.
- Wiengarten, F., Gimenez, C., Fynes, B. and Ferdows, K. (2015). Exploring the importance of cultural collectivism on the efficacy of lean practices: Taking an organisational and national perspective. *International Journal of Operations & Production Management*, vol.35, n.3, pp.370-391.
- Wissler, C. (1929). *An Introduction to Social Anthropology*. New York.
- Wolf, E.J., Harrington, K.M., Clark, S.L. and Miller, M.W. (2013). Sample size requirements for structural equation models: An evaluation of power, bias, and solution propriety. *Educational and Psychological Measurement*, vol.76, n.6, pp.913-934.
- Wolf, J. (2007). "Luc Besson: The most Hollywood of French filmmakers". *The New York Times*, 20 May, available at <http://www.nytimes.com/2007/05/20/arts/20iht-20besson.5796788.html?pagewanted=1> (accessed 26 July 2017).
- Woodside, A.G., Bernal, P.M. and Coduras, A. (2016). Constructing cased-based macro models: cultures' consequences on entrepreneurship, innovation, and quality-of-life. In: A.G. Woodside (Ed.). *Case Study Research*, pp.433-488.
- Wright, S. (2004). 'Culture' in anthropology and organizational studies. In: S. Wright (Ed.). *Anthropology of Organizations*, pp.1-32. London and New York: Routledge.
- Yakubovich, V. (2005). Weak ties, information, and influence: How workers find jobs in a local Russian labor market. *American Sociological Review*, vol.70, n.3, pp.408-421.
- Young, K. (1934). *Introductory Sociology*. New York.
- Youngdahl, W.E. and Loomba, A.P.S. (2000). Service-driven global supply chains. *International Journal of Service Industry Management*, vol.11, n.4, pp.329-347.
- Zaccaro, S.J. and Klimoski, R. (2002). The interface of leadership and team processes. *Group & Organization Management*, vol.27, n.1, pp.4-13.
- Zaheer, A., McEvily, B. and Perrone, V. (1998). The strategic value of buyer-supplier relationships. *International Journal of Purchasing and Materials Management*, vol.34, n.2, pp.20-26.
- Zatzick, C.D., Moliterno, T.P. and Fang, T. (2012). Strategic (mis)fit: The implementation of TQM in manufacturing organizations. *Strategic Management Journal*, vol.33, pp.1321-1330.

- Zhang, S., Van Doorn, J. and Leeftang, P.S.H. (2014). Does the importance of value, brand and relationship equity for customer loyalty differ between eastern and western cultures? *International Business Review*, vol.23, n.1, pp.284-292.
- Zhang, S., Wang, W., Wang, L. and Zhao, X. (2015). Review of China's wind power firms internationalization: Status quo, determinants, prospects and policy implications. *Renewable and Sustainable Energy Reviews*, vol.43, pp.1333-1342.
- Zhang, Z. and Zhang, M. (2013). Guanxi, communication, power, and conflict in industrial buyer-seller relationships: Mitigations against the cultural background of harmony in China. *Journal of Business-to-Business Marketing*, vol.20, pp.99-117.
- Zhao, X., Huo, B., Flynn, B.B. and Yeung, J.H.Y. (2008). The impact of power and relationship commitment on the integration between manufacturers and customers in a supply chain. *Journal of Operations Management*, vol.26, n.3, pp.368-388.

Appendix A: Sample Interviews for the Second Paper

A.1. Interview #1, Brazilian Portuguese

Project: Brazilian “Jeitinho” in Buyer-Supplier Relationships
Projeto: “Jeitinho” brasileiro nas relações Comprador-Fornecedor

Interview Transcript – Transcrição de Entrevista
Interview #1 – Entrevista #1

Q: Você acha que brasileiros possuem uma forma especial ou única de lidar com questões de negócios?

A: Especial ou única? Não sei se é única, eu acho que tem uma forma que é mais brasileira. A minha empresa é uma empresa americana e a forma como a gente faz negócios e vendas é diferente do jeito que a matriz, nos Estados Unidos, trabalha. Então eu acho que sim, é uma cultura diferente. Não sei se é única só do Brasil, talvez seja uma cultura só latina, que tenha mais a ver com outros países da região também.

Q: Esta forma brasileira, você acha que ela possui um nome em particular? Como você chamaria essa forma brasileira de fazer negócios?

A: Eu acho que o brasileiro, uma coisa que mistura um pouco mais é o relacionamento pessoal e não só o profissional. Então em qualquer interação de negócios aqui no Brasil, o relacionamento pessoal também conta bastante. Nos primeiros momentos de uma conversa, de uma negociação, sempre vem aquela introdução quebra-gelo de como vai a família, como foi o fim de semana, falar sobre o futebol, sobre algum aspecto do que está acontecendo na sociedade, e a gente não vai direto ao ponto. Não vai direto ao ponto. Assim como eu acho que também no Brasil as pessoas não são muito claras, elas às vezes pegam desvios, ou quando elas querem responder ‘não’, ao invés de elas falarem ‘não’, elas falam ‘vou pensar’, ‘vou checar, a gente volta a se falar’, elas não são diretas e falam ‘não’ de cara. Mesmo quando elas vão falar ‘sim’ também sempre têm que pensar. Eu acho que o processo de negociação, de venda, compra aqui no Brasil demora um pouco mais por conta disso. As pessoas são menos diretas.

Q: O que você entende por “jeitinho brasileiro”?

A: Eu acho que o “jeitinho brasileiro”... O que eu entendo dessa expressão “jeitinho brasileiro” é 1. não precisar seguir todas as regras, ou achar que as regras existem mas não necessariamente elas valem para mim ou para uma pessoa, elas valem para outros mas não necessariamente para mim; e o “jeitinho brasileiro”... eu acho que tem duas formas de encarar o “jeitinho brasileiro”. Tem algumas pessoas que olham p’ra “jeitinho brasileiro” como se fosse querer tirar vantagem. E tem outras pessoas que olham p’ra “jeitinho brasileiro” como se fosse tentar resolver alguma coisa que um sistema não deixaria, ou uma regra não deixaria. Eu não acho que ela é uma conotação só negativa, acho que tem uma carga bastante negativa, mas eu também acho que tem uma carga positiva, de tentar resolver, tentar achar o melhor para duas partes, sem que a gente fique preso a regras. É menos usar as regras para que a gente fique preso nelas, e mais usar as regras para que elas sejam um direcionamento.

Q: Você pode dar exemplos do “jeitinho” nos negócios?

A: “Jeitinho” nos meus negócios? Por exemplo, eu vendo mídia. Tem muita gente que às vezes comete um erro na hora de comprar mídia, porque a minha mídia é uma compra que a pessoa

faz, a própria pessoa entra no sistema e faz a compra. E às vezes ela se embanana, ela erra, não compra do jeito que deveria ter sido comprado e aí ela liga com a expectativa de que ‘ah, não, olha, eu cometi um erro, mas entenda, eu sou um parceiro, e eu preciso que você resolva isso, etc.’. E o que eu acho que também entra no “jeitinho” é quando você vira para a pessoa e fala assim ‘desculpa, não posso, o erro não foi cometido pelo sistema, não tem como a gente mudar isso, quem cometeu o erro foi você ou alguém da sua equipe.’ Ah, e o ‘vou falar com fulano de tal’. Aí sempre vem um pouco daquela ‘vou conversar com outra pessoa hierarquicamente mais alta para poder resolver o assunto’. E em alguns casos a pessoa consegue resolver quando escala, quando vai para uma hierarquia mais alta. E aí eu vejo isso em vários aspectos, às vezes já me falaram “eu vou falar com o presidente da empresa”, às vezes a gente tem uma equipe, eu vejo que eles estão numa conversa, numa troca de e-mails, e eu sou incluído delicadamente, não é nem que me escrevem direto, mas só de colocar você a par para saber o histórico já tenta trazer um pouco desse “jeitinho”, que é tentar resolver as coisas não da maneira correta.

Q: Você diria que o “jeitinho” ajuda nos negócios? Se sim, como seria isso?

A: Eu acho que sim, ele ajuda, por isso que tem duas formas de olhar o “jeitinho”. Tem uma carga negativa, mas eu não acho que é só negativa. Eu acho que sim ajuda quando a gente também não fica estancado e parado, é contraproducente para os dois lados, porque tem algumas coisas que, tem algumas situações, e aí eu acho que isso é muito da nossa cultura brasileira, e por isso que eu também aceito, em que o “jeitinho” resolve uma situação que ficaria ruim para os dois lados. Às vezes não... eu enxergo assim: quando o “jeitinho” ele não vai prejudicar outros, ou priorizar só um em detrimento de outros, acho que ele não é tão ruim. Mas quando o “jeitinho” vale para um mas não vale para outro, só porque este um conhece não-sei-quem, fica ruim.

Q: E o “jeitinho” causa algum problema nos negócios? Você percebe que ele também causa problemas?

A: Eu acho que ele causa quebra de padrão e de sistemas. Quando a gente vai numa empresa, num negócio, e vai expandindo, evoluindo, a gente precisa ter cada vez mais processos e sistemas para poder escalar sem ter esses desvios. Esses desvios causam perda de tempo, mudança de rotina, e da forma como você está fazendo negócios. Então demanda mais tempo, demanda mais esforços, energia. E geralmente você chega no “jeitinho” também depois que algum erro aconteceu. Talvez em algumas culturas a pessoa absorva o erro e fale ‘errei, aprendi com isso e vamos seguir para fazer o negócio do jeito certo’. E aqui o “jeitinho” às vezes, por exemplo, eu vendo mídia, não sou área financeira, mas muitas vezes o que acontece é que a pessoa tem 30 dias para pagar e ela não paga nos 30 dias. Ela liga no financeiro, o financeiro fala que vai cobrar multa, juro, etcetera e tal tal tal, aí ela pega e liga para quem? Para a área de vendas, para a minha equipe, ‘ah, por favor, não tem como ajudar?’, e aí vem o “jeitinho”. E a gente na posição de vendedor, a gente se coloca na posição do nosso cliente e a gente que ajudá-los. ‘Ah, não, calma, então eu vou falar com o financeiro, tal’; aí você vai falar com o financeiro, o financeiro fala que não, aí o teu cliente já começa a fazer ameaça que não vai mais comprar, ou que vai comprar menos do que queria, ou que isso é ruim para a relação. Então gera um estresse e um gasto de energia que para mim é contraproducente. Se você dá um desconto, ou você não vai cobrar multa e etc., o que acontece, 6 meses depois o cara erra de novo, liga de novo, e acontece todo o processo. Então, a gente acabou estabelecendo na nossa empresa uma cultura que é, nesses casos por exemplo de atraso de pagamento: a primeira vez que a pessoa atrasou, eu vou olhar para o histórico, ver se ela nunca atrasou, se for a primeira vez ok, mas aí eu mando toda a recomendação escrito, por e-mail, falando ‘olha, atrasou, em casos de atrasos a gente cobra multa assim, tal tal tal tal tal tal, como é a primeira vez que isso está acontecendo ok’, mas e aí quando tem a segunda vez, hoje, a gente não... pode ser o maior cliente da empresa,

o que mais invista, a gente não vai deixar de cobrar multa e enfim, e eu acho que com isso eles aprendem também. O cliente acaba aprendendo que “bom, posso errar com aquela empresa, com aquela, com aquela, mas essa é uma empresa séria e com essa empresa eu não posso errar, então vou priorizar para pagar eles”.

Q: Você diria que o “jeitinho” é indispensável para os negócios?

A: Eu não acho que ele é indispensável, acho que mais indispensável é o bom-senso, mais do que o “jeitinho” nessa conotação. Então bom-senso no sentido de que existem casos que são mais compreensíveis, e daí entra um pouco do, voltando nessa questão do atraso, atrasou por quê? ‘Porque a gente se embananou internamente, porque a pessoa que era para pagar saiu de férias, tal tal tal tal tal, ou porque houve uma corrupção no sistema do banco e o que estava programado para ser pago não foi pago’, então existem pesos e situações onde você acaba sendo mais condescendente com atraso e tenta arranjar o “jeitinho” do que se a pessoa se embananou internamente porque o estagiário que era para pagar saiu, desculpa, né, você vai ter que pagar. Não, se foi o banco. Aí você vai dando graus desses “jeitinhos”. Então acho que mais que o “jeitinho” é o bom-senso de entender por quê e como é que a gente faz para evitar no futuro que isso aconteça, porque a pessoa ter saído de férias, ela vai sair de férias de novo, se a pessoa sair de férias de novo, ‘não tem problema, se sair de férias, depois a gente resolve lá, liga e eles não cobram a multa’. Então, acho que tem situações, mas eu não acho que ele é indispensável.

Q: Você preferiria trabalhar em um ambiente completamente livre de “jeitinho”?

A: Não, eu acho que o “jeitinho”, e daí de novo, vem a conotação do “jeitinho”. O ambiente completamente livre do “jeitinho” ou uma cultura do norte da Europa por exemplo onde as coisas são completamente estabelecidas, estruturadas, elas funcionam bem naquela cultura. Eu acho que para uma cultura brasileira, se eu trabalhasse em um ambiente em que eu não pudesse de forma nenhuma ter o “jeitinho”, seria mais difícil. Eu já acho que... a minha empresa é uma empresa norte-americana, que é bastante *by the book*, segue bastante as regras, eu gosto disso. Eu prefiro trabalhar numa empresa norte-americana do que numa empresa brasileira, onde existe corrupção, assim, e eu trabalho com algumas áreas com o Governo, também. Se eu trabalhasse com o Governo numa empresa brasileira, eu me sentiria muito mais exposto do que trabalhando na empresa onde eu trabalho, que eu sei que existem regras a serem seguidas, então eu prefiro trabalhar nesse ambiente mais correto. Mas eu acho que uma cultura completamente sueca ou finlandesa p’ro Brasil sem uma adaptação, uma tranquilização, não seria super efetivo.

Q: Você poderia dar um exemplo de situação em que o “jeitinho” seria esperado? Uma situação em que o “jeitinho” fosse aparecer, isso já esperado, uma situação em que você prevê que isso vá acontecer.

A: Eu acho que um pouco do que eu expliquei agora. A gente já sabe que algumas vezes a pessoa pode atrasar. Então ok, na tese, na documentação, nas regras, multa, tantos % de atraso, atraso é tantos % de multa, e juros, etc., e isso é para todo mundo, a gente nunca fala que ‘se você atrasar a primeira vez a gente te libera, mas a segunda não tem liberação’, então a regra é tem multa para atraso. Se a pessoa reclama, tal tal tal, a gente vai falar no financeiro, e daí o financeiro vai liberar a primeira vez. Então, é uma certa forma de um “jeitinho”, uma flexibilização que a gente estabeleceu na empresa, não-oficialmente, mas eu acho que ela ajuda mais do que ela atrapalha nesse caso, porque é um pouco de você chegar no meio do caminho de uma cultura muito rígida p’ra uma cultura muito permissiva, mas você não fica nem num lado, nem no outro.

Q: Isso tem um pouco a ver com a questão seguinte, que é em que tipo de situações o “jeitinho” é aceitável? Você teria alguma classificação, em que vocêalaria ‘nesta situação é aceitável, nessa situação é inaceitável’?

A: Eu acho que ele é aceitável de novo na questão do bom-senso, quando você vê que o erro aconteceu, o problema aconteceu não por uma má fé, ou por uma má vontade, ou por uma má gestão, e por um erro às vezes muito maior ou alheio ao organismo todo da empresa, e não uma pessoa também, porque acho que pessoas erram mesmo e a gente tem que conviver com isso, ‘ah, não fui eu que errei, foi meu funcionário’, mas ‘você que contratou esse funcionário, você que montou sua equipe, você que não treinou ele’. Então eu acho que de novo é uma coisa alheia, sei lá, teve uma greve dos bancos e não foi pago. O que acontece também às vezes a pessoa faz uma compra de mídia na minha empresa e o meu sistema também está... meu sistema às vezes tem um problema técnico, tem uma falha e eu não consegui entregar a mídia no formato que a pessoa comprou. Então assim como eu também peço para essas pessoas entenderem, às vezes tem um problema técnico, que não é culpa minha, nem culpa dela, mas é culpa do engenheiro de um outro país que fez o sistema ter um problema. Então eu acho que ele é aceitável quando existem essas... numa via de duas mãos, às vezes a gente vai liberar o cara de uma multa, mas ao mesmo tempo se acontecer algum erro e etc. a gente também conta com a compreensão de que o sistema é um sistema falho, que algumas vezes pode... Nesses casos, eu acho que essa condescendência, essa compreensão é importante. Eu acho, de novo, eu acho que não é aceitável quando parte de uma má fé, ou de uma burrice, vai, que a pessoa fez, de uma estupidez que ela criou e que gerou todo o problema e aí você fala ‘ah, não, tudo bem, vamos...’, nesses casos eu acho que ou quando também vai prejudicar um terceiro. Ajudar essa pessoa com “jeitinho”, mas eu não ajudei o outro, porque essa pessoa conhece não-sei-quem, aí eu acho que você começa a criar um sistema corporativista que não é nem um pouco saudável.

Q: Você acha que existem situações em que uma pessoa deve se sentir orgulhosa de usar o “jeitinho”?

A: Orgulhosa? Acho que o orgulho é uma coisa que você expande e mostra p’ra outros também, que você... não sei, teria que ser uma situação muito específica, não consigo pensar em uma situação específica agora de novo, porque eu acho que o “jeitinho” já vem com a conotação negativa, então acho que tem que ser orgulhosa quando... não, não acho que tem que ser orgulhosa, eu acho que a pessoa tem que entender que às vezes o “jeitinho” é necessário p’ra estabelecer um processo, p’ra educar as pessoas, mas não é um orgulho, ‘ah, hoje eu consegui dar um jeito e...’. Ao mesmo tempo eu também acho que tem algumas empresas, e daí eu estou falando como a empresa hoje, mas eu como consumidor também eu acho que tem muitas empresas na nossa cultura do Brasil hoje que desrespeitam o consumidor, que fazem com que o consumidor seja tratado de uma forma desfavorecida. Então eu acho que a empresa que consegue ter uma isonomia e tratar todo mundo da melhor maneira, da melhor forma, deveria ser mais orgulhosa do que a do “jeitinho”. A do “jeitinho” é ‘o nosso serviço é uma merda, e aí algumas pessoas que eu vou priorizar, ou que vão gritar mais, ou que vão espernear mais vão se safar, e eu estou pensando um pouco em companhias aéreas hoje, por exemplo. Companhia aérea, se é por um motivo que não é do aeroporto, que não é da meteorologia, porque eles têm uma falha e aí isso prejudica uma série de passageiros, alguns reclamam mais, alguns reclamam menos, e os que reclamam mais talvez vão ser alocados a outros vôos e os outros não. E aí nesses casos eu acho que é, não é motivo de orgulho, é motivo de vergonha, eles deveriam conseguir entender e priorizar os passageiros de acordo não com quem grita mais ou menos mas com prioridades, com tipo de cliente, com as necessidades de cada um.

Q: A próxima questão era exatamente essa, se existiria algumas situações em que a pessoa deve se sentir envergonhada de usar o “jeitinho”.

A: Eu acho que mais envergonhada do que orgulhosa. Acho que o “jeitinho” às vezes é necessário mas ele não é motivo de orgulho e de divulgação. Eu não acho que ele é motivo de vergonha, de que ‘não vou falar para ninguém’, porque daí quando também você dá um “jeitinho” mas isso se torna um segredo, isso também já me aconteceu como cliente também, de que ‘ah, então, olha, eu vou trazer isso para o senhor, mas não fala com ninguém’. Não deveria ser um segredo também, se a gente estabelece essa regra de que... que nem eu faço com o meu financeiro, na primeira vez tudo bem, na segunda vez, não. A minha própria equipe já entende hoje que ok, se é a primeira vez, a gente vai lá, vai conversar com o financeiro, na segunda vez que o cliente pedir eu não vou nem pedir para o financeiro, porque eu já sei a resposta, já sei que é ‘não’ e ‘não’ e ‘olha, não tem como, não consigo te ajudar, paciência, aprenda a conviver com isso’.

Q: De forma geral, você diria que o “jeitinho” melhora a relação entre empresas, entre compradores e fornecedores?

A: Eu acho que no Brasil, ele aproxima mais, que nem eu falei no começo, que tem essa questão da aproximação pessoal. Eu sinto hoje que quando acontece algum problema e eu consigo acionar alguém ou tentar resolver esse problema não nas vias regulares, e não digo regulares, mas assim formais, estabelecidas, também não acho que a gente tem que ir contra a lei ou contra regras, mas às vezes você tem que criar uma adaptação. O cliente acaba ficando grato e fala ‘bom, nossa, o João está lá p’ro meu melhor interesse e está para me ajudar’. Mas eu sei também que quando a gente vira e fala ‘não, não tem jeito’, aí nisso acabou, eu corto o crédito do cliente, eu não vendo mais para ele, isso também gera um estremecimento de relação. Então, no Brasil, de novo, eu acho que o “jeitinho” ele ainda é necessário, essa flexibilização ela ainda é necessária por conta da cultura massiva dos 200 milhões de brasileiros que vivem aqui e da forma como a gente faz negócio.

Q: A próxima questão é exatamente essa, se o “jeitinho” é útil em manter ou conquistar novos clientes.

A: Eu não acho que para conquistar novos, mas para manter é mais importante. Para conquistar novos, eu acho que você tem que já partir de um pressuposto de quais são as regras sem falar que tem flexibilidade, que tem “jeitinho”, que dá para fazer. Estabelece as regras com os novos e conforme você vai passando também você vai vendo quais são os clientes que vale a pena você abrir certas exceções, porque você sabe que eles não estão agindo de má fé. Eu tenho clientes que eu sei que já agem de má fé de atrasar nota de pagamento, e aí você vê que o negócio é recorrente, e às vezes para o mesmo comprador final. Eu trabalho muito com agência. Às vezes eu tenho um anunciante que tem mais de uma agência. Uma agência sempre paga tudo no ato, outra agência sempre não. Então dá para fazer uma comparação, o cliente final é o mesmo. Essa agência é pior do que essa, logo essa aqui está agindo de má fé ou, enfim, está sendo contraproducente e eu vou ser mais rígido com ela, porque a outra pode fazer e essa não?

Q: O “jeitinho” então te ajuda a manter os clientes que você já tem?

A: Eu acho que ajuda a manter alguns laços, mas ao mesmo tempo isso pode ser prejudicial para a empresa, se você começa a fazer com que o “jeitinho” vire uma coisa recorrente, sempre se sabe que dá um “jeitinho”, não acho bom. Por isso que eu acho que tem uma questão de cultura norte-americana também na forma em que as empresas estabelecem níveis de clientes. Por exemplo, na cultura atual, você vê cada vez mais que tem determinados tipos de clientes, a gente chama de *tiers* de clientes. Tem o cliente que é o VIP, tem cliente intermediário, assim como as companhias aéreas também fazem, e aí elas têm também serviços ou flexibilidades de acordo com o nível de cliente. Então, um determinado cliente que é um nível A, um nível *top*, você vai dar mais liberdades para ele sem que isso seja o “jeitinho”, você estabelece de repente

isso na regra, então tem mais flexibilidade. Eu vejo isso com companhia aérea também, eu uso muito o exemplo de companhia aérea porque eu trabalho com eles e viajo muito. Mas se você pega uma companhia aérea que tem o cliente ouro, diamante. Prata, ouro, diamante. O diamante é o melhor. O diamante tem mais flexibilidade para chegar atrasado, ele pode ser alocado para outro voo sem pagar uma taxa a mais, o prata tem menos benefícios, o diamante pode escolher o assento, o conforto, sem pagar mais. Uma vez que você estabelece essas regras, isso fica claro para todo mundo, o diamante sabe que ele pode usar disso sem que ele esteja tirando vantagem em cima do outro, o prata sabe que para ele conseguir ter esse acesso ele precisa ser mais viajante frequente, aí se elimina o “jeitinho”, você cria essas flexibilizações e começa a pagar. E eu acho que o dinheiro também conta muito nisso, se você começa a dar valor para esses “jeitinhos”. Se esses “jeitinhos” ou essas flexibilizações têm um custo, que é o custo de você parar o processo que você está fazendo e fazer de uma outra maneira, você já vai precificando isso e dando uma oportunidade para todo mundo fazer de acordo com a vontade ou se a pessoa quer marcar um assento no avião, então está bom, então você vai pagar o assento. Se você quer despachar uma mala, então você vai pagar para despachar. Daí você de novo coloca nos níveis de clientes que você estabelece.

Q: Do seu lado, é eventualmente necessário utilizar de “jeitinho” para adaptar produtos ou serviços às necessidades dos compradores? Você percebe isso?

A: Eu percebo e eu venho de uma empresa que é uma empresa grande, hoje, estabelecida, mas que também tem uma cultura de *startup*, é uma empresa que cresceu muito rápido e assim como também a gente cria produtos em beta, às vezes, a gente cria uma forma de compra de mídia que é beta, e a gente sabe que talvez não vá funcionar da melhor maneira desde o início. Você já cria uma relação com o cliente falando ‘olha, isso aqui é um produto em beta, é um produto que não necessariamente está pronto, mas você vai testar ele’. E testar ele implica em ser o primeiro, ser pioneiro, ter acesso aos resultados antes dos outros, mas também implica em talvez não funcione tão bem, ou da forma como a gente espera e a gente está disposto a determinados riscos. Eu acho que quando você estabelece isso desde o início, você já cria uma abertura e aí de novo, assim, você vai alinhar com o teu cliente e falar ‘olha, a gente está fazendo esse teste aqui’. Não é um “jeitinho”, é uma forma diferente de fazer do que a gente vem fazendo. Eu acho que essa forma diferente também cria um dinamismo, e eu acho que é importante para as empresas, para que elas não fiquem sempre fazendo tudo do mesmo jeito, as empresas precisam se reinventar. Às vezes para você se reinventar e criar um novo processo, não necessariamente você tem que criar todas as regras para esse novo processo do zero. Às vezes você tem que criar uma nova forma e ir testando. E aí tem vezes em que você vai adaptando, vai vendo se funciona, você vai mudando, você cria uma regra nova depois que aquilo já está estabelecido. Acho que isso é um pouco de cultura de *hack*, que a gente chama nos Estados Unidos, você vai *hackear* uma coisa não no sentido ruim, mas no sentido de não funciona dessa maneira, mas vamos tentar fazer funcionar por esse jeito.

Q: É eventualmente necessário utilizar de “jeitinho” para adaptar condições de pagamento às necessidades dos compradores?

A: Eu acho que sim em determinados aspectos, deixa eu falar de um outro caso que está acontecendo agora. Tem um cliente nosso, que é um cliente já bastante antigo, que sempre pagou em dia, que conhece toda a equipe, o fundador, e etc. A gente sabe que eles são pessoas e é uma empresa consolidada. A gente está passando por um período de crise no país. E daí nesse período de crise acontecem algumas adversidades que, se são expostas abertamente, a gente também está disposto a entender e conversar. Então o que esse cliente fez: eu tenho um prazo de pagamento de 30 dias. Esse cliente abriu para a gente e falou ‘olha, tive um problema de sistema, comprei um *software* errado, perdi alguns milhões de Reais, e com isso eu estou

com o fluxo de caixa prejudicado, e eu queria alinhar contigo para de hoje até Outubro, pagar em vez de 30 dias, em 60 dias, de Outubro a Dezembro pagar em 45, e em Janeiro eu me comprometo a que a gente volte a fazer o processo normal'. Aí você está exposto a dois pontos: você pode ser rígido e falar 'não, não vou, é assim, e é assim para todo mundo, e assim vai ser com você', e daí você corre o risco também de perder esse cliente, ou de não ser flexível com ele, ou de não entender o momento dele, ou você pode falar 'ok, vamos entrar nessa', mas isso também pode se alongar, pode chegar em Dezembro e ele falar 'putz, ainda não me restabeleci', e uma vez que você dá um benefício, é mais difícil também você tirar esse benefício. Então, eu acho que uma forma importante e importante como a minha empresa está estabelecida, e eu acho que tem que ser estabelecido é que a área de pagamento ou a área de cobrança e a área de vendas sejam muito separadas e que a área de cobrança tenha uma autonomia que vendas não influencie. Eu não posso chegar num ponto que o meu VP de vendas vire para o VP de cobrança financeira e fale 'não, para esse cliente você vai dar esses 45 dias ao invés de 30 dias'. Acho que essa separação é importante, ela protege também uma equipe de vendas para que o comprador também entenda que não sou que não estou dando, é uma questão financeira mesmo e se fosse por mim eu daria. O vendedor sempre, o vendedor quer vender, acima de tudo. Quem quer receber o pagamento é a área de finanças, são áreas diferentes dentro da empresa para não entrar em conflito e também não expor o vendedor.

Q: É eventualmente necessário utilizar de "jeitinho" para adaptar condições de entrega às necessidades do comprador?

A: Eu acho que também em alguns casos é importante, e é importante, de novo, não o "jeitinho" por baixo dos panos, mas o "jeitinho" na maneira de você tentar adaptar um pouco os seus processos. Eu estou há 3 anos e meio na empresa onde eu trabalho hoje e faz 2 anos me deram a responsabilidade de fazer vendas para o Governo, para as empresas do Governo, as empresas públicas. Para as empresas privadas, a forma como a gente vende, a forma como eles compram, a forma como a gente fatura, e etc., os processos, casos, funciona de uma maneira que, para os processos públicos, por regras da TCU, pela forma como o Governo está estruturado, até em compra de mídia, porque compra de mídia ainda é uma legislação arcaica que rege essa compra para esses órgãos públicos, a gente teve que fazer algumas adaptações e a gente teve que criar alguns processos específicos, que a gente foi mais condescendente com o Governo do que a gente é com uma empresa privada. Então, por exemplo, para qualquer empresa eu tenho um produto lá que o prazo de implementação é de 3 dias. E para o Governo às vezes eles queriam isso em 1 dia. E aí eu falei 'bom, não dá para ser em 1 dia, porque tem essa série... mas de repente a gente pode trabalhar para não ser em 3 também, então a gente fica num meio do caminho'. Isso, em 2 anos, fez com que o Governo ganhasse importância e crescesse, e o Governo entender também, as empresas do Governo entenderem que a gente estava criando processos para nos adequarem, e de novo, processos abertos, processos iguais para todos, processos que estão dentro da lei, que estão até mais de acordo com a lei que rege essas empresas que são mais rígidas, porque tem todos os órgãos fiscalizatórios lá. Isso aproximou a gente, fez com que a gente crescesse a receita vinda de empresas de Governo. Então eu acho que o "jeitinho", nesse sentido, uma adaptação sim, é importante e é benéfica.

Q: Você acha que o "jeitinho" existe em outros países?

A: Eu acho, eu acho que o "jeitinho" existe muito mais em países de cultura latina, e não só na América Latina, mas quando você vai para o sul da Europa, ou quando você vai para alguns países da Ásia também, eu acho que ele está muito relacionado à uma cultura mais flexível. Mesmo quando você olha para, fazendo uma comparação entre Estados Unidos e Europa, também, você tem diferentes tipos de cultura dentro da Europa, eu acho que o norte da Europa é uma cultura que é muito mais rígida, e é muito mais pré-estabelecida de como as coisas

funcionam, isso aqui tá claro para todo mundo. Eu acho que tem a ver com o nível de educação das culturas e das sociedades também, uma cultura menos educada, você precisa ter muito mais “jeitinho” do que uma cultura onde o nível de educação é alto, quando o nível de educação é alto, todo mundo já tem conhecimento prévio de como é que as coisas funcionam, e aí o negócio flui. Numa cultura de menos pessoas educadas ou cultas você tem que ser mais condescendente e conseguir ajudar essas pessoas porque é assim, você vai educando as pessoas nessas formas, vem um pouco da cultura de multa. A cultura de multa – de multa de trânsito, por exemplo - tem países onde ela é muito mais educativa, e países onde ela é mais para arrecadar. Eu acho que um país onde ela é mais educativa no final das contas acabam sendo países mais de um nível de educação mais alto. As pessoas aprendem, ‘ok, levei a multa, ok’... enfim.

Q: E quais seriam as diferenças que você vê entre um “jeitinho” de outros países com o “jeitinho” brasileiro?

A: Eu acho que no caso do Brasil às vezes o “jeitinho” pode ser encarado como algo por debaixo dos panos ou algo ilícito, que não deveria ser compartilhado, que vai ser só para você e não conta para ninguém. Ele é para metade das pessoas mas aquilo não fica escrito, estabelecido. Talvez o “jeitinho” de outros países, ao mesmo tempo assim, acho que o brasileiro, ele já tem uma benevolência, ele muitas vezes faz o “jeitinho”, não porque ele quer ser malandro, mas porque ele quer ajudar, porque mistura um pouco os interesses pessoais, a relação pessoal, e aí você fala ‘não, vou ser legal com essa pessoa, porque ela é tão simpática, pediu com jeitinho, pediu adequadamente, então eu vou ajudar’. E em outro país é ‘não, e não’, e acabou. ‘Acabou, tchau, vai embora, e eu não quero ouvir, eu não quero saber se você perdeu a hora porque teve greve do metrô, se você não pagou porque... é isso, e acabou’.

Q: Como os estrangeiros vêem o “jeitinho”? Você percebe que alguém da sua empresa que não é do Brasil, como é que ele reage a isso?

A: Eu acho que os estrangeiros, eles partem do pressuposto de que a regra está lá e ela é seguida e pronto. Eles não questionam uma vez que eles encontram uma barreira, uma resistência, não existe um questionamento, uma pergunta do ‘mas não tem nada mesmo que a gente consiga fazer, alguém com quem eu consiga falar para resolver?’. Um estrangeiro que vem dessa cultura mais rígida, ele já parte do pressuposto de que ‘putz, é isso, e é isso, e acabou’, e o brasileiro, ou uma pessoa que vem de uma cultura mais flexível, permissiva, ele vai tentar achar uma forma. Ele não pára na primeira barreira, ele vai tentar outras formas de resolver.

Q: Você diria que o “jeitinho” pode ser entendido como uma solução criativa para os negócios, para problemas de negócios?

A: Sim, eu diria. Porque eu acho que ele é uma forma de você trabalhar fora da tua rotina, e de alguma maneira às vezes se você começa a perceber que esse “jeitinho”, ou que muita gente está pedindo, ou muitas vezes você tem que alterar a forma como você está fazendo, e talvez você consiga criar uma rotina para fazer isso, talvez você estabeleça isso como a sua regra. É um pouco do exemplo que eu falei das companhias aéreas, elas viram que talvez não fosse tão ruim flexibilizar a mudança de um horário de vôo, a pessoa às vezes chega mais cedo no aeroporto e ela pode entrar naquele avião se tem lugar. Talvez antigamente isso seria encarado como um “jeitinho”, porque não tem a regra. Eu cheguei uma vez no aeroporto em Porto Alegre e tinha um vôo 2 horas antes. ‘Ah, posso antecipar?’ ‘Pode, você vai pagar 2 vezes o que você pagou por esse trecho, só’. Não acho justo, então está bom. Fiquei quieto, esperando no aeroporto. Poderia ter ido no vôo anterior, tinha lugar vazio. Não existia uma regra estabelecida na época e por isso eu fiquei lá esperando. Hoje, essa mesma companhia aérea me deixaria entrar, e isso não é o “jeitinho”, mas talvez ouvindo um pouco, olhando p’ro mercado e vendo que existem formas alternativas, que no fim é melhor para o passageiro, porque ele vai chegar

mais cedo no destino dele, é melhor para a empresa, porque ela antecipa para um avião que tem assento, e talvez vague mais para o outro, para ela poder vender para outros, ninguém sai prejudicado, porque não é que eu estou tirando um passageiro do avião para colocar outro. Nesses casos, o “jeitinho”, que na verdade não se torna um processo, acaba sendo benéfico, mas se você não abre espaço para pensar criativamente, ou diferente, talvez você fique só estanke, fazendo sempre a mesma coisa, da mesma forma.

Q: Isso vai um pouco também com a próxima questão, que seria se na sua visão, o “jeitinho” acrescenta flexibilidade para solução de problemas de negócios?

A: Sim.

Q: Você acha que o “jeitinho” reduz o tempo e/ou o custo de soluções de problemas de negócios?

A: Eu acho que a curto prazo, não, ele aumenta. A curto prazo ele gera uma demanda extra que você vai ter que parar como é o processo e tentar pensar em ‘como é que eu mudo isso?’. Talvez num longo prazo, isso melhore, uma vez que você pára uma vez, você pára a segunda, você pára a terceira, e você vai vendo que existe recorrentemente uma demanda para que as coisas sejam feitas de uma forma diferente, aí você estabelece um processo novo e isso otimiza. Mas num curto prazo, eu acho que aumenta o custo.

Q: Na sua visão, o “jeitinho” melhora a relação entre as empresas e os governos?

A: Depende da forma como você está olhando para o Governo. Eu estou olhando para Governo como comprador de mídia, como meu cliente. Depende da situação. O Governo, ele pode entrar como cliente, ele pode entrar como órgão fiscalizatório também, então o exemplo que eu dei não foi o Governo como Governo, foi como cliente meu, que no caso é uma empresa de Governo que tem todas essas regras, mas poderia ser uma indústria nova que chegasse e falasse que tinha regras específicas, e que eu flexibilizaria meus processos para essa indústria nova. Não sei, o Governo como órgão regulador eu não saberia te dizer.

Q: O “jeitinho” torna mais fácil para as empresas lidarem com a burocracia?

A: Não sei, essa pergunta é... *tricky*, essa pergunta. De novo, vou usar exemplo, eu não sou, acho que talvez seja interessante vocês conversarem com alguém que faz compra internacional, porque daí vocês vão entrar numa questão que é ‘quem importa?’, por exemplo. Quem importa, e daí tem produto que fica preso em alfândega, eu não sei como lidar com isso, mas tem muita gente que fala ‘não, o produto está na alfândega, você tem que molhar a mão de alguém’, você tem que pagar e daí liberam o seu produto e é um negócio meio que recorrente, isso, que é o *bribe*. Então nesses pontos sim, o “jeitinho” nesse ponto ajuda, imagino que ajude muito uma empresa que está com os negócios presos na alfândega. A minha empresa às vezes, ela é uma empresa americana, às vezes vem camiseta, brinde, umas coisas que ficam presas na alfândega. A gente tem uma cultura de não *bribe* nada. Está lá, está preso, por exemplo, tem coisa que ficou já 1 ano preso e voltou, e aí a gente vai aprendendo, vai falando ‘bom, então está bom, então se não dá para trazer a camiseta nessa via, vamos fazer as camisetas localmente, manda a arte’, ou quem for para a sede lá nos Estados Unidos, vai lá e traz uma camiseta, ou traga de repente para 3 outras pessoas. Você vai tentando achar formas para se adequar. Mas aí, de novo, o “jeitinho” na forma de corrupção, de propina, obviamente que ele ajuda a burocracia, mas aí é uma questão da sua empresa também querer se expor e estar disposta a seguir isso ou não, ou seguir a regra e é isso.

Q: Quem você diria que é mais afetado pelo “jeitinho”: as empresas, o governo, ou indivíduos?

A: Afetado em que sentido, positivamente, negativamente, genérico? Eu acho que é muito indivíduo. Assim, a empresa é formada por indivíduos, e daí indivíduos de uma cultura coletiva que é uma cultura brasileira. Eu acho que quem se afeta, quem se... a quem afeta esse “jeitinho” são todos os indivíduos que estão relacionados à essa empresa, não penso num órgão maior, ‘ah, o Governo sai ganhando, a empresa sai ganhando’. Eu acho que todo mundo no fim sai ganhando ou perdendo, depende da forma como você vê. Não saberia te dizer se tem alguém que se sobressai, mas acho que o indivíduo, ou o comprador, ou o vendedor, ou a pessoa da empresa, o cliente da empresa, todo mundo é afetado de alguma maneira.

Q: Existem riscos de algum tipo na utilização do “jeitinho”?

A: Eu vejo, eu acho que quando o “jeitinho”, ele vai contra a lei, vai contra lei mesmo, não regra, porque eu acho que às vezes a regra você tem que pensar em novas formas de você estabelecer a regra, mas quando ele vai contra a lei, quando ele vai prejudicar, quando ele envolve propina, eu acho que ele é sim, prejudicial, porque você estabelece uma lei, que não é certo, que é o que está na legislação. E geralmente isso acontece quando alguém está levando uma vantagem, um dinheiro por fora. Eu acho que o “jeitinho”, ele vem para ajudar a empresa, o comprador, o vendedor, o sistema como um todo para melhorar um processo, ele é benéfico.

Q: A proposição do “jeitinho” pode ser de alguma forma ofensiva?

A: Eu acho que dependendo de cultura, daí sim, quando você vira e pergunta ‘putz, mas não tem nada que a gente possa fazer para resolver isso?’ ‘Não, não tem nada’. Às vezes a pergunta que você está fazendo é realmente num ótimo sentido de ‘puxa, como que a gente pode, isso é...’, ou às vezes pode ter aquele tom também, ‘com quem eu posso falar, quem que pode resolver isso?’, então depende do tom e da forma como a pessoa sugere também e propõe o “jeitinho”, sim, pode ser visto ou recebido de uma forma negativa. Então você tem que tomar cuidado também quando você vai estabelecer o “jeitinho”, é tem que entender o total e não olhar só para a sua situação.

Q: Última pergunta – Quem ou o quê é responsável pelo “jeitinho”: o Governo, as empresas, o povo brasileiro? De onde você diria que vem essa cultura de “jeitinho”?

A: Eu acho que são as pessoas. De novo, eu acho que quando... é, vou falar de corrupção, especificamente, e de política, e do Governo que a gente tem hoje no nosso país. Eu acho que as pessoas só aceitam o nível de corrupção que a gente vê na política, falando de uma forma geral, as pessoas só aceitam que tenha alguém lá em cima no poder que está roubando, que está tirando vantagem, porque elas também sabem que quando elas puderem tirar vantagem de algo, se elas estivessem na posição dessas pessoas, elas também poderiam fazer isso. Então, essa cultura de aceitação vem de diferentes níveis de corrupção que se estabelece. A pessoa, ‘eu aceito que ok, um deputado que está lá e superfaturou e vendeu, e se beneficiou, porque se eu também puder tirar vantagem, às vezes em algo bem menor, sei lá, tirar vantagem de alguma coisa muito pequena, que talvez nem vá ser os milhares, milhões de Reais que a pessoa está superfaturando lá’, essa pessoa também vai tirar vantagem. Então eu acho que o “jeitinho”, ele é muito impregnado na cultura, não acho que é de empresas, não acho que é de... é cultura da sociedade mesmo, por isso que quando você também pega empresas brasileiras *versus* empresas norte-americanas ou japonesas, as regras que regem muitas dessas empresas multinacionais são regras muito voltadas para o país, também. E se é um país mais permissivo como é o Brasil, as regras vão ser mais flexíveis. Se você pega uma empresa japonesa, canadense, sueca, aqui no Brasil, ela vai ter regras mais pré-estabelecidas e rígidas do que uma empresa brasileira.

A.2. Interview #1, English Translation

Project: Brazilian “Jeitinho” in Buyer-Supplier Relationships
Projeto: “Jeitinho” brasileiro nas relações Comprador-Fornecedor

Interview Transcript – Transcrição de Entrevista
Interview #1 – Entrevista #1

Q: Do you think Brazilians have any special or unique way to deal with business questions / issues?

A: Special or unique? I don't know if its unique, I think there is a way that is more Brazilian. My company is an American company and the way we do business and sales is different from the way that the headquarters, in the United States, works. So I guess yes, it is a different culture. I don't know if it is unique only from Brazil, maybe it is just a Latin culture, that has more to do with other countries in the region as well.

Q: This Brazilian way, do you think that it has a particular name? How would you call this Brazilian manner of doing business?

A: I think that the Brazilian, one thing that mixes a little bit more is the personal relationship and not only the professional one. So in any business interaction here in Brazil, personal relationship also counts a lot. In the first moments of a conversation, of a negotiation, there is always that ice-breaking introduction of how the family is going, how was the weekend, talking about football, about some aspect of what is happening in society, and we do not go straight to the point. Do not go straight to the point. As well as I think that also in Brazil people are not very clear, they sometimes take deviations, or when they want to answer ‘no’, instead of them saying ‘no’, they say ‘I will think about it’, ‘I will check, we will talk again’, they are not direct and say ‘no’ right up front. Even when they are going to say ‘yes’ they always have to think. I think that the negotiation process, sales, purchasing here in Brazil takes a little bit longer because of that. People are less direct.

Q: What do you understand by Brazilian *jeitinho*?

A: I think that the Brazilian *jeitinho*... What I understand from this expression “Brazilian *jeitinho*” is 1. Do not need to follow all the rules, or think that the rules exist but not necessarily they are valid for me or for a person, they are valid for others but not necessarily for me; and the Brazilian *jeitinho*... I think that there are two manners of facing the Brazilian *jeitinho*. There are some people that look to Brazilian *jeitinho* as if it was wanting to take advantage. And there are other people that look to Brazilian *jeitinho* as if it was trying to solve something that a system would not allow, or a rule would not allow. I don't think that it is only a negative connotation, I think there is a very negative charge, but I also think that there is a positive charge, of trying to solve, trying to find the best for two parties, without us being tied to rules. It is less using the rules so that we are tied on them, and more using the rules so that they are a direction.

Q: Can you give examples of *jeitinho* in business?

A: Jeitinho in my business? For example, I sell media. There is a lot of people that sometimes make a mistake when buying media, because my media is a purchase that the person does their self, the person their self enters the system and does the purchase. And sometimes they get jammed, they make mistakes, don't purchase they way it was supposed to be purchased and then they call with the expectation that ‘oh, no, look, I made a mistake, but understand, I am a partner, and I need you to solve this, etc.’. And what I think that also enters the *jeitinho* is when

you turn to the person and say such ‘sorry, I cannot, the mistake was not made by the system, there is no way to change this, you were the one who made the mistake, or someone from your team’. Oh, and the ‘I will talk to so-and-so’. Then there always comes some of that ‘I will talk to another person hierarchically higher so that the issue can be solved’. And in some cases the person is able to solve when it scales, when it goes to a higher hierarchy. And then I see this in various aspects, sometimes it was already said to me ‘I will talk to the company’s president’, sometimes we have a team, I see that they are in a conversation, in e-mail exchange, and I am delicately included, it is not that they write to me directly, but only to make you aware of the history already trying to bring some of this *jeitinho*, which is to try to solve things not by the right manner.

Q: Would you say that *jeitinho* helps business? If it does, how?

A: I think yes, it helps, that is why there are two ways of looking at *jeitinho*. There is a negative charge, but I don’t think it is only negative. I think that yes it helps when we also don’t stay tight and still, it is counterproductive for both sides, because there are some things that, there are some situations, and then I think that this is much from our Brazilian culture, and because of that I also accept it, in that the *jeitinho* solves a situation that would be bad for both sides. Sometimes no... I see it like this: when *jeitinho* will not harm others, or prioritize only one in detriment of others, I think it is not so bad. But when *jeitinho* stands for one but does not stand for others, just because this one knows I-don’t-know-who, it is bad.

Q: And does *jeitinho* cause any problem for business? Do you perceive that it also causes problems?

A: I think it causes the rupture of standard and of systems. When we go into a company, into a business, and it keeps expanding, evolving, we need to have each time more processes and systems to be able to escalate without having those deviations. These deviations cause loss of time, routine change, and the way you are doing business. So more time is demanded, more efforts are demanded, energy. And usually you arrive at *jeitinho* also after some mistake has happened. Maybe in some cultures the person absorbs the mistake and says ‘I made a mistake, I learned from it and let’s carry on to do business in the right way’. And here the *jeitinho* sometimes, for example, I sell media, I am not the financial department, but a lot of times what happens is that the person has 30 days to pay and they do not pay in the 30 days. They call the financial department, the financial department says they will charge fine, interest, etc. and so so so, then who do they call? The sales department, my team, ‘oh, please, isn’t there a way to help?’, and then there comes the *jeitinho*. And we in the salesman position, we put ourselves in our clients’ feet and we want to help them. ‘Oh, no, calm down, then I will talk to the financial department, so’; and then you have to talk to the financial department, the financial department says no, then your client starts threatening you that they will not purchase anymore, or that they will buy less than they wanted, or that this is bad for the relationship. So a stress is generated and energy is spent which for me is counterproductive. If you give a discount, or you will not apply the fine and etc., what happens, 6 months after the guy errs again, calls again, and all the process happens. So, we ended up establishing in our company a culture that is, in these cases for example of delayed payment: the first time the person delayed it, I will look at the history, see if they have never delayed, if it is the first time ok, but then I send all the written recommendation, by e-mail, saying ‘look, you delayed, in delaying cases we charge fines this way, so so so so so, as it is the first time this is happening ok’, but then when there is the second time, today, we don’t... could be the company’s biggest client, the one that invests the most, we will not stop charging fines and finally, and I think that with that they learn also. The client ends up learning that ‘well, I can make a mistake with that company, with that one, with that

one, but this is a serious company and with this company I cannot make a mistake, so I will prioritize paying them’.

Q: Would you say that *jeitinho* is indispensable for business?

A: I don’t think it is indispensable, I think that more indispensable is good sense, more that the *jeitinho* in this connotation. So good sense in the sense that there are cases that are more understandable, and then comes a little bit of, going back to the delaying issue, why is it delayed? ‘Because we got jammed internally, because the person who was supposed to pay went out on vacations, so so so so so, or because there was a corruption in the bank’s system and what was programmed to be payed was not payed’, so there are weights and situations where you end up being more condescending with delay and try to arrange the *jeitinho* than if the person was jammed internally because the intern that was supposed to pay left, sorry, right, you will have to pay. No, it it was the bank. Then you give degrees of these *jeitinhos*. Then I think that more than *jeitinho* is the common sense of understanding why and how is it that we can avoid that it happens in the future, because the person going on vacations, they will go on vacations again, if the person goes on vacations again, ‘there is no problem, if they leave on vacations, than afterwards we solve it there, call them and they won’t charge the fine’. So, I think there are situations, but I do not think it is indispensable.

Q: Would you prefer to work in an environment completely free of *jeitinho*?

A: No, I think that the *jeitinho*, and then again, comes the connotation of *jeitinho*. The environment completely free of *jeitinho* or a culture from the North of Europe for example where things are completely established, structured, they work well in that culture. I think that for a Brazilian culture, if I worked in an environment in which I couldn’t in any way have the *jeitinho*, it would be more difficult. I think that... my company is a North American company, which is very by the book, follows the rules a lot, I like this. I prefer to work in a North-American company than in a Brazilian company, where there is corruption, like so, and I work in some areas from the Government, also. If I worked with the Government in a Brazilian company, I would feel much more exposed than working in the company I work for, that I know there are rules to be followed, so I prefer to work in this more correct environment. But I think that a completely Swedish or Finnish culture to Brazil without an adaptation, a tranquilization, would not be super effective.

Q: Could you give an example of situation when *jeitinho* is expected? A situation when *jeitinho* would appear, it is already expected, a situation in which you foresee that this will happen.

A: I think that a little bit of what I explained now. We know that sometimes the person can be delayed. So ok, in theory, in documents, in the rules, fine, so much % of delay, delay is so much % of fine, and interests, etc., and this is for everybody, we never say that ‘if you delay the first time we will let go, but the second there is no letting go’, so the rule is there is fine for delay. If the person complains, so so so, we will talk to the financial department, and then the financial department will let go the first time. So, it is a certain way of a *jeitinho*, a flexibilization that we established in the company, non-officially, but I think that it helps more than hinders in this case, because it is a little bit of you getting in the middle point of a very strict culture to a more permissive culture, but you do not stand in one side, nor in the other.

Q: This has something to do with the next question, which is in what kind of situations is *jeitinho* acceptable? Would you have any classification, in which you would say ‘in this situation it is acceptable, in this situation it is unacceptable’?

A: I think it is acceptable again in the issue of good sense, when you see that the mistake has happened, and because of a sometimes much bigger mistake or alien to the company’s whole

organism, and not a person as well, because I think people make mistakes and we need to live with that, 'oh, it wasn't me that made the mistake, it was my employee', but 'you were the one who hired this employee, you formed your team, you didn't train them'. So I think again that it is an alien thing, I don't know, there was a banks' strike and it wasn't payed. What happens also sometimes the person makes a purchase of media in my company and my system is also... my system sometimes has a technical problem, there is a flaw and I couldn't deliver the media in the format that the person purchased. So as such I also apologize for these people to understand, sometimes there is a technical problem, that is not my fault, nor their fault, but the fault of an engineer from another country that made the system have a problem. So I think that it is acceptable when there are those... in a two-way street, sometimes we will release the guy from a fine, but at the same time if some mistake happens and etc. we also count on the understanding that the system is a flawed system, that sometimes it can... In these cases, I think that this condescendence, this understanding is important. I think, again, I think that it is not acceptable when it comes from bad faith, or from a stupidity, like, that the person did, from a stupidity that they created and that generated a whole problem and then you say 'oh, no, it is fine, let's...', in these cases I think that or when it will harm a third party. Help this person with *jeitinho*, but I didn't help the other, because this person knows I-don't-know-who, then I think that you start to create a corporatist system that is not the least healthy.

Q: Do you think there are situations on which a person should feel proud of using *jeitinho*?

A: Proud? I think that pride is something that you expand and show others too, that you... I don't know, it had to be a very specific situation, I can't think of a specific situation now again, because I think that the *jeitinho* already comes with a negative connotation, so I think that they should be proud when... no, I don't think that they should be proud, I think that the person has to understand that sometimes *jeitinho* is necessary to establish a process, to educate people, but it is not a pride, 'oh, today I was able to find a way and...'. At the same time I also think that there are some companies, and then I am talking about how the company today, but me as a consumer also I think that many companies in our Brazilian culture today that disrespect the consumer, that make as to the consumer is treated in an unfavored manner. So I think that the company that is able to have an isonomy and treat everybody in the best manner, the best way, should be prouder than the one with *jeitinho*. The one with *jeitinho* is 'our service is shit, and then some people that I will prioritize, or that will scream more, or that will flounce more will get away, and I am thinking a little bit in airline companies today, for example. Airline company, if it is for a reason not from the airport, that is not from meteorology, because they have a flaw and then this harms a series of passengers, some complain more, some complain less, and the ones that complain more perhaps will be allocated in other flights and the others won't. And then in these cases I think that it is, not motive for pride, it is motive for shame, they should be able to understand and prioritize the passengers according not to who screams more or less but to priorities, with the type of client, with the needs of each one.

Q: The next question was exactly this, if there were some situations in which a person should feel ashamed of using *jeitinho*.

A: I think that more ashamed than proud. I think that *jeitinho* is sometimes necessary but it is not reason of pride or advertisement. I don't think that it is reason for shame, in that 'I will not tell anybody', because then when also you give a *jeitinho* but it becomes a secret, it also already happened to me as a client as well, the 'oh, so, look, I will bring this to you, but do not tell anybody'. It shouldn't be a secret also, if we establish this rule that... such as I do with my financial department, at the first time it is fine, at the second time, no. My own team already understands today that ok, if it is the first time, we will go there, will talk to the financial department, at the second time that the client asks I will not even ask the financial department,

because I already know the answer, I already know that it is ‘no’ and ‘no’ and ‘look, there is no way, I can’t help you, patience, learn to live with that’.

Q: In a general manner, would you say that *jeitinho* improves the relationship between companies, between buyers and suppliers?

A: I think that in Brazil, it approximates more, such as I spoke in the beginning, that there is this issue of personal approximation. I feel today that when some problem happens and I can trigger someone or try to solve this problem not through the regular paths, and I don’t mean regular, but such as formal, established, also I don’t think that we have to go against the law, but sometimes you have to create an adaptation. The client ends up being grateful and saying ‘well, wow, John is there for my best interest and it is there to help me’. But I also know that when we turn and say ‘no, there is no way’, then with this it is over, I cut the client’s credit, I do not sell to them anymore, this also generates a shudder in the relationship. So, in Brazil, again, I think that *jeitinho* is still necessary, this flexibilization it is still necessary because of the massive culture of the 200 million Brazilians that live here and the way we do business.

Q: The next question is exactly this, if *jeitinho* is useful in keeping or gaining new clients.

A: I don’t think to gain new ones, but to keep it is more important. To gain new, I think that you already have to start from an assumption of which are the rules without saying that there is flexibility, that there is the *jeitinho*, that is doable. Establish the rules with the new ones and as you go by you also see which are the clients that are worthy to open up exceptions for, because you know that they are not acting in bad faith. I have clients that I know that already act in bad faith on delaying a payment note, and then you see that the thing is recurrent, and sometimes to the same final buyer. I work a lot with agency. Sometimes I have an advertiser that has more than an agency. An agency always pays for everything in the act, another agency always does not. So you can make the comparison, the final client is the same. This agency is worse than this one, so this one is acting in bad faith or, finally, is being counterproductive and I will stricter with it, because the other can do it and this one can’t?

Q: So *jeitinho* helps you keeping the clients you already have?

A: I think that it helps to keep some bonds, but at the same time this can be harmful for the company, if you start to make *jeitinho* a recurrent thing, it is always known that you can give a *jeitinho*, I don’t think it is good. For that I think that there is a North-American culture issue also in the way that companies establish levels of clients. For example, in the current culture, you see more and more that there are determined types of clients, we call tiers of clients. There is the client that is the VIP, there is the intermediate client, as well as airline companies also do, and then they also have services or flexibilities according to the level of the client. So, a determined client that is level A, a top level, you will give more liberties to them without it being a *jeitinho*, you establish this in the rule, so there is more flexibility. I see this with airline companies also, I use the example of airline company a lot because I work with them and travel a lot. But if you take an airline company that has the gold client, diamond. Silver, gold, diamond. The diamond is the best. The diamond has more flexibility to arrive late, they can be allocated to another flight without paying an extra fee, the silver has less benefits, the diamond can choose the seat, the comfort, without paying more. Once you establish those rules, this becomes clear for everybody, the diamond knows that they can use this without them taking advantage of another, the silver knows that for them to get this access they need to be a more frequent traveler, then the *jeitinho* is eliminated, you create this flexibilizations and start to pay. And I think that money also counts a lot on this, if you begin to give too much value to these *jeitinhos*. If these *jeitinhos* or these flexibilizations have a cost, that is the cost of you stopping the process of what you are doing and do in another manner, you already put a price on this and give an

opportunity for everybody to do according to their will or if the person wants to mark a seat in the airplane, then it is fine, then you will pay for the seat. If you want to check-in a suitcase, then you will pay to check it in. Then you again put it in the levels of clients that you establish.

Q: From your side, is it eventually necessary to use *jeitinho* to adapt products or services to buyers' needs? Do you perceive this?

A: I perceive it and I come from a company that is a large company, today, established, but that also has a startup culture, it is a company that grew very fast and as we also created beta products, sometimes, we create a form of media purchase that is beta, and we know that maybe it will not function in the best way from the beginning. You already create a relationship with the client saying 'look, this is a beta product, it is a product that is not necessarily ready, but you will test it'. And test it implicates in being the first, being the pioneer, having access to results before the others, but also implicates in maybe it not working so well, or the way we expect and we are willing to take determined risks. I think that when you establish this from the beginning, you already create an opening and then again, like this, you will align with your client and say 'look, we are doing this test here'. It is not a *jeitinho*, it is a different way of doing what we are doing. I think that this different way also creates a dynamism, and I think that it is important to companies, so that they don't rest always doing everything in the same way, companies need to reinvent themselves. Sometimes for you to reinvent yourself and create a new process, not necessarily you have to create all the rules for this new process from scratch. Sometimes you have to create a new way and keep testing. And then there are sometimes when you keep adapting, you keep seeing if it works, you keep changing, you create a new rule after that thing is already established. I think that this is a little bit of the hack culture, as we call it in the United States, you will hack one thing not in a bad sense, but in the sense that it doesn't work this way, but let's try to make it work that way.

Q: Is it eventually necessary to use *jeitinho* to adapt payment conditions to buyers' needs?

A: I think yes in determined aspects, let me talk about another case that is happening now. There is a client of ours, that is a very old client, that always pays on time, that knows all the team, the founder, and etc. We know that they are people and that it is a consolidated company. We are going through a period of crisis in the country. And then in this period of crises some adversities happen that, if exposed openly, we are also willing to understand and talk. So what did this client do: I have a payment term of 30 days. This client opened up to us and said 'look, I had a problem in the system, I bought the wrong software, I lost some millions of Reais, and with that I am with my cash flow damaged, and I want to align with you so that from today until October, I pay instead of 30 days, in 60 days, from October to December pay in 45, and in January I commit so that we go back to doing the normal process'. Then you are exposed to two points: you can be strict and say 'no, I will not, it is how it is, and it is like that for everybody, and it will be like that for you', and then you run the risk of also losing this client, or of not being flexible with him, or of not understanding their moment, or you can say 'ok, let's get into this', but it also can prolong itself, December may arrive and they say 'oh, I have not reestablished myself yet', and once you give a benefit, it is also harder for you to take away this benefit. So, I think that an important way and important as my company is established, and I think that it has to be established that the payment area or charging area and the sales area are very separated and that the charging area has an autonomy the sales won't influence. I cannot arrive at a point where my Sales VP turns to the Financial Charging VP and say 'no, for this client you will give this 45 days instead of 30 days'. I think that this separation is important, it protects also the sales team so that the buyer also understand that it is not me that is not letting go, that it is really a financial issue and that if it was for me I would. The salesman always, the salesman wants to sell, above all. The one who wants to receive the payment is the financial

area, they are different areas inside the company so that they do not engage in conflict and also do not expose the salesman.

Q: Is it eventually necessary to use *jeitinho* to adapt delivery conditions to buyers' needs?

A: I think that also in some cases it is important, and it is important, again, not the under the table *jeitinho*, but the *jeitinho* in the way of you trying to adapt a little bit your processes. There is 3 years and a half since I have been in the company I work for today and 2 years ago I was given the responsibility to do sales for the Government, for the Government's companies, the public companies. For the private companies, the way we sell, the way they buy, the way we facture, and etc., the processes, cases, they work in a manner that, for the public processes, for the TCU [acronym for *Tribunal de Contas da União*, the Brazilian federal accountability office], for the way that the Government is structured, even for media purchase, because media purchase is still an archaic legislation that rules this purchase for these public organs, we had to make some adaptations and we had to create some specific processes, that we were more condescending with the Government than we are with a private company. So, for example, for any company I have a product there for which the implementation period is 3 days. And for the Government sometimes they wanted it for 1 day. Then I said 'well, it cannot be in 1 day, because we have this series... but perhaps we could work for it not to be in 3 also, so we stay in a middle ground'. This, in 2 years, allowed for the Government to gain importance and grow, and for the Government also understand, the Government's companies understand that we were creating processes to adequate ourselves, and again, open processes, processes equal to everybody, processes that are within the law, that are even more in accordance with what the law that rules these companies that are stricter, because there are all the inspector organs there. This approximated us, it made us grow the income from the Government's companies. So I think that the *jeitinho*, in this sense, an adaptation yes, it is important and beneficial.

Q: Do you think *jeitinho* exists in other countries?

A: I think so, I think that *jeitinho* exists much more in countries with Latin culture, and not only in Latin America, but when you go to the south of Europe, or when you go to some countries in Asia also, I think that it is very related to a more flexible culture. Even when you look to, making a comparison between the United States and Europe, also, you have different types of culture inside Europe, I think that the north of Europe is a culture that is stricter, and it is more pre-established of how things work, this is clear for everybody. I think that it has to do with the education level of the cultures and the societies as well, a less educated culture, you have to have much more *jeitinho* than in a culture where the education level is high, when the education level is high, everybody already has previous knowledge of how things work, and then business flows. In a culture of less educated or cult people you have to be more condescending and be able to help those people because it is like that, you go educating people in these ways, it comes a little with the fines culture. The fines culture – traffic fine, for example – there are countries where it is more educative, and countries where it is to collect. I think that a country where it is more educative at the end of the day are countries with a higher education level. People learn, 'ok, I received the fine, ok'... well.

Q: And what would be the differences that you see between a *jeitinho* from other countries with the Brazilian *jeitinho*?

A: I think that in the case of Brazil sometimes *jeitinho* can be seen as something under the table or something illicit, that should not be shared, that will serve only for you and do not tell anybody. It is for half of the people but it is not written, established. Maybe the *jeitinho* from other countries, at the same time, I think that the Brazilian one, it already has a benevolence, they

do *jeitinho* a lot of times, not because they want to be scoundrelly, but because they want to help, because it mixes a little bit of personal interest, the personal relationship, and then you say ‘no, I will be nice to this person, because they are so likeable, they asked with *jeitinho*, asked adequately, so I will help’. And in another country it is ‘no, and no’, and it is over. ‘It is over, goodbye, go away, and I don’t want to hear, I don’t want to know if you lost track of time because there was a subway strike, if you didn’t pay because... that is that, and it is over’.

Q: How do foreigners deal with *jeitinho*? Do you perceive that someone in your company that is not from Brazil, how do they react to that?

A: I think that foreigners, they start from the assumption that the rule is there and that it is followed and that is it. They do not question once they find a barrier, a resistance, there is no questioning, a question of ‘but isn’t there anything really that we can do, anyone with whom I can talk to solve this?’. A foreigner that comes from this stricter culture, they already start from the assumption that ‘well, that is it, and that is it, and it is over’, and the Brazilian, or a person that comes from a more flexible culture, permissive, they will try to find a way. They don’t stop at the first barrier, they will try other ways to solve.

Q: Would you say that *jeitinho* can be understood as a positive solution for business, for business problems?

A: Yes, I would. Because I think that it is a way of you to work outside your routine, and in some manner sometimes if you start to realize that this *jeitinho*, or that a lot of people are asking for it, or many times you have to alter the way you do things, and maybe you can create a routine to do that, maybe you establish it as your rule. It is a bit the example that I told about airline companies, they saw that maybe it was not that bad to flexibilize the change in a flight schedule, the person sometimes arrives sooner at the airport and they can enter that plane if there is a seat. Perhaps in the old days this would be seen as a *jeitinho*, because there isn’t a rule. I once arrive at the airport in Porto Alegre and there was a flight 2 hours before. ‘Oh, can I anticipate?’ ‘You can, you will pay 2 times what you paid for this trip, only that’. I don’t think it is fair, so that is fine. I remained quiet, waiting at the airport. I could have gone in the flight before, there was an empty seat. There was not an established rule at the time and because of that I was there waiting. Today, this same airline company would let me in, and this is not the *jeitinho*, but maybe listening a little bit, looking at the market and seeing that there are alternative ways, that in the end is better for the passenger, because they will arrive sooner on their destination, it is better for the company, because it anticipates for a plane that had a seat, and perhaps vacating more for others, so that it sells more to others, nobody is harmed, because it is not as if I am taking a passenger from the plane to put another one. In those cases, *jeitinho*, which in reality does not become a process, ends up being beneficial, but if you don’t open up space to think creatively, or differently, maybe you will just stand still, always doing the same thing, the same way.

Q: This goes a little bit also with the next question, that would be in your viewpoint, does *jeitinho* add flexibility for the solution of business problems?

A: Yes.

Q: Do you think that *jeitinho* reduces time and cost of solutions of business problems?

A: I think that in the short-term, no, it increases. In the short-term it generates an extra demand that you will have to stop the process as it is and try to think in ‘how can I change this?’. Perhaps in a long-term, this could improve, once you stop one time, you stop the second, you stop the third, and you keep seeing that there is a recurrent demand so that things are done in a different

way, then you establish a new process and this optimizes. But in a short-term, I think it increases the cost.

Q: In your view, does *jeitinho* improve the relationship between companies and governments?

A: It depends on how the way you are looking at the Government. I am looking at the Government as a media purchaser, as my client. It depends on the situation. The Government, it can enter as a client, it can enter as an inspector organ as well, so the example I have was not the Government as a government, it was as my client, which in this case is a Government's company that has all these rules, but could be a new industry that came and stated they had specific rules, and that I would flexibilize my processes for this new industry. I don't know, the Government as regulatory organ I would not know enough to say.

Q: Does *jeitinho* makes it easier for companies to deal with bureaucracy?

A: I don't know, this question is... tricky, this question. Again, I will use an example, I am not, I think that maybe it would be interesting for you to talk to someone that makes international purchasing, because then you will enter an issue that is 'who imports?', for example. Who imports, and then there is products that is stuck at customs, I don't know how to deal with this, but there is a lot of people that says 'no, the product is at customs, you have to wet somebody's hand', you have to pay and then they will release your product and this is something kind of recurrent, this, that is the bribe. So in these points yes, *jeitinho* in this point helps, I imagine it helps a lot a company that has business stuck at customs. My company sometimes, it is an American company, sometimes they send t-shirts, presents, somethings that get stuck at customs. We have a culture of not bribe anything. It is there, it is stuck, for example, there are things that remained stuck for 1 year and went back, and then we keep learning, we keep saying 'well, then it is fine, so if we cannot bring the t-shirt through this path, let's make the t-shirts locally, send the art', or whoever is going to headquarters in the United States, goes there and brings a t-shirt, or brings for example for other 3 people. You keep trying to find ways to adequate yourself. But then, again, *jeitinho* in the corruption form, of bribery, obviously it helps bureaucracy, but then it is a question of your company also wanting to expose itself and being willing to follow this or not, follow the rule or this is it.

Q: Who would you say is most affected by *jeitinho*: Companies, the Government, or individuals?

A: Affected in which sense, positively, negatively, in general? I think that it is the individual. Like this, the company is formed by individuals, and then individuals from a collective culture that is a Brazilian culture. I think that the one that is affected, the one that... who is affected by this *jeitinho* are all the individuals that are related to this company, I don't think in a bigger organ, 'oh, the Government keeps on winning, the company keeps on winning'. I think that everybody in the end wins or loses, it depends on the way you see it. I wouldn't know if there is someone that stands out, but I think that the individual, or the buyer, or the seller, or the person from the company, the company's client, everybody is affect in some manner.

Q: Are there risks of any sort in using *jeitinho*?

A: I see, I think that when *jeitinho*, it goes against the law, goes really against the law, not rule, because I think that sometimes the rule you have to think on new ways of establishing the rule, but when it goes against the law, when it will harm, when it involves bribery, I think that it is yes, harmful, because you establish a law, that is not right, that is what is in the legislation. And usually this happens when someone is trying to take advantage, an outside money. I think that *jeitinho*, when it comes to help the company, the buyer, the seller, the system as a whole to better a process, it is beneficial.

Q: May the proposition of *jeitinho* be somehow offensive?

A: I think that depending on the culture, then yes, when you turn and ask ‘oh, but isn’t there anything that we can do to solve this?’ ‘No, there is nothing’. Sometimes the question you are asking is really in an excellent sense of ‘wow, how can we, that is...’, or sometimes there is that tone also, ‘to whom can I speak to, who can solve this?’, then it depends on the tone and the way that the person suggests also and proposes the *jeitinho*, yes, it could be seen or received in a negative way. So you have to be careful also when you establish the *jeitinho*, you have you understand the total and look not only to the situation.

Q: Last question – Who or what is responsible for *jeitinho*: The Government, companies, the Brazilian people? Where would you say this *jeitinho* culture comes from?

A: I think people. Again, I think that when... yes, I will talk about corruption, specifically, and about politics, and about the Government that we have today in our country. I think that people only accept the corruption level that we see in politics, talking about a general sense, people only accept that there is someone up there with power that is stealing, that is taking advantage, because they also know that when they can take advantage of something, if they were in those people’s position, they could also do this. So, this acceptance culture comes from the different levels of corruption that are established. The person, ‘I accept that ok, a congressman that is there overbilled it and sold, and benefit their selves, because if I could also take advantage, sometimes in something much smaller, I don’t know, take advantage of something very small, that will maybe not be thousands, millions of Reais that the person is overbilling there’, this person will also take advantage. So I think that *jeitinho*, it is very impregnated in the culture, I don’t think that it comes from companies, I don’t think it is from... it is from society’s culture itself, that is why when you also take Brazilian companies versus North-American companies or Japanese, the rules that govern a lot of these multinational companies are rules very focused in the country, too. And if it is a more permissive country as Brazil is, the rules will be more flexible. If you take a Japanese company, Canadian, Swedish, here in Brazil, it will have more pre-established and stricter rules than a Brazilian company.

A.3. Interview #2, Brazilian Portuguese

Project: Brazilian “Jeitinho” in Buyer-Supplier Relationships
Projeto: “Jeitinho” brasileiro nas relações Comprador-Fornecedor

Interview Transcrip – Transcrição de Entrevista
Interview #2 – Entrevista #2

Q: Você acha que os brasileiros possuem uma forma especial ou única de lidar com questões de negócios?

A: Única eu não sei garantir porque eu não conheço talvez culturas suficientes, mas é bem peculiar.

Q: Como assim?

A: Se tratando de... bom, pela experiência profissional que eu tive, passando por diversas indústrias, empresas de capital local, mas em contato com o estrangeiro, a gente no comportamento do brasileiro, existem alguns comportamentos, existe a recorrência de um comportamento que é peculiar, que é diferente do que existe lá fora, em alguns momentos.

Q: Esta forma que o brasileiro tem, possui, peculiar, você daria algum nome particular a ela?

A: Generalizando, é o famoso “jeitinho”. O “jeitinho” é o famoso ‘vai, que vai dar certo’.

Q: O que você entende por “jeitinho brasileiro”?

A: Sem cair na questão do mérito, ou do caráter, é saber que, é estar acostumado com uma série de burocracias em que ele busca formas alternativas ou não tão tradicionais para chegar ao ponto onde você exige. O que às vezes para outras culturas é impensável.

Q: Você pode dar exemplos do “jeitinho” nos negócios?

A: Eu não sei especificar um caso pontual, mas é sabido, por exemplo, acho que principalmente em negociação, o brasileiro gosta sempre de negociar tudo. Existe, acho que, muito comportamento, existem culturas que você sabe como aquela cultura negocia. Existe a cultura americana, que negocia de uma forma, outra de outra. O brasileiro, ele vai querer negociar, você não sabe exatamente o quê, mas ele vai querer dar um jeito de chegar onde precisa. E muitas vezes por não estar tão preparado quanto o outro, mas vai tentar dar um jeito.

Q: Você diria que o “jeitinho” ajuda nos negócios? Se sim, como?

A: Poxa, se aceitar, se for algo que é, que tem a aceitação do seu líder, eu acho que é importante. Mas muitas vezes existe um certo preconceito que vai um pouco além das regras, do que a regra do jogo permite. Aí sim, uma vez ou outra por má fé, ou desconhecimento das regras que também não é o bom, mas em geral acho que é bem visto, porque é uma forma de tentar mudar um pouco o cenário, a previsibilidade é ruim para as coisas.

Q: E você acha que o “jeitinho” causa problemas nos negócios?

A: Às vezes, sim. Olha, o “jeitinho”, ele pode, é o que eu falei, nada muito ao extremo é muito bom, nada muito radical, pelo menos na minha opinião. Então, se você é muito previsível, é algo ruim, agora se você é muito imprevisível, também é complicado. E o “jeitinho” muitas vezes é a arte do improviso, acho que isso para um trabalho em grupo ao longo prazo é complicado. Você pode prejudicar quem está e quem desenvolve um trabalho contigo.

Q: Você diria que o “jeitinho” é indispensável para os negócios, aqui no Brasil?

A: Infelizmente, sim. Porque eu acho que o efeito, não digo que o efeito, já é previsto, já é imaginado que isso vá acontecer, então é necessário você vestir a... você se preparar para isso, e ao se preparar para isso, você inevitavelmente acaba fazendo também. Acho que a tendência de você antecipar o movimento faz com que você faça de fato.

Q: Você preferiria trabalhar em um ambiente completamente livre de “jeitinho”?

A: Sim, porque aí sim o meu “jeitinho” faria diferença.

Q: Em que tipo de situação de negócios o “jeitinho” é esperado?

A: Certamente em ambientes onde existe muita negociação. Acho que qualquer ambiente que tem muita entrega de coisas talvez não muito bem determinadas, vai ser suscetível a alguém tentar botar o “jeitinho”. Quando a regra é muito, muito bem clara, o “jeitinho” acaba... a existência do “jeitinho” é prejudicial a quem tenta. Se está muito claro, tem que ser muito cara-de-pau para fazer.

Q: Em que tipo de situações de negócios o “jeitinho” é aceitável?

A: Exatamente o que eu falei, acho que qualquer ambiente onde não está muito bem definido todas as premissas que condicionem a entrega esperada, ou negociada, o “jeitinho” é mais aceitado, mais aceito. E como aqui no Brasil você não... as coisas não são tão detalhadas, tão precisas quanto fora, é mais esperado realmente algo assim.

Q: E em que situações de negócios o “jeitinho” é inaceitável?

A: De novo, quando está muito clara a entrega, principalmente quando existe um padrão, existe um momento para inventar, existe um momento para tentar fazer diferente. Eu acho que é aí que realmente, principalmente lidando com público externo, estrangeiro, que é realmente... faz com que o “jeitinho” seja mal visto. Seja em querer chegar atrasado e inventar uma desculpa, seja em entregar de forma incompleta e querer mostrar outra coisa, ou realmente não estar tão preparado e querer dar um jeito de entregar outra coisa só para passar. Isso é o que talvez queime um pouco a imagem do brasileiro no exterior, sabe?

Q: Você acha que existem situações em que uma pessoa deve se sentir orgulhosa de usar de “jeitinho”?

A: Sem dúvida. Sem dúvida, porque eu acho que toda vez que você faz uso do “jeitinho”, você está se expondo a algum risco, seja negociação normal ou uma negociação absurda. Mas sendo bem sucedido, acho que tem que ter orgulho, sim. O problema é que muitas vezes pode se denegrir e denegrir a sua instituição, ou o seu trabalho.

Q: Existem situações em que a pessoa deveria se sentir envergonhada de usar o “jeitinho”?

A: Ah, sim, acho que é o famoso, a expressão que existe, que é ‘para você quebrar as regras, você precisa dominá-las’. Acho que você não dominando a regra do jogo, fica um pouco complicado. Para ousar, você tem que saber muito bem. Ousar sem entender muito bem a regra do jogo é um tiro no pé, ou é um golpe de sorte.

Q: E você imagina alguma situação em que a pessoa se sentiria envergonhada? Por qual motivo mais específico?

A: Realmente por não dar o braço a torcer, por não reconhecer um problema, um erro ou uma solução tradicional, é se expor de forma desnecessária e achar que vão aceitar. É o excesso de ‘cara-de-pau’, que é até um termo que é difícil de explicar para um estrangeiro, porque o que é ser ‘cara-de-pau’?

Q: Você diria que o “jeitinho” melhora a relação entre empresas, entre compradores e fornecedores, principalmente?

A: Sendo bem feito, principalmente se se mostrar vantajoso para essas duas partes, com certeza. E aí sim é que cai naquele ponto da pessoa saber realmente a regra do jogo. A pessoa que entende muito bem consegue tirar vantagem, mas eu não acredito que seja a maioria.

Q: Você diria que a capacidade de usar “jeitinho” é um critério informal para a escolha de fornecedores?

A: Eu acho, eu acho. Por exemplo, o mínimo de flexibilidade que permita fazer negócios principalmente no Brasil.

Q: Você percebe que os fornecedores usam de “jeitinho” para adaptar os seus produtos ou os seus serviços às necessidades dos compradores?

A: Demais, demais. Seja desde um código, que de fato não faz diferença nenhuma, mas a operação, a adaptação dele, que seria impensável, que seria um absurdo para um estrangeiro ou realmente querer transformar um produto, enfim, o que você tiver, o que às vezes acaba passando. Pode ser comprometedor, pode, mas é importante.

Q: Os fornecedores usam de “jeitinho” para adaptar condições de pagamento às necessidades dos compradores?

A: Em situações como a atual, em que se vê crise, acho que sim, muito mais. Mas é um, se for algo estratégico, não sendo algo inerente somente à pessoa que está negociando, ou seja, se for uma estratégia corporativa, acho muito importante. Porque é uma forma de retenção até que nível de serviço, de prestação de serviço, que vai além das condições normais que às vezes pode ser vantajoso, numa renovação, enfim, na manutenção desse cliente ou desse fornecedor na sua base.

Q: Você acredita que os fornecedores usam de “jeitinho” para adaptar condições de entrega às necessidades do comprador?

A: Acho que cada vez menos, mas principalmente porque o Brasil está mais exposto a mercados externos, e quanto mais exposto, mais regras de jogo você acaba tendo que condicionar. O que eu vejo com bons olhos, mas quando não existe isso, com certeza, a tentativa de flexibilizar é sempre.

Q: Você acha que o “jeitinho” existe em outros países? E se existe, quais seriam as diferenças?

A: Com certeza ele existe, ainda mais estando numa empresa globalizada, e vendo a preocupação principalmente de áreas de auditoria interna, de *stocks*, que ele existe e muitas vezes ele é cultural, muitas vezes aceito e muitas vezes ele até surpreende até o brasileiro. Então, o que às vezes é absurdo aqui pode ser muito bem aceito em outro lugar, e vice-versa. Sem explicar nenhum caso específico, mas principalmente culturas asiáticas são muito diferentes, o leste europeu também tem suas peculiaridades. Mas acho que tudo é resultado de pouca interação com demais mediados, acho que quanto mais globalizado, mais tende a ficar um padrão. E aí sim, acho que quem tem, quem domina a arte do “jeitinho” é que acaba mostrando o seu talento. Porque você tem que dominar a regra do jogo.

Q: Você enxerga alguma diferença mais específica do que é o “jeitinho” no Brasil e lá fora, algo que salte mais aos olhos?

A: Acho que não, acho que não, tem de tudo um pouco sim, eu poderia até citar um caso ou outro, mas pode ser chocante para mim mas pode não ser para o outro. Eu acho que o que influencia muito mesmo é envolver um ente federal, um ente governamental na história, porque

existem governos em que oficialmente o cenário é mais suscetível a permitir o “jeitinho”. Oficialmente não é aqui, mas em muitos lugares é oficial.

Q: Como os estrangeiros lidam com o “jeitinho” brasileiro, como eles reagem ao “jeitinho” brasileiro?

A: Puxa, de diversas formas. Eu acho que o estrangeiro que é surpreendido é aquele que é despreparado para conhecer o mercado brasileiro, sendo bem honesto. Talvez há 10 anos fosse compreensível saber que o estrangeiro tomou um susto vendo que o pessoal está dando “jeitinho” toda hora. Mas hoje, já com o Brasil... acho que na verdade desde o fim dos anos 90 já, o Brasil mais exposto a mercados externos, um estrangeiro ser surpreendido eu fico até com uma imagem ruim do estrangeiro.

Q: Você diria que o “jeitinho” pode ser entendido como uma solução positiva para problemas de negócios?

A: Com certeza, com certeza. Que nem eu falei, sabendo as regras do jogo e conseguindo enxergar oportunidades nelas, é um talento.

Q: Você diria que o “jeitinho” acrescenta flexibilidade para solução de problemas de negócios?

A: Sim, sim, com certeza. E aí é uma característica que talvez um brasileiro, um russo, um chinês, talvez tenha mais facilidade que em outras culturas.

Q: Você diria que o “jeitinho” reduz o tempo e/ou o custo de soluções de problemas de negócios? Como?

A: Sendo bem sucedido, sim. Talvez por se dar conta que é possível queimar algumas etapas de processo, ou negociando algo que às vezes é demandado, mas tendo conhecimento do todo, você pode queimar umas etapas ou saber se qualificar de uma forma que talvez oficialmente não seja, e tirar vantagem disso. E existe um lado cultural aqui, que é a tentativa de burocratizar cada vez mais, então você sabendo mais as peculiaridades, sempre há um jeitinho. Acho que o Brasil fiscalmente é muito complicado, então você tem que saber “jeitinhos” toda hora, acho que é importante.

Q: O “jeitinho” melhora a relação entre as empresas e os governos?

A: Não sei dizer, não tenho pontos sobre isso.

Q: O “jeitinho” torna mais fácil para as empresas lidarem com a burocracia?

A: Sem dúvida, sem dúvida. Obviamente correndo seus riscos. Eu digo, pode ser bom, mas você acaba se sujeitando a correr alguns riscos dependendo do que você considera como “jeitinho”. Aí é saber medir o risco do “jeitinho” que você está tomando.

Q: Quem é mais afetado pelo “jeitinho”: as empresas, o governo, ou indivíduos? Por quê?

A: Empresas, empresas. Não, perdão, vou mudar a resposta, acho que talvez o Governo. Talvez o Governo. Porque indiretamente vai sempre cascatear o Governo. O efeito do “jeitinho” ele pode afetar o indivíduo. Ele normalmente afeta alguma instituição. Mas ele certamente vai afetar o Governo. Ainda que em uma escala pequena, mas vai afetar.

Q: Existem riscos de algum tipo na utilização do “jeitinho”? Se sim, quais são esses riscos?

A: Prisão. O “jeitinho”, a imprudência no “jeitinho” expõe as instituições de uma forma desnecessária, porque às vezes a imprudência de uma pessoa, ela pode implicar na destruição do todo. Veja o caso da Sadia, por exemplo, a irresponsabilidade de uma área financeira, que

teoricamente deveria cuidar de risco, praticamente quebrou a empresa, e teve que fazer ela ser vendida para a Perdigão. A imprudência de poucos indivíduos praticamente destruiu a empresa.

Q: A proposição do “jeitinho” pode ser de alguma forma ofensiva?

A: Com certeza, com certeza, sem a menor dúvida. Porque nem sempre é sabido se a outra parte ela se sujeita a isso.

Q: Última pergunta – Quem ou o quê é responsável pelo “jeitinho” brasileiro: o Governo, as empresas, os brasileiros, a história? De onde você diria que vem esse “jeitinho”?

A: Eu acho que vem um pouco das influências colonizadoras. Acho não, tenho certeza que a combinação de culturas aqui implicou em uma sociedade mais suscetível ao “jeitinho”. Acho que até pelo fato de o país ser grande, você vê algumas culturas, algumas localidades em que existe mais “jeitinho” que outras, formalmente dizendo. Informalmente é difícil dizer. Mas acho que as influências culturais, sem dúvida. Mas a forma de se reduzir isso, sem dúvida, ela deve vir de quem é mais afetado, no caso o Governo. Então ele sendo mais claro, mais duro com relação ao “jeitinho” prejudicial, digamos assim, ele tem que saber coibir. E aí a não sujeição à tentativa de coibir é o que fazem às vezes um governo perder credibilidade.

Q: Tem alguma coisa que você queira acrescentar, alguma reflexão?

A: Eu acho que a falta de perícia normalmente de quem executa acab a sujando a imagem para o exterior.

A.4. Interview #2, English Translation

Q: Do you think Brazilians have any special or unique way to deal with business issues?

A: That it is unique I cannot guarantee because I don't know perhaps enough cultures, but it is very peculiar.

Q: How so?

A: Concerning... well, as per the professional experience that I have had, going through diverse industries, local capital companies, but in contact with the foreign world, we in the Brazilian behavior, there are some behaviors, there is the recurrence of a behavior that is peculiar, that is different from what exists out there, in some moments.

Q: This way that Brazilians have, peculiar, would you give it a particular name?

A: Generalizing, it is the famous *jeitinho*. The *jeitinho* is the famous 'go, that it will work out'.

Q: What do you understand by Brazilian *jeitinho*?

A: Without falling into the issue of merit, of character, it is knowing that, it is being used to a series of bureaucracies in which they search for alternative or non-traditional ways to reach the point that you demand. Which sometimes for other cultures is unthinkable.

Q: Can you give examples of *jeitinho* in business?

A: I cannot specify a punctual case, but it is known, for example, I think that mainly in negotiation, that Brazilians always like to negotiate everything. There is, I think, a lot of behaviors, there are culture in which you know how that culture negotiates. There is the American culture, that negotiates in one way, others in other way. Brazilians, they will want to negotiate everything, you don't know exactly what, but they will want to find a way to get where they need to. And many times because they are not as prepared as the other ones, but they will try to find a way.

Q: Would you say that *jeitinho* helps business? If it does, how?

A: Well, if they accept, if it something that is, that has the acceptance of your leader, I think it is important. But in many times there is a certain prejudice that goes a little beyond the rules, of what the rules of the game allow. Then yes, one time or the other due to bad faith, or unknowing the rules which is also not good, but in general I think it is well seen, because it is a way to try to change the scenario a little bit, predictability is bad.

Q: And do you think that *jeitinho* causes any problem for business?

A: Sometimes, yes. Look, the *jeitinho*, it can, it's what I said, nothing too much to the extreme is very good, nothing too radical, at least in my opinion. So, if you are very predictable, it is something bad, now if you are very unpredictable, it is also complicated. And *jeitinho* in many times is the art of improvisation, I think that this for group work in the long-term is complicated. You can harm who is and who develops the work with you.

Q: Would you say that *jeitinho* is indispensable for business, here in Brazil?

A: Unfortunately, yes. Because I think that the effect, I am not saying the effect, since it is foreseen, it is already imagined that this is going to happen, so it is necessary for you to put the... you to prepare to that, and when preparing to that, you unavoidably end up doing it too. I think that the trend of you anticipating the movement makes you do it in fact.

Q: Would you prefer to work in an environment completely free of *jeitinho*?

A: Yes, because then my *jeitinho* would make a difference.

Q: In what kind of business situations is *jeitinho* expected?

A: Certainly in environments in which there is a lot of negotiation. I think that in any environment that has a lot of delivery of things that are perhaps not very well determined, it is going to be susceptible to someone trying to put *jeitinho*. When the rule is very, very clear, *jeitinho* ends up... *jeitinho*'s existence is prejudicial to the one who tries. If it is very clear, you would have to have a much poker face to do it.

Q: In what kind of business situations is *jeitinho* acceptable?

A: Exactly what I said, I think that in any environment where all the assumptions that condition the expected delivery are not very well defined, or negotiated, *jeitinho* is more acceptable. And as here in Brazil you don't... things are not so well detailed, well precise as in outside, something like this is really expected.

Q: And in what kind of business situations is *jeitinho* unacceptable?

A: Again, when the delivery is very clear, specially when there is a standard, there is a moment to invent, there is a moment to try to make it different. I think that than it is really, mainly dealing with the external public, foreign, that is really... it makes so that *jeitinho* is badly seen. Be it wanting to arrive late and make up an excuse, be it in delivering something in an incomplete manner and wanting to show another thing, or really not being as well prepared and wanting to find a way to deliver another thing just to pass. This is what perhaps burns a little the image of Brazilians outside [Brazil], you know?

Q: Do you think there are situations on which a person should feel proud of using *jeitinho*?

A: Without a doubt. Without a doubt, because I think that every time you use *jeitinho*, you are exposing yourself to some risk, be it in a normal negotiation or an absurd negotiation. But being successful, I think that it is something to be proud of, yes. The problem is that in many times it can denigrate you and denigrate your institution, or your work.

Q: Are there situations on which a person should feel ashamed of using *jeitinho*?

A: Oh, yes, I think it is the famous, there is the expression, that is 'to break the rules, you need to dominate them'. I think that if you don't dominate the rules of the game, it is a little bit complicated. To dare, you need to know very well. To dare without understanding the rule of the game very well is a shot on the foot, or it is a lucky strike.

Q: And can you imagine a situation in which the person would feel ashamed? For which more specific reason?

A: Really for not giving up, for not recognizing a problem, a mistake or a traditional solution, it is exposing yourself in an unnecessary way and thinking they will accept. It is the excess of 'poker face', which is even an expression that is difficult to explain to a foreigner, because what is to be a 'poker face'?

Q: Would you say that *jeitinho* improves the relationship between companies, between buyers and suppliers, mainly?

A: Being it well done, specially if it is advantageous for these two parties, for sure. And then it falls into that point of the person really knowing the rule of the game. The person that know it very well is able to take advantage, but I don't believe this is the majority of people.

Q: Would you say that the capacity of using *jeitinho* is an informal criterion for the choice of suppliers?

A: I would, I would. For example, the minimum flexibility that allows you to do business specially in Brazil.

Q: Do you perceive that suppliers use *jeitinho* to adapt their products or their services to buyers' needs?

A: A lot, a lot. Be it a code, what in fact doesn't make any difference, but the operation, its adaptation, would be something unthinkable, would be an absurd for a foreigner or really wanting to transform a product, well, whatever you have, what sometimes end up passing. Could be compromising, could be, but it is important.

Q: Do suppliers use *jeitinho* to adapt payment conditions to buyers' needs?

A: In situations such as the current one, that we see crisis, I think so, much more. But it is, if it is something strategic, not being something inherent only to the person negotiation, that is, if it is a corporate strategy, I think it is very important. Because it is a form of retaining even the level of service, of service providence, that goes beyond the normal conditions that sometimes can be very advantageous, in a renewal, finally, the maintenance of this client or this supplier in your base.

Q: Do you believe that suppliers use *jeitinho* do adapt delivery conditions to buyers' needs?

A: I think that less and less, but mainly because Brazil is more exposed to external markets, and the more exposed, more rules of the game you end up having to condition. Which I see with good eyes, but when it doesn't exist, definitely, trying flexibilization always happens.

Q: Do you think *jeitinho* exists in other countries? If so, what would be the differences?

A: Certainly it exists, even more being in a globalized company, and seeing the preoccupation from areas of internal auditing, of stocks, that it exists and a many times it is cultural, many times accepted and many times it surprises even Brazilians. So, what sometimes is absurd here can be very well accepted somewhere else, and vice-versa. Without explaining any specific case, but specially Asian cultures are very different, Eastern Europe also has its peculiarities. But I think that everything is a result of the other mediated, I think that the more globalized, more you tend to be a pattern. And then yes, I think that who has, who dominates the art of *jeitinho* is the one who shows their talent. Because you have to dominate the rule of the game.

Q: Do you see a more specific difference of what is the *jeitinho* in Brazil and out there, something that jumps more to the eye?

A: I don't think so, I don't think so, there is some of everything yes, I could even cite one case or another, but it could be shocking to me but not be shocking to another one. I think that what influences a lot is involving a federal entity, a governmental entity in the story, because there are governments in which officially the scenario is more susceptible of allowing *jeitinho*. It is not officially here, but in some places it is official.

Q: How do foreigners deal with the Brazilian *jeitinho*, how do they react to the Brazilian *jeitinho*?

A: Wow, with diverse ways. I think that the foreigner that is surprised is the one that is unprepared to know the Brazilian market, to be quite honest. Maybe 10 years ago it was understandable to know that the foreigner was scared seeing that people are giving *jeitinho* all the time. But today, with Brazil... I think that in truth from the end of the 90s already, Brazil being more exposed to external markets, a foreigner being surprised I even keep a bad image of this foreigner.

Q: Would you say that *jeitinho* can be understood as a positive solution for business problems?

A: For sure, for sure. As I said, knowing the rules of the game and being able to see opportunities in them, it is a talent.

Q: Would you say that *jeitinho* adds flexibility to the solution for business problems?

A: Yes, yes, surely. And then it is a characteristic that perhaps a Brazilian, a Russian, a Chinese, would have more facility with than in other cultures.

Q: Would you say that *jeitinho* reduces time / cost of solutions of business problems? How so?

A: Being successful, yes. Maybe for realizing that it is possible to burn some stages of the process, or negotiating something that sometimes is demanded, but having a knowledge of the all, you can burn some stages or know to qualify in a way that perhaps would not be the case officially, and take advantage of that. And there is a cultural side here, which is the attempt to bureaucratize more and more, so if you know more of the peculiarities, there is always a *jeitinho*. I think that Brazil fiscally is very complicated, so you have to know *jeitinhos* all the time, I think it is important.

Q: Does *jeitinho* improve the relationship between companies and governments?

A: I wouldn't know, I don't have points on that.

Q: Does *jeitinho* makes it easier for companies to deal with bureaucracy?

A: Undoubtedly, undoubtedly. Obviously running the risks. I mean, it could be good, but you end up putting yourself running some risks depending on what you consider as *jeitinho*. Than it is knowing to measure the risk of *jeitinho* that you are taking on.

Q: Who is most affected by *jeitinho*: Companies, the Government, or individuals? Why?

A: Companies, companies. No, sorry, I will change the answer, I think maybe the Government. Maybe the Government. Because indirectly it will always cascade into the Government. The effect of *jeitinho* can affect the individual. It will usually affect some institution. But it will certainly affect the Government. Even if in a small scale, but it will affect it.

Q: Are there risks of any sort in using *jeitinho*? If so, what risks would that be?

A: Prison. *Jeitinho*, imprudence in *jeitinho* exposes institutions in an unnecessary manner, because sometimes one person's imprudence, it can implicate in the destruction of the whole. See the case of Sadia, for example, the irresponsibility of a financial area, that theoretically is supposed to take attend to risk, practically broke the company, making it be sold to Perdigão. The imprudence of some individuals practically destroyed the company.

Q: May the proposition of *jeitinho* be somehow offensive?

A: Surely, surely, without a doubt. Because not always it is known if the other part will subject itself to it.

Q: Last question – Who or what is responsible for *jeitinho*: The Government, companies, the Brazilian people? Where would you say *jeitinho* comes from?

A: I think that it comes a bit from the colonizer influences. I don't think, I am sure that the combination of the cultures here implicated in a society more susceptible to *jeitinho*. I think that even due to the fact the the country is large, you see in some cultures, some localities where there is more *jeitinho* than in others, formally speaking. Informally it is difficult to say. But I think that cultural influences, without doubt. But the way to reduce this, without doubt, it has to come from the one that is most affect by it, in this case the Government. So it being clearer,

tougher in relation to the harmful *jeitinho*, let's say it like that, it has to know how to restrain. And then the non-subjection to the attempt of restraining is what sometimes make a government to lose credibility.

Q: Do you have something that you might want to add, any reflection?

A: I think that the lack of expertise usually from who executes ends up dirtying the image to the external world.

A.5. Interview #3, Brazilian Portuguese

Project: Brazilian “Jeitinho” in Buyer-Supplier Relationships
Projeto: “Jeitinho” brasileiro nas relações Comprador-Fornecedor

Interview Transcript – Transcrição de Entrevista
Interview #3 – Entrevista #3

Q: Você acha que os brasileiros possuem uma forma especial ou única de lidar com questões de negócios?

A: Isso no geral? Eu acredito que sim, no sentido de... é bem ampla, bem aberta? Eu acredito que sim, porque tem essa coisa da proximidade pessoal que acompanha os negócios, que não tem em outras culturas.

Q: Esta forma brasileira, ela teria algum nome específico?

A: É uma coisa meio vaga, mas é uma coisa de “jeitinho” brasileiro mesmo. De homem cordial, sei lá como descrever isso.

Q: O que você entende por “jeitinho brasileiro”?

A: Bom, não ter uma resposta definitiva para nada nunca, porque sempre pode ter uma exceção, vai depender do teu relacionamento com a pessoa que trabalha, ou com o seu parceiro de negócio. Sempre vai ter algum jeito de burlar alguma coisa. E isso bem baseado no relacionamento, no quão séria a empresa é, no quanto ela vai aderir às regras, e no quão controlada ela é também, no sentido de... no tamanho, o tamanho às vezes ele permite a empresa fazer algumas coisas diferentes, que ela não está tão controlada por auditoria, seja por questões de padronização de ISO, por exemplo. Neste sentido. Eu até mencionei essa questão do homem cordial, porque também acho que é um... eu definiria essa parte do homem cordial como, para fazer negócios tem que ter alguma ligação pessoal, do tipo, é muito forte a coisa da pessoa apresentar uma outra, indicação para contratação também é muito forte, acho que bem mais forte que outras culturas e também acho que sem conexão pessoal, é muito difícil fazer negócio no Brasil e é percebido como uma coisa estranha. Alguma coisa de dificuldade de falar “não” também, que o brasileiro tem.

Q: Você pode fornecer algum exemplo de “jeitinho” nos negócios?

A: “Jeitinho” nos negócios? Alguma coisa que eu vivi ou um exemplo geral que eu já vi de “jeitinho”?

Q: Tanto faz, o que você achar mais representativo.

A: Bom, “jeitinho” nos negócios, acho que é qualquer coisa que esteja ligada à suborno é “jeitinho”. Então, é subornar um fiscal para fazer vista grossa, p’ra voltar outro dia, p’ra... enfim, por exemplo, uma coisa que eu já vivi. Chega a ser “jeitinho”? Um “jeitinho” mais leve, mas por exemplo numa reunião com o Ministério Público, você, o promotor já geralmente é a ação dele, que é assinar um TAC, um termo de ajuste de conduta, mas ao invés de fazer isso, na conversa, você leva ele, e ele faz um acordo informal. ‘Não, tudo bem, você até tal data então me entrega esse resultado’, do tipo que seja uma quantidade de horas extras a ser atingidas, ou senão uma quantidade de aprendizas a serem contratados, sem assinatura e sem assinar um acordo formal.

Q: Você diria que o “jeitinho” ajuda nos negócios?

A: Ele ajuda... ele tem os dois lados, ajuda e atrapalha. Porque ao mesmo tempo em que ele pode te dar alguma vantagem competitiva e acelerar processos, queimar etapas, enfim, para

atender as demandas, ou os objetivos mais rápidos, ele pode dar ao competidor uma competitividade artificial, porque ela é decorrente de um relacionamento, ela é decorrente de uma pessoa ser parente da outra e trabalhar em outra empresa, de fatores que estão fora do controle.

Q: A próxima questão seria exatamente sobre se o “jeitinho” causa problemas nos negócios, você já abordou. Você acha que tem mais alguma forma em que ele possa vir a causar algum tipo de problema?

A: Acho que sim, porque para... imagina assim, com uma, imagina uma situação em que tenha uma pessoa, digamos um fiscal da Receita Federal, ele tem um número limitado de horas de trabalho, se ele ficar só atendendo os “jeitinhos”, sabe, ficar fazendo favor, pagando favor de volta, atendendo parente dele, atendendo um amigo que trabalha em tal empresa, que trabalha de longa data, ou alguém com quem ele tem um relacionamento longo, ele não vai atender alguém que não tenha esse mesmo nível de relacionamento e vantagens. Então acho que também quando a empresa chega no Brasil e vai fazer uma previsão, um *timeline* mais ou menos de entrega, de resultados, ou de desembaraçamento aduaneiro, ela não é confiável. Porque o tempo dele regular pode estar sendo comprometido só com os “jeitinhos”, e aí ele não faz o trabalho dele, que seria atender com impessoalidade, digamos. No Brasil, essa figura de impessoalidade, ela é muito frágil.

Q: Você diria que o “jeitinho” é indispensável para os negócios?

A: Não. Eu discordo que seja indispensável.

Q: Por quê?

A: Porque em outras culturas onde isso é menos relevante as coisas funcionam.

Q: Ele seria indispensável para fazer negócios no Brasil?

A: Sim, aí sim, indispensável para fazer negócios no Brasil.

Q: Você preferiria trabalhar em um ambiente completamente livre de “jeitinho”?

A: Aí é difícil responder, porque ao mesmo tempo isso me favorece. Tem pontos positivos e negativos. Eu acho que quando eu olho para a minha carreira no Brasil, até hoje, isso me privilegiou. Seja pelo *networking* que eu possuo, seja pelas experiências que eu tive, ou enfim apresentações que eu tive, sabe, em questão de *networking* mesmo, falando. Mas eu acredito que seja um ambiente mais justo sem essa questão. Então eu acho que é mais justo sim, eu preferiria trabalhar em um ambiente sem “jeitinho”.

Q: Em que tipo de situações de negócios o “jeitinho” é esperado?

A: Ele é esperado?

Q: É, em que tipo de situação você fala assim, ‘nessa situação provavelmente vai acontecer o “jeitinho”’ ou se espera já antes da situação acontecer de fato, já se tem aquela sensação de que essa questão vai aparecer.

A: Em questão de mesma nacionalidade de empresa, do tipo eu, trabalhando em uma empresa multinacional, eu vou lidar com um fornecedor que é da mesma nacionalidade dessa empresa. Acho que alguma vantagem, alguma proximidade natural vai existir, enfim, alguma preferência também, decorrente da nacionalidade em comum das empresas. E também fazendo parte do *networking*. Se a pessoa, o contato principal do fornecedor, ou do cliente, seja alguém que seja parente da pessoa, tenha trabalhado junto com a pessoa, acho que também isso apareceria com naturalidade.

Q: Em que tipo de situação de negócios o “jeitinho” é aceitável, não se vê problema no “jeitinho”, e por quê? Se é que há.

A: Isso do ponto de vista pessoal, eu falando do “jeitinho”. Bom, eu acredito que desde que não tenha, pensando na realidade do Brasil e como que o negócio é gerido aí, desde que não haja, a pessoa não descumpra com as regras de *compliance* da empresa a qual ela representa, não vejo problema em talvez ter um relacionamento próximo, fazer encontros periódicos para estreitar relacionamento, sem valores, sem suborno envolvido. Acho que agora é uma tendência das empresas de terem códigos internos de conduta para justamente disciplinar isso.

Q: E em que situações ele seria completamente inaceitável?

A: Eu acredito que qualquer situação que envolva dinheiro e vantagem econômica artificial.

Q: Existe algum tipo de situação em que uma pessoa deve se sentir orgulhosa por usar o “jeitinho”?

A: Orgulhosa por usar o “jeitinho”? Acho que quando a gente, quando eu escuto pelo menos essa palavra, ‘orgulho’, eu penso numa coisa mais individual, uma coisa mais introspectiva da pessoa, ela com ela mesmo pensando. Então eu acredito que essa coisa de orgulho, é que assim, não sei como eu respondo essa pergunta. Eu pensando numa pessoa orgulhosa, certo, então é meu juízo de valor, pensando nessa pessoa nessa situação.

Q: Seria uma situação onde você acha que o “jeitinho” seria motivo de orgulho para uma pessoa, a pessoa realizou alguma coisa com “jeitinho” e ela se sentiu orgulhosa de si mesma por ter conseguido, ou por ter feito, você acha que isso é possível? Ou não, o “jeitinho” é simplesmente alguma coisa do dia-a-dia, em que a pessoa não se orgulha, não foi um feito ter feito aquilo, foi só mais alguma coisa.

A: Acredito que sim, quando ela consegue superar o esperado. Então por exemplo, poxa, sujeito tinha que desembarçar uma carga urgente, porque ia chegar na fábrica material para a produção de um modelo que seja chave naquele momento. Por ele conhecer o fiscal há muito tempo, ele consegue desembarçar essa carga antes. Então, nesse sentido, ela fica orgulhosa disso e às vezes ela vende isso também.

Q: Como assim?

A: Ela tem vantagens artificiais que outros competidores não teriam, decorrente do relacionamento, decorrente da proximidade dela, por exemplo, ela consegue desembarçar uma carga e tirar do canal vermelho, que chamam o tipo da carga apreendida, mais rápido que os competidores, então ela vai ganhar contratos, ela vai ganhar vantagens, mais clientes por causa disso.

Q: E existem situações, você acha que existem situações em que a pessoa deve se sentir envergonhada de usar o “jeitinho”?

A: Mais frequentemente do que orgulhosa, eu acho.

Q: Como assim?

A: Acho que em mais situações essa coisa do “jeitinho” deveria ser motivo de vergonha. Mas, por exemplo, um exemplo em que uma pessoa deveria se sentir envergonhada acho que é um exemplo que acaba culminando em vantagem econômica, uma coisa de suborno, que eu acho inadmissível.

Q: Você diria que o “jeitinho” melhora a relação entre as empresas, entre compradores e fornecedores?

A: Não, acho que não.

Q: Por que não?

A: Porque o “jeitinho” para mim cria imperfeições no mercado, ele cria vantagens artificiais, cria desvantagens artificiais e junto com o estilo brasileiro de fazer negócios, essa proximidade pessoal, isso gera ruído, ruído na comunicação, ruído nos negócios, gera, por exemplo, o

impacto de ter uma mudança de funcionário no Brasil é diferente decorrente do “jeitinho”. Porque com aquele funcionário, foi todo o *network* de relacionamentos que ele tem, que ele carrega consigo, porque são pessoais. No Brasil eles têm esse caráter pessoal.

Q: Você acha que a capacidade, quando você avalia um fornecedor, a capacidade dele usar “jeitinho” é um critério informal para a escolha desse fornecedor?

A: Em que tipo de trabalho, especificamente?

Q: No geral, se você percebe se o fornecedor é alguém que não se oporia a usar de “jeitinho”, seja ele do significado que ele tiver, se esse pode ser um critério de seleção.

A: Sim, com certeza.

Q: Como assim? Por quê?

A: Por exemplo, a figura do despachante no Brasil. Ela tangibiliza bem esse conceito do “jeitinho” aplicado a negócios, porque no fundo é uma figura da qual ninguém precisaria. Todas as pessoas iriam, cuidariam dos seus próprios documentos, da própria burocracia, iriam fazer licenciamento de carro, iriam fazer transferência de carro, que seja. Mas não, ao invés disso, o que é mais fácil? Você contrata um despachante, que é seu representante, para cuidar dessas questões. E claro, decorrente disso, você tem prazos menores, tem certeza de entrega do serviço feito, coisas que você sozinho não conseguiria.

Q: Os fornecedores usam de “jeitinho” para adaptar produtos ou serviços às necessidades dos compradores?

A: Sim.

Q: Você consegue dar um exemplo?

A: Para adaptar o serviço. Acredito que sim, tem um pouco disso sim, talvez num ponto de contato que tenha lá dentro para negociação interna dele, então eu peço uma coisa por exemplo que não estava prevista em contrato, principalmente falando de serviços. Eu peço algum favor extra, que não estava previsto em contrato. Mas ele, pelo relacionamento, pela vontade de negócios, ele vai e entrega.

Q: E você imagina que os fornecedores usam de “jeitinho” para adaptar as condições de pagamento às necessidades do comprador?

A: Sim.

Q: Você se lembra de alguma situação mais caricata nesse sentido?

A: Sim, com certeza. Em empresas maiores, geralmente o fluxo de pagamentos é organizado para pagamentos serem feitos uma ou duas vezes ao mês. No caso da [nome da empresa] por exemplo é um caso de duas vezes ao mês. E várias vezes as notas fiscais por questão de greve de Correio ou por questão de alguma desorganização, a nota chega atrasada na empresa. E pela burocracia interna, pelos sistemas internos de aprovação de pagamento e no setor financeiro, eles têm *deadlines* para receber essas notas com a aprovação feita, para efetuar o pagamento. Então, o funcionário, ao receber uma nota e saber que ele precisa daqueles dias para conseguir as aprovações e postar um pagamento no sistema financeiro, ele já liga para o fornecedor e pede para mudar vencimento de nota. É uma prática recorrente.

Q: Você acha que o “jeitinho” existe em outros países? Se sim, quais seriam as diferenças para o “jeitinho” brasileiro?

A: Eu acredito que ele exista sim, em países de cultura latina, em países pensando ali nas dimensões culturais que seja uma coisa de relações pessoais mais próximas. Então eu acho que todo país que não tenha essa coisa de objetividade ao fazer negócios, ou que envolva contato pessoal em negócio, ela tem a tendência a ter essa mesma instituição que tem no Brasil, o “jeitinho”.

Q: E você percebe alguma diferença que seria em outro país para o brasileiro, ou você acha que é mais ou menos similar?

A: No sentido de ter isso? De um país que não tenha, para eu dar um exemplo?

Q: Não, no sentido que você percebe que um outro país, por exemplo latino, ele tem o “jeitinho” também, mas você percebe que o “jeitinho” desse país ele é, por exemplo, o “jeitinho” boliviano, ele é diferente do “jeitinho” brasileiro? Você acha que o brasileiro é diferente do que existe em outro país, ou é mais ou menos a mesma coisa?

A: Acredito que tenha um *cluster* de países que tenha muito similarmente essa questão.

Q: Como os estrangeiros lidam com o “jeitinho”? Como eles reagem quando se deparam com uma situação em que o “jeitinho” está presente?

A: Acredito que isso dá, é uma fonte de medo, porque o que isso gera para os negócios, insegurança, de você não conseguir prever, de você não conseguir estimar com certeza. Então assim, adiciona incerteza ao ambiente de negócios.

Q: Você acha que o “jeitinho” pode ser entendido como uma solução positiva para os problemas de negócios?

A: Pode, pode também.

Q: Por quê?

A: Por esse aspecto positivo que o “jeitinho” traz, de ao mesmo tempo que ele é ruim, pode gerar essas vantagens artificiais para algumas empresas, enfim alguns fornecedores, que seja, ao mesmo tempo ele pode fazer com que o parceiro se esforce de um jeito extra. Seja envolvendo outras pessoas, seja pensando junto para uma outra solução que seja melhor para o cliente, então imagina uma situação. Um fornecedor que tem uma relação muito próxima com o cliente dele, o cliente ao pedir uma coisa, ele não vai ficar no ‘não’. ‘Ah, o cliente pediu isso, o que eu posso fazer para atender de uma forma melhor?’, ele vai pensar nesse sentido, e não responder ‘não’ para uma demanda que saia do padrão, diretamente. Eu acho que pode levar também a pensar em soluções personalizadas que sejam mais adequadas para atender essa demanda.

Q: Nesse mesmo sentido, você diria que o “jeitinho” acrescenta flexibilidade para solução de problemas de negócios?

A: Sim.

Q: Você tem algum comentário para dizer mais especificamente nessa questão de flexibilidade?

A: Que pelo estilo de trabalho, dependendo, comprando um serviço, por exemplo, você pode pedir um prazo que saia do padrão do fornecedor seu, mas você fala que não tem como abrir mão disso, e ele tem que entregar naquela data em que você precisa que aquilo seja entregue. Mesmo sendo regras do fornecedor, ele vai pensar e vai avaliar se ele não consegue entregar antes, dando um “jeitinho”, fazendo essa coisa.

Q: E o “jeitinho” acaba reduzindo tempo, você vê o “jeitinho” como um redutor de tempo ou o custo de soluções de problemas de negócios?

A: Sim, pode ser também.

Q: Como assim, mais específico em custo ou em tempo?

A: Em tempo pode ser esse exemplo que eu dei, então eu saber que uma empresa, pensando em uma empresa de *headhunting*, que ela entregue uma *shortlist* de candidatos em 7 dias, esse é o padrão dela. Mas aí, eu vendo aquilo, isso em papel, eu sei que aquilo pode ser flexibilizado. Eu tenho que pedir, eu tenho que falar que a minha demanda é outra. E aí ele vai dar um jeito de se virar para entregar antes para mim. Então esse seria o exemplo de tempo, e o exemplo financeiro seria o exemplo que eu dei da emissão de novas notas, em datas de vencimento

diferentes, porque não vai dar tempo de fazer a operação interna para fazer o pagamento das notas.

Q: O “jeitinho” melhora a relação entre as empresas e os governos?

A: É, eu acho que falando de “jeitinho”, todos os aspectos têm os dois lados, positivo e negativo. Então pode melhorar.

Q: Como seria essa melhora?

A: No exemplo de ter algum preposto entre governo e setor privado, e esteja ali para defender os interesses da empresa para a qual ele presta serviços. No Brasil, a gente tem essa figura do lobista, eu acho que não é um cara comum no mercado americano, essa figura de lobista, mas tem sim os executivos de relações governamentais. Olhando esse tipo de título, com certeza é alguém que está ali para defender os interesses da empresa junto ao governo.

Q: O “jeitinho” torna mais fácil para as empresas lidarem com a burocracia de forma geral?

A: Sim. Às vezes, assim, não é nem questão de fácil, é questão de dar possibilidades também, de viabilizar um projeto, ou uma coisa que sem ele não seria possível.

Q: Quem você diria que é mais afetado pelo “jeitinho”: as empresas, o governo, ou indivíduos, e por quê?

A: Os indivíduos, porque nessa equação, são os que tem menos recursos. Pensando na empresa, ela pode contratar quantos funcionários ela quiser. Uma empresa de grande porte, ela pode ter um aparato de especialistas num campo específico. Agora um camarada que não tenha condições, ele vai sofrer com o serviço sem “jeitinho”, o que a empresa faz muitas vezes eu acho que é comprar “jeitinhos”.

Q: Existem riscos de algum tipo na utilização do “jeitinho”? E quais seriam esses riscos, em caso afirmativo?

A: Eu acho que tem um risco muito grande que também está intimamente ligado com a incerteza. Do tipo, pensando numa situação concreta, uma empresa que perca um fornecedor que tenha uma *uniqueness*, uma vantagem competitiva muito grande com o governo, ela vai perder prazo, ela não vai conseguir entregar os produtos para o cliente no mesmo tempo, e vai perder o cliente decorrente disso. Seja porque existe uma cláusula de não competição nessa empresa, então esse despachante, usando o exemplo do despachante, atender algum competidor direto dela, ela não poder usar esse parceiro, seja porque... não sei, acho que o exemplo mais concreto que eu consigo pensar é esse.

Q: A proposição do “jeitinho”, se alguém propõe que alguma coisa seja resolvida por meio de “jeitinho”, pode ser de alguma forma ofensiva?

A: Ofensiva? Acredito que sim, quando ela ultrapassa a ética pessoal de cada um, a ética profissional de cada um.

Q: Última pergunta – Quem ou o quê é responsável pelo “jeitinho”: o Governo, as empresas, o povo brasileiro, enfim, a nossa história? De onde você diria que o “jeitinho” vem?

A: Vem da nossa história, é uma coisa que está acima do que está aqui hoje, é uma coisa sociológica, um fenômeno cultural, de herança.

A.6. Interview #3, English Translation

Project: Brazilian “Jeitinho” in Buyer-Supplier Relationships
Projeto: “Jeitinho” brasileiro nas relações Comprador-Fornecedor

Interview Transcript – Transcrição de Entrevista
Interview #3 – Entrevista #3

Q: Do you think Brazilians have any special or unique way to deal with business questions / issues?

A: In general? I believe so, in the sense of... it is quite ample, quite open? I believe yes, because there is this thing of personal proximity that goes with business, that does not exist in other cultures.

Q: This Brazilian way, does it have any particular name?

A: It is somewhat vague, but it is something of Brazilian *jeitinho*. Of the cordial man, I don't know how to describe it.

Q: What do you understand by Brazilian *jeitinho*?

A: Well, don't have a definitive answer to anything never, because there can always be an exception, it will depend on your relationship with the person that you work with, or on your business partner. There will always be a way to cheat something. And this is very much based on the relationship, on how serious the company is, on how much it will follow the rules, and in how controlled it is also, in the sense of... the size, the size sometimes allows the company to do different things, that it is not so much controlled by auditing, be it for issues of ISO standardization, for example. In this sense. I even mentioned the issue of the cordial man, because I also think it is... I would define this part of the cordial man as, to do business there has to be a personal connection, for instance, it is very strong the thing about a person introducing another one, indication for hiring is also very strong, I think that well stronger than in other cultures and I also think that without personal connection, it is very difficult to do business in Brazil and it is perceived as a strange thing. Something about the difficulty of saying 'no' also, that the Brazilian has.

Q: Can you give examples of *jeitinho* in business?

A: *Jeitinho* in business? Something that I lived through or a general example of what I have seen of *jeitinho*?

Q: Whichever, which one you think most representative.

A: Well, *jeitinho* in business, I think that anything that is linked to bribery is *jeitinho*. Therefore, it is bribing an inspector to turn a blind eye, to come back another day, to... at last, for example, something that I have already experienced. Is it a *jeitinho*? A lighter *jeitinho*, but for example in a meeting with the Public Ministry, you, the prosecutor, since usually it is his action, that is to sign a *TAC*, a *termo de ajuste de conduta* (conduct adjustment agreement), but instead of doing that, with conversation, you take them, and they make an informal agreement. 'No, it is fine, you have until this date and then you deliver this result', as if a quantity of extra hours to be achieved, or else a quantity of apprentices to be hired, without a signature and without signing a formal agreement.

Q: Would you say that *jeitinho* helps business?

A: It helps... it has both ways, helps and hinders. Because at the same time that it can give you some competitive advantage and accelerate processes, burn stages, so, to meet demands, or

objectives faster, it can give the competitor an artificial competitiveness, because it is due to a relationship, it is due to a person being related to another and work in another company, of factors that are out of control.

Q: The next question would be exactly about if *jeitinho* causes problems in business, as you already approached. Do you think that there is any other way in which it can come to cause any type of problem?

A: I think so, because to... imagine this, with a, imagine a situation in which a person, let's say a Federal Income inspector, they have a limited number of work hours, if they keep on just meeting the *jeitinhos*, you know, keep doing favors, paying favors back, answering their relatives, addressing a friend that works in such company, that has worked for a long time, or someone with whom they have a long relationship, they will not address someone that does not have this same level of relationship and advantages. So I also think that when the company arrives in Brazil and will perform a forecast, an approximate delivery timeline, of results, or of customs clearance, it is not reliable. Because their regular time can be compromised only with *jeitinhos*, and then they will not do their job, which would be to address with impersonality, let's say it like that. In Brazil, this impersonality figure, it is very fragile.

Q: Would you say that *jeitinho* is indispensable for business?

A: No. I disagree that it is indispensable.

Q: Why?

A: Because in other cultures where this is less relevant things work.

Q: Would it be indispensable to do business in Brazil?

A: Yes, then yes, indispensable to do business in Brazil.

Q: Would you prefer to work in an environment completely free of *jeitinho*?

A: This is hard to answer, because at the same time it favors me. There are positive and negative points. I think that when I look to my career in Brazil, until today, this has privileged me. Be it for the networking I have, be it for the experiences I have had, or finally the presentations I have had, you know, in a matter of networking even. But I believe that it would be a fairer environment without this issue. So I think it is fairer, I would prefer to work in an environment without *jeitinho*.

Q: In what kind of business situations is *jeitinho* expected?

A: Is it expected?

Q: Yes, in what kind of situation you say, 'in this situation *jeitinho* will probably happen or it is expected before the situation actually happens, there is already that feeling that this issue is going to appear.

A: In issues of companies' same nationality, like me, working in a multinational company, I am going to deal with a supplier that is from the same nationality of this company. I think that some advantage, some natural proximity is going to exist, anyway, some preference too, due to the common nationality of the companies. And also being part of the networking. If the person, the suppliers' main contact, or the client's, if someone that is this person's relative, that has worked with this person, I think that would also appear with naturality.

Q: In what kind of business situations is *jeitinho* acceptable, there is no problem in *jeitinho*, and why? If there is any.

A: This from a personal point of view, me talking about *jeitinho*. Well, I think that as long as there is not, thinking on Brazil's reality and how business is managed there, as long as there is not, the person doesn't not fulfill the compliance rules from the company that they represent, I

don't see a problem in perhaps having a close relationship, making periodical encounters to strengthen the relationship, without values, without bribery involved. I think that now it is a trend for companies to have internal conduct codes to precisely discipline this.

Q: And in which situations it would completely unacceptable?

A: I think that any situation that involves money and artificial economic advantage.

Q: Is there any kind of situation in which a person should be proud of using *jeitinho*?

A: Proud of using *jeitinho*? I think that when we, when I listen to this word, 'pride', I think in a more individual thing, a more introspective thing, the person thinking with themselves. So I believe that this pride thing, is that, I don't know how to answer to this question. I am thinking of someone being proud, right, so this is my judgment of value, thinking of this person in this situation.

Q: It would be a situation where you think that *jeitinho* would be a reason for pride for a person, the person achieved something with *jeitinho* and they felt proud of themselves for having achieved it, or having done it, do you think it is possible? Or not, *jeitinho* is simply something of the day-to-day, in which the person is not proud of, it wasn't a big deal doing that, it was just one more thing.

A: I believe so, when they can overcome the expected. So for example, the subject had to clear an urgent cargo, because it would deliver to the factory material for the production of a model that was key at that moment. Because they know the inspector for a long time, they are able to clear this cargo before. So, in this sense, they are proud of it and sometimes they sell it too.

Q: How so?

A: They have artificial advantages that other competitors wouldn't have, due to the relationship, due to the closeness, for example, they can clear a cargo and take it of the red sign, what they call the type of apprehended cargo, faster than the competitors, so they will win contracts, they will win advantages, more clients because of that.

Q: And are there situations, do you think there are situations in which the person should feel ashamed of using *jeitinho*?

A: More frequently than proud, I think.

Q: How so?

A: I think that in more situations this *jeitinho* issue should be reason of shame. But, for example, an example in which a person should feel ashamed I think would be an example that ends up culminating in economic advantage, a bribery thing, which I think is unacceptable.

Q: Would you say that *jeitinho* improves the relationship between companies, between buyers and suppliers?

A: No, I don't think so.

Q: Why not?

A: Because *jeitinho* for me creates imperfections in the market, it creates artificial advantages, creates artificial disadvantages and together with the Brazilian style of doing business, this personal proximity, this generates noise, noise in communication, noise in business, it generates, for example, the impact of having an employee change in Brazil is different due to the *jeitinho*. Because with that employee, it was all the network of relationships that they have, that they carry with them, because they are personal. In Brazil they have this personal trait.

Q: Do you think that the capacity, when you are evaluating a supplier, the capacity of them to use *jeitinho* is an informal criterion for the choice of this supplier?

A: In what type of work, specifically?

Q: In general, if you perceive that the supplier is someone that would not oppose to use *jeitinho*, be it the meaning that it has, if this could be a selection criterion.

A: Yes, for sure

Q: How so? Why?

A: For example, the figure of the forwarding agent in Brazil. It makes tangible this concept of *jeitinho* applied to business, because in the end it is a figure of which nobody would need. All people would go, take care of their own documents, of their own bureaucracy, would make their cars licensing, would make their car transfer, whatever. But no, instead of that, what is easier? You hire an agent, which is your representative, to take care of these issues. And of course, due to that, you have smaller deadlines, the certainty of the done service delivery, things that alone you would not be able to.

Q: Do suppliers use *jeitinho* to adapt their products or services to the buyers' needs?

A: Yes.

Q: Could you give an example?

A: To adapt the service. I believe so, that there is a little bit of this, perhaps in a point of the contract that is there for their internal negotiation, so I ask for something for example that was not foreseen in the contract. But the supplier, for the relationship, for the will to do business, they go on and deliver.

Q: And do you imagine that suppliers use *jeitinho* to adapt payment conditions to buyers' needs?

A: Yes.

Q: Do you recall a more caricatured situation in this sense?

A: Yes, for sure. In larger companies, usually the payment flow is organized so that payments are done once or twice a month. In the case of [company name] for example it is a case of twice a month. And many times the invoices because of a post-office strike or some disorganization issue, the invoice arrives late in the company. And because of the internal bureaucracy, of the internal systems of payment approval and in the financial sector, they have deadlines to receive these invoices with the done approval, to perform the payment. So, the employee, when receiving an invoice and knowing that they need that much days to get the approvals and post a payment in the financial system, they call the supplier and ask them to change the invoice maturity. It is a recurrent practice.

Q: Do you think *jeitinho* exists in other countries? If so, how is it different from the Brazilian *jeitinho*?

A: I do believe it exists, in countries with Latin culture, in countries thinking about the cultural dimensions that are a thing of closer personal relationships. So I think that every country that does not have this objectivity in doing business, or that involves personal contact in business, it has a tendency to have this same institution that Brazil has, the *jeitinho*.

Q: And do you perceive any difference of what it would in another country to the Brazilian one, or do you think it is more or less similar?

A: In the sense of having this? From a country that doesn't, for me to give you an example?

Q: No, in the sense that you perceive that in another country, for example Latin, it has the *jeitinho* too, but you perceive that the *jeitinho* in this country is, for example, the Bolivian *jeitinho*, is it different from the Brazilian *jeitinho*? Do you think that the Brazilian one is different from what exists in another country, or is it more or less the same?

A: I believe there is a cluster of countries that has this issue very similarly.

Q: How do foreigners deal with *jeitinho*? How do they react when they face a situation in which the *jeitinho* is present?

A: I believe this gives, this is a source of fear, because what it generates for the business, insecurity, of you not being able to forecast, of you not being able to estimate for sure. So, it adds uncertainty to the business environment.

Q: Would you say that *jeitinho* can be understood as a positive solution for business, for business problems?

A: It can, it also can.

Q: Why?

A: Because this positive aspect the *jeitinho* brings, of at the same time being bad, could generate these artificial advantages for some companies, some suppliers, whatever, at the same time it can make the partner do an effort in an extra way. Be it involving other people, be it thinking together for another solution that is best for the client, so imagine a situation. A supplier that has a very close relationship with their client, when the client asks for something, he will not stay at 'no'. 'Oh, the client asked for this, what can I do to address this in the best way?', they will think in this sense, and not answer 'no' for a demand that goes outside the standard, directly. I think that it could also lead to thinking in customized solutions that are more adequate to address this demand.

Q: In the same sense, would you say that *jeitinho* adds flexibility for the solution of business problems?

A: Yes.

Q: Would you have a more specific comment on this issue of flexibility?

A: According to the work style, depending, buying a service, for example, you can ask for a deadline that goes out of the standard of your supplier, but you say that you cannot give this up, and they have to deliver on that date in which you need it to be delivered. Even so there are the suppliers' rules, they will think and evaluate if they can't deliver before, giving a *jeitinho*, doing this thing.

Q: And does *jeitinho* reduce time, do you see *jeitinho* as a time or cost reducer of solutions of business problems?

A: Yes, it could also be.

Q: How so, more specific to cost or to time?

A: In time it could be this example I gave, so if I know that a company, thinking about a headhunting company, that delivers a shortlist of candidates in 7 days, this is its standard. But then, seeing that, this is on paper, I know that this could be flexibilized. I have to ask, I have to say that my demand is another one. And then they will find a way to deliver this before to me. So this would be the example on time, and the financial example would be the example that I have on new invoices, in different maturity dates, because there will be no time to do the internal operation to realize the invoices' payment.

Q: Does *jeitinho* improve the relationship between companies and governments?

A: Yes, I think that speaking of *jeitinho*, all of the aspects have two sides, positive and negative. So it could improve.

Q: How would this improvement be?

A: In the example of having some preposterous between government and private sector, and that is there to defend the interests of the company for which it provides services. In Brazil, we have this figure of the lobbyist, I think that it is not a common guy in the American market, this lobbyist figure, but there are the executives of governmental relations. Looking at this type of

title, for sure it is someone that is there to defend the interests of the company along with the government.

Q: Does *jeitinho* makes it easier for companies to deal with bureaucracy in general?

A: Yes, Sometimes, like this, it is not even a question of being easy, it is a question of having possibilities also, of making a project viable, or without it this would not be possible.

Q: Who would you say is most affected by *jeitinho*: Companies, the Government, or individuals, and why?

A: Individuals, because in this equation, they are the ones with less resources. Thinking about the company, it can hire how many employees it wants. A large sized company, it can have an apparatus of specialists in a specific field. Now someone that doesn't have conditions, they will suffer with the service without *jeitinho*, what the company does many times I think is to buy *jeitinhos*.

Q: Are there risks of any sort in using *jeitinho*? What would these risks be, in the affirmative case?

A: I think that there is a very large risk that is also intimately linked to uncertainty. For instance, thinking of a concrete situation, a company that loses a supplier that has a uniqueness, a very big competitive advantage with the government, it will lose deadlines, it will not be able to deliver the products for the client at the same timeline, and will lose the client due to that. Be it because there is a non-competition clause in this company, so this forwarder, using the forwarder example, attends some of its direct competitor, it will not be able to use this partner, be it because... I don't know, I think that the more concrete example in which I can think of is this.

Q: May the proposition of *jeitinho*, if someone proposes that something is solved through *jeitinho*, be somehow offensive?

A: Offensive? I believe so, when it surpasses the personal ethics of each one, the professional ethics of each one.

Q: Last question – Who or what is responsible for *jeitinho*: The Government, companies, the Brazilian people, our history? Where would you say *jeitinho* comes from?

A: It comes from our history, it is something that is above what is here today, it is something sociological, a cultural phenomenon, of heritage.

.

Appendix B: Published Articles



International Journal of Operations & Production Management

How do national cultures impact the operations strategy process?

Camila Lee Park, Ely Laureano Paiva,

Article information:

To cite this document:

Camila Lee Park, Ely Laureano Paiva, (2018) "How do national cultures impact the operations strategy process?", International Journal of Operations & Production Management, Vol. 38 Issue: 10, pp.1937-1963, <https://doi.org/10.1108/IJOPM-03-2017-0145>

Permanent link to this document:

<https://doi.org/10.1108/IJOPM-03-2017-0145>

Downloaded on: 01 January 2019, At: 06:45 (PT)

References: this document contains references to 128 other documents.

To copy this document: permissions@emeraldinsight.com

The fulltext of this document has been downloaded 627 times since 2018*

Users who downloaded this article also downloaded:

(2018), "Designing and developing OM research – from concept to publication", International Journal of Operations & Production Management, Vol. 38 Iss 9 pp. 1836-1856 <<https://doi.org/10.1108/IJOPM-01-2017-0038>><https://doi.org/10.1108/IJOPM-01-2017-0038>

(2018), "Evaluating the impact of modular product design on flexibility performance and cost performance with delivery performance as a moderator", International Journal of Operations & Production Management, Vol. 38 Iss 10 pp. 1987-2008 <<https://doi.org/10.1108/IJOPM-03-2017-0152>><https://doi.org/10.1108/IJOPM-03-2017-0152>

Access to this document was granted through an Emerald subscription provided by

Token: Eprints:KKVHASMP6VRDUMAQDQHV:

For Authors

If you would like to write for this, or any other Emerald publication, then please use our Emerald for Authors service information about how to choose which publication to write for and submission guidelines are available for all. Please visit www.emeraldinsight.com/authors for more information.

About Emerald www.emeraldinsight.com

Emerald is a global publisher linking research and practice to the benefit of society. The company manages a portfolio of more than 290 journals and over 2,350 books and book series volumes, as well as providing an extensive range of online products and additional customer resources and services.

Emerald is both COUNTER 4 and TRANSFER compliant. The organization is a partner of the Committee on Publication Ethics (COPE) and also works with Portico and the LOCKSS initiative for digital archive preservation.

*Related content and download information correct at time of download.

How do national cultures impact the operations strategy process?

Operations
strategy
process

Camila Lee Park
ESCP Europe, Paris, France, and
Ely Laureano Paiva
Fundacao Getulio Vargas, Sao Paulo, Brazil

1937

Received 4 March 2017
Revised 18 July 2017
10 December 2017
Accepted 12 December 2017

Abstract

Purpose – The purpose of this paper is to analyze the extent to which different patterns of cross-functional integration and the operations strategy (OS) process may be explained by national cultures differences.

Design/methodology/approach – Perceptual survey data from 105 manufacturing plants in four countries were used to validate the constructs and to test the hypotheses. The plants are located in two Western and two Eastern countries with different industrialization and development backgrounds (Brazil, China, Germany and South Korea). CFA validated the constructs, and ANOVA and *t*-tests evaluated the differences between levels of four Hofstede's elements (i.e. power distance, individualism vs collectivism, uncertainty avoidance and long-term vs short-term orientation) on the OS process enablers (i.e. leadership for cross-functional integration and functional integration) and elements (i.e. manufacturing strategy linkage to corporate strategy and formulation of manufacturing strategy).

Findings – Results suggest that different OS and OM processes are present in different national cultures. Leadership for cross-functional integration and manufacturing strategy linkage to corporate strategy differ between levels of power distance, individualism vs collectivism and uncertainty avoidance. Functional integration and formulation of manufacturing strategy also present differences according to the degree of individualism vs collectivism and long-term orientation.

Originality/value – Results indicate that national culture is a key aspect for the OS process. Prior studies usually do not consider cultural aspects. Therefore, the OS process varies in different countries and contexts. Managers need to adjust their OS process when they are developing a global OS.

Keywords Operations strategy, National culture, Hofstede's cultural dimensions

Paper type Research paper

1. Introduction

Cross-cultural studies have been considered increasingly important for international management. When country idiosyncrasies are not properly recognized, they represent critical challenges to managers. One of the current questions for research still relies on how to manage network operations when plants are located in different countries. Other questions that have a considerable practical impact in operations management (OM) include internationalization, global supply chains, and international outsourcing, among others. These aspects involve a level of decisions that inevitably extend beyond ordinary managerial choices. The delimitation of eventual variances between countries, which is attributable to geographic, historical, sociological or any other national factor, highlights the importance of this matter, not only for managers but also for scholars.

In this sense, a further understanding of how businesses are impacted by country location (or the specific culture attached to them) is particularly useful for current and future OM research (Pagell *et al.*, 2005). Research exploring international issues usually focus on strategic issues of OM. One example was the study of Prasad *et al.* (2001) that explored the differences in operations strategies in different markets. Rudberg and West (2008) proposed a theoretical model for coordinating international operations and manufacturing networks. Ahmad and Schroeder (2003) explored HRM practices on OM across countries and industries. There is, however, a lack of studies that integrate operations strategy (OS) and cultural aspects.



Some previous studies have associated cross-cultural aspects with the implementation of best quality management practices (Vecchi and Brennan, 2011) and supplier involvement (Ketkar *et al.*, 2012). Also related to the buyer-supplier relationship, Liao *et al.* (2012) analyzed autonomy and long-term strategic alignment as antecedents of trust in supply chain management. Other studies examined the classic comparison of automaker supplier relationships in the USA, Japan and Korea (Dyer and Chu, 2000, 2011), and specific case studies on Toyota's knowledge network with US suppliers (Dyer and Nobeoka, 2000). National cultures have also been found to influence the effect that manufacturing practices investments may have on operational performance (Wiengarten *et al.*, 2011).

There is still a lack of recognition of cultural aspects as a potential explanation for the patterns found in different operational processes in OM studies. There is a need for a further step to be taken towards understanding cultural impacts on OS. In order to fulfill this need, the present work will seek to answer the following research question:

RQ1. To what extent are national cultures related to companies' process of OS?

As a starting point, this research aims to empirically analyze the relationship between national cultures and OS. Based on the database of the fourth round of the high performance manufacturing (HPM) project and on Hofstede's cultural classification, the present study deepens the understanding of some of the issues and fills some of the gaps in OS literature related to cross-cultural issues.

The literature review section presents a discussion of the concepts of the OS process, formulation and implementation, as well as functional integration and leadership, along with previous studies on national cultures and OS. Hofstede's national cultural dimensions are introduced and discussed next, followed by the hypotheses development and description of the method used. The results are then discussed and their theoretical and practical implications and conclusions are presented. Finally, limitations and suggestions for future research are presented.

2. Literature review

The present investigation draws from the conceptualization on enablers and elements of the OS process to understand the extent to which different patterns may be explained by cultural idiosyncrasies. In this sense, the constructs selected for this study (leadership for cross-functional integration, functional integration, manufacturing strategy linkage to corporate strategy and formulation of manufacturing strategy) have been presented since the seminal articles of Skinner (1969), Wheelwright (1984) and Hayes and Wheelwright (1985). These three studies emphasized on the rule of operations managers in the strategy formulation process, the need for integration between operations and other functional areas, like marketing, and the idea of alignment of operations decisions with business strategy. While leadership for cross-functional integration and functional integration are relevant for the success of OS as a communication development that needs to involve different functions within the organization, formulation of manufacturing strategy and manufacturing strategy linkage to corporate strategy are comprehended within the processual approach of OS discussed by Rytter *et al.* (2007), relating to the formulation and implementation of OS, respectively.

2.1 OS process' enablers

Defined as "a process of interdepartmental interaction and collaboration in which multiple functions work together in a cooperative manner to arrive at mutually acceptable outcomes for their organization" (Frankel and Mollenkopf, 2015), the linkage between cross-functional integration and areas of related outcomes has been largely examined by the academic community. The relationship between manufacturing and marketing functional areas, for

instance, has been posited to impact organizational performance (O'Leary-Kelly and Flores, 2002) and business outcomes (Hausman *et al.*, 2002). Through the cumulative capabilities approach, Paiva (2010) assesses the integration between these two functions suggesting that, along with managerial priorities, it is positively related to business performance. Research by Nakata and Im (2010), in turn, reveals cross-functional integration as a major contributor to the performance of new products, with the first being co-determined by internal (i.e. social cohesion and superordinate identity) and external (i.e. market-oriented reward programs, formalization of the planning process and managerial risk encouragement) factors. Cross-functional cooperation can also lead to new product development success in certain environments, such as those presenting high technological and market risks (Gemser and Leenders, 2011). Furthermore, internal integration has been argued to impact firms' profitability through process efficiency (Swink and Schoenherr, 2015).

Relating to cross-functional integration, Wheelwright (1984, p. 79) asserts the "critical importance" of leadership "to the overall success and direction of the company." We go back to Skinner's (1969, p. 145) argument – the need for what he calls the alignment of the manufacturing function with other strategic levels – made possible by the exercise of "innovative management." The author sets the tone for what we understand as leadership for cross-functional integration, demonstrated by the integrative-oriented role of upper management toward subordinates. In a procurement scenario, Trent (1996) highlights the critical impacts of leadership in cross-functional environments, as it nurtures collaboration and coordination in multi-boundary teams. Webber (2002) also reports the influence of leadership actions for establishing trust within cross-functional teams, with leadership individuals having "primary responsibility for team effectiveness" (Zaccaro and Klimoski, 2002, p. 4). Current studies have highlighted the role of industrial directors in the corporate strategy formulation process, suggesting that the companies that have better operational results are those in which their directors are able to harmonize their attention between strategic focus and operational activities (De Meester *et al.*, 2014; Kim *et al.*, 2014). In a broader scope, leadership can be defined as "a process of social influence in which the leader enlists the talents and efforts of other group members, [...] in order to accomplish the group's chosen task" (Chemers, 2003, p. 5). Strategic leadership, in turn, has been linked to business ethics (Thomas *et al.*, 2004), wealth creation (Rowe, 2001), and the capacity to learn and change (Boal and Hooijberg, 2000).

Functional integration, the second aspect, has lately been a trend topic both in academic literature as well as among practitioners. In several studies and business observations the need for clean flows of information and cooperation that are capable of connecting the diverse functions within organizations has been associated with the development of capabilities and with performance. Recent research explores the impact of cross-functional integration and performance (Foerstl *et al.*, 2013), their contribution to knowledge sharing practices or behavior (Ghobadi and D'Ambra, 2012) and the internal drivers that lead to integration success from a team's perspective (Daspit *et al.*, 2013), among others. We borrow from Paiva *et al.*'s (2008, p. 117) definition of cross-functional integration orientation as "the ability of manufacturing to interact with other functional areas in order to improve a company's strategies and processes." The degree of integrative orientation and leadership affects not only the way work is done (i.e. operations), but also the basis on which it is planned (i.e. strategy). Hence, integrative leadership and functional integration are expected to be disturbed by differences within the dimensions of national cultures.

2.2 OS process' elements

Since Leong *et al.*'s (1990) proposed conceptual distinction between the manufacturing strategy process and content, OS literature has been evolving around these two fields.

In their literature review on the *POMS* journal, Boyer *et al.* (2005) identify process and content as the two broad areas approached by OS articles, although Barnes (2001) point to the predominance of process in the field. Brown *et al.* (2007) reinforce the importance of the two topics by indicating the adoption of both OS process and content by world-class manufacturing plants, while in low-performing ones such matters are not developed, whereas Schroeder *et al.* (1986) and Anderson *et al.* (1991) propose “companion articles” to treat content and process issues in OS, respectively. As discussed by Rytter *et al.* (2007, p. 1094), process concerns “how to conduct OS formulation and implementation processes,” as where content refers to “how operations can create competitive advantage, by providing normative guidelines on what to include when formulating an OS.” Focusing on the first, the authors offer a comprehensive view on previous contributions to the OS process. According to them, among other studies, Menda and Dilts (1997) define the OS process as a “strategy formulation process, a technical-rational but also a consensus process to overcome functional barriers” (Rytter *et al.*, 2007, p. 1095), while to Riis *et al.* (2006) the concept relates to a “vision development process with participation followed by implementation and learning. Also a communication process (dialogue) to overcome functional barriers,” where “other differences of viewpoint, facilitation, influence options and context can be important factors” (Rytter *et al.*, 2007, p. 1096). Complementing both notions, Rytter *et al.* (2007, p. 1097) point to the OS process as “formulation and implementation” that is influenced not only by technical-rational factors, but also by political and socio-cultural aspects, the latter referring to “changes in actors’ knowledge, competencies, perceptions, communication patterns, logics, values, needs and interests.”

As for the third component of this study, the connection between manufacturing and corporate strategies has been largely approached in OS literature by enumerating several themes discussed within the manufacturing strategy (e.g. manufacturing capabilities, best practices, strategic decisions and performance) (Dangayach and Deshmukh, 2001). As OS is “expected to specify competitive priorities and objectives for the operations function in alignment with the firm’s overall business strategy” (Kim *et al.*, 2014, p. 463), the fit between manufacturing strategy to the general one is also suggested to have significant impact in performance and competitiveness (Thun, 2008). Practical relevance is also evident in the growing number of infrastructural manufacturing strategies, such as just-in-time, total quality management and statistical process control, among others, as these strategies are prescribed and implemented in the search for productivity and quality enhancement, as well as in cost reduction processes, with several studies surrounding these issues (e.g. Mellor *et al.*, 2014; Zatzick *et al.*, 2012; Rho *et al.*, 2001). The manufacturing strategy linkage to corporate strategy may be defined as the extent to which the strategic planning of firms at the business level is complemented by the strategy established on the manufacturing function, ideally resulting in an alignment between strategic goals and manufacturing performance.

Finally, on what relates to the fourth construct, pioneering authors, such as Cohen and Lee (1985, p. 153), argue that “the development of strategies directed towards improving the performance of manufacturing operations has recently become a critical component of the competitive strategy of many firms.” Formulation of manufacturing strategy has been portrayed as a continuous process (Nielsen-Englyst, 2003), related to a better fit between improvement goals and action programs for competitive objectives (Acur *et al.*, 2003), which reflect the pattern of decisions that will be made over time, and the existence of formal or informal rules within this process, which are dependent on cultural idiosyncrasies (Miltenburg, 2005). Still accordingly, “when a formal manufacturing strategy exists, decisions follow a neat, logical pattern. When no strategy exists, the pattern is erratic and unpredictable” (p. 2). Taking a different approach to the subject, Gebauer (2009) assesses the extent to which service orientation (i.e. strategy formulation and implementation) is affected

by managerial attention, and Ocasio and Joseph's (2015) work brings an attention-based view to bear in order to link the micro and macro perspectives in the strategy formulation process. For these authors, strategy formulation is considered to be "a fluid and distributed process" and "a process of guided evolution" (p. 39), meaning that it builds on organizational attention at the business and corporate levels. Formulation of manufacturing strategy may be understood, then, as the precise definition and communication of the strategic priorities of firms with regard to their manufacturing function.

2.3 *OM and national cultures*

Potential differences that may arise from cultural aspects have also been explored in the previous studies. From this landscape, behavioral issues might play an important role on manufacturing strategies' implementation, as "executives described the implementation process as one of gaining employee acceptance of the strategy through lower level involvement and teamwork" (Maruchek *et al.*, 1990, p. 101). Schroeder and Flynn (2001), for instance, discuss that differences in how manufacturing strategy is implemented have been found according to the specific country analyzed. Such finding may suggest the influence of national cultures on this specific issue. The strategic decision process is also argued to be influenced by national cultures with different countries equally presenting different patterns on that regard (Buitjens and Noorderhaven, 1996). Corroborating with the idea, Rho *et al.* (2001) report significant differences between samples from USA and South Korea when comparing the outcomes of implementation of manufacturing strategies in terms of quality, cost and flexibility. Barnes (2002), in turn, offers a small plants' perspective around the manufacturing strategy building process, arguing that such process is strongly impacted by factors related to political, managerial and cultural matters.

Also in the global context, and because of its multi-countries nature, the HPM project derived studies that encompasses several different topics. Even though not directly considering the impact of cultural issues, examples of such cross-cultural research can be found in Bozarth *et al.*'s (2009) proposed model for connecting supply chain complexity (i.e. upstream, internal manufacturing and downstream complexity) to manufacturing performance of the plant in negative relationships. Hallgren and Olhager (2009) empirically posit that lean and agile manufacturing are driven by different internal and external antecedents (i.e. competitive intensity of industry; differentiation strategy and competitive intensity of industry, respectively), as well as impact in different operational outcomes (i.e. quality, delivery, cost and flexibility). Paiva *et al.* (2014), on the other hand, investigate planning and trust in a supply chain management context, finding positive impacts in supply integration and operational performance. More specifically under the cultural assessment, Naor *et al.* (2008, p. 671) state that "culture can provide insight into the context dependence of quality management practices." Cultural importance is also in the core of the authors' state of empirical proof on the impact of culture in manufacturing performance. In another study, three of these authors reinforce the effects of organizational over national cultures on manufacturing performance, claiming that organizations should develop "an internal organizational culture consistent with high performance manufacturing" (Naor *et al.*, 2010, p. 194).

2.4 *Hofstede and cultural classification*

Geert Hofstede's (1980a, b, 1983, 1993, 1994, 2001) extensive studies on cultural classification and cross-cultural research are arguably few of the most impactful views on management practices across different cultural environments. Based on a survey of 72 national IBM subsidiaries, the author advocates that some management behaviors that are applicable in a specific cultural environment might not actually be appropriate for another. Based on problems commonly identified in societies, four culture dimensions were originally

presented: power distance, uncertainty avoidance, individualism vs collectivism, and masculinity vs femininity (Hofstede, 2001). Between the early 1990s and the end of the first decade of the current century, based on the research of Hofstede and Bond (1988) and Minkov (2007), two additional dimensions were added: long-term orientation and indulgence vs restraint. Indulgence vs restraint considers the difference between enjoying the life and strict social norms. Thus, it is more related to personal aspects than organizational ones. Masculinity vs femininity also has a closer approach to personal characteristics than to organizational processes. An additional constraint for this dimension is its multidimensional definition: masculinity (preference for achievement, heroism, assertiveness and material rewards for success) and femininity (cooperation, modesty, caring for the weak and quality of life), in the sense that they do not represent opposite poles, but rather distinct ones. The four dimensions that were explored in this study are present directly in the seminal OS studies.

Regarding power distance, Skinner (1969, p. 142) mentioned that manufacturing managers were distant from the top management at that time, as “a technical point of view cut them off from the top management.” The four Hofstede’s dimensions are present in what Wheelwright (1984) identified as company’s philosophy or culture. First, power distance is mentioned by the author: “To be really effective, management must work toward the development of a culture – a set of ingrained attitudes – that helps to communicate its goals, plans, and policies to all employees.” On uncertainty avoidance, Wheelwright (1984, p. 89) stated: “There tends to be a ‘company’ way of doing things. There is a sense of tradition and continuity within the firm.” Wheelwright (1984, p. 89) also mentioned clearly aspects related to short- and long-term decision, when discussed the importance of corporate strategy and company’s culture (or philosophy): “[...] this balance tends to ensure a more appropriate trade-off between long-term and short-term actions.” Finally, the author considers that company’s culture is a key aspect for a collective (individualism vs collectivism) development of OS: “[...] a strong philosophy can serve as the glue that makes strategy development an interactive process, with inputs and perspectives from all functions, and ensures consistency and integrity of the individual components” (p. 90).

As the other two dimensions are not directly present in the Wheelwright’s definition of company’s culture, they were not considered in this study. Similar to Wiengarten *et al.*’s (2011) approach, in which four national culture dimensions integrated their study, after assessing the basic problem approached by each one of them, the four dimensions selected to form part of this investigation were: power distance, uncertainty avoidance, individualism vs collectivism and long-term vs short-term orientation. Such dimensions are understood as being those that are more related to managerial processes and have a potential impact on elements of OS.

Table I shows those four dimensions, the basic problem they deal with and their brief description.

3. Hypotheses development

The first set of hypotheses refers to the power distance dimension and its relationship to the aspects related to the OS process. Hope (2004) sought to understand the influence of national culture in OM in the hotel industry, as represented by the adoption of “best practices.” She found that practices involving teamwork, empowerment and communication were largely affected by high levels of power distance between the staff. Chakrabarty (2009) argues that economies with a high power distance index are those in which wealth and opportunities are also available, but unequally distributed. At the same time, Nielsen and Nielsen (2011), also basing their analysis on Hofstede’s cultural classification, found that both international experience and the nationality diversity of top managers have impacts on strategic decision making. In their study of different leadership styles across six different countries (USA, Russia, Germany, Georgia, Kazakhstan and Kyrgyzstan), Ardichvili and

Table I.
Hofstede's
independent national
culture dimensions

Dimension	Basic problem	Description
Power distance	Human inequality	"The extent to which the less powerful members of institutions and organizations within a country expect and accept that power is distributed unequally" (p. 98)
Uncertainty avoidance	Level of stress in unknown future	"The extent to which the members of a culture feel threatened by uncertain or unknown situations" (p. 161)
Individualism, as opposed to collectivism	Integration of individuals	"Individualism stands for a society in which the ties between individuals are loose: Everyone is expected to look after him/herself and her/his immediate family only. Collectivism stands for a society in which people from birth onwards are integrated into strong, cohesive in-groups, which throughout people's lifetime continue to protect them in exchange for unquestioning loyalty" (p. 225)
Long-term orientation, as opposed to short-term orientation	Choice of focus	"Long Term Orientation stands for the fostering of virtues oriented towards future rewards, in particular, perseverance and thrift. Its opposite pole, Short Term Orientation, stands for the fostering of virtues related to the past and present, in particular, respect for tradition, preservation of "face" and fulfilling social obligations" (p. 359)

Source: Hofstede (2001)

Kuchinke (2002) concluded that cultural differences indeed played a strong influence on the perceivable leadership style in each country. Other studies (e.g. Smith *et al.*, 2002; Dorfman *et al.*, 1997) have also pointed out the prominence of power distance over all other cultural dimensions as far as its influence on leadership styles.

In the case of the OS process, we claim that leadership for cross-functional integration is present when the top management has intense influence on the other strategic levels, especially in allowing other hierarchical levels such as middle managers to participate on the companies' strategic initiatives (Slack and Lewis, 2011; Burgelman and Grove, 2007). Thus, a bottom-up orientation will be present when there is a clear integration among hierarchic levels and functions in the strategic decisions (Kim *et al.*, 2014). Consequently, this orientation characterizes a lower power distance among the hierarchical levels. Other aspects related to OS are also expected to present a negative influence of power distance because integration is embedded in all of them. These aspects include functional integration, manufacturing strategy linkage to corporate strategy and formulation of manufacturing strategy.

As power distance relates to the perspective of the less powerful members and the extent to which they accept hierarchy in relationships ruled by fear and respect, we argue that in cultures with high power distance, it would be unnecessary to impose formal rules in order for them to be followed, as subordinates might feel more inclined or even obliged to accept them. On the other hand, greater power distance levels may negatively affect collaborative efforts, as power distance can hinder teamwork and communication attempts. This suggests that power distance levels may have a negative effect on leadership for cross-functional integration, functional integration, manufacturing strategy linkage to corporate strategy and formulation of manufacturing strategy.

The role of operations managers in the strategic process was highlighted by Skinner (1969) and Wheelwright (1984). Those authors stressed that a narrow technical view had isolated operations managers and decreased their influence on the strategic process during decades. Currently, authors like De Meester *et al.* (2014) and Kim *et al.* (2014) showed that the strategic process presents top-down and bottom-up processes simultaneously, and depends on the company's culture. For the first authors, "in high-performing companies the OE tends

to spend less time on strategy making and more on other tasks as the operations function becomes a source of competitive advantage” (p. 412). These tasks include how to explore operational resources and how to integrate to other functional areas. Therefore, we may propose the first hypothesis:

H1a. Whether power distance differs; leadership for cross-functional integration differs.

Cross-functional integration is also present in the seminal works of Skinner (1969) and Wheelwright and Hayes (1985). Those authors showed that operations managers should be involved in the strategic process. According to Swink *et al.* (2007), when there is an integrated participation of the different functional areas in the business strategic process, operational and business performance are improved in different competitive criteria. Other authors like Malhotra and Sharma (2002) showed the importance of marketing and operations integration to improve business performance. Therefore, when different functional areas are more involved in the strategic process, we claim that there is a decrease of hierarchical distances and consequently of the power distance. Thus, we may propose the following two hypotheses:

H1b. Whether power distance differs, functional integration differs.

H1c. Whether power distance differs, manufacturing strategy linkage to business strategy differs.

For Kim *et al.* (2014), decentralized organizations implement more action plans from middle or frontline managers than centralized ones. Similarly, Rytter *et al.* (2007) showed the need to create a shared view of the manufacturing strategy to the middle management. It is worthy to mention Wheelwright (1984), who stressed the importance of the “company’s philosophy.” Company’s philosophy is oriented by how the company competes. This aspect is more linked to the culture and values than to formal and written plans. Therefore, we may address the following hypothesis:

H1d. Whether power distance differs, formulation of manufacturing strategy differs.

Hofstede and Bond (1988, p. 14) also stated that, over and above the power distance influence, leadership may also be influenced by the individualism dimension as, according to the authors, “both power distance and individualism affect the type of leadership most likely to be effective in a country.” In highly individualistic cultures, “employed persons [...] are expected to act rationally according to their own interest, and work should be organized in such a way that this self-interest and the employer’s interest coincide” (Hofstede, 2001, p. 235). Chen and West (2008, p. 259) propose a new scale for the individualism vs collectivism cultural dimension, and argue that individualism can be assessed in terms of “independence, competitiveness and uniqueness,” while collectivism can be defined as “considering of one’s decisions on others, sharing of positive outcomes and sharing of negative outcomes.”

By assessing supply chain integration, Zhao *et al.* (2008) link the high level of collectivism culture to the Chinese normative relationship (i.e. “a mutual, ongoing relationship over an extended period of time which is based on mutual commitment and sharing”; Ellram, 1991; in Zhao *et al.*, 2008, p. 371), which is based mainly on trust. On the other hand, the opposite is an instrumental relationship commitment that is based on compliance (i.e. “when one party accepts the influence of another in hopes of receiving favorable reactions from the other party”; Zhao *et al.*, 2008, p. 371). Power *et al.* (2010, p. 217) divided their sample, composed of cross-national plants, into individualistic and collectivist cultural sub-groups (i.e. industrialized western economies and emerging Asian economies), and found significant differences between their levels of investment in OM practices. The study found evidence of collective cultures being more emphatic on developing teamwork-based capabilities “where commitment to group goals are stronger.” Additionally, Ahmad and

Schroeder (2003) showed that commitment mediates positively the relation between teams' activities and performance. Thus, we argue that high individualism levels should have a negative effect on leadership for cross-functional integration. Therefore, we envisage the following hypothesis:

H2a. Whether individualism vs collectivism differs, leadership for cross-functional integration differs.

According to Wheelwright and Hayes (1985), most competitive companies seek to create a learning process based on collective actions among the functional areas. In the same way, Hayes and Upton (1998) showed that individual knowledge is not enough to build operational capabilities. According to them, companies "must be structured and shaped in a way that facilitates learning and change" (p. 18). Therefore, we address the following hypotheses:

H2b. Whether individualism vs collectivism differs, functional integration differs.

H2c. Whether individualism vs collectivism differs, manufacturing strategy linkage to business strategy differs.

Since Nonaka *et al.* (2000), there is a clear understanding that capabilities are created mainly from tacit knowledge. Other authors like Paiva *et al.* (2008) argue that manufacturing strategy is based on how companies explore their resources (knowledge, teams, equipment and functional areas) in order to create operational capabilities. Tan *et al.* (2007) also stated that capabilities are based on the acquisition and dissemination of superior process knowledge. Thus, we claim that the OS process is related to collective efforts closely regarding the building of capabilities from tacit knowledge than the formalized and written strategic plans. We propose the following hypothesis:

H2d. Whether individualism vs collectivism differs, formulation of manufacturing strategy differs.

The two other dimensions (uncertainty avoidance and long-term orientation) are antecedents of manufacturing strategy formulation, since efforts to reduce ambiguity and establish long-term goals and objectives are ultimately related to how individuals perceive and manage risks. In that sense, prior studies have discussed the relationship between cultures with high scores in uncertainty avoidance and their aversion to risk (Baker and Carson, 2011). De Meester *et al.* (2014) showed that uncertainty affects negatively the interactions between operations executives and other executives. Thus, we may address the next two hypotheses:

H3a. Whether uncertainty avoidance differs, cross-functional integration differs.

H3b. Whether uncertainty avoidance differs, functional integration differs.

Rytter *et al.* (2007) also propose a five-stage process for lean and global manufacturing, with the last stage linked to global and advanced practices in manufacturing. Thus, anticipation of new technologies is a characteristic of the most competitive companies (Hayes and Wheelwright, 1985). Within a complementary view, Finger *et al.* (2014) also identified that this aspect influences positively operational performance. Thus, we may address the following hypothesis:

H3c. Whether uncertainty avoidance differs, manufacturing strategy linkage to corporate strategy differs.

Ayoun and Moreo (2008) found that different levels of uncertainty avoidance had little or no impact on business strategy development. On the other hand, Kull and Wacker's (2010, p. 234)

study on the GLOBE's project extension of Hofstede's cultural classification suggested that this dimension positively impacts quality management effectiveness, since "high uncertainty avoidance cultures are not uncomfortable with rules and process controls." Hence, it is reasonable to argue that low uncertainty avoidance levels should have a negative influence on formalized manufacturing strategy plans. We address the following hypothesis:

H3d. Whether uncertainty avoidance differs, formulation of manufacturing strategy differs.

Voss and Blackmon (1998, p. 152) draw on data from 600 companies in 20 different countries to study how different attitudes in time orientation impact the strategic decisions of firms, specifically in Western and Japanese plants. The authors define corporate strategy as "the overall plan which defines how a company will create competitive advantage in the business in which it competes," with manufacturing strategy being a "functional level" of such strategy. While Japanese managers emphasize both short- and long-term practices and focus on prompt solutions and prevention issues, western organizations treat these two approaches within a trade-off model. Wang and Bansal (2012, p. 1147) argue that new ventures are more inclined to short-term orientation and neglect the development of strategic resources or innovation, as "temporal orientation plays a critical role in decision making."

As discussed by Hofstede (2001), cultures with high long-term orientation index levels are related to lower immediacy. This aspect may lead to a less opportunistic behavior, as people would accept deferred gratification for their actions. Wheelwright (1984) in his seminal article on OS stated that leadership should create a company's philosophy, i.e. a long-term view for the strategic decisions in operations. In this article, the author follows a logic based on the formal strategic planning with the development of the corporate strategy to the operational processes. We argue, therefore, that higher level of long-term orientation is expected to influence positively leadership for cross-functional integration. We propose the following hypothesis:

H4a. Whether long-term orientation differs; leadership for cross-functional integration differs.

Seminal studies (Skinner, 1969; Hayes and Wheelwright, 1985) also indicate that the most competitive companies present a long-term view of their OS process with emphasis in cross-functional integration and learning processes. Thus, we may envisage the next hypothesis:

H4b. Whether long-term orientation differs; functional integration differs.

Rytter *et al.* (2007) argued that the impact of OS in the long term is not easy to identify. At the same time, one of the key aspects of the OS process is to integrate manufacturing decisions to the corporate strategy along time. For Schroeder *et al.* (2002), there is a link between long-term investments in manufacturing processes and competitive advantage. Thus, we may address the next hypothesis:

H4c. Whether long-term orientation differs, manufacturing strategy linkage to corporate strategy differs.

According to Gagnon (1999), the OS process has been developed in highly competitive environments in the last decades. For the authors, companies would have to forget the trade-offs approach and focus on the leverage of the internal recourses. Thus, written and formalized plans such the ones proposed in the 1980s (Wheelwright, 1984) are not feasible for the speedy changes in the competitive environment. We propose the following hypothesis:

H4d. Whether long-term orientation differs, formulation of manufacturing strategy differs.

4. Empirical research and method

4.1 Countries analyzed and national culture

It is worthy to question if the main aspects of the OS process are related to national culture. To fulfill the objective of this research, four countries were selected to integrate the analysis – Brazil, China, Germany, and South Korea. They are at different stages of industrialization and economic development, each of which also presenting singular characteristics regarding their respective national cultures. First, we may mention that Chinese *guanxi* builds a relational network based on reciprocity, loyalty and trust and influence the social relations in the business environment (Chen *et al.*, 2011; Lee and Humphreys, 2007). On the other hand, Brazilian culture faces a continuous tension between European legacy and regional identity. Brazilian *jeitinho* is a way to deal with excessive bureaucracy and to resist to formal rules (Smith *et al.*, 2012). The Korean *yongo*, in turn, also influences social relations in this country. *Yongo* refers to the different networks to which individuals belong (i.e. hometown relationships, school attendance, and family or blood ties), and configures exclusive trusting relationships (Horak and Klein, 2015). Finally, German management presents a long tradition with relations based on technical competence, formalization and hands-on production management. At the same time, these aspects may decrease companies' flexibility (Glunk *et al.*, 1996).

4.2 Sample data

Data were retrieved from the HPM project, previously called WCM (world-class manufacturing) database, which has been expanded since its beginning in the mid-1990s, as it seeks to articulate practices related to world-class manufacturing through the appliance and use of a proper and comprehensive database (Flynn *et al.*, 1999). By creating an international network for cooperation, HPM's fourth round currently involves researchers in production and operations from 11 countries and regions. Measurement instruments were translated into local languages and back-translated to ensure that each country would work with comparable questionnaires. The project aims to assess companies from the machinery, electronics and transport equipment sectors that have more than a hundred employees to ensure that each participating enterprise is of a size that supports the studied areas and practices; there is a minimum of 20 companies per country. Companies were chosen according to the selected industries and sampling relied on each country leaders' efforts and networking, thus generating a group of respondents with the necessary characteristics who were willing to participate in the project.

A total of 105 companies integrate the sample of the study. Germany was a pioneer in global industrialization and forms part of the group of developed countries; South Korea, although it has a recent industrialization history, is also considered to be a developed country today; and finally, both Brazil and China are representative of recent industrialization in countries considered to be emerging economies. Leadership for cross-functional integration (LDINT), manufacturing strategy linkage to corporate strategy (LINKS) and formulation of manufacturing strategy (MFGSTR) measurements were drawn from individual scales of the HPM project's database, originally carrying four, six and four items each, respectively, while functional integration was measured through items pertaining to two different scales, namely achievement for functional integration (INTEG) and integration between functions (FUNCI), initially totalizing 12 items. Missing data accounted for 248 out of the 2,808 items contained in the corresponding original scales (8.83 percent) of respondents from the four countries. Various techniques are advisable to dealing with missing values in a database, such as imputation, deletion and interpolation (Hair *et al.*, 2003). Little's (1988) MCAR tests were carried out, not verifying complete randomness of the missing data. Although mean substitution has been argued to "produce biased parameter estimates, even with MCAR data" (Enders, 2010, p. 55), and

“if there are moderate to large amounts of missing data, simple imputation is likely to underestimate standard errors, distort correlations among variables, and produce incorrect p-values in statistical tests” (Kabacoff, 2011, p. 371), mean substitution was selected since the amount of data missing in the sample is relatively low. Missing values were treated within each country’s limits, so that the inputted mean would not capture potential differences between samples. Therefore, they were replaced with averages calculated for each item on the measurement scales per country.

4.3 Measurement models

The measurement models for the OS constructs were tested for validity and reliability with confirmatory factor analysis (CFA). IBM® SPSS Statistics software was utilized both for construct refinement and empirical research. Similar to Menor and Roth’s (2007) study, which conceptualized the New Service Development competence into five different constructs, the four elements of OS are here considered to be separate elements as a consequence of the sample size. Although relatively small, authors such as Wolf *et al.* (2013) have positioned their results against the “one size fits all” general rule for CFAs, defending the variability of sample size requirements when it comes to applying the technique. The four different models, which were to be assessed individually, underwent their own refinement, validity and reliability test processes. Initially CFAs were run for the four OS construct models, two of which required item refinement before they became part of the final data analysis. Items with low standardized factor loadings (i.e. below 0.60 and 0.70 for constructs with a higher number of initial items) were dropped, being one from the LDINT scale with factor loading 0.40, seven from the INTEG-FUNCI scales with factor loadings 0.62, 0.60, 0.59, 0.43, 0.59, 0.63 and 0.53, and three from the LINKS measurements with factor loadings 0.66, 0.27 and 0.38. The MFGSTR scale remained with no items removed. Table II shows the robustness measurements and indexes for the four final leadership for cross-functional integration (LDINT), functional integration (INTEG-FUNCI), manufacturing strategy linkage to corporate strategy (LINKS) and formulation of manufacturing strategy (MFGSTR) constructs, as well as the factor loadings for each item on the final constructs.

Unidimensionality means that the items within a determined scale measure a single construct and were assessed by way of the overall fit of the absolute and comparative models, or incremental fit indexes. As expected, χ^2 values were not significant in

	LDINT	INTEG-FUNCI	LINKS	MFGSTR
Items	3	5	4	4
Average	3.89	3.90	3.80	3.82
SD	0.56	0.55	0.68	0.69
$\chi^2(p\text{-value})$	0.000 (n.c.)	11.379 (0.044)	0.000 (n.c.)	5.548 (0.062)
χ^2/DF	n.c.	2.276	n.c.	2.774
CFI	1.000	0.979	1.000	0.974
GFI	1.000	0.955	1.000	0.973
NFI	1.000	0.964	1.000	0.961
Composite reliability	0.745	0.898	0.749	0.813
Average variance ext.	0.53	0.64	0.51	0.52
Cronbach’s α	0.756	0.895	0.752	0.806
Item (factor loading)		INTEGN01(0.72)		MFGSTRN01(0.79)
	LDINTN02(0.87)	INTEGN03(0.75)	LINKSN03(0.73)	MFGSTRN02(0.80)
	LDINTN03(0.60)	FUNCIN01(0.90)	LINKSN04(0.76)	MFGSTRN03(0.64)
	LDINTN04(0.69)	FUNCIN04(0.79)	LINKSR06(0.67)	MFGSTRR04(0.65)
		FUNCIN05(0.83)		

Table II. Operations strategy constructs unidimensionality analysis, reliability analysis and items’ standardized factor loadings

the functional integration and formulation of manufacturing strategy scales (99 percent significance). The χ^2 per degrees of freedom ratio (χ^2/df) reveals the relative efficiency of the model; under 5 is acceptable and under 2 is indicative of good fit. The two constructs gave acceptable ratios, while the other two (leadership for cross-functional integration and manufacturing strategy linkage to corporate strategy) were not assessed by χ^2 analysis because their probabilities and degrees of freedom could not be computed. Nevertheless, all four constructs presented good model fit, with incremental fit indexes – comparative fit index, goodness-of-fit index and normed fit index – exceeding the 0.95 threshold, also reinforcing the strong unidimensionality of the scales.

Composite reliability values for all constructs are above 0.70, indicating a very satisfactory result. Reliability was also assessed through the average variance extracted. All constructs demonstrated values above 0.50, meaning that a larger part of the variance is due to the operationalized items. Additionally, Cronbach's α (Cronbach, 1951) presented values higher than 0.70 for the four constructs. Discriminant validity between OS constructs was assessed by comparing their average variance extracted with the squared correlation of every possible pair of constructs (Fornell and Larcker, 1981). Although correlations between each pair of constructs are statistically significant, Table III also shows that each individual extracted variance presented higher values than its shared variance with the other constructs, demonstrating that discriminant validity was present.

4.4 Hofstede's national culture indexes

Hofstede's Indexes for each of the national culture dimensions were based on the Value Survey Module 2013 Questionnaire (Hofstede and Minkov, 2013). The results are openly available for academic studies. Each of the four dimensions is composed of four items, based on a five-point scale, generating indexes ranging from 0 to 100 and with data gathered from 110 countries (Hofstede and Minkov, 2013). National culture dimension index levels were created to assess their impact on OS elements, and each cultural index was classified as low, medium low, moderate high or high, according to the countries' scores (0-25, 26-50, 51-75 and 76-100, respectively). Table IV displays the four assessed countries' national culture dimension indexes and attributed levels.

4.5 Data treatment and analysis

The aim of the study is to test for potential differences that may reside in OS process elements when cultural aspects are factored in. Because it relates to differences rather than causal relationships, analysis of variance (ANOVA) and *t*-tests were run to fulfill that goal. Five cultural groupings were formed. The first four, according to the country,

	OS element	LDINT	INTEG-FUNCI	LINKS	MFGSTR
Individual-shared variances matrix	LDINT	<i>0.5310</i>	0.0595	0.0240	0.0434
	INTEG-FUNCI		<i>0.6407</i>	0.3956	0.4238
	LINKS			<i>0.5198</i>	0.4199
	MFGSTR				<i>0.5240</i>
Correlations matrix	LDINT	1.000	0.244	0.155	0.217
	INTEG-FUNCI	0.012	1.000	0.629	0.599
	LINKS	0.114	0.000	1.000	0.648
	MFGSTR	0.026	0.000	0.000	1.000

Notes: For the Individual-shared variances matrix: numbers in italic represent constructs' individual variances, numbers above represent squared correlations of each pair of constructs'; for the correlations matrix: numbers above the diagonal line represent constructs' correlations, numbers below the diagonal line represent correlations' significance values

Table III.
Operations strategy
constructs'
discriminant validity
analysis

power distance index levels, individualism vs collectivism index levels and uncertainty avoidance index levels, formed part of the ANOVA factors, with which averages of the OS elements were to be compared. Differences for long-term orientation vs short-term index levels were tested through *t*-tests, since there were only two levels identified in the sample. In order to control for differences between industries, an additional grouping was also configured by industry type (i.e. electronics, transport and machinery).

A previous assessment of the several assumptions necessary for defining the type of test and *post hoc* tests was made. For this stage, Anderson *et al.*'s (2010) three assumptions were considered: normal distribution of the response variable, homogeneity of variances, and independence of observations. For the first assumption, Q-Q graphs for the four variables were assessed, presenting distributions that were very approximately normal in every case. Next, Levene's tests defined if variances were homogeneous or heterogeneous between the different groups of factors. Two constructs, leadership for cross-functional integration and manufacturing strategy linkage to corporate strategy, resulted in homogeneous variances, according to their Levene's *p*-values, which were significant at the 99 percent confidence level. Thus, One-Way ANOVAs with Tukey's *post hoc* tests were performed. For the other two constructs, functional integration and formulation of manufacturing strategy, which did not present homogeneity in their variances at the same level of confidence, Welch's ANOVA and Games-Howell *post hoc* tests were conducted, because they do not require that the compared groups present the same standard deviations. Independent groups were created in each of the categories analyzed by country to test the third assumption. This resulted in four different groups: by power distance index levels, individualism vs collectivism index levels and uncertainty avoidance index levels, with three different levels each; and finally, by long-term orientation vs short-term index levels, for which there were two different levels of respondents.

Additionally, data were assessed to ensure continuous dependent variables. The HPM project surveys for the selected constructs were designed with respondents being asked to answer on a five-point Likert scale. While rather an ordinal scale, Likert measurements might be employed as a continuous one (Field, 2009), this being particularly true when it comes to the use of parametric tests such as ANOVA, as, along with "other tests of central tendency are highly robust to things like skewness and non-normality" (Norman, 2010, p. 629). Finally, each group's boxplot was examined for significant outliers, as "analysis of variance methodologies can be sensitive to the presence of outliers" (Kabacoff, 2011, p. 230). Although some outliers were detected, it was decided not to remove them from the data set, since this would lower the sample size.

On what concerns the analysis of results, several scholars have been advocating for a broader interpretation, rather than the extensive search for the "stars" that traditionally indicate accepted significance levels (Brodeur *et al.*, 2016), while "unwarranted faith is placed in the *p*-value as a breakpoint [...] between valuable and worthless results"

Country	PDI		IDV		UAI		LST	
	Index	Level	Index	Level	Index	Level	Index	Level
Brazil	69	Moderate high	38	Medium low	76	High	44	Medium low
China	80	High	20	Low	30	Medium low	87	High
Germany	35	Medium low	67	Moderate high	65	Moderate high	83	High
South Korea	60	Moderate high	18	Low	85	High	100	High

Table IV.
Hofstede's national culture indexes and levels for selected countries

Note: PDI, power distance index; IDV, individualism vs collectivism; UAI, uncertainty avoidance; and LST, long-term orientation vs short-term orientation

Source: www.geerthofstede.edu and elaborated by the authors

(Bettis *et al.*, 2016, p. 259). Although we recognize that such pointer alerts for the fact that false positives may be erroneously inferred, ignoring “marginally insignificant coefficients” (Brodeur *et al.*, 2016, p. 2) may also lead to a misinterpretation of the data. Thus, instead of adopting a “rigid *p*-value breakpoint” that might be considered “inconsistent with good science” (Bettis *et al.*, 2016, p. 259), results are interpreted considering also *p*-values that surround the generally adopted thresholds as possible indicators of statistical relevance.

5. Results

A total of 20 ANOVAs, 20 *post hoc* tests and four *t*-tests were run, with each OS element construct being assessed for the six distinct data groupings. The study showed that there are significant results that suggest the relationship between National Culture dimensions and the OS aspects that were studied. Results are summarized in Table V.

Among the four countries, there is a clear difference in leadership for cross-functional integration (LDINT) (ANOVA *p*-value = 0.041) between China and Germany (*post hoc* Tukey’s test *p*-value = 0.029) and in functional integration (INTEG-FUNCI) (ANOVA *p*-value = 0.050) between Brazil and South Korea (*post hoc* Games-Howell’s test *p*-value = 0.009). Manufacturing strategy linkage to corporate strategy (LINKS) and formulation of manufacturing strategy (MFGSTR) also present differences, but with significance around the acceptable level (ANOVA *p*-values = 0.180 and 0.128, respectively). Therefore, the first evidences suggest that when different levels of Hofstede’s dimensions are identifiable, there are variations in the aspects related to the OS process. No significant differences were found between the three industries assessed, except for in formulation of manufacturing strategy (ANOVA *p*-value = 0.1024), yet with no particularly significant differences in the pairwise comparisons.

The second set of analyses had three different groups of power distance index levels (i.e. medium low, moderate high and high). For power distance, China presented a high level, while Brazil and South Korea presented moderate high levels. On the other hand, Germany has a medium low level. Strong evidence of differences between these groups suggest that leadership for cross-functional integration (ANOVA *p*-value = 0.021) and manufacturing strategy linkage to corporate strategy (ANOVA *p*-value = 0.094) are related to differences between medium low (Germany) and high (China) levels of power distance index (*post hoc* Tukey’s test *p*-values = 0.015 and 0.076, respectively). Contrary to initial expectations, results point to a positive relationship between power distance and leadership for cross-functional integration. This result may be considered as counterintuitive. The results also suggest that functional integration and formulation of manufacturing strategy do not differ among power distance levels (ANOVA *p*-values = 0.888 and 0.260, respectively). ANOVA analysis for functional integration and formulation of manufacturing strategy did not present a statistically significant result. Therefore, *H1a* and *H1c* were confirmed.

Data presented three levels for the individualism vs collectivism dimension in the third set. In this case, Germany presented moderate high level of individualism vs collectivism. Brazil presented medium low level, and China and South Korea, low levels of individualism both (i.e. both have high level of collectivism). There are differences in leadership for cross-functional integration for the levels of individualism (ANOVA *p*-value = 0.061), as expected. Evidences are also present for differences in functional integration (ANOVA *p*-value = 0.031) and formulation of manufacturing strategy (ANOVA *p*-value = 0.062), but for both with a positive relationship, meaning that the higher individualism, the higher the functional integration and the formulation of manufacturing strategy. The results show that manufacturing strategy linkage to corporate strategy also differ (ANOVA *p*-value = 0.117) between low (China and South Korea) and moderate high (Germany) individualism vs collectivism levels (*post hoc* Games-Howell’s test *p*-value = 0.102). Hence, *H2a-H2d* were confirmed.

		Leadership for cross-functional integration Mean(SD)	Operations strategy element Functional integration Mean(SD)	Manufacturing strategy linkage to corporate strategy Mean(SD)	Formulation of manufacturing strategy Mean(SD)
<i>Factors – National Culture Dimension Index Levels</i>					
Country					
1-G	N = 28	3.67 (0.35)[2]	3.91 (0.50)	4.06 (0.47)	3.92 (0.74)
2-C	N = 30	4.08 (0.69)[1]	3.85 (0.68)	3.70 (0.87)	3.64 (0.80)
3-B	N = 21	3.96 (0.53)	4.16 (0.42)[4]	3.92 (0.59)	4.06 (0.64)
4-K	N = 26	3.84 (0.54)	3.71 (0.48)[3]	3.83 (0.42)	3.71 (0.48)
Statistics	<i>p</i> -value	0.041**	0.050**	0.180	0.128
	<i>Z</i>	2.855	2.698	1.663	1.936
	df (in; within)	3;101	3;101	3;101	3;101
Industry					
1-E	N = 29	4.04 (0.59)	3.71 (0.66)	3.88 (0.76)	3.95 (0.62)
2-M	N = 41	3.82 (0.57)	3.77 (0.47)	3.84 (0.62)	3.63 (0.77)
3-T	N = 35	3.84 (0.52)	3.87 (0.55)	3.91 (0.53)	3.91 (0.62)
Statistics	<i>P</i> -value	0.229	0.4962	0.917	0.1024
	<i>F</i>	1.497	0.706	0.087	2.331
	df (in; within)	2;102	2;102	2;102	2;102
Power distance					
1-L	N = 0				
2-ML (G)	N = 28	3.67 (0.35)[4]	3.91 (0.50)	4.06 (0.47)[4]	3.92 (0.74)
3-MH (B, K)	N = 47	3.90 (0.53)	3.91 (0.51)	3.87 (0.50)	3.87 (0.58)
4-H (C)	N = 30	4.08 (0.69)[2]	3.85 (0.68)	3.70 (0.87)[2]	3.64 (0.80)
Statistics	<i>p</i> -value	0.021**	0.888	0.094*	0.260
	<i>Z</i>	4.015	0.119	2.416	1.365
	df (in; within)	2;102	2;102	2;102	2;102
Individualism vs collectivism					
1-L (C, K)	N = 56	3.97 (0.63)[3]	3.78 (0.59)[2]	3.76 (0.70)	3.67 (0.67)[2]
2-ML (B)	N = 21	3.96 (0.53)	4.16 (0.42)[1]	3.92 (0.59)	4.06 (0.64)[1]
3-MH (G)	N = 28	3.67 (0.35)[1]	3.91 (0.50)	4.06 (0.47)	3.92 (0.74)
4-H	N = 0				
Statistics	<i>p</i> -value	0.061*	0.031**	0.117	0.062*
	<i>Z</i>	2.882	3.585	2.196	2.856
	df (in; within)	2;102	2;102	2;102	2;102
Uncertainty avoidance					
1-L	N = 0				
2-ML (C)	N = 30	4.08 (0.69)[3]	3.85 (0.68)	3.70 (0.87)[3]	3.64 (0.80)
3-MH (G)	N = 28	3.67 (0.35)[2]	3.91 (0.50)	4.06 (0.47)[2]	3.92 (0.74)
4-H (B, K)	N = 47	3.90 (0.53)	3.91 (0.51)	3.87 (0.50)	3.87 (0.58)
Statistics	<i>p</i> -value	0.021**	0.888	0.094*	0.260
	<i>Z</i>	4.015	0.119	2.416	1.365
	df (in; within)	2;102	2;102	2;102	2;102
Long-term orientation					
1-L	N = 0				
2-ML (B)	N = 21	3.96 (0.53)	4.05 (0.47)	3.92 (0.59)	4.06 (0.64)
3-MH	N = 0				
4-H (C, G, K)	N = 84	3.87 (0.57)	3.72 (0.56)	3.86 (0.64)	3.75 (0.70)
Statistics	<i>p</i> -value	0.514	0.010**	0.737	0.062*
	<i>t</i>	0.656	2.722	0.337	1.934
	df	32.715	35.511	32.747	32.915

Table V.

Results for OS process elements grouped by countries, industry and national culture dimension index levels

Notes: For country identification: G, Germany, C, China, B, Brazil and K, South Korea; for industry identification: E, electronics, M, machinery and T, transport; for national cultures index levels: L, low, ML, medium-low, MH, moderate high and H, high. The numbers in parentheses are sample standard deviations; the numbers in parenthesis indicate the group means from which this group is significantly different at the 0.10 significance level, as indicated by Tukey's or Games-Howell pairwise comparison test. **p* < 0.10; ***p* < 0.05

The fourth set for uncertainty avoidance index levels aggregated the data in three different groups. In this case, Brazil and Korea presented high levels of uncertainty avoidance and Germany moderate high. In turn, China presented a medium low level. Similar to the power distance grouping, evidence suggests strong differences in leadership for cross-functional integration (ANOVA p -value = 0.021) and manufacturing strategy linkage to corporate strategy (ANOVA p -value = 0.094), both with significant differences between medium low (China) and moderate high (Germany) levels of uncertainty avoidance (*post hoc* Tukey's test p -values = 0.015 and 0.076). On the other hand, the results suggest that functional integration and formulation of manufacturing strategy do not differ among the levels of this national culture dimension. Therefore, only *H3a* and *H3c* were confirmed.

The fifth and final set of analyses contained groups with medium low (Brazil) and high (China, Germany and South Korea) levels of long-term orientation vs short term, with clear evidences pointing to differences on functional integration (t -test p -value = 0.010) and formulation of manufacturing strategy (t -test p -value = 0.062) in negative relationships, having Brazil presented the highest values for both elements. This is also a counterintuitive result. *Post hoc* tests were not performed, since this set only had two groups that were being compared. For the other two elements of OS, leadership for cross-functional integration and manufacturing strategy linkage to corporate strategy, the results suggest that they do not differ between long-term orientation vs short-term index levels. Thus, *H4b* and *H4d* were confirmed.

6. Discussion

Several authors have attributed a great deal of importance to social networking and indigenous management concepts or approaches, stating that they are a fundamental basis for comprehending the development of managerial practices in emerging economies (e.g. Horak and Klein, 2015; Minbaeva and Muratbekova-Touron, 2013; Smith *et al.*, 2012; Motta and Alcadipani, 1999). Such an understanding might also be helpful for explaining the main differences between China and Germany regarding OS. *Guanxi* has been portrayed in literature as a "pervasive relationship lubricant that helps to increase the efficiency and effectiveness of daily business operations" (Luo *et al.*, 2011, p. 140). At the same time, some authors characterize the Chinese leadership as a paternalistic leadership that combines authoritarianism, benevolence and moral leadership (Farh and Bor-Shiuan, 2000). In this sense, even though China has high power distance index levels, its indigenous culture would favor relationships and networking, which may explain higher values of leadership for cross-functional integration in the country. On the other hand, Germany carries a higher level of uncertainty avoidance, which was expected to be reflected in lower levels of leadership for cross-functional integration.

There is also evidence that leadership for cross-functional integration differs between the levels of the individualism vs collectivism dimension, with distinctions between low (China and South Korea) and moderate high (Germany) IDV countries, demonstrating that a more collective culture can facilitate an integration-oriented leadership. Following the same logic argued above, China's *guanxi* practices reflect the country's high collectivism culture, which also nurtures integrating leadership efforts.

There are different levels of functional integration between Brazil and South Korea, as well as between countries with low and medium low individualism vs collectivism dimensions (i.e. China and South Korea; Brazil), but with opposite relationship when compared to the literature. Although Brazil, based on Hofstede's model, carries a more individualistic culture, it had higher levels of cross-functional integration when compared with China and South Korea. According to Holanda (1936), as a result of an historical process, Brazilians hold an "aversion to social ritualism" (p. 147, our translation), which is a possible explanation for the individualistic traits reported by Hofstede's studies. This social ritualism aversion may decrease the barriers between "rival" functional areas, such as

operations and marketing, for instance. Thus, even though this was not an expected result, individualism may overcome functional constraints instead of strengthening them, maybe because individuals are “less” captives of functional or departments groups. In Germany, Brodbeck *et al.* (2002) showed that low compassion, low self-protection, low team orientation, high autonomy, and high participation are not constraints for high performance.

The two groups of long-term orientation vs short-term index levels (medium low – Brazil, and high – Germany, China and South Korea) also resulted in statistically significant differences. Similar to the above analysis, it showed a negative relationship between long-term orientation and functional integration. Besides the cultural traits, Brazil is a country that faces cyclical economic instabilities. This aspect might be a possible explanation for Brazil’s low long-term orientation score. The combination of short-term orientation perception and high functional integration would then be a mechanism by which Brazilian companies deal rapidly with external changes.

Third, manufacturing strategy linkage to corporate strategy carried significant differences among power distance (medium low and high, i.e. Germany and China) and uncertainty avoidance (medium low and moderate high, i.e. China and Germany) levels. For the individualism vs collectivism levels (low and moderate high, i.e. China and Germany), evidence for differences between the countries was present, while its relationship with long-term orientation vs short term could not be proved. These findings strengthen the idea on German companies first proposed by Simon (1992), and his then ground-breaking term, “hidden champions.” Hidden champions are midsized German companies, which had a low profile as far as regards media and consumer attention, but that had market leadership on a global scale (Simon, 1992, 1996, 2009). Such characteristics culminate in a narrow focus on a highly technical, expertise-demanding niche, meaning also that these companies concentrate all of their resources on maintaining the top position in their chosen sector. Germany’s lower power distance and higher uncertainty avoidance could explain the adherence to strategies in the local companies; in other words, they succeed in implementing the manufacturing strategy. In this sense, the latter may also advocate for the high performance levels of such firms.

Finally, moderate evidence of differences between the countries with low and medium low individualism vs collectivism levels (i.e. China and South Korea; Brazil) were found for formulation of manufacturing strategy. This could also be understood from the social networking perspective. As discussed above, China’s *guanxi* relates to the exchange of favours or obligations within social networks, reflected in its low scores on the individualism vs collectivism index. The Korean *yonggo*, in turn, refers to the different networks and configures exclusive trusting relationships (Horak and Klein, 2015). Although these concepts share similarities as well as differences, their contribution to collectivism is perceptible. Along with this trait, they are also reported to be more influential on people’s behavior than formal rules and prescriptions, which would lend a better comprehension as to why these two countries scored lower on formulation of manufacturing strategy than the others.

Empirical evidence also points to relevant differences between the two groups of long-term orientation vs short-term levels (medium low – Brazil, and high – China, Germany and South Korea). Although Brazil has a less long-term oriented culture than the other three countries assessed, it scored higher on the formulation of manufacturing strategy scales. One possible explanation here is also related to the Brazilian aversion to social and formal rules. A formalized manufacturing strategy may be a way for Brazilian companies to strengthen internally their strategic goals. It could also be the case of assessing OS from different perspectives, as “alternative operations strategy” may be detected in organizations with difficulties in the execution of formal strategies (Jagoda *et al.*, 2016, p. 740). Table VI summarizes the results found.

Although comparisons between countries were expected to indicate more significant differences, each country also carries multiple national cultural dimensions. This might open the possibility of the combine impacts of the four assessed dimensions of culture on the aspects of the OS process to be annulled by each other, or at least compensated for. On what concerns differences between industries, it is also possible that the organizational culture present in such sectors may be largely influenced by national cultures traits, as there is reportedly a “logical connection between national and organizational culture via individual socialization and institutional forms” (Nelson and Gopalan, 2003, p. 1116).

7. Conclusion

In addition to analyzing the extent to which national cultures explain the differences in diverse elements of the OS process, from a more generalist perspective this study aimed to achieve a more in-depth understanding of the relationship between these two apparently disconnected topics. In that sense, as discussed throughout the text, the relevance of the research relies on providing empirical evidence for filling some gaps around how national culture may impact on the formulation, implementation and maintenance of OS. Such an effort was conducted by assessing the HPM project’s fourth round data and Hofstede’s cultural classification.

Moreover, we may state that the elements of the OS process differ for the levels of Hofstede’s dimensions of national culture. All the analyzed elements of OS process (leadership for cross-functional integration, functional integration, manufacturing strategy linkage to corporate strategy and formalization of manufacturing strategy) present differences in at least two of the Hofstede’s dimensions. Individualism vs collectivism is the dimension that displayed differences in all the elements of OS process. This is relevant because shows that internal group and teams are essential for the OS process. For example, China and Korea with a high presence of social networks present a low result for formulation of manufacturing strategy and higher results for leadership for cross-functional integration, as expected. On the other hand, more individualistic and formal processes are present in Germany, showing that there the OS process does not follow a “one size fits all” approach.

Nevertheless, some results were counterintuitive. Surprisingly, China with the highest power distance group also presented the higher result for leadership for cross-functional integration. Additionally, Brazil presented the lowest mean for long-term orientation and the highest mean for formulation of manufacturing strategy. Therefore, those results suggest again that the national culture is key for these two aspects of the OS process. China has a strong influence of its leadership approach on their social rules. On the other hand, Brazilian aversion to social rules may create a need for the manufacturing strategy formalization. These results suggest that a narrow and sometimes ethnocentric view is not enough for the OS process.

The assessment of OS from a cultural approach can shed new light on different choices and decisions, as global supply chains emerge as a model for competitiveness, leading to different cultures interacting in cooperative behavior to gain better performance and competitive advantage. The empirical work highlights strong relationships between culture and OS,

	Power distance	Individualism collectivism	Uncertainty avoidance	Long-term orientation
Leadership for cross-functional integration	Significant	Significant	Significant	ns
Functional integration	ns	Significant	ns	Significant
Manufacturing strategy linkage to corporate strategy	Significant	ns	Significant	ns
Formulation of manufacturing strategy	ns	Significant	ns	Significant
Hypotheses confirmation per national culture dimension	Partially confirmed	Confirmed	Partially confirmed	Partially confirmed

Table VI.
Summary of results and hypotheses confirmation

indicating their importance and contributing new perspectives both to theory and practice as far as regards the planning and implementation of strategic and operations management.

One contribution of this study relies on the fact that the results emphasize that culture has an identifiable impact on Operations. Major issues might find answers by assessing the motivations and patterns embedded in cultural characteristics. Since behavioral patterns might be understood to be the result of the social environments that individuals are embedded in (at least partially), some explanations of human actions were brought from the sociology literature. Social relations such as *guanxi* and *yongo* were brought into the discussions, along with historical backgrounds, thus offering additional and complementary views on how expectations and interactions between employees may influence their relationship with companies. Within this reasoning, Hofstede's national culture classifications were contextualized, helping to build the logic behind the general behaviors observed in each society analyzed, and more specifically looking at how they can affect the planning, implementation and results of OS.

As for practical implications, an understanding of the impact of national culture dynamics on OS can enlighten the formulation, implementation and maintenance processes of the latter. Managers involved in internationalization processes might encounter ways of dealing with different cultures if they understand their relevance when it comes to OS. Dealing with high power distance cultures such as the ones located in Asia, for instance, do not necessarily implicate on higher difficulties in functional integration as would intuitively expected. Instead, such companies may find significantly higher levels of integration between different functions in China and South Korea, as they are inserted in cultures that favor the collective identity. At the same time, China has consistently scored lower in formulation of manufacturing strategy for all the comparisons, calling for the need of managers to approach the matter from a different perspective, possibly relying on alternative OS paths, as mentioned before. The study also contributes to the understanding that successful OS is conditional upon its adaptation to specific environments. By doing so, companies could explore the maximum potential of their strategies, thereby avoiding waste caused by any eventual lack of adherence between national and organizational cultures. This is particularly relevant to firms in global supply chains and/or strong internationalization processes, as a better understanding of the supply chain partners' social elements may lead to more efficient OM.

This study has its limitations. The HPM project, although very consolidated and known for its cross-cultural nature and multiple respondents within the plants involved, is based on a cross-sectional investigation. The observation of the longitudinal evolution of OS elements may clarify other issues that were not captured by this data collection. Because of the large extent of the project, respondent selection often relies on a convenience sample, which does not allow for a guarantee on its representativeness. The selection of four countries for the study also results in a relatively small sample size, allowing medium or large effects to be captured by the analysis, yet possibly ignoring smaller differences between the distinct groups as statistically significant.

Moreover, the scales utilized in this study reflect measurement models that were designed and implemented as part of the broader project, meaning that they may not be exactly suited to the purposes of this research. It is also centered on the plant as the basic unit of analysis, instead of the whole supply chain, and relies on respondent perceptions. Future research could encompass other sources of information (i.e. document research, open-ended interviews) to fill the gaps left by the survey technique and possibly involve other supply chain partners.

Additionally, our study presumes that Hofstede's dimension levels have intra-country homogeneity and inter-country heterogeneity, meaning that each plant would reflect its country's cultural behavior. Future studies could also consider administering both cultural dimension and OM questionnaires, thereby confirming such behavior or capturing external influences that may emerge from cross-cultural transactions.

References

- Acur, N., Gertsen, F., Sun, H. and Frick, J. (2003), "The formalisation of manufacturing strategy and its influence on the relationship between competitive objectives, improvement goals, and action plans", *International Journal of Operations & Production Management*, Vol. 23 No. 10, pp. 1114-1141.
- Ahmad, S. and Schroeder, R.G. (2003), "The impact of human resource management practices on operational performance: recognizing country and industry differences", *Journal of Operations Management*, Vol. 21 No. 1, pp. 19-43.
- Anderson, D.R., Sweeney, D.J. and Williams, T.A. (2010), *Essentials of Statistics for Business and Economics*, 6th ed., South Western, Mason, OH.
- Anderson, J.C., Schroeder, R.G. and Cleveland, G. (1991), "The process of manufacturing strategy: some empirical observations and conclusions", *International Journal of Operations & Production Management*, Vol. 11 No. 3, pp. 86-110.
- Ardichvili, A. and Kuchinke, P.K. (2002), "Leadership styles and cultural values among managers and subordinates: a comparative study of four countries of the former Soviet Union, Germany and the USA", *Human Resource Development International*, Vol. 5 No. 1, pp. 99-117.
- Ayoun, B.M. and Moreo, P.J. (2008), "The influence of the cultural dimension of uncertainty avoidance on business strategy development: a cross-national study of hotel managers", *International Journal of Hospitality Management*, Vol. 27 No. 1, pp. 65-75.
- Baker, D.S. and Carson, K.D. (2011), *The Two Faces of Uncertainty Avoidance: Attachment and Adaptation*, Institute of Behavioral and Applied Management, Lafayette.
- Barnes, D. (2001), "Research methods for the empirical investigation of the process of formation of operations strategy", *International Journal of Operations & Production Management*, Vol. 21 No. 8, pp. 1076-1095.
- Barnes, D. (2002), "The complexities of the manufacturing strategy formation process in practice", *Journal of Operations & Production Management*, Vol. 22 No. 10, pp. 1090-1111.
- Bettis, R.A., Ethiraj, S., Gambardella, A., Helfat, C. and Mitchell, W. (2016), "Creating repeatable cumulative knowledge in strategic management: a call for a broad and deep conversation among authors, referees, and editors", *Strategic Management Journal*, Vol. 37 No. 2, pp. 257-261.
- Boal, K.B. and Hooijberg, R. (2000), "Strategic leadership research: moving on", *The Leadership Quarterly*, Vol. 11 No. 4, pp. 515-549.
- Boyer, K.K., Swink, M. and Rosenzweig, E.D. (2005), "Operations strategy research in the POMS Journal", *Production and Operations Management*, Vol. 14 No. 4, pp. 442-449.
- Bozarth, C.C., Warsing, D.P., Flynn, B.B. and Flynn, E.J. (2009), "The impact of supply chain complexity on manufacturing plant performance", *Journal of Operations Management*, Vol. 27 No. 1, pp. 78-93.
- Brodbeck, F.C., Frese, M. and Mansour, J. (2002), "Leadership made in Germany: low on compassion, high on performance", *The Academy of Management Executive*, Vol. 16 No. 1, pp. 16-29.
- Brodeur, A., Lé, M., Sangnier, M. and Zylberberg, Y. (2016), "Star wars: the empirics strike back", *American Economic Journal: Applied Economics*, Vol. 8 No. 1, pp. 1-32.
- Brown, S., Squire, B. and Blackmon, K. (2007), "The contribution of manufacturing strategy involvement and alignment to world-class manufacturing performance", *International Journal of Operations & Production Management*, Vol. 27 No. 3, pp. 282-302.
- Builtjens, R.P.M. and Noorderhaven, N.G. (1996), *The Influence of National Culture on Strategic Decision Making: A Case Study of the Philippines*, Organization Tilburg.
- Burgelman, R.A. and Grove, A.S. (2007), "Let chaos reign, then rein in chaos-repeatedly: managing strategic dynamics for corporate longevity", *Strategic Management Journal*, Vol. 28 No. 10, pp. 965-979.
- Chakrabarty, S. (2009), "The influence of national culture and institutional voids on family ownership of large firms: a country level empirical study", *Journal of International Management*, Vol. 15 No. 1, pp. 32-45.

- Chemers, M.M. (2003), "Leadership effectiveness: functional, constructivist, and empirical perspectives", in Van Knippenberg, D. and Hogg, M.A. (Eds), *Leadership and Power. Identity Processes in Groups and Organizations*, Sage Publications, London, pp. 5-17.
- Chen, F.F. and West, S.G. (2008), "Measuring individualism and collectivism: the importance of considering differential components, reference groups, and measurement invariance", *Journal of Research in Personality*, Vol. 42 No. 2, pp. 259-294.
- Chen, Z., Huang, Y. and Sternquist, B. (2011), "Guanxi practice and Chinese buyer-supplier relationships: the buyer's perspective", *Industrial Marketing Management*, Vol. 40 No. 4, pp. 569-580.
- Cohen, M.A. and Lee, H.L. (1985), "Manufacturing strategy. Concepts and methods", in Kleindorfer, P.R. (Ed.), *The Management of Productivity and Technology in Manufacturing*, Plenum Press, New York, NY, pp. 153-188.
- Cronbach, L.J. (1951), "Coefficient alpha and the internal structure of tests", *Psychometrika*, Vol. 16 No. 3, pp. 297-334.
- Dangayach, G.S. and Deshmukh, S.G. (2001), "Manufacturing strategy: literature review and some issues", *International Journal of Operations & Production Management*, Vol. 21 No. 7, pp. 884-932.
- Daspit, J., Tillman, C.J., Boyd, N.G. and Mckee, V. (2013), "Cross-functional team effectiveness: an examination of internal team environment, shared leadership, and cohesion influences", *Team Performance Management: An International Journal*, Vol. 19 Nos 1/2, pp. 34-56.
- De Meester, L., De Meyer, A. and Grahovac, J. (2014), "The role of operations executives in strategy making", *Journal of Operations Management*, Vol. 32 Nos 7-8, pp. 403-413.
- Dorfman, P.W., Howell, J.P., Hibino, S., Lee, J.K., Tate, U. and Bautista, A. (1997), "Leadership in Western and Asian countries: commonalities and differences in effective leadership processes across cultures", *The Leadership Quarterly*, Vol. 8 No. 3, pp. 233-274.
- Dyer, J.H. and Chu, W. (2000), "The determinants of trust in supplier-automaker relationships in the U.S., Japan, and Korea", *Journal of International Business Studies*, Vol. 31 No. 2, pp. 259-285.
- Dyer, J.H. and Chu, W. (2011), "The determinants of trust in supplier-automaker relationships in the U.S., Japan, and Korea: a retrospective", *Journal of International Business Studies*, Vol. 42 No. 1, pp. 1-7.
- Dyer, J.H. and Nobeoka, K. (2000), "Creating and managing a high performance knowledge-sharing network: the Toyota case", *Strategic Management Journal*, Vol. 21 No. 1, pp. 345-367.
- Ellram, L.M. (1991), "A managerial guideline for the development and implementation of purchasing partnerships", *International Journal of Purchasing and Materials Management*, Vol. 27 No. 3, pp. 2-8.
- Enders, C.K. (2010), *Applied Missing Data Analysis*, The Guilford Press, New York, NY.
- Farh, J. and Bor-Shuan, C. (2000), "A cultural analysis of paternalistic leadership in Chinese organizations", in Li, J.T., Tsui, A.S. and Weldon, E. (Eds), *Management and Organizations in the Chinese Context*, Palgrave Macmillan, London, pp. 84-127.
- Field, A. (2009), *Discovering Statistics Using R*, 3rd ed., Sage Publications, London.
- Finger, A.B., Flynn, B.B. and Paiva, E.L. (2014), "Anticipation of new technologies: supply chain antecedents and competitive performance", *International Journal of Operations & Production Management*, Vol. 34 No. 6, pp. 807-828.
- Flynn, B.B., Schroeder, R.G. and Flynn, E.J. (1999), "World class manufacturing: an investigation of Hayes and Wheelwright's foundation", *Journal of Operations Management*, Vol. 17 No. 3, pp. 249-269.
- Foerstl, K., Hartmann, E., Wynstra, F. and Moser, R. (2013), "Cross-functional integration and functional coordination in purchasing and supply chain management: antecedents and effects on purchasing and firm performance", *International Journal of Operations & Production Management*, Vol. 33 No. 6, pp. 689-721.

- Fornell, C. and Larcker, D.F. (1981), "Evaluating structural equation models with unobservable variables and measurement error", *Journal of Marketing Research*, Vol. 18 No. 1, pp. 39-50.
- Frankel, R. and Mollenkopf, D.A. (2015), "Cross-functional integration revisited: exploring the conceptual elephant", *Journal of Business Logistics*, Vol. 36 No. 1, pp. 18-24.
- Gagnon, S. (1999), "Resource-based competition and the new operations strategy", *International Journal of Operations & Production Management*, Vol. 19 No. 2, pp. 125-138.
- Gebauer, H. (2009), "An attention-based view on service orientation in the business strategy of manufacturing companies", *Journal of Managerial Psychology*, Vol. 24 No. 1, pp. 79-98.
- Gemser, G. and Leenders, M.A.A.M. (2011), "Managing cross-functional cooperation for new product development success", *Long Range Planning*, Vol. 44 No. 1, pp. 26-41.
- Ghobadi, S. and D'Ambra, J. (2012), "Knowledge sharing in cross-functional teams: a cooperative model", *Journal of Knowledge Management*, Vol. 16 No. 2, pp. 285-301.
- Glunk, U., Wilderom, C. and Ogilvie, R. (1996), "Finding the key to German-style management", *International Studies of Management & Organization*, Vol. 26 No. 3, pp. 93-108.
- Hair, J.F. Jr, Babin, B., Money, A.H. and Samouel, P. (2003), *Essentials of Business Research Methods*, Wiley, Hoboken, NJ.
- Hallgren, M. and Olhager, J. (2009), "Lean and agile manufacturing: external and internal drivers and performance outcomes", *International Journal of Operations & Production Management*, Vol. 29 No. 10, pp. 976-999.
- Hausman, W.H., Montgomery, D.B. and Roth, A.V. (2002), "Why should marketing and manufacturing work together? Some exploratory empirical results", *Journal of Operations Management*, Vol. 20 No. 3, pp. 241-257.
- Hayes, R.H. and Upton, D.M. (1998), "Operations-based strategy", *California Management Review*, Vol. 40 No. 4, pp. 8-25.
- Hayes, R.H. and Wheelwright, S.C. (1985), *Restoring Our Competitive Edge: Competing Through Manufacturing*, Wiley, New York, NY.
- Hofstede, G. (1980a), *Culture's Consequences: International differences in Work-Related Values*, Sage Publications, London.
- Hofstede, G. (1980b), "Motivation, leadership and organization: do American theories apply abroad?", *Organizational Dynamics*, Vol. 16 No. 4, pp. 42-63.
- Hofstede, G. (1983), "The cultural reliability of organizational practices and theories", *Journal of International Business Studies*, Vol. 14 No. 2, pp. 75-89.
- Hofstede, G. (1993), "Cultural constraints in management theories", *The Executive*, Vol. 7 No. 1, pp. 81-95.
- Hofstede, G. (1994), "Management scientists are human", *Management Science*, Vol. 40 No. 1, pp. 4-13.
- Hofstede, G. (2001), *Cultures Consequences. Comparing Values, Behaviors, Institutions, and Organizations Across Nations*, 2nd ed., Sage Publications, Inc., London.
- Hofstede, G. and Bond, M.H. (1988), "The confucius connection: from cultural roots to economic growth", *Organizational Dynamics*, Vol. 16 No. 4, pp. 4-21.
- Hofstede, G. and Minkov, M. (2013), "Values survey module 2013 manual", available at: [www.geerthofstede.com/media/2186/Manual%20VSM20.202013\(2008\):202013](http://www.geerthofstede.com/media/2186/Manual%20VSM20.202013(2008):202013)
- Holanda, S.B. (1936), *Raizes do Brasil*, 26th ed., Companhia das Letras, São Paulo.
- Hope, C. (2004), "The impact of national culture on the transfer of 'best practice operations management' in hotels in St. Lucia", *Tourism Management*, Vol. 25 No. 1, pp. 45-59.
- Horak, S. and Klein, A. (2015), "Persistence of informal social networks in East Asia: evidence from South Korea", *Asia Pacific Journal of Management*, Vol. 33 No. 3, pp. 673-694.
- Jagoda, K., Kiridena, S. and Lin, X. (2016), "Alternative operations strategy processes: do they matter?", *Production Planning & Control*, Vol. 27 No. 9, pp. 740-752.

- Kabacoff, R.I. (2011), *R in Action. Data Analysis and Graphics with R*, Manning Publications, Shelter Island, NY.
- Ketkar, S., Kock, N., Parente, R. and Verville, J. (2012), "The impact of individualism on buyer-supplier relationship norms, trust and market performance: an analysis of data from Brazil and the USA", *International Business Review*, Vol. 21 No. 5, pp. 782-793.
- Kim, Y., Sting, F. and Loch, C. (2014), "Top-down, bottom-up, or both? Toward an integrative perspective on operations strategy formation", *Journal of Operations Management*, Vol. 32 Nos 7-8, pp. 462-474.
- Kull, T.J. and Wacker, J.G. (2010), "Quality management effectiveness in Asia: the influence of culture", *Journal of Operations Management*, Vol. 28 No. 3, pp. 223-239.
- Lee, P.K.C. and Humphreys, P.K. (2007), "The role of Guanxi in supply management practices", *International Journal of Production Economics*, Vol. 106 No. 2, pp. 450-467.
- Leong, G.K., Snyder, D.L. and Ward, P.T. (1990), "Research in the process and content of manufacturing strategy", *Omega*, Vol. 18 No. 2, pp. 109-122.
- Liao, K., Sharkey, T.W., Ragu-Nathan, T.S. and Vonderembse, M. (2012), "Trust-driven joint operational activities to achieve mass customization: a culture perspective", *Benchmarking: An International Journal*, Vol. 19 Nos 4/5, pp. 585-603.
- Little, R.J.A. (1988), "A test of missing completely at random for multivariate data with missing values", *Journal of the American Statistical Association*, Vol. 83 No. 404, pp. 1198-1202.
- Luo, Y., Huang, Y. and Wang, S.L. (2011), "Guanxi and organizational performance: a meta-analysis", *Management and Organization Review*, Vol. 8 No. 1, pp. 139-172.
- Malhotra, M.K. and Sharma, S. (2002), "Spanning the continuum between marketing and operations", *Journal of Operations Management*, Vol. 20 No. 3, pp. 209-219.
- Marucheck, A., Pannesi, R. and Anderson, C. (1990), "An exploratory study of the manufacturing strategy process in practice", *Journal of Operations Management*, Vol. 9 No. 1, pp. 101-123.
- Mellor, S., Hao, L. and Zhang, D. (2014), "Additive manufacturing: a framework for implementation", *International Journal of Production Economics*, Vol. 149, March, pp. 194-201.
- Menda, R. and Dilts, D. (1997), "The manufacturing strategy formulation process: linking multifunctional viewpoints", *Journal of Operations Management*, Vol. 15 No. 4, pp. 223-241.
- Menor, L.J. and Roth, A. (2007), "New service development competence in retail banking: construct development and measurement validation", *Journal of Operations Management*, Vol. 25 No. 4, pp. 825-846.
- Miltenburg, J. (2005), *Manufacturing Strategy. How to Formulate and Implement a Winning Plan*, Productivity Press, New York, NY.
- Minbaeva, D.B. and Muratbekova-Touron, M. (2013), "Clanism. Definition and implications for human resource management", *Management International Review*, Vol. 53 No. 1, pp. 109-139.
- Minkov, M. (2007), *What Makes Us Different and Similar: A New Interpretation of the World Values Survey and Other Cross-Cultural Data*, Klasika I Stil, Sofia.
- Motta, F.C.P. and Alcadipani, R. (1999), "Jeitinho brasileiro, controle social e competição", *RAE – Revista de Administração de Empresas*, Vol. 39 No. 1, pp. 6-12.
- Nakata, C. and Im, S. (2010), "Spurring cross-functional integration for higher new product performance: a group effectiveness perspective", *Journal of Product Innovation Management*, Vol. 27 No. 4, pp. 554-571.
- Naor, M., Linderman, K.W. and Schroeder, R.G. (2010), "The globalization of operations in Eastern and Western countries: unpacking the relationship between national and organizational culture and its impact on manufacturing performance", *Journal of Operations Management*, Vol. 28 No. 3, pp. 194-205.
- Naor, M., Goldstein, S.M., Linderman, K.W. and Schroeder, R.G. (2008), "The role of culture as driver of quality management and performance: infrastructure versus core quality practices", *Decision Sciences*, Vol. 39 No. 4, pp. 671-702.

- Nelson, R.E. and Gopalan, S. (2003), "Do organizational cultures replicate national cultures? Isomorphism, rejection and reciprocal opposition in the corporate values of three countries", *Organization Studies*, Vol. 24 No. 7, pp. 1115-1151.
- Nielsen, B.B. and Nielsen, S. (2011), "The role of top management team international orientation in international strategic decision-making: the choice of foreign entry mode", *Journal of World Business*, Vol. 46 No. 2, pp. 185-193.
- Nielsen-Englyst, L. (2003), "Operations strategy formation – a continuous process", *Integrated Manufacturing Systems*, Vol. 14 No. 8, pp. 677-685.
- Nonaka, I., Toyama, R. and Nagata, A. (2000), "A firm as a knowledge-creating entity: a new perspective on the theory of the firm", *Industrial and Corporate Change*, Vol. 9 No. 1, pp. 1-20.
- Norman, G. (2010), "Likert scales, levels of measurement and the 'laws' of statistics", *Advances in Health Sciences Education*, Vol. 15 No. 5, pp. 625-632.
- O'Leary-Kelly, S.W. and Flores, B.E. (2002), "The integration of manufacturing and marketing/sales decisions: impact on organizational performance", *Journal of Operations Management*, Vol. 20 No. 3, pp. 221-240.
- Ocasio, W. and Joseph, J. (2015), "An attention-based theory of strategy formulation: linking micro- and macroperspectives in strategy processes", in Szulanski, G., Porac, J. and Doz, Y. (Eds), *Strategy Process*, Emerald Group Publishing Limited, pp. 39-61.
- Pagell, M., Katz, J.P. and Sheu, C. (2005), "The importance of national culture in operations management research", *International Journal of Operations & Production Management*, Vol. 25 No. 4, pp. 371-394.
- Paiva, E.L. (2010), "Manufacturing and marketing integration from a cumulative capabilities perspective", *International Journal of Production Economics*, Vol. 126 No. 2, pp. 379-386.
- Paiva, E.L., Roth, A. and Fensterseifer, J.E. (2008), "Organizational knowledge and the manufacturing strategy process: a resource-based view analysis", *Journal of Operations Management*, Vol. 26 No. 1, pp. 115-132.
- Paiva, E.L., Teixeira, R., Vieira, L.M. and Finger, A.B. (2014), "Supply chain planning and trust: two sides of the same coin", *Industrial Management & Data Systems*, Vol. 114 No. 3, pp. 405-420.
- Power, D., Schoenherr, T. and Samson, D. (2010), "The cultural characteristic of individualism/collectivism: a comparative study of implications for investment in operations between emerging Asian and industrialized Western countries", *Journal of Operations Management*, Vol. 28 No. 3, pp. 206-222.
- Prasad, S., Babbar, S. and Motwani, J. (2001), "International operations strategy: current efforts and future directions", *International Journal of Operations & Production Management*, Vol. 21 Nos 5/6, pp. 645-665.
- Rho, B.H., Park, K. and Yu, Y.M. (2001), "An international comparison of the effect of manufacturing strategy-implementation gap on business performance", *International Journal of Production Economics*, Vol. 70 No. 1, pp. 89-97.
- Riis, J.O., Dukovska-Popovska, I. and Johansen, J.J. (2006), "Participation and dialogue in strategic manufacturing development", *Production Planning & Control*, Vol. 17 No. 2, pp. 176-188.
- Rowe, W.G. (2001), "Creating wealth in organizations: the role of strategic leadership", *Academy of Management Perspectives*, Vol. 15 No. 1, pp. 81-94.
- Rudberg, M. and West, B.M. (2008), "Global operations strategy: coordinating manufacturing networks", *Omega – The International Journal of Management Science*, Vol. 36 No. 1, pp. 91-106.
- Rytter, N.G., Boer, H. and Koch, C. (2007), "Conceptualizing operations strategy processes", *International Journal of Operations & Production Management*, Vol. 27 No. 10, pp. 1093-1114.
- Schroeder, R.G. and Flynn, B.B. (2001), *High Performance Manufacturing – Global Perspectives*, John Wiley & Sons, Inc., Danvers, MA.
- Schroeder, R.G., Anderson, J.C. and Cleveland, G. (1986), "The content of manufacturing strategy: an empirical study", *Journal of Operations Management*, Vol. 6 No. 4, pp. 405-415.

- Schroeder, R.G., Bates, K.A. and Juntilla, M.M. (2002), "A resource-based view of manufacturing strategy and the relationship to manufacturing performance", *Strategic Management Journal*, Vol. 23 No. 2, pp. 105-117.
- Simon, H. (1992), "Lessons from Germany's midsize", *Harvard Business Review*, Vol. 70 No. 2, pp. 115-123.
- Simon, H. (1996), "You don't need to be German to be a 'hidden champion'", *Business Strategy Review*, Vol. 7 No. 2, pp. 1-13.
- Simon, H. (2009), *Hidden Champions of the Twenty-First Century. Success Strategies of Unknown World Market Leaders*, Springer, New York, NY.
- Skinner, W. (1969), "Manufacturing – missing link in corporate strategy", *Harvard Business Review*, Vol. 47 No. 3, pp. 5-14.
- Slack, N. and Lewis, M. (2011), *Operations Strategy*, Pearson Education Limited, Harlow.
- Smith, P.B., Peterson, M.F. and Schwartz, S.H. (2002), "Cultural values, sources of guidance and their relevance to managerial behavior: a 47-nation study", *Journal of Cross Cultural Psychology*, Vol. 33 No. 2, pp. 188-208.
- Smith, P.B., Torres, C., Leong, C.H., Budhwar, P., Achoui, M. and Lebedeva, N. (2012), "Are indigenous approaches to achieving influence in business organizations distinctive? A comparative study of guanxi, wasta, jeitinho, svyazi and pulling strings", *The International Journal of Human Resource Management*, Vol. 23 No. 2, pp. 333-348.
- Swink, M. and Schoenherr, T. (2015), "The effects of cross-functional integration on profitability, process efficiency, and asset productivity", *Journal of Business Logistics*, Vol. 36 No. 1, pp. 69-87.
- Swink, M., Narasimhan, R. and Wang, C. (2007), "Managing beyond the factory walls: effects of four types of strategic integration on manufacturing plant performance", *Journal of Operations Management*, Vol. 25 No. 1, pp. 148-164.
- Tan, K.C., Kannan, V.R. and Narasimhan, R. (2007), "The impact of operations capability on firm performance", *International Journal of Production Research*, Vol. 45 No. 21, pp. 5135-5156.
- Thomas, T., Schermerhorn, J.R. Jr and Dienhart, J.W. (2004), "Strategic leadership of ethical behavior in business", *Academy of Management Perspectives*, Vol. 18 No. 2, pp. 56-66.
- Thun, J. (2008), "Empirical analysis of manufacturing strategy implementation", *International Journal of Production Economics*, Vol. 113 No. 1, pp. 370-382.
- Trent, R.J. (1996), "Understanding and evaluating cross-functional sourcing team leadership", *International Journal of Purchasing and Materials Management*, Vol. 32 No. 3, pp. 29-36.
- Vecchi, A. and Brennan, L. (2011), "Quality management: a cross-cultural perspective based on the GLOBE framework", *International Journal of Operations & Production Management*, Vol. 31 No. 5, pp. 527-553.
- Voss, C. and Blackmon, K. (1998), "Differences in manufacturing strategy decisions between Japanese and Western manufacturing plants: the role of strategic time orientation", *Journal of Operations Management*, Vol. 16 Nos 2-3, pp. 147-158.
- Wang, T. and Bansal, P. (2012), "Social responsibility in new ventures: profiting from a long-term orientation", *Strategic Management Journal*, Vol. 33 No. 10, pp. 1135-1153.
- Webber, S.S. (2002), "Leadership and trust facilitating cross-functional team success", *Journal of Management Development*, Vol. 21 No. 3, pp. 201-214.
- Wheelwright, S.C. (1984), "Manufacturing strategy: defining the missing link", *Strategic Management Journal*, Vol. 5 No. 1, pp. 77-91.
- Wheelwright, S.C. and Hayes, R.H. (1985), "Competing through manufacturing", *Harvard Business Review*, Vol. 63 No. 1, pp. 99-109.
- Wiengarten, F., Fynes, B., Pagell, M. and Búrca, S. (2011), "Exploring the impact of national culture on investments in manufacturing practices and performance. An empirical multi-country study", *International Journal of Operations & Production Management*, Vol. 31 No. 5, pp. 554-578.

-
- Wolf, E.J., Harrington, K.M., Clark, S.L. and Miller, M.W. (2013), "Sample size requirements for structural equation models: an evaluation of power, bias, and solution propriety", *Educational and Psychological Measurement*, Vol. 76 No. 6, pp. 913-934.
- Zaccaro, S.J. and Klimoski, R. (2002), "The interface of leadership and team processes", *Group & Organization Management*, Vol. 27 No. 1, pp. 4-13.
- Zatzick, C.D., Moliterno, T.P. and Fang, T. (2012), "Strategic (mis)fit: the implementation of TQM in manufacturing organizations", *Strategic Management Journal*, Vol. 33 No. 11, pp. 1321-1330.
- Zhao, X., Huo, B., Flynn, B.B. and Yeung, J.H.Y. (2008), "The impact of power and relationship commitment on the integration between manufacturers and customers in a supply chain", *Journal of Operations Management*, Vol. 26 No. 3, pp. 368-388.

Appendix. Manufacturing strategy constructs

Manufacturing strategy scales items

- (1) Leadership for cross-functional integration:
 - our managers do a good job of solving inter-functional conflicts;
 - we are encouraged to communicate well with different functions in this plant; and
 - our managers communicate effectively with managers in other functions.
- (2) Functional integration:
 - the functions in our plant are well integrated;
 - functional coordination works well in our plant;
 - the functions in our plant work well together;
 - our plant's functions coordinate their activities; and
 - our plant's functions work interactively with each other.
- (3) Manufacturing strategy linkage to corporate strategy:
 - potential manufacturing investments are screened for consistency with our business strategy;
 - at our plant, manufacturing is kept in step with our business strategy; and
 - corporate decisions are often made without consideration of the manufacturing strategy.
- (4) Formulation of manufacturing strategy:
 - our plant has a formal manufacturing strategy process, which results in a written mission, goals and strategies;
 - this plant has a manufacturing strategy, which is put into writing;
 - plant management routinely reviews and updates a long-range manufacturing strategy; and
 - the plant follows an informal manufacturing strategy, with no written strategy document.

Corresponding author

Camila Lee Park can be contacted at: camilapark@gmail.com

For instructions on how to order reprints of this article, please visit our website:

www.emeraldgrouppublishing.com/licensing/reprints.htm

Or contact us for further details: permissions@emeraldinsight.com

This article has been cited by:

1. LiXue, Xue Li, ChenLucy Gongtao, Lucy Gongtao Chen, ChenJian, Jian Chen. 2019. Individual and cultural differences in newsvendor decision making. *International Journal of Operations & Production Management* **39**:1, 164-186. [[Abstract](#)] [[Full Text](#)] [[PDF](#)]
2. 2018. Towards an effective operations strategy process. *Strategic Direction* **34**:6, 16-18. [[Abstract](#)] [[Full Text](#)] [[PDF](#)]



critical perspectives on international business

The duality of the Brazilian jeitinho: An empirical investigation and conceptual framework

Camila Lee Park, Mauro Fracarolli Nunes, Maral Muratbekova-Touron, Valérie Moatti,

Article information:

To cite this document:

Camila Lee Park, Mauro Fracarolli Nunes, Maral Muratbekova-Touron, Valérie Moatti, (2018) "The duality of the Brazilian jeitinho: An empirical investigation and conceptual framework", critical perspectives on international business, Vol. 14 Issue: 4, pp.404-425, <https://doi.org/10.1108/cpoib-04-2017-0022>

Permanent link to this document:

<https://doi.org/10.1108/cpoib-04-2017-0022>

Downloaded on: 01 January 2019, At: 07:02 (PT)

References: this document contains references to 67 other documents.

To copy this document: permissions@emeraldinsight.com

The fulltext of this document has been downloaded 113 times since 2018*

Users who downloaded this article also downloaded:

(2016), "Caught red-handed: the cost of the Volkswagen Dieselgate", Journal of Global Responsibility, Vol. 7 Iss 2 pp. 288-302 https://doi.org/10.1108/JGR-05-2016-0011

(2018), "How do national cultures impact the operations strategy process?", International Journal of Operations & Production Management, Vol. 38 Iss 10 pp. 1937-1963 https://doi.org/10.1108/IJOPM-03-2017-0145

Access to this document was granted through an Emerald subscription provided by

Token: Eprints:ZAJKEYEZZS6QXZRQMIVG:

For Authors

If you would like to write for this, or any other Emerald publication, then please use our Emerald for Authors service information about how to choose which publication to write for and submission guidelines are available for all. Please visit www.emeraldinsight.com/authors for more information.

About Emerald www.emeraldinsight.com

Emerald is a global publisher linking research and practice to the benefit of society. The company manages a portfolio of more than 290 journals and over 2,350 books and book series volumes, as well as providing an extensive range of online products and additional customer resources and services.

Emerald is both COUNTER 4 and TRANSFER compliant. The organization is a partner of the Committee on Publication Ethics (COPE) and also works with Portico and the LOCKSS initiative for digital archive preservation.

*Related content and download information correct at time of download.

The duality of the Brazilian *jeitinho*

An empirical investigation and conceptual framework

Camila Lee Park and Mauro Fracarolli Nunes
NEOMA Business School, Rouen Campus, France, and

Maral Muratbekova-Touron and Valérie Moatti
ESCP Europe, Paris, France

Abstract

Purpose – This paper aims to deepen the understanding of the impact of cultural and national idiosyncrasies on businesses. The authors concentrate on the cultural particularity of the Brazilian *jeitinho* to assess the ethicality of the concept in buyer–supplier relationships.

Design/methodology/approach – Semi-structured interviews were conducted with 28 Brazilian professionals working for both national and international companies, allowing for the analysis of the context in which the Brazilian *jeitinho* is perceived either as positive or negative in terms of ethics.

Findings – The authors propose five distinct dimensions (harm to third parties, seriousness of the issue, formality of relationships, personal benefit and assessed pertinence of rules and laws) to the assessment of Brazilian *jeitinho* as creativity, corruption or more nuanced classifications between them and offer a reviewed definition of the practice.

Practical implications – The results of the study may offer new insights into the Brazilian business environment. Deeper comprehension of the contexts in which *jeitinho* is used and its different connotations may optimise the relations between foreign and Brazilian companies and between foreign and Brazilian professionals and employees.

Originality/value – Within the context of intensified international trade, global supply chains and geographically spread operations, an understanding of cultural and national idiosyncrasies may provide managers with a powerful tool to conduct their business more effectively. With the economic emergence of countries such as China, Russia and Brazil, local practices are also gaining increased importance as they seem to have a direct influence on management in these places and beyond.

Keywords Creativity, International business, Corruption, Brazilian *jeitinho*, Indigenous management

Paper type Research paper

1. Introduction

Unfortunately in Brazil we have not been able to get rid of the so-called “*jeitinho*”. This is observed at every moment, in traffic jams or among those who violate Petrobras’ public patrimony (Lisboa, 2015).

This opening quote, by Brazilian judge Newton Trisotto after denying jail release requests made by two of Petrobras’ former directors, refers to the corruption scheme that was uncovered in an operation by the country’s Federal Police. The local term *jeitinho* is derived from *jeito* (a way out, adroitness, dexterity, aptitude) and is used in its diminutive form to



convey the sense of intimacy and endearment which reflects the emotional way in which Brazilians deal with all kinds of situations, even in business (Duarte, 2006). This practice made its way into the spotlight recently when events involving the country's most prominent company pointed to *jeitinho* as the enabler of what is now being referred to as the biggest corruption scandal of all time, as Petrobras is being investigated on bribery charges involving several foreign companies (Leahy, 2015; Reuters, 2016; Russo, 2017).

Along with national cultures' influences in diverse areas such as corporate governance practices (Daniel *et al.*, 2012), project management (Rees-Caldwell and Pinnington, 2013), customer loyalty (Zhang *et al.*, 2014) and earning management behaviour (Gray *et al.*, 2015), indigenous management concepts such as the Brazilian *jeitinho* have been proven to be critical to understanding business practices, especially in emerging markets (Holtbrügge, 2013). *Guanxi* in China (Fu *et al.*, 2006; Lee and Humphreys, 2007; Chen *et al.*, 2011; Jia *et al.*, 2016), *blat* (Ledeneva, 1998; McCarthy and Puffer, 2008) and more recently *svyazi* (Yakubovich, 2005) in Russia, *jeitinho* in Brazil (Page, 1995; Tanure and Duarte, 2005; Ardichvili *et al.*, 2012), *wasta* in the Middle East and North Africa (Khakhar and Rammal, 2013; Hawkins *et al.*, 2014), *jaan-pehchaan* in India (McCarthy *et al.*, 2012; Puffer *et al.*, 2013) or *clanism* (Minbaeva and Muratbekova-Touron, 2013) in Kazakhstan have been the subject of academic studies examining the impact of these informal institutions on business relations in those countries (McCarthy *et al.*, 2012). Although these studies recognise the existence of such concepts in handling business and assess them in terms of ethics, the general attitude of managers toward these culturally embedded phenomena is ambiguous, with a positive image often clashing with a negative perception of them as being corrupt practices.

In this context, insight into the different connotations of such indigenous practices may be particularly useful for management research. To provide additional evidence in this respect, we focus here on one of these indigenous practices: Brazilian *jeitinho*. It is defined as an informal problem-solving strategy in organisations (Duarte, 2006), a form of creative ingenuity to find quick, short-term solutions to problems (Smith *et al.*, 2012) or "a special way of managing obstacles to find a way out of bureaucracy" (Amado and Vinagre Brasil, 1991, p. 48). The sense of closeness that Brazilians feel towards such practice is representative of its strong presence in their day-to-day lives and also reflects their attitudes in business matters. From a broader perspective, Brazil's position as a strong emerging economy also confirms the importance of studying its managerial particularities.

Existing research shows a certain ambiguity towards the concept: while some scholars state that Brazilian people consider *jeitinho* as a way of using favours and thus see it as ethical (Duarte, 2006; McCarthy *et al.*, 2012), others argue that *jeitinho* can be viewed as corruption (Barbosa, 2006 cited in Smith *et al.*, 2012). Pearson (2015) illustrates this ambivalence as follows:

[...] the *jeitinho* in its most innocuous form is considered a positive trait of Brazilian culture because it is an expression of resourcefulness and informality that is often traced back to the country's mixed heritage and Iberian ancestry. However, the concept also extends to unethical behaviour such as queue-jumping and illegal practices such as parents bribing driving instructors so their children can pass their tests. (Pearson, 2015).

The goal of this paper is therefore to analyse the perception of Brazilian *jeitinho* among practitioners in the country and to attempt to resolve the ambiguity surrounding this concept. More specifically, in light of the contexts in which the term is used, we aim to understand when and why *jeitinho* is perceived as an ethical or an unethical attitude

towards business. In that sense, the objectives of the study may be translated into the following research question:

RQ1. What factors influence the perception of the ethicality of *jeitinho* among Brazilian professionals?

To answer this question, 28 interviews were conducted with professionals in buyer–supplier positions. Inter-organisational relationships have been shown to offer relevant settings for studying indigenous practices (Millington *et al.*, 2006). In addition to providing supplementary elements to clarify the existing literature, the results show that *jeitinho* is generally perceived in two different and arguably opposed ways at one and the same time. While it is seen as a form of creativity serving to solve day-to-day problems, it may also be referred to as a synonym for corruption. Based on the analysis of the data, five dimensions emerged as the basis for the development of a theoretical model to differentiate between these two different facets.

Beyond this introduction, the paper is organised as follows. The literature review section provides a contextualised discussion on the various perceptions of indigenous practices and, more specifically, the existing literature on *jeitinho*. It also examines the literature on corruption to further analyse *jeitinho* in light of corruption classifications. Next, details of the empirical procedures used are presented in the method section. The results of the study are then presented, followed by their discussion. Practical and theoretical implications are addressed, including the development of a theoretical model. Finally, the conclusions and limitations of the study are explored, as well as suggestions for future research.

2. The ethicality of *jeitinho* as an indigenous practice

2.1 *Contrasting perspectives on indigenous practices*

The term “indigenous” is used in the management literature in reference to what is native to or natural of a place, a country or a community. In general, cultures remaining outside the “European identity” (Long and Mills, 2008) are those laid within the concept of “other societies” (Banerjee and Linstead, 2004, p. 222), while the study of local or regional practices, as opposed to the epistemic tradition of international business’ governing, remains urgent (Durepos *et al.*, 2016). Authors such as Crawley and Sinclair (2003, p. 362), for instance, classify Aboriginal communities in Australia as “indigenous people” as, in reference to the later colonisation of the country, they represent what was native to those lands. Dia (1996, p. 7), in his analysis of management in Africa, denominates as indigenous those “institutions born of traditional African culture”, in opposition to non-native institutions or those “transplanted from outside”. Jackson (2013, p. 21) addresses the multitude of definitions for indigenous traits and adopts a political resistance perspective in his approach to the topic, critically indicating the marginalisation of “indigenous voices” in the “dominant global management literature”.

Having developed for centuries as fundamental connectors of societies, social practices and customs are unavoidably present in businesses (Redding and Witt, 2015). Ultimately, the application of indigenous practices in contexts that are different from those in which they have traditionally been developed may generate interferences in their interpretations by western managers, as they may be commonly confused with, or simplified as, a form of local corruption (McCarthy and Puffer, 2008), as any assessment of these culturally embedded phenomena is influenced by the lenses through which they are analysed.

The ambiguity in the assessment of these practices is more evident when they are considered within a business context. For example, Smart and Hsu (2007, p. 167) discuss the different connotations associated with *guanxi* in the literature, either in “positive functions

for building trust” or having “strong links between *guanxi* practice and corruption”. [Gu et al. \(2008\)](#) also uncover the practice in contradictory ways, highlighting its potential benefits and risks. Accordingly, *guanxi* may at the same time represent a core competence of corporations with direct effects on market performance and also engage firms in processes of reciprocal obligation and “collective blindness” ([Gu et al., 2008](#), p. 12), eventually placing governance structures in environments run through with bribery, corruption, obstacles to the rules of law and overdependence, among others. [Dunfee and Warren \(2001\)](#) criticise an instrumental evaluation of *guanxi* as a facilitator of business transactions in China as it does not take ethical issues into account. Proposing a normative assessment of *guanxi*, these scholars call attention to its problematic dimensions: it may reduce societal wealth, “benefits a few at the expense of many” (p. 200), may lead to the violation of fiduciary duties, may not be supported by “authentic norms of relevant communities” (p. 199) and may violate hypernorms, which are manifest universal principles ([Dunfee and Warren, 2001](#)). In the specific context of buyer–supplier relationships, *guanxi* represents an efficient mechanism to reduce transaction costs while also inducing illicit behaviour through bribery ([Millington et al., 2006](#)).

Similar views have been associated with other indigenous practices. *Blat*, for instance, is described as being obscured by the rhetoric of friendship, while actually working as a vector for bribery and corruption ([Ledeneva, 1998](#)). Both *blat*, originally a negative term, and *guanxi*, originally a neutral term, are blurred concepts ([Michailova and Worm, 2003](#)). Such networks may be viewed as positive personal relationships based on cooperation, mutual support and trust that can increase flexibility through gathering and disseminating information and relocating different types of resources in unpredictable and changing environments. However, they can also work on the basis of negative information that one party has about the other party and thus holding the other party hostage if the trust-based relationship is betrayed ([Michailova and Worm, 2003](#)). The negative connotation of these practices concerns possible abuses of political and economic power, increased corruption and a weakening of the development of an open-market economy ([Michailova and Worm, 2003](#)).

Affective (education-based, kinship and of regional origin) ties and networks in South Korea, known as *yongo*, contribute to the challenging and time-consuming trust-building process and thus increase collaboration and coordination efficiency and internal firm group cohesion ([Horak, 2016](#)). They also prevent free-riding through peer pressure, lowering the cost of monitoring and supervision and keeping transaction costs low ([Horak, 2016](#)). *Yongo* can also prevent information leaks to competitors as it implies a strong code of behaviour ([Horak, 2016](#)). However, it may lead to discrimination in the recruitment and selection process, distortion of fair competition and inefficient allocation of resources ([Horak, 2016](#)).

In Kazakhstan, *rushlydyq*, referred to as *clanism* in the political and management literature ([Minbaeva and Muratbekova-Touron, 2013](#); [Schatz, 2004](#)), also has a twofold connotation: while some ethnic Kazakhs strongly support mutual assistance among kin, considering it to define Kazakhness, others believe it to be a menace to their unity as an ethnic group ([Minbaeva and Muratbekova-Touron, 2018](#)). Non-titular citizens of Kazakhstan such as Russians, Uzbeks, Ukrainians, Koreans and others perceive *clanism* as corrupt.

In summary, scholars studying indigenous practices in different countries highlight the duality of perceptions of these practices that have both a positive connotation of networking, and thus development of trustful relationships, and a negative side of corruption ([Dunfee and Warren, 2001](#) or [Warren et al., 2004](#) for *guanxi*; [Horak, 2016](#) for *Yongo*; [Hutchings and Weir, 2006](#) for *guanxi* and *wasta*; [Ledeneva, 1998](#) for *blat*; [Michailova and Worm, 2003](#) for *blat* and *guanxi*; [Minbaeva and Muratbekova-Touron, 2018](#) for *clanism*). Thus, different

scholars discuss the ethicality of indigenous practices or their “double-edged sword” (Warren *et al.*, 2004, p. 355), depending on the lenses through which they are analysed, the context or their impact on management practices.

2.2 *The Brazilian jeitinho*

Building on the analysis of Barbosa (1992, cited in Duarte, 2006), Duarte (2006, p. 511) lists the following characteristics of *jeitinho*:

It is used in response to an extraordinary, unforeseen situation; it involves a conscious act of breaking rules; it provides a short-term solution to a problem; it is normally self-serving but can be also altruistic; it requires certain “techniques” to foster *simpatia* (e.g. a smile and a gentle, pleading tone of voice); it can be used between strangers, but it works more effectively between people who know each other; and it is perceived by Brazilians as an important element of their cultural identity.

As previously discussed, Brazilian *jeitinho* is among the concepts viewed as indigenous as it is considered natural, inherent to and typical of Brazilian society. In that sense, by contrast to more mainstream environments, it would be strange to foreigners, endowing it with a certain exoticism. For that reason, a consideration of its historical and sociological origins may be helpful to define it. According to Amado and Vinagre Brasil (1991) and Duarte (2006), *jeitinho* arose in reaction to the excessive formalism and rigid governmental bureaucracy inherited from the Portuguese colonial administration and which is still present today in Brazilian society.

Like other indigenous concepts, *jeitinho* has been the object of exterior analysis, which may have contributed to an unclear and foggy conceptualisation as regards the ethics behind it. While McCarthy *et al.* (2012) state that Brazilian managers consider *jeitinho* to be ethical, other scholars tend to be more nuanced. Inner to this view, *jeitinho* may be perceived as both a positive and a negative way to “get things done” (Barbosa, 2006, cited in Smith *et al.*, 2012; Duarte, 2006). *Dá um jeitinhoprãmim* (literally “give a *jeitinho* for me”, or “find me a workaround”) is thus perceived as being similar to the use of favours and as a rather positive way of dealing with a difficult situation (Duarte, 2006) or a harmless problem-solving strategy (Duarte, 2018). However, *jeitinho* can also be regarded as ruthless manipulation for personal advantage (Duarte, 2018). Barbosa (2006, cited in Smith *et al.*, 2012) considers *dar um jeitinho* (to find a *workaround*) to be close to the notion of corruption.

The presence of such contrasting perceptions in the literature inherently calls for further investigation into Brazilian *jeitinho*. Beyond searching for a direct and conclusive definition of the term, the quest for a more developed understanding of the different factors leading to its distinct interpretations may be particularly fruitful. Additionally, analysis of the interaction between the different dimensions that may eventually come to impact its connotations can also contribute to our understanding of these complex constructs that have not yet been addressed in full.

2.3 *Corruption*

The word “corruption” has different meanings in different countries (Bardhan, 1997) and varies according to distinct ideological perspectives (Cloke, 2006). What is considered corrupt in one country may seem regular and ordinary in another. Exchanging gifts, for example, is perceived as the norm in business deals in some developing nations (Bardhan, 1997). A strong relationship has also been evidenced between corruption and national cultures’ traits (Gelbrich *et al.*, 2016). Managers working in countries with high levels of regulation may consider arguably unethical mechanisms to reduce transaction costs as a

source of competitive advantage (Cuervo-Cazurra, 2016) and thus not consider them as corruption. Defining the concept is therefore not easy and this makes it difficult to analyse. For example, Jain (2001, p. 73) defines corruption as “acts in which the power of public office is used for personal gain in a manner that contravenes the rules of the game”. This definition implies that some actions, such as money laundering or fraud, are not considered as corruption because they do not use (i.e. abuse) public power. Levine (2005, p. 723), on the other hand, delimits corruption as “an attack on norms of conduct in organizations”. Brown and Cloke (2011, p. 119) also emphasise the “dualistic and derivative nature” of the literature around corruption, leading to a superficial understanding of the concept and its practice. We adopt the definition proposed by Cuervo-Cazurra (2016, p. 36), who describes corruption of government officials in international business broadly as “the abuse of entrusted power for private gain”. This definition embraces corruption in different instances: government, firms, international organisations, and non-profit and non-governmental organisations.

There are numerous classifications of corruption. The most widely used distinction is between public and private corruption (Cuervo-Cazurra, 2016; Argandoña, 2005). Public corruption involves the misuse of power in public office, i.e. when one of the parties is a public official or politician (Argandoña, 2005), whereas private corruption implies abuse of power by the manager of a company or organisation (Cuervo-Cazurra, 2016). Corruption can also be categorised as national (happening within the territory of a single country) versus international (involving parties from different countries); it can be grand (implicating large payments and sizeable effects) or petty (involving small gifts for facilitating payments, for example, also known as grease payments) (Cuervo-Cazurra, 2016); it can be political, bureaucratic or administrative; demand-driven (originating from the person who receives the payment) or supply-driven (originating from the person who pays); individualised (isolated) or systemic (permanent); centralised and organised versus decentralised and disorganised (Argandoña, 2005). Corruption may be based on coercion (when one party dominates the other) or collusion (when there is a mutual agreement between parties) and on actual payment or on just the promise or hope of payment; and it can be predictable (when the desired results are assured) or arbitrary (Argandoña, 2005). Cuervo-Cazurra (2016) also distinguishes between deviation-from-the-rules corruption and changing-the-rules corruption. Deviation-from-the-rules corruption involves payment to “ensure that current regulation is applied differently from its original intention, and corruption to change existing rules or laws, where the payment of the bribe is done to replace current rules with new ones” (Cuervo-Cazurra, 2016, p. 37).

In light of these different classifications, the analysis of the definition of *jeitinho* (Duarte, 2006) suggests that it can be considered as corruption only if it is self-serving (and not altruistic). It can also be perceived as individualised (and not systemic) and a deviation from the rules (rather than changing the rules) because it is used in response to extraordinary or unforeseen situations and provides a short-term solution to the problem.

3. Method

3.1 Sample and data collection

Due to the relatively low level of maturity of this topic, our method is exploratory; semi-structured interviews were conducted with 28 Brazilian professionals involved in a buyer–supplier relationship within their companies. Such a setting allows us to understand indigenous business practices from the local point of view more deeply than the intra-company context where corporate policy prevails, and also in a different way from more commonly studied firm–state relationships (Millington *et al.*, 2006). As evidenced by previous research (Lambert-Mogiliansky and Sonin, 2006; Millington *et al.*, 2006), indigenous practices

are particularly interesting and relevant when observed in inter-company relationships. Because companies' internal compliance measures are often formulated in a centralised fashion and implemented across multiple units, buyer–supplier dyads represent an important context as, configured by the interface with external players, they are expected to be less influenced by organisations' compliance policies. Given that *jeitinho* is a sensitive topic among Brazilians, respondents were chosen through the personal contacts of the first two authors. Interviews were conducted in Portuguese, under a full verbal anonymity agreement and were tape recorded. Interviews lasted between 21 and 67 min. Transcripts of the interviews were then generated from their recordings.

The average age and experience of interviewees was 34.00 and 12.17 years, respectively. Respondents included directors, managers, coordinators, analysts and one entrepreneur. Regarding the dyad position, the sample comprised 14 suppliers and 14 buyers. *Out of the 28 companies, 27* had private capital – among which 9 were multinational organisations from the USA, Europe and Asia, 14 were Brazilian (i.e. both nationality and capital) and 4 were Brazilian with foreign capital – and *the remaining* company had mixed capital with government control. Company sizes were distributed between 10 small, 7 medium and 11 large enterprises. [Table I](#) summarises the profiles of both the respondents and their companies.

3.2 Data analysis

The overall purpose of the interviews was to gain a better understanding of how these managers perceive *jeitinho* from their business experience. The introductory questions in the interviews aimed to check whether Brazilian *jeitinho* was mentioned spontaneously, which was the case in 15 of the 28 interviews. Interviewees were asked whether Brazilians have a particular way of doing business and, if so, they were asked to describe and name it. Whether it appeared spontaneously, they were then asked to explain their understanding of Brazilian *jeitinho*. Given the ambiguity surrounding the term, the subsequent investigation focussed on capturing different perceptions of *jeitinho*, aiming to clarify when it is perceived as a positive or a negative practice.

Transcripts were assessed independently by the two Brazilian researchers, following the two-stage approach recommended by [Miles et al. \(2013\)](#). Stage 1 dealt with the raw data, aiming to reduce the volume of information and to prepare for the following step in the process, consisting in identifying patterns in the data. The primary set of topics guided the interview protocol and was related to the definition of Brazilian *jeitinho*, its social acceptance and its applicability in business matters, addressed in the Section 4.

The interviews were then organised into series of quotes, and similar to the hierarchical coding technique ([King, 2004](#), p. 258), “groups of similar codes” were “clustered together”. Key issues were then isolated, and the topics with higher frequencies were defined for the study. [Table II](#) displays the five topics defined for the study that emerged from data analysis (harm to third parties, seriousness of the issue, formality of relationship, personal benefit and assessed pertinence of rules and laws) and their appearances in each of the interviews, as these were the dimensions used by the participants when assessing whether a given Brazilian *jeitinho* practice is considered as creative or a sign of corruption. These dimensions then gave rise to our theoretical framework in Section 5. The findings for each set were then cross-tabulated, presented and discussed with the rest of the research team.

4. Results

The classification of the data led to the definition of *two* main groups of findings that emerged from the analysis. First, two contrasting perceptions of *jeitinho* are discussed, *along*

No.	Respondent profile				Company profile		
	Age	Gender	Position	Supply chain position	Nationality	Size	Industry/sector
1	32	Male	Director	Supplier	Multi-national	Large	Publicity/digital media
2	30	Male	Director	Buyer	Brazilian/Foreign Capital	Medium	Communications
3	29	Male	Coordinator	Buyer	Multi-national	Large	Electronics/manufacturing
4	33	Male	Analyst	Supplier	Brazilian	Small	Services/consulting
5	31	Female	Director	Buyer	Brazilian	Small	Services/accounting
6	32	Male	Coordinator	Buyer	Multi-national	Large	Electronics/manufacturing
7	34	Female	Analyst	Buyer	Multi-national	Large	Electrics/manufacturing
8	36	Male	Director	Supplier	Brazilian/Multi-national	Large	Mining/transforming
9	39	Female	Analyst	Buyer	Multi-national	Large	Electrics/manufacturing
10	31	Male	Manager	Supplier	Multi-national	Large	Services/consulting
11	33	Male	Manager	Supplier	Brazilian	Medium	Services/consulting
12	28	Male	Analyst	Buyer	Multi-national	Large	Electrics/manufacturing
13	33	Male	Manager	Buyer	Multi-national	Large	Telecommunications
14	31	Female	Manager	Buyer	Multi-national	Medium	Electronics/manufacturing
15	37	Female	Analyst	Supplier	Brazilian	Small	Food and beverages
16	31	Male	Coordinator	Supplier	Brazilian	Small	Services/consulting
17	51	Female	Owner	Supplier	Brazilian	Small	Pet services
18	31	Male	Coordinator	Supplier	Brazilian	Medium	Financial services
19	31	Male	Manager	Buyer	Brazilian	Small	Financial services
20	40	Male	Coordinator	Buyer	Brazilian	Medium	Marketing and advertising
21	36	Male	Director	Supplier	Brazilian	Small	Financial services
22	30	Female	Manager	Supplier	Brazilian	Medium	Marketing and advertising
23	32	Female	Director	Buyer	Brazilian	Large	Food and beverages
24	31	Female	Coordinator	Supplier	Brazilian	Small	Mobile banking
25	35	Male	Manager	Buyer	Brazilian/Foreign Capital	Medium	Financial services
26	44	Female	Manager	Supplier	Brazilian	Small	Hotel and catering
27	34	Female	Coordinator	Supplier	Multi-national	Large	Aviation
28	37	Male	Analyst	Buyer	Brazilian/Foreign Capital	Small	Mobile banking

Table I.
Respondent and company profiles

with the society's assessment of *jeitinho* according to its different connotations. *Second*, the uses, applicability and role of *jeitinho* in business are explored.

4.1 The nature of Brazilian *jeitinho* and its social acceptance

Analysis of the data shows that Brazilian *jeitinho* is usually perceived as any set of actions or behaviours intended to bypass established norms and rules. In that sense, it is perceived

Table II.
Brazilian *jeitinho*
assessment
dimension frequency
in interviews

No.	Harm to third parties	Seriousness of the issue	Formality of relationships	Personal benefit	Assessed pertinence of rules and laws
1	✓			✓	
2					
3			✓	✓	✓
4			✓	✓	✓
5			✓		✓
6	✓		✓	✓	✓
7	✓	✓	✓		✓
8			✓		✓
9	✓		✓		✓
10	✓			✓	✓
11		✓	✓	✓	✓
12		✓		✓	✓
13	✓	✓	✓		✓
14	✓		✓	✓	✓
15			✓		✓
16			✓		✓
17	✓	✓	✓		✓
18		✓	✓	✓	✓
19			✓		✓
20				✓	✓
21	✓	✓	✓	✓	✓
22	✓		✓	✓	
23			✓	✓	
24			✓	✓	✓
25	✓	✓		✓	✓
26	✓			✓	
27	✓			✓	✓
28		✓			✓

as occasionally being the only alternative to make something easier or even possible. The quotes in [Table III](#) illustrate this perception:

Within this reasoning, *jeitinho* is also perceived in two opposing and relatively clear-cut ways. On the one hand, it is often seen as a fair relaxation of the highly bureaucratic rules and norms. Inherently, its use is perceived as a personal ability that can allow individuals to accomplish tasks and solve problems despite difficulties arising from standardisation. *Jeitinho* can also be perceived as a response to a deficiency in resources, with which Brazilians would then be able to cope by forging creative alternatives to the situation. In addition, the ability to remain on the margins of the rules is seen as relatively demanding and therefore reserved to those who boast a high level of knowledge of the standards and laws. From that point of view, the use of *jeitinho* is often reported as something to be proud of, as it demonstrates a high degree of brightness and creativity.

While it may be seen as a sort of harmless, productive and even welcome creativity in solving day-to-day problems, *jeitinho* is also constantly associated with a lack of respect for ethical principles. In its more *negative* uses, *jeitinho* is generally defined as a synonym for illicit practices or corruption, a dimension that comes out more frequently in discussions of the relations between two companies (e.g. buyers and suppliers) and between companies and governments. In these cases, *jeitinho* is frequently seen as shameful behaviour for those who take part in it.

Table III.
Illustrative quotes for
the nature of
Brazilian *jeitinho*

Alternative	<p>“Brazilian <i>jeitinho</i> is to take advantage or try to solve something that a system, a rule would not allow” (#1)</p> <p>“Brazilian <i>jeitinho</i> is to always try to find a way to make things happen, without following any process, doing it in an easier way” (#7)</p> <p>“<i>Jeitinho</i> is to find alternatives to pre-determined rules” (#22)</p>
Action to be proud of	<p>“<i>Jeitinho</i> is the art of improvising. To know the rules of the game and to be able to see opportunities in them is a talent” (#2)</p> <p>“Brazilians are extremely creative in situations of scarcity, and that is a form of <i>jeitinho</i>” (#22)</p> <p>“Brazilian <i>jeitinho</i> is creativity in solving problems, in the face of critical situations or in negotiation contexts” (#25)</p>
Shameful behaviour	<p>“... bribery, informal arrangements with public ministries” (#3)</p> <p>“For instance, if a buyer were to cheat on the weightings of the factors that are employed in a supplier selection process, in order to favour a determined company or contract” (#14)</p> <p>“When you work with integrity and transparency in the negotiation, then the Brazilian <i>jeitinho</i> is completely disposable” (#26)</p>

Along with the contrasting perspectives of *jeitinho*, two different assessments were identified as to the acceptance of its use. Depending on the means applied and on the gravity of the expected consequences, *jeitinho* may be seen either as an acceptable valid practice or as an unacceptable breach of morality. Regarding the former, *jeitinho* is seen as acceptable when it is presumed not to be harmful to third parties, insofar as no major consequences are expected for society on account of these practices. This view would appear to be more closely associated with the perception of *jeitinho* as a form of creativity in solving problems, even if to make things work, “small” misdeeds are required along the way. The quotes in [Table IV](#) embody this view.

On the other hand, *jeitinho* is perceived as unacceptable and undesirable when it is considered to be harmful, illegal or representing abuse of power. It may be linked to deceitful actions carried out with the objective of gaining personal benefits while harming the counterparty involved. Within this reasoning, the use of *jeitinho* is seen as one of the main causes of corruption.

Table IV.
Illustrative quotes for
the social acceptance
of *jeitinho*

Ethical	<p>“<i>Jeitinho</i> is acceptable when it does not harm anybody” (#1)</p> <p>“If it is understood as a way to create alternatives, I think that it [<i>jeitinho</i>] is legit and valid. If it does not cause trouble or harm to another person, there is no problem in using <i>jeitinho</i>” (#10)</p> <p>“<i>Jeitinho</i> is acceptable when it is interpreted as flexibility. [...] When you are in competition with a foreign company, for instance, and you are in Brazil, you know the client, you know what he expects from the product or service. And you have the ability to make your delivery more flexible to meet the client’s demand” (#18)</p>
Unethical	<p>“<i>Jeitinho</i> is unacceptable when you harm other people” (#7)</p> <p>“<i>Jeitinho</i> is unacceptable where it involves economic abuse of power, or comes in the form of exchanging favours for things that are not legal” (#11)</p> <p>“I once watched a company go bankrupt and a CEO get fired because he tried to use <i>jeitinho</i>, and the investors ended up withdrawing the money” (#21)</p> <p>“From my previous experiences, in sales there is a lot of <i>jeitinho</i>, in terms of trickery and roguery. It only serves to ‘push’ a product to someone, regardless of its quality. Sellers just have to sell it, and they do not care if the client will end up making the right purchase or not” (#26)</p>

4.2 *The role of Brazilian jeitinho in business*

Regarding the role and the use of *jeitinho* in business, it is perceived as recurrent in three distinct areas: as an alternative to restrictions and bureaucracy, as a facilitator in buyer-supplier relationships, and as way of dealing with issues related to intra-organisational processes (see the illustrative quotes in Table V).

Concerning its role in dealing with restrictions and bureaucracy, *jeitinho* is seen as a response to the severe and prohibitive Brazilian legal environment. In this respect, it would seem to be viewed as an alternative way of coping with such restrictions to make business possible despite the high level of bureaucratisation of the country. In this sense, some of the bureaucratic impositions are even perceived as barriers to the viability of projects, to the extent that following them would imply in the non-accomplishment of the targeted results. Regarding the internal processes of companies, *jeitinho* is often quoted as a way of dealing with inflexible norms and rules. In that sense, it appears to represent a way of proceeding more permissively in matters of compliance.

When a business-to-business perspective is considered, *jeitinho* is quoted as a facilitator of the relationship between buyers and suppliers, most notably by making operational rules more flexible or by customising general practices for specific partners. These actions would seem to be used mainly to strengthen pre-existing relationships, with *jeitinho* described as being more successful when it comes to keeping clients than winning new ones. Here, the informal dimension of these relations seems to stand out, with *jeitinho* apparently being more easily employed when buyers and suppliers share a relationship that is closer to friendship. Unlike other indigenous practices that presuppose blood or background ties between the parties (i.e. *clanism*, *blat* and *yongo*), *jeitinho* is possible when those ties are weak as long as those involved share a certain friendship. Moreover, although there is not a clear distinction in the perception of *jeitinho* as ethical or unethical between buyers and suppliers, in terms of its mechanics in the context of buyer-supplier relationships, there is a

Alternative to restrictions and bureaucracy	<p>“<i>Jeitinho</i>” not only facilitates, but also makes possible or viable projects that without <i>jeitinho</i> would be impossible to accomplish” (#2)</p> <p>“In Brazil, unfortunately, if a company were to follow all the [legal governmental] protocols, it would waste a lot of time and money” (#10)</p>
Facilitator in buyer-supplier relationships	<p>“Suppliers use <i>jeitinho</i> to adapt products and services all the time, in order to meet our demands” (#2)</p> <p>“Sometimes I have to ask [my supplier] for something that was not defined in our contract. For the relationship’s sake and because of his will to get repeat business, he delivers” (#3)</p> <p>“If you are friends with your client, then <i>jeitinho</i> improves the relationship” (#16)</p> <p>“<i>Jeitinho</i> is an informal criterion for choosing between suppliers. I need suppliers that can solve my problems, and not those who bring more trouble. [...] And in the end, suppliers use <i>jeitinho</i> to deliver what their commercial team have promised” (#25)</p>
Dealing with inflexible intra-organisational norms	<p>“<i>Jeitinho</i> has the function of stepping over rules, and highly bureaucratic companies have a lot of rules” (#3)</p> <p>“When you have to meet some demand or make certain modifications to the system. There is the company’s protocol that takes about two days. But with <i>jeitinho</i>, you can reduce the timing to less than one day, for instance” (#15)</p> <p>“Use of subterfuge means to cheat on a rule. Another example would be not formalizing employees’ contracts. [...] In some sectors [...], it is a very ingrained practice” (#18)</p>

Table V.
Illustrative quotes for the applicability of *jeitinho* in business

clearer understanding as being performed by suppliers to satisfy their clients' needs. When inquired about whether their suppliers made use of *jeitinho* to fulfil their expectations, 11 out of the 14 buyers responded affirmatively, adding that the ability to use *jeitinho* is an informal criterion in choosing among suppliers. On the other hand, with the exception of only one, the respondents that occupy positions on the supplier side of the relationship dyad stated that the use of *jeitinho* is necessary to meet their clients' demands. Such results suggest that, regardless of their dyadic position, *jeitinho* is expected to be used to enhance the quality of the relationship and might be specifically considered as an important attribute when it comes to suppliers' capabilities.

5. Discussion

On the basis of the results presented above, five main dimensions emerged for the assessment of *jeitinho* as a form of creativity or a form of corruption: harm to third parties; seriousness of the issue; formality of relationships; personal benefit; and assessed pertinence of rules and laws. Each dimension is addressed in this section, providing the basis for our proposed definition of the Brazilian *jeitinho*.

Concerning the first dimension, when the use of *jeitinho* is not expected to have major consequences for third parties, it seems to benefit from a less negative connotation and is seen as an inoffensive practice. In line with the conclusions of Warren *et al.* (2004), who discussed the harmfulness and helpfulness of *guanxi* to individuals, business and the Chinese community, our study also considers "third parties" on three levels, including individuals, companies and society in general. In these cases, the bright side of *jeitinho* takes the form of an ethically valid alternative in dealing with difficulties in a creative way. On the other hand, once negative outcomes are expected for third parties, *jeitinho* is perceived as noxious and as a pernicious and unacceptable practice. In this latter perspective, the ethical validity of the practice is questioned, positioning it closer to corruption.

In terms of the seriousness of the issue, when *jeitinho* is used to resolve "small day-to-day" problems, it is generally perceived as a creative and valid method. Small problems can be solved through minor deviations from expected behaviour, and these deviations do not give rise to any major concerns. On the other hand, once issues of a more important nature are considered, the significance of the solutions offered by the use of *jeitinho* also seems to increase. A sense of proportionality to the seriousness of the issue is manifested, which tends to lead people to label the practice as somehow riskier, and thus, preferably avoidable. It seems that the use of *jeitinho* to deal with bigger issues turns the spotlight on the more fragile aspects of such practices and may expose those who make use of them to a moral judgment and to outright condemnation. Apparently, as a way of anticipating any such moral judgment, people seem to condemn the use of *jeitinho* for bigger issues themselves, generally linking it to corruption. Using the classification of corruption as petty versus grand (Argandoña, 2005), only grand corruption is seen as corruption: petty corruption (or grease payment) when associated with *jeitinho* is not considered as corruption by Brazilian practitioners.

As for the formality of relationships, the use of *jeitinho* may occur either individually or collectively. While the former is generally associated with personal responses to one-off situations, the latter commonly involves two separate actors in an *exchange* in which one has a problem and the other the means to offer a possible solution. Analysis of the data revealed that the closer two hypothetical parties are to being friends, the likelier it is that *jeitinho* will be proposed and happen, with the practice remaining within a sort of camaraderie or brotherhood between colleagues or friends. In these cases, it seems that the nature of the relationships spills over into the assessment of the practice, reducing any other

considerations. People tend to perceive it as part of normal and healthy relations, endowing it with a sort of natural character. However, once the practice appears in relationships surrounded by a stronger sense of formality, the perception changes and *jeitinho* tends to be perceived as a transgressive practice. In this view, *jeitinho* requires an extra effort when it is not seen as a natural component of the relationships in question.

In the personal benefit dimension, the assessment of who may eventually benefit from the outcomes of *jeitinho* also seems to affect how people perceive it. When *jeitinho* is used altruistically (i.e. for the benefit of third parties), it tends to be perceived in a more positive light. The alternative solutions offered are generally welcome, as they are seen as representing a creative way of helping people and, ultimately, doing good to society. However, when people use *jeitinho* more selfishly in search for personal benefits, it tends to be associated with negative practices.

Finally, for the assessed pertinence of rules and law, analysis of the data revealed that when *jeitinho* is used as the only alternative to overcome a problem, it is seen as being valid. In these cases, rules and laws are not perceived as relevant or beneficial, but as inappropriate obstacles to be overcome. In these cases, once again, *jeitinho* is associated with a positive projection of creativity, as it ultimately allows a task to be accomplished in an alternative way. This conclusion is *consistent* with the definition of *jeitinho* as an informal problem-solving method to work around bureaucratic rules (Amado and Vinagre Brasil, 1991; Duarte, 2006).

According to the data, *jeitinho* is clearly associated with corruption when it concerns “changing rules”, but not when it deals with “deviation from the rules”, in reference to Cuervo-Cazurra’s (2016) distinction. “Deviation-from-the-rules” corruption is perceived as a positive side of *jeitinho*. However, once rules and laws are perceived as pertinent, the use of *jeitinho* to bypass them is often pointed to as being invalid and reprehensible. In these cases, the association of *jeitinho* with a clear and intentional disrespect for valuable and pertinent laws is closely linked with the practice of corruption.

Based on the discussion above, Figure 1 illustrates the balance of the Brazilian *jeitinho* between creativity and corruption, according to the five emerging dimensions, along with quotes illustrating these two extremes in Table VI.

We propose that the Brazilian *jeitinho* should be analysed from a critical viewpoint, not as an ethical or an unethical action but as a term embedded in semantic instability, meaning that its ethicality is able to range from positive to negative, or from creativity to corruption, depending on the dimensions it is assessed by. In this sense, the definition of theoretical extremes is not intended to delimit punctual situations or cases. Instead, it may be understood as a simplification of reality, delimiting the space within which the combination of different variables may fluctuate and result in a diverse set of combinations (Fracarolli Nunes and Lee Park, 2016). In a complex social phenomenon such as the Brazilian *jeitinho*, it is particularly probable that real circumstances will fall somewhere in the grey area between these two extremes of pure creativity or pure corruption. The following quotes illustrate observed cases that may be argued to fit this scenario in that it is not clear on which side the pendulum is:

Brazil has a lot of taxes, a lot of rules. If you go “by the book”, you cannot succeed. I complain when someone gives a *jeitinho* with me, but I do that too sometimes. [...] Brazilians don’t know how to follow rules. To step outside of a pre-determined path is very natural for us. (#21).

In airports [*jeitinho*] is very common. In some cases, there are people who do not charge a “less affluent” passenger for exceeding the luggage weight, and then move this charge to other passengers who did not really use it. (#27).

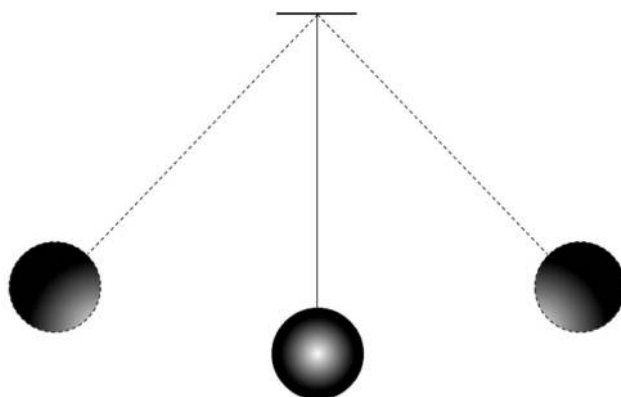

Creativity	Dimension	Corruption
No harm to third parties as a consequence of using <i>jeitinho</i>	Harm to third parties	Third parties harmed from the use of <i>jeitinho</i>
Smaller, lighter day-to-day issues	Seriousness of the issue	Serious issues
Informal relationship or situations, close to friendship	Formality of relationships	In environments of high formality/control
No personal benefit. Benefit to third parties sometimes acceptable	Personal benefit	Personal benefit as a motivator for the use of <i>jeitinho</i>
Low assessed pertinence and/or high malleability (i.e. bendable) of rules and laws	Assessed pertinence of rules and laws	High assessed pertinence and/or low malleability (i.e. breakable) of rules and laws

Figure 1.
The balance of
Brazilian *jeitinho*

Creativity/ethical	Dimension	Corruption/unethical
“A person could be proud of using <i>jeitinho</i> when this unnatural path did not impact any other stakeholder or peer” (#6)	Harm to third parties	“ <i>Jeitinho</i> is unacceptable when there is loss (financial, sustainability, and so on) to any part of the system (company, customer, or supplier, for instance)” (#25)
“In less serious situations, you have to have <i>jeitinho</i> in order to resolve smaller issues, like in human relations, for instance” (#21)	Seriousness of the issue	“If you think of more serious issues, the root of corruption in Brazil is closely linked to <i>jeitinho</i> in business” (#18)
“Sometimes an informal conversation can make a difference when negotiating” (#15)	Formality of relationships	“In situations of higher control and formality, there’s no place for <i>jeitinho</i> ” (#21)
“When you have to deal with issues that are outside your hierarchical scope in order to be able to work, then it is something to be proud of” (#13)	Personal benefit	“[<i>Jeitinho</i>] is unacceptable when it involves personal benefits” (#06)
“Brazil has a lot of taxes, a lot of rules. If you go ‘by the book’, you cannot succeed” (#21)	Assessed pertinence of rules and laws	“For the country’s sake in terms of the future and business, we would be better off without <i>jeitinho</i> ” (#19)

Table VI.
Illustrative quotes for
creativity and
corruption of the
Brazilian *jeitinho*

As portrayed in the examples above, the grey area of *jeitinho* tends to emerge in contexts of greater social complexity, where different dimensions are affected at the same time and to differing intensities. This contributes to the ambiguity in the assessment of the overall ethical outcome of the actions. In this perspective, the interpretation of each case in which *jeitinho* is used may vary considerably from one person to another, as it may be largely based on individual moral judgements and values. Depending on the dimension to which the individual is more sensitive, he or she may interpret *jeitinho* either positively or negatively, as a specific dimension (or set of dimensions) may be more or less important to their own personal judgement.

Creativity might be understood as a process inherent to social interactions (Byron *et al.*, 2015). Moreover, creativity is regarded as a “social cultural and contextually embedded phenomenon” (Fleith, 2011). *Jeitinho may be seen as a creative way to avoid a highly bureaucratic Brazilian administration* (Amado and Vinagre Brasil, 1991; Duarte, 2006). The use of *jeitinho* may provoke quite distinct reactions, as despite the fact that it may be seen as causing no direct harm to third parties and as being beneficial to the local community, it may also be seen as a way of gaining personal benefits, as politicians will benefit directly from it by being able to claim responsibility for building streets and schools.

Even in large companies, you have to benefit public agents all the time. A company I previously worked at had to build streets and a school in order to gain access to a certain city, to be able to open a subsidiary there. (#20).

In this case, dimensions are also being pushed in opposite directions. While the construction of roads and schools may be perceived as a good outcome for the local community, as a benefit to third parties, positioning *jeitinho* on the creative side when such actions pertain to the public sphere, this may imply that the local government has the budgetary power to do so. The fact that it does not act on such and asks a private company to do so instead might mean that unethical practices are taking place (e.g. deviation of resources), clearly pushing *jeitinho* towards a form of corrupt behaviour. Adding to the complexity of the analyses, the same dimensions could also be interpreted in quite opposite ways. It might be argued that in this case, *jeitinho* has actually caused harm to third parties, as companies that may have strictly followed the rules may have been *at disadvantage in a competitive situation* even if they offered better terms. On the other hand, it might be argued that the benefits for society are greater than those for any individual politician, thereby countering the idea of personal benefit.

If other dimensions are also included in the discussion, the conclusions on this situation could become even cloudier. The seriousness of the issue may be seen as either low or high, depending on the lenses applied. One could say that it is not a serious situation as it does not depart much from common practices between players in the private and public sectors. On the other hand, it could be argued that this sort of behaviour encourages corruption at all levels and thus directly harms society by its *perceived* contempt for the norms and rules of a genuinely democratic state. Similar dual treatments may be applied to the other two dimensions. The relationship between members of a company and those of the public sector might be expected to be governed by the formalities set out by the law, while at the same time, this sort of relationship is based on interactions that are closer to friendship. Differentiation between these two distinct situations might be particularly difficult. In turn, the last dimension, the assessed pertinence of rules and laws, can be also dubious. In this case, it is possible that an outside observer might understand that, as the rules have not been strictly followed, they were not respected. However, rules may be interpreted as not having been actually breached, but rather treated in a more flexible manner. In this case, this

dimension may represent the best example of the difficulties surrounding the interpretation of *jeitinho*.

Considering the specificities of each situation, the same rationale could be used, as they all represent situations of potentially increased duality. In this respect, it could be argued that perceptions of *jeitinho* are not only influenced by the combination of different sets of dimensions but also by the countless sets of levels of sensitivity an external observer may have towards these dimensions. We therefore propose the following definition of the Brazilian *jeitinho* and a framework for its assessment (Figure 2):

The Brazilian *jeitinho* is the informal act of circumventing rules in order to achieve specific goals, balancing between the ethical frontiers of creativity and corruption. Its ethicality (corruption versus creative action) depends on the causes (personal benefits versus altruistic intentions and high versus low assessed pertinence of rules and laws) and the consequences (harm versus no harm to third parties) of using it, as well as the context in which it is employed (serious versus not so serious issue and informal versus formal relationships).

The complexities arising from the interpretation of *jeitinho* are not surprising, however. In light of the discussions above, we would seem to be on fairly safe ground in asserting that assessments of this practice are highly dependent on a social construction of meanings (Barkin, 2009), which inherently qualifies it as being highly complex in terms of interpretation. Therefore, despite the propositions put forward by the study, providing a prescriptive formula for assessing *jeitinho* could prove to be far too ambitious. The main contribution of this paper may be seen as drawing attention to the possibility of distinct interpretations of the same social act being highly dependent on the complexities of its observers and its specific context. The practical and theoretical implications are discussed in the next section.

6. Practical and theoretical implications

From a practical perspective, the results of the study may offer new insights into the Brazilian business environment. In that regard, a deeper comprehension of the contexts in which *jeitinho* is used and its different connotations may optimise the relations between foreign and Brazilian companies, as well as between foreign and Brazilian managers and employees. Anticipation of possible misunderstandings may lead to more harmonious relations between foreign and Brazilian actors, thereby minimising the issues of disconnected relations and bringing the benefits of adjusted and consonant business

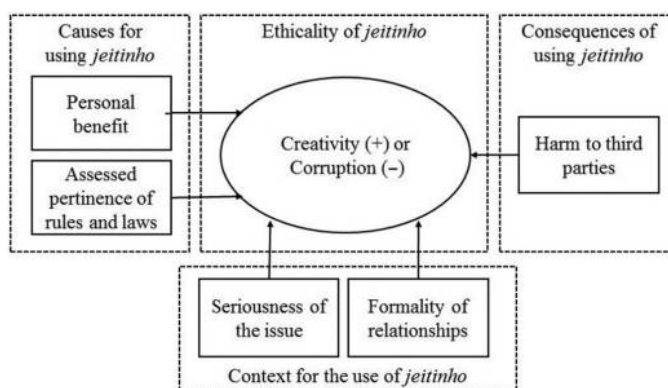

Figure 2.
Proposed framework
for the ethicality of
the Brazilian *jeitinho*

relationships. An integrated assessment of *jeitinho* in the contexts of other business issues may add to a richer and possibly more accurate understanding of the effects of social phenomena in strategic choices. The inclusion of a cultural dimension in international transactions shall be particularly useful, as, through a better understanding of the interaction between players from different countries or cultures, the flow of power in those relations may be better dealt with.

A similar rationale can be used in the design and management of global supply chains in which managers of multinational companies are necessarily in contact with international players. Hennart *et al.* (2015) also analyse how local industry characteristics may impact the choice of foreign investments in the country. In this sense, an extended view of Brazilian *jeitinho* is expected to offer foreigners a chance to develop more effective communication with Brazilian people and reduce misunderstandings in the conduct of business. Suppliers might use *jeitinho* to enhance their ability to meet customers' needs, while buyers may require suppliers to come up with creative or flexible solutions to their problems. Our study provides an ancillary contribution to the understudied field of the influence of culture on inter-company links (Ribbink and Grimm, 2014) and therefore furnishes guidance for improving buyer-supplier relationships in multicultural contexts where Brazilian businesses or managers are involved. Additionally, Brazilian practitioners may benefit from a deeper understanding of the mechanics of *jeitinho* in business relationships, especially when it comes to appraising its ethicality. The proposed framework may help them to better apply the positive and ethical facets of *jeitinho*, generating creative solutions or responses to the demands they face.

From a theoretical outlook, by highlighting the different aspects revolving around the diverse uses, interpretations and contextualisations of *jeitinho*, this study contributes to clarifying the existing literature, while providing the basis for future development, mainly on matters relating to the present ambiguity over indigenous practices. Additionally, in raising the discussion on cultural distance as a potential antecedent for comprehending social phenomena, the study offers valuable perceptions that may extend the assessment of indigenous management concepts in general. In line with recent research in other contexts (Dunfee and Warren, 2001; Gooderham *et al.*, 2006; Gu *et al.*, 2008; Hawkins *et al.*, 2014; Horak, 2016; Hutchings and Weir, 2006; Ledeneva, 1998; Michailova and Worm, 2003; Warren *et al.*, 2004), it reinforces and analyses the ambiguous character of indigenous practices, proposing a critical interpretation of the assessment of their ethicality. The focus of the investigation on the perception of Brazilian managers works as a control variable of the study, as it eliminates possible turbid perceptions arising from the eventual myopia or a vision influenced from outside. In this way, it confirms that *jeitinho* is not entirely linked to corruption. The study's approach may offer a theoretical basis for future research on *jeitinho*, as well on other indigenous management concepts.

7. Conclusion

The contributions of our study are fourfold. First, it fills an important gap in the literature regarding the dual perception of *jeitinho* among Brazilian managers and offers a critical perspective of Brazilian *jeitinho*. We do not merely propose a descriptive and instrumental depiction of *jeitinho*, we answer to the critical questions "is *jeitinho* perceived to be ethical" and "what factors influence the perception of the ethicality of *jeitinho*". To the best of our knowledge, the duality of *jeitinho* has never been studied in detail: when and why this practice is perceived as positive or negative. Our results suggest that Brazilian *jeitinho* is perceived in two opposing ways: either as a creative solution or as synonymous with corrupt and illicit practices. We propose a critical assessment of the ethicality of the practice, in

which such duality is present simultaneously, i.e. individuals hold both perceptions and portray *jeitinho* as positive or negative depending on the context in which it is used. In both cases, the motivations for its use seem to relate to the possibility of making something possible or more efficient, regardless of the requirements of the formal procedures set down by norms, laws and rules. The results also indicate that *jeitinho* is used in a vast range of situations, from day-to-day issues to those encompassing the buyer–supplier relationship and interactions between companies and governments.

Second, in answer to our research question of *what factors influence the perception of the ethicality of jeitinho among Brazilian professionals*, we propose five dimensions through which Brazilian professionals assess *jeitinho* as either creative or corrupt behaviour: harm to third parties, seriousness of the issue, formality of relationships, personal benefit and assessed pertinence of rules and laws. Third, we take a step forward on the issue of perceptions and also study social acceptance of *jeitinho* among Brazilian practitioners. According to our data, the consequences of *jeitinho* are of substantial importance in its social assessment. If no major consequences are perceived, the use of *jeitinho* is considered to be a less significant breach and not worthy of exhaustive analysis or punishment. On the other hand, once negative outcomes result from its use (e.g. harm to third parties), it may be strongly disapproved of. This would appear consistent with the duality of the term. When positive, it can help resolve difficulties and problems, while when negative, it is seen as causing major damage to the Brazilian society.

Finally, we propose a categorisation of the role of *jeitinho* in business. When *jeitinho* is used as a solution to problems arising from bureaucracy, it is regarded as something positive, and even as a personal skill of which people should be proud. In general, this assessment relates to the dimensions of *jeitinho* within the analysis of inter-organisational processes, such as compliance and internal rules of companies. Moreover, interfaces between companies, *such as* buyer–supplier relations, also seem to fall within this scope. In these relations, the data suggest that the presence of *jeitinho* is possibly influenced by the level of informality between the parties involved. The closer buyers and suppliers are to being friends, the more *jeitinho* may be used to resolve their common problems. In line with the discussions in the literature, *jeitinho* works more effectively between people who know each other (Duarte, 2006). Suppliers that have the ability to apply *jeitinho* to fulfil customers' needs might hold an advantage over their competitors, as buyers may appreciate and even expect suppliers' use of flexibility to meet their demands.

On the other hand, Brazilian *jeitinho* is often associated with its “dark side” when it is used between companies and their legal environments. The relationship between firms and governmental entities is perceived as a fertile field for the practice of corruption. Within this view, the term seems to be used as a code or euphemism for the practice of illicit exchanges of money and influence between the private and the public sectors.

8. Limitations and future research

Despite its notable contributions, our study reflects the immaturity of this research field and does have some limitations. Specifically, while our empirical results are interesting, they cannot be generalised due to the exploratory nature of our study and the small number of interviews. However, it offers fruitful ground for further analysis on larger samples and for a finer understanding of different perceptions of *jeitinho* according to respondent profiles and company contexts. It would also be interesting to triangulate our results with perceptions among non-Brazilian managers doing business with Brazilian companies. We hope our future research will contribute to filling these gaps. These limitations aside, we believe that our study brings significant new insight into the duality of Brazilian *jeitinho*.

Regarding future research, progress on the explanations for the different functions and interpretations of national idiosyncrasies may represent a decisive and fundamental aspect for the future of indigenous management research. Empirical work could test, question, confirm or reinforce the theoretical model proposed. This could be particularly useful for extending the present research beyond *jeitinho*.

References

- Amado, G. and Vinagre Brasil, H. (1991), "Organizational behaviors and cultural context: the Brazilian 'jeitinho'", *International Studies of Management and Organization*, Vol. 21 No. 3, pp. 38-46.
- Ardichvili, A., Jondle, D., Kowske, B., Cornachione, E., Li, J. and Thakadipuram, T. (2012), "Ethical cultures in large business organizations in Brazil, Russia, India, and China", *Journal of Business Ethics*, Vol. 105 No. 4, pp. 415-428.
- Argandona, A. (2005), "Corruption and companies: the use of facilitating payments", *Journal of Business Ethics*, Vol. 60 No. 3, pp. 251-264.
- Banerjee, S.B. and Linstead, S. (2004), "Masking subversion: neocolonial embeddedness in anthropological accounts of indigenous management", *Human Relations*, Vol. 57 No. 2, pp. 221-247.
- Barbosa, L. (1992), *O Jeitinho Brasileiro: A arte de ser mais igual do que os outros*, Editora Campos, Rio de Janeiro.
- Barbosa, L. (2006), *O Jeitinho Brasileiro: A arte de ser mais igual do que os outros*, Elsevier, São Paulo.
- Bardhan, P. (1997), "Corruption and development: a review of issues", *Journal of Economic Literature*, Vol. 35 No. 3, pp. 1320-1346.
- Barkin, S. (2009), "Realism, constructivism and international relations theory", American Political Science Association, Toronto Meeting Paper, available at: <http://ssrn.com/abstract=1451682>
- Brown, E. and Cloke, J. (2011), "Critical perspectives on corruption: an overview", *Critical Perspectives on International Business*, Vol. 7 No. 2, pp. 116-124.
- Byron, K., Madjar, N. and Perry-Smith, J. (2015), "Creativity in unexpected places: the role of non-work others from an identity perspective", *The Academy of Management Proceedings*, January.
- Chen, Z., Huang, Y. and Sternquist, B. (2011), "Guanxi practice and Chinese buyer-supplier relationships: the buyer's perspective", *Industrial Marketing Management*, Vol. 40 No. 4, pp. 569-580.
- Cloke, E.B.J. (2006), "The critical business of corruption", *Critical Perspectives on International Business*, Vol. 2 No. 4, pp. 275-298.
- Crawley, A. and Sinclair, A. (2003), "Indigenous human resource practices in Australian mining companies: towards an ethical model", *Journal of Business Ethics*, Vol. 45 No. 4, pp. 361-373.
- Cuervo-Cazurra, A. (2016), "Corruption in international business", *Journal of World Business*, Vol. 51 No. 1, pp. 35-49.
- Daniel, S.J., Cieslewicz, J.K. and Pourjalali, H. (2012), "The impact of national economic culture and country-level institutional environment on corporate governance practices", *Management International Review*, Vol. 52 No. 3, pp. 365-394.
- Dia, M. (1996), *Africa's Management in the 1990s and Beyond: Reconciling Indigenous and Transplanted Institutions*, The World Bank, Washington, DC.
- Duarte, F. (2006), "Exploring the interpersonal transaction of the Brazilian *jeitinho* in bureaucratic contexts", *Organization*, Vol. 13 No. 4, pp. 509-527.
- Duarte, F. (2018), "*Jeitinho*, entry 1.2", in Ledeneva, A. (Ed.), *The Global Encyclopaedia of Informality*, UCL press, London, Vol. 1.

- Dunfee, T.W. and Warren, D.E. (2001), "Is guanxiethical? A normative analysis of doing business in China", *Journal of Business Ethics*, Vol. 32 No. 3, pp. 191-204.
- Durepos, G., Prasad, A. and Villanueva, C.E. (2016), "How might we study international business to account for marginalized subjects? Turning to practice and situating knowledges", *Critical Perspectives on International Business*, Vol. 12 No. 3, pp. 306-314.
- Fleith, D.S. (2011), "Creativity in the Brazilian culture", *Online Readings in Psychology and Culture*, Vol. 4 No. 3.
- Fracarolli Nunes, M. and Lee Park, C. (2016), "Self-claimed sustainability: building social and environmental reputations with words", *Sustainable Production and Consumption*, Vol. 11, pp. 46-57, doi: <http://dx.doi.org/10.1016/j.spc.2016.04.002>.
- Fu, P.P., Tsui, A.S. and Dess, G.G. (2006), "The dynamics of guanxi in Chinese high-tech firms: implications for knowledge management and decision making", *Management International Review*, Vol. 46 No. 3, pp. 277-305.
- Gelbrich, K., Stedham, Y. and Gätke, D. (2016), "Cultural discrepancy and national corruption: investigating the difference between cultural values and practices and its relationship to corrupt behavior", *Business Ethics Quarterly*, Vol. 26 No. 2, pp. 201-225.
- Gooderham, P., Nordhaug, O. and Ringdal, K. (2006), "National embeddedness and calculative human resource management in US subsidiaries in Europe and Australia", *Human Relations*, Vol. 59 No. 11, pp. 1491-1513.
- Gray, S.J., Kang, T. and Lin, Z. (2015), "Earnings management in Europe post IFRS: do cultural influences persist?", *Management International Review*, Vol. 55 No. 6, pp. 827-856.
- Gu, F.F., Hung, K. and Tse, D.K. (2008), "When does guanxi matter? Issues of capitalization and its dark sides", *Journal of Marketing*, Vol. 72 No. 4, pp. 12-28.
- Hawkins, T.G., Randall, W.S., Coyne, A.V. and Baitalmal, M.H. (2014), "Sustainable integrity: how reverse auctions can benefit suppliers in emerging markets", *Supply Chain Management: An International Journal*, Vol. 19 No. 2, pp. 126-141.
- Hennart, J., Sheng, H.H. and Pimenta, G. (2015), "Local complementary inputs as drivers of entry mode choices: the case of US investments in Brazil", *International Business Review*, Vol. 24 No. 3, pp. 466-475.
- Holtbrügge, D. (2013), "Indigenous management research", *Management International Review*, Vol. 53 No. 3, pp. 1-11.
- Horak, S. (2016), "Join in or opt out? A normative-ethical analysis of affective ties and networks in South Korea", *Academy of Management Proceedings*, Vol. 2016 No. 1, doi: <https://doi.org/10.1007/s10551-016-3125-7>.
- Hutchings, K. and Weir, D. (2006), "Understanding networking in China and the Arab world: lessons for international managers", *Journal of European Industrial Training*, Vol. 30 No. 4, pp. 272-290.
- Jackson, T. (2013), "Reconstructing the indigenous in African management research", *Management International Review*, Vol. 53 No. 1, pp. 13-38.
- Jain, A.K. (2001), "Corruption: a review", *Journal of Economic Surveys*, Vol. 15 No. 1, pp. 71-121.
- Jia, F., Rutherford, C. and Lamming, R. (2016), "Cultural adaptation and socialisation between Western buyers and Chinese suppliers: the formation of a hybrid culture", *International Business Review*, Vol. 25 No. 6, pp. 1246-1261.
- Khakhar, P. and Rammal, H.G. (2013), "Culture and business network: international business negotiations with Arab managers", *International Business Review*, Vol. 22 No. 3, pp. 578-590.
- King, N. (2004), "Using templates in the thematic analysis of text", in Cassell, C. and Symon, G. (Eds), *Essential Guide to Qualitative Methods in Organizational Research*, Sage Publications, Thousand Oaks, CA.

- Lambert-Mogiliansky, A. and Sonin, K. (2006), "Collusive market sharing and corruption in procurement", *Journal of Economics and Management Strategy*, Vol. 15 No. 4, pp. 883-908.
- Leahy, J. (2015), "Prosecutor in Petrobras scandal warns foreign companies", *The Financial Times*, 8 November, available at: www.ft.com/content/39964508-84d6-11e5-9dc0-186bb1146746?mhq5j=e6 (accessed 26 October 2017).
- Ledeneva, A.V. (1998), "Russia's economy of favours: blat, networking and informal exchange", *Economic Systems - Journal of Economic Literature*, Vol. 37 No. 1, pp. 322-332.
- Lee, P.K.C. and Humphreys, P.K. (2007), "The role of guanxi in supply management practices", *International Journal of Production Economics*, Vol. 106 No. 2, pp. 450-467.
- Levine, D.P. (2005), "The corrupt organization", *Human Relations*, Vol. 58 No. 6, pp. 723-740.
- Lisboa, P. (2015), "STJ mantém ex-diretores da Petrobras Duque e Cerveró presos", *Folha de S. Paulo*, 18 August, available at: www1.folha.uol.com.br/poder/2015/08/1670301-stj-mantem-ex-diretor-da-petrobras-renato-duque-presos.shtml (accessed 10 October 2017).
- Long, B.S. and Mills, A.J. (2008), "Globalization, postcolonial theory, and organizational analysis. Lessons from the Rwanda genocide", *Critical Perspectives on International Business*, Vol. 4 No. 4, pp. 389-409.
- McCarthy, D.J. and Puffer, S.M. (2008), "Interpreting the ethicality of corporate governance decisions in Russia: utilizing integrative social contracts theory to evaluate the relevance of agency theory norms", *Academy of Management Review*, Vol. 33 No. 1, pp. 11-31.
- McCarthy, D.J., Puffer, S.M., Dunlap, D.R. and Jaeger, A.M. (2012), "A stakeholder approach to the ethicality of BRIC-firm managers' use of favors", *Journal of Business Ethics*, Vol. 109 No. 1, pp. 27-38.
- Michailova, S. and Worm, V. (2003), "Personal networking in Russia and China: blat and guanxi", *European Management Journal*, Vol. 21 No. 4, pp. 509-520.
- Miles, M.B., Huberman, A.M. and Saldaña, J. (2013), *Qualitative Data Analysis: A Methods Sourcebook*, Sage Publications, Thousand Oaks, CA.
- Millington, A., Eberhardt, M. and Wilkinson, B. (2006), "Guanxi and supplier search mechanisms in China", *Human Relations*, Vol. 59 No. 4, pp. 505-551.
- Minbaeva, D.B. and Muratbekova-Touron, M. (2013), "Clanism: definition and implications for human resource management", *Management International Review*, Vol. 53 No. 1, pp. 109-139.
- Minbaeva, D., Muratbekova-Touron, M. (2018), "Rushyldyq, entry 3.4", in Ledeneva, A. (Ed.), *The Global Encyclopaedia of Informality*, UCL press, London, Vol. 1.
- Page, J.A. (1995), *The Brazilians*, Addison-Wiley, Reading.
- Pearson, S. (2015), "Petrobras shows corruption is now a high-stakes game in Brazil", *The Financial Times*, 15 April, available at: <https://next.ft.com/content/2e2a58fede1811e48d1400144feab7de> (accessed 26 July).
- Puffer, S.M., McCarthy, D.J., Jaeger, A.M. and Dunlap, D. (2013), "The use of favors by emerging market managers: facilitator or inhibitor of international expansion?", *Asia Pacific Journal of Management*, Vol. 30 No. 2, pp. 327-349.
- Redding, G. and Witt, M.A. (2015), "Advancing indigenous management theory: executive rationale as an institutional logic", *Management and Organization Review*, Vol. 11 No. 2, pp. 179-203.
- Rees-Caldwell, K. and Pinnington, A.H. (2013), "National culture differences in project management: comparing British and Arab project managers' perceptions of different planning areas", *International Journal of Project Management*, Vol. 31 No. 2, pp. 212-227.
- Reuters (2016), "Brazil seeks deals with 10 companies in Petrobras scandal", 14 January, available at: www.reuters.com/article/brazil-corruption-companies/brazil-seeks-deals-with-10-companies-in-petrobras-scandal-idUSL2N14X2E120160114 (accessed 26 October 2017).

- Ribbink, D. and Grimm, C.M. (2014), "The impact of cultural differences on buyer-supplier negotiations: an experimental study", *Journal of Operations Management*, Vol. 32 No. 3, pp. 114-126.
- Russo, R. (2017), "Several foreign companies may be indicted over Petrobras corruption probe", MLex Market Insight, 9 May, available at: <https://mlexmarketinsight.com/insights-center/editors-picks/anti-bribery-and-corruption/latin-america/several-foreign-companies-may-be-indicted-over-petrobras-corruption-probe> (accessed 26 October).
- Schatz, E. (2004), "Modern clan politics: the power of 'blood'", *Kazakhstan and Beyond*, University of Washington Press, Seattle and London.
- Smart, A. and Hsu, C.L. (2007), "Corruption or social capital? Tact and the performance of guanxi in market socialist China", in Nuijten, M. and Anders, G. (Eds), *Corruption and the Secret of Law, A Legal Anthropological Perspective*, Ashgate, Hampshire, pp. 167-190.
- Smith, P.B., Torres, C., Leong, C.H., Budhward, P., Achouie, M. and Lebedevaf, N. (2012), "Are indigenous approaches to achieving influence in business organizations distinctive? A comparative study of guanxi, wasta, jeitinho, svyazi and pulling strings", *The International Journal of Human Resource Management*, Vol. 23 No. 2, pp. 333-348.
- Tanure, B. and Duarte, R.G. (2005), "Leveraging competitiveness upon national cultural traits: the management of people in Brazilian companies", *International Journal of Human Resource Management*, Vol. 16 No. 12, pp. 2201-2217.
- Warren, D.E., Dunfee, T.W. and Li, N. (2004), "Social exchange in China: the double-edged sword of guanxi", *Journal of Business Ethics*, Vol. 55 No. 4, pp. 355-372.
- Yakubovich, V. (2005), "Weak ties, information, and influence: how workers find jobs in a local Russian labor market", *American Sociological Review*, Vol. 70 No. 3, pp. 408-421.
- Zhang, S., Van Doorn, J. and Leeflang, P.S.H. (2014), "Does the importance of value, brand and relationship equity for customer loyalty differ between Eastern and Western cultures?", *International Business Review*, Vol. 23 No. 1, pp. 284-292.

Further reading

- Drogendijk, R. and Martín, O. (2015), "Relevant dimensions and contextual weights of distance in international business decisions: evidence from Spanish and Chinese outward FDI", *International Business Review*, Vol. 24 No. 1, pp. 133-147.

Corresponding author

Camila Lee Park can be contacted at: camilapark@gmail.com

For instructions on how to order reprints of this article, please visit our website:

www.emeraldgrouppublishing.com/licensing/reprints.htm

Or contact us for further details: permissions@emeraldinsight.com