



**HAL**  
open science

# Optimizing a dynamic and energy efficient network piloting the electrical grid

Adrien Gougeon

► **To cite this version:**

Adrien Gougeon. Optimizing a dynamic and energy efficient network piloting the electrical grid. Networking and Internet Architecture [cs.NI]. Université de Rennes, 2023. English. NNT: 2023UREN0001 . tel-04086397

**HAL Id: tel-04086397**

**<https://theses.hal.science/tel-04086397>**

Submitted on 2 May 2023

**HAL** is a multi-disciplinary open access archive for the deposit and dissemination of scientific research documents, whether they are published or not. The documents may come from teaching and research institutions in France or abroad, or from public or private research centers.

L'archive ouverte pluridisciplinaire **HAL**, est destinée au dépôt et à la diffusion de documents scientifiques de niveau recherche, publiés ou non, émanant des établissements d'enseignement et de recherche français ou étrangers, des laboratoires publics ou privés.

COLLEGE

MATHS, TELECOMS

DOCTORAL

INFORMATIQUE, SIGNAL

BRETAGNE

SYSTEMES, ELECTRONIQUE

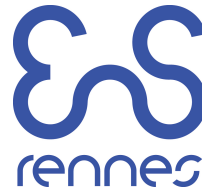

école  
normale  
supérieure

# THÈSE DE DOCTORAT DE

L'ÉCOLE NORMALE  
SUPÉRIEURE RENNES

ÉCOLE DOCTORALE N° 601

MATHS, TELECOMS, INFORMATIQUE, SIGNAL, SYSTEMES,  
ELECTRONIQUE

Spécialité : *INFORMATIQUE*

Par

**Adrien Gougeon**

**Optimizing a Dynamic and Energy Efficient Network Piloting the  
Electrical Grid**

Thèse présentée et soutenue à Rennes, le 11 Janvier 2023

Unité de recherche : IRISA

## Rapporteurs avant soutenance :

Stéphane GENAUD Professeur à l'Université de Strasbourg  
Chantal TACONET Maître de conférences HDR à Telecom SudParis, Evry

## Composition du Jury :

Président :	Mathieu ACHER	Professeur à l'INSA de Rennes
Rapporteurs :	Stéphane GENAUD	Professeur à l'Université de Strasbourg
	Chantal TACONET	Maître de conférences HDR à Telecom SudParis, Evry
Examineurs :	Mathieu ACHER	Professeur à l'INSA de Rennes
	Corinne ALONSO	Professeur à l'Université Paul Sabatier, Toulouse
Dir. de thèse :	Anne-Cécile ORGERIE	Directrice de Recherche au CNRS, Rennes
Co-dir. de thèse :	Martin QUINSON	Professeur des Universités à l'ENS Rennes



# REMERCIEMENTS

---

Je tiens en tout premier lieu à remercier mes encadrants, Anne-Cécile Orgerie et Martin Quinson, pour leur confiance, leur réactivité, leur efficacité et leur soutien. Une thèse est un long parcours où la motivation peut venir à manquer, mais ils ont toujours su dissiper mes doutes et me remettre sur le bon chemin quand j'en avais le plus besoin. Je souhaite à tout étudiant en thèse d'avoir un aussi bon encadrement que celui que j'ai eu la chance d'avoir.

J'aimerais aussi adresser mes remerciements à Chantal Taconet et Stéphane Genaud d'avoir accepté de rapporter mon manuscrit de thèse, ainsi que Mathieu Acher et Corinne Alonso pour leur participation au jury de cette thèse.

Je remercie également mes collègues de réunions hebdomadaires, Benjamin Camus, François Lemerrier et Anne Blavette qui m'ont aidés à combler mes lacunes sur divers sujets tout au long de cette thèse. Ce fut un plaisir d'avancer sur ces travaux de recherche grâce à vous.

Je remercie aussi Matthieu Simonin, qui a toujours su résoudre mes problèmes techniques quand je faisais un détour par son bureau.

Enfin, je remercie l'entiereté de l'équipe Myriads, avec qui j'ai partagé de nombreuses pauses café, essentielles à toute bonne recherche.



# TABLE OF CONTENTS

---

<b>1</b>	<b>Introduction</b>	<b>15</b>
1.1	Context . . . . .	15
1.2	Research Problem and Goal . . . . .	16
1.3	Contributions . . . . .	17
1.4	Publications . . . . .	17
1.5	Organization of this Manuscript . . . . .	18
<b>2</b>	<b>State of the Art on The Smart Grid</b>	<b>19</b>
2.1	The Electrical Grid . . . . .	19
2.1.1	From Electricity Production to Consumption . . . . .	19
2.1.2	New Usages & Limitations . . . . .	22
2.2	The Smart Grid . . . . .	25
2.2.1	General Concept . . . . .	25
2.2.2	Smart Meters . . . . .	27
2.2.3	New Services . . . . .	28
2.3	Demand Response . . . . .	29
2.3.1	Demand Response Programs . . . . .	29
2.3.2	Approaches for Deploying Demand Response Programs . . . . .	31
2.3.3	The Advanced Metering Infrastructure . . . . .	36
2.4	Validating Demand Response Approaches . . . . .	39
2.4.1	Test-Bed . . . . .	40
2.4.2	Simulation . . . . .	40
2.4.3	Traces . . . . .	44
2.5	Conclusion . . . . .	44
<b>3</b>	<b>Co-Simulation of Power Systems and Computing Systems using the FMI Standard</b>	<b>47</b>
3.1	Overview . . . . .	47
3.2	FMU Integration . . . . .	49

## TABLE OF CONTENTS

---

3.2.1	Build a FMU . . . . .	49
3.2.2	SimGrid & pandapower Interactions . . . . .	52
3.3	Example Use Case . . . . .	53
3.4	Extending a Demand-Side Management Use Case . . . . .	55
3.5	Conclusion . . . . .	57
<b>4</b>	<b>Impact of Wired Telecommunication Network Latency on Demand-Side Management in Smart Grids</b>	<b>59</b>
4.1	Overview . . . . .	59
4.2	Case Study . . . . .	60
4.2.1	Power System . . . . .	61
4.2.2	Computing System . . . . .	62
4.2.3	Smart Grid Management . . . . .	62
4.2.4	Centralized Cascado-cyclic Approach . . . . .	64
4.2.5	Decentralized Cascado-cyclic Approach . . . . .	64
4.3	Validation . . . . .	65
4.3.1	Co-Simulation Framework . . . . .	65
4.3.2	Experimental Plan . . . . .	66
4.4	Results . . . . .	67
4.4.1	Cascado-cyclic Behavior Assessment . . . . .	68
4.4.2	Influence of the Upper Current Threshold . . . . .	68
4.4.3	Influence of the Number of Sheddable Households . . . . .	71
4.4.4	Influence of the Communication Latency and Message Size . . . . .	73
4.4.5	Discussion . . . . .	76
4.5	Conclusion . . . . .	77
<b>5</b>	<b>Influence of Communication Technologies in Smart Grid Power Congestion Management</b>	<b>79</b>
5.1	Case Study . . . . .	79
5.1.1	Shedding Policy . . . . .	80
5.1.2	Centralized Management . . . . .	81
5.1.3	Decentralized Management . . . . .	82
5.2	Experimental Framework . . . . .	83
5.2.1	Co-simulation Environment . . . . .	83
5.2.2	Electrical Network . . . . .	83

---

5.2.3	Communication Network . . . . .	84
5.3	Numerical Simulations . . . . .	86
5.3.1	Explored Parameters . . . . .	86
5.3.2	Evaluated Metrics . . . . .	88
5.4	Results . . . . .	88
5.5	Conclusion . . . . .	97
<b>6</b>	<b>Modeling the End-to-End Energy Consumption of a Nation-Wide Smart Metering Infrastructure</b>	<b>101</b>
6.1	Overview . . . . .	101
6.2	Smart Metering Architecture . . . . .	102
6.3	Network Power Models . . . . .	104
6.3.1	Smart Meters . . . . .	104
6.3.2	Concentrators . . . . .	105
6.3.3	Cellular Network . . . . .	105
6.3.4	Core Network . . . . .	106
6.3.5	Servers . . . . .	106
6.4	Evaluation . . . . .	107
6.4.1	Parameters Estimation . . . . .	107
6.4.2	Results . . . . .	110
6.4.3	Discussion . . . . .	114
6.5	Conclusion . . . . .	116
<b>7</b>	<b>Conclusion and Perspectives</b>	<b>117</b>
7.1	Contributions . . . . .	117
7.2	Future Directions . . . . .	119
7.2.1	Algorithm-specific Evaluation and Computation Time Overhead . .	119
7.2.2	Communication Technologies . . . . .	119
7.2.3	Co-optimization . . . . .	120
	<b>Bibliography</b>	<b>121</b>



# LIST OF ACRONYMS

---

- A-AIMD** Adaptive AIMD
- AIMD** Additive-Increase Multiplicative-Decrease
- AARO-ADMM** Affinely Adjustable Robust ADMM
- ADMM** Alternating Direction Method of Multipliers
- AMI** Advanced Metering Infrastructure
- AMR** Automated Meter Reading
- BTS** Base Transceiver Station
- CPP** Critical-Peak-Pricing
- DER** Distributed Energy Resources
- DG** Distributed Generation
- DQPSK** Differential Quadrature Phase-Shift Keying
- DR** Demand Response
- DRL** Deep Reinforcement Learning
- DSLAM** Digital Subscriber Line Access Multiplexer
- DSM** Demand-Side Management
- DSO** Distribution System Operator
- ELVTF** European Low Voltage Test Feeder
- EV** Electric Vehicle
- FMI** Functional Mock-up Interface

**FMU** Functional Mock-up Unit

**GHG** Greenhouse Gas

**HAN** Home Area Network

**HVAC** Heating Ventilation and Air Conditioning

**ICT** Information and Communication Technology

**ISP** Internet Service Providers

**MDMS** Meter Data Management System

**NAN** Neighboring Area Network

**OFDM** Orthogonal Frequency-Division Multiplexing

**PLC** Power Line Communication

**PUE** Power Usage Effectiveness

**PV** Photovoltaic

**RTP** Real-Time-Pricing

**TCP** Transmission Control Protocol

**TOU** Time-Of-Use

**WAN** Wide Area Network

**WECS** Wind Energy Conversion System



# RÉSUMÉ EN FRANÇAIS

---

Au quotidien, l'électricité est fournie à chaque utilisateur, qu'il soit résidentiel ou industriel, par un réseau électrique national. Ce réseau électrique a été construit avec une séparation claire entre la production et la consommation. L'électricité est principalement produite dans de grandes installations comme les centrales à gaz, à pétrole, hydrauliques et nucléaires. La production doit pouvoir suivre les besoins de la consommation à chaque instant. En effet, un déficit de production, ainsi qu'une surproduction, peut causer de graves dommages aux équipements qui composent et sont connectés au réseau électrique. Or, la courbe de consommation est variable et dépend des saisons, du jour de la semaine et des heures de la journée. En conséquence, la production électrique doit s'adapter en permanence pour contrebalancer la consommation.

La production d'électricité est l'une des principales sources d'émissions de Gaz à Effet de Serre (GES), car une grande partie de la production est à base de carbone et néfaste à l'environnement. De nombreuses initiatives ont vu le jour pour remplacer l'électricité à base de carbone par des sources plus respectueuses de l'environnement comme les panneaux solaires et les éoliennes. Le secteur des transports est une autre source importante d'émissions de GES. Pour réduire les émissions provenant de cette source, le marché des véhicules électriques connaît une croissance rapide, encouragée dans de nombreux pays par des mesures d'incitation gouvernementales visant à remplacer les véhicules à fortes émissions.

Ces modifications dans notre façon de produire et de consommer l'électricité ne sont pas sans conséquences. D'une part, la production à partir de sources renouvelables est intermittente par nature et dépend largement des conditions météorologiques. D'autre part, la demande croissante en énergie aggrave la différence de puissance entre les périodes de forte demande et les périodes de faible demande. Cette variabilité accroît la difficulté à gérer l'équilibre entre la production et la consommation d'électricité.

Face à ces enjeux, la gestion du réseau électrique doit être revue. L'idée d'un réseau électrique plus intelligent, appelé Smart Grid, n'est pas récente, mais le contexte actuel le rend nécessaire. Le concept de Smart Grid consiste à améliorer les capacités de mesure et de communication de chaque acteur du réseau électrique, qu'il soit producteur ou

consommateur d'électricité. La communication permet de nombreux nouveaux services centrés sur de la mesure et de la coordination à distance, automatique et rapide des acteurs de la Smart Grid. Cette amélioration associée à des algorithmes de gestion des acteurs porte les promesses d'un réseau électrique plus réactif, d'une consommation lissée, et même d'une réduction de la consommation d'électricité.

Le réseau électrique n'a pas été conçu dans l'optique d'une communication bidirectionnelle, et l'ajout de capacités de communication au réseau existant nécessite le déploiement d'une nouvelle infrastructure. Cette nouvelle infrastructure est appelée *Advanced Metering Infrastructure* (AMI). Pour soutenir le réseau intelligent, l'AMI ajoute de nombreux nouveaux dispositifs. Ces dispositifs jouent un rôle clé dans la surveillance du réseau électrique, l'envoi, la réception et le traitement de grandes quantités de données issues du monitoring fin du réseau électrique.

La variabilité croissante de la consommation et de la production accroît la difficulté de gérer le réseau électrique. La Smart Grid est largement reconnue comme une solution aux problèmes actuels auxquels le réseau électrique est confronté. À terme, la Smart Grid devrait proposer des services qui interagiront directement avec les appareils de certains utilisateurs pour résoudre des événements spécifiques, tels que les pics de consommation, au sein du réseau électrique. Ces interactions reposeront sur une communication bidirectionnelle entre les acteurs de la Smart Grid.

La pierre angulaire des capacités de communication de la Smart Grid est l'AMI. De nombreuses technologies sont disponibles et discutées dans la littérature pour déployer l'AMI. Par exemple, nous pouvons citer Ethernet, Wi-Fi, Courant Porteur en Ligne (CPL), ZigBee, WiMAX, LoRaWAN ou Cellular. Chaque technologie a ses avantages et ses inconvénients, et en général, plusieurs technologies sont combinées en fonction des objectifs du réseau.

Dans ce contexte, un premier objectif de cette thèse est d'étudier les interactions entre le réseau électrique et l'AMI et de fournir des outils fiables pour soutenir cette étude. Un deuxième objectif est d'évaluer, à l'aide des outils développés, l'influence des propriétés de communication de l'AMI sur l'efficacité de certains services de la Smart Grid. Comme mentionné précédemment, la Smart Grid vise également à réduire la consommation d'électricité du réseau électrique. Le déploiement de nombreux capteurs et dispositifs de communication peut avoir un impact non négligeable sur la consommation électrique. Un troisième objectif de cette thèse est de modéliser et d'évaluer la consommation énergétique de l'AMI.

Les contributions de cette thèse sont les suivantes :

- Un environnement de co-simulation dédié à l'évaluation des services de la Smart Grid. Cet environnement combine trois simulateurs, reconnus dans leurs communautés respectives et dédiés aux systèmes distribués, aux réseaux électriques et aux réseaux de communication. L'outil que nous proposons et les simulateurs qui le composent sont tous disponibles sans restrictions en open-source, ce qui facilite la simulation sur des clusters dédiés et la reproductibilité des expériences. Nous illustrons son fonctionnement sur un exemple simple et il sert d'outil d'évaluation pour la contribution suivante de cette thèse.
- Une évaluation quantitative de l'influence de divers paramètres de communication tels que le délai de communication et les technologies de communication sur un cas concret de service réactif de la Smart Grid : un service d'effacement de pic de consommation. L'analyse compare les performances d'une approche centralisée et d'une approche décentralisée pour ce service sur un cas d'étude fondé sur des traces réelles d'un réseau résidentiel. Nos résultats montrent que ne pas prendre en compte la latence du réseau de télécommunication, comme cela est souvent fait dans la littérature, implique une forte surestimation des performances obtenues par l'approche centralisée du point de vue de l'opérateur du système électrique. Nos résultats montrent également que le Wi-Fi et Ethernet offrent des performances similaires. En revanche, la technologie CPL peut présenter des performances nettement inférieures, surtout dans le cas de l'approche centralisée et lorsque de nombreux échanges de messages sont nécessaires dans un court intervalle de temps.
- Une étude de l'architecture de bout en bout d'un AMI, et des modèles de consommation d'énergie pour chaque partie de l'AMI. Les modèles sont utilisés pour évaluer la consommation d'énergie de l'AMI à l'échelle nationale, sur la base du cas d'utilisation français. L'instanciation des paramètres du modèle est une tâche difficile car les données dans ce domaine sont rares. Pour cette raison, nous évaluons la consommation énergétique quotidienne de l'infrastructure en utilisant les valeurs les plus cohérentes trouvées dans la littérature. Nous proposons également une interface qui permet d'explorer nos modèles avec des jeux de paramètres différents. Nos résultats montrent que pour un scénario où les données des compteurs intelligents sont collectées une fois par jour, les concentrateurs et les compteurs intelligents représentent respectivement 68 % et 31 % de l'énergie consommée ; la consom-

mation du réseau cellulaire, du réseau central et des serveurs étant négligeable en comparaison.

# INTRODUCTION

---

## 1.1 Context

Day-to-day electricity is provided to every user either being residential or industrial by a national electrical grid. This electrical grid has been built with a clear separation between production and consumption. Electricity is mostly produced in large facilities like gas, petrol, hydro and nuclear power plants. The production must be able to follow the consumption needs at every instant. Indeed, a deficit in production, and even an overproduction, can cause severe damages to the equipment composing and connected to the electrical grid. However, the consumption curve is variable and depends on seasons, day of the week, and hours of the day. In consequence, production must adapt constantly to counterbalance consumption.

Electricity production is one of the major sources of Greenhouse Gas (GHG) emissions, as a large part of the production is carbon-based and harmful to the environment. Many initiatives arose to replace carbon-based electricity by more environmentally-friendly sources like Photovoltaic (PV) and Wind Energy Conversion System (WECS). Another main source of GHG emission is the transportation sector. To reduce emissions from this source the Electric Vehicle (EV) market is rapidly growing, encouraged in many countries by governmental incentives to replace carbon-based vehicles.

Those modifications in the way we produce and consume electricity are not without consequences. On one hand, production from renewable sources is intermittent by nature and largely depends on the weather. On another hand, the increasing demand in energy on the consumption side worsens the power difference between high demand periods and low demand periods. This variability increases the difficulty to manage the balance between the production and the consumption of electricity.

In front of those issues, the electrical grid calls for a renewal. The idea of a smarter electrical grid, called the Smart Grid, is not recent, but the current context makes it necessary. The Smart Grid concept consists in improving the monitoring and communi-



cation capabilities of each actor of the electrical grid, being either producer or consumer of electricity. Communication enables many new services centered around a remote, automatic and fast monitoring and coordination of the actors of the Smart Grid. This enhancement associated with fine-tuned algorithms for the management of the actors carries the promises of an electrical grid more responsive, a smoothed consumption, and even a reduction of the electricity consumption.

The electrical grid has not been conceived with two-way communication in mind, and adding communication capabilities to the existing network requires the deployment of a new infrastructure. In the research community, this new infrastructure is called the Advanced Metering Infrastructure (AMI). To support the Smart Grid, the AMI adds many new devices. Those devices play a key role in monitoring the electrical grid, send, receive and process large amount of data.

## 1.2 Research Problem and Goal

The increasing variability in consumption and production increases the difficulty to manage the electrical grid. The Smart Grid is largely recognized as a solution to the current issues the electrical grid is facing. Eventually, the Smart Grid will propose services that will directly interact with some users' devices to solve specific events, such as peaks of consumption, inside the electrical grid. Those interactions rely on two-way communication between actors of the Smart Grid.

The cornerstone of the communication capabilities of the Smart Grid is the AMI. Many technologies are available and discussed in the literature to support the AMI. For instance, we can cite Ethernet, Wi-Fi, Power Line Communication (PLC), ZigBee, WiMAX, LoRaWAN or Cellular. Each technology has its advantages and drawbacks, and in general several technologies are combined depending on the objectives of the network.

In this context, a first objective of this thesis is to study the interactions between the power network and the AMI and to provide tools to support this study. A second objective is to evaluate, using the tools we developed, the influence of the communication properties of the AMI on the efficiency of some services of the Smart Grid. As mentioned previously, the Smart Grid also aims at reducing the electricity consumption of the electrical grid. The deployment of many sensors and communication devices may have a non-negligible impact on electricity consumption. A third objective of this thesis is to model and assess the energy consumption of the AMI.

## 1.3 Contributions

The contributions of this thesis are the following:

- A co-simulation framework dedicated to the evaluation of Smart Grid services. The framework consist in a combination of three simulators dedicated to distributed systems, power networks and communication networks. The tool we propose, and the simulators composing it are all license-free, easing simulation on distant test-bed servers and reproducibility.
- A quantitative evaluation of the influence of various communication parameters such as communication delay and communication technologies on a reactive Smart Grid service. The analysis also compares the performance of a centralized and a decentralized algorithm in managing actors to solve a consumption peaks issue.
- An investigation of the end-to-end architecture of an AMI, and energy consumption models for each part of the metering infrastructure. The models are used to assess the energy consumption of the AMI at a nation-wide scale, based on the French use-case.

## 1.4 Publications

- “Influence of Communication Technologies in Smart Grid Power Congestion Management”, Adrien Gougeon, François Lemercier, Anne Blavette, Anne-Cécile Orgerie, GreenCom-2022 - 18th IEEE International Conference on Green Computing and Communications, Aug 2022, Espoo, Finland. pp.1-10, Best Paper Award <https://hal.archives-ouvertes.fr/hal-03711670>
- “Modeling the End-to-End Energy Consumption of a Nation-Wide Smart Metering Infrastructure”, Adrien Gougeon, François Lemercier, Anne Blavette, Anne-Cécile Orgerie, ISCC 2022 - IEEE Symposium on Computers and Communications, Jun 2022, Rhodes, Greece. pp.1-7. <https://hal.archives-ouvertes.fr/hal-03666587>
- “Impact of wired telecommunication network latency on demand-side management in smart grids”, Adrien Gougeon, Benjamin Camus, Anne Blavette, Anne-Cécile Orgerie, IM 2021 - 17th IFIP/IEEE International Symposium on Integrated Network

Management, May 2021, Bordeaux / Virtual, France. pp.295-303. <https://hal.archives-ouvertes.fr/hal-03217562>

- “Co-Simulation of Power Systems and Computing Systems using the FMI Standard”, Adrien Gougeon, Benjamin Camus, François Lemercier, Martin Quinson, Anne Blavette, Anne-Cécile Orgerie, IM 2021 - IFIP/IEEE International Symposium on Integrated Network Management – demo paper, May 2021, Bordeaux / Virtual, France. pp.130-131. <https://hal.archives-ouvertes.fr/hal-03217565>

## 1.5 Organization of this Manuscript

The rest of this manuscript is organized as follows.

In Chapter 2, we present the state of the art on the Smart Grid. We start with a description of the current electrical grid, the main concepts behind the Smart Grid, and the services strongly dependent of the communication infrastructure. Then we review the literature on this subject and highlight some limitations, motivating this thesis.

In Chapter 3, we propose a co-simulation framework dedicated to the simulation of Smart Grids. The framework combines simulators dedicated to distributed networks, power networks and communication networks.

In Chapter 4 we evaluate the impact of wired communication network latency on a reactive Smart Grid service. The evaluation is done on a case study using real traces of a residential district, and uses the framework proposed in the previous chapter.

In Chapter 5, we extend the works presented in chapter 4, and explore the influence of communication technologies on a reactive Smart Grid service. The power network simulation is also extended and uses now an unbalanced power flow.

In Chapter 6, we evaluate the end-to-end energy consumption of a nation-wide advanced metering infrastructure.

Finally, the last chapter concludes and provides directions for future research.

# STATE OF THE ART ON THE SMART GRID

---

The most common deployment of a country-wide electrical grid consists in huge facilities producing large quantities of energy. The production is fully controllable by the grid operators and follows the consumption, with a low level of communication between the two parts. Since several years, this structure, that we will call from now on the conventional electrical grid, shows limitations due to the growing number and variety of actors. The Smart Grid is depicted as an evolution of this conventional electrical grid. In this section, we present the main characteristics of this conventional electrical grid, how the energy is produced and distributed. We highlight its limitations and why the Smart Grid is envisioned as an extension of the conventional electrical grid. We also introduce Demand-Response, which is one of the main features that the Smart Grid bring to the conventional electrical grid, and what are the research advances in this domain. Finally, we discuss the validation techniques in this field of research, and more specifically simulation tools.

## 2.1 The Electrical Grid

At the end of the 1800s, electricity becomes a valid alternative to other power sources, and a global electrification starts. Electricity progressively replaces steam and coal gas in daily life. Structures of various sizes and functions are developed and deployed to meet the growing needs for energy, evolving the electrical grid to the one we use nowadays. In this section, we present an outline of the current architecture of the conventional electrical grid, and what new challenges it is currently facing.

### 2.1.1 From Electricity Production to Consumption

The production-consumption balance is one of the fundamental principle of any electrical network. At every instant, the amount of electricity injected into the grid must be as close as possible to the amount retrieved from it to avoid potentially disastrous conse-

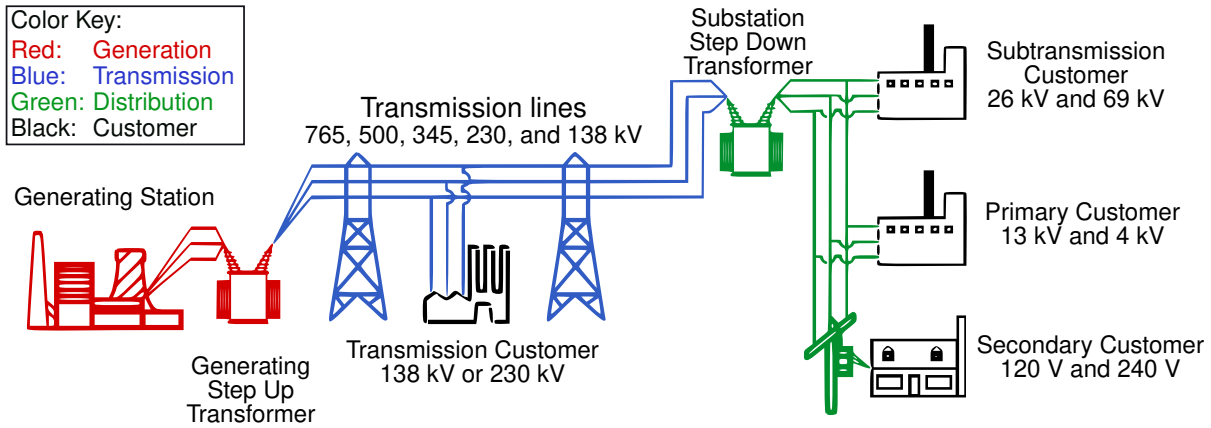

Figure 2.1: Diagram of an electrical grid [1]. The values are given as a insight, and real values may differ depending on countries.

quences such as a global outage. This task is made easier with a large electrical network, increasing the predictability of the consumption. To ease the production-consumption balance at a large scale and the distribution to the largest number of consumers, the conventional electrical grid is organized as a top-down architecture. On Figure 2.1, from left to right, we see that the electricity is produced in generating stations, transported by transmission lines, distributed by the distribution network, and consumed by different consumers profiles. The generation part, in red, is detailed in Section Production below. Each part of the figure is detailed in the following sections.

## Production

Inside the electrical grid, electricity is produced inside large facilities for the vast majority, e.g. coal, gas or nuclear power plant or hydro dam. The primary energy comes mainly from non-renewable sources, as it can be observed on Figure 2.2. On this Figure we see that the global electricity production is increasing and has doubled in less than 25 years. The trend for PV, WECS and other renewable energies is relatively new and the largest part of the production still comes from coal and gas power plants. The electricity produced by those facilities is raised at a high voltage, typically in the order of hundreds of kV, and injected inside the transmission network. The production of electricity is actively tuned in real-time to match the consumption and maintain the production-consumption balance.

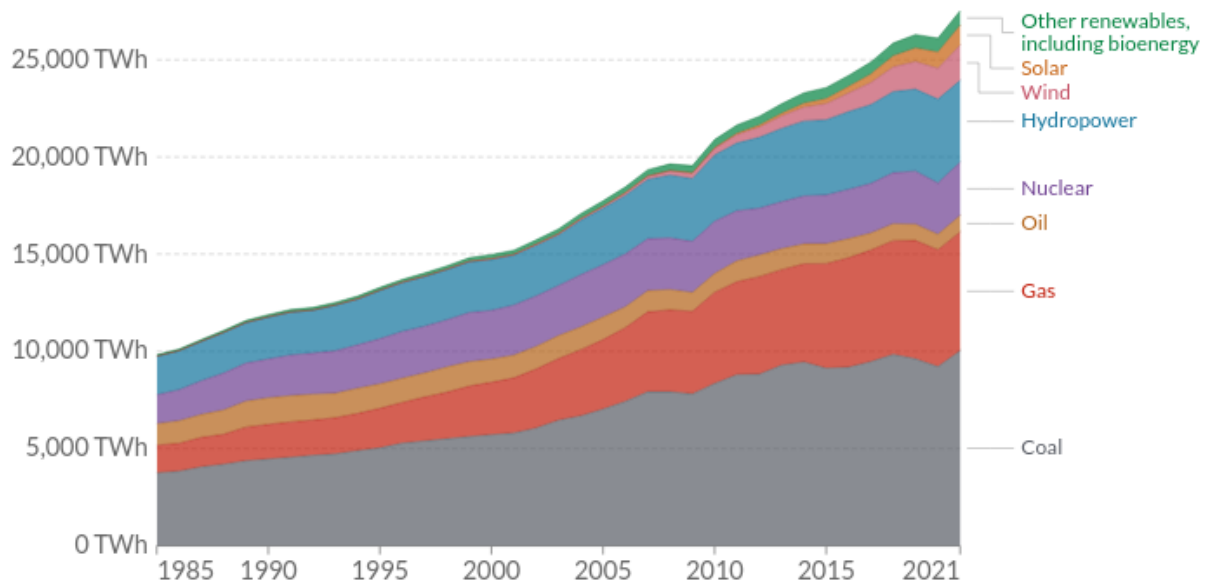

Figure 2.2: World electricity production by source [2].

## Transmission

High voltage electricity is transported by the transmission network interconnecting all major electricity production facilities. The electricity is transported at high voltage to decrease cable size, diminishing costs and reducing power losses. To maintain the power flow when disruptions happen, the transmission network is heavily meshed. Some heavy industrial consumers may be directly connected to the transmission network, such as the industries for paper, basic metals, chemical products, petroleum products, mine and quarries.

## Distribution & Consumption

Before reaching small industrial and residential consumers, the voltage is reduced using local step down transformers inside the distribution network. A first step down is made to obtain voltage in the order of kV or tens of kV, i.e. medium voltage, providing electricity to small industries. Another step down is made to reach low voltage, in the order of hundreds of V, for residential consumers' consumption.

### 2.1.2 New Usages & Limitations

The current concerns of the electrical grid mainly focus on three topics: improve the inclusion of Distributed Energy Resources (DER) and handle the growing peaks of consumption.

#### Environmental Concerns

The environmental crisis forces the electrical grid to adapt to support the evolution of society. The Kyoto Protocol [3] and Paris Agreement [4], adopted respectively in 1997 and 2015, gives objectives toward the reduction of Greenhouse Gas (GHG) emissions to limit the global temperature increase. However, in the current architecture a significant part of electricity production comes from carbon sources [5, 6], inducing important GHG emissions. To reduce those emissions due to the electrical grid, numerous works of the literature explore the DER.

#### Distributed Energy Resources

DER are separated in two categories, Distributed Generation (DG) and Energy Storage Technologies. Akorede et al. [5] define DG as “any source of electric power of limited capacity, directly connected to the power system distribution network where it is consumed by the end users”. The authors highlight the dramatic consequences of the conventional power generation and promote DG as a solution to substantially decrease the environmental impact of electricity production. Beside reducing GHG emissions, they also state that DG increases energy efficiency, notably via co-generation, reduces health damage by improving air quality, and saves land space. Overall, the authors do not present any drawback in including a massive amount of DG in the electrical grid. They provide a description of a wide range of DER solutions, as depicted in Figure 2.3. On the left part of the Figure we see the DG technologies, split into conventional generators and non-conventional generators. In the first category we have reciprocating engines and gas turbines, largely used in power generators, ships, aircraft or trains for instance, but producing large amount of GHG. In the second category we found technologies more environmentally friendly such as PV or WECS. We also observe on this Figure the presence of energy storage technologies. Energy storage is necessary to adapt to the intermittent production of some technologies such as PV and WECS, or to store the excessive energy that could not be consumed, instead of simply discarding it. The electricity is converted

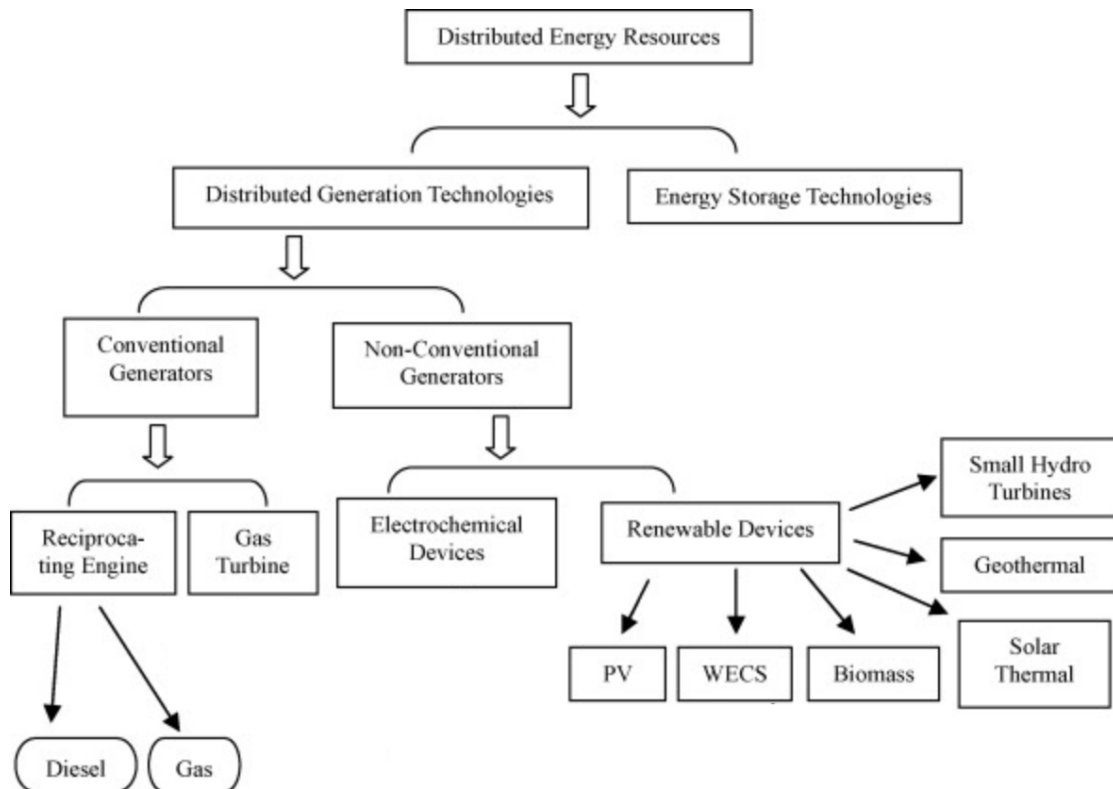

Figure 2.3: DER technologies [5]. Simplified version

into another form of energy that can be stored, for instance in batteries, and released when needed.

Keshav et al. [6] define DG as “the production of energy from tens of millions of small scale sources, rather than a few hundred massive generator”. The authors state that the need for a cleaner energy pushes the deployment of numerous small scale renewable production units closer to the consumer. They explain that the proximity of DER to consumer reduces losses from the transmission and distribution networks and also reduces the fraction of coal and natural gas in the energy mix, decreasing carbon footprint of electricity production. However, the authors express reserves about the deployment of DG. Communication is limited in the conventional electrical grid and endpoints, local consumers or producers, may not be able to receive commands. Consequently, endpoints cannot adapt dynamically to the stress status of the electrical grid, for instance during consumption peaks.



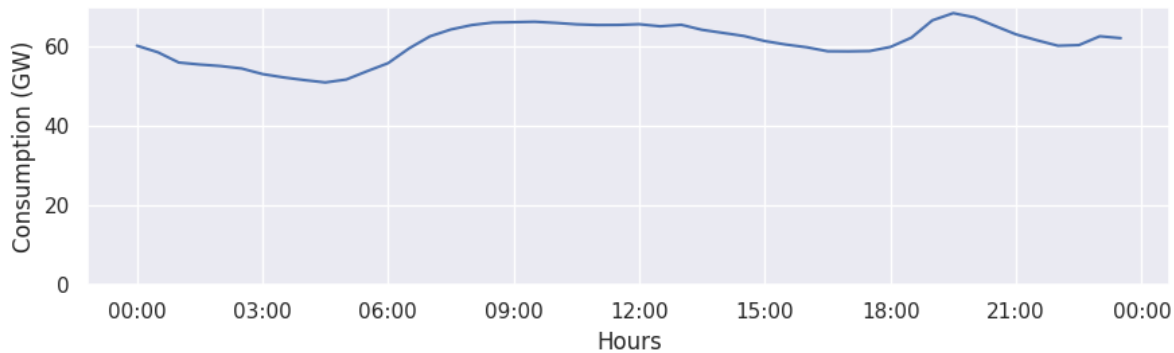

Figure 2.4: France power consumption on July 3rd, 2019 [8].

## Handling Consumption Peaks

To meet the production-consumption balance, the whole electrical power system, from the production to the consumer and including transmission and distribution network, is designed to support consumption peaks. The electricity consumption works in cycles, depending on season, day of the week, and hour of the day. For a typical summer week day, as shown in Figure 2.4, the consumption is low at night, with a medium peak in the morning followed by a decrease through the morning and the afternoon, then there is a great peak in the evening, generally around 7 PM, and finally a low consumption again at night. The intra-day variation pattern is strongly linked to social practices [7], such as watching cooking or charging EV.

To reduce the carbon footprint of transportation, the EV market acknowledged a significant growth in the past few years in various countries. On Figure 2.5 we see that the size of the Portugal EV fleet tripled in three years, going from 5000 units in 2016 to 15000 in 2019. As we see on Figure 2.6, the market is supposed to pursue its growth in the next years. Nogueira et al. [9] discuss the current and future deployment of EV and stress out the impact of this market on the electrical grid, and especially on the consumption peaks hours. Personal EV chargers consume between 3kW and 7kW [10], in comparison a washing machine consume between 0.5kW and 1.5kW at peak consumption. In addition, EV are often connected to the grid in the evening during consumption peaks [10]. The authors conclude that the current network will not be able to bear the charge of a scenario with high penetration of EV, and a reinforcement of the distribution network is pressingly needed, or a smarter charging management to delay charging off consumption peak.



Figure 2.5: EV market in Portugal [9].

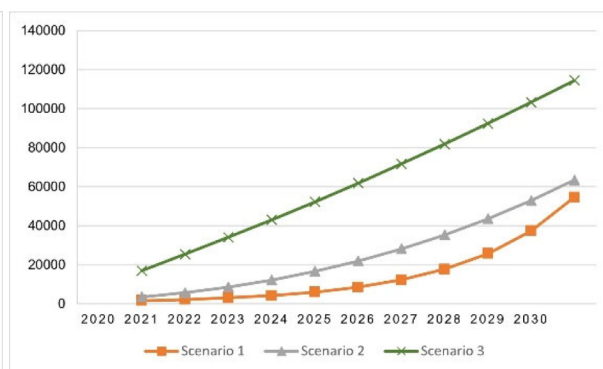

Figure 2.6: EV market forecast in Portugal [9]. Scenarios range from less optimistic to more optimistic.

## 2.2 The Smart Grid

Production and consumption of electricity is quickly evolving. Consumers tend to increase their electricity consumption, for instance by favoring electric heating over gas-based heating. EV are also a great example of new electric intensive usages. The apparition of DG modifies the conventional production of electricity. The electrical grid was originally designed as a one-way circuit with a power flow from the large centralized production facilities to consumers. However, the power flow becomes bidirectional with the apparition of DG. As a result, new difficulties emerge inside the electrical grid management. In this section we present the Smart Grid, a solution envisioned to face the current challenges met in the electrical grid.

### 2.2.1 General Concept

The idea of a smarter electrical grid is not a new concept. Since one or two decades, many initiatives tries to demonstrate how the Smart Grid will be profitable for every actor of the electrical grid and how it can be actually deployed in the real world.

#### Definition

Lorena Tuballa et al. [11] review hundreds of studies about the Smart Grid to define its characteristics, features and functionalities. Based on the reviewed studies we can refer to the Smart Grid as a cooperative system, interconnecting producers and consumers in real-time through a two-way exchange of data and electricity, minimizing disruptions,

Conventional Grid	Smart Grid
Mechanization	Digitization
One-way communication	Two-way real-time communication
Centralized power generation	Distributed power generation
Radial network	Dispersed network
Less data involved	Large volume of data involved
Small number of sensors	Many sensors and monitors
Less or no automatic monitoring	Great automatic monitoring
Less security and privacy concern	Prone to security and privacy issues
Human attention to system disruption	Adaptive protection
Simultaneous production and consumption	Use of storage systems
Limited control	Extensive control systems
Slow response to emergencies	Fast response to emergencies
Fewer user choices	Vast user choices

Table 2.1: Conventional electrical grid versus Smart Grid [11]

security threats, costs, and maximizing power quality, efficiency and reliability. The authors highlight key differences between the conventional electrical grid and the Smart Grid, as shown in Table 2.1. In this table we see that communication takes a particularly important place in the Smart Grid with the need of two-way real-time communication, the large volume of data, the large number of sensors, the extensive control systems and the fast response to emergencies.

Alotaibi et al. [12] also review studies in the Smart Grid paradigm and advances in this domain. Using the various provided references, we can sum up the Smart Grid as the modernization and automatization of the conventional electrical grid from the generation through transmission and distribution up to consumers, adding communication, data monitoring and storage, improving resiliency, optimizing grid operation, allowing bidirectional communication and power flow, and unlocking new functionalities.

## Benefits

The Smart Grid aims at making the power system more flexible in order to integrate variable, less-dispatchable renewable energy sources into the grid [13]. It also aims at operating the power system in a more efficient way, increasingly closer to its physical limits, by adopting less conservative security margins [14, 15]. This should contribute in postponing, or even avoiding, the need for costly grid reinforcement, e.g., new substations, lines and transformers.

Inside the Smart Grid community, there is a consensus that the improvements in communication and monitoring would [12]:

- Increase power quality and reliability
- Improve efficiency of the whole system
- Improve resiliency
- Ease the integration of DER
- Enhance maintenance and self-healing capabilities
- Decrease GHG emissions

## Risks

The deployment of the Smart Grid presents several risks [16]:

- **Privacy:** a lot of user data are monitored and there are concerns in its usage by third parties. In addition, real-time monitoring and fine measurement may give insight of the routine of the consumers, and even insight of their presence in their home
- **Security:** the communication system must be secured to avoid issues such as data leaks, or manipulation of remote controllable actors that would increase disruption risk.
- **Accuracy:** monitoring devices must be precise enough, for instance to avoid complaints from users about inconsistent billing

As we have seen, the Smart Grid requires a high level of communication to be able to communicate efficiently with the growing number of actors of the electrical grid. As a result, communication devices must be deployed at a large scale to make the Smart Grid a viable solution. Several cost benefit analysis approved the deployment of the Smart Grid in European countries and the European Union [16] decided to rely on smart meters for data collection.

### 2.2.2 Smart Meters

The choice has been made to deploy smart meters at each end-point of the Smart Grid, either local consumer or producer of electricity. The role of those devices is to measure several metrics concerning energy production and consumption, and the overall energy quality inside the grid. The models vary from one country to another, and from a constructor to another, but their goal remains mostly the same:

to offer an interface between users and network managers, unlock many new services, improve grid management and consumer satisfaction.

### 2.2.3 New Services

The Smart Grid, and the smart meters supporting it, are envisioned to provide multiple new services that are not possible with the conventional electrical grid. The Benchmarking on smart metering deployment in the EU-28 [16] provides a list of services offered by the Smart Grid:

- Comparison with others consumers (allow consumers to compare their energy consumption with comparable peers)
- Bill forecasting
- Real-time consumption
- Real-time cost
- Unusual usage alert
- Historical consumption
- Real-time carbon impact
- Different tariffs (implicit Demand Response)
- Flexibility provision (through implicit Demand Response with dynamic pricing)
- Flexibility provision (through explicit Demand Response)
- Fuel poverty detection
- Energy sharing
- Smart meter to integrate prosumers in the market
- Smart meter to facilitate smart charging of EV at home
- Smart meters to facilitate smart charging of batteries

In the rest of this manuscript, we focus on Demand Response (DR) services as they are envisioned as a great solution for a better integration of DER and to solve issues related to peaks of consumption. Among the new services offered by the Smart Grid, all of them require communication, either from smart meters to energy providers or vice-versa. DR specifically requires a high level of communication, either to collect data from smart meters to energy providers, or to receive commands from energy providers.

## 2.3 Demand Response

Demand Response (DR) is a subcategory of Demand-Side Management (DSM). There is no consensus on the definition of DSM, but it is generally referred as any method to modify the consumer behavior, either directly or indirectly, to achieve various energy-oriented objectives such as a reduction in emissions or balance supply and demand [17, 18, 19, 20]. Originally oriented toward electric systems, DSM is now considered in other domains such as heating, or co-generation mixing electricity and heating. Among the most popular concepts regrouped under DSM, we find energy efficiency and DR. A typical example of an energy efficiency measure is the improvement of the thermal insulation of buildings, which result in a permanent reduction of the consumption.

In this section we introduce DR programs, we present some literature approaches applying those programs, and we depict the Advanced Metering Infrastructure (AMI) that brings the necessary communication layer into the electrical grid.

### 2.3.1 Demand Response Programs

Similarly to DSM, DR has several definitions. A well known study from the US Department of Energy defines DR as “the changes in electric usage by end-use consumers from their normal consumption patterns in response to changes in the price of electricity over time, or to incentive payments designed to induce lower electricity use at times of high wholesale prices or when system reliability is jeopardized” [21]. Among the various definitions, there is a consensus that DR is a modification of the consumer behavior (the response) to a request (the demand) from the grid manager, in exchange for an incentive. Those requests may be induced by a need to reduce or increase electricity demand to preserve the grid integrity, for instance in the case of peaks of consumption, or to reflect the cost of generation and the dynamicity of the electricity market. DR allows for a more efficient use of the electrical grid and reduces the need to upgrade infrastructures in response to the increase in consumption, saving important costs. The benefits of residential DR for reducing network congestion have been assessed in the literature [22, 23]. In addition, some DR programs, such as Ecowatt [24], have already been deployed. DR programs can be classified in two main categories [21, 25], incentives-based programs and price-based programs, as it can be seen on Figure 2.7.

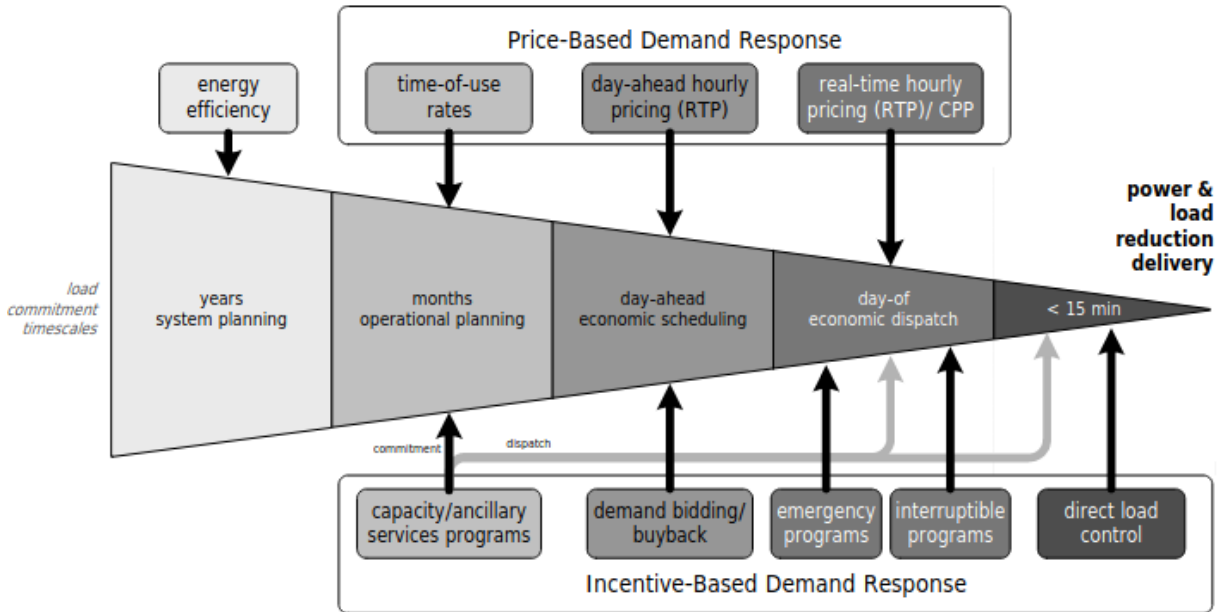

Figure 2.7: DR programs [21].

### Price-based Programs

Price-based programs, on top of Figure 2.7, refer to program where the price of electricity varies during periods of time. In the literature we distinguish three main price-based DR programs:

- Time-Of-Use (TOU): the day is split in blocks of time, often simply an on-peak block and an off-peak block, with different prices for those time periods. This program is already available in many countries, and the time periods are static and known several months in advance.
- Real-Time-Pricing (RTP): the day is split in short blocks of time, often 1-hour blocks, with different prices for those time periods. Most RTP programs fix the price for the time periods on a day-ahead basis.
- Critical-Peak-Pricing (CPP): a very high price for electricity is set beforehand for critical periods of consumption. Those periods occur only for several days or hours per year, and the consumer is warned also several days or hours ahead of the event.

### Incentive-based Programs

Incentives-based programs, at the bottom of Figure 2.7, refer to program where users are rewarded by energy providers, with a refund on their energy bill, when answering to specific events occurring on the electrical grid. In the literature we distinguish four main price-based DR programs:

- Direct load control: the consumer registered to this program are offered incentives in exchange for the possibility of some of their appliances to be remotely shut down during critical events.
- Interruptible programs / Load curtailment: on enrollment the consumer and energy provider agree on an incentive given to the consumer in exchange for the acceptance to reduce its load during specific events. Severe penalties apply if the consumer do not reduce its load as intended.
- Demand bidding: this program is reserved to large consumer which are proposed to bid for the price at which they accept to reduce their load during excessive load events.
- Emergency programs: the consumer is proposed an important incentive to reduce its consumption during specific events to increase grid reliability. The participants of this program may suffer a penalty if they refuse the request.

In this thesis, we focus on the importance of communication for the Smart Grid and for DR programs. In that sense, our main interest is in DR programs closer to real-time and constrained by the communication network, such as RTP and direct load control, on the right of Figure 2.7.

### 2.3.2 Approaches for Deploying Demand Response Programs

The literature is rich on approaches for the deployment of DR programs. In this section we present some common method proposed, and we pay particular attention to the communication aspect.

#### Demand Response Algorithms

A. RezaeeJordehi [25] review DR solutions in power systems. He separates the reviewed studies between two categories of constraint optimization problem: classic optimization



algorithms and metaheuristic optimization algorithms. In the following we detail some examples of those categories.

Mohsenian-Rad et al. [26] present a DR program as a linear optimization problem where the goal is to schedule house appliances to reduce consumer bill, according to real-time pricing of electricity with 1-hour periods. Their results show a 25% reduction in consumer daily bill. In their context, the authors assume that “each residential consumer is equipped with a smart meter, connected to a smart power distribution system with a two-way digital communication capability through computer networking”. They mention the possibility to use ZigBee or PLC for in-home communication. Yet, there is no detail on the communication parameters in their evaluation, while communication from the central utility to the appliances is a key component in their DR proposition.

Samadi et al. [27] formulate their DR algorithm as a convex optimization problem. Their algorithm search to maximize the utility of each user, and minimize the energy cost for every provider, based on RTP of electricity with 1-hour periods. The utility function of a user expresses its level of satisfaction based on its power consumption. Their evaluation show a benefit for both the users and the energy provider. In their study, the authors specify that each user is equipped with a smart meter linked to a communication architecture, allowing two-way data transfer between users and the energy provider. They mention a “limited number of message exchange” without further information, but the communication architecture is not considered in their evaluation.

Pedrasa et al. [28] rely on binary particle swarm optimization to solve their DR problem. Their main objective is to schedule interruptible loads following day-ahead hourly curtailment requirements to maintain a safe and cost-efficient operation of the electrical grid. The constraints considered are a minimization of the cost of electricity for the interruptible loads and their number of interruptions, while also considering the operational constraints of the loads. The authors compare their method with another based on fuzzy dynamic programming and obtain comparable results. The evaluation is done by simulations where order are sent to interruptible loads, but communication means are never mentioned.

Logenthiran et al. [29] propose a DR program relying on a genetic algorithm. The authors use a day-ahead load curve of consumption as their objective, and shift appliances consumption along the day to fit at best this curve, while still trying to respect usual consumption patterns, e.g., coffee machine available in the morning. The evolution is done on chromosomes, which are simply two-dimensional arrays of the size of the number

of time steps and the number of devices. Their simulations effectively show a load pattern closer to the objective load than without load shifting. The model proposed relies heavily on communication as control commands are supposed to be sent in real-time between devices and DSM controller. They also mention that the communication infrastructure must be able to handle two-way data communication. However, the authors do not detail this infrastructure.

Zishan et al. [30] present a method called Adaptive AIMD (A-AIMD) based on reinforcement learning and imitation learning. The concept of their DR program consists in managing the power of EV chargers to optimize their state of charge while mitigating consumption when congestion signals arise from overloaded upstream transformers. Their algorithm provides good results during simulations in comparison to others baseline algorithms. The authors assume the presence of a communication network connecting EV chargers to upstream transformers, but there is no detail about this network.

In the reviewed DR solutions, communication between the utility taking DR decisions and consumer device is a strong requirement to obtain the presented results, yet, none of them takes into account the influence of the underlying communication infrastructure. The quality of service related to a given communication medium, such as delay or bandwidth, is not taken into account. However, communication delays have a non-negligible negative influence on power grid management algorithm and DR programs, as highlighted in the next section.

### **Communication Delay Issue**

In their study, Guo et al. [31] apply asynchronous distributed optimization methods to optimize electrical grid power flow using the Alternating Direction Method of Multipliers (ADMM), an augmented Lagrangian method to reduce the number of iterations to reach convergence. They decompose a large area in smaller regions, where adjacent regions exchange data to solve an optimal power flow problem. In the synchronous method, each region requires data from all neighbors, while the asynchronous one does not. Using simulations, the authors show that for large delays (0.5-2ms), most regions have to wait to obtain at least one neighbor data, leading to a great asynchronism. They demonstrate that asynchronous ADMM can achieve comparable performance than in the synchronous case. However, they point out that communication delays matter and an increase in communication delays affects negatively both the synchronous method and even more the asynchronous method.

Attarha et al. [32] extend the ADMM and propose an Affinely Adjustable Robust ADMM (AARO-ADMM) in the case of DER coordination to avoid network's technical limits violations. The main idea of their method is to adjust battery charge or discharge rate at every 5-min time step to compensate deviations from the load hourly-forecast, using a robust coordination for the first time step of the negotiation. The authors take into account the possible communication delays issues presented in [31] by reducing the frequency of reoptimization and communication.

Ramezanipour et al. [33] explore consumption threshold crossing using a lightweight communication system in an imperfect communication context. Their method consists in using simple 1-bit memoryless communication and a AND, OR or MAJORITY vote system. The authors show that the AND rule have a stable average error probability in guessing the state of the system independently of the communication error probability. This is because it does not detect threshold crossing, and it is the right result most of the time as threshold crossing is a rare event. On the other hand, the MAJORITY rule is better at capturing the system state, but its average error probability grows with the increase in communication error probability. In this study the authors do not consider a specific communication mean, instead they take into account an average error probability in communication.

Xu et al. [34] propose a decentralized coordinated voltage control method to adjust reactive power injection or absorption and prevent issues due to the uncertainty of DG. The authors point out the necessity to consider communication time-delay to prevent voltage instability that would damage the power system. They extend this work in two others studies. In the first one [35], they explore how stochastic communication delays may affect the efficiency of synchronous and asynchronous optimal power flow based on ADMM. They conclude that stochastic communication delays affect the performance of both synchronous and asynchronous algorithms, even with a small probability. In the second one [36], the authors highlight the vulnerability of ADMM to communication delays with a time-delays attack. Similarly to the work of Ramezanipour et al. [33], this study considers a theoretical communication mean, characterized here by its delay, while it was the error probability in the first case.

Burkley Beil [37] discuss the services that could offer EV fleets to the power grid, for instance, frequency regulation. This service is implemented using a consensus algorithm between the distribution transformers in a ring architecture. The algorithm uses available capacity and EV load capability data, and provides a power dispatch for each

transformer as a result. One of the outcomes of this study is the negative impact of communication delays on their consensus algorithm. The author concludes that an increase in communication delays decreases the performance, and that there is a trade-off between communication delays and accuracy in the response of EV for frequency regulation.

Lin et al. [38] experiment DR through a real use case of frequency regulation using Heating Ventilation and Air Conditioning (HVAC) systems of a commercial building of 40000 sq. ft. in the University of Florida. Frequency regulation is done through a direct control of the fan speed, or an indirect control by changing the air-flow rate. The authors conclude that HVAC systems can effectively support frequency regulation for the power grid, while maintaining a comfortable climate for the users inside the building. Yet, they warn that communication delays may reduce performance, and decrease command execution delays by improving the software will supposedly increase performance.

Hui et al. [39] propose a solution to address communication delays and error detection for the control of flexible loads and frequency regulation. Indeed, the authors state that most studies about the control of flexible loads, e.g., DR programs, do not consider communication delays. They also confirm that many studies point out the negative impact of communication delays on DR programs. Their solution is based on a hybrid control method combining the advantages of a centralized control method to reduce frequency detection error, and on a distributed control method to reduce communication delays.

Pruckner et al. [40] study the influence of packet loss and latency on the ability for power production facilities to match power demand in real-time. The authors provide a simulation framework which aims to combine several components of the Smart Grid into a single environment. Simulations show that an increase in packet loss and latency increases the mismatch between demand and supply. The authors conclude by saying that packet loss and latency are crucial factors to take into consideration when designing a system to match supply with demand.

Ledva et al. [41] provide a solution to reduce the influence of communication delays on the control signals and state measurement of residential thermostatically controllable loads, e.g., air conditioner. The main concept is to use a model predictive control algorithm to predict the input using knowledge on delay statistics. Simulation results show a reduction of 39% in the average tracking error.

In [42], the authors propose to study the impact of the communication delay on cascading failures in power grids. Results show that delays in the communication links in the grid can increase drastically the cascading effect of failures. They point out that a

protection deadline has to be taken into account to avoid this cascading failures.

Communication delays should be taken into account when designing control algorithms with a significant share of information transmission, such as DER management strategies. The implied reaction time required for such a scenario is in the order of seconds or lower [15, 43, 44]. Additionally, the need for integrating disparate, intermittent and widely geographically DER (i.e. renewable sources) and flexible loads (i.e. heaters, EV) presenting individual constraints calls for a decentralization of the power system management [23, 45].

The works reviewed in this section underline that communication delays, inherent to the transmission of information, could degrade dramatically the performance of a Smart Grid [46]. Communication delays can impact negatively the power grid management algorithms and the efficiency of DR programs. Those studies remain mostly at a qualitative level, without a proper measurement of this impact. Most of them use theoretical communication means which are not linked to actual technology specifications. Also, they do not explore differences between specific technologies, for instance between wired Ethernet, PLC or Wi-Fi, while each of those technologies have specific communication characteristics. In the context of the Smart Grid, the communication delays depend on the communication network of an infrastructure known as the Advanced Metering Infrastructure (AMI).

### **2.3.3 The Advanced Metering Infrastructure**

The Smart grid is based on an AMI to gather information (about local production/consumption, network state, etc.). The AMI communication network is generally deployed as a hierarchical system, as depicted in Figure 2.8. On this Figure we see that smart meters, collecting houses' consumption data, are spread in clusters. In each cluster there is a local concentrator, aggregating the collected data. This data is then forwarded to a backbone concentrator and to a central utility, the Meter Data Management System (MDMS). The power system performance depends on the design and management of its telecommunication supervising infrastructure [43]. The performance of the former can of course be enhanced by using the additional amount of information provided by the latter [47].

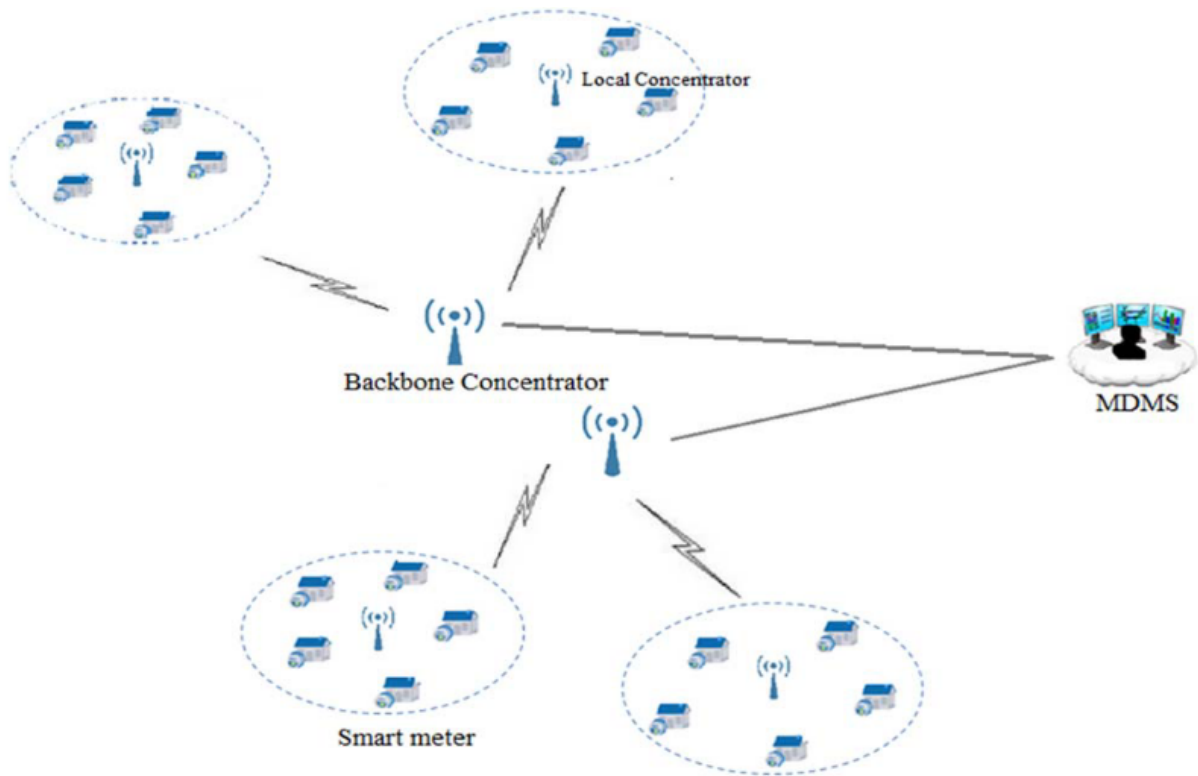

Figure 2.8: AMI communication network model [48].

### Communication Technologies & Latency

Several communication technologies are explored in the literature and are deployed in Smart Grids experimentation and in real deployment. Generally, the PLC technology is cited as a reference in most Smart Grid communication works [49]. It represents a legacy of the traditional Automated Meter Reading (AMR) programs, where signals for on/off-peaks hours are sent through the power system conductors [50]. PLC has a high sensitivity to interference, an attenuation of the signal at every transformer and a low bandwidth compared to other communication technologies. Nevertheless, PLC is often selected due to its lower costs, as it can be deployed on an existing electrical infrastructure [51] without additional communication lines.

Other technologies used to connect the data concentrators to the smart meters include wired (i.e. optic fiber, Ethernet) or wireless technologies (i.e. Zigbee, GPRS, Wi-Fi) [44, 52, 53]. In particular, wired Ethernet-based networks are praised for their reliability and energy efficiency [44], contrary to PLC that present severe channel conditions and are unable to accommodate a massive number of clients [54].

Some works in the literature propose different solutions based on specific technologies, or a combination of these. For instance, in [55] the authors have selected a combination of Zigbee and PLC. This choice is motivated by the cost criterion and the ease of the implementation, without any justification on the impact on the Information and Communication Technology (ICT) infrastructure's performance. Other works use multiple technologies concluding that each one can meet the requirements of specific applications [42, 56]. Authors in [56] encourage the use of a hybrid architecture using domestic Wi-Fi, 4G/LTE, LPWAN and WiMAX. They precise that for cases like frequency response "The faster the response the better the grid-level service provided". However, their test-bed is still in development and the evaluation of their hybrid architecture is incomplete for now.

In the same context, Samarakoon et al. [50] propose an experimentation of a Zigbee load control installation. They measure the delay and its impact on the primary frequency response using smart meters. This study shows the importance of the smart meter, and especially its communication medium, since most of the operation duration to update the frequency measurement is attributed to the communication itself. Similarly, Jahić et al. [57] demonstrate the feasibility of a DSM system with the control of heating appliances connected using Wi-Fi and highlight the necessity of low delays in DSM. However, this study only presents a single scenario and do not provide a comparative analysis of communication technologies.

The choice of a given communication technology over another is often not justified in the literature, and to the best of our knowledge, there are few contributions comparing communication technologies in a Smart Grid context [50, 55, 56, 58]. Moreover, in these studies, the provided comparison remains at a qualitative level, without any quantitative analysis of potential impacts on DSM performance. The AMI infrastructure remains an unexplored prerequisite of DR approaches.

## **Energy Consumption of the Advanced Metering Infrastructure**

In order to achieve a climate neutral economy, a large-scale roll-out of smart meters is strongly encouraged worldwide and in particular in the European Union [16]. The objectives of this roll-out are multiple: (1) having a finer temporal granularity of consumption data for the consumers, grid operators and energy providers, in order to implement energy saving schemes, reduce the consumer's energy bill, increase the consumption share from renewables and improve network planning, (2) allowing remote automated consumption data collection, (3) enabling remote adjustment of the contract power level, (4) providing

two-way data transfer for maintenance and control. The first point underlines one of the main purposes of using an AMI: reducing the grid users energy consumption [59].

While smart metering aims at saving energy, it also induces additional energy consumption to power the AMI which collects measurements from smart meters and presents them to end-users.

Studies on energy-efficiency of Smart Grid communication technologies mainly tackle optimization problems on routing protocols [60], energy harvesting from the smart meter point-of-view [61] or data aggregation to reduce the data volume. The literature is rich on how to optimize the energy efficiency of this ICT system [62], for either actual deployment or envisioned optimized ones [63], but scarce on assessing its energy consumption. Preisel *et al.* accurately measured the electricity consumption of various smart meter devices [64]. These measurements are used by Malmodin *et al.* to estimate the gains and costs in terms of energy consumption of a large-scale smart metering infrastructure [65]. They outline the fact that previous small-case studies tend to be biased towards overly optimistic results, and that: “*the impact of the smart metering system itself, while being typically left out in most former studies reviewed, [...] may be significant in low and even medium reduction scenarios*”. Yet, their study only considers the smart meters themselves and not the overall ICT infrastructure required to collect and process the data produced by the smart meters. Ghasempour *et al.* present in [66] an energy consumption model of an AMI, proposing a new metric that takes into account the product of cost and energy to determine the adequate number of concentrators needed. Despite interesting results verified by simulation on the optimum number of concentrators, this study only consider a 100 km<sup>2</sup> area with a uniform distribution of the meters.

To the best of our knowledge, proposing an end-to-end energy model of a smart metering infrastructure has not been addressed in the literature. In this thesis, we focus on the design of the AMI communication network and explore both the communication characteristics and the energy consumption aspect.

## 2.4 Validating Demand Response Approaches

DR algorithms need to be tested to prove their efficiency and compare against other solutions from the literature. There are two main possibilities to validate a contribution in DR: test-beds or simulations.



### 2.4.1 Test-Bed

A test-bed is a physical evaluation of a concept. In the case of a test-bed for a DR algorithm, an experimentation is deployed in the real world and includes computing and networking components. Generally, the number of devices is reduced due to time and cost of deployment. Test-beds are convincing due to their physical aspect, proving effectively that the concept works in the physical world. In addition, the devices models are generally mentioned, easing reproducibility.

The Enedis Lab [67] is a laboratory dedicated to test Linky smart meters. In this laboratory, more than 700 smart meters are tested to ensure that they are still functioning under various conditions such as vibrations, short-circuits, electromagnetism, water infiltration, etc... They also test their communication capabilities. At a smaller scale, Hamdan et al. [68] propose a platform to emulate a low voltage Smart Grid. Their platform includes a low voltage transformer, several smart meters, a PLC gateway acting as a concentrator, resistor bank acting as loads, programmable power sources acting as PV panels, and several other components. As already mentioned in the previous section, Lin et al. [38] deploy their management algorithm for voltage regulation inside a building of 40000 sq.ft. to validate their proposition.

However, test-beds have some drawbacks. Testing algorithms and collect a satisfying volume of data may take a long time. Also, reconfiguration for parameter exploration can be a tedious task, and may even require the purchase of new equipment. Testing new communication protocol or equipment may take a long time and induce prohibitive costs. All these drawbacks explain the low number of existing Smart Grid test-beds.

### 2.4.2 Simulation

The most common form of simulation in the DR research field consist in using a basic optimization problem solver. As we can see in Table 2.2, more than half of the reviewed articles use an optimization problem solver. They often come as MATLAB packages or Python modules.

Several research fields rely on simulators to explore their hypotheses, and many are at the crossing of several domains. Smart Grids constitute such an example of multi-domain requirements as they rely on computing and telecommunication network resources to pilot the underlying power system networks.

Electrical grid studies usually rely on power system simulators that numerically re-

produce the dynamics of an electrical network and perform power flow calculations for a considered network. Such simulators represent the necessary alternative to performing tests on the actual network, which may cause disturbances detrimental to consumers.

### **Power Network Simulation**

Power network simulators mimic the behavior of actual power networks and allow researchers to perform experimentation campaigns without degrading the safe and reliable operation of actual power systems, while staying in a controllable, modular, and often reproducible environment.

These simulators are used to build power networks models using various basic blocks such as transformers, loads, generators, lines and switches. Once the power network is build, a power flow calculation is done, often based on the Newton-Raphson method [69].

Dozens of power network simulators exists [69, 70, 71, 72]. Some are proprietary tools such as PowerWorld, PowerFactory or NEPLAN. In addition, some may also be limited to the Windows operating system, and with a limited automation due to the mandatory use of the graphical interface. Fortunately, many open source tools [70] overcome those three important drawbacks, such as pandapower [73].

Power network Simulators are great tools to model power networks and compute a power flow, but they are dedicated to this task and do not consider communication networks.

### **Communication Network Simulation**

As in the power network field, the communication network research community largely relies on communication network simulators [74]. These simulators can be classified in two main categories: packet-level simulators and flow-level simulators [75].

Packet-level simulators allow users to build fine-grained representations of telecommunication networks. They aim to model communication in every aspect, including the complete protocol stack from the physical layer to the application layer, and the network packets. Because of this attention to detail, packet-level simulators are recognized for their accuracy. However, this great precision and the large number of parameters associated complicate the task of building a network model, and may be prone to errors. In addition, the precise representation of every element induces an important computational burden, limiting for large scale simulations. Several packet-level simulators exist, with their pros

Paper	Comm. Techno.	Validation Technique	Traces
[26]	n/a	Optimization problem solver	Hourly-based prices adopted by Illinois Power Company from January 2007 to December 2009
[27]	n/a	Particle swarm simulator	n/a
[28]	n/a	Optimization problem solver	n/a
[29]	n/a	Optimization problem solver	n/a
[30]	n/a	Optimization problem solver (CVXPY and MOSEK) & Deep Reinforcement Learning (PyTorch and OpenAI Gym)	IEEE ELVTF & ADRES-CONCEPT dataset & Pecan Street dataset &
[31]	n/a	Matlab R2016a	n/a
[32]	n/a	Optimization problem solver	Australian Electricity Market Operator & Reposit Power
[33]	n/a	Optimization problem solver	“The Reference Energy Disaggregation Data Set”
[34]	n/a	Optimization problem solver	Solax Power Ltd
[35]	n/a	Optimization problem solver	n/a
[36]	n/a	Matpower/Matlab	n/a
[37]	n/a	Optimization problem solver	PJM RegA
[38]	n/a	Real world experimentation	n/a
[39]	n/a	Optimization problem solver	National standards in Hangzhou, China, on August 1st, 2015
[40]	n/a	AnyLogic	ENTSO-E load profiles for the years 2008-2011 & a weather station near Munich
[41]	n/a	Optimization problem solver	n/a
[42]	n/a	Optimization problem solver	n/a
[55]	ZigBee, PLC	Test-bed	n/a
[56]	Wi-Fi, 4G/LTE	Test-bed	Singapore power market and power grid

Table 2.2: Communication technologies, validation setup and traces used in several demand-response studies

and cons [74]. Among the most used we can cite OMNET++ [76] and ns3 [77], the first being free for research purpose, the second open source, and both are C++ libraries.

Flow-level simulators allow users to build coarse-grained representations of telecommunication networks. They aim to reduce simulation time by modeling communication in a simpler way than packet-level simulator and represent communication by a continuous flow instead of every packet. In consequence, flow-level simulators are useful for large scale communication simulations, but particular attention must be paid to their validity as they do not model communication as precisely as packet-level simulators. Among the most used flow-level simulators we can cite DeSiNe [78] and SimGrid [79], both written in C++.

### **Co-Simulation**

Communities have developed and polished their own simulators to answers their needs. These simulators have proven to be consistent with reality either theoretically or experimentally. However, the Smart Grid is at the intersection of power networks and communication networks and none of the simulators cited in the previous sections can model accurately both networks.

In their study, Addisu et al. [80] implement their demand-response algorithm in python, and use afterward the communication simulator OMNET++ to validate the obtained results. This methodology lacks precision as both system are totally decorrelated. A solution to correlate several simulators is to use co-simulation.

Co-simulation can be defined as “a simulation methodology in which several individual components are simulated simultaneously by different tools and exchange information with each other” [81]. This methodology presents several advantages [82]:

- study the global behavior of the system
- enforce a clear separation of concerns in a multidisciplinary modeling and simulation process
- reuse and factorize efforts put into the development and validation of preexisting simulation tools

Camus et al. [82] review several works that propose a co-simulation platform for the Smart Grid context. The authors emphasize that most works are limited to a unique power system simulator, while other reviewed works ignore the computing system execution and its influence on the Smart Grid. Consequently, the authors propose to use the versatility of the Functional Mock-up Interface (FMI) Standard [83] to show how SimGrid can be

combined with PowerFactory to model accurately the Smart Grid.

### 2.4.3 Traces

DSM algorithms explored in Smart Grid case studies, either in test-beds or in simulations, largely depend on data traces. They are necessary to prove that the heuristics can adapt to real world data and are not constrained to research environments.

#### European Low Voltage Test Feeder

Real data from existing power systems are scarce, especially when considering not only few isolated loads, but an entire network, its topology and its loads. Several traces are used in literature, as is can be seen in Table 2.2, but few are publicly available. We chose to base our study on the publicly available electrical network IEEE model European Low Voltage Test Feeder (ELVTF) [84].

The ELVTF network includes a topology of a 3-phase, low voltage (230/400 V) distribution grid with multiple feeders connected to a 11 kV/416 V substation typical of the United Kingdom [85]. The model also provides time series traces of one-minute averaged consumption. Each time series corresponds to the consumption of a single household, for a total of 55 time series for 55 households. A representation of this network is shown in Figure 2.9. The green triangle in the top left represents the substation, connected to the external grid and feeding the district in energy, and each blue square represents a household.

## 2.5 Conclusion

The electrical grid is moving toward the Smart Grid to handle the new usage linked to the evolution of the society. Demand Response (DR) programs are among the main benefits envisioned by the transition to the Smart Grid. There is a wide variety of algorithms proposed in the literature to implement DR.

Several communication technologies are discussed in the literature to support the Advanced Metering Infrastructure (AMI) as the communication backbone of the Smart Grid. However, most DR solutions in the literature do not consider communication at all, and those who take it into account do not consider it as an impactful factor during the evaluation of their solution. Another main goal of the Smart Grid is to improve energy

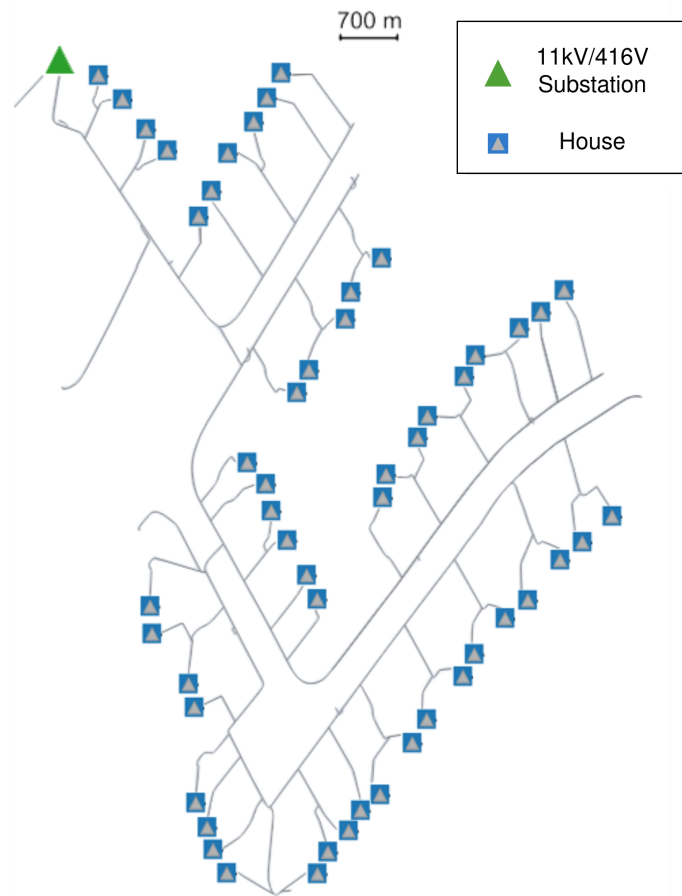

Figure 2.9: Representation of the ELVTF power network.

consumption. To the best of our knowledge, the energy consumption of the AMI has not been assessed yet.

In our work, we explore the effect of communication parameters, such as latency, and also compare quantitatively several communication technologies to evaluate their impact on DR. Next, we model the energy consumption of the AMI to evaluate if the choices made for its deployment are in line with the consumption improvement objectives of the Smart Grid.



# CO-SIMULATION OF POWER SYSTEMS AND COMPUTING SYSTEMS USING THE FMI STANDARD

---

In the previous chapter, we have seen that simulators are great tools to alleviate several difficulties encountered in the real world. However, simulators are often dedicated to a specific domain, and this limits their usability for tackling actual research problems laying at the crossroads of several domains. This chapter presents a way to combine simulation tools for power system networks, communication networks and distributed computing resources in a coherent co-simulation framework. Co-simulation consists in coupling different tried-and-tested simulators from the original communities. Such a combined tool will ease the study of complex Smart Grids scenarios where the performance of each part of the system impacts the rest of the system's functioning. The environment allows for interactions between each simulator at run time.

## 3.1 Overview

Distributed networks, computing systems and communication system are often deeply intricate. Some computing system simulators already propose also communication simulation. This is the case of SimGrid [79]. The SimGrid framework is a toolbox to develop simulators of distributed platforms. SimGrid can either use its own communication system or a fully integrated ns-3 [77] communication mode. When the ns-3 option is used, SimGrid translates its own communication network definition into ns-3 code. This option gives the user the possibility to use a packet-level simulator, instead of the default flow-level simulator. The automatic translation ease the configuration of the communication network, which can be a tedious task in ns-3, but at the cost of a smaller configuration space. SimGrid is also compliant with the Functional Mock-up Interface (FMI) standard [83, 86].



The FMI standard aims to increase the interoperability between simulators by creating a common standard to exchange data between dynamic models. Exported models which can be imported by others FMI compliant tools are called Functional Mock-up Unit (FMU). The FMI standard is well established with more than 170 tools supporting it.

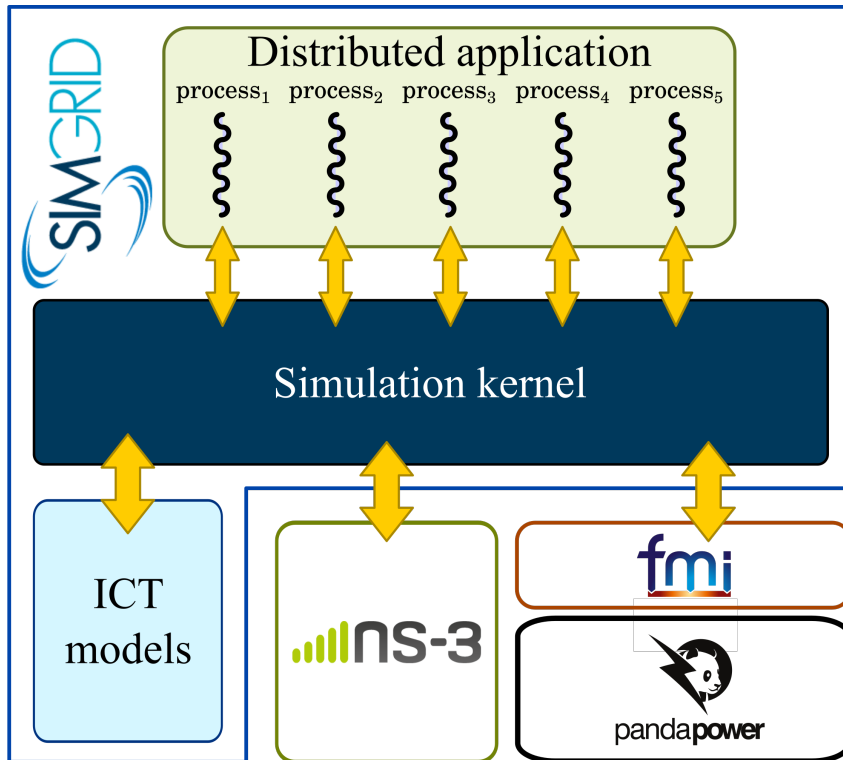

Figure 3.1: Co-simulation framework.

Camus et al. [82] have shown how SimGrid can import a FMU to interact with a power system simulator models, PowerFactory [87], a licensed power system simulator running on the Windows operating system. PowerFactory has proven its efficiency and is largely used in the industrial world. Conversely, pandapower [73, 88] is an open-source python module to simulate power system that can run on any operating system, and it has been compared against PowerFactory with success. We developed a tool to generate pandapower networks FMU<sup>1</sup>. It allows users to build and export power networks models that can then be imported into SimGrid. Inside SimGrid, the predefined input and output of the power network can be respectively modified and accessed during simulation. The electrical network load flow problem is only solved when trying to access an output. We chose to rely on pandapower as it is part of the open source initiative and thus fully free to

1. Tool available: <https://framagit.org/Adrien.Gougeon/pandapower-fmu>

use. As every part of the co-simulation is license-free, the deployment of the simulations on distant test-bed servers is facilitated and reproducible. Also, several simulations can be run in parallel without licence-related constraints. Figure 3.1 shows a simplified view of how ns-3 and pandapower are interacting with SimGrid, which acts as a co-simulation engine for running multi-models of complex systems in this case.

In the rest of this chapter we detail the tool more in depth, how to use it and how it works, and then we introduce a brief example use case to grasp the interest of a co-simulation merging a computing system simulator, a communication simulator and a power system simulator.

## 3.2 FMU Integration

The goal of the tool we developed is to produce a power network model, or FMU, compliant with the FMI standard [83]. As SimGrid is capable to import FMU [86], it can then interact at run time with the power network model.

This section details how to build the FMU step by step, what guidelines we followed to be compliant with the FMI standard and how to interact with the FMU inside SimGrid.

### 3.2.1 Build a FMU

There are three steps to build a FMU using the tool we developed. The first one is to create the power network. The second one is to write the input and output files. And the last one is to use our Python executable to obtain a working FMU.

#### The Power Network

The first step to build a pandapower-fmu is to create the power network you want using the python module pandapower [88]. Then, this power network must be exported to a JSON file. A minimal example is depicted in Listing 3.1. In this example we import at line 4 a simple example network [89], and we export it to a JSON file at line 5.

Listing 3.1: Create and export power network using pandapower.

```

1 import pandapower as pp
2 import pandapower.networks
3
4 net = pandapower.networks.example_simple()
5 pp.to_json(net, "power_network.json")

```

## Input & Output Files

The second step consists in creating the ports files. Indeed, to interact with the power network model we need to define which variables of the network can be accessed and which one can be modified during the simulation. To do so we create a file containing the output ports, the variables that can be accessed, and a file containing the input ports, the variables that can be modified. The syntax is the same for both files and is shown in Listing 3.2. For instance, if you want to be able to modify the active power of the load `LOAD1`, you have to add to the input ports file the line `load/LOAD1/p_mw/Real`. `load` is the name of the pandapower dataframe containing the loads parameters, `LOAD1` is the name of the load, `p_mw` is the modifiable variable, here the active power of the load in MW, and `Real` is the type of this variable. The different types are `Real`, `Integer`, `Boolean` and `String`. The complete list of datastructures and variables, e.g. `load` and `p_mw`, is available in the pandapower documentation [90].

Listing 3.2: Ports file syntax.

```

1 datastructure1/variable1/column1/type1
2 datastructure2/variable2/column2/type2
3 ...

```

## Python Executable

The last step to create a pandapower-fmu is to use our Python executable `makeFMU.py`<sup>2</sup>, as shown in Listing 3.3.

Listing 3.3: Python executable.

```
python makeFMU.py [-n name] -i input -o output -nw network [-u]
```

2. File available: <https://framagit.org/Adrien.Gougeon/pandapower-fmu/-/blob/master/makeFMU.py>

The `-h` option show a detailed help for the executable. If the power network provided is unbalanced you have to provide the `-u` option as pandapower uses a different function to solve balanced and unbalanced power networks. The executable begins by copying the provided input, output and network files into a resource folder. Then, it parses the input and output ports files to build the “modelDescription.xml” file, referencing all the unique identifiers of the accessible variables during simulation. Finally, the xml file, the resource folder and a C binary file are zipped together to form the FMU.

The C binary file contains all the mandatory and standardized functions required by the FMI standard. The simulator able to import the FMU, SimGrid in our case, will use these standardized functions. There is one binary file for balanced load flow and one for unbalanced load flow. The functions we implemented are the function to instantiate the FMU, the functions to set values and the functions to get values. We make extensive use of the Python/C API to embed and use the pandapower module inside our C program.

The instantiation, shown is pseudo-code in Listing 3.4, consists in:

- initialize the python environment;
- import the pandapower module;
- import the power network;
- run an initial load flow. This is useful to check that everything works correctly from the start and to generate the results dataframes, necessary to read values;
- fill tables associating each FMI identifier to a dataframe, column and row index.

In the FMI world, each input or output variable is assigned a unique identifier, visible in the “modelDescription.xml” file. However, in the pandapower world, to access or modify a value you need to access a cell in a specific dataframe, in a specific column and row. The goal of the last part of the instantiation is to store the dataframe, column, and row index inside static arrays. This process saves a lot of computation time as the translation from the FMI identifier to a pandapower cell is done in  $O(1)$ . The original method was to load the xml file, to parse it to associate the FMI identifier to the tuple dataframe/variable/column and finally to associate the pandapower variable name to the pandapower row index. This method used less memory without the static arrays, but was too slow to be used in practice on medium scenarios.

Listing 3.4: Pseudo-code of the function to instantiate the FMU.

```

1 instantiate():
2     Py_Initialize();
3     PyImport_ImportModule("pandapower");
4     import_power_network();
5     run_load_flow();
6     fill_variables_index_table();

```

The functions to set values are separated by type, either Real, Integer, Boolean or String. Yet, they work all the same:

- transform the new C value into a value compliant with the Python/C API
- retrieve the pandapower cell associated to the FMI identifier using the static arrays
- set the new value using the Python/C API
- save into a global variable that the power network has been modified

The functions to get value follow the same rules. However, and if the power network has been modified since the last call, the power flow is solved again to update the results dataframes.

### 3.2.2 SimGrid & pandapower Interactions

Camus et al. [86] describe how they integrate the FMI model into SimGrid to make it able to import and interact with a FMU and produce convincing co-simulations. The documentation, source code and examples of SimGrid-FMI can be found on its official framagit repository <sup>3</sup>.

To be able to interact with the FMI we first have to import it. This is done using the `add_fmu_cs` function, as shown in Listing 3.5. The first parameter is the path to the FMU, the second is the name of the FMU, and the last one determines if the FMU will iterate after receiving an input.

Listing 3.5: Importing the pandapower FMU.

```

simgrid::fmi::add_fmu_cs(path_to_fmu, fmu_name, false);

```

3. Simgrid-FMI : <https://framagit.org/simgrid/simgrid-FMI>

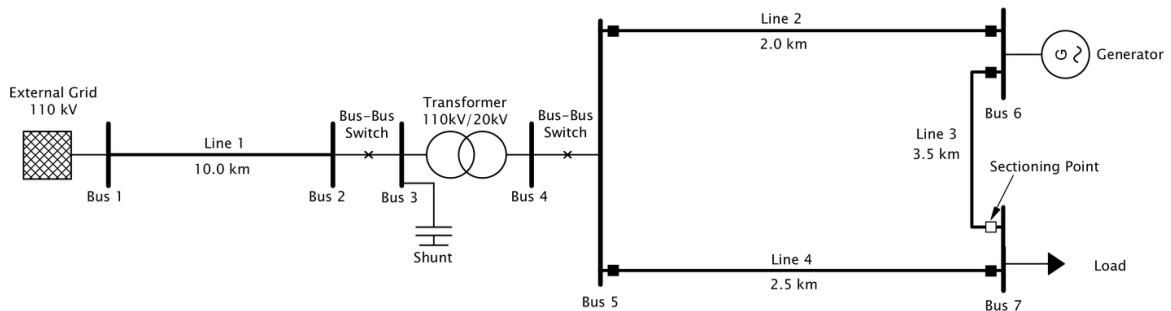

Figure 3.2: Minimal pandapower network.

Getting and setting values inside the FMU is done through a set of functions depending on value type. In Listing 3.6 we show how to get and set real values. The `get_real` function parameters are the name of the FMU and the output variable name. The `set_real` function parameters are the name of the FMU, the input variable name and the new value. The output and input variable names correspond to the variables' unique identifiers defined in the “modelDescription.xml” file and described in Section 3.2.1.

Listing 3.6: Get and set real values inside the pandapower FMU.

```
1 simgrid::fmi::get_real(path_to_fm, output_variable_name);
2 simgrid::fmi::set_real(path_to_fm, input_variable_name, value);
```

### 3.3 Example Use Case

We chose to use a basic, though realistic, example scenario to present our co-simulation environment. In this scenario, there is a load and a generator connected through a power network to a transformer. The generator provides a part of the power demand of the load, while the other part comes from the external grid through the transformer. We simulate an unexpected shutdown of the generator, increasing the power flow through the transformer, due to the load consumption. When the power flow through the transformer exceeds its rated power, the transformer sends a request to the load asking it to reduce its power demand. The power network we chose to rely on is part of the first tutorial of pandapower<sup>4</sup>, presented in Figure 3.2. The load values are randomly generated from a normal distribution.

Interactions between pandapower and SimGrid are done using the SimGrid-FMI plu-

<sup>4</sup>. pandapower tutorial: [https://github.com/e2nIEE/pandapower/blob/develop/tutorials/create\\_simple.ipynb](https://github.com/e2nIEE/pandapower/blob/develop/tutorials/create_simple.ipynb)

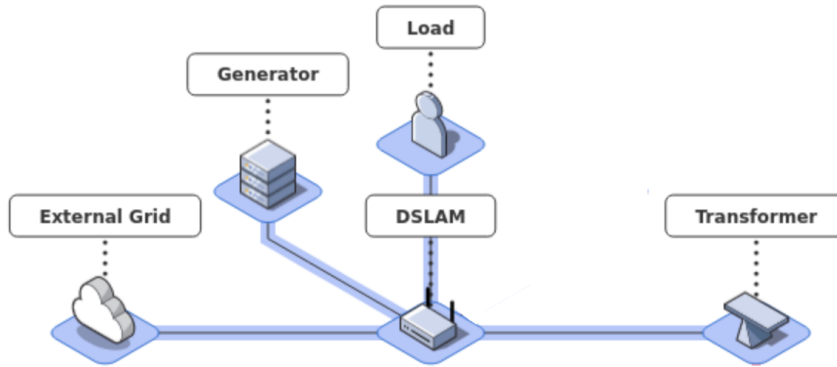

Figure 3.3: Star communication network.

gin. This plugin makes SimGrid compatible with every FMU meeting the FMI standards, including FMU created using pandapower-fmu, developed during this PhD thesis. The plugin allows users to read and / or modify variables of a FMU dynamically during the co-simulation.

On top of the power network, we consider a distributed management orchestrated by SimGrid. Three actors coexist during the simulation:

- The master actor samples the power demand at the transformer every second, like a smart meter. If the demand is above the transformer rated power, 1.5 MW, it sends a message to the load asking it to reduce its power demand;
- The generator killer shuts down the generator after 15 hours of simulated time, changing its power generation to 0 MW. This actor simulates an unexpected shutdown or disconnection of the generator;
- The load manager changes the load power demand every 30 minutes following a normal distribution, in order to simulate a typical fluctuating load profile.

For the communication network, we considered a star topology presented in Figure 3.3, where each entity is connected to a common router. We fixed a wired latency of 10 ms from one entity to the router. We performed two simulations : one with a reactive master shedding the load if needed, and one with a passive master. The total simulated time is 24 hours. The power demand at the transformer during the simulations is depicted in Figure 3.4. The horizontal green line shows the rated power of the transformer. The vertical red line shows the moment at which the generator shutdown is simulated. The orange line shows the power flow through the transformer in a simulation without the

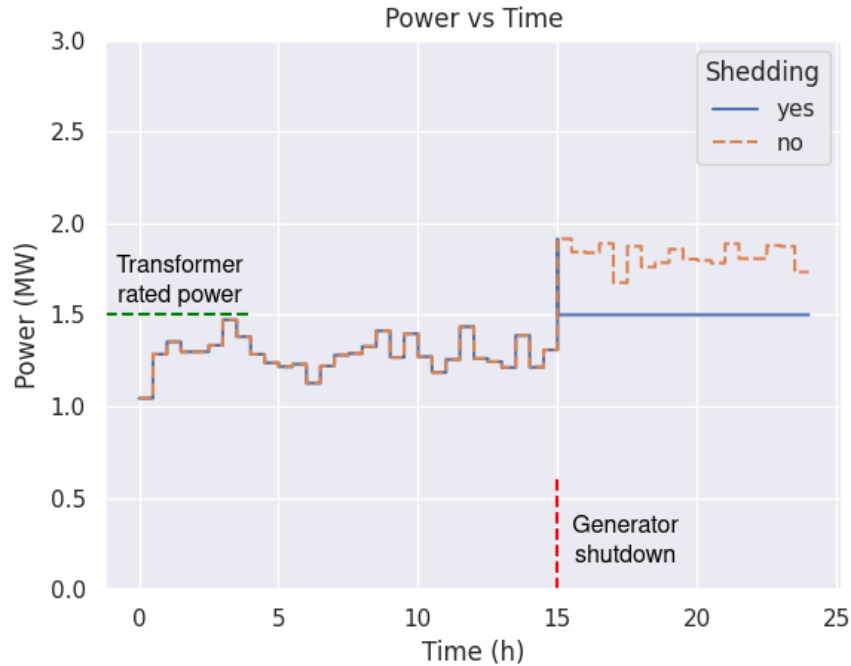

Figure 3.4: Power demand at the transformer.

master reacting to the excessive power demand above its rated power, i.e., when the master actor is passive and does not perform load shedding. The blue line shows the power through the transformer in a simulation when the master actor is active and reacts to the excessive demand by sending a message to the load, i.e., performs load shedding. As expected, the active master reacts quickly due to the low delay, and the power flow stays below the transformer rated power.

The purpose of this simple use case was to show how SimGrid, ns-3, and pandapower through the FMI can interact in a coherent co-simulation. To pursue this work, we wanted to implement and extend a more complex use case from the literature.

### 3.4 Extending a Demand-Side Management Use Case

Zishan et al. [30] propose in their work a demand-response algorithm using multi-agent Deep Reinforcement Learning (DRL). Their study highlights a context where there is a growing penetration of private Electric Vehicle (EV) in residential areas. The EV chargers are connected to the distribution network and consume large amounts of power when in use. This additional charge may lead to congestion, transformer overloading and a reduced service time for equipment. The authors' approach is to take advantage of the flexibility



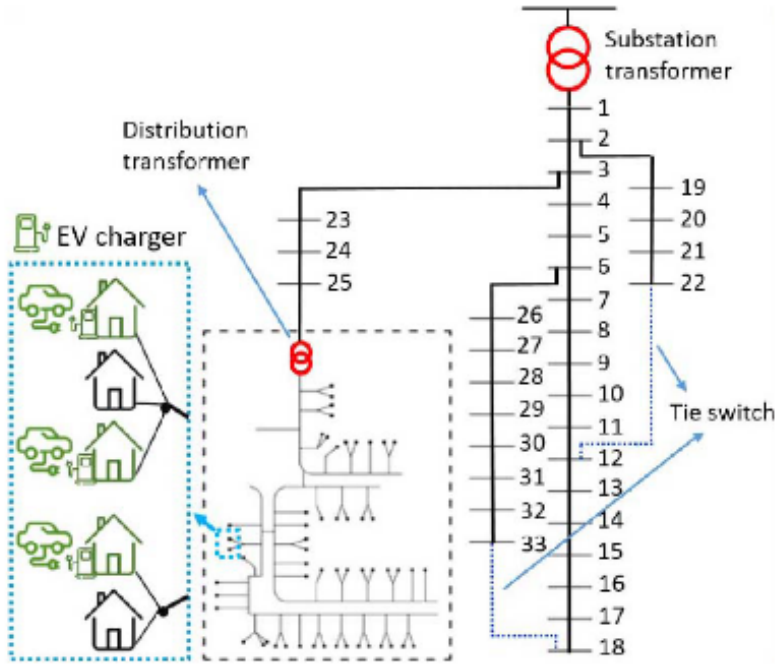

Figure 3.5: Power network presented in [30]

of EV to schedule their charging time to reduce disturbances on the power network.

They propose a method called Adaptive AIMD (A-AIMD). This method is based on the Additive-Increase Multiplicative-Decrease (AIMD) method which consists in: an additive increase of the chargers' power until the distribution network becomes congested, and a multiplicative decrease of the charger's power when there is a congestion. The A-AIMD method extends AIMD by using dynamic rates instead of static rates for the increase and decrease. The dynamic rates are evaluated using DRL for each agent.

The authors' method is evaluated by simulating a use case with a residential distribution network comprising 1760 households and 500 EV. As shown in Figure 3.5, the households are separated in districts inspired by the IEEE European Low Voltage Test Feeder (ELVTF) dataset. Each of the 33 districts includes a distribution transformer, in addition to the substation transformer on top of the Figure. When a congestion is detected by a transformer, a signal is sent to each charging point downstream. The evaluation shows that their method is effective at preventing overloads and voltage violations, and outperforms other methods of the literature.

This study presents some limitations concerning its evaluation. Firstly, there is no detail concerning the simulation of the power network. Secondly, we see that communication is an important point in their method as it impacts directly the reactivity of the charger

when a transformer detects a congestion, but communication is not taken into account for the evaluation. Our proposition was to extend this study by improving its evaluation part using our co-simulation methodology to include an open source and detailed power network and communication simulation.

Unfortunately, reproducibility is a tough task [91, 92], and we encountered several difficulties to reproduce the evaluation as close as possible of the original study. Some parts lack precision, in particular concerning the optimization problem for the offline training phase, and the simulation of the power network and power flow calculation, which are key in the evaluation. The code is not available, and despite our efforts, the authors were not reachable. Some datasets used where not publicly available like the one used for the arrival time of the EV.

We built the power network in pandapower, the communication network using SimGrid and ns-3, their DRL algorithm using python and the Gym module, and we selected an alternative dataset instead of the licensed one.

Ultimately, more time would have been necessary to assemble the parts, test the whole framework, and compare it the results to the original study. The whole process of reproduction would have been a lot easier with answers from the authors and with a source code publicly available, especially to understand how they simulated the power network.

## 3.5 Conclusion

The tool presented in this chapter allows for co-simulations between a computing system simulator, a communication system simulator and a power system simulator. Each specific simulator is recognized by its community and has proven to provide results compliant with the real world. We presented two use cases, one introductory scenario and a more detailed one extending a state-of-the-art scenario. The tools used are all open source, facilitating the deployment of the co-simulation and providing a better cross-checking of the produced results, a key feature of a reproducible research. In the two following chapters, the validations will be based on this framework.



# IMPACT OF WIRED TELECOMMUNICATION NETWORK LATENCY ON DEMAND-SIDE MANAGEMENT IN SMART GRIDS

---

We have seen in Chapter 2 that Demand-Side Management (DSM) implies to adjust the power consumption of so-called “flexible loads” (e.g. smart heaters, EV) in order to prevent or mitigate grid issues in a considered area. This approach may represent a cost-effective alternative to expensive and time-consuming grid reinforcement measures, and it is therefore enthusiastically considered by grid operators. In the previous chapter, we introduced a tool we developed to build co-simulations merging the simulation of computing networks, communication networks and power networks at run time. This chapter use this tool to explore the influence of wired telecommunication latency on DSM inside Smart Grids through a case study.

## 4.1 Overview

The large number of flexible loads to be controlled by DSM, as well as the short timescale at which they should be controlled, will render the traditional centralized approaches obsolete [44, 45]. Under such conditions, these approaches would indeed require a prohibitive computing effort, as well as raise potential privacy issues due to the transmission and centralization of short timescale, and therefore highly sensitive, consumers electricity consumption data.

Hence, decentralized management approaches are now considered [45, 93]. Among them, anticipatory and reactive approaches may be distinguished. The anticipatory approach is intended to generate a load power consumption schedule preventing grid issues, based on forecasts (e.g. of the power consumption and generation in the considered network) and on sufficient knowledge of the network characteristics such as topology and

impedance for instance. However, forecasts inherently present a certain level of error, thus impacting the performance of such an approach, and sufficient information on the network characteristics may be unavailable. Contrary to the anticipatory approach, the reactive approach is envisaged as a mitigation measure once an issue in the grid (e.g. a congestion) is detected or is close to occur [15, 94, 95]. Therefore, it does not require any knowledge on the future and needs only limited to no information on the electrical network characteristics. Such an approach relies on short period measurements in the problematic area (e.g. short period measurements of the electrical current in the potentially congested piece of equipment), and on equally short period flexible loads control.

This chapter presents a comparative analysis of the performance between two such reactive energy management algorithms, one being decentralized and the other being centralized, both based on short frequency measurements and control, and both intended to mitigate congestion in a low-voltage electrical network, whose model is publicly available, and will be detailed later in this chapter. The algorithms are based on the successive and repeated shedding (called “cascado-cyclic shedding”) of a sufficiently important number of direct-acting smart electric heaters [96]. These loads can be reasonably shed during a short amount of time without impacting noticeably their owners’ comfort due to the significant thermal inertia in typical households [96].

In the rest of this chapter we detail the case study we considered, including the power system, the computing system, the management of the Smart Grid and both the centralized and decentralized approaches compared. We present briefly the co-simulation framework, introduced and detailed in the previous chapter. Then, we detail the metrics measured and compared, along with the parameters explored. Finally, we present the results obtained and discuss them.

## 4.2 Case Study

Congestion issues may occur on the electrical grid during peak period times, when consumption is at its highest, that is in the early evening in most countries and especially in winter times when electrical heaters are used. This type of appliance is power and energy intensive, but can be interrupted for a short period without disturbing the consumers. This is why we consider controllable electrical heaters in this case study in order to analyze the influence of the telecommunication network’s performance on the smart management of the electrical grid.

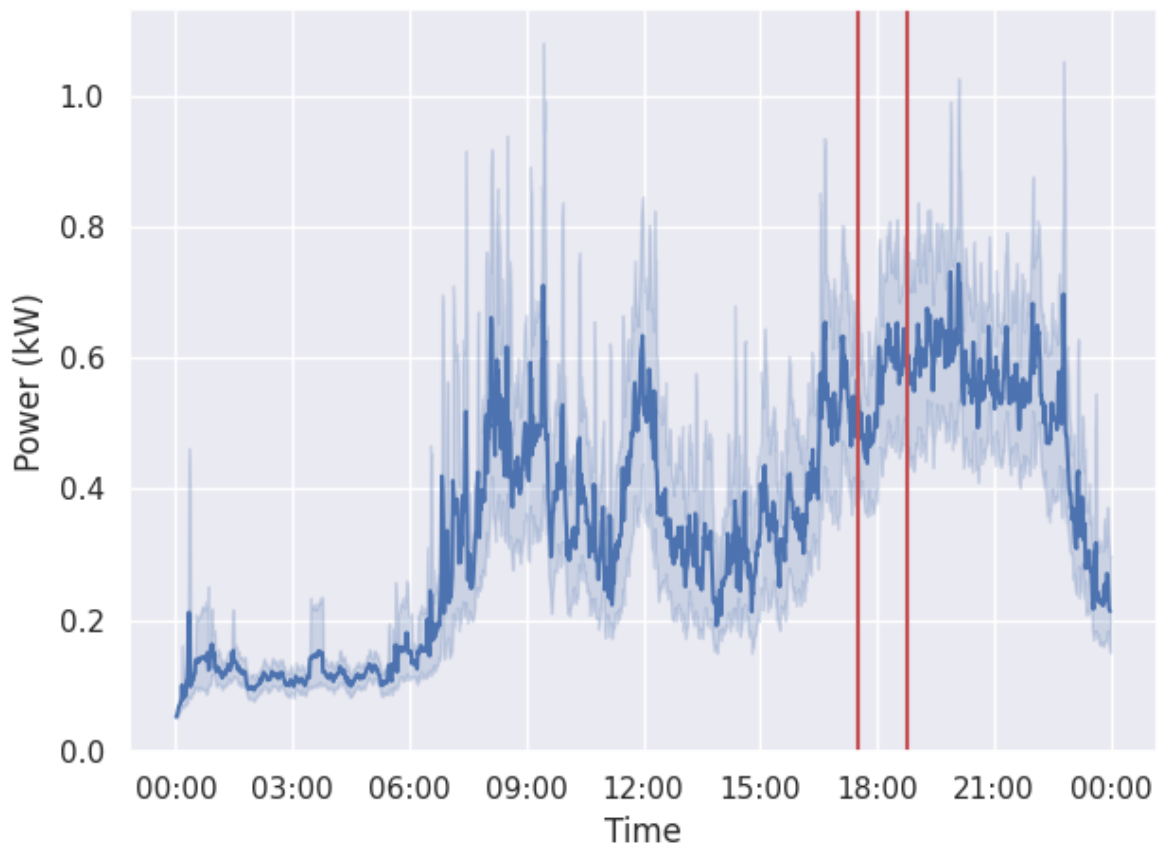

Figure 4.1: Average consumption profile as provided by the ELVTF model. Our shedding scenario is simulated between 5:30 PM to 6:45 PM, between the two red bars.

### 4.2.1 Power System

The European Low Voltage Test Feeder (ELVTF), introduced in Section 2.4.3, provides power consumption and power network topology data about a residential neighborhood, and is therefore a good choice for this study. For the sake of simplicity and as a first step, it is assumed that the electrical network is ideally balanced. Figure 4.1 shows the average consumption profile in the ELVTF dataset. Our study focuses on a peak hour, between 5:30 pm and 6:45 pm, as it constitutes a stressful hour for power system management.

Gas boilers and electric storage radiators are commonly used in the United Kingdom [97]. So, we supposed that domestic direct-acting electric heating was not included in the ELVTF traces for the considered peak period. Nevertheless, our scenario considers a context where direct-acting electric heating is widely used, as it is the case in France [98], in order to provide flexibility to the power system management. Thus, for our scenario, 3

electric heaters are added in each household. Each heater power consumption is modeled as a cyclic profile alternating between typical values of 2 kW and 0 kW. Used values rely on an experiment performed on an electric radiator located in the Rennes region, France on Feb, 11 2019 between 7:15 pm and 8:30 pm, during the French consumption peak period (or more exactly to its second, descending part) [99]. Each radiator has a power profile based on real data on which random time-delays are applied. Each time-delay is equal to the sum of two random time-delays which represent respectively the dephasing between radiators belonging to the same household (arbitrarily-selected to be equal to 30 seconds maximum to illustrate variability within a single house) and the dephasing between two households (arbitrarily-selected to be equal to 15 minutes maximum to showcase the variability among the houses of the same district). It must be pointed out that a simple heater model is considered due to the absence of additional experimental data. In the considered model, the post-shedding rebound effect on the power consumption is not taken into account. It is assumed that the rebound effect due to a relatively short shedding duration is negligible.

### 4.2.2 Computing System

In this scenario, we consider that each household is an actor of the Smart Grid and has a smart electricity meter that can send on/off instructions to the electrical heaters. A TCP/IP telecommunication network is considered in our scenario of automated and intelligent shedding in the electrical network. In order to be managed and monitored, the electric line Line1, feeding the 11 kV/416 V substation, and the households are equipped with computing devices. We assume that these devices belong to the same LAN (local area network), connected through Ethernet links following a star topology, each computing device being linked to a central switch that can be the district Digital Subscriber Line Access Multiplexer (DSLAM). For the sake of simplicity, homogeneous bandwidths and latencies are considered for each link.

### 4.2.3 Smart Grid Management

In order to automate the shedding of the electric heaters in the different households, we consider the *cascado-cyclic* policy. In the cascado-cyclic policy, a shedding process is initiated when the current in Line1 goes above an upper threshold  $\Theta$ . Then, several households are selected to be shed. We considered that, on average, at least one heater

per household is in the on-duty part of its cycle. Assuming that the current  $I_{Line1}$  flowing in the considered line is mostly active (i.e. its reactive part is considered as negligible), then, it can be expressed as:

$$I_{Line1} \approx \frac{\sum_i P_{H,i}}{\sqrt{3}V_{Line}} \quad (4.1)$$

where  $P_{H,i}$  is the instantaneous power consumption of household  $i$  and  $V_{Line1}$  the line phase-to-phase voltage. Following this, the number  $n_H$  of households to shed is approximated using Equation 4.2 according to the current in Line1  $I_{Line1}$ , the maximum consumption  $P_h$  of a single heater of an household and the phase-to-phase voltage  $V_{Line1}$ .

$$n_H = \left\lceil \frac{(I_{Line1} - \Theta) \times \sqrt{3} \times V_{Line1}}{P_h} \right\rceil \quad (4.2)$$

$\Theta$  is the maximum rated current that the line may transmit on a permanent basis. The shedding process stops when the current  $I_{Line1}$  in Line1 goes below a current threshold  $\theta$  (lower than  $\Theta$ ) determined with Equation 4.3. In this equation, we consider the worst case scenario where all the households that stop shedding switch all their three heaters back on at the same time. The resulting power consumption increase would be then of  $3 \times P_h$  per household. Hence, the lower threshold  $\theta$  can be expressed as:

$$\theta = \Theta - \frac{n_H \times P_h \sqrt{3}}{V_{Line1}} \quad (4.3)$$

The lower threshold  $\theta$  is dynamically adapted during the cascado-cyclic process when the current number of shed households  $n_H$  varies. During the shedding process, the group of shed households is regularly modified, avoiding a household being shed for too long consecutively. For the same reason, and also to balance the shedding among the different households, the selection of households to be shed is done in a cyclic way, described hereafter. Indeed, as we do not consider pricing mechanisms to incentivize users to accept shedding policies, we target a fair shedding policy balancing the shedding duration among the users. The cascado-cyclic policy may be implemented by multiple algorithms. In this work, we propose two representative and simple algorithms: a centralized and a decentralized one. Both rely on the telecommunication network among the households



previously described to exchange information. We opted for simple algorithms to highlight the telecommunication network impact without hiding its effects over complex optimizations.

#### 4.2.4 Centralized Cascado-cyclic Approach

The major component of the centralized approach in the cascado-cyclic process consists in the master node. It is in charge of managing the households in order to keep the current below its upper threshold in Line1. It periodically receives information from the power and current probes positioned in each household. According to this data, it decides whether electric heaters should be shed. As a consequence, it sends commands to shut down or switch on electric heaters in households. Taking advantage of the amount of information it receives, the master selects in priority the households that have the highest average power consumption over the last  $\delta$  seconds, but still balances the shedding among the different households, as stated previously. The reactivity of the centralized approach strongly depends on the frequency at which it receives information when no prediction algorithm is used. Consequently, we employ in our scenario a high frequency to guarantee the performance of the power system management: one message per second for each household and for Line1 is sent to the master node. The master node can be located either near the Line1 substation or in a remote location connected through wired telecommunication networks.

In subsequent work, we explored various lower frequencies for information exchange and concluded that decreasing the frequency increases both the cumulative peak duration and its variability, thus leading to closer performance between centralized and decentralized approaches, as expected.

#### 4.2.5 Decentralized Cascado-cyclic Approach

The decentralization of the cascado-cyclic shedding process removes the ability to sample and compare the power consumption of each household. Thus, the only value monitored is the current at the Line1 substation, which is periodically sampled by a probe. For this approach, the households are considered sorted in a predefined and arbitrary order. Whenever the current in Line1 goes above the upper threshold, shedding commands are sent to the first household. The first household then decides whether it will handle the command. If it does, the household is shed for a specific duration, and it sends

the command to the next household afterward. If it does not, the command is directly forwarded to the next household which will decide whether it will handle the command, and so on. A cycle is completed whenever the last household forwards the command to the Line1 probe. The probe keeps track of the number of completed cycles, i.e., a cycle is finished when all sheddable households have handled one command, and adds this information in the shedding commands. Each household may handle a command only if the command has a number of cycles equals to the number of times the household has been shed. This token-based strategy ensure that each household handles the same number of commands. Whenever the current in Line1 goes below the lower threshold a command is sent to stop the shedding process. This command goes through each household similarly to the shedding command. At the time the command reaches the Line1 probe, it ensures that the shedding process has stopped for each household. The cycle is resumed when a new cascado-cyclic process starts, thanks to this decentralized algorithm. This decentralized algorithm is a classical token-based algorithm whose main advantage consists in its simplicity. Indeed, it does not require complex computation or heavy data storage for each node: it simply requires each node to keep track of its number of executed shedding and to compare this number with the cycle number included in the shedding command.

## 4.3 Validation

We explore the effects of the two different management approaches and of the various telecommunication parameters through simulation. In this section we present briefly the co-simulation framework we used, and then we detail our experimental plan, including the metrics we measure and compare, and the parameters explored.

### 4.3.1 Co-Simulation Framework

The framework used in this study is detailed in depth in Chapter 3. The setup is shown in Figure 3.1. It makes SimGrid, ns-3 and pandapower co-evolve and interact to rigorously model and simulate a Smart Grid, while taking into account the electrical and telecommunication intertwined systems.

We use the programming interface of SimGrid to model the distributed control application of the Smart Grid and its computing infrastructure. We can use then the unique

ICT performance models of SimGrid to simulate the execution of this distributed ICT system. Thanks to an ad-hoc coupling between SimGrid and ns-3, we use the telecommunication models of ns-3 to simulate message exchange in the Smart Grid. We benefit then from the high accuracy of ns-3 and from its various communication models.

For this study, we rely on SimGrid v3.24, pandapower v2.1.0 and ns-3 v3.29.

### 4.3.2 Experimental Plan

We compare the centralized and decentralized approaches for three metrics: 1) Cumulative overcurrent duration: cumulative duration during which the current in Line1 is above the upper threshold. This duration is computed by SimGrid and is a measure of our approach efficiency from the perspective of the Distribution System Operator (DSO); 2) Cumulative household shedding duration: cumulative duration of shedding required to solve the congestion problem. It is computed by SimGrid and indicates the efficiency of the approach from the Smart Grid consumers perspective; 3) Total amount of data sent through the telecommunication network. This amount is computed by SimGrid and indicates the impact of the Smart Grid control system on the telecommunication network. The considered telecommunication network is based on Ethernet.

Table 4.1 summarizes the fixed parameters in our experiments: the network bandwidth (voluntarily oversized as its impact for wired network is not a limiting factor in our context), the sampling frequency at which the power and current values are monitored and sent to the master node in the case of the centralized approach, the duration of a single shedding if not interrupted by a switching on command, and the duration for averaging the household consumption in order to select in priority the highest consuming households. Table 4.2 summarizes the variable parameters: the number of sheddable households, the upper current threshold on Line1, the communication latency for each telecommunication link and the size of each command and monitoring message. During a simulation, only one parameter varies from the default parameters. The default parameters are indicated in the last column of Table 4.2 and their choice is explained throughout the simulation results.

To compare the approaches with a given parameter set, we run three simulations: (1) a co-simulation with the centralized approach, (2) a co-simulation with the decentralized one, and (3) a simulation of the electrical network without shedding, in order to build baseline results. When switching to a new set of parameters, a new electric heater power profile with random time-delays (as described on Section 4.2.1) is generated for each

Table 4.1: Co-simulations fixed-parameters.

<b>Network bandwidth</b>	10Gb
<b>Power and current probes sampling frequency</b>	1 sec
<b>Duration of a single shedding (if not interrupted)</b>	60 sec
<b>Duration <math>\delta</math> considered to average households consumption</b>	300 sec

Table 4.2: Co-simulations variable-parameters.

	<b>Range</b>	<b>Step</b>	<b>Default</b>
<b>Number of sheddable households<sup>1</sup></b>	15 to 55	5	30
<b>Upper current threshold</b>	410 to 450 A	10 A	440 A
<b>Communication latency<sup>2</sup></b>	0 to 20 ms	5 ms	5 ms
<b>Messages size</b>	1024 to 10240 kb	1024 kb	1024 kb

household. Each set of parameters is simulated 50 times and the results present mean and standard deviation values. The simulations were run in parallel using several machines on the Grid'5000 [100] platform. We performed a total of 4,200 simulations to execute this experimental plan. The cumulated machine time to execute all the simulations is equivalent to 8 days and 17 hours of computation on a unique single-core machine.

## 4.4 Results

In this section, we explore the impact of:

- the upper current threshold, that is of uttermost importance for the electricity DSO, and that can include a safety margin depending on the expected reactivity of the system;
- the number of sheddable households, that depends on the consumers' willingness to help the DSO, and in our case, this effort is fairly shared among the voluntary users;

---

3. The number of households in the simulation stays the same, 55. However, the number of households that can be shed varies.

4. The configuration with 1 ms latency was also explored.

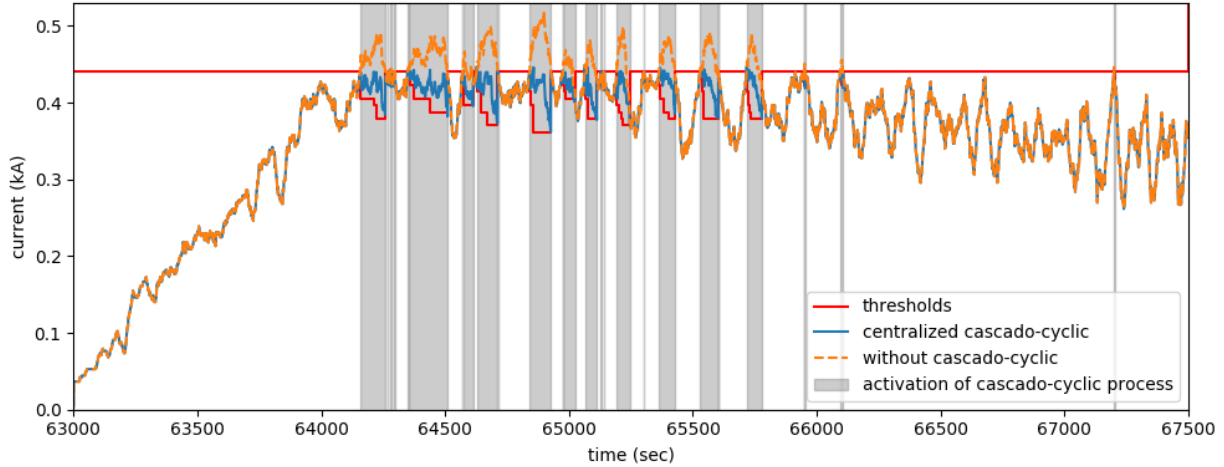

Figure 4.2: Evolution of the current in Line1 over time with the centralized implementation with 30 sheddable households, an upper threshold of 440 A, a communication latency of 5 ms and 1024 kb messages.

- the communication latency and message sizes that are used for implementing the DSM and that depend on the telecommunication network topology and communication protocols.

#### 4.4.1 Cascado-cyclic Behavior Assessment

Figure 4.2 shows the typical evolution of current in Line1 over time for a single simulation run with the centralized approach (the decentralized one follows a similar trajectory). From this figure, we can see that, during peak time, the current progressively increases to reach the upper current threshold of 440 A at 5.49 pm. Then, the cascado-cyclic process starts shedding household heaters to keep the current below the upper threshold. We can see from the variations of the lower current threshold that the cascado-cyclic process dynamically adapts the shedding effort to successfully remain below the upper threshold (i.e. the lower the threshold is, the more important the shedding effort needs to be).

#### 4.4.2 Influence of the Upper Current Threshold

We can see from Figure 4.3 that both cascado-cyclic approaches significantly reduce overcurrent duration. Considering the default value of 440 A for the upper current threshold, the centralized (resp. decentralized) approach reduces overcurrent duration of about 94 % (resp. 89 %) compared to the baseline scenario without any shedding.

We can observe that the two approaches perform even better with lower thresholds when there are more overcurrent peaks to reduce. With a threshold of 410 A, the overcurrent duration is reduced by about 96 % (resp. 94 %) with the centralized (resp. decentralized) approach.

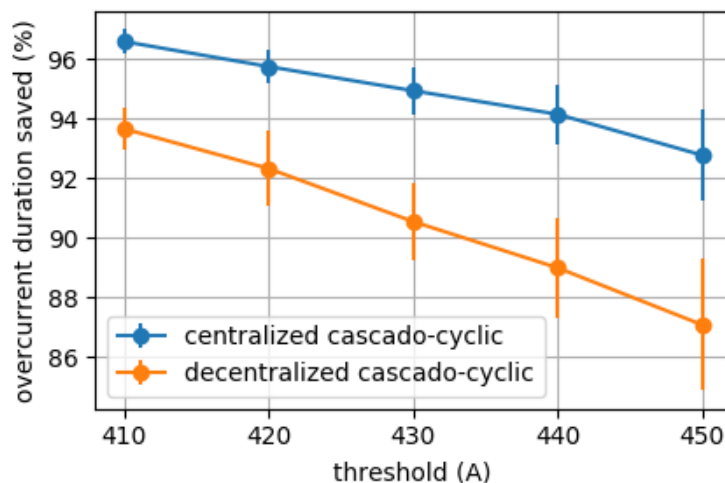

Figure 4.3: Overcurrent reduction in comparison to the baseline scenario (without any shedding) when varying the current threshold.

The required reactivity of the approaches is more important with higher thresholds when the number and the duration of the overcurrent peaks decrease. This explains why the centralized approach outperforms the decentralized one, in particular in this case. Indeed, the decentralized approach is less reactive because the shedding commands may have to be forwarded several times from household to household before being applied. At the opposite, the centralized implementation sends the shedding commands directly to the sheddable households. Nonetheless, even in this context, with a threshold of 450 A, the two approaches significantly reduces overcurrent duration of about 93 % (resp. 87 %) for the centralized (resp. decentralized) approach.

We can observe from Figure 4.4 that both approaches achieve such a performance with a similar amount of shedding for every considered threshold. As expected, the duration of the shedding decreases when there is less overcurrent peaks –i.e. with higher thresholds. Even in the worst considered case with a threshold of 410 A, the shedding remains significantly low with an average cumulative shedding duration per household of about 7 minutes during the considered period. With our threshold default value of 440 A, the shedding becomes negligible for the end-users with an average cumulative shedding time per household of about 2 minutes only.

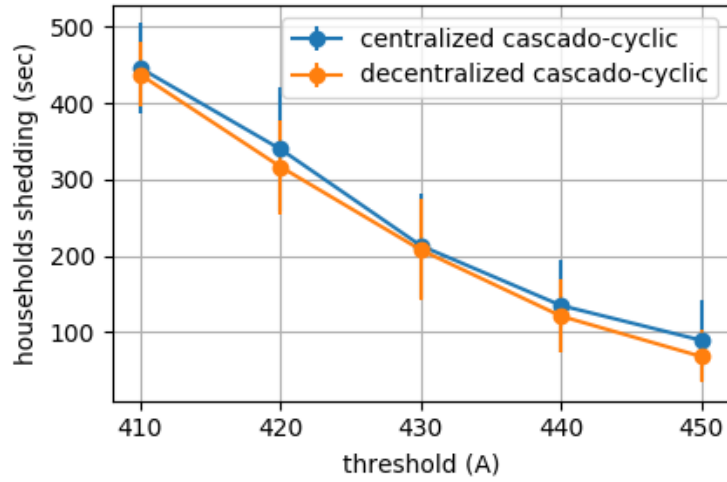

Figure 4.4: figure  
Average cumulative shedding time per household versus current threshold.

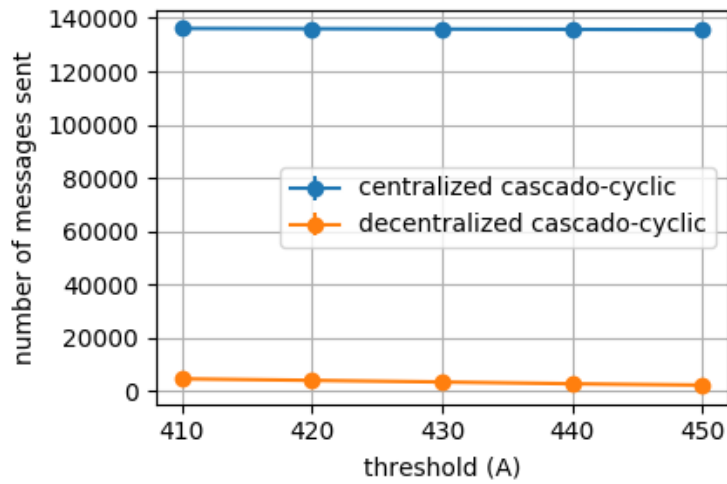

Figure 4.5: figure  
Number of messages sent versus current threshold.

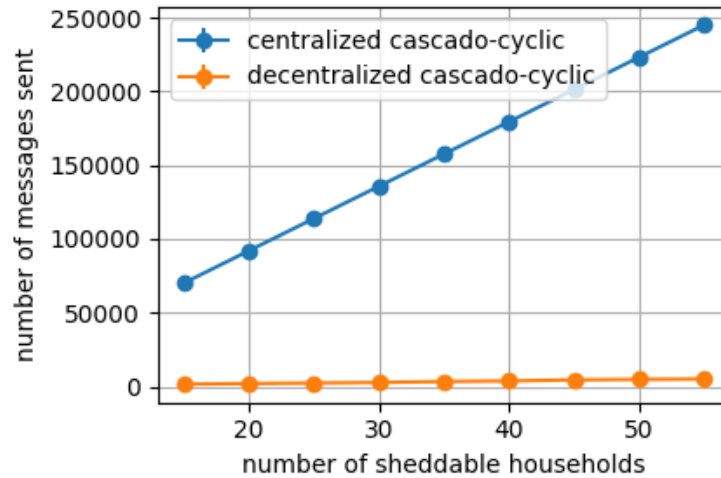

Figure 4.6: figure  
Number of messages sent versus number of sheddable households.

As shown on Figure 4.5 and as expected, the upper threshold does not have a significant impact on the number of messages sent by the two approaches. We observe that, because of its power probes, the centralized approach sends about 27 times more messages through the telecommunication network than the decentralized one, no matter the upper threshold value. This may strongly limit the performance with wireless telecommunication technologies, e.g., Wi-Fi.

### 4.4.3 Influence of the Number of Sheddable Households

Figure 4.6 shows that the gap between the number of sent messages increases linearly with the number of sheddable households, and therefore with the number of power probes in the centralized approach. With 55 households, the centralized approach sends about 50 times more messages than the decentralized one. This may limit the scalability of the centralized approach, which would be even more limited in a wireless context.

Figure 4.7 shows the decreasing standard deviation for the average per-household shedding duration when the number of sheddable households increases. It means that, in this case, both approaches efficiently share the shedding effort between the available households. As expected, the average shedding time per household decreases as the number of sheddable households increases: it goes from about 4.5 minutes with 15 households to about 1 minute with 55 households.

Figure 4.8 shows that the number of households does not impact significantly the cu-



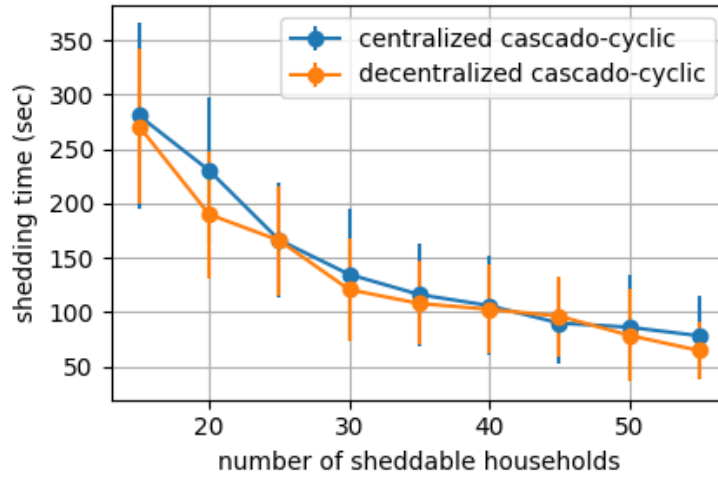

Figure 4.7: figure  
Average cumulative shedding time per household versus number of sheddable households.

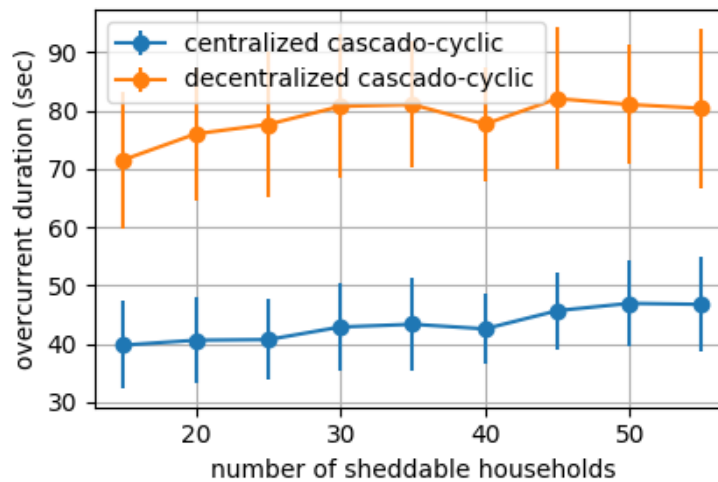

Figure 4.8: figure  
Cumulative overcurrent duration versus number of sheddable households.

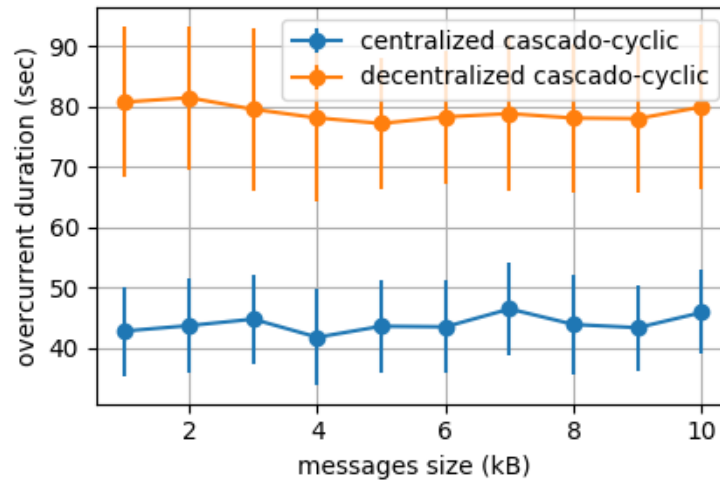

Figure 4.9: figure  
Cumulative overcurrent duration versus messages size.

ulative overcurrent duration. This means that both approaches scale up in our context and do not require a high number of sheddable households for a reasonable upper current threshold. As expected, since the centralized approach is more reactive and takes advantage of more information, it achieves a lower overcurrent duration (about 40% lower) than the decentralized approach.

These results indicate that the telecommunication network size, which represents here the number of sheddable – and thus communicating – households, slightly impacts the cumulative overcurrent duration for both approaches. Yet, the better performance of the centralized approach comes with a strong increase in the required number of messages: 55.5 messages per second on average for 55 households, against 1.1 messages per second for the decentralized approach. Here also, relying on a wired network with a reliable transport protocol makes the scenario feasible for DSM.

#### 4.4.4 Influence of the Communication Latency and Message Size

Figure 4.9 shows that the two approaches are not significantly impacted by the size of the messages. Although the centralized approach outperforms the decentralized approach in terms of overcurrent duration (45 seconds on average against 80 seconds), both equally distribute the shedding duration among the households and present a similar average shedding duration per household.

Concerning the number of sent messages, the decentralized approach largely outper-

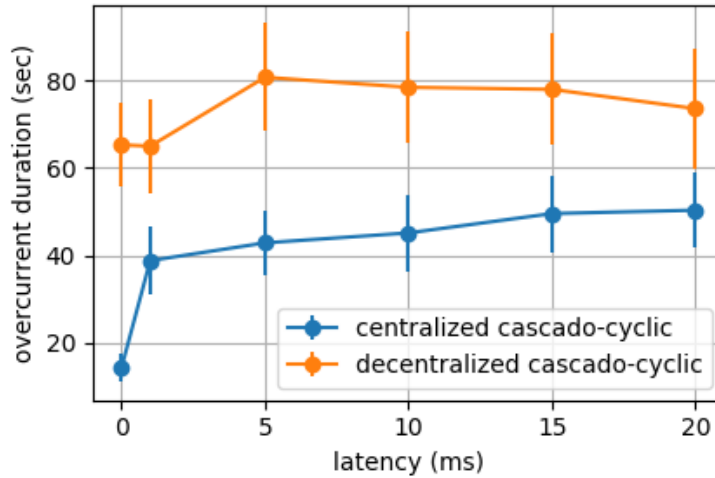

Figure 4.10: figure  
Cumulative overcurrent duration versus telecommunication latency.

forms the centralized one as observed in Figures 4.5 and 4.6. The negligible impact of message size is mainly due to the scenario conditions: packet losses are not considered in this scenario because the wired telecommunication network does not experience congestion, and the transport protocol is reliable (i.e. TCP). This behavior would significantly change using Power Line Communication (PLC) or Wi-Fi networks.

Similarly, the telecommunication network latency does not significantly impact the number of sent messages for both approaches (results are similar to Figure 4.5). However, we observe from Figure 4.10 that the telecommunication latency has a non-negligible impact on the approaches' performance. If we consider an unrealistic 0 ms latency (instantaneous data transfers and reactions), like many studies of the literature, the centralized approach decreases the cumulative overcurrent duration of about 75 % compared to the decentralized one. However, if we consider a 1 ms latency, the centralized approach reduces the overcurrent duration of only about 40 % compared to the decentralized one. With a 20 ms latency, the overcurrent duration is getting even closer in both approaches especially when taking into account the standard deviation. In addition, we observe on Figure 4.11 that the centralized approach also largely outperforms the decentralized one in terms of average overcurrent duration when considering a 0 ms latency, but this gap is tighter for latencies above 0 ms. We also note that results' variability grows faster in the decentralized management as the latency increases. Consequently, the centralized approach significantly outperforms the decentralized one only with low communication latencies, and the difference diminishes for larger latencies.

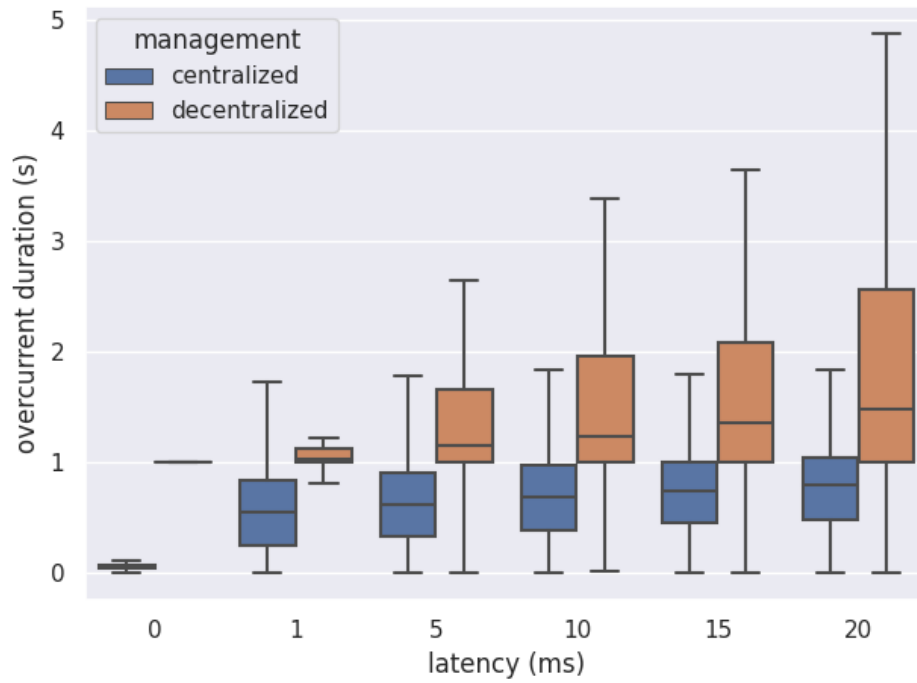

Figure 4.11: figure  
Average overcurrent duration versus telecommunication latency.

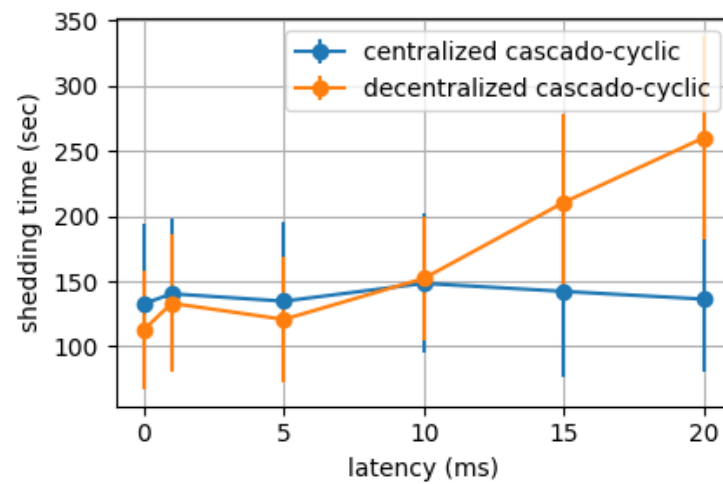

Figure 4.12: figure  
Average cumulative shedding time per household versus latency.

According to Figure 4.12, when considering low latencies, the average cumulative shedding time per household is comparable between both the decentralized and the centralized approaches. However, the gap between them increases with latency because it impacts the propagation delay of the shedding commands in the decentralized approach, which is then outperformed by the centralized one. Hence, with a 20 ms latency, the average shedding per household is about 140 s (resp. 250 s) in the centralized (resp. decentralized) approach. In this case, the decentralized approach overreacts and performs more shedding than required.

#### 4.4.5 Discussion

The two proposed approaches greatly reduce the overcurrent peak duration (from about 96 % to 87 %) without a significant impact on the end-users: the average cumulative shedding per households ranges from about 7 to 1 minutes, corresponding respectively to 9 % and 1 % of the simulated time.

When disregarding the telecommunication network parameters, one may consider that the centralized approach is always better than the decentralized one because it decreases the overcurrent peak duration more with a similar impact for the end-users (i.e. (cumulative) shedding duration per household). However, the centralized approach requires a high number of messages to achieve this level of performance, even on a small-size network (up to 55 households). Since it significantly increases the traffic on the telecommunication network (up to more than 50 times), the centralized approach may not scale up well with the expected large number of households to be deployed on the Smart Grid (e.g. with the Wi-Fi technology). In addition, as the network latency increases, the overcurrent reductions achieved by the centralized approach get closer and even similar to ones obtained with the decentralized one. However, at higher latencies, the decentralized approach has significantly more impact on the end-users as it increases the cumulative shedding duration per household. It means that, although decentralized approaches should better scale with larger networks than centralized ones, they may be less accepted by electrical grid users since their performance in terms of shedding time per household is more impacted by latency. Thus, the approaches should be carefully chosen according to the telecommunication network features and the size of the considered power system. In this work, for both centralized and decentralized cases, we evaluated simple algorithms not requiring significant computation power in order to highlight the network latency influence on the performance of a Smart Grid. In the case of more complex algorithms, the computation

duration adds time to the latency, and can consequently impact the shedding performance as well.

## 4.5 Conclusion

Residential reactive Demand-Side Management (DSM) becomes feasible in the context of Smart Grids and Energy Internet. In this study, we explore the cascado-cyclic shedding strategy with electrical heaters to avoid electrical network congestion. We compare the centralized and decentralized management versions of this strategy and study the impact of wired telecommunication network latency on the performance perceived by the Distribution System Operator (DSO) and by the electricity consumers.

The evaluation exploits a realistic scenario of 55 households based on traces from a real electrical grid and numerical co-simulations, combining SimGrid, ns-3 and pandapower simulators, to faithfully reproduce the co-evolution of the power system and of its wired telecommunication network. We made available the open source co-simulation tools used in this study, as detailed in the previous chapter.

Our results show that not considering any telecommunication network latency, as often assumed in literature, implies a strong overestimation of the performance achieved by the centralized approach from the DSO's perspective. We also show that, for the DSO, larger telecommunication network latency penalizes the centralized approach and favors the decentralized approach, although for the studied latency range, the centralized approach always performs better. As for the electricity consumer's point of view, larger telecommunication network latency has a strong negative impact for the decentralized approach, while it is negligible for the centralized one. Thus, for the decentralized approach, the latency affects negatively and heavily consumers. Considering the studied scenario and from the consumer point of view, the centralized approach is preferable for latencies above 10 ms.



# INFLUENCE OF COMMUNICATION TECHNOLOGIES IN SMART GRID POWER CONGESTION MANAGEMENT

---

In the previous chapter we explored how latency may affect Demand-Side Management (DSM) in a context of a residential neighborhood. Our study was focused on wired communication technology, but as we saw in Section 2.3.3 several communication technologies are envisioned to support Smart Grids. This chapter extends this previous study by providing a comparative analysis of how using specific communication technologies also affect DSM.

This chapter is organized as follows. Section 5.1 presents our case study. Section 5.2 introduces the co-simulation environment and the network models. Sections 5.3 and 5.4 describe the experimentation and the results respectively. Finally, Section 5.5 concludes this chapter.

## 5.1 Case Study

The goal of this study is to compare communication technologies in a DSM context. In order to provide a quantitative analysis, we rely on a case study of a typical DSM problem with real data coming from a well-known public benchmark, the European Low Voltage Test Feeder (ELVTF) [84], described in Section 2.4.3. The case study explores a grid congestion management scenario where the goal of the energy management consists in maintaining the current flowing through the substation of a residential district below a maximum allowed safety threshold, while minimizing the effect on the electricity consumers. In order to explore a challenging case communication-wise, we have selected a reactive approach [101], as opposed to an anticipative approach, for the energy management of the considered Smart Grid. Reactive approaches enable to react to events whereas



anticipative approaches are based on forecasts. The former have the advantage of being able to mitigate events when they actually occur, with the drawback on relying heavily on the ICT infrastructure.

The case study is largely inspired by the one depicted in the previous chapter. We consider a residential district with several households, each equipped with a smart meter and electric heaters that can be shed temporarily on demand by the smart meter. The district is powered by a single substation, connected to the electrical grid through a three-phase low-voltage distribution network. The substation may be subject to grid congestion, which is intended to be mitigated by the flexibility of several households, for instance in exchange for an economic compensation. Grid congestion management is considered to be achieved here through short-term load shedding, where control commands are sent to the smart meters to temporarily shed houses electric heaters. We compare two simple management policies, a centralized one and a decentralized one, based on the same approach [102]. We opted for a simple approach so as not to hide the effects of communication technologies behind complex algorithms, and thus provide generic conclusions.

### 5.1.1 Shedding Policy

The substation has an upper current threshold, simply called “current threshold”. It defines a maximum level of current that is allowed to flow through the substation and can be less than or equal to the current rating of the substation. Whenever the current goes above the current threshold, a shedding process is initiated. This process tries to shed temporarily several houses’ electric heaters to reduce the power demand. When a house is selected for shedding, a command is sent to its smart meter and all its heaters are shed.

Equation 5.1 is used to determine the number of houses that need to receive a shedding command to maintain the current below the threshold.

$$n_{H,x} = \left\lceil \frac{(I_{Line1,x} - \Theta) \times V_{PN,x}}{P_h} \right\rceil \quad (5.1)$$

This equation is close to the Equation 4.2, presented in the previous chapter. However, Equation 4.2 considers a balanced power network and the phase-to-phase voltage of the substation, while Equation 5.1 considers an unbalanced power network and the phase-to-neutral voltage for each phase.  $I_{Line1,x}$  is the current measured at the substation for phase  $x$  (as we are in a three-phase unbalanced electrical network, grid congestion may happen on one or several of the three phases A, B or C),  $\Theta$  is the current threshold,

$V_{PN,x}$  is the phase-to-neutral voltage for phase  $x$ ,  $P_h$  is the power of a single heater, and  $n_{H,x}$  is the number of houses to which shedding commands must be sent to mitigate the grid congestion. Although there is actually three electric heaters per house in our case study, any number of them may be active at any given time. Indeed, to maintain their objective temperature, electric heaters permanently switches between an ON phase and an OFF phase, where they do not consume electricity. Equation 5.1 considers the worst case where only one heater per house is in active phase. Thus, only the current due to one heater may be subtracted from the grid congestion if the house is shed.

The post-shedding rebound effect is not modeled in this study. Our goal is indeed not to present a complete shedding policy considering inhabitants thermal comfort, but to highlight key differences between communication technologies in a DSM context. The shedding of electric heaters is only used as a case study. In addition, the rebound effect, if creating any grid congestion issue, would be treated similarly to the initial grid congestion event. Besides, our co-simulation environment, described in the next section, allows the integration of detailed thermal models implemented in dedicated simulators enabling to integrate this effect in future work.

The shedding policy is ensured by management algorithms, either in a centralized or decentralized way, detailed in the following. Both algorithms are similar to the ones presented in the previous chapter. However, they differ on two important points. First, there is no more a lower threshold  $\theta$ , the houses are shed for a predetermined shedding duration instead. Second, we are now in an unbalanced power network instead of a balanced power network. Consequently, the algorithms manage the congestion for each phase separately.

### 5.1.2 Centralized Management

The centralized management is based on a direct communication between a policy master and the smart meters located in each house. With a centralized management, every smart meter measures the household power consumption every second. This consumption is averaged locally over a sliding window, and the substation sends it to the master periodically. All these data exchanges happen via a communication network.

When receiving data from the substation, the master may detect that the current is above the current threshold for one or several phases. If so, it starts a shedding process. The shedding process begins by using Equation 5.1 to determine the number of houses that need to shed their electric heaters to solve the grid congestion issue. Then, the

master sends directly shedding commands to smart meters connected to the congested phase to shed temporarily houses' electric heaters. We suppose that houses participating in the shedding plan have the same economic compensation, and as a consequence the master sends in priority shedding commands to houses consuming the largest amount of energy, using data collected from the smart meters.

While there is always the same number of houses in the district, only a subset of them is considered as volunteering in the shedding plan in exchange for an economic compensation. In our simulations, the participating houses are selected randomly. In the centralized management, a fair shedding policy is ensured by a cycle mechanism. When a house is shed during a specific cycle, it cannot be shed again during the same cycle. When every house participating in the shedding plan has been shed, the master moves to the next cycle.

### 5.1.3 Decentralized Management

The decentralized algorithm differs from the centralized one since it does not communicate directly with each house. Instead, it relies on a token-based algorithm where houses volunteering for shedding are organized randomly in 3 virtual rings, depending on which phase they are connected to.

Similarly to the centralized management, the substation measures the current periodically for each phase and sends it to the master. When the master detects that the current is above the current threshold for a phase, it determines the number of houses that need to shed their electric heaters to mitigate the grid congestion, using Equation 5.1. Then, in opposition to the centralized management, the master creates a token containing the number of houses to shed. This token is sent to the first house of the concerned ring. When receiving a token, a house shuts its heaters down if possible, and forwards the token to the next house in the ring if more shedding is needed. Otherwise, the token stops. During the next grid congestion event, a new token will continue its way along the ring where the previous one stopped. Excessive shedding may happen if a new token is sent before the shedding initiated by the previous token is carried out due to communication delay. As a consequence, an unnecessarily large number of smart meters would receive a shedding command. To avoid this issue, a new token cannot be issued until the previous has finished.

In the decentralized approach, the fair shedding policy is ensured by the token ring mechanism itself. A house that has been shed cannot be shed again until every other

house of the ring has also been shed.

## 5.2 Experimental Framework

As explained in Section 2.4, experimenting on real infrastructures is costly and constraining in the very least, or even impossible. Using simulators reduces costs, experimentation time, and is also very convenient to explore a broad range of parameters. However, to provide acceptable and convincing results, simulations require models that are proved either theoretically or experimentally, or at least recognized by their community and well established. As good as they are, simulators are often limited to their very specific domain. Co-simulation allows to combine several dedicated simulators into a single environment where models can interact dynamically with each others.

### 5.2.1 Co-simulation Environment

The co-simulation environment we use is described in detail in Chapter 3. This environment, as shown in Figure 3.1, gathers three simulators: SimGrid, ns-3 [77] and pandapower [73].

To perform the co-simulations, the framework relies on two networks: an electrical network and a communication network that are detailed in the following sections.

### 5.2.2 Electrical Network

The case study is based on the publicly available electrical network IEEE model ELVTF, introduced in Section 2.4.3. This model provides data of a 3-phase, low voltage electrical network. The network describes a typical residential district of the United Kingdom [85], with 55 houses and a 11 kV/416 V substation feeding the district. There are respectively 21, 19 and 15 houses connected to phases A, B and C. The provided data also contains time series of one-minute averaged consumption for each house. The average consumption profile is depicted in Figure 4.1. We selected a peak period in terms of consumption, between the two red bars on the figure, since it represents the most challenging one for congestion management.

The shedding scenario is similar to the one described in the previous chapter. We assume that each house of the district is equipped with direct-acting electric heaters, and we add the consumption of those heaters to the consumption profiles of the ELVTF.

### 5.2.3 Communication Network

In this work, we explore and compare three communication technologies in a DSM context: wired Ethernet, Wi-Fi and Power Line Communication (PLC). More specifically, we refer as *wired* the Ethernet standard IEEE 802.3 using 1Gbps links, as *wireless* the Wi-Fi standard IEEE 802.11n with a theoretical throughput of 54Mbps, and as *PLC* the G3 standard in CENELEC Band A (35 kHz - 91 kHz), in accordance with the French Linky project. We fixed the PLC modulation to the maximum possible rate with Differential Quadrature Phase-Shift Keying (DQPSK), and fixed the transmit-power spectral density to - 50 dBm/Hz to make all smart meters reachable by the substation and to each other. Finally, we use a NAYY150SE power supply cable and a typical colored background noise.

The study conditions for each technology reflect realistic deployment scenarios. As detailed in Section 2.3.3, PLC currently represents a cost-effective and widely deployed technology, although it suffers from performance issues when the number of communicating smart meters increases. On the other side, wired and wireless technologies offer appealing alternatives by leveraging already deployed Internet Service Providers (ISP) networks, with better performance in terms of data transfer time and concurrent communication handling.

The wired case, Figure 5.1(a), considers a fully wired end-to-end communication from the smart meter to the central utility, also known as the master. In this case, a communication from a smart meter to the master goes through the house's home router, to an edge router using the ISP's network, and ultimately reaches the master going through the core network. The wireless case, Figure 5.1(b), only differs from the wired case in the medium used to communicate from the smart meter to its home router. The PLC case, Figure 5.1(c), differs significantly from the two others as the communication does not go through the ISP's network but through the electric cable. In this case, smart meters can communicate directly with one another, and a concentrator makes the junction between the PLC network and the edge router. In all three cases, the communication between the substation and the edge router is wired.

Several communication delays apply in each case, as depicted in Figure 5.1.  $D_{HAN}$  is the communication delay in the Home Area Network (HAN) and is fixed at 1 ms as it can be observed in a close point-to-point communication [103].  $D_{NAN}$  is the communication delay in the Neighboring Area Network (NAN). In our study, this delay covers the links between home routers, the concentrator and the substation with the edge router. This delay varies from one user to another, notably due to the technology in use [104, 105].

For this delay we selected 10 ms, as it represents an average between DSL, cable and optical fiber users in EU [105].  $D_{WAN}$  is the communication delay in the Wide Area Network (WAN). Different values are explored in this study ranging from 0 to 150 ms, to explore cases as various as a master located in the neighborhood or in another country, for instance in a Cloud computing environment.  $D_{WIFI}$  and  $D_{PLC}$  are determined at run time by the simulator depending on several specific parameters such as the distance between the two communicating points or interference.

The communication network supports the message transmission between entities composing the Smart Grid. In this case study, we consider three types of messages detailed in the following sections: data messages, control messages, and status messages.

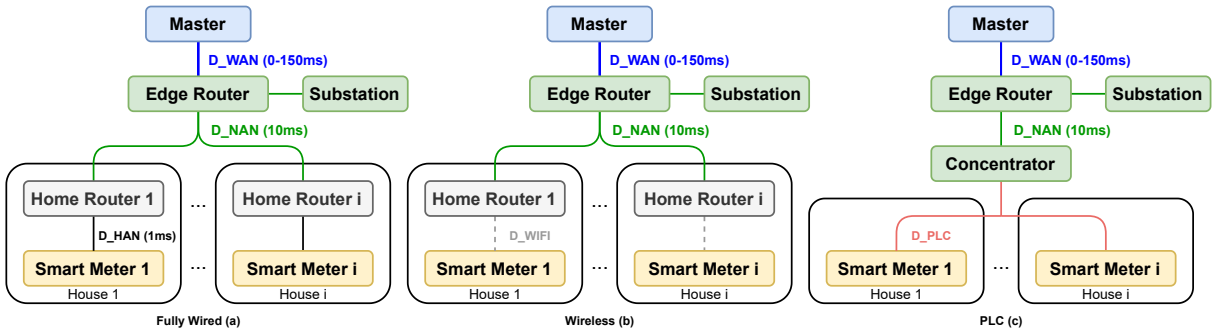

Figure 5.1: Communication topology. (a) is the fully wired case; (b) is the wireless case; (c) is the PLC case.

## Data Messages

Data messages are sent periodically from two sources: the substation and the smart meters. The substation sends data messages providing monitoring information about the current flow in each phase, every second, regardless of the management policy (centralized or decentralized). On the other hand, data messages from the smart meters are sent following a sampling period, which is one of the explored parameters, as detailed in Section 5.3.1. The data size of these messages is also explored. It must be noted that no data messages are sent from the smart meters with the decentralized policy.

## Control Messages

Control messages carry information about the control of the smart meters. With a centralized management policy, only the master may send control messages to the smart

meters, carrying a command to shed their heaters. However, tokens are also considered as control messages, and are sent by smart meters during simulations with a decentralized management policy. According to [106], the typical data size for a Demand Response (DR) action request, e.g., load shedding, in a NAN application is 100 B. Here, control messages' size are fixed to 1 kB to account for potentially more complex requests and for the token required data. Messages are sent sequentially, meaning that the master can only send another control message after the reception of the last one. While this property reduces the reactivity to grid congestion events, it is necessary to propose a coherent comparison between the communication technologies as parallel messages transmission may be difficult with PLC, contrary to with the wired and wireless technologies.

### Status Messages

Status messages are sent by smart meters. They appear only during simulations with a centralized management policy. Smart meters acknowledge the reception of a control message by sending their new status, e.g. heaters off, to the master. Smart meters also send their new status after waking up at the end of a shedding procedure, signaling themselves as available again for shedding if needed.

## 5.3 Numerical Simulations

This section details the numerical simulations. First, we introduce the different parameters explored. Then, we present the metrics used for the comparative analysis.

### 5.3.1 Explored Parameters

The sensitivity analysis concerns several key parameters related to communication means used by DSM strategies that are presented hereafter.

The **number of sheddable houses** defines the number of houses that are available for shedding during the simulation. While this number varies, the total number of houses connected to the network does not change and is always equal to 55. Similarly, the number of houses connected to each phase is always the same: 21 on phase A, 19 on phase B and 15 on phase C, as in [84]. However, the number of sheddable houses connected to the same phase can vary between two simulations as sheddable houses are selected randomly at the beginning of the simulation. We choose to vary the number of sheddable houses from

a minimum of 15 to the maximum of the 55 available houses. From a communication point of view, more sheddable houses means more potential destinations for shedding commands.

The **current threshold** represents a maximum allowed current value that may flow through the 11/0.4 kV substation. It may be less than or equal to the current rating of the substation. The current is measured directly at the substation, and detecting a value above the current threshold initiates the shedding process. The objective of the shedding process is to maintain this current under the current threshold value. Based on the consumption profile shown in Figure 4.1, we chose to explore current threshold values ranging from 0.4 kA to 0.6 kA. Lower thresholds imply more shedding situations, and thus more control messages.

The **message size** modifies the size of the data messages. The shedding process makes extensive use of communication between Smart Grid actors to maintain the current below its maximum allowed threshold. We explore several values of message size to observe the impact of this parameter on the DSM mechanism, depending on the communication technology. As the size of status messages and control messages (which include token messages) are fixed to 100 B and 1 kB respectively, variable message sizes apply exclusively to the data messages. We explored three data message size values: 1 kB, 10 kB and 100 kB. Depending on the communication medium, larger data size may cause data congestion on the communication network.

The **shedding duration** changes the delay before heaters automatically wake-up after receiving a shedding command. This duration is the same for all heaters. We explore a shedding duration ranging from 10 s to 300 s. This short time is intended to provoke a negligible impact on the inhabitants' comfort. Given the average consumption profile (shown in Figure 4.1), a longer shedding duration should imply less shedding commands.

The **sampling period** adjusts the delay between two data messages. The centralized management policy relies on consumption data from the smart meters placed in each house to select to which one it should send shedding commands in priority. While consumption data are updated every second locally at the smart meter, these data are not sent at the same rate to the master. Instead, it is averaged over a sliding window of 5 minutes and this average value is sent periodically to the master. The frequency of these updates depends on the sampling period, for which we explore values ranging from 15 s to 1800 s. It must be noted that, in the decentralized management policy, no central actor selects which houses to shed. Consequently, this parameter has no influence on the decentralized



policy.

The **communication technology** can be either fully Gigabit Ethernet (IEEE 802.3), or IEEE 802.11n Wi-Fi (between the smart meter and the home router) with a theoretical throughput of 54 Mbps associated with Gigabit Ethernet, or G3-PLC.

The **communication delay**  $D_{WAN}$  defines the delay from the master to the edge router located near the district. The other wired communication delays  $D_{HAN}$  and  $D_{LAN}$  are fixed to 1 ms and 2.5 ms respectively.  $D_{WAN}$  varies from 0 ms to 150 ms, to explore scenarios ranging from a master close to the edge router, to a master located in another country, hosted in a Cloud for instance.

### 5.3.2 Evaluated Metrics

We use two main metrics to evaluate the efficiency of the algorithms with respect to all the parameters given above, and for the three communication technologies considered (wired Ethernet, Wi-Fi and PLC): the total overcurrent and the mean shedding time.

The total overcurrent accounts for the number of measurements when the value at the substation is above the current threshold. This metric shows the efficiency of the shedding process from the Distribution System Operator (DSO) point of view, which aims to mitigate the grid congestion. The mean shedding time is calculated by dividing the total shedding time of each sheddable house by the number of sheddable houses, sorted by phase. This metric shows the efficiency of the shedding algorithm from an inhabitant point of view, for whom shedding should be minimized.

## 5.4 Results

In this section, we present the results of the simulations exploring the selected parameters. An imbalance exists between the phases: less households are connected to phase B and C than to phase A. As a consequence, the results for phase B have a similar shape than for phase A, but are less pronounced, and the lack of shedding on phase C in most simulations induces results either without any variance, or with excessively high variance. For these reasons, we only present hereafter the results for phase A.

We explore the influence of several parameters independently, the others being fixed to their default values, shown in Table 5.1. The mean overcurrent over all the simulations for a given configuration (i.e. technology type, policy, etc.) ranges between around 1 and

Table 5.1: Default simulation parameters values and range of exploration. When a parameter is explored during a simulation, the other parameters are set to the default values.

	Default Value	Range Explored
<b>Number of sheddable houses</b>	30	15 to 55
<b>Current threshold</b>	0.5 kA	0.4 to 0.6 kA
<b>Data message size</b>	1 kB	1 to 100 kB
<b>Shedding duration</b>	60 s	10 to 300 s
<b>Sampling period</b>	20 s	15 to 1800 s
<b>WAN delay</b>	10 ms	0 to 150 ms



Figure 5.2: Total overcurrent versus number of sheddable houses. The current threshold is set to 0.5 kA, message size to 1 kB, shedding duration to 60 s, sampling period to 20 s and latency to 10 ms.

2 measurements. It means that when an overcurrent is detected after a current measurement at the substation, in most cases the overcurrent has been mitigated before the next measurement, which is deemed to be considered acceptable from a DSO perspective.

Each bar of a plot is the result of 50 simulations with the same parameters. The variance comes from several factors changing for each simulation: the subset of sheddable houses, the time shift between heaters of the same house as well as their initial start time, the order of the sheddable houses inside the virtual ring in the decentralized management, and also a randomization internal to ns-3 influencing slightly wireless and PLC communication.

### **Number of sheddable houses**

Figure 5.2 shows the total overcurrent depending on the number of sheddable houses. It can be observed that the number of sheddable houses does not have a large impact on this metrics. However, a low number of sheddable houses (less than 25) can be insufficient to reduce satisfactorily the congestion issues. Moreover, it also increases greatly the variance of the results. Excluding results where the number of sheddable houses is less than 25, we observe a decrease in the total overcurrent of respectively 6%, 8% and 13% for the wired, the wireless and the PLC technologies between the centralized and decentralized management policies. As expected, the management policy can have a significant impact on the Smart Grid performance. Considering the same policy (centralized or decentralized), it can be observed that there is less than 2% difference between the wired and wireless technologies. With PLC technology, the total overcurrent is 32% higher (respectively 23% higher) with the centralized approach (resp. the decentralized approach) than with wired technology. This difference is due to the low robustness of the PLC technology to concurrent communications of smart meters in the centralized approach, and to the low bandwidth and high delay for the decentralized approach.

As shown in Figure 5.3, the shedding time per house decreases with the number of sheddable houses. The trend is non-linear with the number of sheddable houses. The management policy seems to have a negligible impact on this metric with wired or wireless communication technologies, but not with PLC. From the consumers thermal comfort standpoint, the decentralized approach remains better than the centralized one when PLC is used, as the shedding time per house is lower in the former case, as shown in Figure 5.3, along with a lower total overcurrent, as depicted in Figure 5.2. As already mentioned, this shows that the type of technology may have a significant influence when comparing

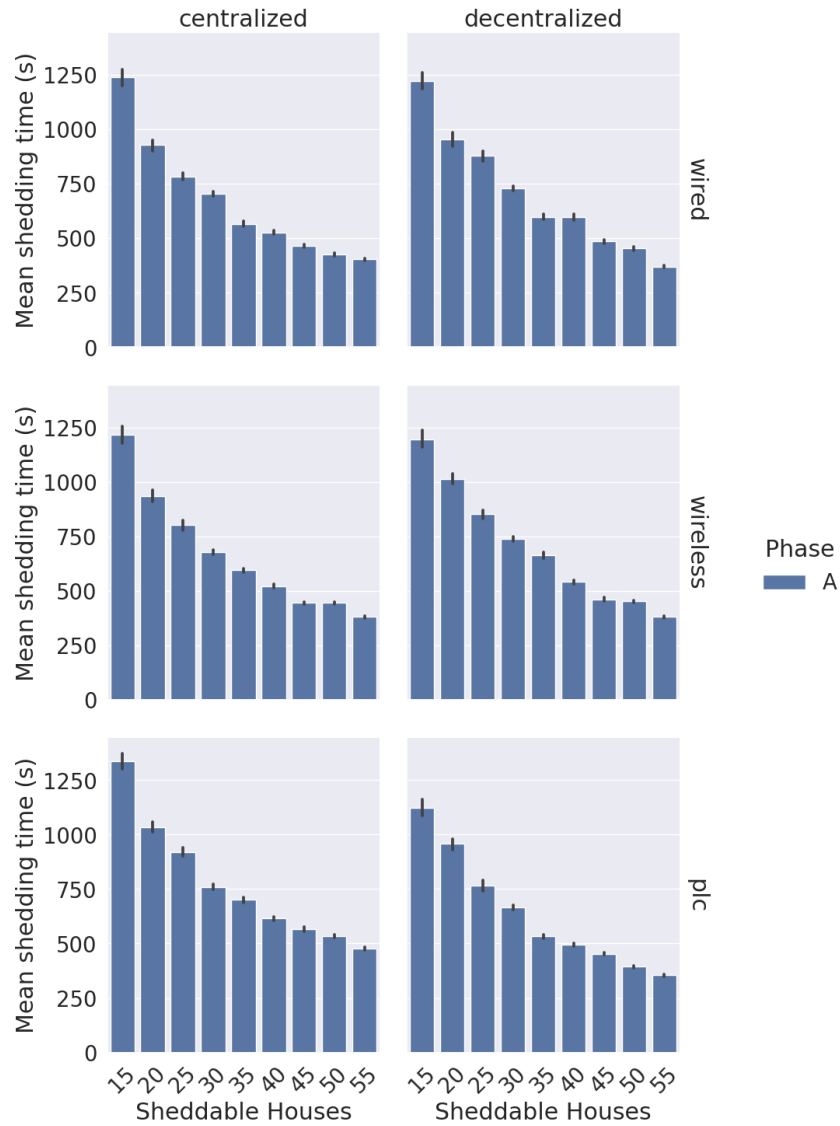

Figure 5.3: Mean shedding time per house versus number of sheddable houses. The current threshold is set to 0.5 kA, the message size to 1 kB, the shedding duration to 60 s, the sampling period to 20 s and the latency to 10 ms.

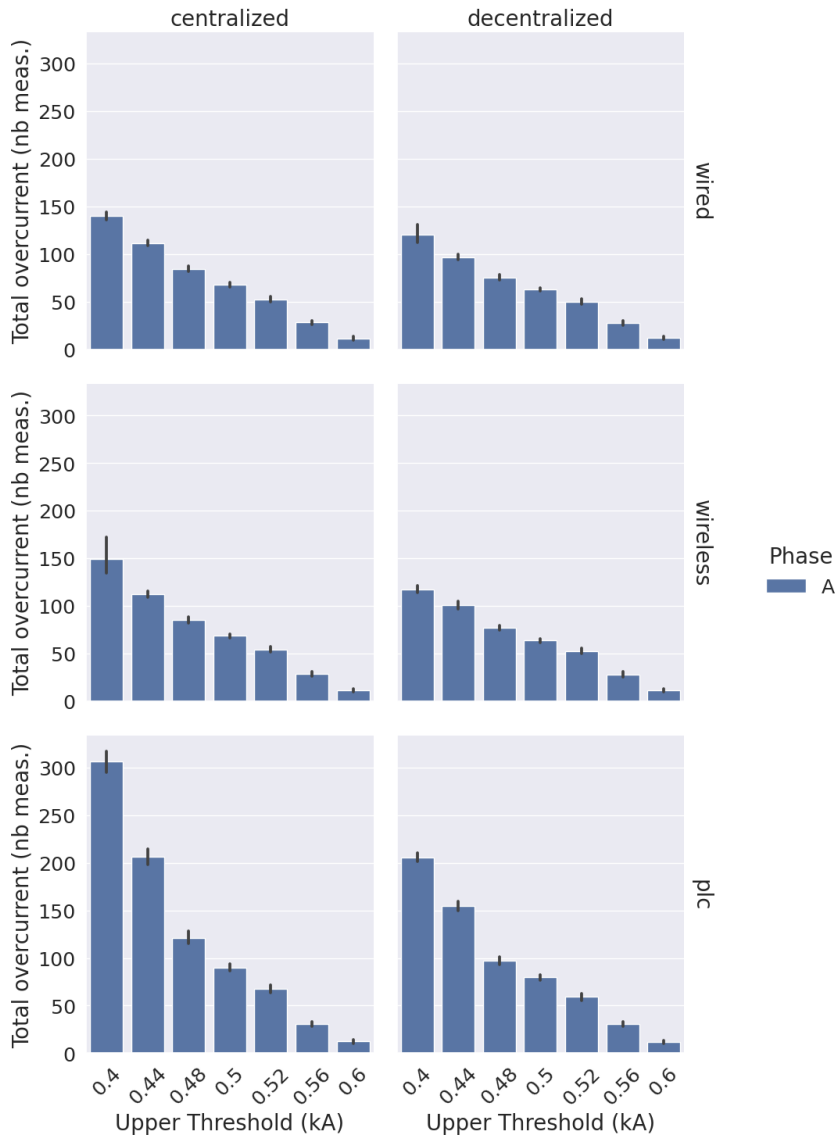

Figure 5.4: Total overcurrent versus current threshold. The number of sheddable houses is set to 30, the message size to 1 kB, the shedding duration to 60 s, the sampling period to 20 s and the latency to 10 ms.

centralized and decentralized approaches.

The shedding time per house can reach high values, should the number of sheddable houses be sufficiently low, depending also on the considered management policy and communication technology, which may affect the thermal comfort of the inhabitants. In other words, in Smart Grids with a low number of flexible entities, the type of policy (centralized or decentralized) and the type of communication technology can have an important influence on the electrical network performance.

### **Current threshold**

Figure 5.4 shows that, as expected, the current threshold has an important impact on the total overcurrent. A high threshold reduces the congestion issues and therefore, the need for shedding, while a low threshold increases the stress on the system. The wired and wireless communication technologies produce similar results with a linear increase in the total overcurrent as the current threshold decreases, whereas the total overcurrent increases exponentially with the PLC technology. This confirms that the PLC technology is less able to deal with large and/or recurrent congestion issues than the wired and wireless technologies which occur when the current threshold is sufficiently low. When the congestion issue is less important (high current threshold), all the technologies seem to lead to similar results. For all the considered communication technologies, the decentralized management performs better than the centralized management, or has at least a similar level of performance in terms of cumulated overcurrent duration. This is even more visible with the PLC technology, for which the difference in terms of performance between the centralized and the decentralized approaches is the largest. This difference may be explained by the fact that PLC shows poor performance when multiple messages are sent simultaneously, which occurs with the centralized approach, even with small message sizes such as 1 kB. This shows again the necessity to take into account the type of communication technology when considering reactive approaches with a highly stressed electrical network.

### **Message Size**

Communication tests were performed to determine the average communication delay between two smart meters, depending on the technology and payload size. The payload delay is determined by measuring the time between the beginning of a TCP communication, and the last acknowledgment received for that payload. The results are shown in

Table 5.2: Average payload delay between each smart meter, depending on the communication technology and payload size.

Comm.	Payload size	Average delay (ms)	Standard deviation
Wired	1 kB	88.0	0
	10 kB	220.0	0
	100 kB	352.1	0
Wireless	1 kB	83.8	3.9
	10 kB	207.8	4.1
	100 kB	347.2	5.7
PLC	1 kB	428.7	50.2
	10 kB	N/A	N/A
	100 kB	N/A	N/A

Table 5.2. There is no standard deviation in the wired case because from one end to the other, the latency is fixed for each wired link in the simulation. No significant differences are observed depending on the payload size for values ranging from 1 kB, 10 kB to 100 kB between the wired and wireless communication technologies. This was expected since we do not consider here overloaded communication networks. The wireless case presents better results than the wired one as an ideal scenario is considered with a single station connected to each access point. Regarding the PLC technology, the average delay is larger but still of the same order of magnitude as the wired and wireless technologies for 1 kB messages. However, the communication channel is often unable to deliver messages with size larger than or equal to 10 kB. This shows that the PLC technology may be irrelevant if a reactive energy management is required in the case where a significant amount of data has to be transferred.

### Shedding duration

The shedding duration has an important impact on both the total overcurrent duration and the shedding time per house, as it can be observed in Figures 5.5 and 5.6. With each communication technology, the total overcurrent duration increases as the shedding duration decreases. This may be explained by the reactive approach of the management policies: as soon as the shedding is over, the current is more susceptible to get over the threshold again. Then, the more often congestion is detected, the more often shedding is required again. However, repeated detection of congestion issues leads to an increasing total overcurrent. Hence, the greater the number of detections (due to a short shedding

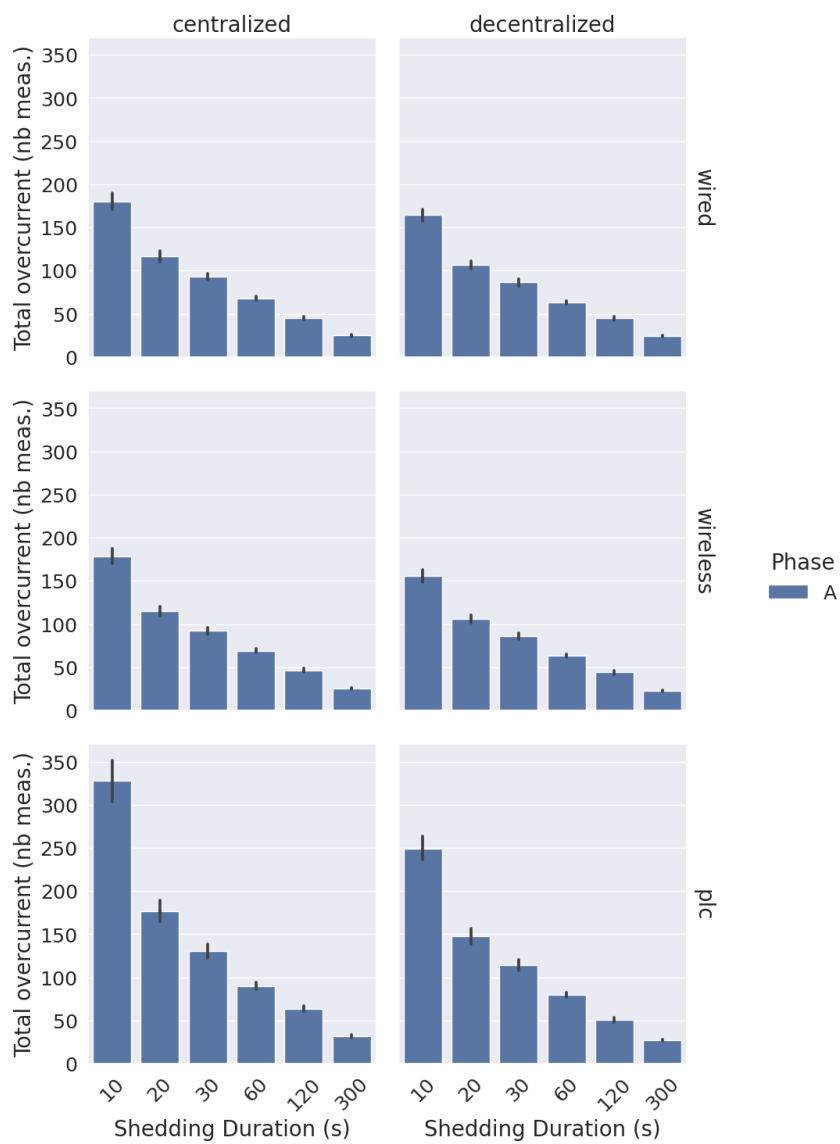

Figure 5.5: Total overcurrent versus shedding duration. The number of sheddable houses is set to 30, the current threshold to 0.5 kA, message size to 1 kB, sampling period to 20 s and latency to 10 ms.



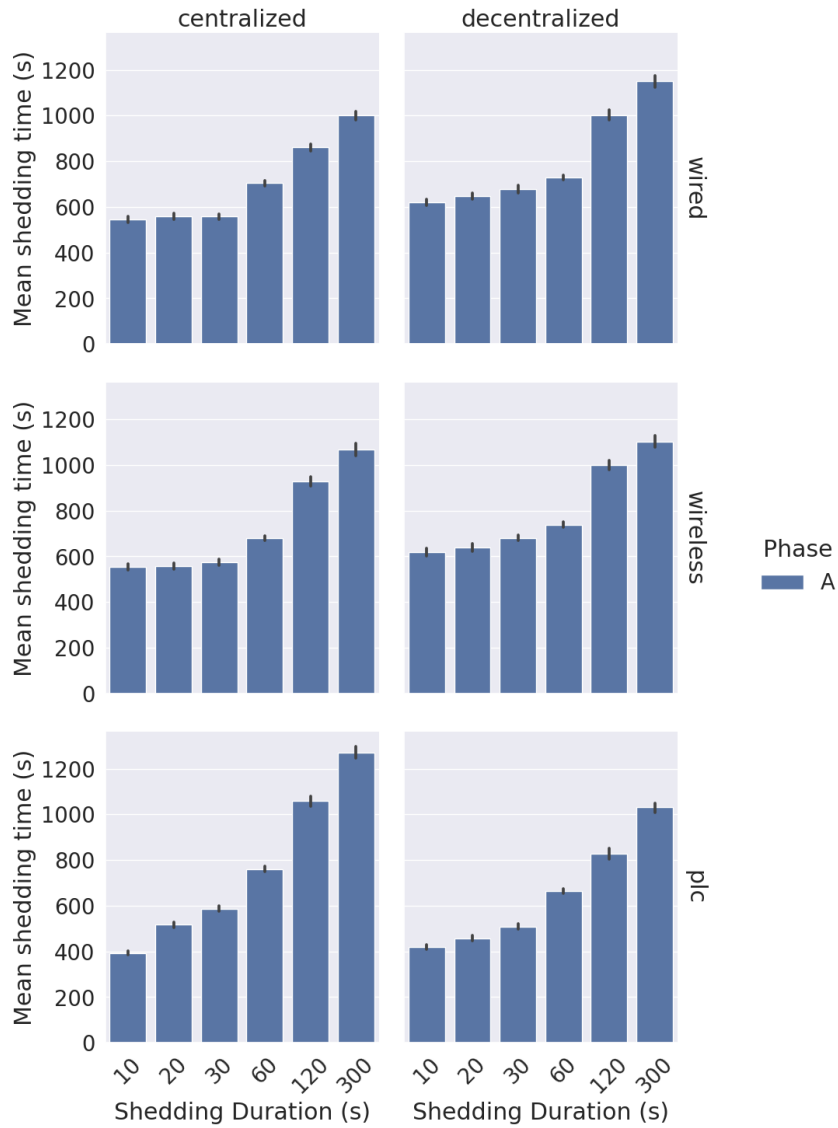

Figure 5.6: Shedding time per house versus shedding duration. The number of sheddable houses is set to 30, current threshold to 0.5 kA, message size to 1 kB, sampling period to 20 s and latency to 10 ms.

duration), the greater the total overcurrent duration.

In addition, decreasing the shedding duration increases the communication traffic, which constitutes an important burden for the PLC technology, thus increasing heavily the total overcurrent in short shedding duration cases. Although increasing shedding duration decreases importantly the total overcurrent, Figure 5.6 shows also that a long shedding duration is more likely to cause excessive shedding, when compared to the remaining total overcurrent, and therefore to affect the inhabitants' thermal comfort unnecessarily.

### **Sampling Period**

According to the simulations, show in Figure 5.7, the sampling period does not impact the efficiency of the shedding process for any of the considered technologies. This is due to the fact that the fair shedding policy implies that, even if a house consumes far more energy than the others, it will not be shed again until the shedding has been applied to every other sheddable houses.

### **WAN delay**

We explore a wide range of WAN delay values, as depicted Figure 5.8. We observe that performance losses could happen if WAN delay, including processing time, reaches more than 100 ms with any communication technology. The decentralized management policy seems more impacted than the centralized one in the wired and wireless cases. Nevertheless, delays below 100 ms have a negligible impact on the total overcurrent, for all communication technologies and management policies.

## **5.5 Conclusion**

In this chapter, we propose a comparative performance analysis of three different communication technologies — Ethernet, Wi-Fi and PLC — to mitigate congestion issues in a Smart Grid through both a centralized and a decentralized shedding algorithm. A reactive approach, as opposed to an anticipative one, is considered here, the former representing a more challenging scenario than the latter from a communication point of view. Based on a realistic case study, relying on publicly available data, we observed the shedding performance through our open-source co-simulation framework considering both the Distribution System Operator (DSO) and the inhabitants' perspectives. A sensitiv-

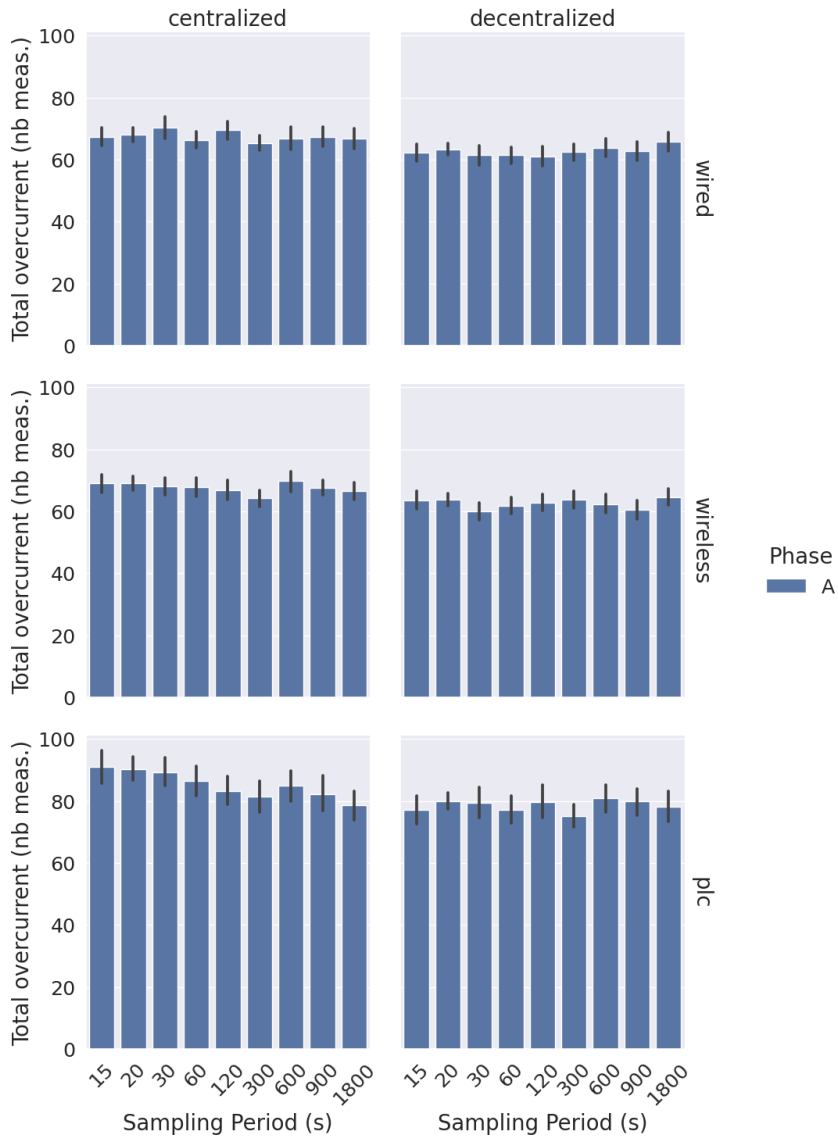

Figure 5.7: Total overcurrent versus sampling period. The number of sheddable houses is set to 30, the current threshold to 0.5 kA, message size to 1 kB, shedding duration to 60 s and latency to 10 ms.

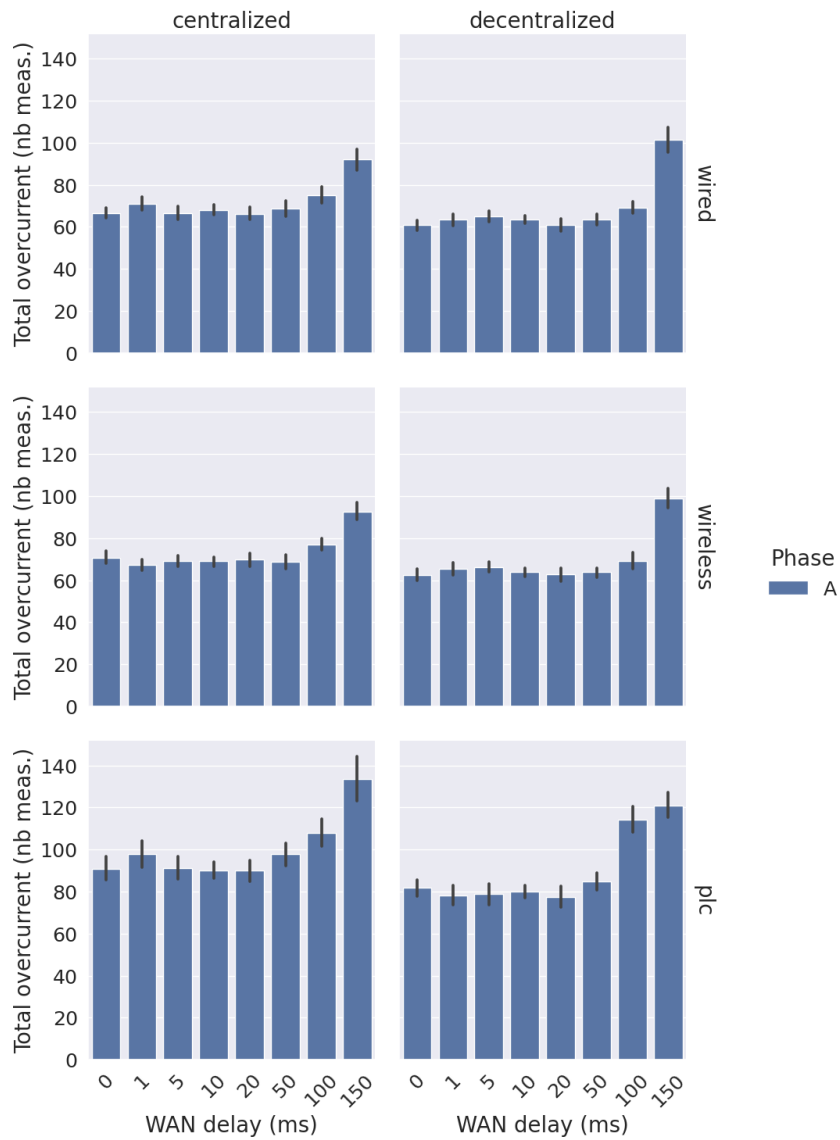

Figure 5.8: Total overcurrent versus latency. The number of sheddable houses is set to 30, current threshold to 0.5 kA, message size to 1 kB, shutdown duration to 60 s and sampling period to 20 s.

ity analysis on key parameters, such as Wide Area Network (WAN) delay, message size, and shutdown duration has been carried out to highlight the cases where communication technologies could reduce the shedding algorithm efficiency.

The simulation results show that Wi-Fi and Ethernet offer similar performances. Conversely, the PLC technology may exhibit significantly poorer performance, with respect to the wired and wireless technologies. This occurs when a centralized management policy is adopted and when control messages must be sent repeatedly to a limited number of sheddable houses. Also, the message size has a negligible impact in the case of the wired and wireless technologies. However, in case of large message sizes, the delay between two smart meters may become prohibitive with PLC if fast-acting Demand Response (DR) is required.

Regarding performance, it can be greatly impacted by the characteristics of the communications links. However, the performance of all the technologies considered here is in the same order of magnitude when the stress on the electrical grid is reduced, i.e. when it is subject to less frequent congestion issues (e.g. more sheddable houses, greater shutdown duration, etc.). Finally, the communication technology may have a significant impact when comparing the centralized and the decentralized version of a Demand-Side Management (DSM) algorithm. The performance of the centralized policy may be better than the performance of the decentralized one with a given technology whereas the contrary may be true for another.

This work has several limitations. Only three technologies are explored, but numerous others are envisioned to support the Smart Grid. Also, we selected a simple algorithm to emphasize on the effect of communication technologies and provide generic conclusion, but using more complex algorithms would provide more specific results.

# MODELING THE END-TO-END ENERGY CONSUMPTION OF A NATION-WIDE SMART METERING INFRASTRUCTURE

---

We have seen in Chapter 2 that one of the objectives of the Smart Grid is to decrease electricity consumption. This objective becomes feasible with the deployment of a new architecture extending the capabilities of the conventional electrical grid. This architecture adds and makes extensive use of sensors and highly communicating devices to provide a wide variety of new services. However, the devices collecting and transferring large volume of data create an additional burden on the electrical grid.

## 6.1 Overview

The purpose of this chapter is to provide an overview of the whole ICT architecture, model and evaluate the energy consumption of an entire smart metering infrastructure, at a nation-wide scale. This is a first step toward a full analysis of the gains and costs in terms of energy consumption related to Smart Grid metering. To obtain concrete results, we study the use-case of the deployment in France. Yet, the methodology that we propose in this chapter can be applied to other countries. Given the recent deployment of the Advanced Metering Infrastructure (AMI) and the expected lifetime of smart meters (around 30 years), this use case represents a good candidate to realistically assess the impact of smart metering in the next years. Our evaluation takes into account the end-to-end consumption, from the smart meter measuring the consumers individual consumption, to the utility storing and processing the collected data. We also consider the energy cost of the communication networks involved in the system. This chapter's contributions can be summarized as follows:

- investigating the end-to-end architecture of the AMI for Smart Grids
- proposing a complete modeling of the energy consumption of the ICT metering infrastructure of a large-scale electrical grid
- applying our model on the French use-case to evaluate the energy consumption of the smart metering infrastructure at a nation-wide scale.

The remaining of this chapter is organized as follows. Section 6.2 provides details about the smart metering infrastructure. Section 6.3 presents the consumption models. Section 6.4 deals with the evaluation of our models presenting the parameters we selected, the results obtained and some suggestions to tackle the issues unveiled by our energy model. Finally, Section 6.5 concludes.

## 6.2 Smart Metering Architecture

Thirty-five million smart meters are deployed in France [107], scattered in clusters, each being connected to one of the 770,000 Power Line Communication (PLC) concentrators [107]. Concentrators collect metering data, alarms and control data of smart meters once a day. They forward these data to a central utility using cellular communication to reach the closest relay antenna. The communication is then relayed using the Wide Area Network (WAN) to the core Internet. Finally, the servers are connected to the Internet via wired communication as depicted in Figure 6.1.

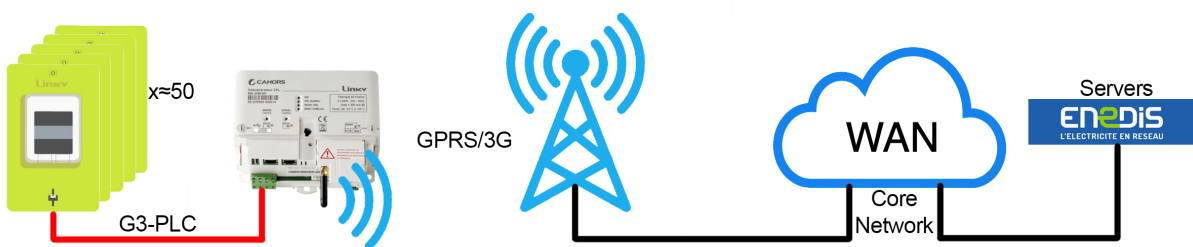

Figure 6.1: Communication path from a smart meter cluster to the central utility in the French case.

A smart meter routine is composed of two tasks: collect local data, and communicate through PLC with its concentrator. Consequently, from an energy consumption perspective, each smart meter is either in idle state, when it does not communicate (either idle or collecting data) or active, when it communicates with its concentrator. The active

state duration depends on the PLC technology considered, either G1-PLC [108] or G3-PLC [109], the latter being an evolution of the former and offering better performance with Orthogonal Frequency-Division Multiplexing (OFDM). PLC technologies are also heavily impacted by the quality of the network and by electromagnetic interference, increasing the number of re-transmissions and the overall communication time. Depending on the type of electrical network, some smart meters belong to small clusters with low network variability while the others belong to large clusters that are more prone to collisions. Collected data is forwarded each day, or on demand, by smart meters to the concentrator to which they are associated.

Concentrators are in charge of collecting data from smart meters, and forward aggregated data through the cellular network to the central utility. They must maintain connectivity with their smart meters at all times, either for contacting a specific smart meter on demand, or for being reachable by a smart meter triggering an alarm. As a consequence, concentrators are always active, and this state corresponds to a fixed power consumption. They also present an additional energy consumption, due to the cellular communication network they employ to reach the core network. The cellular technology in use has evolved with time, formerly mainly based on GPRS, while most concentrators use 3G nowadays. Consequently, we consider that a majority of the concentrators has transitioned to 3G while the others still use GPRS.

The concentrators send data over the Internet using cellular networks which rely on Base Transceiver Station (BTS) for GPRS communication, and on Node B for 3G communication. The energy consumption of cellular network devices is slightly impacted by data traffic [110], in consequence, the total consumption of the cellular network is close to the static consumption of all the devices. Hence, as Guegan *et al* presented in [111], we consider that the static consumption of network devices can be imputed to the users of said devices. The share of energy consumed is based on the duration and capacity usage in comparison to average load of the cellular network devices. Finally, as GPRS and 3G technologies paradigms are different, for instance a BTS provides time slots to a GPRS communication, while a Node B provides bandwidth for a 3G communication, we use two different ways to model the energy consumption of each technology.

Once the data transmitted by the concentrators reach a relay antenna of the cellular network, they go through the core network, passing through several network devices to reach its destination. Similarly to the cellular network and in accordance with [111], the share of the energy consumed due to concentrators traffic depends on the relative use of



the network devices.

Finally, the transiting data reach the central utility servers. The data are stored using the utility operator servers that are replicated for security and availability purposes. The overall energy consumption of the servers is considered, including, among others, the energy needed to cool the servers, using the Power Usage Effectiveness (PUE) factor of the data center. The number of servers depends on the user requests on the website, with a high variability of the requests rate, as often, and on the data flows from the concentrators.

The energy consumption models of the overall infrastructure detailed above are presented in the next section.

## 6.3 Network Power Models

In the remainder of this chapter, our models consider the energy consumption over a typical day.

### 6.3.1 Smart Meters

The smart meters consumption highly depends on the cluster size (small or large) in which they are and on the PLC technology (G1 or G3) they rely on. Thus, four categories can be distinguished for the daily smart meters consumption:

$$E_{SM}^{smallG1} = N_{SM}^{small} \times R_{G1} \times [P_{SM}^{active} \times T_{active}^{small} \times F_{G1} + P_{SM}^{idle} \times (T_{day} - T_{active}^{small}) \times F_{G1}] \quad (6.1)$$

$$E_{SM}^{smallG3} = N_{SM}^{small} \times (1 - R_{G1}) \times [P_{SM}^{active} \times T_{active}^{small} + P_{SM}^{idle} \times (T_{day} - T_{active}^{small})] \quad (6.2)$$

$$E_{SM}^{largeG1} = N_{SM}^{large} \times R_{G1} \times [P_{SM}^{active} \times T_{active}^{large} \times F_{G1} + P_{SM}^{idle} \times (T_{day} - T_{active}^{large}) \times F_{G1}] \quad (6.3)$$

$$E_{SM}^{largeG3} = N_{SM}^{large} \times (1 - R_{G1}) \times [P_{SM}^{active} \times T_{active}^{large} + P_{SM}^{idle} \times (T_{day} - T_{active}^{large})] \quad (6.4)$$

$P_{SM}^{active}$  and  $P_{SM}^{idle}$  are the power consumption in active and idle state, respectively,  $T_{active}^{small}$  and  $T_{active}^{large}$  are the active time of smart meters in small and large clusters, respectively,  $N_{SM}^{small}$  and  $N_{SM}^{large}$  are the number of smart meters in small and large clusters, respectively,  $R_{G1}$  is the fraction of G1 smart meters in proportion to all smart meters in the infrastructure,  $F_{G1}$  is a factor increasing the active time due to the low data rate of G1-PLC,  $T_{day}$  is the duration of a day.

### 6.3.2 Concentrators

Concentrators' consumption depends on their static consumption and on the additional consumption induced by their communication over GPRS and 3G networks. As such, the concentrators daily energy consumption is divided into three categories: their static consumption, their consumption due to GPRS communication and the one due to 3G communication:

$$E_{CT}^{static} = P_{CT}^{static} \times T_{day} \times N_{CT} \quad (6.5)$$

$$E_{CT}^{GPRS} = N_{CT} \times R_{GPRS} \times P_{GPRS} \times \frac{DV_{CT}}{DR_{GPRS}} \quad (6.6)$$

$$E_{CT}^{3G} = N_{CT} \times (1 - R_{GPRS}) \times P_{3G} \times \frac{DV_{CT}}{DR_{3G}} \quad (6.7)$$

$P_{CT}^{static}$  is the static power consumption of a concentrator,  $N_{CT}$  is the number of concentrators,  $P_{GPRS}$  and  $P_{3G}$  are the power consumption delta when using GPRS or 3G communication, respectively,  $R_{GPRS}$  is the proportion of concentrators using GPRS,  $DV_{CT}$  is the data volume a concentrator sends each day,  $DR_{GPRS}$  and  $DR_{3G}$  are the GPRS and 3G data rate, respectively.

### 6.3.3 Cellular Network

Data from concentrators transiting through the cellular network corresponds only to part of the traffic handled by GPRS and 3G network devices. We employ a proportional model to attribute the daily energy consumption induced by concentrators on the cellular infrastructure:

$$E_{GPRS} = \frac{P_{BTS} \times N_{CT}^{timeslots}}{N_{BTS}^{timeslots} \times Load_{BTS}} \times \frac{(DV_{CT} \times N_{CT} \times R_{GPRS})}{DR_{GPRS}} \quad (6.8)$$

$$E_{3G} = \frac{P_{NB} \times DR_{3G}}{DR_{NB} \times Load_{NB}} \times \frac{(DV_{CT} \times N_{CT} \times (1 - R_{GPRS}))}{DR_{3G}} \quad (6.9)$$

$P_{BTS}$  and  $P_{NB}$  are the power consumption of a BTS and a Node B, respectively,  $N_{CT}^{timeslots}$  is the number of time slots used by a concentrator,  $N_{BTS}^{timeslots}$  is the number of time slots on a BTS,  $B_{CT}$  is the cellular bandwidth usage of a concentrator,  $B_{NB}$  is the maximum bandwidth of a Node B,  $Load_{BTS}$  and  $Load_{NB}$  are the average load of a BTS and a Node B, respectively.

### 6.3.4 Core Network

Similarly to the cellular network, data transiting through the core network rely on specific devices, such as switches and routers. Thus, we evaluate the consumption of the core network that can be imputed to their usage by the smart metering infrastructure using a model from [111]:

$$E_{static}^{device} = \frac{P_{static}^{device} \times B^{CT}}{B^{device} \times Load^{device}} \times T \quad (6.10)$$

$$E_{dynamic}^{device} = E_{byte}^{device} \times NbBytes + E_{pkt}^{device} \times NbPkts \quad (6.11)$$

$P_{static}^{device}$  is the power consumption of a core network device,  $B^{CT}$  is the bandwidth used by a concentrator,  $B^{device}$  is the bandwidth of a core network device,  $Load^{device}$  is the average load of a core network device,  $E_{byte}^{device}$  and  $E_{pkt}^{device}$  are the energy consumed to transfer a byte and a packet, respectively,  $NbBytes$  and  $NbPkts$  are the number of bytes and packets to transfer, respectively.

### 6.3.5 Servers

Data storage and availability to the users has an energy cost through the usage of servers, whose daily energy consumption represents:

$$E_{servers} = N_{servers} \times N_{replicas} \times PUE \times P_{server} \times T_{day} \quad (6.12)$$

$$N_{servers} = \max(N_{servers}^{writing}, N_{servers}^{requests}) \quad (6.13)$$

$$N_{servers}^{writing} = \frac{Bandwidth}{Disk_{WritingSpeed}} \quad (6.14)$$

$$N_{servers}^{requests} = \frac{Web_{requests} \times PeakFactor}{server_{requests}} \quad (6.15)$$

$N_{servers}$  is the number of servers,  $N_{replicas}$  is the number of replicas of the servers,  $P_{server}$  is the power consumption of a server,  $N_{servers}^{writing}$  is the number of servers required to store collected data,  $N_{servers}^{requests}$  is the number of servers required to answer the web requests on the website,  $Bandwidth$  is the bandwidth at which collected data arrive to the servers,  $Disk_{WritingSpeed}$  is the writing speed of a hard drive disk,  $Web_{requests}$  is the number of web requests per seconds,  $PeakFactor$  is a factor to reflect the variability at which web requests arrive,  $server_{requests}$  is the number of web requests per second a server can handle. We determine the minimum number of servers needed by considering

the number of servers required to respond to the peak of requests from web users and the servers required to store all the data from the meters.

## 6.4 Evaluation

We evaluate the daily consumption of the smart metering infrastructure using the consumption models detailed in the previous section. These models require coherent instantiation of their variables. We first detail the parameter values taken from literature, and then presents the obtained results. These parameters can be modified freely on the web interface we developed for this work<sup>1</sup>.

### 6.4.1 Parameters Estimation

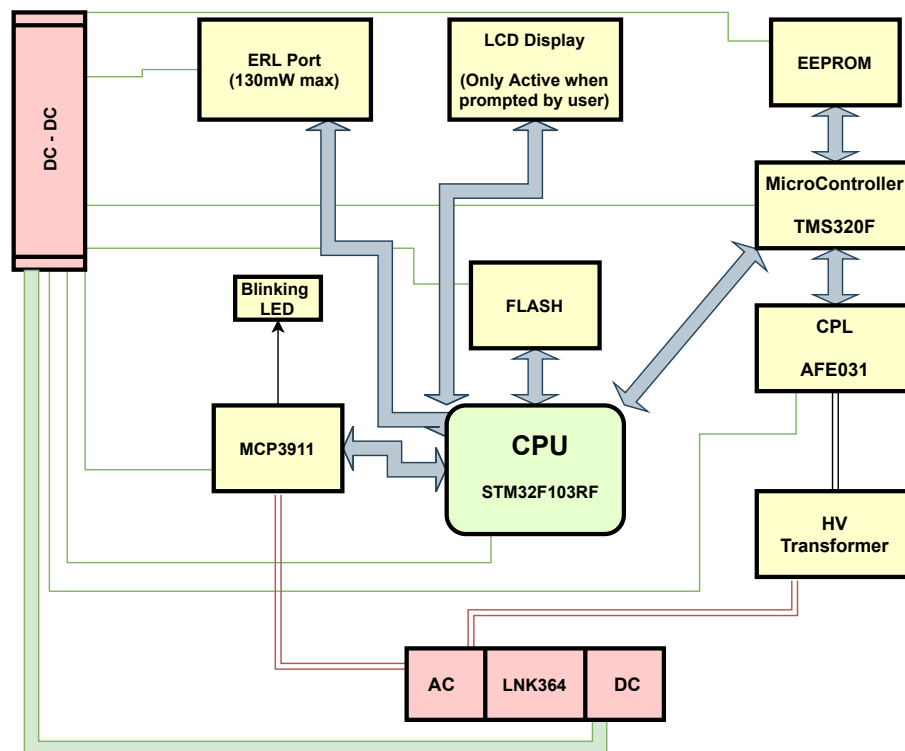

Figure 6.2: Simplified Electronic Architecture of a Linky smart meter.

1. Available here: [https://agougeon.gitlabpages.inria.fr/smart\\_metering\\_consumption/](https://agougeon.gitlabpages.inria.fr/smart_metering_consumption/)

## Smart Meters

The power consumption of a smart meter depends on its current state. A smart meter idle power is evaluated at around 0.2 W [112, 113]. Its active power, when actively communicating through PLC, is highly variable and depends on the impedance of the line to which it is connected. This active power is evaluated around 1 W [112, 113]. To assess the consumption of a smart meter, we analyzed the most important electronic components of a French Linky meter, as shown in Figure 6.2. Concerning the proportion of G1-based meters, this technology was exclusively deployed until 2017 with a total of 7 million smart meters deployed at this moment [114]. Afterward and up to the present day, only G3-based meters were deployed. Hence, around 20% of the smart meters still use the G1-PLC technology.

The active time of a smart meter during a typical day can greatly vary from one meter to another. It depends on the data the smart meter has to transmit each day to its concentrator and also on the maintenance operations of the concentrator. This active time is heavily impacted by the PLC technology in use, as G1 data rate is around 14 times lower than G3 [108, 109]. The active time depends also on the number of smart meters in the same cluster. The PLC technology suffers indeed severely from collision when there are multiple communications on the same channel. To determine the ratio of smart meters in large clusters, we use population statistics, assuming that 80% of the French population is located in dense urban areas [115], and the concentrators are expected to be spread evenly to ensure a full coverage of the territory, inducing large clusters in urban environment and small clusters in rural environment. Consequently, among the 35 million smart meters deployed [107], 28 million are in large clusters, and 7 million in small clusters. The active time in small and large clusters is assumed to be in the order of minutes and in the order of hours, respectively.

## Concentrators

Concentrators must maintain connectivity with their cluster and are consequently always in active state. We assume that their static consumption is around 15 W. In addition to their static consumption, we also take into account the energy consumed by cellular communication. This consumption depends on the additional power consumption during communication, estimated at around 1.4 W for GPRS [116] and 2.1 W for 3G [117]. It also depends on the duration of the communication. This duration depends on the data

volume to transmit, assumed to be 150 kB per concentrator on average, considering that concentrators aggregate on average data from 50 smart meters, each one producing 3 kB of data each day. The duration also depends on the upload data rate of the cellular technologies. The GPRS data rate considered is 24 kbps [118] with the coding scheme CS-2 and using two time slots, while we consider a data rate of 350 kbps for 3G [119]. We expect that the transition from GPRS to 3G followed the transition from G1 to G3, with the production of more modern devices. Thus, 20% of the concentrators are expected to use GPRS while the rest uses 3G.

Finally, there are 770,000 concentrators deployed in the country [107].

### Cellular Network

A BTS site, including an antenna and the necessary pieces of equipment such as batteries and lighting, is assumed to have an average power consumption of 1,430 W [110]. We consider 3 transceivers per BTS, with 8 time slots each [120]. The average load of a BTS is assumed to be similar to a Node B and equal to approximately 30% [120, 121]. A Node B has an average power consumption of 1,450 W [110] and an available bandwidth of 1,361 kbps [121].

### Core Network

According to [111], a typical data transfer has 9 hops to reach the core network, going through 8 edge switches and 1 core router. Network devices parameters are listed in Table 6.1.

Table 6.1: Core network devices model parameters [111].

Parameter	Edge switch	Core router
$P_{static}^{device}$	150 W	555 W
$AggregateBandwidth^{device}$	48 Gbps	48 Gbps
$LinkUtilization^{device}$	25 %	25 %
$P_{byte}^{device}$	3.4 nJ	3.4 nJ
$P_{pkt}^{device}$	192 nJ	192 nJ

## Servers

According to Enedis, the website offering users their detailed consumption<sup>2</sup> had on average 540,000 visits per month in 2021, with on average 2.38 webpages viewed per visit. We assume a conservative client-server architecture where the server can handle 200 concurrent requests per second, and the peak factor in web requests is set to 10 [122]. The writing speed of the server's HDD are set to 150 MBps. A storage oriented server has an estimated power consumption of 108 W [123] and the PUE of a small scale cloud is estimated at 1.7 [124]. Finally, the number of replicas is set to 3.

### 6.4.2 Results

Figure 6.3 presents the overall consumption of the smart metering infrastructure using values defined in Table 6.1 and Table 6.2. The overall consumption of the smart metering infrastructure is estimated at 405 MWh per day. If we assume a static power of 1 W per meter for the previous generation of meters, it would represent 840 MWh per day. In this case, the smart metering infrastructure would consume less than half of the consumption of the previous generation meters.

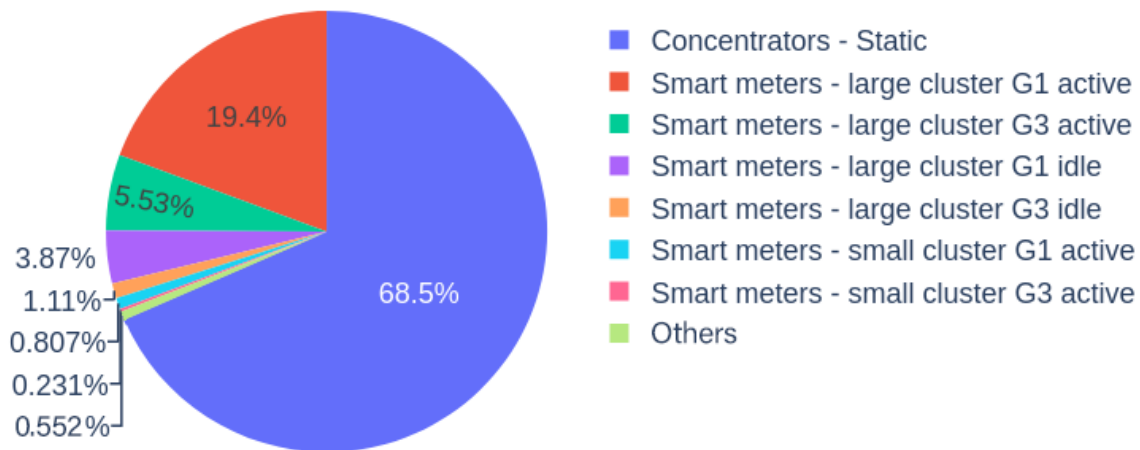

Figure 6.3: Daily energy consumption of the smart metering infrastructure.

The concentrators' energy consumption represents most of the smart metering infrastructure overall consumption (68 %). The additional energy consumption by the concentrators during cellular communication is negligible and accounts for only 0.002 % of the

2. Enedis user website: <https://mon-compte-client.enedis.fr/>

Table 6.2: Models parameters

Parameter	Value	Source
$N_{SM}^{small}, N_{SM}^{large}$	7 M, 28 M	[115]
$P_{SM}^{idle}, P_{SM}^{active}$	0.2 W, 1 W	[112, 113]
$T_{small}^{active}, T_{large}^{active}$	600 s, 3600 s	see Section 6.4.1
$R_{G1}, R_{GPRS}$	0.2, 0.2	[114]
$F_{G1}$	14	[108, 109]
$N_{CT}$	770,000	[107]
$P_{CT}^{static}$	15 W	see Section 6.4.1
$P_{GPRS}$	1.4 W	[116]
$P_{3G}$	2.1 W	[117]
$DV_{CT}$	150 kB	see Section 6.4.1
$DR_{GPRS}$	24 kbps	[118]
$DR_{3G}$	350 kbps	[125]
$P_{BTS}$	1,430 W	[110]
$N_{CT}^{timeslots}$	2	see Section 6.4.1
$N_{BTS}^{timeslots}$	24	[120]
$Load_{NB}, Load_{BTS}$	0.3	[120, 121]
$DR_{NB}$	1,361 kbps	[121]
$P_{NB}$	1,450 W	[110]
$N_{replicas}$	3	see Section 6.4.1
$PUE$	1.7	[124]
$P_{server}$	108 W	[123]
$Disk_{WritingSpeed}$	150 MBps	see Section 6.4.1
$WebRequests$	1.5 M/month	see Section 6.4.1
$PeakFactor$	10	see Section 6.4.1
$CPU_{requests}$	200/s	see Section 6.4.1



concentrators' consumption. This is due to their high static power consumption, and to the low amount of data to transfer, inducing a consumption of only 70 J per day and per concentrator using GPRS, and 7 J per day and per concentrator using 3G.

The smart meters account for 31 % of the total consumption, with 96 % of their consumption due to large clusters. It means that while 20 % of the smart meters are in small clusters, they only account for 4 % of the consumption of the smart meters. This result highlights a strong impact of PLC in large clusters representative of a dense urban environment in our model. We also observe the influence of the lower data rate of G1. Large G1 clusters account for 62 % of the consumption of the smart meters while large G3 clusters only account for 18 %, although there are 4 times more smart meters in large G3 clusters than in large G1 clusters.

The energy consumed by the cellular network is low in comparison to the concentrators and the smart meters with, respectively, 0.21 % and 0.18 % of the total energy consumed due to the 3G and GPRS network.

Finally, the energy consumed by the servers and the core network is negligible, with only 0.003 % of the total energy consumed.

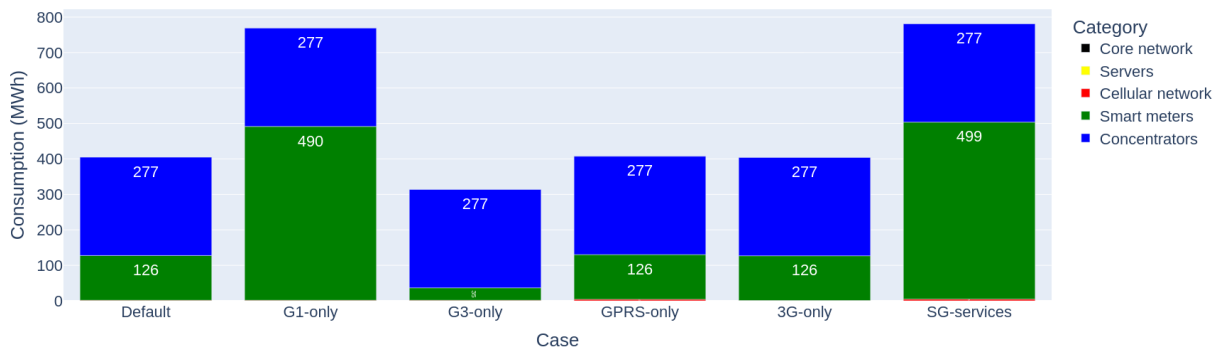

Figure 6.4: Exploration of various consumption cases of the smart metering infrastructure for one day.

Using our energy model, we also explored several other cases, as listed in Table 6.3. The corresponding results are shown in Figure 6.4.

### G1-only and G3-only

These cases highlight the interest of newer PLC technologies, improving data rate and drastically reducing the active time of smart meters. We see with the G1-only case that using the G1 technology exclusively would have almost doubled the energy consumed by

the infrastructure. On the other hand, upgrading the remaining 20 % of G1 smart meters to G3 would reduce the energy consumed by smart meters by 91 MWh (72 % less energy consumed by the smart meters, 22 % of the total).

Table 6.3: Cases explored.

Case	Specificity
Default	Default case
G1-only	Only G1 smart meters
G3-only	Only G3 smart meters
GPRS-only	Only GPRS communication
3G-only	Only 3G communication
SG-services	Future SG services

### **GPRS-only and 3G-only**

These cases investigate the interest of switching from the old GPRS technology to 3G. Sticking to GPRS would have increased the energy consumed by 2.7 MWh according to our model. On the other hand, upgrading the current 20 % concentrators from GPRS to 3G would reduce the energy consumed by 0.7 MWh. This represents a reduction of 58 % in the energy consumption by the cellular network, but this translates into a reduction of only 0.2 % in the overall energy consumption. Hence, although the 3G technology consumes indubitably less energy than GPRS for this given traffic, in comparison to the considerable energy consumed by smart meters and concentrators, the interest of switching from GPRS to 3G is low from an energy consumption point of view, especially when considering the gray energy required to replace the GPRS smart meters. Furthermore, the financial cost may be higher.

### **Energy Reduction**

Using our end-to-end energy model, one can also explore the possibility of using modified smart meters able to directly communicate through 3G. Such smart meters remove the need for concentrators, as they could directly send their data to the central utility using cellular networks. The increase in power consumption while using the 3G module is the same as with a concentrator, 2.1 W. A smart meter now consumes 2.3 W while active (previously 1 W), but with a data rate of 350 kbps. At such a data rate, less than 1 s is necessary to send a smart meter daily payload. The energy consumed by the cellular

network, the core and the servers is the same as the total data volume to transfer remains similar. This case results in a total daily energy consumption of 169 MWh, 2.4 times less than the current energy consumption. Yet, the mobile monthly subscription with this option may be prohibitive if fully supported by the grid operator.

Results show the large energy consumption of the concentrators and the smart meters, accounting for respectively 68 % and 31 % of the energy consumed, making the consumption from the cellular network, the core network and the servers negligible in comparison. They also show that using newer technologies effectively reduces the energy consumed. It is especially visible with the transition from G1 to G3 smart meters, saving 74 % of the energy consumed of the smart meters in comparison to the case where the transition did not happen.

### 6.4.3 Discussion

Several benefits are expected from a smart metering infrastructure. From the user point of view, the main benefit consists in the possibility to have energy consumption data at a smaller temporal resolution. This facilitates changes in energy usage behavior. However, the metering granularity and the important delay before the availability of the data online — every day — may degrade this benefit to a non-negligible extent. From the Distribution System Operator (DSO) point of view, the main benefit is to improve its network planning, control and maintenance, while the energy provider may provide more dynamic energy price schemes to its clients. Nevertheless, the still coarse metering granularity may not be sufficient to get the full benefit of the smart metering infrastructure. The communication technologies are largely limiting the capabilities of the infrastructure. First, PLC is not adapted to transfer data at a high granularity. Secondly, higher granularity would increase the data volume transmitted and the GPRS network could become another bottleneck due to its low data rate.

The smart metering infrastructure has been imagined, developed, and deployed with the idea of a highly communicating Smart Grid. The role of smart meters, in the long term, would consist not only to collect consumption data but to introduce dynamic, and possibly real-time, energy management mechanisms, either through indirect or direct remote control of smart devices inside each equipped home.

Such features would drastically increase the smart meters active time, and therefore their energy consumption. To explore the energy impact of such new features on the infrastructure, we defined a case (SG-services on Figure 6.4) where smart meters are

active for 30 minutes and 12 hours in small and large clusters respectively. In this case, the energy consumed by smart meters is multiplied by 4, and the total consumption by 1.9, slightly exceeding the G1-only case. Yet, this coarse-grain analysis do not guarantee that such a data traffic, corresponding to about ten data gathering per day, would be feasible in all large clusters because of a high potential of collisions.

Based on the observations presented in this study, some solutions can be considered to reduce the energy consumption of the smart metering infrastructure. The main insight of this work is that concentrators and smart meters account for more than 99 % of the infrastructure consumption. Thus, a first option consists in extensively using a low power state, or sleep mode, for concentrators and smart meters. Such sleeping mechanisms have been studied for PLC networks [126] and show that the proposed sleeping strategy performance highly depends on the delay and availability of the nodes. However, the current PLC routing policy requires nodes to be available at all times, which may thus need to be adapted. In addition, maintaining the connectivity between concentrators and smart meters, combined with channel congestion, induces an increase in active time, especially in dense urban areas. In that sense, another option consists in shifting from PLC communication to cellular or long range wireless communication in areas with sufficient coverage. This solution reduces the active time of concentrators and smart meters as it is less subject to channel congestion and provides a significant increase in data rate in comparison to PLC.

In addition, long range wireless communication would allow the management of more smart meters per concentrator, at least in some areas, or even allow direct connectivity between smart meters and a central utility. Thus, a significant amount of concentrators could be removed from the smart metering infrastructure, inducing a significant reduction in energy consumption. Recent studies have shown the suitability of such long range wireless communication in a Smart Grid context, as presented in [127]. However, shifting from one communication technology to another implies a replacement of the current infrastructure, thus inducing gray energy consumption, in addition to installation costs for the grid operator. Further analyses are necessary to evaluate the short and long term benefits of this potential communication technology shift.

## 6.5 Conclusion

In this chapter, we evaluate the end-to-end energy consumption of a smart metering infrastructure at a nation-wide scale. We propose an energy consumption model for each part of the infrastructure. The instantiation of the models parameters is a tough task as data in this domain is scarce. For this reason, we evaluate the daily energy consumption of the infrastructure using the most coherent values found in literature. We also propose an interface that allows the reader to explore our models with its own set of parameters.

For a scenario where data from smart meters are collected once a day, the results show that concentrators and smart meters account for respectively 68 % and 31 % of the energy consumed, making cellular network, core network and servers' consumption negligible in comparison. Our study also highlight the effectiveness of the newer generation (G3-PLC) in reducing the energy consumption. Indeed, G3-PLC saves 74 % of the energy consumed by the G1-PLC smart meters employed in the first phase of Smart Grid deployment.

These technologies allow the French smart metering program to meet the requirements of an Advanced Metering Infrastructure service, i.e. satisfying 99.99 % of the reading rates. However, the granularity offered for measurement purposes, and potentially for control purposes, remains coarse, which may restrain the benefits for energy providers, grid operators and consumers. An improvement of the reactivity could be useful during high consumption events, for instance during winter. Nevertheless, such an increase in the granularity may be limited by the current infrastructure. These issues may incite Smart Grid actors to switch to different communication technologies and rethink the whole smart metering infrastructure.

# CONCLUSION AND PERSPECTIVES

---

The increase in electricity consumption and the environmental concerns highlight the current limitations of the conventional electrical grid. To overcome those limits, the concept of a more complex and more communication-oriented electrical grid is explored in the literature. This upgrade, known as the Smart Grid, brings new challenges as its deployment becomes more concrete and intensifies. Along this manuscript, we explored several points of the emerging Smart Grid concerning the importance of communication means in its efficiency, and its energy consumption.

This chapter begins with a summary of the contributions and major findings during this thesis. Then, we present several future directions to pursue this work.

## 7.1 Contributions

The first objective of this thesis was to study the interactions between the power network and the Advanced Metering Infrastructure (AMI), and to provide tools to support this study. To fulfil this objective we developed a co-simulation environment based on SimGrid and the Functional Mock-up Interface (FMI) standard to produce a framework merging dedicated simulators to emulate the Smart Grid. First, SimGrid provides an automatic translation to the ns-3 simulator, a precise packet-level simulator for communication networks. Second, SimGrid imports the pandapower simulator, a power network simulator, through the FMI standard. Finally, SimGrid provides distributed systems simulation and acts as an orchestrator to pilot the co-simulation and the interactions between the simulators at run-time. Every part of this framework is open source and available online to favor experiments reproducibility.

The second objective was to evaluate the communication properties of the AMI on the efficiency of some services of the Smart Grid. This objective makes extensive use of the tool we developed for the first objective. Using simulations, we explore several key parameters of the communication network, such as the communication delay and com-

---

munication technologies, and their impact on reactive congestion management algorithms on a case study. This case study takes place in a residential district, where the objective is to mitigate power congestion using the flexibility of electric heaters located inside each household. An evaluation is conducted based on a comparison between a centralized and a decentralized management policy. The main metrics measured are the overcurrent duration and the shedding time. The first metric represents the point of view of the Distribution System Operator (DSO) which aims to minimize congestions, and the second one represents the user point of view which aims to minimize discomfort. In our results, we first found that neglecting communication delays in a centralized approach tends to overestimate the reduction in overcurrent duration. Also, in a decentralized approach, important delays tend to affect negatively consumers and positively the power system operator. Second, we highlight some limitations of the Power Line Communication (PLC) technologies in comparison to Wi-Fi and Ethernet. With a small constraint on the communication network, i.e., a low number of small messages, the three technologies have similar performances. However, under a more constrained network (higher traffic), PLC exhibit poorer performances than Wi-Fi and Ethernet.

The third objective was to investigate the end-to-end architecture of an AMI, and model the energy consumption for each part of the metering architecture. We took the example of the AMI deployment in France. We explored the literature to gather information about the topology of the AMI, and about the consumption of the devices composing it. Our consumption models take into account the consumption of the smart meters, the concentrators, the central utility's servers, and the communication between those devices. We used these models to evaluate the relative consumption of each part of the AMI in several scenarios. We showed that the consumption of the cellular network, the core network, and the servers is negligible in comparison to the consumption of the concentrators and smart meters. Also, we highlighted the benefit of using the newer G3-PLC technology instead of the previous G1-PLC to reduce effectively the energy consumption. Finally, an increase in the granularity of measurement and in two-way communications in general would greatly increase the consumption of the smart meters due to the limitations of the PLC in terms of data rate and concurrent communications. The models we developed and the values used are available online, and can be modified at will.

---

## 7.2 Future Directions

As any research work, our study presents some limitations that can be explored in future work. Our congestion management use case relies on the possibility to shut down temporarily electric heaters to mitigate the congestion. However, we did not consider the rebound effect of the electric heaters to compensate the thermal loss. Also, the centralized and decentralized managements approaches used are fairly simple to highlight the effect of the communication network. It would be interesting to extend this study to some of the more advanced algorithms from the literature. In addition to those limitations, our work can be extended in other ways.

### 7.2.1 Algorithm-specific Evaluation and Computation Time Overhead

We have seen in Chapter 2.3 that Demand Response (DR) programs often depends on communication between the actors of the Smart Grid. In addition, we have also seen that the constraints of the communication network, such as communication delays and packet loss, can degrade the performances of DR algorithms. In our work, we evaluated this degradation using simple management algorithms. A future direction can be to assess how more concrete management algorithm are affected by the communication network. Also, using more complex algorithm may induce a computation time overhead that will add up to communication delays, and can potentially affect further the efficiency of the management.

### 7.2.2 Communication Technologies

The communication technologies we explored represent only some possible solutions to deploy the AMI while many other technologies are explored in the literature. For instance, the *Benchmarking smart metering deployment in the EU-28* [16] presents some of the technological choices made for the communication between the various interfaces of the AMI in Europe. Among those technologies we can cite wired Ethernet, fiber optic, PLC, 2G, 3G, 4G, ZigBee, WiMAX. The use of different technologies affects the efficiency of DR algorithms, but also the topology of the AMI, for instance by reducing the need for concentrators. In consequence, further investigation are required to properly assess the benefits and drawbacks of different communication technologies.



---

Due to its limitations, PLC participates in the large consumption of the smart meters and the concentrators. Exploring different communication technologies and topologies require also further study about energy consumption. In addition, shifting to other technologies induce the production of gray energy that need to be assessed to properly evaluate their benefits. On another hand, other studies could be conducted to stick to PLC, but with an increased interest in management and routing policies to support low power states for smart meters and concentrators.

### **7.2.3 Co-optimization**

On a final note, an interesting research subject would be to co-optimize the development of the AMI and of the Smart Grid services. This research could rely on simulations to develop an AMI with respect to the efficiency of the Smart Grid services, and to develop the services with respect to the limitations of the communication capabilities of the AMI.

# BIBLIOGRAPHY

---

- [1] United States Department of Energy, *Simple diagram of electricity grids in North America*, 2008, URL: [https://commons.wikimedia.org/wiki/File:Electricity\\_grid\\_simple-North\\_America.svg](https://commons.wikimedia.org/wiki/File:Electricity_grid_simple-North_America.svg) (visited on 06/15/2022).
- [2] Ember Global Electricity Review (2022) & Ember European Electricity Review (2022) Our World in Data based on BP Statistical Review of World Energy, *Electricity production by source, World*, 2022, URL: <https://ourworldindata.org/electricity-mix> (visited on 06/20/2022).
- [3] *Kyoto Protocol to the United Nations Framework Convention on Climate Change*, tech. rep., UNFCCC, 1997.
- [4] *Paris Climate Change Conference*, tech. rep., UNFCCC, 2015.
- [5] Mudathir Funsho Akorede, Hashim Hizam, and Edris Pouresmaeil, “Distributed energy resources and benefits to the environment”, in: *Renewable and Sustainable Energy Reviews* 14.2 (2010), pp. 724–734, ISSN: 1364-0321, DOI: <https://doi.org/10.1016/j.rser.2009.10.025>, URL: <https://www.sciencedirect.com/science/article/pii/S1364032109002561>.
- [6] Srinivasan Keshav and Catherine Rosenberg, “How Internet Concepts and Technologies Can Help Green and Smarten the Electrical Grid”, in: *Proceedings of the First ACM SIGCOMM Workshop on Green Networking*, Green Networking '10, New Delhi, India: Association for Computing Machinery, 2010, pp. 35–40, ISBN: 9781450301961, DOI: 10.1145/1851290.1851298, URL: <https://doi.org/10.1145/1851290.1851298>.
- [7] Jacopo Torriti, “Understanding the timing of energy demand through time use data: Time of the day dependence of social practices”, in: *Energy Research & Social Science* 25 (2017), pp. 37–47, ISSN: 2214-6296, DOI: <https://doi.org/10.1016/j.erss.2016.12.004>, URL: <https://www.sciencedirect.com/science/article/pii/S2214629616302985>.
- [8] RTE, *RTE France*, <https://www.rte-france.com/eco2mix/la-consommation-delectricite-en-france>, Accessed August, 24 2022.

- 
- [9] Teresa Nogueira, Ezequiel Sousa, and Gustavo R. Alves, “Electric vehicles growth until 2030: Impact on the distribution network power”, *in: Energy Reports* 8 (2022), The 8th International Conference on Energy and Environment Research - “Developing the World in 2021 with Clean and Safe Energy”, pp. 145–152, ISSN: 2352-4847, DOI: <https://doi.org/10.1016/j.egy.2022.01.106>, URL: <https://www.sciencedirect.com/science/article/pii/S2352484722001068>.
- [10] Ida Marie Henriksen et al., “Electric vehicle charging and end-user motivation for flexibility: a case study from Norway”, *in: Energy, Sustainability and Society* 11.1 (Nov. 2021), p. 44, ISSN: 2192-0567, DOI: 10.1186/s13705-021-00319-z, URL: <https://doi.org/10.1186/s13705-021-00319-z>.
- [11] Maria Lorena Tuballa and Michael Lochinvar Abundo, “A review of the development of Smart Grid technologies”, *in: Renewable and Sustainable Energy Reviews* 59 (2016), pp. 710–725, ISSN: 1364-0321, DOI: <https://doi.org/10.1016/j.rser.2016.01.011>, URL: <https://www.sciencedirect.com/science/article/pii/S1364032116000393>.
- [12] Ibrahim Alotaibi et al., “A Comprehensive Review of Recent Advances in Smart Grids: A Sustainable Future with Renewable Energy Resources”, *in: Energies* 13.23 (2020), ISSN: 1996-1073, DOI: 10.3390/en13236269, URL: <https://www.mdpi.com/1996-1073/13/23/6269>.
- [13] M. H. Rehmani et al., “Integrating Renewable Energy Resources Into the Smart Grid: Recent Developments in Information and Communication Technologies”, *in: IEEE Trans. on Indus. Informatics* 14.7 (2018), pp. 2814–2825.
- [14] RTE, *Outlines of RTE’s R&D program for 2017-2020*, tech. rep., RTE, 2017.
- [15] Y. Zhang et al., “Security-Based Load Shedding Strategy Considering the Load Frequency Dependency in Island Distribution System”, *in: IEEE Conference on Energy Internet and Energy System Integration (EI2)*, 2018.
- [16] Tractebel, *Benchmarking smart metering deployment in the EU-28*, tech. rep., European Commission, 2019.
- [17] Clark W. GELLINGS, “Evolving practice of demand-side management”, *in: Journal of Modern Power Systems and Clean Energy* 5.1 (Jan. 2017), pp. 1–9, ISSN: 2196-5420, DOI: 10.1007/s40565-016-0252-1, URL: <https://doi.org/10.1007/s40565-016-0252-1>.

- 
- [18] Peter Palensky and Dietmar Dietrich, “Demand Side Management: Demand Response, Intelligent Energy Systems, and Smart Loads”, *in: IEEE Transactions on Industrial Informatics* 7.3 (2011), pp. 381–388, DOI: 10.1109/TII.2011.2158841.
- [19] Hussein Jumma Jabir et al., “Impacts of Demand-Side Management on Electrical Power Systems: A Review”, *in: Energies* 11.5 (2018), ISSN: 1996-1073, DOI: 10.3390/en11051050, URL: <https://www.mdpi.com/1996-1073/11/5/1050>.
- [20] Peter Warren, “A review of demand-side management policy in the UK”, *in: Renewable and Sustainable Energy Reviews* 29 (2014), pp. 941–951, ISSN: 1364-0321, DOI: <https://doi.org/10.1016/j.rser.2013.09.009>, URL: <https://www.sciencedirect.com/science/article/pii/S1364032113006680>.
- [21] QJUDE Qdr, “Benefits of demand response in electricity markets and recommendations for achieving them”, *in: US Dept. Energy, Washington, DC, USA, Tech. Rep* 2006 (2006).
- [22] Haider Tarish Haider, Ong Hang See, and Wilfried Elmenreich, “A review of residential demand response of smart grid”, *in: Renewable and Sustainable Energy Reviews* 59 (2016), pp. 166–178.
- [23] A. Safdarian, M. Fotuhi-Firuzabad, and M. Lehtonen, “Optimal Residential Load Management in Smart Grids: A Decentralized Framework”, *in: IEEE Transactions on Smart Grid* 7.4 (2016), pp. 1836–1845.
- [24] RTE France, *Ecowatt, votre météo de l’électricité pour une consommation responsable*, Accessed Sept, 16 2022, URL: <https://www.monecowatt.fr/>.
- [25] A. Rezaee Jordehi, “Optimisation of demand response in electric power systems, a review”, *in: Renewable and Sustainable Energy Reviews* 103 (2019), pp. 308–319, ISSN: 1364-0321, DOI: <https://doi.org/10.1016/j.rser.2018.12.054>, URL: <https://www.sciencedirect.com/science/article/pii/S1364032118308566>.
- [26] Amir-Hamed Mohsenian-Rad and Alberto Leon-Garcia, “Optimal Residential Load Control With Price Prediction in Real-Time Electricity Pricing Environments”, *in: IEEE Transactions on Smart Grid* 1.2 (2010), pp. 120–133, DOI: 10.1109/TSG.2010.2055903.

- 
- [27] Pedram Samadi et al., “Optimal Real-Time Pricing Algorithm Based on Utility Maximization for Smart Grid”, *in: 2010 First IEEE International Conference on Smart Grid Communications*, 2010, pp. 415–420, DOI: 10.1109/SMARTGRID.2010.5622077.
- [28] Michael Angelo A. Pedrasa, Ted D. Spooner, and Iain F. MacGill, “Scheduling of Demand Side Resources Using Binary Particle Swarm Optimization”, *in: IEEE Transactions on Power Systems* 24.3 (2009), pp. 1173–1181, DOI: 10.1109/TPWRS.2009.2021219.
- [29] Thillainathan Logenthiran, Dipti Srinivasan, and Tan Zong Shun, “Demand Side Management in Smart Grid Using Heuristic Optimization”, *in: IEEE Transactions on Smart Grid* 3.3 (2012), pp. 1244–1252, DOI: 10.1109/TSG.2012.2195686.
- [30] Abdullah Al Zishan, Moosa Moghimi Haji, and Omid Ardakanian, “Adaptive Congestion Control for Electric Vehicle Charging in the Smart Grid”, *in: IEEE Transactions on Smart Grid* 12.3 (2021), pp. 2439–2449, DOI: 10.1109/TSG.2021.3051032.
- [31] Junyao Guo, Gabriela Hug, and Ozan Tonguz, “Impact of communication delay on asynchronous distributed optimal power flow using ADMM”, *in: 2017 IEEE International Conference on Smart Grid Communications (SmartGridComm)*, 2017, pp. 177–182, DOI: 10.1109/SmartGridComm.2017.8340718.
- [32] Ahmad Attarha, Paul Scott, and Sylvie Thiébaux, “Affinely Adjustable Robust ADMM for Residential DER Coordination in Distribution Networks”, *in: IEEE Transactions on Smart Grid* 11.2 (2020), pp. 1620–1629, DOI: 10.1109/TSG.2019.2941235.
- [33] Iran Ramezanipour et al., “Decision error probability in a two-stage communication network for smart grids with imperfect links”, *in: 2017 IEEE International Conference on Smart Grid Communications (SmartGridComm)*, 2017, pp. 195–199, DOI: 10.1109/SmartGridComm.2017.8340663.
- [34] Jiangjiao Xu, Hongjian Sun, and Chris Dent, “The coordinated voltage control meets imperfect communication system”, *in: 2016 IEEE PES Innovative Smart Grid Technologies Conference Europe (ISGT-Europe)*, 2016, pp. 1–5, DOI: 10.1109/ISGTEurope.2016.7856209.

- 
- [35] Jiangjiao Xu, Hongjian Sun, and Chris J. Dent, “ADMM-Based Distributed OPF Problem Meets Stochastic Communication Delay”, *in: IEEE Transactions on Smart Grid* 10.5 (2019), pp. 5046–5056, DOI: 10.1109/TSG.2018.2873650.
- [36] Jiangjiao Xu et al., “ADMM-based OPF Problem Against Cyber Attacks in Smart Grid”, *in: 2021 IEEE International Conference on Systems, Man, and Cybernetics (SMC)*, 2021, pp. 1418–1423, DOI: 10.1109/SMC52423.2021.9658699.
- [37] Ian Burkley Beil, “Fast-timescale Control Strategies for Demand Response in Power Systems”, PhD thesis, University of Michigan, 2015.
- [38] Yashen Lin et al., “Experimental Evaluation of Frequency Regulation From Commercial Building HVAC Systems”, *in: IEEE Transactions on Smart Grid* 6.2 (2015), pp. 776–783, DOI: 10.1109/TSG.2014.2381596.
- [39] Hongxun Hui et al., “Modeling and control of flexible loads for frequency regulation services considering compensation of communication latency and detection error”, *in: Applied Energy* 250 (2019), pp. 161–174, ISSN: 0306-2619, DOI: <https://doi.org/10.1016/j.apenergy.2019.04.191>, URL: <https://www.sciencedirect.com/science/article/pii/S0306261919308335>.
- [40] Marco Pruckner, Abdalkarim Awad, and Reinhard German, “A study on the impact of packet loss and latency on real-time demand response in smart grid”, *in: 2012 IEEE Globecom Workshops*, 2012, pp. 1486–1490, DOI: 10.1109/GLOCOMW.2012.6477805.
- [41] Gregory S. Ledva et al., “Applying Networked Estimation and Control Algorithms to Address Communication Bandwidth Limitations and Latencies in Demand Response”, *in: 2015 48th Hawaii International Conference on System Sciences*, 2015, pp. 2645–2654, DOI: 10.1109/HICSS.2015.319.
- [42] Jose Cordova-Garcia et al., “Control of Communications-Dependent Cascading Failures in Power Grids”, *in: IEEE Transactions on Smart Grid* 10.5 (2019), pp. 5021–5031.
- [43] Ardiansyah et al., “Latency Minimization for Energy Internet Communications with SDN Virtualization Infrastructure”, *in: IEEE SmartGridComm*, 2019.
- [44] Maedeh Ghorbanian et al., “Communication in Smart Grids: A Comprehensive Review on the Existing and Future Communication and Information Infrastructures”, *in: IEEE Systems Journal* 13.4 (2019), pp. 4001–4014.

- 
- [45] A. Shrestha et al., “Peer-to-Peer Energy Trading in Micro/Mini-Grids for Local Energy Communities: A Review and Case Study of Nepal”, *in: IEEE Access* 7 (2019), pp. 131911–131928.
- [46] J. Guo, G. Hug, and O. Tonguz, “Impact of Communication Delay on Asynchronous Distributed Optimal Power Flow Using ADMM”, *in: IEEE SmartGridComm*, 2017.
- [47] B. Vinot et al., “Congestion Avoidance in Low-Voltage Networks by using the Advanced Metering Infrastructure”, *in: ACM e-Energy*, 2018.
- [48] D. Bian et al., “Analysis of communication schemes for Advanced Metering Infrastructure (AMI)”, *in: 2014 IEEE PES General Meeting Conference & Exposition*, 2014, pp. 1–5, DOI: 10.1109/PESGM.2014.6939562.
- [49] Sung-Guk Yoon, “Performance analysis of power saving strategies for power line communications”, *in: IEEE International Conference on Smart Grid Communications (SmartGridComm)*, 2017, pp. 314–319.
- [50] Kamalanath Samarakoon, Janaka Ekanayake, and Nick Jenkins, “Investigation of Domestic Load Control to Provide Primary Frequency Response Using Smart Meters”, *in: IEEE Trans. on Smart Grid* 3.1 (2012), pp. 282–292.
- [51] A. De Domenico et al., “Communication network assessment for distributed smart grid applications”, *in: General Assembly and Scientific Symposium of the International Union of Radio Science (URSI GASS)*, 2017.
- [52] D. Baimel, S. Tapuchi, and N. Baimel, “Smart grid communication technologies - overview, research challenges and opportunities”, *in: Int. Symp. on Power Electronics, Electrical Drives, Automation and Motion*, 2016, pp. 116–120.
- [53] Rahul N. Gore and Simi P. Valsan, “Wireless communication technologies for smart grid (WAMS) deployment”, *in: IEEE International Conference on Industrial Technology (ICIT)*, 2018, pp. 1326–1331.
- [54] C. Deng et al., “CSMA-and-NOMA-based Random Massive Access in Power Line Communication for Smart Grid Applications”, *in: IEEE SmartGridComm*, 2019.
- [55] P. Wang et al., “Demand Side Load Management of Smart Grids using intelligent trading/Metering/ Billing System”, *in: IEEE PES General Meeting*, 2010.

- 
- [56] John C. Hastings, David M. Laverty, and D John Morrow, “A Converged Approach to Physical-Layer Communications in Supporting Domestic-Level Automated Demand-Response Systems utilizing ISO/IEC 20922”, *in: IEEE PES General Meeting*, 2018.
- [57] Admir Jahić et al., “Hardware-in-the-loop demonstration of automated demand response for distribution networks using PMU and MQTT”, *in: IET Smart Grid* 5 (2021), DOI: 10.1049/stg2.12009.
- [58] Agustin Zaballo, Alex Vallejo, and Josep M. Selga, “Heterogeneous communication architecture for the smart grid”, *in: IEEE Network* 25 (2011), pp. 30–37.
- [59] Nataliya Mogles et al., “How smart do smart meters need to be?”, *in: Building and Environment* 125 (2017), pp. 439–450.
- [60] Rehmat Ullah, Yasir Faheem, and Byung-Seo Kim, “Energy and Congestion-Aware Routing Metric for Smart Grid AMI Networks in Smart City”, *in: IEEE Access* 5 (2017), pp. 13799–13810, DOI: 10.1109/ACCESS.2017.2728623.
- [61] Samaresh Bera, Sudip Misra, and Mohammad S. Obaidat, “Energy-efficient smart metering for green smart grid communication”, *in: 2014 IEEE Global Communications Conference*, 2014, pp. 2466–2471, DOI: 10.1109/GLOCOM.2014.7037178.
- [62] Melike Erol-Kantarci and Hussein T. Mouftah, “Energy-Efficient Information and Communication Infrastructures in the Smart Grid: A Survey on Interactions and Open Issues”, *in: IEEE Communications Surveys & Tutorials* 17.1 (2015), pp. 179–197.
- [63] Forkan Uddin, “Energy-Aware Optimal Data Aggregation in Smart Grid Wireless Communication Networks”, *in: IEEE Trans. on Green Communications and Networking* 1.3 (2017), pp. 358–371.
- [64] Michael Preisel, Adriana Diaz, and Wolfgang Wimmer, “Energy Consumption of Smart Meters”, *in: Int. Conf. on ICT for Sustainability*, 2013.
- [65] Jens Malmodin and Vlad Coroama, “Assessing ICT’s enabling effect through case study extrapolation — The example of smart metering”, *in: Electronics Goes Green*, 2016.



- 
- [66] Alireza Ghasempour and Jacob H. Gunther, “Finding the optimal number of aggregators in machine-to-machine advanced metering infrastructure architecture of smart grid based on cost, delay, and energy consumption”, *in: IEEE Ann. Consumer Comm. Netw. Conf.* 2016, pp. 960–963, DOI: 10.1109/CCNC.2016.7444917.
- [67] Enedis, *Enedis Lab*, <https://www.enedis.fr/le-compteur-linky-un-grand-projet-industriel-francais>, Accessed July, 27 2022.
- [68] Ali Hamdan, “Smart Metering for Smart-grid Applications : building a hardware and software platform for testing and validating smart-grid technologies using Smart Meters”, Theses, Université Grenoble Alpes [2020-....], Mar. 2022, URL: <https://tel.archives-ouvertes.fr/tel-03702581>.
- [69] A. Fernández-Guillamón et al., “Comparison of different tools for power flow analysis with high wind power integration”, *in: 2019 International Conference on Clean Electrical Power (ICCEP)*, 2019, pp. 82–86, DOI: 10.1109/ICCEP.2019.8890163.
- [70] Stefan Pfenninger et al., “Opening the black box of energy modelling: Strategies and lessons learned”, *in: Energy Strategy Reviews* 19 (2018), pp. 63–71, ISSN: 2211-467X, DOI: <https://doi.org/10.1016/j.esr.2017.12.002>, URL: <https://www.sciencedirect.com/science/article/pii/S2211467X17300809>.
- [71] Tamali Mohammed et al., “Electrical Network’s Modeling & Simulation Tools: The State of the Art.”, *in: Journal of Electrical and Control Engineering* 3 (Oct. 2013), pp. 1–12.
- [72] F. Milano and L. Vanfretti, “State of the art and future of OSS for power systems”, *in: 2009 IEEE Power & Energy Society General Meeting*, 2009, pp. 1–7, DOI: 10.1109/PES.2009.5275920.
- [73] L. Thurner et al., “pandapower — An Open-Source Python Tool for Convenient Modeling, Analysis, and Optimization of Electric Power Systems”, *in: IEEE Transactions on Power Systems* 33.6 (Nov. 2018), pp. 6510–6521, ISSN: 0885-8950, DOI: 10.1109/TPWRS.2018.2829021.
- [74] Mohammed Kabir et al., “Detail Comparison of Network Simulators”, PhD thesis, Nov. 2014, DOI: 10.13140/RG.2.1.3040.9128.
- [75] Loic Guegan, “Scalable end-to-end models for the time and energy performance of Fog infrastructures”, Theses, École normale supérieure de Rennes, Jan. 2021, URL: <https://tel.archives-ouvertes.fr/tel-03134046>.

- 
- [76] András Varga and Rudolf Hornig, “An overview of the OMNeT++ simulation environment”, *in: Proceedings of ICST*, 2008, p. 60.
- [77] Thomas R Henderson et al., “NS-3 project goals”, *in: Proceeding of WNS2*, ACM, 2006.
- [78] Tom Kleiberg et al., “DeSiNe: a flow-level QoS Simulator of Networks”, *in: Jan. 2008*, p. 10, DOI: 10.1145/1416222.1416236.
- [79] Henri Casanova et al., “Versatile, Scalable, and Accurate Simulation of Distributed Applications and Platforms”, *in: J. of Par. and Dist. Comp.* 74.10 (2014), pp. 2899–2917.
- [80] Alemayehu Addisu et al., “An efficient production scheduling based on queuing theory in systems with synchronous part transfer during a demand response event”, *in: 2017 IEEE International Conference on Smart Grid Communications (SmartGridComm)*, 2017, DOI: 10.1109/SmartGridComm.2017.8340724.
- [81] Robin Roche et al., “A Framework for Co-simulation of AI Tools with Power Systems Analysis Software”, *in: 2012 23rd International Workshop on Database and Expert Systems Applications*, 2012, pp. 350–354, DOI: 10.1109/DEXA.2012.9.
- [82] Benjamin Camus et al., “Co-simulation of an electrical distribution network and its supervision communication network”, *in: CCNC 2020 - IEEE Consumer Communications & Networking Conference*, CCNC: IEEE Consumer Communications & Networking Conference, Las Vegas, United States: IEEE, Jan. 2020, pp. 1–6, URL: <https://hal.archives-ouvertes.fr/hal-02352832>.
- [83] T. Blochwitz et al., “Functional Mockup Interface 2.0: The Standard for Tool independent Exchange of Simulation Models”, *in: Sept. 2012*, DOI: 10.3384/ecp12076173.
- [84] IEEE PES AMPS DSAS Test Feeder Working Group, *European Low Voltage Test Feeder*, <http://sites.ieee.org/pes-testfeeders/resources/>, Accessed March, 9 2020.
- [85] P. Schneider et al., “Analytic Considerations and Design Basis for the IEEE Distribution Test Feeder”, *in: IEEE Transactions on Power Systems* 33.3 (2018), pp. 3181–3188.

- 
- [86] Benjamin Camus, Anne-Cécile Orgerie, and Martin Quinson, “Co-simulation of FMUs and Distributed Applications with SimGrid”, *in: SIGSIM Principles of Advanced Discrete Simulation (PADS)*, 2018, pp. 145–156, DOI: 10.1145/3200921.3200932.
- [87] DIgSILENT, *Official website*, <https://www.digsilent.de/en/powerfactory.htm>, Accessed March, 9 2020.
- [88] pandapower, *Official website*, <http://www.pandapower.org/>, Accessed December, 18 2019.
- [89] Fraunhofer IEE and University of Kassel, *Simple Example Network*, Accessed July, 28 2022, URL: <https://pandapower.readthedocs.io/en/latest/networks/example.html#simple-example-network>.
- [90] Fraunhofer IEE and University of Kassel, *Network Elements*, Accessed July, 28 2022, URL: <https://pandapower.readthedocs.io/en/v2.9.0/elements.html>.
- [91] Juliana Freire, Philippe Bonnet, and Dennis Shasha, “Computational Reproducibility: State-of-the-Art, Challenges, and Database Research Opportunities”, *in: SIGMOD ’12*, Scottsdale, Arizona, USA: Association for Computing Machinery, 2012, pp. 593–596, ISBN: 9781450312479, DOI: 10.1145/2213836.2213908, URL: <https://doi.org/10.1145/2213836.2213908>.
- [92] Vaibhav Bajpai et al., “Challenges with Reproducibility”, *in: Proceedings of the Reproducibility Workshop*, Reproducibility ’17, Los Angeles, CA, USA: Association for Computing Machinery, 2017, pp. 1–4, ISBN: 9781450350600, DOI: 10.1145/3097766.3097767, URL: <https://doi.org/10.1145/3097766.3097767>.
- [93] N. Nimalsiri et al., “A Survey of Algorithms for Distributed Charging Control of Electric Vehicles in Smart Grids”, *in: IEEE Trans. on Intelligent Transportation Systems* (2019).
- [94] S. Singh, A. Namboodiri, and M. P. Selvan, “Simplified Algorithm for Dynamic Demand Response in Smart Homes Under Smart Grid Environment”, *in: IEEE PES GTD Asia*, 2019, pp. 259–264.
- [95] S. P. Meyn et al., “Ancillary Service to the Grid Using Intelligent Deferrable Loads”, *in: IEEE Transactions on Automatic Control* 60.11 (2015), pp. 2847–2862.

- 
- [96] J. Vaubourg et al., “Multi-agent multi-model simulation of smart grids in the MS4SG project”, in: *Advances in Practical Applications of Agents, Multi-Agent Systems, and Sustainability (PAAMS)*, 2015.
- [97] OFGEM, *Insights paper on households with electric and other non-gas heating*, EU, 2015.
- [98] ADEME, *Les Avis de l’ADEME, Modes de chauffage dans l’habitat individuel*, tech. rep., ADEME, 2014.
- [99] RTE, *French national daily load curves*, [http://clients.rte-france.com/lang/fr/visiteurs/vie/vie\\_histo\\_courbes.jsp](http://clients.rte-france.com/lang/fr/visiteurs/vie/vie_histo_courbes.jsp), Accessed March, 9 2020.
- [100] Grid’5000, *Official website*, <https://www.grid5000.fr/w/Grid5000:Home>, Accessed March, 9 2020.
- [101] O. Ardakanian, C. Rosenberg, and S. Keshav, “Real-Time Distributed Congestion Control for Electrical Vehicle Charging”, in: *ACM SIGMETRICS Performance Evaluation Review* 40.3 (2012).
- [102] Julien Vaubourg et al., “Multi-agent Multi-Model Simulation of Smart Grids in the MS4SG Project”, in: *Advances in Practical Applications of Agents, Multi-Agent Systems, and Sustainability*, 2015, pp. 240–251.
- [103] B.-K. Choi et al., “Analysis of point-to-point packet delay in an operational network”, in: *IEEE INFOCOM 2004*, vol. 3, 2004, 1797–1807 vol.3, DOI: 10.1109/INFOCOM.2004.1354590.
- [104] Srikanth Sundaresan et al., “Broadband Internet Performance: A View From the Gateway”, in: *ACM SIGCOMM*, 2011, pp. 134–145.
- [105] Vaibhav Bajpai, Steffie Jacob Eravuchira, and Jürgen Schönwälder, “Dissecting Last-Mile Latency Characteristics”, in: *SIGCOMM Comput. Commun. Rev.* 47.5 (2017), pp. 25–34, ISSN: 0146-4833.
- [106] Murat Kuzlu, Manisa Pipattanasomporn, and Saifur Rahman, “Communication network requirements for major smart grid applications in HAN, NAN and WAN”, in: *Computer Networks* 67 (2014), pp. 74–88.
- [107] Enedis, *Programme de R&D et d’Innovation d’Enedis*, report, 2019.
- [108] IEC, *Distribution automation using distribution line carrier systems*, Standard, International Electrotechnical Commission, 2004.

- 
- [109] ITU, *Narrowband orthogonal frequency division multiplexing power line communication transceivers for G3-PLC networks*, Standard, Telecommunication Standardization Sector of ITU, Aug. 2017.
- [110] Oliver Arnold et al., “Power Consumption Modeling of Different Base Station Types in Heterogeneous Cellular Networks”, *in: ICT Mobile Summit*, 2010.
- [111] Loic Guegan and Anne-Cécile Orgerie, “Estimating the End-to-End Energy Consumption of Low-Bandwidth IoT Applications for WiFi Devices”, *in: IEEE Int. Conf. on Cloud Comp. Technology and Science*, 2019.
- [112] *Powerline Communications Analog Front-End*, AFE030, Texas Instr., 2011.
- [113] *Powerline Communications Analog Front-End*, AFE031, Rev.E, Texas Instrument, 2010, URL: <https://www.ti.com/lit/gpn/afe031>.
- [114] Enedis, *Plus de 7 millions de familles équipées d'un compteur Linky, et alors ?*, Enedis press kit, 2017.
- [115] Vianney Costemalle, *Toujours plus d'habitants dans les unités urbaines*, tech. rep., INSEE, 2020.
- [116] *AirPrime HL6528 Embedded Module*, HL6528, Rev. 15, Sierra Wireless, 2019.
- [117] *AirPrime HL8518, HL8528 and HL8529 Embedded Modules*, HL8528, Rev. 2.1, Sierra Wireless, 2015.
- [118] Bernd Pfitzinger et al., “Network-Wide Measurement of GPRS Bandwidth and Latency”, *in: Int. Conf. on System Sciences*, 2019.
- [119] Toni Anwar and Lim Wern Li, “Performance Analysis of 3G Communication Network”, *in: ITB Journal of ICT 2* (2008).
- [120] Lempiäinen Jukka and Manninen Matti, *Radio Interface System Planning for GSM/GPRS/UMTS*, Springer, 2002.
- [121] Y. H. Chen et al., “Precise Estimation of WCDMA Downlink Pole Capacity in Multipath Propagation Channel by Monte Carlo Method”, *in: IEEE VTC-Spring*, 2007.
- [122] A. Prasad et al., “Optimal Resource Configuration of Complex Services in the Cloud”, *in: IEEE/ACM Int. Symp. on Cluster, Cloud and Grid Computing*, 2017.

- 
- [123] Takuro Inoue et al., “Power consumption and processing models of servers in computation and storage based applications”, *in: Mathematical and Computer Modelling* 58.5 (2013), pp. 1475–1488.
- [124] Yunbo Li et al., “End-to-end energy models for Edge Cloud-based IoT platforms: Application to data stream analysis in IoT”, *in: Future Generation Computer Systems* 87 (2018), pp. 667–678.
- [125] 3GPP, *Group Services and System Aspects; Services and service capabilities*, Technical Specification (TS) 22.105, Version 16.0.0, 3rd Generation Partnership Project (3GPP), 2020.
- [126] Sung-Guk Yoon, “Performance analysis of power saving strategies for power line communications”, *in: IEEE Int. Conf. on Smart Grid Communications (Smart-GridComm)*, 2017, pp. 314–319, DOI: 10.1109/SmartGridComm.2017.8340679.
- [127] José Luis Gallardo, Mohamed A. Ahmed, and Nicolás Jara, “LoRa IoT-Based Architecture for Advanced Metering Infrastructure in Residential Smart Grid”, *in: IEEE Access* 9 (2021), pp. 124295–124312, DOI: 10.1109/ACCESS.2021.3110873.







---

**Titre :** Optimisation d'un réseau dynamique et efficace en énergie servant à piloter la grille électrique

**Mot clés :** Smart Grid, AMI, Communication, Co-Simulation, Consommation Énergétique

**Résumé :** Face aux défis concernant les secteurs de l'énergie et de l'environnement, le réseau électrique est confronté à certaines limites. Un problème majeur du réseau électrique actuel est le manque de communication et de coordination entre ses acteurs pour exploiter pleinement son potentiel. Pour surmonter ces limites et offrir de nouveaux services aux acteurs du réseau électrique, nous nous dirigeons vers un réseau plus intelligent, la Smart Grid. Le déploiement d'une infrastructure supplémentaire est nécessaire pour réaliser cette transition. Cette infrastructure, Advanced Metering Infrastructure (AMI), vise à améliorer les capacités de surveillance et de communication des acteurs du ré-

seau électrique. L'objectif de cette thèse est de quantifier la dégradation de performance de certains nouveaux services de la Smart Grid, due à la qualité de service de l'AMI. Nous explorons plusieurs paramètres de l'infrastructure de communication et observons par co-simulation comment ces paramètres influencent l'efficacité de ces services. Un des objectifs principaux de la Smart Grid est aussi de réduire la consommation d'énergie. Dans un deuxième temps, nous modélisons la consommation énergétique de bout en bout de l'AMI afin d'évaluer sa propre consommation. Les outils de co-simulation proposés ainsi que les modèles de consommation sont tous disponibles sans restrictions.

---

**Title:** Optimizing a dynamic and energy efficient network piloting the electrical grid

**Keywords:** Smart Grid, AMI, Communication, Co-Simulation, Energy Consumption

**Abstract:** In front of the challenges concerning the energy and environmental sectors, the electrical grid faces some limitations. A major issue of the current power network is the lack of communication and coordination between its actors to fully exploit its potential. To overcome those limitations, and offer new services to the actors of the electrical grid, we are moving toward the Smart Grid. The deployment of an additional infrastructure is necessary to enable the Smart Grid. This infrastructure, known as the Advanced Metering Infrastructure (AMI), aims to enhance the monitoring and communication capabilities of the actors of the electrical grid. The goal of this

thesis is to quantify the performance degradation of some new services of the Smart Grid, due to the quality of service of the AMI. We explore several parameters of the communication infrastructure and observe through co-simulation how those parameters influence the efficiency of those services. One of the main objectives of the Smart Grid is to reduce energy consumption. In a second stage, we model the end-to-end energy consumption of an AMI at a large scale to assess its own consumption. The proposed co-simulation framework and consumption models are all license-free.