



HAL
open science

What makes us allergic? Defining common features of an “allergic” immune phenotype

Yu Wang

► **To cite this version:**

Yu Wang. What makes us allergic? Defining common features of an “allergic” immune phenotype. Immunology. Université Paris Cité, 2020. English. NNT : 2020UNIP5062 . tel-04093074

HAL Id: tel-04093074

<https://theses.hal.science/tel-04093074>

Submitted on 9 May 2023

HAL is a multi-disciplinary open access archive for the deposit and dissemination of scientific research documents, whether they are published or not. The documents may come from teaching and research institutions in France or abroad, or from public or private research centers.

L'archive ouverte pluridisciplinaire **HAL**, est destinée au dépôt et à la diffusion de documents scientifiques de niveau recherche, publiés ou non, émanant des établissements d'enseignement et de recherche français ou étrangers, des laboratoires publics ou privés.



Distributed under a Creative Commons Attribution - NonCommercial - NoDerivatives 4.0 International License

Université de Paris

**Ecole doctorale Frontières de l'Innovation en Recherche et
Education (ED474)**

Anticorps en Thérapie et Pathologies

What makes us allergic? Defining common features of an "allergic" immune phenotype

Par Yu WANG

Thèse de doctorat d'Immunologie

Dirigée par Friederike Jönsson

Présentée et soutenue publiquement le 10/07/2020

Devant un jury composé de :

Professeur Antonino Nicoletti

Université de Paris

Président

Professeur Jean-Luc Teillaud

Université Pierre et Marie Curie

Rapporteur

Professeur Nadine Varin-Blank

Université Sorbonne Paris Nord

Rapporteur

Professeur Sabine Flicker

Medical University of Vienna

Examineur

Dr. Catherine Neukirch

Université de Paris

Examineur



Except where otherwise noted, this is work licensed under
<https://creativecommons.org/licenses/by-nc-nd/3.0/fr/>

Table of contents

Abstract	6
Résumé	8
1. Introduction	10
1.1. Healthy immune response	11
1.1.1. Elements in innate immunity	11
Human FcγRs	13
Mouse FcγRs.....	17
1.1.2. Adaptive immunity.....	18
Two important features of adaptive immunity: specificity and memory	18
Cell-mediated adaptive immunity	21
Antibody-mediated immunity.....	24
1.2. Example of an immune system out of balance - allergy	32
1.2.1. Clinical features of allergic diseases	32
Allergy diagnosis	33
Allergens composition and example of allergic disease.....	36
Current allergy treatments and their limitations	40
1.2.2. Immunopathogenesis of allergic disorders	48
Allergen recognition.....	50
IgE receptors:.....	51
IgE.....	52
Regulation of serum IgE level by IgE receptors:	53
Generation of IgE memory.....	53
Alternative anaphylaxis pathway	55
2. Summary and objectives	57
3. Results	58
3.1. Part I Environmental, immunological and genetic parameters associated with total serum IgE concentration in healthy individuals	58
3.2. Part II – Characterizing the immune phenotype of allergic individuals.....	81
3.2.1 WASPenIP study.....	90
3.2.2 Wasp venom allergy mouse model:	114

3.3.	Part III IgG-FcγRs interspecies cross-binding	134
4.	Discussion:	149
4.1.	High total serum IgE, an indicator for individuals at-risk to develop an allergic condition?	151
4.2.	One allergic immune phenotype fits all?	154
4.3.	From antibody evolution to application.	159
5.	Perspective	167
6.	Reference.....	169
7.	Annex.....	191
7.1.	Platelets expressing IgG receptor FcγRIIA/CD32A determine the severity of experimental anaphylaxis.....	191
7.2.	Expression, Role, and Regulation of Neutrophil Fcγ Receptors	204

Tables in the Introduction and discussion

Table 1 Human FcγRs expression pattern.....	15
Table 2 Binding affinity of IgGs to FcγRs.....	16
Table 3 Mouse FcγR expression pattern.	17
Table 4 Number of HLA alleles Category.....	22
Table 5 Human IgGs properties..	27
Table 6 (a) Classification of systemic reactions to insect stings by Mueller, (b) classification of systemic reactions modified according to Ring and Messmer.....	37
Table 7 Biomarkers for the prognosis of inhaled allergen immunotherapy.....	47

Figures in the Introduction and discussion

Figure 1 Proposed model for the evolution of rat and mouse C γ genes	28
Figure 2 Possible interactions between the stromal reticulum, plasma cells, and eosinophils	30
Figure 3 Short algorithm for beta-lactam allergy diagnoses.	38
Figure 4 Summary of the four types of hypersensitivity reaction.....	48
Figure 5 Models of mast cell bound IgE binding to antigens.....	50
Figure 6 IgE receptors.	51
Figure 7 Modeled structure of the entire IgE molecule in different biological contexts..	52
Figure 8 The scheme of the Milieu Interieur Project.....	59
Figure 10 The different immunoglobulin classes evolved in various clades of vertebrates.....	160
Figure 11 Species tree generated with PhyloT.	161
Figure 12 Phylogenetic analyses of selected mammalian IgG and chicken IgY.	162
Figure 13 Phylogenetic analyses of human and mouse Fc γ R proteins.....	166

Abstract

The immune system consists of an innate and an adaptive branch that interact with each other to preserve body homeostasis and defend the organism against invading pathogens. This is partly achieved by the action of antibodies that can bind to antigen via their Fab portion and trigger effector functions with their Fc portion. Produced by cells of the adaptive immune system, antibodies enable cells of the innate immune system to react in an antigen-specific manner. Antibodies are mainly characterized in or generated from animal models that support particular infections, respond to particular antigens or allow the generation of hybridomas. Due to the availability of numerous transgenic mouse models and the ease of performing bioassays with human blood cells *in vitro*, most antibodies from species other than mice and humans are tested *in vitro* using human cells and/or *in vivo* using mice. In my thesis, I undertook a systematic approach to characterize interactions between IgG from different species and mouse and human IgG receptors (FcγRs) that will be a useful reference for the transition from one animal model to preclinical mouse models or human cell-based bioassays.

Non-infectious diseases can arise from an imbalanced immune homeostasis. Allergic conditions are one such example and are in general associated with a Th2-driven IgE-dependent physiopathology involving mast cells and basophils. More recently, the contribution of other cellular populations and antibody subclasses to allergic diseases was put forward. To systematically characterize the immune phenotype of allergic patients, we recruited a new cohort of patients severely allergic to wasp venom or amoxicillin. Using fresh blood samples, I analysed steady state and induced immune responses and compared them to healthy individuals. My preliminary data document a trend for elevated Th2 and Th17 cells in allergic individuals and fewer but more mature dendritic cells. They also illustrate a large inter-individual variability in terms of induced immune responses. To identify immunological, genetic and environmental factors that determine the concentration of total serum IgE in healthy individuals, I also explored available data of an extensively analysed cohort of age- and sex-stratified 1000 healthy donors (Milieu Intérieur). My analysis reveals that total serum IgE concentrations in

these donors are associated with age, sex, smoking habits, certain HLA alleles, FcεRI expression on basophils, and a particular profile of cytokines released in whole blood stimulation assays.

My thesis provides a basis for the in-depth characterization of the immune phenotype of severely allergic patients and contributes to a better understanding of the parameters that associate with serum IgE concentrations in healthy individuals. Additionally, my work draws a comprehensive map of the interactions between IgG from different species and mouse and human FcγRs that will help to anticipate FcγR-dependent effector functions when using IgGs from other species with human or mouse effector cells.

Keywords : Allergy; Immune phenotype; IgE; IgG; FcγRs; Interspecies cross-binding

Résumé

Le système immunitaire est constitué d'une branche innée et d'une branche adaptative qui interagissent ensemble et qui permettent de préserver l'homéostasie et de se défendre contre des agents pathogènes. Ceci dépend notamment de l'action d'anticorps, qui peuvent se lier à des antigènes via leur région Fab et activer des fonctions effectrices grâce à leur région Fc. Produits par les cellules du système immunitaire adaptatif, les anticorps permettent aux cellules du système immunitaire inné de répondre de manière spécifique à un antigène donné. Les anticorps sont principalement caractérisés et synthétisés en laboratoire, à partir de modèles animaux d'infections particulières, répondant à des antigènes d'intérêts, ou permettant la génération d'hybridomes.

Grâce au développement de nombreux modèles de souris transgéniques et de la facilité à effectuer des tests biologiques avec des cellules sanguines humaines *in vitro*, la plupart des anticorps d'espèces autres que murins et humains sont étudiés *in vitro* à partir de cellules humaines et / ou *in vivo* en utilisant des modèles murins. Au cours de ma thèse, j'ai entrepris une approche systématique afin de caractériser les interactions entre les IgG de différentes espèces et les récepteurs aux IgG (FcγR) murins et humains. Ce travail pourra à terme servir de référence pour le passage de modèles animaux à des modèles précliniques utilisant les souris, ou des bio-essais à partir de cellules humaines.

Des maladies non infectieuses peuvent être le résultat d'une homéostasie immunitaire déséquilibrée. Les allergies en sont un exemple, et sont généralement associées à physiopathologie orientée Th2, dépendante des IgE et faisant intervenir mastocytes et basophiles. Récemment, la contribution d'autres populations cellulaires et d'autres sous-classes d'anticorps a été mise en évidence lors de réactions allergiques. Dans le but de caractériser systématiquement le phénotype immun de patients allergiques, nous avons participé au recrutement d'une nouvelle cohorte de patients sévèrement allergiques au venin de guêpe ou à l'amoxicilline. À partir de prélèvements sanguins, j'ai analysé les

caractéristiques de leur état basal et lors de l'induction de réactions immunitaires, et les ai comparés à des donneurs contrôles sains.

Mes résultats préliminaires démontrent une tendance à l'augmentation des cellules Th2 et Th17 chez les patients allergiques et suggèrent une diminution de la taille de la population des cellules dendritiques, mais qui sont néanmoins plus matures. Ils illustrent également une grande variabilité interindividuelle lors de l'induction de réponses immunitaires. Pour identifier les facteurs immunologiques, génétiques et environnementaux qui déterminent la concentration d'IgE sériques totales chez des individus sains, j'ai également étudié les données disponibles d'une cohorte de 1000 donneurs sains stratifiés par âge et par sexe (Milieu Intérieur). Mon analyse révèle que les concentrations sériques totales d'IgE chez ces donneurs sont corrélés à des facteurs tels que l'âge, le sexe, le tabagisme, certains allèles HLA, l'intensité d'expression de Fc RI sur les basophiles et un profil particulier de cytokines libérées lors de tests de stimulation du sang total.

Ma thèse fournit ainsi une base pour la caractérisation approfondie du phénotype immunitaire des patients gravement allergiques et contribue à une meilleure compréhension des paramètres associés aux concentrations sériques d'IgE chez des individus sains. De plus, mon travail dresse une carte complète des interactions entre les IgG de différentes espèces et les FcγR murins et humains, qui aideront à terme à anticiper les fonctions effectrices dépendantes de FcγR lors de l'utilisation d'IgG d'autres espèces avec des cellules effectrices humaines ou murines.

Mots-clés : allergie ; phénotype immunitaire, IgE, IgG, FcγRs, interactions inter-espèces.

1. Introduction

The immune system maintains body homeostasis through many aspects; these include the surveillance and elimination of endogenous and exogenous factors, regulation of inflammation, as well as the repair of damaged tissues. One can distinguish two arms of the immune system that act through different mechanisms: the innate immunity and the adaptive immunity. The innate immunity includes physical and chemical barriers, cellular and humoral components, which non-specifically defend against pathogens. In contrast, the adaptive immune system can specifically recognize and clear pathogens through cell-mediated or/and antibody-mediated immune responses. In addition to its specificity, another essential feature of the adaptive immunity is the immunological memory, which allows a potent and effective recall response to already encountered pathogen.

In the introduction I will first introduce features and functions of a healthy immune response. While I will outline general mechanisms and important aspects of this immune response, it is however important to bear in mind that the exact expression and intensity of the immune response to challenges varies greatly from one individual to another. It is shaped by our genetics, our personal life history and environmental factors each individual is exposed to. In the second part I will give outline key concepts of an unbalanced immune response by introducing allergy as an example. As my main Ph.D. project focus on allergy, I will start from clinical features of allergic disease, then move to the immunopathogenesis of allergic reactions.

1.1. Healthy immune response

1.1.1. Elements in innate immunity

From an evolutionary point of view, the innate immune system is the ancestral branch of the immune system. Sometimes falsely regarded as “simple” or even “primitive”, the innate immune system defends the host against invading pathogens through rapid and well-defined mechanisms. Indeed, these were so successful and effective that the adaptive immune system made its appearance only in jawed vertebrates¹.

Innate immunity consists of physical and chemical barriers, cellular and humoral components that non-specifically defend the body against pathogens. Physical barriers include the skin and epithelial surfaces, which separate our body from the outside environment² Moreover, the dry skin surface avoids the attachment of microbiome, and mucus on the epithelium surface cooperates with cilia, which pushes the pathogen outside of the body³. Chemical barriers like gastric acid with low pH inhibit the growth of the pathogens (with *Helicobacter pylori* as an exception).

In vertebrates, a crucial function of innate immunity exerts through myeloid cells and innate lymphoid cells. Myeloid cells mostly develop in the bone marrow and derive from a common precursor cell the common myeloid progenitor, which gives rise to lineages of megakaryoblast and platelets, erythrocytes, mast cells, granulocytes and monocytes. Granulocytes include neutrophils, eosinophils and basophils. Monocytes can further differentiate into macrophages or dendritic cells in tissues or lymphoid organs.

Most myeloid cells express different receptors capable of sensing pathogens and for their recruitment to the local site during inflammation. Those receptors include pattern recognition receptors (PPRs) for sensing pathogen-associated molecular patterns (PAMPs) and damage-associated molecular patterns (DAMPs), chemokine receptors guiding the migration of myeloid cells in distinct stages, complement receptors serving as opsonins during the elimination of the pathogen⁴. Among those receptors, Fc

receptors (FcRs) that bind the Fc portion of antibodies stand out. FcRs equip cells of the innate immunity with the capacity to react in an antigen-specific manner and hence serve as a link between innate and adaptive immunity. There are different types of Fc receptors that bind to distinct antibody classes. For example, in humans Fc γ Rs bind IgG; Fc ϵ RI and Fc ϵ RII bind IgE, and Fc α / μ R binds both IgA and IgM. In my work I especially focused on Fc γ Rs that I will introduce in the following chapter in more detail.

Human FcγRs

In humans, there exist 6 classical FcγRs: 4 activating FcγRs: FcγRI (CD64), FcγRIIA (CD32A), FcγRIIC (CD32C), FcγRIIIA (CD16A); 1 inhibitory FcγR: FcγRIIB (CD32B); 1 FcγR without intracellular signalling motif, FcγRIIIB (CD16B). FcγRIIIB is a glycosylphosphatidylinositol (GPI) anchored protein, which also named human neutrophil antigen (HNAs), and mainly express on neutrophils^{5,6}.

FcγR encoding genes and polymorphism

All genes encoding human FcγRs are found on chromosome 1: FCGR1A, FCGR1B, and FCGR3C at the locus 1q21. The other genes encoding low affinity FcγRs cluster at 1q23^{7,8}. FcγRI is encoded by FCGR1A. FCGR1B and FCGR1C are pseudogenes⁹. The FCGR2A gene arose from gene duplication events, which occurred before primate divergence, explaining why gene homology analysis reveals that FCGR2A is unique to humans and primates^{10,11}. FCGR2A shows like FCGR3A a polymorphic variation that affect its affinity to IgG. The best-characterized polymorphism of FCGR2A is H131R (rs1801274), which decreased its binding affinity to IgG¹² and is associated with susceptibility to autoimmune disorders¹³⁻¹⁷. More recently, a splice variant of FCGR2A, FcγRIIA (exon6*), has been described^{18,19} that retains a cryptic exon in the cytoplasmic tail of the receptor. It results in a gain-of-function allele that increases neutrophil sensitivity to IgG stimulation²⁰. FCGR2C is the product of non-allelic homologous recombination between FCGR2A and FCGR2B, which is only present in human and chimpanzee genomes^{8,10,21}. 80% of individuals don't express this receptor, because of a polymorphism introducing a stop codon in its third exon (FcγR2C-Stop)^{22,23}. FCGR3A and FCGR3B are paralogous genes and they are orthologous to mouse Fcgr4. For FCGR3A a polymorphism is described inducing an amino acid change in position 176, F or V²⁴. FcγRIIIA-176V shows an increased binding affinity to most IgG subclasses, which translates into a better therapeutical response to monoclonal antibodies treatments^{25,26}. For FCGR3B, three variants have been described: NA1 (R₃₆ N₆₅ A₇₈ D₈₂ V₁₀₆), NA2 (S₃₆ S₆₅ A₇₈ N₈₂ I₁₀₆),

and SH (S₃₆ S₆₅ D₇₈ N₈₂ I₁₀₆)²⁷. Those variants don't result in detectable affinity difference to IgGs¹² for FcγRIIIB.

Human FcγR expression and downstream signaling

Each FcγR shows a unique expression pattern on the different immune cells, and thus contributes to immune responses in a specific fashion. As the only high affinity FcγR in humans, capable of binding monomeric IgG, FcγRI is constitutively expressed on monocytes, macrophages and DCs. There is also minor expression of FcγRI on neutrophils at steady state. Upon in vitro activation by interferon-γ (IFN-γ) or granulocyte colony-stimulating factor, the FcγRI expression can rapidly increase, up to 20 fold on neutrophils²⁸⁻³¹. In addition, it can be inducible expressed on mast cells³². FcγRIIA is the most abundantly expressed receptor and is present on all myeloid cells including platelets³³. FcγRIIB is highly expressed on B cells and basophils but poorly expressed on monocytes, neutrophils, macrophages and DCs^{34,35}. FcγRIIC is expressed by NK cells, monocytes, macrophage³³ in 20% of individuals. FcγRIIIA is expressed by NK cells, monocytes, macrophages and possibly at very low amounts by neutrophils³⁶. FcγRIIIB is mainly restricted to neutrophils. Table 1 summarizes the human FcγRs expression for each FcγR.

	FcγRI	FcγRIIA	FcγRIIB	FcγRIIC*	FcγRIIIA	FcγRIIIB
B cells	-	-	+	-	-	-
T cells	-	-	-	-	-	-
NK cells	-	-	-†	+	+	-
Monocytes/macrophages	+	+	+/-	+	+	-
Neutrophils	(+)	+	+/-	+	-	+
DCs	+	+	+	-	-	-
Basophils	-	+	+	-	-	+/-
Mast cells	(+)	+	-	-	-	-
Eosinophils	-	+	-	-	-	-
Platelets	-	+	-	-	-	-

Table 1 Human FcγRs expression pattern. +, indicates expression; -, no expression; +/-, very low percentages or rare subsets express the receptor; * In Fcgr2c-ORF persons; † Detectable and functional expression in nonconventional Fcgr2c-Stop persons. Adapted from³⁷.

Upon crosslinking by polymeric ligands, FcγRs transduce signals to the cytoplasm. Human FcγRIIA and FcγRIIC carry in the cytoplasmic portion their own immunoreceptor tyrosine-based activation motif (ITAM) enabling cell activation. The capacity of FcγRI and FcγRIIIA relies on their association with the accessory FcRγ chain carrying an ITAM. Human FcγRIIB negatively regulates the cell activation through immunoreceptor tyrosine-based inhibition motif (ITIM)³³. The exact function of FcγRIIIB as a GPI-anchored protein devoid of any signalling motif remains a matter of active debate³⁸. Its abundant expression on the neutrophil surface at steady state, and association with lipid rafts however suggests that it can contribute to cell activation via co-clustering with integrins and by helping FcγRIIA to efficiently capture immune complexes (ICs)^{28,39}.

Binding of human IgGs to human FcγRs

In humans four different IgG subclasses exist. The binding specificity and affinity of each human FcγR varies from one IgG subclass to another. Furthermore, most FcγRs display some polymorphic variations that affect its affinity to IgG. By convention and depending on their binding affinity for IgGs, human FcγRs are classified as high affinity and low affinity FcγRs. The only human high-affinity FcγR is FcγRI, which has an equilibrium association constant (KA) for human IgGs higher than 10^7 M^{-1} . The other FcγRs are low affinity FcγRs, with KA for human IgGs ranging from 10^4 to 10^7 M^{-1} ⁴⁰. High affinity FcγRs can bind and retain to human monomeric IgG, whereas the low affinity FcγRs can only retain IgGs when they are present in immune complexes (ICs) or when opsonizing a surface, which enables binding by avidity. Whether this differentiation is however relevant in vivo remains debated, because immune complexes can rapidly displace monomeric IgG from high-affinity FcγRs⁴⁰. Table 2 summarizes the binding affinity and specificity of FcγRs for human IgGs. Section 1.2.2 will further introduce human IgGs.

Subclasses	IgG1	IgG2	IgG3	IgG4
FcγRI	+++ ^a	-	++++	++
FcγRIIA H131	+++	++	++++	++
FcγRIIA R131	+++	+	++++	++
FcγRIIB/C	+	-	++	+
FcγRIIIA F176	++	-	++++	-
FcγRIIIA V176	+++	+	++++	++
FcγRIIIB	+++	-	++++	-
FcRn (at pH<6.5)	+++	+++	++/+++ ^b	+++

Table 2 Binding affinity of IgGs to FcγRs. ^a Multivalent binding to transfected cells; ^b Depend on allotype. Adapted from⁴¹

Mouse FcγRs

Mice express only four classical FcγRs^{5,42}. FcγRI, FcγRIII and FcγRIV are activating FcγRs and associate with the ITAM-carrying FcRγ subunit for cell activation. As in humans, mouse FcγRIIB contains an ITIM and is an important negative regulator of cell activation. Mouse FcγRI is largely restricted to monocyte-derived DCs, and possesses a high affinity for IgG2a, but low affinity to IgG2b⁴³ and IgG3⁴⁴. FcγRIIB and FcγRIII are expressed on all myeloid cells, but not on platelets. Moreover, FcγRIII also expressed by NK cells and NKT cells, whereas the inhibitory receptor is highly express by B cells. Both FcγRIIB and FcγRIII can bind mouse IgG1, IgG2a and IgG2b with low affinity. Compared to the other FcγRs, FcγRIV shows a restricted expression profile, being only present on macrophages, neutrophils and a subset of monocytes, where it binds IgG2a and IgG2b with high affinity³³. In opposition to human FcγRs, mouse FcγRIIB, FcγRIII and FcγRIV were reported to also bind IgE.^{43,45} Table 3 summarizes mouse FcγR expression.

	FcγRI	FcγRIIB	FcγRIII	FcγRIV
B cells	-	+	-	-
T cells	-	-	-	-
NK cells	-	-	+	-
Monocytes/macrophages	-	+	+	+
Neutrophils	-	+	+	+
DCs	+*	+	+	-
Basophils	-	+	+	-
Mast cells	-	+	+	-
Eosinophils	-	+	+	-
Platelets	-	-	-	-

Table 3 Mouse FcγR expression pattern. +, Indicates expression; -, no expression; +/-, very low percentages or rare subsets express the receptor; * monocyte-derived DCs. Adapted from³³.

1.1.2. Adaptive immunity

Two important features of adaptive immunity: specificity and memory

In the early 20th century, scientists had already been aware that the adaptive immune system functioned through two main components: the cellular component⁴⁶ and the humoral (antibody) component⁴⁷. However, it was not until the 1960s that the cellular players started to get characterized. In 1961, Miller described that thymectomies in neonatal mice lead to infection and a remarkable paucity of certain lymphocytes in peripheral immune organ⁴⁸. Based on this observation, he proposed that thymus may regulate the production of these lymphocytes especially in early life, and termed them accordingly T cells. In addition, specially selected lymphocytes leaving from thymus would migrate to other sites at about the time of birth. Only a few years later, these findings were complemented by Cooper, who reported that the removal of a specific organ (the bursa of Fabricius) in chickens lead to the suppression of immunoglobulin-producing cells, suggesting that these cells originate from this organ. He therefore named these cells B cells (for bursa) ⁴⁹. Together, those works identify and distinguish the two main populations of cells responsible for the cellular and humoral components of adaptive immunity.

These two lymphocyte populations share a critical feature of the adaptive immune response: i) they exert pathogen-specific recognition and ii) they can give rise to an immunological memory.

Pathogen-specific recognition is achieved through antigen receptors. These are unique receptors that are composed of different gene segments V (variable) D (diversity) J (joining). These gene segments exist in several variants in the genome and their random assembly (VDJ recombination) generates a first level of diversity. Additional diversity is created through the process of end joining, during which the enzymes contributing to

this process add nucleotides or delete parts of these regions. Finally, during an immune response, during which an expansion of a specific lymphocyte population is observed, a process termed somatic hypermutation edits already recombined antigen receptors thereby generating mutations of the receptor that may show increased binding to the target (affinity maturation). In this way a comparably small number of genes can generate a vast amount of antigen receptors with different specificities: B cell receptors (BCR or antibodies) can display up to $\sim 10^{10}$ specificities, and T cell receptors (TCR) up to $\sim 10^{12}$.

Another crucial feature for adaptive immunity is immunological memory, which relies on the formation of memory T and B cells after immune responses⁵⁰. Although the term “immunological memory” started to be widely used in the scientific literature only in the 1950s, the concept has been used in practice long time before⁵¹. One example is vaccination. At the end of the 18th century, Edward Jenner formalized the beneficial effects of immunization with cowpox to prevent smallpox infections. 80 years later, Louis Pasteur realized that injection of chickens with less virulent bacterial cultures could protect them from chicken cholera⁵². This observation revolutionized immunology and marked the beginning of fruitful period of Pasteur, during which he pursued vaccine studies against several infectious diseases: In 1881 he developed the vaccine against anthrax; in 1885, he tested his first human vaccine against rabies, which saved (or not) the life of a nine-year-old boy. Today vaccination is commonly used to protect against various infectious diseases, as well as for the prevention against certain types of infection-triggered cancers.

Traditionally, the concept of immunological memory is limited to T cells and B cells, and it is based on the survival and rapid response of cells that have undergone somatic recombination and clonal expansion. Recently, this paradigm has been expanded both in terms of cells capable or acquiring memory as well as in terms of its appearance during evolution. Immunological memory is no longer restricted to adaptive immune cells but is also recognized in innate immune cells like NK cells, monocytes, and macrophages. This was exemplified by the observation that mice deficient in T cells and B cells were

capable of responding more rapidly to hapten exposure after sensitization than without. This memory response was mediated by hapten-trained NK cells and could be transferred to naïve recipients through hapten-trained NK cells⁵³. Similar observations have been made for macrophages, which acquire memory through epigenetic programming⁵⁴.

Adaptive immune cells appeared during evolution in jawed vertebrates. Hence, immunological memory was believed to not exist in more ancient phyla. Recent studies however suggest that some sort of immunological memory may be at work independently of somatic recombination and clonal expansion. For example, immunological memory in *Drosophila* was reported to be achieved through RNA interference amplification and dissemination. During viral infections, *Drosophila* haemocytes are able to convert viral RNA to DNA, which induces the synthesis of virus-derived siRNA. Those siRNAs can then be loaded into exosome-like vesicles and transferred to naïve cells to exert anti-viral immunity⁵⁵. Bacteria and archaea protect themselves from phages through the now famous CRISPR (Clustered, regularly interspaced, short palindromic repeats)- Cas system. Once invaded, the DNA from phages was incorporated into CRISPR array, and then CRISPR array transcribed to generate CRISPR RNAs. Finally, CRISPR RNAs guide a Cas protein complex to cut the nucleic acids of the invader⁵⁶.

Cell-mediated adaptive immunity

T cells

T cells originate from bone marrow progenitors, which migrate into thymus for development⁵⁷. In the thymus, progenitor lymphocytes go through a series of developmental steps. Based on their surface expression of CD4 and CD8, developing T lymphocytes are named double negative (CD4⁻CD8⁻ T cells), double positive (CD4⁺CD8⁺ T cells), and single positive (CD4⁺ T cells or CD8⁺ T cells)⁵⁸. As double negative cells in the thymic cortex, they start to undergo VDJ recombination before migrating towards the medulla of the thymus. Double positive T cells are selected through positive and negative selection. In this process thymocytes have to interact via their TCR with its binding partner, the major histocompatibility complex (MHC), loaded with self-antigens on the thymic epithelium. During positive selection, a thymocyte bearing a TCR that does not bind to an MHC or bind too weakly will undergo apoptosis. On the other hand during negative selection, thymocytes that recognize self-peptide-MHC complexes are eliminated to avoid auto-immunity (central tolerance). After passing both selections, thymocytes expressing either CD8 or CD4 on their surface reach the medulla. Single positive cells then exit from the thymus to circulations as naive T cells⁵⁹.

Naïve T cells circulate through the blood stream and lymphoid tissue until they encounter MHC complex loaded with a peptide that they recognize, by which they become activated. In humans, the MHC is coded on chromosome 6p21 and is composed of 5 regions coding classes of human leukocyte antigen complex (HLA): extended class I, class I, class III, class II and extended class II. Many HLA gene products are components involved in the inflammatory response, antigen processing and presentation⁶⁰. HLA class I molecules, such as HLA-A, -B, -C, are expressed on all nucleated cells and are responsible for presenting peptides from intracellular pathogens to CD8⁺ T cells. HLA class II, such as HLA-DP, -DQ, -DR, are exclusively expressed by professional antigen presenting cells, notably dendritic cells, B cells, macrophages, and present peptides from extracellularly derived antigens to CD4⁺ T cells⁶¹. Importantly, HLA genes show a high

degree of polymorphism. There are 2110 alleles for HLA-A, -B, -C, and 954 alleles on HLA-DP, -DQ, -DR⁶⁰. Detailed numbers of HLA alleles are listed in Table 4. Although in each individual expresses only 6 HLA genes, with maximal 12 different alleles, such a gene pool results in a large number of possible variations and therefore heterogeneity in a population. This is important for the overall fitness, because any HLA gene comes with its own limitations and peptid preferences.

item under unauthorized distribution right

Table 4 Number of HLA alleles Category. This information was obtained from IMGT/HLA Database release 2.22. Bold letters show the HLA genes with classical functions. Reprinted from Shiina T. J. Hum. Genet. 2009⁶⁰.

In a primary immune response, naïve CD8 T cells are activated when they recognize their cognate antigen presented by MHC class I. Then the activated CD8⁺ T cells undergo clonal expansion reach to 10⁴-10⁶ clones in one week and differentiate into cytotoxic T cells (CTLs)⁶²⁻⁶⁴. CTLs not only have the capacity to quickly migrate between lymphoid organs and peripheral tissue, but also have enhanced killing function⁶⁵. CTLs kill target

cells through a contact-dependent mechanism⁶⁶. Upon recognition CTLs will release perforin and granzyme to target cells to induce cell death. Activation of naïve CD4⁺ T cells results in the differentiation of T helper (Th) cells. Th cells regulate and orchestrate the activity of the immune response mainly through the secretion of cytokines. Depending on the cytokines secretion profile; several types of Th cells can be distinguished: Th1 cells secrete IFN- γ and IL-2, which augment the immune response against the intracellular pathogen; Th2 cells mainly secrete IL-4, IL-5, IL-13 and participate in antibody-mediated immunity; Th17 cells secrete IL-17, IL-22, TNF- α to defend against extracellular bacteria. Of note, other types of T cells, like follicular helper T cells (T_{FH} cells), regulatory T cells (Tregs), as well as Gamma delta T cells ($\gamma\delta$ T cells) contribute to the cellular compartment of the adaptive immunity, but will not be introduced in this chapter.

The majority of effector T cells are short-lived. They die after the elimination of the pathogens. Whereas a small fraction of primed T cells enters into a memory phase, which provides long-term protection. Although further researches are still needed to clarify the molecular pathways which determine the effector and memory fate of the T cells, there is already some evidence suggesting that the transcriptional regulators expressed during the early stage of immune response may determine the entry into memory state⁶⁷. Memory T cells are a heterogeneous cell populations in terms of phenotype, function, and also the anatomic site they locate to⁶⁸. Memory T cells can be subdivided into distinct populations based on their phenotype: stem-cell memory T cells (T_{SCM}, CD45RA⁺CCR7⁺CD95⁺CD122⁺), central-memory T cells (T_{CM}, CD45RA⁻CCR7⁺), effector-memory T cells (T_{EM}, CD45RA⁻CCR7⁻), and terminal effector cells (T_{EMRA}, CD45RA⁺CCR7⁻)^{69,70}. Each of these memory subsets has distinct functions. T_{SCM} keeps the stem-cell properties among memory T cells with the least differentiation status; self-renew capacity and attribute to the other memory T cell subsets⁶². T_{CM} express the chemokine receptor CCR7 are prone to migrate to secondary lymphoid tissues to keep central memory. T_{EM} cells exert rapid effector functions and notably cytokine secretion upon reactivation. CD4⁺ T_{EM} and CD8⁺ T_{EM} have different cytokine secretion profile. CD4⁺ T_{EM} cells secrete high level of IL-4 and IL-5 and IFN- γ . CD8⁺ T_{EM} only secrete IFN- γ ⁷⁰. T_{EMRA} is a subset exhibiting “terminal effector” function⁷¹.

Antibody-mediated immunity

B cells

B cell development takes place in a primary lymphoid organ (fetal liver and bone marrow). Mature naïve B cells subsequently migrate towards secondary lymphoid organ (lymph node and spleen) for functional maturation. Naïve B cells circulate in the blood and lymphoid tissues until they get activated by antigen⁷². Depending on the type of antigen, the antibody-mediated (or humoral) immune response can be dependent on or independent of the help of T cells⁷³. For T-independent antigens, such as lipopolysaccharides (LPS), B cells elicit rapid antibody response upon activation⁷⁴. The majority of antigens, however, are T-dependent antigens, which means that such antigens require a presentation to T cells through MHC. Antigen presenting cells present peptides of these antigens in their MHC class II to specific CD4⁺ T cells. Those T cells then help B cells proliferate and differentiate^{75,76} through secretion of cytokines and direct B cell activating contact signals, such as CD40L expression. B cells can differentiate along distinct pathways. Upon recognition of an antigen via their BCR, a proportion of B cells differentiate into short-lived extrafollicular plasmablasts with the ability to rapidly produce antibodies^{73,77}. Another fraction of B cells migrate into B cell follicles where they undergo germinal center (GC) reaction⁷⁸.

In the GC, B cells vigorously proliferate, and their BCR undergoes somatic hypermutation (SHM), generating thereby new affinities and specificities. Spatially, GC can be divided into the light zone (LZ) and dark zone (DZ)⁷⁹⁻⁸¹. In the LZ B cells test their BCR affinity to antigens presented by follicular dendritic cells (FDC): B cells with low affinity BCR will undergo apoptosis; whereas high affinity BCR B cells will get sufficiently stimulated and receive survival signals from limited numbers of T_{FH} cells⁸². These B cells can then either migrate from LZ to DZ for another round of clonal expansion or stay in the LZ undergo class-switch recombination⁷⁸. During class-switch recombination, the C_μ gene (coding for the constant portion of the IgM heavy chain) is replaced by one of the downstream CH genes: C_γ1-4, C_α1-2, or C_ε. Class switch

recombination enables the production of the different classes of antibodies with distinct effector functions⁸³. Subsequentially, GC B cells differentiate into antibodies secreting cells to participate in humoral immunity.

Human immunoglobulins

There are five classes of human immunoglobulins (Ig): IgM, IgD, IgA, IgG and IgE^{84,85}. They are composed of two pairs of identical light and heavy chains, which are linked together by interchain disulphide bonds⁸⁶. The light chain consists of one N-terminal variable domain (VL) and one constant domain (CL). The heavy chain has one N-terminal variable domain (VH)⁴¹ with 3 (IgD, IgG, IgA) or 4 (IgM and IgE) constant domains. All immunoglobulin classes (with the exception of IgE) possess a hinge region between CH1 and CH2, which increases the flexibility of the molecule. The light chain together with the VH and CH1 of the heavy chain forms the antibody-binding fragment (Fab). Other parts of the heavy chain and the lower hinge region form the fragment crystalline (Fc). The antibody binds to antigen through their variable region⁸⁷. Their Fc part can trigger effector function by binding to Fc receptors expressed on or inside the cells or complement components.

Immunoglobulins are glycoproteins, which are composed of 82%-96% protein and 4%-18% of carbohydrate. These carbohydrate structures are critical determinants for their biological activity. Immunoglobulins exert their function through different mechanisms, such as antibody-dependent cell-mediated cytotoxicity (ADCC), antibody-dependent cellular phagocytosis (ADCP), or complement-dependent cytotoxicity (CDC).

Among the five Ig classes, IgG is the most abundant in the blood, the concentration goes up to 10-15 mg/mL⁸⁸. In humans, IgG can further subdivide into four subclasses IgG1, IgG2, IgG3, and IgG4⁸⁹.

Human IgG subclasses

Among all IgGs, IgG1 is the most abundant IgG subclass in circulation. IgG1 is capable of binding to all of the IgG receptors and can induce ADCC, ADCP and CDC⁴¹. Of note, IgG1 is

the most commonly used IgG subclass for the development of therapeutic antibodies. Until now, there are 55 IgG1 therapeutic antibodies approved in EU or US (www.antibodysociety.org/resources/approved-antibodies/).

IgG2 are the dominant Ig class produced in response to bacterial capsular polysaccharide antigens⁹⁰. Compared with IgG1, IgG2 show a weaker binding to FcγRs. They can elicit monocyte-mediated ADCC and macrophage-mediated ADCC. Their hinge region is rigid when compared to IgG1, making it the most proteolytic cleavage resistant IgG subclass⁸⁷. Until today, there are 10 approved IgG2 therapeutic antibodies (www.antibodysociety.org/resources/approved-antibodies/) that target mainly autoimmune diseases and metabolism disorders.

IgG3 shows potent binding to all FcγRs and is also a strong inducer of the complement system. However, their effector functions are limited by their short half-life, which is only 7 days (as compared to an average of 21 days for IgG1) and due to the presence of an arginine at position 435 instead of a histidine, which is found in all other IgG subclasses. This amino acid change reduces IgG3 interactions with the receptor for antibody recycling named neonatal Fc receptor (FcRn)⁹¹. Additionally, IgG3 has a long hinge region containing up to 11 disulfide bridges in its core region, which makes it susceptible to proteolytic cleavage⁹¹.

IgG4 is mainly produced during long-term antigen exposure. It generally presents a minor component of the Ig pool in the circulation (around 0,5 g/L). IgG4 is a poor inducer of Fc-dependent and independent Ig effector functions. In vivo, IgG4 can furthermore undergo Fab-arm exchange, thereby generating bi-specific, functional monovalent antibodies⁹². As a consequence, this bi-specific IgG4 show a diminished capacity to form immune complexes (IC) that require cross-linking of antigens. Together, this endows IgG4 with a possible anti-inflammatory role. The main characteristics of human Ig subclasses are summarized in Table 5.



Subclasses	IgG1	IgG2	IgG3	IgG4
Structure				
General				
Molecular mass (kD)	146	146	170	146
Amino acid in hinge region	15	12	62 ^a	12
Inter-heavy chain disulfide bonds	2	4 ^b	11 ^a	2
Mean adult serum level (g/l)	6.98	3.8	0.51	0.56
Relative abundance (%)	60	32	4	4
Half-life (days)	21	21	7/21 ^a	21
Placental transfer	++++	++	++/++++ ^a	+++
Antibody response to:				
Proteins	++	+/-	++	++ ^c
Polysaccharides	+	+++	+/-	+/-
Allergens	+	-	-	++
Complement activation				
C1q binding	++	+	+++	-

Table 5 Human IgGs properties. ^a Depending on the allotype; ^b for A/A isomer; ^c After repeated encounters with protein antigens, often allergens. Adapted from⁹³.

Mouse IgGs

Similar to humans, there exist 4 IgG subclasses in mice: IgG1, IgG2a/c, IgG2b and IgG3⁹⁴⁻⁹⁶. Whether a mouse expresses IgG2c (C57BL/6, NOD, SJL) or IgG2a (Balb/c and many other strains) depends on the strain^{96,97}. IgG subclasses expression is influenced by many factors, such as cytokine profile and the nature of antigen. Th1 cytokines and protein antigen elicit T cell-dependent antibody production of IgG2a, IgG2b and IgG3. Th2 cytokines induce the expression of IgG1>>IgG2a⁹⁸. Carbohydrate antigen elicits T-independent immune responses favoring the production of IgG3.

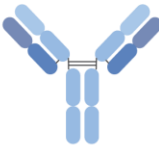
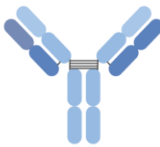
Rat IgGs

In rat, there are also four IgG subclasses: IgG1⁹⁹, IgG2a^{100,101}, IgG2b^{100,101}, IgG2c¹⁰². It has been proposed that rat and mouse C γ gene probably evolved from a common set of ancestral genes: the rat γ 2c gene shows homology to mouse γ 3; the rat γ 2a/ γ 1 pair to mouse γ 1; and the rat γ 2b is homologous to mouse γ 2a/2b. Functionally, all of the rat IgGs can bind to complement component C1q, with rat IgG2b being the most effective and rat IgG2c showing reduced activity^{103–105}.

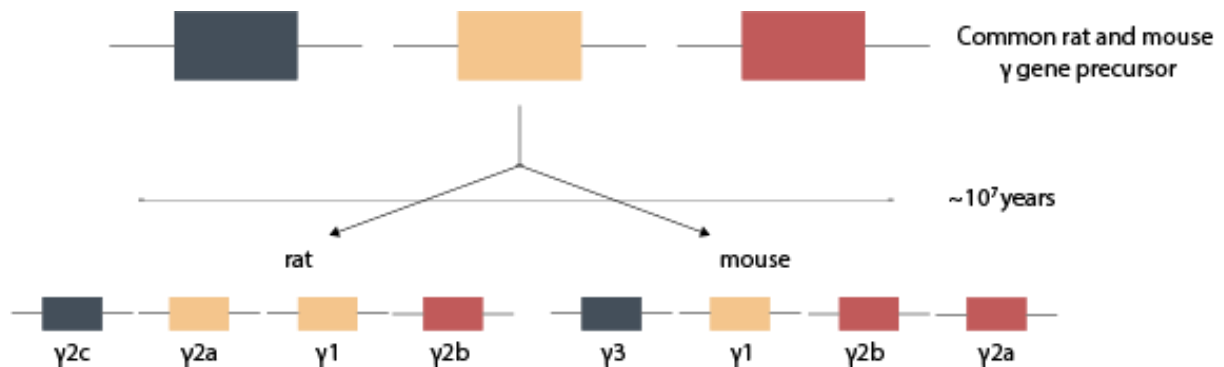

Figure 1 Proposed model for the evolution of rat and mouse C γ genes. Adapted from¹⁰³.

IgG-Fc γ Rs interspecies cross-binding

Antibody and Fc receptor interactions play a critical role in the immune response. Since the late 1980s this potential is being harnessed by the development of antibody-based therapeutics. Indeed, there are today over 500 monoclonal antibodies licensed for use in humans. Before their approval, these therapeutic antibodies have to go through vigorous pre-clinical and clinical validations. Preclinical studies are often done in animal models, and most frequently those are mouse models. Although humans and mice share some similarities in IgG and Fc γ Rs, their difference in genetics, affinity, expression, endogenous IgG and polymorphic variations largely affect biological functions. In order to anticipate therapeutic success of antibodies tested and developed in animal models, a precise understanding of binding capacity between human and mouse Fc γ Rs and IgGs from various species is therefore of critical importance.

Memory B cells

In adaptive immunity, B cell memory plays a critical role in humoral immune response. As previously mentioned, many memory B cells are produced during GC reactions. One hypothesis proposes that the BCR affinity and antigen avidity determine the fate of B cells in GC reaction: GC B cells with low-affinity BCRs differentiate into memory B cells; those with high-affinity BCR differentiate into plasma cells and the intermediate-affinity ones re-enter the GC reaction¹⁰⁶. Besides, B cells with high-affinity BCR would get more potent T cell help through CD40 signaling, when this help presented over prolonged periods of time, B cells differentiate into plasma cells¹⁰⁷. In the re-activation phase, memory B cells differentiate into plasma cells or re-enter GC. Although it is still debated how the memory fate decision is made, it is plausible to think that it may depend on the location of the memory B cell and/or the Ig isotype it expresses. Memory B cells with Ig switched isotype may thus directly differentiate into plasma cells, whereas memory B cells with an IgM isotype would re-enter GC, where they undergo affinity maturation and further differentiate into memory B cells or plasma cells¹⁰⁸⁻¹¹⁰. However, this view was challenged by the observation that IgM memory B cells appeared to have much less GC forming capacity than Ig switched memory B cells that rapidly re-form GCs upon antigen re-exposure, leading to further diversification of their BCRs¹¹¹. Furthermore, in malaria rechallenge, IgM memory B cells were reported to directly differentiate into plasma cells enabling them to rapidly secrete antibodies¹¹².

Plasma cells

Antibody-secreting cells mark the terminal stage in B cell differentiation, which includes plasmablasts and plasma cells. Plasmablasts are antibody-secreting cells with the capacity to divide and migrate. They can further differentiate into plasma cells. Plasma cells are terminally differentiated B cells with the ability to secrete large amounts of antibodies¹¹³. The current paradigm proposes that two populations of plasma cells existed: Short-lived plasma cells and long-lived plasma cells. Like memory B cells, long-lived plasma cells are another cell population that through their existence keep the memory of previous immunological challenges. The bone marrow provides niche for

plasma cells. It provides factors and ligands (including IL-5, IL-6, TNF- α , BAFF, APRIL, CXCL12) crucial for plasma cell survival¹¹⁴. It has been proposed that plasma cells, stromal cells and eosinophils engaged in a complicated interplay necessary for the survival of plasma cells (Figure 2): eosinophils and plasma cells attached to stromal cells through chemokines (CXCR4 to CXCL12) and adhesion molecules (VLA-4 to VCAM-1); components of the extracellular matrix, like hyaluronic acid and fibronectin, are also involved in these interactions; the interaction between CD28 and CD80 promotes plasma cells survival; plasma cells secrete Ig that binds to eosinophils and stimulates their production of cytokines like IL-1 and TGF- β . These cytokines in turn induce stromal cells to secrete IL-6 and CXCL12 required for the survival of plasma cells, and IL-5 and GM-CSF for the maturation of eosinophils¹¹⁴.

item under unauthorized distribution right

Figure 2 Possible interactions between the stromal reticulum, plasma cells, and eosinophils. Reprinted from¹¹⁴.

Although the majority of long-lived plasma cells were found in the bone marrow, other organs or tissues may also provide a niche for their survival. Indeed, intestinal stromal cells expressed adhesion molecules like VCAM-1 and ICAM-1 and some cells in intestinal mucosa (monocytes, macrophages, dendritic cells and also regulatory T cells) express abundantly APRIL, the proliferation-inducing ligand¹¹⁵, suggesting that the intestine could also serve as an survival niche for long-lived plasma cells. Furthermore, certain

disease conditions may promote plasma cell survival outside the bone marrow. This has for example been suggested for multiple sclerosis patients, in which the presence of non-proliferating plasma cells in the central nervous system (CNS) was observed¹¹⁶, or in spleen biopsies of patients with primary warm autoimmune hemolytic and treated with rituximab¹¹⁷. More studies are however needed to clarify the presence of plasma cell survival niches outside of bone marrow in healthy and pathological conditions.

1.2. Example of an immune system out of balance - allergy

1.2.1. Clinical features of allergic diseases

Allergic diseases regroup a rather large spectrum of afflictions, including allergic asthma, rhinitis and conjunctivitis, as well as atopic dermatitis, and hypersensitivity towards food, drugs, insect stings and others. Common to all allergic conditions is the overreaction of the immune system to a generally harmless trigger. The prevalence of allergic diseases is rising dramatically worldwide in both developed and developing countries. Allergies are now the most common chronic afflictions in Europe and affect up to 20% of the population¹¹⁸. The European Academy of Allergology and Clinical Immunology (EAACI) defines allergy as “a hypersensitivity reaction initiated by specific immunologic mechanisms.”¹¹⁹ The term hypersensitivity is used to describe: “Objectively reproducible symptoms or signs initiated by exposure to a defined stimulus at a dose tolerated by normal person”¹¹⁹.

Antigens at the origin of allergic diseases are termed allergens. Depending on the route of exposure to an allergen, allergic patients will develop local symptoms: inhaled allergens composed of pollen, fungi, animal products (from mammalian and arthropod), dust and other small particles are likely to induce coughing, wheezing and shortness of breath; ingested allergens like food or drugs, rather provoke swelling of the tongue (Quincke’s edema), vomiting, and diarrhea. There exist also contact allergens (nickel, chemicals/drugs applied topically) that often induce dysesthesia, pruritus, or purpura on the exposed skin. In the case of drugs, venom or saliva of insects the allergens may be injected and frequently trigger pruritus or erythema. In rare cases, allergies can be overwhelming and evolve from locally restricted reactions to systemic manifestations that can be life threatening. This is the case for anaphylaxis. “Anaphylaxis is a severe, life-threatening generalized or systemic hypersensitivity reaction.”¹¹⁹ In Europe, 0.3% of the population will experience anaphylaxis throughout their lives¹²⁰. In the US, the prevalence of anaphylaxis is even reported to be 5.1%¹²⁰. Food, drugs, and hymenoptera venom are the most common triggers of the anaphylaxis¹²⁰.

Allergy diagnosis

Overview

The diagnosis of allergic diseases always starts with a careful patient history and physical examination. When an allergic disorder is suspected, a series of tests can be conducted to confirm the presence of hallmarks of allergic physiopathology. Those tests include allergen-specific IgE assay, basophil activation assay, skin tests, and in some circumstances even challenge tests. Additional criteria listed in box I further apply in the special case of anaphylaxis:

Anaphylaxis is highly likely if any one of the following three conditions is satisfied.

1. Acute onset of illness with:

Mucocutaneous involvement (pruritus, flushing, urticaria, angioedema) and one of the following:

A. Respiratory complications (wheezing, stridor, hypoxemia/cyanosis)

B. Hypotension^a or end-organ damage (encephalopathy, kidney injury, etc.)

2. Two or more of the following occurring rapidly after exposure to known or likely allergen:

- Mucocutaneous involvement (pruritus, flushing, urticaria, angioedema)
- Respiratory complications (wheezing, stridor, hypoxemia/cyanosis)
- Hypotension^a or evidence of end organ hypoperfusion (encephalopathy, kidney injury, etc.)
- Persistent gastrointestinal symptoms (pain, nausea, vomiting)

3. Reduced BP soon after exposure to a known allergen.

^a Hypotension in adults is regarded as systolic BP of <90 mm Hg or greater than a 30% decrease in systolic BP from the patient's baseline. Hypotension in infants and children: systolic BP < 70 mm Hg (1 - 12 months); <(70 mm Hg + [2x age]) (1 - 10 years); <90 mm Hg (11-17 years); or >30% decrease in systolic BP.

Box I: Adapted from¹²¹.

Allergen-specific IgE assay

Allergen-specific IgE is generally considered to be a necessity for the occurrence of most allergies. Its clinical detection is based on the incubation of patients' samples, generally serum, with allergens coupled to a solid phase, with subsequent specific detection and quantification.

Basophil activation test

Basophils are besides mast cells the prototype of allergic effector cells. Whereas mast cells are tissue resident cells and hence difficult to obtain, basophils can be directly tested in fresh blood samples of patients. Both cell types express high-affinity IgE receptors (FcεRI) that capture circulating IgE enabling them to instantaneously react upon exposure to allergens. In contrast to the allergen-specific IgE assay, the basophil activation test (BAT) is a functional assay, which evaluates the response of basophils to exposure with allergen. The principle of BAT is based on the detection of basophil activation markers, such as CD63, CD203c, CD13, and CD69 by flow cytometry. There is little consensus about gold standard conditions in which BATs should be executed and as a consequence many clinical laboratories have established their own protocol and criteria. Variations include use of whole blood or isolated peripheral blood mononuclear cells (PBMCs), allergen concentrations tested, activation markers evaluated, addition of IL-3 for basophil priming, and the formula to quantify BAT positivity. The sensitivity of BAT varies from 55% to 97.6% depending on the allergen type¹²².

Skin test

Skin tests are the most widely used functional *in vivo* tests in allergy diagnosis. In analogy to the BAT that test IgE-loaded basophils, skin tests directly monitor the response of resident mast cells. Upon challenge with the allergen, cross-linking of allergen-specific IgE-loaded mast cells will degranulate and release mediators that induce local vasodilation and increased capillary permeability. As a consequence, wheal-

and-flare reactions appear within 15 min to 20 min upon challenge that can be quantified by the allergologist. There are two types of skin tests: epicutaneous and intracutaneous. The epicutaneous test is easy and rather safe to perform and causes little pain. The intracutaneous test is 100 to 1000 more sensitive than epicutaneous test and is more reproducible¹²³.

Provocation tests

Compare to all the tests mentioned above, allergen challenge tests might be of the biggest diagnostic use, but also bare the largest potentiel of causing adverse reactions¹²³. Provocation tests are based on the controlled introduction of the allergen through inhalation, application, injection and ingestion and can be done as bronchial challenges (especially in occupational asthma), nasal challenges for the diagnosis of allergic rhinitis, oral challenges for the food or drug allergy and also injections for drug or insect sting allergy. Due to the associated risk they need to be performed in appropriate supportive care units. Challenge tests are especially useful in the absence of all classical signs of IgE-driven allergies (specific IgE, positive BAT and skin test), in order to establish a diagnosis.

Allergens composition and example of allergic disease

As mentioned before, allergies can develop towards nearly every molecule the human body is exposed to. With the exception of drugs, most allergy-inducing substances are composed of different molecules that can alone or in combination trigger the reaction. In my thesis, I was particularly focused on allergies to wasp venom and the beta-lactam antibiotics amoxicillin that I will introduce in more detail below. The three major components in vespid/wasp venom are: VesV1, VesV2, and VesV5. VesV1 is a phospholipase A1, which participates in the hydrolysis of phosphatidylcholine. VesV2 is an enzyme hydrolyzing high molecular weight hyaluronic acid to derive smaller oligosaccharides. VesV5 is a member of the CAP (cysteine-rich secretory protein/antigen 5/pathogenesis related-1) family with unknown function¹²⁴. Penicillin belongs to beta-lactam antibiotic, which shares the common feature in their structure: the 3-carbon and 1-nitrogen ring (beta-lactam ring)¹²⁵. Penicillin group includes penicillin G, penicillin V, ampicillin, amoxicillin and methicillin. Their structural difference is based on R group on the acyl side chain¹²⁶. Like most of the drugs, penicillin is too small to be immunogenic; the allergic response to penicillin is against the complexes of penicillin products covalently bound to self-proteins. The penicillin allergen component derived from beta-lactam ring or a specific side chain R group. Upon administration, the beta-lactam ring opens and forms several breakdown products. Among those products, the major allergenic determinant is penicilloyl. In some cases, individuals do not react to beta-ring products but react to R-chain groups¹²⁷, which means they could be sensitized to amoxicillin without developing allergic reaction to penicillin G.

Hymenoptera venom allergy

Hymenoptera venom allergy includes any allergic reaction caused by the sting of Hymenoptera insects¹²⁸. 55%-95% of individuals are stung at least once by a hymenoptera species in their lifetime¹²⁹. The resulting reaction can range from local to systemic anaphylactic¹²⁴ with large local reactions and systemic anaphylactic reactions being the most frequent ones. A large local reaction is defined as a swelling exceeding a diameter of 10 cm and lasting for longer than 24 hours. The systemic anaphylactic reaction includes generalized skin symptoms such as flushing, urticaria, dizziness, dyspnea, and even cardiac or respiratory arrest. Systemic anaphylactic reactions are further classified in different grades of severity according to Mueller¹³⁰ and Ring and Messmer¹³¹.

item under unauthorized distribution right

Table 6 (a) Classification of systemic reactions to insect stings by Mueller, (b) classification of systemic reactions modified according to Ring and Messmer.

Diagnosis of hymenoptera sting allergy is based on information about the date of sting, the severity of the symptoms, the interval between sting and symptoms, ideally the insect itself in combination with the general allergic testing (epicutaneous or the intracutaneous test; allergen-specific IgE test; other in vitro tests like basophil activation test and leukotriene release test¹²⁴). Patients that experienced a severe reaction will be proposed to undergo venom immunotherapy, the only treatment able to reduce the severity of allergic reactions. This therapy is effective in 77%-84% of patients with allergies to honeybee venom, and 91%-96% of patients with wasp venom allergy¹³². Mechanisms of allergen specific immunotherapy will be further discussed in section 4.3.

Beta-Lactam drug allergy

Drugs are the most frequent trigger of anaphylaxis in adults¹³³. Among those drugs, beta-lactam antibiotics are the most common causative drugs. About 8% of individuals in the USA are reported to have a history of penicillin allergy¹³⁴. Depending on the time interval between drug administration and the onset of allergic reactions, drug allergic reactions can be classified as immediate, accelerated, and delayed¹³⁵. Typical symptoms for the immediate reaction include urticaria, angioedema, and even anaphylaxis. The diagnosis for beta-lactam drug allergy is difficult and includes skin testing, allergen-specific IgE, drug provocation test, and BAT. It is however noteworthy that the BAT frequently returns a negative result. Furthermore, it is frequently observed that re-introduction of penicillin in individuals with reported penicillin allergy do not elicit allergic reactions. Due to the diagnostic difficulties the European Network for Drug Allergy and EAACI interest group on drug hypersensitivity recommended two diagnostic algorithms: the short algorithm and the long algorithm¹³⁶. The short algorithm is depicted in Figure 3.

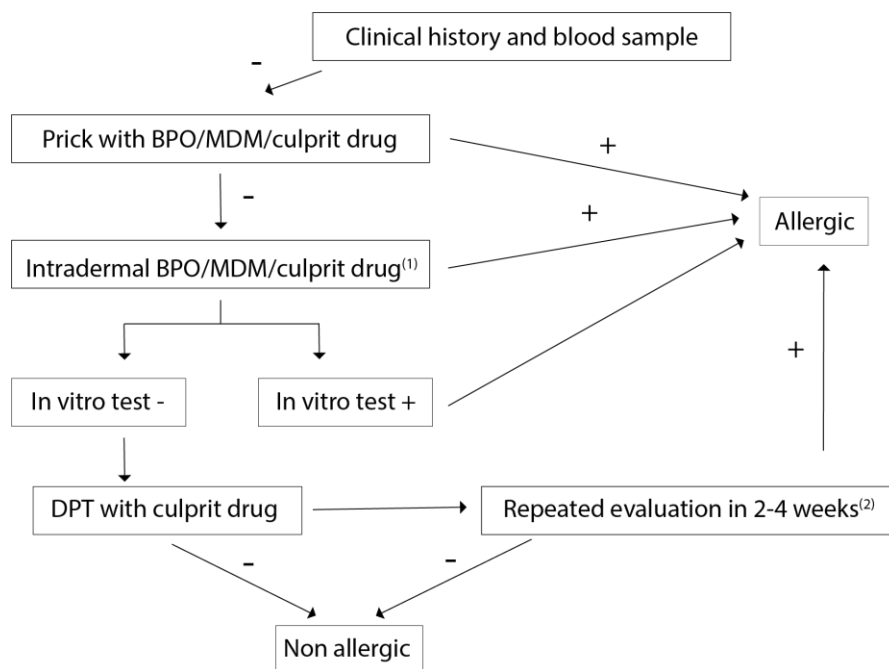

Figure 3 Short algorithm for beta-lactam allergy diagnoses. BPO: benzylpenicilloyl; MDM: minor determinants mixture; DPT: drug provocation test; (1) If chronology unknown for uncertain check for late reading; (2) If positive clinical history and long interval of the reaction. Adapted from¹³⁶.

Notably, patients allergic to beta-lactam may be sensitized to several antibiotics from the same family, while being tolerant to others. For those patients, it is not recommended to prohibit the whole group of beta-lactams but carefully evaluate reactivity to each molecule. Finally, for multi-sensitized patients there is the possibility to move to alternative antibiotic families, such as cephalosporins that show little cross-reactivity¹³⁷. For all the above-mentioned reasons, immunotherapy is usually not proposed to patients allergic to beta-lactams.

Current allergy treatments and their limitations

To limit the clinical signs associated with allergic diseases, there exist three major strategies: avoidance, control of symptoms by pharmacotherapy and allergen-specific immunotherapy (AIT). Without doubt the most effective way to prevent the occurrence of allergic reactions is to avoid any contact with allergen. Depending on the allergen, however, this strategy can be anything ranging from easily achieved to inapplicable in everyday life. Amoxicillin allergy is a good example for the first case. Amoxicillin is generally not required on a daily basis and additionally it can be rather easily replaced by an alternative drug of a different chemical class, when there is an indication for antibiotic therapy. On the contrary, it is close to impossible to avoid exposure to host dust mite-related allergens in daily life or pollen during flower season. Both types of allergens spread through the air in such quantities that they are present everywhere in the environment. In such cases, clinical signs of allergic diseases can be reduced by pharmacotherapy. Currently, there are several kinds of anti-allergy medicines on market: blockers or competitors of the most prominent allergic players, such receptor antagonists of histamine or platelet activating factor (PAF) receptors, anti-IgE monoclonal antibodies (mAbs), and mAbs interfering with IL-4/IL-13 signalling or the IL-5 pathway. Finally, in some cases of allergy (e.g. hymenoptera venom and some cases of food or pollen allergy), in which the causative allergen has been identified, AIT can be applied aiming to profoundly alter the immune response of the patients to an allergen. It can sustainably induce immune tolerance, allowing patients to re-expose themselves to their allergic trigger without any or only mild adverse reactions; sometime even years after cessation of AIT.

Pharmacotherapy to reduce symptoms associated with allergies

Bioactive mediators released from mast cells or basophils during allergic reactions are at the origin of various clinical signs associated to allergies. For example, mast cell-derived histamine binds to histamine 1 receptors (H1Rs) expressed by smooth muscle cells, endothelium and sensory nerves in the periphery, resulting in

bronchoconstriction, vasodilation and hyper-nociception. Therefore antihistamines (or better H1R antagonists) are widely used to control the symptoms of allergic disease. However, H1R are not only expressed in the periphery but also in the central nervous system and additionally to H1R three other histamine receptors exist that may be blocked concomitantly if the drugs used are not specific enough to only block H1R. This is the reason, why the first generation of antihistamines often caused side effects, including dizziness, blurred vision, nausea and vomiting. The second antihistamine drugs were designed to reduce their passage through the blood-brain barrier and thus somnolence as a side effect, undesired effects on the periphery however remain a matter of concern. Compared to the second generation, the third generation of antihistamines further reduced those side effects, and show for example no more cardiac toxicity¹³⁸.

Anti-IgE monoclonal antibodies (Omalizumab and Ligelizumab)

Because IgE plays a central role in allergic reactions, reducing the amount of IgE in an allergic individual became one of the lead strategies to reduce allergic symptoms. Omalizumab (Xolair®; Novartis) is a humanized IgG1, κ anti-IgE mAb, which binds to the heavy chain C ϵ 3 domain of free IgE, thus preventing its binding to Fc ϵ RI¹³⁹. It triggers the clearance of IgG-bound IgE, thereby leading to an immediate reduction of total IgE levels. Because Fc ϵ RI requires binding of IgE to be stabilized on the cell surface, Omalizumab treatment also reduces in the long run Fc ϵ RI-expression levels on mast cells and basophils¹⁴⁰ and hence mediator release and symptoms of allergic crises. This observation is in agreement with my observation that serum IgE concentrations positively correlate with basophil Fc ϵ RI expression. Omalizumab has been approved in 2003 for the treatment of severe allergic asthma and chronic idiopathic urticaria¹⁴¹.

The resolution of the crystal structure of the omalizumab-IgE complex revealed that omalizumab-Fab binds to the middle part of the IgE C ϵ 3 domain, its heavy chain interacts with a reagent proximal to the CD23 binding site and its light chain with a segment proximal to Fc ϵ RI binding sites¹⁴². This explains its capacity to only bind free IgE. On average Omalizumab is administered at a dose of 75-375 mg every 2-4 weeks in the case of asthma and at 150 mg or 300 mg every 4 weeks for urticaria. At a price of

541\$/150mg, the monthly cost of Omalizumab treatment therefore ranges between \$541-\$2706, which is a heavy economic burden.

Last year, a second generation high-affinity humanized monoclonal anti-IgE antibody named Ligelizumab has been tested in a phase 2b trial for chronic spontaneous urticaria¹⁴³. Compared to Omalizumab, patients needed 10 times lower doses of Ligelizumab to achieve the same effect on IgE reduction. It could therefore present an interesting alternative to Omaluzimab treatment.

Furthermore, Omaluzimab has been described to trigger adverse reactions and notably anaphylaxis in 0.1-0.2% fraction of patients^{144,145}. It also was reported to transiently increase basophil sensitivity¹⁴⁶. It is therefore recommended to be used only when IgE titers are lower than 500-700 IU/mL¹⁴⁷. Our laboratory has recently published a Fc-engineered Omalizumab which has the equivalent IgE blocking efficacy without inducing FcγR-dependent adverse effect¹⁴⁸. In extension, a similar approach could be applied to make Ligaluzimab safer.

Blockade of IL-4 and IL-13 signaling (Dupilumab)

IL-4 and IL-13 are critical cytokines involved in Th2 biased allergic reactions. They are predominantly secreted by Th2 cells, ILC2s and basophils and trigger class-switch reactions to IgE in antibodies secreting cells. In addition, they enhance the contractility of smooth muscles in the airways, mucus production and expression of inducible nitric oxide synthase in airway epithelial cell. Il-4 has furthermore been described to upregulate collagen and fibronectin synthesis in fibroblasts thus participating to tissue remodelling, which is hallmark of severe asthma¹⁴⁹. Besides IL-4 and IL-13, Th2 cells also produce large quantities of other cytokines, such as IL-5 and IL-9¹⁵⁰. IL-5 promotes eosinophil egress from the bone marrow in cooperation with eotaxin¹⁵¹. IL-9 attracts mast cells to tissues and promotes their growth ¹⁵². Together these cytokines are involved in many key aspect of the allergy pathology.

IL-4 and IL-13 exert their biological activity through binding to a heterodimeric receptor, composed of the IL-4 receptor α -subunit and the IL-13 receptor α 1-subunit (IL-4R α /IL-13R α 1)¹⁵³. IL-4 can additionally induce signal transduction through a receptor complex made of IL-4R α and the common gamma (γ C) chain, shared among many cytokine receptors. IL-13-driven cell activation can be counter-balanced through expression of the IL-13 receptor α 2 chain (IL-13R α 2), which does not contain an intracellular signalling domain and competes with the activating receptor¹⁵⁴. It follows that productive IL-4 and IL-13 signalling requires in all cases the IL-4R α , which makes it a prime target to contain exaggerated Th2-driven immune responses.

In 2017, the FDA has approved Dupilumab (Dupixent®), a human IgG4 anti-IL-4R α mAb¹⁴⁹ for the treatment of moderate-to-severe atopic dermatitis. Its application was since extended to moderate-to-severe asthma, and inadequately controlled chronic rhinosinusitis with nasal polyps in adults. The administration of Dupilumab significantly reduces Th2 associated cytokines, IgE levels and fractional exhaled NO (FE_{NO}) concentration (as a measure for the extent of eosinophilic inflammation) in asthma patients. However, it was also reported to transiently induce eosinophilia in a fraction of the patients¹⁴⁹. In addition, persistent anti-drug antibodies were also observed in Dupilumab-treated patients, limiting its effect and use¹⁵⁵. The list price for Dupilumab exceeds with \$3110 per month of treatment the costs of Omalizumab treatment.

Anti-IL-5/ anti-IL-5R monoclonal antibodies (Mepolizumab, Reslizumab, and Benralizumab)

As mentioned above, IL-5 plays an essential role in eosinophil production and survival, which made IL-5 and its receptor an attractive therapeutic target in allergic disease. IL-5, IL-3 and GM-CSF belong to the β common chain (β c) cytokine family. They all bind to a heterodimeric receptor consisting of the β c and a cytokine specific α chain¹⁵⁶. Unlike IL-3 and GM-CSF, IL-5 is a homodimeric cytokine. It first binds to the IL-5R α chain in its homodimeric form and then this tertiary complex associates with the β c subunit. In

addition to Th2 cells and ILC2s, IL-5 can be secreted by eosinophils as an autocrine growth factor or by mast cells. The IL-5 receptor is highly expressed on eosinophils and their precursors, as well as on neutrophils and basophils in humans.

Eosinophil infiltration is one of the often-cited hallmarks of several allergic diseases and notably asthma. In some asthma patients, eosinophil infiltration of the airways results in reduced responses to bronchodilator therapy and inhaled corticosteroids. Two anti-IL-5 and one anti-IL-5R mAbs are available for the treatment of eosinophilic asthma.

Mepolizumab is a humanized IgG1 anti-IL-5 monoclonal antibody¹⁵⁷. The administration of Mepolizumab to severe eosinophilic asthma patients significantly reduces asthma exacerbations and markedly decreases blood eosinophil numbers. No anti-drug antibodies were described. Reslizumab is another anti-IL-5 mAb, it comes in the format of a human IgG4. A recent study shows Reslizumab has higher binding affinity for IL-5 and a greater IL-5 inhibition potency in vitro than Mepolizumab¹⁵⁸.

Benralizumab is an anti-IL-5R α mAb, which entered the market in 2017. The administration of Benralizumab decreases the blood eosinophil numbers in patients with baseline blood eosinophils > 300 cells per μL ¹⁵⁹ and reduces the annual number of asthma exacerbations. However, compared to Mepolizumab and Reslizumab, Benralizumab shows a high rate of adverse reactions with around 10% of patients experiencing serious adverse events during treatment¹⁶⁰.

Allergen specific immunotherapy

Allergen specific immunotherapy (AIT) has been used for around 100 years¹⁶¹. Its application has been approved for respiratory allergies, venom hypersensitivity as well as more recently for food allergy¹⁶². The concept of AIT is to “desensitize” the immune system by gradually increasing the allergen exposure until reaching a maintenance dose, which is often comparable to the dose of exposure to the allergen upon a natural

encounter. In comparison to drugs that control allergic symptoms or mAbs, patients receiving AIT generally show long-term remission of symptoms after discontinuation. This is due to the profound modulation of the immune system that is induced by AIT. Generally, AIT consists of two phases: a build-up phase and a maintenance phase¹⁶³. Depending on the protocol, the build-up phase can last between days and months. For example, in ultra-rush venom immunotherapy (VIT), the build-up phase is performed in a single day with repeated incremental injections, whereas in the conventional protocol, this phase lasts for four months with injections at defined intervals. After reaching the maintenance dose, AIT enters a maintenance phase, which generally lasts for 3 to 5 years. AIT administration can be done subcutaneously, sublingually, or orally^{132,164,165}. Subcutaneous injections and oral immunotherapy during build-up stage require specialized clinical settings as severe adverse reactions can occur in rare cases that require immediate medical assistance. Sublingual immunotherapy is considered to be sufficiently safe to be self-administered by the patient at home.

AIT re-establishes tolerance towards a given antigen or sometime even group of antigens. It acts through different immune pathways that show considerable variations between patients and as a function of the protocol employed. AIT was reported to reduce Th2 cell and ILC2 numbers, and with them the production of IL-4 and IL-13¹⁶⁶. AIT was also described to induce both T and B regulatory cells and thus to increase secretion of IL-10^{167,168}. B regulatory cells display an immunoregulatory receptor profile, with the expression of CD25, PD-L1, SOCS3¹⁶⁸. Antibody responses are also modified during AIT, notably an increase of allergen-specific IgG4 can be observed, that is considered to compete with IgE for allergen binding and to “neutralize” the antigen due to its poor capacity to induce Fc-dependent effector functions¹⁶⁹⁻¹⁷². In the build-up phase of AIT, there is often a transient increase of allergen-specific IgE to be observed that gradually decreases during AIT¹⁷³⁻¹⁷⁵, but does not necessarily go back to baseline levels. AIT was finally reported to decrease mast cells and basophils degranulation^{176,177}, as well as eosinophil infiltration to sites of allergic inflammation¹⁷⁸.

Compared to therapeutic mAbs, AIT has a low cost and together with its long-lasting

beneficial effects could be considered the treatment of choice for all allergic diseases, but in practice the use of AIT is limited for several reasons: Firstly, a complete cycle of AIT lasts years, which can be as such a reason for some patients not to initiate the treatment or for discontinuation. Adherence, however, notably to VIT is high¹³², which might be due to the patients' fear of reliving a severe allergic reaction if left untreated, or the perspective of suffering life-long from allergic rhinitis. Secondly, the causative allergen for a given allergy needs to be identified and available as a high-quality, standardized allergen extract or recombinant protein needed for AIT. Together these factors limit the actual application of AIT. Finally, an important disadvantage of AIT lies in that fact that there exist no validated biomarkers that could inform on the success of the therapy. As a consequence patients treated with AIT often continue to live as if they were still allergic. Also there are no markers defined that allow to estimate the chances of a successful AIT for a given patient. Several biological parameters, including cell populations or antibodies response have been reported to be different before and after AIT and could be candidates for such "prediction" or "AIT success markers" in inhaled allergen immunotherapy. They are summarized in Table 7¹⁷⁹.

Domains	Biomarkers
Antibodies	IgE (serum IgE, total IgE, serum IgE/ total IgE)
	serum IgG4
	IgA
Serum Inhibitory activity for IgE	IgE-FAB
	ELIFAB
Basophil activation	CD63
	CD203c
	Diamine oxidase
	Basophil histamine release
Cytokines and chemokines	Th2: IL-4, IL-13, IL-9, IL-17, eotaxin, TNF- α
	Th1: IFN- γ , IL-12
	Regulatory: IL-10, TGF- β
Cellular biomarkers	Treg cells
	Breg cells
	DCs
In vivo biomarkers	Allergen provocation tests
	Chamber studies

Table 7 Biomarkers for the prognosis of inhaled allergen immunotherapy. Adapted from¹⁷⁹.

1.2.2. Immunopathogenesis of allergic disorders

In an attempt to clarify the immunopathologic mechanism of hypersensitivity, Gell and Coombs classified the reactions into four different groups: Type I (immediate or anaphylactic), Type II (cytotoxic, or cytolytic), Type III (antigen-antibody complex), and Type IV (delayed or cell-mediated)¹⁸⁰. During hypersensitivity reactions only one or several reaction types can be at play at the same time. For example, the major reaction in the immediate phase of penicillin allergy is Type I, and the Type IV pattern participates in the late phase reaction¹²³.

item under unauthorized distribution right

Figure 4 Summary of the four types of hypersensitivity reaction. Type I: mast cells or basophils (not shown) bind to IgE through FcεRI. Surface-bound IgE is cross-linked by allergen, which leads to the activation of mast cells or basophils. Activated cells release mediators. Type II: Antibodies directly bind antigen on target cells, which leads to CDC or cytotoxicity by killer cells. Type III: Immune complexes are deposited in the tissue, and induce complement activation, attract polymorphonuclear cells causing local damage. Type IV: Antigen-specific T cells release cytokines, which attract and activate macrophages leading to the damage. Reprinted from google: <https://clinicalgate.com/immediate-hypersensitivity-type-i/>

Classically, the allergic reaction considered to be Type I reaction, which is an IgE-dependent Th2-biased immune reaction. Upon first exposure to an allergen, antigen-presenting cells process and present allergen peptides through MHC class II to CD4⁺ T cells. Antigen recognition and epithelium derived cytokines IL-25, IL-33 and thymic

stromal lymphopoietin (TSLP) induce CD4⁺ T cell activation^{181,182}. Activated T cells get expanded, secrete type 2 cytokines, upregulate chemokine receptors and integrins to migrate to the inflammatory site. The type 2 cytokines promote eosinophil maturation and survival, participate in airway hyperresponsiveness, as well as induce B cell isotype switching to IgE¹⁸³. During this process, T_{FH} closely cooperate with Th2 cells to favor IgE production¹⁸⁴. Apart from Th2 cells and T_{FH}, another type of T cells, type2 innate lymphoid cells (ILC2) also participate. ILC2 develop from common lymphoid progenitors. Although they lack antigen specific receptors, ILC2 could also respond to certain cytokine stimulations (IL-25, IL-33 and TSLP) and secrete type 2 cytokines, which contribute to tissue eosinophilia and mucus production¹⁸⁵. One important negative regulator cell type in this process are Tregs, which secrete anti-inflammatory cytokines like IL-10 and TGF- β ¹⁸⁶.

The IgE further binds to IgE receptors expressed on mast cells in tissue or basophils in the circulation, thereby sensitizing them to the allergen recognized by that IgE. The initial sensitizing phase is “silent “and not associated with any clinical signs. Upon re-exposure to the same allergen, however, the allergen will cross-link the pre-bound IgE on target cells. As a consequence, target cells get activated and release biologically active mediators, such as preformed histamine, tryptase, chymase and proteoglycans, or newly formed lipid-derived mediators, such as PGD₂, LTB₄, LTC₄, LTD₄ and LTE₄. Those mediators lead to an increase in vascular permeability and mucus production, bronchoconstriction and vasodilation. It also attracts other immune cells to the inflammatory site¹⁸⁷. Moreover, a wide spectrum of cytokines and chemokines are subsequently produced, further attracting cells to the inflammatory site, including neutrophils and eosinophils, which sustain the inflammatory reaction.

In addition to the cells mentioned above, there is also other types of cells involved in this classical pathway, which will be discussed in section 4.1.

Allergen recognition

Recognition of allergens by specific antibodies can occur in different manners, depending on the abundance and structures of the recognized epitope: 1) allergens like polysaccharides often present several repeated epitopes sufficient to cluster IgE-bound FcεRI ; 2) very small molecules, such as haptens, have only one epitope are incapable of cross-link antibodies by themselves; 3) Some allergens may have several different epitopes with different binding specificity to antibodies; 4) for some allergens, the epitopes could be the mixture of the three conditions¹⁸⁸. In addition, the distance between epitope have an influence on the shape of the immune complex, thus this distance can determine the strength of effector cell activation¹⁸⁹.

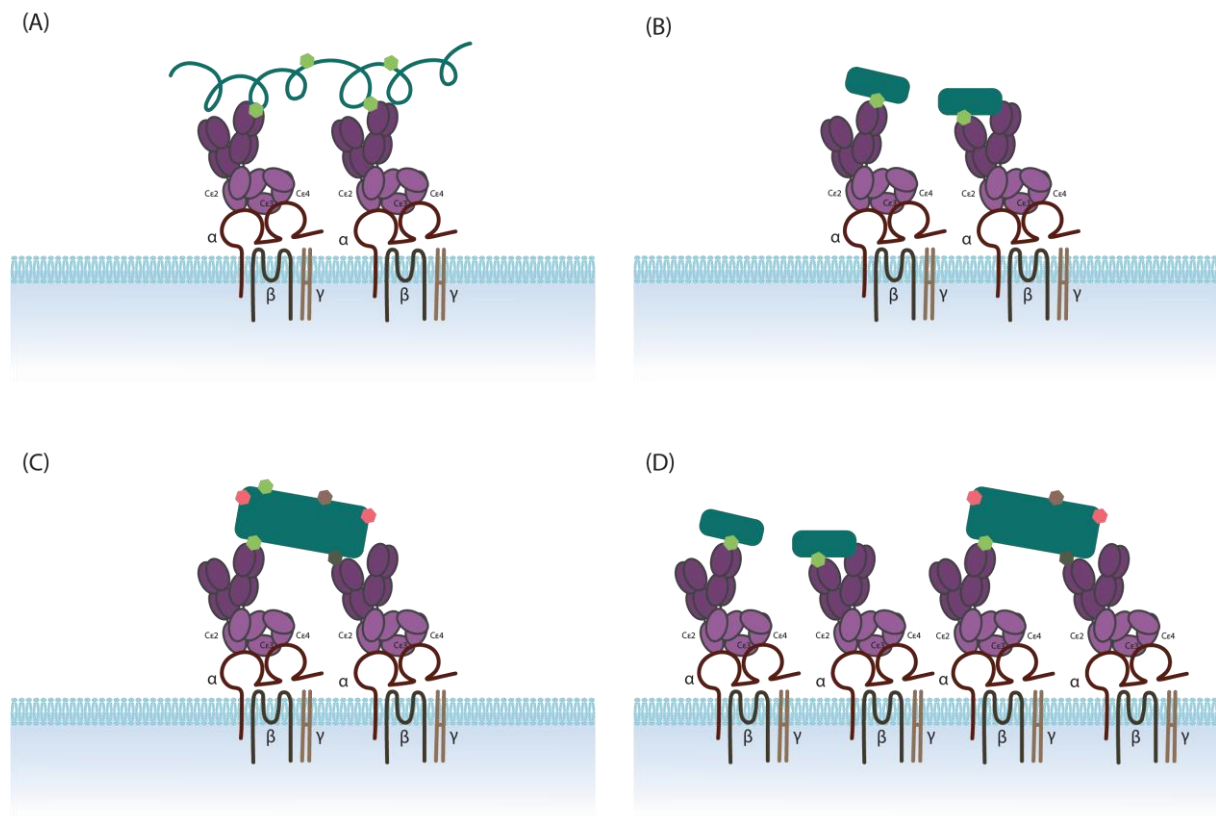

Figure 5 Models of mast cell bound IgE binding to antigens. Two IgE molecules on FcεRI receptors attached to a mast cell can bind to (A) a single antigen with multiple identical epitopes (B) an oligomeric antigen with identical epitopes on the subunits, (C) a single antigen with two different epitopes and (D) two different antigens with different epitopes. Adapted from¹⁸⁸. The structure of FcεRI will introduce in the following section.

IgE receptors:

In humans, two IgE receptors exist that bind IgE at the Cε3 domain in its Fc portion: the high affinity IgE receptor (FcεRI) and low affinity IgE receptor (FcεRII or CD23). FcεRI is expressed by mast cells and basophils in a tetrameric form, $\alpha\beta\gamma_2$, and on dendritic cells, monocytes and eosinophils in a trimeric form $\alpha\gamma_2$ ¹⁹⁰. Some reports also found FcεRI expressed on neutrophils from allergic individuals¹⁹¹. FcεRI is an activating receptor that transduces signal via the ITAM-containing associated common gamma chain.

CD23 has a broader expression profile and is present on B cells, follicular dendritic cells, monocytes, macrophages, eosinophils, neutrophils and intestinal epithelium. Unlike the classical Fc receptor FcεRI, CD23 belongs to the C-type lectin superfamily. Its extracellular domain contains a trimeric alpha-helical coiled-coil “head”, which is connected to a “stalk” region. N-terminal of CD23 is intracellular, with two isoforms, CD23a and CD23b. CD23a is constitutively expressed, whereas CD23b is inducibly expressed in response to IL-4.

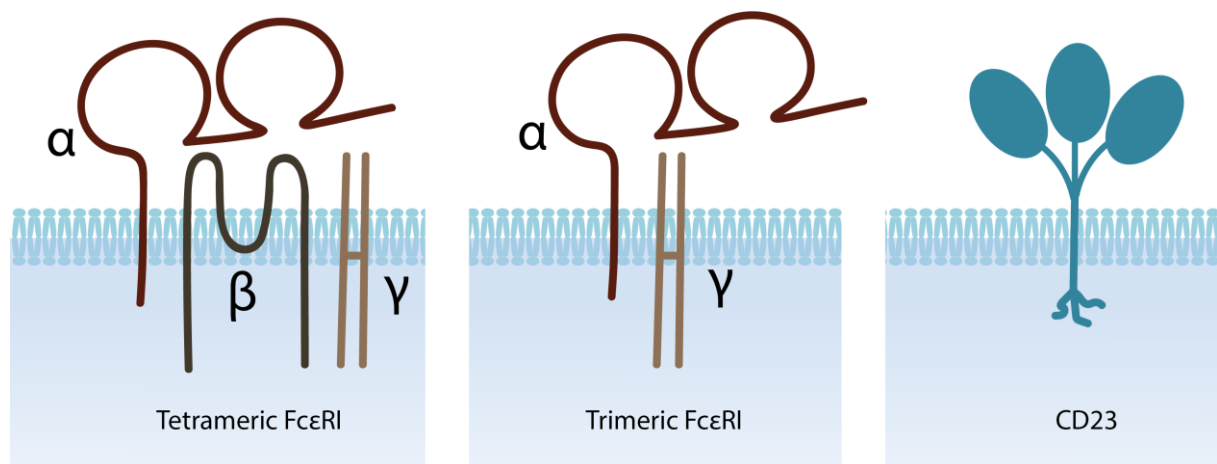

Figure 6 IgE receptors. The high-affinity IgE receptor FcεRI is expressed in its tetrameric form (left) a trimeric form (middle). CD23, the low-affinity IgE receptor, is a type II transmembrane protein (N-terminus intracellular) assembled as a multimer with α -helical coiled-coil stalks terminating in IgE-binding C-type lectin heads. Adapted from¹⁹⁰.

IgE

IgE is the most recently discovered immunoglobulin and was first described by Teruko Ishizaka in the 1960s¹⁹². Like all other human immunoglobulins, IgE consists of two pairs of identical heavy and light chains, with four constant domains in its heavy chain. However, IgE does not contain a hinge region, but uses disulphide bonds in the C ϵ 2 to connect the two heavy chains. Moreover, IgE is devoid of any complement-binding site. IgE binds to both IgE receptors in a bent conformation¹⁹³. The crystal structure reveals that in bent conformation, C ϵ 2 domains are folded back onto C ϵ 3 and C ϵ 4 domains¹⁹⁴. As a part of a BCR complex, membrane IgE exists in a bent and extended conformation. The later conformation is optimal for capturing allergens, since it has a greater range of conformational space.

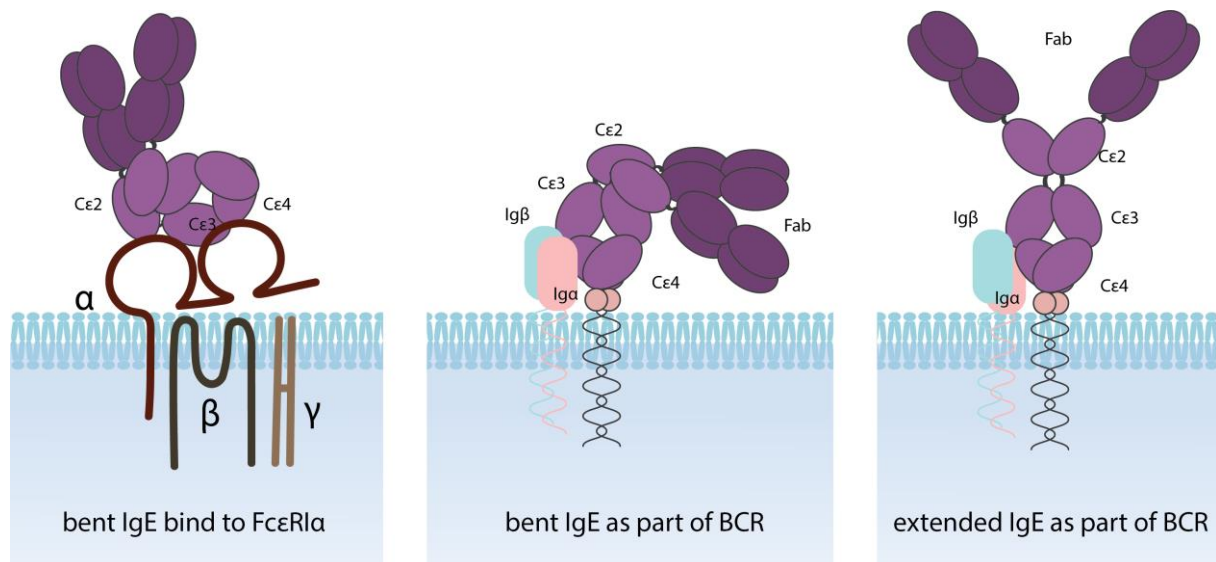

Figure 7 Modeled structure of the entire IgE molecule in different biological contexts. Acutely and rigidly bent IgE bound to Fc ϵ RI α (left), membrane bent IgE as part of the BCR (middle); extended IgE conformation as part of the BCR (right). Adapted from¹⁹⁵.

IgE is produced by plasma cells in lymphoid organs or local tissues, by both extrafollicular and GC pathways. It appears, however, that early IgE results mainly from extrafollicular production¹⁹⁶, albeit with limited affinity maturation¹⁹⁷. The role of IgE production by the GC pathway, is currently under debate and will be discussed later. There are two possibilities of class switch recombination described to move from an IgM

producing cell to an IgE producer: direct switch and sequential switch. During direct class switching, B cells will undergo $S\mu$ - $S\epsilon$ recombination. In the sequential switch, the B cell will first switch towards an IgG producer (generally IgG1) and then recombine a second time to gain IgE producing capacity ($S\mu$ - $S\gamma$ switch; then $S\gamma$ - $S\epsilon$)¹⁹⁸.

Regulation of serum IgE level by IgE receptors:

Due to the extremely high affinity of $Fc\epsilon RI$ for IgE, it is difficult to estimate the total amount of IgE in the human body, because most IgE will be bound to these receptors on mast cells and basophils and not be free in the circulation. The IgE concentration in the serum of a healthy individual ranges between 20.8-83.3 IU/mL¹⁹⁹. The IgE serum concentration seems to be regulated by binding of IgE to its receptors. In this context it has been proposed that IgE binding to $Fc\epsilon RI$ especially on dendritic cells and monocytes induces its internalization and clearance²⁰⁰. Additionally, CD23 plays a dual role in IgE level regulation, which is due to its susceptibility to be cleaved in its stalk region²⁰¹. The soluble and membrane form of CD23 are involved in IgE up- and down- regulation, respectively. Soluble CD23 triggers up-regulation of IgE concentration through its capacity to co-ligate CD21 and membrane IgE on transitional B cells and thus stimulate B cell proliferation²⁰². On the contrary, membrane CD23 cross-linked by IgE-antigen complex inhibites B cell proliferation and IgE production^{203,204}.

Generation of IgE memory

How exactly IgE memory is kept is still a matter of active debate. One of the reasons is that IgE^+ B cells and plasma cells are rare and particularly difficult to distinguish from other types of B cells due to their expression of CD23 that can also bind IgE. Among all plasma cells in blood, IgE^+ plasma cells account for only 0.32% in allergic patients and only 0.06% in healthy individuals²⁰⁵. By analyzing blood B cell IGH repertoires from healthy individuals and allergic patients, Looney et al. concluded that IgE^+ B cells can derive from IgM^+ B cells either through direct switching or from IgG-expressing B cells following at least two sequential recombination events (IgM - IgG - IgE)²⁰⁶. Blood, however, does not seem to be a good source of IgE^+ B cells, because another study suggested that

in allergic patients, the majority of allergen-specific IgE were produced locally, in allergen-exposed tissues²⁰⁷. In line with this observation, IgE-producing cells were observed in human nasal mucosa, adenoids, tonsils, the lung, spleen and bone marrow²⁰⁸. It remains however an open question, whether these cells are capable to constitute an IgE memory cell pool.

In mouse models, several studies have tried to solve this question and reached seemingly contradictory conclusions: While Yang et al. described IgE⁺B cells in germinal centers, these decreased in numbers after day 6 of immunization and notably showed different patterns of mutations than IgE-producing plasma cells¹⁹⁷, suggesting that GC IgE B cells were not the precursors of IgE-producing plasma cells. In addition, *Huizhong Xiong et al.* reported that IgE inherits fingerprints of somatic hypermutation of IgG1 GC B cells²⁰⁹. On the contrary, *Talay et al.* observed IgE⁺ GC B cells 35 days after parasite infection. They also visualized a dynamic population of IgE-switched B cells in the draining lymph node 13 days after infection by two-photon microscopy²¹⁰ and thus proposed that IgE⁺ GC B cells gave rise to IgE memory B cells and IgE plasma cells. As a consequence, it is still unclear whether IgE memory is maintained in the form of IgG1⁺ memory cells^{197,209} that require switching to yield new IgE-producing cells or directly as IgE⁺ memory cells²¹⁰. In my opinion it is a caveat of many of the cited studies that they used transgenic mice infected with parasites to study IgE memory. Parasites are indeed well-known to induce a strong pan IgE responses that are not targeted to a given antigen²¹¹.

Alternative anaphylaxis pathway

Many studies addressed the contribution of IgE-dependent mast cells and basophils activation in the physiopathology of anaphylaxis. However, several arguments support the hypothesis that anaphylaxis can occur without contribution of the classical type I hypersensitivity reaction: 1) anaphylaxis can be induced in IgE-deficient mice immunized with ovalbumin²¹²; 2) γ 1-antibodies were found to be capable of sensitizing mice in cutaneous anaphylaxis²¹³; 3) mast cell activation was not required in an anaphylaxis mouse model²¹⁴ and histamine antagonists are not sufficient to prevent anaphylactic symptoms in most models of anaphylaxis²¹⁵.

Among IgE-independent anaphylaxis pathways, probably the best described one is IgG dependent anaphylaxis. A large body of evidence support its existence in mice²¹⁵⁻²¹⁸. Interestingly, whereas there seems to be a consensus on the fact that IgG (and Fc γ R) can be at the origin of anaphylactic symptoms in mice, the effector cell population(s) contributing to the reaction seems to vary depending on the model used²¹⁹.

Among the four mouse Fc γ Rs, Fc γ RIII is the activating IgG receptor with the largest expression and not surprisingly was found to be the dominant contributor to IgG1-, IgG2a-, and IgG2b-trinitrophenyl immune complex induced passive systemic anaphylaxis. Fc γ RIV can also contribute at high doses of IgG2-induced reactions. Depending on the IgG-subclass used to trigger the reaction, mast cells, basophils, neutrophils, and monocyte/macrophages participate to different extends and hence the reaction depends on histamine and/or platelet activating factor (PAF)²²⁰. In a mouse model deficient for Fc ϵ RI, Fc ϵ RII, Fc γ RI, Fc γ RIIb and Fc γ RIII (5KO mice), active anaphylaxis was dependent on neutrophil Fc γ RIV leading to the release of PAF²²¹. Other groups have suggested that basophils were the main inducers of IgG1 dependent anaphylaxis²¹⁵, which was put into question with the appearance of a new basophil-deficient mouse model²²². And macrophages were suggested to be the main players in anti Goat-IgD immunized mice challenged with goat IgD²²³

As already introduced (chapter 1.2.1 and 1.2.2), human and mouse IgG-Fc γ Rs have different properties in terms of binding affinities and expression profile. The use of mice

expressing humanized FcγRs in the absence of mouse FcγRs, enabled my lab to demonstrate that human FcγRIIA is sufficient to trigger both passive and active anaphylaxis. Human FcγRIIA dependent anaphylaxis was associated with IgG-activation of monocytes/macrophages and neutrophils leading to the release of PAF.^{224,225} As part of my thesis I contributed to further investigate the role of FcγRIIA-expressing cells in this model. Notably, we focussed on the role of platelets that express FcγRIIA in humans, but no IgG receptor in mice. We found that activation of FcγRIIA-expressing platelets were activated by IgG ICs in vivo, leading to their aggregation and activation. This translated into a severe thrombocytopenia and the release of serotonin by platelets, which critically contributed to the severity of anaphylaxis²²⁵. Interestingly platelet depletion prior to anaphylaxis was sufficient to prevent the reaction in mice expressing exclusively hFcγRIIA, whereas it only reduced the allergic reaction in mice expressing all human IgG receptors (hFcγR^{KI} mice). The article describing these findings is attached to this thesis (Annex 7.1). Similar findings were reported in mice that express hFcγRIIA in WT mice²²⁶. In addition, in the mouse strain comprising both low affinity activating human FcγR (hFcγRIIA, hFcγRIIIA, and hFcγRIIIB) and inhibitory (hFcγRIIB), the contribution of anaphylaxis is predominantly by hFcγRIIA, which is abundant on neutrophils. Also, in this mouse strain, depletion of neutrophils protected the mice from hypothermia²²⁷.

Building on the results obtained from mouse data, a clinical study could recently provide new lines of evidence for a contribution of IgG-dependent pathway to human drug-induced anaphylaxis. Human anaphylaxis severity was correlated with elevated anti-drug IgG levels, FcγR downregulation on neutrophils, and associated with neutrophil and platelet activation^{225,228}. Collectively, these examples illustrate that multiple pathways can be at play in human anaphylactic reactions and therefore probably in allergies in general.

2. Summary and objectives

Until today it is largely unknown what events drive the development of allergies. The same stimuli and exposure may trigger their occurrence in one individual, while others remain tolerant. The goal of my thesis was to gain new insights into what makes a person allergic and in which way the immune system of an allergic individual differs from the one of a healthy person. To this aim, I evaluated the immune phenotype in a small number of allergic patients in steady state as well as in induced immune responses and compared them to the phenotype of healthy individuals. I could also profit from the available data of the Milieu Interieur cohort, an extensively analysed cohort of 1000 healthy donors to question which immunological, genetic and environmental factors determine the concentration of serum IgE. Additionally, in an attempt to better predict desired and adverse reactions to therapeutic antibodies and to guide the choice of target formats, I evaluated the capacity of IgG from different species to bind human and mouse FcγRs. Finally, I contributed to unveil the role of FcγRIIA-bearing platelets in IgG anaphylaxis. This latter study was a side project and I therefore I decided to include the article summarizing our findings in the annex.

3. Results

3.1. Part I Environmental, immunological and genetic parameters associated with total serum IgE concentration in healthy individuals

The term “Milieu Intérieur” was coined in 1859 by Claude Bernard to describe the internal environment, which is at the basis of a “free and independent life.” The immune system plays a key role in maintaining this internal environment through its capacity to prevent infections and malignant transformations as well as through its role in tissue homeostasis. Whenever this equilibrium is perturbed, inflammatory processes are initiated that can either be resolved in a timely manner or trigger the onset of diseases if they result in a permanent disequilibrium of the internal environment. Parameters that determine the magnitude of this inflammation and the speed of its resolution are still ill defined and include intrinsic, environmental, and genetic determinants.

The Milieu Intérieur (MI) project aims to determine what genetic and environmental factors drive the human immune response. To do so, extended epidemiological and biological data was collected from 1,000 healthy donors with a homogeneous ethnic background, stratified across gender (50% men/women) and age (20 to 69 years). In order to minimize pre-analytical biases, a huge effort has been made in the establishment of standardized and robust procedures. In this context, a suite of whole blood, syringe-based assay systems have been developed, thus permitting reproducible assessment of induced innate and adaptive immune responses. The final goal is to define healthy donor reference values for induced inflammatory genes and propose an analytical strategy for deconvoluting inter-cellular interactions. This approach may help identify new applications for therapeutic inhibition of selected cytokine pathways

The Milieu Interieur project set out to characterize the boundaries of a healthy immune response, to reveal natural variations between individuals and to determine how immune responses are influenced by environmental and genetic factors. To this aim, the consortium recruited 1000 healthy donors spanning 5 decades of life with an equal

representation of men and women. Extended epidemiological and biological data were collected and efforts made to establish standardized and robust analysis procedures. Notably, a collection of whole blood, syringe-based assay systems were developed to allow reproducible assessment of induced innate and adaptive immune responses (these procedures were likewise adapted to the WASPenIP study presented in chapter 3.2). The gathered information on the 1000 healthy donors were stored in a dataware house and made accessible to members of the Milieu Interieur consortium. Figure 8 presents an overview on the collected samples and analysis effectuated for each individual.

item under unauthorized distribution right

Figure 8 The scheme of the Milieu Interieur Project. Reprinted from: <http://www.milieuinterieur.fr/en/project/project-overview>.

Numerous studies have described the pathways involved in different pathologies (e.g., infectious diseases, auto-immunity, allergy), but few have provided an exhaustive description of healthy immune responses. However, knowledge of baseline responses in healthy persons is crucial for the understanding of the pathologic context and can be used as a reference.

Despite an ever-increasing incidence of allergies in the global population, it is largely unknown what events drive the development of allergies. The same stimuli and exposures may trigger their occurrence in one individual, while others remain tolerant. In the first part of my thesis, I explored the rich database from the Milieu Interieur Consortium in collaboration with a bioinformatician to reveal associations between total serum IgE concentrations and the immunological, environmental and genetic determinants in healthy individuals.

I surprisingly found that nearly 20 % of healthy individuals showed elevated total serum IgE concentrations (>114 kU/L), while reporting no allergic disease or helminth infection. I confirmed that a number of social- demographic factors (age, sex, smoking habit, and family history of allergic diseases), are associated with IgE concentrations, and reproduced the tight relationship between serum IgE concentration and the level of high-affinity IgE receptor (FcεRI) expression on basophils. My analyses reveal that individuals with high IgE concentrations in their serum, showed a distinct pattern of secreted cytokines in certain whole blood stimulation assays and showed significant overrepresentation of certain HLA alleles.

The following summarizes my findings in the form of an article, which will be submitted to a scientific journal, as soon as we will have the green light from the Milieu Interieur Consortium.

item under unauthorized distribution right

item under unauthorized distribution right

item under unauthorized distribution right

item under unauthorized distribution right

item under unauthorized distribution right

item under unauthorized distribution right

item under unauthorized distribution right

item under unauthorized distribution right

item under unauthorized distribution right

item under unauthorized distribution right

item under unauthorized distribution right

item under unauthorized distribution right

item under unauthorized distribution right

item under unauthorized distribution right

item under unauthorized distribution right

References

1. Wu LC, Zarrin AA. The production and regulation of IgE by the immune system. *Nat Rev Immunol*. 2014;14(4):247-259.
2. Lawrence MG, Woodfolk JA, Schuyler AJ, Stillman LC, Chapman MD, Platts-Mills TA. Half-life of IgE in serum and skin: Consequences for anti-IgE therapy in patients with allergic disease. *J Allergy Clin Immunol*. 2017;139(2):422-428 e424.
3. Mankarious S, Lee M, Fischer S, et al. The half-lives of IgG subclasses and specific antibodies in patients with primary immunodeficiency who are receiving intravenously administered immunoglobulin. *J Lab Clin Med*. 1988;112(5):634-640.
4. Roopenian DC, Akilesh S. FcRn: the neonatal Fc receptor comes of age. *Nat Rev Immunol*. 2007;7(9):715-725.
5. Cheng LE, Hartmann K, Roers A, Krummel MF, Locksley RM. Perivascular mast cells dynamically probe cutaneous blood vessels to capture immunoglobulin E. *Immunity*. 2013;38(1):166-175.
6. Greer AM, Wu N, Putnam AL, et al. Serum IgE clearance is facilitated by human FcεRI internalization. *J Clin Invest*. 2014;124(3):1187-1198.
7. Kubo S, Nakayama T, Matsuoka K, Yonekawa H, Karasuyama H. Long term maintenance of IgE-mediated memory in mast cells in the absence of detectable serum IgE. *J Immunol*. 2003;170(2):775-780.
8. Macglashan D, Jr. IgE and Fc{epsilon}RI regulation. *Ann NY Acad Sci*. 2005;1050:73-88.
9. Letellier M, Nakajima T, Pulido-Cejudo G, Hofstetter H, Delespesse G. Mechanism of formation of human IgE-binding factors (soluble CD23): III. Evidence for a receptor (Fc epsilon RII)-associated proteolytic activity. *J Exp Med*. 1990;172(3):693-700.
10. Hibbert RG, Teriete P, Grundy GJ, et al. The structure of human CD23 and its interactions with IgE and CD21. *J Exp Med*. 2005;202(6):751-760.
11. Luo HY, Hofstetter H, Banchereau J, Delespesse G. Cross-linking of CD23 antigen by its natural ligand (IgE) or by anti-CD23 antibody prevents B lymphocyte proliferation and differentiation. *J Immunol*. 1991;146(7):2122-2129.
12. Sherr E, Macy E, Kimata H, Gilly M, Saxon A. Binding the low affinity Fc epsilon R on B cells suppresses ongoing human IgE synthesis. *J Immunol*. 1989;142(2):481-489.
13. Galli SJ, Tsai M. IgE and mast cells in allergic disease. *Nat Med*. 2012;18(5):693-704.
14. Niederberger V, Ring J, Rakoski J, et al. Antigens drive memory IgE responses in human allergy via the nasal mucosa. *Int Arch Allergy Immunol*. 2007;142(2):133-144.
15. van Loon AM, van der Logt JT, Heessen FW, van der Veen J. Quantitation of immunoglobulin E antibody to cytomegalovirus by antibody capture enzyme-linked immunosorbent assay. *J Clin Microbiol*. 1985;21(4):558-561.
16. Rossi RE, Monasterolo G. Prevalence of serum IgE antibodies to the Staphylococcus aureus enterotoxins (SAE, SEB, SEC, SED, TSST-1) in patients with persistent allergic rhinitis. *Int Arch Allergy Immunol*. 2004;133(3):261-266.
17. Fitzsimmons CM, Falcone FH, Dunne DW. Helminth Allergens, Parasite-Specific IgE, and Its Protective Role in Human Immunity. *Front Immunol*. 2014;5:61.
18. Santiago Hda C, Ribeiro-Gomes FL, Bennuru S, Nutman TB. Helminth infection alters IgE responses to allergens structurally related to parasite proteins. *J Immunol*. 2015;194(1):93-100.
19. Bahna SL, Heiner DC, Myhre BA. Immunoglobulin E pattern in cigarette smokers. *Allergy*. 1983;38(1):57-64.
20. Diaz-Sanchez D, Dotson AR, Takenaka H, Saxon A. Diesel exhaust particles induce local IgE production in vivo and alter the pattern of IgE messenger RNA isoforms. *J Clin Invest*. 1994;94(4):1417-1425.
21. Al-Shaikhly T, Ochs HD. Hyper IgE syndromes: clinical and molecular characteristics. *Immunol Cell Biol*. 2019;97(4):368-379.
22. Ochs HD, Thrasher AJ. The Wiskott-Aldrich syndrome. *J Allergy Clin Immunol*. 2006;117(4):725-738; quiz 739.
23. Bin Dhuban K, Piccirillo CA. The immunological and genetic basis of immune dysregulation, polyendocrinopathy, enteropathy, X-linked syndrome. *Curr Opin Allergy Clin Immunol*. 2015;15(6):525-532.

24. Honig M, Schwarz K. Omenn syndrome: a lack of tolerance on the background of deficient lymphocyte development and maturation. *Curr Opin Rheumatol*. 2006;18(4):383-388.
25. Holland SM, DeLeo FR, Elloumi HZ, et al. STAT3 mutations in the hyper-IgE syndrome. *N Engl J Med*. 2007;357(16):1608-1619.
26. Frey-Jakobs S, Hartberger JM, Fliegau M, et al. ZNF341 controls STAT3 expression and thereby immunocompetence. *Sci Immunol*. 2018;3(24).
27. Beziat V, Li J, Lin JX, et al. A recessive form of hyper-IgE syndrome by disruption of ZNF341-dependent STAT3 transcription and activity. *Sci Immunol*. 2018;3(24).
28. Engelhardt KR, McGhee S, Winkler S, et al. Large deletions and point mutations involving the dedicator of cytokinesis 8 (DOCK8) in the autosomal-recessive form of hyper-IgE syndrome. *J Allergy Clin Immunol*. 2009;124(6):1289-1302 e1284.
29. Sassi A, Lazaroski S, Wu G, et al. Hypomorphic homozygous mutations in phosphoglucomutase 3 (PGM3) impair immunity and increase serum IgE levels. *J Allergy Clin Immunol*. 2014;133(5):1410-1419, 1419 e1411-1413.
30. Wieczorek M, Abualrous ET, Sticht J, et al. Major Histocompatibility Complex (MHC) Class I and MHC Class II Proteins: Conformational Plasticity in Antigen Presentation. *Front Immunol*. 2017;8:292.
31. Dendrou CA, Petersen J, Rossjohn J, Fugger L. HLA variation and disease. *Nat Rev Immunol*. 2018;18(5):325-339.
32. Thomas S, Rouilly V, Patin E, et al. The Milieu Interieur study - an integrative approach for study of human immunological variance. *Clin Immunol*. 2015;157(2):277-293.
33. Scepanovic P, Alanio C, Hammer C, et al. Human genetic variants and age are the strongest predictors of humoral immune responses to common pathogens and vaccines. *Genome Med*. 2018;10(1):59.
34. Zetterstrom O, Johansson SG. IgE concentrations measured by PRIST in serum of healthy adults and in patients with respiratory allergy. A diagnostic approach. *Allergy*. 1981;36(8):537-547.
35. Hasan M, Beitz B, Rouilly V, et al. Semi-automated and standardized cytometric procedures for multi-panel and multi-parametric whole blood immunophenotyping. *Clin Immunol*. 2015;157(2):261-276.
36. Patin E, Hasan M, Bergstedt J, et al. Natural variation in the parameters of innate immune cells is preferentially driven by genetic factors. *Nat Immunol*. 2018;19(3):302-314.
37. Conroy MC, Adkinson NF, Jr., Lichtenstein LM. Measurement of IgE on human basophils: relation to serum IgE and anti-IgE-induced histamine release. *J Immunol*. 1977;118(4):1317-1321.
38. Duffy D, Rouilly V, Libri V, et al. Functional analysis via standardized whole-blood stimulation systems defines the boundaries of a healthy immune response to complex stimuli. *Immunity*. 2014;40(3):436-450.
39. Matsumoto M, Seya T. TLR3: interferon induction by double-stranded RNA including poly(I:C). *Adv Drug Deliv Rev*. 2008;60(7):805-812.
40. Wittig HJ, Belloit J, De Fillippi I, Royal G. Age-related serum immunoglobulin E levels in healthy subjects and in patients with allergic disease. *J Allergy Clin Immunol*. 1980;66(4):305-313.
41. Carosso A, Bugiani M, Migliore E, Anto JM, DeMarco R. Reference values of total serum IgE and their significance in the diagnosis of allergy in young European adults. *Int Arch Allergy Immunol*. 2007;142(3):230-238.
42. Omenaas E, Bakke P, Elsayed S, Hanao R, Gulsvik A. Total and specific serum IgE levels in adults: relationship to sex, age and environmental factors. *Clin Exp Allergy*. 1994;24(6):530-539.
43. Saini SS, Klion AD, Holland SM, Hamilton RG, Bochner BS, Macglashan DW, Jr. The relationship between serum IgE and surface levels of FcepsilonR on human leukocytes in various diseases: correlation of expression with FcepsilonRI on basophils but not on monocytes or eosinophils. *J Allergy Clin Immunol*. 2000;106(3):514-520.
44. Malveaux FJ, Conroy MC, Adkinson NF, Jr., Lichtenstein LM. IgE receptors on human basophils. Relationship to serum IgE concentration. *J Clin Invest*. 1978;62(1):176-181.
45. Sihra BS, Kon OM, Grant JA, Kay AB. Expression of high-affinity IgE receptors (Fc epsilon RI) on peripheral blood basophils, monocytes, and eosinophils in atopic and nonatopic subjects: relationship to total serum IgE concentrations. *J Allergy Clin Immunol*. 1997;99(5):699-706.
46. Van der Pouw Kraan TC, Van der Zee JS, Boeije LC, De Groot ER, Stapel SO, Aarden LA. The role of IL-13 in IgE synthesis by allergic asthma patients. *Clin Exp Immunol*. 1998;111(1):129-135.
47. Levy Y, Brouet JC. Interleukin-10 prevents spontaneous death of germinal center B cells by induction of the bcl-2 protein. *J Clin Invest*. 1994;93(1):424-428.

48. Rousset F, Garcia E, Defrance T, et al. Interleukin 10 is a potent growth and differentiation factor for activated human B lymphocytes. *Proc Natl Acad Sci U S A*. 1992;89(5):1890-1893.
49. Jeannin P, Lecoanet S, Delneste Y, Gauchat JF, Bonnefoy JY. IgE versus IgG4 production can be differentially regulated by IL-10. *J Immunol*. 1998;160(7):3555-3561.
50. Kobayashi N, Nagumo H, Agematsu K. IL-10 enhances B-cell IgE synthesis by promoting differentiation into plasma cells, a process that is inhibited by CD27/CD70 interaction. *Clin Exp Immunol*. 2002;129(3):446-452.
51. Akdis CA, Blesken T, Akdis M, Wuthrich B, Blaser K. Role of interleukin 10 in specific immunotherapy. *J Clin Invest*. 1998;102(1):98-106.
52. Punnonen J, de Waal Malefyt R, van Vlasselaer P, Gauchat JF, de Vries JE. IL-10 and viral IL-10 prevent IL-4-induced IgE synthesis by inhibiting the accessory cell function of monocytes. *J Immunol*. 1993;151(3):1280-1289.
53. Uejima Y, Takahashi K, Komoriya K, Kurozumi S, Ochs HD. Effect of interleukin-10 on anti-CD40- and interleukin-4-induced immunoglobulin E production by human lymphocytes. *Int Arch Allergy Immunol*. 1996;110(3):225-232.
54. Alexopoulou L, Holt AC, Medzhitov R, Flavell RA. Recognition of double-stranded RNA and activation of NF-kappaB by Toll-like receptor 3. *Nature*. 2001;413(6857):732-738.
55. Ritchie AI, Farne HA, Singanayagam A, Jackson DJ, Mallia P, Johnston SL. Pathogenesis of Viral Infection in Exacerbations of Airway Disease. *Ann Am Thorac Soc*. 2015;12 Suppl 2:S115-132.
56. Weber F, Wagner V, Rasmussen SB, Hartmann R, Paludan SR. Double-stranded RNA is produced by positive-strand RNA viruses and DNA viruses but not in detectable amounts by negative-strand RNA viruses. *J Virol*. 2006;80(10):5059-5064.
57. Torres D, Dieudonne A, Ryffel B, et al. Double-stranded RNA exacerbates pulmonary allergic reaction through TLR3: implication of airway epithelium and dendritic cells. *J Immunol*. 2010;185(1):451-459.
58. Bruhns P, Iannascoli B, England P, et al. Specificity and affinity of human Fc gamma receptors and their polymorphic variants for human IgG subclasses. *Blood*. 2009;113(16):3716-3725.
59. Tax WJ, Willems HW, Reekers PP, Capel PJ, Koene RA. Polymorphism in mitogenic effect of IgG1 monoclonal antibodies against T3 antigen on human T cells. *Nature*. 1983;304(5925):445-447.
60. Stein MM, Hrusch CL, Sperling AI, Ober C. Effects of an Fc gammaRIIA polymorphism on leukocyte gene expression and cytokine responses to anti-CD3 and anti-CD28 antibodies. *Genes Immun*. 2019;20(6):462-472.
61. Gaston JS, Goodall JC, Young JL, Young SP. Effect of polymorphism of the HLA-DPA1 chain on presentation of antigenic peptides. *Hum Immunol*. 1997;54(1):40-47.
62. Varney MD, Valdes AM, Carlson JA, et al. HLA DPA1, DPB1 alleles and haplotypes contribute to the risk associated with type 1 diabetes: analysis of the type 1 diabetes genetics consortium families. *Diabetes*. 2010;59(8):2055-2062.
63. Noguchi E, Sakamoto H, Hirota T, et al. Genome-wide association study identifies HLA-DP as a susceptibility gene for pediatric asthma in Asian populations. *PLoS Genet*. 2011;7(7):e1002170.
64. Howell WM, Standring P, Warner JA, Warner JO. HLA class II genotype, HLA-DR B cell surface expression and allergen specific IgE production in atopic and non-atopic members of asthmatic family pedigrees. *Clin Exp Allergy*. 1999;29 Suppl 4:35-38.
65. D'Amato M, Picardi A, Menna T, et al. HLA-DRB1* and allergy to Parietaria: linkage and association analyses. *Hum Immunol*. 1999;60(12):1250-1258.
66. D'Amato M, Scotto d'Abusco A, Maggi E, et al. Association of responsiveness to the major pollen allergen of Parietaria officinalis with HLA-DRB1* alleles: a multicenter study. *Hum Immunol*. 1996;46(2):100-106.
67. Novak N, Bieber T. Allergic and nonallergic forms of atopic diseases. *J Allergy Clin Immunol*. 2003;112(2):252-262.
68. Dehlink E, Baker AH, Yen E, Nurko S, Fiebiger E. Relationships between levels of serum IgE, cell-bound IgE, and IgE-receptors on peripheral blood cells in a pediatric population. *PLoS One*. 2010;5(8):e12204.
69. Law CW, Alhamdoosh M, Su S, et al. RNA-seq analysis is easy as 1-2-3 with limma, Glimma and edgeR. *F1000Res*. 2016;5.

item under unauthorized distribution right

item under unauthorized distribution right

3.2. Part II – Characterizing the immune phenotype of allergic individuals

WASPenIP study

Introduction

Allergic diseases are often considered to be the result of a biased Th2/Th1 response, resulting in the overproduction of Th2 cytokines (IL-4, IL-5 and IL-13) that favor IgE secretion from B cells¹⁹⁹. These IgE are then bound by high affinity FcεRI on mast cells and basophils, thus arming them for immediate responses upon encounter of a cognate allergen. However, this concept has been considerably extended by our growing understanding of immunology. Apart from Th2 cells, other cell types have been described to significantly contribute to allergy¹⁶⁶. For example, innate lymphoid cells, which contribute to Th2 response through their production of IL-5 and IL-13²²⁹ and promoting activated dendritic cells to drain lymph nodes for Th2 cell differentiation²³⁰. Another study showed that infants suffering from food allergy had a higher CD14⁺ monocytes/CD4⁺ T cell ratio in their cord blood at birth.²³¹ For the reason that CD14⁺ monocytes suppressed CD4⁺ T cells IL-2 secretion; the absence of IL-2 decreased activated natural regulatory T cells and promoted the differentiation of Th2 cells²³¹. Furthermore, allergic patients are known to respond differently to allergic specific immunotherapy (AIT). AIT is frequently used in patients with pollen or insect sting allergy and has proven effective in most patients to prevent or at least ameliorate allergic symptoms. (Advanced discussion about benefit and limitation of AIT is in section 4.3) It follows that the mechanisms underlying allergic diseases are much more complicated than previously thought and it highlights the necessity to reconsider allergy as a systemic change of immune phenotype.

To systematically identify characteristic features of the allergic immune phenotype, including immune particularities of steady state, induced immune responses, and to what extent it is influenced by environmental and genetic factors, we applied an

adapted methodology from the Milieu Interieur cohort analysis to a newly recruited cohort of severely allergic patients, the WASPenIP cohort. Over a period of 3 years, we aimed at recruiting two groups of severely allergic, but otherwise healthy patients: i) 30 individuals with wasp venom allergy, ii) 15 individuals with allergy to amoxicillin. This clinical study was designed to achieve two goals: 1) the characterization of the immune phenotype of allergic patients; and 2) the definition of novel biomarker candidates that would allow prediction of the success of AIT.

The scope of this project unfortunately had to be revised several times throughout my PhD: First, due to the delay in the legal validation, patient inclusions could only start with a 6-month delay (May 2017 instead of December 2016). Secondly, whereas estimations suggested that we would be able to recruit 20-30 patients a year, only four patients could be included over the first year in our affiliated center. In order to adapt to this situation, we opened our second recruitment center at the Hopital Bichat. Thirdly and completely unexpected by all allergologists, there was a stock rupture of authorized clinical grade wasp venom for diagnosis in the French market, putting all new inclusions on ice for a period of nearly 9 months. Finally, our clinical lead collaborator left the recruitment center, requiring 1) a new submission of legal forms to the ethics committees, 2) the opening of a third center and 3) further delays.

For all the above reasons, only eight patients were included in this cohort, with three wasp venom allergic patients and five amoxicillin allergic patients. To complement this group of allergic patients, eight healthy donors were included as controls from the Clinical Investigation and Access to BioResources platform (ICAReB) at the Institut Pasteur.

As a consequence, the initial scope of my PhD project had to be revised and this translational project only describes some of this preliminary work I have undertaken to characterize the immune phenotype of allergic patients. All results reported in this chapter are preliminary and reflect the state of the project at this moment (March 2020).

Due to the small number of inclusions the analyses lack statistical power, but allow a glimpse of what can be a possible outcome if confirmed with higher patient numbers.

In addition, to facilitate future mechanistic studies on wasp venom allergy and to complete findings from the clinical cohort, I established a mouse model of experimental wasp venom allergy that will be introduced in the second part of this chapter.

Materials and methods:

Patient recruitment

Samples came from the WASPenIP Cohort, which was approved by the Comité de Protection des Personnes – Sud-Ouest et outre mer II (Committee for the protection of persons) on April 7th, 2016. The study was sponsored by Institut Pasteur (Pasteur ID-RCB Number: 2016-A02013-48), and was conducted as a multi-centres interventional study with minimal risks and constraints (RIPH 2). The original protocol was registered under ClinicalTrials.gov (study# NCT01699893). The study planned to recruit two groups of allergic individuals (30 allergic individuals to wasp venom the other 15 to amoxicillin, aged [20 – 69]) having experienced either an anaphylactic reaction of \geq grade 3 or a quincke edema that are otherwise healthy. Patients were informed and their consent obtained prior to inclusion. Until today, all allergic patients were recruited at the Medical Center of the Institut Pasteur by Dr. Nhan Pham Ti and Dr. Alice Seringulian. Blood samples from healthy individuals were obtained from the ICAREB platform (Institut Pasteur) as part of their CoSIImmGEn cohort.

Study design

Patients underwent two consecutive visits: At visit V0 (enrolment), which was conducted at least 6 weeks after exposure to the allergen, general demographic data, serology and health parameters were recorded. Furthermore, an antigen-dependent

basophil activation test (BAT) was conducted in the laboratory of Pr. Sylvie Chollet-Martin at the Bichat hospital. If the BAT for wasp venom or amoxicillin, respectively, was negative, the patient would not be recruited for a V1 visit. The laboratory of Pr. Sylvie Chollet-Martin at the Bichat hospital monitored the presence of allergen-specific IgE antibodies in the serum of patients. Although this parameter could confirm an allergic phenotype, it would not be considered an exclusion criterion, if no allergen-specific IgE antibodies could be detected; as long as the BAT yields a positive result. At visit V1 (inclusion) a detailed medical history and questionnaires collecting lifestyle and family health history were collected. Furthermore, after blood drawing for immune assays and genetic analysis, skin tests were undertaken to confirm the specific allergy and would allow final diagnostics.

For patients with suspicion of allergy to amoxicillin:

Intra dermal skin testing was performed with diluted antibiotic solution. To this aim dilutions of amoxicillin were prepared (1:100 to 1:10000)²³². Following, intradermal injection of physiological saline (control solution) and the amoxicillin solution were injected in distinct sites, with minimal distances of 2 cm between the drops on the palmar forearm. A positive skin reaction was characterised by the formation of a papule with characteristic look of “orange peel”. After 15 to 20 min, the readings were done in the same way as the prick test.

For patients with suspicion of allergy to wasp venom:

In subjects with a history of anaphylactic sting reaction, sensitization was confirmed by the demonstration of venom sensitization by a skin test reaction to venom. Skin tests were performed by skin prick or intradermal testing with stepwise incremental venom skin tests. When the patient had a conclusive reaction at a set concentration the test can be stopped. For skin prick test venom concentrations of 0.01–100 µg/ml were used. Intradermally a 0.02 ml venom concentration ranging from 0.001 to 1 µg/ml was injected into the volar surface of the forearm. The techniques were described in the European position paper¹²⁴.

Based on the results of V0 (BAT, wasp-specific IgE) and V1 (skin test) the decision was taken if the patient receives immunotherapy to wasp venom or not.

Flow cytometry analysis

Flow cytometry procedures were adapted from the Milieu Interieur study²³³. In brief, 2 mL fresh whole blood samples were collected on Li-heparin and washed by mixing with PBS at a 1:1 ratio, followed by centrifugation at 1500 rpm for 5 min at room temperature. The supernatant was aspirated and discarded, followed by the addition of fresh PBS taking it to the same final volume as input whole blood. Antibody premixes were prepared and 100 µl/ 200 µl of the resuspended cells was aliquoted into tubes containing the pre-mixed antibody cocktail. The samples were shortly vortexed and incubated 20 min in the dark at room temperature. Thereafter, all samples, irrespective of the panel used, were resuspended in 2 ml of 1x RBC lysing solution (BD Biosciences, ref. 349202), shortly vortexed and incubated 15 min at RT protected from light. After centrifugation for 5 min at 1500 rpm, the supernatant was aspirated; the samples were washed by 1mL of PBS and then resuspended in 200 µl PBS and immediately acquired on a MACSQuant analyzer. Calibration of the instruments was done using MacsQuant calibration beads (Miltenyi, ref. 130-093-607) and samples were acquired using bank setting to avoid variation during sample processing in different days. Flow cytometry antibodies were purchased from BD Bioscience or MiltenyiBiotec and listed in the Supplementary Table 1.

Truculture stimulation

Preloaded TruCulture tubes (null, CD3/CD28, LPS, poly I:C) were purchased from RBM Myriad and maintained at – 20 °C until use. Wasp venom (Citeq biologics) and amoxicillin (Sigma) were aliquoted and added freshly to a set of null tubes on the day of analysis. Within 15 min after blood collection, 1 ml of fresh whole blood drawn on Na-heparine was added to each pre-warmed TruCulture tube (37 °C), mixed by several inversions and incubated in a dry block incubator at 37 °C (± 1 °C) in room air for 22 h.

At the end of the incubation period, tubes were opened and a plunger was inserted to separate the sedimented cells from the supernatant. Supernatant were aliquot and frozen at -80°C until protein analysis. Pellets were mixed with 1.6 mL of Trizol (Sigma), vortexed at RT for 10 min and then frozen at -80°C .

Truculture basophil activation test

A 600 μl sample of Truculture tubes containing wasp venom and amoxicillin was taken after 1 hour of incubation at 37°C . Li-heparin blood was used as negative control. The samples were washed using 600 μl of PBS, centrifuged at 1500 rpm for 5 min at room temperature and the pellet resuspended in 200 μl fresh PBS. The staining procedure was the same as described above. The basophils were defined as $\text{CCR3}^+\text{SSC}^{\text{low}}\text{Fc}\epsilon\text{RI}^+$ cells. The up-regulation of CD63^+ or CD203c^+ basophils were calculated as previously described²³⁴ and showed in Figure 1.

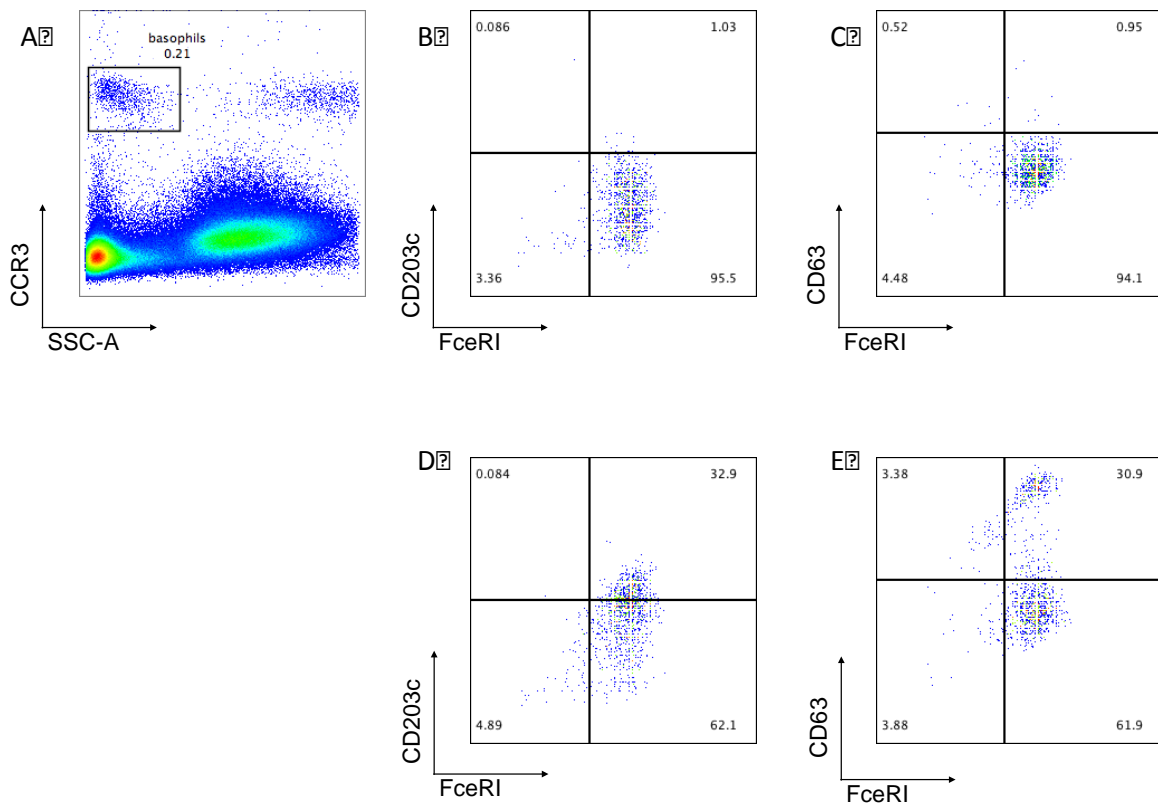

Figure 1 Quantitation of CD203c and CD63 up-regulation in basophils. Basophils were identified as CCR3⁺SSC^{low} cells (A). Up-regulation of CD203c in basophils was quantified as percentage of CD203c⁺ cells (FcεRI⁺CD203c⁺) after stimulation (D) compared with no stimulation (B). Up-regulation of CD63 in basophils was quantified as percentage of CD63⁺ cells (FcεRI⁺CD63⁺) after stimulation (E) compared with no stimulation (C).

Luminex multianalyte profiling

Supernatants from Truculture stimulations were analyzed by Luminex® xMAP technology using a Human cytokine & chemokine (34 plex) ProcartaPlex (Thermo Fisher), able to quantify Eotaxin/CCL11; GM-CSF; GRO alpha/CXCL1; IFN alpha; IFN gamma; IL-1 beta; IL-1 alpha; IL-1RA; IL-2; IL-4; IL-5; IL-6; IL-7; IL-8/CXCL8; IL-9; IL-10; IL-12 p70; IL-13; IL-15; IL-17A; IL-18; IL-21; IL-22; IL-23; IL-27; IL-31; IP-10/CXCL10;

MCP-1/CCL2; MIP-1 alpha/CCL3; MIP-1 beta/CCL4; RANTES/CCL5; SDF1 alpha/CXCL12; TNF alpha and TNF beta/LTA simultaneously. We used Droparrays® plates (Curiox), that allow the use of a single reagent batch for all tested samples. The experimental procedure was prescribed in more detail in²³⁵.

Data analysis and statistical methods

Unless stated otherwise, I used unpaired Student's t-test and power test for flow cytometry data; t-SNE analysis of cytokine responses were performed using the *tsne* package in R. Graphs were generated with the graphical packages ggplot2 v.2.1.0, ggpubr v.0.2.4 and GraphPad Prism 6.

Results and Discussion:

3.2.1 WASPenIP study

Cohort description

Until January 2020, we could only recruit eight allergic patients for the WASPenIP cohort, with three wasp venom allergic patients and five amoxicillin allergic patients. Those eight patients included five women and three men, aged 33 to 64. Among these eight patients, only two patients declared they had family members affected by allergic diseases (Table 1). Much information on each patient's lifestyle including work and living environment, eating habits, physical parameters and medical history were available through the questionnaire. The low number of patients, however, did not allow at this point identifying socio-demographic parameters associated with an allergic immune phenotype with statistical significance. I therefore reported in the table below only the intrinsic factors identified in the IgE study in chapter 3.1.

ID	Sex	Age	Allergen	Family allergic disease history	Tobacco Consumption
AD 1	M	41	WASP venom	Yes	Smoker
AD 2	M	33	WASP venom	Not known	Ex-smoker
AD 3	F	64	Amoxicillin	Not known	Non-smoker
AD 4	F	45	Amoxicillin	No	Ex-smoker
AD 5	F	35	Amoxicillin	Not known	Smoker
AD 6	F	56	WASP venom	No	Non-smoker
AD 7	M	61	Amoxicillin	No	Ex-smoker
AD 8	F	55	Amoxicillin	Yes	Ex-smoker
HC 1	M	54	N.C.	N.C.	N.C.
HC 2	F	54	N.C.	N.C.	N.C.
HC 3	F	54	N.C.	N.C.	N.C.
HC 4	M	66	N.C.	N.C.	N.C.
HC 5	F	21	N.C.	N.C.	N.C.
HC 6	F	29	N.C.	N.C.	N.C.
HC 7	F	37	N.C.	N.C.	N.C.
HC 8	M	31	N.C.	N.C.	N.C.

Table 1 Demographic information in WASPenIP cohort and healthy control subjects. AD, allergic donor; HC, healthy control; F, female; M, male; N.C. not conducted.

Phenotype of blood cell populations in allergic individuals

To determine immune phenotypes in steady state conditions, I performed flow cytometry analyses on the major cell populations in freshly drawn blood. The 7 flow cytometry panels to monitor the blood cell populations included: 1) major cell lines in

blood, 2) T helper (Th) cells, 3) Memory T cell subsets, 4) Treg cells, 5) DCs, 6) granulocytes, and 7) the panel corresponding to the basophil activation test (BAT). These panels were designed in consideration of the limited amount of available blood and to mirror to the best of our possibilities the panels used in the initial Milieu Interieur study, while extending a number of parameters that seemed appropriate to characterize blood samples from allergic patients (Figure 2) The gating strategy to define cells populations are indicated in supplementary Figure1-6.

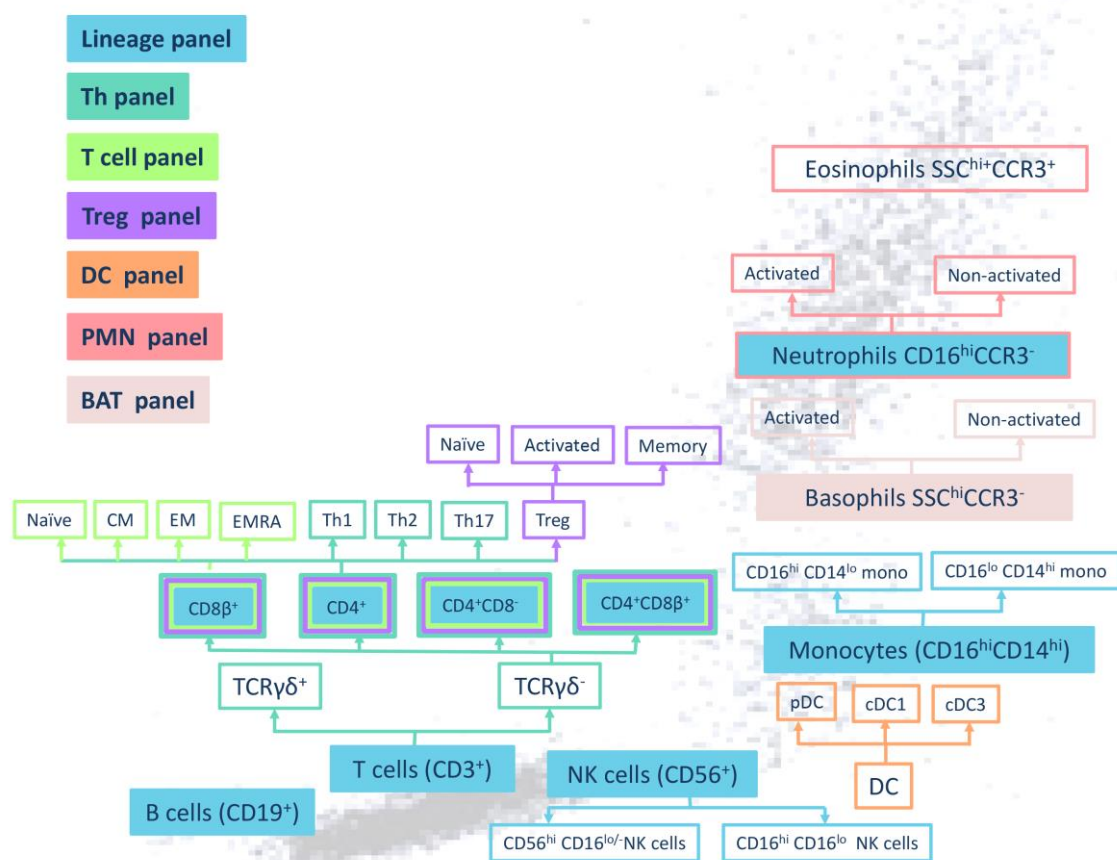

Figure 2 Immunophenotype included in WASPenIP study. Flow cytometry was used to analyze major blood cells populations. The panels used for the measurement of a cell subsets are color-coded: blue fill color - lineage panel; outlines of dark green - Th panel; light green - T cells panel; purple - Treg panel; orange - DC panel; red - PMN panel; and pink as fill color for the BAT panel. Multiple outlines indicate cells populations analysed in different panels.

Because of the low number of allergic patients included, I had to pool the two groups: wasp venom allergy and amoxicillin allergy together for statistical analysis. In the following figures, I will therefore represent each individual donor to account for their heterogeneity. Among all measured flow cytometry data (see Supplementary table 2), only a couple of parameters showed a differential behavior that I will present in the following:

As allergic conditions are often characterized by a Th2-biased immune response, I first evaluated their T helper cell subsets. The three wasp venom allergic patients had increased Th2 cell numbers compared to amoxicillin allergic patients and healthy donors (Figure 3A); and all allergic donors had increased Th17 cell numbers (Figure 3B). Only there was a trend in wasp venom allergic patients had higher percentages of Th2 and Th17 among all CD4 T cells (Figure 3C, 3D). There was no significant difference between the cohort and control groups when I pooled the data from the two allergic groups together.

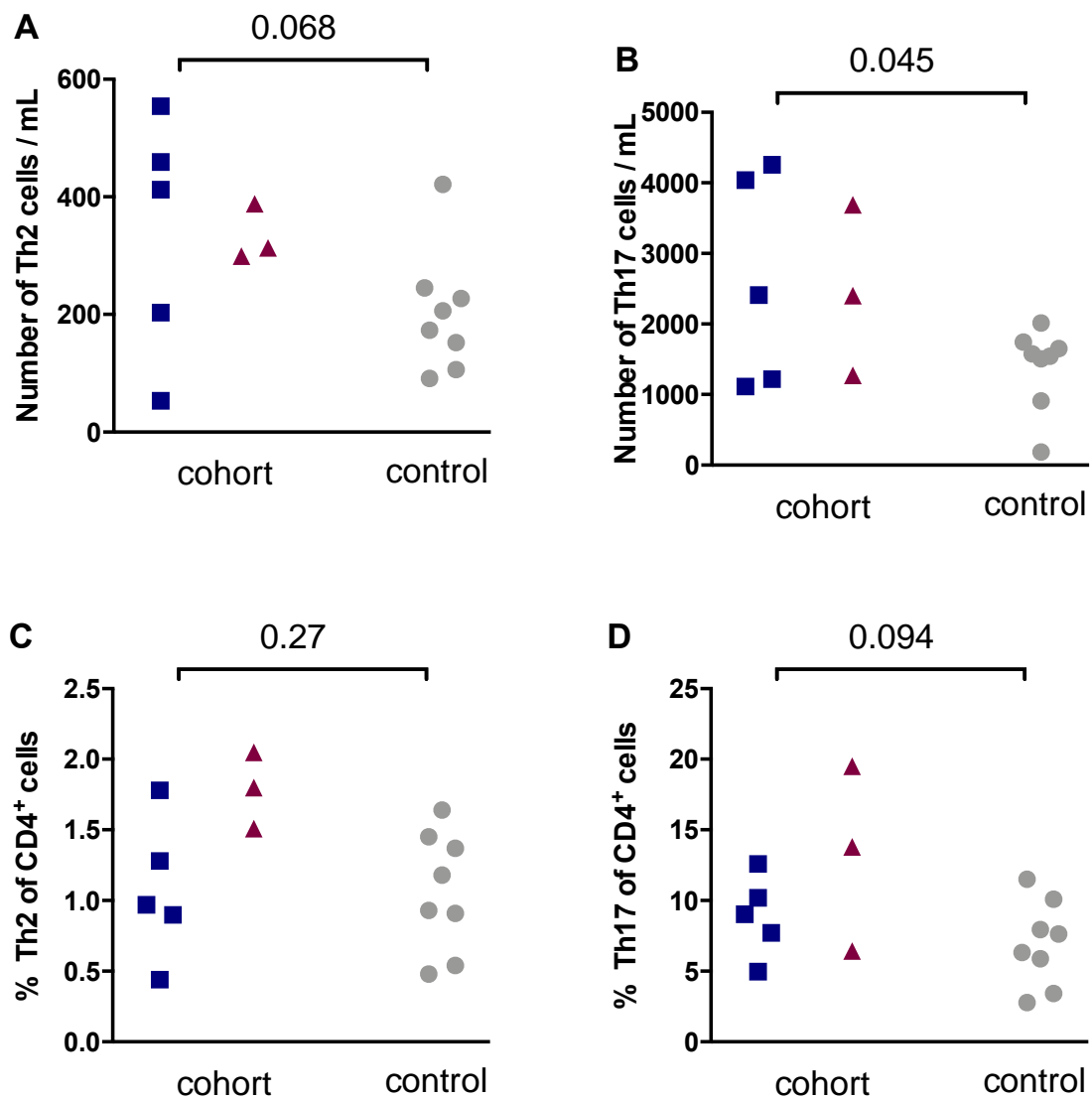

Figure 3 Number and phenotype of T cells subsets in WASPenIP cohort and healthy control subjects. Number of Th2 cells (A) and Th17 cells (B) per mL blood and percentage of Th2 cells (C) and Th17 (D) cells in CD4⁺ T cells and were represented as individual measurements from amoxicillin allergic patients (blue squares), wasp venom allergic patients (red triangles) and healthy individuals (grey dots). Unpaired t-test on grouped allergic donors vs healthy subject were performed and P values were indicated.

To explore the memory T cell subsets proportion and their phenotype in allergic donors, I analyzed the data obtained from memory T cell panel. This panel included CD4⁺ and CD8⁺ naïve, T_{CM}, T_{EM}, T_{EMRA} cells as well as their surface expression of HLA-DR and CCR7. Interestingly, I could only detect increased HLA-DR expression on naïve CD4⁺ T cells from allergic donors (Figure 4A), which could suggest that they stay in a priming state in naïve stage. Moreover, CD8⁺ T_{CM}, T_{EM}, T_{EMRA} from allergic patients expressed less CCR7 on their surface than their corresponding population from healthy donors (Figure 4B-4D). CCR7 is expressed by DCs, B cells, and also memory T cells subsets and is critical for homing of immune cells to secondary lymphoid organs¹¹⁷. It has been proposed that CD8⁺ CCR7⁺ T cells suppress CD4⁺ T cells proliferation and cytokine production *in vitro*²³⁶. Thus the lower CCR7 expression on CD8 T cells from allergic donors may translate into a reduced suppressive function from CD8⁺ T cells to CD4⁺ T cells.

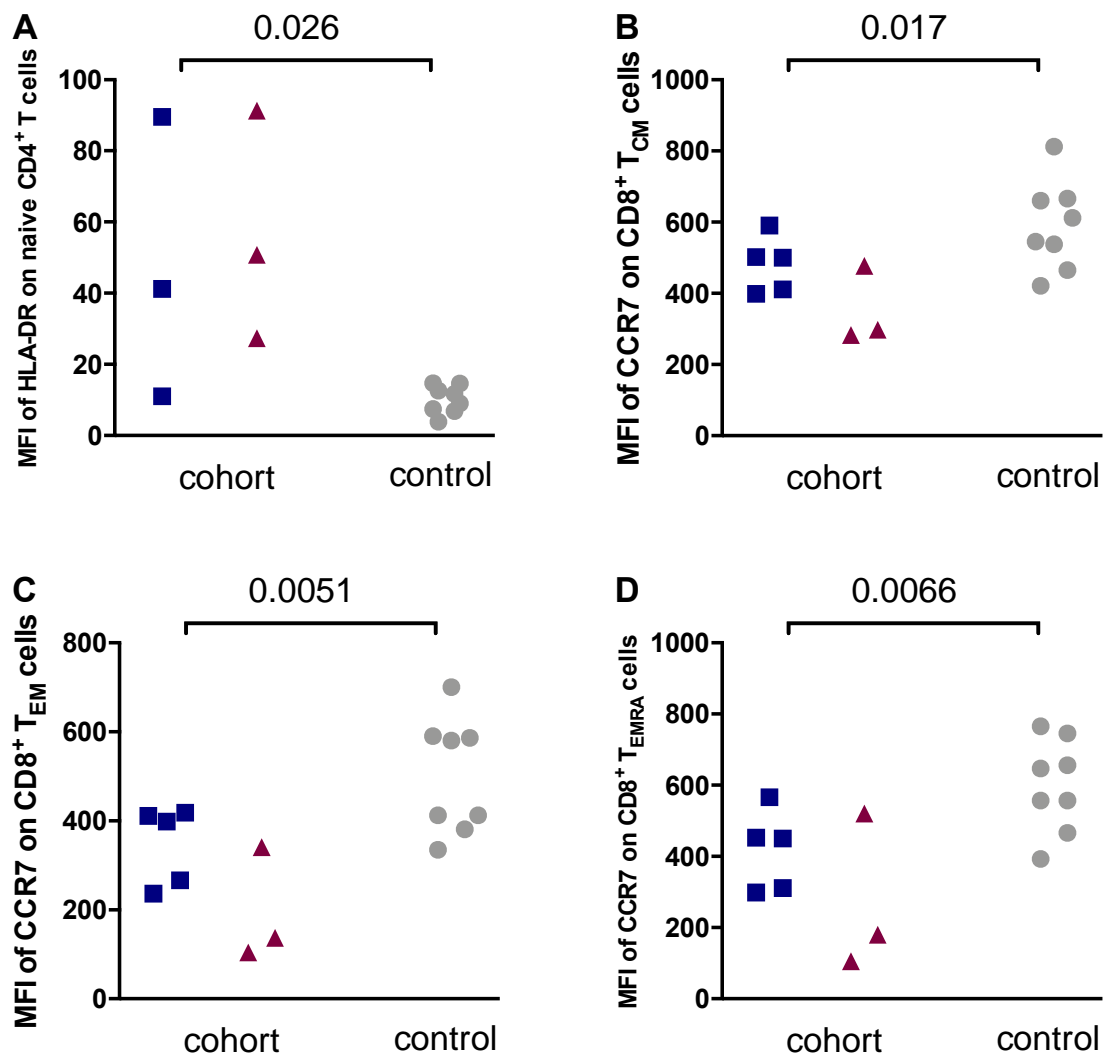

Figure 4 Phenotype of memory T cells subsets in WASPenIP cohort and healthy control subjects. MFI of HLA-DR on naïve CD4⁺ T cells (A) and CCR7 on CD8⁺ T_{CM} cells (B), CD8⁺ T_{EM} cells (C), CD8⁺ T_{EMRA} cells (D) were represented as individual measurements from amoxicillin allergic patients (blue squares), wasp venom allergic patients (red triangles) and healthy individuals (grey). Unpaired t-test on grouped allergic donors vs healthy subject were performed and P values were indicated.

Since the allergic immune response could also reflect a failure to maintain tolerance towards a specific allergen²³⁷, I also compared the absolute number, percentage and subsets (naïve, memory, activated) of T regulatory cells (Tregs) (Supplementary table 2). Unexpectedly, most allergic donors had increased percentages of Tregs among total cells (Figure 5). This difference however did not appear when looking at absolute numbers. Because another study showed that Tregs from allergic donors inhibited less efficiently

CD4⁺ T cells proliferation and IL-5 production than T regs from healthy individuals²³⁸, the increased Tregs in allergic cohort could be a compensatory mechanism to overcome possibly defective inhibitory functions.

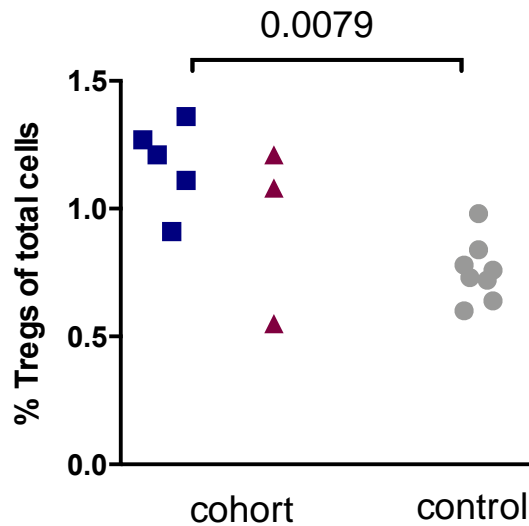
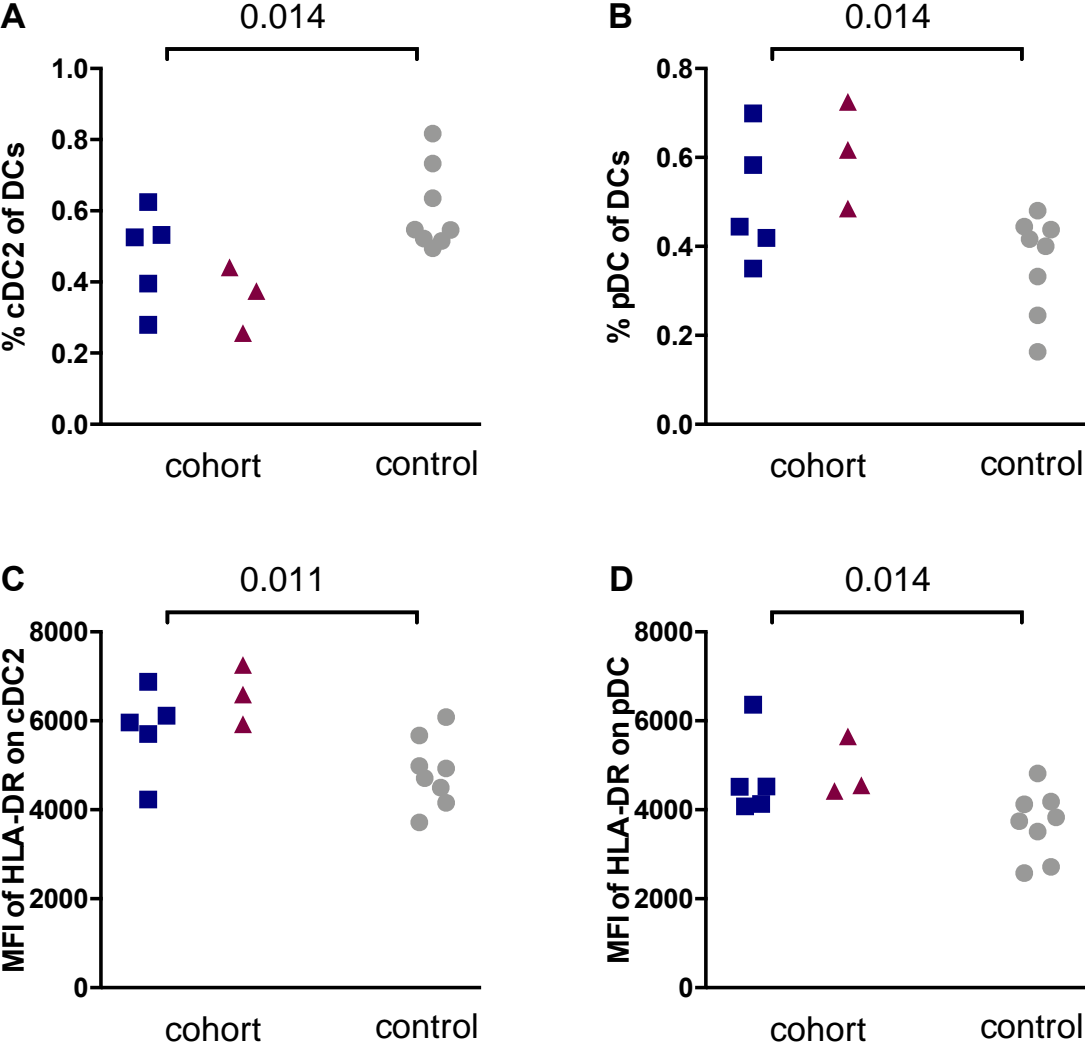

Figure 5 Percentage of memory Tregs cells subsets in WASPenIP cohort and healthy control subjects. Data were represented as individual measurements from amoxicillin allergic patients (blue squares), wasp venom allergic patients (red triangles) and healthy individuals (grey). Unpaired t-test on grouped allergic donors vs healthy subject were performed and P values are indicated.

In the DC panel, I observed a low percentage of cDC2 (Figure 6A) and high percentage of pDC (Figure 6B) in allergic cohort, which was the opposite of what I had expected. Human cDC2 expresses lectins, TLRs, NOD-like receptors and RIG-I-like receptors on their surface and respond well to LPS, flagellin, poly I:C and R484²³⁹. Upon stimulation, they were capable of secreting IL-12, IL-23, IL-1 and TNF- α . In an asthma mouse model, cDC2 promoted eosinophil recruitment²⁴⁰. Thus, it was surprising to me that allergic patients had lower percentage of cDC2. Plasmacytoid DC are characterized by rapid production of large quantities of type I and type III interferons in response to viral infections²³⁹. Several studies indicated that pDC played a regulatory role in allergic conditions²⁴¹⁻²⁴³. Heer and colleagues reported that pDCs were able to restore tolerance in an asthma mouse model²⁴³, while Antonia L and colleagues found that IFN secreted by pDCs constrain the Th2 cytokines production. In addition, the number of cDC1, cDC2 and

pDC showed a trend to be decreased in our allergic cohort compared to healthy individuals (supplementary table 2). Of note, cDC2s and pDCs express higher levels of the activation marker CD86 (Figure 6C-6F), which suggests that these cells, albeit present in lower numbers, are more proficient in activating T cells in allergic individuals.



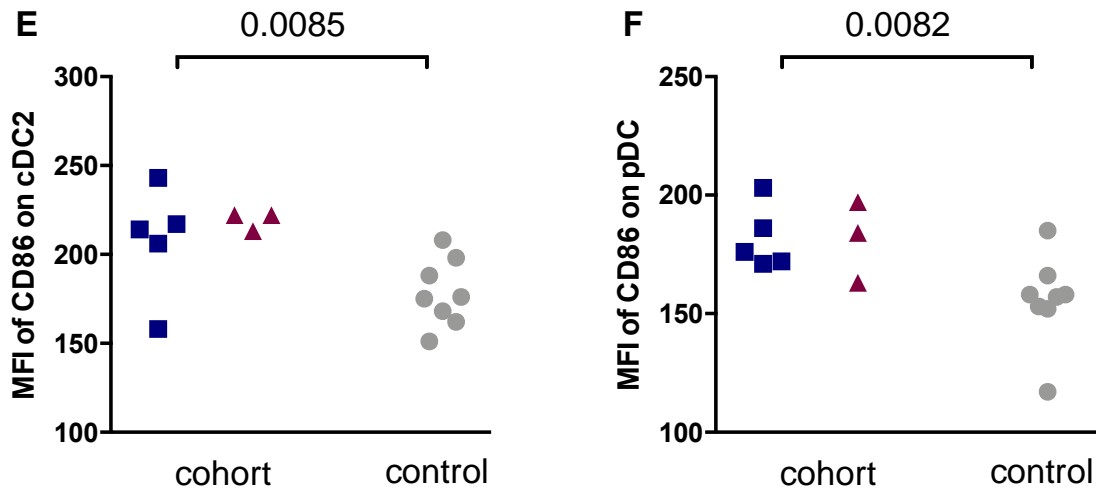

Figure 6 Percentage and phenotype of cDC2 and pDC in WASPenIP cohort and healthy control subjects. Percentage of cDC2s (A) and pDCs (B) among total DCs and Mean fluorescence intensity (MFI) of HLA-DR and CD86 on cDC2s (C, E) and pDCs (D,F), were represented as individual measurements from amoxicillin allergic patients (blue squares), wasp venom allergic patients (red triangles) and healthy individuals (grey). Unpaired t-test on grouped allergic donors vs healthy subject were performed and P values are indicated.

My lab showed previously that FcγRs and neutrophils play important roles in IgG-mediated anaphylactic reactions. It was therefore of particular interest for me to determine the phenotype of neutrophils and their expression of FcγRs in this cohort. I found that neutrophils from allergic patients expressed more CD10 and CD32/FcγRII on their surface (Figure 7A-7B). CD10 was described as a marker to distinguish mature neutrophils from immature neutrophils in G-CSF treated donors. Whereas CD10⁺ neutrophils could inhibit T cells proliferation through a CD18-mediated contact-dependent mechanism, CD10⁻ neutrophils promoted T-cell survival, T cell proliferation and IFN-γ production¹²². Importantly, I could not detect CD10⁻ neutrophils in the individuals of the cohort, which is likely due to the fact that neutrophils without inflammatory stimulation exit the bone marrow as mature cells.

CD32 regroup FcγRIIA, FcγRIIB and FcγRIIC. Neutrophils, however, express mainly FcγRIIA and very little FcγRIIB. Very little is known about the factors that regulate CD32 expression on neutrophils. It is generally accepted that the engagement of FcγRIIA on

neutrophils by IgG immune complexes triggers their internalization. However, for this to happen in measurable proportions, there must be a certain amount of circulating immune complexes in the blood. Here, however, the blood was taken at a distance from any allergic event that may include the generation of allergen immune complexes with anti-allergen IgG in these individuals that are otherwise healthy. It is therefore remarkable that an increased CD32 expression of neutrophils could be observed in the allergic individuals of our cohort compared to healthy donors. Neutrophils express large amounts of CD16/ FcγRIIIB on their surface, which is also named neutrophil antigens (NAs)^{5,6}. Its abundant expression on the neutrophil surface at steady state, and association with lipid rafts suggests that it can contribute to cell activation via co-clustering with integrins and by helping FcγRIIA to efficiently capture immune complexes (ICs)^{28,39}.

Together an increased CD10 and CD32 expression could indicate a possible regulatory role of neutrophils: on the one hand, neutrophils may contribute to regulate T cell proliferation by increased CD10 expression; on the other hand, increased CD32 could trap more allergen-IgG immune complexes on neutrophils and thereby decrease the chance of allergen capture by FcεRI-bound IgE on mast cells or basophils. Paralleling to the observation on neutrophils, I also found an increased expression of CD16 (Figure 7C) and CD32 (Figure 7D) on eosinophils of allergic patients. A similar finding was reported for eosinophils from asthmatic patients, which was interpreted as a sign of eosinophil priming associated with systemic inflammatory response during late asthmatic response²⁴⁴.

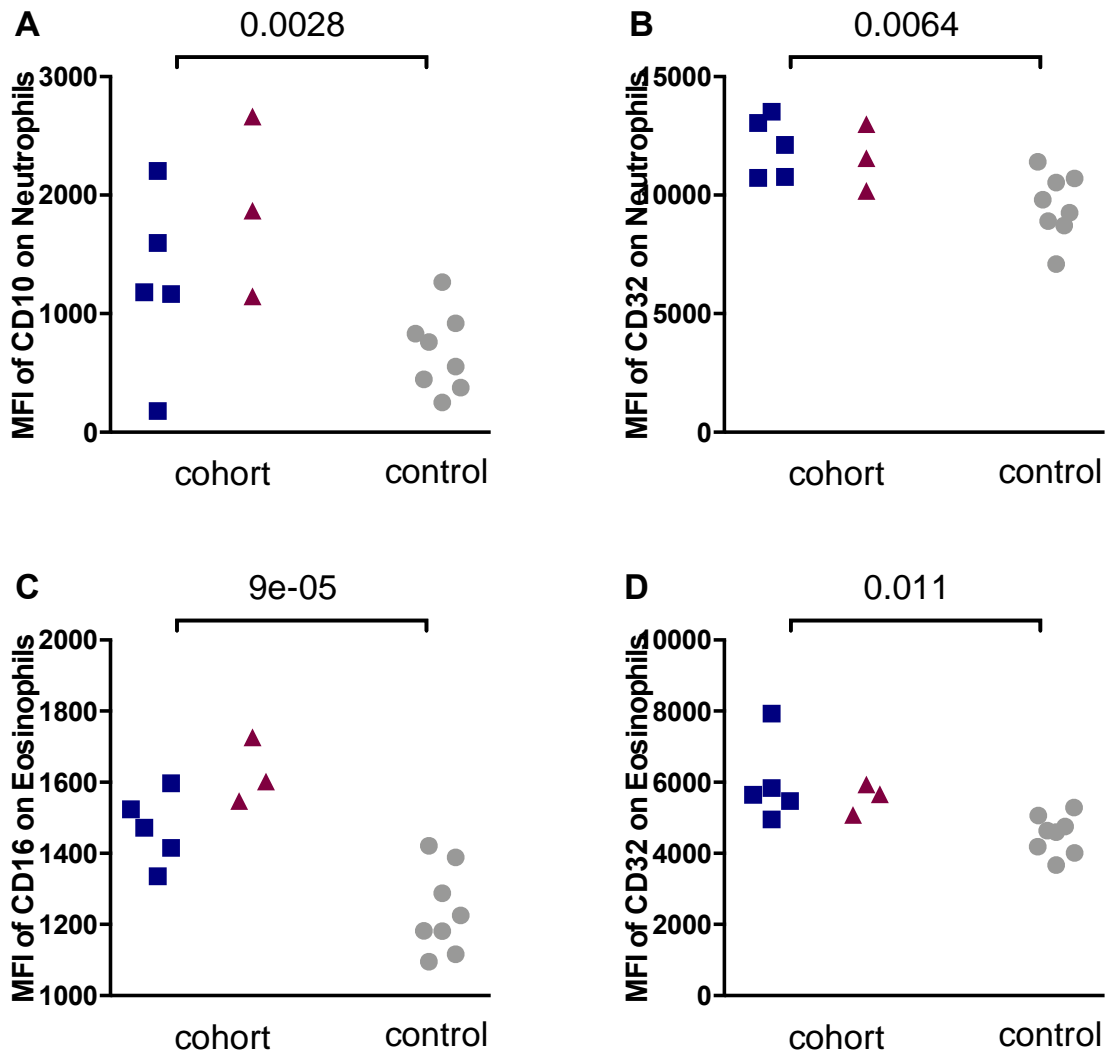

Figure 7 Phenotype of neutrophils and eosinophils in WASPenIP cohort and healthy control subjects. Mean fluorescence intensity (MFI) of CD10 (A) and CD32 (B) on neutrophils, and MFI of CD16 (C) and CD32 (D) on eosinophils were represented as individual measurements from amoxicillin allergic patients (blue squares), wasp venom allergic patients (red triangles) and healthy individuals (grey). Unpaired t-test on grouped allergic donors vs healthy subject were performed and P values were indicated.

Finally, we included in our FACS panel a panel aimed to analyse basophil phenotype and activation. We used this panel to evaluate basophil activation at steady state and also after 1-hour incubation of blood in the Truculture tube assays, either stimulated by wasp venom or by amoxicillin. Allergic samples were stimulated systematically with both compounds, amoxicillin serving as a control for the WASP-allergic samples, and

wasp venom serving as a control for the amoxicillin-allergic samples. We named this test “adapted basophil activation test” (adapted BAT), because it is a flow cytometry-based functional assay for to diagnosis of allergic sensitization. Classical BAT analysis for patient care was performed in parallel at the Hopital Bichat under the supervision of

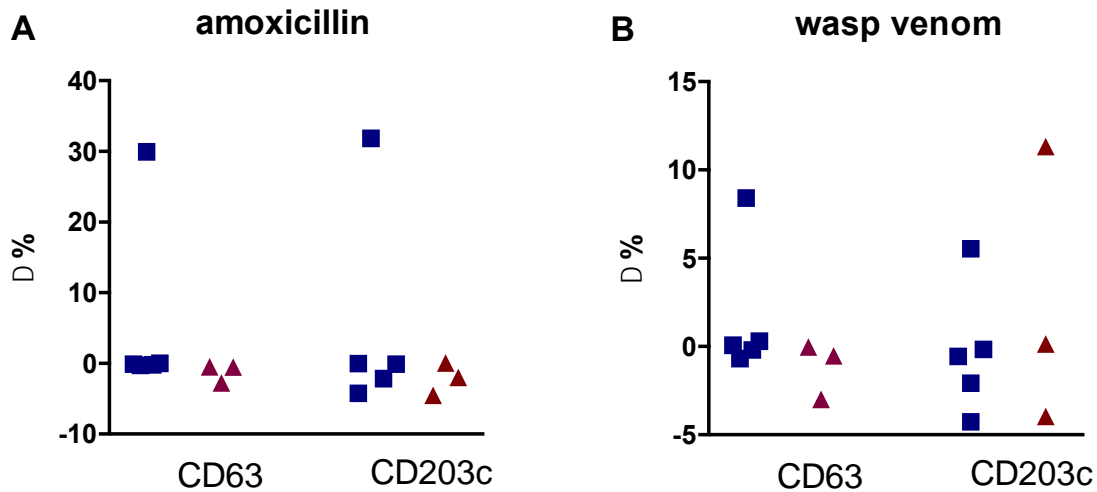

Figure 8 Basophil activation tests in WASPenIP cohort. Percentage of increased CD63⁺ basophils and CD203c⁺ basophils upon stimulate with amoxicillin (A) or wasp venom (B) were represented as individual measurements from amoxicillin allergic patients (blue squares) and wasp venom allergic patients (red triangles).

Pascale Roland-Nicaise.

In steady state, basophils from allergic donors express low amounts of CD63 and CD203c on their surface. Among the 5 amoxicillin allergic individuals only 1 showed increased CD63⁺ and CD203c⁺ expression on basophils upon amoxicillin stimulation (Figure 8A) in this adapted BAT and 1 wasp venom allergic patients out of three showed increased CD203c but no increased CD63 expression on their basophils after wasp venom stimulation (Figure 8B). On the other hand, all of these patients showed a positive response in the classical BAT performed at the hospital. Basophil reactivity is influenced by many factors¹²², such as time between blood collection and BAT; anticoagulants used, whether IL-3 is used to prime basophils; and finally the range and quality of the allergen. The cut-off values for a classical BAT used in amoxicillin allergy

diagnostics is a minimum of 5% CD63⁺ basophils, with 55% sensitivity and 80% specificity²³⁴. For wasp venom allergy, it was described as 2.5 - fold increase in the number of activated basophils (>25%) as compared with the negative control (10%), with 85.3% sensitivity and 83.3% specificity²⁴⁵. The low sensitivity of this adapted BAT could be due to the absence of IL-3 during the stimulation or the quantity (100ng/mL) or quality (wasp venom extract) of allergen used.

Cytokines and chemokines concentration upon stimulation

In addition to the phenotyping of blood cells populations in steady state conditions, the WASPenIP study included the assessment of whole blood stimulation assays that aimed to capture differences in induced immune responses between allergic patients and healthy donors. To minimize variations between samples, we used preloaded Truculture tubes, in which 1 ml of blood was added within 30 minutes of sampling. Six different stimuli were included in the study: a null tube to measure baseline activation, LPS as a mimic of a gram-negative bacterial infection, α -CD3/ α -CD28 as a T cells stimulus, poly I:C as a surrogate for a viral infection, and finally two tubes loaded with wasp venom, and amoxicillin, respectively. After 22 hours incubation at 37°C, the supernatant was recovered and, after a storage period at -80°C, subjected to quantification of 34 cytokines and chemokines using luminex technology.

My analysis shows that the inter-individual variations in such a small sample number is too big to detect any significant differences using supervised statistical. Nevertheless, I will describe some of the observed trends that seem interesting paths for future investigations.

In the Milieu Interieur cohort approximately 1 out of 3 donors failed to fully respond to stimulation with α -CD3/ α -CD28²⁴⁶. It was therefore not unexpected that in our cohort 2 allergic patients and 2 healthy individuals failed to produce IL-2 (Figure 9A), 2 allergic patients and 4 healthy individuals failed to produce IL-6 (Figure 9B) in response to α -CD3/ α -CD28 stimulation. All of the donors in our cohort and control group were capable

of producing IFN- γ (Figure 9C).

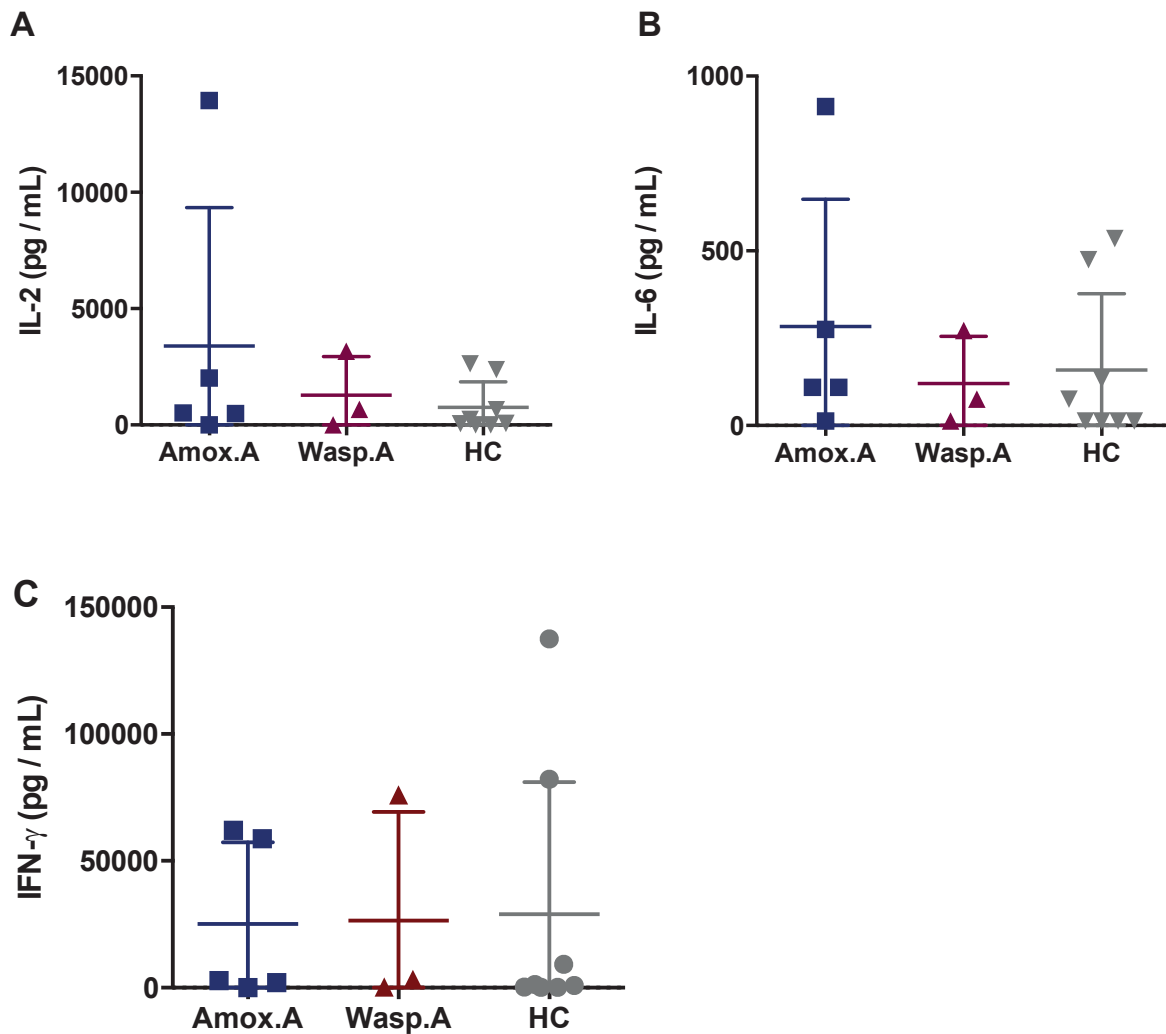

Figure 9 IL-2, IL-6 and IFN- γ concentration in whole blood stimulation assay following α -CD3/ α -CD28 stimulation. Dot plots with individual measurements for induced IL-2 (A), IL-6 (B) and IFN- γ (C) in response to incubation of whole blood with α -CD3/ α -CD28 in allergic patients (wasp venom allergic patients: red triangles, amoxicillin allergic patients: blue squares) and healthy subjects (grey dots). Mean and SEM were indicated by overlaid horizontal bar and whiskers.

To question whether allergic patients in the cohort show a pronounced Th2 bias, I compared Th2 cytokines following α -CD3/ α -CD28 stimulation to the null condition. Importantly my flow cytometry data revealed that there was no statistical difference in

Th2 cell numbers, and Th2 cell percentage between healthy donors and allergic patients in steady state, a difference could therefore only arise from cell intrinsic effects.

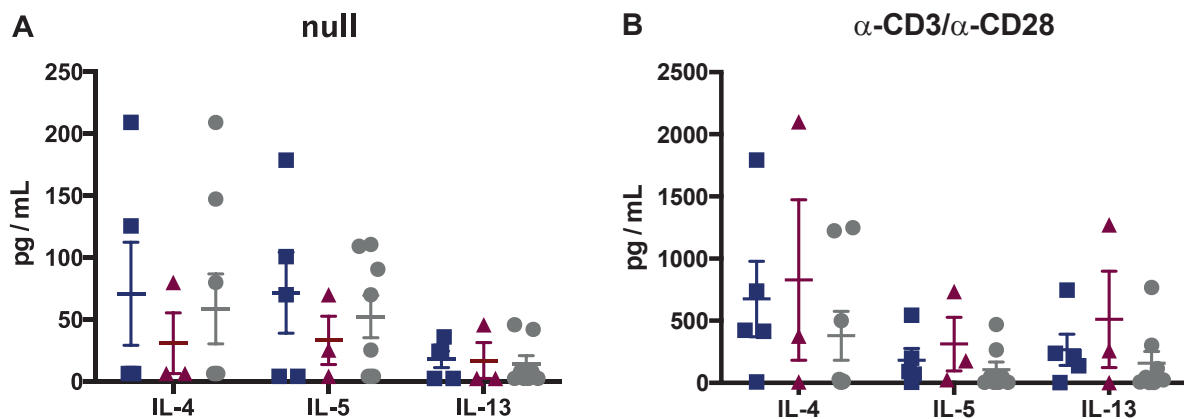

Figure 10 Measurement of Th2 cytokine concentrations in Truculture supernatant. Dot plot with individual measurements indicated IL-4, IL-5 and IL-13 concentration in response upon incubation of whole blood without stimuli (A) and with α -CD3/ α -CD28 (B) stimulation in allergic patients (wasp venom allergic patients: triangles; amoxicillin allergic patients: blue squares) and healthy subjects (grey dots) Incomplete responders are indicated with an x in the symbol. Mean and SEM were indicated by overlaid horizontal bar and whiskers.

Without stimulation, there were no differences in IL-4, IL-5 and IL-13 concentrations between the groups (Figure 10A). T cells stimulation induced measurable Th2 cytokine concentrations irrespectively of the test group, but it appears that the blood from allergic donors produced slightly more IL-4, IL-5 and IL-13 than cells from the control group (Figure 10B). These data therefore suggest that allergic donors may respond stronger after induction of Th2 cytokines upon T cells stimulation, in agreement with Th2 biased immune responses.

Based on my observation that allergic donors show higher ratios of Th17 cells - CD4 T cells in my flow cytometry analysis, I next investigated whether this difference would also functionally translate into augmented cytokine concentrations typically associated with Th17 cells upon T cells stimulation (Figure 11).

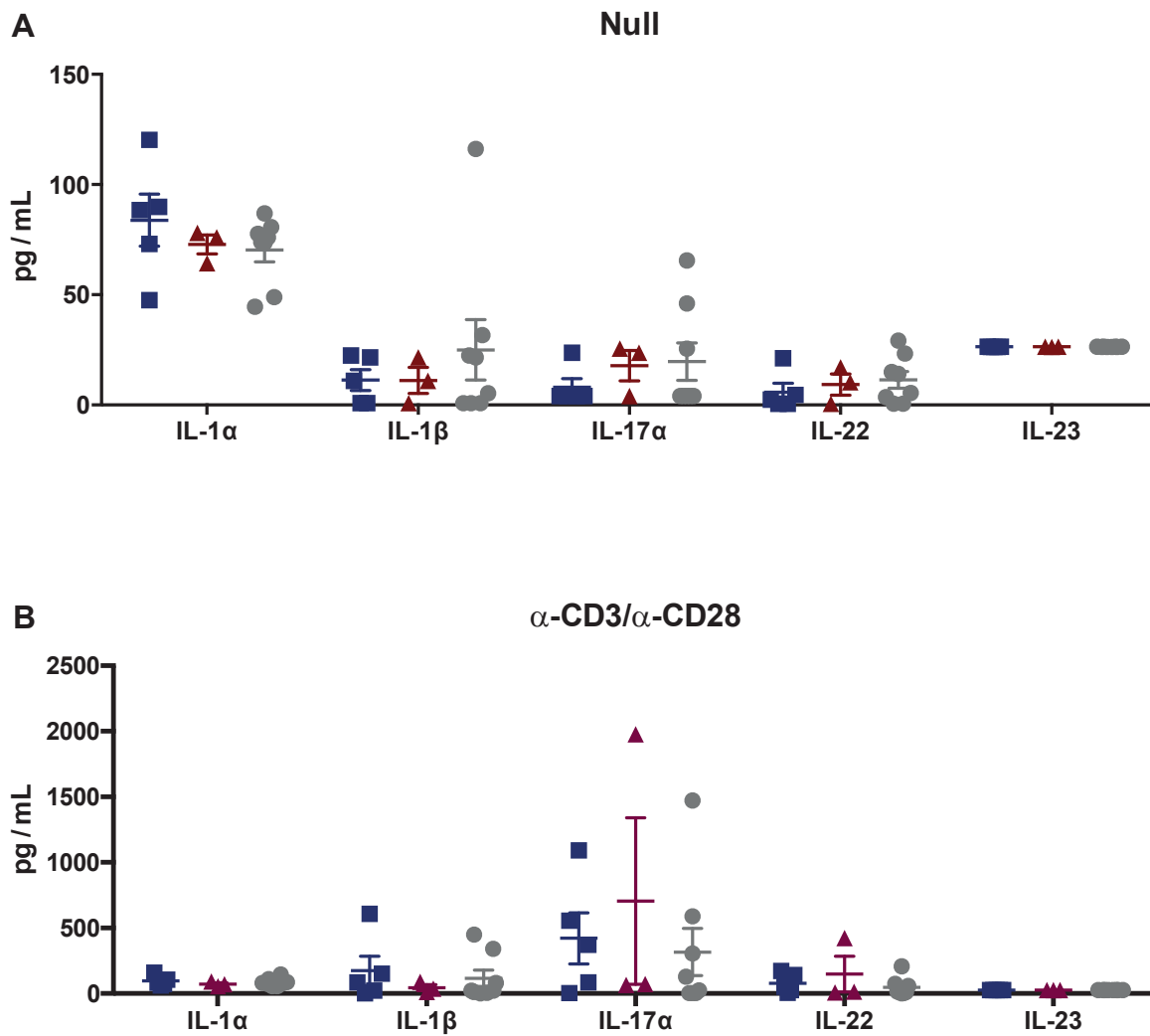

Figure 11 Measurement of Th17 cytokine concentrations in Truculture supernatant. Dot plot with individual measurements indicated IL-1A, IL-B, IL-17A, IL-22 and IL-23 concentration in response upon incubation of whole blood without stimuli (A) and with α -CD3/ α -CD28 (B) stimulation in allergic patients (wasp venom allergic patients: triangles, amoxicillin allergic patients: blue squares) and healthy subjects (grey dots). Mean and SEM were indicated by overlaid horizontal bar and whiskers.

As expected, there were little Th17 cytokines detected without stimulation (Figure 11A). I however observed a tendency for augmented IL-17 and IL-22 secretion in blood samples from allergic donors compared to controls, in agreement with my flow cytometry data revealing augmented Th17 /CD4 T cell ratios. Inter-individual variations within each group were high, precluding any analysis of significance.

The hygiene hypothesis postulates that a the loss of infection pressure on the population leading to the reduction of Th1 immunity, and as a consequence to an imbalance of Th1/Th2 immunity, resulting in a higher incidence of allergic disorders²⁴⁷. Although I did not observe a reduction of Th1 cells in allergic donors, I wanted to compare their Th1 cytokine profile without stimulation, as well as following surrogate bacteria and virus infection stimulants with LPS and poly I:C respectively (Figure 12).

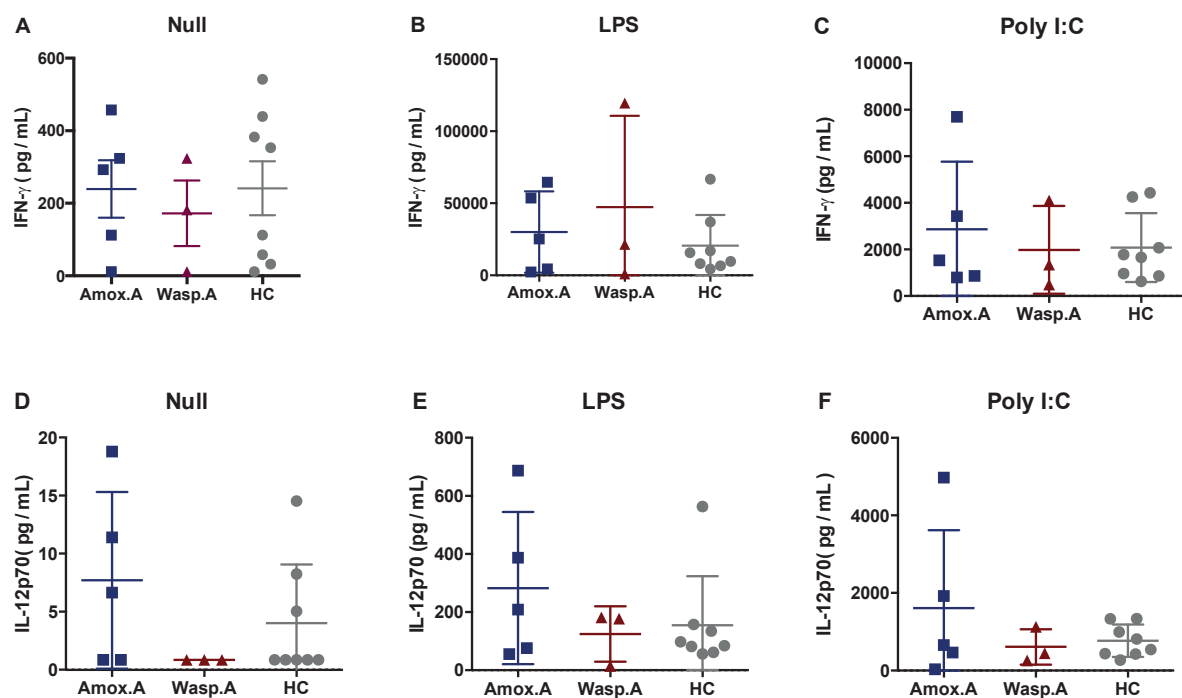

Figure 12 Measurement of Th1 cytokine concentrations in Truculture supernatant. Dot plot with individual measurements indicated IFN-γ and IL-12p70 concentration in response upon incubation of whole blood without stimuli (A, D) and with α -CD3/ α -CD28 (B, E) stimulation, with LPS (C, F) stimulation in allergic patients (wasp venom allergic patients: triangles, amoxicillin allergic patients: blue squares) and healthy subjects (grey dots). Mean and SEM were indicated by overlaid horizontal bar and whiskers.

Again, the inter-individual variations did not enable me to determine any clear trends between the groups for neither IFN-γ (Figure 12A-C) nor IL-12p70 (Figure D, E, F) secretions.

In the IgE association study, I could show that individuals with high serum IgE concentrations secreted more of the regulatory cytokine IL-10 upon T cell stimulation with α -CD3/ α -CD28. I therefore tested whether the IL-10 secretion was also augmented in allergic individuals and compared the 6 conditions of stimulation (Figure 13). Surprisingly, there is no difference between the null, T cell stimulation and LPS stimulation. However, the wasp venom allergic individuals had even lower IL-10 secreted in Poly I: C, wasp venom and amoxicillin stimulation compared to the null condition.

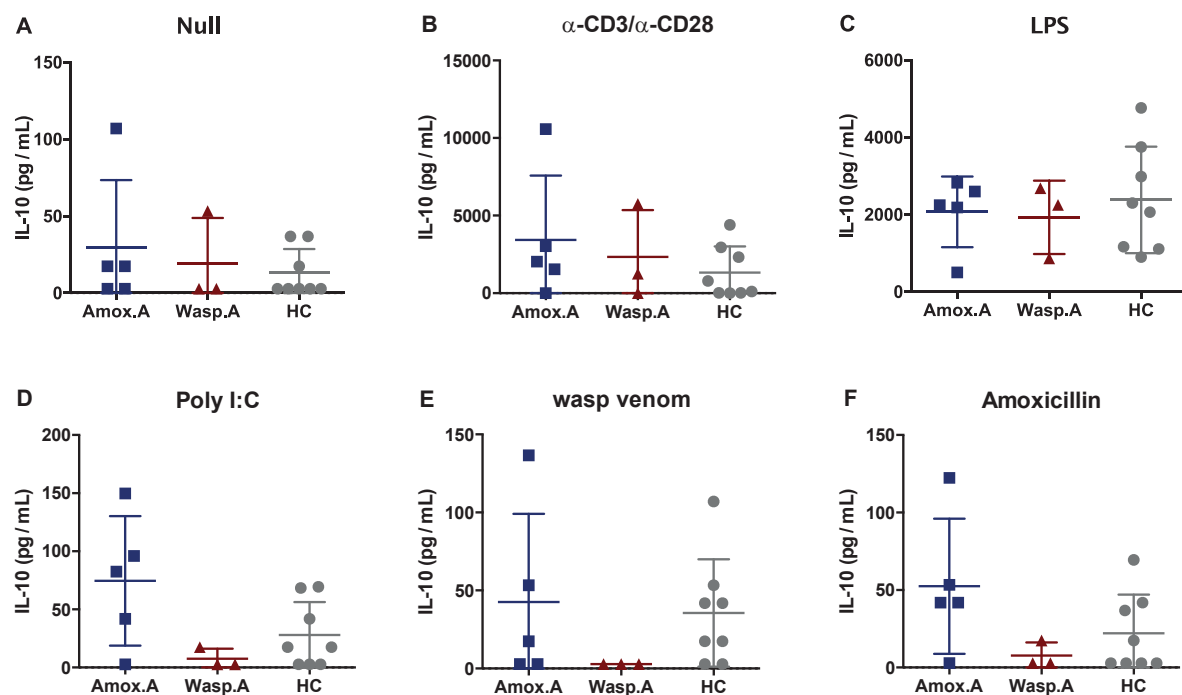

Figure 13 Measurement of IL-10 concentrations in Truculture supernatant. Dot plot with individual measurements indicated IL-10 concentration in response upon incubation of whole blood without stimuli (A) and with α -CD3/ α -CD28 (B) stimulation, with LPS (C) stimulation, with Poly I: C stimulation (D), with wasp venom (E) and with (amoxicillin) in allergic patients (wasp venom allergic patients: red triangles, amoxicillin allergic patients: blue squares) and healthy subjects (grey dots). Mean and SEM were indicated by overlaid horizontal bar and whiskers.

With so few samples it is again difficult to determine a trend from these results. Notably in the amoxicillin group there was a larger heterogeneity that was already visible in the null condition. Surprisingly, in samples from wasp venom allergic individuals there

seemed to be lower IL-10 secreted upon poly I:C, wasp venom and amoxicillin stimulation than in the null condition and less than in the controls and amoxicillin allergic groups.

Indeed, for most of the chemokines tested, there was no difference between healthy controls and the two groups of allergic patients, as exemplified for Eotaxin, an eosinophil chemotactic protein (Figure 14).

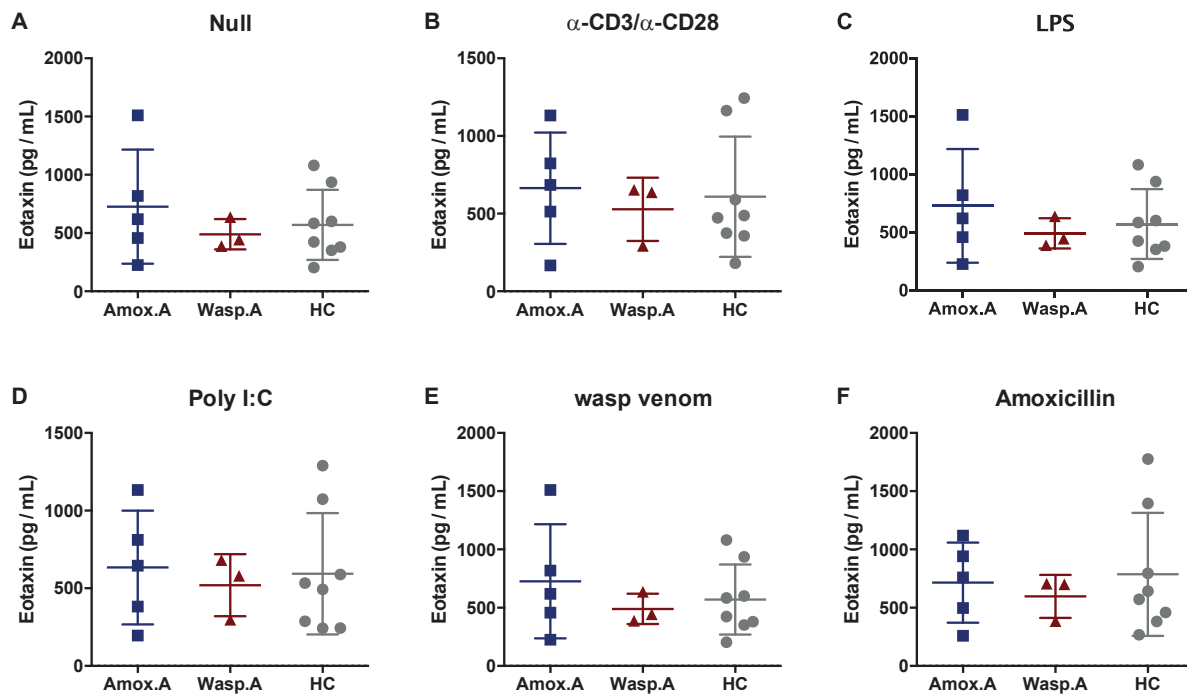

Figure 14 Measurement of Eotaxin concentrations in Truculture supernatant. Dot plot with individual measurements indicated induced CCL5 levels in response upon incubation of whole blood without stimuli (A), with α -CD3/ α -CD28 (B), with LPS (C), with poly I: C (D), with wasp venom (E) and with amoxicillin (F) in allergic patients (wasp venom allergic patients: red triangles, amoxicillin allergic patients: blue squares) and healthy subjects (grey dots). Mean and SEM were indicated by overlaid horizontal bar and whiskers.

Remarkably, however, the two groups of allergic donors showed a distinct response from each other in certain conditions and for some released proteins. Of course, one has to keep in mind the very low sample number, but to give just two examples: amoxicillin allergic donors tended to produce more CCL5 (Figure 15) and CXCL12 (Figure 16) than

wasp venom allergic donors in relevant and non-relevant allergen stimulation conditions.

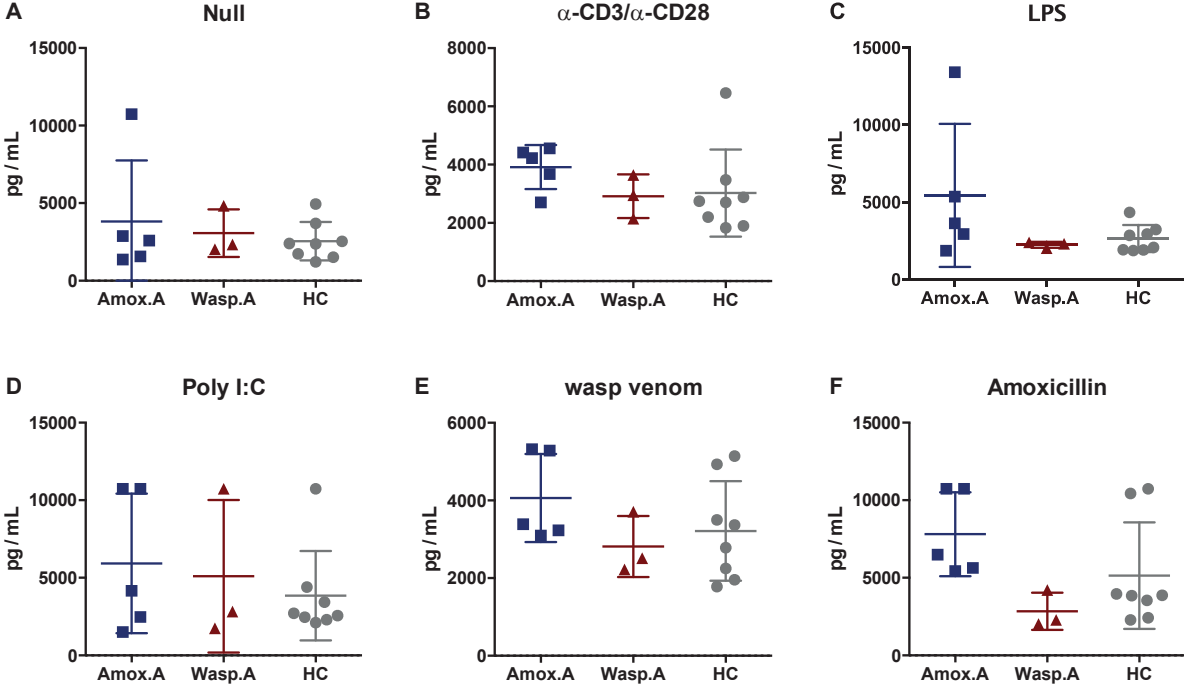

Figure 15 Measurement of CCL5 concentrations in Truculture supernatant. Dot plot with individual measurements indicated induced CCL5 levels in response upon incubation of whole blood without stimuli (A), with α -CD3/ α -CD28 (B), with LPS (C), with poly I: C (D), with wasp venom (E) and with amoxicillin (F) in allergic patients (wasp venom allergic patients: red triangles, amoxicillin allergic patients: blue squares) and healthy subjects (grey dots). Mean and SEM were indicated by overlaid horizontal bar and whiskers.

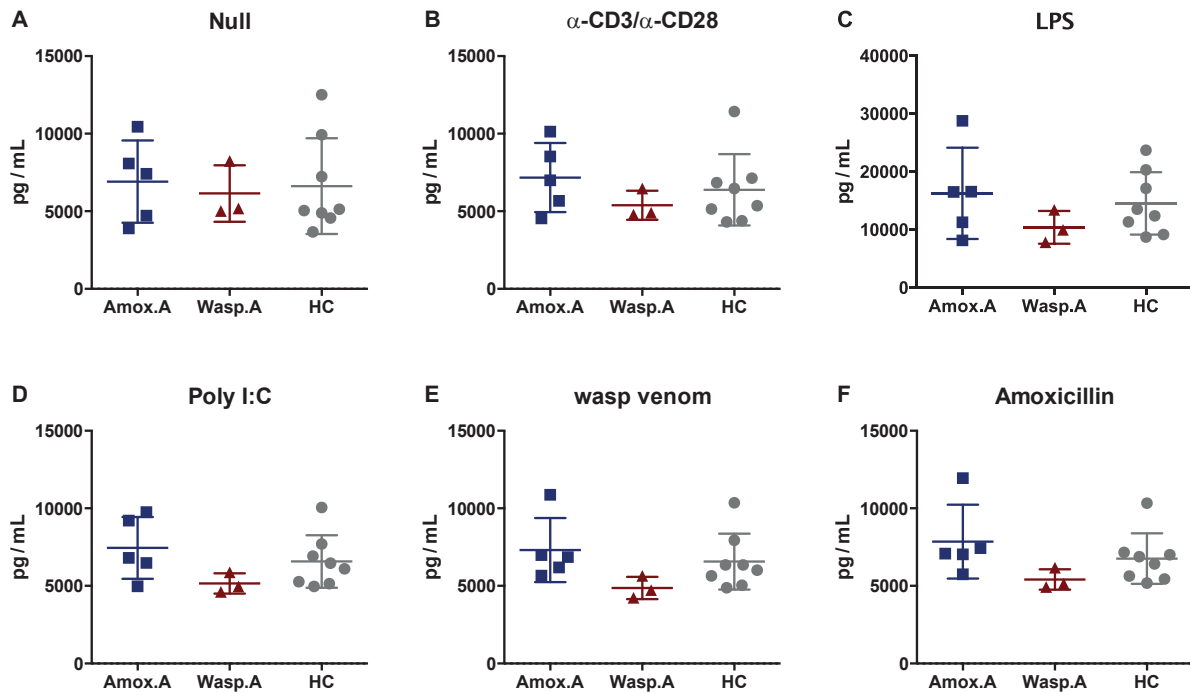

Figure 16 Measurement of CXCL12 concentrations in Truculture supernatant. Dot plot with individual measurements indicated induced CCL5 levels in response upon incubation of whole blood without stimuli (A), with α -CD3/ α -CD28 (B), with LPS (C), with poly I: C (D), with wasp venom (E) and with amoxicillin (F) in allergic patients (wasp venom allergic patients: red triangles, amoxicillin allergic patients: blue squares) and healthy subjects (grey dots). Mean and SEM were indicated by overlaid horizontal bar and whiskers.

Of course, this behaviour needs to be confirmed with a bigger number of included patients. Our limited data concluded that in the steady state, allergic donors had increased Th2 cells, Th17 cells as well as Tregs, although there was no difference in their related cytokines been observed in our 6 conditions of stimulation. Of note, the amoxicillin allergic patients had high CCL5 concentrations upon relevant and non-relevant allergen stimulation. CCL5 was expressed by T cells upon stimulation²⁴⁸, which had been shown to play a critical role in recruiting leukocytes²⁴⁹. The high CCL5 concentrations in amoxicillin allergic patients indicated that in amoxicillin allergic conditions, leukocytes were prone to be recruited in the circulation upon stimulation and induced systematic reaction; while in wasp venom allergy, the situation was reverse. The sensitization route in these two types of allergies could also explain such difference:

oral/injection sensitization in amoxicillin allergy and skin sensitization (through insect sting) in wasp venom allergy. Moreover, another potent leukocytes activator CXCL12 was also increased in amoxicillin allergic patients²⁵⁰.

In the next step, since the high inter-individuals variations could not provide us more evidence on difference between allergic and healthy individuals from single cytokine detected. I applied a machine-learning algorithm to visualize proximity of these multi-dimensional samples in a two-dimensional space. For each of the conditions, I performed a t-distributed stochastic neighbour embedding (t-SNE) analysis (Figure 17).

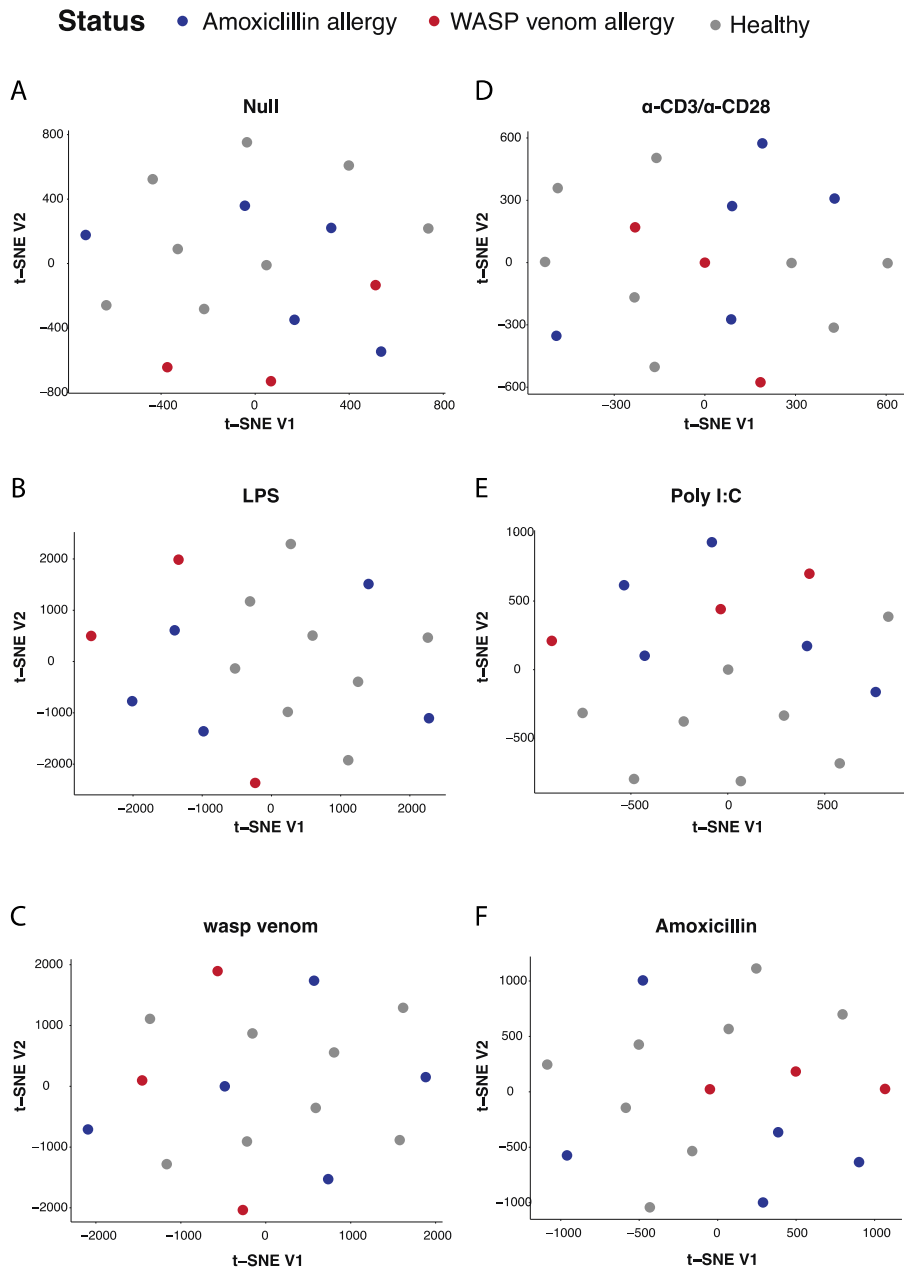

Figure 17 T-SNE analysis of induced immune response in WASPenIP cohort. Data used for t-SNE approach were cytokines and chemokine levels from null stimulation condition (A), CD3/CD28 stimulation condition (D), LPS stimulation condition (B), poly I:C condition (E), wasp venom condition (C), and amoxicillin condition (F). Each dot represented result calculated from one individual. Healthy individuals are depicted in grey; amoxicillin allergic patients in blue; and wasp venom allergic patients in red.

As expected allergic patients and controls showed an almost perfect mixing in the null

condition with no clusters that could be identified (Figure 17A). But also in the other conditions the groups stayed mostly mixed and no distinct clusters could be identified that would allow separation of the patient groups (Figure 17). This failure to separate the two or three groups is mostly due to the low sample number and the rather large inter-individual variations.

Conclusion WASpenIP

Taken together, my analysis of the WASPenIP study remains preliminary due to the small numbers of inclusions and the resulting limited statistical power. My results seem to suggest that allergic patients present with increased Th2 cells and Th17 cells ratios, augmented expression of HLA-DR in naive T cells, and CD86 on cDC2s and pDCs, suggestive of a more mature/activated phenotype. My data further reveal a higher expression of CD32 by neutrophils as well as CD16 and CD32 eosinophils and a higher expression of CD10 on neutrophils. Finally, the analysis of induced immune responses failed so far to identify different immune phenotype between allergic individuals and healthy donors, it however seems to be in accordance with the data from the flow cytometry analyses. Interestingly, analysis of induced responses points towards distinct immune responses of wasp venom and amoxicillin allergic patients that need to be confirmed with greater patient number.

3.2.2 Wasp venom allergy mouse model:

Clinical studies in humans remain often descriptive and it was my goal to accompany the WASPenIP study with some fundamental research in a mouse model to tackle some more mechanistic questions. Surprisingly there were only 2 reports on mouse models of wasp venom allergy^{251,252}; both were both done in Balb/c mice, a mouse strain known to favour Th2-driven immune responses.

To be able to mechanistically investigate the physiopathology involved in sensitization during wasp venom allergy, I chose to complement my research project with a wasp venom allergy mouse model in C57Bl/6 mice. This would allow me to use transgenic mice that are mostly on this background to address questions about the antibody subclass, the effector cell type and the antibody receptors responsible for the reaction.

A wasp injects between 15µg-50 µg of wasp venom per sting¹²⁸. Wasp venom is a natural product of several components, the relative contribution of which may vary from one preparation to another. After a first series of failed immunizations using only wasp venom at natural sting doses via the subcutaneous route, I applied a standard immunization procedure including adjuvant. I augmented the venom dose and added an adjuvant to obtain a good and reproducible level of immunization. I decided to use Freund's Complete adjuvant/ Freund's Incomplete adjuvant (CFA/IFA), that induces a similar antibody secretion profile in C57BL/6J mice as does alum adjuvant in Balb/c mice (internal communication, unpublished). I used 100 µg of wasp venom in presence of CFA/IFA to immunize mice via an intraperitoneal (i.p.) route. After a first injection of wasp venom in CFA, three boosts of venom in IFA were separated by 2-4 weeks (Figure 18).

Although all mice showed similar wasp venom specific antibody levels following immunization, only two-thirds of mice developed hypothermia after challenge (Figure 20/19). The heterogeneity in response could be caused by the already mentioned variations in wasp venom composition, but also by differences in induced anti-wasp venom antibody classes, notably IgE vs IgG. As our tools did not allow separating these two phenomena, we decided to change the experimental approach and to focus on immunizations elicited against only one component of wasp venom.

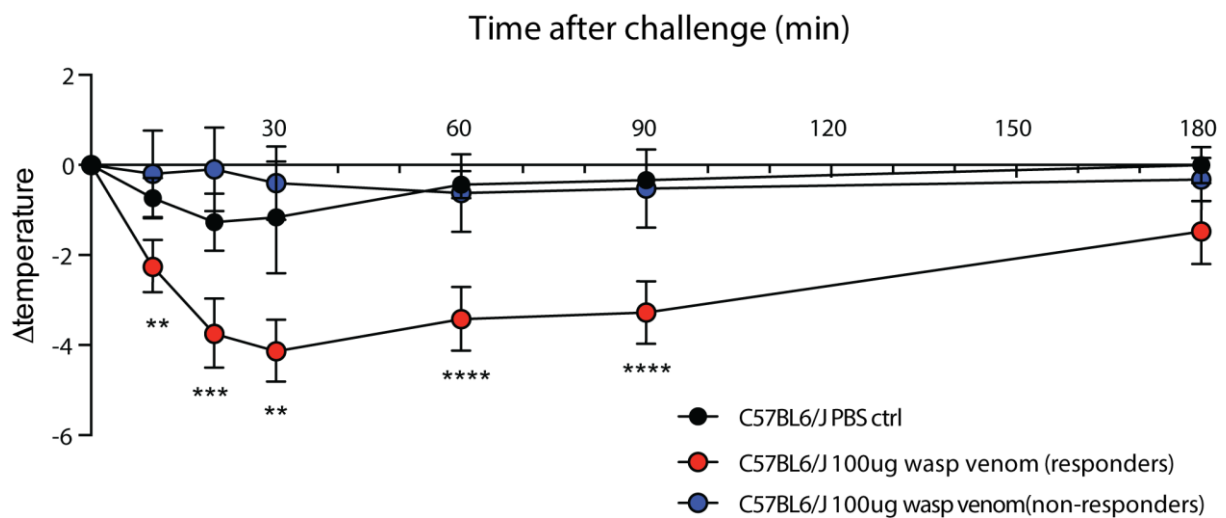

Figure 19 Heterogenous hypothermia responses in mice sensitized and challenged with wasp venom. Changes in body temperature in each time points after challenge with wasp venom in wasp venom sensitized (red and blue dots) or PBS treated mice (black dot). N=4 in PBS treated group; 8 mice showed hypothermia after challenge (red dots); 4 mice didn't response to wasp venom challenge. T-test was performed between responder group and control group separately in each time points. *P<0.05, **P<0.01, ***P<0.001, ****P<0.0001.

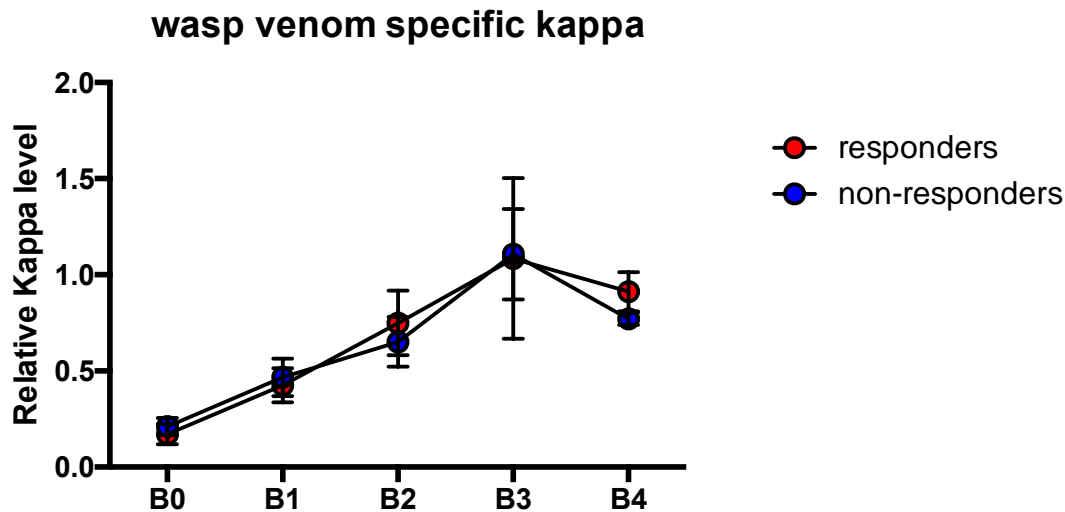

Figure 20 Relative wasp venom specific kappa levels. Blood was taken before immunization as B0 and after the first immunization B1, first boost B2, second boost B3 and last boost B4. The wasp venom specific kappa ELISA were tested by coating plate with 10ug/mL wasp venom and detected with 1:4000 dilutions anti-mouse kappa antibody. Relative kappa level was calculated by dividing the OD values in each sample to the standard sample (pooled serum from the immunized mice).

To this aim, I first tried to produce the major wasp venom allergens, Ves V 1 and Ves V 5 in insect cells using a baculovirus infection approach²⁵³. However, despite a promising production at low scale, it was impossible to obtain sufficient intact protein for immunization of larger groups of mice. Building on the laboratory's expertise in Expi293 liquid culture transfections, I then developed a mammalian expression system and could successfully obtain large amounts of Strep-tagged Ves V 5. Supernatant from transfected cells was purified on a streptactin column (Iba) and dialysed to remove biotin used for protein elution. Currently, the immunizations are ongoing and first results will be presented during my oral PhD defence. The Ves V 5 sensitization mouse model would provide a tool for the mechanistical studies of wasp venom allergy. Once established, we will apply our immunization protocol in the mice expressing human FcεRI, human IgE and human FcγRs, human IgG mouse model to clarify the contribution of classical pathway and alternative pathway in wasp venom allergy. Moreover, Strep-tagged Ves V 5 could be a tool to label B cells specific for Ves V 5 in immunized mice or patient samples (as done now in our lab), which would help in identifying the antibody repertoires against Ves V 5.

Supplementary Table 1 Antibodies used in Flow cytometry

Antigen	Fluorophore	Clone	Supplier	Panel
CD8b	VioBlue	REA715	Miltenyi Biotech	1
CD4	VioGreen	REA623	Miltenyi Biotech	1
CD56	VioBright 515	REA196	Miltenyi Biotech	1
CD45 (LCA)	PE	REA747	Miltenyi Biotech	1
CD14	PerCP-Vio700	REA599	Miltenyi Biotech	1
CD19	PE-Vio770	REA675	Miltenyi Biotech	1
CD16 (FcγRIIIA, FcγRIIIB)	APC	REA423	Miltenyi Biotech	1
CD3	APC-Vio770	REA613	Miltenyi Biotech	1
CD8b	VioBlue	REA715	Miltenyi Biotech	2
CD4	VioGreen	REA623	Miltenyi Biotech	2
CD185 (CXCR5)	FITC	REA103	Miltenyi Biotech	2
CD294 (CRTH2)	PE	REA	Miltenyi Biotech	2
CD196 (CCR6)	PE-Vio615	REA190	Miltenyi Biotech	2
CD194 (CCR4)	PE-Vio770	REA279	Miltenyi Biotech	2
CD183 (CXCR3, CKR- L2, GPR9)	APC	REA232	Miltenyi Biotech	2
TCRg/δ	APC-Vio770	REA	Miltenyi Biotech	2
CD8b	VioBlue	REA715	Miltenyi Biotech	3
Viability Fixable Dye	VioGreen		Miltenyi Biotech	3

CD45RA	FITC	REA562	Miltenyi Biotech	3
CD25 (IL-2R α)	PE	REA570	Miltenyi Biotech	3
HLA-DR	PerCP-Vio700	REA805	Miltenyi Biotech	3
CD278 (ICOS)	PE-Vio770	REA192	Miltenyi Biotech	3
CD127 (IL-7R α chain)	APC	REA614	Miltenyi Biotech	3
CD4	APC-Vio770	REA623	Miltenyi Biotech	3
CD8b	VioBlue	REA734	Miltenyi Biotech	4
CD4	VioGreen	REA623	Miltenyi Biotech	4
CD45RA	FITC	REA562	Miltenyi Biotech	4
CD27	PE	REA499	Miltenyi Biotech	4
HLA-DR	PerCP-Vio700	REA805	Miltenyi Biotech	4
CD8	PE-Vio770	REA715	Miltenyi Biotech	4
CD197	APC	REA546	Miltenyi Biotech	4
(CCR7)	APC	REA546	Miltenyi Biotech	4
CD86 (B7-2)	VioBlue	FM95	Miltenyi Biotech	5
Viability Fixable Dye	VioGreen		Miltenyi Biotech	5
CD19	VioGreen	REA675	Miltenyi Biotech	5
CD3	VioGreen	REA613	Miltenyi Biotech	5
CD335 (NKp46, NCR1)	BV510	29A1.4	BD Biosciences	5
CD1c (BDCA-1, R7, M241)	VioBright FITC	REA694	Miltenyi Biotech	5
CD303 (BDCA-2)	PE	REA693	Miltenyi Biotech	5

HLA-DR	PerCP-Vio700	REA805	Miltenyi Biotech	5
CD141 (BDCA-3)	PE-Vio770	REA674	Miltenyi Biotech	5
CD304 (BDCA-4, Neuropilin-1, NRP1)	APC	REA774	Miltenyi Biotech	5
CD14	APC-Vio770	REA599	Miltenyi Biotech	5
CD193(CCR3)	VioBlue	REA574	Miltenyi Biotech	6
CD16 (FcγRIIIA, FcγRIIIB)	VioGreen	REA423	Miltenyi Biotech	6
CD62L	FITC	145/15	Miltenyi Biotech	6
CD32 (FcγRII)	PE	2E1 / REA	Miltenyi Biotech	6
CD10 (CALLA, neprilysin)	PerCP-Vio700	REA877	Miltenyi Biotech	6
CD184 (CXCR4)	PE-Vio770	REA649	Miltenyi Biotech	6
CD177	APC	REA258	Miltenyi Biotech	6
CD66b (CEACAM8)	APC-Vio770	REA306	Miltenyi Biotech	6
Viability Fixable Dye	VioGreen		Miltenyi Biotech	7
FcεRIα	FITC	REA758	Miltenyi Biotech	7
CD193 (CCR3)	PE	REA574	Miltenyi Biotech	7
CD63 (LIMP1, LAMP-3)	PE-Vio770	H5C6	Miltenyi Biotech	7
CD203c	APC	REA826	Miltenyi Biotech	7

Supplementary Table 2 Immunephenotypes determined by flow cytometry

Phenotype	Mean (cohort)	Mean (control)	Standard Error	Panel
Number of CD45 ⁺ cells/mL	208404	146424	31349	1
Number of CD19 ⁺ cells/mL	4369	3355	1176	1
Number of CD3 ⁺ cells/mL	30547	30613	6784	1
Number of CD4 ⁺ CD8 ⁻ cells/mL	15775	19135	3362	1
Number of CD8 ⁺ CD4 ⁻ cells/mL	9901	8056	2572	1
Number of CD56 ⁺ cells/mL	6418	5681,38	1397	1
Number of CD56 ^{dim} cells/mL	5904	5029	1249	1
Number of CD56 ^{hi} cells/mL	359	416,88	115,29	1
Number of neutrophil/mL	145122	91867	21489	1
Number of CD16 ⁺ monocytes cells/mL	1154	1177	354	1
Number of CD16 ⁻ monocytes cells/mL	285	203	124	1
% CD45 ⁺ cells in total cells	81,53	71,61	6,56	1
% of CD19 ⁺ cells in CD45 ⁺ cells	1,91	2,26	0,44	1
% of CD3 ⁺ cells in CD45 ⁺ cells	13,56	22,16	3,12	1
% of CD4 ⁺ CD8 ⁻ cells in CD3 ⁺ cells	50,59	65,93	5,05	1
% of CD8 ⁺ CD4 ⁻ cells in CD3 ⁺ cells	32,93	24,36	4,35	1
% of CD56 ⁺ cells in CD45 ⁺ cells	2,94	4,19	0,80	1
% of CD56 ^{dim} cells in CD56 ⁺ cells	92,26	87,54	2,54	1
% of CD56 ^{hi} cells in CD56 ⁺ cells	5,58	8,61	2,25	1
% of neutrophil in CD45 ⁺ cells	66,33	57,7	3,71	1
% of CD16 ⁻ monocytes in monocytes	82,06	86,28	2,61	1

% of CD16 ⁺ monocytes in monocytes	17,63	13,70	2,59	1
Number of $\gamma\delta$ T cells/mL	1557	2020	1322	2
Number of CD4 ⁺ CD8 ⁻ cells/mL	25110	21385	5763	2
Number of Th1 cells/mL	6658	6599	1915	2
Number of Th2 cells/mL	335	203	66	2
Number of Th17 cells/mL	2551	1391	505	2
Number of CD8 ⁺ cells/mL	8674	7322	2464	2
% of $\gamma\delta$ T cells in total cells	0,79	0,81	0,39	2
% of CD4 ⁺ CD8 ⁻ in total cells	16,09	8,90	2,01	2
% of Th1 cells in CD4 ⁺ cells	25,03	34,48	4,78	2
% of Th2 cells in CD4 ⁺ cells	1,34	1,06	0,24	2
% of Th17 cells in CD4 ⁺ cells	10,53	6,95	1,97	2
% of CD8 ⁺ in total cells	5,08	3,17	0,69	2
% of CCR6 ⁺ cells in CD8 ⁺ cells	2,76	0,86	0,88	2
% of CCR6 ⁻ cells in CD8 ⁺ cells	96,40	98,38	1,03	2
Number of CD4 ⁺ CD8 ⁻ cells/mL	40431	47557	7117	3
Number of Tregs/mL	3949	4028	787	3
% of CD4 ⁺ CD8 ⁻ in total cells	11,65	9,02	1,28	3
% of Tregs in total cells	1,09	0,76	0,10	3
% of activated Tregs in Tregs	19,81	21,26	2,92	3
% of memory Tregs in Tregs	55,31	61,16	3,73	3
% of naïve Tregs in Tregs	24,28	17,33	3,58	3
MFI of ICOS on activated Tregs	1396	1127,75	201,60	3
MFI of ICOS on memory Tregs	745,38	605,88	109,41	3
MFI of ICOS on naïve Tregs	294,38	204,75	50,16	3

Number of CD3 ⁺ cells/mL	37127	38479	7574	4
Number of CD4 ⁺ CD8 ⁻ cells/mL	20880	23096	4821	4
Number of CD4 ⁺ CD8a ⁺ cells/mL	373	480	236	4
Number of CD4 ⁺ T _{CM} /mL	10975	10572	2602	4
Number of CD4 ⁺ T _{EM} /mL	1570	1553	555	4
Number of CD4 ⁺ T _{EMRA} /mL	429	398	347	4
Number of naïve CD4 ⁺ /mL	7906	10574	3416	4
Number of CD8 ⁺ CD4 ⁻ cells/mL	8937	11061	2557	4
Number of CD8 ⁺ T _{CM} /mL	4036	5004	1373	4
Number of CD8 ⁺ T _{EM} /mL	921	1736	679	4
Number of CD8 ⁺ T _{EMRA} /mL	1263	1029	652	4
Number of naïve CD8 ⁺ /mL	2717	3292	820	4
% of CD3 ⁺ in total cells	18,89	14,46	5,98	4
% of CD4 ⁺ CD8 ⁻ in CD3 ⁺ cells	64,53	59,38	0,82	4
% of CD4 ⁺ CD8a ⁺ cells in CD4 ⁺ cells	1,69	2,01	6,64	4
% of CD4 ⁺ T _{CM} in CD4 ⁺ cells	51,33	48,90	2,14	4
% of CD4 ⁺ T _{EM} in CD4 ⁺ cells	7,04	7,37	1,22	4
% of CD4 ⁺ T _{EMRA} in CD4 ⁺ cells	1,86	1,54	8,78	4
% of naïve CD4 ⁺ in CD4 ⁺ cells	39,77	42,19	5,98	4
% of CD8 ⁺ CD4 ⁻ in CD3 ⁺ cells	23,51	28,91	4,44	4
% of CD8 ⁺ T _{CM} in CD8 ⁺ cells	43,54	46,40	6,25	4
% of CD8 ⁺ T _{EM} in CD8 ⁺ cells	8,07	13,68	3,67	4
% of CD8 ⁺ T _{EMRA} in CD8 ⁺ cells	11,09	8,23	4,03	4
% of naïve CD8 ⁺ in CD8 ⁺ cells	37,31	31,71	8,09	4
MFI of HLA-DR on CD4 ⁺ T _{CM}	177,83	141,28	44,13	4

MFI of HLA-DR on CD4 ⁺ T _{EM}	394,83	404	110,01	4
MFI of HLA-DR on CD4 ⁺ T _{EMRA}	364,12	134,15	157,97	4
MFI of HLA-DR on naïve CD4 ⁺	51,87	10,11	13,43	4
MFI of HLA-DR on CD8 ⁺ T _{CM}	327,83	182,88	70,82	4
MFI of HLA-DR on CD8 ⁺ T _{EM}	328,17	253,63	73,18	4
MFI of HLA-DR on CD8 ⁺ T _{EMRA}	252,33	164,40	80,61	4
MFI of HLA-DR on naïve CD8 ⁺	84,95	36,68	23,09	4
MFI of CCR7 on CD4 ⁺ T _{CM}	821,67	989,63	102,10	4
MFI of CCR7 on CD4 ⁺ T _{EM}	380,17	524,50	78,96	4
MFI of CCR7 on CD4 ⁺ T _{EMRA}	382,20	546,38	106,35	4
MFI of CCR7 on naïve CD4 ⁺	1885,33	1906,88	185,34	4
MFI of CCR7 on CD8 ⁺ T _{CM}	424,83	589,88	66,18	4
MFI of CCR7 on CD8 ⁺ T _{EM}	301,50	499,50	74,41	4
MFI of CCR7 on CD8 ⁺ T _{EMRA}	379	598,25	90,06	4
MFI of CCR7 on naïve CD8 ⁺	1289,17	1232,13	181,99	4
Number of CD14 ⁺ cells/mL	18117	35414	6538	5
Number of cDC1/mL	24	39	9	5
Number of cDC2/mL	306	762	154	5
Number of pDC/mL	414	438	153	5
% of cDC1 in DC	0,03	0,03	-0,30	5
% of cDC2 in DC	0,43	0,60	-2,82	5
% of pDC in DC	0,54	0,36	2,83	5
MFI of HLA-DR on cDC1	4413,75	3894,88	448,79	5
MFI of HLA-DR on cDC2	6081,88	4843,25	422,90	5
MFI of HLA-DR on pDC	4778,13	3687,00	388,10	5

MFI of CD86 on cDC1	229,38	218,63	14,56	5
MFI of CD86 on cDC2	211,88	178,25	10,89	5
MFI of CD86 on pDC	181,50	155,75	8,23	5
Number of eosinophils/mL	4105	6569	1924	6
Number of neutrophils/mL	87441	137497	24439	6
Number of CD177 ⁺ neutrophils/mL	49420	83798	16795	6
Number of CD177 ^{int} neutrophils/mL	8591	48425	25174	6
Number of CD177 ⁻ neutrophils/mL	30383	33568	6608	6
% of neutrophils in total cells	37,29	50,75	5,98	6
% of eosinophils in total cells	1,74	2,39	0,58	6
% of CD177 ⁺ neutrophils in neutrophils	52,23	62,04	6,67	6
% of CD177 ^{int} neutrophils in neutrophils	8,78	26,87	11,91	6
% of CD177 ⁻ neutrophils in neutrophils	40,14	25,59	7,55	6
MFI of CD16 on eosinophils	1554,71	1237,13	56,95	6
MFI of CD32 on eosinophils	5863,14	4525,25	418,48	6
MFI of CD62L on eosinophils	1582,57	1409,50	122,81	6
MFI of CD16 on neutrophils	6496,43	5578,88	660,35	6
MFI of CD32 on neutrophils	11829,00	9552,63	699,95	6
MFI of CD62L on neutrophils	3552,00	3331,88	324,77	6
MFI of CD10 on neutrophils	1689,43	675,38	251,74	6
MFI of CD66b on neutrophils	2702,57	1712,00	444,88	6
MFI of CD16 on CD177 ⁺ neutrophils	6716,57	5662,00	676,88	6
MFI of CD32 on CD177 ⁺ neutrophils	11547,00	9399,50	684,35	6
MFI of CD62L on CD177 ⁺ neutrophils	3662,14	3354,00	322,99	6
MFI of CD16 on CD177 ^{int} neutrophils	6208,71	5377,50	677,01	6

MFI of CD32 on CD177 ^{int} neutrophils	12050,71	9808,38	705,98	6
MFI of CD62L on CD177 ^{int} neutrophils	3398,86	3177,88	342,13	6
MFI of CD16 on CD177 ⁻ neutrophils	6211,00	5336,13	668,68	6
MFI of CD32 on CD177 ⁻ neutrophils	12011,86	9720,25	699,84	6
MFI of CD62L on CD177 ⁻ neutrophils	3422,43	3220,25	329,42	6
Number of basophils/mL	1823	2453	378	7
% of basophils in total cells	0,52	0,53	0.08	7

Supplementary Figure 1 Gating strategy used in panel 1 to define major cells populations in blood

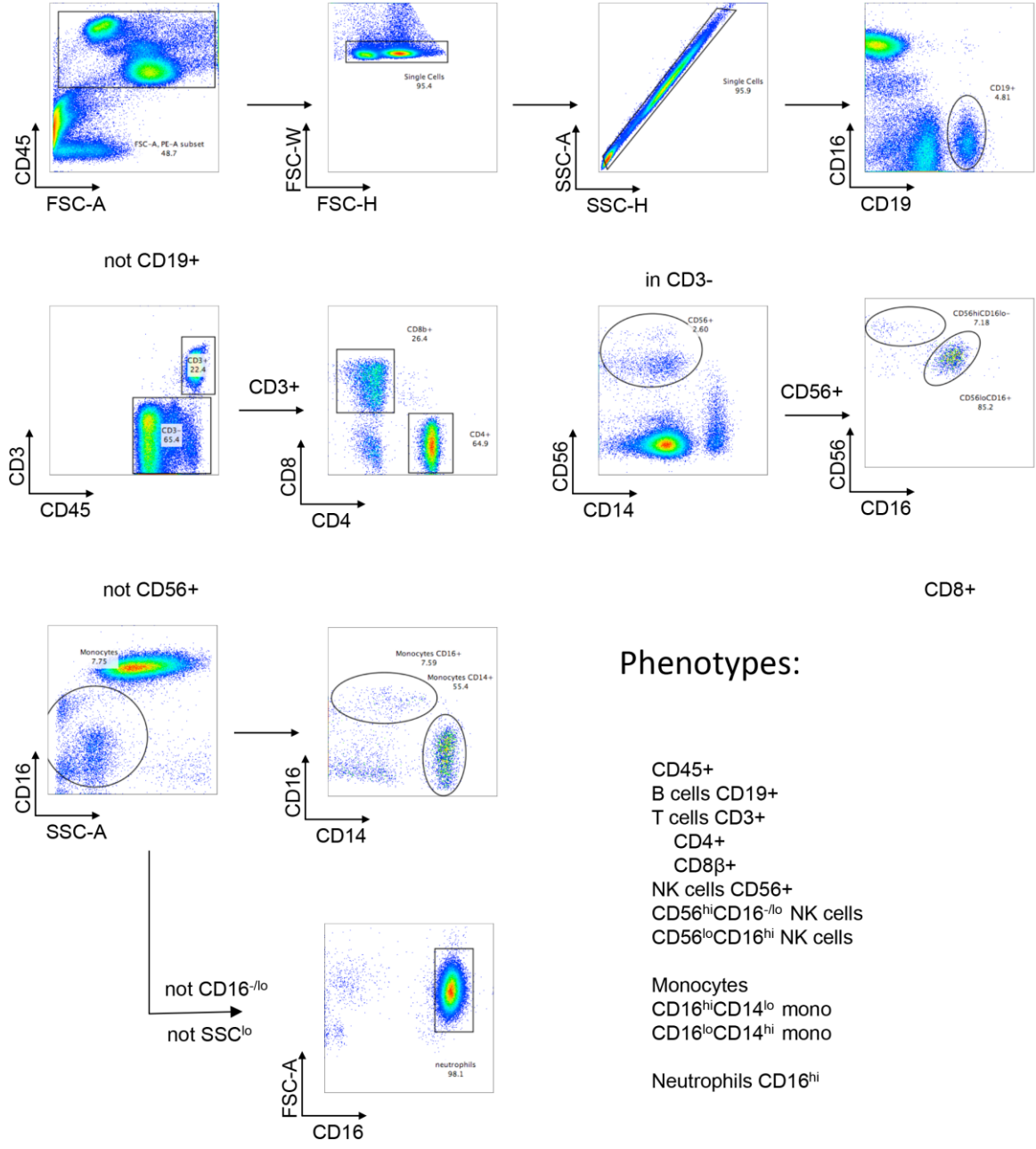

Supplementary Figure 2 Gating strategy used in panel 2 to define Th cells.

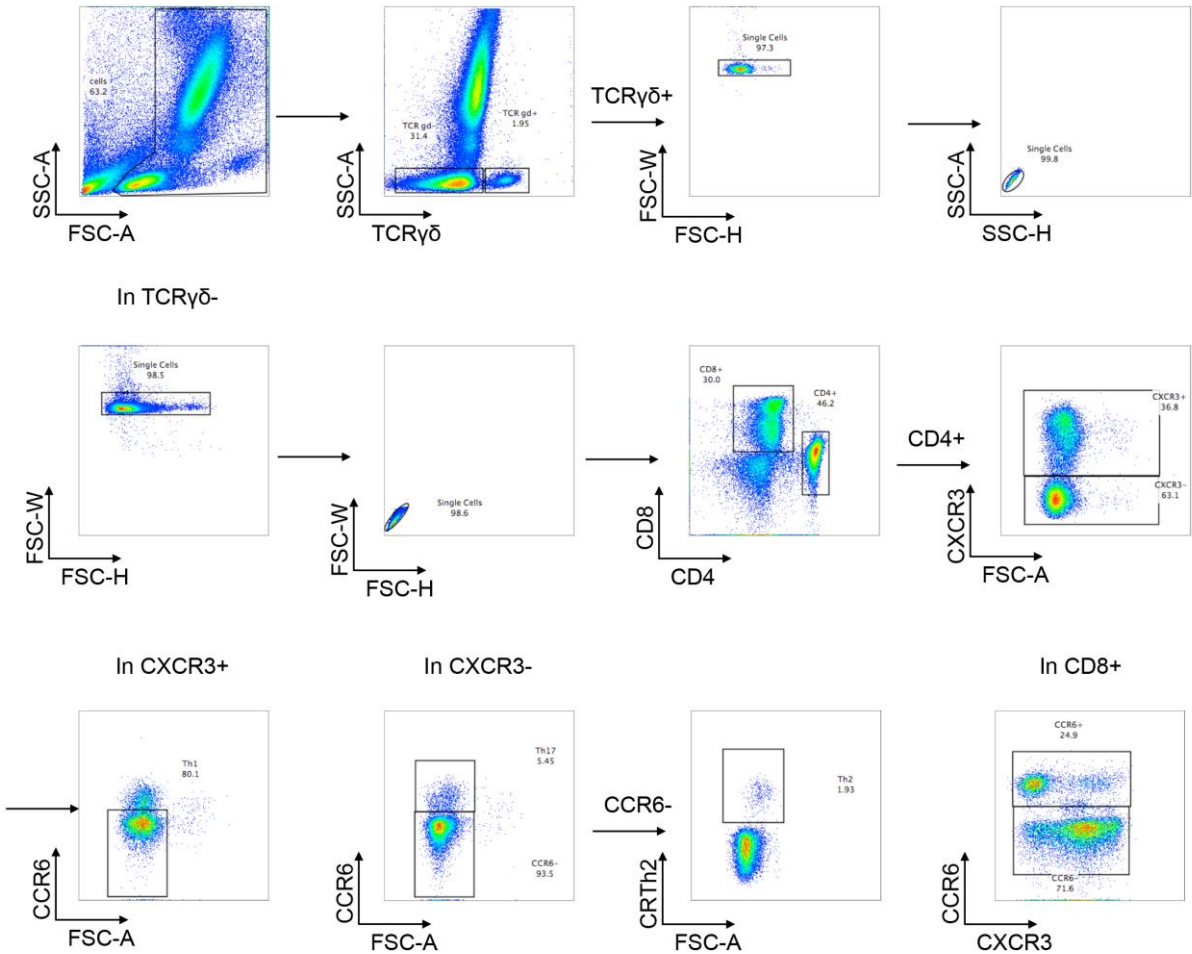

Phenotypes:

- TCRγδ+
- TCRγδ-
- CD8β+TCRγδ-
- CCR6+
- CCR6-
- CD4+TCRγδ-
- CXCR3+CCR6- → Th1
- CXCR3-
- CXCR3-CCR6+ → Th17
- CXCR3-CCR6-CRTh2+ → Th2

Supplementary Figure 3 Gating strategy used in panel 3 to define Tregs subsets and phenotype.

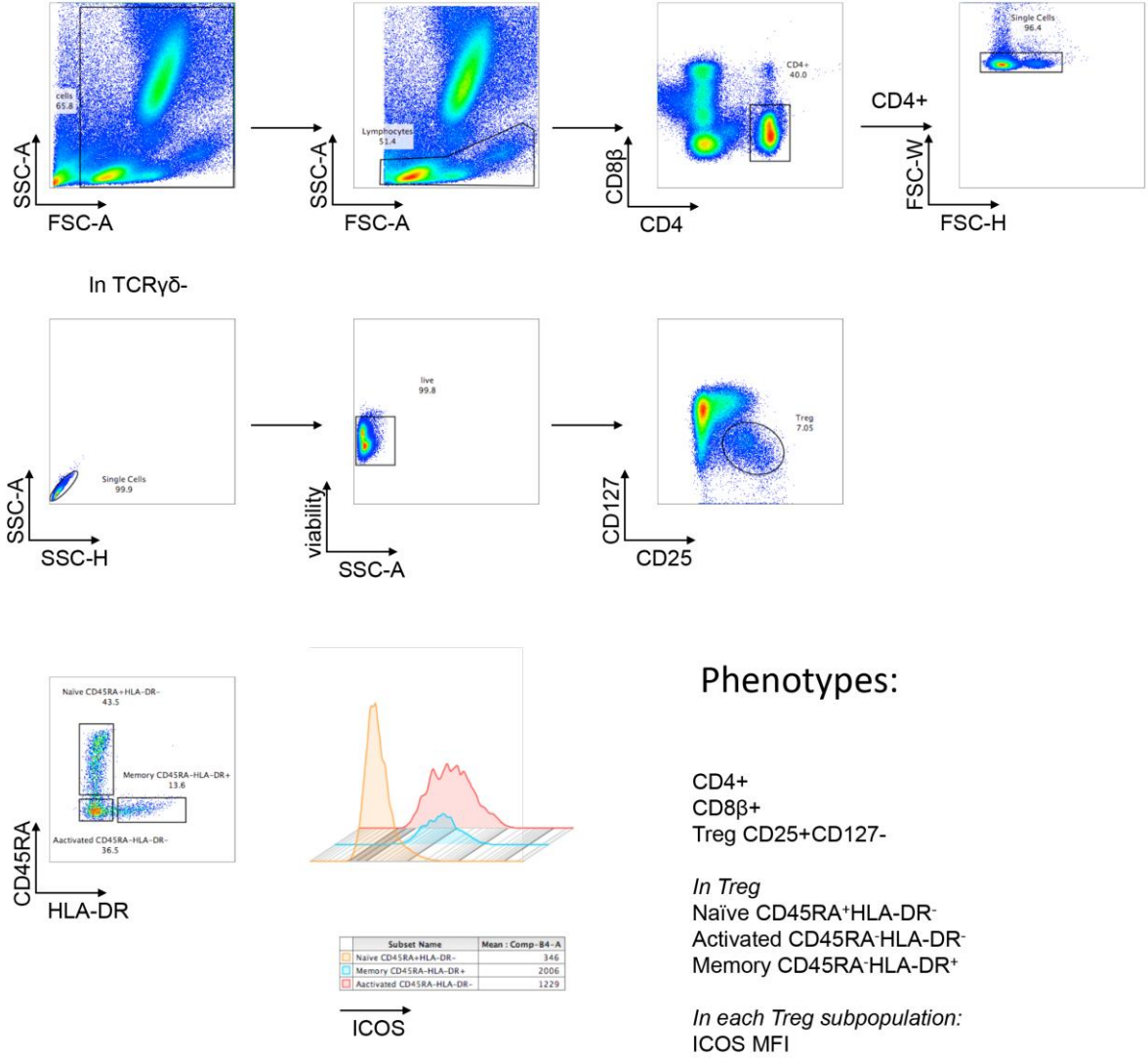

Supplementary Figure 4 Gating strategy used in panel 4 to define memory T cells subsets and phenotype.

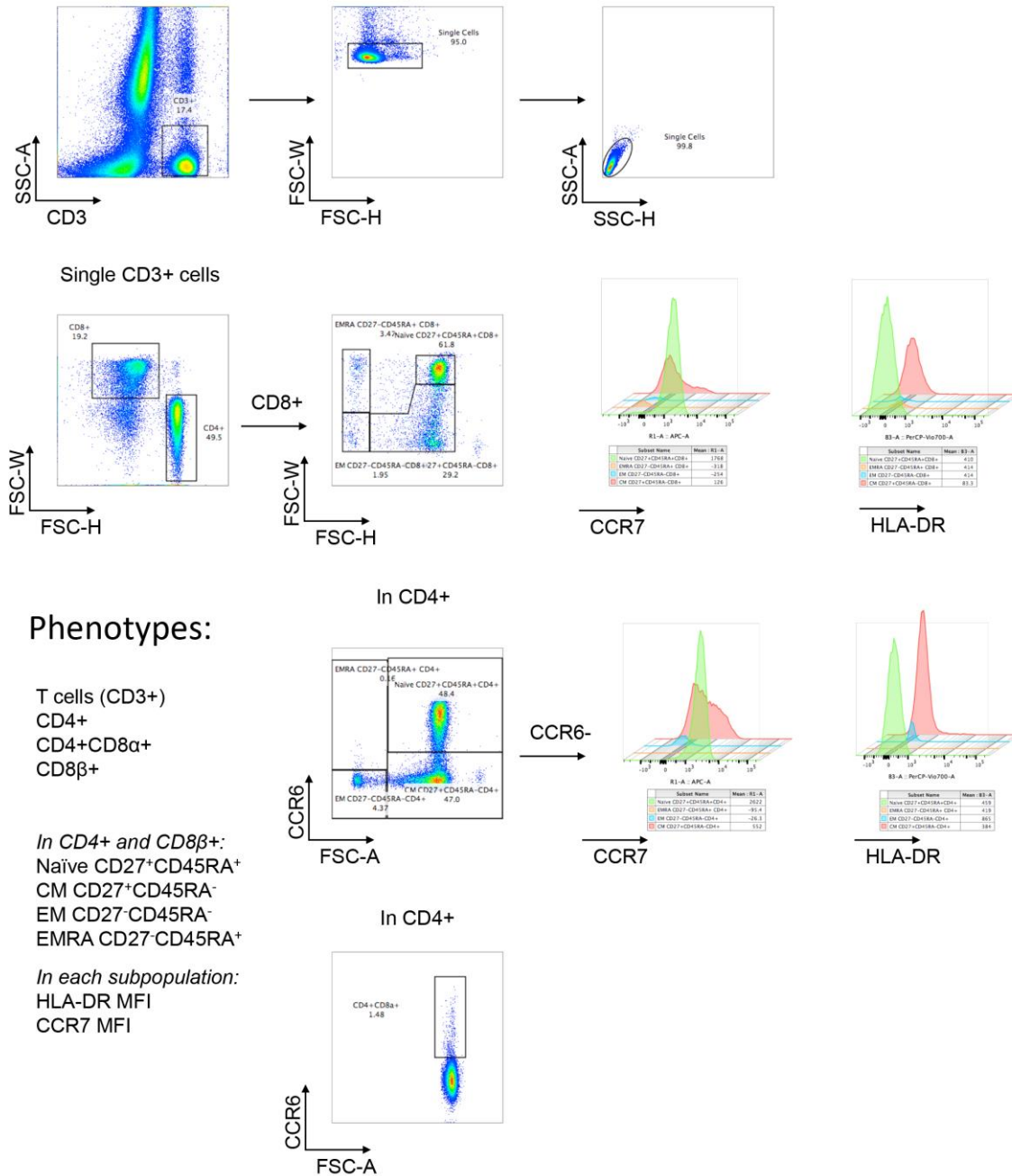

Supplementary Figure 5 Gating strategy used in panel 5 to define DC subsets and phenotype.

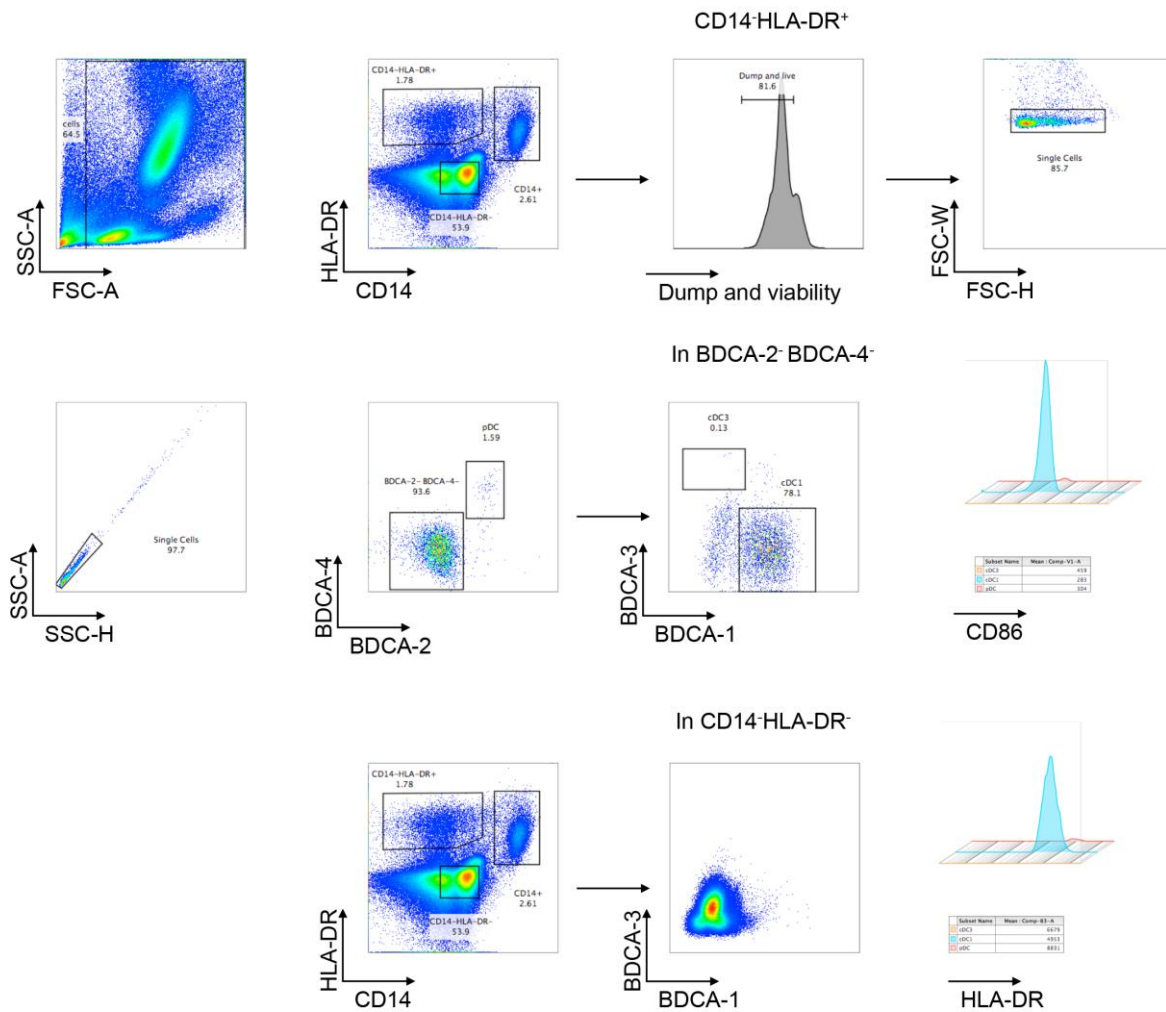

Phenotypes:

- pDC BDCA-2⁺BDCA-4⁺
- cDC1 BDCA-1⁺BDCA-3⁻
- cDC2/3 BDCA-1⁻BDCA-3⁺
- CD14^{hi} monocytes

In each DC subpopulation
 CD86 MFI
 HLA-DR MFI

Supplementary Figure 6 Gating strategy used in panel 6 to define neutrophils and eosinophils and phenotype.

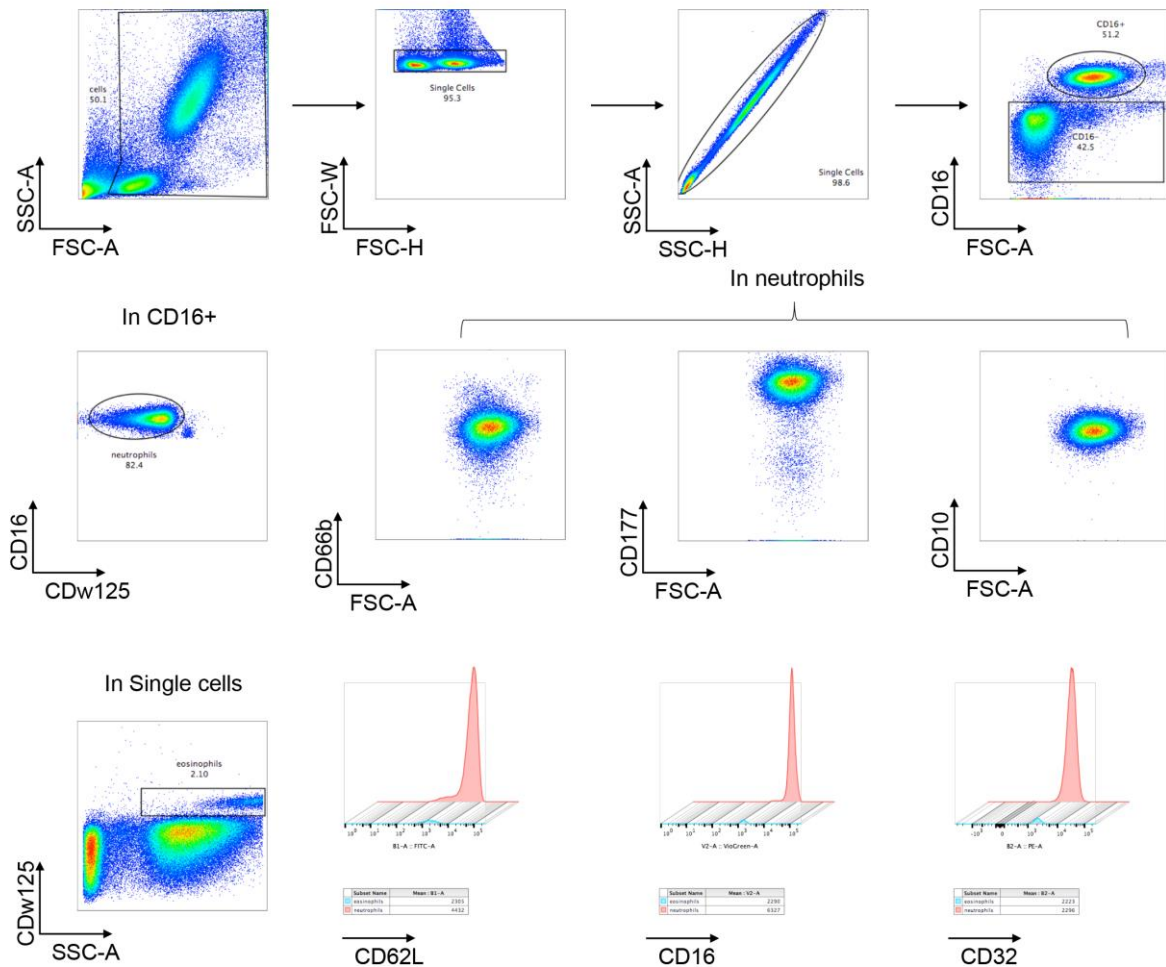

Phenotypes:

Neutrophils CD16^{hi}CCR3⁻
Eosinophils SSC^{hi}CCR3⁺

In neutrophils
CD66b⁺ neutrophils
CD177⁺ neutrophils
CD10⁺neutrophils

In neutrophils and eosinophils:

CD62L MFI
CD32 MFI
CD16MFI

3.3. Part III IgG-FcγRs interspecies cross-binding

Different animal models have been widely used in researches for the reason that they shared some similarities with human. In the studies involved in antibodies and antibodies receptor functions, it was inevitable that the human antibodies may bind to the antibodies receptors expressed by the animal model, or the human cells with antibodies receptor expression could bind to the endogenous antibodies produced by animal model. Additionally, we also used antibodies from different species in *in vitro* and *in vivo* experiment. The choice of host species or antibodies subclasses sometimes influenced the experiment results. Thus, it is important to know the interspecies antibodies-antibodies receptor-binding pattern, especially for IgG and FcγRs.

In analogy to the previous work from my group, I evaluated the capacity of complexed IgG from various species (human, mouse, macaque, rat, hamster, guinea pig, rabbit, goat, horse, sheep, bovine and chicken (IgY)) to bind to human and mouse FcγRs by flow cytometry. F(ab')₂-aggregated IgG and immune complexes (ICs, TNP-BSA – anti-TNP IgG) were used in parallel. My results document the specific binding patterns for each of these IgG (sub)classes and will be a useful reference for the transition from one animal model to preclinical mouse models or human cell-based bioassays.

The results of my work are presented in form of an article. It will be submitted for publication in a scientific journal once a limited number of control experiments have been done.

Specificity of human and mouse Fcγ receptors for IgG subclasses of different species

Yu Wang^{1,2}, Bruno Iannascoli¹, Odile Richard-Le Goff¹, David Mancardi¹, Leoni Ramke¹, Pierre Bruhns¹ and Friederike Jönsson¹

¹Unit of Antibodies in Therapy and Pathology, Institut Pasteur, UMR 1222 INSERM, Paris, France

²Université de Paris, Frontières de l'Innovation en Recherche et Education, Paris, France

Correspondence to: Friederike Jönsson, Unit of Antibodies in Therapy and Pathology, UMR 1222 INSERM, Department of Immunology, Institut Pasteur, 25 rue du Docteur Roux, 75015 Paris, France. Phone: +33140613545. Mail: joensson@pasteur.fr.

Keywords: IgG, Fcγ receptors, cross-binding, immune complexes, F(ab')₂-IgG aggregates

Abstract (194/200 Words)

Immunoglobulin G (IgG) is the predominant antibody class generated during infections and used for the generation of therapeutic antibodies. Antibodies are mainly characterized in or generated from animal models that support particular infections, respond to particular antigens or allow the generation of hybridomas. Due to the availability of numerous transgenic mouse models and the ease of performing bioassays with human blood cells *in vitro*, most antibodies from species other than mice and humans are tested *in vitro* using human cells and/or *in vivo* using mice. In this process, it is expected, but not yet systematically documented, that IgG from these species interact with human or mouse IgG receptors (FcγRs). In this study, we undertook a systematic assessment of binding specificities of IgG from various species - macaque, hamster, rat, rabbit, guinea pig, cow, sheep, goat, horse, chicken, and mouse and human as controls - to the families of human FcγRs, including their polymorphic variants, and of mouse FcγRs. Our results document the specific binding patterns for each of these IgG (sub)classes and will be a useful reference for the transition from one animal model to preclinical mouse models or human cell-based bioassays.

Introduction

Different animal models are used to study various aspects of immunity and in particular antibody-driven functions. Therapeutic antibodies are often generated from and evaluated in different animal models for efficacy and toxicity. Mice, rats and guinea pigs are primary models for infection studies, because they share similarities to humans regarding symptoms and triggered immune responses. Macaques are regularly used for preclinical vaccine development but while their IgG subclasses carry the same denomination as their human counterparts, their sequences are different from and their structure less divergent than human IgG subclasses¹. IgG antibodies exert many of their biological functions through the crystallizable fragment (Fc) that can engage IgG receptors (FcγRs) and complement². Transfer of polyclonal IgG, purified antigen-specific IgG fractions or even purified antibodies from hybridomas or cloned antibodies from various species into validated *in vitro* bioassays involving human cells or into transgenic or advantageous strains of mice for *in vivo* studies is tempting, but requires knowledge on IgG-FcγR interactions that may result from these experimentations. In addition, IgGs from rabbit, rat, hamster, goat and sheep are widely used as reagents for routine experimental procedures and notably immunostainings that may be affected by IgG-FcγR interactions. In humans four IgG subclasses exist (IgG1-4) that all have specific binding profiles to the six human FcγRs and their polymorphic variants, as demonstrated in our landmark publication³. Mice produce four IgG subclasses (IgG1, IgG2a/c, IgG2b, IgG3) and express four classical IgG receptors. While binding of IgG to FcγRs within a given species is rather well-documented³⁻⁶, only a few studies investigated binding specificities across species using various assays⁷⁻¹¹. We therefore undertook herein to describe the interaction of IgG (sub)classes from twelve different species to human and mouse FcγRs.

Methods

Cells

Stably transfected CHO-K1 expressing either human or mouse FLAG-tagged FcγRs were cultured as described¹². Cells were used for binding experiments 3 days after passage. Ig binding, transfection level and FcγR expressed were analyzed by flow cytometry (MACSQuant10/16, Miltenyi Biotec).

Antibodies and reagents

Bovine serum albumin (BSA) (Sigma-Aldrich) was tri-nitrophenylated by incubation with picric acid (Eastman Kodak) and the product fractionated on a gel filtration column (AKTA, GE Healthcare). Collected TNP₃-BSA was biotinylated using the Pierce Biotin-Conjugated Molecule kit (Thermo Fisher). The hybridoma producing mAbs mouse IgG2a anti-TNP (Hy1.2) were provided by S. Izui (University of Geneva, Geneva, Switzerland), IgG2b anti-TNP (GORK) by B. Heyman (Uppsala Universitet, Uppsala, Sweden) and IgG3 anti-TNP (C3110E3) by J. Van Snick (Ludwig Institute for Cancer Research Ltd, Brussels, Belgium). Codon-usage optimized variable regions of the mouse H and L chain hybridoma IGELa2 (X65772.1, X65774.1) were cloned into human pUC19-Igγ1-or -Igκ expression

vectors (a kind gift from Hugo Mouquet, Institut Pasteur, Paris), respectively¹⁰. Antibody switch variants were generated by replacement of the human L or H chain C regions by human C regions with IgG2, IgG3 and IgG4₃₂₂₀; mouse κ L chain (AJ487682.1) or γ 2b H chain C regions (J00479.1); Cynomolgus κ L chain (JN984930) or γ 1-4 H chain C regions (IgG1: JN984927; IgG2: JN984928; putative IgG3: DJ444798, IgG4: JN984929¹⁰ – gene synthesis: Synbio Technologies). All in house produced antibodies were obtained by FectoPRO (Polyplus) transfection of Expi cells purified on a ProteinG column followed by a desalting column on an HPLC instrument (AKTA, GE Healthcare).

Immunoglobulin binding assays

Two types of IgG complexes were formed: i) *F(ab')₂-aggregated IgG complexes*, preformed by incubating 10 μ g/ml IgG (Table S1) with 5 μ g/ml fluorescently-labeled anti-IgG F(ab')₂ fragments (Table S2) in MACS buffer (PBS 0.05% BSA 2 μ M EDTA pH7.4) for 30 minutes at 37°C; ii) *immune complexes (ICs)* made of 10 μ g/mL anti-TNP IgG mAbs incubated with 3.3 μ g/mL TNP₃₃-BSA-Biotin for 30 min at 37°C in MACS buffer. 2×10^5 transfectants CHO cells expressing human or mouse FLAG-tagged Fc γ Rs were incubated with either of these two types of IgG complexes for 30 minutes at 4°C, washed, and cell-bound IgG complexes were revealed using 1 μ g/mL APC-labeled streptavidin for 30 minutes at 4°C.

Results and Discussion

The vast majority of human and mouse Fc γ Rs display low affinities for human and mouse IgG, precluding detectable interactions with IgG monomers. They do, however, readily interact with IgG complexes, either immune complexes (ICs) made of antigen and antigen-specific IgG, or complexes made of anti-IgG F(ab')₂ fragments and IgG (Fab₂Cs)¹⁴. We used from our previous studies^{3,12} CHO transfectants expressing a single human or mouse Fc γ R to evaluate the binding of Ig complexes from different species, including human, cynomolgus monkey, mouse, rat, hamster, rabbit, cow, horse, sheep, goat IgG, and also chicken IgY, for fluidity hereafter termed chicken IgG. Binding of Ig complexes was either assessed for all species by incubation of these CHO cells with fluorescently-labelled Fab₂Cs, but also in addition for mouse, human and macaque IgG by incubating cells with preformed ICs of engineered switch-variants or hybridomas of anti-trinitrophenyl (TNP) IgGs and biotinylated TNP-labeled BSA. Untransfected CHO cells were included in each experiment to monitor unspecific binding.

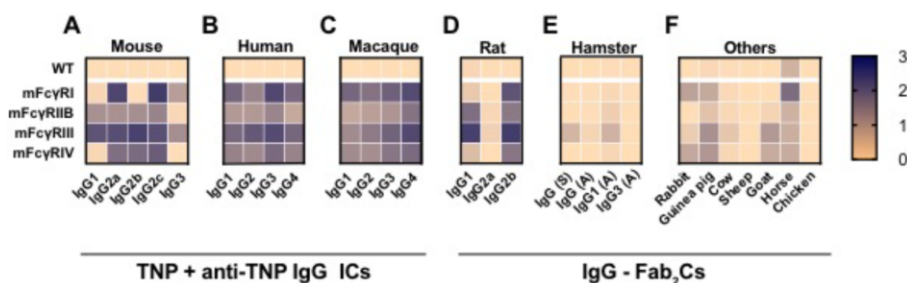

Figure 1: Binding of IgG complexes from indicated species to mFcγRs.

Heatmaps summarizing binding of complexed mouse (A), human (B), macaque (C), rat (D), hamster (E), and rabbit, guinea pig, cow, sheep, goat, horse and chicken IgG (“others” (F)) to FLAG-tagged mFcγRs on CHO transfectants. Preformed immune complexes (ICs) of biotinylated TNP₆-BSA and anti-TNP IgG were revealed by streptavidin-APC, Fab₂Cs formed by aggregating IgG with fluorescently labeled-F(ab')₂ anti-IgG (F(ab')₂ fragment-specific for rat, rabbit and goat). Values are log₁₀ transformed MFI of IgG binding and represent means of at least three independent experiments.

IgG binding to mouse FcγRs

To validate our approach, we first assayed mouse IgG subclasses with mouse FcγR interactions using both types of IgG complexes (Figure 1A/S1A) and reproduced the pattern previously described by us and others^{5,6}. Mouse IgG1 bound exclusively to mFcγRIIB and mFcγRIII, mouse IgG2a and IgG2c bound to all mFcγRs, mouse IgG2b to mFcγRIIB, mFcγRIII and mFcγRIV, and mouse IgG3 to mFcγRI¹⁴. Unexpectedly, mIgG3 immune complexes bound detectably to mFcγRIII. In terms of binding strength to mouse IgG complexes, mFcγRI bound mIgG2a=2c>>3, mFcγRIIB bound mIgG1=2a=2b=2c, mFcγRIII bound mIgG2a=2b=2c>1 and mFcγRIV bound mIgG2a=2b=2c.

We next investigated binding of human IgG subclasses (IgG1, IgG2, IgG3, IgG4) to mouse FcγRs using the same approach and conditions (Figure 1B/S1B). All four human IgG subclasses bound all mFcγRs, with hIgG3 showing the strongest interactions among all subclasses. Our data using human IgG complexes reveal more generalized crossbinding towards mFcγRs than previous reported using a binding competition assay⁷ that might require stronger IgG-FcγR interactions to be revealed, or using surface plasmon resonance (SPR) that relied on monomeric interactions between human IgG and mFcγRs⁸. Of note, we used herein the S₂₂₈P variant of hIgG4 that enhances its stability and minimizes the dissociation of its two heavy chains (a process termed “Fab arm exchange”)¹⁵. This enables its binding to mFcγRIIB¹¹.

Similarly to human IgG subclasses, the four macaque IgG subclasses (IgG1, IgG2, IgG3, IgG4) complexed as anti-TNP mAbs in ICs bound to all mFcγRs (Figure 1C). Macaque IgG4 binding strength was surprisingly stronger than the other subclasses: IgG4 > IgG3 > IgG1 = IgG2. Macaque Fab₂Cs show overall lower binding to mFcγRs than ICs (Figure S1C).

Fab₂Cs from rat IgG1, IgG2a, and IgG2b demonstrated a peculiar pattern (Figure 1D), with rat IgG2b complexes binding to all mFcγRs¹⁶, rat IgG1 complexes exclusively to mFcγRIIB and mFcγRIII, and rat IgG2a complexes not binding mFcγRs. This striking difference may explain why rat IgG2b depletes cells in mice much more efficiently than rat IgG2a for the same target¹⁷.

Hamster IgG subclasses are still ill-defined and classified so far only as IgG1 and IgG3. They may originate from Syrian (S) or Armenian (A) hamsters. All hamster IgGs tested showed poor binding to mFcγRs, with low detectable binding of total IgG (S) and IgG1 (A) to mFcγRIII (Figure 1E). These results are in agreement with the observation that the Armenian hamster IgG1 anti-mFcγRIV mAb 9E9 can also block mFcγRIII in vivo through its Fc portion¹⁸.

Other species, express only one IgG subclass (rabbit, chicken IgY), or could only be tested on a pool of total IgG (horse - 7 IgG subclasses¹⁹; sheep, cow and goat - 3 IgG subclasses²⁰; guinea pig, - 1 or 2 IgG subclasses^{21,22}; Figure 1F). Rabbit IgG complexes bound weakly to all mFcγRs with the exception of

mFcγRIIB; guinea pig IgG to all mFcγRs; cow IgG bound only to mFcγRIII; sheep IgG complexes did not bind; goat IgG complexes only to mFcγRIII and mFcγRIV; horse IgG complexes only to mFcγRI above background levels; chicken IgY complexes did not bind.

IgG binding to human FcγRs

To assess the binding of IgGs from different species to human FcγRs and their polymorphic variants, hFcγRI, hFcγRIIA (H₁₃₁ and R₁₃₁), hFcγRIIB, hFcγRIIA (F₁₅₈ and V₁₅₈), and hFcγRIIB (NA1, NA2, and SH), we used a collection of CHO cells transfected with N-terminal FLAG-tagged hFcγRs sorted to express comparable levels of each hFcγR³. This collection therefore allows ranking of interactions between similarly complexed IgG subclasses.

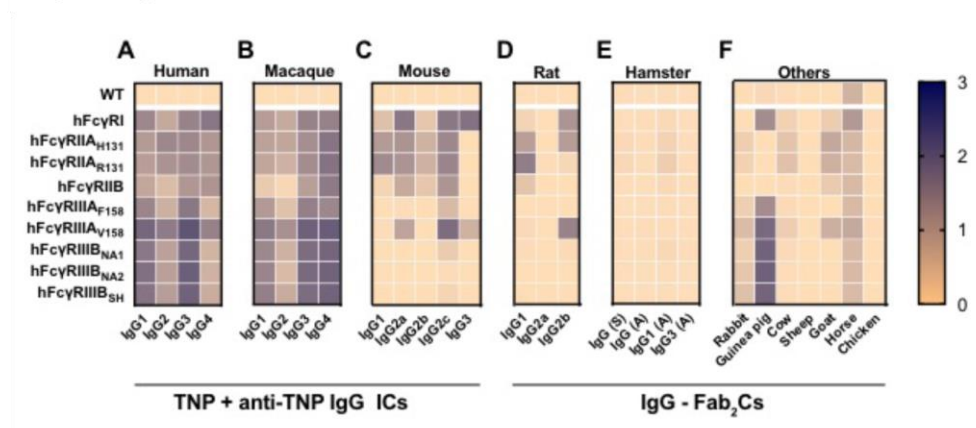

Figure 2: Binding of IgG complexes from indicated species to hFcγRs.

Heatmaps summarizing binding of complexed human (A), macaque (B), mouse (C), rat (D), hamster (E), and rabbit, guinea pig, cow, sheep, goat, horse IgG and chicken IgY (“others” (F) to FLAG-tagged hFcγRs on CHO transfectants. Preformed immune complexes (ICs) of biotinylated TNP_o-BSA and anti-TNP IgG were revealed by streptavidin-APC, Fab₂Cs formed by aggregating IgG with fluorescently labeled-F(ab')₂ anti-IgG (F(ab')₂ fragment-specific for rat, rabbit and goat). Values are log₁₀ transformed MFI of IgG binding and represent means of at least three independent experiments.

ICs made of any of anti-TNP mAbs of the four human IgG subclasses bound to all hFcγRs, but with different overall binding strength: IgG3 > IgG1 > IgG2 > IgG4 (Figure 2A). Fab₂Cs of the same mAbs showed a very similar pattern, except for an undetectable interaction between hFcγRIIB and IgG2 (Figure S2A). These datasets are mostly in agreement with our landmark study published in 2009³ using polyclonal human IgG subclasses, but reveal interactions using human IgG subclass mAbs: IgG2 interactions with hFcγRIIB, and IgG2 and IgG4_{S228P} interactions with hFcγRIIA_{F158} and the three hFcγRIIB variants. We confirm that hFcγRIIB has the overall weakest capacity to bind IgG among all hFcγRs, and that hFcγRIIA_{V158} shows a higher avidity for IgG aggregates than its polymorphic variant hFcγRIIA_{F158}^{3,4}.

Macaque IgG ICs made of anti-TNP macaque IgG subclasses showed a very similar binding pattern than human IgG ICs, with macaque IgG4 ICs however demonstrating a stronger binding strength than the

other subclasses: IgG4 > IgG3 > IgG1 > IgG2 (Figure 2B/S2B). As for human IgG subclasses, macaque IgG subclasses bound with the weakest strength to hFcγRIIB, as reported previously¹⁰.

Mouse IgG complexes demonstrated few interactions with hFcγRs (Figure 2C/S2C), as anticipated²³. Mouse IgG1 complexes bound predominantly to hFcγRIIA_{R131} and hFcγRIIA_{H131}; mouse IgG2a and IgG2c complexes to all hFcγRs except hFcγRIIA_{F158} and hFcγRIIB variants; IgG2b complexes weakly to hFcγRIIA variants and hFcγRIIB; IgG3 complexes to FcγRI and weakly to hFcγRIIA_{V158}.

Rat IgG Fab₂Cs demonstrated restricted binding to hFcγRs (Figure 2D). Rat IgG1 Fab₂Cs bound hFcγRIIA_{R131} > hFcγRIIA_{H131} > hFcγRIIB; rat IgG2a complexes did not bind; rat IgG2b complexes bound exclusively hFcγRI, hFcγRIIA_{H131} and hFcγRIIA_{V158}.

Hamster IgG complexes demonstrated no binding to hFcγRs (Figure 2E), except a weak binding of hamster IgG1 complexes to hFcγRIIA_{R131} and even weaker to hFcγRIIA_{H131}.

Rabbit Fab₂Cs demonstrated a weak binding to hFcγRIIA, hFcγRIIA and hFcγRIIB (Figure 2F). This may explain the ability of rabbit IgG to trigger human neutrophil (which express hFcγRIIA and hFcγRIIB) responses *in vitro*²⁴.

Unexpectedly, guinea pig IgG complexes demonstrated strong and selective interaction with hFcγRI, hFcγRIIA and hFcγRIIB variants, but no detectable interaction with hFcγRIIA, hFcγRIIB and hFcγRIIC (Figure 2F).

Cow and Goat IgG Fab₂Cs weakly interacted with hFcγRIIA and hFcγRIIA_{V158} and hFcγRII, as reported²⁵, and Goat IgG also detectably with hFcγRI and hFcγRIIB.

Horse IgG complexes bound only to hFcγRI above background levels.

Chicken IgY complexes did not bind to hFcγRs.

This study demonstrates that with the exceptions of sheep IgG and chicken IgY, it is to be expected that IgG from species other than human and mice will interact with at least one, and mostly a sizeable fraction of, human and mouse FcγR(s). Our study presents several limitations: Firstly, the level of IgG receptors expressed by these CHO transfectants does not reflect the endogenous expression of FcγRs. A high (non-physiological) density of FcγRs on transfectants might enable avidity interactions that may not occur *in vivo*. Also, some IgG complexes were generated using anti-IgG (H+L) F(ab')₂ fragments that may alter the binding of the Fc domain with FcγR binding (Table S2), or even account for the absence of binding of sheep IgG and chicken IgY complexes.

Collectively, our data draw a comprehensive map of interactions between IgG from various species and mouse and human FcγRs. It allows inferring FcγR effector functions triggered by each of these IgG subclasses.

Acknowledgements

We are grateful to Thibaut Naninck for adapting cloning protocols. This work was supported by a Jeunes Chercheuses/Jeunes Chercheurs grant from the *Agence Nationale de la Recherche* (ANR-16-CE15-0012), *Institut National de la Recherche Médicale* (INSERM) and Institut Pasteur. YW is part of the Pasteur–Paris University (PPU) International PhD Program. This project has received funding from the European Union's Horizon 2020 research and innovation programme under the Marie Skłodowska-Curie grant agreement No. 665807, and from the Labex Milieu Intérieur, Institut Pasteur. FJ is an employee of CNRS (Centre national de la recherche scientifique).

Authorship Contributions

YW performed binding experiments. BI, OR, LR, DAM, PB and FJ prepared cell lines and reagents. YW, PB and FJ wrote the manuscript.

Disclosure of Conflicts of Interest

The authors declare that the research was conducted in the absence of any commercial or financial relationships that could be construed as a potential conflict of interest.

References

1. Hogarth PM, Anania JC, Wines BD. The Fc γ R of Humans and Non-human Primates and Their Interaction with IgG: Implications for Induction of Inflammation, Resistance to Infection and the Use of Therapeutic Monoclonal Antibodies. *Curr Top Microbiol Immunol*. 2014;382:321-352.
2. Vidarsson G, Dekkers G, Rispens T. IgG subclasses and allotypes: from structure to effector functions. *Front Immunol*. 2014;5:520.
3. Bruhns P, Iannascoli B, England P, et al. Specificity and affinity of human Fc γ receptors and their polymorphic variants for human IgG subclasses. *Blood*. 2009;113:3716-3725.
4. Lux A, Yu X, Scanlan CN, Nimmerjahn F. Impact of immune complex size and glycosylation on IgG binding to human Fc γ Rs. *J Immunol*. 2013;190(8):4315-4323.
5. Nimmerjahn F, Bruhns P, Horiuchi K, Ravetch JV. Fc γ RIV: a novel FcR with distinct IgG subclass specificity. *Immunity*. 2005;23(1):41-51.
6. Nimmerjahn F, Ravetch JV. Divergent immunoglobulin g subclass activity through selective Fc receptor binding. *Science*. 2005;310(5753):1510-1512.
7. Overdijk MB, Verploegen S, Ortiz Buijsse A, et al. Crosstalk between Human IgG Isotypes and Murine Effector Cells. *J Immunol*. 2012;189(7):3430-3438.
8. Dekkers G, Bentlage AEH, Stegmann TC, et al. Affinity of human IgG subclasses to mouse Fc γ receptors. *MAbs*. 2017;9(5):767-773.
9. Jönsson F, Mancardi DA, Kita Y, et al. Mouse and human neutrophils induce anaphylaxis. *J Clin Invest*. 2011;121(4):1484-1496.
10. Warncke M, Calzascia T, Coulot M, et al. Different adaptations of IgG effector function in human and nonhuman primates and implications for therapeutic antibody treatment. *J Immunol*. 2012;188(9):4405-4411.
11. Derebe MG, Nanjunda RK, Gilliland GL, Lacy ER, Chiu ML. Human IgG subclass cross-species reactivity to mouse and cynomolgus monkey Fc γ receptors. *Immunol Lett*. 2018;197:1-8.
12. Mancardi DA, Iannascoli B, Hoos S, England P, Daeron M, Bruhns P. Fc γ RIV is a mouse IgE receptor that resembles macrophage Fc ϵ RI in humans and promotes IgE-induced lung inflammation. *J Clin Invest*. 2008;118(11):3738-3750.
13. Tiller T, Meffre E, Yurasov S, Tsuiji M, Nussenzweig MC, Wardemann H. Efficient generation of monoclonal antibodies from single human B cells by single cell RT-PCR and expression vector cloning. *J Immunol Methods*. 2008;329(1-2):112-124.
14. Bruhns P, Jonsson F. Mouse and human FcR effector functions. *Immunol Rev*. 2015;268(1):25-51.
15. Silva JP, Vetterlein O, Jose J, Peters S, Kirby H. The S228P mutation prevents in vivo and in vitro IgG4 Fab-arm exchange as demonstrated using a combination of novel quantitative immunoassays and physiological matrix preparation. *J Biol Chem*. 2015;290(9):5462-5469.

16. Biburger M, Trenkwald I, Nimmerjahn F. Three blocks are not enough--Blocking of the murine IgG receptor Fcγ₄R1 is crucial for proper characterization of cells by FACS analysis. *Eur J Immunol*. 2015;45(9):2694-2697.
17. Goldschmidt TJ, Holmdahl R, Klareskog L. Depletion of murine T cells by in vivo monoclonal antibody treatment is enhanced by adding an autologous anti-rat kappa chain antibody. *J Immunol Methods*. 1988;111(2):219-226.
18. Tipton TR, Mockridge CI, French RR, Tutt AL, Cragg MS, Beers SA. Anti-mouse Fcγ₄R1 antibody 9E9 also blocks Fcγ₄R2 in vivo. *Blood*. 2015;126(24):2643-2645.
19. Lewis MJ, Wagner B, Woof JM. The different effector function capabilities of the seven equine IgG subclasses have implications for vaccine strategies. *Mol Immunol*. 2008;45(3):818-827.
20. Schwartz JC, Philp RL, Bickhart DM, Smith TPL, Hammond JA. The antibody loci of the domestic goat (*Capra hircus*). *Immunogenetics*. 2018;70(5):317-326.
21. Guo Y, Bao Y, Meng Q, et al. Immunoglobulin genomics in the guinea pig (*Cavia porcellus*). *PLoS One*. 2012;7(6):e39298.
22. Phizackerley RP, Wishner BC, Bryant SH, Amzel LM, Lopez de Castro JA, Poljak RJ. Three dimensional structure of the pFc' fragment of guinea pig IgG1. *Mol Immunol*. 1979;16(11):841-850.
23. Lubeck MD, Steplewski Z, Baglia F, Klein MH, Dorrington KJ, Koprowski H. The interaction of murine IgG subclass proteins with human monocyte Fc receptors. *J Immunol*. 1985;135(2):1299-1304.
24. Rakita RM, Quan VC, Jacques-Palaz K, et al. Specific antibody promotes opsonization and PMN-mediated killing of phagocytosis-resistant *Enterococcus faecium*. *FEMS Immunol Med Microbiol*. 2000;28(4):291-299.
25. Jungi TW, Peterhans E, Pfister H, Fey H. The interaction of ruminant IgG with receptor type II for IgG on human phagocytes. *Immunology*. 1989;66(1):143-148.

Supplemental Material:

Supplemental Table 1: Primary antibodies used in the study

Species	Antibody subclass	Clone	Source	Secondary Ab used	Antigen
Human	IgG1, κ	(IgELa)*	home made	109-606-097	TNP
	IgG2, κ	(IgELa)*	home made	109-606-097	TNP
	IgG3, κ	(IgELa)*	home made	109-606-097	TNP
	IgG4, κ	(IgELa)*	home made	109-606-097	TNP
Macaque	IgG1, κ	(IgELa)*	home made	109-606-097	TNP
	IgG2, κ	(IgELa)*	home made	109-606-097	TNP
	IgG3, κ	(IgELa)*	home made	109-606-097	TNP
	IgG4, κ	(IgELa)*	home made	109-606-097	TNP
Mouse	IgG1, κ	107.3	BD Biosciences	115-606-072	TNP
	IgG2a, κ	Hyl.2	home made	115-606-072	TNP
	IgG2b, κ	GORK	home made	115-606-072	TNP
	IgG2c, κ	(IgELa)*	home made	115-606-072	TNP
	IgG3, κ	C3110E3	home made	115-606-072	TNP
Rat	IgG1, κ	RTK2071	Biologend	112-606-072	TNP-KLH
	IgG2a, κ	RTK2758	Biologend	112-606-072	KLH
	IgG2b, κ	RTK4530	Biologend	112-606-072	TNP-KLH
Syrian Hamster	IgG	SHG-1	Biologend	6062-02	TNP-KLH
Armenian Hamster	IgG	HTK888	Biologend	6062-02	TNP-KLH
	Hamster IgG1, κ	A19-3	BD Biosciences	6062-02	TNP
	Hamster IgG3, κ	E36-239	BD Biosciences	6062-02	TNP-KLH
Rabbit	Purified Serum IgG	011-000-003	Jackson ImmunoResearch	111-096-047	/
Guinea pig	Purified Serum IgG	006-000-003	Jackson ImmunoResearch	706-606-148	/
Bovine	Purified Serum IgG	001-000-003	Jackson ImmunoResearch	101-606-003	/
Sheep	Purified Serum IgG	013-000-003	Jackson ImmunoResearch	713-546-147	/
Goat	Purified Serum IgG	005-000-003	Jackson ImmunoResearch	305-606-047	/
Horse	Purified Serum IgG	008-000-003	Jackson ImmunoResearch	108-606-003	/
Chicken	Purified Serum IgY	003-000-003	Jackson ImmunoResearch	703-606-155	/

Supplemental Table 2: Secondary antibodies used in the study

Specificity and Format	Label	Provider	Order number	Used for
F(ab') ₂ Fragment Goat Anti-Human IgG, F(ab') ₂ fragment specific	Alexa Fluor® 647	Jackson ImmunoResearch	109-606-097	Human/ Macaque
F(ab') ₂ Fragment Goat Anti- Mouse IgG, F(ab') ₂ fragment specific	Alexa Fluor® 647	Jackson ImmunoResearch	115-606-072	Mouse
F(ab') ₂ Fragment Goat Anti- Rat IgG, F(ab') ₂ fragment specific	Alexa Fluor® 647	Jackson ImmunoResearch	112-606-072	Rat
F(ab') ₂ fragment specific Goat F(ab') ₂ Anti- Hamster IgG(H+L)	FITC	SouthernBiotech	6062-02	Hamster
F(ab') ₂ Fragment Goat Anti- Rabbit IgG, F(ab') ₂ fragment specific	FITC	Jackson ImmunoResearch	111-096-047	Rabbit
F(ab') ₂ Fragment Donkey Anti- Guinea Pig IgG (H+L)	Alexa Fluor® 647	Jackson ImmunoResearch	706-606-148	Guinea Pig
F(ab') ₂ Fragment Goat Anti- Bovine IgG (H+L)	Alexa Fluor® 647	Jackson ImmunoResearch	101-606-003	Cow
F(ab') ₂ Fragment Donkey Anti- Sheep IgG (H+L)	Alexa Fluor® 488	Jackson ImmunoResearch	713-546-147	Sheep
F(ab') ₂ Fragment Rabbit Anti- Goat IgG F(ab') ₂ fragment specific	Alexa Fluor® 647	Jackson ImmunoResearch	305-606-047	Goat
F(ab') ₂ Fragment Goat Anti- Horse IgG (H+L)	Alexa Fluor® 647	Jackson ImmunoResearch	108-606-003	Horse
F(ab') ₂ Fragment Donkey Anti- Chicken IgY (IgG) (H+L)	Alexa Fluor® 647	Jackson ImmunoResearch	703-606-155	Chicken
Anti-Flag	APC	Miltenyi biotec	130-101-565	
Anti-hFcγRI (10.1)	FITC	BD Pharmingen	555527	
Anti-hFcγRIIA (IV.3)	FITC	StemCell Technologies	60012FI	
Anti-hFcγRIIB (2B6)	FITC	home made	/	
Anti-hFcγRIII (3G8)	FITC	BD Pharmingen	555406	
Anti-mFcγRI (290322)	FITC	R&D Systems	FAB20741G	
Anti-mFcγRIIB (AT130-2)	APC	eBioscience	17-0321-80	
Anti-mFcγRII/III (2.4G2)	FITC	BD Pharmingen	553144	
Anti-hFcγRIII (270053)	FITC	R&D Systems	FAB19601F	
Anti-hFcγRIV (9E9)	FITC	home made	/	
Streptavidin	APC	BD Biosciences	554067	

Supplemental Figure 1:

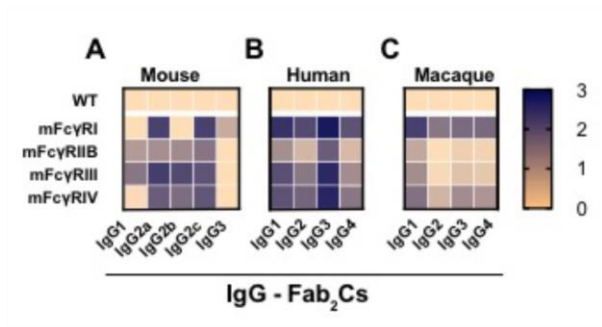

Figure S1: Binding of Fab.Cs from indicated species to mFcγRs.

Heatmaps summarizing binding of Fab.Cs of mouse (A), human (B), macaque (C) IgG with fluorescently labeled-F(ab'), anti-IgG (F(ab')₂ fragment-specific) to mFcγRs. Values are log₁₀ transformed MFI of IgG binding and represent means of at least three independent experiments.

Supplemental Figure 2

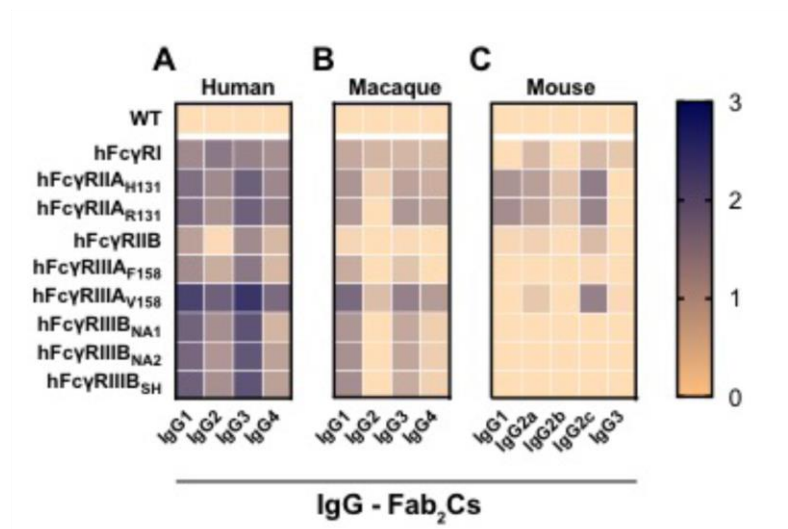
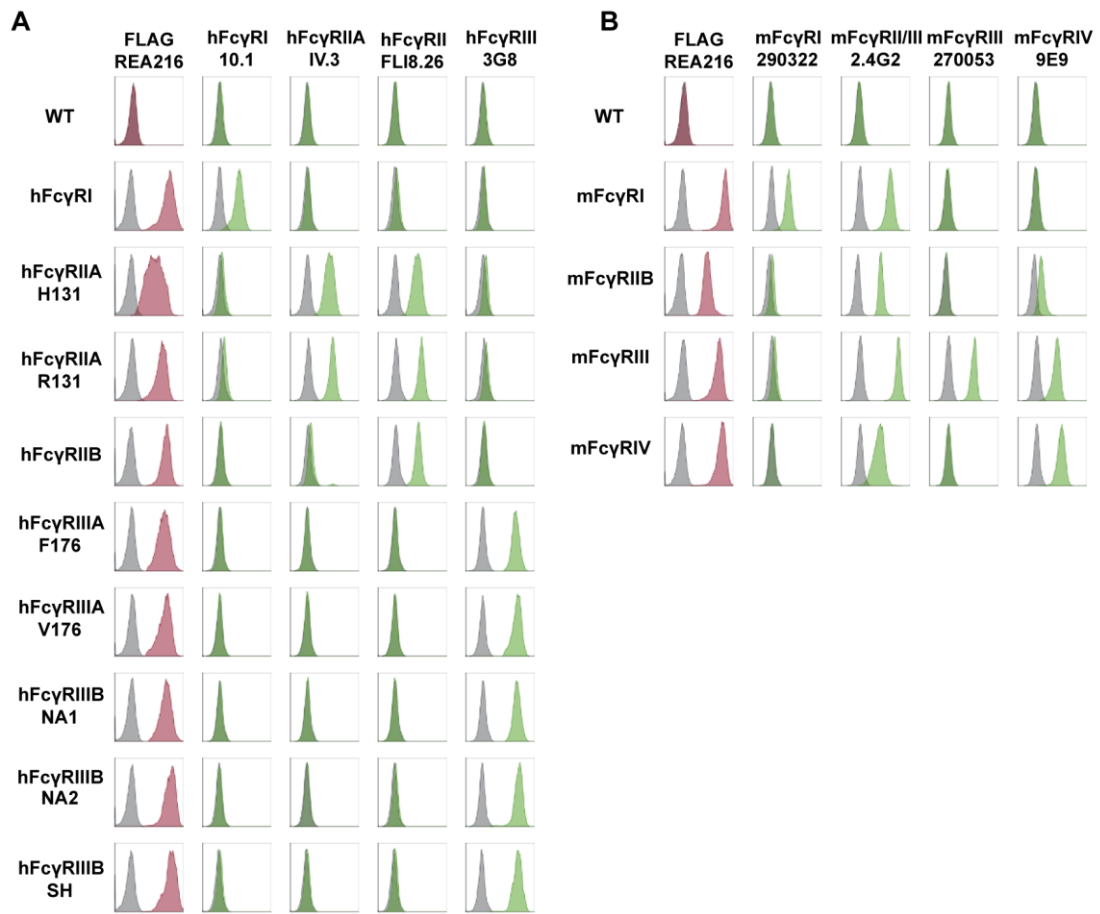

Figure S2: Binding of Fab₂Cs from indicated species to hFcγRs.

Heatmaps summarizing binding of Fab₂Cs formed of human (A), macaque (B) and mouse (C) IgG with fluorescently labeled-F(ab')₂ anti-IgG (F(ab')₂ fragment-specific) to hFcγRs. Values are log₁₀ transformed MFI of IgG binding and represent means of at least three independent experiments.

Supplemental Figure 3



Supplemental Figure 3: Characterization of CHO transfectants. CHO transfectants expressing no, or a single human (A) or mouse (B) FcγR were analyzed by flow cytometry. Histograms represent fluorescent intensity of unstained cells (grey), cell stained with an anti-Flag (red) or with indicated FcγR-specific antibodies (green).

4. Discussion:

Until today, it is still unclear how the switch in immunity occurs that renders a given individual allergic. One possibility is that these individuals are prone to develop allergies, and that factors like lifestyle, environmental exposure but also genetic factors may pre-dispose otherwise healthy individuals to develop an allergic condition throughout their lives²⁵⁴. As many allergic diseases are characterized by a Th2 biased IgE mediated immune response, we hypothesized that elevated total serum IgE (tIgE) concentration may identify in a cohort of healthy donors, individuals at risk for developing allergies. Unexpectedly, I identified in a 1000-healthy donor cohort a large variability of the tIgE concentrations among individuals, ranging from 1-3,000 IU/mL, and around 20% of the participants with a serum IgE concentration above the normal range 114 IU/mL. This is different to other studies that reported 21-83 IU/mL. This observation drove me to question which intrinsic and extrinsic factors lead to high tIgE concentration in these donors and I will discuss the question whether this elevated tIgE could serve as an indicator of a transitional immune state towards an allergic condition in chapter 4.1.

In the second results part of my thesis, I attempted to compare the immune phenotypes of severely allergic patients with healthy controls. However, due to the limited number of recruited patients, this part of my PhD remains preliminary. Until today, I could observe some immune characteristics of allergic donors that are in agreement with previously reported findings (e.g. increased Th2 and Th17 cells), but also made some new observations that were previously not described (increased HLA-DR in naïve CD4⁺T cells and decreased CCR7 on CD8⁺ T_{CM}, T_{EM} and T_{EMRA}). Notably, some of the measured immune parameters appear to be different in amoxicillin allergy and wasp venom allergy, indicating that many pathways may lead to allergies, involving different cellular actors and cytokines and are hence affected differently by environmental and genetic parameters. I will discuss in chapter 4.2 whether it is possible to define one allergic immune phenotype to regroup all the individual causes that may underlie allergy.

Finally, in the last chapter 4.3 of the discussion I will come back to my results of the interspecies IgG- FcγR cross-binding study that I undertook during the last part of my thesis. Beyond the discussion that is already integrated in the article, I will discuss the results on the observed interaction patterns from an evolutionary point of view, highlighting expected relationships and surprising results.

I will then conclude my work and provide some outlooks into future steps of this research in the perspectives.

4.1. High total serum IgE, an indicator for individuals at-risk to develop an allergic condition?

item under unauthorized distribution right

item under unauthorized distribution right

item under unauthorized distribution right

4.2. One allergic immune phenotype fits all?

One of the major goals of the WASPenIP cohort is to answer the question whether all wasp venom allergic individuals have a similar immune phenotype, when compared to healthy controls; and whether this immune phenotype resemble the one of amoxicillin-allergic donors. In other words: does an allergic immune phenotype exists that extends over a specific allergy and embraces all causes of allergy that have in common to potentially cause severe systemic reactions, such as anaphylaxis? And even all types of allergies, be it hay fever, food allergies, atopic dermatitis or even allergic asthma? The simplified model of allergy as a Th2 biased, IgE-dependent immune response would indeed suggest so, however my preliminary data from the WASPenIP study suggest that allergic donors show an individually dysregulated immune phenotype with a more or less pronounced involvement of the different immune compartments. In this chapter, I will discuss the implication of these different cellular players in allergic diseases.

My results show that the variations of immune parameters tested were larger among amoxicillin allergic patients than among wasp venom allergic patients, suggesting that amoxicillin allergy shows a more heterogeneous phenotype.

Although allergic diseases are characterized by Th2 response, however, in the two types of allergies we tested, their Th2 cell numbers and percentage of Th2 cells among all the CD4⁺ T cells did not show significant difference compared to healthy donors. One reason for this might be that we analysed these blood samples more than 6 weeks after allergen exposure, at a time when allergen-triggered immune reactions are thought to have come back to baseline levels. In addition, in contrast to exposure with other types of allergens such as house dust mite or pollen, the contact of amoxicillin and wasp venom can be avoided in daily life. It was therefore even more surprising that, unlike Th2 cells, Th17 cells in both allergic groups were augmented.

Implication of Th17 cells in allergic diseases

Th17 cells are characterized by the capacity to secrete IL-17 cytokines²⁶⁷. The IL-17 cytokine family consist of IL-17A, IL-17B, IL-17C, IL-17D, IL-17E, IL-17F and contributes to immunity through the induction of chemokines such as CXCL1, CXCL2 and CXCL8, which attract myeloid cells²⁶⁸ and cytokines such as IL-6 and GM-CSF that promote inflammation²⁶⁹. Although Th17 cells are the major source of IL-17, other cells like CD8⁺ T cells, natural killer T cells, $\gamma\delta$ T cells, and ILC3s can also produce IL-17²⁷⁰.

Recently, there is increasing evidence for the participation of the Th17 pathway in allergic diseases, and especially in severe asthma. In severe asthma patients the number of IL-17 producing cells presented in the bronchoalveolar lavage fluid, lung biopsies, sputum, and in the blood was positively correlated with asthma severity and accompanied by neutrophil infiltration²⁷¹. Furthermore, gene expression analysis from endobronchial tissues of asthmatic patients separated patients into three phenotypical clusters, which were Th2-high, Th17-high, Th2 and Th17 low²⁷². Notably, both of the Th2-high and Th17-high phenotypes were associated with both neutrophil and eosinophil infiltration²⁷². It possible that co-induction of Th2 and Th17 reflects a compensatory mechanism aiming at limiting an unbalanced cytokine production. Other in vitro and in vivo studies suggested that Th2 cytokines are negatively regulated Th17 cytokines^{273,274}, which could explain why I could not detect elevated numbers of Th2 cells in the WASPenIP cohort, characterized by increased Th17 cells numbers. Previous research further demonstrated that asthma patient's infiltration of neutrophils in the lung resistant to corticosteroid therapy¹⁵⁸.

Furthermore, to reduce airway inflammation, corticosteroids can be given locally or systematically. In nowadays inhaled corticosteroid are one of the major medicines to control asthma crises. However, 10% of asthma patients are resistant to this therapy²⁷⁵. Some of these patients show a high degree of neutrophil infiltration in the lungs, together with elevated IL-17 levels in the airway tissues or in the bronchoalveolar lavage fluids, suggesting that IL-17 could be causal in this neutrophil accumulation. Corticosteroids have been suggested to exert anti-apoptotic effects on neutrophils and thus prolong their survival, whereas they seem to have the opposite effect on

eosinophils²⁷⁶. It has also been reported that the infiltration of neutrophils resulted from corticosteroid therapy²⁷⁷. In the WASPenIP cohort, I could not observe elevated neutrophil numbers that accompanied the augmented Th17 cells. This might be due to the fact that I sampled blood and not tissue from allergic sites or by the fact that the allergies I was studying are not chronic conditions like asthma (in which the neutrophil accumulation could be escalated by the corticosteroid therapy).

Monocytes/ macrophages

Human monocytes are a heterogeneous cell population of mononuclear cells that circulate in the blood. Two subsets are generally distinguished based on their expression of CD16 on their surface. Classical monocytes are CD14⁺⁺CD16⁻²⁷⁸, they exert multiple functions to preserve homeostasis, and contribute to pathogen defence and tissue repair. Inflammatory monocytes express CD16 on their surface and notably expand during inflammatory conditions^{279,280}. Depending on the expression level of CD16, these can be further divided into two subsets with proinflammatory properties: intermediate CD14⁺⁺CD16⁺ monocytes and non-classical CD14⁺CD16⁺⁺ monocytes²⁷⁸. Interestingly, the percentage of CD14⁺⁺CD16⁺ monocytes was reported to increase in the blood of patients with severe asthma as compared to patients with mild/moderate asthma²⁸¹. In the WASPenIP study, I also included the detection of monocyte subsets in the flow cytometry analysis panels. However, I could not observe the increase of CD16⁺ blood monocytes. A possible reason could be that CD16⁺ monocytes depend on sustained allergen stimulation for their expansion. K. Kowal and colleagues showed that house dust mite allergic patients had elevated CD14⁺⁺CD16⁺ monocytes upon bronchial challenges in the blood²⁸². Another possibility could be that CD16⁺ monocytes only contribute to severe asthma instead of amoxicillin allergy or wasp venom allergy. Upon extravasation and migration into tissues, monocytes can differentiate into macrophages. Depending on the microenvironment, macrophages can polarize into classically activated macrophages (M1) or alternatively activated macrophages (M2)²⁸³. Similar to the concept of Th1-Th2, M1 macrophages are induced by LPS and exert pro-inflammatory functions, such as the release of IFN- γ , in response to clearance of intracellular pathogens; on the contrary M2 macrophages will be induced by exposure to IL-4 and IL-13 and play important roles in clearance of damaged cells as well as in

wound healing²⁸⁴. Increased M2 macrophage polarization has been observed in a mouse model of allergic airway inflammation²⁸⁵ and in human asthma, M2 macrophages were reported to become a major source of IL-13, thus driving the amplification of Th2 response²⁸³. In the WASPenIP cohort I only had access to blood samples and therefore could not analyse tissue macrophages. However, in the wasp allergic mouse model, we could evaluate the role of M2 macrophages in the future.

Dendritic cells

It has been proposed that pDCs balance allergic inflammatory conditions through induction of T regulatory cells by the release of retinoic acid and the induction of retinaldehyde dehydrogenase enzymes. Several lines of research have shown a role for tolerogenic pDCs in allergic diseases including allergic asthma. In a clinical study, it was found that the number of pDCs in infancy inversely correlates with asthma development during the first five years of life²⁸⁶. A recent study shows that human tonsillar pDCs suppress effector T cell through the induction of Tregs²⁸⁷. In mice, the depletion of pDC caused the lung inflammation in asthma model²⁴³, and the increased number of pDC could alleviate the asthma-like symptoms²⁸⁸. Moreover, other study also showed the tolerogenic roles of pDC in food allergy²⁸⁹. In our study, I observed an increased percentage of pDC and a decrease percentage of cDC2 in the blood of allergic patients as compared to healthy donors. This observation was surprising, because cDCs were described to participate in the initiation of Th2 responses and to attract eosinophils into tissues²⁹⁰. On the other hand, I observed that cDCs in the allergic donors were more activated and expressed elevated levels of CD86 and HLA-DR, which makes them more proficient in activating naïve T cells.

Importantly, although allergic donors had increased Th17 cells, pDCs and Tregs in their blood, their Th1 cytokines, Th2 cytokines, Th17 cytokines and IL-10 were comparable with healthy donors in the six whole blood stimulation conditions. This could be a consequence from the above-described homeostasis between inflammatory and anti-inflammatory responses, which restrict exaggerated responses by any of these cell

types. In contrast to the comparable cytokine levels, some of the chemokines showed distinct expression between healthy donors and allergic patients in certain stimulatory conditions. Amoxicillin allergic patients had a tendency to release more CCL5 and CXCL12 upon stimulation with relevant allergens. CCL5 is chemotactic for T cells, eosinophils, and basophils and CXCL12 for T cells and monocytes, suggesting that these patients could show enhanced leukocyte mobilization into the circulation. As mentioned in the chapter 3.2, this difference may be related to the sensitizing route: amoxicillin sensitization occurs most likely systemically, whereas wasp venom sensitization happens in skin.

item under unauthorized distribution right

Figure 9 Molecular mechanisms in allergic inflammation. Reprinted from²⁹¹.

In conclusion, and as summarized in Figure 9, multiple cellular players contribute to allergic diseases and their respective contribution may differ from one allergic disease to another, and more importantly from one patient to another. While some features may be shared between different allergic conditions and/or patients it is unlikely that a unique immune phenotype is at the origin of these diverse conditions, which indicated that one allergic immune phenotype could not fit all of the allergic conditions.

4.3. From antibody evolution to application.

In the last part of my thesis, I evaluated the binding of IgG (sub) classes from different species to human and mouse FcγRs. This allowed me to draw a comprehensive map of interspecies cross-binding interactions that allows inferring FcγR effector functions triggered by each of these IgG subclasses in in vitro studies using human cells or in vivo when using mouse models. In the following chapter, I would like to discuss these results from an evolutionary point of view. I will therefore begin this chapter with a brief introduction to the evolution of immunoglobulins and FcγRs.

The evolution of immunoglobulins

The diversity of the adaptive immune system relies on immunoglobulins (Ig), T cell receptors (TCR), and MHC. Expression of both Ig and TCR requires somatic recombination of germline-coded gene segments and evolved in vertebrates almost 500 million years ago. With the exception of agnatha (lamprey and hagfish), all vertebrates possess Ig of the M class (Figure 10) that exist in both a membrane-bound as well as in a secreted form¹, revealing that IgM are the evolutionary oldest and most successful Ig still found in mammals today. Cartilaginous fish have three types of immunoglobulins IgM, IgW, and IgNAR (new antigen receptor). Their IgM is an orthologue to mammalian IgM and can be present as monomers or pentamers. IgW has two membrane-expressed forms and two secreted forms with different CH length. Compare to IgM and IgW, IgNAR appears to be the most recent isotype and shows some homology to mammalian IgD. The ray-finned fish also has three immunoglobulin classes IgM, IgD, and IgZ (catfish lack IgZ). IgZ is a smaller than IgM and possesses only limited complement activation function. Interestingly, the ray-finned fish Cδ locus is already linked to Cμ, and therefore presents a similar organisation as observed in mammals. In amphibians, such as *Xenopus tropicalis*, five immunoglobulin classes can be found: IgM, IgD, IgX, IgY, and IgF. IgX appears to be an analogue of mammalian IgA, whereas IgF and IgY show sequence similarities, with IgF and IgY having two and three constant domains, respectively. IgY indeed is thought to be a key isotype during immunoglobulin evolution⁸⁴. It has been suggested that it originates from an IgM gene duplication event and is present in reptiles, together with IgM, IgD, and IgX, and in chicken alongside with IgA and IgM⁸⁴.

Except for analogy to IgX, IgA also shares features with IgM and IgY. IgG and IgE finally appeared in mammals (the duck-billed platypus) and are thought to have derived from IgY²⁹².

item under unauthorized distribution right

Figure 10 The different immunoglobulin classes evolved in various clades of vertebrates. Filled cycles mark whole-genome duplication events. Reprinted from¹.

IgG in mammals

As one of the most recent immunoglobulin classes, IgG plays an important role in the immune homeostasis in circulation. During my thesis, I investigated crossbinding of IgGs from different mammalian species and the chicken IgY to mouse and human FcγRs. I focused on species that are among the most relevant models used in immunology to develop models of infections, test antibody-related hypotheses or generate hybridomas. Among mammalian IgG, I tested IgGs from Perissodactyla (horse/*Equus caballus*),

Artiodactyla (ruminants: cow/*Bos taurus*, goat/*Hircus capra* and sheep/*Ovis aries*), Lagomorpha (rabbit/ *Oryctolagus cuniculus*), Rodents (hamster/ *Cricetinae*, guinea pig/ *Cavia porcellus*, rat/ *Rattus* and mouse/ *Mus musculus*), and Primates (Cynomolgus monkey/ *Macaca fascicularis* and human/ *Homo sapiens*). The overall phylogenetic relationship between the species used in my work is depicted in Figure 11.

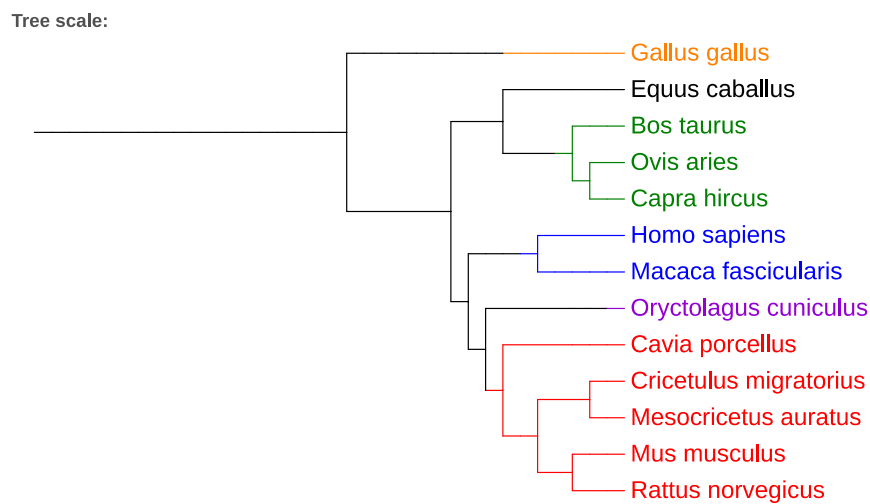

Figure 11 Species tree generated with PhyloT. Representation in ITOL IgG/Fc R tree. Fasta sequences aligned using ClustalW with standard settings for slow/accurate alignment of Protein sequences. Species trees were generated using the PhyML Bootstrap method.

The evolutionary relationships of these species is mostly conserved on the level of IgG immunoglobulins, with maybe the exception of rabbit/rabbit IgG that appear closer related to rodents in the species tree and whose IgG forms a (badly supported) node with primates. It is noteworthy that IgG subclasses from a given animal showed sometimes a closer relationship with the same subclass from a closely related species (e.g. mouse, rat and hamster IgG1), and sometimes with other IgG subclasses within a given animal (rat IgG1 and IgG2a) (Figure 12).

Tree scale: 0.1 ⇐

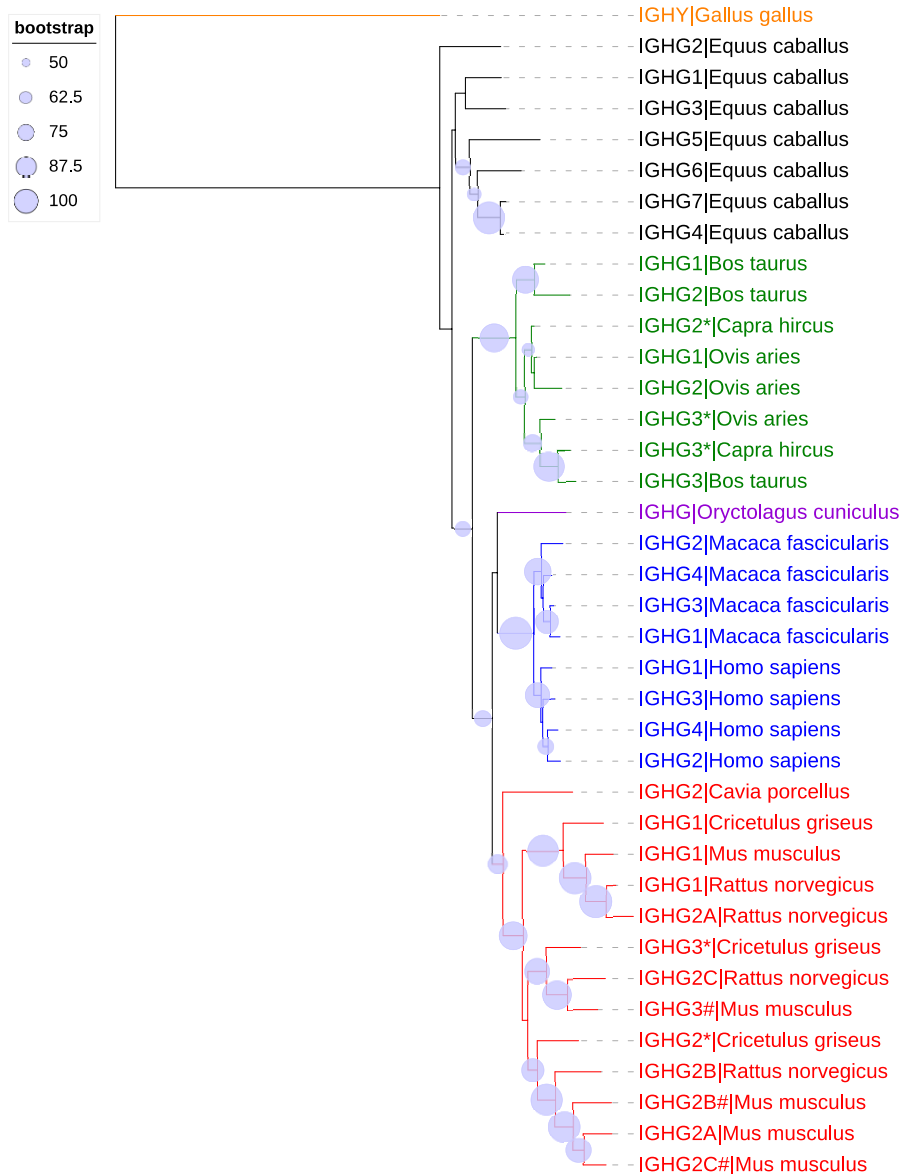

Figure 12 Phylogenetic analyses of selected mammalian IgG and chicken IgY. Protein sequences were aligned using ClustalW with standard settings for slow/accurate alignment of Protein sequences. Trees were generated using the PhyML Bootstrap method. Alignments were done on the whole constant region sequence, including CH1, hinge, CH2, CH3 (and CH4 for Gallus). * Indicates hypothetical/predicted protein, # indicates truncated sequences after CH3 domain.

As expected, chicken IgY forms an outgroup of the IgG tree and also did not bind to any human or mouse FcγR in the assays I used. This suggests that chicken IgY is an antibody class of choice to avoid unspecific (FcR-mediated) binding when working with mouse or human cells or tissues. In horse seven IgG subclasses were identified²⁹³. Horse IgG1-7

bind to Staphylococcal protein A and protein G with different affinities, show differences in complement C1q engagement and have different capacities to induce respiratory burst in equine peripheral blood leukocytes²⁹⁴. Due to a lack of tools, I could only test whole equine IgGs in my work, and surprisingly these bound only to the human and mouse high affinity IgG receptor, FcγRI. This is an interesting observation and may explain the successful use of horse-derived snake venom antiserum in humans²⁹⁵. Cow, goat and sheep all belong to Bovidae, in which three subclasses of IgG were identified²⁹⁶. For all these species we again only had access to whole purified IgG. Unexpectedly, IgG complexes from these three species showed different binding to human and mouse FcγRs: sheep IgG did not bind to either mouse or human FcγRs, whereas goat and cow IgG complexes showed the same binding pattern, with binding to human FcγRI, FcγRIIA H131, FcγRIIIA V131, and all the mouse FcγRs. How can we reconcile this discrepancy? Indeed, in order to aggregate IgGs, I used anti-IgG F(ab')₂ fragments. Whenever available, I used F(ab')₂ fragments directed against the F(ab')₂ fragment of the target antibody. For sheep, cow, horse, guinea pig and chicken these were, however, not available. I therefore used for anti-IgG (H+L) to aggregate IgG from these species that could bind to the Fc portion of these IgGs and interfere or even block the interaction site with FcγRs. Rabbit only have one IgG subclass²⁹⁷ that bound to all mouse and human activating FcγRs except human FcγRI, consistent with the use of rabbit IgG to trigger human FcγR-expressing cells in vitro²⁹⁸.

Guinea pig has two IgG subclasses²⁹⁹, but we could only retrieve the sequence of one of them. The phylogenetic analyses showed that those two Guinea pig IgG subclasses are next to each other. Rabbit IgG was closer to human IgG, whereas guinea pig IgG are closer to mouse IgGs. Thus it is not a surprise to us that the binding patterns of those rabbit and guinea pig IgGs are similar, with rabbit IgGs showing a boarder binding profile to human FcγRs. Nevertheless, it is interesting to see that guinea pig IgGs have also a potent binding avidity for human FcγRs.

Syrian hamsters used in laboratories are believed to have originated from only three to four littermates captured in 1930³⁰⁰. All the hamster IgGs I could test (Syrian hamster

total IgG, Armenian hamster IgG1, Armenian hamster IgG3, Armenian hamster total IgG), Syrian hamster IgG, Armenian hamster IgG1, and Armenian hamster IgG bound to mouse FcγRIII and weakly to human FcγRIIA R131. Armenian hamster IgG3 did not bind to any human or mouse FcγRs. The divergent evolutionary time of hamster from Muridae was twice as long as the split between mouse and rat; this could explain the rather poor binding of complexed hamster IgGs to mouse (and human) FcγRs (Figure 10 and³⁰¹).

As indicated in the introduction, it has been proposed that mouse and rat IgGs derived from a common set of ancestral genes: with rat $\gamma 2c$ gene showing homology to mouse $\gamma 3$; the rat $\gamma 2a/\gamma 1$ pair to mouse $\gamma 1$; and the rat $\gamma 2b$ is homologous to mouse $\gamma 2a/2b$. Our results partially support this hypothesis: complexed mouse IgG1, and rat IgG1 showed the same binding pattern to mouse and human FcγRs, rat IgG2a, however only showed very weak interactions with FcγRs; mouse IgG2a/2b/2c binding resembled the pattern observed with rat IgG2b.

Macaques are widely used non-human primates for studies on vaccination and infection diseases, especially HIV. *Cynomolgus* monkeys have four IgG subclasses. Their intron-exon organization is similar to their human counterparts and also their amino acid sequences share 86.3-90.3% with human IgGs. Macaque IgG1-4 carry however a number of amino acid changes which are thought to be potentially affecting their effector functions³⁰². In agreement with their evolutionary proximity, we found the macaque IgGs shared overall a very similar binding pattern with their human counterparts.

IgG-FcγRs cross binding between human and mouse

The phylogenetic analysis of human and mouse FCGR genes in Figure 13 reveals the sometimes misleading denomination of these genes in the two species, which mixes historical discovery with functional resemblance. The FCGR1 locus separated from the low affinity IgG receptor locus and indeed mouse and human FCGR1 are closely related. Thus one could expect that mouse and human FcγRI show similar binding patterns to IgGs from different species. Indeed, both FcγRIs bound to all human complexed IgGs

with lowest binding to human IgG2; and to mouse IgG2a/c and IgG3 and much weaker or not to mouse IgG1 and IgG2b. Human FcγRIIA, IIB and IIC derived from gene duplication and exon swapping events. Albeit the closer evolutionary relationship of mouse FcγRIIB to human FcγRIIB, than to human FcγRIIA, the binding pattern of mouse FcγRIIB showed higher overlap to the one observed for human FcγRIIA (H131).

Other than what one may think from the common denomination mouse and human FcγR do not show many similarities. Indeed, mouse FcγRIII is rather related to mouse FcγRIIB and the human FcγRIIIA and FcγRIIIB show commonality with mouse FcγRIV. Among the 4 mouse FcγRs, mouse FcγRIII displayed the broadest binding profile: interacting with all complexed human and mouse IgGs. However, its counterpart human FcγRIIIA and FcγRIIIB selectively bound to mouse IgGs: human FcγRIIIA F176 bound to mouse IgG2c; FcγRIIIA F176 bound to mouse IgG2a/c and IgG3; FcγRIIIB did not bind any mouse IgGs.

While these similarities may explain some of the observed binding patterns, they can not explain all the observations, I have made during this study. On example is the mouse FcγRIV: Although the amino acid sequence clusters with human FcγRIIIA and FcγRIIIB, its binding pattern to mouse IgGs rather resembles the one of human FcγRIIB. Indeed, the phylogenetic analysis is based on the alignment of the whole amino acid sequence of the different receptors whereas the binding to IgG is mediated by certain regions of the receptor and strongly depends on a couple of amino acids³⁰³.

This also explains why some well-documented polymorphisms of human FcγRs show such a strong impact on IgG binding of the receptors. FcγRIIA H131 is generally described to show better binding to human IgG2 than hFcγRIIA, except for mouse IgG1. Additionally, I could confirm that the human FcγRIIIA V176 variant showed more binding to all human IgGs tested, and extend this observation to IgGs from other species.

Tree scale: 0.1 ⇄

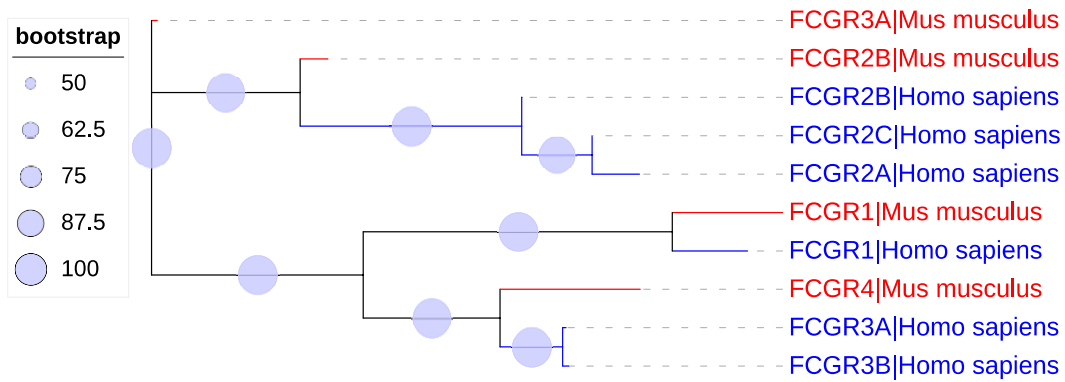

Figure 13 Phylogenetic analyses of human and mouse FcγR proteins. FcγR protein sequences were aligned using ClustalW with standard settings for slow/accurate alignment of Protein sequences. Trees were generated using the PhyML Bootstrap method detailed below.

Collectively, my data adds interesting insights into the co-evolution of IgGs and FcγRs and identifies crossbinding patterns between IgGs from different species and human and mouse FcγRs that allow inferring FcγR effector functions.

5. Perspective

The results of my thesis can be summarized by three major outcomes:

In healthy individuals, total serum IgE concentrations are associated with age, sex, smoking habits, certain HLA alleles, FcεRI expression on basophils, and a particular profile of cytokines released in whole blood stimulation assays. The observation that the group of individuals with high IgE concentrations contained a two times higher proportion of individuals with a reported family history of allergic diseases (12.4 % instead of 6 % in the overall cohort), suggests that this group is “at-risk” of developing allergies. This should be particularly true for individuals that present with persisting high IgE concentrations, because their “milieu interieur” may be permanently challenged by augmented cytokine productions and notably cytokines of the Th2 type.

My preliminary data from the analysis of the WASPenIP cohort suggest that classical features of an allergic immune phenotype are conserved in this cohort. Data from induced immune responses, however, are yet too preliminary to draw solid conclusions. This study will continue after my PhD. We expect that we will be able to present a complete description on immune phenotypes of these two types of allergies at the end of the study. Furthermore, the WASPenIP study will in the future include the analysis of wasp venom allergic individuals before and after 1 year of VIT, which will shed light on the changes induced by this therapy in these allergic patients. It will be particularly interesting to test whether we can define biomarker candidates that will allow measuring the success of VIT, and/or predict the appropriateness of this therapy for individual patients. As VIT is unsuccessful in 10% of treated patients after 2-3 years of therapy, it would be very informative to determine, which immune parameters preclude successful VIT, in order to propose to these patients’ alternative treatment approaches before engaging into this long therapeutic process.

The wasp venom allergy mouse model that I have established will further provide a valuable tool for more mechanistic studies of wasp venom allergy. To my knowledge, it

is the first model working in C57BL/6 mice, the genetic background on which most genetically modified lines were generated. Using these transgenic mice will enable to identify key components of the effector phase of this allergy model. Furthermore, this model will help to answer the following questions:

- Where is anatomical IgE production site and does it depend on the location of antigen exposure?
- How are allergen-specific memory B cells produced?
- Can we detect allergen-specific long-lived plasma cells?

Indeed, as outlined in my introduction the mechanisms underlying IgE memory are still very much debated and this model may help to elucidate the generation of allergen-specific memory B cells and antibody producing cells, because we have in the laboratory the capability to functionally phenotype these cell types using microfluidics-based single cell approaches to identify specific antibody producing cells in droplets using fluorescently labelled recombinant antigen(s).

Lastly, my analysis of the binding of IgG from various species to human and mouse FcγRs provide a comprehensive map of their interactions that provides a useful reference for the transition from one animal model to preclinical mouse models or human cell-based bioassays. It allows inferring FcγR-dependent effector mechanisms at play when using IgG(s) from “exotic” species in mice or in vitro on human cells. It adds also to our understanding of IgG and FcγR co-evolution. In the future, it would be interesting to test isolated subclasses from species from which only pooled total IgG could be tested during my PhD. Furthermore, the aggregation of IgGs using F(ab')₂ anti-IgG F(ab')₂, but even more so using F(ab')₂ anti-IgG (H+L), is suboptimal and probably shows limited steric resemblance with antigen-induced IgG aggregation. It would therefore be interesting to test the binding of immune complexes formed with these antibodies to mouse and human FcγRs, to comfort the observations made with F(ab')₂ aggregates.

6. Reference

1. Danilova N, Amemiya CT. Going Adaptive. *Ann. N. Y. Acad. Sci.* 2009;1168(1):130–155.
2. Riera Romo M, Pérez-Martínez D, Castillo Ferrer C. Innate immunity in vertebrates: an overview. *Immunology.* 2016;148(2):125–139.
3. Elias PM. The skin barrier as an innate immune element. *Semin. Immunopathol.* 2007;29(1):3–14.
4. Kawamoto H, Minato N. Myeloid cells. *Int. J. Biochem. Cell Biol.* 2004;36(8):1374–1379.
5. Daëron M. Fc receptor biology. *Annu. Rev. Immunol.* 1997;15(1):203–234.
6. Tsuboi N, Asano K, Lauterbach M, Mayadas TN. Human Neutrophil Fcγ Receptors Initiate and Play Specialized Nonredundant Roles in Antibody-Mediated Inflammatory Diseases. *Immunity.* 2008;28(6):833–846.
7. Ernst LK, Van de Winkel JGJ, Chiu IM, Anderson CL. Three genes for the human high affinity Fc receptor for IgG (FcγRI) encode four distinct transcription products. *J. Biol. Chem.* 1992;267(22):15692–15700.
8. Qiu WQ, De Bruin D, Brownstein BH, Pearse R, Ravetch J V. Organization of the human and mouse low-affinity FcγR genes: Duplication and recombination. *Science (80-.).* 1990;248(4956):732–735.
9. Mancardi D a., Albanesi M, Jönsson F, et al. The high-affinity human IgG receptor FcγRI (CD64) promotes IgG-mediated inflammation, anaphylaxis, and antitumor immunotherapy. *Blood.* 2013;121(9):1563–1573.
10. Hargreaves CE, Rose-Zerilli MJJ, Machado LR, et al. Fcγ receptors: Genetic variation, function, and disease. *Immunol. Rev.* 2015;268(1):6–24.
11. Lejeune J, Brachet G, Watier H. Evolutionary Story of the Low/Medium-Affinity IgG Fc Receptor Gene Cluster. *Front. Immunol.* 2019;10:.
12. Bruhns P, Iannascoli B, England P, et al. Specificity and affinity of human Fcγ receptors and their polymorphic variants for human IgG subclasses. *Blood.* 2009;113(16):3716–25.
13. Duits AJ, Bootsma H, Derksen RHW, et al. Skewed distribution of IGG FC receptor iia (CD32) polymorphism is associated with renal disease in systemic lupus erythematosus patients. *Arthritis Rheum.* 1995;38(12):1832–1836.
14. Haseley LA, Wisnieski JJ, Denburg MR, et al. Antibodies to C1q in systemic lupus erythematosus: Characteristics and relation to FcγRIIA alleles. *Kidney Int.*

- 1997;52(5):1375–1380.
15. Williams Y, Lynch S, Mccann S, et al. Correlation of platelet FcγRIIA polymorphism in refractory idiopathic (immune) thrombocytopenic purpura. *Br. J. Haematol.* 1998;101(4):779–782.
 16. Myhr KM, Raknes G, Nyland H, Vedeler C. Immunoglobulin G Fc-receptor (FcγR) IIA and IIIB polymorphisms related to disability in MS. *Neurology.* 1999;52(9):1771–1776.
 17. Karassa FB, Bijl M, Davies KA, et al. Role of the Fcγ receptor IIA polymorphism in the antiphospholipid syndrome: An international meta-analysis. *Arthritis Rheum.* 2003;48(7):1930–1938.
 18. Van Der Heijden J, Geissler J, Van Mirre E, et al. A novel splice variant of FcγRIIa: A risk factor for anaphylaxis in patients with hypogammaglobulinemia. *J. Allergy Clin. Immunol.* 2013;131(5):.
 19. Anania JC, Trist HM, Palmer CS, et al. The Rare Anaphylaxis-Associated FcγRIIa3 Exhibits Distinct Characteristics From the Canonical FcγRIIa1. *Front. Immunol.* 2018;9:1809.
 20. van der Heijden J, Nagelkerke S, Zhao X, et al. Haplotypes of FcγRIIa and FcγRIIb polymorphic variants influence IgG-mediated responses in neutrophils. *J. Immunol.* 2014;192(6):2715–21.
 21. Lejeune J, Brachet G, Watier H. Evolutionary story of the low/medium-affinity IgG Fc receptor gene cluster. *Front. Immunol.* 2019;10(JUN):
 22. Metes D, Ernst LK, Chambers WH, et al. Expression of functional CD32 molecules on human NK cells is determined by an allelic polymorphism of the Fcγ/RIIC gene. *Blood.* 1998;91(7):2369–2380.
 23. van der Heijden J, Breunis WB, Geissler J, et al. Phenotypic Variation in IgG Receptors by Nonclassical FCGR2C Alleles. *J. Immunol.* 2012;188(3):1318–1324.
 24. Wu J, Edberg JC, Redecha PB, et al. A novel polymorphism of FcγRIIIa (CD16) alters receptor function and predisposes to autoimmune disease. *J. Clin. Invest.* 1997;100(5):1059–1070.
 25. Mendrinou E, Patsatsi A, Zafiriou E, et al. FCGR3A-V158F polymorphism is a disease-specific pharmacogenetic marker for the treatment of psoriasis with Fc-containing TNFα inhibitors. *Pharmacogenomics J.* 2017;17(3):237–241.
 26. Wang W, Somers EB, Ross EN, et al. FCGR2A and FCGR3A Genotypes Correlate with Farletuzumab Response in Patients with First-Relapsed Ovarian Cancer Exhibiting Low CA125. *Cytogenet. Genome Res.* 2017;152(4):169–179.
 27. Bux J, Stein EL, Bierling P, et al. Characterization of a new alloantigen (SH) on the human neutrophil Fc gamma receptor IIIb. *Blood.* 1997;89(3):1027–34.

28. Fanger MW, Shen L, Graziano RF, Guyre PM. Cytotoxicity mediated by human Fc receptors for IgG. *Immunol. Today*. 1989;10(3):92–99.
29. Perussia B. Immune interferon induces the receptor for monomeric IgG1 on human monocytic and myeloid cells. *J. Exp. Med.* 1983;158(4):1092–1113.
30. Guyre PM, Campbell AS, Kniffin WD, Fanger MW. Monocytes and polymorphonuclear neutrophils of patients with streptococcal pharyngitis express increased numbers of type I IgG Fc receptors. *J. Clin. Invest.* 1990;86(6):1892–1896.
31. Repp R, Valerius T, Sandler A, et al. Neutrophils express the high affinity receptor for IgG (Fc gamma RI, CD64) after in vivo application of recombinant human granulocyte colony- stimulating factor. *Blood*. 1991;78(4):885–889.
32. Okayama Y, Kirshenbaum AS, Metcalfe DD. Expression of a Functional High-Affinity IgG Receptor, FcγRI, on Human Mast Cells: Up-Regulation by IFN-γ. *J. Immunol.* 2000;164(8):4332–4339.
33. Bruhns P. Properties of mouse and human IgG receptors and their contribution to disease models. *Blood*. 2012;119(24):5640–9.
34. Magnusson SE, Engström M, Jacob U, Ulfgren AK, Kleinau S. High synovial expression of the inhibitory FcγRIIb in rheumatoid arthritis. *Arthritis Res. Ther.* 2007;9:.
35. Veri MC, Gorlatov S, Li H, et al. Monoclonal antibodies capable of discriminating the human inhibitory Fcγ-receptor IIB (CD32B) from the activating Fcγ-receptor IIA (CD32A): Biochemical, biological and functional characterization. *Immunology*. 2007;121(3):392–404.
36. Golay J, Valgardsdottir R, Musaraj G, et al. Human neutrophils express low levels of FcγRIIIA, which plays a role in PMN activation. *Blood*. 2019;133(13):1395–1405.
37. Gillis C, Gouel-Chéron A, Jönsson F, Bruhns P. Contribution of human FcγRs to disease with evidence from human polymorphisms and transgenic animal studies. *Front. Immunol.* 2014;5(MAY):1–13.
38. Wang Y, Jönsson F. Expression, role, and regulation of neutrophil Fcγ receptors. *Front. Immunol.* 2019;10(AUG):
39. Vossebeld PJ, Homburg CH, Roos D, Verhoeven AJ. The anti-Fc gamma RIII mAb 3G8 induces neutrophil activation via a cooperative actin of Fc gamma RIIIb and Fc gamma RIIa. *Int. J. Biochem. Cell Biol.* 1997;29(3):465–73.
40. Bruhns P. Mouse and human FcR effector functions. 2015;25–51.
41. Vidarsson G, Dekkers G, Rispens T. IgG Subclasses and Allotypes: From Structure to Effector Functions. *Front. Immunol.* 2014;5:520.

42. Nimmerjahn F, Bruhns P, Horiuchi K, Ravetch J V. FcγRIV: A Novel FcR with Distinct IgG Subclass Specificity. *Immunity*. 2005;23(1):41–51.
43. Mancardi DA, Iannascoli B, Hoos S, et al. FcγRIV is a mouse IgE receptor that resembles macrophage FcεRI in humans and promotes IgE-induced lung inflammation. *J. Clin. Invest.* 2008;118(11):3738–3750.
44. Gavin AL, Barnes N, Dijstelbloem HM, Hogarth PM. Cutting Edge: Identification of the Mouse IgG3 Receptor: Implications for Antibody Effector Function at the Interface Between Innate and Adaptive Immunity. *J Immunol.* 160(1):20–23.
45. Takizawa F, Adamczewski M, Kinet JP. Identification of the low affinity receptor for immunoglobulin E on mouse mast cells and macrophages as FcγRII and FcγRIII. *J. Exp. Med.* 1992;176(2):469–476.
46. Gordon S. Phagocytosis: The Legacy of Metchnikoff. *Cell.* 2016;166(5):1065–1068.
47. Germain RN. The Cellular Determinants of Adaptive Immunity. *N. Engl. J. Med.* 2019;381(11):1083–1085.
48. Miller JFAP. Immunological Function of the Thymus. *Lancet.* 1961;278(7205):748–749.
49. Cooper MD, Peterson RDA, Good RA. Delineation of the thymic and bursal lymphoid systems in the chicken. *Nature.* 1965;205(4967):143–146.
50. Wherry EJ, Masopust D. Adaptive Immunity: Neutralizing, Eliminating, and Remembering for the Next Time. *Viral Pathog. From Basics to Syst. Biol. Third Ed.* 2016;57–69.
51. Pradeu T, Du Pasquier L. Immunological memory: What's in a name? *Immunol. Rev.* 2018;283(1):7–20.
52. Plotkin SA, Plotkin SL. The development of vaccines: How the past led to the future. *Nat. Rev. Microbiol.* 2011;9(12):889–893.
53. O'Leary JG, Goodarzi M, Drayton DL, von Andrian UH. T cell- and B cell-independent adaptive immunity mediated by natural killer cells. *Nat. Immunol.* 2006;7(5):507–516.
54. Saeed S, Quintin J, Kerstens HHD, et al. Epigenetic programming of monocyte-to-macrophage differentiation and trained innate immunity. *Science (80-.).* 2014;345(6204):.
55. Tassetto M, Kunitomi M, Andino R. Circulating Immune Cells Mediate a Systemic RNAi-Based Adaptive Antiviral Response in Drosophila. *Cell.* 2017;169(2):314–325.e13.
56. Jackson SA, McKenzie RE, Fagerlund RD, et al. CRISPR-Cas: Adapting to change. *Science.* 2017;356(6333):.

57. Kumar B V., Connors TJ, Farber DL. Human T Cell Development, Localization, and Function throughout Life. *Immunity*. 2018;48(2):202–213.
58. Zúñiga-Pflücker JC. T-cell development made simple. *Nat. Rev. Immunol.* 2004;4(1):67–72.
59. Von Boehmer H. Selection of the T-cell repertoire: Receptor-controlled checkpoints in T-cell development. *Adv. Immunol.* 2004;84:201–238.
60. Shiina T, Hosomichi K, Inoko H, Kulski JK. The HLA genomic loci map: Expression, interaction, diversity and disease. *J. Hum. Genet.* 2009;54(1):15–39.
61. Lefranc MP, Giudicelli V, Ginestoux C, et al. IMGT, the international ImMunoGeneTics database. *Nucleic Acids Res.* 1999;27(1):209–212.
62. Zhang N, Bevan MJ. CD8(+) T cells: foot soldiers of the immune system. *Immunity*. 2011;35(2):161–8.
63. Badovinac VP, Haring JS, Harty JT. Initial T cell receptor transgenic cell precursor frequency dictates critical aspects of the CD8(+) T cell response to infection. *Immunity*. 2007;26(6):827–41.
64. Gerlach C, Rohr JC, Perié L, et al. Heterogeneous differentiation patterns of individual CD8+ T cells. *Science (80-.).* 2013;340(6132):635–639.
65. Masopust D, Schenkel JM. The integration of T cell migration, differentiation and function. *Nat. Rev. Immunol.* 2013;13(5):309–320.
66. Halle S, Halle O, Förster R. Mechanisms and Dynamics of T Cell-Mediated Cytotoxicity In Vivo. *Trends Immunol.* 2017;38(6):432–443.
67. Yang CY, Best JA, Knell J, et al. The transcriptional regulators Id2 and Id3 control the formation of distinct memory CD8 + T cell subsets. *Nat. Immunol.* 2011;12(12):1221–1229.
68. Chang JT, Wherry EJ, Goldrath AW. Molecular regulation of effector and memory T cell differentiation. *Nat. Immunol.* 2014;15(12):1104–1115.
69. Gattinoni L, Lugli E, Ji Y, et al. A human memory T cell subset with stem cell-like properties. *Nat. Med.* 2011;17(10):1290–1297.
70. Sallusto F, Lenig D, Förster R, Lipp M, Lanzavecchia A. Two subsets of memory T lymphocytes with distinct homing potentials and effector functions. *Nature.* 1999;401(6754):708–712.
71. Thome JJC, Farber DL. Emerging concepts in tissue-resident T cells: lessons from humans. *Trends Immunol.* 2015;36(7):428–35.
72. LeBien TW, Tedder TF. B lymphocytes: How they develop and function. *Blood.* 2008;112(5):1570–1580.

73. Liu Y, Zhang J, Lane P, Chan EY., MacLennan ICM. Sites of specific B cell activation in primary and secondary responses to T cell-dependent and T cell-independent antigens. *Eur. J. Immunol.* 1991;21(12):2951–2962.
74. Coutinho A, Möller G. Thymus-Independent B-Cell Induction and Paralysis. *Adv. Immunol.* 1975;21(C):113–236.
75. Lanzavecchia A. Antigen-specific interaction between T and B cells. *Nature.* 1985;314(6011):537–539.
76. Rock KL, Benacerraf B, Abbas AK. Antigen presentation by hapten-specific B lymphocytes: I. Role of surface immunoglobulin receptors. *J. Exp. Med.* 1984;160(4):1102–1113.
77. Jacob J, Kassir R, Kelsoe G. In situ studies of the primary immune response to (4-hydroxy-3-nitrophenyl)acetyl. I. The architecture and dynamics of responding cell populations. *J. Exp. Med.* 1991;173(5):1165–1175.
78. Gatto D, Brink R. The germinal center reaction. *J. Allergy Clin. Immunol.* 2010;126(5):898–907.
79. MacLennan ICM. Germinal Centers. *Annu. Rev. Immunol.* 1994;12(1):117–139.
80. Victora GD, Nussenzweig MC. Germinal Centers. *Annu. Rev. Immunol.* 2012;30(1):429–457.
81. Mesin L, Ersching J, Victora GD. Germinal Center B Cell Dynamics. *Immunity.* 2016;45(3):471–482.
82. Vinuesa CG, Linterman MA, Yu D, MacLennan ICM. Follicular Helper T Cells. *Annu. Rev. Immunol.* 2016;34(1):335–368.
83. Stavnezer J, Schrader CE. IgH Chain Class Switch Recombination: Mechanism and Regulation. *J. Immunol.* 2014;193(11):5370–5378.
84. Zhang X, Calvert RA, Sutton BJ, Doré KA. IgY: a key isotype in antibody evolution. *Biol. Rev.* 2017;92(4):2144–2156.
85. Senger K, Hackney J, Payandeh J, Zarrin AA. Antibody isotype switching in vertebrates. *Results Probl. Cell Differ.* 2015;57:295–324.
86. Ma H, O’Kennedy R. The structure of natural and recombinant antibodies. *Methods Mol. Biol.* 2015;1348:7–11.
87. Brezski RJ, Georgiou G. Immunoglobulin isotype knowledge and application to Fc engineering. *Curr. Opin. Immunol.* 2016;40:62–69.
88. Gonzalez-Quintela A, Alende R, Gude F, et al. Serum levels of immunoglobulins (IgG, IgA, IgM) in a general adult population and their relationship with alcohol consumption, smoking and common metabolic abnormalities. *Clin. Exp. Immunol.* 2007;151(1):42–50.

89. Schur PH. IgG subclasses. A historical perspective. *Monogr. Allergy*. 1988;23:1–11.
90. Ferrante A, Beard LJ, Feldman RG. IgG subclass distribution of antibodies to bacteria and viral antigens. *Pediatr. Infect. Dis. J.* 1990;9(8):S16–S24.
91. Stapleton NM, Andersen JT, Stemerding AM, et al. Competition for FcRn-mediated transport gives rise to short half-life of human IgG3 and offers therapeutic potential. *Nat. Commun.* 2011;2(1):.
92. Aalberse RC, Schuurman J. IgG4 breaking the rules. *Immunology*. 2002;105(1):9–19.
93. Vidarsson G, Dekkers G, Rispens T. IgG subclasses and allotypes: From structure to effector functions. *Front. Immunol.* 2014;5(OCT):1–17.
94. FAHEY JL, WUNDERLICH J, MISHELL R. THE IMMUNOGLOBULINS OF MICE. I. FOUR MAJOR CLASSES OF IMMUNOGLOBULINS: *J. Exp. Med.* 1964;120:223–242.
95. Grey HM, Hirst JW, Cohn M. A new mouse immunoglobulin: IgG3. *J. Exp. Med.* 1971;133(2):289–304.
96. Morgado MG, Cam P, Gris-Liebe C, Cazenave PA, Jouvin-Marche E. Further evidence that BALB/c and C57BL/6 gamma 2a genes originate from two distinct isotypes. *EMBO J.* 1989;8(11):3245–3251.
97. Collins AM. IgG subclass co-expression brings harmony to the quartet model of murine IgG function. *Immunol. Cell Biol.* 2016;94(10):949–954.
98. Yan XM, Guo J, Pichurin P, et al. Cytokines, IgG subclasses and costimulation in a mouse model of thyroid autoimmunity induced by injection of fibroblasts co-expressing MHC class II and thyroid autoantigens. *Clin. Exp. Immunol.* 2000;122(2):170–179.
99. Banovitz J, Ishizaka K. Detection of Five Components Having Antibody Activity in Rat Antisera. *Proc. Soc. Exp. Biol. Med.* 1967;125(1):78–82.
100. Binaghi RA, Sarandon de Merlo E. Characterization of Rat IgA and Its Non-Identity with the Anaphylactic Antibody. *Int. Arch. Allergy Immunol.* 1966;30(6):589–596.
101. Binaghi RA, Boussac-Aron Y. Isolation and properties of a 7 S rat immunoglobulin different from IgG. *Eur. J. Immunol.* 1975;5(3):194–197.
102. Bazin H, Beckers A, Querinjean P. Three classes and four (sub)classes of rat immunoglobulins: IgM, IgA, Ige and IgG1, IgG2a, IgG2b, IgG2c. *Eur. J. Immunol.* 1974;4(1):44–48.
103. Brüggemann M. Evolution of the rat immunoglobulin gamma heavy-chain gene family. *Gene*. 1988;74(2):473–482.
104. Medgyesi GA, Fóris G, Dezső B, Gergely J, Bazin H. Fc receptors of rat peritoneal macrophages: immunoglobulin class specificity and sensitivity to drugs affecting

- the microfilament or microtubule system. *Immunology*. 1980;40(3):317–23.
105. Hughes-Jones NC, Gorick BD, Howard JC. The mechanism of synergistic complement-mediated lysis of rat red cells by monoclonal IgG antibodies. *Eur. J. Immunol.* 1983;13(8):635–641.
 106. Inoue T, Moran I, Shinnakasu R, Phan TG, Kurosaki T. Generation of memory B cells and their reactivation. *Immunol. Rev.* 2018;283(1):138–149.
 107. Zhang TT, Gonzalez DG, Cote CM, et al. Germinal center B cell development has distinctly regulated stages completed by disengagement from T cell help. *Elife*. 2017;6:.
 108. Seifert M, Przekopowicz M, Taudien S, et al. Functional capacities of human ighm memory b cells in early inflammatory responses and secondary germinal center reactions. *Proc. Natl. Acad. Sci. U. S. A.* 2015;112(6):E546–E555.
 109. Pape KA, Taylor JJ, Maul RW, Gearhart PJ, Jenkins MK. Different B cell populations mediate early and late memory during an endogenous immune response. *Science (80-.)*. 2011;331(6021):1203–1207.
 110. Kurosaki T, Kometani K, Ise W. Memory B cells. *Nat. Rev. Immunol.* 2015;15(3):149–159.
 111. Mcheyzer-Williams LJ, Milpied PJ, Okitsu SL, Mcheyzer-Williams MG. Class-switched memory B cells remodel BCRs within secondary germinal centers. *Nat. Immunol.* 2015;16(3):296–305.
 112. Krishnamurty AT, Thouvenel CD, Portugal S, et al. Somatic Hypermutated Plasmodium-Specific IgM(+) Memory B Cells Are Rapid, Plastic, Early Responders upon Malaria Rechallenge. *Immunity*. 2016;45(2):402–14.
 113. Nutt SL, Hodgkin PD, Tarlinton DM, Corcoran LM. The generation of antibody-secreting plasma cells. *Nat. Rev. Immunol.* 2015;15(3):160–171.
 114. Chu VT, Berek C. The establishment of the plasma cell survival niche in the bone marrow. *Immunol. Rev.* 2013;251(1):177–188.
 115. Jahnsen FL, Bækkevold ES, Hov JR, Landsverk OJ. Do Long-Lived Plasma Cells Maintain a Healthy Microbiota in the Gut? *Trends Immunol.* 2018;39(3):196–208.
 116. Pollok K, Mothes R, Ulbricht C, et al. The chronically inflamed central nervous system provides niches for long-lived plasma cells. *Acta Neuropathol. Commun.* 2017;5(1):88.
 117. Mahévas M, Michel M, Vingert B, et al. Emergence of long-lived autoreactive plasma cells in the spleen of primary warm auto-immune hemolytic anemia patients treated with rituximab. *J. Autoimmun.* 2015;62:22–30.
 118. Pawankar R. Allergic diseases and asthma: a global public health concern and a

call to action. 2014.

119. Johansson SGO, Bieber T, Dahl R, et al. Revised nomenclature for allergy for global use: Report of the Nomenclature Review Committee of the World Allergy Organization, October 2003. *J. Allergy Clin. Immunol.* 2004;113(5):832–836.
120. Tejedor Alonso MA, Moro Moro M, Múgica García M V. Epidemiology of anaphylaxis. *Clin. Exp. Allergy.* 2015;45(6):1027–1039.
121. LoVerde D, Iweala OI, Eginli A, Krishnaswamy G. Anaphylaxis. *Chest.* 2018;153(2):528–543.
122. Hemmings O, Kwok M, McKendry R, Santos AF. Basophil Activation Test: Old and New Applications in Allergy. *Curr. Allergy Asthma Rep.* 2018;18(12):1–12.
123. Fireman P. Atlas of allergies and clinical immunology. Mosby; 2006.
124. Bilò BM, Rueff F, Mosbech H, Bonifazi F, Oude-Elberink JNG. Diagnosis of Hymenoptera venom allergy. Munksgaard International Publishers; 2005.
125. Pandey N, Cascella M. Beta Lactam Antibiotics. StatPearls Publishing; 2020.
126. T W, A A, G t’Jong, et al. Beta-lactam Allergy in the Paediatric Population. *Paediatr. Child Health.* 2020;25(1):.
127. Har D, Solensky R. Penicillin and Beta-Lactam Hypersensitivity. *Immunol. Allergy Clin. North Am.* 2017;37(4):643–662.
128. Bilò BM, Rueff F, Mosbech H, Bonifazi F, Oude-Elberink JNG. Diagnosis of Hymenoptera venom allergy. *Allergy.* 2005;60(11):1339–1349.
129. Antonicelli L, Bilò MB, Bonifazi F. Epidemiology of hymenoptera allergy. *Curr. Opin. Allergy Clin. Immunol.* 2002;2(4):341–346.
130. Mueller HL. Diagnosis and treatment of insect sensitivity. *J. Asthma.* 1966;3(4):331–333.
131. Ring J, Messmer K. Incidence and Severity of Anaphylactoid Reactions To Colloid Volume Substitutes. *Lancet.* 1977;309(8009):466–469.
132. Sturm GJ, Varga EM, Roberts G, et al. EAACI guidelines on allergen immunotherapy: Hymenoptera venom allergy. *Allergy Eur. J. Allergy Clin. Immunol.* 2018;73(4):744–764.
133. Montañez MI, Mayorga C, Bogas G, et al. Epidemiology, mechanisms, and diagnosis of drug-induced anaphylaxis. *Front. Immunol.* 2017;8(MAY):
134. Macy E. Penicillin and Beta-Lactam Allergy: Epidemiology and Diagnosis. *Curr. Allergy Asthma Rep.* 2014;14(11):1–7.
135. Levine BB. Immunologic mechanisms of penicillin allergy. A haptenic model system for the study of allergic diseases of man. *N. Engl. J. Med.*

- 1966;275(20):1115–1125.
136. Torres MJ, Blanca M, Fernandez J, et al. Diagnosis of immediate allergic reactions to beta-lactam antibiotics. *Allergy*. 2003;58(10):961–972.
 137. Romano A, Mayorga C, Torres MJ, et al. Immediate allergic reactions to cephalosporins: Cross-reactivity and selective responses. *J. Allergy Clin. Immunol.* 2000;106(6):1177–1183.
 138. Handley DA, Magnetti A, Higgins AJ. Therapeutic advantages of third generation antihistamines. *Expert Opin. Investig. Drugs*. 1998;7(7):1045–1054.
 139. Dantzer JA, Wood RA. The use of omalizumab in allergen immunotherapy. *Clin. Exp. Allergy*. 2018;48(3):232–240.
 140. Eckman JA, Sterba PM, Kelly D, et al. Effects of omalizumab on basophil and mast cell responses using an intranasal cat allergen challenge. *J. Allergy Clin. Immunol.* 2010;125(4):889.
 141. Pelaia C, Calabrese C, Terracciano R, et al. Omalizumab, the first available antibody for biological treatment of severe asthma: more than a decade of real-life effectiveness. *Ther. Adv. Respir. Dis.* 2018;12:.
 142. Pennington LF, Tarchevskaya S, Brigger D, et al. Structural basis of omalizumab therapy and omalizumab-mediated IgE exchange. *Nat. Commun.* 2016;7(1):1–12.
 143. Maurer M, Giménez-Arnau AM, Sussman G, et al. Ligelizumab for Chronic Spontaneous Urticaria. *N. Engl. J. Med.* 2019;381(14):1321–1332.
 144. Limb SL, Starke PR, Lee CE, Chowdhury BA. Delayed onset and protracted progression of anaphylaxis after omalizumab administration in patients with asthma. *J. Allergy Clin. Immunol.* 2007;120(6):1378–1381.
 145. Lieberman PL, Umetsu DT, Carrigan GJ, Rahmaoui A. Anaphylactic reactions associated with omalizumab administration: Analysis of a case-control study. *J. Allergy Clin. Immunol.* 2016;138(3):913-915.e2.
 146. Macglashan DW, Saini SS. Omalizumab increases the intrinsic sensitivity of human basophils to IgE-mediated stimulation. *J. Allergy Clin. Immunol.* 2013;132(4):906-911.e4.
 147. Xolair (Omalizumab): Uses, Dosage, Side Effects, Interactions, Warning.
 148. Pagovich OE, Wang B, Chiuchiolo MJ, et al. Anti-hIgE gene therapy of peanut-induced anaphylaxis in a humanized murine model of peanut allergy. *J. Allergy Clin. Immunol.* 2015;138(6):1652-1662.e7.
 149. Vatrella A, Fabozzi I, Calabrese C, Maselli R, Pelaia G. Dupilumab: A novel treatment for asthma. *J. Asthma Allergy*. 2014;7:123–130.
 150. Larché M, Robinson DS, Kay AB. The role of T lymphocytes in the pathogenesis of

- asthma. *J. Allergy Clin. Immunol.* 2003;111(3):450–463.
151. Broughton SE, Dhagat U, Hercus TR, et al. The GM-CSF/IL-3/IL-5 cytokine receptor family: From ligand recognition to initiation of signaling. *Immunol. Rev.* 2012;250(1):277–302.
 152. Kaiko GE, Foster PS. New insights into the generation of Th2 immunity and potential therapeutic targets for the treatment of asthma. *Curr. Opin. Allergy Clin. Immunol.* 2011;11(1):39–45.
 153. Oh CK, Geba GP, Molino N. Investigational therapeutics targeting the IL-4/IL-13/STAT-6 pathway for the treatment of asthma. *Eur. Respir. Rev.* 2010;19(115):46–54.
 154. Zheng T, Liu W, Oh S-Y, et al. IL-13 Receptor $\alpha 2$ Selectively Inhibits IL-13-Induced Responses in the Murine Lung. *J. Immunol.* 2008;180(1):522–529.
 155. Castro M, Corren J, Pavord ID, et al. Dupilumab Efficacy and Safety in Moderate-to-Severe Uncontrolled Asthma. *N. Engl. J. Med.* 2018;378(26):2486–2496.
 156. Dougan M, Dranoff G, Dougan SK. GM-CSF, IL-3, and IL-5 Family of Cytokines: Regulators of Inflammation. *Immunity.* 2019;50(4):796–811.
 157. Ortega HG, Liu MC, Pavord ID, et al. Mepolizumab Treatment in Patients with Severe Eosinophilic Asthma. *N. Engl. J. Med.* 2014;371(13):1198–1207.
 158. Liddament M, Husten J, Estephan T, et al. Higher binding affinity and in vitro potency of reslizumab for interleukin-5 compared with mepolizumab. *Allergy, Asthma Immunol. Res.* 2019;11(2):291–298.
 159. FitzGerald JM, Bleecker ER, Nair P, et al. Benralizumab, an anti-interleukin-5 receptor α monoclonal antibody, as add-on treatment for patients with severe, uncontrolled, eosinophilic asthma (CALIMA): a randomised, double-blind, placebo-controlled phase 3 trial. *Lancet.* 2016;388(10056):2128–2141.
 160. Casale TB, Pacou M, Mesana L, et al. Reslizumab Compared with Benralizumab in Patients with Eosinophilic Asthma: A Systematic Literature Review and Network Meta-Analysis. *J. Allergy Clin. Immunol. Pract.* 2019;7(1):122–130.e1.
 161. Noon L. Prophylactic inoculation against hay fever. *Lancet.* 1911;177(4580):1572–1573.
 162. Agache I. EAACI guidelines on allergen immunotherapy—Out with the old and in with the new. *Allergy Eur. J. Allergy Clin. Immunol.* 2018;73(4):737–738.
 163. Ring J, Messmer K. Venom immunotherapy: clinical efficacy, safety and contraindications. *Lancet.* 2015;309(8009):466–469.
 164. Roberts G, Pfaar O, Akdis CA, et al. EAACI Guidelines on Allergen Immunotherapy: Allergic rhinoconjunctivitis. *Allergy Eur. J. Allergy Clin. Immunol.* 2018;73(4):765–

798.

165. Pajno GB, Fernandez-Rivas M, Arasi S, et al. EAACI Guidelines on allergen immunotherapy: IgE-mediated food allergy. *Allergy Eur. J. Allergy Clin. Immunol.* 2018;73(4):799–815.
166. Everaere L, Ait-Yahia S, Molendi-Coste O, et al. Innate lymphoid cells contribute to allergic airway disease exacerbation by obesity. *J. Allergy Clin. Immunol.* 2016;138(5):1309-1318.e11.
167. Francis JN, Till SJ, Durham SR. Induction of IL-10+CD4+CD25+T cells by grass pollen immunotherapy. *J. Allergy Clin. Immunol.* 2003;111(6):1255–1261.
168. Stanic B, Van De Veen W, Wirz OF, et al. IL-10-overexpressing B cells regulate innate and adaptive immune responses. *J. Allergy Clin. Immunol.* 2015;135(3):771-780.e8.
169. Flicker S, Valenta R. Renaissance of the blocking antibody concept in type I allergy. *Int. Arch. Allergy Immunol.* 2003;132(1):13–24.
170. Wachholz PA, Durham SR. Mechanisms of immunotherapy: IgG revisited. *Curr. Opin. Allergy Clin. Immunol.* 2004;4(4):313–318.
171. Nouri-Aria KT, Wachholz PA, Francis JN, et al. Grass Pollen Immunotherapy Induces Mucosal and Peripheral IL-10 Responses and Blocking IgG Activity. *J. Immunol.* 2004;172(5):3252–3259.
172. Golden DBK, Meyers DA, Kagey-Sobotka A, Valentine MD, Lichtenstein LM. Clinical relevance of the venom-specific immunoglobulin G antibody level during immunotherapy. *J. Allergy Clin. Immunol.* 1982;69(6):489–493.
173. Van Ree R, Van Leeuwen WA, Dieges PH, et al. Measurement of IgE antibodies against purified grass pollen allergens (Lol p 1, 2, 3 and 5) during immunotherapy. *Clin. Exp. Allergy.* 1997;27(1):68–74.
174. Bousquet J, Braquemonde P, Feinberg J, et al. Specific IgE response before and after rush immunotherapy with a standardized allergen or allergoid in grass pollen allergy. *Ann. Allergy.* 1986;56(6):456–459.
175. Gleich GJ, Zimmermann EM, Henderson LL, Yunginger JW. Effect of immunotherapy on immunoglobulin E and immunoglobulin G antibodies to ragweed antigens: A six-year prospective study. *J. Allergy Clin. Immunol.* 1982;70(4):261–271.
176. Treter S, Luqman M. Antigen-specific T cell tolerance down-regulates mast cell responses in vivo. *Cell. Immunol.* 2000;206(2):116–124.
177. Shim JY, Kim BS, Cho SH, Mint KU, Hong SJ. Allergen-specific conventional immunotherapy decreases immunoglobulin e-mediated basophil histamine releasability. *Clin. Exp. Allergy.* 2003;33(1):52–57.

178. Wilson DR, Irani AM, Walker SM, et al. Grass pollen immunotherapy inhibits seasonal increases in basophils and eosinophils in the nasal epithelium. *Clin. Exp. Allergy*. 2001;31(11):1705–1713.
179. Shamji MH, Durham SR. Mechanisms of allergen immunotherapy for inhaled allergens and predictive biomarkers. *J. Allergy Clin. Immunol.* 2017;140(6):1485–1498.
180. T.V.Rajan. The Gell-Coombs classification of hypersensitivity reactions: a re-interpretation. *TREND Immunol.* 2003;24(7):376.
181. Fort MM, Cheung J, Yen D, et al. IL-25 Induces IL-4, IL-5, and IL-13 and Th2-associated pathologies in vivo. *Immunity*. 2001;15(6):985–995.
182. Fallon PG, Ballantyne SJ, Mangan NE, et al. Identification of an interleukin (IL)-25-dependent cell population that provides IL-4, IL-5, and IL-13 at the onset of helminth expulsion. *J. Exp. Med.* 2006;203(4):1105–1116.
183. Shinoda K, Hirahara K, Nakayama T. Maintenance of pathogenic Th2 cells in allergic disorders. *Allergol. Int.* 2017;66(3):369–376.
184. Kubo M. T follicular helper and TH2 cells in allergic responses. *Allergol. Int.* 2017;66(3):377–381.
185. Lambrecht BN, Hammad H. The immunology of asthma. *Nat. Immunol.* 2015;16(1):45–56.
186. Hartl D, Koller B, Mehlhorn AT, et al. Quantitative and functional impairment of pulmonary CD4+CD25hi regulatory T cells in pediatric asthma. *J. Allergy Clin. Immunol.* 2007;119(5):1258–1266.
187. Galli SJ, Tsai M. IgE and mast cells in allergic disease. *Nat. Med.* 2012;18(5):693–704.
188. Gould HJ, Wu Y-CB. IgE repertoire and immunological memory: compartmental regulation and antibody function. *Int. Immunol.* 2018;30(9):403–412.
189. Gieras A, Linhart B, Roux KH, et al. IgE epitope proximity determines immune complex shape and effector cell activation capacity. *J. Allergy Clin. Immunol.* 2016;137(5):1557–1565.
190. Oettgen HC. Fifty years later: Emerging functions of IgE antibodies in host defense, immune regulation, and allergic diseases. *J. Allergy Clin. Immunol.* 2016;137(6):1631–1645.
191. Mora J, Riggs EK, Fu J, et al. Expression of the high affinity IgE receptor by neutrophils of individuals with allergic asthma is both minimal and insensitive to regulation by serum IgE. *Clin. Immunol.* 2009;132(1):132–140.
192. Ishizaka K, Ishizaka T. Identification of IgE. *J. Allergy Clin. Immunol.*

- 2016;137(6):1646–1650.
193. Zheng Y, Holowka D, Baird B, Shopes B. Conformations of IgE Bound to Its Receptor FcεRI and in Solution. *Biochemistry*. 1991;30(38):9125–9132.
 194. Wan T, Beavil RL, Fabiane SM, et al. The crystal structure of IgE Fc reveals an asymmetrically bent conformation. *Nat. Immunol.* 2002;3(7):681–686.
 195. Drinkwater N, Cossins BP, Keeble AH, et al. Human immunoglobulin E flexes between acutely bent and extended conformations. *Nat. Struct. Mol. Biol.* 2014;21(4):397–404.
 196. Vinuesa CG, Linterman MA, Goodnow CC, Randall KL. T cells and follicular dendritic cells in germinal center B-cell formation and selection. *Immunol. Rev.* 2010;237(1):72–89.
 197. Yang Z, Sullivan BM, Allen CDC. Fluorescent In Vivo Detection Reveals that IgE+ B Cells Are Restrained by an Intrinsic Cell Fate Predisposition. *Immunity*. 2012;36(5):857–872.
 198. Xiong H, Curotto de Lafaille MA, Lafaille JJ. What is Unique About the IgE Response? *Adv. Immunol.* 2012;116:113–141.
 199. Wu LC, Zarrin AA. The production and regulation of IgE by the immune system. *Nat. Rev. Immunol.* 2014 144. 2014;14(4):247–259.
 200. Greer AM, Wu N, Putnam AL, et al. Serum IgE clearance is facilitated by human FcεRI internalization. *J. Clin. Invest.* 2014;124(3):1187–1198.
 201. Letelfer M, Nakajima T, Pufdo-Cejudo G, Hofstetter H, Delespesse G. Mechanism of formation of human IgE-binding factors (Soluble CD23): III. Evidence for a receptor (FCERII)-associated proteolytic activity. *J. Exp. Med.* 1990;172(3):693–700.
 202. Hibbert RG, Teriete P, Grundy GJ, et al. The structure of human CD23 and its interactions with IgE and CD21. *J. Exp. Med.* 2005;202(6):751–760.
 203. Luo HY, Hofstetter H, Banchereau J, Delespesse G. Cross-linking of CD23 antigen by its natural ligand (IgE) or by anti-CD23 antibody prevents B lymphocyte proliferation and differentiation. *J. Immunol.* 1991;146(7):2122–9.
 204. Sherr E, Macy E, Kimata H, Gilly M, Saxon A. Binding the low affinity Fc epsilon R on B cells suppresses ongoing human IgE synthesis. *J. Immunol.* 1989;142(2):481–9.
 205. Horst A, Hunzelmann N, Arce S, et al. Detection and characterization of plasma cells in peripheral blood: correlation of IgE+ plasma cell frequency with IgE serum titre. *Clin. Exp. Immunol.* 2002;130(3):370–8.
 206. Looney TJ, Lee JY, Roskin KM, et al. Human B-cell isotype switching origins of IgE.

- J. Allergy Clin. Immunol.* 2016;137(2):579-586.e7.
207. Eckl-Dorna J, Pree I, Reisinger J, et al. The majority of allergen-specific IgE in the blood of allergic patients does not originate from blood-derived B cells or plasma cells. *Clin. Exp. Allergy.* 2012;42(9):1347–1355.
 208. Eckl-Dorna J, Niederberger V. What is the source of serum allergen-specific IgE? *Curr. Allergy Asthma Rep.* 2013;13(3):281–287.
 209. Xiong H, Dolpady J, Wabl M, de Lafaille MAC, Lafaille JJ. Sequential class switching is required for the generation of high affinity IgE antibodies. *J. Exp. Med.* 2012;209(2):353–364.
 210. Talay O, Yan D, Brightbill HD, et al. IgE + memory B cells and plasma cells generated through a germinal-center pathway. *Nat. Immunol.* 2012;13(4):396–404.
 211. BELL R. IgE, allergies and helminth parasites: A new perspective on an old conundrum. *Immunol. Cell Biol.* 1996;74(4):337–345.
 212. Oettgen HC, Martin TR, Wynshaw-Boris A, et al. Active anaphylaxis in IgE-deficient mice. *Nature.* 1994;370(6488):367–370.
 213. NUSSENZWEIG RS, MERRYMAN C, BENACERRAF B. ELECTROPHORETIC SEPARATION AND PROPERTIES OF MOUSE ANTIHAPTEN ANTIBODIES INVOLVED IN PASSIVE CUTANEOUS ANAPHYLAXIS AND PASSIVE HEMOLYSIS. *J. Exp. Med.* 1964;120:315–28.
 214. Takeishi T, Martin TR, Katona IM, Finkelman FD, Galli SJ. Differences in the expression of the cardiopulmonary alterations associated with anti-immunoglobulin E-induced or active anaphylaxis in mast cell-deficient and normal mice: Mast cells are not required for the cardiopulmonary changes associated with certain. *J. Clin. Invest.* 1991;88(2):598–608.
 215. Tsujimura Y, Obata K, Mukai K, et al. Basophils Play a Pivotal Role in Immunoglobulin-G-Mediated but Not Immunoglobulin-E-Mediated Systemic Anaphylaxis. *Immunity.* 2008;28(4):581–589.
 216. Jönsson F, Mancardi D a, Kita Y, et al. Mouse and human neutrophils induce anaphylaxis. 2011;121(4):.
 217. Beutier H, Gillis CM, Iannascoli B, et al. IgG subclasses determine pathways of anaphylaxis in mice. *J. Allergy Clin. Immunol.* 2017;139(1):269-280.e7.
 218. Strait RT, Morris SC, Yang M, Qu X-W, Finkelman FD. Pathways of anaphylaxis in the mouse. *J. Allergy Clin. Immunol.* 2002;109(4):658–68.
 219. Reber LL, Hernandez JD, Galli SJ. The pathophysiology of anaphylaxis. *J. Allergy Clin. Immunol.* 2017;140(2):335–348.

220. Elo€ Ise Beutier H, Gillis CM, Iannascoli B, et al. IgG subclasses determine pathways of anaphylaxis in mice. *J. Allergy Clin. Immunol.* 2017;139:269-280.e7.
221. Jönsson F, Mancardi DA, Kita Y, et al. Mouse and human neutrophils induce anaphylaxis. 2011;121(4):.
222. Ohnmacht C, Schwartz C, Panzer M, et al. Basophils Orchestrate Chronic Allergic Dermatitis and Protective Immunity against Helminths. *Immunity.* 2010;33(3):364–374.
223. Jönsson F, Mancardi DA, Kita Y, et al. Mouse and human neutrophils induce anaphylaxis. *J. Clin. Invest.* 2011;121(4):1484–1496.
224. Jonsson F, Mancardi D a., Zhao W, et al. Human Fc RIIA induces anaphylactic and allergic reactions. *Blood.* 2012;119(11):2533–2544.
225. Beutier H, Hechler B, Godon O, et al. Platelets expressing IgG receptor FcγRIIA/CD32A determine the severity of experimental anaphylaxis. *Sci. Immunol.* 2018;3(22):eaan5997.
226. Cloutier N, Allaeyes I, Marcoux G, et al. Platelets release pathogenic serotonin and return to circulation after immune complex-mediated sequestration. *Proc. Natl. Acad. Sci. U. S. A.* 2018;115(7):E1550–E1559.
227. Gillis CM, Jönsson F, Mancardi DA, et al. Mechanisms of anaphylaxis in human low-affinity IgG receptor locus knock-in mice. *J. Allergy Clin. Immunol.* 2016;
228. Jönsson F, De Chaisemartin L, Granger V, et al. An IgG-induced neutrophil activation pathway contributes to human drug-induced anaphylaxis. *Sci. Transl. Med.* 2019;11(500):.
229. Wolterink RGJK, Kleinjan A, van Nimwegen M, et al. Pulmonary innate lymphoid cells are major producers of IL-5 and IL-13 in murine models of allergic asthma. *Eur. J. Immunol.* 2012;42(5):1106–1116.
230. Halim TYF, Steer CA, Mathä L, et al. Group 2 innate lymphoid cells are critical for the initiation of adaptive T helper 2 cell-mediated allergic lung inflammation. *Immunity.* 2014;40(3):425–435.
231. Zhang Y, Collier F, Naselli G, et al. Cord blood monocyte-derived inflammatory cytokines suppress IL-2 and induce nonclassic “TH2-type” immunity associated with development of food allergy. *Sci. Transl. Med.* 2016;8(321):.
232. Brockow K, Garvey LH, Aberer W, et al. Skin test concentrations for systemically administered drugs - an ENDA/EAACI Drug Allergy Interest Group position paper. *Allergy.* 2013;68(6):702–712.
233. Hasan M, Beitz B, Rouilly V, et al. Semi-automated and standardized cytometric procedures for multi-panel and multi-parametric whole blood immunophenotyping. *Clin. Immunol.* 2015;157(2):261–276.

234. Eberlein B, Suárez IL, Darsow U, et al. A new basophil activation test using CD63 and CCR3 in allergy to antibiotics. *Clin. Exp. Allergy*. 2010;40(3):411–418.
235. Urrutia. Standardized Whole-Blood Transcriptional Profiling Enables the Deconvolution of Complex Induced Immune Responses. *CellReports*. 2016;16:2777–2791.
236. Kim KW, Kim BM, Doh KC, et al. Clinical significance of CCR7+CD8+ T cells in kidney transplant recipients with allograft rejection. *Sci. Rep*. 2018;8(1):.
237. Noval Rivas M, Chatila TA. Regulatory T cells in allergic diseases. *J. Allergy Clin. Immunol*. 2016;138(3):639–652.
238. Ling EM, Smith T, Nguyen XD, et al. Relation of CD4+CD25+ regulatory T-cell suppression of allergen-driven T-cell activation to atopic status and expression of allergic disease. *Lancet (London, England)*. 2004;363(9409):608–15.
239. Collin M, Bigley V. Human dendritic cell subsets: an update. *Immunology*. 2018;154(1):3–20.
240. Yi S, Zhai J, Niu R, et al. Eosinophil recruitment is dynamically regulated by interplay among lung dendritic cell subsets after allergen challenge. *Nat. Commun*. 2018;9(1):.
241. Froidure A, Vandenplas O, D'Alpaos V, Evrard G, Pilette C. Defects in Plasmacytoid Dendritic Cell Expression of Inducible Costimulator Ligand and IFN- α Are Associated in Asthma with Disease Persistence. *Am. J. Respir. Crit. Care Med*. 2015;192(3):392–395.
242. Pritchard AL, Carroll ML, Burel JG, et al. Innate IFNs and Plasmacytoid Dendritic Cells Constrain Th2 Cytokine Responses to Rhinovirus: A Regulatory Mechanism with Relevance to Asthma. *J. Immunol*. 2012;188(12):5898–5905.
243. De Heer HJ, Hammad H, Soullié T, et al. Essential role of lung plasmacytoid dendritic cells in preventing asthmatic reactions to harmless inhaled antigen. *J. Exp. Med*. 2004;200(1):89–98.
244. Kanters D, ten Hove W, Luijk B, et al. Expression of activated Fc gamma RII discriminates between multiple granulocyte-priming phenotypes in peripheral blood of allergic asthmatic subjects. *J. Allergy Clin. Immunol*. 2007;120(5):1073–81.
245. Sturm GJ, Bohm E, Trummer M, et al. The CD63 basophil activation test in Hymenoptera venom allergy: a prospective study. *Allergy*. 2004;59(10):1110–1117.
246. Duffy D, Rouilly V, Libri V, et al. Functional analysis via standardized whole-blood stimulation systems defines the boundaries of a healthy immune response to complex stimuli. *Immunity*. 2014;40(3):436–450.

247. Lambrecht BN, Hammad H. The immunology of the allergy epidemic and the hygiene hypothesis. *Nat. Immunol.* 2017;18(10):1076–1083.
248. Schall TJ. Biology of the rantes/sis cytokine family. *Cytokine.* 1991;3(3):165–183.
249. Schall TJ, Bacon K, Toy KJ, Goeddel D V. Selective attraction of monocytes and T lymphocytes of the memory phenotype by cytokine RANTES. *Nature.* 1990;347(6294):669–671.
250. Bleul CC, Fuhlbrigge RC, Casasnovas JM, Aiuti A, Springer TA. A highly efficacious lymphocyte chemoattractant, stromal cell-derived factor 1 (SDF-1). *J. Exp. Med.* 1996;184(3):1101–1109.
251. Ikeno Y, Hirata H, Arima M, et al. Wasp venom allergy: effect of anti-IgE antibody on wasp venom anaphylaxis in a mouse model.
252. Winkler B, Bolwig C, Seppälä U, et al. Allergen-specific immunosuppression by mucosal treatment with recombinant Ves v 5, a major allergen of *Vespula vulgaris* venom, in a murine model of wasp venom allergy. *Immunology.* 2003;110(3):376–85.
253. Perez-Riverol A, Justo-Jacomini D, Zollner R, Brochetto-Braga M. Facing Hymenoptera Venom Allergy: From Natural to Recombinant Allergens. *Toxins (Basel).* 2015;7(7):2551–2570.
254. Haahtela T, Holgate S, Pawankar R, et al. The biodiversity hypothesis and allergic disease: World allergy organization position statement. *World Allergy Organ. J.* 2013;6(1):1–18.
255. Eckl-Dorna J, Villazala-Merino S, Campion NJ, et al. Tracing IgE-Producing Cells in Allergic Patients. *Cells.* 2019;8(9):994.
256. Limaye AP, Abrams JS, Silver JE, Ottesen EA, Nutman TB. Regulation of parasite-induced eosinophilia : Selectively increased interleukin 5 production in helminth-infected patients. *J. Exp. Med.* 1990;172(1):399–402.
257. Thomas S, Rouilly V, Patin E, et al. The Milieu Intérieur study - an integrative approach for study of human immunological variance. *Clin. Immunol.* 2015;157(2):277–93.
258. OMENAAS E, BAKKE P, ELSAYED S, HANOA R, GULSVIK A. Total and specific serum IgE levels in adults: relationship to sex, age and environmental factors. *Clin. <html_ent glyph="@amp;" ascii="&"/> Exp. Allergy.* 1994;24(6):530–539.
259. Barbee RA, Halonen M, Lebowitz M, Burrows B. Distribution of IgE in a community population sample: correlations with age, sex, and allergen skin test reactivity. *J. Allergy Clin. Immunol.* 1981;68(2):106–111.
260. Wüthrich B, Schindler C, Medici TC, Zellweger J-P, Leuenberger P. IgE Levels, Atopy Markers and Hay Fever in Relation to Age, Sex and Smoking Status in a

- Normal Adult Swiss Population. *Int. Arch. Allergy Immunol.* 1996;111(4):396–402.
261. Kerkhof M, Droste JHJ, Monchy JGR, Schouten JP, Rijcken B. Distribution of total serum IgE and specific IgE to common aeroallergens by sex and age, and their relationship to each other in a random sample of the Dutch general population aged 20–70 years. *Allergy.* 1996;51(11):770–776.
 262. Howell WM, Holgate ST. HLA genetics and allergic disease. *Thorax.* 1995;50(8):815–818.
 263. Rossman MD, Thompson B, Frederick M, et al. HLA-DRB1*1101: A Significant Risk Factor for Sarcoidosis in Blacks and Whites. *Am. J. Hum. Genet.* 2003;73(4):720–735.
 264. Ober C, Yao T-C. The genetics of asthma and allergic disease: a 21st century perspective. *Immunol. Rev.* 2011;242(1):10–30.
 265. Barbee RA, Halonen M, Kaltenborn W, Lebowitz M, Burrows B. A longitudinal study of serum IgE in a community cohort: Correlations with age, sex, smoking, and atopic status. *J. Allergy Clin. Immunol.* 1987;79(6):919–927.
 266. Youssef LA. Roles for the High Affinity IgE Receptor, Fc ϵ RI, of Human Basophils in the Pathogenesis and Therapy of Allergic Asthma: Disease Promotion, Protection or Both? *Open Allergy J.* 2010;3(1):91–101.
 267. Harrington LE, Hatton RD, Mangan PR, et al. Interleukin 17-producing CD4+ effector T cells develop via a lineage distinct from the T helper type 1 and 2 lineages. *Nat. Immunol.* 2005;6(11):1123–1132.
 268. Onishi RM, Gaffen SL. Interleukin-17 and its target genes: Mechanisms of interleukin-17 function in disease. *Immunology.* 2010;129(3):311–321.
 269. Gaffen SL, Jain R, Garg A V., Cua DJ. The IL-23-IL-17 immune axis: From mechanisms to therapeutic testing. *Nat. Rev. Immunol.* 2014;14(9):585–600.
 270. Cua DJ, Tato CM. Innate IL-17-producing cells: The sentinels of the immune system. *Nat. Rev. Immunol.* 2010;10(7):479–489.
 271. Chesné J, Braza F, Mahay G, et al. IL-17 in severe asthma: Where do we stand? *Am. J. Respir. Crit. Care Med.* 2014;190(10):1094–1101.
 272. Choy DF, Hart KM, Borthwick LA, et al. TH2 and TH17 inflammatory pathways are reciprocally regulated in asthma. *Sci. Transl. Med.* 2015;7(301):301ra129–301ra129.
 273. Newcomb DC, Boswell MG, Huckabee MM, et al. IL-13 Regulates Th17 Secretion of IL-17A in an IL-10-Dependent Manner. *J. Immunol.* 2012;188(3):1027–1035.
 274. Newcomb DC, Boswell MG, Zhou W, et al. Human TH17 cells express a functional IL-13 receptor and IL-13 attenuates IL-17A production. *J. Allergy Clin. Immunol.*

- 2011;127(4):.
275. Wenzel S. Severe asthma in adults. *Am. J. Respir. Crit. Care Med.* 2005;172(2):149–160.
 276. Cox G. Glucocorticoid treatment inhibits apoptosis in human neutrophils. Separation of survival and activation outcomes. *J. Immunol.* 1995;154(9):4719–25.
 277. Sampson AP. The role of eosinophils and neutrophils in inflammation. *Clin. Exp. Allergy, Suppl.* 2000;30(1):22–27.
 278. Ziegler-Heitbrock L, Ancuta P, Crowe S, et al. Nomenclature of monocytes and dendritic cells in blood. *Nomenclature of monocytes and dendritic cells in blood.* 2014;116(16):5–7.
 279. Fingerle G, Pforte A, Passlick B, et al. The novel subset of CD14⁺/CD16⁺ blood monocytes is expanded in sepsis patients. *Blood.* 1993;82(10):3170–3176.
 280. Nockher WA, Scherberich JE. Expanded CD14⁺ CD16⁺ Monocyte subpopulation in patients with acute and chronic infections undergoing hemodialysis. *Infect. Immun.* 1998;66(6):2782–2790.
 281. Shrestha Palikhe N, Nahirney D, Laratta C, et al. Increased Protease-Activated Receptor-2 (PAR-2) Expression on CD14⁺⁺CD16⁺ Peripheral Blood Monocytes of Patients with Severe Asthma. *PLoS One.* 2015;10(12):e0144500.
 282. Kowal K, Moniuszko M, Dabrowska M, Bodzenta-Lukaszyk A. Allergen Challenge Differentially Affects the Number of Circulating Monocyte Subsets. *Scand. J. Immunol.* 2012;75(5):531–539.
 283. Saradna A, Do DC, Kumar S, Fu QL, Gao P. Macrophage polarization and allergic asthma. *Transl. Res.* 2018;191:1–14.
 284. Wynn TA, Chawla A, Pollard JW. Macrophage biology in development, homeostasis and disease. *Nature.* 2013;496(7446):445–455.
 285. Raes G, Brys L, Dahal BK, et al. Macrophage galactose-type C-type lectins as novel markers for alternatively activated macrophages elicited by parasitic infections and allergic airway inflammation. *J. Leukoc. Biol.* 2005;77(3):321–327.
 286. Maazi H, Lam J, Lombardi V, Akbari O. Role of plasmacytoid dendritic cell subsets in allergic asthma. *Allergy Eur. J. Allergy Clin. Immunol.* 2013;68(6):695–701.
 287. Palomares O, Rückert B, Jartti T, et al. Induction and maintenance of allergen-specific FOXP3⁺ Treg cells in human tonsils as potential first-line organs of oral tolerance. *J. Allergy Clin. Immunol.* 2012;129(2):.
 288. Shao Z, Bharadwaj AS, McGee HS, Makinde TO, Agrawal DK. Fms-like tyrosine kinase 3 ligand increases a lung DC subset with regulatory properties in allergic airway inflammation. *J. Allergy Clin. Immunol.* 2009;123(4):917.

289. Smit JJ, Bol-Schoenmakers M, Hassing I, et al. The role of intestinal dendritic cells subsets in the establishment of food allergy. *Clin. Exp. Allergy*. 2011;41(6):890–898.
290. Lambrecht BN, De Veerman M, Coyle AJ, et al. Myeloid dendritic cells induce TH2 responses to inhaled antigen, leading to eosinophilic airway inflammation. *J. Clin. Invest*. 2000;106(4):551–559.
291. Breiteneder H, Diamant Z, Eiwegger T, et al. Future research trends in understanding the mechanisms underlying allergic diseases for improved patient care. *Allergy Eur. J. Allergy Clin. Immunol*. 2019;74(12):2293–2311.
292. Gambón Deza F, Sánchez Espinel C, Valdueza Beneitez J. A novel IgA-like immunoglobulin in the reptile *Eublepharis macularius*. *Dev. Comp. Immunol*. 2007;31(6):596–605.
293. Wagner B, Miller DC, Lear TL, Antczak DF. The Complete Map of the Ig Heavy Chain Constant Gene Region Reveals Evidence for Seven IgG Isotypes and for IgD in the Horse. *J. Immunol*. 2004;173(5):3230–3242.
294. Lewis MJ, Wagner B, Woof JM. The different effector function capabilities of the seven equine IgG subclasses have implications for vaccine strategies. *Mol. Immunol*. 2008;45(3):818–827.
295. Sapsutthipas S, Leong PK, Akesowan S, et al. Effective Equine Immunization Protocol for Production of Potent Poly-specific Antisera against *Calloselasma rhodostoma*, *Cryptelytrops albolabris* and *Daboia siamensis*. *PLoS Negl. Trop. Dis*. 2015;9(3):.
296. Micusan V V, Borduas AG. Biological properties of goat immunoglobulins G. *Immunology*. 1977;32(4):373–81.
297. Johnson M. Rabbit Antibody. *Mater. Methods*. 2013;3:.
298. Zand MS, Vo T, Huggins J, et al. Polyclonal Rabbit Antithymocyte Globulin Triggers B-Cell and Plasma Cell Apoptosis by Multiple Pathways. *Transplantation*. 2005;79(11):1507–1515.
299. Guo Y, Bao Y, Meng Q, et al. Immunoglobulin Genomics in the Guinea Pig (*Cavia porcellus*). *PLoS One*. 2012;7(6):e39298.
300. The Laboratory Rabbit, Guinea Pig, Hamster, and Other Rodents. 2012;
301. Coe JE, Schell RF, Ross MJ. Immune response in the hamster: definition of a novel IgG not expressed in all hamster strains. *Immunology*. 1995;86(1):141–8.
302. Nguyen DC, Sanghvi R, Scinicariello F, et al. Cynomolgus and pigtail macaque IgG subclasses: Characterization of IGHG genes and computational analysis of IgG/Fc receptor binding affinity. *Immunogenetics*. 2014;66(6):361–377.

303. Powell MS, Hogarth PM. Fc Receptors. *Adv. Exp. Med. Biol.* 2008;640:22-34.

7. Annex

7.1. Platelets expressing IgG receptor FcγRIIA/CD32A determine the severity of experimental anaphylaxis

Héloïse Beutier^{1,2,3,*}, Béatrice Hechler^{4,*}, Ophélie Godon^{1,2}, Yu Wang^{1,2,5}, Caitlin M. Gillis^{1,2,3}, Luc de Chaisemartin^{6,7}, Aurélie Gouel-Chéron^{1,2,8}, Stéphanie Magnenat⁴, Lynn E. Macdonald⁹, Andrew J. Murphy⁹, NASA study group[†], Sylvie Chollet-Martin^{6,7}, Dan Longrois^{8,10}, Christian Gachet⁴, Pierre Bruhns^{1,2}, ‡ and Friederike Jönsson^{1,2,‡}

1. Institut Pasteur, Department of Immunology, Unit of Antibodies in Therapy and Pathology, Paris, France.
2. INSERM U1222, Paris, France.
3. Université Pierre et Marie Curie, Paris, France.
4. Université de Strasbourg, INSERM, Etablissement Français du Sang (EFS) Grand Est, Biologie et Pharmacologie des plaquettes sanguines (BPPS) UMR_S1255, Fédération de Médecine Translationnelle de Strasbourg (FMTS), F-67000 Strasbourg, France.
5. Université Diderot Paris VII, Paris, France.
6. Unité Fonctionnelle Auto-immunité et Hypersensibilités, Hôpital Bichat, Assistance Publique–Hôpitaux de Paris (AP-HP), Paris, France.
7. UMR996—Inflammation, Chemokines et Immunopathology, INSERM, Université Paris-Sud, Université Paris-Saclay, Châtenay-Malabry, France.
8. Département d’Anesthésie-Réanimation, Hôpital Bichat, AP-HP, Paris, France.
9. Regeneron Pharmaceuticals Inc., Tarrytown, NY 10591, USA.
10. INSERM UMR1152, Université Paris Diderot Paris 7, Paris, France.

‡Corresponding author. Email: joensson@pasteur.fr (F.J.); bruhns@pasteur.fr (P.B.)

* These authors contributed equally to this work.

item under unauthorized distribution right

item under unauthorized distribution right

item under unauthorized distribution right

item under unauthorized distribution right

item under unauthorized distribution right

item under unauthorized distribution right

item under unauthorized distribution right

item under unauthorized distribution right

item under unauthorized distribution right

item under unauthorized distribution right

item under unauthorized distribution right

item under unauthorized distribution right

7.2. Expression, Role, and Regulation of Neutrophil Fcγ Receptors

Yu Wang^{1,2} and Friederike Jönsson^{1*}

1. Unit of Antibodies in Therapy and Pathology, Institut Pasteur, UMR 1222
INSERM, Paris, France
2. Université Diderot Paris VII, PSL University, Paris, France



Expression, Role, and Regulation of Neutrophil Fcγ Receptors

Yu Wang^{1,2} and Friederike Jönsson^{1*}

¹ Unit of Antibodies in Therapy and Pathology, Institut Pasteur, UMR 1222 INSERM, Paris, France, ² Université Diderot Paris VII, PSL University, Paris, France

Neutrophils are best known for their critical role in host defense, for which they utilize multiple innate immune mechanisms, including microbe-associated pattern recognition, phagocytosis, production of reactive oxygen species, and the release of potent proteases, mediators, antimicrobials, and neutrophil extracellular traps. Beyond their well-established contribution to innate immunity, neutrophils were more recently reported to interact with various other cell types, including cells from the adaptive immune system, thereby enabling neutrophils to tune the overall immune response of the host. Neutrophils express different receptors for IgG antibodies (Fcγ receptors), which facilitate the engulfment of IgG-opsonized microbes and trigger cell activation upon cross-linking of several receptors. Indeed, FcγRs (via IgG antibodies) confer neutrophils with a key feature of the adaptive immunity: an antigen-specific cell response. This review summarizes the expression and function of FcγRs on human neutrophils in health and disease and how they are affected by polymorphisms in the *FCGR* loci. Additionally, we will discuss the role of neutrophils in providing help to marginal zone B cells for the production of antibodies, which in turn may trigger neutrophil effector functions when engaging FcγRs.

Keywords: neutrophils, Fcγ receptors, IgG, immune complexes, B cells

OPEN ACCESS

Edited by:

Christian Jan Lood,
University of Washington,
United States

Reviewed by:

Ian Dransfield,
University of Edinburgh,
United Kingdom
Sietse Quirijn Nagelkerke,
Sanquin Diagnostic
Services, Netherlands

*Correspondence:

Friederike Jönsson
joensson@pasteur.fr

Specialty section:

This article was submitted to
Molecular Innate Immunity,
a section of the journal
Frontiers in Immunology

Received: 24 May 2019

Accepted: 02 August 2019

Published: 27 August 2019

Citation:

Wang Y and Jönsson F (2019)
Expression, Role, and Regulation of
Neutrophil Fcγ Receptors.
Front. Immunol. 10:1958.
doi: 10.3389/fimmu.2019.01958

INTRODUCTION

Neutrophils are key players of the innate immune response. They are the most abundant leukocytes in the human blood ($4.5\text{--}11 \times 10^3/\text{mm}^3$). Following a circadian rhythm, neutrophils are released from the bone marrow (1–3) and circulate in the blood for 4–6 days (4, 5). If they are not attracted to sites of inflammation, they will express markers of aged neutrophils, and preferentially home to the liver, spleen, or bone marrow, where they undergo apoptosis and are cleared by resident macrophages (6–8). This immunologically silent mechanism allows for maintaining a high number of functional neutrophils in the blood (55–70% of all blood leukocytes in the periphery), while guaranteeing a quick removal of deregulated or altered neutrophils. The tight control of neutrophil homeostasis is critical for the organism as many of their effector functions [i.e., production of reactive oxygen species (ROS), release of neutrophil extracellular traps (NETs), or granules containing potent proteases and lipophosphatases (9)] bare the potential to be deleterious for the host and damage surrounding tissues and organs.

Neutrophils express various receptors that enable them to respond almost instantaneously to diverse inflammatory stimuli and danger signals. Among these, receptors for the constant region of IgG immunoglobulins (FcγRs) stand out. They bestow on neutrophils the capacity to react in an antigen-specific way—hence to acquire a key feature of the adaptive immunity. FcγRs enable neutrophils to interact with and respond to monomeric or aggregated immunoglobulins,

antigen–antibody immune complexes, and opsonized (antibody-coated) particles, cells, or surfaces. Humans express six classical FcγRs: FcγRI/CD64, FcγRIIA/CD32A, FcγRIIB/CD32B, FcγRIIC/CD32C, FcγRIIIA/CD16A, and FcγRIIIB/CD16B (**Table 1**). All these FcγRs bind at least two of the four different human IgG subclasses with association constants (K_A) ranging from 8×10^7 down to $2 \times 10^4 \text{ M}^{-1}$ (10).

All FcγRs, except for FcγRIIB and FcγRIIIB, are classical activating receptors. Their activating signals are transduced by an immunoreceptor tyrosine-based activation motif (ITAM) that is either present in the cytoplasmic domain of the FcγR itself (FcγRIIA/FcγRIIC) or in an associated signaling subunit, notably the FcRγ chain. Upon FcγR aggregation by multimeric ligands, Src family kinases phosphorylate these motifs, allowing the activation of a signaling cascade, involving the spleen tyrosine kinase (SYK), phosphatidylinositol 3-kinase (PI3K), phospholipase C (PLC)-γ, Rho, and Rac, resulting in calcium mobilization, cell activation, cytokine/chemokine production, and cell migration (11–13). Counterbalancing these activating FcγRs, the inhibitory receptor FcγRIIB possesses an immunoreceptor tyrosine-based inhibition motif (ITIM) in its intracytoplasmic domain. Upon its co-engagement with an activating receptor, the phosphorylated ITIM recruits the inositol polyphosphate-5-phosphatase SHIP1 (14) that negatively regulates the signaling cascades initiated by ITAM-containing receptors (15–17). Moreover, several FCGR polymorphisms have been described in humans, adding to the complexity of this receptor family with overlapping functions and affinities for their ligands that collaborate, regulate, or compete with each other to tune cellular responses.

In this review, we will focus on IgG receptors (FcγRs) on neutrophils and their role and regulation in steady state and inflammatory conditions.

EXPRESSION AND ROLE OF FcγR ON NEUTROPHILS DURING HOMEOSTASIS

Blood neutrophils from healthy individuals express large amounts of a rather atypical FcγR, the FcγRIIIB. FcγRIIIB is a glycosylphosphatidylinositol (GPI)-anchored protein with no signaling capacity on its own. It was first described on neutrophils in 1982 with the means of a newly developed monoclonal antibody (mAb, 3G8) that also recognizes FcγRIIIA on monocytes and NK cells (18). Incubation of neutrophils with 3G8 could efficiently block binding of rabbit IgG-opsonized sheep erythrocytes and soluble rabbit IgG immune complexes (ICs), demonstrating that the newly identified receptor is an IgG Fc receptor (18). FcγRIIIB is one of the most abundant proteins on the surface of neutrophils, with each cell expressing between 100,000 and 200,000 copies (19). In resting neutrophils, the receptor is equally distributed over the cell membrane and is present in both low- and high-density detergent-resistant membranes (DRMs) (20). Additionally, intracellular storage compartments have been described that allow rapid FcγRIIIB mobilization to the cell surface upon receptor engagement (21, 22). Previously thought to have no signaling function, it is now generally accepted that FcγRIIIB can trigger neutrophil activation. Following multivalent cross-linking, FcγRIIIB accumulates in high-density DRMs (20) and elicits downstream signals, leading to Ca^{2+} mobilization, cell adhesion, and degranulation, but not to respiratory burst (23–27). The exact intracellular signaling cascade remains a matter of debate (20, 27–29), but seems to involve phosphorylation of the Src kinase Hck, mitogen-activated kinases (MAPKs) ERK (extracellular signal regulated kinase), and p38 and the tyrosine kinase Pyk2 (30–32). In this context, it is noteworthy that the 3G8 antibody, which is often used to block FcγRIIIB, can trigger

TABLE 1 | Classical FcγRs and their expression on neutrophils.

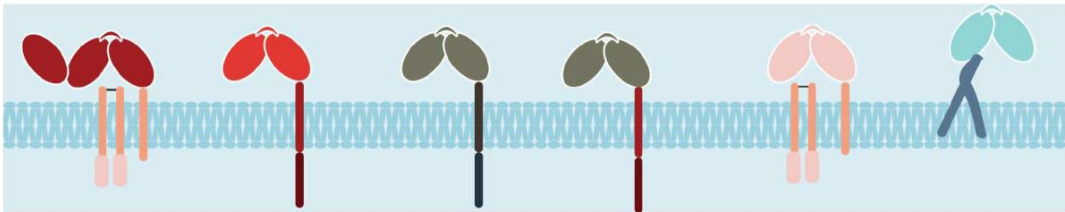

Name	FcγRI	FcγRIIA	FcγRIIB	FcγRIIC	FcγRIIIA	FcγRIIIB
CD	CD64	CD32A	CD32B	CD32C	CD16A	CD16B
Gene	<i>FCGR1A</i>	<i>FCGR2A</i>	<i>FCGR2B</i>	<i>FCGR2C</i>	<i>FCGR3A</i>	<i>FCGR3B</i>
Alleles	–	H ₁₃₁ R ₁₃₁	I ₂₃₂ T ₂₃₂	Q ₅₇ stop ₅₇	V ₁₇₆ F ₁₇₆	NA1 NA2 SH
Affinity	High	Low to medium	Low to medium	Low to medium	Low to medium	Low to medium
Expression on resting neutrophils	< 2,000 copies	30,000–60,000 copies	Low to none; increase when 2B4 promotor haplotype	Low to none	Low to none	100,000–200,000 copies
Neutrophil expression in inflammatory conditions	Up to 10-fold increased expression in presence of IFN-γ and G-CSF	Upregulated in presence TNF-α	Low to none; increase when 2B4 promotor haplotype	Low to none	Low to none	100,000–200,000 copies, subject to shedding

intracellular Ca-mobilization and neutrophil aggregation on its own. This cell activation requires co-engagement of another neutrophil FcγR, FcγRIIA *via* the Fc portion of the intact antibody (33). The main functions of neutrophil FcγRIIIB during homeostasis are the removal of spontaneously forming ICs from the vasculature, and the maintenance of the soluble FcγRIIIB (sFcγRIIIB) pool. FcγRIIIB-bound ICs are internalized through a mechanism used by GPI-anchored receptors and fluid-phase endocytosis (27), thereby clearing ICs without triggering further cell activation that could be deleterious to the host. sFcγRIIIB is present in serum of healthy individuals at concentrations of 5 nM (34). It is generated by proteolytic cleavage of surface FcγRIIIB on activated and apoptotic neutrophils (34, 35). Despite its relative abundance, the function of sFcγRIIIB remains elusive. sFcγRIIIB retains Fc-binding capacities and hence competes with membrane low-affinity receptors to dampen Fc-dependent immune reactions (36, 37). Due to the fact that FcγRIIIB binds to multimeric IgG1 and IgG3, but not or poorly IgG2 or IgG4 (10), the biological activity of these latter IgG subclasses should not be affected by sFcγRIIIB. Notably, both IgG2 and IgG4 also bind less well to other low-affinity FcγRs (with the exception of FcγRIIA-H131) (10). Adding to this possible immunomodulatory function, it also has been reported that sFcγRIIIB can bind to complement receptors CD11b/CD18 or CR3/Mac-1 and CD11c/CD18 or CR4 *via* lectin/carbohydrate interactions (38). These interactions can result in cytokine production by neutrophils and monocytes or may inhibit β2 integrin-dependent adhesion and subsequent transendothelial migration (38).

Neutrophils constitutively express a second low-affinity IgG receptor, the FcγRIIA. Albeit less abundant than FcγRIIIB, each neutrophil expresses between 30,000 and 60,000 copies of FcγRIIA (19). Interestingly, this receptor was described to have a lower affinity for IgG on resting than on primed or activated neutrophils (39), a feature that has been attributed to its interactions with integrins (40). Upon efficient cross-linking of FcγRIIA *in vitro*, neutrophils become activated, degranulate, and produce inflammatory mediators and ROS and trigger neutrophil extracellular trap (NET) formation (27, 41–44). More recent data, however, suggest that resting neutrophils rather poorly respond to FcγRIIA-induced activation. One possible explanation for these divergent observations may be found in the purification techniques used to isolate neutrophils. Indeed, density gradient centrifugation or dextran sedimentation used to be the standard techniques. Nowadays, neutrophils are mostly isolated by negative selection procedures that maintain the cells in isotonic buffer, but expose them to magnetic fields. Indeed, while comparative data between the procedures are sparse (45, 46), possible differences in neutrophil priming and purity need to be taken into account when interpreting the data.

In contrast to the abundant FcγRIIIB and FcγRIIA, neutrophils express less than 2,000 copies of the high-affinity FcγRI (19). Ligation of FcγRI on resting neutrophil with a specific antibody does not induce a significant degree of cell activation (47) and neutrophils show poor binding to monomeric IgG1 and phagocytosis of IgG-opsonized particles (48, 49). Neutrophils can also express FcγRIIB; however, its detection is variable among individuals ranging from low to undetectable (27, 50).

Although it is well-established that co-engagement of FcγRIIIB potentially inhibits FcγR-driven cell activation (15–17), it is questionable if the low expression of FcγRIIIB on neutrophils could oppose signals generated by the other FcγRs in this context. Finally, a very recent report suggests that neutrophils may also express modest amounts of FcγRIIIA (51), a receptor that was previously thought to be exclusively expressed by NK cells and monocytes (52). In this study, the authors report that FcγRIIIA engagement on neutrophils from FcγRIIIB-deficient and normal individuals efficiently triggers cell activation and mediates phagocytosis of IgG-opsonized beads that could not be blocked by anti-FcγRIIA F(ab')₂ fragments (51). Many different groups have studied FcγR expression on neutrophils before, but were incapable to affirm FcγRIIIA expression. This might be due to the fact that most antibodies used to study FcγRIII recognize both FcγRIIIA and FcγRIIIB, and that FcγRIIIB deficiency is rare. In a study from 1994, one can however appreciate some residual FcγRIII [3G8] staining on neutrophils from paroxysmal nocturnal hemoglobinuria patients [a disorder characterized by the deficiency of glycosyl phosphatidylinositol (GPI)-anchored proteins in blood cell membranes] and an FcγRIIIB-deficient patient, as well as on neutrophils treated with GPI-phospholipase C as compared to an isotype control (53). This residual binding, if specific, could support the hypothesis of a low expression of FcγRIIIA on neutrophils. The central piece of evidence for FcγRIIIA expression on neutrophils in the recent report is a single FcγRIIIB-deficient donor, whose genotype was confirmed by RT-PCR and not by sequencing of the FcγR locus. This allows speculation about a cryptic FcγRIIIB expression in this donor. Furthermore, if a low expression of FcγRIIIA can be confirmed in other FcγRIIIB-deficient donors, it will be necessary to clarify to what extent it can contribute to neutrophil effector functions *in vivo*. One point is certain, this study refuels the discussion about the capacity of FcγRIIIB to trigger cell activation and suggests that neutrophil activation observed following receptor cross-linking with anti-FcγRIII F(ab')₂ fragments or ICs can be rather attributed to FcγRIIIA than to the GPI-anchored receptor.

NEUTROPHIL FcγR IN AN INFLAMMATORY CONTEXT

Neutrophil FcγR expression can change dramatically in the context of an inflammation or infection. Notably, FcγRI is strongly upregulated in the presence of inflammatory cytokines such as interferon-γ (IFN-γ) or granulocyte colony-stimulating factor reaching up to 20,000 copies per cell (19, 48, 54, 55). This confers neutrophils the capacity to efficiently bind monomeric IgG (48), phagocytose IgG-opsonized bacteria (49), exert anti-fungal functions (56), and induce ROS production in response to FcγRI cross-linking (47). FcγRI upregulation also enables neutrophils to efficiently trigger antibody-dependent cytotoxicity (ADCC) (55). As a consequence, neutrophil FcγRI expression has been shown to reflect infection state and disease activity in numerous inflammatory conditions (57–61), and a low CD64 expression is a marker for sustained remission in Crohn's disease patients receiving infliximab (62). Consecutively, neutrophil

CD64 has been discussed as an interesting biomarker, especially in the case of sepsis (57). Sepsis diagnosis includes a blood culture that allows specific identification of the disease-causing bacteria and their antibiotic resistances, but takes up to 2 days to generate results. Precious time, during which patients with sepsis suspicion commonly receive broad-spectrum antibiotics to avoid deterioration of their condition. This common practice has its flaws, because antibiotics are not adapted in case of non-bacterial infections, and because some bacteria require specific antibiotics and are not targeted by broad-spectrum ones. Certainly, inappropriate use of antibiotics contributes to the increase of antibiotic resistance among different bacteria that has been classified as “one of the biggest threats to global health, food security, and development today” by the WHO. Neutrophil CD64 expression was proposed as a way to detect infection so that timely decisions and treatment refinement can be made. Neutrophil CD64 can be evaluated within 1–2 h, making it a rapid diagnostic and prognostic marker. Indeed, a study reported not only elevated CD64 expression in septic patients compared to healthy controls, but also a decrease in CD64 expression following treatment with an appropriate antibiotic compared to inefficient treatment (63). However, not all studies find in neutrophil CD64 a reliable marker for sepsis detection, and different studies report divergent sensitivity and specificity for sepsis detection by neutrophil CD64 (64–67). Two meta-analyses report a large heterogeneity in study design and results (68, 69). This may be due to the fact that this test can be run in any laboratory with a flow cytometer and that the results can be expressed either as percentage of neutrophils expressing CD64 or as mean fluorescent intensity of the whole neutrophil population. In the absence of a standardized assay, each laboratory needs to establish its own cutoff. Furthermore, confounding factors (previous use of antibiotics, delayed culture collection, etc.) may result in a negative result from the microbiological test that, as a consequence, poses problems with the classification of the patients. Given the low costs of the assay, neutrophil CD64 remains an interesting candidate to monitor in case of sepsis suspicion. Larger prospective studies are however required to conclude on its sensitivity and suitability as a biomarker, especially in light of new approaches for sepsis diagnosis and the evolution of our understanding of sepsis as a condition involving not only the bacterial infection and its resulting immune response, but also changes in coagulation, immunosuppression, and organ dysfunction (70).

IFN- γ treatment has little effect on neutrophil Fc γ RIIA expression but can induce Fc γ RIIB expression (albeit on a low level) and, depending on the experimental conditions, may induce Fc γ RIIIB down-modulation (19, 71). Fc γ RIIA expression on neutrophils may however be induced by TNF- α (72). As a consequence, primed neutrophils and neutrophils from individuals with inflammatory conditions show enhanced Fc γ R-dependent responses (73–75).

Finally, IgG ICs can also be at the onset of inflammation, allergic reactions, and autoimmunity (76, 77). This is notably the case, when the amounts of circulating ICs suddenly rise and exceed the body's capacity to silently remove them, when ICs form that are insoluble and “precipitate” onto endothelial

cells, or when autoantibodies bind to large surfaces, i.e., cartilage, thereby opsonizing phagocytosis-resistant structures. All these conditions can be mimicked *in vitro* and helped to understand that soluble ICs require primed neutrophils to efficiently trigger external ROS production and degranulation, while insoluble ICs can activate unprimed neutrophils, leading to intracellular ROS production, degranulation, and sustained liberation of inflammatory mediators such as IL-8 and leukotriene B₄ (LTB₄) that sustain neutrophil-driven inflammation (73, 78). An elegant study, using transgenic mice expressing either Fc γ RIIA or Fc γ RIIIB or both in the absence of endogenous activating Fc γ R, demonstrated that Fc γ RIIIB has a primordial role in the homeostatic removal of soluble ICs within the vasculature, whereas Fc γ RIIA engagement by soluble ICs in tissues generates NETs, a pro-inflammatory process linked to autoimmunity (27, 44). Engagement of either Fc γ R by deposited ICs leads to neutrophil accumulation (44). These data illustrate the specialized role of Fc γ Rs in triggering neutrophil effector functions, despite their overlapping binding properties to IgG.

GENETIC VARIATIONS AFFECTING NEUTROPHIL FC γ R EXPRESSION AND FUNCTIONS

A number of polymorphisms have been identified in the *FCGR* loci that affect their biological functions and may consequently impact the individual's susceptibility for diseases and their capacity to respond to therapies based on monoclonal antibodies. This is notably the case for polymorphisms that alter the affinity of Fc γ Rs for IgG, thus directly affecting their capacity to clear immune complexes.

Until today, no polymorphism of Fc γ RI has been identified that modifies the affinity of the receptor for IgG or its associated functions. In contrast, the low-affinity IgG receptor locus on chromosome 1q23.3 coding for all *FCGR2/3* genes is home to multiple genetic variants, including single-nucleotide polymorphisms (SNPs) and copy number variations (CNVs). These genetic variants display heterogeneity among ethnic groups (79). The best-characterized polymorphism of *FCGR2A* results in substitution of an arginine residue by a histidine at position 131 (rs1801274) that results in a receptor variant with an improved binding to IgG2 (and to a lesser extent to IgG1 and IgG3) (80). The *FCGR2A-R131* variant is therefore expected to show lower clearance of IgG immune complexes and is indeed associated with susceptibility to auto-immune disorders (81–85) and recurrent bacterial infections with encapsulated bacteria (86). The *FCGR2A-H131* variant, on the other hand, predisposes individuals to Kawasaki disease and Myasthenia gravis (87, 88). More recently, a splice variant of *FCGR2A*, Fc γ RIIA(exon6*), has been described that retains a cryptic exon in the cytoplasmic tail of the receptor (89, 90). This results in a gain-of-function allele that increases neutrophil sensitivity to IgG stimulation and hence predisposes to anaphylactic reactions following IVIg infusions in patients with hypogammaglobulinemia (71). As described above, Fc γ RIIB is poorly expressed on neutrophils (50). A specific haplotype in the promoter region, termed 2B.4,

was shown to augment Fc γ RIIB expression on myeloid cells, including neutrophils (91). This promoter variant enables a more efficient binding of the transcription factors GATA4 and Yin-Yang1, resulting in a higher promoter activity and hence higher Fc γ RIIB expression (92). Surprisingly, this gain-of-function promoter haplotype was found to be associated with systemic lupus erythematosus (SLE) (91). A possible explanation might reside in an Fc γ RIIB-dependent inhibition of IC-phagocytosis, but experimental data to support this hypothesis are still missing. Additionally, a polymorphism of *FCGR2B* (rs1050501) results in the replacement of a threonine by an isoleucine in the transmembrane domain (I232T). The presence of threonine in that position entails a failure of Fc γ RIIB to enter lipid rafts and, as a consequence, reduces its ability to inhibit activatory receptors (93). For *FCGR3B*, three different allotypes have been described, resulting from five non-synonymous polymorphisms that all affect the neutrophil antigen (NA) located in the membrane-distal Ig-like domain. These variants are termed NA1 (R₃₆ N₆₅ A₇₈ D₈₂ V₁₀₆), NA2 (S₃₆ S₆₅ A₇₈ N₈₂ I₁₀₆), and SH (S₃₆ S₆₅ D₇₈ N₈₂ I₁₀₆) (94). They do not result in detectable differences in affinity for hIgG subclasses (10). The NA1 allotype was nevertheless reported to increase phagocytosis of IgG-opsonized particles (95) and is associated with a reduced responsiveness to IVIG therapy in Kawasaki disease (96). The SH allotype is the rarest allele and less well-characterized. Recently, it has been reported to be associated to increased *FCGR3B* copy numbers (79) that could account for the higher Fc γ RIIB expression levels described earlier (97).

A rather large number of studies have associated a single Fc γ R polymorphism with the induction or severity of antibody-related diseases, or the efficacy of antibody-based therapies. It is however important to bear in mind that all low-affinity IgG receptors are encoded in a single locus on chromosome 1 (1q23). Indeed, a high degree of linkage disequilibrium has been reported for the *FCGR2/3* locus (79, 98, 99) that are strongly linked to ethnic background (79). Association studies should therefore take into account the entire locus and not investigate an isolated gene (100). Adding to the complexity of the 1q23 locus, gene copy number variations (CNVs) have been described for *FCGR3A*, *FCGR3B*, and *FCGR2C* that directly impact the expression level of the receptors (97). These CNV can include deletions of parts of the locus, giving rise to *FCGR2A/2C* chimeric genes, reducing the expression and function (ROS induction) of the resulting receptor (101). CNVs of *FCGR3B* have been associated to a number of autoimmune disorders, including SLE, rheumatoid arthritis, and systemic auto-immunity (102–106). Indeed, fewer than two copies of *FCGR3B* have been associated to SLE susceptibility (107, 108), which has been confirmed in meta-analysis (109, 110).

Lastly, 0.03–0.1% of the population show a deficiency of *FCGR3B* (and the *FCGR2C* gene) (101, 107). While most studies did not find an association of the *FCGR3B*^{null} genotype with a disease phenotype, one report suggested an association with SLE (102, 111, 112). This apparent contradiction with the finding that low copy numbers increase SLE susceptibility could be due to the low frequency of this genotype in the population, resulting in an insufficient power for calculation.

On the other hand, Fc γ RIIB-deficient individuals were included at the estimated frequency in a selective cohort of healthy donors with a long list of exclusion criteria, suggesting that Fc γ RIIB deficiency remains undetected in most carriers (113). This suggests that *FCGR3B* deficiency does not directly cause disease, but possibly aggravates disease pathogenesis when ICs are accumulating.

REGULATION OF NEUTROPHIL Fc γ RS

The best-described pathway of inhibiting activating Fc γ Rs is, without doubt, through co-engagement of the inhibitory Fc γ RIIB by the same immune complexes (114, 115). However, as mentioned earlier, human neutrophils express little to no Fc γ RIIB (50), and it appears therefore mandatory that neutrophils rely on other mechanisms to regulate their activation by Fc γ Rs.

Recently, several groups have reported that the glycosylation state of the IgG antibodies significantly modifies their affinity for Fc γ Rs (116–118). Indeed, all human IgG contain a single N-linked glycan positioned at asparagine 297 in the antibody Fc portion, which is critical for their interaction with Fc γ Rs. Several studies have illustrated how the composition of the Fc glycan influences IgG effector functions (119, 120) (Figure 1A). As an example, IgG Fc glycans lacking fucose display a greatly enhanced affinity to the Fc γ Rs, Fc γ RIIA, and Fc γ RIIB, compared to fucosylated IgG. Besides their well-established improvement of NK cell-dependent ADCC *in vivo* (121–123), afucosylated IgG used to opsonize target cells also activate neutrophils more efficiently than wild-type IgG, inducing pro-inflammatory cytokines and phagocytosis of target cells, but no ROS production or antibody-dependent cellular cytotoxicity activity (124). Addition of an afucosylated anti-CD20 mAb (obinutuzumab) to blood samples from RA and SLE patients resulted in a superior B cell deletion than wt anti-CD20 mAb, concomitantly with neutrophil and NK cell activation (125), suggesting that both cells cooperate to eliminate target cells *in vitro*. Opposing these results, another study reported Fc γ RIIB-dependent inhibition of neutrophil ADCC or trogocytosis of solid cancer cells coated with either anti-HER2 mAb (trastuzumab) or anti-EGFR mAb (cetuximab). Notably, copy numbers of Fc γ RIIB could be linked to the inhibitory effect and blocking Fc γ RIIB with F(ab')₂ 3G8 improved target cell killing (126). Further studies are required to determine whether these discrepancies depend on the target cell (solid tumor vs. hematological) and how neutrophil Fc γ RIIB (and Fc γ RIIA) (51) contribute to cancer elimination *in vivo*. Terminal sialylation of the Fc glycan, instead, decreases the affinity for activating Fc γ Rs (while maintaining the affinity for inhibitory Fc γ RIIB), and sialylated IgG has reduced capacity to initiate ADCC *in vivo* (118, 127). This might explain why antibodies against autoantigens can often be detected months to years before the first sign of an autoimmune inflammation (128–130). De-sialylation of these antibodies might therefore be a hallmark of autoimmune disease progression (131, 132). In this context, it is noteworthy that a recent report evidenced the potential of *in vivo* glycan engineering of antibodies to

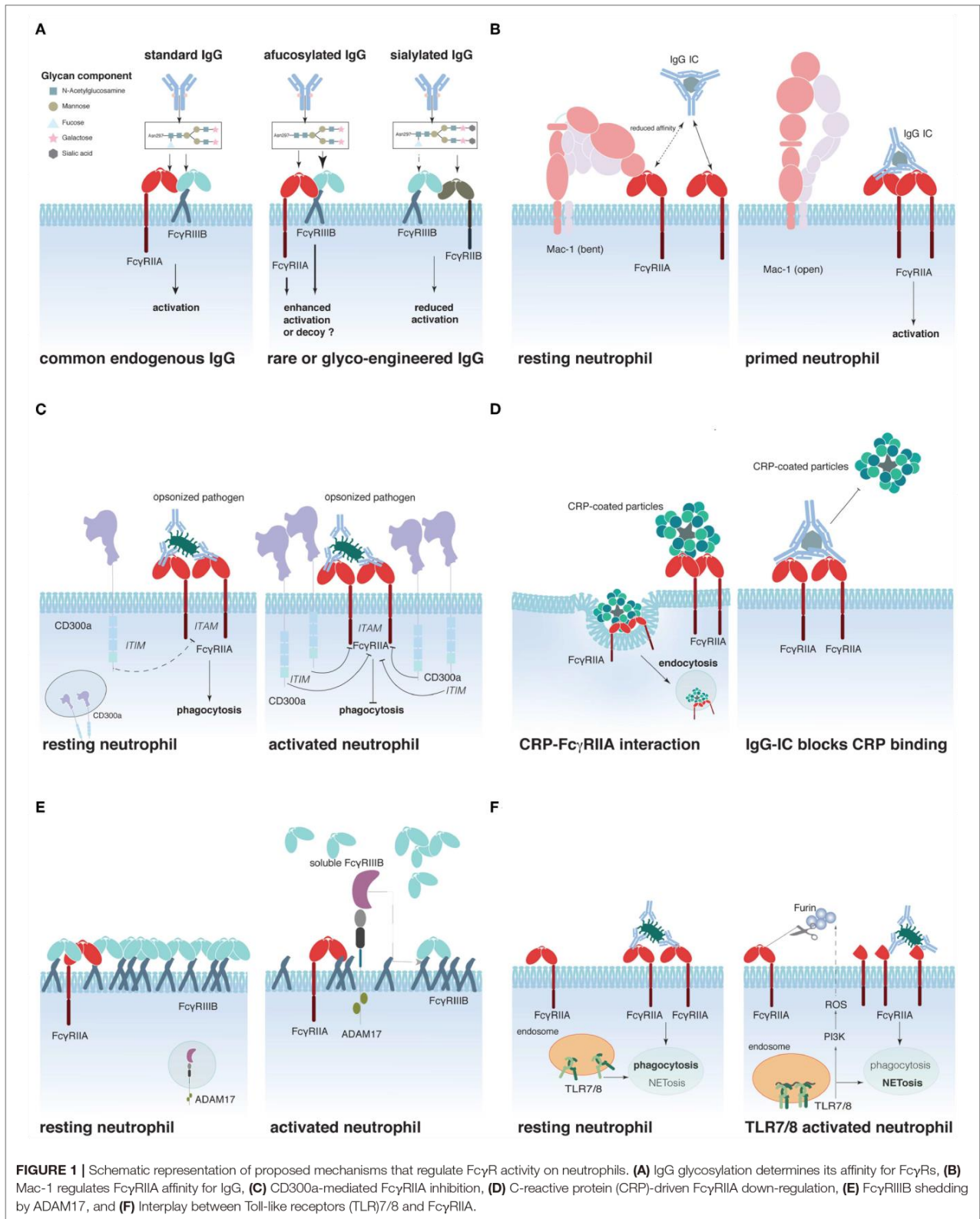

FIGURE 1 | Schematic representation of proposed mechanisms that regulate FcγR activity on neutrophils. **(A)** IgG glycosylation determines its affinity for FcγRs, **(B)** Mac-1 regulates FcγRIIA affinity for IgG, **(C)** CD300a-mediated FcγRIIA inhibition, **(D)** C-reactive protein (CRP)-driven FcγRIIA down-regulation, **(E)** FcγRIIIB shedding by ADAM17, and **(F)** Interplay between Toll-like receptors (TLR)7/8 and FcγRIIA.

modulate of IgG effector functions. Indeed, application of soluble glycosyl-transferases could reduce autoantibody-induced inflammation in models of arthritis and nephrotoxic nephritis (133). However, it remains to be determined whether these very promising findings are exclusively due to IgG glycan modulation or the result of a more complex alteration of multiple glycan structures.

Sialic acid residues have recently been reported to contribute to another mechanism of FcγR regulation (**Figure 1B**). Prompted by the finding that CD18-deficient neutrophils show an enhanced recruitment to IgG-coated endothelium (134) and that an SNP in the CD18 integrin Mac-1 (rs1143679) is a risk factor for SLE (135), Saggi et al. investigated the interaction between FcγRIIA and Mac-1 on the cell surface. The authors convincingly show that the extracellular portion of Mac-1 in its inactive bend configuration interacts with sialylated FcγRIIA on resting neutrophils and thereby lowers the affinity of the receptor for IgG (40). Interestingly, once the interaction between FcγRIIA and IgG is sufficiently strong to overcome this increased activation threshold, Mac-1 assists FcγRIIA to induce cell spreading (136). This study provides a mechanistic explanation for the observation made earlier that FcγRIIA appears to have a lower affinity for IgG on resting neutrophils than on pre-activated ones.

Other molecules have been suggested to interact and modulate FcγRIIA activity. These include the ITIM-containing CD300a that can be rapidly mobilized from an intracellular pool to the surface of peripheral blood neutrophils following stimulation. Co-engagement of CD300a and FcγRIIA reduced FcγRIIA-dependent activation in an *in vitro* system (137) (**Figure 1C**). Furthermore, two plasma proteins produced in the liver during the acute phase of inflammations were described to interact with FcγRIIA (and FcγRIIIB), the C-reactive protein (CRP) and the serum amyloid P (SAP) component (138, 139). CRP preferentially interacts with the FcγRIIA-R131-allele and can act like an opsonin, triggering the uptake of CRP-coated particles (140) (**Figure 1D**). Interestingly, IgG ICs can reduce CRP binding to FcγRIIA, whereas the reverse is not true (141). SAP was similarly described to act as an opsonin that could enhance phagocytosis *via* FcγRs (139). Additionally, it was described to reduce neutrophil adhesion by binding to FcγRIIA (142). Whether SAP binding can regulate IgG-dependent FcγRIIA activation remains however to be determined.

Another possibility to modulate FcγR-induced cell activation is to regulate receptor availability on the cell surface. This can be achieved by receptor internalization (8, 90, 93), translocation from intracellular storage compartments to the cell surface (22), or shedding of the extracellular portion of the FcγR. This latter phenomenon is best documented for FcγRIIIB, which is rapidly and efficiently cleaved from the cell surface following neutrophil stimulation (143), and during neutrophil apoptosis (34, 35). The main protease responsible for this ectodomain shedding appears to be ADAM17 (A Disintegrin and Metalloprotease-17) (144) that is rapidly activated following multiple cell stimulating pathways, such as FcγR/CR-dependent phagocytosis or stimulation with fMLP or PMA (145) (**Figure 1E**). ADAM17 activation appears to require

activation of caspase 8 and mitochondrial ROS production (146). Supporting an important role for the regulation of cell activation by ADAM17, ADAM17 deficiency in humans has been associated with severe inflammatory disorders of the skin and the gut, resulting in recurrent sepsis and poor survival (147, 148). Similar to the ectodomain shedding of FcγRIIIB, reduction of surface FcγRIIA on Langerhans cells and activated neutrophils has been described (39, 149). These initial observations have recently gained attention by the demonstration that TLR-induced activation resulted in the cleavage of extracellular FcγRIIA on the neutrophil surface, thus removing the N-terminal portion of the receptor (150) (**Figure 1F**). This cleavage has functional consequences for the neutrophils. It reduces their phagocytic activity, while augmenting their propensity to produce NETs, thereby supporting the concept that phagocytosis and NETosis could be neutrophil effector functions that oppose each other, as had been suggested by the finding that NETosis was reduced when microbes were small enough to be phagocytized (151). Similarly, neutrophils from SLE patients and especially their low-density granulocytes that were reported to spontaneously release NETs (152) seem to express less “full-length” FcγRIIA than neutrophils from healthy donors (150). This might explain why neutrophils from SLE patients fail to efficiently clear circulating ICs and are NET-prone (153). The cleavage of the N-terminal portion of FcγRIIA involves a PI3K-dependent production of ROS and seems to be mediated by the serin-protease furin (150); the exact mechanism of its action, however, as well as the fate and role of the N-terminal fragment of FcγRIIA following cleavage remains to be discovered. Similarly, questions on the stability, function, and possibly altered affinity of the shortened membrane-bound FcγRIIA justify further research in this area.

Finally, it has been suggested that FcγRIIIB could represent an efficient modulator of FcγRIIA activity in neutrophils. Indeed, the weakly signaling FcγRIIIB predominant FcγRIIA expression on resting neutrophils. Furthermore, CD16B extends out further from the cell surface membrane (154, 155), implying that FcγRIIIB is likely to capture circulating immune complexes, thus competing with and preventing FcγRIIA–IgG interactions. The picture is very different with regard to activated neutrophils that, through FcγRIIIB ectodomain shedding, grant access to cell-activating FcγRIIA (154).

CROSS-TALK OF NEUTROPHILS AND B CELLS

Collectively, these studies underline the critical involvement of IgGs in the modulation of neutrophil activity. Indeed, IgGs through FcγRs render neutrophils capable to act to threats to the host in an antigen-specific manner, but are also the trigger for tissue damage if autoantigens are being targeted. Interestingly, there is accumulating evidence that neutrophils are not mere effector cells of the immune system, but actively shape and modulate immune responses through interactions with other cells and the release of mediators. In the context of

IgG-dependent immunity, their recently described interactions with B cells are of particular interest.

Data from patients receiving G-CSF suggested that neutrophils can communicate with B cells through production of BAFF (B cell-activating factor) (156), a molecule known to sustain B cell survival and responsiveness (157, 158). Similarly, APRIL (A Proliferation Inducing Ligand) was suggested to be an important survival proliferation factor for human B cells, which additionally drives class-switching reactions (159–161). Neutrophils constitutively secrete APRIL (162), but circulating neutrophils fail to directly activate B cells. Upon infection, neutrophil-derived APRIL is retained by heparan sulfate proteoglycans in mucosal tissues, thereby creating a niche for local plasma cell survival and sustained antibody production (163). Similarly, it has been reported that diffuse large B cell lymphoma secretes chemokines to recruit APRIL-producing blood neutrophils to the tumor (162) and that high APRIL concentrations in tumors are correlated with decreased patient survival rates (164). In SLE, neutrophils interact with B cells in many different ways. SLE neutrophils were reported to show increased expression of BAFF, APRIL, and IFN- α that fuels B cell development and autoantibody production in the bone marrow. In the circulation, SLE neutrophils secrete increased amounts of IL-6 upon IFN- α stimulation that supports survival and maturation of B cells and plasma blasts (165). Concomitantly, they are also NET-prone and release LL37–DNA complexes that trigger polyclonal B cell activation *via* TLR9, giving rise to more NET-specific autoantibodies (166).

Neutrophils can also be found in multiple locations of the spleen, including the perifollicular zone, around the marginal zone (MZ) and the red pulp (167–170). Their exact role in each of these compartments is not fully understood. In the spleen, a specialized subset of neutrophils has been described that has the capacity to provide B cell support. These “B cell helper neutrophils” (N_{BH}) are located around the MZ of healthy human donors and express high levels of the B cell-stimulating cytokines BAFF, APRIL, and IL-21 in response to microbial stimuli and thereby provide help to MZ B cells to trigger antibody production against T cell-independent antigens (169). In patients with severe congenital neutropenia (SCN), CD27⁺IgD^{low} circulating MZ B cells and levels of IgM, IgG, and IgA antibodies against T cell-independent antigens were less abundant than in healthy subjects (169). Contradicting this report, no N_{BH} could be identified in spleen samples from organ transplant donors (171); also, similar numbers of CD27⁺IgD⁺ memory B cells were reported in patients suffering from chronic idiopathic neutropenia and healthy subjects (172). In addition to BAFF and APRIL, Pentraxin3 (PTX3) has been proposed to be a neutrophil-derived factor that supports B cell functions (173). PTX3 is stored in secondary granules of neutrophils and released upon stimulation with Toll-like receptor agonists (174). PTX3 binds to MZ B cells and enhances the secretion of class-switched IgG in the presence of BAFF (173).

The capacity of neutrophils to secrete B cell-stimulating factors enables them to directly interact with the adaptive immune system and shape antibody responses, which, in turn, can trigger potent neutrophil effector functions. This underlines the complexity of our immune system and the multiple layers of regulation that are at play to efficiently protect us from external threats.

CONCLUDING REMARKS

Collectively, the discussed literature exemplifies how our understanding of neutrophils has evolved from their early descriptions as simple first-line defense cells, equipped with powerful weapons to defend the host but unable to differentiate between different threats, to portrayals of cells capable of tailoring their responses according to their environment. We now appreciate that neutrophils interact with various other cell types, integrate complex stimuli, and cooperate with other players of the immune system to fine-tune their responses. The role and regulation of Fc γ R on neutrophils is not an exception to this rule. Early reports frequently suggested that IgG ICs had very strong neutrophil-activating capacities, but more recently, a much more detailed picture has been drawn, taking into account the size, solubility, composition, and location of ICs. Furthermore, IgG enables neutrophils to function as antigen-specific cells; at the same time, accumulating evidence suggest that neutrophils in turn tune the activity of (at least some) B cells to regulate antibody production. Much remains to be discovered and hopefully new techniques will allow us to unravel previously unappreciated functions of neutrophils and revise others. We are looking forward to hearing more about these exciting cells.

AUTHOR CONTRIBUTIONS

All authors listed have made a substantial, direct and intellectual contribution to the work, and approved it for publication.

FUNDING

This work was supported by a Jeunes Chercheuses/Jeunes Chercheurs grant from the Agence Nationale de la Recherche (ANR-16-CE15-0012-01). YW is part of the Pasteur–Paris University (PPU) International Ph.D Program. This project has received funding from the European Union’s Horizon 2020 research and innovation programme under the Marie Skłodowska-Curie grant agreement No. 665807, and from the Labex Milieu Intérieur, Institut Pasteur. FJ is an employee of CNRS (Centre national de la recherche scientifique).

ACKNOWLEDGMENTS

We are grateful to Kasia Kready for critical reading of the manuscript.

REFERENCES

- Ella K, Csepanyi-Komi R, Kaldi K. Circadian regulation of human peripheral neutrophils. *Brain Behav Immun.* (2016) 57:209–1. doi: 10.1016/j.bbi.2016.04.016
- Adrover JM, Del Fresno C, Crainiciuc G, Cuartero MI, Casanova-Acebes M, Weiss LA, et al. A neutrophil timer coordinates immune defense and vascular protection. *Immunity.* (2019) 50:390–402:e310. doi: 10.1016/j.immuni.2019.01.002
- Jilma B, Hergovich N, Stohlawetz P, Eichler HG, Bauer P, Wagner OF. Circadian variation of granulocyte colony stimulating factor levels in man. *Br J Haematol.* (1999) 106:368–70. doi: 10.1046/j.1365-2141.1999.01543.x
- Fliedner TM, Cronkite EP, Killmann SA, Bond VP. Granulocytopenia. II. emergence and pattern of labeling of neutrophilic granulocytes in humans. *Blood.* (1964) 24:683–700.
- Pillay J, den Braber I, Vrsekooop N, Kwast LM, de Boer RJ, Borghans JA, et al. *In vivo* labeling with 2H₂O reveals a human neutrophil lifespan of 5.4 days. *Blood.* (2010) 116:625–7. doi: 10.1182/blood-2010-01-259028
- Martin C, Burdon PC, Bridger G, Gutierrez-Ramos JC, Williams TJ, Rankin SM. Chemokines acting via CXCR2 and CXCR4 control the release of neutrophils from the bone marrow and their return following senescence. *Immunity.* (2003) 19:583–93. doi: 10.1016/S1074-7613(03)00263-2
- Furze RC, Rankin SM. Neutrophil mobilization and clearance in the bone marrow. *Immunology.* (2008) 125:281–8. doi: 10.1111/j.1365-2567.2008.02950.x
- Jonsson F, de Chaisemartin L, Granger V, Gouel-Cheron A, Gillis CM, Zhu Q, et al. An IgG-induced neutrophil activation pathway contributes to human drug-induced anaphylaxis. *Sci Transl Med.* (2019) 11:eaat1479. doi: 10.1126/scitranslmed.aat1479
- Yin C, Heit B. Armed for destruction: formation, function and trafficking of neutrophil granules. *Cell Tissue Res.* (2018) 371:455–71. doi: 10.1007/s00441-017-2731-8
- Bruhns B, Iannascoli B, England P, Mancardi DA, Fernandez N, Jorieux S, et al. Specificity and affinity of human Fc[γ] receptors and their polymorphic variants for human IgG subclasses. *Blood.* (2009) 113:3716–25. doi: 10.1182/blood-2008-09-179754
- Daëron M. Fc receptor biology. *Annu Rev Immunol.* (1997) 15:203–34. doi: 10.1146/annurev.immunol.15.1.203
- Nimmerjahn F, Ravetch JV. Fcγ receptors as regulators of immune responses. *Nat Rev Immunol.* (2008) 8:34–47. doi: 10.1038/nri2206
- Blank U, Launay P, Benhamou M, Monteiro RC. Inhibitory ITAMs as novel regulators of immunity. *Immunol Rev.* (2009) 232:59–71. doi: 10.1111/j.1600-065X.2009.00832.x
- Ono M, Bolland S, Tempst P, Ravetch JV. Role of the inositol phosphatase SHIP in negative regulation of the immune system by the receptor Fc(γ)RIIB. *Nature.* (1996) 383:263–6. doi: 10.1038/383263a0
- Amigorena S, Bonnerot C, Drake JR, Choquet D, Hunziker W, Guillet JG, et al. Cytoplasmic domain heterogeneity and functions of IgG Fc receptors in B lymphocytes. *Science.* (1992) 256:1808–12. doi: 10.1126/science.1535455
- Malbec O, Fong DC, Turner M, Tybulewicz VL, Cambier JC, Fridman WH, et al. Fc epsilon receptor I-associated lyn-dependent phosphorylation of Fc gamma receptor IIB during negative regulation of mast cell activation. *J Immunol.* (1998) 160:1647–58.
- Malbec O, Cassard L, Albanesi M, Jonsson F, Mancardi D, Chicanne G, et al. Trans-inhibition of activation and proliferation signals by Fc receptors in mast cells and basophils. *Sci Signal.* (2016) 9:ra126. doi: 10.1126/scisignal.aag1401
- Fleit HB, Wright SD, Unkeless JC. Human neutrophil Fc gamma receptor distribution and structure. *Proc Natl Acad Sci USA.* (1982) 79:3275–9. doi: 10.1073/pnas.79.10.3275
- Fanger MW, Shen L, Graziano RF, Guyre PM. Cytotoxicity mediated by human Fc receptors for IgG. *Immunol Today.* (1989) 10:92–9. doi: 10.1016/0167-5699(89)90234-X
- Fernandes MJ, Rollet-Labelle E, Pare G, Marois S, Tremblay ML, Teillaud JL, et al. CD16b associates with high-density, detergent-resistant membranes in human neutrophils. *Biochem J.* (2006) 393(Pt 1):351–9. doi: 10.1042/BJ20050129
- Jost CR, Huizinga TW, de Goede R, Fransen JA, Tetteroo PA, Daha MR, et al. Intracellular localization and *de novo* synthesis of FcRIII in human neutrophil granulocytes. *Blood.* (1990) 75:144–51.
- Tosi MF, Zakem H. Surface expression of Fc gamma receptor III (CD16) on chemoattractant-stimulated neutrophils is determined by both surface shedding and translocation from intracellular storage compartments. *J Clin Invest.* (1992) 90:462–70. doi: 10.1172/JCI115882
- Huizinga TW, Dolman KM, van der Linden NJ, Kleijer M, Nuijens JH, von dem Borne AE, et al. Phosphatidylinositol-linked FcRIII mediates exocytosis of neutrophil granule proteins, but does not mediate initiation of the respiratory burst. *J Immunol.* (1990) 144:1432–7.
- Kimberly RP, Ahlstrom JW, Click ME, Edberg JC. The glycosyl phosphatidylinositol-linked Fc gamma RIIIPMN mediates transmembrane signaling events distinct from Fc gamma RII. *J Exp Med.* (1990) 171:1239–55. doi: 10.1084/jem.171.4.1239
- Kocher M, Siegel ME, Edberg JC, Kimberly RP. Cross-linking of Fc gamma receptor IIa and Fc gamma receptor IIIB induces different proadhesive phenotypes on human neutrophils. *J Immunol.* (1997) 159:3940–8.
- Coxon A, Cullere X, Knight S, Sethi S, Wakelin MW, Stavrakis G, et al. Fc gamma RIII mediates neutrophil recruitment to immune complexes. A mechanism for neutrophil accumulation in immune-mediated inflammation. *Immunity.* (2001) 14:693–704. doi: 10.1016/S1074-7613(01)00150-9
- Chen K, Nishi H, Travers R, Tsuboi N, Martinod K, Wagner DD, et al. Endocytosis of soluble immune complexes leads to their clearance by FcγRIIIB but induces neutrophil extracellular traps via FcγRIIA *in vivo*. *Blood.* (2012) 120:4421–31. doi: 10.1182/blood-2011-12-401133
- Garcia-Garcia E, Nieto-Castaneda G, Ruiz-Saldana M, Mora N, Rosales C. FcγRIIA and FcγRIIIB mediate nuclear factor activation through separate signaling pathways in human neutrophils. *J Immunol.* (2009) 182:4547–56. doi: 10.4049/jimmunol.0801468
- Lindorfer MA KJ, Taylor RP. Interactions between the complement system and Fcγ receptors. In: Nimmerjahn Ackerman FME, editor. *Antibody Fc: Linking Adaptive and Innate Immunity*. Philadelphia, PA: Elsevier (2014), p. 49–74. doi: 10.1016/B978-0-12-394802-1.00003-0
- Zhou MJ, Lublin DM, Link DC, Brown EJ. Distinct tyrosine kinase activation and Triton X-100 insolubility upon Fc gamma RII or Fc gamma RIIIB ligation in human polymorphonuclear leukocytes. implications for immune complex activation of the respiratory burst. *J Biol Chem.* (1995) 270:13553–60. doi: 10.1074/jbc.270.22.13553
- Coxon PY, Rane MJ, Powell DW, Klein JB, McLeish KR. Differential mitogen-activated protein kinase stimulation by Fc gamma receptor IIa and Fc gamma receptor IIIB determines the activation phenotype of human neutrophils. *J Immunol.* (2000) 164:6530–7. doi: 10.4049/jimmunol.164.12.6530
- Hazan-Halevy I, Seger R, Levy R. The requirement of both extracellular regulated kinase and p38 mitogen-activated protein kinase for stimulation of cytosolic phospholipase A(2) activity by either FcγRIIA or FcγRIIIB in human neutrophils. A possible role for Pyk2 but not for the Grb2-Sos-Shc complex. *J Biol Chem.* (2000) 275:12416–23. doi: 10.1074/jbc.275.17.12416
- Vossebeld PJ, Homburg CH, Roos D, Verhoeven AJ. The anti-Fc gamma RIII mAb 3G8 induces neutrophil activation via a cooperative actin of Fc gamma RIIIB and Fc gamma RIIa. *Int J Biochem Cell Biol.* (1997) 29:465–73. doi: 10.1016/S1357-2725(96)00160-4
- Huizinga TW, de Haas M, Kleijer M, Nuijens JH, Roos D, von dem Borne AE. Soluble Fc gamma receptor III in human plasma originates from release by neutrophils. *J Clin Invest.* (1990) 86:416–23. doi: 10.1172/JCI114727
- Dransfield I, Buckle AM, Savill JS, McDowall A, Haslett C, Hogg N. Neutrophil apoptosis is associated with a reduction in CD16 (Fc gamma RIII) expression. *J Immunol.* (1994) 153:1254–63.
- Teillaud JL, Bouchard C, Astier A, Teillaud C, Tartour E, Michon J, et al. Natural and recombinant soluble low-affinity Fc gamma R: detection, purification, and functional activities. *Immunomethods.* (1994) 4:48–64. doi: 10.1006/immu.1994.1007

37. Esposito-Farese ME, Sautes C, de la Salle H, Latour S, Bieber T, de la Salle C, et al. Membrane and soluble Fc gamma RII/III modulate the antigen-presenting capacity of murine dendritic epidermal Langerhans cells for IgG-complexed antigens. *J Immunol.* (1995) 155:1725–36.
38. Galon J, Gauchat JF, Mazieres N, Spagnoli R, Storkus W, Lotze M, et al. Soluble Fc gamma receptor type III (Fc gamma RIII, CD16) triggers cell activation through interaction with complement receptors. *J Immunol.* (1996) 157:1184–92.
39. Nagarajan S, Venkiteswaran K, Anderson M, Sayed U, Zhu C, Selvaraj P. Cell-specific, activation-dependent regulation of neutrophil CD32A ligand-binding function. *Blood.* (2000) 95:1069–77. Available online at: <http://www.bloodjournal.org/content/95/3/1069?so=checked=true>
40. Saggi G, Okubo K, Chen Y, Vattepu R, Tsuboi N, Rosetti F, et al. Cis interaction between sialylated Fc gamma RIIA and the alpha1-domain of Mac-1 limits antibody-mediated neutrophil recruitment. *Nat Commun.* (2018) 9:5058. doi: 10.1038/s41467-018-07506-1
41. Crockett-Torabi E, Fantone JC. Soluble and insoluble immune complexes activate human neutrophil NADPH oxidase by distinct Fc gamma receptor-specific mechanisms. *J Immunol.* (1990) 145:3026–32.
42. Bredius RG, Fijen CA, De Haas M, Kuijper EJ, Weening RS, Van de Winkel JG, et al. Role of neutrophil Fc gamma RIIa (CD32) and Fc gamma RIIb (CD16) polymorphic forms in phagocytosis of human IgG1- and IgG3-opsonized bacteria and erythrocytes. *Immunology.* (1994) 83:624–30.
43. Unkeless JC, Shen Z, Lin CW, DeBeus E. Function of human Fc gamma RIIA and Fc gamma RIIIB. *Semin Immunol.* (1995) 7:37–44. doi: 10.1016/1044-5323(95)90006-3
44. Tsuboi N, Asano K, Lauterbach M, Mayadas TN. Human neutrophil Fc gamma receptors initiate and play specialized nonredundant roles in antibody-mediated inflammatory diseases. *Immunity.* (2008) 28:833–46. doi: 10.1016/j.immuni.2008.04.013
45. Zyttek C, Schmitz J, Winkels G. (2013). Untouched isolation of functionally unaffected neutrophils from whole blood within 20 minutes. *Front Immunol.* 2:621. doi: 10.3389/conf.fimmu.2013.02.00621
46. Calzetti F, Tamassia N, Arruda-Silva F, Gasperini S, Cassatella MA. The importance of being “pure” neutrophils. *J Allergy Clin Immunol.* (2017) 139:352–5e356. doi: 10.1016/j.jaci.2016.06.025
47. Akerley WL, 3rd, Guyre PM, Davis BH. Neutrophil activation through high-affinity Fc gamma receptor using a monomeric antibody with unique properties. *Blood.* (1991) 77:607–15.
48. Perussia B, Dayton G, Lazarus R, Fanning V, Trinchieri G. Immune interferon induces the receptor for monomeric IgG1 on human monocytic and myeloid cells. *J Exp Med.* (1983) 158:1092–113. doi: 10.1084/jem.158.4.1092
49. Schiff DE, Rae J, Martin TR, Davis BH, Curnutte JT. Increased phagocyte Fc gamma RI expression and improved Fc gamma-receptor-mediated phagocytosis after *in vivo* recombinant human interferon-gamma treatment of normal human subjects. *Blood.* (1997) 90:3187–94.
50. Su K, Yang H, Li X, Li X, Gibson AW, Cafardi JM, et al. Expression profile of Fc gamma RIIb on leukocytes and its dysregulation in systemic lupus erythematosus. *J Immunol.* (2007) 178:3272–80. doi: 10.4049/jimmunol.178.5.3272
51. Golay J, Valgardsdottir R, Musaraj G, Giupponi D, Spinelli O, Introna M. Human neutrophils express low levels of Fc gamma RIIIA, which plays a role in PMN activation. *Blood.* (2019) 133:1395–405. doi: 10.1182/blood-2018-07-864538
52. Bruhns P, Jonsson F. Mouse and human FcR effector functions. *Immunol Rev.* (2015) 268:25–51. doi: 10.1111/imr.12350
53. Hundt M, Schubert J, de Haas M, Zielinska-Skowronek M, Schmidt RE. The loss of Fc gamma RIIb in paroxysmal nocturnal hemoglobinuria is functionally replaced by Fc gamma RII. *Blood.* (1994) 83:3574–80.
54. Guyre PM, Campbell AS, Kniffin WD, Fanger MW. Monocytes and polymorphonuclear neutrophils of patients with streptococcal pharyngitis express increased numbers of type I IgG Fc receptors. *J Clin Invest.* (1990) 86:1892–6. doi: 10.1172/JCI114921
55. Repp R, Valerius T, Sandler A, Gramatzki M, Iro H, Kalden JR, et al. Neutrophils express the high affinity receptor for IgG (Fc gamma RI, CD64) after *in vivo* application of recombinant human granulocyte colony-stimulating factor. *Blood.* (1991) 78:885–9.
56. Roilides E, Holmes A, Blake C, Pizzo PA, Walsh TJ. Effects of granulocyte colony-stimulating factor and interferon-gamma on antifungal activity of human polymorphonuclear neutrophils against pseudohyphae of different medically important *Candida* species. *J Leukoc Biol.* (1995) 57:651–6. doi: 10.1002/jlb.57.4.651
57. Davis BH, Bigelow NC. Comparison of neutrophil CD64 expression, manual myeloid immaturity counts, and automated hematology analyzer flags as indicators of infection or sepsis. *Lab Hematol.* (2005) 11:137–47. doi: 10.1532/LH96.04077
58. Layseca-Espinosa E, Perez-Gonzalez LF, Torres-Montes A, Baranda L, de la Fuente H, Rosenstein Y, et al. Expression of CD64 as a potential marker of neonatal sepsis. *Pediatr Allergy Immunol.* (2002) 13:319–27. doi: 10.1034/j.1399-3038.2002.01064.x
59. Ng PC, Li K, Wong RP, Chui KM, Wong E, Fok TF. Neutrophil CD64 expression: a sensitive diagnostic marker for late-onset nosocomial infection in very low birthweight infants. *Pediatr Res.* (2002) 51:296–303. doi: 10.1203/00006450-200203000-00006
60. Strohmeyer JC, Blume C, Meisel C, Doecke WD, Hummel M, Hoeflich C, et al. Standardized immune monitoring for the prediction of infections after cardiopulmonary bypass surgery in risk patients. *Cytometry B Clin Cytom.* (2003) 53:54–62. doi: 10.1002/cyto.b.10031
61. Song SH, Kim HK, Park MH, Cho HI. Neutrophil CD64 expression is associated with severity and prognosis of disseminated intravascular coagulation. *Thromb Res.* (2008) 121:499–507. doi: 10.1016/j.thromres.2007.05.013
62. Minar P, Jackson K, Tsai YT, Rosen MJ, Northcutt M, Khodoun M, et al. A low neutrophil CD64 index is associated with sustained remission during infliximab maintenance therapy. *Inflamm Bowel Dis.* (2016) 22:2641–7. doi: 10.1097/MIB.0000000000000922
63. Dimoula A, Pradier O, Kassenger Z, Dalcomune D, Turkan H, Vincent JL. Serial determinations of neutrophil CD64 expression for the diagnosis and monitoring of sepsis in critically ill patients. *Clin Infect Dis.* (2014) 58:820–9. doi: 10.1093/cid/cit936
64. Livaditi O, Kotanidou A, Psarra A, Dimopoulou I, Sotiropoulou C, Augustatou K, et al. Neutrophil CD64 expression and serum IL-8: sensitive early markers of severity and outcome in sepsis. *Cytokine.* (2006) 36:283–90. doi: 10.1016/j.cyt.2007.02.007
65. Gamez-Diaz LY, Enriquez LE, Matute JD, Velasquez S, Gomez ID, Toro F, et al. Diagnostic accuracy of HMGB-1, sTREM-1, and CD64 as markers of sepsis in patients recently admitted to the emergency department. *Acad Emerg Med.* (2011) 18:807–15. doi: 10.1111/j.1553-2712.2011.01113.x
66. Gros A, Roussel M, Sauvadet E, Gacouin A, Marque S, Chimot L, et al. The sensitivity of neutrophil CD64 expression as a biomarker of bacterial infection is low in critically ill patients. *Intensive Care Med.* (2012) 38:445–52. doi: 10.1007/s00134-012-2483-6
67. Dal Ponte ST, Alegretti AP, Pilger DA, Rezende GP, Andrioli G, Ludwig HC, et al. Diagnostic accuracy of CD64 for sepsis in emergency department. *J Glob Infect Dis.* (2018) 10:42–6. doi: 10.4103/jgid.jgid_130_16
68. Cid J, Aguinaco R, Sanchez R, Garcia-Pardo G, Llorente A. Neutrophil CD64 expression as marker of bacterial infection: a systematic review and meta-analysis. *J Infect.* (2010) 60:313–9. doi: 10.1016/j.jinf.2010.02.013
69. Li S, Huang X, Chen Z, Zhong H, Peng Q, Deng Y, et al. Neutrophil CD64 expression as a biomarker in the early diagnosis of bacterial infection: a meta-analysis. *Int J Infect Dis.* (2013) 17:e12–23. doi: 10.1016/j.ijid.2012.07.017
70. Gyawali B, Ramakrishna K, Dharmoon AS. Sepsis: the evolution in definition, pathophysiology, and management. *SAGE Open Med.* (2019) 7:1–13. doi: 10.1177/2050312119835043
71. van der Heijden J, Nagelkerke S, Zhao X, Geissler J, Rispen T, van den Berg TK, et al. Haplotypes of Fc gamma RIIa and Fc gamma RIIb polymorphic variants influence IgG-mediated responses in neutrophils. *J Immunol.* (2014) 192:2715–21. doi: 10.4049/jimmunol.1203570
72. Belostocki K, Park MS, Redecha PB, Masuda E, Salmon JE, Pricop L. Fc gamma RIIa is a target for modulation by TNFalpha in human neutrophils. *Clin Immunol.* (2005) 117:78–86. doi: 10.1016/j.clim.2005.07.001
73. Fossati G, Bucknall RC, Edwards SW. Insoluble and soluble immune complexes activate neutrophils by distinct activation mechanisms: changes

- in functional responses induced by priming with cytokines. *Ann Rheum Dis.* (2002) 61:13–9. doi: 10.1136/ard.61.1.13
74. Lauterbach M, O'Donnell P, Asano K, Mayadas TN. Role of TNF priming and adhesion molecules in neutrophil recruitment to intravascular immune complexes. *J Leukoc Biol.* (2008) 83:1423–30. doi: 10.1189/jlb.0607421
 75. Higurashi S, Machino Y, Suzuki E, Suzuki M, Kohroki J, Masuho Y. Both the Fab and Fc domains of IgG are essential for ROS emission from TNF- α -primed neutrophils by IVIG. *Biochem Biophys Res Commun.* (2012) 417:794–9. doi: 10.1016/j.bbrc.2011.12.038
 76. Jönsson F, Mancardi DA, Zhao W, Kita Y, Iannascoli B, Khun H, et al. Human Fc γ RIIA induces anaphylactic and allergic reactions. *Blood.* (2012) 119:2533–44. doi: 10.1182/blood-2011-07-367334
 77. Suurmond J, Diamond B. Autoantibodies in systemic autoimmune diseases: specificity and pathogenicity. *J Clin Invest.* (2015) 125:2194–202. doi: 10.1172/JCI78084
 78. Mayadas TN, Tsokos GC, Tsuboi N. Mechanisms of immune complex-mediated neutrophil recruitment and tissue injury. *Circulation.* (2009) 120:2012–4. doi: 10.1161/CIRCULATIONAHA.108.771170
 79. Nagelkerke SQ, Tacke CE, Breunis WB, Tanck MWT, Geissler J, Png E, et al. Extensive ethnic variation and linkage disequilibrium at the FCGR2/3 locus: different genetic associations revealed in Kawasaki disease. *Front Immunol.* (2019) 10:185. doi: 10.3389/fimmu.2019.00185
 80. Warmerdam PA, van de Winkel JG, Gosselin EJ, Capel PJ. Molecular basis for a polymorphism of human Fc gamma receptor II (CD32). *J Exp Med.* (1990) 172:19–25. doi: 10.1084/jem.172.1.19
 81. Duits AJ, Bootsma H, Derksen RH, Spronk PE, Kater L, Kallenberg CG, et al. Skewed distribution of IgG Fc receptor IIa (CD32) polymorphism is associated with renal disease in systemic lupus erythematosus patients. *Arthritis Rheum.* (1995) 38:1832–6. doi: 10.1002/art.1780381217
 82. Haseley LA, Wisnieski JJ, Denburg MR, Michael-Grossman AR, Ginzler EM, Gourley ME, et al. Antibodies to C1q in systemic lupus erythematosus: characteristics and relation to Fc gamma RIIA alleles. *Kidney Int.* (1997) 52:1375–80. doi: 10.1038/ki.1997.464
 83. Williams Y, Lynch S, McCann S, Smith O, Feighery C, Whelan A. Correlation of platelet Fc γ RIIA polymorphism in refractory idiopathic (immune) thrombocytopenic purpura. *Br J Haematol.* (1998) 101:779–82. doi: 10.1046/j.1365-2141.1998.00802.x
 84. Myhr K-M, Raknes G, Nyland H, Vedeler C. Immunoglobulin G Fc-receptor (FcyR) IIA and IIIB polymorphisms related to disability in MS. *Neurology.* (1999) 52:1771. doi: 10.1212/WNL.52.9.1771
 85. Karassa FB, Bijl M, Davies KA, Kallenberg CGM, Khamashta MA, Manger K, et al. Role of the Fcy receptor IIA polymorphism in the antiphospholipid syndrome: an international meta-analysis. *Arthritis Rheum.* (2003) 48:1930–8. doi: 10.1002/art.11059
 86. Sanders LA, van de Winkel JG, Rijkers GT, Voorhorst-Ogink MM, de Haas M, Capel PJ, et al. Fc gamma receptor IIa (CD32) heterogeneity in patients with recurrent bacterial respiratory tract infections. *J Infect Dis.* (1994) 170:854–61. doi: 10.1093/infdis/170.4.854
 87. Raknes G, Skeie GO, Gilhus NE, Aadland S, Vedeler C. FcyRIIA and FcyRIIIB polymorphisms in myasthenia gravis. *J Neuroimmunol.* (1998) 81:173–6. doi: 10.1016/S0165-5728(97)00174-4
 88. Khor CC, Davila S, Breunis WB, Lee Y-C, Shimizu C, Wright VJ, et al. Genome-wide association study identifies FCGR2A as a susceptibility locus for Kawasaki disease. *Nat Genet.* (2011) 43:1241–6. doi: 10.1038/ng.981
 89. van der Heijden J, Geissler J, van Mirre E, van Deuren M, van der Meer JW, Salama A, et al. A novel splice variant of Fc γ RIIA: a risk factor for anaphylaxis in patients with hypogammaglobulinemia. *J Allergy Clin Immunol.* (2013) 131:1408–1416.e1405. doi: 10.1016/j.jaci.2013.02.009
 90. Anania JC, Trist HM, Palmer CS, Tan PS, Kouskousis BP, Chenoweth AM, et al. The rare anaphylaxis-associated Fc γ RIIA3 exhibits distinct characteristics from the canonical Fc γ RIIA1. *Front Immunol.* (2018) 9:1809. doi: 10.3389/fimmu.2018.01809
 91. Su K, Wu J, Edberg JC, Li X, Ferguson P, Cooper GS, et al. A promoter haplotype of the immunoreceptor tyrosine-based inhibitory motif-bearing Fc γ RIIB alters receptor expression and associates with autoimmunity. I. regulatory FCGR2B polymorphisms and their association with systemic lupus erythematosus. *J Immunol.* (2004) 172:7186–91. doi: 10.4049/jimmunol.172.11.7186
 92. Su K, Li X, Edberg JC, Wu J, Ferguson P, Kimberly RP. A promoter haplotype of the immunoreceptor tyrosine-based inhibitory motif-bearing Fc γ RIIB alters receptor expression and associates with autoimmunity. II. differential binding of GATA4 and Yin-Yang1 transcription factors and correlated receptor expression and function. *J Immunol.* (2004) 172:7192–9. doi: 10.4049/jimmunol.172.11.7192
 93. Floto RA, Clatworthy MR, Heilbronn KR, Rosner DR, MacAry PA, Rankin A, et al. Loss of function of a lupus-associated Fc γ RIIB polymorphism through exclusion from lipid rafts. *Nat Med.* (2005) 11:1056–8. doi: 10.1038/nm1288
 94. Bux J, Stein EL, Bierling P, Fromont P, Clay M, Stroncek D, et al. Characterization of a new alloantigen (SH) on the human neutrophil Fc gamma receptor IIIB. *Blood.* (1997) 89:1027–34.
 95. Salmon JE, Edberg JC, Kimberly RP. Fc gamma receptor III on human neutrophils. Allelic variants have functionally distinct capacities. *J Clin Invest.* (1990) 85:1287–95. doi: 10.1172/JCI114566
 96. Shrestha S, Wiener H, Shendre A, Kaslow RA, Wu J, Olson A, et al. Role of activating Fc γ RII gene polymorphisms in Kawasaki disease susceptibility and intravenous immunoglobulin response. *Circ Cardiovasc Genet.* (2012) 5:309–16. doi: 10.1161/CIRCGENETICS.111.962464
 97. Koene HR, Kleijer M, Roos D, de Haas M, Von dem Borne AE. Fc gamma RIIIB gene duplication: evidence for presence and expression of three distinct Fc gamma RIIIB genes in NA(1+,2+)SH(+) individuals. *Blood.* (1998) 91:673–9.
 98. Lejeune J, Thibault G, Ternant D, Cartron G, Watier H, Ohresser M. Evidence for linkage disequilibrium between Fc γ RIIA-V158F and Fc γ RIIA-H131R polymorphisms in white patients, and for an Fc γ RIIA-restricted influence on the response to therapeutic antibodies. *J Clin Oncol.* (2008) 26:5489–91. doi: 10.1200/JCO.2008.19.4118
 99. Breunis WB, van Mirre E, Bruin M, Geissler J, de Boer M, Peters M, et al. Copy number variation of the activating FCGR2C gene predisposes to idiopathic thrombocytopenic purpura. *Blood.* (2008) 111:1029–38. doi: 10.1182/blood-2007-03-079913
 100. Mellor JD, Brown MP, Irving HR, Zalberg JR, Dobrovic A. A critical review of the role of Fc gamma receptor polymorphisms in the response to monoclonal antibodies in cancer. *J Hematol Oncol.* (2013) 6:1. doi: 10.1186/1756-8722-6-1
 101. Nagelkerke SQ, Tacke CE, Breunis WB, Geissler J, Sins JW, Appelhof B, et al. Nonallelic homologous recombination of the FCGR2/3 locus results in copy number variation and novel chimeric FCGR2 genes with aberrant functional expression. *Genes Immun.* (2015) 16:422–9. doi: 10.1038/gene.2015.25
 102. de Haas M, Kleijer M, van Zwieten R, Roos D, von dem Borne AE. Neutrophil Fc gamma RIIIB deficiency, nature, and clinical consequences: a study of 21 individuals from 14 families. *Blood.* (1995) 86:2403–13.
 103. Fanciulli M, Norsworthy PJ, Petretto E, Dong R, Harper L, Kamesh L, et al. FCGR3B copy number variation is associated with susceptibility to systemic, but not organ-specific, autoimmunity. *Nat Genet.* (2007) 39:721–3. doi: 10.1038/ng2046
 104. Bournazos S, Bournazos I, Murchison JT, Wallace WA, McFarlane P, Hirani N, et al. Copy number variation of FCGR3B is associated with susceptibility to idiopathic pulmonary fibrosis. *Respiration.* (2011) 81:142–9. doi: 10.1159/000321997
 105. Graf SW, Lester S, Nossent JC, Hill CL, Proudman SM, Lee A, et al. Low copy number of the FCGR3B gene and rheumatoid arthritis: a case-control study and meta-analysis. *Arthritis Res Ther.* (2012) 14:R28. doi: 10.1186/ar3731
 106. McKinney C, Broen JC, Vonk MC, Beretta L, Hesselstrand R, Hunzelmann N, et al. Evidence that deletion at FCGR3B is a risk factor for systemic sclerosis. *Genes Immun.* (2012) 13:458–60. doi: 10.1038/gene.2012.15
 107. Niederer HA, Willcocks LC, Rayner TF, Yang W, Lau YL, Williams TN, et al. Copy number, linkage disequilibrium and disease association in the FCGR locus. *Hum Mol Genet.* (2010) 19:3282–94. doi: 10.1093/hmg/ddq216
 108. Barbosa FB, Simioni M, Wiesel CEV, Torres FR, Molck MC, Bonilla MM, et al. Copy number variation in the susceptibility to systemic lupus erythematosus. *PLoS ONE.* (2018) 13:e0206683. doi: 10.1371/journal.pone.0206683
 109. Lee YH, Bae SC, Seo YH, Kim JH, Choi SJ, Ji JD, et al. Association between FCGR3B copy number variations and susceptibility to

- autoimmune diseases: A meta-analysis. *Inflamm Res.* (2015) 64:983–1. doi: 10.1007/s00011-015-0882-1
110. Zhu XW, Wang Y, Wei YH, Zhao PP, Wang XB, Rong JJ, et al. Comprehensive assessment of the association between FCGRs polymorphisms and the risk of systemic lupus erythematosus: evidence from a meta-analysis. *Sci Rep.* (2016) 6:31617. doi: 10.1038/srep31617
 111. Clark MR, Liu L, Clarkson SB, Ory PA, Goldstein IM. An abnormality of the gene that encodes neutrophil Fc receptor III in a patient with systemic lupus erythematosus. *J Clin Invest.* (1990) 86:341–6. doi: 10.1172/JCI114706
 112. Li X, Ptacek TS, Brown EE, Edberg JC. Fcγ receptors: Structure, function and role as genetic risk factors in SLE. *Genes Immun.* (2009) 10:380–9. doi: 10.1038/gene.2009.35
 113. Patin E, Hasan M, Bergstedt J, Rouilly V, Libri V, Urrutia A, et al. Publisher correction: natural variation in the parameters of innate immune cells is preferentially driven by genetic factors. *Nat Immunol.* (2018) 19:645. doi: 10.1038/s41590-018-0105-3
 114. Daëron M, Latour S, Malbec O, Espinosa E, Pina P, Pasmans S, et al. The same tyrosine-based inhibition motif in the intracytoplasmic domain of FcγRIIB, regulates negatively BCR-, TCR-, and FcR-dependent cell activation. *Immunity.* (1995) 3:635–46. doi: 10.1016/1074-7613(95)90134-5
 115. Ravetch JV, Bolland S. IgG Fc receptors. *Annu Rev Immunol.* (2001) 19:275–90. doi: 10.1146/annurev.immunol.19.1.275
 116. Subedi GP, Barb AW. The structural role of antibody N-glycosylation in receptor interactions. *Structure.* (2015) 23:1573–83. doi: 10.1016/j.str.2015.06.015
 117. Subedi GP, Barb AW. The immunoglobulin G1 N-glycan composition affects binding to each low affinity Fcγ receptor. *MAbs.* (2016) 8:1512–24. doi: 10.1080/19420862.2016.1218586
 118. Li T, DiLillo DJ, Bournazos S, Giddens JP, Ravetch JV, Wang LX. Modulating IgG effector function by Fc glycan engineering. *Proc Natl Acad Sci USA.* (2017) 114:3485–90. doi: 10.1073/pnas.1702173114
 119. Jefferis R. Glycosylation of recombinant antibody therapeutics. *Biotechnol Prog.* (2005) 21:11–6. doi: 10.1021/bp040016j
 120. Jefferis R. Glycosylation as a strategy to improve antibody-based therapeutics. *Nat Rev Drug Discov.* (2009) 8:226–34. doi: 10.1038/nrd2804
 121. Shields RL, Lai J, Keck R, O'Connell LY, Hong K, Meng YG, et al. Lack of fucose on human IgG1 N-linked oligosaccharide improves binding to human FcγRIII and antibody-dependent cellular toxicity. *J Biol Chem.* (2002) 277:26733–40. doi: 10.1074/jbc.M202069200
 122. Okazaki A, Shoji-Hosaka E, Nakamura K, Wakitani M, Uchida K, Kakita S, et al. Fucose depletion from human IgG1 oligosaccharide enhances binding enthalpy and association rate between IgG1 and FcγRIIIa. *J Mol Biol.* (2004) 336:1239–49. doi: 10.1016/j.jmb.2004.01.007
 123. Ferrara C, Grau S, Jager C, Sondermann P, Brunker P, Waldhauer I, et al. Unique carbohydrate–carbohydrate interactions are required for high affinity binding between FcγRIII and antibodies lacking core fucose. *Proc Natl Acad Sci USA.* (2011) 108:12669–74. doi: 10.1073/pnas.1108455108
 124. Golay J, Da Roit F, Bologna L, Ferrara C, Leusen JH, Rambaldi A, et al. Glycoengineered CD20 antibody obinutuzumab activates neutrophils and mediates phagocytosis through CD16B more efficiently than rituximab. *Blood.* (2013) 122:3482–91. doi: 10.1182/blood-2013-05-504043
 125. Reddy V, Klein C, Isenberg DA, Glennie MJ, Cambridge G, Cragg MS, et al. Obinutuzumab induces superior B-cell cytotoxicity to rituximab in rheumatoid arthritis and systemic lupus erythematosus patient samples. *Rheumatology (Oxford).* (2017) 56:1227–37. doi: 10.1093/rheumatology/kex067
 126. Treffers LW, van Houdt M, Bruggeman CW, Heineke MH, Zhao XW, van der Heijden J, et al. FcγRIIIb restricts antibody-dependent destruction of cancer cells by human neutrophils. *Front Immunol.* (2018) 9:3124. doi: 10.3389/fimmu.2018.03124
 127. Scallion BJ, Tam SH, McCarthy SG, Cai AN, Raju TS. Higher levels of sialylated Fc glycans in immunoglobulin G molecules can adversely impact functionality. *Mol Immunol.* (2007) 44:1524–34. doi: 10.1016/j.molimm.2006.09.005
 128. Rantapää-Dahlqvist S, de Jong BA, Berglin E, Hallmans G, Wadell G, Stenlund H, et al. Antibodies against cyclic citrullinated peptide and IgA rheumatoid factor predict the development of rheumatoid arthritis. *Arthritis Rheum.* (2003) 48:2741–9. doi: 10.1002/art.11223
 129. Nielen MM, van Schaardenburg D, Reesink HW, van de Stadt RJ, van der Horst-Bruinsma IE, de Koning MH, et al. Specific autoantibodies precede the symptoms of rheumatoid arthritis: a study of serial measurements in blood donors. *Arthritis Rheum.* (2004) 50:380–6. doi: 10.1002/art.20018
 130. Heinen LD, McClain MT, Merrill J, Akbarali YW, Edgerton CC, Harley JB, et al. Clinical criteria for systemic lupus erythematosus precede diagnosis, and associated autoantibodies are present before clinical symptoms. *Arthritis Rheum.* (2007) 56:2344–51. doi: 10.1002/art.22665
 131. Harre U, Lang SC, Pfeifle R, Rombouts Y, Fruhbesser S, Amara K, et al. Glycosylation of immunoglobulin G determines osteoclast differentiation and bone loss. *Nat Commun.* (2015) 6:6651. doi: 10.1038/ncomms7651
 132. Rombouts Y, Ewing E, van de Stadt LA, Selman MH, Trouw LA, Deelder AM, et al. Anti-citrullinated protein antibodies acquire a pro-inflammatory Fc glycosylation phenotype prior to the onset of rheumatoid arthritis. *Ann Rheum Dis.* (2015) 74:234–41. doi: 10.1136/annrheumdis-2013-203565
 133. Pagan JD, Kitaoka M, Anthony RM. Engineered sialylation of pathogenic antibodies *in vivo* attenuates autoimmune disease. *Cell.* (2018) 172:564–577.e513. doi: 10.1016/j.cell.2017.11.041
 134. Tang T, Rosenkranz A, Assmann KJ, Goodman MJ, Gutierrez-Ramos JC, Carroll MC, et al. A role for Mac-1 (CD11b/CD18) in immune complex-stimulated neutrophil function *in vivo*: Mac-1 deficiency abrogates sustained Fcγ receptor-dependent neutrophil adhesion and complement-dependent proteinuria in acute glomerulonephritis. *J Exp Med.* (1997) 186:1853–63. doi: 10.1084/jem.186.11.1853
 135. Nath SK, Han S, Kim-Howard X, Kelly JA, Viswanathan P, Gilkeson GS, et al. A nonsynonymous functional variant in integrin-α(M) (encoded by ITGAM) is associated with systemic lupus erythematosus. *Nat Genet.* (2008) 40:152–4. doi: 10.1038/ng.71
 136. SL Jones EB (1996). *Functional Cooperation Between Fcγ Receptors and Complement Receptors in Phagocytes.* Austin: R.G Landes.
 137. Alvarez Y, Tang X, Coligan JE, Borrego F. The CD300a (IRp60) inhibitory receptor is rapidly up-regulated on human neutrophils in response to inflammatory stimuli and modulates CD32a (FcγRIIIa) mediated signaling. *Mol Immunol.* (2008) 45:253–8. doi: 10.1016/j.molimm.2007.05.006
 138. Bharadwaj D, Stein MP, Volzer M, Mold C, Du Clos TW. The major receptor for C-reactive protein on leukocytes is fcyγ receptor II. *J Exp Med.* (1999) 190:585–90. doi: 10.1084/jem.190.4.585
 139. Bharadwaj D, Mold C, Markham E, Du Clos TW. Serum amyloid P component binds to Fcγ receptors and opsonizes particles for phagocytosis. *J Immunol.* (2001) 166:6735–41. doi: 10.4049/jimmunol.166.11.6735
 140. Stein MP, Edberg JC, Kimberly RP, Mangan EK, Bharadwaj D, Mold C, et al. C-reactive protein binding to FcγRIIIa on human monocytes and neutrophils is allele-specific. *J Clin Invest.* (2000) 105:369–76. doi: 10.1172/JCI7817
 141. Zeller JM, Kubak BM, Gewurz H. Binding sites for C-reactive protein on human monocytes are distinct from IgG Fc receptors. *Immunology.* (1989) 67:51–5.
 142. Cox N, Pilling D, Gomer RH. Distinct Fcγ receptors mediate the effect of serum amyloid p on neutrophil adhesion and fibrocyte differentiation. *J Immunol.* (2014) 193:1701–8. doi: 10.4049/jimmunol.1400281
 143. Galon J, Moldovan I, Galinha A, Provost-Marloie MA, Kaudewitz H, Roman-Roman S, et al. Identification of the cleavage site involved in production of plasma soluble Fcγ receptor type III (CD16). *Eur J Immunol.* (1998) 28:2101–7. doi: 10.1002/(SICI)1521-4141(199807)28:07<2101::AID-IMMU2101>3.0.CO;2-W
 144. Wang Y, Wu J, Newton R, Bahaie NS, Long C, Walcheck B. ADAM17 cleaves CD16b (FcγRIIIb) in human neutrophils. *Biochim Biophys Acta.* (2013) 1833:680–5. doi: 10.1016/j.bbamer.2012.11.027
 145. Walcheck B, Herrera AH, St. Hill C, Mattila PE, Whitney AR, Deleo FR. ADAM17 activity during human neutrophil activation and apoptosis. *Eur J Immunol.* (2006) 36:968–76. doi: 10.1002/eji.200535257
 146. Wang Y, Robertson JD, Walcheck B. Different signaling pathways stimulate a disintegrin and metalloprotease-17 (ADAM17) in neutrophils during apoptosis and activation. *J Biol Chem.* (2011) 286:38980–8. doi: 10.1074/jbc.M111.277087

147. Blaydon DC, Biancheri P, Di WL, Plagnol V, Cabral RM, Brooke MA, et al. Inflammatory skin and bowel disease linked to ADAM17 deletion. *N Engl J Med.* (2011) 365:1502–8. doi: 10.1056/NEJMoa1100721
148. Bandsma RH, van Goor H, Yourshaw M, Horlings RK, Jonkman ME, Scholvinck EH, et al. Loss of ADAM17 is associated with severe multiorgan dysfunction. *Hum Pathol.* (2015) 46:923–8. doi: 10.1016/j.humpath.2015.02.010
149. de la Salle C, Esposito-Farese ME, Bieber T, Moncuit J, Morales M, Wollenberg A, et al. Release of soluble Fc gamma RII/CD32 molecules by human langerhans cells: a subtle balance between shedding and secretion? *J Invest Dermatol.* (1992) 99:15S–7S. doi: 10.1111/1523-1747.ep12668250
150. Lood C, Arve S, Ledbetter J, Elkon KB. TLR7/8 activation in neutrophils impairs immune complex phagocytosis through shedding of FcγRIIA. *J Exp Med.* (2017) 214:2103–19. doi: 10.1084/jem.20161512
151. Branzk N, Lubojemska A, Hardison SE, Wang Q, Gutierrez MG, Brown GD, et al. Neutrophils sense microbe size and selectively release neutrophil extracellular traps in response to large pathogens. *Nat Immunol.* (2014) 15:1017–25. doi: 10.1038/ni.2987
152. Denny MF, Yalavarthi S, Zhao W, Thacker SG, Anderson M, Sandy AR, et al. A distinct subset of proinflammatory neutrophils isolated from patients with systemic lupus erythematosus induces vascular damage and synthesizes type I IFNs. *J Immunol.* (2010) 184:3284–97. doi: 10.4049/jimmunol.0902199
153. Kaplan MJ. Neutrophils in the pathogenesis and manifestations of SLE. *Nat Rev Rheumatol.* (2011) 7:691–9. doi: 10.1038/nrrheum.2011.132
154. Selvaraj P, Fifadara N, Nagarajan S, Cimino A, Wang G. Functional regulation of human neutrophil Fc gamma receptors. *Immunol Res.* (2004) 29:219–30. doi: 10.1385/IR:29:1-3:219
155. Ramsland PA, Farrugia W, Bradford TM, Sardjono CT, Esparon S, Trist HM, et al. Structural basis for Fc gammaRIIa recognition of human IgG and formation of inflammatory signaling complexes. *J Immunol.* (2011) 187:3208–17. doi: 10.4049/jimmunol.1101467
156. Scapini P, Nardelli B, Nadali G, Calzetti F, Pizzolo G, Montecucco C, et al. G-CSF-stimulated neutrophils are a prominent source of functional BLYS. *J Exp Med.* (2003) 197:297–302. doi: 10.1084/jem.20021343
157. Scapini P, Bazzoni F, Cassatella MA. Regulation of B-cell-activating factor (BAFF)/B lymphocyte stimulator (BLYS) expression in human neutrophils. *Immunol Lett.* (2008) 116:1–6. doi: 10.1016/j.imlet.2007.11.009
158. Parsa R, Lund H, Georgoudaki AM, Zhang XM, Ortlieb Guerreiro-Cacais A, Grommisch D, et al. BAFF-secreting neutrophils drive plasma cell responses during emergency granulopoiesis. *J Exp Med.* (2016) 213:1537–53. doi: 10.1084/jem.20150577
159. Litinskiy MB, Nardelli B, Hilbert DM, He B, Schaffer A, Casali P, et al. DCs induce CD40-independent immunoglobulin class switching through BLYS and APRIL. *Nat Immunol.* (2002) 3:822–9. doi: 10.1038/ni829
160. Salzer U, Neumann C, Thiel J, Woellner C, Pan-Hammarstrom Q, Lougaris V, et al. Screening of functional and positional candidate genes in families with common variable immunodeficiency. *BMC Immunol.* (2008) 9:3. doi: 10.1186/1471-2172-9-3
161. Gustafson CE, Higbee D, Yeckes AR, Wilson CC, De Zoeten EF, Jedlicka P, et al. Limited expression of APRIL and its receptors prior to intestinal IgA plasma cell development during human infancy. *Mucosal Immunol.* (2014) 7:467–77. doi: 10.1038/mi.2013.64
162. Manfroi B, McKee T, Mayol JE, Tabruyn S, Moret S, Villiers C, et al. CXCL8/IL8 produced by diffuse large B-cell lymphomas recruits neutrophils expressing a proliferation-inducing ligand APRIL. *Cancer Res.* (2017) 77:1097–107. doi: 10.1158/0008-5472.CAN-16-0786
163. Huard B, McKee T, Bosshard C, Durual S, Matthes T, Myit S, et al. APRIL secreted by neutrophils binds to heparan sulfate proteoglycans to create plasma cell niches in human mucosa. *J Clin Invest.* (2008) 118:2887–95. doi: 10.1172/JCI33760
164. Schwaller J, Schneider P, Mhawech-Fauceglia P, McKee T, Myit S, Matthes T, et al. Neutrophil-derived APRIL concentrated in tumor lesions by proteoglycans correlates with human B-cell lymphoma aggressiveness. *Blood.* (2007) 109:331–8. doi: 10.1182/blood-2006-02-001800
165. Zimmermann M, Arruda-Silva F, Bianchetto-Aguilera F, Finotti G, Calzetti F, Scapini P, et al. IFNα enhances the production of IL-6 by human neutrophils activated via TLR8. *Sci Rep.* (2016) 6:19674. doi: 10.1038/srep19674
166. Gestermann N, Di Domizio J, Lande R, Demaria O, Frasca L, Feldmeyer L, et al. Netting neutrophils activate autoreactive B cells in lupus. *J Immunol.* (2018) 200:3364–71. doi: 10.4049/jimmunol.1700778
167. Nolte MA, Hoen EN, van Stijn A, Kraal G, Mebius RE. Isolation of the intact white pulp. Quantitative and qualitative analysis of the cellular composition of the splenic compartments. *Eur J Immunol.* (2000) 30:626–34. doi: 10.1002/1521-4141(200002)30:2<626::AID-IMMU626>3.0.CO;2-H
168. Steiniger B, Barth P. Microanatomy and function of the spleen. *Adv Anat Embryol Cell Biol.* (2000) 151:1–101. doi: 10.1007/978-3-642-57088-9_1
169. Puga I, Cols M, Barra CM, He B, Cassis L, Gentile M, et al. B cell-helper neutrophils stimulate the diversification and production of immunoglobulin in the marginal zone of the spleen. *Nat Immunol.* (2011) 13:170–80. doi: 10.1038/ni.2194
170. Deniset JF, Surewaard BG, Lee WY, Kubes P. Splenic Ly6G(high) mature and Ly6G(int) immature neutrophils contribute to eradication of *S. pneumoniae*. *J Exp Med.* (2017) 214:1333–50. doi: 10.1084/jem.20161621
171. Nagelkerke SQ, aan de Kerk DJ, Jansen MH, van den Berg TK, Kuijpers TW. Failure to detect functional neutrophil B helper cells in the human spleen. *PLoS ONE.* (2014) 9:e88377. doi: 10.1371/journal.pone.0088377
172. Mavroudi I, Eliopoulos AG, Pontikoglou C, Pyrovolaki K, Damianaki A, Koutala H, et al. Immunoglobulin and B-cell disturbances in patients with chronic idiopathic neutropenia. *Clin Immunol.* (2017) 183:75–81. doi: 10.1016/j.clim.2017.07.009
173. Chorny A, Casas-Recasens S, Sintès J, Shan M, Polentarutti N, Garcia-Escudero R, et al. The soluble pattern recognition receptor PTX3 links humoral innate and adaptive immune responses by helping marginal zone B cells. *J Exp Med.* (2016) 213:2167–85. doi: 10.1084/jem.20150282
174. Jaillon S, Peri G, Delneste Y, Fremaux I, Doni A, Moalli F, et al. The humoral pattern recognition receptor PTX3 is stored in neutrophil granules and localizes in extracellular traps. *J Exp Med.* (2007) 204:793–804. doi: 10.1084/jem.20061301

Conflict of Interest Statement: The authors declare that the research was conducted in the absence of any commercial or financial relationships that could be construed as a potential conflict of interest.

Copyright © 2019 Wang and Jönsson. This is an open-access article distributed under the terms of the Creative Commons Attribution License (CC BY). The use, distribution or reproduction in other forums is permitted, provided the original author(s) and the copyright owner(s) are credited and that the original publication in this journal is cited, in accordance with accepted academic practice. No use, distribution or reproduction is permitted which does not comply with these terms.

Abstract

The immune system consists of an innate and an adaptive branch that interact with each other to preserve body homeostasis and defend the organism against invading pathogens. This is partly achieved by the action of antibodies that can bind to antigen via their Fab portion and trigger effector functions with their Fc portion. Produced by cells of the adaptive immune system, antibodies enable cells of the innate immune system to react in an antigen-specific manner. Antibodies are mainly characterized in or generated from animal models that support particular infections, respond to particular antigens or allow the generation of hybridomas. Due to the availability of numerous transgenic mouse models and the ease of performing bioassays with human blood cells *in vitro*, most antibodies from species other than mice and humans are tested *in vitro* using human cells and/or *in vivo* using mice. In my thesis, I undertook a systematic approach to characterize interactions between IgG from different species and mouse and human IgG receptors (FcγRs) that will be a useful reference for the transition from one animal model to preclinical mouse models or human cell-based bioassays.

Non-infectious diseases can arise from an imbalanced immune homeostasis. Allergic conditions are one such example and are in general associated with a Th2-driven IgE-dependent physiopathology involving mast cells and basophils. More recently, the contribution of other cellular populations and antibody subclasses to allergic diseases was put forward. To systematically characterize the immune phenotype of allergic patients, we recruited a new cohort of patients severely allergic to wasp venom or amoxicillin. Using fresh blood samples, I analysed steady state and induced immune responses and compared them to healthy individuals. My preliminary data document a trend for elevated Th2 and Th17 cells in allergic individuals and fewer but more mature dendritic cells. They also illustrate a large inter-individual variability in terms of induced immune responses. To identify immunological, genetic and environmental factors that determine the concentration of total serum IgE in healthy individuals, I also explored available data of an extensively analysed cohort of age- and sex-stratified 1000 healthy donors (Milieu Intérieur). My analysis reveals that total serum IgE concentrations in these donors are associated with age, sex, smoking habits, certain HLA alleles, FcεRI expression on basophils, and a particular profile of cytokines released in whole blood stimulation assays.

My thesis provides a basis for the in-depth characterization of the immune phenotype of severely allergic patients and contributes to a better understanding of the parameters that associate with serum IgE concentrations in healthy individuals. Additionally, my work draws a comprehensive map of the interactions between IgG from different species and mouse and human FcγRs that will help to anticipate FcγR-dependent effector functions when using IgGs from other species with human or mouse effector cells.

Keywords : Allergy; Immune phenotype; IgE; IgG; FcγRs; Interspecies cross-binding

Résumé

Le système immunitaire est constitué d'une branche innée et d'une branche adaptative qui interagissent ensemble et qui permettent de préserver l'homéostasie et de se défendre contre des agents pathogènes. Ceci dépend notamment de l'action d'anticorps, qui peuvent se lier à des antigènes via leur région Fab et activer des fonctions effectrices grâce à leur région Fc. Produits par les cellules du système immunitaire adaptatif, les anticorps permettent aux cellules du système immunitaire inné de répondre de manière spécifique à un antigène donné. Les anticorps sont principalement caractérisés et synthétisés en laboratoire, à partir de modèles animaux d'infections particulières, répondant à des antigènes d'intérêts, ou permettant la génération d'hybridomes.

Grâce au développement de nombreux modèles de souris transgéniques et de la facilité à effectuer des tests biologiques avec des cellules sanguines humaines *in vitro*, la plupart des anticorps d'espèces autres que murins et humains sont étudiés *in vitro* à partir de cellules humaines et / ou *in vivo* en utilisant des modèles murins. Au cours de ma thèse, j'ai entrepris une approche systématique afin de caractériser les interactions entre les IgG de différentes espèces et les récepteurs aux IgG (FcγR) murins et humains. Ce travail pourra à terme servir de référence pour le passage de modèles animaux à des modèles précliniques utilisant les souris, ou des bio-essais à partir de cellules humaines.

Des maladies non infectieuses peuvent être le résultat d'une homéostasie immunitaire déséquilibrée. Les allergies en sont un exemple, et sont généralement associées à une physiopathologie orientée Th2, dépendante des IgE et faisant intervenir mastocytes et basophiles. Récemment, la contribution d'autres populations cellulaires et d'autres sous-classes d'anticorps a été mise en évidence lors de réactions allergiques. Dans le but de caractériser systématiquement le phénotype immunitaire de patients allergiques, nous avons participé au recrutement d'une nouvelle cohorte de patients sévèrement allergiques au venin de guêpe ou à l'amoxicilline. À partir de prélèvements sanguins, j'ai analysé les caractéristiques de leur état basal et lors de l'induction de réactions immunitaires, et les ai comparés à des donneurs contrôles sains.

Mes résultats préliminaires démontrent une tendance à l'augmentation des cellules Th2 et Th17 chez les patients allergiques et suggèrent une diminution de la taille de la population des cellules dendritiques, mais qui sont néanmoins plus matures. Ils illustrent également une grande variabilité interindividuelle lors de l'induction de réponses immunitaires. Pour identifier les facteurs immunologiques, génétiques et environnementaux qui déterminent la concentration d'IgE sériques totales chez des individus sains, j'ai également étudié les données disponibles d'une cohorte de 1000 donneurs sains stratifiés par âge et par sexe (Milieu Intérieur). Mon analyse révèle que les concentrations sériques totales d'IgE chez ces donneurs sont corrélées à des facteurs tels que l'âge, le sexe, le tabagisme, certains allèles HLA, l'intensité d'expression de FcεRI sur les basophiles et un profil particulier de cytokines libérées lors de tests de stimulation du sang total.

Ma thèse fournit ainsi une base pour la caractérisation approfondie du phénotype immunitaire des patients gravement allergiques et contribue à une meilleure compréhension des paramètres associés aux concentrations sériques d'IgE chez des individus sains. De plus, mon travail dresse une carte complète des interactions entre les IgG de différentes espèces et les FcγR murins et humains, qui aideront à terme à anticiper les fonctions effectrices dépendantes de FcγR lors de l'utilisation d'IgG d'autres espèces avec des cellules effectrices humaines ou murines.

Mots-clés : allergie ; phénotype immunitaire, IgE, IgG, FcγRs, interactions inter-espèces.