



**HAL**  
open science

# Physiopathologie du virus Chikungunya: RAW264.7, un modèle d'infection des macrophages murins

Shiril Kumar

## ► To cite this version:

Shiril Kumar. Physiopathologie du virus Chikungunya: RAW264.7, un modèle d'infection des macrophages murins. Maladies infectieuses. Université de la Réunion, 2013. Français. NNT: 2013LARE0012 . tel-04094035

**HAL Id: tel-04094035**

**<https://theses.hal.science/tel-04094035v1>**

Submitted on 10 May 2023

**HAL** is a multi-disciplinary open access archive for the deposit and dissemination of scientific research documents, whether they are published or not. The documents may come from teaching and research institutions in France or abroad, or from public or private research centers.

L'archive ouverte pluridisciplinaire **HAL**, est destinée au dépôt et à la diffusion de documents scientifiques de niveau recherche, publiés ou non, émanant des établissements d'enseignement et de recherche français ou étrangers, des laboratoires publics ou privés.



Université de La Réunion

## THESE

Présentée pour obtenir le titre de Docteur en Sciences de l'Université de la Réunion

Spécialité: BIOCHIMIE (Immunologie)

Par

**SHIRIL KUMAR**

**Physiopathologie du virus Chikungunya : RAW264.7, un modèle  
d'infection des macrophages murins**

**Physiopathology of CHIKV: The RAW264.7 mouse macrophage model of  
infection**

Soutenue publiquement le mardi 19 mars 2013

Dr. Pierre ROQUES	C.E.A (France)	Rapporteur
Dr. Philippe DESPRES	Institut Pasteur (France)	Rapporteur
Pr. Philippe GASQUE (Thesis Director)	Université de La Réunion (France)	Examineur
Dr. Jean-Jacques HOARAU (Thesis Supervisor)	Université de La Réunion (France)	Examineur



# Acknowledgement

First, I would like to acknowledge Dr. Philippe DESPRES and Dr. Pierre ROQUES for giving their valuable time to review my thesis.

I would like to express my sincere gratitude and deep respect to my thesis director Professor Philippe GASQUE for his continuous support and guidance throughout my PhD programmed. He is a complete encyclopedia together with his patience, motivation and immense knowledge of science. Throughout my PhD career, he has always been patient and encouraging in times with new ideas in writing reports and to face difficulties. I will always admire his care and concern for me.

I am also very grateful to my thesis supervisor Dr. Jean Jacques HOARAU for his immense support throughout my PhD career. He has always been there for discussion and insightful comments on my work and thesis. I admire his approach for a problem, motivating discussion, research interest, French bureaucracy issues and above all his coolness and consistency.

I would also like to thank Dr. Marie Christine Jaffar-Bandjee for her valuable support throughout my research work and also to provide a unique state level research facility at CHU, Bellepierre.

Furthermore, I am also thankful to my lab mates Pascale, Claude, Wildriss, Thomas, Vincent, Audrey, Ghislaine, Johanna, Jessica and many more. All together, they do make a fantastic group of people who always encouraged and stand with me during my research, to handle new problems and to develop new technique. Not only about work but I did learn and understand a lot about life from them. A special thanks to Audrey for helping me with French administrative work of different organizations.

A special thanks to Dr. Christian Lefebvre d'Hellencourt, Dr. Joel Couprie, Dr. Christophe Dugue, Dr. Christine Robert Da Silva, Dr. Maya Cesari, Dr. Regis Roche, Dr. Laurence Hoarau and many others for their constant supports and encouragements.

I also thank to all my friends from Reunion Island and Europe: Sebastien, Guy, Roma, Audrey, Melinda, Clelia, Lucy, Claire, Miriame, Elisa, Patrick, Cynthia, Laura, Hella, Fabien,

Gregory, Laura, Tony, Sophie and Sofiane for the wonderful time in Reunion Island regarding all aspects of life and always been by my side in both good and difficult situations.

I would like to thank many graduate and undergraduate students I worked with, which was a good experience in terms of exchange of ideas and knowledge.

I thank my friends from India: Manoj, Avinash, Jibesh, Ravi, Trina, Victor, Sapan, Shelly, Harsha, Prashant, Abhishek and many more for their support and encouragement.

A special thanks to my parents who have always been with me during the course of my research. They have always stand by my side during all my difficult situations and for their undivided support and interest who inspired me and encouraged me to go my own way, without whom I would be unable to complete my project.

I would also thank all the people I encounter during my stay in Reunion Island and the effort put from both the side without knowing the language of either.

Once again I thank everyone for their immense support without which I wouldn't been able to complete my Thesis.

Last but not the least I thank God who made all the things possible...

Shiril Kumar



**Dedicated to my Parents and Beloved  
Ones!!**

## Table of contents:

<b>I.</b>	<b>CHIKUNGUNYA VIRUS (CHIKV)</b> .....	<b>21</b>
A.	GENERAL INTRODUCTION .....	21
B.	GENERAL CLASSIFICATION OF VIRUSES .....	22
C.	THE ALPHAVIRUSES .....	23
1.	<i>Structure of Alphaviruses</i> .....	26
2.	<i>Alpha virus life cycle</i> .....	31
3.	<i>Clinical symptoms induced by Alphaviruses</i> .....	36
D.	CHIKV .....	46
1.	<i>Physiopathology of CHIKV:</i> .....	46
2.	<i>Arthritogenic clinical manifestations of CHIKV</i> .....	47
3.	<i>Encephalitic clinical manifestations of CHIKV</i> .....	50
4.	<i>Animal models:</i> .....	53
5.	<i>Epidemiology: Historical and geographical distribution of CHIKV</i> .....	55
6.	<i>Phylogenetic analysis of the virus</i> .....	60
7.	<i>Transmission cycle of CHIKV</i> .....	64
8.	<i>Diagnosis and treatments of CHIKV</i> .....	66
9.	<i>Public health response</i> .....	71
<b>II.</b>	<b>IMMUNE RESPONSE</b> .....	<b>72</b>
A.	THE INNATE IMMUNE SYSTEM.....	73
B.	THE PATHOGEN RECOGNITION RECEPTORS (PRRs) .....	73
1.	<i>Secreted pattern recognition molecules</i> .....	74
2.	<i>Transmembrane receptors:</i> .....	75
3.	<i>Cytosolic PRRs (RLR and NLR)</i> .....	87
4.	<i>CHIKV and PRRs</i> .....	100
C.	THE IFN AND THE ANTIVIRAL RESPONSE.....	101

1.	<i>Interferon signaling</i> .....	103
2.	<i>IFN stimulated genes (ISGs)</i> .....	106
3.	<i>ISGs and CHIKV</i> .....	109
D.	APOPTOSIS .....	110
1.	<i>Extrinsic apoptotic pathway</i> .....	110
2.	<i>Intrinsic apoptotic pathway</i> .....	117
3.	<i>Viral induced apoptosis</i> .....	118
4.	<i>Strategies used by viruses to control apoptosis</i> .....	121
5.	<i>CHIKV and apoptosis</i> .....	122
E.	CELLS OF IMMUNE SYSTEM .....	124
1.	<i>Cells of the innate immune system</i> .....	124
2.	<i>Cells of adaptive immune system:</i> .....	132
<b>III.</b>	<b>IMMUNOBIOLOGY OF ALPHAVIRUS AND CHIKV</b> .....	<b>136</b>
A.	OVERVIEW OF ARTHRITIS INDUCED BY VIRUSES.....	137
1.	<i>General pathogenic mechanisms of virus-induced arthritis</i> .....	137
2.	<i>Protective Chikungunya-induced innate immune response</i> .....	140
3.	<i>The viral persistence</i> .....	145
4.	<i>Evidence for Alphavirus/CHIKV persistence in macrophages</i> .....	149
<b>IV.</b>	<b>OBJECTIVES OF THE THESIS</b> .....	<b>153</b>
<b>V.</b>	<b>RESULTS</b> .....	<b>156</b>
<b>VI.</b>	<b>GENERAL DISCUSSION</b> .....	<b>211</b>
<b>VII.</b>	<b>PERSPECTIVES:</b> .....	<b>218</b>
<b>VIII.</b>	<b>CONCLUSION</b> .....	<b>220</b>
<b>IX.</b>	<b>BIBLIOGRAPHIC REFERENCES</b> .....	<b>222</b>
<b>X.</b>	<b>ANNEXES</b> .....	<b>269</b>

## List of Figures:

Figure 1: Baltimore classification of virus on the basis of mRNA production with specific PRRs recognizing them (Iwasaki 2012) .....	22
Figure 2: Structure of alphaviruses .....	26
Figure 3: Diagram of the Alphavirus genome .....	27
Figure 4: Outline of alphavirus genome structure and replication .....	33
Figure 5: Alphavirus lifecycle .....	35
Figure 6: Symptoms of disease in adults caused by arthritogenic alphaviruses .....	36
Figure 7: Approximate geographical locations of diseases associated with arthritogenic alphaviruses.....	38
Figure 8: Follow up of CHIKV disease in adults with time. ....	47
Figure 9: Acute symptoms of CHIKV fever in patients.....	48
Figure 10: Arthritis in elderly patients following CHIKV infection .....	50
Figure 11: An 8-month-old girl during week 3 of hospitalization .....	51
Figure 12: Global distribution of CHIKV .....	58
Figure 13: Distribution of CHIKV based on endemic and imported strain.....	59
Figure 14: Epidemiological features of chikungunya transmission .....	60
Figure 15: Phylogenetic analysis of CHIK and ONN.....	61
Figure 16: Phylogenetic Relationships based on E1 nucleotide sequence .....	62
Figure 17: Maximum clade credibility (MCC) tree of 80 CHIKV strains.....	63
Figure 18: The urban and sylvatic cycle .....	64
Figure 19: Different species of mosquitoes detected for CHIKV .....	65
Figure 20: An outline of chimeric alphavirus .....	70
Figure 21: TLR structure.....	77
Figure 22: TLRs and TIR domain-containing adaptor molecules.....	77
Figure 23: Ligand specificities of TLRs .....	80
Figure 24: Intracellular RNA recognition and signaling .....	84
Figure 25: Retinoic acid-inducible gene-I (RIG-I)-like receptor (RLR)-mediated signaling and its regulation ...	92
Figure 26: Signaling pathways of long dsRNAs in the cytoplasm.....	95

Figure 27: Intracellular nucleic acid sensors for triggering innate immune responses.....	98
Figure 28: Intracellular nucleic acid sensors triggering innate immune responses .....	100
Figure 29: Activation of cardinal Jak-STAT pathway by three types of IFNs.....	105
Figure 30: Functions of selected IFN-inducible proteins .....	107
Figure 31: Extrinsic apoptosis pathway .....	112
Figure 32: TNF signal transduction pathway .....	116
Figure 33: Intrinsic apoptosis pathway .....	119
Figure 34: Innate immune sensing, apoptosis signaling pathways and antiviral responses possibly involved to ward off CHIKV infection.....	123
Figure 35: The growth and differentiation of myeloid progenitor cell to macrophage .....	125
Figure 36: Classification of macrophage depending upon cytokine produced from different immune cells .....	126
Figure 37: Cross talks between neutrophils (PMN) and other immune components .....	128
Figure 38: Current understanding of NK and NKT cell induction and function during viral infections.....	130
Figure 39: Induction of humoral and cellular immunity .....	134
Figure 40: Mechanisms of CHIKV persistence and tissue inflammation in patients with chronic disease.....	144
Figure 41: The macrophage is central to chronic signs of chikungunya disease.....	152

**List of Tables:**

Table 1. Alphaviruses - Geographical distribution, vertebrate reservoir and most common virus associated joint (arthritis) and neurological (encephalitis) disease ..... 24

Table 2. Different viruses causing CNS disease/ encephalitis ..... 45

## List of Abbreviations

### A)

ADAR1	Adenosine deaminase, RNA-specific 1
ADE	Antibody-dependent enhancement
AIF	Apoptosis inducing factor
AIM2	Absent in melanoma 2
ALR	AIM2 like receptor
AP-1	Activator protein-1
APAF1	Apoptotic protease-activating factor 1
APCs	Antigen-presenting cells
ASC	Apoptosis associated speck like protein containing a caspase recruitment domain
ASK1	Apoptosis signal-regulating kinase 1

### B)

B6	Black 6
B19	Parvovirus B19
BBB	Blood-brain barrier
Bcl-2	B-cell CLL/lymphoma 2
BCR	B-cell receptor
BDV	Borna disease virus
BFV	Barmah Forest virus
BID	BCL-2 interacting domain death agonist

### C)

C57BL/6	C57 black 6
CARD	Caspase recruitment domain
CARDIF	CARD adaptor inducing INF- $\beta$
CBP	c AMP responsive element binding protein (CREB) binding protein
CCHFV	Crimean-Congo hemorrhagic fever virus
CD-1	Cluster of differentiation-1
cDCs	Conventional DCs

CHIKV	Chikungunya virus
CHIKVF	CHIKV fever
CNS	Central nervous system
CP	Capsid protein
CPE	Cytopathic effect
CrmA	Cytokine response modifier A
CRP	C-reactive protein
CSE	Conserved sequence element
CSF	Cerebrospinal fluid
CTLs	C-type lectins
CV	Coxsackie virus
CVB3	Coxsackie virus B3
CYLD	OTU- containing DUB, A20 and DVB protein

#### D)

DAF	Decay-accelerating factor
DAMP	Danger associated molecular patter
DAP	Death associated proteins
DAPK1	Death associated protein kinase1
DCs	Dendritic cells
DCC	Deleted in colorectal carcinoma
DCR1	Decoy receptor 1
DD	Death domain
DEDs	Death effector domains
DEET	N,N- diethyl-3-methylbenzamide
DENV	Dengue virus
DI	Defective interfering
DIABLO	Direct IAP binding protein binding protein with low pI
DISC	Death inducing signal complex
DR	Death inducing receptor
dsRNA	Double-stranded RNA
DUBA	De-ubiquitinating enzyme A



**E)**

EBV	Epstein-Barr virus
ECSA	Eastern-Central-South African phylogroup
EEEV	Eastern Equine Encephalitis virus
eIF2 $\alpha$	Eukaryotic translation initiation factor 2 $\alpha$
ELISA	Enzyme linked immunoassay
EM	Endoplasmic membrane
EMCV	Encephalomyocarditis virus
ENDO G	Endonuclease G
EPA	epidemic polyarthritis
ER	Endoplasmic reticulum
ERK2	Extracellular-signal-regulated kinase 2

**F)**

FADD	Fas-Associated protein with Death Domain
FasL	Fas ligand
FGF	Fibroblast growth factor
FLICE	FADD like IL-1 converting enzyme
FLIP	FLICE like inhibitory protein

**G)**

GAS	IFN- $\gamma$ -activated sites
GAF	IFN- $\gamma$ -activated factor
GC	Germinal center
G-CSF	Granulocyte colony-stimulating factor
GM-CSF	Granulocyte monocyte colony stimulating factor
GTPase	Guanosine triphosphatase

**H)**

HAAP	HTLV-1 associated therapy
HBV	Hepatitis B virus
HCMV	Human cytomegalovirus

HCV	Hepatitis C virus
HIV	Human immunodeficiency virus
HPV	Human papillomavirus
HTLV	Human T cell lymphotropic virus
HTNV	Hantaan virus
HTRA2	High temperature requirement protein 2
HSV1/2	Herpes simplex virus 1/2

## **D)**

IAP	Inhibitor of apoptosis
ICAD	Inhibitor of caspase-activated DNase
IFI16	IFN-inducible protein 16
IFN	Interferon
IFNAR	IFN $\alpha$ receptor
IFNGR	IFN $\gamma$ receptor
IgM	Immunoglobulin M
I $\kappa$ B	Inhibitor of NF $\kappa$ B
IKKs	I kappa B kinases
IL	Interleukin
IL-1 $\beta$	Interleukin- 1 $\beta$
IL-1R	IL-1 receptor
IMP	Inosine-5'- monophosphate
IPS-1	IFN- $\beta$ promoter stimulator-1
IRAK	IL-1 receptor associated kinase
IRF	Interferon regulatory factor
IRS	Insulin receptor substrate
ISD	IFN stimulatory DNA
ISGs	Interferon stimulating genes
ISGF3	IFN-stimulated gene factor 3
ISREs	IFN-stimulated response elements
ITAM	Immunoreceptor tyrosine based activating motif

**J)**

JAK1	Janus-activated kinase 1
JAM	Junctional adhesion molecules
JEV	Japanese encephalitis virus

**K)**

KIR	Killer cell immunoglobulin like receptor
KO	Knockout

**L)**

LBP	LPS binding protein
LCMV	Lymphocytic choriomeningitis virus
LGP2	Laboratory of genetics and physiology 2
LIF	Leukemia inhibitory factor
LPS	Lipopolysaccharides
LTA	Lipoteichoic acid

**M)**

MALP-2	Macrophage activating lipopeptide-2
MAPK	Mitogen-activated protein kinases
MAPKK	MAPK kinase
MASP	MBL-associated serine proteases
MARCO	Macrophage receptor with collagenous structure
MAVS	Mitochondria antiviral signaling protein
MAYV	Mayaro virus
MBL	Mannan-binding lectin
MCMV	Murine cytomegalovirus
MCP-1	Monocyte chemoattractant protein-1
MDA5	Melanoma differentiation-associated antigen 5
mDC	Myeloid DC
MEFs	Mouse embryonic fibroblasts
MHC	Major Histocompatibility complex

MHV	Murine hepatitis virus
MIP-2	Macrophage-inflammatory protein-2
MITA	Mediator of IRF-3 activation
MMR	Macrophage mannose receptor
MMTV	Mouse mammary tumor virus
MOMP	Mitochondrial outer membrane permeabilization
MSR	Macrophage scavenger receptor
mTOR	Mammalian target of rapamycin
MTase	Methyltransferase
MV	Measles virus
MyD88	Myeloid differentiation factor 88

## **N)**

NAIP	Neuronal apoptosis inhibitory protein
NAP1	NAK associated protein 1
NC	Nucleocapsid
NEMO	IKK gamma/ NF- $\kappa$ B essential modulator
NF- $\kappa$ B	Nuclear factor kappa B
NHP	Non-human primate
NK	Natural killer
NKT	Natural killer T
NLR	Nucleotide binding oligomerization domain-like receptor
NOD	Nucleotide oligomerization domain
NOS	Nitric oxide synthetase
NSINV	Neurovirulent Sindbis virus
nsPs	Non-structural proteins
nt	Nucleotide

## **O)**

2'-5' OAS	2'-5' oligoadenylate synthetase
ODN	Oligodeoxynucleotides
ONNV	O'nyong-nyong virus

OPG	Osteoprotegerin
ORN	Oligoriboxynucleotide
ORFs	Open reading frames
OTU	Ovarian tumor domain

**P)**

PAMPs	Pathogen-associated molecular patterns
PAN	Polyarthritis nodosa
PARP	Poly (ADP-ribose) polymerase
PBMCs	Peripheral blood mononuclear cells
pDCs	Plasmacytoid DCs
PDGF	Platelet derived growth factors
PFU	Particle forming unit
PI3K	Phosphoinositide-3 kinase
PI	Phosphatidylinositol
PKR	Protein kinase R
PLAD	Preligand assembly domain
Poll III	RNA polymerase III
Poly I:C	polyinosinic-polycytidylic acid
PP2A	Protein phosphatase 2A
PPM1B	Protein phosphate 1B
PRRs	Pattern recognition receptors
PYHIN	Pyrin and HIN domain containing protein

**R)**

RA	Rheumatoid arthritis
RD	Repressor domain
RF	Rheumatoid factor
RIG-I	Retinoic acid-inducible gene I
RIP-1	Receptor interacting protein-1
RIPK1	Receptor interacting proteinkinase 1
RLRs	Retinoic acid-inducible gene I like receptors

RNA	Ribonucleic acid
RNaseL	Ribonuclease-L
RNF	Ring finger protein
RNF125	Ring finger protein 125
RRV	Ross River virus
RRVD	Ross river virus disease
RSV	Respiratory syncytial virus

## S)

SAP	Serum amyloid protein
SARM	Sterile $\alpha$ -and armadillo-motif containing protein
SFV	Semliki forest virus
SINV	Sindbis virus
SMAC	Second mitochondria derived activator of caspase
SODD	Silencer of death domain
SR	Scavenger receptor
ssRNA	Single-stranded RNA
STAT	Signal transducer and activator of transcription

## T)

T2bs-C	Carboxy terminal TRAF2-binding site
T2bs-N	Amino terminal TRAF2-binding site
TAK1	TGF- $\beta$ -activated kinase 1
TANK	TRAF family member-associated NF $\kappa$ B activator
TBK	TANK binding kinase1
Tc	T cytotoxic
TGF- $\beta$	Transforming growth factor-beta
T <sub>H</sub>	T helper
TIM	TRIF interacting motif
TIR	Toll/IL-1 receptor domain
TLRs	Toll-like receptors
TMV	Tobacco mosaic virus

TNF	Tumor necrosis factor
TNFR	TNF receptor
TPR	Tetratricopeptide repeat
TRAF6	Tumor necrosis factor receptor-associated factor-6
TRAIL	TNF $\alpha$ related apoptosis-inducing ligand
TRIF	TIR-domain containing adaptor protein inducing IFN $\beta$
TRIM	Tripartite-motif containing
TRIM25	Tripartite motif 25
TS-IAP	Testis-specific IAP
TYK2	Tyrosine kinase 2

#### V)

V2V	Varicella-zoster virus
VEEV	Venezuelan Equine Encephalitis virus
VEGF	Vascular endothelial growth factor
Viperin	encoding virus-inhibitory protein endoplasmic reticulum-associated IFN-inducible
VISA	Virus-induced signaling adaptor
VSIGs	Viral stress inducible gene
VSV	Vascular stomatitis virus
VV	Vaccinia virus

#### W)

WEEV	Western equine encephalitis virus
WHO	World health organization
WNV	West Nile virus

#### X)

XIAP	X-linked IAP
XLP2	X-linked IAP- like protein 2

“It was last May 25, in the afternoon at 5:00 when I noted while talking with two good friends of mine, a gnawing pain in my right hand, and in the joints of the hand and arm, which gradually increased, extending to the shoulder and then over my whole body, so that at 9:00 that evening I was in my bed with a high fever. . . It’s now been three weeks since I . . . was stricken by the illness, and because of that had to stay home for 5 days; but even until today I have continuously pain and stiffness in the joints of both feet, with swelling of both ankles; so much so, that when I get up in the morning, or have sat up for a while and start to move again, I cannot do so very well and going up and down stairs is very painful.”

*David Bylon*  
*1779*



## **INTRODUCTION**

# I. Chikungunya Virus (CHIKV)

## A. General introduction

Viruses are responsible for many disease like common cold, influenza, rabies, measles, many forms of diarrhea, hepatitis, yellow fever, polio, smallpox or AIDS. Clinical pattern of viral infection are classified as acute, the one with finite beginning and end in which host is able to overcome the pathogen and associated disease with it, whereas clinical condition were primary infection is followed by a prolonged and often lifelong period of latency is known as chronic condition.

Chikungunya virus (CHIKV) is a re-emerging virus in Africa, Asia and in Indian Ocean region causing large outbreaks of human disease. It belongs to genus *Alphavirus* of the *Togaviridae* family which includes a wide range of viruses causing arthritis (Ross river virus (RRV), Sindbis virus (SINV), O'nyong-nyong (ONNV)) or encephalitis (Western Equine Encephalitis Virus (WEEV), Eastern Equine Encephalitis Virus (EEEV)). The name chikungunya, which describe both the virus and the disease, is derived from a Swahili or Makonde word Kun qunwala, meaning "to become contorted" or "that which bends up". The virus was considered to be an old world virus that causes disease which is characterized by fever, headache, myalgia, rash and both acute and persistent arthralgia. But recent outbreak has shown a paradigm shift in CHIKV from 'old' to 'new' world alphaviruses causing severe acute and chronic encephalitis and other Central Nervous System (CNS) symptoms. In Africa CHIKV is maintained in a sylvatic transmission between the non-human primate and mammals, and *Aedes* mosquitoes. During epidemics CHIKV can also circulate between human and mosquitoes. *Aedes aegypti* was the primary vector for the virus during 2005-2006 outbreak in India but the recent outbreak in Indian ocean region have shown a drastic change in transmission cycle of the virus due to a mutation of the membrane fusion glycoprotein E1 inducing a shift from *Aedes aegypti* to *Aedes albopictus*. Since *Aedes albopictus* have a wider distribution mostly in urban area and have been distributed and established as an endemic in new region around the world due to world trade, which cause the spread of CHIKV in new geographical areas. Several approaches had been tested or undergoing for viral treatment ranging from antiviral drug to vaccines development.

## B. General classification of viruses

Viruses are intracellular parasites. They are simple organism which lack metabolic activities restricting it to take replication and transfer process by them, making dependent on host machinery. Viral particles are composed of nucleic acids (RNA or DNA), proteins, and, in case of enveloped virus, lipids. The proteins include structural components such as membrane proteins, capsid proteins, membrane glycoproteins, and, non-structural components such as reverse transcriptases, RNA polymerases, kinases and proteases. Viruses can be classified based on a number of microbiological and molecular features and are classified broadly as to whether their genome contain DNA or RNA. The most accepted classification of viruses was proposed by David Baltimore on the basis of mRNA production (Baltimore 1971) (Figure 1).

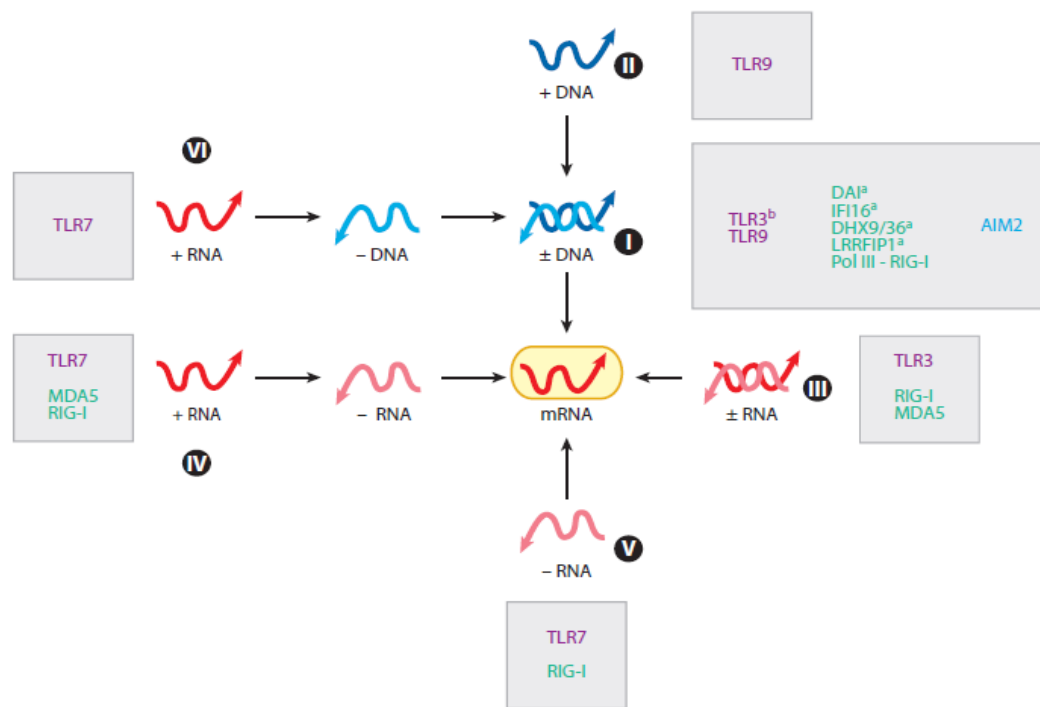

**Figure 1: Baltimore classification of virus on the basis of mRNA production with specific PRRs recognizing them (Iwasaki 2012)**

There are estimated  $10^{31}$  viruses on earth (Breitbart and Rohwer 2005) inducing a vast spectrum of human viral infection. A wide variety of viruses can infect cells of immune system like T-cells, dendritic cell, macrophages and microglia of the CNS. These immune cells, like macrophages, identify viral pathogen associated molecular patterns (PAMPs) by pattern recognition receptors (PRR). In certain cases, these cells can act as a reservoir and a source of viral persistence. For example, with evolution, few viruses have adapted different mechanism to infect or to enter the macrophage and influencing the antiviral pathway. A narrow niche exists for most of the virus, like HIV, depending on receptors and co-receptors.

### C. The Alphaviruses

The alphavirus group comprises 29 viruses, six of which are called ‘old-world’ alphaviruses and they can cause human joint disorders (arthralgia evolving to arthritis). This is the case for CHIKV, O’nyong-nyong virus (ONNV), Semliki forest virus (SFV), RRV, SINV, Mayaro virus (MAYV). The acute phase of the disease with old-world alphaviruses is highly symptomatic (over 90%) and is characterized mostly by fever, generalized myalgia and arthralgia (Borgherini, Poubeau et al. 2007; Borgherini, Poubeau et al. 2008). In certain cases, arthralgia and crippling arthritis are symptoms that can persist for years (Sissoko, Malvy et al. 2009; Simon, Javelle et al. 2011).

In contrast, the so-called ‘New World Alphaviruses’, such as EEEV and Venezuelan equine encephalitis virus (VEEV) are mostly known for their profound neuropathological activities. These alphaviruses were isolated from diseased horses in California, in Virginia and New Jersey, and from humans in Venezuela. Since then, these viruses have been isolated from infected mosquitoes (*Culex*), horses, humans, and other vertebrate species, predominantly birds and rodents (**Table 1**).

Due to their worldwide emergence/reemergence as well as potential agents of bioterrorism, EEEV, VEEV, and CHIKV have been declared high priority pathogens by the National Institutes of Health.

**Table 1. Alphaviruses - Geographical distribution, vertebrate reservoir and most common virus associated joint (arthritis) and neurological (encephalitis) disease**

Complex	Virus name	Distribution	Vertebrate reservoir	Joint Disorder (Arthritis) Human /Mouse	Neurological disorder (Encephalitis) Human /Mouse
VEE/EEE group	EASTERN EQUINE ENCEPHALITIS	Eastern and North US, South America	Birds		(Liu, Voth et al. 1970; Weaver, Powers et al. 1999; Vogel, Kell et al. 2005)
	VENEZUELAN EQUINE	South America, Central America	Rodent, Horses		(Calisher and Maness 1974; Ludwig, Kondig et al. 1996; Weaver, Powers et al. 1999; Charles, Trgovcich et al. 2001; Weaver, Ferro et al. 2004; Zacks and Paessler 2010)
	Everglades	Florida			
	Mucambo	Brazil, Peru			
	Pixuna	Brazil			
SF group	SEMLIKI FOREST	Africa, Eurasia	Birds	(Mathiot, Grimaud et al. 1990; Rulli, Melton et al. 2007)	
	Middelburg	Africa			
	CHIKUNGUNYA	Africa, south and east Asia, sporadic case in Europe and US	Primates, Humans	(McGill 1995; Borgherini, Poubeau et al. 2008; Vassilopoulos and Calabrese 2008; Ziegler, Lu et al. 2008; Morrison, Oko et al. 2011)	(Robin, Ramful et al. 2008; Wang, Volkova et al. 2008; Economopoulou, Dominguez et al. 2009)
	O'NYONG-NYONG	Central and east Africa	Primates, Humans	(McGill 1995; Rulli, Melton et al. 2007)	
	ROSS RIVER	Australia, Oceania	Mammals, Humans	(Suhrbier and La Linn 2004; Rulli, Melton et al. 2007)	
	Barmah Forest	Australia			

	Getah	Australia, Asia			
	Sagiyama	Japan			
	Bebaru	Malaysia			
	MAYARO	South America	Primates, Humans	(McGill 1995; Toivanen and Toivanen 2006; Rulli, Melton et al. 2007)	
	Una	South America			
SIN group	SINDBIS	Africa, Asia, Europe	Birds	(Mathiot, Grimaud et al. 1990; McGill 1995; Rulli, Melton et al. 2007)	
	Aura	Brazil, Argentina			
	Vhataroa	New Zealand			
	Babanki	West Africa			
	Kyzylagach	USSR			
Recombinant or uncertain	WESTERN EQUINE ENCEPHALITIS	North America, South America	Birds, Mammals		(Danes and Kimerlingova 1957; Delfraro, Burgueno et al. 2011)
	Highlands J	Eastern U.S.A.			
	Fort Morgan	Western U.S.A.			
Ungrouped	Ndumu	Africa			
	Buggy Creek	Western U.S.A.			

*Joint and neurological associated (Arthritis and Encephalitis) viruses are in blue color. (Strauss and Strauss 1994; Laine, Luukkainen et al. 2004; Weaver and Barrett 2004; Vassilopoulos and Calabrese 2008).*

## 1. Structure of Alphaviruses

Alphavirus particles are icosahedral structures with an external diameter of about 700 Å, a molecular mass of  $5.2 \times 10^6$  Da and a density of  $1.22 \text{ g/cm}^3$  (Paredes, Simon et al. 1992; Cheng, Kuhn et al. 1995) (Figure 2).

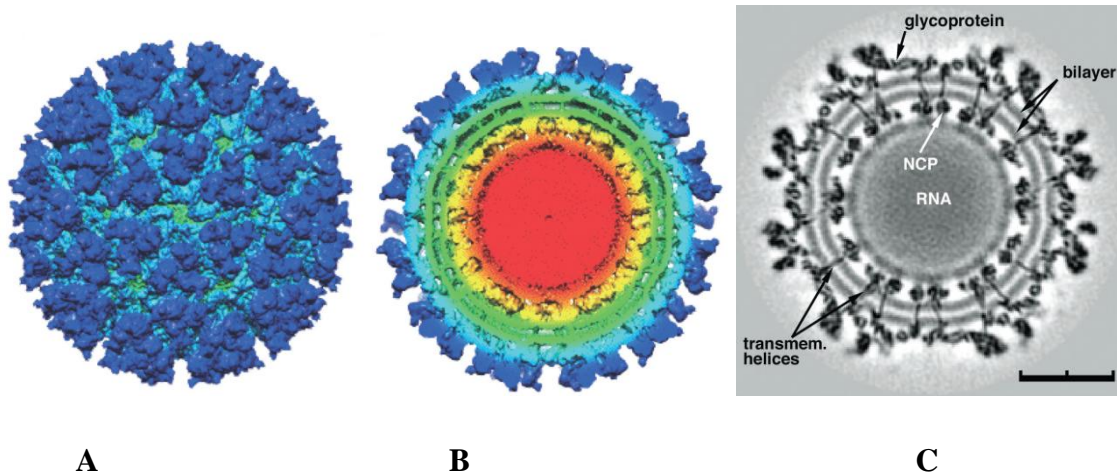

**Figure 2: Structure of alphaviruses**

(A) Surface view of icosahedral twofold axis of alphavirus (Sindbis); Flower-like trimeric spikes (blue), lipid bilayer (green). (B) A central cross-section of the virus particle: glycoproteins (blue), envelope region (turquoise), the lipid bilayer (green), protease domain of the capsid protein (yellow), disordered protein-RNA region (orange) and RNA region (red). (C) Cross section of alphavirus showing RNA genome covered with lipid bilayer studded with nucleocapsid protein and glycoprotein (Zhang, Mukhopadhyay et al. 2002; Jose, Snyder et al. 2009).

### a. The virion envelope

The virion envelope consists of a lipid bilayer in which are embedded multiple copies of two virus encoded glycoproteins (E1 and E2). The lipid bilayer is composed of lipids derived from the plasma membrane of the host cell, and its composition closely approximates that of the host plasma membrane. The two glycoproteins, E1 and E2, each have a molecular mass of about 50 kDa and are anchored in the membrane by conventional membrane spanning anchors in the C-terminal regions (Strauss and Strauss 1994). Each alphavirus particle contains 240 copies of the E1 (439 amino acid residues; Sindbis virus numbering), E2 (423 amino acid residues), and capsid proteins (264 amino acid residues).

## b. The viral nucleocapsid

Alphaviruses contain an icosahedral nucleocapsid. The alphavirus nucleocapsid contains the single-stranded plus-sense RNA genome of approximately 11.7 kb complexed with multiple copies of a single species of capsid protein of about 30 kDa (Strauss and Strauss 1994).

## c. The viral genome

The alphavirus genomic RNA consist of the 5'-terminal cap and a 3'-terminal poly(A) tract (Strauss, Rice et al. 1984). It is divided into two major regions: a nonstructural domain encoding the nonstructural or replicase proteins, which forms the 5'-terminal two-thirds of the RNA, and a structural domain encoding the three structural proteins of the virus, which forms the 3'-terminal one-third.

The structural domain is translated as a polyprotein from a subgenomic messenger RNA (mRNA), the 26S mRNA. The 26S mRNA is also capped and polyadenylated. Five structural proteins, capsid, E1, E2, E3, E2 and 6K are translated during virus replication (**Figure 3**).

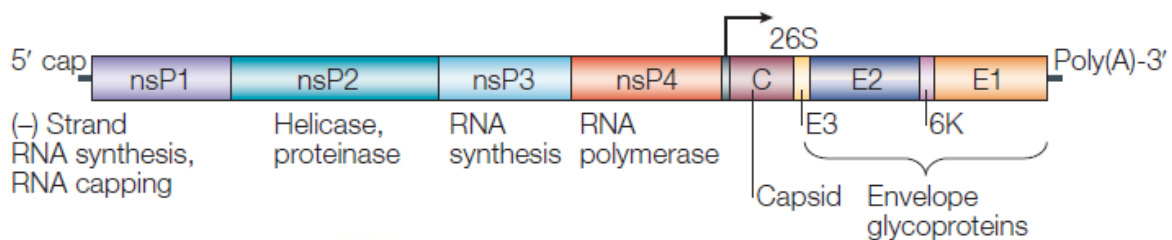

**Figure 3: Diagram of the Alphavirus genome**

*Showing the 5' cap, 5' untranslated region, ORF and functions of nonstructural polyproteins, subgenomic promoter, ORF of structural polyproteins, 3' untranslated region, and poly (A) tail (Weaver and Barrett 2004).*



#### **d. The capsid protein**

The alphavirus structural proteins are translated from the subgenomic 26S mRNA as a polyprotein that is processed both cotranslationally and posttranslationally. Capsid protein also binds specifically to the viral genomic RNA, and this binding is believed to be important for the initiation of nucleocapsid formation and possibly for the stimulation of RNA synthesis (Weiss, Nitschko et al. 1989; Strauss and Strauss 1994). For the new world alphavirus capsid protein is found to be a key player in transcription inhibition (Aguilar, Weaver et al. 2007; Garmashova, Atasheva et al. 2007; Garmashova, Gorchakov et al. 2007).

#### **e. Envelope proteins (E1, E2 and E3)**

Translated from the subgenomic 26S RNA, E1 and pE2 (precursor to the E3 and E2 proteins before cleavage of E3) are assembled as heterodimers in the endoplasmic reticulum. E3 is cleaved in as a byproduct (Mayne, Rice et al. 1984) and the resultant E1-E2 heterodimers are then transported to the plasma membrane. These heterodimers, to which E3 may or may not remain associated, depending on the virus, self-assemble into 80 trimeric spikes on the virus surface (von Bonsdorff and Harrison 1975; von Bonsdorff and Harrison 1978; Strauss and Strauss 1994). E1 is responsible for the cell fusion in presence of acidic environment and cholesterol membrane component whereas E2 is primarily involved in receptor binding and cell entry (Garoff, Frischauf et al. 1980; Dubuisson and Rice 1993; Kielian 1995; Lu, Cassese et al. 1999). In addition, E2 has a role in determining mosquito infectivity (Myles, Pierro et al. 2003). E3 is a small, cysteine rich, extracellular glycoprotein that mediates proper folding of pE2, its subsequent association with E1 lead to the transport of this pE2/E1 structural component to the site of budding (Jose, Snyder et al. 2009). In addition, cleavage of E3 from the assembled spike is required to make the virus particles efficiently fusion competent (Parrott, Sitarski et al. 2009).

#### **f. 6K**

The 6K protein is encoded within the genome of the alphaviruses by a set of 165 nucleotides. It's has been found to be important for virus assembly and to be incorporated into virions in small amounts (7 to 30 copies) relative to the glycoproteins (Gaedigk-Nitschko and Schlesinger 1990; Lusa, Garoff et al. 1991). It is also involved in membrane modification in *Escherichia coli* and mammalian cell (Sanz, Perez et al. 1994; Sanz, Madan et al. 2003).

#### **g. The nonstructural proteins (nsPs)**

The non-structural proteins are translated from the 42S mRNA as either polyproteins P123, containing the sequences of nsP1, nsP2, and nsP3 or Polyprotein P1234, containing in addition the sequence of nsP4, produced upon read-through of this opal codon (Takkinen 1986; Li and Rice 1993). These polyproteins are cleaved to produce nsP1, nsP2, nsP3, and nsP4, in the early phase of infection (**Figure 3**).

In the first step of viral replication, a full length minus strand is synthesized, which then serves as a template for new plus strand of RNA synthesis (Takkinen 1986). The non-structural proteins form the transcription/replication complex that mediates the synthesis of diverse viral RNAs of both polarities.

#### **i. nsP1**

nsP1 protein possess both guanine-7-methyltransferase and guanyl-transferase enzymatic activities (Cross 1983; Laakkonen, Hyvonen et al. 1994) and is implicated in capping of viral RNAs (Scheidel, Durbin et al. 1989; Mi and Stollar 1991; Laakkonen, Hyvonen et al. 1994; Ahola and Kaariainen 1995), initiating synthesis and maintenance of negative strand of RNA and its replicative intermediates (Wang, Sawicki et al. 1991; Sawicki and Sawicki 1994) as well as membrane association of alphavirus-specific RNA replication complex (Peranen, Laakkonen et al. 1995; Ahola, Lampio et al. 1999; Ahola, Kujala et al. 2000).

## ii. **nsP2**

nsP2 protein belongs to a superfamily of proteins containing nucleoside triphosphate (NTP)-binding domains. The N-terminal domain of nsP2 (residues 1 to 459 in SIN) is believed to have an RNA helicase activity required for RNA duplex unwinding during RNA replication and transcription (Rikkonen, Peranen et al. 1994; Gomez de Cedron, Ehsani et al. 1999). The N-terminal domain also contains RNA triphosphatase and nucleoside triphosphatase activity (Rikkonen, Peranen et al. 1994; Vasiljeva, Merits et al. 2000). It has a vital function in initiation of 26S mRNA synthesis (Hahn, Strauss et al. 1989). In addition, the C-terminal part of nsP2 shares homology with papain proteinases as well as enzymatically nonfunctional methyltransferase (MTase) domain. Papain proteolytic activity is responsible for the processing of the nonstructural polyprotein into intermediate and final component protein and MTase domain is proposed to regulate minus strand synthesis and cellular cytopathic effect (Ding and Schlesinger 1989; Hardy and Strauss 1989; Strauss, De Groot et al. 1992; Vasiljeva, Valmu et al. 2001; Mayuri, Geders et al. 2008). In its free form nsP2 is involved in cytotoxicity and transcriptional and translational shut-off in SINV infected cells (Gorchakov, Frolova et al. 2005; Garmashova, Gorchakov et al. 2007; Gorchakov, Frolova et al. 2008). It has been recently shown that 50% of nsP2 is found in nucleus during viral infection and a nuclear localization signal was found at the C-terminal region of nsp2 (Peranen, Rikkonen et al. 1990; Rikkonen, Peranen et al. 1992).

## iii. **nsP3**

nsP3 is a phosphoprotein (Peranen, Takkinen et al. 1988; Li, La Starza et al. 1990) with two distinct domain: a N-terminal conserved domain and a C-terminal non-conserved domain (Lastarza, Grakoui et al. 1994; Frolova, Gorchakov et al. 2006) . It plays an important role in formation of replication complex transcribing negative strand synthesis (Wang, Sawicki et al. 1994; Frolova, Gorchakov et al. 2006). A functional analysis of the C-terminal region of nsP3 of SFV revealed the presence of a degradation signal that overlaps with a sequence element located between nsP3 and nsP4 that is required for proteolytic processing (Varjak, Zusinaite et al. 2010). The N terminal domain of nsP3 of CHIKV and VEEV macro

domains have been crystallized and were shown to possess both ADP-ribose 1'-phosphatase and RNA-binding activity (Malet, Coutard et al. 2009).

#### iv. **nsP4**

The RNA-dependent RNA polymerase nsP4 is an integral part of the alphavirus replication complex and plays an important role in maintenance and repair of the poly(A) tail (Tomar, Hardy et al. 2006). The Sindbis virus RNA-dependent RNA polymerase nsP4 possesses an amino-terminal region that is unique to alphaviruses. This amino-terminal domain participates in distinct interactions with other nsPs in the context of differentially functioning RNA synthetic complexes or may serve to interact with unidentified host protein (Shirako, Strauss et al. 2000; Fata, Sawicki et al. 2002; Rupp, Jundt et al. 2011).

## **2. Alpha virus life cycle**

### **a. Entry**

Entering a susceptible cell should in principle begin with the engagement of a host receptor by the virus. Specific host receptors vary among different alphavirus species, and are believed to be proteinaceous, although non-protein attachment factors may be utilized by the virus to aid in initial binding to the cell (Smith and Tignor 1980). The viral E2 glycoprotein is primarily responsible for receptor interaction, although the E1 protein may also play a role in receptor engagement. Sometime virus use conserved receptor of multiple host type, like eukaryotic laminin receptor, for entry (Wang, Kuhn et al. 1992; Ludwig, Kondig et al. 1996).

Engagement of the virus with the host receptor induces conformational changes in the E2 and E1 glycoproteins (Flynn, Meyer et al. 1990; Meyer and Johnston 1993). Virions bound to a receptor molecule are endocytosed in a clathrin-dependent manner (Helenius, Kartenbeck et al. 1980; Marsh, Bolzau et al. 1983).

The low pH of the virus containing mature endosome causes a structural rearrangement of the virion, and exposes the fusion peptide of E1 (Ahn, Klimjack et al. 1999; Lescar,

Roussel et al. 2001; Gibbons, Erk et al. 2003; Hammar, Markarian et al. 2003). As a consequence of fusion peptide insertion, a pore is formed between viral and endosomal mix, allowing the nucleocapsid (NC) to be released into the cytoplasm. Once in the cytoplasm, the NC disassembles to expose the encapsidated genome for translation. Thin-section electron micrographs have shown that incoming NCs enter the cytoplasm intact, but disassemble within 5 min (Anthony, Paredes et al. 1992).

### **b. Replication and transcription of Viral RNA**

The nonstructural proteins are initially translated from the incoming full-length genomic viral RNA. Replication of viral RNA takes place in cytoplasmic vacuoles derived from lysosomal and endosomal membranes. The nonstructural protein products form replicase complexes on these membranes (Froshauer, Kartenbeck et al. 1988; Kujala, Ikaheimonen et al. 2001). Minus-strand synthesis predominates early in infection, and plus-strand and subgenomic RNA synthesis occurs exclusively later in infection. Minus-strand synthesis utilizes genomic RNA as a template, and requires a replication complex composed of P123 and nsP4, the former of which is only present in high concentrations early in infection (Shirako and Strauss 1990; Strauss, De Groot et al. 1992; Shirako and Strauss 1994). This complex is effective at synthesizing minus-strand RNAs from genomic templates, but does not efficiently synthesize plus-strand RNAs. As the infection proceeds, minus-strand synthesis wanes as P123 polyproteins are efficiently cleaved *in trans* to yield the individual nonstructural proteins. The plus-strand replicase is composed of the individual nonstructural proteins (plus host factors), presumably in a conformation different from that of the P123/nsP4 replication complex (Strauss and Strauss 1994). Plus strands are synthesized from either the genomic or subgenomic promoter. An intermediate replication complex, composed of nsP1, P23 and nsP4, may exist transiently, and may be capable of both plus- and minus-strand synthesis (Wang, Sawicki et al. 1994; Lemm, Bergqvist et al. 1998; Gorchakov, Frolova et al. 2008) (**Figure 4**).

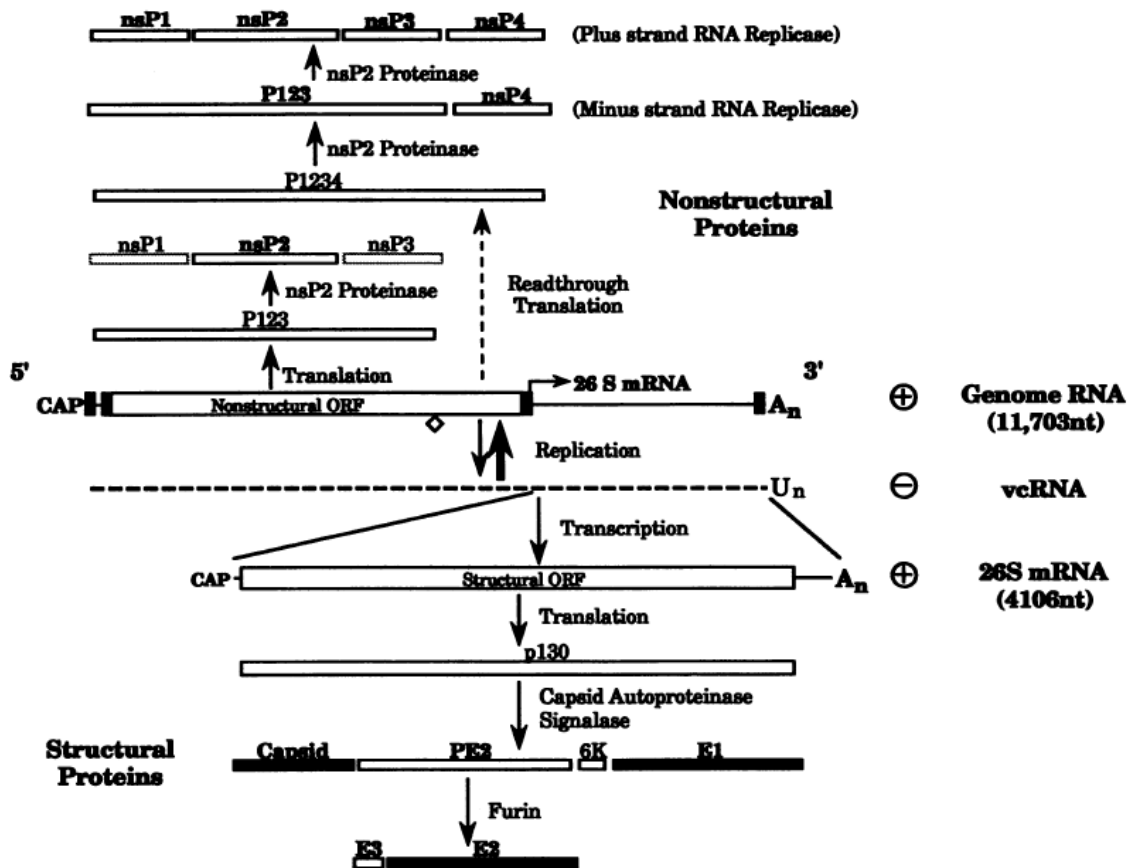

Figure 4: Outline of alphavirus genome structure and replication (Strauss and Strauss 1994).

### c. Structural element within the viral RNA

Conserved sequence elements (CSE) within the viral RNA aid in transcription initiation, act as translational enhancers and function as packaging signals. The 5' non-translated region of the genome has been implicated as a component of the promoter for both minus- and plus-strand RNA synthesis (Frolov, Hardy et al. 2001). A CSE found at the 5' end of the genomic RNA (CSE 1) forms a stem-loop structure containing approximately the first 44 nucleotide (nt) of the genome, and is believed to function, in the context of the minus-strand, as a promoter for the plus-strand synthesis from minus-strand templates (Ou, Strauss et

al. 1983). A second 51 nt CSE (CSE 2) also resident near the 5' end of the genome within the coding sequence for nsP1 (beginning around nt 155) may act as a promoter for initiation of minus-strand synthesis from a genomic RNA template, and has been implicated in enhancing both minus- and plus-strand RNA synthesis (Frolov, Hardy et al. 2001). A 19-nt CSE found just upstream of the polyA tract in the 3' untranslated region of the genome (CSE 4) is also believed to act as a copromoter for initiation of minus-strand synthesis, perhaps via interaction of the 5' and 3' ends of the full-length genomic RNA (Kuhn, Hong et al. 1990; Frolov, Hardy et al. 2001; Hardy 2006). 24-nt CSE (CSE 3) is located in the junction of the coding sequence for non-structural and structural protein and is necessary for the efficient transcription of the subgenomic RNA (Pushko, Parker et al. 1997).

#### **d. Nucleocapsid (NC) assembly**

The structural proteins are translated from the subgenomic RNA. The capsid protein assembles into NCs with the full-length viral RNA. Alphavirus NC assembly is a multistep event involving nucleic acid bound dimer of capsid protein (CP) (Tellinghuisen and Kuhn 2000).

These structural proteins of alphaviruses are translated as a polyprotein from the subgenomic RNA in the order of CP-pE2-6K-E1 (Raju and Huang 1991). Once CP is released, pE2 and E1 is translocated in endoplasmic membrane (ER). Here they undergo post translational modification. Before reaching the trans-Golgi network, pE2 is cleaved by furin to form E3 and E2 (**Figure 5**).

#### **e. Virus budding**

NCs interact with the cytoplasmic domain of E2, become enveloped by the E1/E2 icosahedral lattice and bud from the plasma membrane (Liu and Brown 1993; Liu and Brown 1993; Strauss, Lenches et al. 2002) (**Figure 5**).

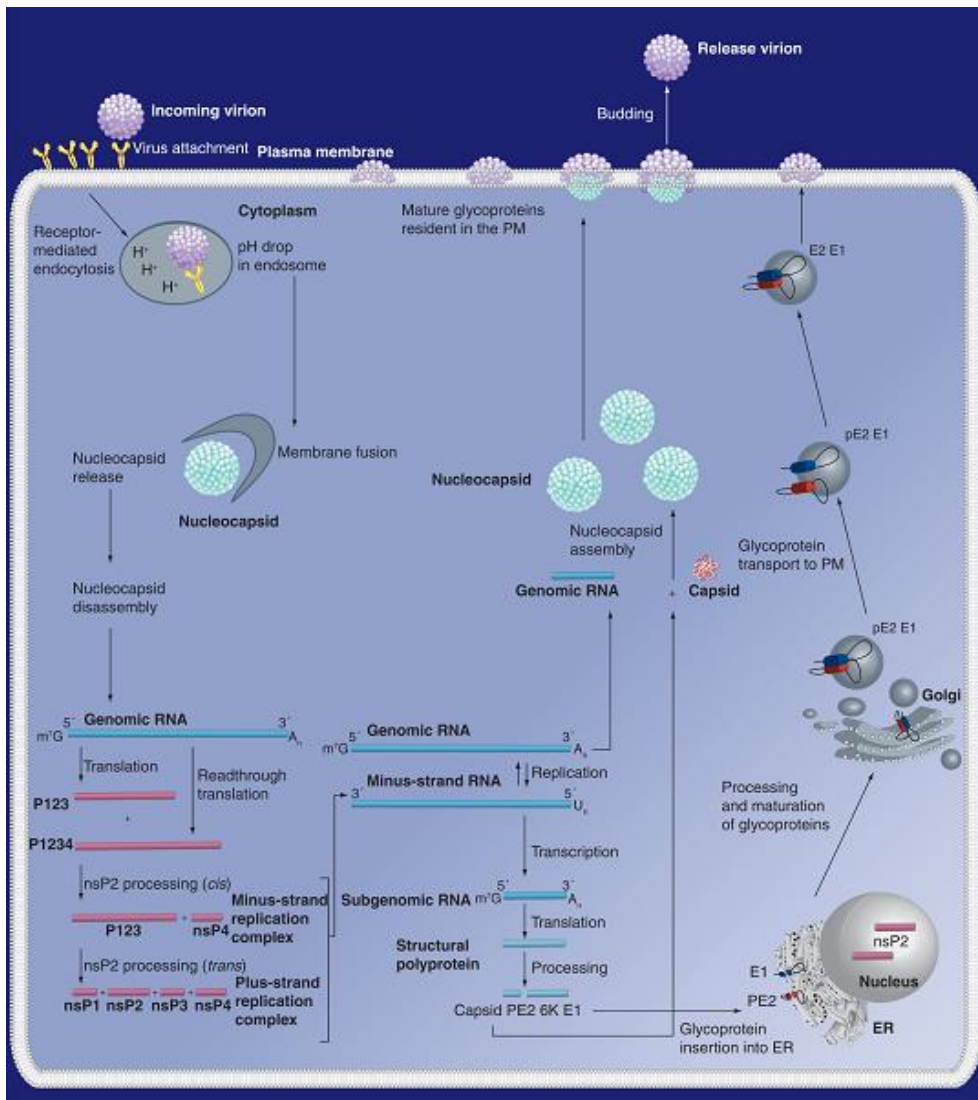

**Figure 5: Alphavirus lifecycle**

*Lifecycle start with viral attachment followed by endocytosis, nucleocapsid release, nucleocapsid disassembly, translation, minus and plus strand synthesis, synthesis of non-structural and structural protein, synthesis of genomic RNA, capsid to nucleocapsid as well as maturation of E1 and pE2, finally viral budding after the assembly of nucleocapsid, genomic RNA and structural protein (Jose, Snyder et al. 2009).*



### 3. Clinical symptoms induced by Alphaviruses

#### a. Arthritogenic alphaviruses

Inflammatory arthritis has long been associated with alphavirus infections. Total of six ‘old world’ viruses namely CHIKV, ONNV, SFV, RRV, SINV and MAYV are transmitted by mosquitoes and are known to cause arthritis in human (Suhrbier and La Linn 2004; Toivanen 2008). The main symptoms of disease caused by arthritogenic alphaviruses are summarized in (Figure 6).

Table 2   Symptoms of disease in adults caused by arthritogenic alphaviruses					
Virus	Usual incubation period (range)	% Asymptomatic	Frequency of main symptoms (%)	Other symptoms noted (% frequency)	References
CHIKV	2–6 days (2–12)	≈5–18	Fever: 90 Rash: 40–50 Myalgia: 90 Arthralgia or arthritis: >95	Fatigue, tenosynovitis, headache, nausea, oedema, vomiting, conjunctivitis, occasional bleeding gums and epistaxis*	Toivanen (2008) <sup>2</sup> Jaffar-Bandjee et al. (2010) <sup>5</sup> Staikowsky et al. (2009) <sup>64</sup> Vijavakumar et al. (2011) <sup>65</sup> Simon et al. (2011) <sup>66</sup> Queyriaux et al. (2008) <sup>67</sup> Moro et al. (2010) <sup>123</sup>
RRV	7–9 days (3–21)	55–75	Fever: 20–60 Rash: 40–60 Myalgia: 40–80 Arthralgia or arthritis: 80–100 (3–6 months)	Fatigue (>50), headache, photophobia, lymphadenopathy, sore throat and rarely encephalitis*	Harley & Suhrbier (2012) <sup>17</sup> Harley et al. (2001) <sup>19</sup> Mylonas et al. (2002) <sup>44</sup> Flexman et al. (1998) <sup>74</sup>
BFV	7–9 days	Unknown	Fever: 50 Rash: 40–60 Myalgia: 50–80 Arthralgia or arthritis: 70–95	Lethargy (90) and headache 60	Flexman et al. (1998) <sup>74</sup> Passmore et al. (2002) <sup>124</sup>
Sindbis virus	2–10 days	Very common*	Fever: 15–40 Rash: 90 Myalgia: 50 Arthralgia or arthritis: 95	Fatigue (60), headache (40) nausea (13) and dizziness (16)	Brummer-Korvenkontio et al. (2002) <sup>21</sup> Laine et al. (2004) <sup>22</sup> Kurkela et al. (2005) <sup>45</sup>
O’nyong-nyong virus	Unknown	Unknown	Fever: 80–100 Rash: 70–90 Myalgia: 70 Arthralgia or arthritis: 60–100	Headache (83), pruritis (71), lymphadenopathy (45%), red eyes (45) and bleeding gums (3)	Kiwanuka et al. (1999) <sup>30</sup> Posey et al. (2005) <sup>104</sup>
Mayaro virus	Unknown	8	Fever: 100 Rash: 30–50 Myalgia: 75 Arthralgia or arthritis: 50–90	Headache (60–100), oedema (58), retroocular pain (40–60), dizziness (25), anorexia (22), nausea (18), sore throat (18), swollen lymph nodes (17%), vomiting (4–14), diarrhoea (9), bleeding gums (4.5)	Azevedo et al. (2009) <sup>24</sup> Tesh et al. (1999) <sup>125</sup>

**Figure 6: Symptoms of disease in adults caused by arthritogenic alphaviruses**

(Suhrbier, Jaffar-Bandjee et al. 2012).

i. **Ross River Virus (RRV)**

An unusual symptoms of rash and temporary arthritis was first recognized in 1928 by Nimmo in 105 soldiers in tropical region of Australia. The disease was termed as ‘epidemic polyarthritis’ (EPA). EPA was shown linked to alphavirus when the virus was isolated in 1959 from a mosquito near Ross River in Townsville, Queensland, Australia (Doherty 1977) (**Figure 7**). Human infection have been also reported from New Guinea and Solomon island (Scrimgeour, Aaskov et al. 1987). Patients bitten by infected mosquito show the first symptoms of Ross River virus disease (RRVD) after 1–2 days. Myalgia and headache are common symptoms of RRVD. Arthritis occur in one third of all patients (Fraser 1986).

ii. **Barmah Forest Virus (BFV)**

BFV was first isolated in 1974 in the Murray River basin, Australia and subsequently in most state of Australia (1991) (**Figure 7**). An analysis of 47 laboratory confirmed cases revealed presence of arthralgia in 95% of patients.

iii. **O’Nyong-Nyong Virus (ONNV)**

ONNV was identified as a disease in 1959 in Uganda (Toivanen 2008). It was the largest *Arbovirus* outbreak with more than 2 million cases in Africa alone (**Figure 7**). A symptom for ONNV is fever with arthralgia and lymphadenopathy (Kiwanuka, Sanders et al. 1999; Sanders, Rwaguma et al. 1999).

iv. **Mayaro Virus (MV)**

Mayaro virus was first isolated in 1954 and the first epidemics were describe in Brazil and Bolivia (Toivanen 2008) (**Figure 7**). Mayaro fever includes arthralgia as a most severe incapacitating manifestations. They may persist for two months (Tesh, Watts et al. 1999).

v. **Sindbis Virus (SINV)**

SINV is the most widely distributed (Eurasia, Africa and Oceania) of all known viruses (Brummer-Korvenkontio, Vapalahti et al. 2002; Laine, Luukkainen et al. 2004; Toivanen 2008). In Northern Europe, there are three closely related but unidentical SINV-like virus strain, namely Ockelbo virus in Sweden, Karelian fever virus in Russian Karelia and Pogosta virus in Finland (**Figure 7**). They give rise to the same clinical symptoms, namely fever, rash and arthritis (Turunen, Kuusisto et al. 1998; Laine, Luukkainen et al. 2000; Kurkela, Manni et al. 2005; Kurkela, Helve et al. 2008).

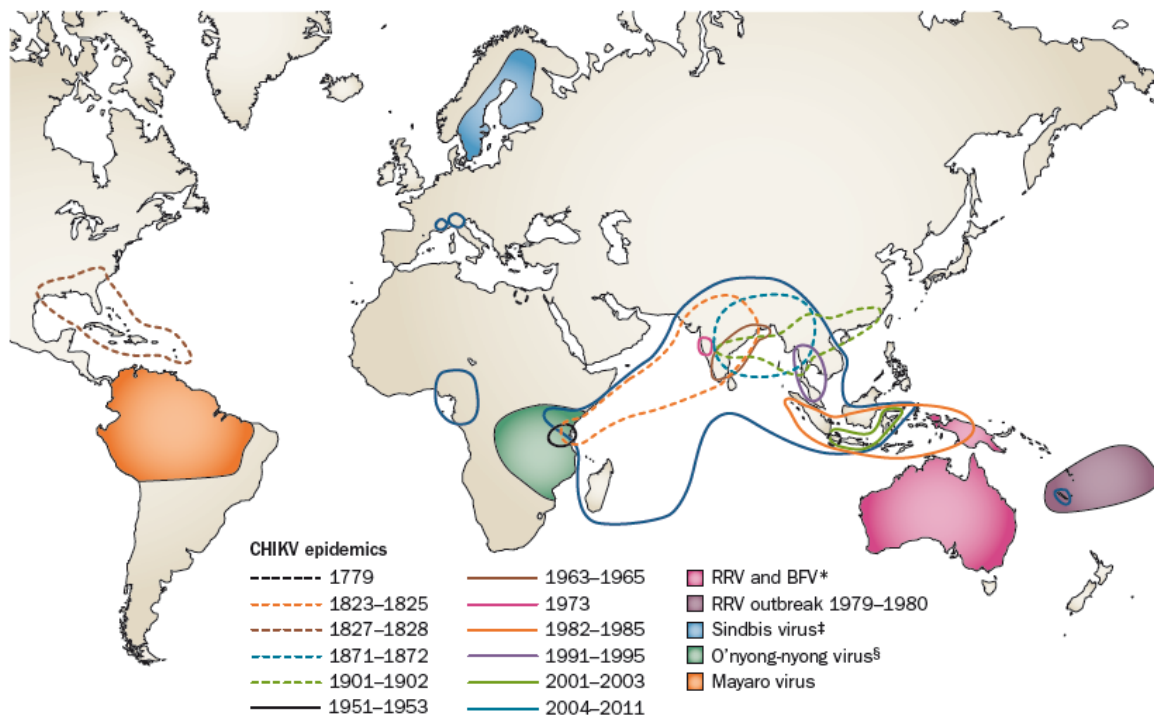

**Figure 7: Approximate geographical locations of diseases associated with arthritogenic alphaviruses**

*For CHIKV disease, epidemics prior to 1902 are shown in dashed lines. Geographical locations of RRV and BFV (Australian mainland), Sindbis virus family (Europe), O'nyong-nyong virus (East Africa, Uganda and West Africa) and Mayaro virus (South America). Virus associated regions were represented in different colors (Suhrbier, Jaffar-Bandjee et al. 2012).*

## **b. Encephalitic Alphaviruses**

EEEV, VEEV and WEEV are new-world alphaviruses causing severe encephalitis in humans and horses (Zacks and Paessler 2010). They are naturally maintained through enzootic cycles involving arthropods as vectors with ensuing amplification in small mammals or birds, and epizootic cycles between bridging mosquitoes vectors and large mammals such as horses and humans which are dead-end hosts as they are not enough viremic to infect mosquitoes and propagate the cycle. EEEV seems to be the most virulent in humans, causing mortality in approximately 40% of symptomatic cases (Deresiewicz, Thaler et al. 1997).

### **i. EEEV**

EEEV was first recognized to infect humans in 1938 after an outbreak in Massachusetts (Feemster 1938). The primary EEEV transmission cycle occurs between birds and mosquitoes (*Culiseta melanura*). However, the principal arthropod vector for transmission of EEEV to humans or to horses are; *Aedes*, *Coquillettidia*, and *Culex* species which, unlike *Culiseta melanura*, tend to feed on both birds and mammals (Scott and Weaver 1989; Komar and Spielman 1994; Zacks and Paessler 2010). In human cases of encephalitis, fever, headache, vomiting, respiratory symptoms, leukocytosis, hematuria, seizures and coma may occur. The eastern strain of the equine encephalomyelitis virus had next been isolated from human brain tissues of the first case (Feemster 1938). EEE usually begins abruptly and rapidly instigate fever, chills, myalgia and arthralgia. After a few days, neurologic signs may appear. Variety of animal models have been described, such as mice, hamsters, guinea pigs and non-human primates (NHP) which are the best studied (Zacks and Paessler 2010). In mice and human, EEEV is known to infect neurons (Deresiewicz, Thaler et al. 1997; Griffin 2003).

### **ii. VEEV**

VEEV was first isolated in Venezuela from the brain of an encephalitic horse in 1938 (Kubes and Rios 1939) and first recognized to infect humans in 1943 (Casals, Curnen et al.

1943). VEEV is a zoonotic pathogen, transmitted between vector mosquitoes and vertebrate hosts, namely rodents and humans in enzootic cycles, and horses and humans in epidemic or epizootic cycles that occur in an agricultural area (Aguilar, Estrada-Franco et al. 2011) . VEEV viruses are highly infectious via the aerosol route. In human, VEEV is usually an acute and often mild systemic disease. Clinical signs can be characterized by fever, chills, generalized malaise, severe headache, photophobia and myalgia mainly localized in the legs and lumbosacral region, congestion, hemorrhages, vasculitis, meningitis and encephalitis (Zacks and Paessler 2010).

### iii. **WEEV**

WEEV was first isolated in California from the brain of horses suffering from encephalitis in 1930 (Meyer, Haring et al. 1931). In 1938, the virus has been recovered for the first time from the brain of a 20-months-old boy in California (Howitt 1938). WEEV is maintained in an enzootic cycle between passerine birds and culicine mosquitoes, with a variety of mammals as incidental hosts. Acute symptoms are fever, chills, headache, nausea, vomiting, anorexia, malaise and occasional respiratory signs. In a minority of infected individuals, encephalitis or encephalomyelitis occurs and may lead to neck stiffness, confusion, tonic-clonic seizures, somnolence, coma and death (Zacks and Paessler 2010).

### c. **Other viruses causing arthritis and encephalitis**

Not only alphavirus but other viruses are also involved in arthritis and encephalitis. Understanding the physiopathology of these viruses could increase our understanding of alphavirus-induced arthritis and encephalitis.

i. **Other viruses causing arthritis**

**α. Hepatitis B (HBV) and C (HCV) viruses**

Global epidemic of hepatitis B and hepatitis C is a serious public health problem. Chronic hepatitis B and hepatitis C are among the leading causes of preventable death worldwide. According to World Health Organization (WHO) up to two billion people in the world have been infected with HBV; about 350 million people live with chronic HBV infection, and about 600,000 people die from HBV-related liver disease or HCC each year (Gacche and Kaid 2012).

HBV is an enveloped double-stranded DNA virus transmitted parenterally, sexually, or vertically. There are two possibilities for HBV associated arthritis in patients: as an RA-like, acute, self-limited polyarthritis during the presymptomatic phase of acute hepatitis B or more rarely as arthritis occurring in the context of HBV-associated polyarthritis nodosa (PAN). In both cases, the arthritis pathogenesis is attributed to the deposition of immune complexes containing viral antigens (HBV surface antigen HBsAg or HBeAg) and their respective antibodies (anti-HBs and anti-HBe) in synovial tissues. HBV induced inflammation in tissue has also been proposed based on the detection of active HBV replication in endothelial cells from diseased tissues in HBV-associated PAN (Mason, Theal et al. 2005). Clearly identified arthritis, affecting predominantly large joints (knees, ankles, and wrists), is observed in only a small proportion of patients (Guillevin, Mahr et al. 2005).

HCV is an RNA hepatotropic virus that is transmitted parenterally, mainly through injection drug use. Articular symptoms are observed in the form of either arthralgia's or arthritis in a patient with chronic HCV infection. Arthropathy is one of the common extrahepatic manifestations of HCV infection. It is displayed by up to 20% of infected patients. The arthritis associated with HCV involves multiple small joints, usually symmetrically, with morning stiffness and positive Rheumatoid factor (RF) as found in Rheumatoid arthritis (RA) (Masuko-Hongo, Kato et al. 2003). Joint manifestations in patients with chronic HCV infection can be encountered in four different forms: a coexistent arthropathy (not related to HCV), arthritis in the setting of mixed cryoglobulinemia, arthritis

directly related to HCV (HCV-associated arthritis), and arthritis induced by antiviral therapy (interferon-alpha [IFN $\alpha$ ]) (Vassilopoulos and Calabrese 2003).

### **$\beta$ . Parvovirus B19**

Parvovirus B19 is a member of the family of small, non-enveloped, single-stranded DNA viruses *Parvoviridae* and is the cause of the common childhood illness erythema infectiosum as well as of transient aplastic crisis, hydrops fetalis, and bone marrow suppression in immunocompromised patients (Young and Brown 2004). In children with erythema infectiosum, articular disease is uncommon, with joint swelling in less than 3% of those infected under 10 years of age. In adults, however, where the infection commonly occurs in the absence of the characteristic rash, arthralgia is far more common (Young and Brown 2004). The pattern of joint involvement is RA-like and is accompanied by prominent morning stiffness, thus posing a diagnostic challenge in patients presenting with acute-onset polyarthritis. B19-associated arthritis is self-limited and generally resolves in a few weeks but occasionally last much longer. Chronic arthritis secondary to B19 infection has been reported but its causal role in such cases is uncertain (Calabrese and Naides 2005).

### **$\gamma$ . HTLV-1-associated arthropathy (HAAP):**

Human T-cell lymphotropic virus type I (HTLV-I) is a type C retrovirus initially discovered as a causative agent of adult T-cell leukemia (ATL). In the 1980s, after the identification of HTLV-I, an occurrence of destructive arthritis was observed which was similar to idiopathic RA in a subset of HTLV-I infected patients. Thus disease was reported as ‘HTLV-I-associated arthropathy (HAAP)’ (Nishioka, Maruyama et al. 1989). HAAP was further supported by an occurrence of inflammatory arthritis in mice transgenic for the HTLV-I env-pX region (Iwakura, Tosu et al. 1991).

## **δ. Other viruses**

Rarely, other viruses, including rubella virus (Smith, Petty et al. 1987), Epstein-Barr virus EBV (Ray, Gall et al. 1982) and coxsackie virus (CV) (Hurst, Martynoga et al. 1983) have been implicated as causes of acute self-limited arthritis.

### ii. Other viruses causing encephalitis

#### **α. Experimental neuroinfection by ‘Old World’ SINV**

SINV was named after its first isolation in Sindbis health district near Cairo (Egypt) from a pool of *Culex pipiens* and *Cx univittatus* mosquitoes (Taylor, Hurlbut et al. 1955). Other synonyms or subtypes of SINV have been described in Sweden (Ockelbo disease), Finland (Pogosta disease) and Russia (Karelian fever) in the early 80s according to the region involved (Skogh and Espmark 1982; Vershinskii, L'Vov D et al. 1983; Laine, Luukkainen et al. 2000). SINV can cause fever, rash and arthralgia in human (Turunen, Kuusisto et al. 1998) but can cause encephalomyelitis in mice (Jackson, Moench et al. 1987). Neurovirulent strain of SINV (NSINV) was developed by serial passage of the original isolate AR339 of SINV from mouse brain (Griffin and Johnson 1977). Infection of weanling mice with NSINV induced an acute encephalomyelitis with high mortality rate and animals can develop kyphoscoliosis which is an abnormal curvature of the spine and also hind limb paralysis (Jackson, Moench et al. 1987; Jackson, Moench et al. 1988). Swellings of lumbar and thoracic neurons have also been documented in NSINV infection (Jackson, Moench et al. 1988). NSINV is known to infect purkinje cells of the cerebellum, meningeal and ependymal cells in mouse (Johnson 1965; Griffin and Johnson 1977; Jackson, Moench et al. 1987; Jackson, Moench et al. 1988). Immature neurons replicate NSINV to high titers and undergo apoptosis whereas mature neurons are more resistant to NSINV replication and survive viral infection (Binder and Griffin 2001; Burdeinick-Kerr and Griffin 2005). It was shown that infection of neonatal mice with a NSINV chimera expressing anti-apoptotic bcl-2 gene, induced a lower mortality rate (7.5%) (Levine, Goldman et al. 1996). Hence, controlling neuronal apoptosis protects mice against fatal SINV encephalitis. After intracerebral inoculation of NSINV in mice, transcripts of IL-1 $\beta$ , IL-4, IL-6, IL-10, TNF- $\alpha$ , leukemia inhibitory factor (LIF) and



TGF- $\beta$  were produced by brain cells in response to infection and may contribute to neuronal loss (Wesselingh, Levine et al. 1994).

### **$\beta$ . West Nile virus:**

It was detected for the first time during an outbreak of encephalitis like symptoms in the summer of 1999 in New York City (NYC), New York, USA. The West Nile virus is a mosquito-borne Flavivirus. Birds are frequently natural carriers of arthropod-borne viruses. General symptoms include fever, muscle weakness, headache, and altered mental status. Rash, nuchal rigidity, arthralgia, photophobia, and myalgia were less frequently seen (Hinson and Tyor 2001). The neurologic syndromes are: encephalitis with muscle weakness, encephalitis without muscle weakness, aseptic meningitis, and milder illness with headache and fever only. Guillain-Barre syndrome was also reported (Ahmed, Libman et al. 2000) (**Table 2**).

### **$\chi$ . Japanese encephalitis virus (JEV)**

Japanese encephalitis virus (JEV) is one of the most important causes of viral encephalitis worldwide, with an estimated 50 000 cases and 15 000 deaths annually (Solomon, Dung et al. 2000). Children and young adults are more susceptible. Clinical symptoms include nonspecific prodromal stage, followed by headaches, nausea, vomiting, behavioral changes, altered state of consciousness, and often seizures. A dull mask-like face with wide staring eyes, tremor, choreoathetosis, head nodding, and rigidity are also found (Kumar, Mathur et al. 1990). Approximately one-third of patients die, and 50% of the encephalitis survivors have severe neuropsychiatric sequelae (Solomon, Dung et al. 2000).

### **$\delta$ . Nymph virus**

Nymph virus was the causative agent for an outbreak of encephalitis among pig farmers in Malaysia during the period 1998-1999. Clinical signs include fever, headache, altered mental

status, areflexia, cerebellar and brain stem signs, and segmental myoclonus. Significant hypertension and tachycardia may be found (Burke, Nisalak et al. 1985).

#### ε. Enteroviruses

The enteroviruses include Coxsackie A and B viruses, poliovirus, echovirus, and enteroviruses 68 and 71. The chief neurologic syndrome was rhombencephalitis meningitis or flaccid paralysis. Rhombencephalitis is followed by myoclonus, tremor, ataxia, cranial nerve involvement, respiratory distress, neurogenic pulmonary edema, and coma (Huang, Liu et al. 1999; Hinson and Tyor 2001) (**Table 2**).

#### φ. Other viruses

Herpes simplex virus (**Table 2**), Lymphocytic choriomeningitis virus, Rabies virus are few of the other viruses causing CNS infection and neurological diseases.

**Table 2. Different viruses causing CNS disease/ encephalitis**

Name	HSV	HIV	WNV	POLIO	VEEV/ WEEV/EEEV	CHIKV
Virus family	Alpha herpes virus	Retrovirus	Flavivirus	Picornavirus	Alphavirus	Alphavirus
Targets in CNS :	Neurons	Myeloid cell Microglia	Myeloid cell Microglia	Neurons	Neurons	Epithelia cells, Neurons, Glia
Clinical symptoms:	Encephalitis Meningitis Guillain-Barre syndrome	Encephalitis Dementia Neuropathy	Encephalitis Meningitis Myopathy	Paralysis, Respiratory arrest	Encephalitis, Seizure, Coma, Meningitis, Encephalomyelitis	Encephalitis, Meningitis, Acute- encephalopathy, Flaccid paralysis
Geographic distribution:	Worldwide	Worldwide	Europe, America, Africa	India, Africa	Western hemisphere, North America, South and central America	Africa, South and south east Asia, Europe

Table 2: from book chapter review I and II; S Tkachev Edition, *Intech.*, 2011

## D. CHIKV

Despite the classification as an “Old World” with prominent arthritogenic activity recent CHIKV outbreak has shown neurovirulence of the virus indicating a shift in virus pathology and placing it as a transition virus between an (‘Old’ and ‘New’ World) alphavirus.

### 1. Physiopathology of CHIKV

CHIKV is an important human pathogen that causes a syndrome characterized by fever, chills, headache and severe joint pain with or without swelling (usually the smaller joints). His name derive from the Kimakonde word meaning ‘that which bends up’ in reference to the stooped posture developed as a result of the arthritic symptoms of the disease (Jaffar-Bandjee, Das et al. 2009). Since 1953, numerous well-documented outbreaks and epidemics in both Africa and Southeast Asia, involving thousands of people were reported (Rao 1971; Mackenzie, Chua et al. 2001; Porter, Tan et al. 2004). More recently, a CHIK virus outbreak of unprecedented magnitude was ongoing in Indian Ocean territories principally involving Reunion Island, Comoro, Mauritius, Seychelles and southwestern India (Diallo, Thonnon et al. 1999; Chastel 2005). On Reunion Island, between March 2005 and March 2006, 3115 cases of CHIK were notified. Estimates from a mathematical model indicate that 204 000 people may have been infected by CHIK virus since March 2005 on Reunion Island.

The clinical follow-up during the recent outbreak has revealed that the CHIKV infection not only causes arthritis but also CNS related disease. Joint symptoms may also persist for several months after CHIKV infection (Bonn 2006; Simon, Parola et al. 2007; Taubitz, Cramer et al. 2007). The normal time course, based on CHIKV symptoms, incubation and biomarker is summarized in (**Figure 8**).

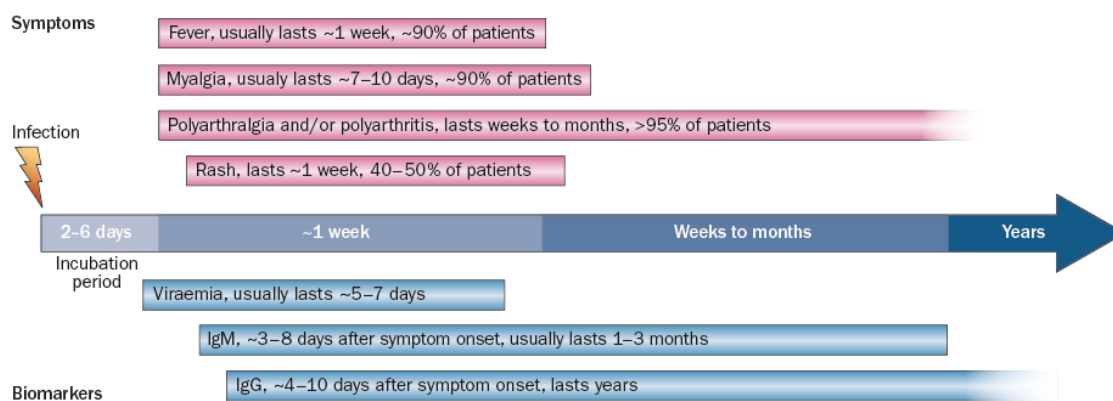

**Figure 8: Follow up of CHIKV disease in adults with time**

*The figure shows the typical symptoms, incubation period and biomarkers. The viraemia is usually followed by fever, myalgia, polyarthralgia and/or polyarthritis. A rash can appear 2–4 days after symptom onset. Virus-specific IgM and IgG can be detected as early as 3 or 4 days after symptom onset, respectively. IgG generally persists, and IgM can persist in some patients (Suhrbier, Jaffar-Bandjee et al. 2012).*

## 2. Arthritogenic clinical manifestations of CHIKV

### a. Acute phase

The incubation period for CHIKV ranges from day 1 to 12, with an average 2-4 days and is followed by classic clinical symptoms like fever (temperature usually  $>38.9$  °C) and in some case chills and rigors (Staikowsky, Talarmin et al. 2009; Vijayakumar, Nair Anish et al. 2011), polyarthralgia (over 90% of cases) (Robinson 1955; Lam, Chua et al. 2001) and maculopapular rash (a form of micro-vasculitis, more than 1/3rd of cases) (Morrison 1979; Riyaz, Riyaz et al. 2010; Bhat, Rai et al. 2011). The pain can be excruciating and is usually symmetrical and involved more than one joint. Fingers, wrists, elbows, toes, ankles and knees are most commonly affected as described for most of the alphaviruses (Tesh 1982; Queyriaux, Simon et al. 2008; Staikowsky, Talarmin et al. 2009; Vijayakumar, Nair Anish et al. 2011) (**Figure 9**). For CHIKV infection, viral loads usually range from  $1 \times 10^5$  to  $1 \times 10^9$  viral RNA copies per ml of blood (Laurent, Le Roux et al. 2007).

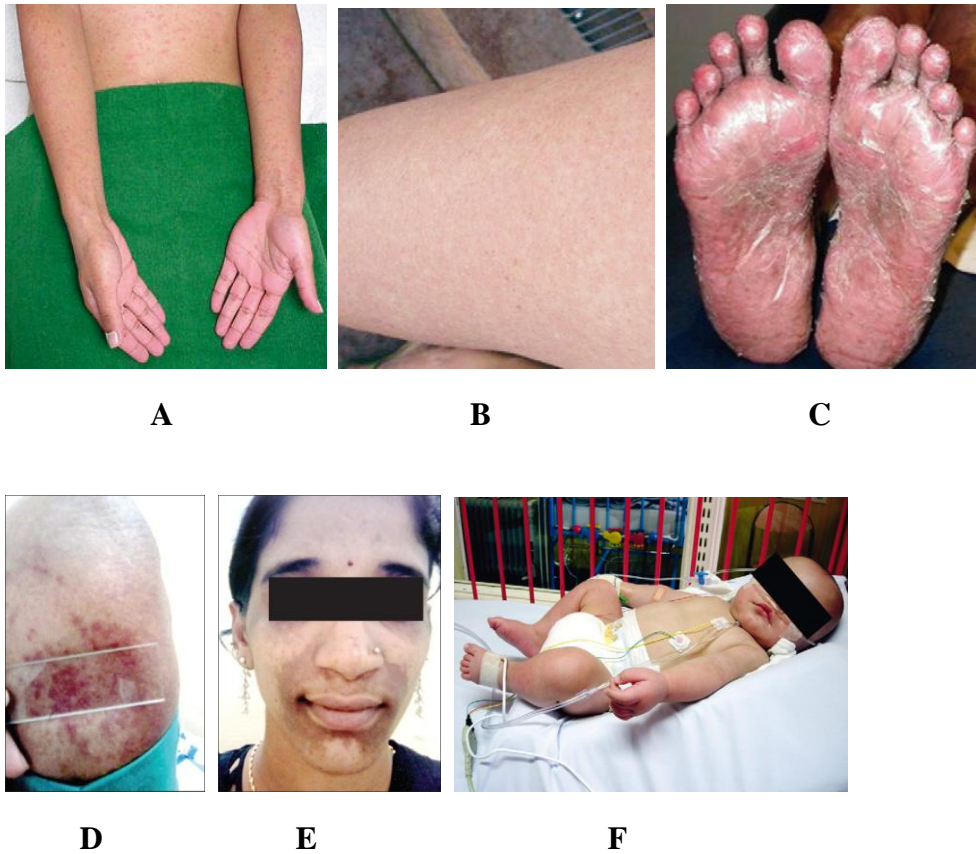

**Figure 9: Acute symptoms of CHIKV fever in patients**

*Maculopapular rash, petechial spots and erythroderma of arms (A), legs (B), and feet (C), Ecchymotic rash (D), Centropacial hyperpigmentation (E), Hyperalgesic infant aged 7 months with maculopapular rash presented with oedema of hands and feet. Other presentations include swollen ankles or wrists, without typical inflammatory joints (F) (Bhat, Rai et al. 2011; Burt, Rolph et al. 2012).*

The other symptoms include myalgia (muscle pain), headache, edema of the extremities, and gastrointestinal complaints (Borgherini, Poubeau et al. 2007; Lakshmi, Neeraja et al. 2008). Atypical CHIKV cases were also observed during 2005-2006 epidemic in La Reunion, were patients developed other symptoms then fever and arthralgia were recorded (Economopoulou, Dominguez et al. 2009). Among 610 adult patients presenting atypical cases of CHIKV fever, 222 (36%) were severe cases, 84 (14%) were admitted to ICU and 65 (36%) of severe cases died (Lemant, Boisson et al. 2008). Overall, 546 cases had underlying medical conditions (226 cardiovascular, 147 neurological and 150 respiratory disorders). It has been presumed

that CHIKV infection is much higher than reported due to misdiagnosis of Dengue Virus (DENV) infection (Myers and Carey 1967; Carey 1971). Indeed, clinical features are similar to Dengue fever except for hemorrhagic or shock syndrome, which are only seen in CHIKV infection (Her, Kam et al. 2009).

### **b. Chronic phase: Arthralgia and Arthritis**

Chronic arthritis has been already described for several alphaviruses. Generally acute symptoms after CHIKV usually resolve within few weeks, but sometime it can persist for week, months or even years. Arthritis due to CHIKV can remain unresolved from 6 months to ~3 years in 1.6-57% of patients (Brighton, Prozesky et al. 1983; Borgherini, Poubeau et al. 2008; Manimunda, Vijayachari et al. 2010; Ganu and Ganu 2011; Gerardin, Fianu et al. 2011; Chopra, Anuradha et al. 2012).

The chronic symptoms at one month (M1) could be rheumatism (75%) and fatigue (30%). After tenth month the symptoms/signs observed were joint pain/swelling (46%), fatigue (13%) and neuritis (6%) (Manimunda, Vijayachari et al. 2010). High level of CHIKV Immunoglobulin M (IgM) were found in patients, naïve for musculoskeletal disorders, with post-CHIKV associated rheumatoid arthritis like illness (Chopra, Anuradha et al. 2008). Severe chronic rheumatism accompanied by progressive destructive arthritis and dysregulation of inflammatory mediators was seen in a patient from La Reunion. At the 15-month-period evaluation after diagnosis, 84 of 147 participants (57%) self-reported rheumatic symptoms. Of these 84 patients, 53 (63%) reported permanent trouble while 31 (37%) had recurrent symptoms (Sissoko, Malvy et al. 2009). Radiographic analyses of hands and feet of 21 patients with RA after Chikungunya fever infection after a mean follow-up of 11.7 months showed hand erosions for five out of six patients (Bouquillard and Combe 2009) (**Figure 10**).

A small group of patients with persistent arthralgia develop authentic inflammatory destructive rheumatism (Chopra, Anuradha et al. 2008; Bouquillard and Combe 2009; Malvy, Ezzedine et al. 2009; Manimunda, Vijayachari et al. 2010). For assessment of the quality of life after the CHIKV infection, subjects reported more disabilities compare to CHIKV negative, in a cohort study of 199 patients (Soumahoro, Gerardin et al. 2009). Rheumatic

manifestations like edematous polyarthrititis in fingers and toes, with morning pain and stiffness, severe tenosynovitis of the wrist, hands and ankles and exacerbation of pain in previously injured joint were also reported in travelers from infected area (Parola, Simon et al. 2007).

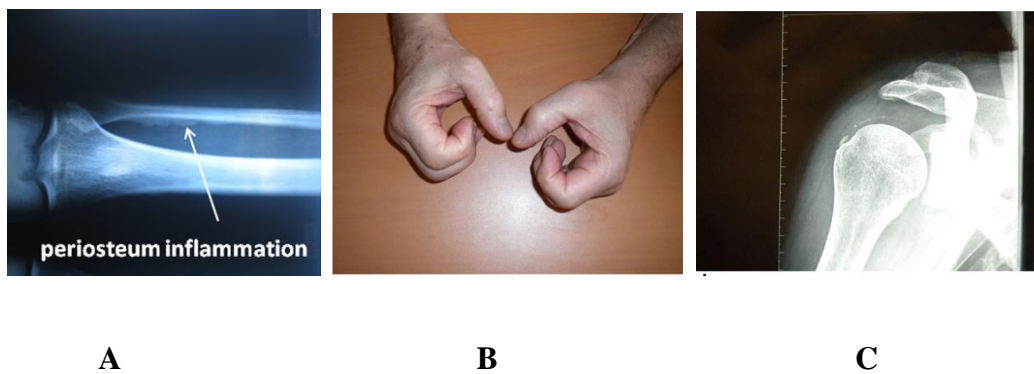

**Figure 10: Arthritis in elderly patients following CHIKV infection**

*A. Inflammation of the periosteum (enthesopathy) is clearly depicted in this X-ray picture of this elderly patient and indicative of the connective tissue reaction post- CHIKV infection. B) CHIKV infection, chronic stage with swollen and stiff hands in a 55-year-old man who was infected 5 years earlier. C) Bilateral calcifications of shoulder tendons in a 36-year-old woman who was infected 18 months previously (Jaffar-Bandjee, Das et al. 2009; Simon, Javelle et al. 2011).*

### **3. Encephalitic clinical manifestations of CHIKV**

#### **a. Chikungunya, a paradigm shift from ‘Old’ to ‘New’ World alphavirus**

After CHIKV fever was identified in 1953 in Africa and in India in 1960s and 1970s (Powers and Logue 2007), it was generally thought not be a neurotropic virus, although some previous studies reported neurological symptoms (Chatterjee, Chakravarti et al. 1965; Mazaud, Salaun et al. 1971), but much evidence exist after the outbreak in Indian ocean region in the last decade (Yergolkar, Tandale et al. 2006; Lemant, Boisson et al. 2008; Mavalankar, Shastri et al. 2008). Recent outbreak in 2005-2006 in Indian ocean region,

particularly Reunion island, where one third of the population was infected, including death (Lemant, Boisson et al. 2008) and in India (Yergolkar, Tandale et al. 2006; Mavalankar, Shastri et al. 2008), has shown acute and chronic CNS related diseases.

### **b. Acute phase**

Neurological related acute symptoms include headache, flaccid paralysis, septic shock followed by encephalopathy. Three cases of Guillain-Barre syndrome with associated symptoms of facial palsy and weakness in hand, feet or both after CHIKV infection was observed in La Reunion (Wielanek, Monredon et al. 2007; Lemant, Boisson et al. 2008; Robin, Ramful et al. 2008; Lewthwaite, Vasanthapuram et al. 2009). In a case study by Lewthwaite *et.al*, an 8-month-old girl patient was admitted with fever multiple seizures, a widespread rash, loss of appetite, and reduced hearing. While she was inpatient, gangrene developed in her fingers and toes (**Figure 11**).



**Figure 11: An 8-month-old girl during week 3 of hospitalization**

*The child was admitted with fever, multiple seizures, and a widespread rash; CHIKV was detected in her plasma. Atypical case of gangrene: A) Little finger of the left hand; B) index finger of the right hand; and C) 4 toes on the right foot (Lewthwaite, Vasanthapuram et al. 2009).*

Other neurological symptoms include confusion, drowsiness and delirium after CHIKV infection (Rampal, Sharda et al. 2007). Skin lesions including vesiculobullous lesions with desquamation, aphthous like ulcers, vasculitis as well as atypical complication such as hepatitis, pneumonia, pre renal failure and cardiologic manifestations were found to be



associated with patients with neurological symptoms (Pialoux, Gauzere et al. 2007; Jaffar-Bandjee, Das et al. 2009; Robin, Ramful et al. 2010).

### **c. Chronic phases of CHIKV fever**

Clinical neurological symptoms include encephalitis, meningoencephalitis and deaths in recent outbreak (Robin, Ramful et al. 2008; Economopoulou, Dominguez et al. 2009; Lewthwaite, Vasanthapuram et al. 2009). Encephalomyelordiculitis was observed after CHIKV infection by neuroimaging data in 2 patients and brain autopsy in 1 patient. In both the cases the symptoms was associated with neck rigidity, drowsiness and extensor plantar response (Ganesan, Diwan et al. 2008). Febrile seizures were found to be associated with both adults (complex febrile seizures) and neonates (simple febrile seizures) (Ramful, Carbonnier et al. 2007; Robin, Ramful et al. 2008; Lewthwaite, Vasanthapuram et al. 2009) . Severe CHIKV infection and neurological disorders of neonates was confirmed and considered as Mother-to-child transmission of CHIKV (Ramful, Carbonnier et al. 2007; Gerardin, Barau et al. 2008; Haas, Robin et al. 2009) during the recent outbreak in Reunion Island. Neurological manifestations described in adults requiring hospitalization (incidence of 15-25%) involved cases of encephalopathy frequently associated with the presence of IgM anti-CHIKV in the Cerebrospinal fluid (CSF), encephalitis, and rare deaths (Casolari, Briganti et al. 2008; Lemant, Boisson et al. 2008; Economopoulou, Dominguez et al. 2009). The viral load in the CSF was generally lower than in blood, brain biopsies were found positive for CHIKV by RT-PCR and these data seem to indicate that CHIKV infection may also affect brain functions (Grivard, Le Roux et al. 2007; Laurent, Le Roux et al. 2007). Detection of psychosis, total blindness due to retro-bulbar neuritis lower motor neuron type paraplegia hemiparesis has shown drastically increased spectrum of CHIKV on neuropathology. These recent CHIKV epidemic with increase cases of CNS infection and deaths in neonates (mother-to-child infection) has shown a shift towards “New World” alphavirus.

#### **4. Animal models**

Several animal models have been elaborated for development and testing of new intervention which can mimic and provide insights of disease pathogenesis in human.

##### **a. Mouse model of arthritis**

Mouse model have been developed and used extensively for alphavirus infection. The most extensively studied arthritogenic alphavirus on mouse is RRV. Primary targets of RRV infection in outbred cluster of differentiation-1 (CD-1) mice and inbred adult black-6 (B6) mice are bone- and joint- associated connective tissue and skeletal muscle (Morrison, Whitmore et al. 2006). RRV detection in synovial tissues, periosteum, tendons, and ligaments are consistent with observations of RRV-infected humans in whom both viral antigen and viral RNA have been detected from synovial effusions and synovial biopsy samples (Fraser, Cunningham et al. 1981). The joint and connective tissue tropism of CHIKV is similar to other alphaviruses (Couderc, Chretien et al. 2008). Primary mouse fibroblast cells are found to be the principal CHIKV cell target, which are consistent with the finding of CHIKV permissive to human lung and mouse skin fibroblasts (Sourisseau, Schilte et al. 2007; Couderc, Chretien et al. 2008). Subcutaneously inoculated new born and 14-day-old mice with CHIKV developed lethargy, difficulty walking, dragging of hind limbs, and reduced weight gain within 7–10 days post infection (PI). High levels of viremia ( $10^6$ – $10^8$  particle forming unit (PFU)) of CHIKV was seen in infected tissue. Recently developed mouse model of chikungunya arthritis in adult wild type mice shows clear sign of self-limiting arthritis, which share multiple inflammatory processes with RA (Suhriebier and Mahalingam 2009; Nakaya, Gardner et al. 2012). Gardner et al, proposed that inflammatory cells (such as monocytes, CD4, CD8) and particularly macrophages were essential in CHIKV-induced muscle and ankle joint inflammation and tissue damage in CHIKV infected mice (Gardner, Anraku et al. 2010). These data were similar to RRV infected mouse models (Lidbury, Simeonovic et al. 2000; Rulli, Suhriebier et al. 2005; Morrison, Whitmore et al. 2006). The major histopathologic changes were in skeletal muscle with focal necrosis and inflammation, followed by fibrosis and dystrophic calcification. Some mice also showed dystrophic

calcification in the joint cartilage, with few deaths. These mouse models of CHIKV serve as an accurate model to study disease pathogenesis and new treatment due to recapitulation of many aspects of the human disease.

#### **b. Mouse model of encephalitis**

The pathogenesis of CHIKV in human CNS infection and its mechanism of disease and immune response is poorly understood. Scarcity of data related to CNS infection due to unavailability of biopsies during ongoing viral infection stress in need for the development of other animal models. It's been shown that CHIKV can enter the brain of new born mice and can initially replicate for the short time as after 10 days no virus could be detected in brain culture may be due to robust innate immune and inflammatory response (Ziegler, Lu et al. 2008). Powers and Logue reported that intranasal infection of BALB/c mice with CHIKV led to neuronal infection and tissue necrosis in the anterior olfactory lobe (Powers and Logue 2007). Interestingly, 5-week-old C57 black-6 (C57BL/6) mice developed encephalitis 7 days post-infection with severe multifocal infection and liquefactive necrosis in the cerebral cortex (Wang, Volkova et al. 2008). These observations bear resemblance to the anatomopathological hallmarks of elderly patients with CHIKV neuroinfection reported by Ganesan *et al* (Ganesan, Diwan et al. 2008). In inbred mice deficient in the IFN- $\alpha$  signaling pathway (knock out (KO) for the interferon alpha receptor (IFNAR)), severe neuroinfection, targeting the leptomeninges, the choroid plexus and ependymal cells lining the subventricular zone, was seen after CHIKV infection (Couderc, Chretien et al. 2008).

#### **c. Other animal models**

Non-human primate (NHP) have been used widely for virus-induced pathology and development of vaccine and drugs (Verrier, Le Grand et al. 2002; Reed, Larsen et al. 2005; Vierboom, Jonker et al. 2007). Early data for CHIKV infection have shown that NHP was susceptible to infection and were probably part of the natural reservoir in Africa and Asia (McCrae, Henderson et al. 1971; Marchette, Rudnick et al. 1978). First experimental proof of

CHIKV infection in Rhesus macaques date back to 1967 with the animals showing primary symptoms of fever within a few days of virus inoculation. The viral replication pattern in macaques was very similar to that reported in humans with the same Asian strains, with plasma viremia from days 1 to 6 and titers ranging from 3 to  $5.3 \log^{10}$  pfu/ml (Binn, Harrison et al. 1967). Viral titers were reduced to basal levels at day 10 post-infection as described in humans and mice (Ziegler, Lu et al. 2008). Viremia peak during acute phase in macaques was similar as it is in humans. Chronic phase was characterized by the persistence of CHIKV in lymphoid organs and liver and to lesser extent, muscle and joints. Arthritis, meningoencephalitis, and death were observed for high dose of virus whereas at intermediate doses, only fever and rash were observed; and at the lowest dose, no clinical signs were observed. CHIKV also exhibited a marked tropism for spleen, lymph nodes, and liver during the viremia peak. Arthritic symptoms were marked by joint inflammation and swelling of joints, whereas CNS infection was marked by meningoencephalitis (Labadie, Larcher et al. 2010). High levels of CHIKV RNA were detected in the spleen, lymph nodes, and liver, and to a lesser extent in joints, muscle, skin, and the central nervous system. Interestingly, many of these tissues were shown to be affected during human diseases (Renault, Solet et al. 2007; Economopoulou, Dominguez et al. 2009).

## **5. Epidemiology: Historical and geographical distribution of CHIKV**

History of CHIKV is dated back to 1779 when a person by name David Bylon witnessed an epidemic febrile disease in the city of Batavia (current Jakarta, Indonesia). The observation cited by him was

“It was last May 25, in the afternoon at 5:00 when I noted while talking with two good friends of mine, a gnawing pain in my right hand, and in the joints of the hand and arm, which gradually increased, extending to the shoulder and then over my whole body, so that at 9:00 that evening I was in my bed with a high fever. . . It’s now been three weeks since I. . . was stricken by the illness, and because of that had to stay home for 5 days; but even until today I have continuously pain and stiffness in the joints of both feet, with swelling of both

ankles; so much so, that when I get up in the morning, or have sat up for a while and start to move again, I cannot do so very well and going up and down stairs is very painful.’’

These symptoms were reported for dengue fever but now believed to be for chikungunya (Carey 1971). In 1820s chikungunya fever was again reported in Africa, the Caribbean, West Indies and India. In Calcutta (current Kolkatta), India, 95% of the population was affected during a 3-month period. In 1853, and subsequently in 1871, Calcutta (current Kolkatta) was again hit by an epidemic fever characterized by residual arthralgia, affecting 75% of the population. Fifty years later in 1923, India once again reported a similar outbreak (Carey 1971)

The first confirmed chikungunya fever outbreak was reported in 1952 and was first isolated by Ross in 1953 during a dengue epidemic that occurred in the Newala district of Tanzania (Robinson 1955; Ross 1956). This outbreak was again mistaken to be a dengue virus but serological and antigenic characterization of the isolates indicated that it was an alphavirus closely related to Mayaro and SFV (Casals and Whitman 1957; Spence and Thomas 1959). In Asia chikungunya was first isolated in 1958 in Bangkok, (Hammon and Sather 1964). In the 1960s, clinical and virological investigations among children in Bangkok showed that 6.1% hemorrhagic fever cases and 8% of outpatients were due to chikungunya fever (Halstead, Nimmannitya et al. 1969; Nimmannitya, Halstead et al. 1969). In India first confirmed epidemic was in 1963 in Calcutta (current Kolkatta) and subsequently in Madras (current Chennai), where more than 3 million individuals were affected (Banerjee 1965; Dandawate, Thiruvengadam et al. 1965; Rao, Carey et al. 1965; Sarkar, Chatterjee et al. 1965; Thiruvengadam, Kalyanasundaram et al. 1965; Sarkar, Chatterjee et al. 1967).

Frequent outbreaks were reported from the 1960s through to 2003 in western Africa (Senegal, Benin, the Republic of Guinea, Ivory Coast and Nigeria) as well as in central and southern Africa (Sudan, Uganda, Democratic Republic of Congo, the Central African Republic, Malawi, Zimbabwe, Kenya and South Africa). During the same period, sporadic, localized outbreaks have also been reported in south Asia (India, Sri Lanka and Pakistan) and south-east Asia (Malaysia, Philippines, Indonesia, Cambodia, Vietnam, Myanmar and Thailand) (**Figure 12**) (Chastel 1963; Jadhav, Namboodripad et al. 1965; Myers, Carey et al. 1965; Munasinghe, Amarasekera et al. 1966; Halstead, Nimmannitya et al. 1969; Halstead,

Scanlon et al. 1969; Halstead, Udomsakdi et al. 1969; Halstead, Udomsakdi et al. 1969; Nimmannitya, Halstead et al. 1969; Thaung, Ming et al. 1975; Marchette, Rudnick et al. 1978; Thein, La Linn et al. 1992; Thaikruea, Charearnsook et al. 1997; Mourya, Thakare et al. 2001; Kit 2002; Pastorino, Muyembe-Tamfum et al. 2004; Laras, Sukri et al. 2005; Parola, de Lamballerie et al. 2006; Powers and Logue 2007).

Sporadic re-emergence of CHIKV outbreaks from 1980 is frequent around the globe with major documented in Senegal in 1986 and 1996/1997 (Diallo, Thonnon et al. 1999), Ivory Coast in 1996/1997 (Thonnon, Spiegel et al. 1999), Democratic Republic of Congo during 1998–2000 (Nur, Groen et al. 1999; Pastorino, Muyembe-Tamfum et al. 2004), Indonesia in 2003 (Porter, Tan et al. 2004), Kenya in 2004, Comoros in 2005 (Sergon, Yahaya et al. 2007), the Seychelles, Mauritius, Madagascar and Reunion islands during 2005-2006 and in India in 2006/2007 (Ravi 2006; Saxena, Singh et al. 2006) (**Figure 12**).

Since 2006, CHIKV has been imported into Europe and the western hemisphere (Including the United States) via many viremic travelers. In Italy an epidemic was initiated by a traveler from India. In Brazil travelers returned from infected area shows the symptoms of CHIKV disease (Hochedez, Jaureguiberry et al. 2006; Parola, de Lamballerie et al. 2006; 2007; Charrel, de Lamballerie et al. 2007; Lanciotti, Kosoy et al. 2007; Rezza, Nicoletti et al. 2007; Veber, Arroe et al. 2007; Sambri, Cavrini et al. 2008; Chaves Tdo, Pellini et al. 2012). 2004-2007 outbreak reported thousands of cases and spread the CHIKV in new geographical areas like Singapore (Leo, Chow et al. 2009; Ng, Tan et al. 2009), Sri-Lanka (Hapuarachchi, Bandara et al. 2008), Maldives and Malaysia (AbuBakar, Sam et al. 2007; Yoosuf, Shiham et al. 2009) and Cambodia (2012) (**Figure 13**).

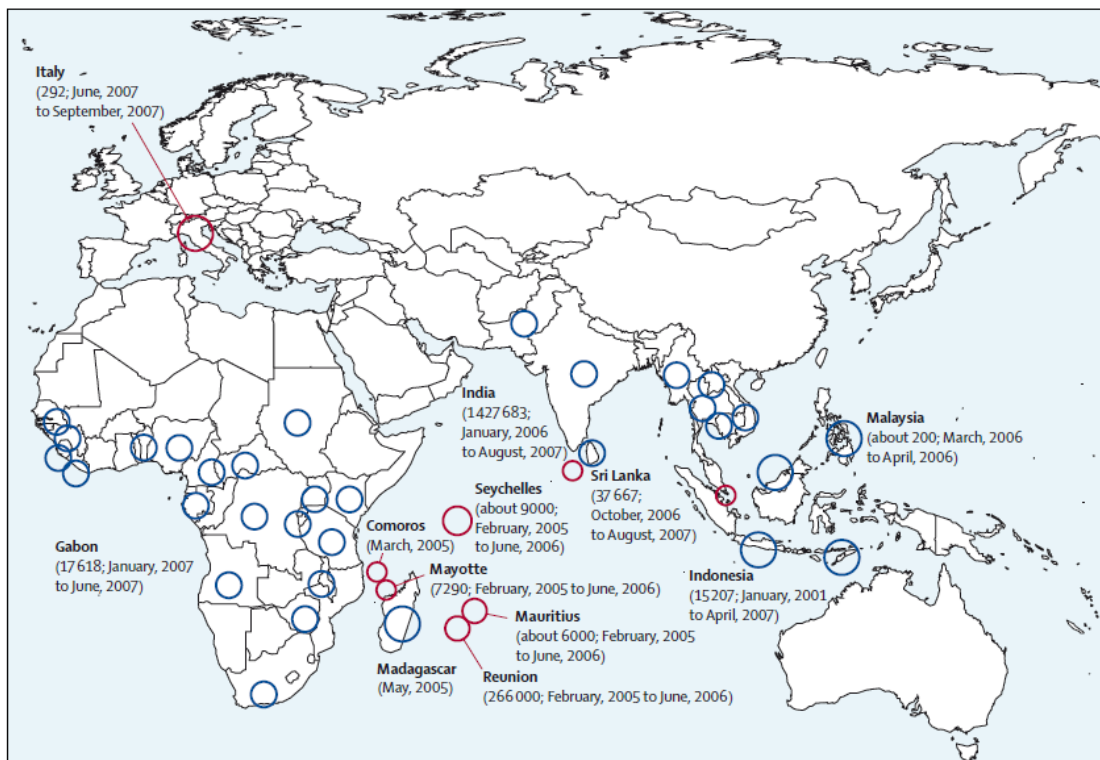

**Figure 12: Global distribution of CHIKV**

*Blue circles indicate historical distribution of CHIKV in countries where the virus has been identified by virus isolation or serological evidence. Red circles indicate global re-emergence within the past decade. The number of cases, when available, is given in parentheses, along with dates of outbreak (Burt, Rolph et al. 2012).*

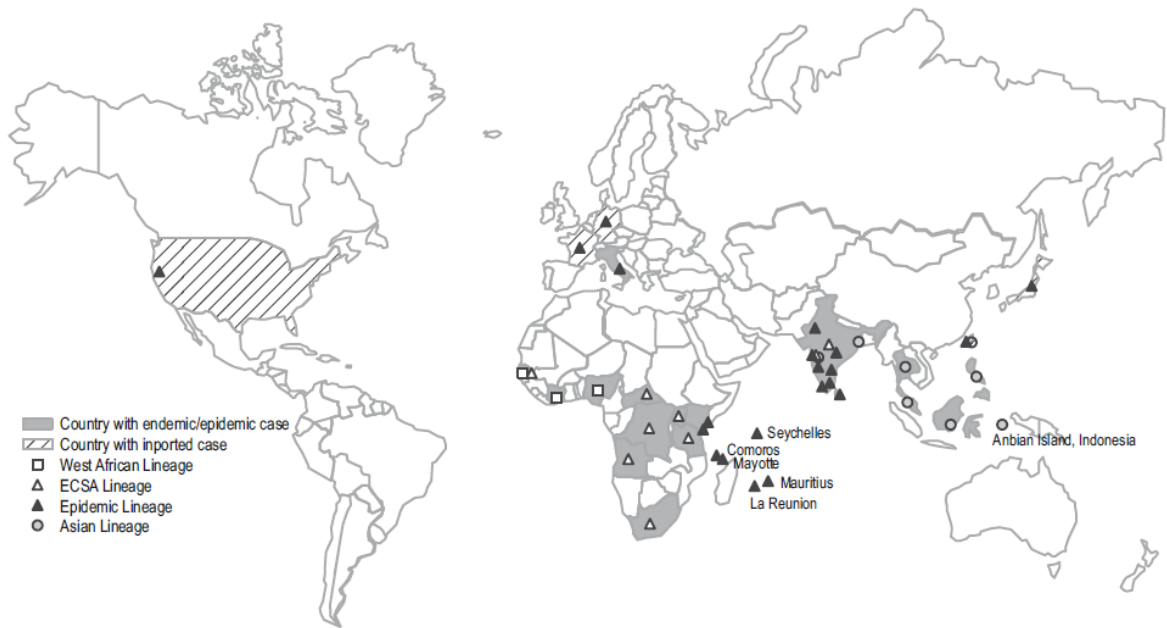

Figure 13: Distribution of CHIKV based on endemic and imported strain (Volk, Chen et al. 2010).

During previous epidemic (1950–2000), only two epidemiological profiles of chikungunya fever were described.

- The classical African profile which is characterized by occasional small epidemics in rural areas similar to sylvatic yellow fever and with little impact on public health.
- On other hand the classical Asian profile is responsible for urban outbreaks involving mainly *Ae. Aegypti* mosquitoes, as observed in Dengue fever.

The situation changed rapidly in Reunion Island, where a mutation at residue 226 of the membrane fusion glycoprotein E1 (E1- A226 V) which was absent during the first month of ongoing outbreak CHIKV strain quickly became predominant and generated an explosive outbreak because of its adaptation to *Ae. albopictus*, a previously minor vector (Schuffenecker, Iteman et al. 2006). A third epidemiological profile was born, distinct from those of Africa and Asia and having a simple cycle well suited for invading certain urban areas (Figure 14).



The A226V-CHIKV is highly efficient at spreading through human populations in tropical and temperate countries enhancing the transmissibility of the virus by *Ae. albopictus*. Several studies have shown that this single mutation renders the virus higher replication and dissemination rates in *Ae. Albopictus* thereby shortens the extrinsic incubation period (Tsetsarkin, Vanlandingham et al. 2007; Vazeille, Moutailler et al. 2007). Within the past 6 years, this global profile has been responsible for more than 2 million cases, mostly during outbreaks in the Indian Ocean, India, and South-Eastern Asia, but also in Africa and in Europe, whereas “only” a few hundred thousand cases were reported for African and Asian profiles during the past five decades.

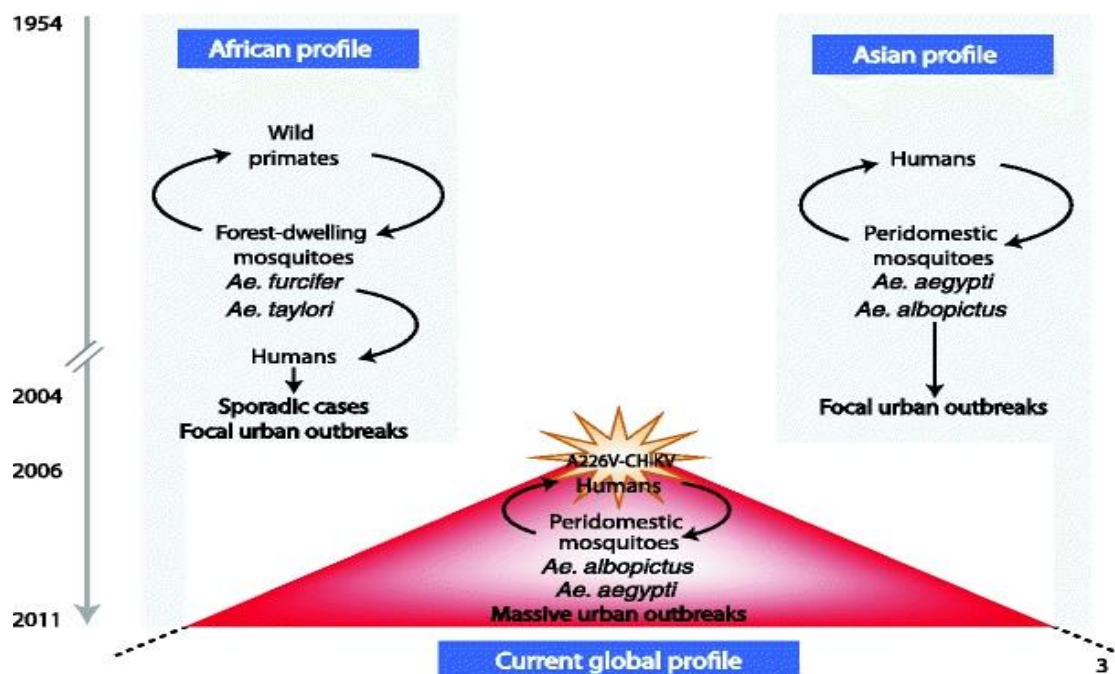
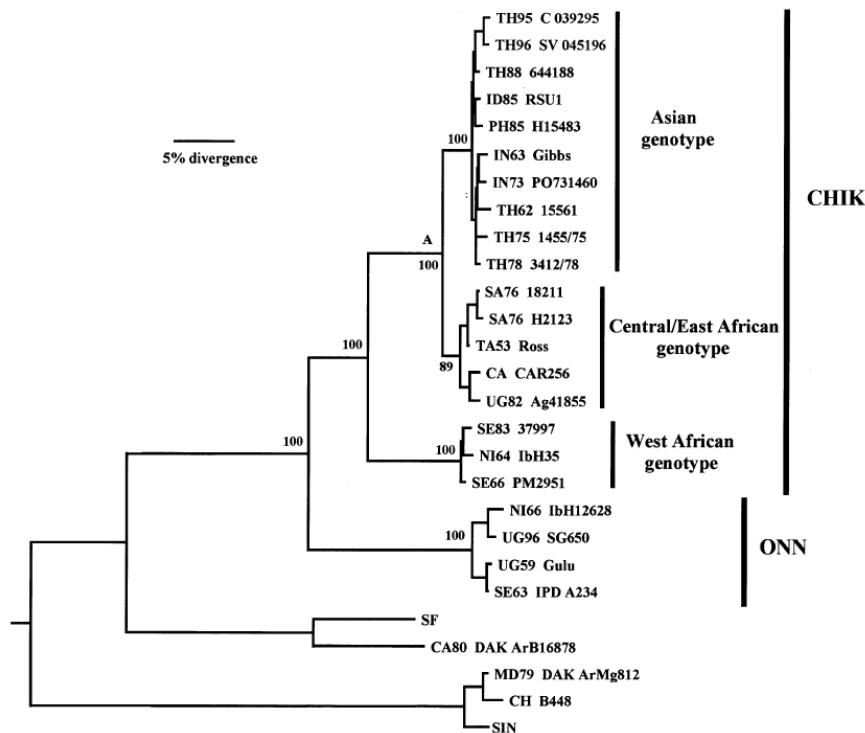

Figure 14: Epidemiological features of chikungunya transmission (Simon, Javelle et al. 2011).

## 6. Phylogenetic analysis of the virus

It is estimated that the ancestor of all of the CHIKV strains is estimated to have emerged between 150 and 1350 years ago. Whereas the Asian CHIK virus genotype emerged

between 50 and 310 years ago, the West and East African genotypes diverged 100 to 840 years ago (Powers, Brault et al. 2000) (**Figure 15**).

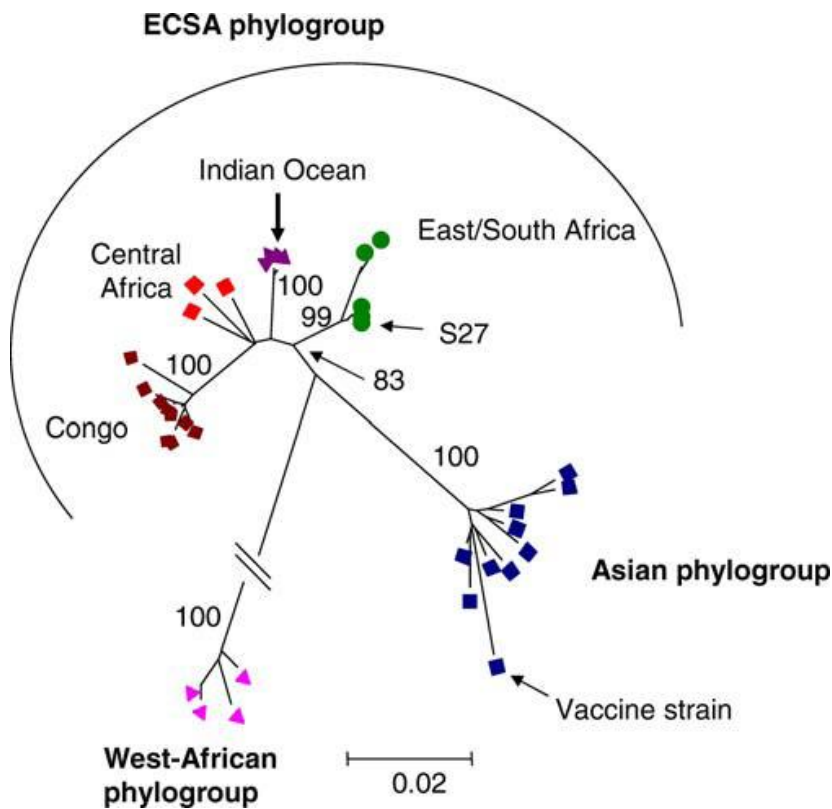

**Figure 15: Phylogenetic analysis of CHIK and ONN**

*Phylogenetic analysis of CHIK and ONN viruses on the 1050 bp partial E1 gene sequence. Numbers indicate bootstrap values for the groups to the right. Letter A indicates the hypothetical ancestor used to estimate the time of divergence of Asian CHIK isolates from the African progenitor. The bar indicates horizontal distance corresponding to 5% nucleotide sequence divergence (Powers, Brault et al. 2000).*

All phylogenetic methods divided the CHIKV isolates into three distinct genotypes, based on geographical origins; CHIKV isolates from Senegal and Nigeria, forming the West African genotype, having only 78 to 85% nucleotide sequence identity with remaining CHIKV clad. The remaining CHIK virus isolates formed two clades: one contained strains from central and eastern Africa, while the other contained solely Asian isolates (Powers, Brault et al. 2000). To determine the origin of Indian Ocean CHIKV outbreak, a 1044-nt region within the E1 coding sequence (positions 271-1314, i.e., codons 91–438) from the six

complete genomes with 29 other available chikungunya sequences was compared. Asian isolates were more distantly related to Indian Ocean isolates and constituted the sister group of group East-Central and South African (ECSA), whereas West-African isolates were even more divergent (Schuffenecker, Itean et al. 2006) (**Figure 16**).



**Figure 16:** Phylogenetic Relationships based on E1 nucleotide sequence

*Phylogenetic Relationships among Chikungunya Isolates Based on Partial E1 Nucleotide Sequences. Isolates from the Indian Ocean outbreak (Reunion, Seychelles, Mayotte, Mauritius, and Madagascar) represent a distinct clade within a large East-, Central-, and South-African (ECSA) phylogroup. Bootstrap resampling values are indicated at major nodes. The branch leading to West-African phylogroup (of length of approximately 15%) was shortened for convenience. Maximum-likelihood analysis resulted in a very similar phylogeny (Schuffenecker, Itean et al. 2006).*

Based on complete genome of CHIKV, analysis of 40 CHIKV was performed and the strains confirm the divergence of the ECSA and Asian lineages 150 years ago with the Asia group splitting into two clades: an Indian lineage, likely went extinct (Lahariya and Pradhan 2006; Arankalle, Shrivastava et al. 2007) and still circulating Southeast Asian lineage. The paraphyletic grouping of the African CHIK viruses supports the historical evidence that the virus was introduced into Asia from Africa whereas recent Indian Ocean and Indian subcontinent outbreak that began in 2004 apparently originated from 2004 Kenyan strain. There was no ECSA group member showing a significantly closer relationship with the Indian Ocean isolates (Figure 17).

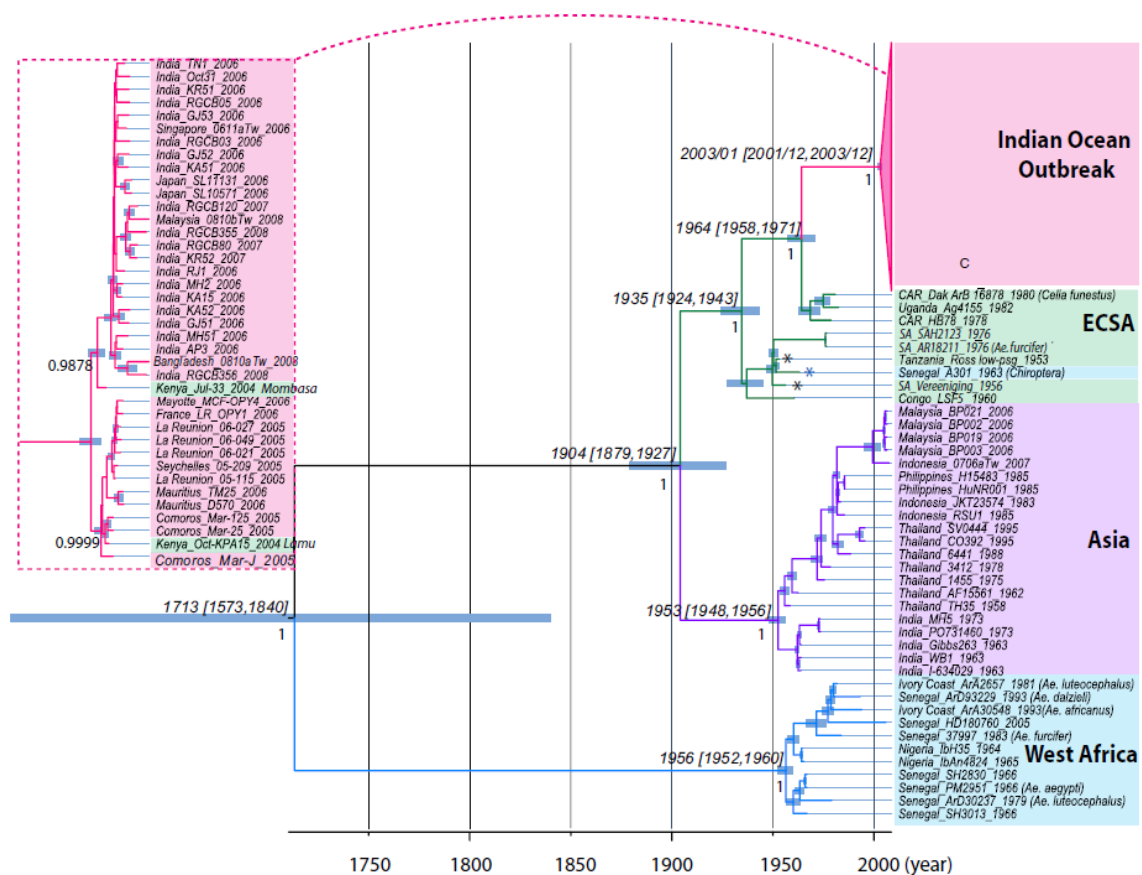

**Figure 17: Maximum clade credibility (MCC) tree of 80 CHIKV strains**

The four major lineages are highlighted with different branch colors, with the sample origin highlighted by the corresponding color. The estimated 95% HPD values for most recent common ancestors are labeled beside the node and are also indicated by the thick blue horizontal node bars. The numbers adjacent to nodes indicate Bayesian posterior probability values. For clarity, the 2004 to 2009 epidemic clade is shown enlarged in the inset at upper left. Sequences with internal poly (A) insertion in the 3' UTR are marked with an asterisk (\*).

Strains are labeled as follows: location\_strain name\_date (year) of collection (Volk, Chen et al. 2010).

## 7. Transmission cycle of CHIKV

For many years CHIKV was usually described as enzootic virus that circulated in a natural sylvatic cycle amongst forest-associated simians and forest dwelling mosquito species causing spasmodically outbreaks in the local populations living near the jungles (Gould and Higgs 2009) (**Figure 18**). The virus has been found and isolated from sylvatic mosquito species in several countries including Senegal, Cote d'Ivoire, Central African Republic and South Africa.

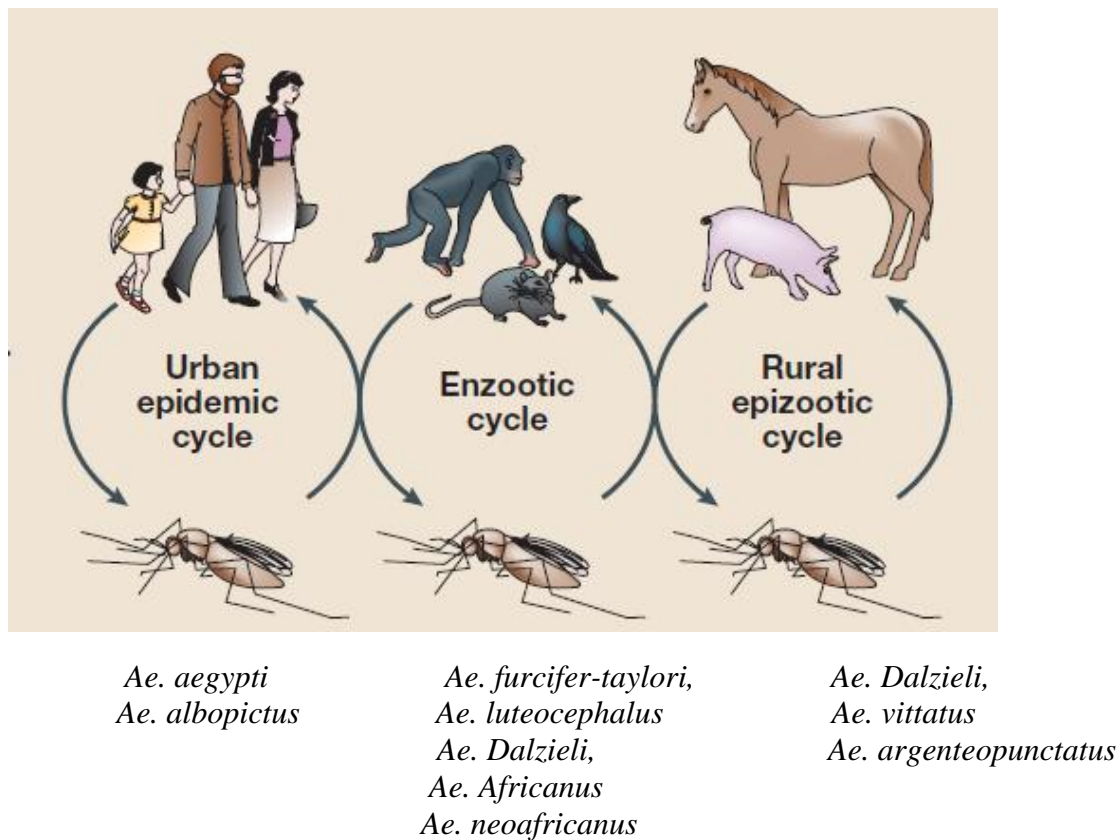

**Figure 18: The urban and sylvatic cycle**

(Gould and Higgs 2009). Reference used for mosquitoes not for the figure.

CHIKV was isolated from 13 mosquito species. All except *Ae. Aegypti* are sylvatic in nature. Major species involved in sylvatic cycles are of *Aedes* species mosquitoes (particularly *Aedes furcifer-taylori*, *Ae. luteocephalus* and *Ae. Dalzieli*, *Ae. Africanus* and *Ae. neoaffricanus*) (Diallo, Thonnon et al. 1999) (**Figure 19**).

Species	Mosquitoes captured			Strains of CHIK virus isolated		MIR* (%)
	No.	(%)	No. of pools	No.	(%)	
<i>Aedes furcifer</i>	143,460	(18.38)	4,180	63	(35.4)	0.44
<i>Aedes taylori</i>	38,421	(4.92)	1,206	6	(3.4)	0.15
<i>Aedes furcifer-taylori</i>	68,267	(8.74)	2,858	60	(33.7)	0.88
Subtotal <i>Aedes (Diceromyia)</i>	250,148	(32)	8,244	129	(72.5)	0.51
<i>Aedes luteocephalus</i>	100,469	(12.87)	3,347	27	(15.2)	0.27
<i>Aedes africanus</i>	4,088	(0.52)	211	1	(0.6)	0.24
<i>Aedes neoaffricanus</i>	3,963	(0.51)	272	2	(1.1)	0.50
Subtotal <i>Aedes (Stegomyia)</i>	108,520	(13.90)	3,830	30	(16.8)	0.28
<i>Aedes dalzieli</i>	93,330	(11.95)	2,069	12	(6.7)	0.13
<i>Aedes argenteopunctatus</i>	26,356	(3.38)	894	1	(0.6)	0.04
<i>Aedes vittatus</i>	67,682	(8.67)	3,234	3	(1.7)	0.04
Subtotal <i>Aedes (Aedimorphus)</i>	187,368	(24)	6,197	16	(8.9)	0.08
<i>Anopheles coustani</i>	14,589	(1.87)	630	1	(0.6)	0.07
<i>Anopheles rufipes</i>	38,495	(4.93)	861	1	(0.6)	0.02
<i>Culex ethiopicus</i>	462	(0.06)	77	1	(0.6)	2.16

**Figure 19: Different species of mosquitoes detected for CHIKV**

*Infection rates and abundance of potential CHIKV vectors captured in Kedougou, Senegal from 1972 to 1996 (Diallo, Thonnon et al. 1999).*

In Asian epidemics CHIKV is maintained between human and mosquito vector *Ae. aegypti* and *Ae. albopictus* (Tesh, Gubler et al. 1976; Banerjee, Mourja et al. 1988; Turell, Beaman et al. 1992). The transmission cycle of CHIKV occur periodically between every silence intervals of 3–4 years. Different species of mosquitoes have different host and can facilitate circulation of CHIKV, like *Aedimorphus*, which prefer to feed on cattle. Isolates of CHIKV from zoophilic mosquitoes suggest that the virus circulates in rodents and cattle, although in Central African Republic, the role of ruminants appears to be negligible (Guilherme, Gonella-Legall et al. 1996). Isolates obtained from a squirrel, chiropter, and ticks (*Alectorobius sonrai*), as well as the presence of antibodies specific for CHIKV in rodents and birds, support the assumption that secondary wild cycles exist. As previously shown the adaption of *A. albopictus*, to CHIKV, and replacing *Ae. aegypti* in urban area is attributed to

the substitution of amino acid alanine by valine at position 226 in the envelope gene E1 of the virus (Sawicki and Sawicki 1994; Tsetsarkin, Vanlandingham et al. 2007).

This particular amino acid substitution were stick to CHIKV isolate only from *Ae. Albopictus* during Chikungunya outbreaks observed in Cameroon (2006) and Gabon (2007), where *Ae. albopictus* has displaced *Ae. aegypti* supports the case for independent mutations (Fontenille and Toto 2001; Krueger and Hagen 2007). *Ae. aegypti* had been the primary vector for CHIKV in Asian urban cycles. During the current resurgence, *Ae. aegypti*, remained as the major vector in the initial phase of CHIKV emergence in Kenya, Seychelles, Comoros, Singapore and India (Chretien, Anyamba et al. 2007; Kaur, Ponniah et al. 2008; Kumar, Chhabra et al. 2008; Sang, Ahmed et al. 2008; Leo, Chow et al. 2009; Ng, Tan et al. 2009). However, *Ae. albopictus* emerged as the major CHIKV vector in the Reunion Island, Mayotte, Cameroon, Gabon, Thailand and Malaysia (Delatte, Paupy et al. 2008; Bagny, Delatte et al. 2009), as well as in India, Singapore, and Sri Lanka, during the late phase of outbreaks (Schuffenecker, Iteaman et al. 2006; Kumar, Joseph et al. 2008; Santhosh, Dash et al. 2008; Ng, Tan et al. 2009; Samuel, Krishnamoorthi et al. 2009; Thavara, Tawatsin et al. 2009). Presence of CHIKV in other species of mosquitoes (*Culex spp.* And *Anopheles spp*) are rare and for some other species (*An. Gambiae* and *Cx. quinquefasciatus*) are not feasible for viral transmission *in vitro* (Paterson and McIntosh 1964; Jupp, McIntosh et al. 1981).

## **8. Diagnosis and treatments of CHIKV**

### **a. Diagnosis of CHIKV**

Uncontrolled dispersion of CHIKV and continuously geographical expanding of vector had put a need to develop a quick technique for the detection of CHIKV. Serodiagnosis technique for early and late detection of IgM and IgG respectively is widely used for different alphavirus (Flexman, Smith et al. 1998; Kurkela, Manni et al. 2005; Posey, O'Rourke et al. 2005; Azevedo, Silva et al. 2009; Naish, Hu et al. 2011). Enzyme linked immunoassays (ELISAs) for CHIKV IgM have been developed and are in current use in many countries and labs for diagnosis and research (Borgherini, Poubeau et al. 2008; Yap, Pok et al. 2010; Blacksell, Tanganuchitcharnchai et al. 2011). Caution should be taken while analyzing

serological results as they can give false signals due to CHIKV induced mixed cryoglobulinemia and cross reaction with Semliki forest serocomplex. RT-qPCR is a widely used technique for quick detection and absolute quantification of CHIKV RNA (Pastorino, Muyembe-Tamfum et al. 2004). Numerous commercial kit are now available with high sensitivity and specificity (Panning, Hess et al. 2009).

### **b. Treatment of CHIKV**

Currently there are no recognized antiviral therapies or human vaccines to control the infection by CHIKV. Lack of antiviral drugs and vaccine had push the treatment based on non-salicylate analgesics and non-inflammatory drugs (Pialoux, Gauzere et al. 2007). However combined effort of mouse and nonhuman primate model (Couderc, Chretien et al. 2008; Ziegler, Lu et al. 2008; Labadie, Larcher et al. 2010) clubbing with a new approach with plant products (Li, Wang et al. 2007) is providing the stimulus for antiviral candidate. Thus, different approaches are made for the treatment of CHIKV and associated symptoms.

#### **a. Chloroquine**

Chloroquine and its derivative, hydroxylchloroquine has been in use for long time in treating chronic inflammatory disease such as systemic lupus erythematosus and spondyloarthritis (Ermann and Bermas 2007). Chloroquine was used to inhibit SINV and SFV infectivity *in vitro* (Shimizu, Yamamoto et al. 1972; Coombs, Mann et al. 1981; Helenius, Marsh et al. 1982; Cassell, Edwards et al. 1984) but studies in mice suggested that the drug might enhance viral replication and aggravate the disease (Maheshwari, Srikantan et al. 1991). Chloroquine phosphate has also been used to treat chronic chikungunya arthritis (Brighton 1984). A pilot clinical project assayed that after 200 days PI Chloroquine treated patient declared frequent arthralgia compare to placebo patients (Leyssen, De Clercq et al. 2006; De Lamballerie, Boisson et al. 2008). Thus chloroquine is not justified to be used.

#### **b. Quinine**

This antimalarial drug, inhibits replication of CHIKV *in vitro*. It induces mutation in the nsP1 protein, suggesting impairment of function of the viral guanylyltransferase enzyme. MTase activity in SINV isolates is linked to nsP1 (Mi, Durbin et al. 1989; Mi and Stollar 1991; Laakkonen, Hyvonen et al. 1994; Wang, O'Rear et al. 1996) which has been shown to



be an essential component of SINV pathogenicity in mice (Zhu, Yang et al. 2009). So, quinine appears to be a better candidate for antiviral therapy.

#### **c. Ribavirin**

Ribavirin shows inhibitory activity *in vitro* against RNA viruses with different modes of action depending on the virus (Leyssen, De Clercq et al. 2006). In some cases it inhibits Inosine-5'-monophosphate (IMP) dehydrogenase. In others, it is used as a non-canonical substrate for RNA synthesis introducing mutations which lead to virus inactivation due to error (Crotty, Cameron et al. 2001; Severson, Schmaljohn et al. 2003). In the case of some arenaviruses, ribavirin 5'-tri-phosphate interacts with the viral polymerase (Sun, Chung et al. 2007). Predominant mode of action of ribavirin is antiviral activity against flaviviruses and paramyxoviruses which is mediated by inhibition of IMP dehydrogenase (Leyssen, Balzarini et al. 2005). Therefore, it could be used against alphaviruses.

#### **d. Interferon**

IFN- $\alpha$  was more effective in inhibiting CHIKV replication, which is consistent with other studies on alphaviruses (Briolant, Garin et al. 2004; Gardner, Anraku et al. 2010). A combination of interferon-alpha and ribavirin shows a synergistic effect on the *in vitro* inhibition of CHIKV (Briolant, Garin et al. 2004).

#### **e. Inhibitors of alphavirus entry and maturation**

Inhibiting the viral entry can be a potential target to control CHIKV infection. It's been shown that CHIKV infection of human cells can be inhibited by impairing the maturation of the CHIKV E2 surface glycoprotein using furin inhibitors (Ozden, Lucas-Hourani et al. 2008).

#### **f. Carbodine**

Recent studies suggested the potential antiviral activity of carbocyclic analogue of cytidine (cyclopentylcytosine or carbodine) against VEEV (Julander, Bowen et al. 2008). In culture condition, carbodine is having a broad antiviral spectrum, against several unrelated

viruses (Andrei and De Clercq 1990; Neyts, Meerbach et al. 1996) although cytotoxicity has been shown.

#### **g. Small RNA molecules**

Mixture of four short interfering RNAs (O'Brien 2007) can inhibit VEEV and antisense morpholino oligomers has been valued for the inhibition of SINV infection, in cell culture and in mice (Paessler, Rijnbrand et al. 2008). These would suggest that the same approach could be applied for CHIKV.

#### **h. Other plant compounds**

Recent studies have shown that compound extract from plants have encouraging antiviral effects against certain RNA viruses. The seco-pregnane steroid glaucogenin C and its monosugar-glycoside cynatratoside A extracted from *Strobilanthes cusia*, together with three new pentasugar-glycosides of glaucogenin C from *Cynanchum paniculatum*, can suppress a range of positive-strand RNA viruses including Tobacco mosaic virus (TMV), and the alphaviruses, SINV, EEEV, and Getah virus in cell culture. Moreover, mice were protected from lethal SINV infections with no adverse effects of the compounds on the infected animals (Li, Wang et al. 2007).

#### **i. nsPs active domains as a target for CHIKV inhibition**

Recent efforts have focused on the identification of specific inhibitors of viral enzymes involved in replication. Availability of enzyme production processes, activity assays, and structural data could therefore provide a basis for inhibitor screening of non-structural proteins (Gould and Higgs 2009).

#### **j. Vaccine development**

An alternative and straightforward approach for viral disease control is the use of vaccines which could be the most cost effective measures of protecting population at risk of CHIKV induced disease. Vaccination approach is widely used from long time after its discovery. Most of the virus, such as small pox, has been eradicated globally and others, like polio, will be eradicated soon. Different approach had been used for the development of

vaccine against CHIKV. In general this vaccine will elicit neutralizing antibody and protect against CHIKV replication and disease. A live attenuated CHIKV vaccine was developed by US army TSI-GSD-218, strain 181/25, is immunogenic in mice, rhesus monkey and human but proved to be reactogenic during phase II safety studies (Edelman, Tacket et al. 2000). A new approach is in the form of chimeric alphavirus, where VEEV (strain TC-83), EEEV (strain BeAr436087), and SINV (strain AR339) specific nonstructural protein is replaced by CHIKV nonstructural protein coding region, whereas the replicase of the other virus were retained (Wang, Volkova et al. 2008) (**Figure 20**). This chimeric vaccine thought to produce robust humoral immunity in vaccinated mice, no detectable reactogenicity and no sign of neurological disease. They also produced robust neutralizing Antibody titers. The other approach for the vaccine development includes DNA (Muthumani, Lankaraman et al. 2008) and virus like particle CHIKV vaccine in primates (Akahata, Yang et al. 2010). These upcoming techniques for vaccine development are relatively safe and elicit very strong neutralizing anti-CHIKV response.

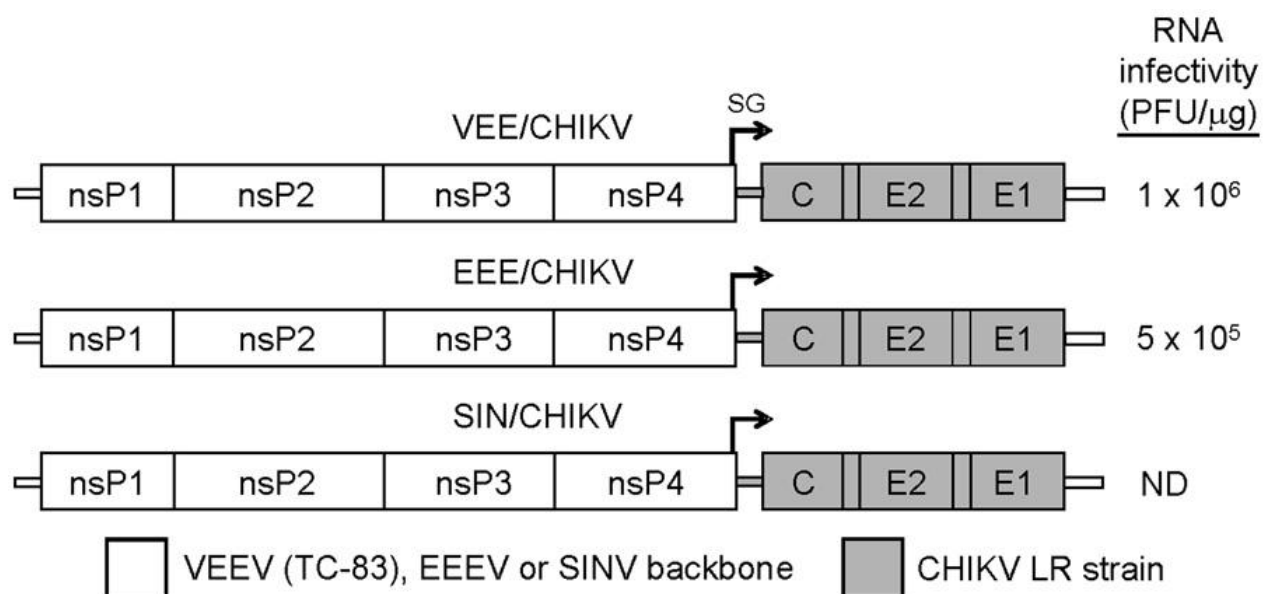

**Figure 20: An outline of chimeric alphavirus**

(Wang, Volkova et al. 2008).

#### **k. Immune (Immunoglobulin, Ig) serum**

Recently it was observed that a preparation of anti CHIKV human Immunoglobulins may constitute an effective medical intervention for humans with a known exposure to CHIKV who are at risk of severe disease (neonates born to viremic mothers as well as for immunocompromised patients). This approach should be applicable to other emerging infectious agents for whom we don't have either the treatment or available prevention (Couderc, Khandoudi et al. 2009).

### **9. Public health response**

An enhanced surveillance system by updating medical practitioners and educating people for environmental hygiene and sanitation and good housekeeping can help in the early detection of alphavirus outbreak as well as recognition of disease. Extensive “search and destroy” operation can be carried out by treating the Aedes breeding habitat with larvicides, thermal fogging and residual spraying (Ho, Ang et al. 2011). Since neonates and young infants are more prone to CHIKV infection, parental training during perinatal period and distribution of impregnated mosquitoes nets and use of protective clothing should be carried out during the outbreak. The formulation of new repellents is required since DEET (N, N-diethyl-3-methylbenzamide) is having potential neurotoxic effects.

## II. Immune response

All living organisms have developed several mechanisms for their protection by invading microorganisms. One of these mechanisms is the innate immune system which makes the first line of defense for the detection and removal of the harmful microorganism. The innate immunity use multiple strategies to detect the molecular signatures of invading viruses. These viruses have unique molecular features, such as viral genome or viral replication intermediates, known as PAMPs. These PAMPs are recognized by a plethora of pattern recognition receptors (PRRs) such as endosome based Toll-like receptors (TLR), cytosol based Retinoic acid-inducible gene I like receptors (RLR), Absent in melanoma 2 (AIM2) like Receptors (ALRs) and Nucleotide binding oligomerization domain like receptors (NLRs). Upon activation, these receptors switch on several genes to mediate the antiviral response through the production of interferon (IFN) and IFN stimulated genes (ISGs), such as Protein kinase R (PKR) and ISGs, or through inflammation by secreting different cytokines and chemokine's. Apoptosis is one of the other mechanism to prevent the spreading and persistence of the virus. Generally two type of apoptotic pathway are involved in defense system, one is the extrinsic pathway and the other is the intrinsic pathway.

The innate immune system comprises of different cells such as monocytes, macrophages, DCs and NK cells. Among these cells, monocytes/macrophages play an essential role in virus-induced arthritis. Synovial macrophages were found to be the target for RRV infection and persistence causing severe chronic arthritis (Fraser, Cunningham et al. 1981; Linn, Mateo et al. 1998). These persistently infected macrophages secrete MCP1, CXCL8 and many other cytokines and chemokines. Other cells of immune system like DC and NK cells together with adaptive immune cells, like T and B cells, are known to regulate the immunopathology of virus-induced arthritis. To skip all of these defense mechanisms these viruses have developed different strategies at different level, such as the inhibition of IFN synthesis or of the IFN signaling pathway, interference with IFN induced proteins. Some of these virus genes are homologous to cytokines and chemokines and can also interfere with apoptotic pathways.

## **A. The innate immune system**

The immune system is a complex and dynamic network of soluble factors and specific cells. Function of the immune system is to maintain the individual organism in a healthy state by protecting them from invading pathogens, which are detected as a 'non self' antigen to it. Generally immune system act in two steps, the first one being the 'recognition' of the pathogen and second one is the 'response' to the pathogen.

The mammalian immune system is comprised of two types of immune system; the innate and the acquired immunity, based on the use of either germline encoded or somatically generated receptors, respectively. As the thesis is mainly focused on the interaction between CHIKV and monocyte/macrophages, "soldier" of the innate immune system, the role of the adaptive immune system to control the alphavirus/CHIKV infection will not be discussed in details.

The innate immune system is the first line of host defense against pathogens. It is based principally on physical and chemical barriers to infection, represented by antimicrobial secretions from vascular endothelium, ciliated respiratory epithelium, epidermis and mucosal surfaces (Medzhitov and Janeway 2000; Basset, Holton et al. 2003). On the other hand cellular components of innate immunity include those white blood cells which are not B or T lymphocytes such as antigen-presenting Dendritic cells (DCs), phagocytic macrophages and granulocytes, cytotoxic natural killer (NK) cells, and  $\gamma\delta$  T lymphocytes (Basset, Holton et al. 2003; Mogensen 2009).

## **B. The Pathogen Recognition Receptors (PRRs)**

Initially the innate immune response was thought to be completely nonspecific, but recent development from last few years based on the hypothesis of germline-encoded PRRs had led to the selectivity of the innate immune response against pathogens (microbes and danger signals). These PRRs possess common characteristics. First, PRRs recognize not exclusively microbial components, known as pathogen associated molecular patterns (PAMPs), which are associated with the microorganism and are essential for their survival. Second, PRRs are constitutively expressed by the host which detects the pathogens regardless of their life-cycle

stage. Third, PRRs are germline encoded, nonclonal, expressed on almost all cells, and independent of immunologic memory (Akira, Uematsu et al. 2006).

Different PRRs react with specific PAMPs, show distinct expression patterns, activate specific signaling pathways and lead to distinct anti-pathogen responses (Medzhitov and Janeway 1997). Some of these receptors are transmembrane proteins (e.g., TLRs and Dectins), some are secreted (e.g., pentraxins and collectins), and some are intracellular cytoplasmic receptors (e.g., RIG-I/MDA-5, NODs) (Brown 2006; Meylan, Tschopp et al. 2006). All these receptors detect conserved microbial structures (PAMPs) and function as PRRs.

### **1. Secreted pattern recognition molecules**

Mannan-binding lectin (MBL), C-reactive protein (CRP), and serum amyloid protein (SAP) are secreted PRRs produced by the liver at the early stages of infection (Gewurz 1982; Pepys 1982; Schwalbe, Dahlback et al. 1992; Fraser, Koziel et al. 1998).

- CRP and SAP are members of the pentraxin family, and both can function as opsonins upon binding to phosphorylcholine on bacterial surfaces as well as activate the classical complement pathway by binding to C1q (Gewurz 1982; Schwalbe, Dahlback et al. 1992; Agrawal, Shrive et al. 2001). This action will lead to the removal of the pathogens by lysis or phagocytosis.
- MBL is a member of the collectin and complement families, typically characterized by the presence of a collagenous region and a C-type lectin (CTL) domain, forming oligomeric receptors and also includes pulmonary surfactant proteins A and D (Epstein, Eichbaum et al. 1996; Holmskov 2000). MBL binds specifically to terminal mannose residues, which are abundant on the surface of many microorganisms, and associates with MBL-associated serine proteases (MASP). MASP1 and MASP2 are activated by MBL and initiate the lectin pathway of complement by cleaving C2 and C4 proteins (Fraser, Koziel et al. 1998).

## 2. Transmembrane receptors:

**Non- TLRs:** Several PRRs (which are not TLRs) are expressed on macrophages cell surface and are involved in phagocytosis of microorganisms.

- Macrophage mannose receptor (MMR) is a member of the C-type lectin family and is closely related to DEC205, a receptor expressed on dendritic cells. MMR interacts and help in phagocytosis of variety of gram-positive and gram-negative bacteria and fungal pathogens and their delivery into the lysosomal compartment where they are destroyed by lysosomal enzymes (Fraser, Koziel et al. 1998). The function and ligand specificity of DEC205 has not yet been characterized, but its similarity to MMR and its expression on dendritic cells suggest that it may also function as a phagocytic receptor.
- Macrophage scavenger receptor (MSR) is another phagocytic pattern recognition receptor expressed on macrophages. MSR belongs to the scavenger receptor type A (SR-A) family and has an unusually broad specificity to a variety of ligands, including double-stranded RNA (dsRNA), lipopolysaccharide (LPS), and lipoteichoic acid (LTA) (Pearson 1996; Peiser, Mukhopadhyay et al. 2002). MSR function as to protects against endotoxic shock by scavenging LPS and in host defense, as demonstrated in MSR-deficient mice to *Listeria monocytogenes*, herpes simplex virus, and malaria infections (Suzuki, Kurihara et al. 1997; Thomas, Li et al. 2000). Another Scavenger receptor (SR) family member, macrophage receptor with collagenous structure (MARCO), binds to bacterial cell walls and LPS, and it also mediates phagocytosis of bacterial pathogens (Elomaa, Kangas et al. 1995).

**TLRs:** The family of TLRs is the major and most extensively studied class of PRRs. TLRs derived their name and were originally discovered based on homology to the *Drosophila melanogaster* Toll protein (Medzhitov, Preston-Hurlburt et al. 1997), which plays a role in dorso-ventral patterning during embryogenesis as well as in the antifungal response in *Drosophila* (Lemaitre, Nicolas et al. 1996). TLRs are type I transmembrane proteins with ectodomains containing leucine-rich repeats that mediate the recognition of PAMPs;



transmembrane domains; and intracellular Toll–interleukin 1 (IL-1) receptor (TIR) domains required for downstream signal transduction (**Figure 21**).

So far, 10 and 12 functional TLRs have been identified in humans and mice, respectively, with TLR1–TLR9 being conserved in both species. Mouse TLR10 is not functional because of a retrovirus insertion, and TLR11, TLR12 and TLR13 have been lost from the human genome. Studies in deficient mice in each TLR have demonstrated that each TLR has a distinct function in terms of PAMP recognition and immune responses. TLR ectodomains has provided structural insights suggesting that several PAMPs act as ‘ligands’ for TLRs (Akira, Uematsu et al. 2006; Jin and Lee 2008). PAMPs recognized by TLRs include lipids, lipoproteins, proteins and nucleic acids derived from a wide range of microbes such as bacteria, viruses, parasites and fungi (Akira, Uematsu et al. 2006).

TLRs are largely divided into two subgroups depending on their cellular localization and respective PAMP ligands:

- One group is composed of TLR1, TLR2, TLR4, TLR5, TLR6 and TLR11, which are expressed on cell surfaces and recognize mainly microbial membrane components such as lipids, lipoproteins and proteins.
- The other group is composed of TLR3, TLR7, TLR8 and TLR9, which are expressed exclusively in intracellular vesicles such as the endoplasmic reticulum (ER), endosomes, lysosomes and endolysosomes, where they recognize microbial nucleic acids (**Figure 22**).

TLRs are expressed on various immune cells, including macrophages, DCs, B cells, specific types of T cells and even on non-immune cells such as fibroblasts and epithelial cells with nevertheless important innate immune functions. Expression of TLRs is not static but rather is modulated rapidly in response to pathogens, a variety of cytokines, and environmental stresses (Akira, Uematsu et al. 2006). The role of TLR signaling in controlling pathogen phagocytosis is controversial. Early papers suggested a role of TLR in phagocyte maturation, whereas others did not find such a role (Blander and Medzhitov 2004; Yates and Russell 2005).

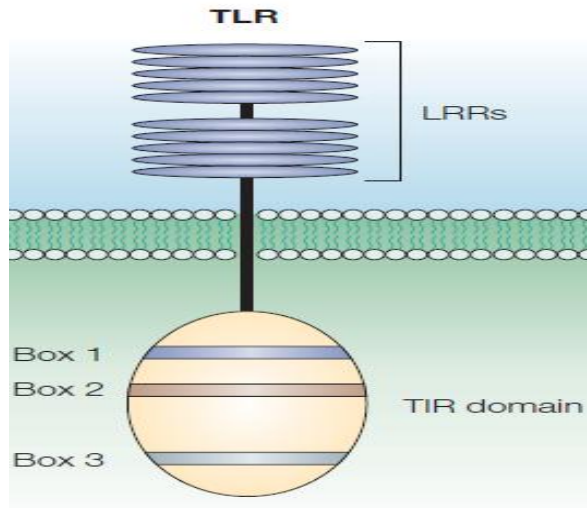

**Figure 21: TLR structure**

*Toll-like receptors (TLRs) have a conserved cytoplasmic domain that is known as the Toll/IL-1R (TIR) domain. The TIR domain is characterized by the presence of three highly homologous regions (known as boxes 1, 2 and 3). TLRs have tandem repeats of leucine-rich regions (known as leucine rich repeats, LRR) (Akira and Takeda 2004).*

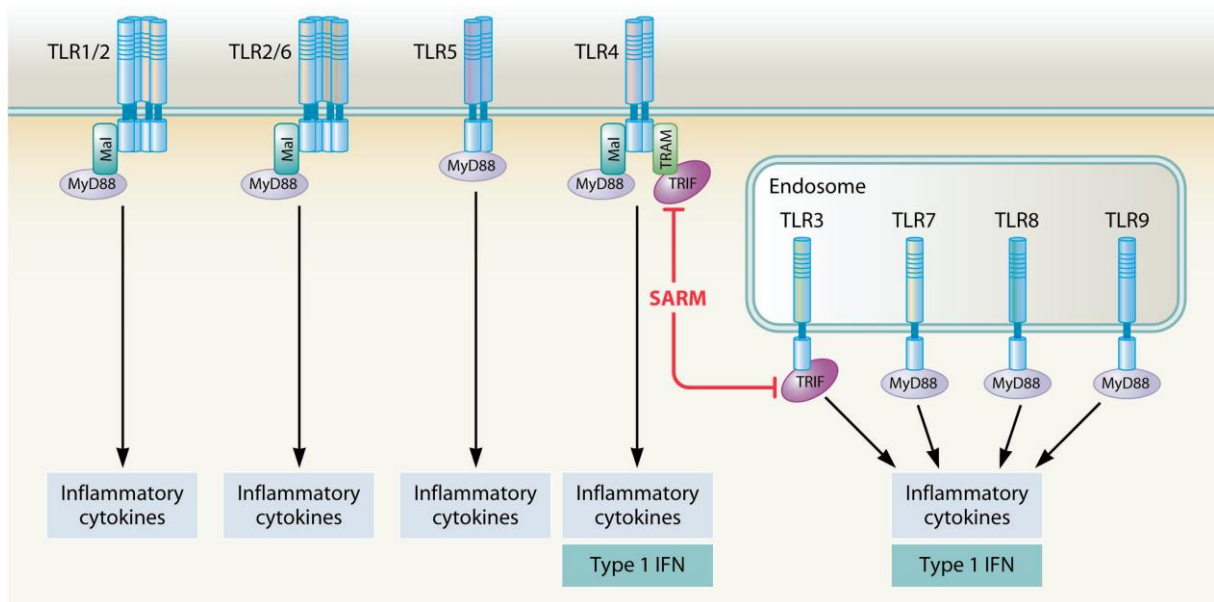

**Figure 22: TLRs and TIR domain-containing adaptor molecules**

*TLR1/2 and TLR2/6 utilize MyD88 and Toll/IL-1R domain containing adaptor protein (TIRAP) as adaptors. TLR3 is dependent on TRIF for signaling. In the case of TLR4, four different adaptors, i.e., MyD88, TIRAP, TRIF, and TRAM, are involved, whereas TLR5, -7, -8, and -9 utilize only MyD88. The fifth adaptor, Sterile $\alpha$ - and armadillo-motif containing protein (SARM), negatively regulates TRIF-dependent signaling. Overall, MyD88-dependent signaling induces proinflammatory cytokine production, whereas TRIF-dependent signaling stimulates a type I IFN response. In pDCs, stimulation of TLR7 or TLR9 induces type I IFN production by a mechanism dependent on MyD88 (Mogensen 2009).*

**a. Cell surface transmembrane TLRs (Nucleic acid independent viral recognition)**

TLR4 and TLR2 (in association with TLR1 & TLR6) are also well known for virus recognition, whereas TLR5 and TLR11 are not well known for virus recognition.

**i. TLR4**

The first indication that mammalian TLRs may function as pattern recognition receptors came with the description of a human homologue of *Drosophila* Toll, now known as TLR4 (Medzhitov, Preston-Hurlburt et al. 1997). Subsequently, positional cloning analysis of the LPS-nonresponsive mouse strain, C3H/HeJ, showed that a point mutation in the TIR domain of TLR4 was responsible for the defect in LPS signal transduction. Another mouse strain, B10.ScCR, did not respond to LPS and turned out to lack the genomic region that contains the entire TLR4 gene. Finally, mice with a targeted deletion of the TLR4 gene were unresponsive to LPS. Together, these studies demonstrated the essential role for TLR4 in recognition of a major component of gram-negative bacteria (Poltorak, He et al. 1998; Hoshino, Takeuchi et al. 1999; Qureshi, Lariviere et al. 1999) (**Figure 23**). TLR4, however, is not the sole receptor involved in LPS recognition. Transport of LPS molecules in the serum is mediated by LPS-binding protein (LBP) (Ulevitch and Tobias 1995).

At the plasma membrane, LBP is thought to transfer LPS monomers to CD14, a GPI-linked cell surface protein in monocytes and myeloid cells (Ulevitch and Tobias 1995).

Exactly how CD14 facilitates recognition of LPS by TLR4 is not clear, but its critical role is underscored by the LPS hyporesponsive phenotype of CD14-deficient mice (Haziot,

Ferrero et al. 1996; Moore, Andersson et al. 2000). Over expression of TLR4 did not confirm LPS responsiveness on human embryonic kidney 293 cell, which suggest the additional molecule requirement for TLR4 mediated LPS signaling, which subsequently was identified as the secreted molecule MD2. MD-2 lacks a transmembrane anchor but is associated with the extracellular region of TLR4 (Shimazu, Akashi et al. 1999). MD-2 is required for cellular responsiveness to LPS, as demonstrated by both transfection studies and an analysis of a CHO cell line with a mutated MD-2 gene (Shimazu, Akashi et al. 1999; Schromm, Lien et al. 2001). Although the cell-surface events that confer LPS recognition have not been unambiguously determined, most of the available evidence indicates that a complex of TLR4/MD-2/CD14 directly binds LPS (Lien, Means et al. 2000; Poltorak, Ricciardi-Castagnoli et al. 2000; da Silva Correia, Soldau et al. 2001).

CD14 in conjugation with TLR4 not only recognized LPS but also responds to F protein of respiratory syncytial virus (Kurt-Jones, Popova et al. 2000) and envelope protein of mouse mammary tumor virus (MMTV) (Haynes, Moore et al. 2001; Rassa, Meyers et al. 2002).

#### ii. **TLR2 (in combination with TLR1 & 6)**

TLR2 recognizes the largest number of ligands. The list includes peptidoglycan (**Figure 23**) (Takeuchi, Hoshino et al. 1999; Kurt-Jones, Popova et al. 2000), bacterial lipoproteins derived from *M. tuberculosis*, *Borrelia burgdorferi*, *Treponema palladium* and *Mycoplasma fermentans* (Aliprantis, Yang et al. 1999; Brightbill, Libraty et al. 1999; Takeuchi, Kaufmann et al. 2000), a phenol soluble factor from *Staphylococcus epidermidis* (Hajjar, O'Mahony et al. 2001), LPS from *Prophyromonas gingivitis* (Hirschfeld, Weis et al. 2001), *Leptospira interrogans* (which differs in structure from the LPS of gram-negative bacteria) (Werts, Tapping et al. 2001), glycosylphosphatidylinositol lipid from *Trypanosoma cruzi* (Campos, Almeida et al. 2001), and zymosan, a component of yeast cell walls (Underhill, Ozinsky et al. 1999). TLR2 does not recognize these PAMPs independently, but through heterodimeric interactions with either TLR1 or TLR6 (Ozinsky, Underhill et al. 2000; Takeuchi, Kawai et al. 2001).

It was also observed that inflammatory monocytes induce type I interferon in response to viral but not bacterial ligands through TLR2 (Barbalat, Lau et al. 2009). For example, TLR

2 is stimulated by a variety of viruses like Herpes simplex virus -1 and 2 (HSV-1 and HSV-2) (Kurt-Jones, Chan et al. 2004; Sato, Linehan et al. 2006), HCV (Chang, Dolganiuc et al. 2007), Lymphocytic choriomeningitis virus (LCMV) (Zhou, Kurt-Jones et al. 2005), Varicella zoster virus (VZV) (Wang, Kurt-Jones et al. 2005), and Vaccinia virus (VV) (Zhu, Martinez et al. 2007). Human cytomegalovirus (HCMV) gB protein and measles virus (MV) H protein also activate TLR2 (Bieback, Lien et al. 2002; Compton, Kurt-Jones et al. 2003).

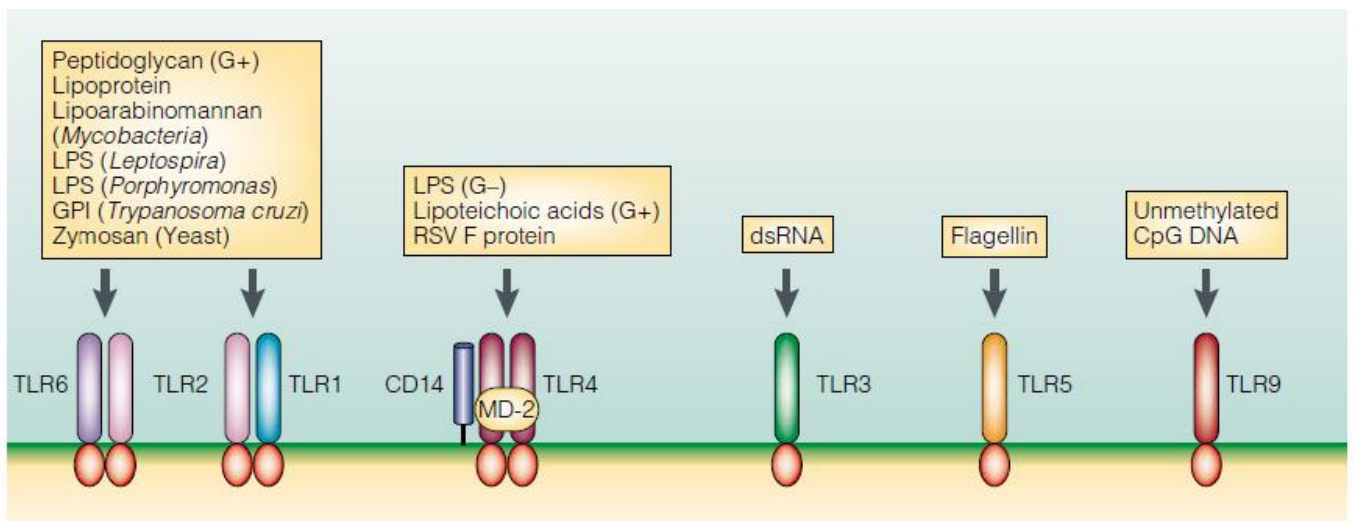

**Figure 23: Ligand specificities of TLRs**

*Toll-like receptors (TLRs) recognize a variety of pathogen-associated molecular patterns (PAMPs). Recognition of lipopolysaccharide (LPS) by TLR4 is aided by two accessory proteins: CD14 and MD-2. TLR2 recognizes a broad range of structurally unrelated ligands and functions in combination with several (but not all) other TLRs, including TLR1 and TLR6. TLR3 is involved in recognition of double-stranded (dsRNA). TLR5 is specific for bacterial flagellin, whereas TLR9 is a receptor for unmethylated CpG motifs, which are abundant in bacterial DNA. G+, Gram-positive; G-, Gram negative; GPI, glycosylphosphatidylinositol; RSV, respiratory syncytial virus (Medzhitov 2001).*

### iii. **TLR5**

TLR5 recognizes the flagellin protein component of Gram positive and Gram negative bacterial (**Figure 23**) (Hayashi, Smith et al. 2001; Smith and Ozinsky 2002). TLR5 is supposed to detect domain D1 of flagellin which is relatively conserved among different species (Hayashi, Smith et al. 2001). TLR5 is expressed by epithelial cells, monocytes, and immature DCs, whereas highly expressed in the lungs and seems to play an important role in the defense against pathogens of the respiratory tract. TLR5 is not involved in virus detection.

### iv. **TLR 11**

TLR11 is highly expressed by the kidney and bladder of mouse, which is a relative of TLR5, thought to recognize uropathogenic bacterial components, as TLR11-deficient mice were found to be susceptible to infection with these bacteria (Zhang, Zhang et al. 2004). TLR11 also recognizes the profilin-like molecule derived from *Toxoplasma gondii* (Yarovinsky, Zhang et al. 2005). TLR11 is also not involved in virus detection.

## **b. Intracellular vesicle TLRs**

Several kinds of viruses utilize host endocytic pathways like endocytosis or autophagy, at the cell entry phase or budding, which are recognize by endosomal innate immune sensors (Kawai, Sato et al. 2004; Uematsu, Sato et al. 2005). Endosomal TLRs, including TLR3, TLR7, TLR8 and TLR9, share the property of being activated by nucleic acids. The antiviral functions of the nucleic acid-binding TLRs are correlated with their unique subcellular environments. TLR3, 7, 8, and 9 are present in the endoplasmic reticulum (ER) and are delivered to the endosomes through their association with ER membrane protein UNC93B1 (Latz, Schoenemeyer et al. 2004; Kim, Brinkmann et al. 2008). This strategic compartmentalization and trafficking of TLRs appears to have evolved to prevent inadvertent reaction to host nucleic acids. However, exceptions have been reported for TLR9 and TLR3 in their cellular localization.

i. **TLR3**

It is a type I integral membrane glycoprotein located in intercellular endosomal membranes. The N-terminal region of the protein recognizes the ligand, dsRNA, in the lumen of endosomes whereas the C-terminal signaling domain resides in the cytoplasm (Matsumoto, Funami et al. 2003). TLR3 was originally identified as a synthetic analog of double-stranded RNA (dsRNA), polyinosinic-polycytidylic acid (poly (I: C)), which mimics viral infection and induces antiviral immune responses through type I interferon and inflammatory cytokines (Matsumoto, Funami et al. 2003; Kawai and Akira 2010).

It is expressed in specific myeloid cells, vascular endothelial cells and airway epithelial cells. Human TLR3 is highly expressed in immature DC whereas mouse TLR3 is highly expressed in macrophages (Rehli 2002).

Viral dsRNA in infected cells can arise from several sources. The genome of the infecting virion itself could be dsRNA, as is the case for natural dsRNA viruses. Sometimes double strand defective genomes are packaged in a population of single stranded RNA (ssRNA) virus. Intracellular viral dsRNA can be generated by a variety of means. Formation of dsRNA replication intermediates during ssRNA virus's replication (including CHIKV), where intermediate formation is an obligatory step in virus reproduction. For DNA viruses, complementary mRNAs are often produced; they are encoded by partially overlapping genes, located on the opposite strands of the viral genome.

TLR3 recognizes influenza virus, vaccinia virus, flavivirus, and MCM, WNV, encephalomyocarditis virus, respiratory syncytial virus (Wang, Town et al. 2004; Rudd, Burstein et al. 2005; Akira, Uematsu et al. 2006; Kawai and Akira 2006; Hardarson, Baker et al. 2007; Pichlmair and Reis e Sousa 2007; Kawai and Akira 2008). Evidence showed that in case of encephalomyocarditis virus and SFV, TLR3 can recognize dsRNA produced during viral infection in the context of phagocytosed dying cells. Both the viruses are positive strand ssRNA viruses and generate dsRNA intermediates during viral replication (Schulz, Diebold et al. 2005).

Work on MCMV infection showed that TLR3 dependent signaling is needed for the defense against the systemic infection. TLR3-deficient mice show a higher viral load in contrast to wild-type mice, with high degree of susceptibility, reduced production of type I IFN, IL-12p40, and IFN $\gamma$  and reduced activation of NK and Natural killer T (NKT), suggesting a protective role of TLR3 (Tabeta, Georgel et al. 2004). Apart from the protection from virus, few study reported the pathogenesis through TLR3 dependent response. WNV induces inflammatory responses in a TLR3-dependent manner which results in enhanced brain infection. TLR3-deficient mice are more resistant to lethality than wild-type mice as a result of reduced virus entry into the brain (Wang, Town et al. 2004). Low levels of inflammatory cytokines, which result in increased survival despite higher viral loads in the lung was observed in TLR3-deficient mice infected with influenza A virus (Le Goffic, Balloy et al. 2006)

Among the TLR family members, only TLR3 does not use myeloid differentiation factor 88 (MyD88) as a signaling adaptor (Akira, Uematsu et al. 2006). This MyD88-independent pathway is initiated by another TIR-domain-containing adaptor protein inducing IFN- $\beta$  (TRIF) (Hoebe, Du et al. 2003; Yamamoto, Sato et al. 2003). TRIF activates TNF receptor associated factor (TRAF) family- member-associated NF- $\kappa$ B activator (TANK) binding kinase 1 (TBK1; also known as NAK or T2K) via TRAF3 (Hacker, Redecke et al. 2006; Oganessian, Saha et al. 2006). TBK1 comprises a family with inducible inhibitor of NF $\kappa$ B (I $\kappa$ B) kinase (IKK-i, also known as IKK-3) and these kinases directly phosphorylate interferon regulatory factor-3 and -7 (IRF-3 and IRF-7) (Fitzgerald, McWhirter et al. 2003; Sharma, tenOever et al. 2003).

As a consequence of phosphorylation, IRF3 and IRF7 form hetero- or homodimers, translocate to the nucleus, and, in association with transcriptional co-activators such as “cAMP responsive element binding protein” (CREB) and p300, bind to target sequences in DNA, such as IFN-stimulated response elements (Fitzgerald, McWhirter et al. 2003; Sharma, tenOever et al. 2003) (**Figure 24**).



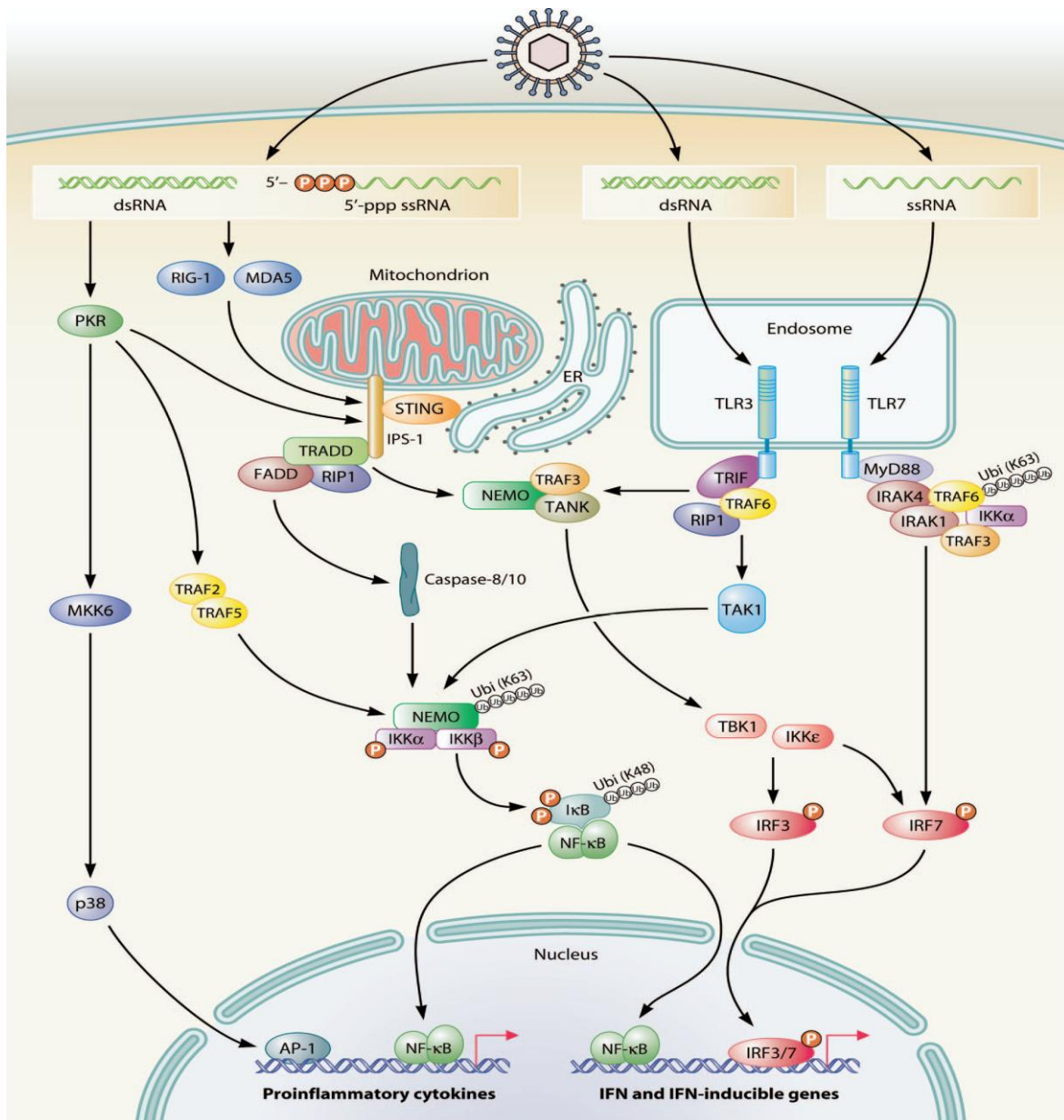

**Figure 24: Intracellular RNA recognition and signaling**

*Cytosolic dsRNA or 5'-triphosphate ssRNA is recognized primarily by the cytoplasmic RNA helicases RIG-I and MDA5, and trigger signaling to NF- $\kappa$ B and IRF3 via. dsRNA can also be recognized by TLR3 localized in the endosomal compartment or by cytosolic PKR, but whereas TLR3 triggers signaling to NF- $\kappa$ B and IRF3, PKR instead activates NF- $\kappa$ B and MAPKs. Finally, ssRNA is recognized by TLR7/8 in endosomes and induces signaling to IRF7 as well as to NF- $\kappa$ B and MAPKs (Mogensen 2009).*

TRIF-dependent activation of NF- $\kappa$ B occurs through binding of TRAF6 to TRIF and subsequent ubiquitination-dependent recruitment and activation of TAK1 (Sato, Sugiyama et al. 2003). For robust NF- $\kappa$ B activation, a second molecule, receptor interacting protein 1 (RIP1), involved in TNF-receptor mediated NF- $\kappa$ B activation, is also recruited to TRIF (Meylan, Burns et al. 2004). RIP1 is polyubiquitinated at K63 to form a complex with TRAF6, and these two molecules appear to cooperate in facilitating TAK1 activation. Collectively, TRIF forms a multiprotein signaling complex along with TRAF6, TNF $\alpha$  receptor associated death domain (TRADD), Pellino-1 and RIP1 for the activation of TAK1, which in turn activates the nuclear factor kappa B (NF- $\kappa$ B) and mitogen activated protein kinase (MAPK) pathways.

## ii. **TLR7/8**

TLR7/8 recognize ssRNA and show high homology to each other. There is high expression of TLR7 on plasmacytoid DC (pDCs) that are able to produce large amounts of type I interferon after virus infection, and cytokine induction (Colonna, Trinchieri et al. 2004; Liu 2005; Akira, Uematsu et al. 2006; Kawai and Akira 2006). TLR7 and TLR8 are expressed in mice, but mouse TLR8 appears to be nonfunctional. TLR8 is expressed in various tissues, with its highest expression in monocytes, and is upregulated after bacterial infection. Recently it has been reported that, in case of Vascular stomatitis virus (VSV) infection, autophagy can also deliver viral TLR7 ligand to endosomal compartment, ultimately recognizing the viral genome (Lee, Lund et al. 2007).

Using stabilized RNA and viral infection, the natural ligand of mouse TLR7 and human TLR8 was identified as viral, guanosine (G)- and uridine (U)-rich ssRNA (Diebold, Kaisho et al. 2004; Heil, Hemmi et al. 2004; Lund, Alexopoulou et al. 2004). It was suggested by Diebold *et al.* that the uracil content and motifs in Oligoriboxynucleotide (ORNs) define the ability of the ORN to act as a TLR7 ligand, whereas the G content is important for TLR8 ligands. Since many enveloped viruses enter the cytosol through the endosomal compartment, the highly acidified phagolysosomal environment containing abundant degradation enzymes can damage the viral particles, leading to ssRNA release and recognition by TLR7 or TLR8.

Mouse TLR7 and human TLR8 recognize synthetic antiviral imidazoquinoline (Imiquimod) (Soria, Myhre et al. 2000). Loxoribine, a guanine nucleotide analog, was characterized as a ligand restricted to TLR7 (Heil, Ahmad-Nejad et al. 2003; Lee, Chuang et al. 2003). However, in a recent, coincubation of loxoribine with phosphorothioate oligo (deoxythymidine)<sub>17</sub> led to a complete switch from TLR7- to TLR8- mediated NF- $\kappa$ B activation, suggesting the presence of thymidine (T)-rich oligodeoxynucleotides (ODNs) might enhance the affinity of loxoribine to TLR8, although the basal affinity of loxoribine to TLR8 is too weak to detect in current biological assays (Jurk, Kritzler et al. 2006).

TLR7 and TLR9 activation triggers IFN production in pDCs, a subset of DCs specialized in producing large amounts of type I IFN in response to viral infection. After the engagement of TLRs by their cognate PAMPs, myeloid differentiation factor 88 (MyD88), an encoded protein has an amino (N)-terminal death domain (DD), which is separated from its carboxy (C)-terminal TIR domain by a short linker sequence recruits the IL-1 receptor-associated kinases IRAK4, IRAK1, IRAK2 and IRAK-M. The IRAKs are characterized by an N-terminal DD and a C-terminal serine/threonine kinase domain. IRAK activation results in an interaction activation of TRAF6 (Akira and Takeda 2004; Takeda and Akira 2005). TRAF6 then catalyzes the synthesis of polyubiquitin linked to Lys63 (K63) on target proteins, including TRAF6 itself and on IKK- $\gamma$ /NF- $\kappa$ B essential modulator (NEMO), together with an ubiquitination E2 enzyme complex consisting of UBC13 and UEV1A (Chen 2005). Activated TRAF6 also activate transforming growth factor- $\beta$  (TGF- $\beta$ )-activated kinase 1 (TAK1) (Deng, Wang et al. 2000; Wang, Deng et al. 2001). IRAK1-TRAF6 complex then disengages from the receptor and interacts with complex consisting of TGF $\beta$  activated kinase 1 (TAK1), TAB1, and TAB2 or TAB3. This interaction induces phosphorylation of TAB2/TAB3 and TAK1, which then translocate together with TRAF6 and TAB1 to the cytoplasm. TAK1 is subsequently activated in the cytoplasm, leading to the activation of IKKs, which then phosphorylate the I $\kappa$ Bs allowing nuclear factor NF- $\kappa$ B to translocate into the nucleus (Ishitani, Takaesu et al. 2003; Akira and Takeda 2004). In-turn TAK1 activates the MAPKs Erk1, Erk2, p38 and Jnk by inducing the phosphorylation of MAPK kinases, which then activate various transcription factors, including activator protein 1 (AP-1), as well as influencing translation (Akira and Takeda 2004) (**Figure 24**).

An additional MyD88-dependent pathway is triggered by TLR7/8 and induces type I IFN production, particularly in pDCs. IRF7, which is constitutively expressed by pDCs, binds MyD88 and forms a multiprotein signaling complex with IRAK4, TRAF6, TRAF3, IRAK1 and IKK $\alpha$  (Kawai, Sato et al. 2004; Kawai and Akira 2008). In this complex, IRF7 becomes phosphorylated by IRAK1 and/or IKK $\alpha$ , dissociates from the complex and translocate into the nucleus to activate the promoters of type I IFN and IFN-inducible genes.

### iii. **TLR9**

Bacterial DNA (CpG) is considered to be an immune stimulant and is recognized by TLR9 (Hemmi, Takeuchi et al. 2000; Krieg 2002). CpG motif is abundant in bacterial genomes and is unmethylated due to absence of methylating enzyme, whereas it is highly methylated in mammalian genomes. The methylated CpG motif does not activate mammalian immune cells (Krieg 2000). CpG directly stimulates B cells, macrophage and DCs cells to secrete T<sub>H</sub>1 like cytokine such as IL-12 and IL-18. TLR<sup>-/-</sup> are defective in response to CpG DNA (Hemmi, Takeuchi et al. 2000) and recent studies indicate that TLR9 alone can presumably recognize CpG DNA directly (Bauer, Kirschning et al. 2001). Endosomal acidification and/ or maturation are prerequisites for the activation of signaling pathway mediated by CpG DNA, which argue for the generation of signaling cascade inside the endosome (Hacker, Mischak et al. 1999; Latz, Schoenemeyer et al. 2004).

TLR9 was also found to increase IFN production by pDCs following infection by DNA virus like murine cytomegalovirus (MCMV), HSV-1, and HSV-2 (Lund, Sato et al. 2003; Krug, French et al. 2004; Krug, Luker et al. 2004).

### **3. Cytosolic PRRs (RLR and NLR)**

After the discovery of TLRs, several classes of cytosolic PRRs, including RIG-I-like receptors (RLRs), which sense RNA; AIM2-like receptors (ALRs), which sense DNA; and

nucleotide-binding oligomerization domain (NOD)-like receptors (NLRs), which are sensors of viral PAMPs and virus-inflicted cellular stress were identified.

The RLR family consists of three members, RIG-I, MDA5 and laboratory of genetics and physiology 2 (LGP2), that detect RNA viruses (Yoneyama and Fujita 2009).

- RIG-I belongs to the DExD /H box-containing RNA helicase family and has two characteristic caspase recruitment domains (CARDs) at its N-terminus in addition to the C-terminal helicase domain. CARD is responsible for the downstream signaling cascade, whereas the C-terminal region containing the helicase domain, requires ATP to activate signaling, is responsible for the recognition of specific viral RNA when overlap with repressor domain (RD) (Cui, Eisenacher et al. 2008; Takahasi, Yoneyama et al. 2008).
- MDA5 was isolated as a gene induced by the IFN- and protein kinase C-activating compound in a melanoma cell line (Kang, Gopalkrishnan et al. 2002). MDA5 shows 23% similarity to RIG-I in the N-terminal tandem CARD and 35% amino acid similarity to RIG-I helicase domains, however, the C-terminal portion of MDA5 lacks inhibitory function similar to RD (Yoneyama, Kikuchi et al. 2005; Saito, Hirai et al. 2007). Functional analyses shows similarity of MDA5 to RIG-I as a positive regulator. MDA5 in virus-induced innate immunity was demonstrated by analysis of KO mice (Kato, Takeuchi et al. 2006). Interestingly, comparison of RIG-I KO and MDA5 KO mice revealed that these sensors detect different types of viruses (Kato, Sato et al. 2005; Kato, Takeuchi et al. 2006). Involvement of MDA5 was also seen in growth inhibition, apoptosis and type I diabetes (Kang, Gopalkrishnan et al. 2004; Smyth, Cooper et al. 2006).
- LGP2 was identified as the gene adjacent to the STAT3 / 5 loci (Cui, Li et al. 2001). LGP2 protein shows 41% and 31% amino acid similarity to helicase domain of RIG-I and MDA5, whereas it is devoid of an N-terminal CARD. Previous study shows that it is having a inhibitory role in RIG-I /MDA5-mediated signaling (Rothenfusser, Goutagny et al. 2005; Yoneyama, Kikuchi et al. 2005; Komuro and Horvath 2006),

However, KO analysis indicated that LGP2 plays a positive role in encephalomyocarditis virus (EMCV) infection (Venkataraman, Valdes et al. 2007).

#### **a. Viral RNA and RNA structure recognized by RLRs**

##### **i. RNA sensors**

Most of ssRNA viruses, including positive and negative-stranded viruses, are recognized by RIG-I, whereas Picornaviridae and murine norovirus (Calcioviridae) recognition is MDA5 dependent (Loo, Fornek et al. 2008; McCartney, Thackray et al. 2008). Double-stranded segmented RNA virus, Reoviridae, is detected by either RIG-I or MDA5 in a segment length-dependent manner (Kato, Takeuchi et al. 2008; Loo, Fornek et al. 2008) (55, 57). Flaviviridae, JEV and HCV are detected specifically by RIG-I, whereas West Nile virus and Dengue virus are likely to be recognized redundantly by both RIG-I and MDA5 (Fredericksen and Gale 2006; Loo, Fornek et al. 2008). Coronaviridae virus like murine hepatitis virus (MHV) was impaired in MDA5 KO cells but not in RIG-I KO cells, suggesting the MDA5-dependent detection of MHV (Roth-Cross, Bender et al. 2008). Most of the viral RNA contain 5'-triphosphate (5'-ppp) which was recognized selectively by RIG-I (Hornung, Ellegast et al. 2006; Pichlmair, Schulz et al. 2006). Host transcripts escaped RIG-I since they are either masked by a 7 – methyl guanosine capping (mRNA) or removed during post-transcriptional modification. A recent study showed that viral genome recognition through RIG-I depend upon replication of the genome but not with the complementary positive-strand RNA suggesting that virion-associated genomes are not sufficient to serve as the viral ligand (Rehwinkel, Tan et al. 2010). In addition, relatively short (approximately 25 bp) dsRNA with at least a single phosphate at either the 5'- or 3'-ends could be recognized by RIG-I (Takahasi, Yoneyama et al. 2008). RIG-I specifically bound to defective interfering (DI) particle but not to full length virus genome in Sendai virus infected cells, shorter subgenomic and subgenomic DI in influenza virus infected cell, negative-strand RNA viruses that contain blunt, short, double-stranded 5'-triphosphate RNA (Schmidt, Schwerd et al. 2009).

Picornaviridae and Calcioviridae are recognized by MDA5, because their 5'-terminus is masked by the viral peptide VPg, resulting in escape from RIG-I detection. It has also been reported that viral genome of Hantaan virus (HTNV), Crimean-Congo hemorrhagic fever virus (CCHFV) (Bunyaviridae), and Borna disease virus (BDV) (Bornaviridae) cannot trigger RIG-I signaling, because their 5'-ppp structure is removed in infected cells, suggesting another viral strategy to escape from RIG-I detection (Habjan, Andersson et al. 2008). Another study reported that highly structured RNA in infected cells is recognized by MDA5 (Pichlmair, Schulz et al. 2009). Recently it was found that Sendai virus infection trigger MDA5 in antiviral defense in vivo (Gitlin, Benoit et al. 2010) whereas it was supposed to be trigger by RIG-I but not MDA5 in vitro (Kato, Takeuchi et al. 2006), revealing the importance of MDA5 in antiviral defense in vivo (Gitlin, Benoit et al. 2010).

#### **$\alpha$ . RIG-I/MDA5 dependent signaling pathway**

After sensing the viral RNA or 5'-phosphate RNA the RLR system get activated through CARD-CARD homotypic interactions between the helicase RIG-I/MDA5 system and adaptor protein. These adaptor protein is characterized independently by different group as interferon- $\beta$  promoter stimulator 1 (IPS-1) (Kawai, Takahashi et al. 2005), CARD adapter inducing IFN- $\beta$  (CARDIF) (Meylan, Curran et al. 2005), mitochondrial antiviral Signaling MAVS (Seth, Sun et al. 2005) and virus-induced signaling adaptor (VISA) (Xu, Wang et al. 2005). IPS-1 consists of an N-terminal single CARD and a proline-rich region in the middle of the protein and a transmembrane domain at its C-terminal end expressed on the outer membrane of mitochondria (Seth, Sun et al. 2005) suggesting the role of mitochondria in RLR mediated signaling. Next molecule to downstream signaling after RLR activation is tumor necrosis factor (TNF) receptor-associated factor (TRAF) family members, a E3 ligase for Lys63-linked polyubiquitination, which directly interacts with the TRAF-interacting motif (TIM) in the PRR of IPS-1 (Oganesyan, Saha et al. 2006; Saha, Pietras et al. 2006). TRAF transmit signals, downstream, to protein kinases, inhibitor of NF- $\kappa$ B (I $\kappa$ B) kinase (IKK) family members, which are essential for the activation of transcription factors IRF-3 / 7 and NF- $\kappa$ B. The canonical IKK complex, consisting of IKK- $\alpha$ , IKK- $\beta$ , and the regulatory subunit NF- $\kappa$ B essential modulator (NEMO) (also termed IKK-c), phosphorylates I $\kappa$ B, and allows

functional NF- $\kappa$ B to translocate to the nucleus (Karin and Ben-Neriah 2000). By contrast, noncanonical IKKs, TRAF family member-associated NF- $\kappa$ B activator (TANK)-binding kinase 1 (TBK1) and IKK-i), phosphorylate IRF3 and IRF7 (Fitzgerald, McWhirter et al. 2003; Sharma, tenOever et al. 2003; Hemmi, Takeuchi et al. 2004; McWhirter, Fitzgerald et al. 2004). TRAF3 is essential for the recruitment of both IKK complexes, whereas TRAF2/6 is likely to be responsible for NF- $\kappa$ B activation (Xu, Wang et al. 2005; Saha, Pietras et al. 2006). TANK and NAK-associated protein 1 (NAP1) are commonly involved in TBK-1 / IKK-i-mediated activation of IRFs (Sasai, Shingai et al. 2006; Guo and Cheng 2007).

NEMO, plays a role in both canonical and noncanonical pathway (Zhao, Yang et al. 2007), suggesting crosstalk between these two IKK complexes in RLR-mediated signaling. Death domain (DD)-containing Fas-associated death domain (FADD) and receptor interacting protein 1 (RIP1) (Balachandran, Thomas et al. 2004; Kawai, Takahashi et al. 2005), interact with the C-terminal portion of IPS-1 and activate NF- $\kappa$ B- via interaction and activation of caspase-8 and caspase-10 (Kawai, Takahashi et al. 2005; Takahashi, Kawai et al. 2006). IRF3 and NF- $\kappa$ B are also activated by a complex of TNFR-associated DD (TRADD), IPS-1, TRAF3, TANK, FADD, and RIP1 (Michallet, Meylan et al. 2008). MITA, a four transmembrane domains, interacts directly with IPS-1 and IRF-3 (Ishikawa and Barber 2008).

Different cellular proteins are also found to regulate RLR signaling. Tripartite motif protein 25 (TRIM25) ubiquitinylates RIG-I CARD which are essential for the interaction with IPS-1, but TRIM25 does not induce the ubiquitinylation of MDA5 (Gack, Shin et al. 2007). Ring finger protein 125 (RNF125) and IFN stimulated gene15 (ISG15) are also involved in negative regulation of RIG-I-mediated signaling and possibly MDA5 (Zhao, Denison et al. 2005; Arimoto, Takahashi et al. 2007; Kim, Hwang et al. 2008). De-ubiquitination of Lys-63-linked ubiquitin chains of TRAF3 by de-ubiquitinating enzyme A (DUBA), which is a characteristic of ovarian tumor domain (OTU), results in the sequestration of RLR-mediated signaling (Kayagaki, Phung et al. 2007). OTU-containing DUB, A20 and DUB protein, CYLD has also been reported to be a negative regulator of RIG-I-mediated signaling (Wang, Li et al. 2004; Saitoh, Yamamoto et al. 2005; Lin, Yang et al. 2006; Friedman, O'Donnell et al. 2008; Zhang, Wu et al. 2008) (**Figure 25**).



Several molecules interact directly with RLRs or related molecules and attenuate their signaling activities have been described. Suppressor of IKKe (SIKE) inhibits non-canonical kinases from interacting with RIG-I or IRF3 (Huang, Liu et al. 2005). Atg5–Atg12 conjugate, inhibits the interactions between CARD of RIG-I and IPS-1 (Jounai, Takeshita et al. 2007). Interestingly, NLR family protein, NLRX1, has also been identified as a negative regulator of RLR-mediated antiviral signal (Moore, Bergstralh et al. 2008). Collectively, the RLR-mediated signaling pathway is regulated by a complicated mode of actions with multiple molecules.

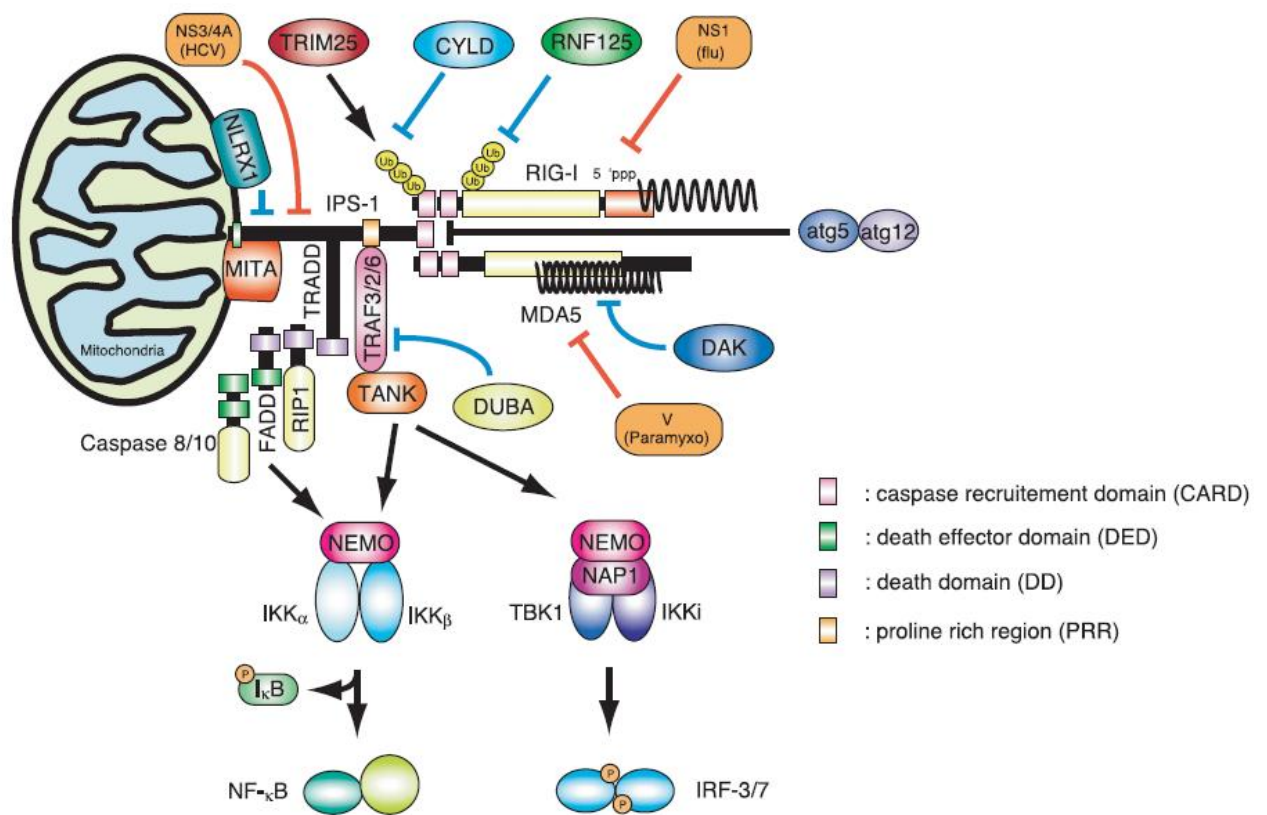

**Figure 25: Retinoic acid-inducible gene-I (RIG-I)-like receptor (RLR)-mediated signaling and its regulation**

*The black arrows and blue lines indicate positive or negative regulation of the signal, respectively, by cellular proteins. The red lines represent inhibition by viral inhibitors (Yoneyama and Fujita 2009).*

## **β. Protein Kinase R (PKR)**

Double-stranded RNA (dsRNA), both natural and synthetic, plays a centrally important role in antiviral innate immunity, both for the production of interferon (IFN) (Field, Tytell et al. 1967; Tytell, Lampson et al. 1967; Colby and Morgan 1971; Samuel 1979) and also in the actions of IFN. PKR production is induced by the IFN (Samuel 1979; Toth, Zhang et al. 2006; Sadler and Williams 2007; Pindel and Sadler 2011). It is also known as eukaryotic translation initiation factor 2-alpha kinase 2 [eIF2AK2], P1 kinase, or p68 kinase. PKR belongs to a small family of protein kinases that respond to environmental stresses to regulate protein synthesis. Members of this kinase family phosphorylate the translation initiation factor EIF2 $\alpha$  at serine residue 51, resulting in sequestration of the limiting guanine nucleotide exchange factor EIF2 $\beta$  (Roberts, Hovanessian et al. 1976). Antiviral and antiproliferative activities of PKR are due to phosphorylation of eIF2 $\alpha$ .

Also the mechanism of apoptosis induction by PKR involves phosphorylation of eIF-2 $\alpha$  and activation of NF- $\kappa$ B by promoting the phosphorylation of I $\kappa$ B via the IKK complex (Gil, Garcia et al. 2004) (**Figure 26**). PKR-induced apoptosis involves FADD activation of caspase 8 by a mechanism independent of Fas and TNFR (Balachandran, Kim et al. 1998). PKR is constitutively expressed in all tissues at a basal level and is induced by type I and III IFNs (Ank, West et al. 2006). Under normal circumstances, PKR is maintained as an inactive monomer, through steric hindrance of the kinase domain by the N-terminus of the protein (Nanduri, Rahman et al. 2000; Gelev, Aktas et al. 2006). Two RNA binding motifs (RI, RII) are present within the N-terminal portion of PKR; the C terminal region includes the kinase catalytic domain (McCormack, Thomis et al. 1992; Toth, Zhang et al. 2006; Pindel and Sadler 2011). Binding of dsRNA leads to a PKR conformational change (Nanduri, Rahman et al. 2000; Sadler and Williams 2007). RNA-mediated activation of PKR involves phosphorylation of both serine and threonine sites (Toth, Zhang et al. 2006), including the T446 residue within the catalytic region that is commonly used as a measure of activation. PKR also plays an important role in the induction of type I IFNs, particularly IFN $\beta$  during viral infections (Yang, Reis et al. 1995; Gilfoy and Mason 2007; Panne, Maniatis et al. 2007; Schulz, Pichlmair et al.

2010; Pindel and Sadler 2011). Among the genes upregulated in response to PKR are Fas, Bax and p53 (Yeung and Lau 1998).

It was demonstrated that in response to poly(rI) .poly(rC), or dsRNA, 5'-triphosphate RNA, conformational changes were induced in PKR, resulting in autophosphorylation, dimerization, and substrate phosphorylation (Romano, Green et al. 1995; Carpick, Graziano et al. 1997; Nallagatla, Hwang et al. 2007). Once active, PKR dissociates from the RNA and phosphorylates the eukaryotic initiation factor 2 $\alpha$  (EIF2 $\alpha$ ) on serine 51 which results in the strong binding of EIF-2 $\alpha$  to EIF-2 $\beta$ , subsequently inhibiting protein synthesis (Samuel 1993; Sadler and Williams 2007) and therefore of virus replication (Moore, Bergstralh et al. 2008) within infected cells.

PKR activates I $\kappa$ B kinase (IKK), leading to the degradation of the inhibitors I $\kappa$ B $\alpha$  and I $\kappa$ B $\beta$  and the concomitant release of NF- $\kappa$ B (Zamanian-Daryoush, Mogensen et al. 2000). Different studies had shown involvement of PKR in signaling pathway including TNF $\alpha$  (Der, Zhou et al. 1998; Zamanian-Daryoush, Mogensen et al. 2000), IFN $\gamma$  (Deb, Haque et al. 2001) and LPS (Gusella, Musso et al. 1995) . The involvement of PKR as a prerequisite for signal transduction or as a structural protein is still debated. PKR can act as a intracellular complex containing TRAF6, TAK1 and TAB2 downstream to TLR3 dependent NF $\kappa$ B activation (Jiang, Zamanian-Daryoush et al. 2003), or can interact with TRAF2 and TRAF5 for the activation of IKK (Gil, Garcia et al. 2004) or by TLR3 and RIG-I signaling pathway (Kalali, Kollisch et al. 2008). Finally evidence suggest that PKR activates p38 in response to dsRNA by a mechanism that may include PKR-mediated phosphorylation of the p38 upstream kinase MKK6 (Silva, Whitmore et al. 2004).

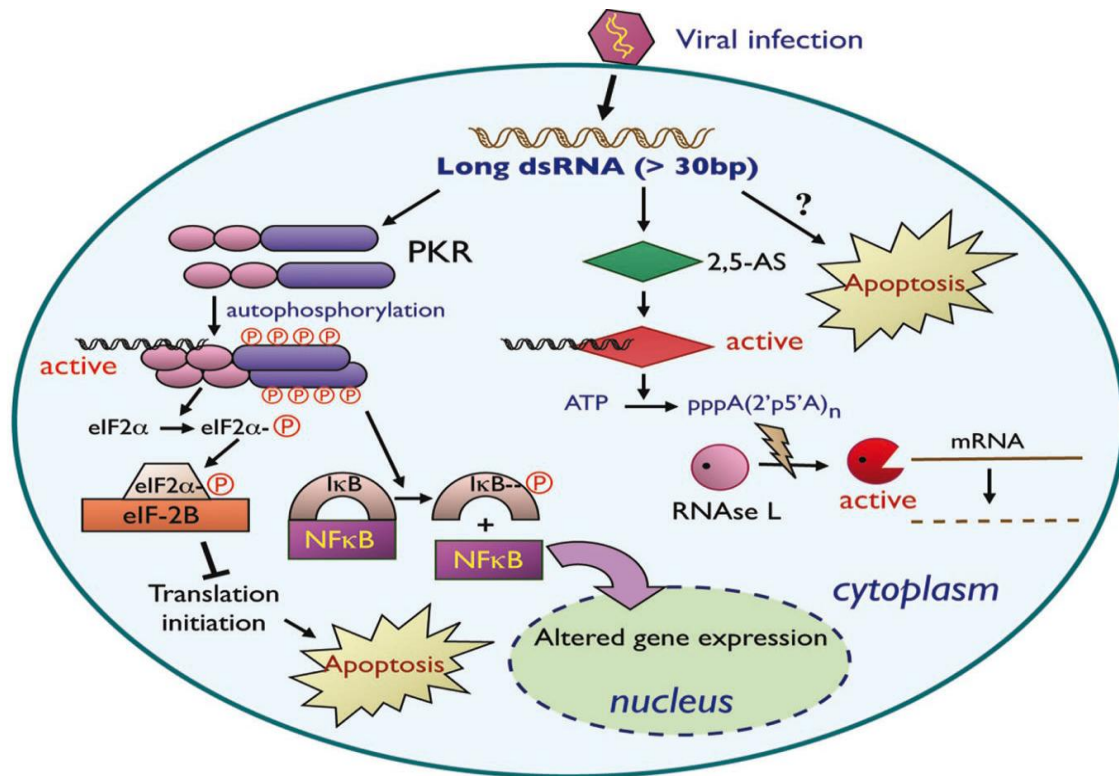

**Figure 26: Signaling pathways of long dsRNAs in the cytoplasm**

Most long cytoplasmic dsRNAs which result from virus infections, can bind to and activate PKR and 2',5'-AS as well as activating the interferon pathway. Activated PKR phosphorylates a number of targets, including the translation factor eIF2α and the IκB protein, leading to translation inhibition and effects on gene expression in the nucleus. Activated 2',5'-AS leads to activation of RNase L, which degrades mRNAs. Long dsRNAs can also lead to apoptosis (Wang and Carmichael 2004).

### χ. OAS

OAS (2', 5'-AS) are initially identified as IFN-induced proteins which are able to synthesize 2', 5'-linked phosphodiester bonds to polymerize ATP into oligomers of adenosine (Kerr, Brown et al. 1977; Rebouillat and Hovanessian 1999). These oligomers specifically activate the latent form of RNaseL leading to extensive cleavage of single strand RNA (Clemens and Vaquero 1978; Floyd-Smith, Slattery et al. 1981; Wreschner, McCauley et al. 1981; Carroll, Chen et al. 1996) (**Figure 26**). Constitutively expression at low levels allow them to act as PRRs for the detection of viral dsRNA in the cytosol (Hoenen, Liu et al. 2007).

RNA degraded by RNaseL is able to activate the other cytoplasmic PRRs RIG-I and MDA5 resulting in IFN gene induction. There are four type of OAS genes identified in humans, termed *OAS1*, *OAS2*, *OAS3* and *OASL* (OAS-like), (Hovanessian and Justesen 2007). *OAS1* has two spliced forms of 40 and 46 kDa in humans (eight in mice). *OAS2* produces four alternatively spliced transcripts that encode two proteins of 69 and 71 kDa. *OAS3* encodes a single transcript of 100 kDa protein. The most distinctive of the OAS proteins is *OASL*. Two *OASL* transcripts are expressed producing two proteins of 30 and 59 kDa. IFN and OAS may play a critical role for induced pathogenesis as seen for WNV (Lucas, Mashimo et al. 2003). Interestingly, *OAS3* was found to exert antiviral effect as observed in HeLa cells against CHIKV infection (Brehin, Casademont et al. 2009).

## ii. DNA sensors

Since DNA sensors are not implicated in the detection of alphaviruses, which are RNA viruses, therefore it will be discussed briefly in this thesis.

DNA in the cytosol from viruses, bacteria, and apoptotic cells are recognizing by multiple sensors. Synthetic B-form DNA (poly dA:dT) and IFN stimulatory DNA (ISD) are used to probe distinct pathways of cytosolic DNA recognition. ISDs are dsDNA which are at least 25 base pairs, stimulate type I IFNs downstream of TBK1 and IRF3 but not MAVS (Stetson and Medzhitov 2006). Interestingly, ISD does not engage NF- $\kappa$ B or MAPK pathways, thus activating only IRF3-induced pathways. DNA-dependent activator of IRFs (DAI) (also known as DLM-1/ZBP1) was identified as a candidate intracellular DNA-sensing molecule (Takaoka, Wang et al. 2007).

### $\alpha$ . IFI16/p204

IFI16 (interferon-inducible protein 16) and its mouse ortholog, p204, are members of the PYHIN (pyrin and HIN domain-containing protein) protein family, which contains a pyrin domain and two DNA-binding HIN (hemopoietic expression, interferon-inducibility, nuclear localization) domains. IFI16 can stimulate inflammatory and interferon response by HSV-1 infection through NF- $\kappa$ B and IRF3 activation in bone-marrow-derived macrophages

(Unterholzner, Keating et al. 2010). Response through IFI16 was observed for synthetic ds-DNA of 60-70 oligomers and STING (stimulator of interferon genes) in the cytosolic compartment. IFI16/p204 dependent inhibition viral of replication appears to be restricted to MCMV and HCMV. Role of IFI16 in IFN induction is not clear as IFI16 upon detection of nuclear viral DNA of Kaposi's sarcoma-associated herpesvirus in human endothelial cell forms ASC-dependent inflammasomes (Kerur, Veetil et al. 2011) (**Figure 28**).

### **β. AIM2**

AIM2 is an IFN-inducible protein that contains the N-terminal pyrin domain and the C-terminal HIN-200 domain. AIM2 recognizes certain dsDNA viruses (MCMV and VV, but not HSV-1) through HIN-200 upon infection in primed macrophages (Fernandes-Alnemri, Yu et al. 2009; Hornung, Ablasser et al. 2009). Few studies shows AIM2 response to synthetic dsDNA in THP-1 cells and in mouse bone-marrow-derived macrophages (Burckstummer, Baumann et al. 2009; Roberts, Idris et al. 2009) (**Figure 27**).

### **χ. DHX 9-36**

DHX9 and DHX36 are aspartate-glutamate-any amino acid-aspartate/ histidine (DExD/H)-box helicase (DHX) proteins that localize in the cytosol. In pDCs, DHX9 and DHX36 bind to synthetic oligodeoxynucleotides, CpG-A and CpG-B, respectively, and induce MyD88 dependent, TLR9-independent IFN production (Kim, Pazhoor et al. 2010). These molecules recognized cytosolic DNA virus, like HSV-1 and MCMV (Hochrein, Schlatter et al. 2004; Hokeness-Antonelli, Crane et al. 2007) but not HSV-2 (Lund, Sato et al. 2003), through TLR-independent in pDCs. Whether these molecules have a role in viral detection in non-pDC cell types is unknown (**Figure 28**).

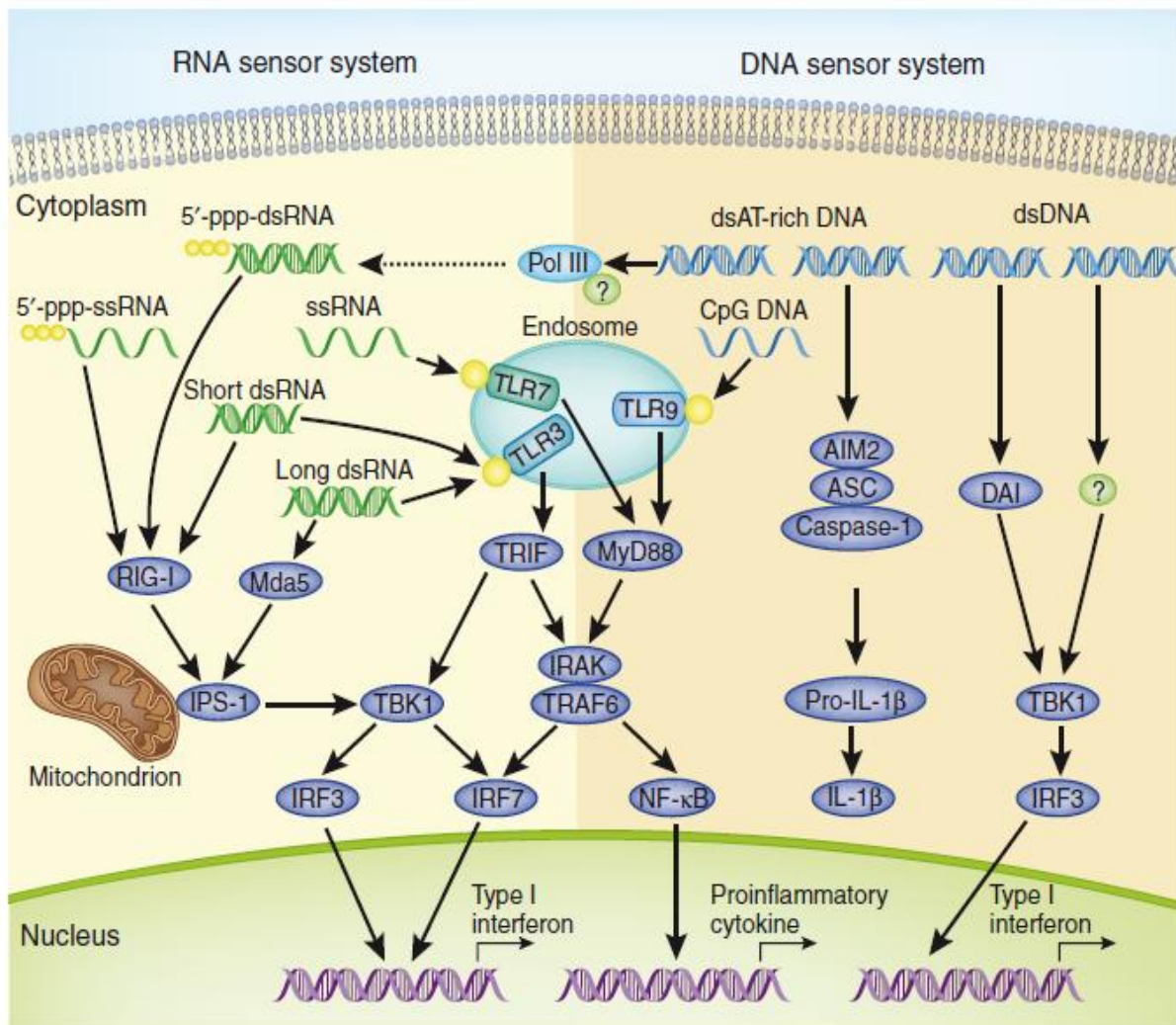

**Figure 27: Intracellular nucleic acid sensors for triggering innate immune responses**

*In response to infection, microbial RNA and DNA are detected by intracellular nucleic acid-sensing system and activate the induction of type I interferons and proinflammatory cytokines. TLR3, TLR7 and TLR9, receptors in endosomes, recognize dsRNA, single-stranded RNA (ssRNA) and CpG DNA, respectively. RIG-I and MDA5 are cytosolic RNA sensors that bind the adaptor protein IPS-1 and induce type I interferon. DAI and AIM2 are the two cytosolic sensors for DNA. Cytosolic RNA polymerase III (Pol III) can sense microbial DNA in the cytosol and transcribe the DNA templates into 5'-triphosphate (5'-ppp) dsRNA, the RNA species being sensed by RIG-I. (Cao 2009).*

## **δ. Innate recognition of DNA viral transcripts by host RNA polymerase III**

Two independent studies demonstrated that RIG-I recognizes DNA viral infections. In infected cells, host RNA polymerase III (Pol III) transcribes a certain region of the DNA virus genome to produce 5'-ppp RNA, which becomes a target of recognition by RIG-I (Ablasser, Bauernfeind et al. 2009; Chiu, Macmillan et al. 2009). Polymerase III based transcription of small, noncoding RNAs are done to counter host innate defense mechanisms, specifically PKR. These viruses include adenovirus and Epstein-Barr virus (EBV). Therefore, the Pol III–RIG-I pathway of viral recognition represents a counter-countermeasure by the host to guarantee type I IFN production even in the face of viral evasion (**Figure 27**).

### **b. Virus recognition by NLR**

NLR family consists of more than 20 members (23 in human and 34 in mouse), and several respond to various PAMPs, non-PAMP particles and cellular stresses to trigger proinflammatory responses (Franchi, Eigenbrod et al. 2009; Martinon, Mayor et al. 2009). NOD2 binds to MAVS and induces IRF3 activation upon ssRNA viral infections (respiratory syncytial virus, VSV, parainfluenza virus) but not following vaccinia virus (VV, DNA virus) infection (Sabbah, Chang et al. 2009). NLRs are expressed in many cell types including immune cells and epithelial cells.



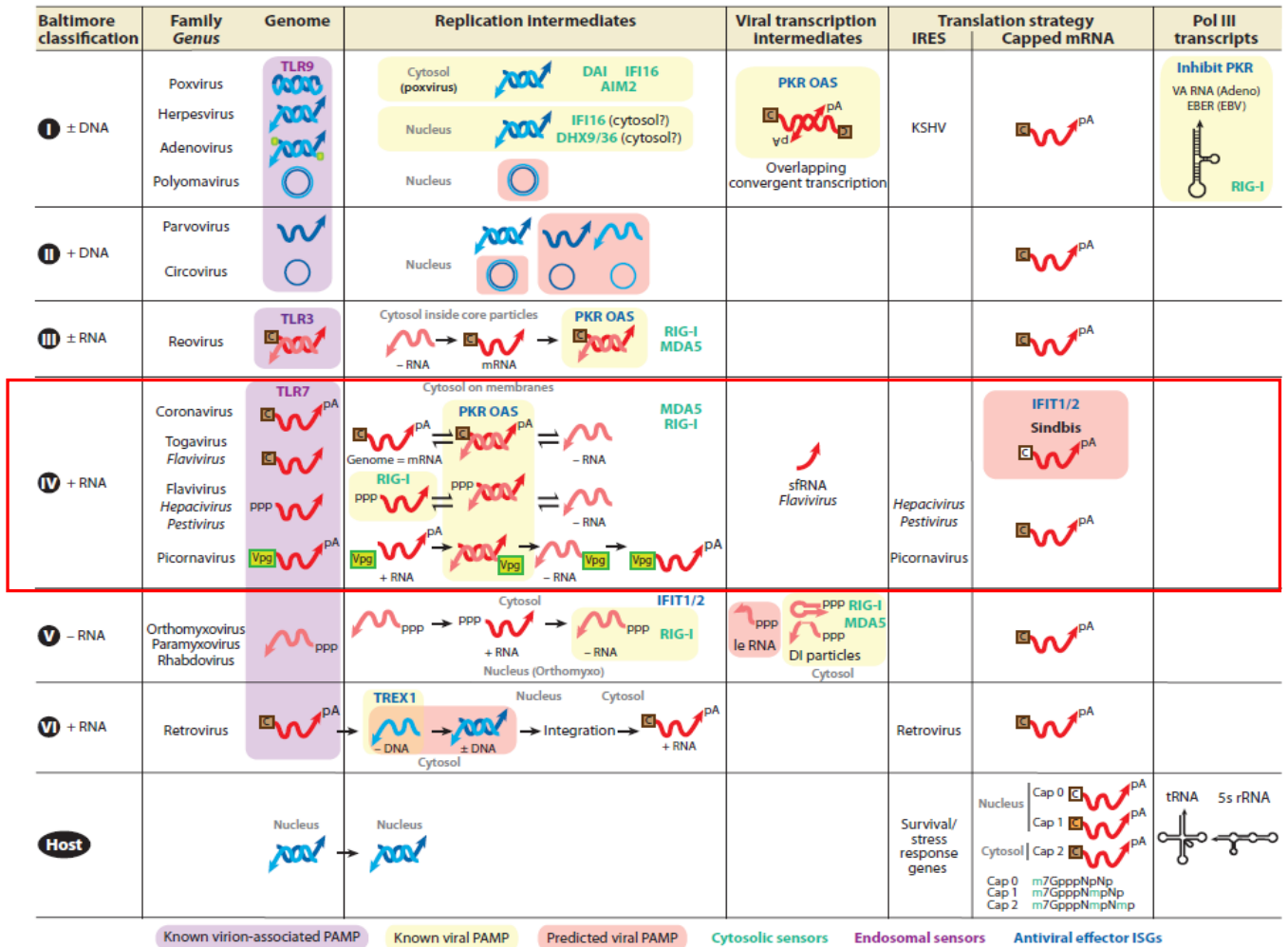

**Figure 28: Intracellular nucleic acid sensors triggering innate immune responses**

*Alphavirus falls in the red box (Iwasaki 2012).*

#### 4. CHIKV and PRRs

Several studies have stressed the key role of PRRs in CHIKV infection and pathogenesis and this will be discussed in length in the manuscript and articles of this thesis. More briefly, it has been shown that:

- *In vitro*: The relative expression of RIG-I was significantly increased in HS 633T fibroblast cell line whereas no significant change was observed for TLR7 (Thon-Hon,

Denizot et al. 2012). Moreover, it has been observed that Poly (I:C) and CHIKV infection can enhance the expression of TLR3 in human bronchial epithelial cells.

- In mice, CHIKV significantly up-regulated the transcription of TLR-3 (Thangamani, Higgs et al. 2010).
- The most comprehensive study was carried out by Schilte et al in 2010 using several KO mice for TLR (MyD 88<sup>-/-</sup>) or RLR (IPS-1 <sup>-/-</sup>) signaling. It was shown that both pathways) were acting in synergy to control infection and that this response was mediated essentially by non-hematopoietic cells such as fibroblasts.
- The role of other soluble PRRs such as complement (MBL) and pentraxins remains to be explored.

### **C. The IFN and the antiviral response**

The first line of defense against infection provided by the innate immune system is dependent on various cell types such as dendritic cells (DCs) and macrophages, which respond to the infections through secretion of proinflammatory cytokines, chemokine's, and interferons, and processing and presenting antigens to naïve T cells to activate the adaptive immune system. Interferons (IFNs) are the first known members of biological regulatory proteins called cytokines. They are induced in cells as a response to virus infection, secreted to circulation, and act on same infected or uninfected cells to activate a global antiviral state. Thus, IFNs are the mediators of cellular homeostatic responses to virus infection. IFNs also have pleiotropic effects on many aspects of cell physiology, including cell growth, cell motility, and cell functions. Relevant studies led to the discovery of the Janus activated kinase - Signal transducer and activator of transcription (JAK-STAT) pathway of signal transduction by IFN.

In the context of host-virus infection, regulation of components of the IFN system is multifaceted and complex. As already shown, dsRNA of virus, induce the synthesis of IFNs. These IFN after secretion outside the infected cell bind to the extracellular domains of specific cell-surface receptors and transcriptionally activate the IFN-stimulated genes (ISG) whose products interfere at different stages of viral replication. To the opposite, many viral proteins and RNAs interfere with functioning of the IFN system at every step, like IFN

signaling, dsRNA signaling, induction of ISGs, and functioning of the induced proteins. Thus, a dynamic equilibrium is reached between the opposing forces of IFNs and viruses.

Experimentally, this equilibrium can be shifted one way by increasing the dose of IFN and the other way by increasing the multiplicity of viral infection.

IFN was discovered, when it was found to inhibit replication of influenza virus (Isaacs and Lindenmann 1957). Since after its discovery the IFN family is recognized as first line of defense against virus infection and is the leading therapeutic agents against some virus infection, like Hepatitis C virus (HCV). The IFN family is divided broadly into three classes, depending on the receptor complex they signal through, designated as types I to III.

- Type II IFN consists of single IFN $\gamma$  gene which binds the IFNGR receptor complex. It is produced by T lymphocytes and NK cells, and play a central role in macrophage activation (Huang, Hendriks et al. 1993).
- Type III IFNs is new in the family and include three IFN $\lambda$  gene products that signal via the combined IFNLR1 and interleukin-10 receptor 2 (IL-10R2) receptors. Type III IFNs, also have antiviral response and are similar to type I IFNs (Ank, West et al. 2006; Levraud, Boudinot et al. 2007).
- Type I IFNs, which in humans comprise 13 IFN $\alpha$  subtypes, IFN $\beta$ , IFN $\kappa$ , IFN $\epsilon$ , IFN $\omega$ , IFN $\tau$  and IFN $\delta$ , engage with IFNAR1 and IFNAR2 components of IFN $\alpha$  receptor (IFNAR) complex (Sadler and Williams 2008). Type I IFNs mounts a robust host response against viral infection. Interestingly, IFNAR-deficient mice are susceptible to virus infection but are resistant to other microbial pathogens, such as *Listeria monocytogenes* (Muller, Steinhoff et al. 1994; O'Connell, Saha et al. 2004). Humans with genetic defects in type I IFN (rather than IFN $\gamma$ ) signaling die of viral disease (Dupuis, Jouanguy et al. 2003; Casrouge, Zhang et al. 2006; Minegishi, Saito et al. 2006; Jouanguy, Zhang et al. 2007). Activation of type I IFNs via IFNAR leads to the induction of more than 300 IFN-stimulated genes (ISGs) (Der, Zhou et al. 1998). Few of these ISGs are having antiviral activity like cytoskeletal remodeling, apoptosis, splicing, mRNA editing, RNA degradation, protein translation, as well as subsequent post-translational modification whereas many other ISGs encode PRRs that detect

viral molecules like PKR and OAS, which are involved in eliminating viral components, inducing apoptosis from infected cells and conferring resistance to viral infection on uninfected cells (Sadler and Williams 2008). Proinflammatory cytokines and chemokines are also critical for eliminating virus infection by provoking inflammation and recruiting innate and acquired immune cells at the site of infection while costimulatory molecules are essential for the activation of T cells, leading to acquired immune reactions. In pDC type I IFN is induced by TLR7 and TLR9 in MyD88 dependent manner (Honda, Yanai et al. 2004; Kawai, Sato et al. 2004) whereas in macrophage, conventional DCs and fibroblast they are induced by RLR mediated signaling or by TLR3 and TLR4 in a TRIF dependent manner (Yamamoto, Sato et al. 2003; Kato, Sato et al. 2005). IRF3 and IRF7 are the intermediates of IFN mediated response. IRF3 is constitutively expressed whereas IRF7 is weakly expressed in unstimulated non pDC. Phosphorylation of both IRF3/7 amplify the response of IFN $\beta$  and IFN $\alpha$  upon viral infection (Marie, Durbin et al. 1998; Sato, Suemori et al. 2000; Honda, Yanai et al. 2005).

### **1. Interferon signaling**

IFNs mediated responses is via specific type 1 or 2 receptors that bind to Janus kinases (JAKs) and subsequently activate activators of transcription (STATs), resulting in expression of a broad range of IFN-stimulated genes (Der, Zhou et al. 1998; Stark, Kerr et al. 1998).

IFN $\alpha/\beta$  signaling involves five major steps:

- (a) IFN-induce dimerization of the receptor on cell surface
- (b) Initiation of a tyrosine phosphorylation cascade inside the cell
- (c) Dimerization of the phosphorylated STATs, activating them for
- (d) Transport into the nucleus
- (e) Where they bind to specific promoter site on DNA sequences and stimulate transcription.

### a. Type I Interferon signaling

Type I IFN signaling required seven proteins, which include: the two receptor subunits IFNAR1 and IFNAR2c, the Tyrosine kinase 2 (TYK2) and JAK1, the STAT proteins STAT1 and STAT2, and the DNA-binding protein of the IRF family 9/P48. Upon stimulation of receptor by IFN the two receptor subunit IFNAR1 and IFNAR2c (Novick, Cohen et al. 1994) dimerise. This result in the phosphorylation of TYK2, which is associated with IFN $\alpha$ RI , by Janus kinases (JAK) 2 (Colamonici, Domanski et al. 1995). Activation of TYK2 phosphorylate JAK1 which is associated with IFNR $\alpha$ R2 subunit. STAT1 and STAT2 are pre-bound IFN $\alpha$ R2 subunit (Stark, Kerr et al. 1998).

Phosphorylation of IFN $\alpha$ RI by JAK1 allows the phosphorylation of STAT2 creating a binding site for STAT1 (Leung, Qureshi et al. 1995), causing their dimerization and translocation to the nucleus. The STAT heterodimer forms a transcript complex ISGF3 with IRF9/P48 to facilitate transcription of ISGs, by binding to interferon stimulated response element (ISRE) in the nucleus (**Figure 29**).

The existence of an additional subtype-specific signaling pathway (through  $\beta$ R1 gene, which is preferentially induced by IFN- $\beta$ ) from the canonical JAK-STAT pathway was reported by several individual studies (Rani, Leaman et al. 1999; Takaoka and Yanai 2006).

IFN- $\alpha/\beta$  can also activate the MAP kinase pathway, extracellular signal regulated kinase 2 (ERK2) and p38 (David, Petricoin et al. 1995; Goh, Haque et al. 1999).

One of the IFN-induced signaling pathway involves phosphatidylinositol (PI) 3-kinase. In response to IFN members of insulin receptor substrate (IRS)-1 and IRS-2 become tyrosine-phosphorylated, allowing for the N- and C-terminal SH2 domain-mediated binding of the p85 subunit of phosphatidylinositol (PI) 3-kinase (Uddin, Yenush et al. 1995; Plataniias, Uddin et al. 1996; Burfoot, Rogers et al. 1997), resulting in the activation of the p110 catalytic subunit of PI3-kinase.

- IFN-  $\alpha/\beta$  activated PI3-kinase signaling mediates survival signals through the activation of its downstream effector, Akt or PKC $\delta$ , in cells like, primary astrocytes and neutrophils (Barca, Ferre et al. 2003; Wang, Scheel-Toellner et al. 2003).

- By contrast, the activation of PI3-kinase and its downstream molecule, mammalian target of rapamycin (mTOR) serine-threonine protein kinase, is also essentially involved in the IFN- $\alpha$ - induced apoptosis of multiple myeloma cells (Thyrell, Hjortsberg et al. 2004). Thus, IFN-activated PI3-kinase signaling seems to regulate apoptotic responses.

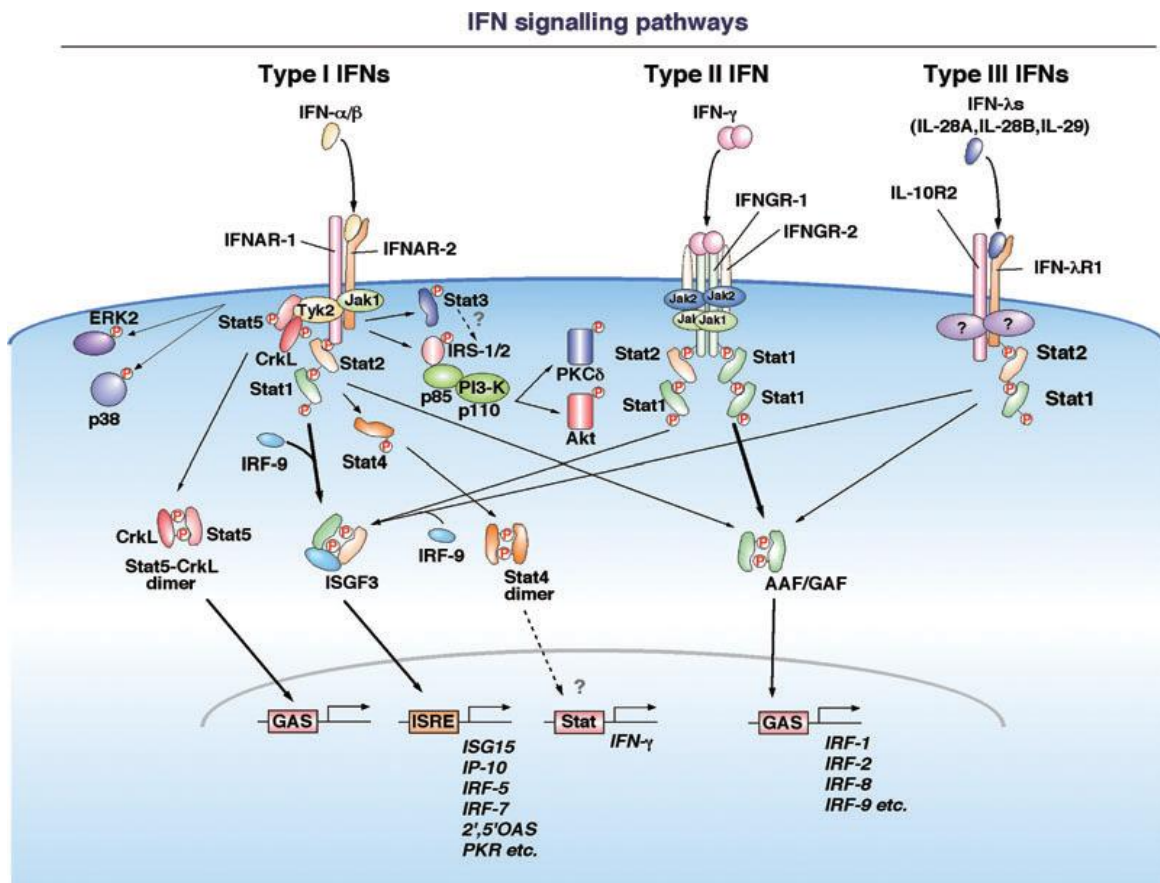

Figure 29: Activation of cardinal Jak-STAT pathway by three types of IFNs

*IFNs are categorized into three types on the basis of the type of receptor. Type I IFNs (only IFN- $\alpha$  and IFN- $\beta$  are shown for simplicity), type II IFN (IFN- $\gamma$ ) and type III IFNs (IFN- $\lambda$ 1/ IL-29, IFN- $\lambda$ 2/IL-28A and IFN- $\lambda$ 3/IL-28B) bind to their corresponding distinct receptor complex as indicated. All of them activate the canonical Jak-Stat pathway (Takaoka and Yanai 2006).*

Type I IFNs also induce other types of STAT complex, such as STAT3 or STAT5 homodimer and STAT1-STAT3 or STAT5-CrkL (*v-crk* sarcoma virus CT10 oncogene homologue) heterodimers. STAT5 undergoes phosphorylation after interacting with TYK2. CrkL binds to the tyrosine-phosphorylated STAT5 via its SH2 domain. This STAT5-CrkL heterodimeric complex translocates to the nucleus and binds to the GAS element (TTCTAGGAA) (Fish, Uddin et al. 1999).

#### **b. Type II Interferon signaling:**

IFN- $\gamma$  signaling pathway dependent transcriptional activation of genes through IFN $\gamma$  activated site (GAS) elements requires the two subunits of the receptor, IFNGR1 and IFNGR2, JAK1 and JAK2, and STAT1. STAT1 forms homodimers after tyrosine dependent phosphorylation, called IFN $\gamma$  activated factor (GAF), which translocate to the nucleus and bind to GAS. In addition, STAT1 is also phosphorylated at Serine residue by MAP kinases, resulting in a further activated STAT1. IFN- $\gamma$  signal to the ISRE elements using a transcription factor that contains P48 (Sen 2001). Similarly, IFN- $\gamma$  can induce the expression of *c-myc* and *c-jun* in the absence of STAT1 (Ramana, Chatterjee-Kishore et al. 2000) (**Figure 29**).

#### **c. Type III Interferon signaling**

Type III IFNs were reported to activate STAT1 and STAT2 through the activation of as-yet determined Jak kinase(s), leading to downstream gene induction in an ISGF3- or GAF/AAF-dependent manner (Dumoutier, Lejeune et al. 2003; Sutejo, Yeo et al. 2012) (**Figure 29**).

## **2. IFN stimulated genes (ISGs)**

### **a. Protein Mx GTPase**

Proteins MxA and Mx1 of the Mx family of proteins are possibly the best characterized of the known IFN-inducible gene products with antiviral activity. Mx proteins are Guanosine triphosphatases (GTPases) that belong to the superfamily of dynamin-like

GTPases (Staehele, Pitossi et al. 1993; van der Blik 1999). The central and C-terminal regions of Mx play important roles in these protein-protein interactions between themselves and with viral protein complex (Ponten, Sick et al. 1997; Kochs and Haller 1999) (**Figure 30**). The spectrum of antiviral activities of the Mx proteins, and the molecular mechanisms by which they act to inhibit virus replication, are dependent on the specific Mx protein, its subcellular site of localization, and the type of challenge virus examined. Mx1 and Mx2 was found to confer the resistance against influenza and VSV virus respectively (Krug, Shaw et al. 1985; Pavlovic, Haller et al. 1992; Jin, Takada et al. 1999).

### Antiviral Actions of Interferon

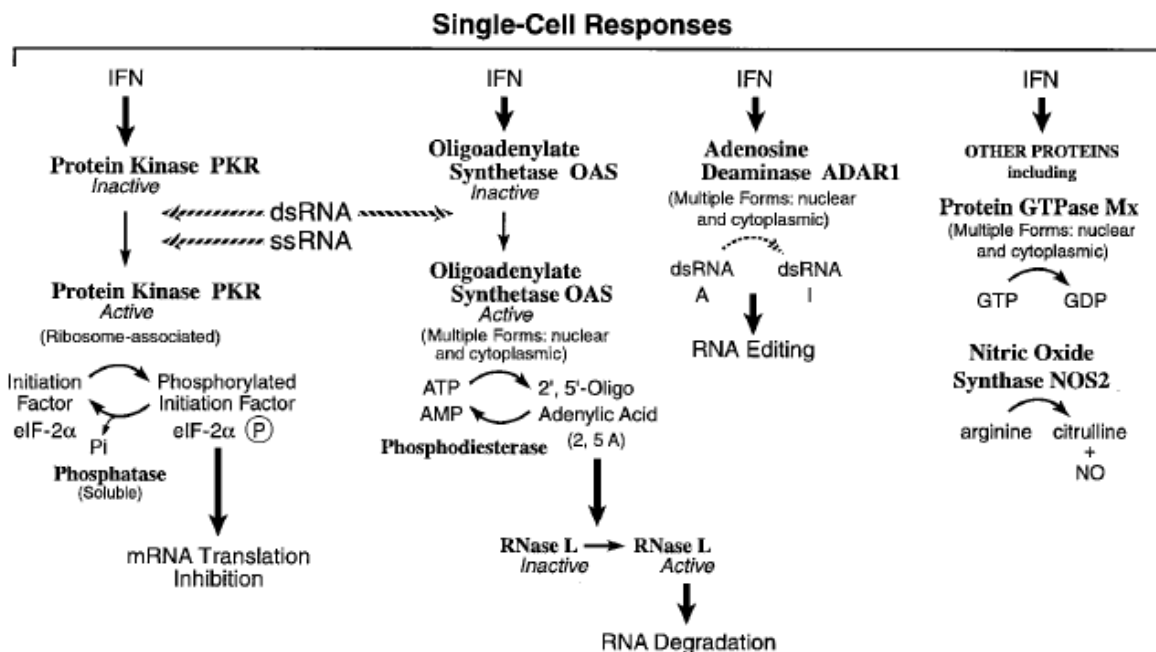

**Figure 30: Functions of selected IFN-inducible proteins**

*Among the IFN-induced proteins believed to affect virus multiplication within single cells are the family of Mx protein GTPases, which appear to target viral nucleocapsids and inhibit RNA synthesis; PKR kinase, which inhibits translation initiation through the phosphorylation of protein synthesis initiation factor eIF-2 $\alpha$ ; the OAS synthetase family and RNase L nuclease, which mediate RNA degradation; and ADAR, which edits double-stranded RNA by deamination of adenosine to yield inosine (Samuel 2001).*



### **b. RNA-Specific Adenosine Deaminase ADAR1**

Post-transcriptional RNA modifications such as deamination of adenosine to yield inosine provide an important mechanism by which the functional activity of viral and cellular RNAs can be altered and, hence, by which biological processes can be affected (Cattaneo 1994; Maitra, McMillan et al. 1994; Simpson and Emeson 1996; Bass 1997). ADAR1, is an IFN-inducible RNA-specific adenosine deaminase (Patterson and Samuel 1995; Patterson, Thomis et al. 1995; George and Samuel 1999) which catalyzes the covalent modification of highly structured RNA substrates by hydrolytic C-6 deamination of adenosine to yield inosine (**Figure 30**). The result is a destabilization of the dsRNA helix by disrupting base pairing. RNA becomes more single stranded because stable AU base pairs are changed to the considerably less stable IU pair (Bass and Weintraub 1988; Wagner, Smith et al. 1989).

### **c. ISG15/54/56**

Among the first IFN-inducible genes to be discovered and cloned was human IFN-stimulated gene 56 (Chebath, Merlin et al. 1983; Kusari and Sen 1987) which belong to a small family of closely related genes with responsiveness to not only IFN treatment but also to certain viral and bacterial molecular patterns. IFN- $\alpha/\beta$ , are the strong inducer of ISG54/56 whereas IFN- $\gamma$  is a weak inducer (Der, Zhou et al. 1998). These genes are hence termed viral Stress-inducible genes (VSIG) (Sarkar and Sen 2004). Expression of VSIGs is based on the activation of IRFs, which recognize the ISREs in the VSIG promoters and initiate transcription: ISGF3 composed of IRF-9 along with STAT1/2, activated by the IFN- $\alpha/\beta$  receptor, mediates the IFN response; IRF-3, activated by dsRNA via TLR3 or via RIG-I/MDA-5, and by lipopolysaccharides via TLR4, potently induces ISG54/56 (Grandvaux, Servant et al. 2002; Sarkar, Peters et al. 2004; Ogawa, Lozach et al. 2005; Terenzi, Hui et al. 2006). The protein product of ISG54/56 is named as P54/56. Murine P56 and P54 expression was observed in various tissues and cell types of mice treated with dsRNA or virus infection (Terenzi, White et al. 2007). Approximate molecular weight of both the proteins is in between 47 and 56 kDa and they are cytoplasmic proteins without any enzymatic activity. Instead, all share a single structural motif in multiple repeats, the 34 amino acid motif tetratricopeptide

repeat (TPR) (D'Andrea and Regan 2003). Both P56 and P54 selectively inhibit translation initiation by binding to subunit eIF3e (human) and eIF3c (mouse).

ISG15 is one of the most highly IFN induced ISGs. ISG15 is a 17 kDa protein expressed as a 165 amino acid precursor and was identified soon after the landmark discovery of ubiquitin. At least 158 putative ISG15 target proteins have been identified (Giannakopoulos, Luo et al. 2005; Zhao, Denison et al. 2005; Takeuchi and Yokosawa 2008). Many of these substrates are important in the IFN response, including the signaling components JAK1 and STAT1, PRRs such as RIG-I and the antiviral effector proteins MxA, PKR and RNaseL (Zhao, Denison et al. 2005). ISG15 has been reported to prevent virus mediated degradation of the IFN regulatory factor 3 (IRF3), thereby enhancing induction of IFN $\beta$  (Lu, Reinert et al. 2006). Conjugation of ISG15 to the Protein Phosphatase 1B (PPM1B) suppressed enzyme activity, thereby enhancing NF- $\kappa$ B signaling (Takeuchi, Kobayashi et al. 2006). In addition to its intracellular role, ISG15 is secreted in large amounts and act as a cytokine to modulate immune responses (D'Cunha, Ramanujam et al. 1996). Isg15<sup>-/-</sup> mouse have increased susceptibility to a number of viruses, including the influenza A and B viruses, SINV, and both HSV-1 and murine  $\gamma$ -herpes virus (Lenschow, Giannakopoulos et al. 2005; Osiak, Utermohlen et al. 2005)

#### **d. PKR and OAS:**

PKR and OAS are also important IFN inducible ISGs which play an important role in antiviral activity. This ISG was discussed before (**Figure 30**).

### **3. ISGs and CHIKV**

Very few reports are available regarding the expression and the plausible role of ISGs in CHIKV infection. Briefly, it has been emphasized that:

- PBMCs of CHIKV infected patients have high expression of ISGs such as Viperin, ISG15, ISG54, ISG56, PKR (Teng, Foo et al. 2012). ISG15 play a role in controlling

CHIKV infection in mice but independently of its ubiquitination activity (Werneke, Schilte et al. 2011).

- ISG54 and ISG56 were highly expressed in CHIKV infected fibroblasts HS 633T compare to relatively modest expression in HT-1080 (Thon-Hon, Denizot et al. 2012).

Our understanding of ISGs response to control CHIKV infection is still in infancy stage.

## **D. Apoptosis**

Apoptosis is one of the first protective barriers to prevent viral replication, spread and its persistence by inducing apoptotic cell death (programmed cell death) that aims to limit the availability of the cellular components for viral amplification. To survive, viruses need to overcome the host cellular machinery. Existence of anti-apoptotic product in the viral kingdom proves that apoptosis is a major concern for the virus survival. Advance in apoptosis related work have recently shown that virus can also use apoptosis to avoid immune system activation and for its persistence in the host. Generally two type of apoptotic pathway plays a major role in the defense system, including some caspase independent pathway. These apoptotic pathways are discussed below:

### **1. Extrinsic apoptotic pathway**

The term ‘extrinsic apoptosis’ is related to the apoptotic cell death that is induced by extracellular stress signals and propagated through specific transmembrane receptors (Wajant 2002; Schutze, Tchikov et al. 2008; Mehlen and Bredesen 2011). Extrinsic apoptosis can be initiated by the ligands, such as tumor necrosis factor  $\alpha$  (TNF $\alpha$ ) and TNF (ligand) superfamily, FAS/ CD95 ligand (FASL/CD95L), member 10 (TNFSF10, best known as TNF-related apoptosis inducing ligand, TRAIL), to various death receptors (i.e., TNF $\alpha$  receptor 1

(TNFR1), FAS/CD95 and TNF $\alpha$  receptor 1 (TNFR1) and TRAIL receptor (TRAILR)1–2, respectively) (Wajant 2002).

#### **a. FASL apoptotic pathway**

One pro-apoptotic signaling pathway leading to extrinsic apoptosis is mediated by FAS ligation. The specific interaction of Fas with its membrane-bound cognate ligand, FasL, trigger the assembly of FAS subunits at the plasma membrane to generate trimers, which is also known as pre-ligand assembly domain (PLAD) (Siegel, Frederiksen et al. 2000). Ligand binding allow the assembly of a dynamic multiprotein complex at the cytosolic tail of the receptor; a conserved sequence of 80 residues that is shared by all death receptors, the so-called ‘death domain’ (DD) (Boldin, Mett et al. 1995; Schulze-Osthoff, Ferrari et al. 1998). This enables the DD in the cytoplasmic tail of Fas to immediately recruit the Death inducing signal complex (DISC) (Medema, Scaffidi et al. 1997).

The DISC is composed of receptor-interacting protein kinase 1 (RIPK1, best known as RIP1) (Stanger, Leder et al. 1995), FAS-associated protein with a DD (FADD) (Chinnaiyan, O'Rourke et al. 1995), Pro- caspase 8 (or -10) (Boldin, Goncharov et al. 1996; Muzio, Chinnaiyan et al. 1996; Wang, Chun et al. 2001; Lavrik, Golks et al. 2005; Meier and Vousden 2007), multiple isoforms of c-FLIP (Thome, Schneider et al. 1997; Budd, Yeh et al. 2006), and cellular inhibitor of apoptosis proteins (cIAPs), E3 ubiquitin ligases, (Deveraux, Roy et al. 1998). FADD is a universal adapter protein that mediates signaling by DD-containing members of the TNFRSF (Kabra, Kang et al. 2001). FADD harbors an N-terminal death effector domain (DED) along with a C-terminal DD. The interaction of FADD and Fas through their C-terminal DDs unmasks the N-terminal DED of FADD, allowing it to recruit pro-caspase 8 to the Fas signaling complex (Boldin, Goncharov et al. 1996; Muzio, Chinnaiyan et al. 1996). Formation of the DISC triggers the self-cleavage of pro-caspase 8 into active caspase 8. Activated caspase 8 (also called FADD like IL-1 converting enzyme (FLICE) then cleaves the downstream pro-caspases 3, 6, and 7 (**Figure 31**).

Activated caspase 3 cleaves a variety of cellular substrates, including DNA repair enzymes, cellular and nuclear structural proteins, and endonuclease inhibitors. Moreover,

caspase 3 has the ability to activate other caspases, such as caspases 6 and 7, normally found in their zymogenic forms, resulting in an amplification of cellular destruction that ensures full execution of Fas-induced apoptosis. The caspase 8-activating capacity of the Fas-DISC complex is regulated mainly by an inhibitory protein called FLICE-like inhibitory protein (FLIP) (Ahmad, Srinivasula et al. 1997; Goltsev, Kovalenko et al. 1997; Han, Chaudhary et al. 1997; Inohara, Koseki et al. 1997; Irmeler, Thome et al. 1997). Incorporation of FLIP into the DISC of death receptors disables DISC-mediated processing, thus preventing the activation caspase 8 (Irmeler, Thome et al. 1997). In addition, Fas-mediated apoptosis is controlled by several regulators of the mitochondrial cell death pathway, for example, by some Bcl-2 family members or inhibitor of apoptosis proteins (IAPs).

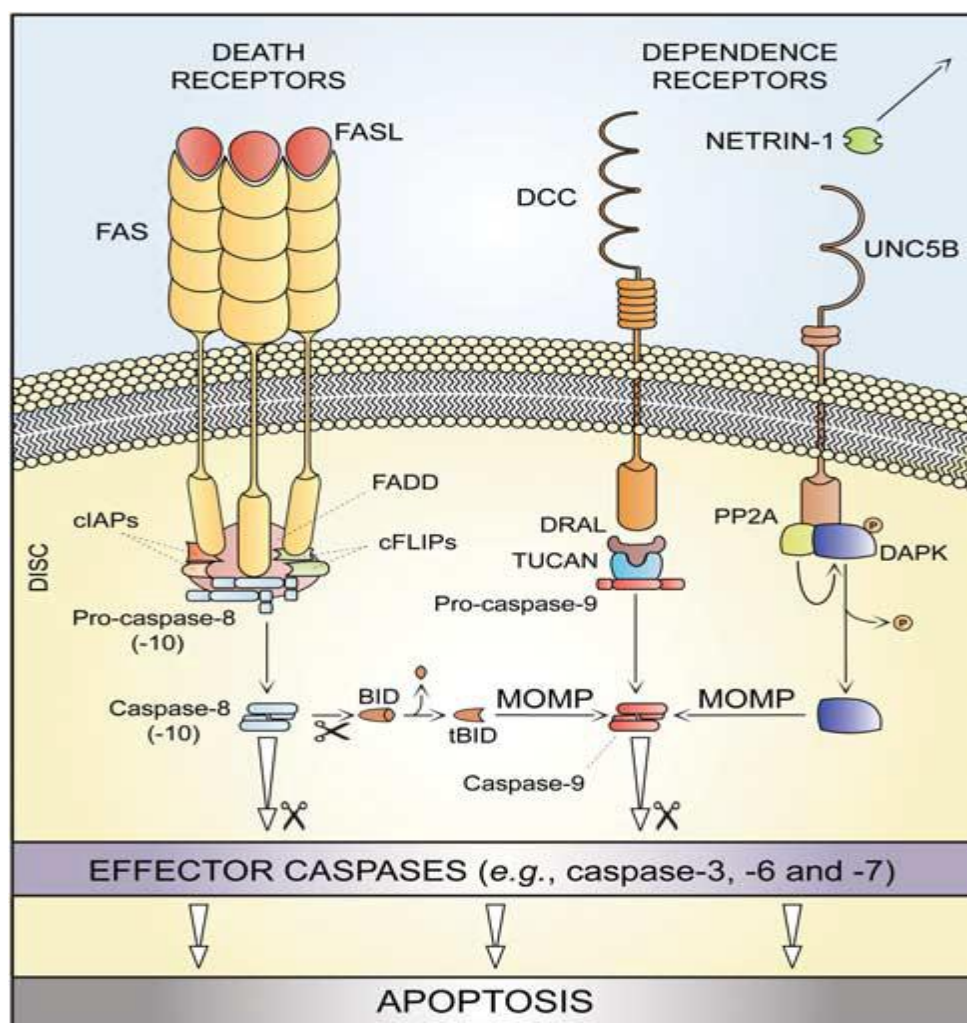

**Figure 31: Extrinsic apoptosis pathway**

*Upon FAS ligand (FASL) binding, the cytoplasmic tail of FAS (also known as CD95, a prototypic death receptor) trimers recruit DISC. DISC controls the activation of caspase-8 (-10). Within the DISC, c-FLIPs and cIAPs exert pro-survival functions. However, when lethal signals prevail, caspase-8 gets activated and can directly trigger the caspase cascade by mediating the proteolytic maturation of caspase-3 or stimulate mitochondrial outer membrane permeabilization (MOMP) by cleaving the BH3-only protein BID. Extrinsic apoptosis can also be ignited by dependence receptors like DCC or UNC5B (Galluzzi, Vitale et al. 2012).*

## **b. Dependence receptors**

The new field of dependence receptors and the activation of apoptosis by activation of executioner caspases, in particular caspase-3, through these receptors have only recently begun to emerge. Thus, in the absence of their ligands, some dependence receptors like Patched and DCC interact with the cytoplasmic adaptor protein DRAL to assemble a caspase-9-activating platform (Mille, Thibert et al. 2009). Another dependence receptor, UNC5B, responds to the withdrawal of netrin-1 by recruiting a signaling complex that includes protein phosphatase 2A (PP2A) and death associated protein kinase 1 (DAPK1) (Guenebeaud, Goldschneider et al. 2010), which lead to dephosphorylation of DAPK through PP2A leading to apoptosis (Bialik and Kimchi 2006) (**Figure 31**).

It's been found that apoptosis can be activated directly through active caspase-8 which catalyzes the proteolytic maturation of caspase-3, in lymphocytes (Srinivasula, Ahmad et al. 1996) by triggering the executioner phase of caspase-dependent apoptosis in a mitochondrion-independent manner, and in hepatocytes and pancreatic  $\beta$  cells mediates the proteolytic cleavage of BH3-interacting domain death agonist (BID), leading to the generation of a mitochondrion-permeabilizing fragment (truncated BID or tBID) (Li, Zhu et al. 1998; Luo, Budihardjo et al. 1998; Yin, Wang et al. 1999).

## **c. TNF dependent apoptotic pathway**

TNF induced signaling pathway for apoptosis or inflammatory response occurs by binding of TNF to one of two distinct receptors, designated TNFR1 (also known as

TNFRSF1A, CD120a, p55) and TNFR2 (also known as TNFRSF1B, CD120b, p75), which are differentially regulated on various cell types in normal and diseased tissue (Al-Lamki, Wang et al. 2001).

Surface-expressed TNFR1 exist as trimmers associated through pre-ligand assembly domains (PLADs) (Chan, Chun et al. 2000) on cell surface. In unstimulated condition these receptors are pre-associated with a cytoplasmic protein designated silencer of death domain (SODD) through the interaction of their DD (Jiang, Woronicz et al. 1999). SODD through its DD binds to the DD of TNFR1, preventing signaling.

Activation by TNF binding to TNFR1 may result in the release of SODD, allowing binding of TNF receptor-associated death domain (TRADD). TRADD initiates signaling by recruiting two additional proteins, receptor interacting protein-1 (RIP-1), a serine/threonine kinase which binds to TRADD through its own DD (Motaln, McWhir et al. 2005), and TNFR-associated factor-2 (TRAF-2, an E3 ubiquitin ligase) (Takeuchi, Rothe et al. 1996) and FADD. TNFR1- induced apoptosis involves two sequential signaling complexes.

- First, the binding of TNF to TNFR1 recruits TRADD, RIP1, and TRAF2 to form a plasma membrane bound complex (complex I consisting of TNFR1, TRADD, RIP1 and TRAF2) (Micheau and Tschopp 2003). This complex recruits and activates different mitogen activated protein kinase kinases (MAP3Ks). RIP-1 (RIP is critical to the functional activation of the transcription factor NF- $\kappa$ B) is thought to mediate recruitment of Mitogen-activated protein/ERK kinase kinases-3 (MEKK-3) and transforming growth factor-beta (TGF $\beta$ )-activated kinase (TAK)1, which in turn, activate the  $\beta$ -subunit of the inhibitor of  $\kappa$ B (I $\kappa$ B) kinase (IKK) complex (Yang, Lin et al. 2001; Blonska, Shambharkar et al. 2005), leading to phosphorylation of I $\kappa$ B proteins, signaling I $\kappa$ B ubiquitination and proteasome-mediated degradation. I $\kappa$ B proteins forms a complex with the NF- $\kappa$ B family transcription factors, masking nuclear localization signals within NF- $\kappa$ B, and I $\kappa$ B degradation allows NF- $\kappa$ B to enter the nucleus and initiate gene transcription. After forming complex I, TRADD and RIP1 become modified and dissociate from TNFR1, then TRADD and/or RIP1 binds to FADD resulting in recruitment of caspase 8/10, forming a cytoplasmic complex

(complex II consisting of TRADD, RIP1, FADD, and caspase 8/10) and leading to apoptosis. The FLIP levels determine complex formation for either NF- $\kappa$ B induced transcription or apoptosis.

- Upon NF- $\kappa$ B activation by complex I, cellular FLIP levels increases to inhibit the formation of complex II and block apoptosis. If the initial signal by complex I fails to activate NF- $\kappa$ B, complex II signals for apoptosis (Micheau and Tschopp 2003). TRAF2 recruits cellular inhibitor of apoptosis protein-1 (cIAP-1) and cIAP-2. TRAF2 is also thought to activate MAPKKs, such as extracellular signal-regulated kinase kinase kinase 1 (MEKK1) or ASK1 (Nishitoh, Saitoh et al. 1998), in a complex at or near the receptor, thereby activating a cascade of kinases including MEK-4 and -6 (Ichijo, Nishida et al. 1997; Nishitoh, Saitoh et al. 1998) resulting in the activation of JNK. The biological outcome of TNF $\alpha$  ligation is determined by the balance between NF- $\kappa$ B and JNK signaling: NF- $\kappa$ B promotes survival, whereas JNK enhances cell death (**Figure 32**).

TNFR2 lacks DD, but can interact with TRAFs. TRAFs like TRAF1 and TRAF2, and can form homo- and heterotypic dimers. Consequently, heterodimeric complex of TRAF1 and TRAF2 can make complex with cytoplasmic domain of TNFR2 where only TRAF2 contacts the receptor directly. However, strong TRAF2 binding activity of TNFR2 does not appear to deliver strong TRAF2-dependent signals. This may be due to the TRAF2-binding site, T2bs-C, on TNFR2 binding site, T2bs-N, (Grech, Gardam et al. 2005). This may provide a mechanism for diverting TRAF2 from TNFR1 via T2bs-C without inducing TRAF2 mediated signals. Binding of TNF to TNFR2 can also limit signaling by c-IAP1-dependent ubiquitination and degradation of TRAF2 and ASK1, terminating MAP3K signaling (Zhao, Conze et al. 2007). TNFR2 can also activate endothelial/epithelial tyrosine kinase (Etk), a cytosolic kinase implicated in cell adhesion, migration, proliferation and survival, independently of TRAF2.



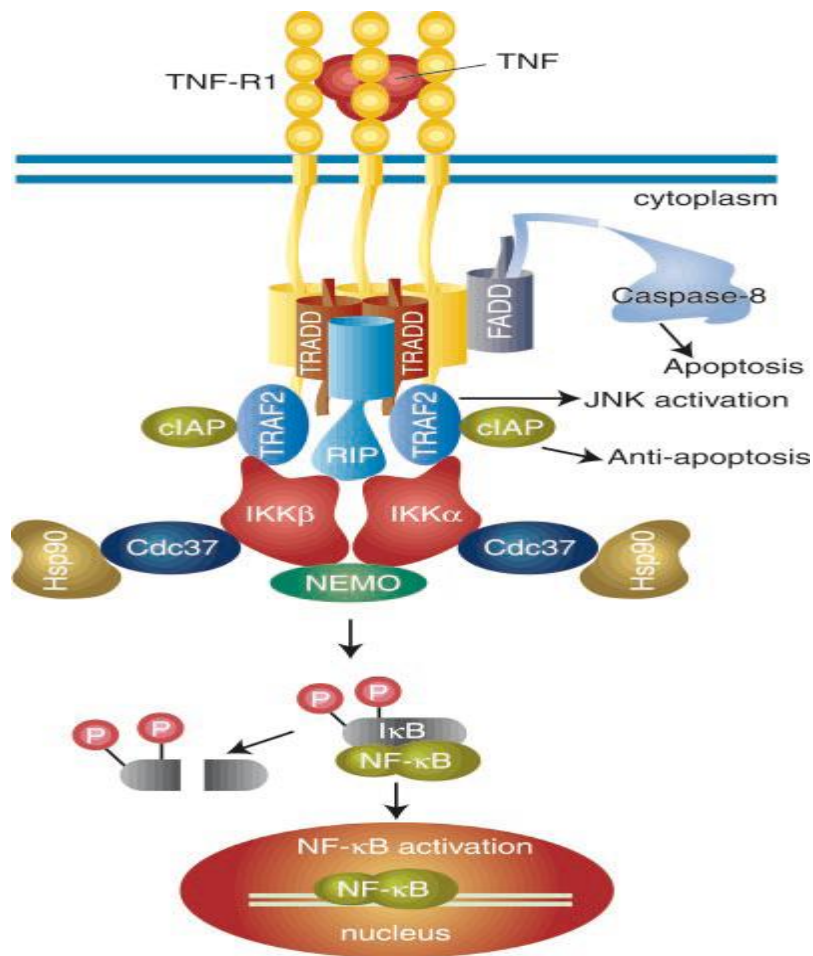

**Figure 32: TNF signal transduction pathway**

*Engagement of TNF with its cognate receptor TNF-R1 results in the release of SODD and formation of a receptor-proximal complex containing the important adaptor proteins TRADD, TRAF2, RIP, and FADD. These adaptor proteins in turn recruit additional key pathway-specific enzymes (for example, caspase-8 and IKKb) to the TNF-R1 complex, where they become activated and initiate downstream events leading to apoptosis, NF-κB activation, and JNK activation (Chen and Goeddel 2002).*

#### **d. The TRAIL-DR pathway**

Like other TNF family ligands, TRAIL exists as a type II membrane-bound protein, or it can be cleaved from the membrane by cysteine proteases to generate a soluble form. Both human and mice have five receptors for TRAIL: the death-inducing receptors DR4 (Pan, Ni et al. 1997) and DR5 (Irmeler, Thome et al. 1997; MacFarlane, Ahmad et al. 1997; Screaton,

Mongkolsapaya et al. 1997; Walczak, Degli-Esposti et al. 1997; Wu, Wallen et al. 1997) and the decoy receptors DcR1 (Irmeler, Thome et al. 1997; MacFarlane, Ahmad et al. 1997; Marsters, Sheridan et al. 1997; Pan, Ni et al. 1997), DcR2 and OPG (osteoprotegerin) (Degli-Esposti, Dougall et al. 1997; Marsters, Sheridan et al. 1997; Simonet, Lacey et al. 1997; Pan, Ni et al. 1998). Apoptosis is mediated through only DR4 and DR5 receptor's DD. DISC formation downstream of DR4 and DR5 is similar to that seen in Fas-induced apoptosis. Briefly, TRAIL triggers clustering of DR4 or DR5, which recruits FADD and procaspase 8 to form the DISC. After the activation of caspase 8, effector caspases are subsequently activated.

## **2. Intrinsic apoptotic pathway**

Intrinsic pathways occur via mitochondria by the release of mitochondrial outer membrane permeabilization (MOMP) considered to be the point-of-no return in apoptosis induction. Permeabilization leads to the release of certain proteins which triggers a cascade of caspase activation that result in irreversible events of apoptosis. In normal condition MOMP remain inactive due to anti-apoptotic members of the Bcl-2 family, an anti-apoptotic and pro-apoptotic proteins family.

Bcl-2 was first described as a unique oncogene in B cell lymphomas that acted to inhibit cell death (Bakhshi, Jensen et al. 1985; Cleary and Sklar 1985; Tsujimoto, Cossman et al. 1985). Bcl-2 family is generally divided into three subgroups based on their roles in apoptosis and the Bcl-2 homology domains (BH) regions they shared: one anti-apoptotic group and two pro-apoptotic groups.

- The anti-apoptotic group contains Bcl-2, Bcl-xL, Bcl-w, Bcl-B, A1 and Mcl-1, sharing three or four BH regions.
- One group of the pro-apoptotic Bcl-2 family members, including Bax, Bak, Bcl-xs, Bok, and Bcl-GL, have two or three BH domains.
- The other group contains the BH3-only proteins, including Bad, Bid, Bim, Bik, Noxa, Puma, Bcl-Gs, Blk, Bmf and Hrk, which share only the BH3 domain (Xu and Shi 2007).

Among the pro-apoptotic proteins, Bax and Bak directly mediate MOMP by forming size-indeterminate openings in the outer mitochondrial membrane (Danial and Korsmeyer 2004). Once activated, Bax and Bak permeabilize the outer membrane of mitochondria, resulting in release of pro-apoptotic factors such as cytochrome *c*, apoptosis-inducing factor (AIF), endonuclease G (ENDOG), direct IAP-binding protein with low pI (DIABLO, also known as second mitochondria-derived activator of caspases, SMAC) and high temperature requirement protein A2 (HTRA2) (Liu, Kim et al. 1996; Kroemer, Galluzzi et al. 2007). Cytochrome *c*, binds to cytosolic, monomeric apoptotic protease activating factor-1 (APAF-1) at its WD40 domain which induces a conformational change in APAF-1, promoting APAF-1 oligomerization to initiate apoptosome formation (Ahmad, Srinivasula et al. 1997; Zou, Henzel et al. 1997; Zou, Li et al. 1999).

The apoptosome then binds to the proform of caspase 9, the initiator caspase of the intrinsic pathway, via the caspase recruitment domains in both APAF-1 and pro-caspase 9. The oligomerization of pro-caspase 9 on the apoptosome triggers auto-cleavage, giving rise to active caspase 9. Active caspase 9 then cleaves the effector caspases, such as caspase 3 and caspase 7, resulting in their activation (**Figure 33**). Caspase activity can be modulated by caspase-binding proteins of the inhibitor of apoptosis proteins (IAPs) family (Duckett, Nava et al. 1996; Uren, Pakusch et al. 1996).

Caspase-independent mechanisms occur via AIF and ENDOG. They relocate to the nucleus, and mediate large-scale DNA fragmentation independently of caspases (Susin, Lorenzo et al. 1999; Joza, Susin et al. 2001; Li, Luo et al. 2001; Buttner, Eisenberg et al. 2007). SMAC/DIABLO and HTRA2 inhibit the antiapoptotic function of several members of the IAP family, thereby derepressing caspase activation (Chai, Du et al. 2000; Srinivasula, Gupta et al. 2003; Yang, Church-Hajduk et al. 2003). In addition, HTRA2 exerts caspase-independent pro-apoptotic effects by virtue of its serine protease activity (Hegde, Srinivasula et al. 2002; Vande Walle, Van Damme et al. 2007) (**Figure 33**).

### 3. Viral induced apoptosis

Apoptosis, serve as a defense mechanism to combat viral infection. The apoptotic response involves a cascade of intracellular signals and induces morphologic changes

associated with apoptosis of virus-infected cells like condensation of chromatin and vacuolization of the infected-cell cytoplasm and degradation of cell DNA. Viral infection either induce or inhibit apoptosis (Shen and Shenk 1995; Teodoro and Branton 1997; Hardwick 1998; Everett and McFadden 1999). Since early destruction of infected host cells may greatly reduce virus yields, hence viruses have evolved strategies to antagonize the apoptotic response by encoding viral gene products that target effector components in the apoptotic cascade. Virus stimulated IFN and IFN induced PKR play an important role in regulating the apoptosis; as discussed below:

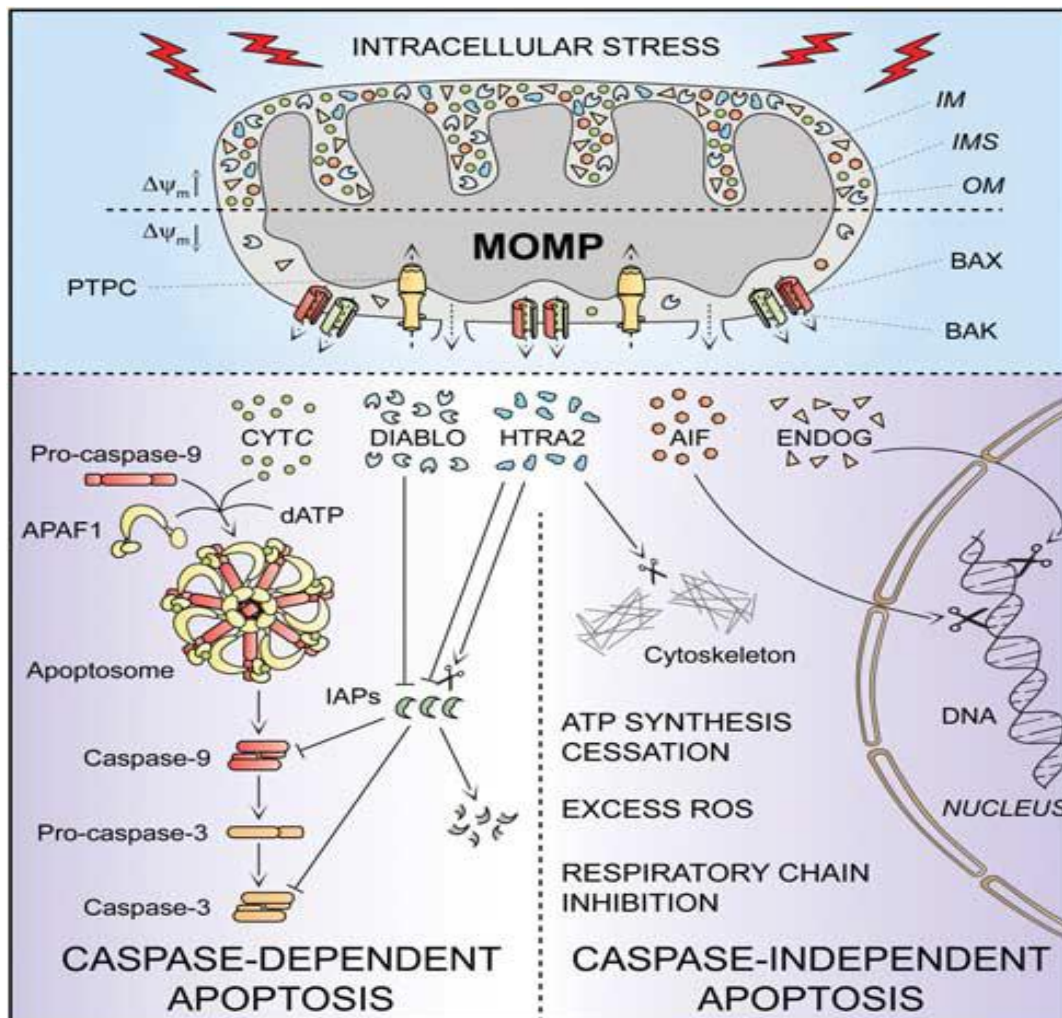

**Figure 33: Intrinsic apoptosis pathway**

*When lethal signals prevail, mitochondrial outer membrane permeabilization (MOMP) occurs and leads to mitochondrial transmembrane potential ( $\Delta\psi_m$ ) dissipation, arrest of mitochondrial ATP synthesis and  $\Delta\psi_m$  dependent transport activities. Moreover, the*

*respiratory chains gets uncoupled, leading to reactive oxygen species (ROS) overgeneration, and proteins that are normally confined within the mitochondrial intermembrane space are released into the cytosol. Among these, cytochrome c drives – together with the cytoplasmic adaptor protein APAF1 and dATP – the assembly of the apoptosome, a multiprotein complex that triggers the caspase-9-caspase-3 proteolytic cascade. DIABLO and HTRA2 facilitate caspase activation by sequestering and/or degrading several members of the IAP family. On the contrary, AIF and ENDOG function in a caspase-independent manner by relocating to the nucleus and mediating large-scale DNA fragmentation. Of note, the serine protease HTRA2 also contributes to caspase-independent apoptosis by cleaving a wide array of cellular substrates (including cytoskeletal proteins). IM, mitochondrial inner membrane; OM, mitochondrial outer membrane; PTPC, permeability transition pore complex (Galluzzi, Vitale et al. 2012).*

#### **a. Role of IFN in apoptosis**

IFN are essential mediators of apoptosis in response to virus. IFNs have either pro or anti- apoptotic activities depending on the state of cell differentiation. For instant, IFN $\gamma$  either induced or inhibited the apoptosis of murine pre-B cells or B chronic lymphocytic leukemia cells, respectively (Buschle, Campana et al. 1993; Grawunder, Melchers et al. 1993; Rojas, Roman et al. 1996). Similarly, IFN $\gamma$  promotes proliferation or apoptosis in malignant human T cells, depending on the presence or absence of serum and the levels of the IFN $\gamma$  receptor (Novelli, Di Pierro et al. 1994). IFN response also depends with the modulation of other enzymes and apoptotic factors like dsRNA produced during viral infections which dsRNA induces the production of IFN $\alpha/\beta$  and is a pro-apoptotic agent (Der, Yang et al. 1997). Primary mouse embryonic fibroblast (MEF) undergo apoptosis when infected with EMC virus, VSV, and HSV, and the apoptotic machinery can be inhibited by anti-IFN- $\alpha/\beta$  antibodies and or due to the lack of IFN receptor or the Stat-1 signaling factor as observed in homozygous null cells (Tanaka, Sato et al. 1998).

IFN-induced apoptosis have focused either on the antiviral enzymes or on identifying other proteins in the pathway. Five novel genes for death-associated proteins, involved in suppression, downregulation growth inhibitory or apoptotic activities have been cloned which include DAP-1 to -5, and two other proteins (thioredoxin and the protease cathepsin D) (Deiss and Kimchi 1991; Deiss, Feinstein et al. 1995; Feinstein, Kimchi et al. 1995; Kissil, Deiss et al. 1995; Deiss, Galinka et al. 1996; Levy-Strumpf, Deiss et al. 1997). Down-regulation of DAP-1 (a proline-rich protein), DAP-2 (DAP kinase), DAP-3, or cathepsin D

with antisense RNAs blocked the apoptotic activity but not the cytostatic effect of IFN $\gamma$  (Cohen, Feinstein et al. 1997; Kissil, Feinstein et al. 1997). DAP-2 is a tumor suppressor gene that couples the control of apoptosis to metastasis (Inbal, Cohen et al. 1997). DAP-5 encodes a dominant negative protein related to the protein-synthesis initiation factor eIF4G (Levy-Strumpf, Deiss et al. 1997).

#### **b. PKR as regulator of apoptosis**

PKR (Balachandran, Kim et al. 1998; Tan and Katze 1999) and the 2-5A-dependent RNase L (Diaz-Guerra, Rivas et al. 1997; Zhou, Paranjape et al. 1997), the mediators of the IFN induced antiviral response, play a key roles in apoptosis. Overexpression of wild-type PKR but not inactive PKR causes apoptosis in the presence of dsRNA (Balachandran, Kim et al. 1998). PKR induced apoptosis involves eIF-2 $\alpha$  and NF- $\kappa$ B, as the mutant of eIF-2 $\alpha$  (S51A) or the I $\kappa$ B $\alpha$  (S32, 36A) leads to an inhibition of apoptosis (Thanos and Maniatis 1995; Gil, Alcamí et al. 1999). Up-regulation of Fas receptor mRNA activate PKR induced apoptosis (Donze, Dostie et al. 1999; Gil, Alcamí et al. 1999). Apoptosis can be inhibited by treatment with dsRNA, TNF- $\alpha$ , or lipopolysaccharide with disruption of either the PKR gene (Der, Yang et al. 1997) or the RNase L gene (Zhou, Paranjape et al. 1997). Role of PKR through repression, in apoptosis can be inhibited by virus antagonist (Samuel 1993; Gale and Katze 1998). For example, the antiapoptotic and oncogenic potentials of HCV are linked to IFN resistance by viral repression of PKR (Gale, Kwieciszewski et al. 1999).

#### **4. Strategies used by viruses to control apoptosis**

Viruses use a variety of strategies to control host cell growth and death. For example; adenovirus E1A gene induces p53-dependent apoptosis (Shen and Shenk 1995; Teodoro and Branton 1997), whereas its E1B-19K protein, a Bcl2 homolog, through Bax (White 1996), E1B-55K through antagonism of p53 function (Teodoro and Branton 1997) and E3 proteins through the degradation of Fas, prevents apoptosis (Tollefson, Hermiston et al. 1998).

Other viral Bcl-2 homologues are known: The E6 protein of HPV and SV40 large-T antigen which impair p53-mediated apoptosis (Shen and Shenk 1995; Teodoro and Branton 1997; Hardwick 1998); LMW5-HL protein of African swine fever virus, which functions to antagonize apoptotic cell death, and the BHRF1 protein of EBV, which protects human B cells from programmed death (Hardwick 1998). Lymphotropic gammaherpesviruses including HHV-8, herpesvirus saimiri, equine herpesvirus -2, and bovine herpesvirus 4, encode FLICE-inhibitory proteins known as vFLIPS that lack proteolytic activity does not activate death signals (Tschopp, Thome et al. 1998). Vaccinia virus B13R gene product is homologous to CrmA and inhibits apoptosis induced by Fas or TNF- $\alpha$  (Dobbelstein and Shenk 1996).

## 5. CHIKV and apoptosis

Not much development has been done in term of CHIKV induced apoptosis, even if we know that after CHIKV infection there is a rapid shut off of host transcription and translation followed by apoptosis, assessed by the presence of cleaved caspase-3 in HeLa cells. The cytopathic and pro-apoptotic effect of CHIKV was observed for several mammalian cells (Sourisseau, Schilte et al. 2007). CHIKV can also induce apoptosis in human satellite cells (Ozden, Huerre et al. 2007). Both extrinsic (Fas/TRAIL-) and intrinsic pathways (mitochondrial) were found to be involved after CHIKV infection and subsequently to activate caspase 3 (Jaffar-Bandjee, Das et al. 2009; Krejbich-Trotot, Denizot et al. 2011). Apoptosis also help the virus to hide inside the apoptotic vesicle possibly shielded from the immune system and subsequently leads to the persistence of the virus in macrophages after phagocytosis (Krebjich-Trotot, Gay et al. 2011).. Mouse neurons and astrocytes were found to be infected by CHIKV and to undergo apoptosis (Das, Jaffar-Bandjee et al. 2010) (**Figure 34**).

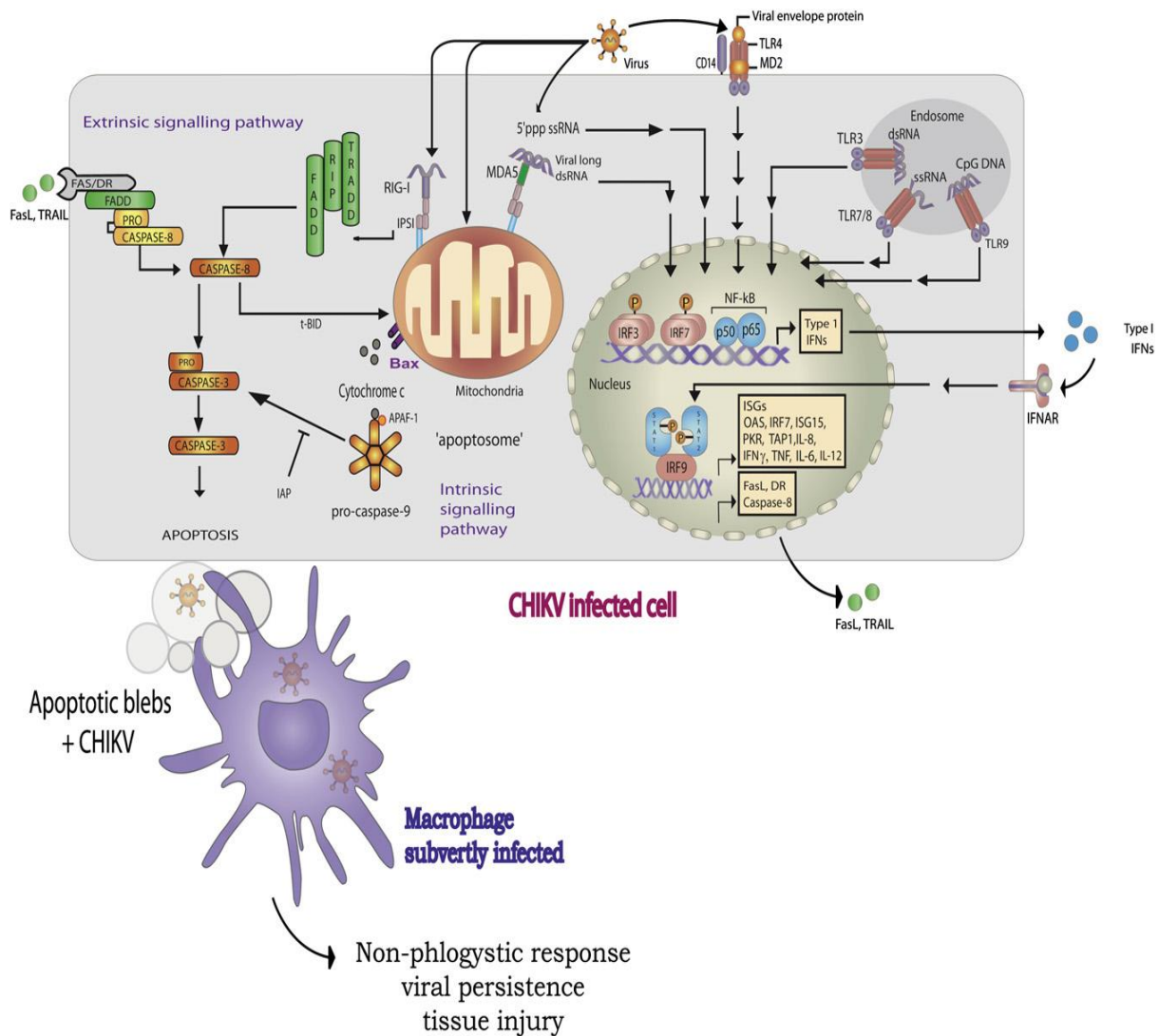

**Figure 34: Innate immune sensing, apoptosis signaling pathways and antiviral responses possibly involved to ward off CHIKV infection**

Several PRRs, such as RIG-I and TLRs initiate signaling pathways that converge at the activation of the transcription factors IRF3/7 and/or NF- $\kappa$ B leading to the expression of IFN- $\alpha/\beta$ . IFNs binding to the receptor (IFNAR) then numerous IFN-stimulated genes (ISGs) and proinflammatory cytokines and chemokine's. ISGs such as oligoadenylate synthetase (OAS) and ribonuclease L (RNaseL), IFN-inducible dsRNA-dependent protein kinase (PKR), myxovirus resistance (Mx) protein, are involved in antiviral mechanisms that interfere with the life cycle of individual viruses. OAS and PKR are further activated by double-stranded RNA (dsRNA). The intrinsic apoptosis pathway is initiated by the release of Cytochrome c from the mitochondria which promotes the formation of the apoptosome, including APAF-1 (apoptotic protease activating factor) and caspase 9 which in turn activates the effector caspase-3. Some viruses can escape apoptosis by inducing the expression of anti-apoptotic proteins such as IAP and Bcl2 (Jaffar-Bandjee, Das et al. 2009).



## E. Cells of immune system

Cells of immune system arise from a type of cell called hematopoietic stem cell. These stem cells have a property to divide for infinite time and to differentiate into other cell type depending on their migration and the micro-environment (Falk, Hogan et al. 1988; Lagasse, Connors et al. 2000; Bhattacharyya, Kumar et al. 2012). The differentiation of these stem cells occurs either by intermediate lymphoid progenitor cells or myeloid progenitor cells. Immune cells are categorized into either cells of innate immunity or adaptive immunity. Here, I will discuss about the cells involved in the innate and adaptive immune system. The role of these cells in immune regulation and response, particularly for macrophages, will be discussed in chapter III.

### 1. Cells of the innate immune system

#### a. Monocyte and Macrophage

Monocytes originate from a common myeloid progenitor cell in the bone marrow. They are released in the bloodstream as non-differentiated cells and circulate in the blood (Tacke and Randolph 2006). Upon migration to tissues, which involves PECAM-1, CD99, CD226, and the junctional adhesion molecules (JAMs), (Imhof and Aurrand-Lions 2004; Bardin, Blot-Chabaud et al. 2009), they differentiate into tissue macrophages ( $M\phi$ ) or DCs (Stein and Keshav 1992; Sallusto and Lanzavecchia 1994; Randolph, Beaulieu et al. 1998; Geissmann, Auffray et al. 2008; Martinez, Helming et al. 2009) (**Figure 35**).

They are divided into three major subtypes, depending on expression of different adhesion molecules and chemokine receptors (Ziegler-Heitbrock, Fingerle et al. 1993; Ziegler-Heitbrock, Ancuta et al. 2010): classical  $CD14^{++}/CD16^{-}$ , intermediate  $CD14^{++}/CD16^{+}$  and the nonclassical  $CD14^{+}/CD16^{++}$  subpopulations. For mouse blood monocytes, a subdivision into three subsets similar to humans is also proposed that is classical, intermediate, and nonclassical.

The classical CD14<sup>+</sup> monocytes express high levels of CCR2 (the receptor for CCL2/MCP-1), low levels of CCR5 and low levels of CX3CR1. Conversely, CD16<sup>+</sup> monocytes express high levels of CX3CR1 and CCR5 (receptors for CCL3/MIP1 $\alpha$ ). In mice, inflammatory monocytes express CD62L (L-selectin), LFA-1 ( $\alpha$ L $\beta$ 2 integrin), Mac-1 ( $\alpha$ M $\beta$ 2 integrin), PECAM-1 (CD31), and VLA-4 ( $\alpha$ 4 $\beta$ 1).

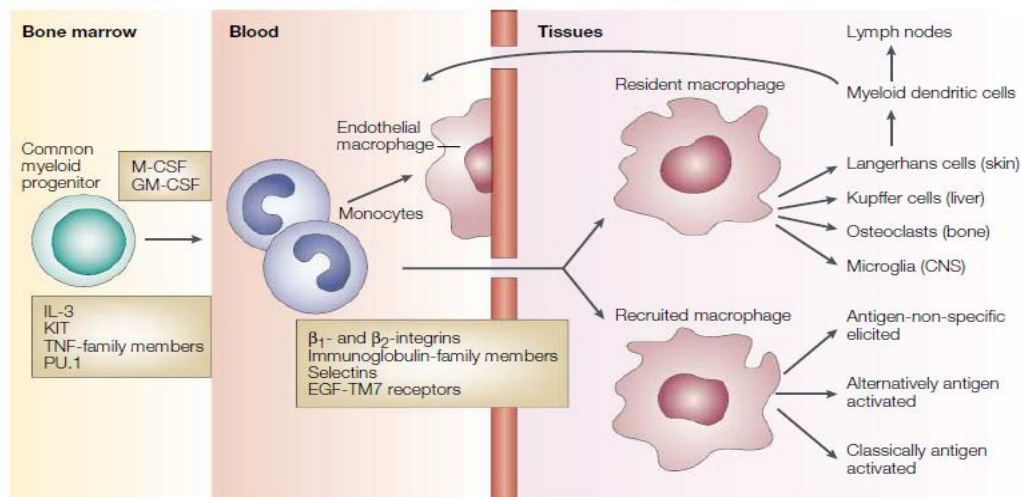
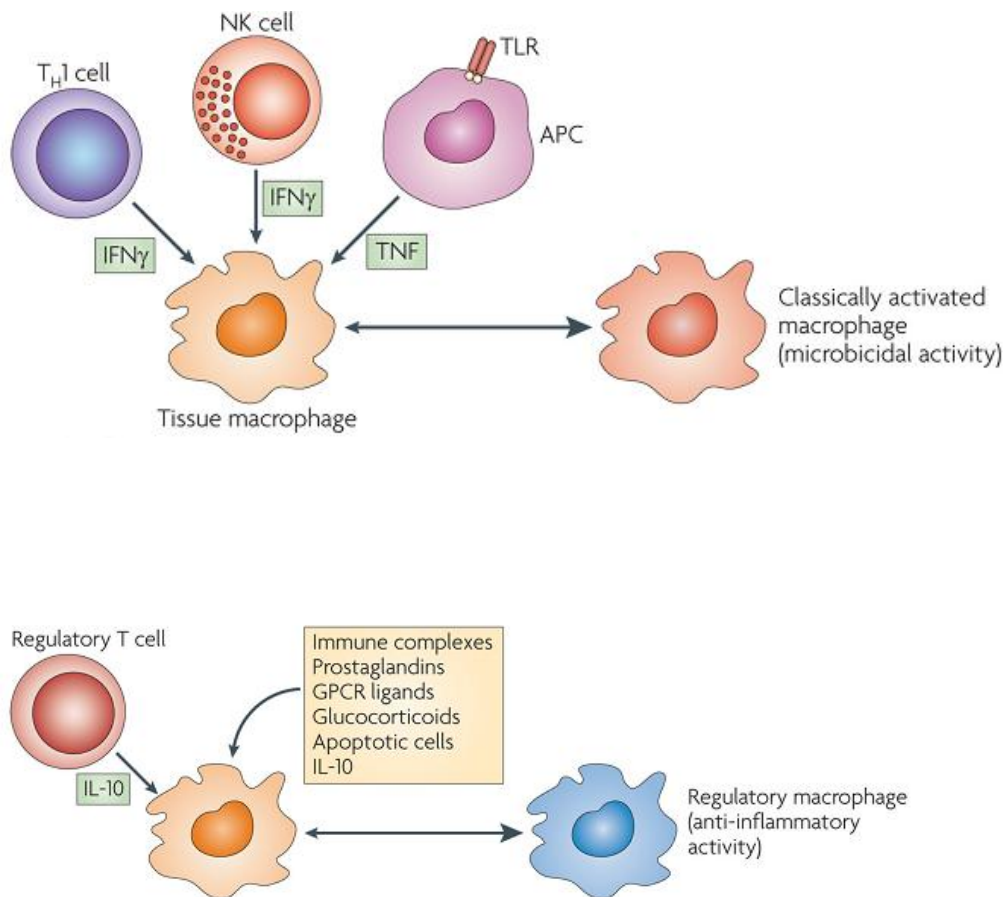

Figure 35: The growth and differentiation of myeloid progenitor cell to macrophage

*The growth and differentiation of myeloid progenitor cell to macrophage depends upon M-CSF, GM-CSF, IL-3, KIT, TNF family member, and PU.1. The signal specific for tissue specific macrophage are integrins  $\beta$ 1 and  $\beta$ 2, immunoglobulin superfamily molecules; CD31, selectins and epidermal growth factors seven transmembrane spanning (EGF-TM7) type receptor related to the (F4/80) (EMRI) antigen (Gordon 2003).*

Tissue macrophages have a broad role in the maintenance of tissue homeostasis, remodeling and repair of tissues after inflammation (Gordon 1998). Macrophages are also involved in the removal of cellular debris generated during tissue remodeling and rapidly and efficiently can clear the cells that have undergone apoptosis. Macrophages are able to detect endogenous danger signals that are present in the necrotic cell debris through TLRs, intracellular PRRs, and IL-1R, through MyD88 dependent manner (Mosser and Edwards 2008). Depending on their inflammatory response they are either classically activated

macrophages (M1) type or the alternatively activated macrophages (M2) type (**Figure 36**). Upon IFN ( $\text{IFN-}\gamma$ ) and LPS activation, macrophage polarized to M1 or M2 type. M1 type polarization depends on the strong expression of proinflammatory cytokines like  $\text{TNF}\alpha$ , IL-12 whereas, M2 type on anti-inflammatory cytokines such as IL-4 or IL-13.



**Figure 36: Classification of macrophage depending upon cytokine produced from different immune cells**

*Classically activated macrophages arise in response to interferon- $\gamma$  ( $\text{IFN}\gamma$ ), which can be produced during an adaptive immune response by T helper 1 ( $T_H1$ ) cells or  $CD8^+$  T cells or during an innate immune response by natural killer (NK) cells, and tumor-necrosis factor (TNF), which is produced by antigen-presenting cells (APCs). Regulatory macrophages are generated in response to various stimuli, including immune complexes, prostaglandins, G-protein coupled receptor (GPCR)(Mosser and Edwards 2008).*

## **b. Neutrophils**

Neutrophils are polymorphonuclear (PMN) cells that belong to the granulocyte family of leukocytes. They are the most abundant cells of the innate immune system. During pathogenic invasion, neutrophils migrate from blood to tissue. Mature neutrophils are professional phagocytic granulocytes with numerous antimicrobial molecules, which include defensins, HCAP-18/LL-37, bactericidal/permeability-increasing protein (B/PI), a cationic protein that binds LPS, phospholipase A2, lysozyme, lactoferrin and cathepsin G, stored in their cytoplasmic granules (**Figure 37**). These granules have cytotoxicity and potential tissue damaging activity and can also contribute in neutrophilic processes including adhesion, migration, and antibacterial activities (Borregaard and Cowland 1997).

- During infections, resident macrophages and DCs detect invading pathogens (via PRRs/PAMPs mechanisms) and release chemokine's CXCL8 (IL-8), CXCL1, 2, 3, CCL2, 3, 4 to attract neutrophils and monocytes at the site of infection (Cailhier, Partolina et al. 2005; Nathan 2006; De Filippo, Henderson et al. 2008).
- Arrival of neutrophils to the site of infection leads to the change of their phenotype and to their activation to release cytotoxic antimicrobial molecules (Levy and Viljoen 1995; Borregaard and Cowland 1997; Levy 2004; Zanetti 2004; Selsted and Ouellette 2005).
- Activated neutrophils attract primarily more neutrophils as well as monocytes, (Yamashiro, Kamohara et al. 2001) by secreting factors such as IL-1 $\beta$ , TNF $\alpha$ , G-CSF and GM-CSF (Lee, Whyte et al. 1993).

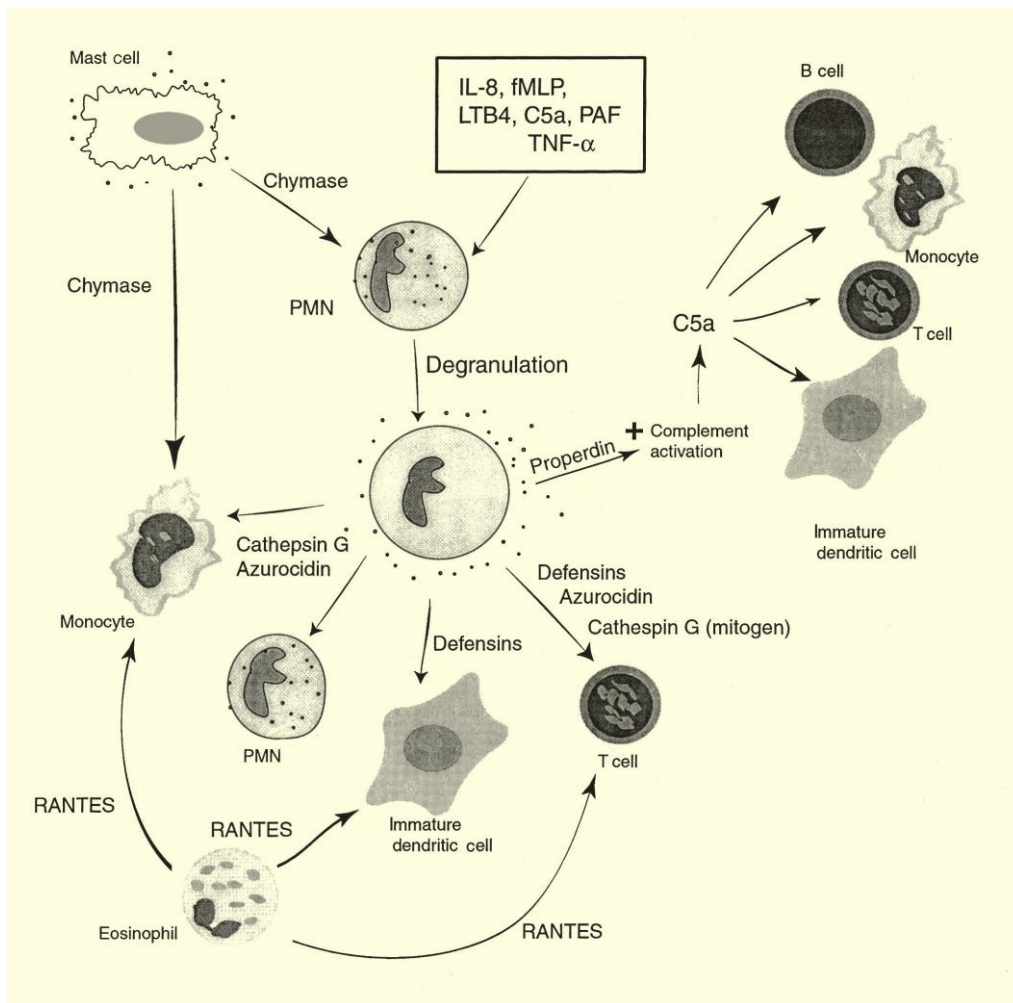

**Figure 37: Cross talks between neutrophils (PMN) and other immune components**

*Mature polymorphonuclear neutrophils (PMN) are stimulated by IL-8, fMLP, leukotriene B4, complement anaphylatoxin C5a, PAF, and TNF- $\alpha$  to release granule components. Direct chemoattractant activity is shown with a straight arrow. Individual cell types are labeled (Chertov, Yang et al. 2000).*

### c. NK & NKT cells

These are large, granular lymphocytes having cytotoxic activity against a wide range of tumor and few virus infected cells.

Natural killer (NK) cells are an important component of innate immunity, able to limit viremia and tumor burden even before the adaptive immune system can be activated. Whereas

human peripheral blood NK cells have been characterized in considerable detail (Trinchieri 1989), the NK cell subset in secondary lymphoid organs has just recently been identified (Fehniger, Cooper et al. 2003; Ferlazzo, Thomas et al. 2004). Secondary lymphoid tissues harbor NK cells that are CD56<sup>high</sup>/CD16<sup>dim</sup>/CD3<sup>-</sup> and CD56<sup>dim</sup>/CD16<sup>bright</sup>/CD3<sup>-</sup>. This subset of NK cells secretes large amounts of IFN- $\gamma$ , tumor necrosis factor (TNF), and granulocyte-macrophage colony-stimulating factor (GM-CSF) upon activation but requires longer stimulation to become cytolytic (Ferlazzo, Thomas et al. 2004). In contrast, the majority of NK cells in peripheral blood are CD56<sup>dim</sup>/CD16<sup>bright</sup>/CD3<sup>-</sup> and cytolytic but poor in cytokine secretion (Campbell, Qin et al. 2001; Cooper, Fehniger et al. 2001; Jacobs, Hintzen et al. 2001).

Type I interferons (IFN- $\alpha$  / $\beta$ ) induced cytokine enhance NK cell mediated cytotoxicity. Activated NK cell in response to viral infection elicit IL-12, which in turn induces IFN- $\gamma$  production (Biron and Brossay 2001). IFN- $\gamma$  can activate a number of important pathways associated with direct antiviral functions and/or immunoregulatory effects promoting other downstream protective immune responses by activating NK cells. NK cells can also produce TNF, another factor mediating antiviral and immunoregulatory effects. They also secrete chemotactic chemokine's including macrophage inflammatory protein 1 $\alpha$  (MIP-1 $\alpha$ , also known as CCL3) (Bluman, Bartynski et al. 1996; Oliva, Kinter et al. 1998). NK response depends upon number of activating or inhibitory receptors (Lanier 1998).

- Activating receptors are immunoreceptor tyrosine-based activating motif (ITAM)-bearing adaptor molecules such as DAP12, Fc $\epsilon$ RI $\gamma$  or  $\zeta$  and others like NKG2D, associate with DAP10, an adapter protein bearing a motif activating an alternative intracellular signaling pathway (Lanier 2001).
- The inhibitory receptors are the Ly-49 in rodents, the killer cell immunoglobulin-like receptor (KIR) family, which appears to be functional in primates but not rodents and CD94-NKG2A heterodimers, which are functional in both primates and rodents (Lanier 1998; Lanier 2001).

There are likely to be a number of mechanisms by which NK cell IFN- $\gamma$  promotes defense. IFN- $\gamma$  has induce a number of different biochemical pathways leading to antiviral effects (Biron and Brossay 2001). IFN- $\gamma$  is, however, very good at inducing a nitric oxide synthase

(NOS) enzyme identified as NOS2 (MacMicking, Xie et al. 1997), which promotes the production of reactive oxygen intermediates, particularly NO, and these can modify a variety of molecules important for replication of particular viruses. Recently, MIP-1 $\alpha$ -dependent trafficking of NK cells for IFN- $\gamma$  delivery in the liver has been shown to be important for the induction of another chemokine, the monokine induced by IFN- $\gamma$  (CX3CL1) (Salazar-Mather, Hamilton et al. 2000). In vivo mouse studies had shown that intraperitoneal injection of Poly (I:C) elicited IFN- $\alpha/\beta$  production and NK cells activation (Gidlund, Orn et al. 1978; Djeu, Heinbaugh et al. 1979) (Figure 38).

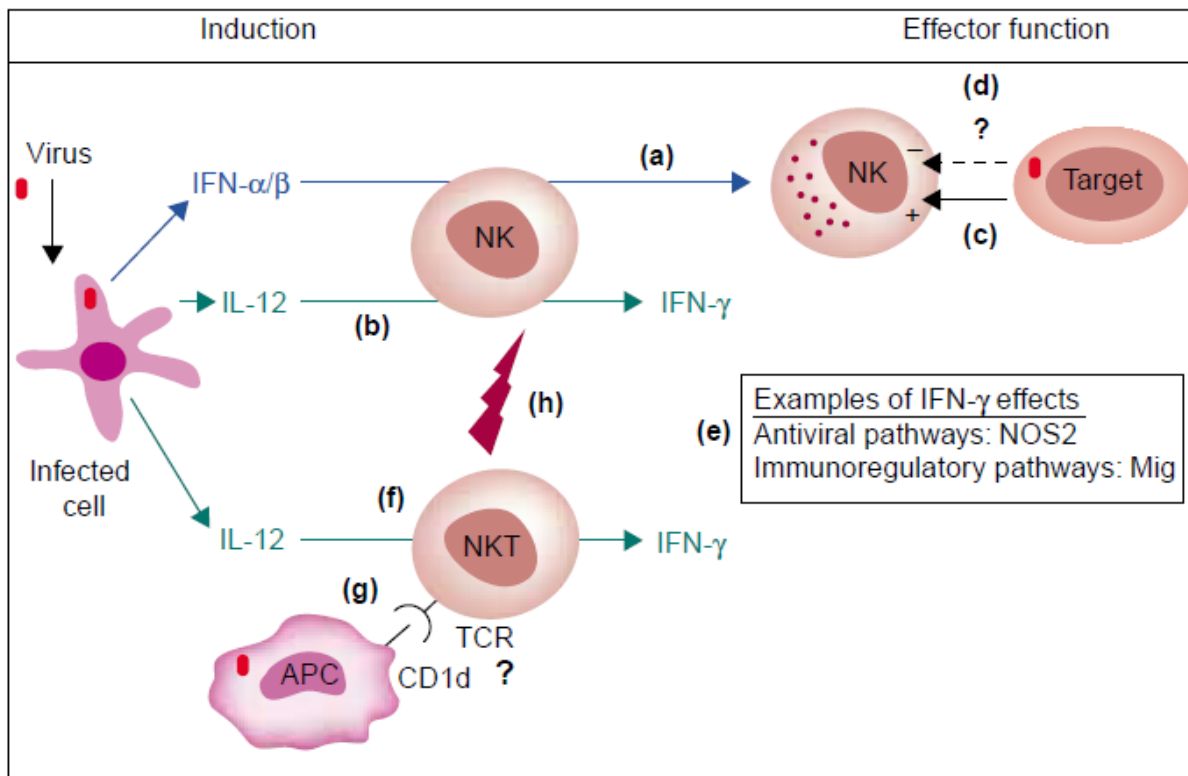

**Figure 38: Current understanding of NK and NKT cell induction and function during viral infections**

*Following, for example, virus infection of host cells, (a) classical NK cell cytotoxicity is induced in response to IFN- $\alpha/\beta$  induction. (b) NK cell production of IFN- $\gamma$  is induced through T cell independent pathways if IL-12 responses are elicited. Cytotoxic responses of NK cells may be important to antiviral defense in certain but not all compartments. (c) There is evidence that NK cell receptors delivering positive signals are important in defense against at least MCMV-infected targets but (d) the role for negative receptors is not yet clear. IFN- $\gamma$  is important to antiviral defense, particularly in the liver. (e) The IFN- $\gamma$  effects may be mediated*

*through induction of mediators of antiviral functions, such as NOS2-mediated NO production, or of immunoregulatory functions, via the chemokine, Mig. (f) NKT cells also can be activated and release IFN- $\gamma$  if IL-12 is induced. (g) They may also have a unique pathway to activation through their restricted TCR if glycolipid antigens recognized by this receptor are presented on CD1d during infection. (h) Because NKT cell responses can 'cross-talk' to activate NK cells, this pathway to NK cell functions may be particularly important under conditions of low innate cytokine induction (i.e. of IL-12 and/or IFN- $\alpha/\beta$ ) during viral infections (Biron and Brossay 2001).*

NKT cells, express both T-cell receptor and natural killer cell surface markers. They are a heterogeneous group which recognizes lipid antigen presented by CD1d (Seino and Taniguchi 2005) and classified into Type I and Type II NKT cells. Human NKT cells express TCR  $\alpha\beta$  or TCR  $\gamma\delta$  and a variety of NK cell receptors, which include CD161, CD69 and CD56 (Gao, Radaeva et al. 2009; Gao 2010). Host antigen presenting cells present microbial glycolipid antigens to CD1d and NKT cells release Th1 (IFN- $\gamma$ , TNF- $\alpha$ ), Th2 (IL-4, IL-5, IL-10) or Th17 (IL-17, IL-22) cytokines which in turn activate other innate immune cells and adaptive T cells (Swain 2008).

#### **d. Dendritic cells (DCs)**

DCs, are professional antigen presenting cells which control immunity and tolerance. They initiate and regulate immune responses depending on signals received from the invading microbes and their cellular environment. They are divided into two major population; myeloid CD11c<sup>+</sup> DCs (mDCs) expressing DC-SIGN and plasmacytoid CD123<sup>+</sup> DCs (pDCs) which are also known as IFN producing cells (Liu 2001; Liu, Kanzler et al. 2001).

- Myeloid DCs are HLA-DR<sup>+</sup>/CD11c<sup>+</sup>, express TLR 2, 3, 4, 5, 8 and are present in peripheral tissues, secondary lymphoid organs and in circulating blood (Ueno, Klechevsky et al. 2007).
- pDCs are HLA-DR<sup>+</sup>/CD123<sup>+</sup>, express TLR 7, 9, 10 and are present in blood, secondary lymphoid organs and peripheral tissues (Altfeld, Fadda et al. 2011).



Their main function is to secrete IFN- $\alpha$  in response to viral infections and to prime T cells against viral antigens (Liu 2005). Plasmacytoid and myeloid DCs, after capture antigens and upon stimulation via pattern recognition receptors, activate NK cells and induce the proliferation of antigen-specific T cells. They also activate T cell ligands by presenting antigens to CD4<sup>+</sup> by MHC class II and CD8<sup>+</sup> T cells by MHC class I interactions (Bhardwaj, Bender et al. 1994; Bender, Bui et al. 1995; Ingulli, Mondino et al. 1997). DCs express several receptors for recognizing viruses including PRRs such as TLRs and C-type lectins (Mancuso, Gambuzza et al. 2009). Inflammatory cytokines secreted by DCs (Kobayashi, Kweon et al. 2003; Zipris, Lien et al. 2005; Kawai and Akira 2008) and IFN type I, secreted at high levels by pDCs can activate B cells (Diebold, Kaisho et al. 2004; Heil, Hemmi et al. 2004; Bekeredjian-Ding, Wagner et al. 2005).

pDCs secrete large amount of type I IFN in response to viral encounter (Siegal, Kadowaki et al. 1999). Activated mDCs produce cytokines such as interleukin-12, IL-15, and IL-18. IL-12 is crucial for mDCs to promote T lymphocyte (CTL) responses, necessary for clearing microbe-infected cells (Shaw 2008). DCs at peripheral tissue sites after detection and uptake of microbes migrate to lymph nodes and activate NK cells. DCs also activate NKT cells to secrete IFN- $\gamma$  and IL-4 (Hermans, Silk et al. 2003). DCs can also activate adaptive T-cells immune responses by T-cell development through IL-10 secreting (Steinbrink, Wolfi et al. 1997), induce Th1 response (Martin-Fontecha, Thomsen et al. 2004) through upregulation of IL-12 secretion and Th2 responses (Soumelis, Reche et al. 2002) via secreting Th2 cytokines.

## **2. Cells of adaptive immune system:**

Lymphocytes constitute around 20% to 40% of body white blood cells and 99% in lymph. Lymphocytes can broadly be divided into three types of cells: B cells, T cells and natural killer cells (Galy, Travis et al. 1995; Blom and Spits 2006).

### **a. B lymphocytes**

B cells, derived from their site of maturation, in the bursa of fabricius in birds. These are mononuclear cell specialized in display and production of membrane bound immunoglobulin such that 'antibodies', which act as a receptor for antigens. When a naïve B cell counter an antigen, it divides into its progeny cell such as effector or plasma cell and memory B cell. Mature naïve B cells are subdivided into B1 cells, which are found primarily in body cavities, and B2 cells are found in secondary lymphoid organs. B2 cells are again divided into marginal zone B cells or follicular B cells which are responsible for T-cell-dependent antibody responses that develop into germinal centers (GCs), whereas marginal zone B cells express polyreactive B-cell receptors (BCRs) and are considered to have a more 'innate' role in host defense (Meyer-Bahlburg and Rawlings 2012). Type I IFNs can regulate B cell function through a variety of mechanisms, including effects on Toll-like receptor expression, cell migration, antigen presentation, receptor engagement, cytokine responsiveness, cytokine production, survival, differentiation and class-switch recombination. Type I IFN can promotes B-cell through different accessory cells as well as by increasing B-cell survival factors, such as B lymphocyte stimulator, produced by dendritic cells (Kiefer, Oropallo et al. 2012).

DCs activate and expand T-helper cells, which in turn induce B cells growth and antibody production. Naïve B cell can respond to soluble factors including IL-12 and can proliferate by CD40L on activated T cell (Dubois, Vanbervliet et al. 1997). TLR expressed on B cell can also activate B cell for antibody production (Pasare and Medzhitov 2005) (**Figure 39**).

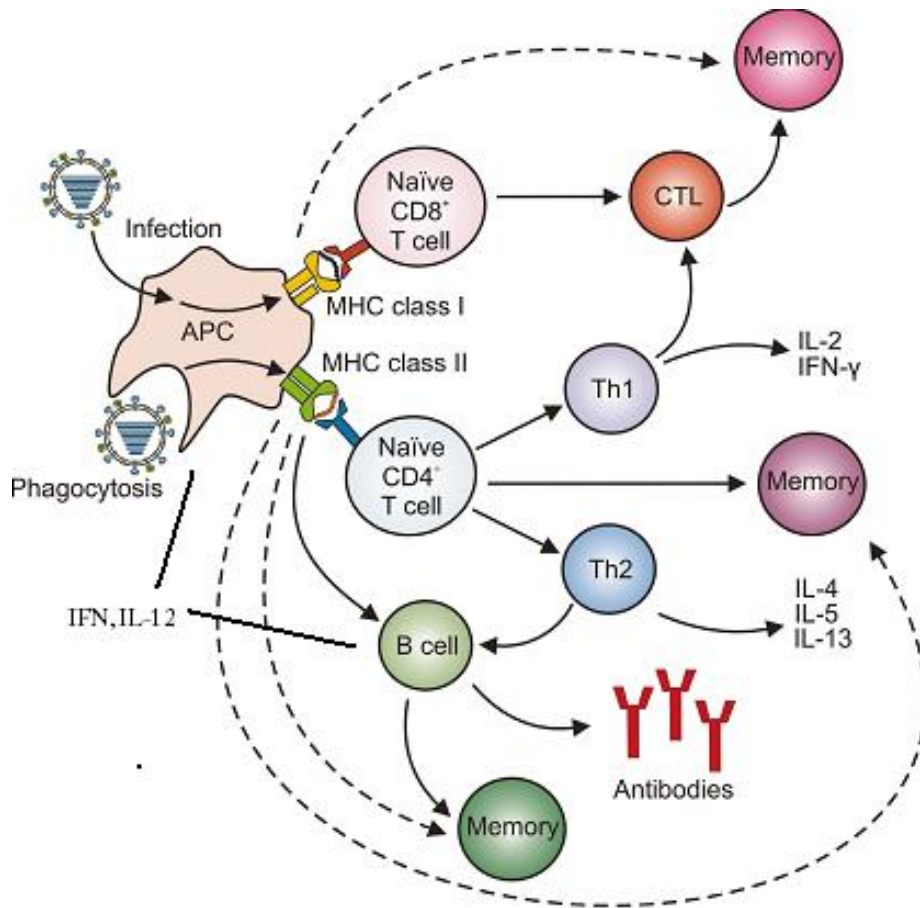

**Figure 39: Induction of humoral and cellular immunity**

*Induction of immune responses after a primary virus infection (ex: influenza A) is indicated by solid arrows. The more rapid activation of virus-specific memory cell populations upon secondary encounter with an virus are indicated by dotted arrows (van de Sandt, Kreijtz et al. 2012).*

### **b. T lymphocytes**

T cells, derived their name from the site of maturation in the thymus. During their maturation they get specialized for unique antigen, called T cell receptor. They can only recognize antigen bound to cell membrane protein known as major histocompatibility complex (MHC) molecules. There are essentially three subtypes of T cells:

- T-helper cell ( $T_h$ ): These cells are  $CD4^+$  positive cells and differentiate into effector cells that help to activate cytotoxic T cells ( $T_c$ ), macrophage, B cells and various other cells of immune system.
- T-cytotoxic cells ( $T_C$ ): These cells participate in immune response.
- T-regulatory cells ( $T_{reg}$ ): These are the negative regulators of immune response.

Activation of DC through uptake of antigen induces their migration to regional lymph nodes. Stimulation of DC enhances costimulatory molecules (including CD80, CD86, and CD40, and antigen-presenting MHC molecules), chemokine receptor expression, and cytokine secretion (Hoshino, Kaisho et al. 2002; Hoebe, Janssen et al. 2003; Honda, Sakaguchi et al. 2003; Iwasaki and Medzhitov 2004).

Then, Activated DCs stimulate naïve  $CD4^+$  T lymphocytes into different Th subsets, depending on TLR-induced cytokines. Th cells can be separated into two distinct subsets, Th1 or Th2 depending on the cytokines they produce (Mosmann, Cherwinski et al. 1986).

- Th1 response protects against viruses and intracellular bacteria. In the process of DC-mediated polarization of different Th subsets, IL-12 plays a critical role in inducing Th1 responses, most notably  $IFN-\gamma$  (Trinchieri 2003)
- Whereas Th2 responses mediate immunity to extracellular protozoa at mucosal surfaces and allergic responses. Th2 responses consisting of IL-4, IL-5, and IL-13 are largely dependent on IL-4 (Mosmann, Cherwinski et al. 1986).

Processed viral protein antigen by MHC class I is restricted to  $CD8^+$  T cells and MHC class II to  $CD4^+$  T cells (York and Rock 1996; Liu and Chambers 2001). Both  $IFN-\alpha/\beta$  and  $IFN-\gamma$  are known to increase level of class I (HLA-A, HLA-B, and HLA-C) MHC molecule but only  $IFN-\gamma$  induces class II (HLA-D) MHC molecule on monocyte/macrophage, astrocytes, fibroblast and endothelial cells (Collins, Korman et al. 1984; Boehm, Klamp et al. 1997; Waldburger, Masternak et al. 2000). Differential regulation of MHC class I expression is seen on B and T lymphocytes (Lee, Gimeno et al. 1999) (**Figure 39**).

### **III. Immunobiology of alphavirus and CHIKV**

## **A. Overview of arthritis induced by viruses**

Generally acute infection may be clinical or subclinical followed by a prolonged and continuous viral replication as seen in all cases of HIV infection, most cases of HCV infection, and less commonly in adult-acquired HBV infection, with some exceptional co-existing cases of acute, latent and persisting infection. For example, parvovirus B19 represents an infection that – in hosts with normal immune systems – is clinically acute, but persisting with replicating virus in bone marrow of patients with arthritis (Lundqvist, Isa et al. 2005).

Different hypotheses for virus-induced arthritic disease mechanism have been put forward including direct viral infection and the induction or amplification of autoimmunity by the virus. In either case, immune factors are central. When a pathogen invades a joint, it may induce an inflammatory reaction via lytic effects on host tissues, immune complex formation, or the induction of inflammatory cytokines (Rulli, Melton et al. 2007). Alternatively, viruses can induce autoimmunity and inflammation via numerous mechanisms such as molecular mimicry, bystander activation, or epitope spreading (Franssila and Hedman 2006; Kim, Kaistha et al. 2006; Bokarewa, Tarkowski et al. 2007; Munz, Lunemann et al. 2009). In most cases of virally associated arthritis, however, the mechanisms are poorly understood.

### **1. General pathogenic mechanisms of virus-induced arthritis**

Generally, virus-associated arthritis seems to be caused by one or a combination of mechanisms.

#### **a. Specific or non-specific modulation of the host's immune system by virus**

Viruses that infect immune cells (e.g. T lymphocytes) cause a variety of immunological disorders in the host. For example, HIV infects CD4<sup>+</sup>, inducing a severe defect in T-cell-mediated immunity (Chun, Chadwick et al. 1997; Masuko-Hongo, Kato et al.

2003). However, HIV-specific CD8<sup>+</sup> T cells ultimately fail to control the virus. Various mechanisms related either to HIV-infected cells or to intrinsic defects in CD8<sup>+</sup> T cells themselves have been proposed to explain this failure (Xu, Screaton et al. 2001; Lieberman, Manjunath et al. 2002; Gougeon 2003). On the other hand, Epstein–Barr virus infects B cells, inducing polyclonal activation of B cells and subsequent production of autoantibodies (Masuko-Hongo, Kato et al. 2003; Al Tabaa, Tuailleon et al. 2011). In such cases, arthritis might occur as the result of impaired or abnormal immune response.

There might be a more non-specific modulation of the host's immunity by viral infection. Host immune system exerts, especially in the initial stage of the infection, innate defense against microbe infections. This may trigger a cascade of immune responses evoking the expressions of various cytokines, chemokines, complement or proteinases, eventually manifesting a systemic or local inflammation. In addition, such activation may possibly give rise to a 'bystander' effect in other cells which had been latently infected by viruses. As a result of these immune effects, arthritis would become apparent as a symptom of a systemic or local inflammatory response (Masuko-Hongo, Kato et al. 2003).

Infection of synovial tissues with different viruses has been shown to be associated with increased expression of cytokines and chemokines and inducing a robust inflammation.

- Tumor necrosis factors  $\alpha$  (TNF $\alpha$ ), released from activated macrophages, was found in synovial tissues of patients with arthropathy associated with HTLV-I infection (Yin, Hasunuma et al. 2000).
- IFN $\gamma$ , IL-2, MCP-1/CCL2, TNF $\alpha$  and IL-6 were found in the joints of goats infected with caprine arthritis encephalitis virus (Lechner, Vogt et al. 1997).
- MCP-1, TNF $\alpha$  and IFN $\gamma$  were detected in synovial effusions of RRVD patients, whereas in the mouse model of RRVD elevated expression of MCP-1, TNF $\alpha$ , IFN $\gamma$  and IL-1 $\beta$  was observed (Lidbury, Rulli et al. 2008).
- IFN $\alpha/\beta$ , GM-CSF and IL-8 were detected in vitro following infection of human synovial cells with RRV (Mateo, La Linn et al. 2000), rubella (Cunningham and Fraser 1985), and HTLV-1 (Sakai, Eguchi et al. 1993).

- MCP-1, TNF $\alpha$ , IFN $\gamma$ , IL-6, IL-4, IL-8, GM-CSF and TGF $\beta$  were found to be elevated in the serum of patients with parvovirus B19 associated arthritis (Kerr, Cunniffe et al. 2004).

#### **b. Viral infection induces novel or aberrant expression of autoantigen**

After viral infection, cells/tissue are lysed, chronically infected or transformed by the virus. Viral components are processed and presented as a novel antigen by cells with antigen-presenting capacity (antigen presenting cells: APC), such as macrophages. These antigens are then recognized by T cells with the antigen-specific T-cell receptor (TCR). Virus induces aberrant expression MHC molecules or costimulatory molecules (Lehky, Cowan et al. 1994). Functionally, APC become more potent, and the new epitopes expressed will activate T cells that have been 'resting' or 'ignorant' of the antigen. However, on the other hand, some viruses, such as herpesvirus, are known to evade the host's immune surveillance by inhibiting antigen presentation (Yewdell and Bennink 1999).

It's not necessary that target antigen should be peptide derived from the virus itself. Sometime infected cells or tissue might become antigenic as a result of the presence of the virus. For example, viral infection may enhance apoptotic cell death of the infected cells and the apoptotic cells will aberrantly express or form antigenic neoepitopes on the cell surface (Zhu 1996).

#### **c. Viral antigen mimics autoantigen (cross-reactivity and autoimmunity)**

Molecular mimicry is one mechanism by which infectious agents (or other exogenous substances) may trigger an immune response against autoantigens. It has been widely reported that significant similarity between certain viruses and autoantigens, in the structure of their nucleotide or amino acid sequences, exists. After viral invasion of the host's immune system, viral-antigen-specific T and B cells are activated. As a result, the tolerance to autoantigens breaks down, and the pathogen-specific immune response that is generated cross-reacts with host autoantigen to cause tissue damage and disease (Albert and Inman 1999; Benoist and Mathis 2001). According to this hypothesis a susceptible host acquires an infection with an



agent that has antigens that are immunologically similar to the host antigens but differ sufficiently to induce an immune response when presented to T cells.

#### **d. Modulation of cell proliferation by the virus**

It is suggested that few viruses can induce proliferation in their host cells. A good example is a subset of oncoviruses that induce autonomous proliferation of synovial cells. HTLV-I is the first retrovirus observed able to induce proliferation in human synovial cells causing virus-associated arthritis. Besides the pro-oncogenic genes, genes for pro-inflammatory cytokines such as IL-1 $\alpha$ , IL-6 and TNF- $\alpha$  and GM-CSF are activated by the virus, and these reactions result in synovial hyperplasia and inflammation reminiscent of rheumatoid arthritis (Sakai, Eguchi et al. 1993). Cell hyperplasia could also be assisted by proliferation of vessels (neovascularization) and endothelial cells stimulated by proangiogenic factors. Few virus such as EBV, HPV and HTLV-I are known to induced angiogenesis (Martin and Gutkind 2008). There is increasing evidence that viruses may also regulate angiogenesis either directly, by (i) producing viral chemokines, growth factors and/or receptors or (ii) activating blood vessels as a consequence of endothelial cell tropism, or indirectly, by (iii) modulating the activity of cellular proteins and/or (iv) inducing a local or systemic inflammatory response, thereby creating an angiogenic microenvironment. As such, viruses may modulate several signal transduction pathways involved in angiogenesis leading to changes in endothelial cell proliferation, migration, adhesion, vascular permeability and/or protease production (Vrancken, Vervaeke et al. 2011).

## **2. Protective Chikungunya-induced innate immune response**

Various evidence indicate that arthritis is induced by presence of virus or their products within joint tissues (Suhrbier and Mahalingam 2009). Viral arthropathies arise from the replication, persistence and/or presence of the pathogen and/or pathogen derived materials in synovial tissues (Gordon and Lauter 1984; Ueno, Umadome et al. 1993; Mody, Parke et al. 2003). Protective antiviral innate immune responses are induced by the virus or virus-mediated cell damage (Morrison, Whitmore et al. 2006; Morrison, Fraser et al. 2007) (Kawai and Akira 2006; Magnusson, Zare et al. 2006), and promoting a long lasting adaptive immune

responses directed at viral antigens (Wilkerson, Davis et al. 1995; Pertile, Walser et al. 1996; Kato, Asahara et al. 2004).

The innate immune response is important to clear CHIKV in infected cells (Li, Siripanyaphinyo et al. 2012). CHIKV can also activate TLR7 and TLR8 localized into endosomes together with TLR9 and TLR3. This activation step is dependent on the acidification of the endosomes which is blocked by chloroquine (Lund, Sato et al. 2003; Lund, Alexopoulou et al. 2004), a drug tested for CHIKV treatment but unlikely protect from infection (Coombs, Mann et al. 1981; Maheshwari, Srikantan et al. 1991; De Lamballerie, Boisson et al. 2008). IFN induced ISG, OAS is shown to be active against CHIKV replication in HeLa cells (Brehin, Casademont et al. 2009). CHIKV is sensitive to innate immune response induced by Poly (I:C). Poly (I:C) decreased CPE and inhibited the CHIKV replication in BEAS-2B cells through induction of TLR3 which triggers the production of IFNs and other anti-viral genes, such as MxA and OAS.

First, viral infection rapidly induces the expression of type I IFN response such as IFN- $\alpha/\beta$  and ISGs. IFN- $\alpha/\beta$  production after CHIKV infection was first reported in Chik embryo fibroblast like cells but the effect of IFN was not assessed (Friedman 1964; Wagner 1964). Potential role of IFN in limiting CHIKV infection was studied on HeLa cells more recently (Sourisseau, Schilte et al. 2007). Analysis using PBMCs from CHIKV-infected patients revealed that type I IFNs is probably implicated in the upregulation of RSAD2 (which encodes viperin, a critical antiviral host protein). More importantly, mice lacking RSAD2 had higher viremia and severe joint inflammation compared with wild-type mice following CHIKV infection (Teng, Foo et al. 2012). ISG15 is induced during CHIKV infection and plays a critical role in protecting neonatal mice from viral induced lethality. Furthermore, ISG15 does not directly inhibit viral replication, as suggested in WT and ISG15<sup>-/-</sup> mice. Instead, ISG15 appears to function as an immunomodulatory molecule in this model (Werneke, Schilte et al. 2011).

Recently it was observed that CHIKV can interfere in IFN response by inhibiting the translocation of pSTAT1 in nucleus of two fibroblast cell lines, HS 633T and HT-1080 (Thon-Hon, Denizot et al. 2012). CHIKV nonstructural proteins (nsPs) showed that nsP2 was

a potent inhibitor of IFN-induced JAK-STAT signaling (Fros, Liu et al. 2010). CHIKV infection leads to activation of the transcription factor interferon regulatory factor 3 (IRF3) and subsequent transcription of IRF3-dependent antiviral genes, including beta interferon (IFN- $\beta$ ). Despite strong transcriptional upregulation of these genes, however, translation of the corresponding proteins is not observed (White, Sali et al. 2011).

Cytokines and chemokine's like IL-16, IL-17, MCP-1, IP-10, including high levels of MIP-1 $\alpha$  in few cases are the sign of acute phase followed by the high production of pro-inflammatory MIF, MIP-1 $\beta$ , SDF-1 $\alpha$ , IL-6 and IL-8. RANTES during the first week after symptom onset (Wauquier, Becquart et al. 2011). RANTES, MCP-1, IP-10, MIP-1 $\beta$ , and IL-8 are produced by activated macrophages that are susceptible to CHIKV infection (Sourisseau, Schilte et al. 2007).

Second, the role of specific immune cells such as NK cells, and CTLs starts to be unraveled. In CHIKV infected patients population of NK cells shifted, to create a specific subset of highly mature CD56<sup>dim</sup> NK cells unresponsive to cytokine stimulation, but with strong cytolytic capacity for killing diseased host cells (Petitdemange, Becquart et al. 2011). Analysis of circulating T lymphocytes have showed a CD8<sup>+</sup> T lymphocyte response in the early and CD4<sup>+</sup> T lymphocyte in late stage of disease (Wauquier, Becquart et al. 2011).

Interactions of the virus with monocytes and to a lower extent with B cells and myeloid DCs (mDCs) in vitro induce a rapid innate immune response, through the antiviral cytokines IFN- $\alpha$ . CHIKV pathogenesis may be due to blood monocytes, since they are early target of CHIKV infection. In the context of macrophages they could act as reservoirs to favor persistent viral infections as evidenced in the macaque's model (Labadie, Larcher et al. 2010) and in chronic patients (Her, Malleret et al. 2010; Hoarau, Jaffar Bandjee et al. 2010).

#### **a. Adverse immune mechanisms involved in virus/ CHIKV-induced arthritis**

Viruses activate a vast array of innate and adaptive immune responses including the interferon pathways (Eisenacher, Steinberg et al. 2007), NK cells (Lee, Miyagi et al. 2007), complement (Roozendaal and Carroll 2006), B cells (Baumgarth, Choi et al. 2008), T cells (Zhou 2008) and macrophages (Suhriebier and La Linn 2003). As a result, arrays of

inflammatory mediators are released, usually including cytokines, chemokine's, reactive oxygen and nitrogen species and prostaglandins (Steer and Corbett 2003). Viruses from a diverse range of virus families are a significant cause of rheumatic disease in humans involving inflammation and cytopathic effect in joints and muscles (Masuko-Hongo, Kato et al. 2003; Franssila and Hedman 2006; Rulli, Melton et al. 2007).

NK cells, monocytes and macrophages in synovial exudates and, CD4<sup>+</sup> and CD8<sup>+</sup> T lymphocytes, but no B cells or neutrophils, were detected from the knees of RRV-infected patients (Clarris, Doherty et al. 1975; Fraser, Ratnamohan et al. 1983; Fraser 1986). CD8<sup>+</sup> T cells, found in the skin of patients suffering from epidemic polyarthritis (EPA), are responsible for killing virus-infected cells by inducing cytolytic mechanisms and producing a variety of antiviral factors. CD4<sup>+</sup> T cells were found in great numbers in synovial effusions of infected patients (Fraser, Ratnamohan et al. 1983; Fraser and Becker 1984). Since there were no changes in antibody level after RRV infection, the involvement of T cells has been valued. (Fraser and Becker 1984).

IFN- $\gamma$  has been detected in the synovial exudate from RRVD patients and the detection of IFN- $\gamma$  secreting RRV specific CD8<sup>+</sup> T cells in human and mice suggested a requirement for CD8<sup>+</sup> T cells to mediate viral clearance but also lysis of infected cells (Linn, Mateo et al. 1998; Suhrbier and La Linn 2004). Viral antigen were found in association with synovial macrophages of some EPA patients (Fraser, Ratnamohan et al. 1983; Hazelton, Hughes et al. 1985), suggesting the susceptibility of macrophages on monocytes (Mateo, La Linn et al. 2000).

During CHIKV infection, T cells (CD4 and CD8) are the main infiltrating cells particularly during the acute phase and their responses is amplified in the chronic phase with a robust recruitment and activation of macrophages (CD68+), CD3 T cells, and few CD8 T cells, NK cells (CD56+) and B cells (CD20+) (Ozden, Huerre et al. 2007). Synovial tissues from a patient with chronic CHIKV disease at 18 months showed macrophages and monocytes with large inclusions, NK cells and CD4<sup>+</sup> T cells, with PMN cells largely absent, and elevated levels of CCL2, IL-6 and IL-8 (Hoarau, Jaffar Bandjee et al. 2010) (**Figure 40**).

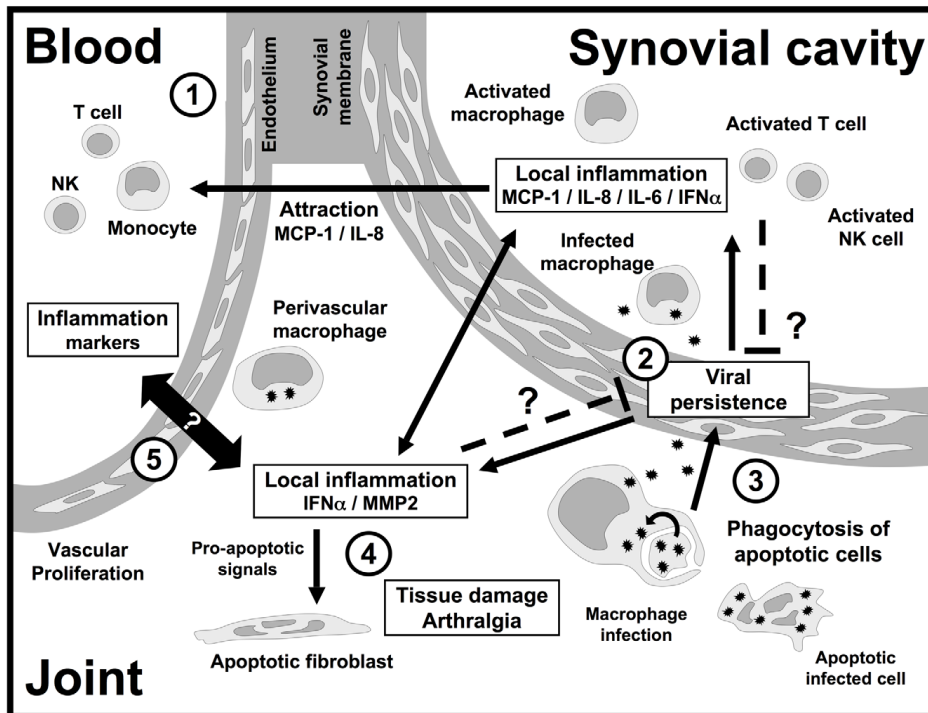

**Figure 40: Mechanisms of CHIKV persistence and tissue inflammation in patients with chronic disease**

(1) Months after the acute infection, monocytes, T cells, and natural killer (NK) cells are still attracted to the inflamed joint, where they become activated. (2) The infection of macrophages in joints is associated with local inflammation and the production of cytokines, chemokine's, and pro-inflammatory effectors, such as MCP-1/CCL-2, IL-8, IL-6, IFN- $\alpha$ , and MMP2. (3) The phagocytosis of apoptotic bodies from infected cells probably contributes to viral persistence. (4) Arthritis is accompanied by high rates of fibroblast apoptosis and cartilage destruction. Chronic inflammation probably plays a major role in this damage and associated pain. (5) The potential relationship between local inflammation of the joint and a state of systemic activation, as demonstrated by the presence of inflammation markers in plasma and blood cells, remains unclear (Dupuis-Maguiraga, Noret et al. 2012).

CHIKV induced strong innate responses, involving antiviral IFN- $\alpha$ , pro inflammatory cytokines, chemokine's and growth factors, followed by activation of the adaptive immunity through activation and proliferation of CD8+ T cells in the early stages of the disease and CD4+ T-cell response and the production of anti-inflammatory proteins IL-1ra and IL-2ra in late stage of the acute phase (Wauquier, Becquart et al. 2011).

It was observed that CHIKV-specific CD4<sup>+</sup>, but not CD8<sup>+</sup>, T cells are essential for the development of joint swelling. Infection in IFN- $\gamma$ <sup>-/-</sup> mice demonstrated that pathogenic CD4<sup>+</sup> T cells do not mediate inflammation via an IFN- $\gamma$ -mediated pathway. These observations suggest that joint pathology induced by CHIKV in mice resemble those in humans but not to other arthritogenic viruses, such as RRV (Teo, Lum et al. 2013).

Recently in plasma sample of CHIKVF patients, different biomarkers (cytokines, chemokine's and growth factors) were analyzed which are associated with infection and/or disease severity.

- Cytokines (IL-2R, IL-5, IL-6, IL-7, IL-8, IL-10, IL-15 and IFN- $\alpha$ ), chemokine's (IP-10 and MIG) and growth factors (HGF, FGF-basic and VEGF) were significantly elevated in CHIKVF patients.
- No difference in the levels of other chemokine's (MCP-1, MIP-1 $\alpha$ , MIP-1 $\beta$  and RANTES) was observed whereas EGF was significantly decreased.
- High disease severity was associated with increased plasma levels of IL-1 $\beta$  and IL-6 and a decreased level in RANTES (Ng, Chow et al. 2009).
- In an another study on plasma and PBMCs from CHIKVF patients IL-16, IL-17, MCP-1, MIF, SDF-1 $\alpha$ , IL-1ra, IL-2r $\alpha$ , G-CSF, GM-CSF, IL-7, IL-12p40, and IFN- $\alpha$ 2 were higher than the corresponding control values at every time point. Pro-angiogenic factors (such as PDGF- $\beta$  $\beta$  and VEGF) and IL-4 were also upregulated for first 48hr (Wauquier, Becquart et al. 2011).

### **3. The viral persistence**

Persistence of virus in human is not only a major health concerns but also a unique opportunity for investigative virologists. For viral persistence two criteria should be met:

- Viral replication; that is, instead of killing its host cell, the pathogen causes little to no damage so it can continue to reside in those cells

- An immune response that does not react to or remove efficiently virus-infected cells.

Even though, up to now, viral persistence is not completely understood, we do have some knowledge on physiologic functions and interrelationships of viral genes to host cell. Virus are recognized when the cell are acutely infected and express viral peptides, these peptides are then processed through the host MHC molecules on their surfaces to signal the immune system to kill such cells. However, with evolution virus have acquired numerous strategies to escape or interfere with immune system and to persist.

One is to suppress the infected host's innate and/or adaptive immune system that would otherwise destroy them (Zuniga, Liou et al. 2008). For example:

- Viruses can alter or interfere with the processing of viral peptides by professional antigen-presenting cells, thereby restricting expression of MHC/peptide complexes on cell surfaces, which activate adaptive immune system cells like T cells that normally remove infected cells.
- Virus also encode homologous of cytokines and chemokine's, essentials for immune response (Roux, Simon et al. 1991; Alcamì 2003).
- Viruses can also persist frequently in infected neurons, which have defects in TAP, a molecule required for the translocation of viral peptides to endoplasmic reticulum (ER) and or by lack of major histocompatibility class I expression (Joly, Mucke et al. 1991; Joly and Oldstone 1992).

#### **a. Virus strategies for persistence**

Virus frequently evolved various strategies either to inhibit cytokine and chemokine's effect, for their replication or to take advantage of their function to promote viral propagation. In particular, virus constantly tries to evade antiviral IFN response. Viral strategies counteract two major aspects of IFN system: inhibition of IFN synthesis or inhibition of IFN signaling.

### i. **Inhibition of IFN synthesis**

IFN synthesis is inhibited by many viral genes. For examples:

- HBV open reading frame C (ORF-C) product inhibit IFN $\beta$  gene induction (Whitten, Quets et al. 1991).
- Expression of IRF-3 can be blocked by HPV16 E6 oncoprotein as well as an unidentified protein present in rhesus CMV virions, finally influencing IFN induction (Ronco, Karpova et al. 1998; DeFilippis and Fruh 2005).

Recent studies have also shown that viral protein can interfere with TLR and RIG-I mediated pathways.

- The VV A46R protein binds to TIR domain of several TLR adaptor protein and block their signaling function (Stack, Haga et al. 2005).
- The N terminal protein of swine fever virus inhibits synthesis of IRF3, as also seen for rotavirus NSP1 where IRF-3 was degraded (La Rocca, Herbert et al. 2005; Barro and Patton 2007).
- RIG-I pathway is blocked by HCV NS3/4A associated protein activity (Foy, Li et al. 2005).
- The NS1 and NS2 protein of human respiratory syncytial virus can block activation of IRF-3 and NF $\kappa$ B (Spann, Tran et al. 2005) and induction of IFN whereas the glycoprotein of the same virus can block TLR2, TLR4 and TLR9 mediated induction of cytokines (Polack, Irusta et al. 2005).

-

### ii. **Inhibition of IFN signaling**

Another step of interference by the virus is at the level of IFN mediated signal transduction.

For examples:

- Infection with HCMV decreases JAK1 level in infected cells by degrading the protein and finally disruption of induction of class II MHC expression.



- Murine polyomavirus large T antigen (pRB binding site) binds to JAK1 and inhibits IFN signaling (Miller, Rahill et al. 1998; Weihua, Ramanujam et al. 1998).
- E1A of adenovirus block ISGF3 formation and also disrupts the interaction between STAT proteins (STAT1 and STAT2) and CBP/P300 required for ISG transcription (Bhattacharya, Eckner et al. 1996; Leonard and Sen 1996; Leonard and Sen 1997).
- The human papillomavirus E7 binds to p48 and inhibits its translocation to the nucleus (Barnard and McMillan 1999).
- Numerous RNA viruses also interfere with IFN signaling like Ebola in endothelial cell (Harcourt, Sanchez et al. 1999) and Dengue virus (DENG V) by inhibiting STAT2 expression (Jones, Davidson et al. 2005).

### iii. **Interference with IFN-induced proteins**

Many viruses have developed mechanisms to counteract specific functions of various IFN induced proteins.

- VV E3L gene product inhibits the activation of PKR and OAS (2', 5'-oligoadenylate synthetase), both of which require dsRNA for their activation (Chang, Watson et al. 1992).
- VV K3L gene product also decoy of eIF-2 $\alpha$  disrupt the interaction of eIF-2 $\alpha$  with PKR. Thus, K3L competitively inhibits eIF-2 $\alpha$  phosphorylation as well as the autophosphorylation of PKR (Davies, Elroy-Stein et al. 1992). In conjunction with the soluble viral type I and type II IFN receptors, E3L and K3L contribute to viral resistance to IFN signaling.
- HCV encodes NS5A protein which binds to the dimerization domain of PKR and blocks its activation (Gale, Korth et al. 1997).

iv. **Other possible mechanisms of virus persistence:**

Viruses have developed many other mechanisms to counteract or to take advantage of host cytokines or their action (Gooding 1992; Spriggs 1994; Smith 1996).

- T2 protein of poxvirus can protect virus infected cells from TNF actions (Gooding 1992; Essani, Chalasani et al. 1994; Loparev, Parsons et al. 1998).
- Tanapox virus infected cell secrete a protein that can bind to and inactivate IFN $\gamma$ , IL-2 and IL-5 (Essani, Chalasani et al. 1994).
- Myxoma virus MT-2, a homolog of cellular receptor for TNF acts as a decoy and block signal through host TNF receptor.
- Myxoma virus also code an homolog of epidermal growth factor (EGF) and immunoregulatory TGF- $\beta$  (Alcami and Smith 1995).
- HHV8 codes a cytokine similar to IL-6 which promotes the growth of transformed B cells (Burger, Neipel et al. 1998).
- Other viruses have also genes with homology to host chemokine's or chemokine's receptor and other gene products with chemokine binding activity (Gao and Murphy 1994; Graham, Lalani et al. 1997; Lalani, Graham et al. 1997; MacDonald, Li et al. 1997; Penfold, Dairaghi et al. 1999).

**4. Evidence for Alphavirus/CHIKV persistence in macrophages**

Alphavirus are believed to cause acute infection, through a strong cycle of virus production (up to  $10^9$ / ml of blood), with recovery of the host acute clinical syndromes like rash and acute arthritis and rare encephalitis. The first evidence of alphavirus persistence was reported after an outbreak of WEEV in North America in 1941 (Noran 1944; Levine, Hardwick et al. 1994). Macrophages and monocytes are essential in the innate immune system. Studies have shown that these cells can be infected persistently by viruses like the Aleutian Mink disease Parvovirus and persistence can be increase with antibody dependent

enhancement (ADE) in presence of IgG (Kanno, Wolfenbarger et al. 1993; Despres, Griffin et al. 1995; Griffin, Levine et al. 1997).

Since immunopathologic mechanisms responsible for viral arthropathies in chronic settings are poorly understood, a mouse model of RRVD that recapitulates many aspects of RRVD in humans was developed (Morrison, Whitmore et al. 2006; Lidbury, Rulli et al. 2008). RRV infection in mice model results in inflammation of the joints and skeletal muscles followed by symmetric hind limb dysfunction, ranging from loss of hind limb gripping ability to very severe hind limb dragging (Lidbury, Simeonovic et al. 2000). Macrophages appear to play a central role in mediating the disease in this model (Lidbury, Simeonovic et al. 2000; Lidbury, Rulli et al. 2008), an observation consistent with presence of activated macrophages in the synovial infiltrates of RRVD patients (Fraser, Cunningham et al. 1981), with a broad range of cytokines and chemokine's (Tak 2006; Asquith and McInnes 2007) expression.

During RRV infection, the physiologic function of macrophages is to mediate phagocytosis of RRV-infected cells undergoing apoptosis, and their processing through a dominated anti-inflammatory response (Erwig and Henson 2007). However inflammatory mediators such as MCP-1, CXCL8, CXCL2 and antiviral IFN-  $\gamma$  were found associated with persistently infected macrophages by RRV (Gerszten, Garcia-Zepeda et al. 1999; Mateo, La Linn et al. 2000; Way, Lidbury et al. 2002). MCP-1 contributes directly to the activation of monocytes or macrophages, and notably to control TNF- $\alpha$  expression in murine peritoneal macrophages (Biswas and Sodhi 2002).

Viral persistence was also found in human synovial macrophages associated with pathogenesis of viral arthritis (Fraser, Cunningham et al. 1981; Linn, Aaskov et al. 1996). Absence of alphavirus specific cytotoxic T lymphocytes could be one of the reason of persisting synovial infection leading to chronic arthritis (Linn, Mateo et al. 1998).

Surprisingly no TNF- $\alpha$  could be detected in RRV infection (Elliott, Maini et al. 1993; Linn, Aaskov et al. 1996; Elliot, Maini et al. 2008). Alphavirus persistence in macrophages were first reported by *Linn et al.* RAW264.7, J774A.1 and Mono Mac 6 cells were found to be persistently infected by RRV alphavirus, with continuous production of virus for 50 days PI without any sign of CPE (Linn, Aaskov et al. 1996).

- RR virus can establish a persistent productive infection in the mouse RAW264.7 macrophage cell line which represent a good in vitro model of the behavior for RRV similar to macrophages in the chronic arthritic joints of patients (Linn, Aaskov et al. 1996).
- These persistent cultures were similar to many persistent cytopathic viral infections in vitro , with a characteristic IFN  $\alpha/\beta$  production protecting the majority of cells from CPE (Friedman and Ramseur 1979).
- RRV infection also induced dysregulation of TNF- $\alpha$ , IFN  $\gamma$  and CCL2 in RAW264.7 cells and also increase the expression of costimulatory molecule CD80 (involved in antigen presentation) but did not change for CD86 (Way, Lidbury et al. 2002).
- ADE-induced RRV infection suppresses the expression of antiviral factors (Lidbury and Mahalingam 2000; Mahalingam and Lidbury 2002).

In analogy to RRV, CHIKV RNA and protein was found in persistently infected synovial macrophages 18 months after infection (Hoarau, Jaffar Bandjee et al. 2010). Analyses of synovial fluid from a this patient shows monocytes and macrophages with large inclusions, NK cells and CD4+ T cells and absence of PMN cells, with elevated levels of CCL2, IL6 IL8, IL10 and IFN $\alpha$  (Hoarau, Jaffar Bandjee et al. 2010). Similarly to RRV infection rare relapses or persistence of arthralgia's was observed in CHIKV infection also (Nkoghe, Kassa et al. 2012). Persistence of CHIKV could be due to the failure of detection or neutralization of virus, finally escaping the innate immune cells such as DCs, NK and T cells. Muscle biopsies of CHIKV infection shows viral persistence associated with myositis (Ozden, Huerre et al. 2007). Primary human macrophages can be infected by CHIKV (5 to 50% infection rate) and allowing low viral replication and release of non-infectious particles (Sourisseau, Schilte et al. 2007; Solignat, Gay et al. 2009; Krejbich-Trotot, Denizot et al. 2011). The capacity of these CHIKV infected macrophages to control infection by apoptosis and to drive a proinflammatory response remains ill-characterized and will be the subject of this thesis (**Figure 41**).

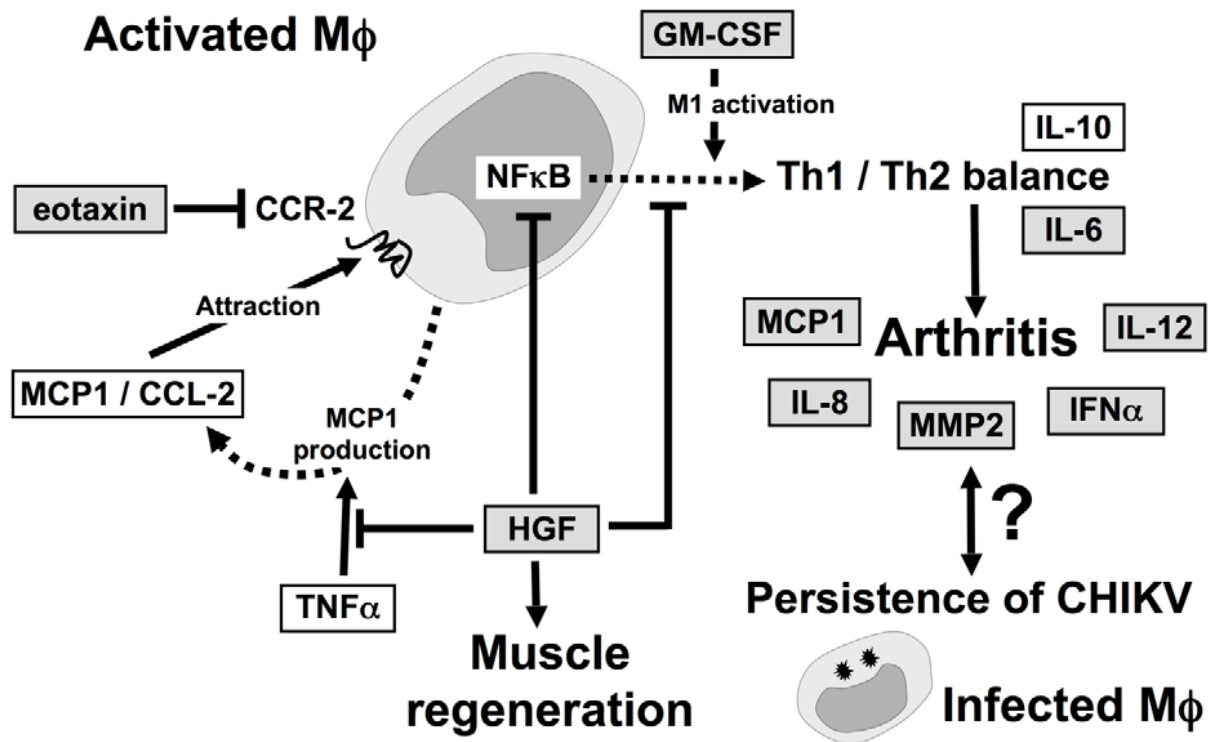

**Figure 41: The macrophage is central to chronic signs of chikungunya disease**

*Macrophage infiltration, under the control of MCP 1/CCL-2, is a critical feature of damaged tissues. The inflammatory effectors IL-6, IL-8, MCP-1/CCL-2, MMP2, and INF-α are specifically **expressed** in the tissues of patients with chronic chikungunya, who have high IFN-α and IL-12 mRNA levels in their circulating leukocytes. This classical inflammatory process may be regulated by HGF and eotaxin. HGF also promotes muscle regeneration. Once they have infiltrated the joint or muscle, the macrophages are activated and regulate the local Th1/Th2 balance as a function of their own activation status (classical/M1 or alternative/M2). GM-CSF and HGF, which have M1 and M2 effector activities, respectively, may modulate this balance as they are differentially expressed in acute and chronic chikungunya. CHIKV persists in infected macrophages only in patients with a chronic rheumatic syndrome. CHIKV persists in infected macrophages only in patients with a chronic rheumatic syndrome. Solid arrows: activation. Solid stopped lines: regulation. Dotted arrows: expression (Dupuis-Maguiraga, Noret et al. 2012).*

## **IV. Objectives of the Thesis**

CHIKV infection generally causes an acute self-limited illness with clinical symptoms of fever, rash and incapacitating joint and muscle pain, and poly arthralgia (Jaffar-Bandjee, Das et al. 2009). The arthritogenic characteristics caused by CHIKV is similar to other alphaviruses, such as SINV, SFV, and RRV.

The long term sequelae of joint inflammation due to CHIKV could be because of viral persistence in the tissue reservoir as reported for RRV and involving monocytes and macrophages. These cells were found to be associated with arthritic conditions and indeed synovial macrophages were found to be persistently infected by RRV (Lidbury, Rulli et al. 2008).

CHIKV can cause joint pain and chronic arthritis in humans and these events were thought also to be associated with virus persistence in perivascular synovial macrophages (Hoarau, Jaffar Bandjee et al. 2010). Human and animal studies (NHP) are limited by various experimental factors (ethical issues, limited number of tissue samples...) to analyze the role of macrophages in the physiopathology of CHIKV, and hence it was necessary to develop an in vitro macrophage cell model of CHIKV infection.

Hence the first objective of the study was to develop an in vitro model of mouse macrophage infection, based on the RAW264.7 cell line which was shown to be persistently infected by RRV for over 50 days (Linn, Aaskov et al. 1996). Second, we wanted to analyze the inflammatory response following infection with CHIKV. From this model, I started to analyze the expression of PRRs and antiviral genes (IFN, ISGs) prior to and after CHIKV infection, given that these molecules are known to play an effective role against the alphaviruses (Ryman, Klimstra et al. 2000). Apoptosis is one of the mechanisms against virus infection. Like for other cells type involved in CHIKV pathogenesis, fibroblast and neuronal cell which undergo apoptosis after CHIKV, apoptotic hallmarks were also analyzed in CHIKV-infected RAW cells. My results were published in virology journal entitled "Mouse Macrophage Innate Immune Response to CHIKV Infection" (Kumar, Jaffar-Bandjee et al. 2012) (**Article 1**).

Interestingly, RAW cells didn't engage a robust innate immune response following CHIKV exposure. This observation led to the question whether arthritogenic alphaviruses follow the same pattern of infection and host response. Herein I investigated the response of

RAW cells to Sindbis virus , Old World alphavirus but with neuropathological potential. In addition to the expression of IFN and ISGs I also analyzed cytokine expression (particularly TNF $\alpha$ ) and hallmarks of apoptosis. The manuscript entitled “Innate Immune Response to Sindbis Virus Infection in mouse RAW264.7 Cell line” describes a **(Preliminary study 1)** to be submitted.

Macrophages are known to have a direct role in angiogenesis, an important component of rheumatoid arthritis controlling panus formation and hyperplasia of fibroblasts. In CHIKV infected patients we found that the proliferation of synovial fibroblasts was assisted by a major angiogenesis by ill-characterized mechanisms (Hoarau et al. 2010). Herein, I addressed the putative role of macrophages infected by CHIKV in favoring angiogenesis. Since vascular endothelial growth factor (VEGF) and Platelet derived growth factor (PDGF) are involved in angiogenesis, the expression of these factors were analyzed in mouse RAW264.7 macrophage cell infection model.

The results obtained are presented in a manuscript entitled “Pro-angiogenic response in mouse RAW264.7 macrophage cell follow CHIKV Infection” **(Preliminary study 2)** to be submitted.



## **V. Results**

## Article 1

### Mouse Macrophage Innate Immune Response to CHIKV Infection

KUMAR Shiril<sup>1</sup>, JAFFAR-BANDJEE Marie-Christine<sup>1,2</sup>, GIRY Claude<sup>1</sup>, CONNEN de KERILLIS Léa<sup>1</sup>, MERITS Andres<sup>3</sup>, GASQUE Philippe<sup>1</sup> and HOARAU Jean-Jacques<sup>1\*</sup>

In this article, the RAW264.7 cell line was used in an attempt to develop an in vitro model of mouse macrophage infection by CHIKV.

- 1) First, the sensitivity of the RAW264.7 cell line to CHIKV was tested by immunofluorescence for viral proteins at 24hr and 48hr at MOI of 1. By comparison to CLTT mouse astrocyte cell line, used as a positive control and already described to be 90-100% susceptible to the virus, we found that less than 5 % of RAW264.7 cells were infected at 48h PI indicating clearly a limited sensitivity .
- 2) Despite the low number of infected cells observed, the capacity of the virus to replicate his genome and to release new infective virus particles was evaluated. To do this, the presence of positive and negative strands of the virus RNA was quantified by quantitative real-time PCR (RT-qPCR) and the formation of double strand of CHIKV RNA was detected by immunofluorescence technique using an anti-dsRNA antibody (J2 antibody). The capacity of the virus to spread was assessed by plaque assay. Positive strand of CHIKV RNA were detected in cells and culture supernatants of both cell types whereas the negative strand was detected only in CLTT infected cell supernatants. Expression of double stranded CHIKV RNA was observed by immunofluorescence study. These data confirmed the replication of the virus.
- 3) We next investigated the expression of different PRRs implicated in the specific recognition of RNA viruses, such as TLR-3,-7, MDA-5 and RIG-I by RT-qPCR. Surprisingly, TLR -3,-7 and MDA-5 were not detected and no significant difference was seen for RIG-I at mRNA level.

- 4) The type I IFN dependent innate immune response (RT-qPCR) levels was also evaluated. Again, no significant changes for IFN $\alpha$ 4 and ISG56 was observed for RAW264.7 cells by whereas for CLTT mouse astrocyte cell line, expression of gene was significantly increased
- 5) As an antiviral mechanism of cell defense, the induction of apoptosis in mouse macrophages following CHIKV infection was followed by immunofluorescence study at 24hr and 48hr PI. All apoptotic markers (cleaved caspase-3 and -9, TUNEL+ DNA fragmentation) were absent in RAW264.7 infected cells in contrast to CLTT infected cells.
- 6) During the time course of infection, cytokine expression were also evaluated: Interestingly, a robust TNF $\alpha$  expression (at both the RNA and protein levels) was evidenced at 24hr, and at 48hr PI it was associated with a significant expression of GM-CSF and IL-6.

**General conclusion:** Our data clearly show that the RAW264.7 mouse macrophage cell line can be infected in-vitro by CHIKV, but only at a very low frequency. Surprisingly, this infection was not followed by a robust type I IFN innate immune and apoptotic responses but by a TNF $\alpha$  and IL-6 cytokine production. All together, these observations indicate that RAW264.7 cells display a poor antiviral innate immune response following CHIKV infection associated with a robust pro-inflammatory cytokine profile which may contribute to arthritis. In addition, the capacity of the virus to propagate seems to be limited.

**My contribution:** I was involved in the designing of the experiment. I performed the experiment except the detection of positive and negative strands of the virus. I also analyzed the results and wrote the article.

This Provisional PDF corresponds to the article as it appeared upon acceptance. Fully formatted PDF and full text (HTML) versions will be made available soon.

**Mouse macrophage innate immune response to chikungunya virus infection**

*Virology Journal* 2012, **9**:313 doi:10.1186/1743-422X-9-313

Shiril Kumar (shiril.kumar@gmail.com)  
Marie-Christine Jaffar-Bandjee (marie-christine.jaffarbandjee@chr-reunion.fr)  
Claude Giry (giry\_claude@yahoo.fr)  
Léa Connen de Kerillis (lea.connen@wanadoo.fr)  
Andres Merits (andres.merits@ut.ee)  
Philippe Gasque (philippe.gasque@gmail.com)  
Jean-Jacques Hoarau (Jean-Jacques.Hoarau@univ-reunion.fr)

**ISSN** 1743-422X

**Article type** Short report

**Submission date** 27 December 2011

**Acceptance date** 12 December 2012

**Publication date** 19 December 2012

**Article URL** <http://www.virologyj.com/content/9/1/313>

This peer-reviewed article can be downloaded, printed and distributed freely for any purposes (see copyright notice below).

Articles in *Virology Journal* are listed in PubMed and archived at PubMed Central.

For information about publishing your research in *Virology Journal* or any BioMed Central journal, go to

<http://www.virologyj.com/authors/instructions/>

For information about other BioMed Central publications go to

<http://www.biomedcentral.com/>

© 2012 Kumar *et al.*

This is an open access article distributed under the terms of the Creative Commons Attribution License (<http://creativecommons.org/licenses/by/2.0>), which permits unrestricted use, distribution, and reproduction in any medium, provided the original work is properly cited.

# Mouse macrophage innate immune response to chikungunya virus infection

Shiril Kumar<sup>1</sup>  
Email: shiril.kumar@gmail.com

Marie-Christine Jaffar-Bandjee<sup>1,2</sup>  
Email: marie-christine.jaffarbandjee@chr-reunion.fr

Claude Giry<sup>1</sup>  
Email: giry\_claude@yahoo.fr

Léa Connen de Kerillis<sup>1</sup>  
Email: lea.connec@wanadoo.fr

Andres Merits<sup>3</sup>  
Email: andres.merits@ut.ee

Philippe Gasque<sup>1</sup>  
Email: philippe.gasque@gmail.com

Jean-Jacques Hoarau<sup>1,4,\*</sup>  
Email: Jean-Jacques.Hoarau@univ-reunion.fr

<sup>1</sup> GRI/IRG (EA4517), Immunopathology and infectious diseases research grouping, University of La Reunion, CHU and CYROI research centres, St-Denis, La Reunion, France

<sup>2</sup> Microbiology/Virology laboratory, CHU Félix-Guyon, Saint-Denis, La Reunion F-97400, France

<sup>3</sup> Institute of Technology, University of Tartu, Tartu, Estonia

<sup>4</sup> GRI – (EA4517) Université de la Réunion, Recherche – RDC, CHU Félix-Guyon, Bellepierre, Saint-Denis cedex, Ile de la Réunion 97405, France (DOM)

\* Corresponding author. GRI – (EA4517) Université de la Réunion, Recherche – RDC, CHU Félix-Guyon, Bellepierre, Saint-Denis cedex, Ile de la Réunion 97405, France (DOM)

## Abstract

### Background

Infection with Chikungunya alphavirus (CHIKV) can cause severe arthralgia and chronic arthritis in humans with persistence of the virus in perivascular macrophages of the synovial membrane by mechanisms largely ill-characterized.

## Findings

We herein analysed the innate immune response (cytokine and programmed cell death) of RAW264.7 mouse macrophages following CHIKV infection. We found that the infection was restrained to a small percentage of cells and was not associated with a robust type I IFN innate immune response (IFN- $\alpha$ 4 and ISG56). TNF- $\alpha$ , IL-6 and GM-CSF expression were upregulated while IFN- $\gamma$ , IL-1 $\alpha$ , IL-2, IL-4, IL-5, IL-10 or IL-17 expression could not be evidenced prior to and after CHIKV exposure. Although CHIKV is known to drive apoptosis in many cell types, we found no canonical signs of programmed cell death (cleaved caspase-3, -9) in infected RAW264.7 cells.

## Conclusion

These data argue for the capacity of CHIKV to infect and drive a specific innate immune response in RAW264.7 macrophage cell which seems to be polarized to assist viral persistence through the control of apoptosis and IFN signalling.

## Keywords

Chikungunya virus, Macrophage, Apoptosis, Viral persistence, Inflammation

## Introduction

Chikungunya virus (CHIKV) belongs to genus *Alphavirus* of the *Togaviridae* family and was first isolated in Tanzania in 1953 [1,2]. The viral genome is a single strand positive sense RNA of approximately 12kb. Together with other alphaviruses such as Ross river virus, Semliki forest virus and Sindbis virus (SINV), they are significant causes of arthritis in elderly patients [3-6].

The innate immune response can be engaged by several virus-associated molecular patterns recognized by a plethora of pattern recognition receptors (PRRs) such as toll-like receptors (TLR), retinoic acid inducible gene-I (RIG-I) like receptors (RLR), nucleotide oligomerization domain like receptors and protein kinase receptor [7,8]. These receptors, upon activation, switch on several genes which may regulate a protective response through the production of interferon (IFN) and IFN-stimulated genes (ISG).

Apoptosis or programmed cell death is one of the mechanisms used to limit viral dissemination to other cells [9]. Caspases are the main executor of apoptosis. Depending on their role, they are categorized into initiators (caspase-2,-8,-9-10), effectors or executioners (caspase-3,-6,-7) and inflammatory caspases (caspase-1,-4, -5) [10,11].

Recent human and non-human primate studies have shown that CHIKV can infect monocytes/macrophages and can also persist in perivascular macrophages of the synovial tissue in chronic conditions [12-15]. Interestingly, only a subset of human monocyte/macrophage cells (less than 10% of the CD14+ cells) can be infected *in vitro* and leading to a rather transient innate immune response (IL-8, RANTES, IFN- $\alpha$ ) which rapidly tails off at 48h post-infection (PI). Further FACS analyses of the infected monocyte cultures showed that expression of activation markers such HLA-DR and adhesion molecules CD54

(ICAM-1), CD106 (VCAM-1), and CD31 (PECAM-1) were not modified after CHIKV infection [14]. In contrast, a decrease in CD14 expression on CHIKV-infected blood monocytes may be associated with apoptosis by unknown mechanisms [14].

Here we used RAW264.7 mouse cell line to investigate the capacity of a CHIKV clinical isolate to infect mouse macrophages. We analysed the IFN $\alpha$ 4/ISG56, the apoptosis and the cytokine responses prior to and after CHIKV infection. The relative contribution of these different pathways may help to decipher the plausible role of persistently CHIKV-infected macrophages in chronic arthritis as reported in human, monkey and more recently in mice [16].

## Materials and methods

### CHIKV isolate

CHIKV (clone #4), isolated from a patient's serum during the 2006 epidemic at Reunion island, was collected as part of the research program supported by a PHRC (health French Ministry). The research protocol was validated by the Tours IRB France (Agreement 2006-10) and collection was consented for by the patient. After amplification by a single passage on Vero cells, supernatant was collected when cytopathic conditions were detected, centrifuged at 2000 rpm and 0.2 $\mu$ m filtered. Aliquots were stored at -80°C until used. Serially diluted ( $10^{-1}$  to  $10^{-12}$ ) virus were added to confluent Vero cell cultured in 96 well plate to establish the TCID $_{50}$  estimated at  $10^7$ /ml.

### Cells and culture condition

Cell lines used were: mouse RAW264.7 macrophage (ECACC, 91062702), mouse CLT1 astrocyte, African green monkey Vero cells (ATCC, CCL-81) and baby hamster kidney BHK-21 (ATCC, CCL-10). Cells were maintained in DMEM (PAN Biotech, France) medium, except BHK-21 in GMEM, containing 10% heat inactivated FCS with penicillin (100U/ml), streptomycin (0.1mg/ml), sodium pyruvate (100mM), L-Glutamine (200mM) and fungizone (0.5 $\mu$ g/ml) at 37°C under 5% CO $_2$ . For BHK-21, medium was supplemented with 10 ml HEPES (PAN Biotech) and 50ml of tryptose phosphate broth (Sigma). Infections were performed by addition of CHIKV at a multiplicity of infection of 1.

### Quantitative RT-PCR (RT-qPCR)

Total RNAs were extracted from culture cells using TRIzol® reagent (Invitrogen, France) and quantified using a picodrop (Labgene scientific, France). Reverse transcription (RT) was performed in a final volume of 30 $\mu$ l containing 3 $\mu$ g of RNA per reaction, 1X RT buffer, 5 $\mu$ M DTT, 1Mm dNTP mix, 7.5U pDn6 and 60U RNasin incubated at 65°C for 5 min then cooled in ice for 5min before addition of 98.4u of Reverse transcriptase (MMLV) and again incubated at 37°C for 1hr followed by 5 min at 95°C. All products were from Promega, France. RNA expression level between samples, for mouse interferon alpha-4 (IFN $\alpha$ 4), mouse interferon stimulated gene-56 (ISG-56), tumor necrosis factor alpha (TNF $\alpha$ ), were performed using SYBR RT-qPCR with the ABI7500 sequence detection system (Applied Biosystem, France). Mouse Glyceraldehyde-3- phosphate dehydrogenase was used as reference housekeeping gene. Cycling conditions were: 10min at 95°C followed by 40 cycles consisting on 15sec at 95°C, 30sec at 60°C and 45sec at 72°C before a final step to establish

the dissociation curve. Amplicons were verified by 1.2% agarose gel-electrophoresis. CHIKV absolute quantification from infected cells and TCS was performed as previously described using a plasmid containing E1 insert as a standard, (kindly provided by Prof. X. de Lamballerie, Marseille, France) [12,17]. Primers used are listed in Table 1.

**Table 1 List of primers used**

Gene	Primer 1 (5' → 3')	Primer 2 (5' → 3')	Amplicon (bp)
GAPDH	GAACGGGAAGCTTGTTCATCA	TGACCTTGCCACAGCCTTG	473
IFN $\alpha$ 4	AGCCTGTGTGATGCAGGAACC	CAGCAAGTTGGTTGAGGAAGAG	171
ISG56	CTCAGAGCAGGTCCAGTTCC	TCCATCTCAGCACACTCCAG	300
TNF $\alpha$	ACGGCATGGATCTCAAAGAC	CGGACTCCGCAAAGTCTAAG	325
CHIKV_E1	AAGCTYCGCGTCCTTTACCAAG	CCAAATTGTCCYGGTCTTCCT	209
Probe_E1	FAM – CCAATGTCYTCMGCCTGGACACCTTT - TAMRA		
CHIKV_E2	ACKCTGACRGTGGGATTYAC	ACGTGCTGCAAGGTARCTCT	139
CHIKV_Pos	ACGTGCTGCAAGGTARCTCT		
CHIKV_Neg	ACKCTGACRGTGGGATTYAC		

### Amplification of CHIKV positive or negative RNA strands

Total RNAs from CHIKV infected cells (RAW264.7 or CLTT) or cell culture supernatant were extracted using the Nuclisens® easyMAG® system (bioMerieux SA, France). 2 $\mu$ l of 20 $\mu$ M biotinylated primers specific for either positive strand (CHIKV\_Pos) or negative strand (CHIKV\_Neg) of CHIKV E2 gene (CHIKV\_E2 primers) were mixed with 2 $\mu$ l of total RNA for denaturation at 65°C for 2 minutes in a final volume of 20 $\mu$ l, then cooled in ice for 5 min. Reverse transcription (RT) was performed in a final volume of 20 $\mu$ l using the PrimeScript RT reagent kit (TAKARA, France), containing 4.5 $\mu$ l of denatured RNA, 4 $\mu$ l of 5X RT buffer and 1 $\mu$ l of RT enzyme, in a thermocycler (Eppendorf, France) at 37°C for 15 min followed by 5sec at 85°C. The biotinylated cDNAs were then purified using the Dynabeads M-270 streptavidin system (Invitrogen, France) and finally suspended in 20 $\mu$ l of EASY dilution solution (TAKARA, France). 5 $\mu$ l of purified cDNA were amplified in a final volume of 20 $\mu$ l containing 500nM of primers (CHIKV\_E2), 10 $\mu$ l of 2X SYBR Premix Ex Taq II polymerase buffer (TAKARA, France) with a LightCycler 480/96 (Roche, France). Cycling conditions were: 30sec at 95°C followed by 40 cycles consisting on 5sec at 95°C, 15sec at 56°C and 15sec at 72°C before a final step to establish the dissociation curve.

### Immunofluorescence staining (IFs)

Adherent cells (RAW264.7 and CLTT cells) were grown on glass coverslips, washed to remove debris and fixed by chilled ethanol for 5 min at different time PI. Cells were incubated at 4°C overnight with primary antibody in PBS-BSA 1%, washed 3 times in PBS followed by 2 hours incubation at room temperature with secondary antibody conjugated with Alexa Fluor 488 or 594 and DAPI (Invitrogen, France) in PBS/BSA. After washing in PBS, coverslips were mounted in Vectashield (VectorLab, France), visualized using a Nikon Eclipse 80i microscope with a Hamamatsu ORCA-ER camera and acquired with NIS-Element BR v2.30 imaging software (Nikon, France). Antibodies used were: Mouse monoclonal anti CHIKV E1 clone 6C4A5 (kindly provided by Biomerieux and IMTSSA, France), FDO (Human serum anti-CHIKV), mouse anti-cleaved Caspase-9 (cell signaling, France), polyclonal rabbit anti-cleaved Caspase-3 (cell signaling), monoclonal rabbit anti p-



IRF3 (cell signaling), polyclonal rabbit anti ISG-15 (cell signaling), rabbit anti-SFV Nsp1 (kindly provided by A. Merits) and mouse anti-dsRNA J2 (English and scientific consulting, Hungary). For each marker, photographs were taken with equal exposure time.

### **Cytokines titration**

Cytokines released by RAW264.7 or CLTT cells in tissue culture supernatants (TCS) were measured using the mouse TNF $\alpha$  ELISA Ready-SET-GO kit (eBioscience, France) and by FACS using the mouse Th1/Th2 10 plex Flowcytomix kit (eBioscience, France) on a FC500 flow cytometer (Beckman coulter, France) according to manufacturer's protocols.

### **Plaque assay**

Supernatant from cell cultures (TCS) infected by CHIKV were collected at 2, 8, 24 and 48hrs PI and filtered thru 0.2 $\mu$ M. 300 $\mu$ l of diluted supernatant ( $10^{-1}$  to  $10^{-7}$  dilution) in serum free GMEM medium was added on confluent BHK-21 cells grown on 6 well plates and incubated for 1 hour shaking every 10 minutes in an incubator at 37°C under 5% CO $_2$ . After infectious media was aspirated, each well was overlaid with 2ml of CMC/GMEM mixture composed of 2 parts of 2% CMC (carboxymethylcellulose, Sigma) and 3 parts of complete GMEM containing 2% FCS, then cultured for 72 hours. CMC/GMEM mixture was removed and cells were stained with crystal violet dye solution at room temperature for 30 min. Plates were washed under tap water and the number of plaques/well were counted to determine the virus titer (pfu/ml) calculated as the number of plaques/well  $\times$  Dilution factor  $\times$  K (compensation factor to 1ml).

### **TUNEL assay**

Infected cells were grown on coverslips for 8 and 24hrs. To detect cells undergoing apoptosis, the Deadend colorimetric TUNEL system (Promega) was used according to the manufacturer's protocol. Coverslips were mounted with permanent mounting medium VectaMount (Vector laboratories, USA) for analysis.

### **Statistical analysis**

*Paired t* test statistical analysis was performed using Sigma plot version 9.0.1 software (Systat, UK). Values are represented as Mean  $\pm$  SEM from three independent experiments.

## **Results**

### **CHIKV infects and replicates in a subset of RAW264.7 macrophage cells**

At 48hrs PI, we observed that only a subset of RAW264.7 cells was infected in the form of clusters by CHIKV (less than 5% of the total population) compared to CLTT (100% infection). We found that infected RAW cells produced ISG15 but were not stained for phospho IRF3 at 24h PI although at a level much lower than CLTT astrocytes. Simultaneous expression of dsRNA (J2 antibody), CHIKV structural proteins (E2, E1, Capsid using FDO human antiserum and mouse anti-E1) and non-structural protein Nsp1 (antiserum) following CHIKV infection of RAW 264.7 cells was also observed (Figures 1 and 2). We used CLTT astrocyte cell line as a positive control of CHIKV infection as shown previously [18]. The

release of CHIKV particles from infected cells was confirmed by RT-qPCR and plaque assay. By RT-qPCR, CHIKV RNA was detected from 8h PI in RAW cells and at a level at least 1000 fold lower when compared to CLTT (Figure 3). In TCS of infected RAW264.7, a stable level of virus ( $\sim 3 \times 10^3$  pfu/ml) was measured at 8, 24 and 48hrs PI compared to CLTT (respectively  $\sim 3.3 \times 10^7$ ,  $1.3 \times 10^8$  and  $2.3 \times 10^7$  pfu/ml at 8, 24 and 48hrs PI). Interestingly, in contrast to CLTT, the level of CHIKV RNA produced in RAW264.7 cells decreased rapidly between 8 and 24hrs PI to become undetectable at 48h. Positive strands of CHIKV RNA were detected in both RAW cells and culture supernatants whereas the negative strand was detected only in RAW 264.7 infected cells (Figure 4).

---

**Figure 1 CHIKV infects and replicates in RAW264.7 mouse macrophages.** (A) Immunostainings using FDO (human anti-CHIKV polyclonal Ab, red fluorescence) and J2 (mouse anti-double stranded RNA, green) or ISG-15 or specific rabbit anti-phospho IRF3 at 24hrs PI. Nuclei were counterstained with DAPI (blue). Only a limited number of total RAW264.7 cells were infected (<5%) in form of clusters, as focused on here, compared to CLTT (> 95% of infected cells). (B) During the time course of infection, both structural and non-structural proteins of CHIKV were produced in infected cells as shown by double staining with FDO (green fluorescence) and rabbit anti cross-reacting SFV/CHIKV Nsp1 antibody (red fluorescence). Nuclei were stained with DAPI (blue fluorescence). Negative controls are shown as insets. \* Cluster of infected cells.

**Figure 2 RAW264.7 infected cells does not undergo apoptosis.**(A& B) Immunofluorescence of RAW264.7 and CLTT at 48hrs PI (mouse monoclonal anti-CHIKV E1, green fluorescence) and apoptosis markers (initiator cleaved caspase-9 or executor cleaved caspase-3, red fluorescence). Nuclei were stained with DAPI (blue fluorescence). (C) No DNA fragmentation (TUNEL assay) was observed in RAW264.7 cells (Inset, positive control of apoptosis) during the time course of infection.

**Figure 3 CHIKV replication in RAW (macrophages) and CLTT (astrocyte control).** (A) With time, CHIKV RNA raised in RAW264.7 cells and supernatants but remained low compared to CLTT as tested by RT-qPCR for E1 (n=3). The graph was plotted after adjusting the background level of the residual virus following the washing steps at T0 (2hrs PI).

**Figure 4 CHIKV positive and negative RNA strands expression.** Positive (-) and negative (-) E2 RNAs were detected at very high levels in CLTT cells ( both in cells and supernatants) whereas RAW264.7 expressed the positive strand at level 1000 fold lower than CLTT (both in cells and supernatants) while the negative strand was detected at a low level and only in cell extract. The quantity of RNA strands (arbitrary unit) was estimated with the  $\Delta C_t$  method as  $2^{-\Delta C_t}$  with  $\Delta C_t = C_t$  (at 8h or 48h PI) -  $C_t$  (at T0). Ndt (Not detected).

---

### **The infection of mouse RAW264.7 macrophage cells by CHIKV does not lead to apoptosis**

The majority of CLTT cells at 24hrs PI were positive for both initiator cleaved caspase-9 and executor cleaved caspase-3 with condensed or fragmented nuclei whereas among the clusters of infected RAW264.7 cells, these markers remained negatives and only a few nuclei were condensed (Figure 2). Moreover, no sign of DNA fragmentation was observed by TUNEL assay for RAW264.7 at 24hrs PI compare to CLTT (Figure 2C).

## **RAW264.7 mounts a rather poor innate immune response against CHIKV in contrast to CLTT**

RT-qPCR analysis showed no significant changes in IFN $\alpha$ 4 and ISG-56 mRNA expression levels for RAW264.7 when compared to CLTT cell line at 24hrs PI (Figure 5). Since PRRs are critical sensors to initiate the antiviral innate immunity, we also tested TLRs and RIG-I expression in RAW cells prior to and after CHIKV infection. TLR-3, 7, 8 and 9 were not detected (Ct values >35) and no significant changes were found for RIG-I from 8 to 48h PI (data not shown).

---

**Figure 5 Polarized innate immune response in CHIKV-infected RAW264.7.** (A) During the time course of infection, RAW264.7 shows no significant change in IFN $\alpha$ 4 mRNA expression by RT-qPCR compared to CLTT. However, a significant increase of ISG-56 at 24hrs PI was measured for CLTT (fold increase =  $121.5 \pm 11.5$ ) compare to RAW264.7 ( $0.7 \pm 0.1$ ). (B) A significant increase of TNF $\alpha$  for RAW264.7 at 24hr PI (fold change =  $17.9 \pm 3.2$ ) was observed by RT-qPCR and validated by ELISA (fold change =  $3.3 \pm 0.3$ ). Fold change over non-infected control is expressed as mean + SEM of three independent experiments.

---

## **Robust TNF-alpha expression in CHIKV-infected RAW264.7 cells**

TNF $\alpha$  release was significantly increased at 24hrs PI (control:  $1025 \pm 183$  pg/ml to CHIKV-infected RAW:  $3421 \pm 766$ pg/ml,  $p=0.02$ ) as measured by ELISA and confirmed by FACS beads array (control:  $1021 \pm 266$  pg/ml; CHIKV:  $3931 \pm 1207$ pg/ml) (Figure 5B). TNF $\alpha$  expression at the mRNA level was also significantly increased at 24hrs PI (fold change:  $18 \pm 3.2$  over control,  $p=0.034$ ) compared to 8hrs PI (fold change:  $0.6 \pm 0.3$  over control, not significant) (Figure 5B). Low but significantly elevated expression of IL-6 ( $46.6$  pg/ml) and GM-CSF ( $395.4$  pg/ml) was observed at 24hrs PI compared to undetectable levels in mock-infected RAW cells. No expression of IFN- $\gamma$ , IL-1 $\alpha$ , IL-2, IL-4, IL-5, IL-10 or IL-17 was detected by FACS analysis in RAW TCS prior to and after CHIKV exposure.

## **Discussion**

There is considerable evidence that several RNA/DNA viruses such as RRV, HCV, HIV, Measles and CMV can persist in monocytes/macrophages [6,19,20]. In patients suffering from chronic arthritis post RRV- and CHIKV- infection, it is generally accepted that inflammation is associated with productive viral gene expression in synovial macrophages and despite neutralizing antibodies and antiviral interferon/cytokine responses [5,6]. Persistence may be facilitated by down-regulation of pro-inflammatory cytokine responses by virus-antibody complexes binding to Fc receptors, the induction of immunoregulatory interleukin-10 and phagocytosis of apoptotic virus-infected cells in a non-phlogistic manner [6,21,22]. Another strategy developed by viruses to persist in infected cells is to render them resistant to apoptosis notably through the up-regulation of the cellular oncogene Bcl-2 and NF- $\kappa$ B activity [23,24]. Our understanding of the possible contribution of these different mechanisms to control CHIKV-persistence and to polarize the innate immune macrophage responses is still in its infancy.

It has already been shown that CHIKV can infect human monocytes/macrophages [12-15] but little is known about the cell response to the infection. Our study shows for the first time that mouse macrophage cell line RAW264.7 can be infected by CHIKV. Interestingly, this occurs only for a subset of cells and spreading to surrounding cells to form clusters of infected cells.

In opposite to previous studies which only shown the capacity of CHIKV to infect macrophages (both cell lines and primary cultures) [15,21], we demonstrate here that RAW264.7 macrophage cells were able to produce also competent CHIKV particles (PFU) during the early phase of infection and this was confirmed by the capacity of the virus to replicate its genome evidenced by the detection of the negative strand RNA. Remarkably, the level of infectious particles produced by RAW cells was much lower when compared to that of CLTT astrocyte cell line.

Type I IFN dependent innate immune response plays an effective role against alphavirus infection [25]. Type I IFN also induces expression of ISGs with antiviral, anti-proliferative and immunomodulatory functions. No significant changes of IFN $\alpha$ 4 and ISG56 expression in RAW macrophage cells were observed in contrast to robust type I IFN and ISG56 levels in CLTT astrocyte cell line at the same MOI and time PI. Although a low level of ISG15 was evidenced in RAW264.7 infected cells, which could also be induced by IFN-independent pathways [26], only weak levels of phospho-IRF3 translocating to the nucleus was detected. This observation is to be correlated with the low levels of RIG-I in RAW264.7 macrophage cells (even after CHIKV infection) while TLR-3, 7, 8 and 9 were not expressed. Hence, the absence of IFN $\alpha$  and ISG response in infected-RAW264.7 could be due to the lack of PRRs to sense virus RNA and proteins. Many alphaviruses are known to interfere with the IFNAR/Jak/STAT pathway as illustrated in CHIKV-infected Vero cells [27] and this remains to be tested in macrophage cells.

The extrinsic signalling apoptotic pathway involves death receptors that are members of TNF $\alpha$  receptor gene family. Interestingly, we have found robust levels of TNF $\alpha$  mRNA in RAW264.7 cells but not in CLTT astrocytes. This finding was confirmed when looking at the expression of TNF $\alpha$  protein by ELISA and FACS bead assays of TCS. TNF $\alpha$  signalling, in turn, may control apoptosis but this hypothesis was not validated in our RAW264.7 cell model given that cleaved caspase-3 was not detected in RAW264.7 cells. Cleaved caspase-9 (marker of the intrinsic pathway of apoptosis) was also not detected. This finding is in line with the observation that persistent HIV-1 infection of macrophages is linked to increased levels of TNF $\alpha$  controlled by NF $\kappa$ B activation and decreased susceptibility to apoptosis [23,28]. Of note, a recent study illustrated the capacity of adjuvant doses of LPS to assist RRV persistence in RAW264.7 cells and this may also involve TLR4/CD14/NF $\kappa$ B signalling to control for apoptosis [29]. Experiments to test whether these paradigms can explain CHIKV persistence in macrophages are now highly warranted at least *in vitro*.

Understanding the intimate mechanisms of CHIKV-persistence is a prerequisite to devise new and original therapies aiming to control for chronic pathologies experienced by patients even 5-6 years post-infection [30].

## Abbreviations

(IFs), Immunofluorescence staining; (PI), Post infection; (CHIKV), Chikungunya virus; (IFN), Interferon; (PRR), Pattern recognition receptor; (TLR), Toll-like receptor; (RIG-I), Retinoic acid inducible gene-1; (IFN $\alpha$ 4), Interferon alpha 4; (ISG), Interferon stimulated gene; (TNF $\alpha$ ), Tumor necrosis factor alpha; (PBS), Phosphate buffer saline; (BSA), Bovine serum albumin; (FACS), Fluorescence analysis cell sorting; (TCS), Tissue culture supernatants.

## Competing interests

The authors have no competing interests

## Authors' contributions

Conceived and designed the experiments: KS, IJJ, GP, CG Performed the Experiments: KS; CG, CDKL Analyzed the data: KS, HJJ, CG, GP; Contributed reagents/materials/analysis tools: GP, MCJB, AM; Wrote the paper: KS, HJJ, GP. All authors have read and approved this manuscript.

## Acknowledgements

The authors thank G. Lee Pat Yuen, P. Krejbich-Trotot and V. Thon-Hon for help and Advices. This work is supported by a Ph.D. student fellowship to KS by the Regional Council (Reunion Island). Lab funding has been granted by CPER/FEDER to GRII and other European funding from FP7/ICRES (Integrated Chikungunya Research) project. We thank Dr M. Mallat (INSERM U495, Hôpital Salpêtrière, Paris) for kindly providing the CLTT cell line. PG is a fellow of INSERM U945 (Pr B. Autran).

## References

1. Mason PJ, Haddow AJ: **An epidemic of virus disease in Southern Province, Tanganyika Territory, in 1952-53; an additional note on Chikungunya virus isolations and serum antibodies.** *Trans R Soc Trop Med Hyg* 1957, **51**:238–240.
2. Calisher CH, Shope RF, Brandt W, Casals J, Karabatsos N, Murphy FA, Tesh RB, Wiebe ME: **Proposed antigenic classification of registered arboviruses I. Togaviridae, Alphavirus.** *Intervirology* 1980, **14**:229–232.
3. Tesh RB: **Arthritides caused by mosquito-borne viruses.** *Annu Rev Med* 1982, **33**:31–40.
4. Mathiot CC, Grimaud G, Garry P, Bouquety JC, Mada A, Daguisy AM, Georges AJ: **An outbreak of human Semliki Forest virus infections in Central African Republic.** *AmJTrop Med Hyg* 1990, **42**:386–393.

5. Jaffar-Bandjee MC, Das T, Hoarau JJ, Krejbich Trotot P, Denizot M, Ribera A, Roques P, Gasque P: **Chikungunya virus takes centre stage in virally induced arthritis: possible cellular and molecular mechanisms to pathogenesis.** *Microbes and infection / Institut Pasteur* 2009, **11**:1206–1218.
6. Suhrbier A, La Linn M: **Clinical and pathologic aspects of arthritis due to Ross River virus and other alphaviruses.** *Curr Opin Rheumatol* 2004, **16**:374–379.
7. Bowie AG, Unterholzner L: **Viral evasion and subversion of pattern-recognition receptor signalling.** *Nat Rev Immunol* 2008, **8**:911–922.
8. Yoneyama M, Fujita T: **RNA recognition and signal transduction by RIG-I-like receptors.** *Immunol Rev* 2009, **227**:54–65.
9. Griffin DE, Hardwick JM: **Regulators of apoptosis on the road to persistent alphavirus infection.** *Annu Rev Microbiol* 1997, **51**:565–592.
10. Cohen JJ: **Programmed cell death in the immune system.** *Adv Immunol* 1991, **50**:55–85.
11. Rai NK, Tripathi K, Sharma D, Shukla VK: **Apoptosis: a basic physiologic process in wound healing.** *Int J Low Extrem Wounds* 2005, **4**:138–144.
12. Hoarau JJ, Jaffar Bandjee MC, Krejbich Trotot P, Das T, Li-Pat-Yuen G, Dassa B, Denizot M, Guichard E, Ribera A, Henni T, *et al*: **Persistent chronic inflammation and infection by Chikungunya arthritogenic alphavirus in spite of a robust host immune response.** *J Immunol* 2010, **184**:5914–5927.
13. Labadie K, Larcher T, Joubert C, Mannioui A, Delache B, Brochard P, Guigand L, Dubreil L, Lebon P, Verrier B, *et al*: **Chikungunya disease in nonhuman primates involves long-term viral persistence in macrophages.** *J Clin Invest* 2010, **120**:894–906.
14. Her Z, Malleret B, Chan M, Ong EK, Wong SC, Kwek DJ, Tolou H, Lin RT, Tambyah PA, Renia L, Ng LF: **Active infection of human blood monocytes by Chikungunya virus triggers an innate immune response.** *J Immunol* 2010, **184**:5903–5913.
15. Sourisseau M, Schilte C, Casartelli N, Trouillet C, Guivel-Benhassine F, Rudnicka D, Sol-Foulon N, Ie Roux K, Prevost MC, Fsihi H, *et al*: **Characterization of reemerging chikungunya virus.** *PLoS Pathog* 2007, **3**:e89.
16. Gardner J, Anraku I, Le TT, Larcher T, Major L, Roques P, Schroder WA, Higgs S, Suhrbier A: **Chikungunya virus arthritis in adult wild-type mice.** *J Virol* 2010, **84**:8021–8032.
17. Pastorino B, Bessaud M, Grandadam M, Murri S, Tolou HJ, Peyrefitte CN: **Development of a TaqMan RT-PCR assay without RNA extraction step for the detection and quantification of African Chikungunya viruses.** *J Virol Methods* 2005, **124**:65–71.

18. Das T, Jaffar-Bandjee MC, Hoarau JJ, Krejbich Trotot P, Denizot M, Lee-Pat-Yuen G, Sahoo R, Guiraud P, Ramful D, Robin S, *et al*: **Chikungunya fever: CNS infection and pathologies of a re-emerging arbovirus.** *Prog Neurobiol* 2009.
19. Griffin DE: **Measles virus-induced suppression of immune responses.** *Immunol Rev* 2010, **236**:176–189.
20. Le Douce V, Herbein G, Rohr O, Schwartz C: **Molecular mechanisms of HIV-1 persistence in the monocyte-macrophage lineage.** *Retrovirology* 2010, **7**:32.
21. Krejbich-Trotot P, Denizot M, Hoarau JJ, Jaffar-Bandjee MC, Das T, Gasque P: **Chikungunya virus mobilizes the apoptotic machinery to invade host cell defenses.** *The FASEB J* 2011, **25**:314–325.
22. Savill J, Dransfield I, Gregory C, Haslett C: **A blast from the past: clearance of apoptotic cells regulates immune responses.** *Nat Rev Immunol* 2002, **2**:965–975.
23. McElhinny JA, MacMorrán WS, Bren GD, Ten RM, Israel A, Paya CV: **Regulation of I kappa B alpha and p105 in monocytes and macrophages persistently infected with human immunodeficiency virus.** *J Virol* 1995, **69**:1500–1509.
24. Levine B, Huang Q, Isaacs JT, Reed JC, Griffin DE, Hardwick JM: **Conversion of lytic to persistent alphavirus infection by the bcl-2 cellular oncogene.** *Nature* 1993, **361**:739–742.
25. Ryman KD, Klimstra WB, Nguyen KB, Biron CA, Johnston RE: **Alpha/beta interferon protects adult mice from fatal Sindbis virus infection and is an important determinant of cell and tissue tropism.** *J Virol* 2000, **74**:3366–3378.
26. Chairatvit K, Wongnoppavich A, Choonate S: **Up-regulation of interferon-stimulated gene15 and its conjugates by tumor necrosis factor-alpha via type I interferon-dependent and -independent pathways.** *Mol Cell Biochem* 2012, **368**:195–201.
27. Fros JJ, Liu WJ, Prow NA, Geertsema C, Ligtenberg M, Vanlandingham DL, Schnettler E, Vlak JM, Suhrbier A, Khromykh AA, Pijlman GP: **Chikungunya virus nonstructural protein 2 inhibits type I/II interferon-stimulated JAK-STAT signaling.** *J Virol* 2010, **84**:10877–10887.
28. Van Antwerp DJ, Martin SJ, Kafri T, Green DR, Verma IM: **Suppression of TNF-alpha-induced apoptosis by NF-kappaB.** *Science* 1996, **274**:787–789.
29. Lidbury BA, Rulli NE, Musso CM, Cossetto SB, Zaid A, Suhrbier A, Rothenfluh IIS, Rolph MS, Mahalingam S: **Identification and characterization of a ross river virus variant that grows persistently in macrophages, shows altered disease kinetics in a mouse model, and exhibits resistance to type I interferon.** *J Virol* 2011, **85**:5651–5663.
30. Jaffar-Bandjee MC, Ramful D, Gauzere BA, Hoarau JJ, Krejbich-Trotot P, Robin S, Ribera A, Selambarom J, Gasque P: **Emergence and clinical insights into the pathology of Chikungunya virus infection.** *Expert Rev Anti Infect Ther* 2010, **8**:987–996.

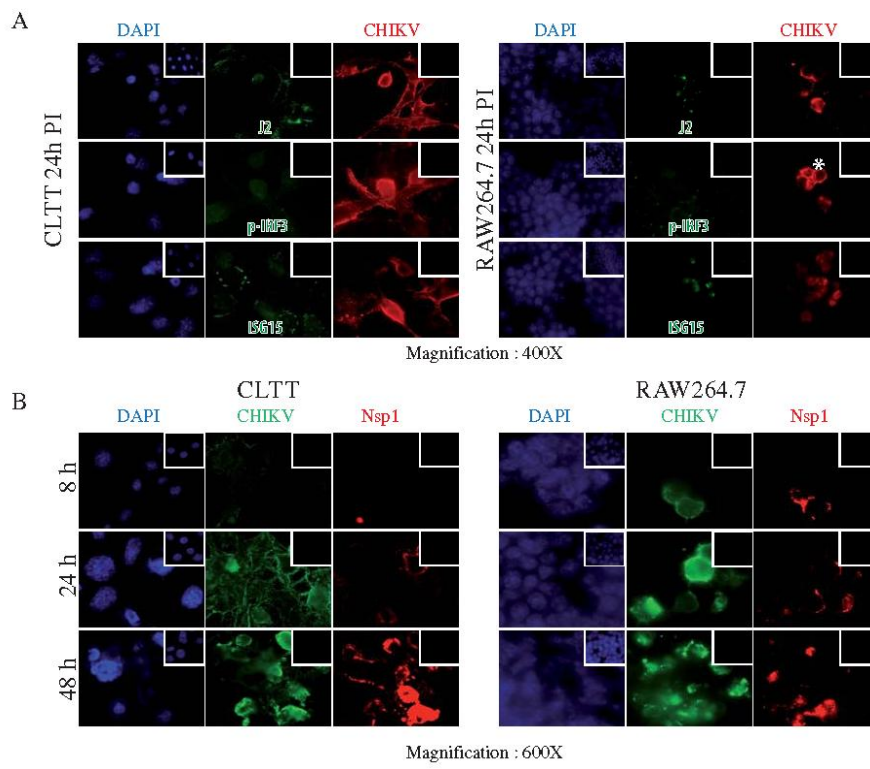

Figure 1  
Kumar et al.



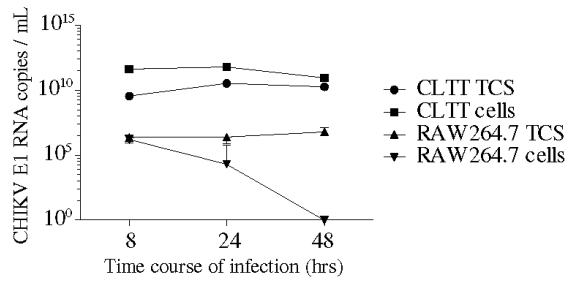
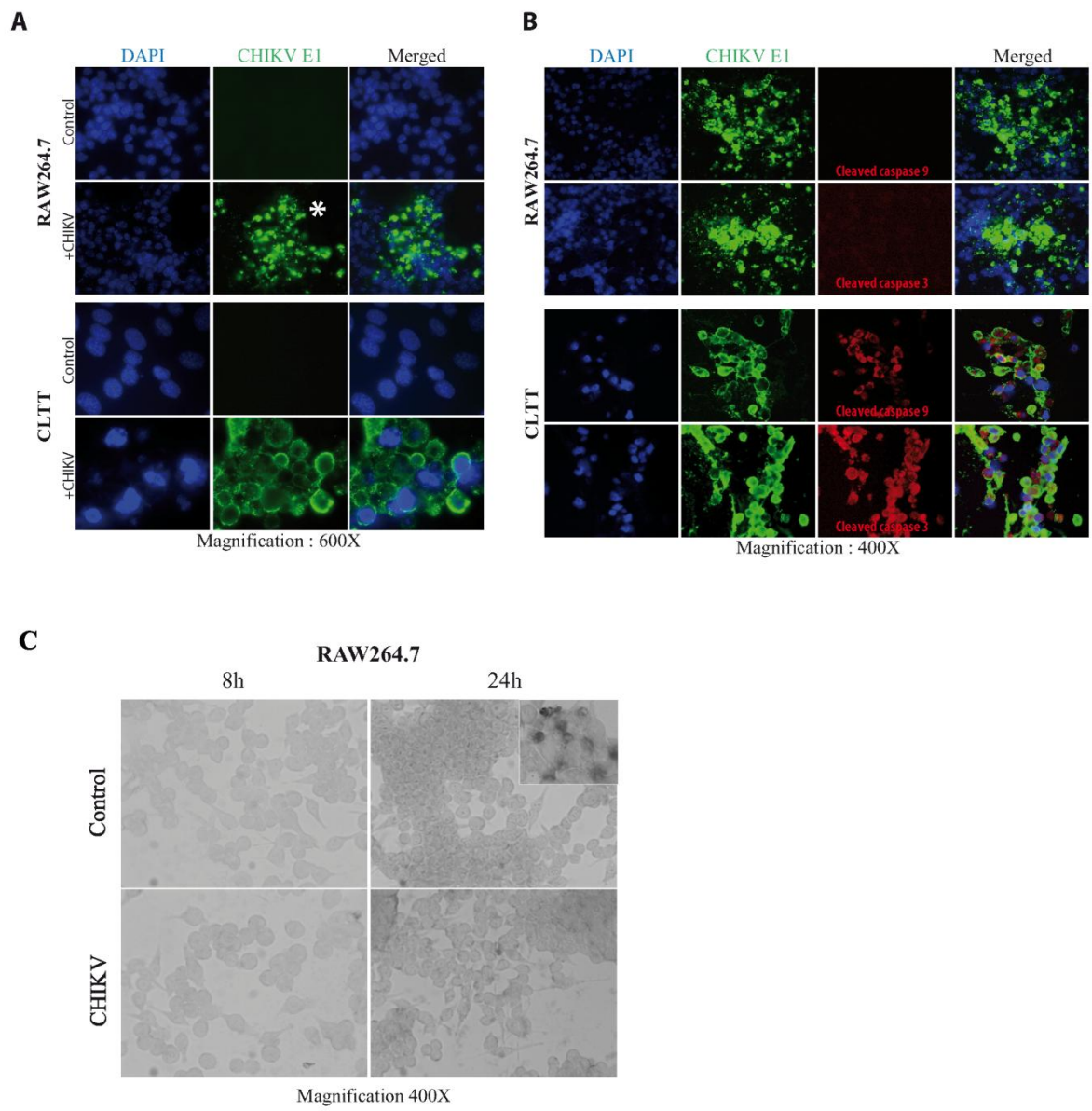

Figure 2  
Kumar et al.



**Figure 3**  
Kumar et al.

A

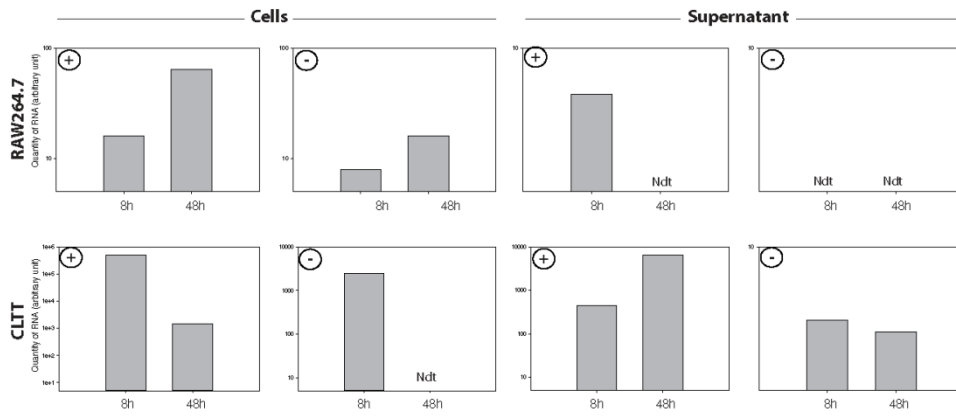
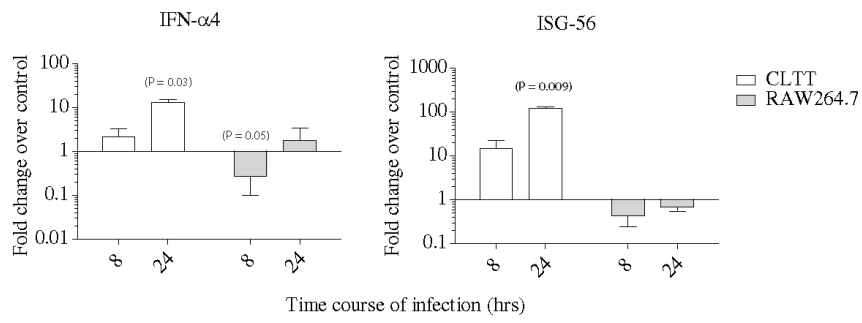

Figure 4  
Kumar et al.

A



B

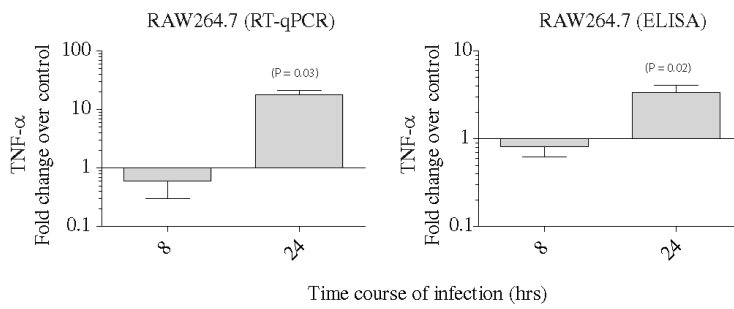

Figure 5  
Kumar et al.

## Preliminary study 1

### Innate Immune Response to Sindbis Virus Infection in mouse RAW264.7 Cell line

KUMAR Shiril<sup>1\*</sup>, JAFFAR-BANDJEE Marie-Christine<sup>1,2</sup>, GASQUE Philippe<sup>1</sup> and HOARAU Jean-Jacques<sup>1\*</sup>

In this article we aimed to compare the innate immune response of RAW264.7 for SINV to that of CHIKV infection (see article 1).

- 1) First the susceptibility of RAW264.7 cells to Sindbis infection was tested: RAW264.7 was found to be more receptive to SINV (35% infection at 48hr PI by immunofluorescence study) at MOI of 1, as compared to less than 5% infection by CHIKV.
- 2) Expression of PRRs in response to SINV infection: TLR-3, RIG-I, and MDA5 were significantly up regulated at 24hr PI in contrast to CHIKV infection.
- 3) Antiviral type I IFN dependent innate immune response: SINV significantly induced type I IFN response (IFN $\alpha$ 4) which in turn increased ISGs such as PKR and ISG-15,-54,-56 as observed at mRNA levels by RT-q PCR. This is not evidenced in CHIKV-infected RAW cells.
- 4) Apoptotic response of SINV-infected macrophages: RAW264.7 cells were found to undergo robust apoptosis with the detection of positive apoptotic marker cleaved caspase-3 and -9 at 24hr PI, as observed by immunofluorescence in SINV infected cells but not in response to CHIKV.
- 5) During the time course of infection, a robust TNF $\alpha$  mRNA expression was evidenced at 24hr PI in SINV-infected RAW cells and corroborating the data with CHIKV.

**Conclusion:** SINV infection mobilized a strong innate immune in RAW264.7 cell line compared to CHIKV infection. The increase in the expression of different PRRs is to be linked with the observed robust expression of type I IFN and several ISGs. SINV infected macrophages clearly showed apoptosis hallmarks and hence with the possibilities to control virus replication. These observations contrast sharply with our CHIKV data and arguing for different ways of RAW cells to handle infection by alphaviruses.

**My contribution:** I was involved in the designing of the experiment. I also performed the experiment, analyzed the results and wrote the article.

## **Innate Immune Response to Sindbis Virus Infection in mouse RAW264.7**

### **Cell line**

KUMAR Shiril <sup>1\*</sup>, JAFFAR-BANDJEE Marie-Christine <sup>1,2</sup>, GASQUE Philippe <sup>1</sup> and HOARAU Jean-Jacques <sup>1\*</sup>

<sup>1</sup> GRI/IRG (EA4517), Immunopathology and infectious diseases research grouping, University of La Reunion, CHU and CYROI research centers, St-Denis, La Reunion

<sup>2</sup> Microbiology/Virology laboratory, CHU Félix-Guyon, Saint-Denis, F-97400, La Reunion

\* **Correspondence:** [Jean-Jacques.Hoarau@univ-reunion.fr](mailto:Jean-Jacques.Hoarau@univ-reunion.fr), [shiril.kumar@gmail.com](mailto:shiril.kumar@gmail.com), GRI (EA4517), Université de La Réunion, Recherche, Ancienne Admission – RDC, CHU Félix-Guyon, Bellepierre, 97405, Saint-Denis cedex, Ile de La Réunion - France (DOM)

**Abstract:**

Infection with alphavirus such as Sindbis virus (SINV) is known to cause fever, rash arthritis and chronic arthralgia and implicate a robust innate immune response yet to be fully characterized. Here we developed an in vitro model to analyze the innate immune response (PRR, cytokine expression and apoptotic pathway) mobilized by the mouse macrophages RAW264.7 following SINV infection. Quantitative RNA analysis (RT-q PCR) confirmed the infection of the RAW264.7 cells together with a significant increase in TLR-3, RIG-I and MDA5 expression. Significant increases were also seen for robust antiviral responsive marker IFN $\alpha$ 4 and ISGs (ISG15/54/56 and PKR). By immunofluorescence, we showed that SINV infection was associated with canonical signs of apoptosis (cleaved caspase-3 and -9). Thus, RAW264.7 cell line can be used as a good model system to study the selective innate immune response which is mobilized differentially by different alphaviruses infecting macrophages.

**Keywords:** Sindbis virus, Macrophage, RAW264.7, Innate immune, Apoptosis.



## Introduction:

Insects like mosquitoes and ticks are a good vector for harboring and transfer of parasites such as malaria, bacteria and various viruses. Group of virus transferred to humans by these vectors are known as arboviruses. There are over 500 ecologically and epidemiologically distinct arboviruses (Tesh 1982). Sindbis (SINV) virus is an “Old World” *alphavirus*, found to have a wide distribution from Europe to Asia and Australia to Africa. SINV was first isolated from *Culex* mosquitoes in a Sindbis village near Cairo in 1952 (Taylor, Hurlbut et al. 1955). The same virus was then isolated from a bird, namely a juvenile hooded crow (*Corvus corone sardonius*) (Taylor, Hurlbut et al. 1955).

In Northern Europe there are three closely related but unidentical Sindbis like virus strain called Ockelbo in Sweden, Pogosta in Finland and Karelian fever in Russian Karelia (Skogh and Espmark 1982; Vershinskii, L'Vov D et al. 1983; Brummer-Korvenkontio, Vapalahti et al. 2002). *Aedes*, *Culiseta* and *Culex* mosquitoes are the main vectors, transferring the virus from birds to humans. Many migratory and residential birds were found to be reservoirs of the SINV or SINV like virus (Laine, Luukkainen et al. 2004).

The SINV genome is a positive strand RNA of 11,703 nucleotide in length exclusive of 5' terminal cap and 3' terminal poly(A) tract (Strauss and Strauss 1994). SINV causes rash, fever, arthralgia or arthritis which may persist for months or years (Turunen, Kuusisto et al. 1998; Laine, Luukkainen et al. 2000; Kurkela, Manni et al. 2005; Kurkela, Helve et al. 2008). In mice viral replication was focused in bone associated with connective tissue (Heise, Simpson et al. 2000). The macrophage is a central player of the innate immune system which can be activated by several viruses associated molecules binding to PRRs which in turn activate specific antiviral signaling pathways to initiate immune responses. However, this mechanism can also contribute and lead to pathogenesis like Rheumatoid Arthritis (RA) through the expression of various cytokines and chemokines (Levine, Hardwick et al. 1994; Asquith and McInnes 2007). Macrophages can be activated by several viruses associated molecules binding to PRRs and which in turn activate specific antiviral signaling pathways.

Another effective barrier to prevent viral replication, persistence and spreading is apoptosis programmed cell death. Generally, two types of apoptosis pathways play a major

role in this defense mechanism, the extrinsic and the intrinsic apoptotic pathways. The extrinsic pathway, through activated caspase 8, and the intrinsic pathway, through activated caspase 9, activate executioner caspases-3/7/9 to finally induce cell death (Cohen 1991; Rai, Tripathi et al. 2005).

Our previous study on RAW264.7 exposed to CHIKV didn't show a robust immune response and apoptosis hallmarks (Kumar, Jaffar-Bandjee et al. 2012). Herein, we analyzed the response of RAW264.7 after SINV infection and addressed the selective and differential aspects of immune response and apoptosis between these alphaviruses.

## **Materials and Methods**

**Sindbis virus isolates:** SINV (strain Edgar 399) was obtained from the National collection of pathogenic viruses (NCPV) (UK). After amplification by a single passage on African green monkey Vero cells (ATCC, CCL-81), cell culture supernatant was harvested after 48 hrs, centrifuged at 2000 rpm and 0.2µm filtered. Aliquots were made and stored at -80°C until used. Serially diluted ( $10^{-1}$  to  $10^{-12}$ ) virus were added to confluent Vero cell cultured in 96 well plate to establish the TCID<sub>50</sub> established at  $10^6$ /ml.

**Cells and culture condition:** Cell lines used were: mouse RAW264.7 macrophage (ECACC, 91062702) and mouse CLTT astrocyte. Cells were maintained in DMEM medium (PAN Biotech, France), containing 10% heat inactivated FCS with penicillin (100U/ml), sodium pyruvate (100mM), L-Glutamine (200mM), streptomycin (0.1mg/ml) and fungizone (0.5µg/ml) at 37°C under 5% CO<sub>2</sub>. Infections were performed by addition of SINV at an MOI of 1.

**Quantitative RT-PCR (RT-qPCR):** Total RNAs were extracted from culture cells using TRIzol<sup>®</sup> reagent (Invitrogen, France) and quantified using a picodrop (Labgene scientific, France). Reverse transcription (RT) was performed in a final volume of 30µl containing 3µg of RNA per reaction, 1X RT buffer, 5µM DTT, 1Mm dNTP mix, 7.5U pDn6 and 60U RNasin incubated at 65°C for 5 min then cooled in ice for 5min before addition of 98.4u of Reverse transcriptase (MMLV) and again incubated at 37°C for 1hr followed by 5 min at 95°C. All products were from Promega, France. RNA expression levels between samples, for SINV E2

and mouse IFN $\alpha$ 4, ISG-15/54/56, TNF $\alpha$ , RIG-I, PKR, MDA5, were performed using SYBR RT-qPCR with the ABI7500 sequence detection system (Applied Biosystem, France). Mouse Glyceraldehyde-3-phosphate dehydrogenase (GAPDH) was used as the reference housekeeping gene. Cycling conditions were: 10 min. at 95°C followed by 40 cycles consisting of 15 sec at 95°C, 30 sec at 60°C and 45 sec at 72°C before a final step to establish the dissociation curve. Amplicons were verified by 1.2% agarose gel-electrophoresis, stained with SYBR green dye and photographed using the InGenius LHR Gel Imaging System (Syngene, France). Primers used are listed in **Table 1**.

**Immunofluorescence staining (IFs):** Adherent cells (RAW264.7 and CLTT) were grown on glass coverslips, washed to remove debris and fixed by chilled ethanol for 5 min at different time post-infection (PI). Cells were incubated at 4°C overnight with primary antibody in PBS-BSA 1%, washed 3 times in PBS followed by 2 hours incubation at room temperature with secondary antibody conjugated with Alexa Fluor 488 or 594 and DAPI (Invitrogen, France) in PBS/BSA. After washing in PBS, coverslip were mounted in Vectashield (Vector Lab, France), visualized using a Nikon Eclipse 80i microscope with a Hamamatsu ORCA-ER camera and acquired with NIS-Element BR v2.30 imaging software (Nikon, France). Antibodies used were: mouse monoclonal anti-Alphavirus (Santa Cruz, France), rabbit anti-cleaved Caspase-9 (cell signaling, France) and a polyclonal rabbit anti-cleaved Caspase-3 (cell signaling, France).

### **Statistical analysis**

*Paired t* test statistical analysis was performed using Sigma plot version 9.0.1 software (Systat, UK). Values are represented as Mean  $\pm$  SEM from three independent experiments.

## **Results:**

### **Detection of viral RNA and innate immune responses following exposure of RAW264.7 cells to SINV**

RAW264.7 cells were infected by SINV at a MOI of 1 and found to support viral replication at 8, 12, 24 and 48hr PI by classical RT-PCR (Figure 1). PRRs are critical sensors to detect and to initiate the antiviral innate immunity. We found that, by RT-qPCR analysis, a significant increase for RIG-I, MDA5, and TLR-3 at both 8 and 24hr PI (Figure 2A) whereas the antiviral IFN $\alpha$ 4 response was found to be significantly increased only at only 24hr PI (Figure 2D). Since IFN is known to induce genes which can inhibit the viral replication by interfering with the virus genome or proteins, we tested the mRNA expression levels of several interferon stimulated genes ISG-15/54/56 and PKR. Expression of these genes was found to be significantly increased at both 8 and 24 hrs PI (Figure 2B). TNF $\alpha$  as a profoundly pro-inflammatory key cytokine was also increased at 8 and 24hr PI (Figure 2C). In term of expression modulation, TLR3 and RIG-I, PKR and TNF $\alpha$  mRNAs were lowly increased (<10 fold) whereas MDA-5, IFN $\alpha$ 4 and ISG-15 were intermediate (<10 fold) compared to the highly increase expression of ISGs 54 and 56 (>40 fold) at 24h PI.

### **SINV infection of RAW264.7 cells lead to apoptosis**

As previously observed for CHIKV, the pattern of infection of RAW264.7 cells by SINV was in form of isolated small clusters (Figure 3). At 24hr PI, approximately 20% of the cells were infected compared to CLTT (~100% infection), reaching approximately 35% at 48hr (Figure 4). Like CLTT cells, RAW264.7 cells were positive for initiator cleaved caspase-9 at 48hr PI (Figure 4). In addition, at 24hr PI, only a limited number of RAW264.7 cells were already positive for executioner cleaved caspase 3, increasing at 48hr PI (Figure 3). Non-infected RAW264.7 and CLTT cells were used as negative controls. Interestingly, few non-infected cells were also undergoing apoptosis suggesting a putative bystander effect (Figure 4B).

## Discussion

Several viruses cause acute and chronic joint inflammation in humans, and among them, the alphaviruses are of special interest due to the increasing number of outbreaks in which they are the etiological factor. Although alphaviruses causes arthritis in humans, the molecular and cellular factors that contribute to the pathogenesis of this disease are almost completely unknown. Despite the crucial role of macrophages in innate and adaptive immunity and the development of arthritis, these cells have only recently been recognized as potential targets for viruses causing arthritis. In our previous study, we found that RAW264.7 cells were not highly susceptible to CHIKV and failed to mount a robust innate immune and apoptosis responses to CHIKV infection. In sharp contrast we herein observed that expression of PRRs such as TLR-3, RIG-I, MDA5 was elevated in SINV-infected RAW cells. TLR-3 recognize double strand RNA (Alexopoulou, Holt et al. 2001), whereas RIG-I and MDA5 detect single strand RNA, (Loo, Fornek et al. 2008; McCartney, Thackray et al. 2008). These PRR, once activated are known to induce innate immune signaling against the virus through the production of type I interferon. We found a significant increase in IFN $\alpha$ 4 at 24h PI. The IFNs act either in an autocrine or paracrine manner and induces IFN dependent signaling. The binding of IFN to its IFNAR can lead to the induction of more than 300 IFN stimulated gene (ISGs) (Der, Zhou et al. 1998). In our study we found a significant increase in ISGs like PKR and ISG15/54/56. These ISGs will interfere with virus replication (Zhao, Denison et al. 2005; Moore, Bergstralh et al. 2008). In contrast to these observations CHIKV infected RAW cell did not show the expression of type I IFN and ISGs.

The extrinsic signaling apoptotic pathway involves TNF $\alpha$  induced death receptor gene family. We have found significantly elevated levels of TNF $\alpha$  mRNA in SINV-infected RAW264.7 cells by RT-qPCR. TNF $\alpha$  signaling, in turn, may induce apoptosis and this will need to be ascertained using specific blocking agents such as TNF antibodies or a soluble form of the receptor. Cleaved caspase-9, a marker for the intrinsic pathway of apoptosis was also detected indicating the involvement of this pathway in SINV infected RAW macrophages.

Our results indicate that two viruses of the same family, SINV and CHIKV despite their reported similar clinical symptoms after infection did not respond in the same manner in mobilizing the immune and inflammatory potential of macrophage RAW cells.

This is, to our knowledge, the first report deciphering the activity of SINV on mouse RAW cells and this model cell line will have to be extended to observations of primary cultures of mouse macrophages. However, it has already been shown that human macrophages can be infected by SINV and displayed a pro-arthritis potential. Indeed, SINV-infected human macrophages released elevated levels of macrophage migration inhibitor factor (MIF) from intracellular stores and induced higher expression and secretion of TNF- $\alpha$ , IL-1 $\beta$ , and IL-6 (Assuncao-Miranda, Bozza et al. 2010). Production of these cytokines was followed by elevated expression of matrix metalloproteinases (MMPs) 1 and 3, which could be involved in the articular damage that has been observed in arthritis induced by SINV.

Given the remarkable similarities between macrophage responses induced by SINV infection and those observed in rheumatoid arthritis, despite the different etiologies of infectious and autoimmune arthritides, the RAW cell model maybe a valuable tool to study the role of macrophages in arthritis. It should be stressed that CHIKV may subvert the macrophage activation process and leading to a polarization of these cells towards a more anti-inflammatory phenotype attributed for instance to M2-macrophages. It has been proposed that the severe damage to musculoskeletal tissues observed in RRV- or CHIKV-infected mice would promote a wound-healing response characterized by M2-like macrophages (Stoermer, Burrack et al. 2012). Indeed, it was found that macrophages present in RRV- and CHIKV-induced musculoskeletal inflammatory lesions, had a unique gene-expression pattern characterized by high expression of arginase 1 and Ym1/Chi3l3 in the absence of FIZZ1/Relm $\alpha$  that is consistent with an M2-like activation phenotype. Strikingly, mice specifically deleted for arginase 1 in neutrophils and macrophages had dramatically reduced viral loads and improved pathology in musculoskeletal tissues at late times post-RRV infection. These findings indicate that at arthritogenic alphavirus infection may drive a unique myeloid cell activation program at the route to arthritis, autoimmune arthritis and fibrosis.

### **List of abbreviations used**

Immunofluorescence staining (IFs); Post infection (PI); CHIKV (CHIKV); Interferon (IFN); Pattern recognition receptors (PRRs); Toll-like receptors (TLRs); Retinoic acid inducible gene-I (RIG-I); Interferon alpha 4 (IFN $\alpha$ 4); Interferon stimulated gene (ISG); Tumor necrosis factor alpha (TNF $\alpha$ ); Phosphate buffer saline (PBS); Bovine serum albumin (BSA); Melanoma Differentiation-Associated protein 5 (MDA5).

### **Competing interests**

The authors have no competing interests

### **Author's contributions:**

Conceived and designed the experiments: KS, HJJ, GP, Performed the Experiments: KS; Analyzed the data: KS, HJJ, GP; Contributed reagents/materials/analysis tools: GP, MCJB, Wrote the paper: KS, HJJ, GP. All authors have read and approved this manuscript.

### **Acknowledgements:**

This work is supported by a Ph.D. student fellowship to KS by the Regional Council (Reunion Island). Lab funding has been granted by CPER/FEDER to GRII and other European funding from FP7/ICRES (Integrated Chikungunya Research) project. We thank Dr M. Mallat (INSERM U495, Hôpital Salpêtrière, Paris) for kindly providing the CLTT cell line. GP is a fellow of INSERM U945 (Pr B. Autran).

### **References**

- Alexopoulou, L., A. C. Holt, et al. (2001). "Recognition of double-stranded RNA and activation of NF-kappaB by Toll-like receptor 3." *Nature* **413**(6857): 732-738.
- Asquith, D. L. and I. B. McInnes (2007). "Emerging cytokine targets in rheumatoid arthritis." *Curr Opin Rheumatol* **19**(3): 246-251.

- Assuncao-Miranda, I., M. T. Bozza, et al. (2010). "Pro-inflammatory response resulting from sindbis virus infection of human macrophages: implications for the pathogenesis of viral arthritis." *J Med Virol* **82**(1): 164-174.
- Brummer-Korvenkontio, M., O. Vapalahti, et al. (2002). "Epidemiology of Sindbis virus infections in Finland 1981-96: possible factors explaining a peculiar disease pattern." *Epidemiol Infect* **129**(2): 335-345.
- Cohen, J. J. (1991). "Programmed cell death in the immune system." *Adv Immunol* **50**: 55-85.
- Der, S. D., A. Zhou, et al. (1998). "Identification of genes differentially regulated by interferon alpha, beta, or gamma using oligonucleotide arrays." *Proc Natl Acad Sci U S A* **95**(26): 15623-15628.
- Heise, M. T., D. A. Simpson, et al. (2000). "Sindbis-group alphavirus replication in periosteum and endosteum of long bones in adult mice." *J Virol* **74**(19): 9294-9299.
- Kumar, S., M. C. Jaffar-Bandjee, et al. (2012). "Mouse macrophage innate immune response to chikungunya virus infection." *Virology* **9**(1): 313.
- Kurkela, S., T. Helve, et al. (2008). "Arthritis and arthralgia three years after Sindbis virus infection: clinical follow-up of a cohort of 49 patients." *Scand J Infect Dis* **40**(2): 167-173.
- Kurkela, S., T. Manni, et al. (2005). "Clinical and laboratory manifestations of Sindbis virus infection: prospective study, Finland, 2002-2003." *J Infect Dis* **191**(11): 1820-1829.
- Laine, M., R. Luukkainen, et al. (2000). "Prolonged arthritis associated with sindbis-related (Pogosta) virus infection." *Rheumatology (Oxford)* **39**(11): 1272-1274.
- Laine, M., R. Luukkainen, et al. (2004). "Sindbis viruses and other alphaviruses as cause of human arthritic disease." *J Intern Med* **256**(6): 457-471.
- Levine, B., J. M. Hardwick, et al. (1994). "Persistence of alphaviruses in vertebrate hosts." *Trends Microbiol* **2**(1): 25-28.
- Loo, Y. M., J. Fornek, et al. (2008). "Distinct RIG-I and MDA5 signaling by RNA viruses in innate immunity." *J Virol* **82**(1): 335-345.
- McCartney, S. A., L. B. Thackray, et al. (2008). "MDA-5 recognition of a murine norovirus." *PLoS Pathog* **4**(7): e1000108.
- Moore, C. B., D. T. Bergstralh, et al. (2008). "NLRX1 is a regulator of mitochondrial antiviral immunity." *Nature* **451**(7178): 573-577.
- Rai, N. K., K. Tripathi, et al. (2005). "Apoptosis: a basic physiologic process in wound healing." *Int J Low Extrem Wounds* **4**(3): 138-144.
- Skogh, M. and A. Espmark (1982). "[Ockelby disease--a skin and joint disease probably caused by a mosquito-borne alpha arbovirus]." *Lakartidningen* **79**(24): 2379-2380.
- Stoermer, K. A., A. Burrack, et al. (2012). "Genetic ablation of arginase 1 in macrophages and neutrophils enhances clearance of an arthritogenic alphavirus." *J Immunol* **189**(8): 4047-4059.
- Strauss, J. H. and E. G. Strauss (1994). "The alphaviruses: gene expression, replication, and evolution." *Microbiol Rev* **58**(3): 491-562.
- Taylor, R. M., H. S. Hurlbut, et al. (1955). "Sindbis virus: a newly recognized arthropodtransmitted virus." *Am J Trop Med Hyg* **4**(5): 844-862.
- Tesh, R. B. (1982). "Arthritides caused by mosquito-borne viruses." *Annu Rev Med* **33**: 31-40.
- Turunen, M., P. Kuusisto, et al. (1998). "Pogosta disease: clinical observations during an outbreak in the province of North Karelia, Finland." *Br J Rheumatol* **37**(11): 1177-1180.
- Vershinskii, B. V., K. L'Vov D, et al. (1983). "[Karelian fever--a new nosological form of arbovirus etiology (togaviridae, alphavirus, Sindbis complex)]." *Tr Inst Im Pastera* **60**: 31-35.
- Zhao, C., C. Denison, et al. (2005). "Human ISG15 conjugation targets both IFN-induced and constitutively expressed proteins functioning in diverse cellular pathways." *Proc Natl Acad Sci U S A* **102**(29): 10200-10205.



### Figure legends:

**Figure 1.** Detection of SINV RNA in infected RAW264.7 cells by RT-qPCR. Viral RNA was detected as soon as 8h PI in contrast to mock infected controls.

**Figure 2.** Expression of PRRs and innate immune response in SINV-infected RAW264.7 cells. (A) At 8 and 24hrs PI, RAW264.7 cells show a significant increase in mRNA expression of TLR-3 ( $2.5 \pm 0.03$  and  $3.9 \pm 0.3$  fold change at respectively 8 and 24h PI), RIG-I (8h;  $2.3 \pm 0.2$ ; 24h;  $2.8 \pm 0.4$ ) and MDA5 (8h;  $3.1 \pm 0.5$ ; 24h;  $18.5 \pm 2.4$ ). A significant increase of antiviral response through IFN $\alpha$ 4 was measured at 24h PI ( $16.8 \pm 2.8$ ) but not at 8h ( $0.9 \pm 0.3$ ). For ISGs, significant increases were observed for ISG-15 (8h;  $4.5 \pm 0.7$ ; 24h;  $13.7 \pm 1.6$ ), ISG-54 (8h;  $2.0 \pm 0.1$ ; 24h;  $45.6 \pm 8.4$ ), ISG-56 (8h;  $3.6 \pm 0.3$ ; 24h;  $107.8 \pm 11.3$ ) and PKR (8h;  $1.7 \pm 0.1$ ; 24h;  $4.0 \pm 0.7$ ). The mRNA expression of the pro-inflammatory cytokine TNF $\alpha$  was also upregulated (8h;  $6.1 \pm 0.3$ ; 24h;  $5.1 \pm 0.4$ ). Fold changes over mock-infected control are expressed as mean  $\pm$  SEM of three independent experiments.

**Figure 3:** SINV infected RAW264.7 cells undergo apoptosis. Cells were stained for SINV (mouse monoclonal anti-alphavirus, green fluorescence) and apoptotic executioner marker cleaved caspase-3 (red fluorescence) at 24hr and 48 hrs PI. Nuclei were stained with DAPI (blue fluorescence). Magnifications 600X.

**Figure 4:** Hallmark of apoptosis in infected RAW264.7 and CLTT astrocytes. Immunofluorescence for SINV (mouse monoclonal anti alphavirus, green fluorescence) and apoptotic marker for initiator cleaved caspase-9 (red fluorescence) at 48h PI was observed for both CLTT (panel A) and RAW264.7 cells (panel B). Nuclei were stained with DAPI (blue fluorescence). Magnifications 600X.

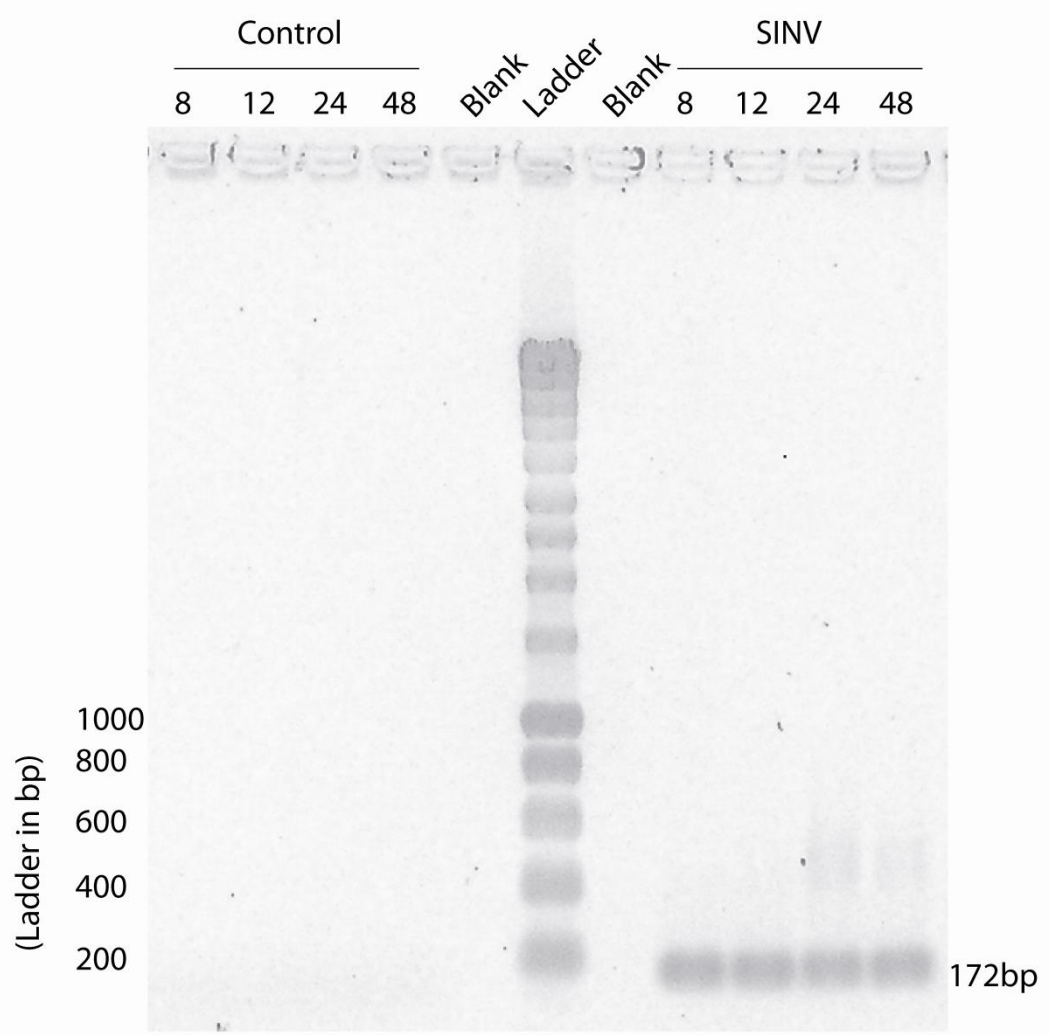

Figure 1  
Kumar et al.

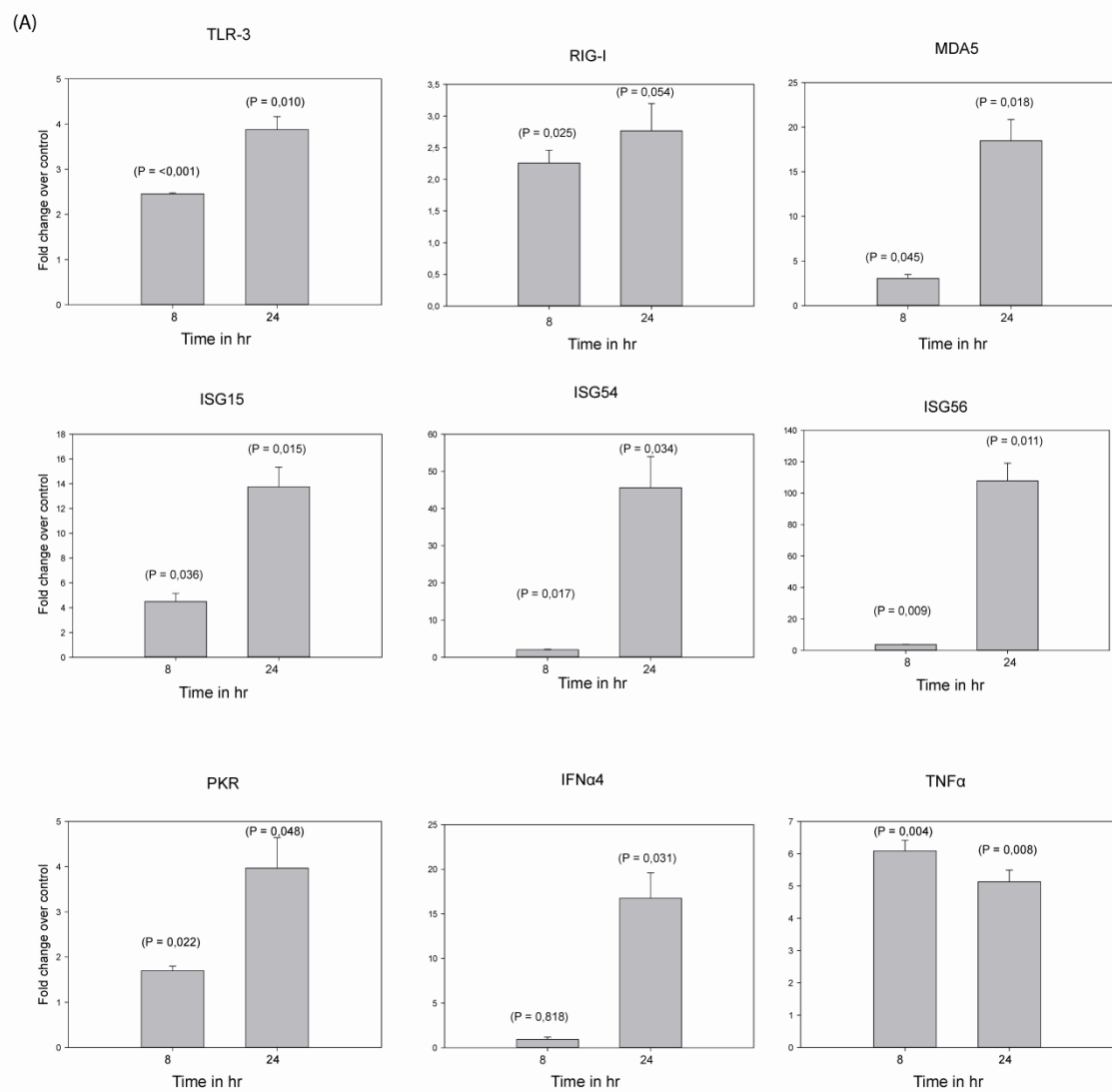
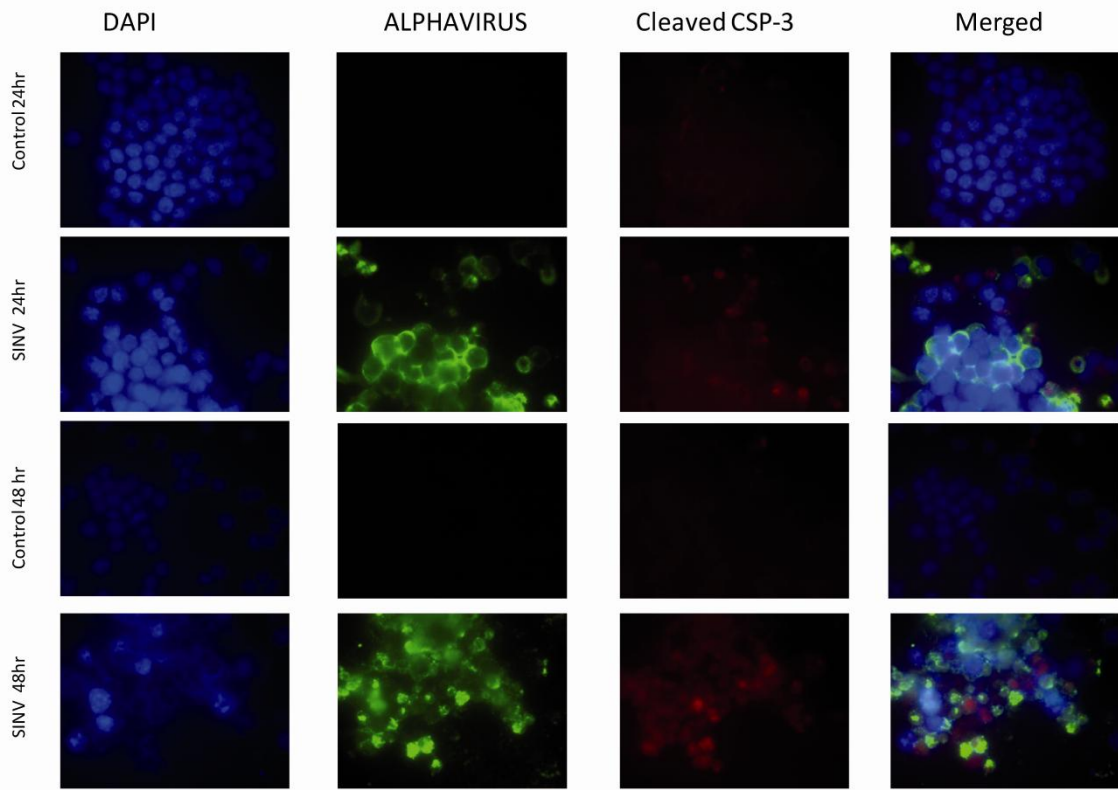

Figure 2

Kumar et al.

# RAW264.7



Magnification600X

Figure 3

Kumar et al.

**CLTT**

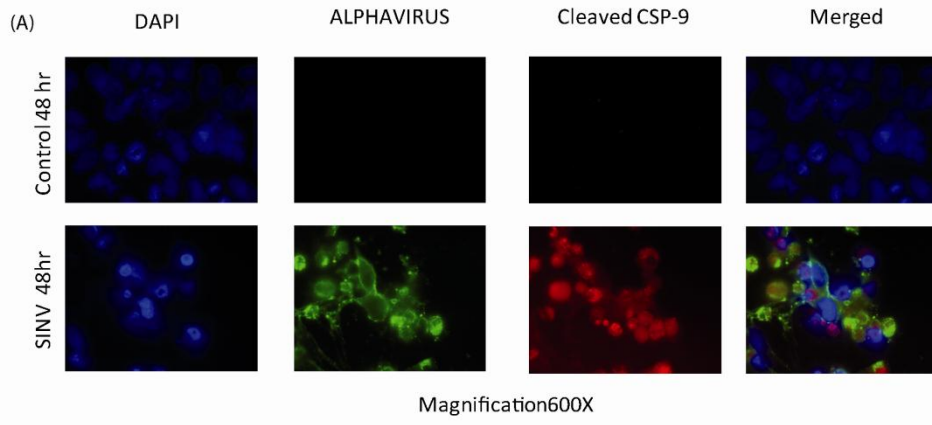

**RAW264.7**

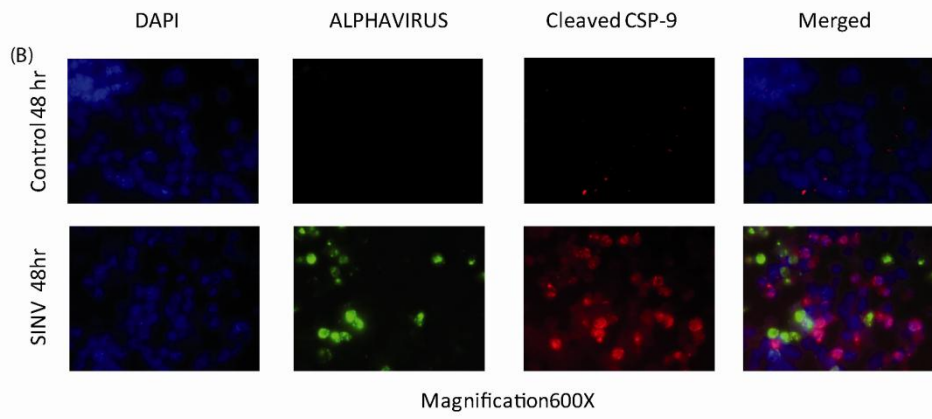

Figure 4

**Table 1.** List of primers used:

<b>Gene</b>	<b>Primer 1 (5'→3')</b>	<b>Primer 2 (5'→3')</b>	<b>Amplicon (bp)</b>
<b>GAPDH</b>	GAACGGGAAGCTTGTCATCA	TGACCTTGCCCACAGCCTTG	473
<b>TLR-3</b>	GCAAGTTATTCGCCCTCCTCT	ATGCTCGCTTCAAACCTCAGGT	316
<b>RIG-I</b>	AGAGCCAGCGGAGATAACAA	GTATGCGGTGAACCGTCTTT	295
<b>MDA5</b>	TGTCTTGGACACTTGCTTCG	TGCCCATGTTGCTGTTATGT	446
<b>IFN<math>\alpha</math>4</b>	AGCCTGTGTGATGCAGGAACC	CAGCAAGTTGGTTGAGGAAGAG	171
<b>ISG15</b>	ACCCTTTCCAGTCTGGGTCT	CGCAAATGCTTGATCACTGT	281
<b>ISG54</b>	CACCTTCGGTATGGCAACTT	TGCTTCATCCAAAGATGCTG	291
<b>ISG56</b>	CTCAGAGCAGGTCCAGTTCC	TCCATCTCAGCACACTCCAG	300
<b>PKR</b>	CAGTGTGAGCCCAACTCTGA	GCTGACTGGGAAACACCATT	248
<b>TNF<math>\alpha</math></b>	ACGGCATGGATCTCAAAGAC	CGGACTCCGCAAAGTCTAAG	325
<b>SINV E2</b>	CACCATACTGTACCGTGCTTCAG	CTTTAACGGTGTGATCCTGCTT	172

## Preliminary study 2

### Pro-angiogenic response in mouse RAW264.7 macrophage cell infected by CHIKV Infection

KUMAR Shiril<sup>1\*</sup>, GIRY Claude<sup>2</sup>, JAFFAR-BANDJEE Marie-Christine<sup>1,2</sup>, GASQUE Philippe<sup>1</sup> and HOARAU Jean-Jacques<sup>1\*</sup>

CHIKV can affect several cell types in acute infectious settings (fibroblasts, macrophages) as well as cells of the vascular bed. This incidence may explain some of the hallmarks experienced by the patients such as vasculitis associated with petechial spots and edema. Interestingly, it has been shown that endothelial cells can be directly affected by CHIKV. *In vitro*, endothelial cell lines from some (bone marrow) but not all (brain) tissues were shown to support CHIKV infection and replication (Sourisseau, Schilte et al. 2007). Whether these cells are affected in their capacity to proliferate (angiogenesis), to control the coagulation or immune cell recruitment through the expression of adhesion molecules remain to be tested. In the NHP model, CHIKV was found to persist in sinusoidal endothelial cells of the liver and of the vascular bed of the spleen and muscles (Labadie, Larcher et al. 2010). We herein tested the capacity of CHIKV-infected macrophages to affect indirectly the pro-angiogenic capacities of endothelial cells through the expression of pro-angiogenic factors such as VEGF and PDGF-B. This study was motivated by the observations that in a chronic patient (18 Mo PI), synovial tissues enriched for CHIKV-infected macrophages were displaying major angiogenesis with the detection of numerous new vessels CD31+ at the site of viral persistence (Hoarau, Jaffar Bandjee et al. 2010).

Hence, using our validated CHIKV-infected RAW macrophages, we investigated:

- 1) The capacity of RAW264.7 cells to express and release pro-angiogenic molecules following CHIKV infection as evaluated by (RT-qPCR), immunofluorescence and ELISA. We found that following CHIKV infection, RAW264.7 cells express significantly elevated level of PDGF-B but no VEGF.

- 2) To define precisely which cells were responsible for the modulated expression of the angiogenic factors, double immunofluorescence studies were performed. We found that CHIKV-infected cells had higher expression of PDGFB but not VEGF.
- 3) To confirm these results, ex-vivo experiments are undergoing using primary cultures of macrophages from CD1 mice following CHIKV infection.

**General conclusion:** Herein, we observed by RT-qPCR that during CHIKV infection, RAW macrophages cells express pro-angiogenic factors like PDGF-B but not VEGF. Moreover, immunofluorescence studies have revealed that this production was specifically associated with infected cells compared to non-infected. PDGF-B is known to have potent chemoattractant and mitogenic activities and can enhance capillary formation. Increased expression in CHIKV-infected RAW264.7 is an indication of possible contribution in angiogenesis and arthritis by favoring cell proliferation (fibroblasts contributing to panus formation) in a manner reminiscent to cancer.

**My contribution:** I was involved in the designing of the experiment. I performed the experiment. Analyzed results and wrote the article.



**Short report:**

**Pro-angiogenic response in mouse RAW264.7 macrophage cell infected by CHIKV  
Infection**

KUMAR Shiril <sup>1\*</sup>, GIRY Claude <sup>1</sup>, KREJBICH-TROTOT Pascale <sup>1</sup>, JAFFAR-BANDJEE Marie-Christine <sup>1,2</sup>, GASQUE Philippe <sup>1</sup> and HOARAU Jean-Jacques <sup>1\*</sup>

<sup>1</sup> GRI/IRG (EA4517), Immunopathology and infectious disease research grouping, University of La Reunion, CHU and CYROI, St-Denis, La Reunion

<sup>2</sup> Microbiology/virology laboratory, CHU Félix-Guyon, Saint-Denis, F-97400, La Reunion

\* **Correspondence:** [Jean-Jacques.Hoarau@univ-reunion.fr](mailto:Jean-Jacques.Hoarau@univ-reunion.fr), [shiril.kumar@gmail.com](mailto:shiril.kumar@gmail.com), GRI (EA4517), Université de La Réunion, Recherche, Ancienne Admission – RDC, CHU Félix-Guyon, Bellepierre, 97405, Saint-Denis cedex, Ile de La Réunion - France (DOM)

**Abstract:** Chikungunya is a re-emerging virus causing several arthralgia/arthritis and virus persistence in synovial macrophages by mechanisms largely-ill characterized. The macrophages are known to secrete many angiogenic factors including PDGFB and VEGF. In this study we analyzed the pro-angiogenic activity of CHIKV on the mouse RAW264.7 macrophage cell line. We found a significant increase of PDGFB at RNA level by RT-qPCR and an accumulation of the protein in CHIKV infected cells were compared to non-infected cells (immunofluorescence study). The expression of VEGF was not affected. These findings support the hypothesis that CHIKV-infected mouse macrophages are polarized and can contribute to chronic disease pathogenesis through the release of proangiogenic factors. RAW is a good model to study CHIKV-induced angiogenesis as evidenced in the synovial tissues of chronic arthritic patients. Inhibitors of PDGF-B may be of clinical benefit.

**Keywords:** Macrophage, RAW264.7, Chikungunya, Angiogenesis, Platelet derived growth factors (PDGF-B)

## **Introduction:**

The formation of new blood vessels, a process called angiogenesis, generally occurs in response to normal physiological stimuli like fetal development, wound healing growth and development. More precisely, angiogenesis is the formation of new blood vessels from preexisting one.

Angiogenesis is regulated by a wide variety of pro-angiogenic and anti-angiogenic factors like chemokines, angiogenic factors and extracellular matrix components. Process of angiogenesis occur in different stages, first being the release of angiogenic factors like vascular endothelial growth factors (VEGF) and platelet derived growth factors (PDGF) (Liao and Johnson 2007). This will be followed by the detachment of pericytes (responding to PDGF) and breakdown of basement membrane (through matrix metalloproteinase, MMPs) of existing vessels (Bourboulia and Stetler-Stevenson 2010). Migration and proliferation of endothelial cells (EC) will follow in response to pro-angiogenic factors like FGF2, CXCL8, COX2 and pro-inflammatory cytokines (TNF $\alpha$ , IL-6), to give rise to new blood capillaries for blood flow (Liekens, De Clercq et al. 2001; Aggarwal, Shishodia et al. 2006).

Upcoming research has shown that angiogenesis is not only induced in response to hypoxia but can also be induced by DNA viruses like Epstein-Barr virus (EBV), Kaposi's associated sarcoma virus (KSHV), Human papilloma virus (HPV) and RNA virus like Hepatitis C virus (HCV) and Human T-cell lymphotropic virus (HTLV-I) (Martin and Gutkind 2008). These viruses use a different pathway for angiogenesis, like modulating signaling pathways and direct activation of ECs, in response to inflammatory molecules and/or viral proteins. A pro-angiogenic condition was found to be associated with virus infection and chronic inflammation through NF $\kappa$ B pathway activation (Vrancken, Vervaeke et al. 2011).

Macrophages, was found to have a direct role in inflammatory angiogenesis as confirmed by two observations (1) DNA synthesis by EC and appearance of mononuclear cell infiltrate during contact dermatitis and (2) macrophages induced vascularization as seen in a variety of angiogenic assay (Clark, Stone et al. 1976; Thakral, Goodson et al. 1979).

Macrophage can affect the different stages of angiogenesis (migration and proliferation of EC, modulation of extracellular matrix) by the release of different growth factors (bFGF, GM-CSF, TGF- $\beta$ 1, IGF-I, PDGF, VEGF/VPF, TGF- $\beta$ ), cytokines (IL-1, IL-6, IL-8, TNF- $\alpha$ ) substance P, prostaglandins, interferons, thrombospondin 1) and proteases (Sunderkotter, Steinbrink et al. 1994). One of the interesting facts about macrophage polarization is its phenotypic shift towards either, classically activated pro-inflammatory, M1 type or alternatively activated anti-inflammatory, M2 type. Conventionally, M2 type is associated with angiogenesis and suppress the activation of cytotoxic T lymphocytes, DC and NK cells (Mantovani and Sica 2010).

Two of the macrophage derived factors, VEGF and PDGF, play an important role in angiogenesis. PDGF belongs to a family of highly basic and dimeric proteins consisting of homodimer A chain (18 kDa, PDGFA), B chain (16 kDa, PDGFB) or as heterodimer PDGFAB (Ross, Raines et al. 1986; Hammacher, Hellman et al. 1988; Hart, Bailey et al. 1990). The angiogenic nature of macrophage derived VEGF was confirmed by ChorioAllantoic Membrane (CAM) assay (Leung, Cachianes et al. 1989).

CHIKV, an *Alphavirus* belongs to the family *Togaviridae*, was first isolated in Tanzania in 1953 (Mason and Haddow 1957). The viral genome is a single strand positive sense RNA of approximately 12kb. CHIKV infection can lead to chronic arthritis in patients with persistence of virus in synovial tissue macrophages and with major angiogenesis at the site of viral persistence (Hoarau, Jaffar Bandjee et al. 2010). Recently in PBMCs of CHIKV fever (CHIKVF) patients, VEGF and PDGF mRNA expression was shown to be elevated (Wauquier, Becquart et al. 2011).

Herein, we investigated the capacity of CHIKV to control the pro-angiogenic activity of RAW264.7 mouse macrophage cell line. We analyzed the expression of pro-angiogenic factors, particularly PDGF and VEGF response to CHIKV infection.

## **Materials and Methods:**

**CHIKV isolate:** CHIKV (clone #4), isolated from a patient's serum during the 2006 epidemic in La Reunion island, was amplified by a single passage on African green monkey Vero cells (ATCC, CCL-81). Supernatant was centrifuged at 2000 rpm and 0.2µm filtered once the cytopathic condition was reached. Aliquots were stored at -80°C until used. The TCID<sub>50</sub> was estimated at 10<sup>7</sup> viral particles/ml as already described (Krejbich-Trotot, Gay et al. 2011).

**Cells and culture conditions:** the mouse RAW264.7 macrophage cell line was acquired from European Collection of Cell Cultures (ECACC, ref. 91062702). Cells were maintained in DMEM (PAN Biotech, France) medium containing 10% heat inactivated FCS with penicillin (100U/ml), streptomycin (0.1mg/ml), sodium pyruvate (100mM), L-Glutamine (200mM) and fungizone (0.5µg/ml) at 37°C under 5% CO<sub>2</sub>. Infections were performed by addition of CHIKV at a multiplicity of infection of 1.

**Quantitative RT-PCR (RT-qPCR):** Total RNAs were extracted from control and CHIKV infected RAW264.7 culture cells using TRIzol<sup>®</sup> reagent (Invitrogen, France) and quantified using a Picodrop (Labgene scientific, France). Reverse transcription (RT) was performed in a final volume of 30µl containing 3µg of RNA per reaction, 1X RT buffer, 5µM DTT, 1Mm dNTP mix, 7.5U pDn6 and 60U RNasin incubated at 65°C for 5 min then cooled in ice for 5 min before addition of 98.4u of Reverse transcriptase (MMLV) and again incubated at 37°C for 1hr followed by 5 min at 95°C. All products were from Promega, France. RNA expression level between samples, for mouse platelet derived growth factor (PDGFB) or mouse vascular endothelial growth factor (VEGF) genes, were performed using SYBR RT-qPCR with the ABI7500 sequence detection system (Applied Biosystem, France). Mouse Glyceraldehyde-3-phosphate dehydrogenase (GAPDH) was used as a reference housekeeping gene. Cycling conditions were: 10 min at 95°C followed by 40 cycles consisting of 15 sec at 95°C, 30 sec at 60°C and 45 sec at 72°C before a final step to establish the dissociation curve. Primers used are listed in **Table 1**.

**Immunofluorescence staining (IFs):** RAW264.7 cells were grown on glass cover slips for 24hrs and then permeabilized with Brefeldin A (5µg/ml) (Sigma, France) for 18 hrs, washed to remove debris and fixed by chilled ethanol for 5 min at different time post infection (PI).

Cells were incubated at 4°C overnight with primary antibody in PBS-BSA 1%, washed 3 times in PBS followed by 2 hours incubation at room temperature with secondary antibody conjugated with Alexa Fluor 488 or 594 and DAPI (Invitrogen, France) in PBS/BSA. After washing in PBS, coverslip were mounted in Vectashield (Vector Lab, France), visualized using a Nikon Eclipse 80i microscope with a Hamamatsu ORCA-ER camera and acquired with NIS-Element BR v2.30 imaging software (Nikon, France). Antibodies used were: rabbit polyclonal anti PDGFB (Santa Cruz), rabbit polyclonal anti VEGF (Santa Cruz) and FDO (Human serum anti-CHIKV).

**ELISA titration:** RAW264.7 tissue culture supernatants (TCS) were titrated using the mouse PDGFBB ELISA kit (Sunred, China) according to the manufacturer's protocols.

### **Statistical analysis**

*Paired t* test statistical analysis was performed using Sigma plot version 9.0.1 software (Systat, UK). Values are represented as Mean  $\pm$  SEM from three independent experiments.

## **Results**

### **Pro-angiogenic response against CHIKV in RAW264.7**

#### **RT-qPCR**

As revealed by quantitative PCR, a 9 fold ( $9.1 \pm 1.5$ ) significant increase of PDGFB mRNA expression was observed in RAW264.7 at 24hr post-infection (PI) when compared to mock infected cells (Figure 1A). In contrast, no significant modulation in the transcription of VEGF gene was observed.

## **Immunofluorescence (IF)**

Interestingly, at 24hrs PI, the observed up-regulation of PDGFB gene was correlated with an increased level of the corresponding protein PDGFBB restricted only to the CHIKV infected macrophages (Figure 2), whereas no difference was found for VEGF (data not shown).

## **ELISA**

However, when trying to detect the release of PDGFBB in the cell culture supernatant, no significant change could be measured at 8 hrs PI (control,  $2897 \pm 33$  ng/L; CHIKV,  $3091 \pm 71$  ng/L) and 24hr PI (control,  $2802 \pm 6$  ng/L; CHIKV,  $2987 \pm 55$  ng/L) as measured by ELISA (Figure 1B).

## **Discussion**

Angiogenic mediators produced by various cell types in the synovium activate endothelial cells to release proteolytic enzymes (MMPs). We have already shown that MMP2 was elevated in synovial tissues of a patient with chronic post-CHIKV-arthritis but the exact cellular source remains to be established by ISH techniques. These enzymes degrade the endothelial basement membrane and the perivascular extracellular matrix. ECs then proliferate and emigrate into the interstitial tissue forming “primary sprouts”. The lumen formation within these sprouts leads to the formation of “capillary loops” followed by synthesis of new basement membrane and finally, capillary formation (Folkman and Klagsbrun 1987; Szekanecz and Koch 2007).

In autoimmune Rheumatoid arthritis (RA), as well as in other types of arthritis (virus induced arthritis), leukocytes migrate from the bloodstream through endothelia into the synovial tissue. Leukocyte-endothelial interactions are mediated by numerous cell adhesion receptors, primarily by integrins, selectins and their respective ligands (Agarwal and Brenner 2006; Szekanecz and Koch 2008). Angiogenesis increases the number of endothelial cells and blood vessels within a given compartment of the synovium. These may result in the perpetuation of inflammatory leukocyte migration and fibroblast proliferation contributing to

the formation of the panus involved in arthritis (Agarwal and Brenner 2006; Szekanecz and Koch 2007).

Macrophages are known to play an important role in wound healing by producing a variety of growth factors and cytokines (ex, transforming growth factor- $\alpha$  [TGF- $\alpha$ ], TGF- $\beta$ , insulin-like growth Factor-1 [IGF-1]) and by phagocytosing cellular and matrix debris (Rappolee, Mark et al. 1988). Synovial tissue macrophages and angiogenic mediators (Szekanecz, Besenyei et al. 2009) produced by these and other cells are primarily involved in RA-associated neovascularization (Szekanecz and Koch 2007). Subsequent studies reported that alveolar macrophage and activated monocytes constitutively express the PDGF-B at the transcription level (Mornex, Martinet et al. 1986).

PDGF is a mitogen for various cell types, including fibroblasts and smooth muscle cells. It was originally purified from human platelets (Heldin, Westermark et al. 1979) but can also produce by different cell type *in vitro* and *in vivo* (Heldin and Westermark 1999). PDGF-B can induced macrophages migration through PDGFR- $\beta$  (Siegbahn, Hammacher et al. 1990). Previous study have shown that a robust angiogenesis was observed at the site of chronically infected synovial tissue macrophages by CHIKV (Hoarau, Jaffar Bandjee et al. 2010). In our previous study CHIKV infected RAW264.7 do express high levels of TNF $\alpha$ , at both on RNA and protein level (Kumar, Jaffar-Bandjee et al. 2012) and may therefore control subsequent PDGF expression. There was only limited percentage of cells infected by CHIKV and only those displayed increased expression of PDGF which remained associated at the cell membrane (or in cytoplasmic stores, IF data) but was not secreted (ELISA data).

VEGF is an important angiogenic factor, but we did not see significant changes in VEGF expression in our study. Recent evidence demonstrated that macrophage can promote angiogenesis independently of VEGF signaling (Rymo, Gerhardt et al. 2011).

Hereby we conclude that RAW264.7 can be an ideal model for the study of macrophage induces angiogenesis after CHIKV infection. This is the first report that a virus can control the expression of angiogenic factors by macrophages. This study will have to be extended to primate cultures of mouse macrophages and addressing the expression of PDGF-B in a mouse model of CHIKV infection associated with arthritis.



The role of PDGF in the context of viral infection can be extended to other newly described effects of signaling through its receptor. It has been shown that signaling through PDGFR can impair viral (HCMV) entry through the control of macropinocytosis and the protective activity of RNase L and PKR (Jha, Polyakova et al. 2011; Vanarsdall, Wisner et al. 2012). Experiments are now highly warranted to address specifically the role of PDGF and PDGFR signaling during the process of CHIKV infection and chronic arthritis.

### **List of abbreviations used**

Immunofluorescence staining (IFs); Post infection (PI); CHIKV (CHIKV); Tumor necrosis factor alpha (TNF $\alpha$ ); Phosphate buffer saline (PBS); Bovine serum albumin (BSA); Tissue culture supernatants (TCS), Reverse transcription (RT), Epstein-Barr virus (EBV), Kaposi's sarcoma associated herpesvirus (KSHV), human papiloma virus (HPV) and RNA virus like Hepatitis C virus (HCV) and Human T-cell lymphotropic virus type I (HTLV-I), basic fibroblast growth factor (bFGF), granulocyte-macrophage colony-stimulating factor (GM-CSF), transforming growth factor (TGF- $\beta$ ), insulin-like growth factor (IGF-I), platelet-derived growth factor (PDGF), vascular endothelial growth factor/ vascular permeability factor (VEGF/VPF), interleukin 1/6/8 (IL-1, IL-6, IL-8), Chorio allantoic membrane (CAM).

### **Competing interests**

The authors have no competing interests

### **Author's contributions**

Conceived and designed the experiments: KS, HJJ, GP, Performed the Experiments: KS, CG, KTP; Analyzed the data: KS, KTP, HJJ, GP; Contributed reagents/materials/analysis tools: GP, JBMC; Wrote the paper: KS, HJJ, GP. All authors have read and approved this manuscript.

## Acknowledgements

This work is supported by a Ph.D. student fellowship to KS by the Regional Council (Reunion Island). Lab funding has been granted by CPER/FEDER to GRII and other European funding to FP7/ICRES (Integrated Chikungunya Research) project. PG is a fellow 'contrat d'interface' of INSERM U945.

## References

- Agarwal, S. K. and M. B. Brenner (2006). "Role of adhesion molecules in synovial inflammation." Curr Opin Rheumatol **18**(3): 268-276.
- Aggarwal, B. B., S. Shishodia, et al. (2006). "Inflammation and cancer: how hot is the link?" Biochem Pharmacol **72**(11): 1605-1621.
- Bourboulia, D. and W. G. Stetler-Stevenson (2010). "Matrix metalloproteinases (MMPs) and tissue inhibitors of metalloproteinases (TIMPs): Positive and negative regulators in tumor cell adhesion." Semin Cancer Biol **20**(3): 161-168.
- Clark, R. A., R. D. Stone, et al. (1976). "Role of macrophages in wound healing." Surg Forum **27**(62): 16-18.
- Folkman, J. and M. Klagsbrun (1987). "Angiogenic factors." Science **235**(4787): 442-447.
- Hammacher, A., U. Hellman, et al. (1988). "A major part of platelet-derived growth factor purified from human platelets is a heterodimer of one A and one B chain." J Biol Chem **263**(31): 16493-16498.
- Hart, C. E., M. Bailey, et al. (1990). "Purification of PDGF-AB and PDGF-BB from human platelet extracts and identification of all three PDGF dimers in human platelets." Biochemistry **29**(1): 166-172.
- Heldin, C. H. and B. Westermark (1999). "Mechanism of action and in vivo role of platelet-derived growth factor." Physiol Rev **79**(4): 1283-1316.
- Heldin, C. H., B. Westermark, et al. (1979). "Platelet-derived growth factor: purification and partial characterization." Proc Natl Acad Sci U S A **76**(8): 3722-3726.
- Hoarau, J. J., M. C. Jaffar Bandjee, et al. (2010). "Persistent chronic inflammation and infection by Chikungunya arthritogenic alphavirus in spite of a robust host immune response." J Immunol **184**(10): 5914-5927.
- Jha, B. K., I. Polyakova, et al. (2011). "Inhibition of RNase L and RNA-dependent protein kinase (PKR) by sunitinib impairs antiviral innate immunity." J Biol Chem **286**(30): 26319-26326.
- Krejchich-Trotot, P., B. Gay, et al. (2011). "Chikungunya triggers an autophagic process which promotes viral replication." Virology **432**: 432.
- Kumar, S., M. C. Jaffar-Bandjee, et al. (2012). "Mouse macrophage innate immune response to chikungunya virus infection." Virology **432**(1): 313.
- Leung, D. W., G. Cachianes, et al. (1989). "Vascular endothelial growth factor is a secreted angiogenic mitogen." Science **246**(4935): 1306-1309.
- Liao, D. and R. S. Johnson (2007). "Hypoxia: a key regulator of angiogenesis in cancer." Cancer Metastasis Rev **26**(2): 281-290.

- Liekens, S., E. De Clercq, et al. (2001). "Angiogenesis: regulators and clinical applications." Biochem Pharmacol **61**(3): 253-270.
- Mantovani, A. and A. Sica (2010). "Macrophages, innate immunity and cancer: balance, tolerance, and diversity." Curr Opin Immunol **22**(2): 231-237.
- Martin, D. and J. S. Gutkind (2008). "Human tumor-associated viruses and new insights into the molecular mechanisms of cancer." Oncogene **27 Suppl 2**: S31-42.
- Mason, P. J. and A. J. Haddow (1957). "An epidemic of virus disease in Southern Province, Tanganyika Territory, in 1952-53; an additional note on Chikungunya virus isolations and serum antibodies." Trans R Soc Trop Med Hyg **51**(3): 238-240.
- Mornex, J. F., Y. Martinet, et al. (1986). "Spontaneous expression of the c-sis gene and release of a platelet-derived growth factorlike molecule by human alveolar macrophages." J Clin Invest **78**(1): 61-66.
- Rappolee, D. A., D. Mark, et al. (1988). "Wound macrophages express TGF-alpha and other growth factors in vivo: analysis by mRNA phenotyping." Science **241**(4866): 708-712.
- Ross, R., E. W. Raines, et al. (1986). "The biology of platelet-derived growth factor." Cell **46**(2): 155-169.
- Rymo, S. F., H. Gerhardt, et al. (2011). "A two-way communication between microglial cells and angiogenic sprouts regulates angiogenesis in aortic ring cultures." PLoS One **6**(1): e15846.
- Siegbahn, A., A. Hammacher, et al. (1990). "Differential effects of the various isoforms of platelet-derived growth factor on chemotaxis of fibroblasts, monocytes, and granulocytes." J Clin Invest **85**(3): 916-920.
- Sunderkotter, C., K. Steinbrink, et al. (1994). "Macrophages and angiogenesis." J Leukoc Biol **55**(3): 410-422.
- Szekanecz, Z., T. Besenyei, et al. (2009). "Angiogenesis in rheumatoid arthritis." Autoimmunity **42**(7): 563-573.
- Szekanecz, Z. and A. E. Koch (2007). "Macrophages and their products in rheumatoid arthritis." Curr Opin Rheumatol **19**(3): 289-295.
- Szekanecz, Z. and A. E. Koch (2007). "Mechanisms of Disease: angiogenesis in inflammatory diseases." Nat Clin Pract Rheumatol **3**(11): 635-643.
- Szekanecz, Z. and A. E. Koch (2008). "Vascular involvement in rheumatic diseases: 'vascular rheumatology'." Arthritis Res Ther **10**(5): 224.
- Thakral, K. K., W. H. Goodson, 3rd, et al. (1979). "Stimulation of wound blood vessel growth by wound macrophages." J Surg Res **26**(4): 430-436.
- Vanarsdall, A. L., T. W. Wisner, et al. (2012). "PDGF receptor-alpha does not promote HCMV entry into epithelial and endothelial cells but increased quantities stimulate entry by an abnormal pathway." PLoS Pathog **8**(9): e1002905.
- Vrancken, K., P. Vervaeke, et al. (2011). "Viruses as key regulators of angiogenesis." Rev Med Virol **21**(3): 181-200.
- Wauquier, N., P. Becquart, et al. (2011). "The acute phase of Chikungunya virus infection in humans is associated with strong innate immunity and T CD8 cell activation." J Infect Dis **204**(1): 115-123.

**Figure legends:**

**Figure 1.** Upregulation of PDGFB mRNA expression following CHIKV infection.

(A) By RT-qPCR, a 9 fold ( $9.073 \pm 1.545$ ) increase of PDGFB transcription was evidenced in RAW264.7 cells at 24hrs PI whereas the expression of VEGF $\alpha$  remain unchanged compared to mock infected control cells. (B) No significant change was seen for PDGFB secreted protein in TCS by ELISA. Fold change over non-infected control is expressed as mean $\pm$ SEM of three independent experiments.

**Figure 2.** The increase expression of PDGFB is restricted to CHIKV-infected cells.

At 24hrs PI, the presence of PDGFB (green fluorescence) in infected RAW264.7 cells (red fluorescence) was visualized by Immunofluorescence. Nuclei were stained with DAPI (blue fluorescence). For each marker, photographs were taken with equal exposure time. Magnification 600x.

(A)

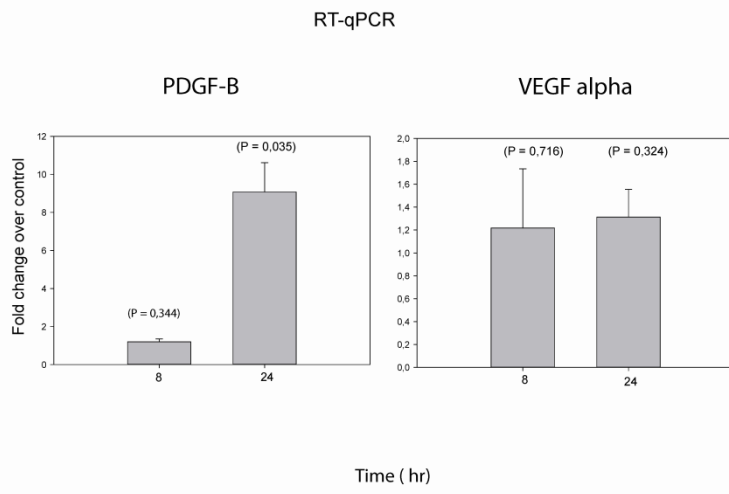

(B)

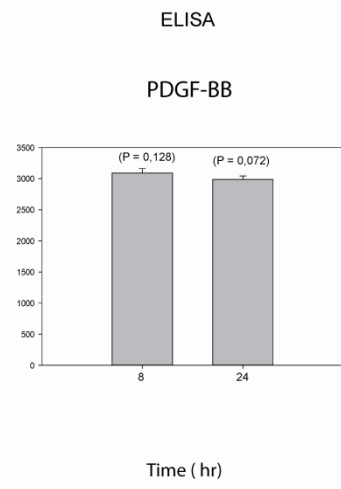
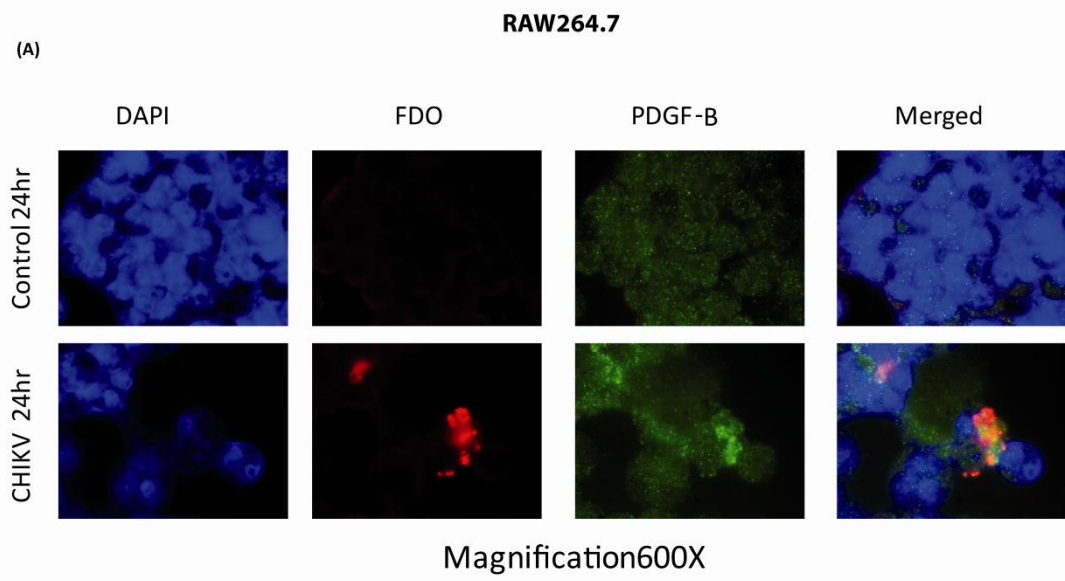

Figure 1

Kumar et.al



**Figure 2**

**Kumar et.al**

**Table 1.** List of primers:

<b>Gene</b>	<b>Primer 1 (5'→3')</b>	<b>Primer 2 (5'→3')</b>	<b>Amplicon (bp)</b>
<b>GAPDH</b>	GAACGGGAAGCTTGTCATCA	TGACCTTGCCCACAGCCTTG	473
<b>PDGFB</b>	AGCCTGTGTGATGCAGGAACC	CAGCAAGTTGGTTGAGGAAGAG	201
<b>VEGF<math>\alpha</math></b>	CTCAGAGCAGGTCCAGTCC	TCCATCTCAGCACACTCCAG	131

## **VI. General discussion**



A plethora of defense mechanism has been developed by all living things against pathogens. Humans have co-existed and were continuously exposed to these pathogens throughout the evolution and trying to overcome and to prevent the numerous associated diseases in acute and chronic settings.

Among all the organisms such as mammals, particularly human and mice have developed more advanced and complex immune system. Mice are the preferred model species for immunological research. However, with million years of divergent evolution mice have developed differences in immune sensing (Waterston, Lindblad-Toh et al. 2002).

Difference in immune system between human and mice is also confined to innate immunity, which gets activated during the first days after infection until the activation adaptive immune response takes place (Mestas and Hughes 2004).

The use of different mouse strains have filled the gap and with validated models to study infection and to some extent immune control of human pathogens *in vivo*. The same benefit could be attributed to cell lines which have been invaluable in addressing specifically the molecular pathways of innate immune control and inflammation in response to different infectious challenges. We herein used a mouse macrophage cell line RAW 264.7 and with the overall conclusion that they reproduce several hallmarks of macrophages behavior exposed to CHIKV. They are readily infected but only by a small subset of cells. Surrounding cells probably mount a robust anti-viral response and responsible to the refractory activities yet to be identified. At least in response to CHIKV, the interference does not seem to be due to a robust IFN and ISG response in sharp contrast to what is observed in SINV-infected RAW cells. Extended transcriptomic analyses will have to be performed to address the specific antiviral responses. We cannot also exclude that RAW cells express differentially the receptor(s) to allow entry of the different alphaviruses.

Viruses are known to infect different kind of cells including major innate immune cells like NK, DCs, neutrophils, monocytes and macrophages. The latter are not only the major player of innate immune but also activate adaptive immunity. Apart from sensing PAMPs, PRRs were also found to be engaged in case of 'danger' such as cellular injury and stressed e.g., necrosis or oxidative damage cells and tissues, as exemplified by uric acid, hyaluronate fragments, HMGB1, ATP, potassium and HSPs. Therefore PRRs act as a sensor

for both PAMPs and “danger associated molecular pattern” (DAMP) (Matzinger 2002; Taylor, Trowbridge et al. 2004; Meylan, Tschopp et al. 2006; Tian, Avalos et al. 2007; Imai, Kuba et al. 2008). In considering the innate immune response polarized by CHIKV or SINV in RAW cells, we did not take into account the fact that these two viruses were affecting differentially the levels of apoptosis (cell death) of RAW cells. It will be important to address the contribution of DAMPS in the specific antiviral response mounted by RAW cells against either SINV or CHIKV. The release of DAMPs will have to be explored by proteomics study and testing for instance whether HMGB1 (nucleus) , HSP (from ER) and other proteins from intracellular organelles are released during the process of infection. The contribution of these DAMPs to cell signaling can be addressed with shRNA or soluble inhibitors of the receptors for these DAMPs (RAGE, TLR4).

Signaling pathways induced by the PRRs are shared to great extent and have the same overall molecular mechanisms and for instance, RLR share some of the same molecules as of TNF $\alpha$  signaling pathways (Michallet, Meylan et al. 2008). Recent development in innate immunity of macrophages has shown that PRRs can activate both proinflammatory responses against the pathogen and can also induce anti-inflammatory responses once the acute infection has been resolved (Mogensen 2009) through a polarization towards an M2 phenotype. The capacity of the virus to control the switch between a protective M1 versus a facilitating M2 responses remains poorly characterized. Moreover, a too robust and sustained M1 activation can have collateral damage to the infected tissues.

Recently, monocyte/macrophage infiltration in the synovial fluid of RRV/CHIKV-infected patients (Fraser, Cunningham et al. 1981; Soden, Vasudevan et al. 2000) and in a monkey model of CHIKV infection (Labadie, Larcher et al. 2010) have been reported. Mouse macrophage RAW264.7 cell line was found to be persistently infected by RRV with continuous production of the virus (Linn, Aaskov et al. 1996). Apart from this abundance in the swollen joint and as a hallmark of a protective antiviral response, the ability of macrophage depletion to ameliorate disease progression reaffirms the importance of these cells in the rheumatic disease induced by alphaviral infections (Morrison, Whitmore et al. 2006; Lidbury, Rulli et al. 2008; Rulli, Guglielmotti et al. 2009; Suhrbier and Mahalingam 2009). This mobilization of the macrophages in response to CHIKV infection is a double-

edged sword situation which needs to be considered while defining the best treatment regimes.

In a study where clodronate-based depletion of macrophages was performed, macrophages and/or their inflammatory products (e.g., TNF- $\alpha$ ) (Suhrbier and Mahalingam 2009) were also seen to be involved in promoting the clearance of virus. So, macrophages are essential to promote viral clearance, but in the same time constitute a target for infection contributing to the development of rheumatic diseases. Long-term persistent infection of macrophages was reported previously for primates (Labadie, Larcher et al. 2010), and such infections may give rise to the chronic disease seen for some patients (Larrieu, Pouderoux et al. 2010).

Levels of chemokine and cytokines such as MCP-1, IFN- $\alpha/\beta$ , IFN- $\gamma$ , IL-6, and TNF- $\alpha$  were found to be increased in serum of mouse and peripheral blood of monkey (Labadie, Larcher et al. 2010), whereas level of IFN $\gamma$ , TNF $\alpha$  and MCP-1, in CHIKV infected human monocytes (Her, Malleret et al. 2010) and serum collected from control and CHIKV patients, doesn't show any modulation (Ng, Chow et al. 2009). The levels of these inflammatory mediators are usually also elevated in a number of viral arthritides and in rheumatoid arthritis (Suhrbier and Mahalingam 2009). Persistent of RRV in patients with polyarthritis (Soden, Vasudevan et al. 2000) have also shown increased levels of MCP-1, IFN- $\gamma$ , and TNF- $\alpha$  (Lidbury, Rulli et al. 2008). RAW cells infected by CHIKV also displayed an increased expression of TNF- $\alpha$ . This response can be under the control of signaling pathways of TLR or RLR responding to viral components but we cannot exclude the role of DAMPs signaling to RAGE in controlling TNF expression. Experiments using shRNA or soluble inhibitors of the suspected receptors should be valued.

Surprisingly, RAW264.7 cell mounted a poor innate immune response as there were no significant changes in the expression of IFN and ISGs. Elevated TNF $\alpha$  was observed at 24hr PI, which in turn, is known to induce apoptotic cell death but the canonical apoptotic markers, cleaved caspase -9 and -3 were not detected. Other study have also shown that autophagy could also play a role in both innate and adaptive immunity in response to pathogens (Schmid and Munz 2007) by limiting virus replication, as seen for tobacco mosaic virus, parvovirus B19 and Sindbis virus (Liang, Kleeman et al. 1998; Liu, Schiff et al. 2005;

Nakashima, Tanaka et al. 2006). Inhibition of autophagic machinery by some viruses such as in case of HSV-1 which encodes the ICP34.5 protein implicated in autophagy inhibition (Orvedahl, Alexander et al. 2007), can promote replication of some viruses. In the case of CHIKV infection it was shown that autophagy can also promote CHIKV replication (Krejchich-Trotot, Gay et al. 2011). CHIKV induced cell death can be limited by endoplasmic reticulum and oxidative stress induced autophagy. Moreover in accordance to our observations, recently it was observed that autophagy can inhibit caspase dependent apoptosis (Joubert, Werneke et al. 2012; Joubert, Werneke et al. 2012). By controlling viral infection or promoting virus spreading and pathogenicity it seems that CHIKV has evolved to control both apoptosis and autophagic process by ill-characterized mechanism that will need to be deciphered.

All in all, these observations support the view that CHIKV arthritis/arthralgia is an inflammatory disease but yet failing to control virus persistence (Pialoux, Gauzere et al. 2007). Different hypotheses have been proposed for virus persistence depending on several mechanisms such as antibody dependent enhancement and /or Fc receptor engagement by immune complexes to control the antiviral response or the induction of immunosuppressive cytokine like IL-10 (Mahalingam and Lidbury 2002; Suhrbier and La Linn 2003). CHIKV was found to follow the RRV symptoms as persistently infected macrophage was seen after 18 months of infection with elevated level of CCL2, IL-6 and IL-8 in the synovium of a patient suffering from chronic pain (Hoarau, Jaffar Bandjee et al. 2010) . This persistence is consistent with the observation in macaque in which CHIKV was detected up to 90 days in joint tissues. These finding relate the persistence of CHIKV in joints with chronic local inflammation causing pain and which may involve specific neurotransmitters such as substance P. In fact a unique local inflammation could favor a microenvironment to establish a “niche” of CHIKV persistence, similar to what was observed for HIV/AIDS studies where inflammation is maintained at a level of activation required for sustained replication and viral persistence in tissues, particularly in macrophages (Biswas, Poli et al. 1992; Dhawan, Heredia et al. 1995). CHIKV persistence may be initiated by the ingestion of apoptotic cells by macrophages (Fadok, Bratton et al. 1998; Chow, Her et al. 2011). This persistence within the joint and bone erosion was also found to be associated with and probably contributing to persisting IgM antibodies (Borgherini, Poubeau et al. 2008; Malvy, Ezzedine et al. 2009)

Globally, we observed that the anti-CHIKV Immune response engaged by RAW264.7 cells was very poor. In fact, macrophage cells are showing different immune response against the virus of this family. For example, human primary macrophages can be infected by SINV and can support productive virus replication. This seems to be not the case for CHIKV also this is a matter of debate (Sourisseau et al. 2007). SINV is known to induce TNF $\alpha$ , IL-1 $\beta$ , and IL-6 in macrophage similar to that observed in RA (Assuncao-Miranda, Bozza et al. 2010). Expression of TNF $\alpha$  from SINV infected macrophage (Assuncao-Miranda, Bozza et al. 2010) could activate synovial fibroblasts and T cells to express genes associated with arthritis such as receptor activated NF $\kappa$ B (RANK) ligand (RANKL) (Horwood, Elliott et al. 1998; Lacey, Timms et al. 1998). Cytokine IL-6 is also involved in pathogenesis of RA and its known to be regulated by TNF $\alpha$  or other stimuli (Park and Pillinger 2007). SINV induced these regulatory cascades of cytokine which promote inflammation and could explain articular damage in viral arthritis. Our comparative study between CHIKV and SINV has also demonstrated the expression of TNF $\alpha$  in macrophage induced by SINV infection. This might be due to expression of PRRs and the IFN response to SINV in RAW264.7 cells which was robust compared to CHIKV and the IFN induced ISGs were also found to be highly increased with time.

Angiogenesis, the formation of new blood vessels from existing one, was another symptom observed in some arthritogenic chronic CHIKV patients. Angiogenesis, mostly implicated in tumor condition, is also induced by many viruses. Macrophage is known to affect the different stages of angiogenesis by the release of different growth factors like VEGF, PFGEF, G-CSF GM-CSF, IGF-I, TGF- $\alpha/\beta$ . In our RAW264.7 model of CHIKV infection, we analyzed the expression of pro-angiogenic factors PDGF-B and VEGF $\alpha$ . We observed a significant increase in PDGF-B mRNA expression but not for VEGF $\alpha$  expression.

Over all, we established that RAW264.7 mouse macrophage cell line is a good model of CHIKV infection that could be used to study the virus persistence and the induced angiogenesis mechanisms at the route of chronic arthritis. The study of alphaviruses in general to mediate pathology, will also benefit from the comparison between different members of the alphavirus family and particularly to instruct an M1 or M2 polarization of macrophages.

Different antiviral drugs are currently being developed to control CHIKV infection. To prevent infection, a vaccine is now required. A live, attenuated vaccine did advance up to phase II clinical trial but its development was halted due to poor tolerance. Knowing that a non-negligible number of CHIKV patients are experiencing arthritogenic chronic symptoms post-CHIKV, it is also urgent to address the mechanisms responsible for these associated pathologies. Deciphering the role of macrophages in the persistence of virus in “niche” and their contribution to the chronic alteration of the tissues would be of great benefit to the patient medical conditions. We herein propose to use the mouse in-vitro cell line like the RAW264.7 model of infection presented herein to tackle these issues in a first instance before moving to animal models and clinical studies.

## **VII. Perspectives**

A great deal of research are being done to understand the physiopathology of virus-induced disease but for most of them, our understanding is still in its infancy stage. Long neglected CHIKV came in lime light during the recent outbreak in 2005-2006 in Indian Ocean region particularly in Reunion Island. This outbreak has shown new atypical symptoms consisting of long lasting arthralgia and encephalitis, indicating the evolvement of the virus in CNS infection. Our study has shown that RAW264.7 macrophages can be infected but does not induced a robust innate immune response probably contributing to a viral persistence mechanism. This observation opens a new window to study different aspects of virus-host interaction. A better understanding as to how the virus interferes with the immune response at the level of the IFN, ISGs or cytokine responses will be required. Since the macrophage infection is limited it is still unresolved how precisely the viral entry mechanism works and which molecules could interfere to explain why most of macrophages cells remain refractory to infection. We need to address specifically the role of macrophages in a context of arthritogenic induced symptoms but the same approach can be used to study the role of macrophages (microglia) in the induced inflammation of the CNS. Other mechanism should now also be addressed to understand all the aspects of CHIKV infection. Autophagy, also known to inhibit apoptosis, can open new frontier to understand the mechanism of virus persistence.

Based on the results obtained with the RAW264.7 model described here, others in-vitro and ex-vivo models (mouse, NHPs, human) of macrophage CHIKV infection will need to be developed to confirm and validate our observations. These models are essentials as they will probably constitute the starting point to test the future anti-viral drug candidates, their efficiency and innocuity before patients would benefit in return.



## **VIII. Conclusion**

Alphaviruses are known to infect and persist in infected cells and derived chronic pathologies. Macrophage is the main innate immune cells to control virus infection. Virus infection polarizes the macrophage towards proinflammatory response. Limited availability of human tissue samples has encouraged researchers to develop different animal model to study virus pathology. Our RAW264.7 model of CHIKV infection doesn't show innate immune response and apoptosis, irrespective of virus replication and production, and expression of proinflammatory cytokines like TNF $\alpha$  and IL-6. This induced inflammation can in turn increase the efficiency of virus to persist. Macrophages usually remain nonangiogenic in inactivated state. Virus infection can stimulate them to be angiogenic, as observed in our study. These angiogenic macrophages in turn activate and or effectively increase inflammatory response, which might contribute to disease severity in chronic phase and fibrosis. RAW264.7 mouse macrophage model was also used to study the immune response for other Sindbis virus. It should also be envisaged to use RAW in a coculture system to explore the cross-talks between virus-macrophages and synovial fibroblast and to be extended to endothelial cells.

Our model can also be used to study the limiting factors involved in virus infection as we saw only a small population of infected cells.

## **IX. Bibliographic References**

- (1991). "Barmah Forest virus." Lancet **337**(8747): 948-949.
- (2007). "Update: chikungunya fever diagnosed among international travelers--United States, 2006." MMWR Morb Mortal Wkly Rep **56**(12): 276-277.
- (2012). "Chikungunya outbreak--Cambodia, February-March 2012." MMWR Morb Mortal Wkly Rep **61**: 737-740.
- Ablasser, A., F. Bauernfeind, et al. (2009). "RIG-I-dependent sensing of poly(dA:dT) through the induction of an RNA polymerase III-transcribed RNA intermediate." Nat Immunol **10**(10): 1065-1072.
- AbuBakar, S., I. C. Sam, et al. (2007). "Reemergence of endemic Chikungunya, Malaysia." Emerg Infect Dis **13**(1): 147-149.
- Agarwal, S. K. and M. B. Brenner (2006). "Role of adhesion molecules in synovial inflammation." Curr Opin Rheumatol **18**(3): 268-276.
- Aggarwal, B. B., S. Shishodia, et al. (2006). "Inflammation and cancer: how hot is the link?" Biochem Pharmacol **72**(11): 1605-1621.
- Agrawal, A., A. K. Shriv, et al. (2001). "Topology and structure of the C1q-binding site on C-reactive protein." J Immunol **166**(6): 3998-4004.
- Aguilar, P. V., J. G. Estrada-Franco, et al. (2011). "Endemic Venezuelan equine encephalitis in the Americas: hidden under the dengue umbrella." Future Virol **6**(6): 721-740.
- Aguilar, P. V., S. C. Weaver, et al. (2007). "Capsid protein of eastern equine encephalitis virus inhibits host cell gene expression." J Virol **81**(8): 3866-3876.
- Ahmad, M., S. M. Srinivasula, et al. (1997). "CRADD, a novel human apoptotic adaptor molecule for caspase-2, and FasL/tumor necrosis factor receptor-interacting protein RIP." Cancer Res **57**(4): 615-619.
- Ahmed, S., R. Libman, et al. (2000). "Guillain-Barre syndrome: An unusual presentation of West Nile virus infection." Neurology **55**(1): 144-146.
- Ahn, A., M. R. Klimjack, et al. (1999). "An epitope of the Semliki Forest virus fusion protein exposed during virus-membrane fusion." J Virol **73**(12): 10029-10039.
- Ahola, T. and L. Kaariainen (1995). "Reaction in alphavirus mRNA capping: formation of a covalent complex of nonstructural protein nsP1 with 7-methyl-GMP." Proc Natl Acad Sci U S A **92**(2): 507-511.
- Ahola, T., P. Kujala, et al. (2000). "Effects of palmitoylation of replicase protein nsP1 on alphavirus infection." J Virol **74**(15): 6725-6733.
- Ahola, T., A. Lampio, et al. (1999). "Semliki Forest virus mRNA capping enzyme requires association with anionic membrane phospholipids for activity." EMBO J **18**(11): 3164-3172.
- Akahata, W., Z. Y. Yang, et al. (2010). "A virus-like particle vaccine for epidemic Chikungunya virus protects nonhuman primates against infection." Nat Med **16**(3): 334-338.
- Akira, S. and K. Takeda (2004). "Toll-like receptor signalling." Nat Rev Immunol **4**(7): 499-511.
- Akira, S., S. Uematsu, et al. (2006). "Pathogen recognition and innate immunity." Cell **124**(4): 783-801.
- Al-Lamki, R. S., J. Wang, et al. (2001). "Expression of tumor necrosis factor receptors in normal kidney and rejecting renal transplants." Lab Invest **81**(11): 1503-1515.
- Al Tabaa, Y., E. Tuaille, et al. (2011). "B-cell polyclonal activation and Epstein-Barr viral abortive lytic cycle are two key features in acute infectious mononucleosis." J Clin Virol **52**(1): 33-37.
- Albert, L. J. and R. D. Inman (1999). "Molecular mimicry and autoimmunity." N Engl J Med **341**(27): 2068-2074.
- Alcami, A. (2003). "Viral mimicry of cytokines, chemokines and their receptors." Nat Rev Immunol **3**(1): 36-50.
- Alcami, A. and G. L. Smith (1995). "Cytokine receptors encoded by poxviruses: a lesson in cytokine biology." Immunol Today **16**(10): 474-478.

- Alexopoulou, L., A. C. Holt, et al. (2001). "Recognition of double-stranded RNA and activation of NF-kappaB by Toll-like receptor 3." *Nature* **413**(6857): 732-738.
- Aliprantis, A. O., R. B. Yang, et al. (1999). "Cell activation and apoptosis by bacterial lipoproteins through toll-like receptor-2." *Science* **285**(5428): 736-739.
- Altfeld, M., L. Fadda, et al. (2011). "DCs and NK cells: critical effectors in the immune response to HIV-1." *Nat Rev Immunol* **11**(3): 176-186.
- Andrei, G. and E. De Clercq (1990). "Inhibitory effect of selected antiviral compounds on arenavirus replication in vitro." *Antiviral Res* **14**(4-5): 287-299.
- Ank, N., H. West, et al. (2006). "Lambda interferon (IFN-lambda), a type III IFN, is induced by viruses and IFNs and displays potent antiviral activity against select virus infections in vivo." *J Virol* **80**(9): 4501-4509.
- Ank, N., H. West, et al. (2006). "IFN-lambda: novel antiviral cytokines." *J Interferon Cytokine Res* **26**(6): 373-379.
- Anthony, R. P., A. M. Paredes, et al. (1992). "Disulfide bonds are essential for the stability of the Sindbis virus envelope." *Virology* **190**(1): 330-336.
- Arankalle, V. A., S. Shrivastava, et al. (2007). "Genetic divergence of Chikungunya viruses in India (1963-2006) with special reference to the 2005-2006 explosive epidemic." *J Gen Virol* **88**(Pt 7): 1967-1976.
- Arimoto, K., H. Takahashi, et al. (2007). "Negative regulation of the RIG-I signaling by the ubiquitin ligase RNF125." *Proc Natl Acad Sci U S A* **104**(18): 7500-7505.
- Asquith, D. L. and I. B. McInnes (2007). "Emerging cytokine targets in rheumatoid arthritis." *Curr Opin Rheumatol* **19**(3): 246-251.
- Assuncao-Miranda, I., M. T. Bozza, et al. (2010). "Pro-inflammatory response resulting from sindbis virus infection of human macrophages: implications for the pathogenesis of viral arthritis." *J Med Virol* **82**(1): 164-174.
- Azevedo, R. S., E. V. Silva, et al. (2009). "Mayaro fever virus, Brazilian Amazon." *Emerg Infect Dis* **15**(11): 1830-1832.
- Bagny, L., H. Delatte, et al. (2009). "Aedes (Diptera: Culicidae) vectors of arboviruses in Mayotte (Indian Ocean): distribution area and larval habitats." *J Med Entomol* **46**(2): 198-207.
- Bakhshi, A., J. P. Jensen, et al. (1985). "Cloning the chromosomal breakpoint of t(14;18) human lymphomas: clustering around JH on chromosome 14 and near a transcriptional unit on 18." *Cell* **41**(3): 899-906.
- Balachandran, S., C. N. Kim, et al. (1998). "Activation of the dsRNA-dependent protein kinase, PKR, induces apoptosis through FADD-mediated death signaling." *EMBO J* **17**(23): 6888-6902.
- Balachandran, S., E. Thomas, et al. (2004). "A FADD-dependent innate immune mechanism in mammalian cells." *Nature* **432**(7015): 401-405.
- Baltimore, D. (1971). "Expression of animal virus genomes." *Bacteriol Rev* **35**(3): 235-241.
- Banerjee, K. (1965). "A note on antibodies to chikungunya virus in human sera collected in Madras state in 1956." *Indian J Med Res* **53**(8): 715-719.
- Banerjee, K., D. T. Mourja, et al. (1988). "Susceptibility & transmissibility of different geographical strains of Aedes aegypti mosquitoes to Chikungunya virus." *Indian J Med Res* **87**: 134-138.
- Barbalat, R., L. Lau, et al. (2009). "Toll-like receptor 2 on inflammatory monocytes induces type I interferon in response to viral but not bacterial ligands." *Nat Immunol* **10**(11): 1200-1207.
- Barca, O., S. Ferre, et al. (2003). "Interferon beta promotes survival in primary astrocytes through phosphatidylinositol 3-kinase." *J Neuroimmunol* **139**(1-2): 155-159.
- Bardin, N., M. Blot-Chabaud, et al. (2009). "CD146 and its soluble form regulate monocyte transendothelial migration." *Arterioscler Thromb Vasc Biol* **29**(5): 746-753.
- Barnard, P. and N. A. McMillan (1999). "The human papillomavirus E7 oncoprotein abrogates signaling mediated by interferon-alpha." *Virology* **259**(2): 305-313.

- Barro, M. and J. T. Patton (2007). "Rotavirus NSP1 inhibits expression of type I interferon by antagonizing the function of interferon regulatory factors IRF3, IRF5, and IRF7." *J Virol* **81**(9): 4473-4481.
- Bass, B. L. (1997). "RNA editing and hypermutation by adenosine deamination." *Trends Biochem Sci* **22**(5): 157-162.
- Bass, B. L. and H. Weintraub (1988). "An unwinding activity that covalently modifies its double-stranded RNA substrate." *Cell* **55**(6): 1089-1098.
- Basset, C., J. Holton, et al. (2003). "Innate immunity and pathogen-host interaction." *Vaccine* **21 Suppl 2**: S12-23.
- Bauer, S., C. J. Kirschning, et al. (2001). "Human TLR9 confers responsiveness to bacterial DNA via species-specific CpG motif recognition." *Proc Natl Acad Sci U S A* **98**(16): 9237-9242.
- Baumgarth, N., Y. S. Choi, et al. (2008). "B cell lineage contributions to antiviral host responses." *Curr Top Microbiol Immunol* **319**: 41-61.
- Bekeredjian-Ding, I. B., M. Wagner, et al. (2005). "Plasmacytoid dendritic cells control TLR7 sensitivity of naive B cells via type I IFN." *J Immunol* **174**(7): 4043-4050.
- Bender, A., L. K. Bui, et al. (1995). "Inactivated influenza virus, when presented on dendritic cells, elicits human CD8+ cytolytic T cell responses." *J Exp Med* **182**(6): 1663-1671.
- Benoist, C. and D. Mathis (2001). "Autoimmunity provoked by infection: how good is the case for T cell epitope mimicry?" *Nat Immunol* **2**(9): 797-801.
- Bhardwaj, N., A. Bender, et al. (1994). "Influenza virus-infected dendritic cells stimulate strong proliferative and cytolytic responses from human CD8+ T cells." *J Clin Invest* **94**(2): 797-807.
- Bhat, R. M., Y. Raj, et al. (2011). "Mucocutaneous manifestations of chikungunya Fever: a study from an epidemic in coastal karnataka." *Indian J Dermatol* **56**(3): 290-294.
- Bhattacharya, S., R. Eckner, et al. (1996). "Cooperation of Stat2 and p300/CBP in signalling induced by interferon-alpha." *Nature* **383**(6598): 344-347.
- Bhattacharyya, S., A. Kumar, et al. (2012). "The voyage of stem cell toward terminal differentiation: a brief overview." *Acta Biochim Biophys Sin (Shanghai)* **44**(6): 463-475.
- Bialik, S. and A. Kimchi (2006). "The death-associated protein kinases: structure, function, and beyond." *Annu Rev Biochem* **75**: 189-210.
- Bieback, K., E. Lien, et al. (2002). "Hemagglutinin protein of wild-type measles virus activates toll-like receptor 2 signaling." *J Virol* **76**(17): 8729-8736.
- Binder, G. K. and D. E. Griffin (2001). "Interferon-gamma-mediated site-specific clearance of alphavirus from CNS neurons." *Science* **293**(5528): 303-306.
- Binn, L. N., V. R. Harrison, et al. (1967). "Patterns of viremia and antibody observed in rhesus monkeys inoculated with chikungunya and other serologically related group A arboviruses." *Am J Trop Med Hyg* **16**(6): 782-785.
- Biron, C. A. and L. Brossay (2001). "NK cells and NKT cells in innate defense against viral infections." *Curr Opin Immunol* **13**(4): 458-464.
- Biswas, P., G. Poli, et al. (1992). "Interferon gamma induces the expression of human immunodeficiency virus in persistently infected promonocytic cells (U1) and redirects the production of virions to intracytoplasmic vacuoles in phorbol myristate acetate-differentiated U1 cells." *J Exp Med* **176**(3): 739-750.
- Biswas, S. K. and A. Sodhi (2002). "In vitro activation of murine peritoneal macrophages by monocyte chemoattractant protein-1: upregulation of CD11b, production of proinflammatory cytokines, and the signal transduction pathway." *J Interferon Cytokine Res* **22**(5): 527-538.
- Blacksell, S. D., A. Tanganuchitcharnchai, et al. (2011). "Poor diagnostic accuracy of commercial antibody-based assays for the diagnosis of acute Chikungunya infection." *Clin Vaccine Immunol* **18**(10): 1773-1775.

- Blander, J. M. and R. Medzhitov (2004). "Regulation of phagosome maturation by signals from toll-like receptors." *Science* **304**(5673): 1014-1018.
- Blom, B. and H. Spits (2006). "Development of human lymphoid cells." *Annu Rev Immunol* **24**: 287-320.
- Blonska, M., P. B. Shambharkar, et al. (2005). "TAK1 is recruited to the tumor necrosis factor-alpha (TNF-alpha) receptor 1 complex in a receptor-interacting protein (RIP)-dependent manner and cooperates with MEKK3 leading to NF-kappaB activation." *J Biol Chem* **280**(52): 43056-43063.
- Bluman, E. M., K. J. Bartynski, et al. (1996). "Human natural killer cells produce abundant macrophage inflammatory protein-1 alpha in response to monocyte-derived cytokines." *J Clin Invest* **97**(12): 2722-2727.
- Boehm, U., T. Klamp, et al. (1997). "Cellular responses to interferon-gamma." *Annu Rev Immunol* **15**: 749-795.
- Bokarewa, M., A. Tarkowski, et al. (2007). "Pathological survivin expression links viral infections with pathogenesis of erosive rheumatoid arthritis." *Scand J Immunol* **66**(2-3): 192-198.
- Boldin, M. P., T. M. Goncharov, et al. (1996). "Involvement of MACH, a novel MORT1/FADD-interacting protease, in Fas/APO-1- and TNF receptor-induced cell death." *Cell* **85**(6): 803-815.
- Boldin, M. P., I. L. Mett, et al. (1995). "Self-association of the "death domains" of the p55 tumor necrosis factor (TNF) receptor and Fas/APO1 prompts signaling for TNF and Fas/APO1 effects." *J Biol Chem* **270**(1): 387-391.
- Bonn, D. (2006). "How did chikungunya reach the Indian Ocean?" *Lancet Infect Dis* **6**(9): 543.
- Borgherini, G., P. Poubeau, et al. (2008). "Persistent arthralgia associated with chikungunya virus: a study of 88 adult patients on reunion island." *Clin Infect Dis* **47**(4): 469-475.
- Borgherini, G., P. Poubeau, et al. (2007). "Outbreak of chikungunya on Reunion Island: early clinical and laboratory features in 157 adult patients." *Clin Infect Dis* **44**(11): 1401-1407.
- Borregaard, N. and J. B. Cowland (1997). "Granules of the human neutrophilic polymorphonuclear leukocyte." *Blood* **89**(10): 3503-3521.
- Bouquillard, E. and B. Combe (2009). "A report of 21 cases of rheumatoid arthritis following Chikungunya fever. A mean follow-up of two years." *Joint Bone Spine* **76**(6): 654-657.
- Bouquillard, E. and B. Combe (2009). "Rheumatoid arthritis after Chikungunya fever: a prospective follow-up study of 21 cases." *Ann Rheum Dis* **68**(9): 1505-1506.
- Bourboulia, D. and W. G. Stetler-Stevenson (2010). "Matrix metalloproteinases (MMPs) and tissue inhibitors of metalloproteinases (TIMPs): Positive and negative regulators in tumor cell adhesion." *Semin Cancer Biol* **20**(3): 161-168.
- Brehin, A. C., I. Casademont, et al. (2009). "The large form of human 2',5'-Oligoadenylate Synthetase (OAS3) exerts antiviral effect against Chikungunya virus." *Virology* **384**(1): 216-222.
- Breitbart, M. and F. Rohwer (2005). "Here a virus, there a virus, everywhere the same virus?" *Trends Microbiol* **13**(6): 278-284.
- Brightbill, H. D., D. H. Libraty, et al. (1999). "Host defense mechanisms triggered by microbial lipoproteins through toll-like receptors." *Science* **285**(5428): 732-736.
- Brighton, S. W. (1984). "Chloroquine phosphate treatment of chronic Chikungunya arthritis. An open pilot study." *S Afr Med J* **66**(6): 217-218.
- Brighton, S. W., O. W. Prozesky, et al. (1983). "Chikungunya virus infection. A retrospective study of 107 cases." *S Afr Med J* **63**(9): 313-315.
- Briolant, S., D. Garin, et al. (2004). "In vitro inhibition of Chikungunya and Semliki Forest viruses replication by antiviral compounds: synergistic effect of interferon-alpha and ribavirin combination." *Antiviral Res* **61**(2): 111-117.

- Brown, G. D. (2006). "Dectin-1: a signalling non-TLR pattern-recognition receptor." Nat Rev Immunol **6**(1): 33-43.
- Brummer-Korvenkontio, M., O. Vapalahti, et al. (2002). "Epidemiology of Sindbis virus infections in Finland 1981-96: possible factors explaining a peculiar disease pattern." Epidemiol Infect **129**(2): 335-345.
- Budd, R. C., W. C. Yeh, et al. (2006). "cFLIP regulation of lymphocyte activation and development." Nat Rev Immunol **6**(3): 196-204.
- Burckstummer, T., C. Baumann, et al. (2009). "An orthogonal proteomic-genomic screen identifies AIM2 as a cytoplasmic DNA sensor for the inflammasome." Nat Immunol **10**(3): 266-272.
- Burdeinick-Kerr, R. and D. E. Griffin (2005). "Gamma interferon-dependent, noncytolytic clearance of sindbis virus infection from neurons in vitro." J Virol **79**(9): 5374-5385.
- Burfoot, M. S., N. C. Rogers, et al. (1997). "Janus kinase-dependent activation of insulin receptor substrate 1 in response to interleukin-4, oncostatin M, and the interferons." J Biol Chem **272**(39): 24183-24190.
- Burger, R., F. Neipel, et al. (1998). "Human herpesvirus type 8 interleukin-6 homologue is functionally active on human myeloma cells." Blood **91**(6): 1858-1863.
- Burke, D. S., A. Nisalak, et al. (1985). "Kinetics of IgM and IgG responses to Japanese encephalitis virus in human serum and cerebrospinal fluid." J Infect Dis **151**(6): 1093-1099.
- Burt, F. J., M. S. Rolph, et al. (2012). "Chikungunya: a re-emerging virus." Lancet **379**(9816): 662-671.
- Buschle, M., D. Campana, et al. (1993). "Interferon gamma inhibits apoptotic cell death in B cell chronic lymphocytic leukemia." J Exp Med **177**(1): 213-218.
- Buttner, S., T. Eisenberg, et al. (2007). "Endonuclease G regulates budding yeast life and death." Mol Cell **25**(2): 233-246.
- Cailhier, J. F., M. Partolina, et al. (2005). "Conditional macrophage ablation demonstrates that resident macrophages initiate acute peritoneal inflammation." J Immunol **174**(4): 2336-2342.
- Calabrese, L. H. and S. J. Naides (2005). "Viral arthritis." Infect Dis Clin North Am **19**(4): 963-980, x.
- Calisher, C. H. and K. C. Maness (1974). "Virulence of Venezuelan equine encephalomyelitis virus subtypes for various laboratory hosts." Appl Microbiol **28**(5): 881-884.
- Campbell, J. J., S. Qin, et al. (2001). "Unique subpopulations of CD56+ NK and NK-T peripheral blood lymphocytes identified by chemokine receptor expression repertoire." J Immunol **166**(11): 6477-6482.
- Campos, M. A., I. C. Almeida, et al. (2001). "Activation of Toll-like receptor-2 by glycosylphosphatidylinositol anchors from a protozoan parasite." J Immunol **167**(1): 416-423.
- Cao, X. (2009). "New DNA-sensing pathway feeds RIG-I with RNA." Nat Immunol **10**(10): 1049-1051.
- Carey, D. E. (1971). "Chikungunya and dengue: a case of mistaken identity?" J Hist Med Allied Sci **26**(3): 243-262.
- Carpick, B. W., V. Graziano, et al. (1997). "Characterization of the solution complex between the interferon-induced, double-stranded RNA-activated protein kinase and HIV-1 trans-activating region RNA." J Biol Chem **272**(14): 9510-9516.
- Carroll, S. S., E. Chen, et al. (1996). "Cleavage of oligoribonucleotides by the 2',5'-oligoadenylate-dependent ribonuclease L." J Biol Chem **271**(9): 4988-4992.
- Casals, J., E. C. Curnen, et al. (1943). "Venezuelan Equine Encephalomyelitis in Man." J Exp Med **77**(6): 521-530.
- Casals, J. and L. Whitman (1957). "Mayaro virus: a new human disease agent. I. Relationship to other arbor viruses." Am J Trop Med Hyg **6**(6): 1004-1011.
- Casolari, S., E. Briganti, et al. (2008). "A fatal case of encephalitis associated with Chikungunya virus infection." Scand J Infect Dis **40**(11-12): 995-996.
- Casrouge, A., S. Y. Zhang, et al. (2006). "Herpes simplex virus encephalitis in human UNC-93B deficiency." Science **314**(5797): 308-312.



- Cassell, S., J. Edwards, et al. (1984). "Effects of lysosomotropic weak bases on infection of BHK-21 cells by Sindbis virus." *J Virol* **52**(3): 857-864.
- Cattaneo, R. (1994). "Biased (A→I) hypermutation of animal RNA virus genomes." *Curr Opin Genet Dev* **4**(6): 895-900.
- Chai, J., C. Du, et al. (2000). "Structural and biochemical basis of apoptotic activation by Smac/DIABLO." *Nature* **406**(6798): 855-862.
- Chan, F. K., H. J. Chun, et al. (2000). "A domain in TNF receptors that mediates ligand-independent receptor assembly and signaling." *Science* **288**(5475): 2351-2354.
- Chang, H. W., J. C. Watson, et al. (1992). "The E3L gene of vaccinia virus encodes an inhibitor of the interferon-induced, double-stranded RNA-dependent protein kinase." *Proc Natl Acad Sci U S A* **89**(11): 4825-4829.
- Chang, S., A. Dolganiuc, et al. (2007). "Toll-like receptors 1 and 6 are involved in TLR2-mediated macrophage activation by hepatitis C virus core and NS3 proteins." *J Leukoc Biol* **82**(3): 479-487.
- Charles, P. C., J. Trgovcich, et al. (2001). "Immunopathogenesis and immune modulation of Venezuelan equine encephalitis virus-induced disease in the mouse." *Virology* **284**(2): 190-202.
- Charrel, R. N., X. de Lamballerie, et al. (2007). "Chikungunya outbreaks--the globalization of vectorborne diseases." *N Engl J Med* **356**(8): 769-771.
- Chastel, C. (1963). "[Human Infections in Cambodia by the Chikungunya Virus or an Apparently Closely Related Agent. I. Clinical Aspects. Isolations and Identification of the Viruses. Serology]." *Bull Soc Pathol Exot Filiales* **56**: 892-915.
- Chastel, C. (2005). "[Chikungunya virus: its recent spread to the southern Indian Ocean and Reunion Island (2005-2006)]." *Bull Acad Natl Med* **189**(8): 1827-1835.
- Chatterjee, S. N., S. K. Chakravarti, et al. (1965). "Virological investigation of cases with neurological complications during the outbreak of haemorrhagic fever in Calcutta." *J Indian Med Assoc* **45**(6): 314-316.
- Chaves Tdo, S., A. C. Pellini, et al. (2012). "Travelers as sentinels for chikungunya fever, Brazil." *Emerg Infect Dis* **18**(3): 529-530.
- Chebath, J., G. Merlin, et al. (1983). "Interferon-induced 56,000 Mr protein and its mRNA in human cells: molecular cloning and partial sequence of the cDNA." *Nucleic Acids Res* **11**(5): 1213-1226.
- Chen, G. and D. V. Goeddel (2002). "TNF-R1 signaling: a beautiful pathway." *Science* **296**(5573): 1634-1635.
- Chen, Z. J. (2005). "Ubiquitin signalling in the NF-kappaB pathway." *Nat Cell Biol* **7**(8): 758-765.
- Cheng, R. H., R. J. Kuhn, et al. (1995). "Nucleocapsid and glycoprotein organization in an enveloped virus." *Cell* **80**(4): 621-630.
- Chertov, O., D. Yang, et al. (2000). "Leukocyte granule proteins mobilize innate host defenses and adaptive immune responses." *Immunol Rev* **177**: 68-78.
- Chinnaiyan, A. M., K. O'Rourke, et al. (1995). "FADD, a novel death domain-containing protein, interacts with the death domain of Fas and initiates apoptosis." *Cell* **81**(4): 505-512.
- Chiu, Y. H., J. B. Macmillan, et al. (2009). "RNA polymerase III detects cytosolic DNA and induces type I interferons through the RIG-I pathway." *Cell* **138**(3): 576-591.
- Chopra, A., V. Anuradha, et al. (2012). "Acute Chikungunya and persistent musculoskeletal pain following the 2006 Indian epidemic: a 2-year prospective rural community study." *Epidemiol Infect* **140**(5): 842-850.
- Chopra, A., V. Anuradha, et al. (2008). "Chikungunya virus aches and pains: an emerging challenge." *Arthritis Rheum* **58**(9): 2921-2922.

- Chow, A., Z. Her, et al. (2011). "Persistent arthralgia induced by Chikungunya virus infection is associated with interleukin-6 and granulocyte macrophage colony-stimulating factor." *J Infect Dis* **203**(2): 149-157.
- Chretien, J. P., A. Anyamba, et al. (2007). "Drought-associated chikungunya emergence along coastal East Africa." *Am J Trop Med Hyg* **76**(3): 405-407.
- Chun, T. W., K. Chadwick, et al. (1997). "Differential susceptibility of naive and memory CD4+ T cells to the cytopathic effects of infection with human immunodeficiency virus type 1 strain LAI." *J Virol* **71**(6): 4436-4444.
- Clark, R. A., R. D. Stone, et al. (1976). "Role of macrophages in wound healing." *Surg Forum* **27**(62): 16-18.
- Clarris, B. J., R. L. Doherty, et al. (1975). "Epidemic polyarthritis: a cytological, virological and immunochemical study." *Aust N Z J Med* **5**(5): 450-457.
- Cleary, M. L. and J. Sklar (1985). "Nucleotide sequence of a t(14;18) chromosomal breakpoint in follicular lymphoma and demonstration of a breakpoint-cluster region near a transcriptionally active locus on chromosome 18." *Proc Natl Acad Sci U S A* **82**(21): 7439-7443.
- Clemens, M. J. and C. M. Vaquero (1978). "Inhibition of protein synthesis by double-stranded RNA in reticulocyte lysates: evidence for activation of an endoribonuclease." *Biochem Biophys Res Commun* **83**(1): 59-68.
- Cohen, J. J. (1991). "Programmed cell death in the immune system." *Adv Immunol* **50**: 55-85.
- Cohen, O., E. Feinstein, et al. (1997). "DAP-kinase is a Ca<sup>2+</sup>/calmodulin-dependent, cytoskeletal-associated protein kinase, with cell death-inducing functions that depend on its catalytic activity." *EMBO J* **16**(5): 998-1008.
- Colamonici, O. R., P. Domanski, et al. (1995). "Vaccinia virus B18R gene encodes a type I interferon-binding protein that blocks interferon alpha transmembrane signaling." *J Biol Chem* **270**(27): 15974-15978.
- Colby, C. and M. J. Morgan (1971). "Interferon induction and action." *Annu Rev Microbiol* **25**: 333-360.
- Collins, T., A. J. Korman, et al. (1984). "Immune interferon activates multiple class II major histocompatibility complex genes and the associated invariant chain gene in human endothelial cells and dermal fibroblasts." *Proc Natl Acad Sci U S A* **81**(15): 4917-4921.
- Colonna, M., G. Trinchieri, et al. (2004). "Plasmacytoid dendritic cells in immunity." *Nat Immunol* **5**(12): 1219-1226.
- Compton, T., E. A. Kurt-Jones, et al. (2003). "Human cytomegalovirus activates inflammatory cytokine responses via CD14 and Toll-like receptor 2." *J Virol* **77**(8): 4588-4596.
- Coombs, K., E. Mann, et al. (1981). "Effects of chloroquine and cytochalasin B on the infection of cells by Sindbis virus and vesicular stomatitis virus." *J Virol* **37**(3): 1060-1065.
- Cooper, M. A., T. A. Fehniger, et al. (2001). "The biology of human natural killer-cell subsets." *Trends Immunol* **22**(11): 633-640.
- Couderc, T., F. Chretien, et al. (2008). "A mouse model for Chikungunya: young age and inefficient type-I interferon signaling are risk factors for severe disease." *PLoS Pathog* **4**(2): e29.
- Couderc, T., N. Khandoudi, et al. (2009). "Prophylaxis and therapy for Chikungunya virus infection." *J Infect Dis* **200**(4): 516-523.
- Cross, R. K. (1983). "Identification of a unique guanine-7-methyltransferase in Semliki Forest virus (SFV) infected cell extracts." *Virology* **130**(2): 452-463.
- Crotty, S., C. E. Cameron, et al. (2001). "RNA virus error catastrophe: direct molecular test by using ribavirin." *Proc Natl Acad Sci U S A* **98**(12): 6895-6900.
- Cui, S., K. Eisenacher, et al. (2008). "The C-terminal regulatory domain is the RNA 5'-triphosphate sensor of RIG-I." *Mol Cell* **29**(2): 169-179.

- Cui, Y., M. Li, et al. (2001). "The Stat3/5 locus encodes novel endoplasmic reticulum and helicase-like proteins that are preferentially expressed in normal and neoplastic mammary tissue." Genomics **78**(3): 129-134.
- Cunningham, A. L. and J. R. Fraser (1985). "Persistent rubella virus infection of human synovial cells cultured in vitro." J Infect Dis **151**(4): 638-645.
- D'Andrea, L. D. and L. Regan (2003). "TPR proteins: the versatile helix." Trends Biochem Sci **28**(12): 655-662.
- D'Cunha, J., S. Ramanujam, et al. (1996). "In vitro and in vivo secretion of human ISG15, an IFN-induced immunomodulatory cytokine." J Immunol **157**(9): 4100-4108.
- da Silva Correia, J., K. Soldau, et al. (2001). "Lipopolysaccharide is in close proximity to each of the proteins in its membrane receptor complex. transfer from CD14 to TLR4 and MD-2." J Biol Chem **276**(24): 21129-21135.
- Dandawate, C. N., K. V. Thiruvengadam, et al. (1965). "Serological survey in Madras city with special reference to chikungunya." Indian J Med Res **53**(8): 707-714.
- Danes, L. and M. Kimerlingova (1957). "[Fatal human case of encephalomyelitis caused by a virus identical with the strain of western equine encephalomyelitis]." Cesk Epidemiol Mikrobiol Imunol **6**(2): 80-84.
- Danial, N. N. and S. J. Korsmeyer (2004). "Cell death: critical control points." Cell **116**(2): 205-219.
- Das, T., M. C. Jaffar-Bandjee, et al. (2010). "Chikungunya fever: CNS infection and pathologies of a re-emerging arbovirus." Prog Neurobiol **91**(2): 121-129.
- David, M., E. Petricoin, 3rd, et al. (1995). "Requirement for MAP kinase (ERK2) activity in interferon alpha- and interferon beta-stimulated gene expression through STAT proteins." Science **269**(5231): 1721-1723.
- Davies, M. V., O. Elroy-Stein, et al. (1992). "The vaccinia virus K3L gene product potentiates translation by inhibiting double-stranded-RNA-activated protein kinase and phosphorylation of the alpha subunit of eukaryotic initiation factor 2." J Virol **66**(4): 1943-1950.
- De Filippo, K., R. B. Henderson, et al. (2008). "Neutrophil chemokines KC and macrophage-inflammatory protein-2 are newly synthesized by tissue macrophages using distinct TLR signaling pathways." J Immunol **180**(6): 4308-4315.
- De Lamballerie, X., V. Boisson, et al. (2008). "On chikungunya acute infection and chloroquine treatment." Vector Borne Zoonotic Dis **8**(6): 837-839.
- Deb, A., S. J. Haque, et al. (2001). "RNA-dependent protein kinase PKR is required for activation of NF-kappa B by IFN-gamma in a STAT1-independent pathway." J Immunol **166**(10): 6170-6180.
- DeFilippis, V. and K. Fruh (2005). "Rhesus cytomegalovirus particles prevent activation of interferon regulatory factor 3." J Virol **79**(10): 6419-6431.
- Degli-Esposti, M. A., W. C. Dougall, et al. (1997). "The novel receptor TRAIL-R4 induces NF-kappaB and protects against TRAIL-mediated apoptosis, yet retains an incomplete death domain." Immunity **7**(6): 813-820.
- Deiss, L. P., E. Feinstein, et al. (1995). "Identification of a novel serine/threonine kinase and a novel 15-kD protein as potential mediators of the gamma interferon-induced cell death." Genes Dev **9**(1): 15-30.
- Deiss, L. P., H. Galinka, et al. (1996). "Cathepsin D protease mediates programmed cell death induced by interferon-gamma, Fas/APO-1 and TNF-alpha." EMBO J **15**(15): 3861-3870.
- Deiss, L. P. and A. Kimchi (1991). "A genetic tool used to identify thioredoxin as a mediator of a growth inhibitory signal." Science **252**(5002): 117-120.
- Delatte, H., C. Paupy, et al. (2008). "[Aedes albopictus, vector of chikungunya and dengue viruses in Reunion Island: biology and control]." Parasite **15**(1): 3-13.

- Delfraro, A., A. Burgueno, et al. (2011). "Fatal human case of Western equine encephalitis, Uruguay." Emerg Infect Dis **17**(5): 952-954.
- Deng, L., C. Wang, et al. (2000). "Activation of the I $\kappa$ B kinase complex by TRAF6 requires a dimeric ubiquitin-conjugating enzyme complex and a unique polyubiquitin chain." Cell **103**(2): 351-361.
- Der, S. D., Y. L. Yang, et al. (1997). "A double-stranded RNA-activated protein kinase-dependent pathway mediating stress-induced apoptosis." Proc Natl Acad Sci U S A **94**(7): 3279-3283.
- Der, S. D., A. Zhou, et al. (1998). "Identification of genes differentially regulated by interferon alpha, beta, or gamma using oligonucleotide arrays." Proc Natl Acad Sci U S A **95**(26): 15623-15628.
- Deresiewicz, R. L., S. J. Thaler, et al. (1997). "Clinical and neuroradiographic manifestations of eastern equine encephalitis." N Engl J Med **336**(26): 1867-1874.
- Despres, P., J. W. Griffin, et al. (1995). "Effects of anti-E2 monoclonal antibody on sindbis virus replication in AT3 cells expressing bcl-2." J Virol **69**(11): 7006-7014.
- Deveraux, Q. L., N. Roy, et al. (1998). "IAPs block apoptotic events induced by caspase-8 and cytochrome c by direct inhibition of distinct caspases." EMBO J **17**(8): 2215-2223.
- Dhawan, S., A. Heredia, et al. (1995). "Interferon-gamma-induced downregulation of CD4 inhibits the entry of human immunodeficiency virus type-1 in primary monocytes." Pathobiology **63**(2): 93-99.
- Diallo, M., J. Thonnon, et al. (1999). "Vectors of Chikungunya virus in Senegal: current data and transmission cycles." Am J Trop Med Hyg **60**(2): 281-286.
- Diaz-Guerra, M., C. Rivas, et al. (1997). "Activation of the IFN-inducible enzyme RNase L causes apoptosis of animal cells." Virology **236**(2): 354-363.
- Diebold, S. S., T. Kaisho, et al. (2004). "Innate antiviral responses by means of TLR7-mediated recognition of single-stranded RNA." Science **303**(5663): 1529-1531.
- Ding, M. X. and M. J. Schlesinger (1989). "Evidence that Sindbis virus NSP2 is an autoprotease which processes the virus nonstructural polyprotein." Virology **171**(1): 280-284.
- Djeu, J. Y., J. A. Heinbaugh, et al. (1979). "Role of macrophages in the augmentation of mouse natural killer cell activity by poly I:C and interferon." J Immunol **122**(1): 182-188.
- Dobbelstein, M. and T. Shenk (1996). "Protection against apoptosis by the vaccinia virus SPI-2 (B13R) gene product." J Virol **70**(9): 6479-6485.
- Doherty, R. L. (1977). "Arthropod-borne viruses in Australia, 1973-1976." Aust J Exp Biol Med Sci **55**(2): 103-130.
- Donze, O., J. Dostie, et al. (1999). "Regulatable expression of the interferon-induced double-stranded RNA dependent protein kinase PKR induces apoptosis and fas receptor expression." Virology **256**(2): 322-329.
- Dubois, B., B. Vanbervliet, et al. (1997). "Dendritic cells enhance growth and differentiation of CD40-activated B lymphocytes." J Exp Med **185**(5): 941-951.
- Dubuisson, J. and C. M. Rice (1993). "Sindbis virus attachment: isolation and characterization of mutants with impaired binding to vertebrate cells." J Virol **67**(6): 3363-3374.
- Duckett, C. S., V. E. Nava, et al. (1996). "A conserved family of cellular genes related to the baculovirus iap gene and encoding apoptosis inhibitors." EMBO J **15**(11): 2685-2694.
- Dumoutier, L., D. Lejeune, et al. (2003). "Cloning of a new type II cytokine receptor activating signal transducer and activator of transcription (STAT)1, STAT2 and STAT3." Biochem J **370**(Pt 2): 391-396.
- Dupuis-Maguiraga, L., M. Noret, et al. (2012). "Chikungunya disease: infection-associated markers from the acute to the chronic phase of arbovirus-induced arthralgia." PLoS Negl Trop Dis **6**(3): e1446.
- Dupuis, S., E. Jouanguy, et al. (2003). "Impaired response to interferon-alpha/beta and lethal viral disease in human STAT1 deficiency." Nat Genet **33**(3): 388-391.

- Economopoulou, A., M. Dominguez, et al. (2009). "Atypical Chikungunya virus infections: clinical manifestations, mortality and risk factors for severe disease during the 2005-2006 outbreak on Reunion." *Epidemiol Infect* **137**(4): 534-541.
- Edelman, R., C. O. Tacket, et al. (2000). "Phase II safety and immunogenicity study of live chikungunya virus vaccine TSI-GSD-218." *Am J Trop Med Hyg* **62**(6): 681-685.
- Eisenacher, K., C. Steinberg, et al. (2007). "The role of viral nucleic acid recognition in dendritic cells for innate and adaptive antiviral immunity." *Immunobiology* **212**(9-10): 701-714.
- Elliot, M. J., R. N. Maini, et al. (2008). "Treatment of rheumatoid arthritis with chimeric monoclonal antibodies to tumor necrosis factor alpha." *Arthritis Rheum* **58**(2 Suppl): S92-S101.
- Elliott, M. J., R. N. Maini, et al. (1993). "Treatment of rheumatoid arthritis with chimeric monoclonal antibodies to tumor necrosis factor alpha." *Arthritis Rheum* **36**(12): 1681-1690.
- Elomaa, O., M. Kangas, et al. (1995). "Cloning of a novel bacteria-binding receptor structurally related to scavenger receptors and expressed in a subset of macrophages." *Cell* **80**(4): 603-609.
- Epstein, J., Q. Eichbaum, et al. (1996). "The collectins in innate immunity." *Curr Opin Immunol* **8**(1): 29-35.
- Ermann, J. and B. L. Bermas (2007). "The biology behind the new therapies for SLE." *Int J Clin Pract* **61**(12): 2113-2119.
- Erwig, L. P. and P. M. Henson (2007). "Immunological consequences of apoptotic cell phagocytosis." *Am J Pathol* **171**(1): 2-8.
- Essani, K., S. Chalasani, et al. (1994). "Multiple anti-cytokine activities secreted from tanapox virus-infected cells." *Microb Pathog* **17**(5): 347-353.
- Everett, H. and G. McFadden (1999). "Apoptosis: an innate immune response to virus infection." *Trends Microbiol* **7**(4): 160-165.
- Fadok, V. A., D. L. Bratton, et al. (1998). "Macrophages that have ingested apoptotic cells in vitro inhibit proinflammatory cytokine production through autocrine/paracrine mechanisms involving TGF-beta, PGE2, and PAF." *J Clin Invest* **101**(4): 890-898.
- Falk, L. A., M. M. Hogan, et al. (1988). "Bone marrow progenitors cultured in the presence of granulocyte-macrophage colony-stimulating factor versus macrophage colony-stimulating factor differentiate into macrophages with distinct tumoricidal capacities." *J Leukoc Biol* **43**(5): 471-476.
- Fata, C. L., S. G. Sawicki, et al. (2002). "Modification of Asn374 of nsP1 suppresses a Sindbis virus nsP4 minus-strand polymerase mutant." *J Virol* **76**(17): 8641-8649.
- Feemster, R. F. (1938). "Outbreak of Encephalitis in Man Due to the Eastern Virus of Equine Encephalomyelitis." *Am J Public Health Nations Health* **28**(12): 1403-1410.
- Fehniger, T. A., M. A. Cooper, et al. (2003). "CD56bright natural killer cells are present in human lymph nodes and are activated by T cell-derived IL-2: a potential new link between adaptive and innate immunity." *Blood* **101**(8): 3052-3057.
- Feinstein, E., A. Kimchi, et al. (1995). "The death domain: a module shared by proteins with diverse cellular functions." *Trends Biochem Sci* **20**(9): 342-344.
- Ferlazzo, G., D. Thomas, et al. (2004). "The abundant NK cells in human secondary lymphoid tissues require activation to express killer cell Ig-like receptors and become cytolytic." *J Immunol* **172**(3): 1455-1462.
- Fernandes-Alnemri, T., J. W. Yu, et al. (2009). "AIM2 activates the inflammasome and cell death in response to cytoplasmic DNA." *Nature* **458**(7237): 509-513.
- Field, A. K., A. A. Tytell, et al. (1967). "Inducers of interferon and host resistance. II. Multistranded synthetic polynucleotide complexes." *Proc Natl Acad Sci U S A* **58**(3): 1004-1010.
- Fish, E. N., S. Uddin, et al. (1999). "Activation of a CrkL-stat5 signaling complex by type I interferons." *J Biol Chem* **274**(2): 571-573.

- Fitzgerald, K. A., S. M. McWhirter, et al. (2003). "IKKepsilon and TBK1 are essential components of the IRF3 signaling pathway." *Nat Immunol* **4**(5): 491-496.
- Flexman, J. P., D. W. Smith, et al. (1998). "A comparison of the diseases caused by Ross River virus and Barmah Forest virus." *Med J Aust* **169**(3): 159-163.
- Floyd-Smith, G., E. Slattery, et al. (1981). "Interferon action: RNA cleavage pattern of a (2'-5')oligoadenylate--dependent endonuclease." *Science* **212**(4498): 1030-1032.
- Flynn, D. C., W. J. Meyer, et al. (1990). "A conformational change in Sindbis virus glycoproteins E1 and E2 is detected at the plasma membrane as a consequence of early virus-cell interaction." *J Virol* **64**(8): 3643-3653.
- Folkman, J. and M. Klagsbrun (1987). "Angiogenic factors." *Science* **235**(4787): 442-447.
- Fontenille, D. and J. C. Toto (2001). "Aedes (Stegomyia) albopictus (Skuse), a potential new Dengue vector in southern Cameroon." *Emerg Infect Dis* **7**(6): 1066-1067.
- Foy, E., K. Li, et al. (2005). "Control of antiviral defenses through hepatitis C virus disruption of retinoic acid-inducible gene-I signaling." *Proc Natl Acad Sci U S A* **102**(8): 2986-2991.
- Franchi, L., T. Eigenbrod, et al. (2009). "The inflammasome: a caspase-1-activation platform that regulates immune responses and disease pathogenesis." *Nat Immunol* **10**(3): 241-247.
- Franssila, R. and K. Hedman (2006). "Infection and musculoskeletal conditions: Viral causes of arthritis." *Best Pract Res Clin Rheumatol* **20**(6): 1139-1157.
- Fraser, I. P., H. Koziel, et al. (1998). "The serum mannose-binding protein and the macrophage mannose receptor are pattern recognition molecules that link innate and adaptive immunity." *Semin Immunol* **10**(5): 363-372.
- Fraser, J. R. (1986). "Epidemic polyarthritis and Ross River virus disease." *Clin Rheum Dis* **12**(2): 369-388.
- Fraser, J. R. and G. J. Becker (1984). "Mononuclear cell types in chronic synovial effusions of Ross River virus disease." *Aust N Z J Med* **14**(4): 505-506.
- Fraser, J. R., A. L. Cunningham, et al. (1981). "Cytology of synovial effusions in epidemic polyarthritis." *Aust N Z J Med* **11**(2): 168-173.
- Fraser, J. R., V. M. Ratnamohan, et al. (1983). "The exanthem of Ross River virus infection: histology, location of virus antigen and nature of inflammatory infiltrate." *J Clin Pathol* **36**(11): 1256-1263.
- Fredericksen, B. L. and M. Gale, Jr. (2006). "West Nile virus evades activation of interferon regulatory factor 3 through RIG-I-dependent and -independent pathways without antagonizing host defense signaling." *J Virol* **80**(6): 2913-2923.
- Friedman, C. S., M. A. O'Donnell, et al. (2008). "The tumour suppressor CYLD is a negative regulator of RIG-I-mediated antiviral response." *EMBO Rep* **9**(9): 930-936.
- Friedman, R. M. (1964). "Role of Interferon in Viral Interference." *Nature* **201**: 848-849.
- Friedman, R. M. and J. M. Ramseur (1979). "Mechanisms of persistent infections by cytopathic viruses in tissue culture. Brief review." *Arch Virol* **60**(2): 83-103.
- Frolov, I., R. Hardy, et al. (2001). "Cis-acting RNA elements at the 5' end of Sindbis virus genome RNA regulate minus- and plus-strand RNA synthesis." *RNA* **7**(11): 1638-1651.
- Frolova, E., R. Gorchakov, et al. (2006). "Formation of nsP3-specific protein complexes during Sindbis virus replication." *J Virol* **80**(8): 4122-4134.
- Fros, J. J., W. J. Liu, et al. (2010). "Chikungunya virus nonstructural protein 2 inhibits type I/II interferon-stimulated JAK-STAT signaling." *J Virol* **84**(20): 10877-10887.
- Froshauer, S., J. Kartenbeck, et al. (1988). "Alphavirus RNA replicase is located on the cytoplasmic surface of endosomes and lysosomes." *J Cell Biol* **107**(6 Pt 1): 2075-2086.
- Gacche, R. N. and A. M. Kaid (2012). "Epidemiology of viral hepatitis B and C infections in ibb city, yemen." *Hepat Mon* **12**(7): 460-462.

- Gack, M. U., Y. C. Shin, et al. (2007). "TRIM25 RING-finger E3 ubiquitin ligase is essential for RIG-I-mediated antiviral activity." *Nature* **446**(7138): 916-920.
- Gaedigk-Nitschko, K. and M. J. Schlesinger (1990). "The Sindbis virus 6K protein can be detected in virions and is acylated with fatty acids." *Virology* **175**(1): 274-281.
- Gale, M., Jr. and M. G. Katze (1998). "Molecular mechanisms of interferon resistance mediated by viral-directed inhibition of PKR, the interferon-induced protein kinase." *Pharmacol Ther* **78**(1): 29-46.
- Gale, M., Jr., B. Kwieciszewski, et al. (1999). "Antiapoptotic and oncogenic potentials of hepatitis C virus are linked to interferon resistance by viral repression of the PKR protein kinase." *J Virol* **73**(8): 6506-6516.
- Gale, M. J., Jr., M. J. Korth, et al. (1997). "Evidence that hepatitis C virus resistance to interferon is mediated through repression of the PKR protein kinase by the nonstructural 5A protein." *Virology* **230**(2): 217-227.
- Galluzzi, L., I. Vitale, et al. (2012). "Molecular definitions of cell death subroutines: recommendations of the Nomenclature Committee on Cell Death 2012." *Cell Death Differ* **19**(1): 107-120.
- Galy, A., M. Travis, et al. (1995). "Human T, B, natural killer, and dendritic cells arise from a common bone marrow progenitor cell subset." *Immunity* **3**(4): 459-473.
- Ganesan, K., A. Diwan, et al. (2008). "Chikungunya encephalomyeloradiculitis: report of 2 cases with neuroimaging and 1 case with autopsy findings." *AJNR Am J Neuroradiol* **29**(9): 1636-1637.
- Ganu, M. A. and A. S. Ganu (2011). "Post-chikungunya chronic arthritis--our experience with DMARDs over two year follow up." *J Assoc Physicians India* **59**: 83-86.
- Gao, B. (2010). "Natural killer group 2 member D, its ligands, and liver disease: good or bad?" *Hepatology* **51**(1): 8-11.
- Gao, B., S. Radaeva, et al. (2009). "Liver natural killer and natural killer T cells: immunobiology and emerging roles in liver diseases." *J Leukoc Biol* **86**(3): 513-528.
- Gao, J. L. and P. M. Murphy (1994). "Human cytomegalovirus open reading frame US28 encodes a functional beta chemokine receptor." *J Biol Chem* **269**(46): 28539-28542.
- Gardner, J., I. Anraku, et al. (2010). "Chikungunya virus arthritis in adult wild-type mice." *J Virol* **84**(16): 8021-8032.
- Garmashova, N., S. Atasheva, et al. (2007). "Analysis of Venezuelan equine encephalitis virus capsid protein function in the inhibition of cellular transcription." *J Virol* **81**(24): 13552-13565.
- Garmashova, N., R. Gorchakov, et al. (2007). "The Old World and New World alphaviruses use different virus-specific proteins for induction of transcriptional shutoff." *J Virol* **81**(5): 2472-2484.
- Garoff, H., A. M. Frischauf, et al. (1980). "Nucleotide sequence of cDNA coding for Semliki Forest virus membrane glycoproteins." *Nature* **288**(5788): 236-241.
- Geissmann, F., C. Auffray, et al. (2008). "Blood monocytes: distinct subsets, how they relate to dendritic cells, and their possible roles in the regulation of T-cell responses." *Immunol Cell Biol* **86**(5): 398-408.
- Gelev, V., H. Aktas, et al. (2006). "Mapping of the auto-inhibitory interactions of protein kinase R by nuclear magnetic resonance." *J Mol Biol* **364**(3): 352-363.
- George, C. X. and C. E. Samuel (1999). "Human RNA-specific adenosine deaminase ADAR1 transcripts possess alternative exon 1 structures that initiate from different promoters, one constitutively active and the other interferon inducible." *Proc Natl Acad Sci U S A* **96**(8): 4621-4626.
- Gerardin, P., G. Barau, et al. (2008). "Multidisciplinary prospective study of mother-to-child chikungunya virus infections on the island of La Reunion." *PLoS Med* **5**(3): e60.
- Gerardin, P., A. Fianu, et al. (2011). "Perceived morbidity and community burden after a Chikungunya outbreak: the TELECHIK survey, a population-based cohort study." *BMC Med* **9**: 5.

- Gerszten, R. E., E. A. Garcia-Zepeda, et al. (1999). "MCP-1 and IL-8 trigger firm adhesion of monocytes to vascular endothelium under flow conditions." *Nature* **398**(6729): 718-723.
- Gewurz, H. (1982). "Biology of C-reactive protein and the acute phase response." *Hosp Pract (Hosp Ed)* **17**(6): 67-81.
- Giannakopoulos, N. V., J. K. Luo, et al. (2005). "Proteomic identification of proteins conjugated to ISG15 in mouse and human cells." *Biochem Biophys Res Commun* **336**(2): 496-506.
- Gibbons, D. L., I. Erk, et al. (2003). "Visualization of the target-membrane-inserted fusion protein of Semliki Forest virus by combined electron microscopy and crystallography." *Cell* **114**(5): 573-583.
- Gidlund, M., A. Orn, et al. (1978). "Enhanced NK cell activity in mice injected with interferon and interferon inducers." *Nature* **273**(5665): 759-761.
- Gil, J., J. Alcami, et al. (1999). "Induction of apoptosis by double-stranded-RNA-dependent protein kinase (PKR) involves the alpha subunit of eukaryotic translation initiation factor 2 and NF-kappaB." *Mol Cell Biol* **19**(7): 4653-4663.
- Gil, J., M. A. Garcia, et al. (2004). "TRAF family proteins link PKR with NF-kappa B activation." *Mol Cell Biol* **24**(10): 4502-4512.
- Gilfoy, F. D. and P. W. Mason (2007). "West Nile virus-induced interferon production is mediated by the double-stranded RNA-dependent protein kinase PKR." *J Virol* **81**(20): 11148-11158.
- Gitlin, L., L. Benoit, et al. (2010). "Melanoma differentiation-associated gene 5 (MDA5) is involved in the innate immune response to Paramyxoviridae infection in vivo." *PLoS Pathog* **6**(1): e1000734.
- Goh, K. C., S. J. Haque, et al. (1999). "p38 MAP kinase is required for STAT1 serine phosphorylation and transcriptional activation induced by interferons." *EMBO J* **18**(20): 5601-5608.
- Goltsev, Y. V., A. V. Kovalenko, et al. (1997). "CASH, a novel caspase homologue with death effector domains." *J Biol Chem* **272**(32): 19641-19644.
- Gomez de Cedron, M., N. Ehsani, et al. (1999). "RNA helicase activity of Semliki Forest virus replicase protein NSP2." *FEBS Lett* **448**(1): 19-22.
- Gooding, L. R. (1992). "Virus proteins that counteract host immune defenses." *Cell* **71**(1): 5-7.
- Gorchakov, R., E. Frolova, et al. (2005). "Inhibition of transcription and translation in Sindbis virus-infected cells." *J Virol* **79**(15): 9397-9409.
- Gorchakov, R., E. Frolova, et al. (2008). "A new role for ns polyprotein cleavage in Sindbis virus replication." *J Virol* **82**(13): 6218-6231.
- Gordon, S. (1998). "The role of the macrophage in immune regulation." *Res Immunol* **149**(7-8): 685-688.
- Gordon, S. (2003). "Alternative activation of macrophages." *Nat Rev Immunol* **3**(1): 23-35.
- Gordon, S. C. and C. B. Lauter (1984). "Mumps arthritis: a review of the literature." *Rev Infect Dis* **6**(3): 338-344.
- Gougeon, M. L. (2003). "Apoptosis as an HIV strategy to escape immune attack." *Nat Rev Immunol* **3**(5): 392-404.
- Gould, E. A. and S. Higgs (2009). "Impact of climate change and other factors on emerging arbovirus diseases." *Trans R Soc Trop Med Hyg* **103**(2): 109-121.
- Graham, K. A., A. S. Lalani, et al. (1997). "The T1/35kDa family of poxvirus-secreted proteins bind chemokines and modulate leukocyte influx into virus-infected tissues." *Virology* **229**(1): 12-24.
- Grandvaux, N., M. J. Servant, et al. (2002). "Transcriptional profiling of interferon regulatory factor 3 target genes: direct involvement in the regulation of interferon-stimulated genes." *J Virol* **76**(11): 5532-5539.
- Grawunder, U., F. Melchers, et al. (1993). "Interferon-gamma arrests proliferation and causes apoptosis in stromal cell/interleukin-7-dependent normal murine pre-B cell lines and clones



- in vitro, but does not induce differentiation to surface immunoglobulin-positive B cells." Eur J Immunol **23**(2): 544-551.
- Grech, A. P., S. Gardam, et al. (2005). "Tumor necrosis factor receptor 2 (TNFR2) signaling is negatively regulated by a novel, carboxyl-terminal TNFR-associated factor 2 (TRAF2)-binding site." J Biol Chem **280**(36): 31572-31581.
- Griffin, D., B. Levine, et al. (1997). "The role of antibody in recovery from alphavirus encephalitis." Immunol Rev **159**: 155-161.
- Griffin, D. E. (2003). "Immune responses to RNA-virus infections of the CNS." Nat Rev Immunol **3**(6): 493-502.
- Griffin, D. E. and R. T. Johnson (1977). "Role of the immune response in recovery from Sindbis virus encephalitis in mice." J Immunol **118**(3): 1070-1075.
- Grivard, P., K. Le Roux, et al. (2007). "Molecular and serological diagnosis of Chikungunya virus infection." Pathol Biol (Paris) **55**(10): 490-494.
- Guenebeaud, C., D. Goldschneider, et al. (2010). "The dependence receptor UNC5H2/B triggers apoptosis via PP2A-mediated dephosphorylation of DAP kinase." Mol Cell **40**(6): 863-876.
- Guilherme, J. M., C. Gonella-Legall, et al. (1996). "Seroprevalence of five arboviruses in Zebu cattle in the Central African Republic." Trans R Soc Trop Med Hyg **90**(1): 31-33.
- Guillevin, L., A. Mahr, et al. (2005). "Hepatitis B virus-associated polyarteritis nodosa: clinical characteristics, outcome, and impact of treatment in 115 patients." Medicine (Baltimore) **84**(5): 313-322.
- Guo, B. and G. Cheng (2007). "Modulation of the interferon antiviral response by the TBK1/IKKi adaptor protein TANK." J Biol Chem **282**(16): 11817-11826.
- Gusella, G. L., T. Musso, et al. (1995). "Potential requirement of a functional double-stranded RNA-dependent protein kinase (PKR) for the tumoricidal activation of macrophages by lipopolysaccharide or IFN-alpha beta, but not IFN-gamma." J Immunol **154**(1): 345-354.
- Haas, H., S. Robin, et al. (2009). "[Chikungunya virus infections in children]." Arch Pediatr **16 Suppl 2**: S72-79.
- Habjan, M., I. Andersson, et al. (2008). "Processing of genome 5' termini as a strategy of negative-strand RNA viruses to avoid RIG-I-dependent interferon induction." PLoS One **3**(4): e2032.
- Hacker, H., H. Mischak, et al. (1999). "Cell type-specific activation of mitogen-activated protein kinases by CpG-DNA controls interleukin-12 release from antigen-presenting cells." EMBO J **18**(24): 6973-6982.
- Hacker, H., V. Redecke, et al. (2006). "Specificity in Toll-like receptor signalling through distinct effector functions of TRAF3 and TRAF6." Nature **439**(7073): 204-207.
- Hahn, Y. S., E. G. Strauss, et al. (1989). "Mapping of RNA- temperature-sensitive mutants of Sindbis virus: assignment of complementation groups A, B, and G to nonstructural proteins." J Virol **63**(7): 3142-3150.
- Hajjar, A. M., D. S. O'Mahony, et al. (2001). "Cutting edge: functional interactions between toll-like receptor (TLR) 2 and TLR1 or TLR6 in response to phenol-soluble modulin." J Immunol **166**(1): 15-19.
- Halstead, S. B., S. Nimmannitya, et al. (1969). "Dengue d chikungunya virus infection in man in Thailand, 1962-1964. II. Observations on disease in outpatients." Am J Trop Med Hyg **18**(6): 972-983.
- Halstead, S. B., J. E. Scanlon, et al. (1969). "Dengue and chikungunya virus infection in man in Thailand, 1962-1964. IV. Epidemiologic studies in the Bangkok metropolitan area." Am J Trop Med Hyg **18**(6): 997-1021.
- Halstead, S. B., S. Udomsakdi, et al. (1969). "Dengue and chikungunya virus infection in man in Thailand, 1962-1964. V. Epidemiologic observations outside Bangkok." Am J Trop Med Hyg **18**(6): 1022-1033.

- Halstead, S. B., S. Udomsakdi, et al. (1969). "Dengue chikungunya virus infection in man in Thailand, 1962-1964. 3. Clinical, epidemiologic, and virologic observations on disease in non-indigenous white persons." *Am J Trop Med Hyg* **18**(6): 984-996.
- Hammacher, A., U. Hellman, et al. (1988). "A major part of platelet-derived growth factor purified from human platelets is a heterodimer of one A and one B chain." *J Biol Chem* **263**(31): 16493-16498.
- Hammar, L., S. Markarian, et al. (2003). "Prefusion rearrangements resulting in fusion Peptide exposure in Semliki forest virus." *J Biol Chem* **278**(9): 7189-7198.
- Hammon, W. M. and G. E. Sather (1964). "Virological Findings in the 1960 Hemorrhagic Fever Epidemic (Dengue) in Thailand." *Am J Trop Med Hyg* **13**: 629-641.
- Han, D. K., P. M. Chaudhary, et al. (1997). "MRIT, a novel death-effector domain-containing protein, interacts with caspases and BclXL and initiates cell death." *Proc Natl Acad Sci U S A* **94**(21): 11333-11338.
- Hapuarachchi, H. A., K. B. Bandara, et al. (2008). "Laboratory confirmation of dengue and chikungunya co-infection." *Ceylon Med J* **53**(3): 104-105.
- Harcourt, B. H., A. Sanchez, et al. (1999). "Ebola virus selectively inhibits responses to interferons, but not to interleukin-1beta, in endothelial cells." *J Virol* **73**(4): 3491-3496.
- Hardarson, H. S., J. S. Baker, et al. (2007). "Toll-like receptor 3 is an essential component of the innate stress response in virus-induced cardiac injury." *Am J Physiol Heart Circ Physiol* **292**(1): H251-258.
- Hardwick, J. M. (1998). "Viral interference with apoptosis." *Semin Cell Dev Biol* **9**(3): 339-349.
- Hardy, R. W. (2006). "The role of the 3' terminus of the Sindbis virus genome in minus-strand initiation site selection." *Virology* **345**(2): 520-531.
- Hardy, W. R. and J. H. Strauss (1989). "Processing the nonstructural polyproteins of sindbis virus: nonstructural proteinase is in the C-terminal half of nsP2 and functions both in cis and in trans." *J Virol* **63**(11): 4653-4664.
- Hart, C. E., M. Bailey, et al. (1990). "Purification of PDGF-AB and PDGF-BB from human platelet extracts and identification of all three PDGF dimers in human platelets." *Biochemistry* **29**(1): 166-172.
- Hayashi, F., K. D. Smith, et al. (2001). "The innate immune response to bacterial flagellin is mediated by Toll-like receptor 5." *Nature* **410**(6832): 1099-1103.
- Haynes, L. M., D. D. Moore, et al. (2001). "Involvement of toll-like receptor 4 in innate immunity to respiratory syncytial virus." *J Virol* **75**(22): 10730-10737.
- Hazelton, R. A., C. Hughes, et al. (1985). "The inflammatory response in the synovium of a patient with Ross River arbovirus infection." *Aust N Z J Med* **15**(3): 336-339.
- Haziot, A., E. Ferrero, et al. (1996). "Resistance to endotoxin shock and reduced dissemination of gram-negative bacteria in CD14-deficient mice." *Immunity* **4**(4): 407-414.
- Hegde, R., S. M. Srinivasula, et al. (2002). "Identification of Omi/HtrA2 as a mitochondrial apoptotic serine protease that disrupts inhibitor of apoptosis protein-caspase interaction." *J Biol Chem* **277**(1): 432-438.
- Heil, F., P. Ahmad-Nejad, et al. (2003). "The Toll-like receptor 7 (TLR7)-specific stimulus loxoribine uncovers a strong relationship within the TLR7, 8 and 9 subfamily." *Eur J Immunol* **33**(11): 2987-2997.
- Heil, F., H. Hemmi, et al. (2004). "Species-specific recognition of single-stranded RNA via toll-like receptor 7 and 8." *Science* **303**(5663): 1526-1529.
- Heise, M. T., D. A. Simpson, et al. (2000). "Sindbis-group alphavirus replication in periosteum and endosteum of long bones in adult mice." *J Virol* **74**(19): 9294-9299.
- Heldin, C. H. and B. Westermark (1999). "Mechanism of action and in vivo role of platelet-derived growth factor." *Physiol Rev* **79**(4): 1283-1316.

- Heldin, C. H., B. Westermark, et al. (1979). "Platelet-derived growth factor: purification and partial characterization." Proc Natl Acad Sci U S A **76**(8): 3722-3726.
- Helenius, A., J. Kartenbeck, et al. (1980). "On the entry of Semliki forest virus into BHK-21 cells." J Cell Biol **84**(2): 404-420.
- Helenius, A., M. Marsh, et al. (1982). "Inhibition of Semliki forest virus penetration by lysosomotropic weak bases." J Gen Virol **58 Pt 1**: 47-61.
- Hemmi, H., O. Takeuchi, et al. (2000). "A Toll-like receptor recognizes bacterial DNA." Nature **408**(6813): 740-745.
- Hemmi, H., O. Takeuchi, et al. (2004). "The roles of two IkappaB kinase-related kinases in lipopolysaccharide and double stranded RNA signaling and viral infection." J Exp Med **199**(12): 1641-1650.
- Her, Z., Y. W. Kam, et al. (2009). "Chikungunya: a bending reality." Microbes Infect **11**(14-15): 1165-1176.
- Her, Z., B. Malleret, et al. (2010). "Active infection of human blood monocytes by Chikungunya virus triggers an innate immune response." J Immunol **184**(10): 5903-5913.
- Hermans, I. F., J. D. Silk, et al. (2003). "NKT cells enhance CD4+ and CD8+ T cell responses to soluble antigen in vivo through direct interaction with dendritic cells." J Immunol **171**(10): 5140-5147.
- Hinson, V. K. and W. R. Tyor (2001). "Update on viral encephalitis." Curr Opin Neurol **14**(3): 369-374.
- Hirschfeld, M., J. J. Weis, et al. (2001). "Signaling by toll-like receptor 2 and 4 agonists results in differential gene expression in murine macrophages." Infect Immun **69**(3): 1477-1482.
- Ho, K., L. W. Ang, et al. (2011). "Epidemiology and control of chikungunya fever in Singapore." J Infect **62**(4): 263-270.
- Hoarau, J. J., M. C. Jaffar Bandjee, et al. (2010). "Persistent chronic inflammation and infection by Chikungunya arthritogenic alphavirus in spite of a robust host immune response." J Immunol **184**(10): 5914-5927.
- Hochedez, P., S. Jaureguiberry, et al. (2006). "Chikungunya infection in travelers." Emerg Infect Dis **12**(10): 1565-1567.
- Hochrein, H., B. Schlatter, et al. (2004). "Herpes simplex virus type-1 induces IFN-alpha production via Toll-like receptor 9-dependent and -independent pathways." Proc Natl Acad Sci U S A **101**(31): 11416-11421.
- Hoebe, K., X. Du, et al. (2003). "Identification of Lps2 as a key transducer of MyD88-independent TIR signalling." Nature **424**(6950): 743-748.
- Hoebe, K., E. M. Janssen, et al. (2003). "Upregulation of costimulatory molecules induced by lipopolysaccharide and double-stranded RNA occurs by Trif-dependent and Trif-independent pathways." Nat Immunol **4**(12): 1223-1229.
- Hoenen, A., W. Liu, et al. (2007). "West Nile virus-induced cytoplasmic membrane structures provide partial protection against the interferon-induced antiviral MxA protein." J Gen Virol **88**(Pt 11): 3013-3017.
- Hokeness-Antonelli, K. L., M. J. Crane, et al. (2007). "IFN- $\alpha$ -mediated inflammatory responses and antiviral defense in liver is TLR9-independent but MyD88-dependent during murine cytomegalovirus infection." J Immunol **179**(9): 6176-6183.
- Holmskov, U. L. (2000). "Collectins and collectin receptors in innate immunity." APMIS Suppl **100**: 1-59.
- Honda, K., S. Sakaguchi, et al. (2003). "Selective contribution of IFN- $\alpha$ /beta signaling to the maturation of dendritic cells induced by double-stranded RNA or viral infection." Proc Natl Acad Sci U S A **100**(19): 10872-10877.

- Honda, K., H. Yanai, et al. (2004). "Role of a transductional-transcriptional processor complex involving MyD88 and IRF-7 in Toll-like receptor signaling." Proc Natl Acad Sci U S A **101**(43): 15416-15421.
- Honda, K., H. Yanai, et al. (2005). "IRF-7 is the master regulator of type-I interferon-dependent immune responses." Nature **434**(7034): 772-777.
- Hornung, V., A. Ablasser, et al. (2009). "AIM2 recognizes cytosolic dsDNA and forms a caspase-1-activating inflammasome with ASC." Nature **458**(7237): 514-518.
- Hornung, V., J. Ellegast, et al. (2006). "5'-Triphosphate RNA is the ligand for RIG-I." Science **314**(5801): 994-997.
- Horwood, N. J., J. Elliott, et al. (1998). "Osteotropic agents regulate the expression of osteoclast differentiation factor and osteoprotegerin in osteoblastic stromal cells." Endocrinology **139**(11): 4743-4746.
- Hoshino, K., T. Kaisho, et al. (2002). "Differential involvement of IFN-beta in Toll-like receptor-stimulated dendritic cell activation." Int Immunol **14**(10): 1225-1231.
- Hoshino, K., O. Takeuchi, et al. (1999). "Cutting edge: Toll-like receptor 4 (TLR4)-deficient mice are hyporesponsive to lipopolysaccharide: evidence for TLR4 as the Lps gene product." J Immunol **162**(7): 3749-3752.
- Hovanessian, A. G. and J. Justesen (2007). "The human 2'-5'oligoadenylate synthetase family: unique interferon-inducible enzymes catalyzing 2'-5' instead of 3'-5' phosphodiester bond formation." Biochimie **89**(6-7): 779-788.
- Howitt, B. (1938). "Recovery of the Virus of Equine Encephalomyelitis from the Brain of a Child." Science **88**(2289): 455-456.
- Huang, C. C., C. C. Liu, et al. (1999). "Neurologic complications in children with enterovirus 71 infection." N Engl J Med **341**(13): 936-942.
- Huang, J., T. Liu, et al. (2005). "SIKE is an IKK epsilon/TBK1-associated suppressor of TLR3- and virus-triggered IRF-3 activation pathways." EMBO J **24**(23): 4018-4028.
- Huang, S., W. Hendriks, et al. (1993). "Immune response in mice that lack the interferon-gamma receptor." Science **259**(5102): 1742-1745.
- Hurst, N. P., A. G. Martynoga, et al. (1983). "Coxsackie B infection and arthritis." Br Med J (Clin Res Ed) **286**(6365): 605.
- Ichijo, H., E. Nishida, et al. (1997). "Induction of apoptosis by ASK1, a mammalian MAPKKK that activates SAPK/JNK and p38 signaling pathways." Science **275**(5296): 90-94.
- Imai, Y., K. Kuba, et al. (2008). "Identification of oxidative stress and Toll-like receptor 4 signaling as a key pathway of acute lung injury." Cell **133**(2): 235-249.
- Imhof, B. A. and M. Aurrand-Lions (2004). "Adhesion mechanisms regulating the migration of monocytes." Nat Rev Immunol **4**(6): 432-444.
- Inbal, B., O. Cohen, et al. (1997). "DAP kinase links the control of apoptosis to metastasis." Nature **390**(6656): 180-184.
- Ingulli, E., A. Mondino, et al. (1997). "In vivo detection of dendritic cell antigen presentation to CD4(+) T cells." J Exp Med **185**(12): 2133-2141.
- Inohara, N., T. Koseki, et al. (1997). "CLARP, a death effector domain-containing protein interacts with caspase-8 and regulates apoptosis." Proc Natl Acad Sci U S A **94**(20): 10717-10722.
- Irmmler, M., M. Thome, et al. (1997). "Inhibition of death receptor signals by cellular FLIP." Nature **388**(6638): 190-195.
- Isaacs, A. and J. Lindenmann (1957). "Virus interference. I. The interferon." Proc R Soc Lond B Biol Sci **147**(927): 258-267.
- Ishikawa, H. and G. N. Barber (2008). "STING is an endoplasmic reticulum adaptor that facilitates innate immune signalling." Nature **455**(7213): 674-678.

- Ishitani, T., G. Takaesu, et al. (2003). "Role of the TAB2-related protein TAB3 in IL-1 and TNF signaling." *EMBO J* **22**(23): 6277-6288.
- Iwakura, Y., M. Tosu, et al. (1991). "Induction of inflammatory arthropathy resembling rheumatoid arthritis in mice transgenic for HTLV-I." *Science* **253**(5023): 1026-1028.
- Iwasaki, A. (2012). "A virological view of innate immune recognition." *Annu Rev Microbiol* **66**: 177-196.
- Iwasaki, A. and R. Medzhitov (2004). "Toll-like receptor control of the adaptive immune responses." *Nat Immunol* **5**(10): 987-995.
- Jackson, A. C., T. R. Moench, et al. (1987). "The pathogenesis of spinal cord involvement in the encephalomyelitis of mice caused by neuroadapted Sindbis virus infection." *Lab Invest* **56**(4): 418-423.
- Jackson, A. C., T. R. Moench, et al. (1988). "Basis of neurovirulence in Sindbis virus encephalomyelitis of mice." *Lab Invest* **58**(5): 503-509.
- Jacobs, R., G. Hintzen, et al. (2001). "CD56bright cells differ in their KIR repertoire and cytotoxic features from CD56dim NK cells." *Eur J Immunol* **31**(10): 3121-3127.
- Jadhav, M., M. Namboodripad, et al. (1965). "Chikungunya disease in infants and children in Vellore: a report of clinical and haematological features of virologically proved cases." *Indian J Med Res* **53**(8): 764-776.
- Jaffar-Bandjee, M. C., T. Das, et al. (2009). "Chikungunya virus takes centre stage in virally induced arthritis: possible cellular and molecular mechanisms to pathogenesis." *Microbes Infect* **11**(14-15): 1206-1218.
- Jha, B. K., I. Polyakova, et al. (2011). "Inhibition of RNase L and RNA-dependent protein kinase (PKR) by sunitinib impairs antiviral innate immunity." *J Biol Chem* **286**(30): 26319-26326.
- Jiang, Y., J. D. Woronicz, et al. (1999). "Prevention of constitutive TNF receptor 1 signaling by silencer of death domains." *Science* **283**(5401): 543-546.
- Jiang, Z., M. Zamanian-Daryoush, et al. (2003). "Poly(I-C)-induced Toll-like receptor 3 (TLR3)-mediated activation of NFkappa B and MAP kinase is through an interleukin-1 receptor-associated kinase (IRAK)-independent pathway employing the signaling components TLR3-TRAF6-TAK1-TAB2-PKR." *J Biol Chem* **278**(19): 16713-16719.
- Jin, H. K., A. Takada, et al. (1999). "Identification of the murine Mx2 gene: interferon-induced expression of the Mx2 protein from the feral mouse gene confers resistance to vesicular stomatitis virus." *J Virol* **73**(6): 4925-4930.
- Jin, M. S. and J. O. Lee (2008). "Structures of the toll-like receptor family and its ligand complexes." *Immunity* **29**(2): 182-191.
- Johnson, R. T. (1965). "Virus Invasion of the Central Nervous System: A Study of Sindbis Virus Infection in the Mouse Using Fluorescent Antibody." *Am J Pathol* **46**: 929-943.
- Joly, E., L. Mucke, et al. (1991). "Viral persistence in neurons explained by lack of major histocompatibility class I expression." *Science* **253**(5025): 1283-1285.
- Joly, E. and M. B. Oldstone (1992). "Neuronal cells are deficient in loading peptides onto MHC class I molecules." *Neuron* **8**(6): 1185-1190.
- Jones, M., A. Davidson, et al. (2005). "Dengue virus inhibits alpha interferon signaling by reducing STAT2 expression." *J Virol* **79**(9): 5414-5420.
- Jose, J., J. E. Snyder, et al. (2009). "A structural and functional perspective of alphavirus replication and assembly." *Future Microbiol* **4**(7): 837-856.
- Jouanguy, E., S. Y. Zhang, et al. (2007). "Human primary immunodeficiencies of type I interferons." *Biochimie* **89**(6-7): 878-883.
- Joubert, P. E., S. Werneke, et al. (2012). "Chikungunya-induced cell death is limited by ER and oxidative stress-induced autophagy." *Autophagy* **8**(8): 1261-1263.

- Joubert, P. E., S. W. Werneke, et al. (2012). "Chikungunya virus-induced autophagy delays caspase-dependent cell death." *J Exp Med* **209**(5): 1029-1047.
- Jounai, N., F. Takeshita, et al. (2007). "The Atg5 Atg12 conjugate associates with innate antiviral immune responses." *Proc Natl Acad Sci U S A* **104**(35): 14050-14055.
- Joza, N., S. A. Susin, et al. (2001). "Essential role of the mitochondrial apoptosis-inducing factor in programmed cell death." *Nature* **410**(6828): 549-554.
- Julander, J. G., R. A. Bowen, et al. (2008). "Treatment of Venezuelan equine encephalitis virus infection with (-)-carbodine." *Antiviral Res* **80**(3): 309-315.
- Jupp, P. G., B. M. McIntosh, et al. (1981). "Laboratory vector studies on six mosquito and one tick species with chikungunya virus." *Trans R Soc Trop Med Hyg* **75**(1): 15-19.
- Jurk, M., A. Kritzler, et al. (2006). "Modulating responsiveness of human TLR7 and 8 to small molecule ligands with T-rich phosphorothiate oligodeoxynucleotides." *Eur J Immunol* **36**(7): 1815-1826.
- Kabra, N. H., C. Kang, et al. (2001). "T cell-specific FADD-deficient mice: FADD is required for early T cell development." *Proc Natl Acad Sci U S A* **98**(11): 6307-6312.
- Kalali, B. N., G. Kollisch, et al. (2008). "Double-stranded RNA induces an antiviral defense status in epidermal keratinocytes through TLR3-, PKR-, and MDA5/RIG-I-mediated differential signaling." *J Immunol* **181**(4): 2694-2704.
- Kang, D. C., R. V. Gopalkrishnan, et al. (2004). "Expression analysis and genomic characterization of human melanoma differentiation associated gene-5, mda-5: a novel type I interferon-responsive apoptosis-inducing gene." *Oncogene* **23**(9): 1789-1800.
- Kang, D. C., R. V. Gopalkrishnan, et al. (2002). "mda-5: An interferon-inducible putative RNA helicase with double-stranded RNA-dependent ATPase activity and melanoma growth-suppressive properties." *Proc Natl Acad Sci U S A* **99**(2): 637-642.
- Kanno, H., J. B. Wolfinger, et al. (1993). "Aleutian mink disease parvovirus infection of mink macrophages and human macrophage cell line U937: demonstration of antibody-dependent enhancement of infection." *J Virol* **67**(12): 7017-7024.
- Karin, M. and Y. Ben-Neriah (2000). "Phosphorylation meets ubiquitination: the control of NF- $\kappa$ B activity." *Annu Rev Immunol* **18**: 621-663.
- Kato, H., S. Sato, et al. (2005). "Cell type-specific involvement of RIG-I in antiviral response." *Immunity* **23**(1): 19-28.
- Kato, H., O. Takeuchi, et al. (2008). "Length-dependent recognition of double-stranded ribonucleic acids by retinoic acid-inducible gene-I and melanoma differentiation-associated gene 5." *J Exp Med* **205**(7): 1601-1610.
- Kato, H., O. Takeuchi, et al. (2006). "Differential roles of MDA5 and RIG-I helicases in the recognition of RNA viruses." *Nature* **441**(7089): 101-105.
- Kato, T., H. Asahara, et al. (2004). "HTLV-I env protein acts as a major antigen in patients with HTLV-I-associated arthropathy." *Clin Rheumatol* **23**(5): 400-409.
- Kaur, P., M. Ponniah, et al. (2008). "Chikungunya outbreak, South India, 2006." *Emerg Infect Dis* **14**(10): 1623-1625.
- Kawai, T. and S. Akira (2006). "Innate immune recognition of viral infection." *Nat Immunol* **7**(2): 131-137.
- Kawai, T. and S. Akira (2008). "Toll-like receptor and RIG-I-like receptor signaling." *Ann N Y Acad Sci* **1143**: 1-20.
- Kawai, T. and S. Akira (2010). "The role of pattern-recognition receptors in innate immunity: update on Toll-like receptors." *Nat Immunol* **11**(5): 373-384.
- Kawai, T., S. Sato, et al. (2004). "Interferon-alpha induction through Toll-like receptors involves a direct interaction of IRF7 with MyD88 and TRAF6." *Nat Immunol* **5**(10): 1061-1068.
- Kawai, T., K. Takahashi, et al. (2005). "IPS-1, an adaptor triggering RIG-I- and Mda5-mediated type I interferon induction." *Nat Immunol* **6**(10): 981-988.

- Kayagaki, N., Q. Phung, et al. (2007). "DUBA: a deubiquitinase that regulates type I interferon production." *Science* **318**(5856): 1628-1632.
- Kerr, I. M., R. E. Brown, et al. (1977). "Nature of inhibitor of cell-free protein synthesis formed in response to interferon and double-stranded RNA." *Nature* **268**(5620): 540-542.
- Kerr, J. R., V. S. Cunniffe, et al. (2004). "Circulating cytokines and chemokines in acute symptomatic parvovirus B19 infection: negative association between levels of pro-inflammatory cytokines and development of B19-associated arthritis." *J Med Virol* **74**(1): 147-155.
- Kerur, N., M. V. Veetil, et al. (2011). "IFI16 acts as a nuclear pathogen sensor to induce the inflammasome in response to Kaposi Sarcoma-associated herpesvirus infection." *Cell Host Microbe* **9**(5): 363-375.
- Kiefer, K., M. A. Oropallo, et al. (2012). "Role of type I interferons in the activation of autoreactive B cells." *Immunol Cell Biol* **90**(5): 498-504.
- Kielian, M. (1995). "Membrane fusion and the alphavirus life cycle." *Adv Virus Res* **45**: 113-151.
- Kim, B., S. D. Kaistha, et al. (2006). "Viruses and autoimmunity." *Autoimmunity* **39**(1): 71-77.
- Kim, M. J., S. Y. Hwang, et al. (2008). "Negative feedback regulation of RIG-I-mediated antiviral signaling by interferon-induced ISG15 conjugation." *J Virol* **82**(3): 1474-1483.
- Kim, T., S. Pazhoor, et al. (2010). "Aspartate-glutamate-alanine-histidine box motif (DEAH)/RNA helicase A helicases sense microbial DNA in human plasmacytoid dendritic cells." *Proc Natl Acad Sci U S A* **107**(34): 15181-15186.
- Kim, Y. M., M. M. Brinkmann, et al. (2008). "UNC93B1 delivers nucleotide-sensing toll-like receptors to endolysosomes." *Nature* **452**(7184): 234-238.
- Kissil, J. L., L. P. Deiss, et al. (1995). "Isolation of DAP3, a novel mediator of interferon-gamma-induced cell death." *J Biol Chem* **270**(46): 27932-27936.
- Kissil, J. L., E. Feinstein, et al. (1997). "DAP-kinase loss of expression in various carcinoma and B-cell lymphoma cell lines: possible implications for role as tumor suppressor gene." *Oncogene* **15**(4): 403-407.
- Kit, L. S. (2002). "Emerging and re-emerging diseases in Malaysia." *Asia Pac J Public Health* **14**(1): 6-8.
- Kiwanuka, N., E. J. Sanders, et al. (1999). "O'nyong-nyong fever in south-central Uganda, 1996-1997: clinical features and validation of a clinical case definition for surveillance purposes." *Clin Infect Dis* **29**(5): 1243-1250.
- Kobayashi, M., M. N. Kweon, et al. (2003). "Toll-like receptor-dependent production of IL-12p40 causes chronic enterocolitis in myeloid cell-specific Stat3-deficient mice." *J Clin Invest* **111**(9): 1297-1308.
- Kochs, G. and O. Haller (1999). "GTP-bound human MxA protein interacts with the nucleocapsids of Thogoto virus (Orthomyxoviridae)." *J Biol Chem* **274**(7): 4370-4376.
- Komar, N. and A. Spielman (1994). "Emergence of eastern encephalitis in Massachusetts." *Ann N Y Acad Sci* **740**: 157-168.
- Komuro, A. and C. M. Horvath (2006). "RNA- and virus-independent inhibition of antiviral signaling by RNA helicase LGP2." *J Virol* **80**(24): 12332-12342.
- Krejbich-Trotot, P., M. Denizot, et al. (2011). "Chikungunya virus mobilizes the apoptotic machinery to invade host cell defenses." *FASEB J* **25**(1): 314-325.
- Krejbich-Trotot, P., B. Gay, et al. (2011). "Chikungunya triggers an autophagic process which promotes viral replication." *Virology* **432**: 432.
- Krieg, A. M. (2000). "The role of CpG motifs in innate immunity." *Curr Opin Immunol* **12**(1): 35-43.
- Krieg, A. M. (2002). "CpG motifs in bacterial DNA and their immune effects." *Annu Rev Immunol* **20**: 709-760.
- Kroemer, G., L. Galluzzi, et al. (2007). "Mitochondrial membrane permeabilization in cell death." *Physiol Rev* **87**(1): 99-163.

- Krueger, A. and R. M. Hagen (2007). "Short communication: first record of *Aedes albopictus* in Gabon, Central Africa." Trop Med Int Health **12**(9): 1105-1107.
- Krug, A., A. R. French, et al. (2004). "TLR9-dependent recognition of MCMV by IPC and DC generates coordinated cytokine responses that activate antiviral NK cell function." Immunity **21**(1): 107-119.
- Krug, A., G. D. Luker, et al. (2004). "Herpes simplex virus type 1 activates murine natural interferon-producing cells through toll-like receptor 9." Blood **103**(4): 1433-1437.
- Krug, R. M., M. Shaw, et al. (1985). "Inhibition of influenza viral mRNA synthesis in cells expressing the interferon-induced Mx gene product." J Virol **56**(1): 201-206.
- Kubes, V. and F. A. Rios (1939). "The Causative Agent of Infectious Equine Encephalomyelitis in Venezuela." Science **90**(2323): 20-21.
- Kuhn, R. J., Z. Hong, et al. (1990). "Mutagenesis of the 3' nontranslated region of Sindbis virus RNA." J Virol **64**(4): 1465-1476.
- Kujala, P., A. Ikaheimonen, et al. (2001). "Biogenesis of the Semliki Forest virus RNA replication complex." J Virol **75**(8): 3873-3884.
- Kumar, K., M. Chhabra, et al. (2008). "Investigation of an outbreak of chikungunya in Malegaon Municipal areas of Nasik district, Maharashtra (India) and its control." J Vector Borne Dis **45**(2): 157-163.
- Kumar, N. P., R. Joseph, et al. (2008). "A226V mutation in virus during the 2007 chikungunya outbreak in Kerala, India." J Gen Virol **89**(Pt 8): 1945-1948.
- Kumar, R., A. Mathur, et al. (1990). "Clinical features & prognostic indicators of Japanese encephalitis in children in Lucknow (India)." Indian J Med Res **91**: 321-327.
- Kumar, S., M. C. Jaffar-Bandjee, et al. (2012). "Mouse macrophage innate immune response to chikungunya virus infection." Virology **9**(1): 313.
- Kurkela, S., T. Helve, et al. (2008). "Arthritis and arthralgia three years after Sindbis virus infection: clinical follow-up of a cohort of 49 patients." Scand J Infect Dis **40**(2): 167-173.
- Kurkela, S., T. Manni, et al. (2005). "Clinical and laboratory manifestations of Sindbis virus infection: prospective study, Finland, 2002-2003." J Infect Dis **191**(11): 1820-1829.
- Kurt-Jones, E. A., M. Chan, et al. (2004). "Herpes simplex virus 1 interaction with Toll-like receptor 2 contributes to lethal encephalitis." Proc Natl Acad Sci U S A **101**(5): 1315-1320.
- Kurt-Jones, E. A., L. Popova, et al. (2000). "Pattern recognition receptors TLR4 and CD14 mediate response to respiratory syncytial virus." Nat Immunol **1**(5): 398-401.
- Kusari, J. and G. C. Sen (1987). "Transcriptional analyses of interferon-inducible mRNAs." Mol Cell Biol **7**(1): 528-531.
- La Rocca, S. A., R. J. Herbert, et al. (2005). "Loss of interferon regulatory factor 3 in cells infected with classical swine fever virus involves the N-terminal protease, Npro." J Virol **79**(11): 7239-7247.
- Laakkonen, P., M. Hyvonen, et al. (1994). "Expression of Semliki Forest virus nsP1-specific methyltransferase in insect cells and in *Escherichia coli*." J Virol **68**(11): 7418-7425.
- Labadie, K., T. Larcher, et al. (2010). "Chikungunya disease in nonhuman primates involves long-term viral persistence in macrophages." J Clin Invest **120**(3): 894-906.
- Lacey, D. L., E. Timms, et al. (1998). "Osteoprotegerin ligand is a cytokine that regulates osteoclast differentiation and activation." Cell **93**(2): 165-176.
- Lagasse, E., H. Connors, et al. (2000). "Purified hematopoietic stem cells can differentiate into hepatocytes in vivo." Nat Med **6**(11): 1229-1234.
- Lahariya, C. and S. K. Pradhan (2006). "Emergence of chikungunya virus in Indian subcontinent after 32 years: A review." J Vector Borne Dis **43**(4): 151-160.
- Laine, M., R. Luukkainen, et al. (2000). "Prolonged arthritis associated with sindbis-related (Pogosta) virus infection." Rheumatology (Oxford) **39**(11): 1272-1274.



- Laine, M., R. Luukkainen, et al. (2004). "Sindbis viruses and other alphaviruses as cause of human arthritic disease." *J Intern Med* **256**(6): 457-471.
- Lakshmi, V., M. Neeraja, et al. (2008). "Clinical features and molecular diagnosis of Chikungunya fever from South India." *Clin Infect Dis* **46**(9): 1436-1442.
- Lalani, A. S., K. Graham, et al. (1997). "The purified myxoma virus gamma interferon receptor homolog M-T7 interacts with the heparin-binding domains of chemokines." *J Virol* **71**(6): 4356-4363.
- Lam, S. K., K. B. Chua, et al. (2001). "Chikungunya infection--an emerging disease in Malaysia." *Southeast Asian J Trop Med Public Health* **32**(3): 447-451.
- Lanciotti, R. S., O. L. Kosoy, et al. (2007). "Chikungunya virus in US travelers returning from India, 2006." *Emerg Infect Dis* **13**(5): 764-767.
- Lanier, L. L. (1998). "NK cell receptors." *Annu Rev Immunol* **16**: 359-393.
- Lanier, L. L. (2001). "On guard--activating NK cell receptors." *Nat Immunol* **2**(1): 23-27.
- Laras, K., N. C. Sukri, et al. (2005). "Tracking the re-emergence of epidemic chikungunya virus in Indonesia." *Trans R Soc Trop Med Hyg* **99**(2): 128-141.
- Larrieu, S., N. Poudroux, et al. (2010). "Factors associated with persistence of arthralgia among Chikungunya virus-infected travellers: report of 42 French cases." *J Clin Virol* **47**(1): 85-88.
- Lastarza, M. W., A. Grakoui, et al. (1994). "Deletion and duplication mutations in the C-terminal nonconserved region of Sindbis virus nsP3: effects on phosphorylation and on virus replication in vertebrate and invertebrate cells." *Virology* **202**(1): 224-232.
- Latz, E., A. Schoenemeyer, et al. (2004). "TLR9 signals after translocating from the ER to CpG DNA in the lysosome." *Nat Immunol* **5**(2): 190-198.
- Laurent, P., K. Le Roux, et al. (2007). "Development of a sensitive real-time reverse transcriptase PCR assay with an internal control to detect and quantify chikungunya virus." *Clin Chem* **53**(8): 1408-1414.
- Lavrik, I., A. Golks, et al. (2005). "Death receptor signaling." *J Cell Sci* **118**(Pt 2): 265-267.
- Le Goffic, R., V. Balloy, et al. (2006). "Detrimental contribution of the Toll-like receptor (TLR)3 to influenza A virus-induced acute pneumonia." *PLoS Pathog* **2**(6): e53.
- Lechner, F., H. R. Vogt, et al. (1997). "Expression of cytokine mRNA in lentivirus-induced arthritis." *Am J Pathol* **151**(4): 1053-1065.
- Lee, A., M. K. Whyte, et al. (1993). "Inhibition of apoptosis and prolongation of neutrophil functional longevity by inflammatory mediators." *J Leukoc Biol* **54**(4): 283-288.
- Lee, C. K., R. Gimeno, et al. (1999). "Differential regulation of constitutive major histocompatibility complex class I expression in T and B lymphocytes." *J Exp Med* **190**(10): 1451-1464.
- Lee, H. K., J. M. Lund, et al. (2007). "Autophagy-dependent viral recognition by plasmacytoid dendritic cells." *Science* **315**(5817): 1398-1401.
- Lee, J., T. H. Chuang, et al. (2003). "Molecular basis for the immunostimulatory activity of guanine nucleoside analogs: activation of Toll-like receptor 7." *Proc Natl Acad Sci U S A* **100**(11): 6646-6651.
- Lee, S. H., T. Miyagi, et al. (2007). "Keeping NK cells in highly regulated antiviral warfare." *Trends Immunol* **28**(6): 252-259.
- Lehky, T. J., E. P. Cowan, et al. (1994). "Induction of HLA class I and class II expression in human T-lymphotropic virus type I-infected neuroblastoma cells." *J Virol* **68**(3): 1854-1863.
- Lemaitre, B., E. Nicolas, et al. (1996). "The dorsoventral regulatory gene cassette spatzle/Toll/cactus controls the potent antifungal response in *Drosophila* adults." *Cell* **86**(6): 973-983.
- Lemant, J., V. Boisson, et al. (2008). "Serious acute chikungunya virus infection requiring intensive care during the Reunion Island outbreak in 2005-2006." *Crit Care Med* **36**(9): 2536-2541.
- Lemm, J. A., A. Bergqvist, et al. (1998). "Template-dependent initiation of Sindbis virus RNA replication in vitro." *J Virol* **72**(8): 6546-6553.

- Lenschow, D. J., N. V. Giannakopoulos, et al. (2005). "Identification of interferon-stimulated gene 15 as an antiviral molecule during Sindbis virus infection in vivo." *J Virol* **79**(22): 13974-13983.
- Leo, Y. S., A. L. Chow, et al. (2009). "Chikungunya outbreak, Singapore, 2008." *Emerg Infect Dis* **15**(5): 836-837.
- Leonard, G. T. and G. C. Sen (1996). "Effects of adenovirus E1A protein on interferon-signaling." *Virology* **224**(1): 25-33.
- Leonard, G. T. and G. C. Sen (1997). "Restoration of interferon responses of adenovirus E1A-expressing HT1080 cell lines by overexpression of p48 protein." *J Virol* **71**(7): 5095-5101.
- Lescar, J., A. Roussel, et al. (2001). "The Fusion glycoprotein shell of Semliki Forest virus: an icosahedral assembly primed for fusogenic activation at endosomal pH." *Cell* **105**(1): 137-148.
- Leung, D. W., G. Cachianes, et al. (1989). "Vascular endothelial growth factor is a secreted angiogenic mitogen." *Science* **246**(4935): 1306-1309.
- Leung, S., S. A. Qureshi, et al. (1995). "Role of STAT2 in the alpha interferon signaling pathway." *Mol Cell Biol* **15**(3): 1312-1317.
- Levy, P. F. and M. Viljoen (1995). "Lactoferrin: a general review." *Haematologica* **80**(3): 252-267.
- Levine, B., J. E. Goldman, et al. (1996). "Bc1-2 protects mice against fatal alphavirus encephalitis." *Proc Natl Acad Sci U S A* **93**(10): 4810-4815.
- Levine, B., J. M. Hardwick, et al. (1994). "Persistence of alphaviruses in vertebrate hosts." *Trends Microbiol* **2**(1): 25-28.
- Levrud, J. P., P. Boudinot, et al. (2007). "Identification of the zebrafish IFN receptor: implications for the origin of the vertebrate IFN system." *J Immunol* **178**(7): 4385-4394.
- Levy-Strumpf, N., L. P. Deiss, et al. (1997). "DAP-5, a novel homolog of eukaryotic translation initiation factor 4G isolated as a putative modulator of gamma interferon-induced programmed cell death." *Mol Cell Biol* **17**(3): 1615-1625.
- Levy, O. (2004). "Antimicrobial proteins and peptides: anti-infective molecules of mammalian leukocytes." *J Leukoc Biol* **76**(5): 909-925.
- Lewthwaite, P., R. Vasanthapuram, et al. (2009). "Chikungunya virus and central nervous system infections in children, India." *Emerg Infect Dis* **15**(2): 329-331.
- Leysen, P., J. Balzarini, et al. (2005). "The predominant mechanism by which ribavirin exerts its antiviral activity in vitro against flaviviruses and paramyxoviruses is mediated by inhibition of IMP dehydrogenase." *J Virol* **79**(3): 1943-1947.
- Leysen, P., E. De Clercq, et al. (2006). "The anti-yellow fever virus activity of ribavirin is independent of error-prone replication." *Mol Pharmacol* **69**(4): 1461-1467.
- Li, G. and C. M. Rice (1993). "The signal for translational readthrough of a UGA codon in Sindbis virus RNA involves a single cytidine residue immediately downstream of the termination codon." *J Virol* **67**(8): 5062-5067.
- Li, G. P., M. W. La Starza, et al. (1990). "Phosphorylation of Sindbis virus nsP3 in vivo and in vitro." *Virology* **179**(1): 416-427.
- Li, H., H. Zhu, et al. (1998). "Cleavage of BID by caspase 8 mediates the mitochondrial damage in the Fas pathway of apoptosis." *Cell* **94**(4): 491-501.
- Li, L. Y., X. Luo, et al. (2001). "Endonuclease G is an apoptotic DNase when released from mitochondria." *Nature* **412**(6842): 95-99.
- Li, Y., L. Wang, et al. (2007). "Seco-pregnane steroids target the subgenomic RNA of alphavirus-like RNA viruses." *Proc Natl Acad Sci U S A* **104**(19): 8083-8088.
- Li, Y. G., U. Siripanyaphinyo, et al. (2012). "Poly (I:C), an agonist of toll-like receptor-3, inhibits replication of the Chikungunya virus in BEAS-2B cells." *Virology* **9**: 114.
- Liang, X. H., L. K. Kleeman, et al. (1998). "Protection against fatal Sindbis virus encephalitis by beclin, a novel Bcl-2-interacting protein." *J Virol* **72**(11): 8586-8596.

- Liao, D. and R. S. Johnson (2007). "Hypoxia: a key regulator of angiogenesis in cancer." Cancer Metastasis Rev **26**(2): 281-290.
- Lidbury, B. A. and S. Mahalingam (2000). "Specific ablation of antiviral gene expression in macrophages by antibody-dependent enhancement of Ross River virus infection." J Virol **74**(18): 8376-8381.
- Lidbury, B. A., N. E. Rulli, et al. (2008). "Macrophage-derived proinflammatory factors contribute to the development of arthritis and myositis after infection with an arthrogenic alphavirus." J Infect Dis **197**(11): 1585-1593.
- Lidbury, B. A., C. Simeonovic, et al. (2000). "Macrophage-induced muscle pathology results in morbidity and mortality for Ross River virus-infected mice." J Infect Dis **181**(1): 27-34.
- Lieberman, J., N. Manjunath, et al. (2002). "Avoiding the kiss of death: how HIV and other chronic viruses survive." Curr Opin Immunol **14**(4): 478-486.
- Liekens, S., E. De Clercq, et al. (2001). "Angiogenesis: regulators and clinical applications." Biochem Pharmacol **61**(3): 253-270.
- Lien, E., T. K. Means, et al. (2000). "Toll-like receptor 4 imparts ligand-specific recognition of bacterial lipopolysaccharide." J Clin Invest **105**(4): 497-504.
- Lin, R., L. Yang, et al. (2006). "Negative regulation of the retinoic acid-inducible gene I-induced antiviral state by the ubiquitin-editing protein A20." J Biol Chem **281**(4): 2095-2103.
- Linn, M. L., J. G. Aaskov, et al. (1996). "Antibody-dependent enhancement and persistence in macrophages of an arbovirus associated with arthritis." J Gen Virol **77 ( Pt 3)**: 407-411.
- Linn, M. L., L. Mateo, et al. (1998). "Alphavirus-specific cytotoxic T lymphocytes recognize a cross-reactive epitope from the capsid protein and can eliminate virus from persistently infected macrophages." J Virol **72**(6): 5146-5153.
- Liu, C., D. W. Voth, et al. (1970). "A comparative study of the pathogenesis of western equine and eastern equine encephalomyelitis viral infections in mice by intracerebral and subcutaneous inoculations." J Infect Dis **122**(1): 53-63.
- Liu, N. and D. T. Brown (1993). "Phosphorylation and dephosphorylation events play critical roles in Sindbis virus maturation." Virology **196**(2): 703-711.
- Liu, N. and D. T. Brown (1993). "Transient translocation of the cytoplasmic (endo) domain of a type I membrane glycoprotein into cellular membranes." J Cell Biol **120**(4): 877-883.
- Liu, T. and T. J. Chambers (2001). "Yellow fever virus encephalitis: properties of the brain-associated T-cell response during virus clearance in normal and gamma interferon-deficient mice and requirement for CD4+ lymphocytes." J Virol **75**(5): 2107-2118.
- Liu, X., C. N. Kim, et al. (1996). "Induction of apoptotic program in cell-free extracts: requirement for dATP and cytochrome c." Cell **86**(1): 147-157.
- Liu, Y., M. Schiff, et al. (2005). "Autophagy regulates programmed cell death during the plant innate immune response." Cell **121**(4): 567-577.
- Liu, Y. J. (2001). "Dendritic cell subsets and lineages, and their functions in innate and adaptive immunity." Cell **106**(3): 259-262.
- Liu, Y. J. (2005). "IPC: professional type 1 interferon-producing cells and plasmacytoid dendritic cell precursors." Annu Rev Immunol **23**: 275-306.
- Liu, Y. J., H. Kanzler, et al. (2001). "Dendritic cell lineage, plasticity and cross-regulation." Nat Immunol **2**(7): 585-589.
- Loo, Y. M., J. Fornek, et al. (2008). "Distinct RIG-I and MDA5 signaling by RNA viruses in innate immunity." J Virol **82**(1): 335-345.
- Loparev, V. N., J. M. Parsons, et al. (1998). "A third distinct tumor necrosis factor receptor of orthopoxviruses." Proc Natl Acad Sci U S A **95**(7): 3786-3791.
- Lu, G., J. T. Reinert, et al. (2006). "ISG15 enhances the innate antiviral response by inhibition of IRF-3 degradation." Cell Mol Biol (Noisy-le-grand) **52**(1): 29-41.

- Lu, Y. E., T. Cassese, et al. (1999). "The cholesterol requirement for sindbis virus entry and exit and characterization of a spike protein region involved in cholesterol dependence." *J Virol* **73**(5): 4272-4278.
- Lucas, M., T. Mashimo, et al. (2003). "Infection of mouse neurones by West Nile virus is modulated by the interferon-inducible 2'-5' oligoadenylate synthetase 1b protein." *Immunol Cell Biol* **81**(3): 230-236.
- Ludwig, G. V., J. P. Kondig, et al. (1996). "A putative receptor for Venezuelan equine encephalitis virus from mosquito cells." *J Virol* **70**(8): 5592-5599.
- Lund, J., A. Sato, et al. (2003). "Toll-like receptor 9-mediated recognition of Herpes simplex virus-2 by plasmacytoid dendritic cells." *J Exp Med* **198**(3): 513-520.
- Lund, J. M., L. Alexopoulou, et al. (2004). "Recognition of single-stranded RNA viruses by Toll-like receptor 7." *Proc Natl Acad Sci U S A* **101**(15): 5598-5603.
- Lundqvist, A., A. Isa, et al. (2005). "High frequency of parvovirus B19 DNA in bone marrow samples from rheumatic patients." *J Clin Virol* **33**(1): 71-74.
- Luo, X., I. Budihardjo, et al. (1998). "Bid, a Bcl2 interacting protein, mediates cytochrome c release from mitochondria in response to activation of cell surface death receptors." *Cell* **94**(4): 481-490.
- Lusa, S., H. Garoff, et al. (1991). "Fate of the 6K membrane protein of Semliki Forest virus during virus assembly." *Virology* **185**(2): 843-846.
- MacDonald, M. R., X. Y. Li, et al. (1997). "Late expression of a beta chemokine homolog by murine cytomegalovirus." *J Virol* **71**(2): 1671-1678.
- MacFarlane, M., M. Ahmad, et al. (1997). "Identification and molecular cloning of two novel receptors for the cytotoxic ligand TRAIL." *J Biol Chem* **272**(41): 25417-25420.
- Mackenzie, J. S., K. B. Chua, et al. (2001). "Emerging viral diseases of Southeast Asia and the Western Pacific." *Emerg Infect Dis* **7**(3 Suppl): 497-504.
- MacMicking, J., Q. W. Xie, et al. (1997). "Nitric oxide and macrophage function." *Annu Rev Immunol* **15**: 323-350.
- Magnusson, M., F. Zare, et al. (2006). "Requirement of type I interferon signaling for arthritis triggered by double-stranded RNA." *Arthritis Rheum* **54**(1): 148-157.
- Mahalingam, S. and B. A. Lidbury (2002). "Suppression of lipopolysaccharide-induced antiviral transcription factor (STAT-1 and NF-kappa B) complexes by antibody-dependent enhancement of macrophage infection by Ross River virus." *Proc Natl Acad Sci U S A* **99**(21): 13819-13824.
- Maheshwari, R. K., V. Srikantan, et al. (1991). "Chloroquine enhances replication of Semliki Forest virus and encephalomyocarditis virus in mice." *J Virol* **65**(2): 992-995.
- Maitra, R. K., N. A. McMillan, et al. (1994). "HIV-1 TAR RNA has an intrinsic ability to activate interferon-inducible enzymes." *Virology* **204**(2): 823-827.
- Malet, H., B. Coutard, et al. (2009). "The crystal structures of Chikungunya and Venezuelan equine encephalitis virus nsP3 macro domains define a conserved adenosine binding pocket." *J Virol* **83**(13): 6534-6545.
- Malvy, D., K. Ezzedine, et al. (2009). "Destructive arthritis in a patient with chikungunya virus infection with persistent specific IgM antibodies." *BMC Infect Dis* **9**: 200.
- Mancuso, G., M. Gambuzza, et al. (2009). "Bacterial recognition by TLR7 in the lysosomes of conventional dendritic cells." *Nat Immunol* **10**(6): 587-594.
- Manimunda, S. P., P. Vijayachari, et al. (2010). "Clinical progression of chikungunya fever during acute and chronic arthritic stages and the changes in joint morphology as revealed by imaging." *Trans R Soc Trop Med Hyg* **104**(6): 392-399.
- Mantovani, A. and A. Sica (2010). "Macrophages, innate immunity and cancer: balance, tolerance, and diversity." *Curr Opin Immunol* **22**(2): 231-237.

- Marchette, N. J., A. Rudnick, et al. (1978). "Alphaviruses in Peninsular Malaysia: I. Virus isolations and animal serology." *Southeast Asian J Trop Med Public Health* **9**(3): 317-329.
- Marie, I., J. E. Durbin, et al. (1998). "Differential viral induction of distinct interferon-alpha genes by positive feedback through interferon regulatory factor-7." *EMBO J* **17**(22): 6660-6669.
- Marsh, M., E. Bolzau, et al. (1983). "Penetration of Semliki Forest virus from acidic prelysosomal vacuoles." *Cell* **32**(3): 931-940.
- Marsters, S. A., J. P. Sheridan, et al. (1997). "A novel receptor for Apo2L/TRAIL contains a truncated death domain." *Curr Biol* **7**(12): 1003-1006.
- Martin-Fontecha, A., L. L. Thomsen, et al. (2004). "Induced recruitment of NK cells to lymph nodes provides IFN-gamma for T(H)1 priming." *Nat Immunol* **5**(12): 1260-1265.
- Martin, D. and J. S. Gutkind (2008). "Human tumor-associated viruses and new insights into the molecular mechanisms of cancer." *Oncogene* **27 Suppl 2**: S31-42.
- Martinez, F. O., L. Helming, et al. (2009). "Alternative activation of macrophages: an immunologic functional perspective." *Annu Rev Immunol* **27**: 451-483.
- Martinon, F., A. Mayor, et al. (2009). "The inflammasomes: guardians of the body." *Annu Rev Immunol* **27**: 229-265.
- Mason, A., J. Theal, et al. (2005). "Hepatitis B virus replication in damaged endothelial tissues of patients with extrahepatic disease." *Am J Gastroenterol* **100**(4): 972-976.
- Mason, P. J. and A. J. Haddow (1957). "An epidemic of virus disease in Southern Province, Tanganyika Territory, in 1952-53; an additional note on Chikungunya virus isolations and serum antibodies." *Trans R Soc Trop Med Hyg* **51**(3): 238-240.
- Masuko-Hongo, K., T. Kato, et al. (2003). "Virus-associated arthritis." *Best Pract Res Clin Rheumatol* **17**(2): 309-318.
- Mateo, L., M. La Linn, et al. (2000). "An arthrogenic alphavirus induces monocyte chemoattractant protein-1 and interleukin-8." *Intervirology* **43**(1): 55-60.
- Mathiot, C. C., G. Grimaud, et al. (1990). "An outbreak of human Semliki Forest virus infections in Central African Republic." *Am J Trop Med Hyg* **42**(4): 386-393.
- Matsumoto, M., K. Funami, et al. (2003). "Subcellular localization of Toll-like receptor 3 in human dendritic cells." *J Immunol* **171**(6): 3154-3162.
- Matzinger, P. (2002). "The danger model: a renewed sense of self." *Science* **296**(5566): 301-305.
- Mavalankar, D., P. Shastri, et al. (2008). "Increased mortality rate associated with chikungunya epidemic, Ahmedabad, India." *Emerg Infect Dis* **14**(3): 412-415.
- Mayne, J. T., C. M. Rice, et al. (1984). "Biochemical studies of the maturation of the small Sindbis virus glycoprotein E3." *Virology* **134**(2): 338-357.
- Mayuri, T. W. Geders, et al. (2008). "Role for conserved residues of sindbis virus nonstructural protein 2 methyltransferase-like domain in regulation of minus-strand synthesis and development of cytopathic infection." *J Virol* **82**(15): 7284-7297.
- Mazaud, R., J. J. Salaun, et al. (1971). "[Acute neurologic and sensorial disorders in dengue and Chikungunya fever]." *Bull Soc Pathol Exot Filiales* **64**(1): 22-30.
- McCartney, S. A., L. B. Thackray, et al. (2008). "MDA-5 recognition of a murine norovirus." *PLoS Pathog* **4**(7): e1000108.
- McCormack, S. J., D. C. Thomis, et al. (1992). "Mechanism of interferon action: identification of a RNA binding domain within the N-terminal region of the human RNA-dependent P1/eIF-2 alpha protein kinase." *Virology* **188**(1): 47-56.
- McCrae, A. W., B. E. Henderson, et al. (1971). "Chikungunya virus in the Entebbe area of Uganda: isolations and epidemiology." *Trans R Soc Trop Med Hyg* **65**(2): 152-168.
- McGill, P. E. (1995). "Viral infections: alpha-viral arthropathy." *Baillieres Clin Rheumatol* **9**(1): 145-150.

- McWhirter, S. M., K. A. Fitzgerald, et al. (2004). "IFN-regulatory factor 3-dependent gene expression is defective in Tbk1-deficient mouse embryonic fibroblasts." *Proc Natl Acad Sci U S A* **101**(1): 233-238.
- Medema, J. P., C. Scaffidi, et al. (1997). "FLICE is activated by association with the CD95 death-inducing signaling complex (DISC)." *EMBO J* **16**(10): 2794-2804.
- Medzhitov, R. (2001). "Toll-like receptors and innate immunity." *Nat Rev Immunol* **1**(2): 135-145.
- Medzhitov, R. and C. Janeway, Jr. (2000). "Innate immunity." *N Engl J Med* **343**(5): 338-344.
- Medzhitov, R. and C. A. Janeway, Jr. (1997). "Innate immunity: impact on the adaptive immune response." *Curr Opin Immunol* **9**(1): 4-9.
- Medzhitov, R., P. Preston-Hurlburt, et al. (1997). "A human homologue of the Drosophila Toll protein signals activation of adaptive immunity." *Nature* **388**(6640): 394-397.
- Mehlen, P. and D. E. Bredesen (2011). "Dependence receptors: from basic research to drug development." *Sci Signal* **4**(157): mr2.
- Meier, P. and K. H. Vousden (2007). "Lucifer's labyrinth--ten years of path finding in cell death." *Mol Cell* **28**(5): 746-754.
- Mestas, J. and C. C. Hughes (2004). "Of mice and not men: differences between mouse and human immunology." *J Immunol* **172**(5): 2731-2738.
- Meyer-Bahlburg, A. and D. J. Rawlings (2012). "Differential impact of Toll-like receptor signaling on distinct B cell subpopulations." *Front Biosci* **17**: 1499-1516.
- Meyer, K. F., C. M. Haring, et al. (1931). "The Etiology of Epizootic Encephalomyelitis of Horses in the San Joaquin Valley, 1930." *Science* **74**(1913): 227-228.
- Meyer, W. J. and R. E. Johnston (1993). "Structural rearrangement of infecting Sindbis virions at the cell surface: mapping of newly accessible epitopes." *J Virol* **67**(9): 5117-5125.
- Meylan, E., K. Burns, et al. (2004). "RIP1 is an essential mediator of Toll-like receptor 3-induced NF-kappa B activation." *Nat Immunol* **5**(5): 503-507.
- Meylan, E., J. Curran, et al. (2005). "Cardif is an adaptor protein in the RIG-I antiviral pathway and is targeted by hepatitis C virus." *Nature* **437**(7062): 1167-1172.
- Meylan, E., J. Tschopp, et al. (2006). "Intracellular pattern recognition receptors in the host response." *Nature* **442**(7098): 39-44.
- Mi, S., R. Durbin, et al. (1989). "Association of the Sindbis virus RNA methyltransferase activity with the nonstructural protein nsP1." *Virology* **170**(2): 385-391.
- Mi, S. and V. Stollar (1991). "Expression of Sindbis virus nsP1 and methyltransferase activity in Escherichia coli." *Virology* **184**(1): 423-427.
- Michallet, M. C., E. Meylan, et al. (2008). "TRADD protein is an essential component of the RIG-like helicase antiviral pathway." *Immunity* **28**(5): 651-661.
- Micheau, O. and J. Tschopp (2003). "Induction of TNF receptor I-mediated apoptosis via two sequential signaling complexes." *Cell* **114**(2): 181-190.
- Mille, F., C. Thibert, et al. (2009). "The Patched dependence receptor triggers apoptosis through a DRAL-caspase-9 complex." *Nat Cell Biol* **11**(6): 739-746.
- Miller, D. M., B. M. Rahill, et al. (1998). "Human cytomegalovirus inhibits major histocompatibility complex class II expression by disruption of the Jak/Stat pathway." *J Exp Med* **187**(5): 675-683.
- Minegishi, Y., M. Saito, et al. (2006). "Human tyrosine kinase 2 deficiency reveals its requisite roles in multiple cytokine signals involved in innate and acquired immunity." *Immunity* **25**(5): 745-755.
- Mody, G. M., F. A. Parke, et al. (2003). "Articular manifestations of human immunodeficiency virus infection." *Best Pract Res Clin Rheumatol* **17**(2): 265-287.
- Mogensen, T. H. (2009). "Pathogen recognition and inflammatory signaling in innate immune defenses." *Clin Microbiol Rev* **22**(2): 240-273, Table of Contents.

- Moore, C. B., D. T. Bergstralh, et al. (2008). "NLRX1 is a regulator of mitochondrial antiviral immunity." *Nature* **451**(7178): 573-577.
- Moore, K. J., L. P. Andersson, et al. (2000). "Divergent response to LPS and bacteria in CD14-deficient murine macrophages." *J Immunol* **165**(8): 4272-4280.
- Mornex, J. F., Y. Martinet, et al. (1986). "Spontaneous expression of the c-sis gene and release of a platelet-derived growth factorlike molecule by human alveolar macrophages." *J Clin Invest* **78**(1): 61-66.
- Morrison, J. G. (1979). "Chikungunya fever." *Int J Dermatol* **18**(8): 628-629.
- Morrison, T. E., R. J. Fraser, et al. (2007). "Complement contributes to inflammatory tissue destruction in a mouse model of Ross River virus-induced disease." *J Virol* **81**(10): 5132-5143.
- Morrison, T. E., L. Oko, et al. (2011). "A mouse model of chikungunya virus-induced musculoskeletal inflammatory disease: evidence of arthritis, tenosynovitis, myositis, and persistence." *Am J Pathol* **178**(1): 32-40.
- Morrison, T. E., A. C. Whitmore, et al. (2006). "Characterization of Ross River virus tropism and virus-induced inflammation in a mouse model of viral arthritis and myositis." *J Virol* **80**(2): 737-749.
- Mosmann, T. R., H. Cherwinski, et al. (1986). "Two types of murine helper T cell clone. I. Definition according to profiles of lymphokine activities and secreted proteins." *J Immunol* **136**(7): 2348-2357.
- Mosser, D. M. and J. P. Edwards (2008). "Exploring the full spectrum of macrophage activation." *Nat Rev Immunol* **8**(12): 958-969.
- Motaln, H., J. McWhir, et al. (2005). "In situ analysis of Raidd-beta-galactosidase fusion gene expression in transgenic mouse midgestation embryos." *Transgenic Res* **14**(1): 27-40.
- Mourya, D. T., J. R. Thakare, et al. (2001). "Isolation of chikungunya virus from Aedes aegypti mosquitoes collected in the town of Yawat, Pune District, Maharashtra State, India." *Acta Virol* **45**(5-6): 305-309.
- Muller, U., U. Steinhoff, et al. (1994). "Functional role of type I and type II interferons in antiviral defense." *Science* **264**(5167): 1918-1921.
- Munasinghe, D. R., P. J. Amarasekera, et al. (1966). "An epidemic of dengue-like fever in Ceylon (chikungunya--a clinical and haematological study." *Ceylon Med J* **11**(4): 129-142.
- Munz, C., J. D. Lunemann, et al. (2009). "Antiviral immune responses: triggers of or triggered by autoimmunity?" *Nat Rev Immunol* **9**(4): 246-258.
- Muthumani, K., K. M. Lankaraman, et al. (2008). "Immunogenicity of novel consensus-based DNA vaccines against Chikungunya virus." *Vaccine* **26**(40): 5128-5134.
- Muzio, M., A. M. Chinnaiyan, et al. (1996). "FLICE, a novel FADD-homologous ICE/CED-3-like protease, is recruited to the CD95 (Fas/APO-1) death--inducing signaling complex." *Cell* **85**(6): 817-827.
- Myers, R. M. and D. E. Carey (1967). "Concurrent isolation from patient of two arboviruses, Chikungunya and dengue type 2." *Science* **157**(3794): 1307-1308.
- Myers, R. M., D. E. Carey, et al. (1965). "The 1964 epidemic of dengue-like fever in South India: isolation of chikungunya virus from human sera and from mosquitoes." *Indian J Med Res* **53**(8): 694-701.
- Myles, K. M., D. J. Pierro, et al. (2003). "Deletions in the putative cell receptor-binding domain of Sindbis virus strain MRE16 E2 glycoprotein reduce midgut infectivity in Aedes aegypti." *J Virol* **77**(16): 8872-8881.
- Naish, S., W. Hu, et al. (2011). "Spatio-temporal patterns of Barmah Forest virus disease in Queensland, Australia." *PLoS One* **6**(10): e25688.
- Nakashima, A., N. Tanaka, et al. (2006). "Survival of parvovirus B19-infected cells by cellular autophagy." *Virology* **349**(2): 254-263.

- Nakaya, H. I., J. Gardner, et al. (2012). "Gene profiling of Chikungunya virus arthritis in a mouse model reveals significant overlap with rheumatoid arthritis." *Arthritis Rheum* **64**(11): 3553-3563.
- Nallagatla, S. R., J. Hwang, et al. (2007). "5'-triphosphate-dependent activation of PKR by RNAs with short stem-loops." *Science* **318**(5855): 1455-1458.
- Nanduri, S., F. Rahman, et al. (2000). "A dynamically tuned double-stranded RNA binding mechanism for the activation of antiviral kinase PKR." *EMBO J* **19**(20): 5567-5574.
- Nathan, C. (2006). "Neutrophils and immunity: challenges and opportunities." *Nat Rev Immunol* **6**(3): 173-182.
- Neyts, J., A. Meerbach, et al. (1996). "Use of the yellow fever virus vaccine strain 17D for the study of strategies for the treatment of yellow fever virus infections." *Antiviral Res* **30**(2-3): 125-132.
- Ng, L. C., L. K. Tan, et al. (2009). "Entomologic and virologic investigation of Chikungunya, Singapore." *Emerg Infect Dis* **15**(8): 1243-1249.
- Ng, L. F., A. Chow, et al. (2009). "IL-1beta, IL-6, and RANTES as biomarkers of Chikungunya severity." *PLoS One* **4**(1): e4261.
- Nimmannitya, S., S. B. Halstead, et al. (1969). "Dengue and chikungunya virus infection in man in Thailand, 1962-1964. I. Observations on hospitalized patients with hemorrhagic fever." *Am J Trop Med Hyg* **18**(6): 954-971.
- Nishioka, K., I. Maruyama, et al. (1989). "Chronic inflammatory arthropathy associated with HTLV-I." *Lancet* **1**(8635): 441.
- Nishitoh, H., M. Saitoh, et al. (1998). "ASK1 is essential for JNK/SAPK activation by TRAF2." *Mol Cell* **2**(3): 389-395.
- Nkoghe, D., R. F. Kassa, et al. (2012). "Clinical forms of chikungunya in Gabon, 2010." *PLoS Negl Trop Dis* **6**(2): e1517.
- Noran, H. H. (1944). "Chronic Equine Encephalitis." *Am J Pathol* **20**(2): 259-267.
- Novelli, F., F. Di Pierro, et al. (1994). "Environmental signals influencing expression of the IFN-gamma receptor on human T cells control whether IFN-gamma promotes proliferation or apoptosis." *J Immunol* **152**(2): 496-504.
- Novick, D., B. Cohen, et al. (1994). "The human interferon alpha/beta receptor: characterization and molecular cloning." *Cell* **77**(3): 391-400.
- Nur, Y. A., J. Groen, et al. (1999). "An outbreak of West Nile fever among migrants in Kisangani, Democratic Republic of Congo." *Am J Trop Med Hyg* **61**(6): 885-888.
- O'Brien, L. (2007). "Inhibition of multiple strains of Venezuelan equine encephalitis virus by a pool of four short interfering RNAs." *Antiviral Res* **75**(1): 20-29.
- O'Connell, R. M., S. K. Saha, et al. (2004). "Type I interferon production enhances susceptibility to *Listeria monocytogenes* infection." *J Exp Med* **200**(4): 437-445.
- Oganesyan, G., S. K. Saha, et al. (2006). "Critical role of TRAF3 in the Toll-like receptor-dependent and -independent antiviral response." *Nature* **439**(7073): 208-211.
- Ogawa, S., J. Lozach, et al. (2005). "Molecular determinants of crosstalk between nuclear receptors and toll-like receptors." *Cell* **122**(5): 707-721.
- Oliva, A., A. L. Kinter, et al. (1998). "Natural killer cells from human immunodeficiency virus (HIV)-infected individuals are an important source of CC-chemokines and suppress HIV-1 entry and replication in vitro." *J Clin Invest* **102**(1): 223-231.
- Orvedahl, A., D. Alexander, et al. (2007). "HSV-1 ICP34.5 confers neurovirulence by targeting the Beclin 1 autophagy protein." *Cell Host Microbe* **1**(1): 23-35.
- Osiak, A., O. Utermohlen, et al. (2005). "ISG15, an interferon-stimulated ubiquitin-like protein, is not essential for STAT1 signaling and responses against vesicular stomatitis and lymphocytic choriomeningitis virus." *Mol Cell Biol* **25**(15): 6338-6345.



- Ou, J. H., E. G. Strauss, et al. (1983). "The 5'-terminal sequences of the genomic RNAs of several alphaviruses." *J Mol Biol* **168**(1): 1-15.
- Ozden, S., M. Huerre, et al. (2007). "Human muscle satellite cells as targets of Chikungunya virus infection." *PLoS One* **2**(6): e527.
- Ozden, S., M. Lucas-Hourani, et al. (2008). "Inhibition of Chikungunya virus infection in cultured human muscle cells by furin inhibitors: impairment of the maturation of the E2 surface glycoprotein." *J Biol Chem* **283**(32): 21899-21908.
- Ozinsky, A., D. M. Underhill, et al. (2000). "The repertoire for pattern recognition of pathogens by the innate immune system is defined by cooperation between toll-like receptors." *Proc Natl Acad Sci U S A* **97**(25): 13766-13771.
- Paessler, S., R. Rijnbrand, et al. (2008). "Inhibition of alphavirus infection in cell culture and in mice with antisense morpholino oligomers." *Virology* **376**(2): 357-370.
- Pan, G., J. Ni, et al. (1997). "An antagonist decoy receptor and a death domain-containing receptor for TRAIL." *Science* **277**(5327): 815-818.
- Pan, G., J. Ni, et al. (1998). "TRUND, a new member of the TRAIL receptor family that antagonizes TRAIL signalling." *FEBS Lett* **424**(1-2): 41-45.
- Panne, D., T. Maniatis, et al. (2007). "An atomic model of the interferon-beta enhanceosome." *Cell* **129**(6): 1111-1123.
- Panning, M., M. Hess, et al. (2009). "Performance of the RealStar Chikungunya virus real-time reverse transcription-PCR kit." *J Clin Microbiol* **47**(9): 3014-3016.
- Paredes, A. M., M. N. Simon, et al. (1992). "The mass of the Sindbis virus nucleocapsid suggests it has T = 4 icosahedral symmetry." *Virology* **187**(1): 329-332.
- Park, J. Y. and M. H. Pillinger (2007). "Interleukin-6 in the pathogenesis of rheumatoid arthritis." *Bull NYU Hosp Jt Dis* **65 Suppl 1**: S4-10.
- Parola, P., X. de Lamballerie, et al. (2006). "Novel chikungunya virus variant in travelers returning from Indian Ocean islands." *Emerg Infect Dis* **12**(10): 1493-1499.
- Parola, P., F. Simon, et al. (2007). "Tenosynovitis and vascular disorders associated with Chikungunya virus-related rheumatism." *Clin Infect Dis* **45**(6): 801-802.
- Parrott, M. M., S. A. Sitariski, et al. (2009). "Role of conserved cysteines in the alphavirus E3 protein." *J Virol* **83**(6): 2584-2591.
- Pasare, C. and R. Medzhitov (2005). "Control of B-cell responses by Toll-like receptors." *Nature* **438**(7066): 364-368.
- Pastorino, B., J. J. Muyembe-Tamfum, et al. (2004). "Epidemic resurgence of Chikungunya virus in democratic Republic of the Congo: identification of a new central African strain." *J Med Virol* **74**(2): 277-282.
- Paterson, H. E. and B. M. McIntosh (1964). "Further Studies on the Chikungunya Outbreak in Southern Rhodesia in 1962. II. Transmission Experiments with the Aedes Furcifer-Taylori Group of Mosquitoes and with a Member of the Anopheles Gambiae Complex." *Ann Trop Med Parasitol* **58**: 52-55.
- Patterson, J. B. and C. E. Samuel (1995). "Expression and regulation by interferon of a double-stranded-RNA-specific adenosine deaminase from human cells: evidence for two forms of the deaminase." *Mol Cell Biol* **15**(10): 5376-5388.
- Patterson, J. B., D. C. Thomis, et al. (1995). "Mechanism of interferon action: double-stranded RNA-specific adenosine deaminase from human cells is inducible by alpha and gamma interferons." *Virology* **210**(2): 508-511.
- Pavlovic, J., O. Haller, et al. (1992). "Human and mouse Mx proteins inhibit different steps of the influenza virus multiplication cycle." *J Virol* **66**(4): 2564-2569.
- Pearson, A. M. (1996). "Scavenger receptors in innate immunity." *Curr Opin Immunol* **8**(1): 20-28.

- Peiser, L., S. Mukhopadhyay, et al. (2002). "Scavenger receptors in innate immunity." Curr Opin Immunol **14**(1): 123-128.
- Penfold, M. E., D. J. Dairaghi, et al. (1999). "Cytomegalovirus encodes a potent alpha chemokine." Proc Natl Acad Sci U S A **96**(17): 9839-9844.
- Pepys, M. B. (1982). "C-reactive protein and the acute phase response." Nature **296**(5852): 12.
- Peranen, J., P. Laakkonen, et al. (1995). "The alphavirus replicase protein nsP1 is membrane-associated and has affinity to endocytic organelles." Virology **208**(2): 610-620.
- Peranen, J., M. Rikonen, et al. (1990). "Nuclear localization of Semliki Forest virus-specific nonstructural protein nsP2." J Virol **64**(5): 1888-1896.
- Peranen, J., K. Takkinen, et al. (1988). "Semliki Forest virus-specific non-structural protein nsP3 is a phosphoprotein." J Gen Virol **69** ( Pt 9): 2165-2178.
- Pertile, T. L., M. M. Walser, et al. (1996). "Immunohistochemical detection of lymphocyte subpopulations in the tarsal joints of chickens with experimental viral arthritis." Vet Pathol **33**(3): 303-310.
- Petitdemange, C., P. Becquart, et al. (2011). "Unconventional repertoire profile is imprinted during acute chikungunya infection for natural killer cells polarization toward cytotoxicity." PLoS Pathog **7**(9): e1002268.
- Pialoux, G., B. A. Gauzere, et al. (2007). "Chikungunya, an epidemic arbovirolosis." Lancet Infect Dis **7**(5): 319-327.
- Pichlmair, A. and C. Reis e Sousa (2007). "Innate recognition of viruses." Immunity **27**(3): 370-383.
- Pichlmair, A., O. Schulz, et al. (2006). "RIG-I-mediated antiviral responses to single-stranded RNA bearing 5'-phosphates." Science **314**(5801): 997-1001.
- Pichlmair, A., O. Schulz, et al. (2009). "Activation of MDA5 requires higher-order RNA structures generated during virus infection." J Virol **83**(20): 10761-10769.
- Pindel, A. and A. Sadler (2011). "The role of protein kinase R in the interferon response." J Interferon Cytokine Res **31**(1): 59-70.
- Platanias, L. C., S. Uddin, et al. (1996). "The type I interferon receptor mediates tyrosine phosphorylation of insulin receptor substrate 2." J Biol Chem **271**(1): 278-282.
- Polack, F. P., P. M. Irusta, et al. (2005). "The cysteine-rich region of respiratory syncytial virus attachment protein inhibits innate immunity elicited by the virus and endotoxin." Proc Natl Acad Sci U S A **102**(25): 8996-9001.
- Poltorak, A., X. He, et al. (1998). "Defective LPS signaling in C3H/HeJ and C57BL/10ScCr mice: mutations in Tlr4 gene." Science **282**(5396): 2085-2088.
- Poltorak, A., P. Ricciardi-Castagnoli, et al. (2000). "Physical contact between lipopolysaccharide and toll-like receptor 4 revealed by genetic complementation." Proc Natl Acad Sci U S A **97**(5): 2163-2167.
- Ponten, A., C. Sick, et al. (1997). "Dominant-negative mutants of human MxA protein: domains in the carboxy-terminal moiety are important for oligomerization and antiviral activity." J Virol **71**(4): 2591-2599.
- Porter, K. R., R. Tan, et al. (2004). "A serological study of Chikungunya virus transmission in Yogyakarta, Indonesia: evidence for the first outbreak since 1982." Southeast Asian J Trop Med Public Health **35**(2): 408-415.
- Posey, D. L., T. O'Rourke, et al. (2005). "O'Nyong-nyong fever in West Africa." Am J Trop Med Hyg **73**(1): 32.
- Powers, A. M., A. C. Brault, et al. (2000). "Re-emergence of Chikungunya and O'nyong-nyong viruses: evidence for distinct geographical lineages and distant evolutionary relationships." J Gen Virol **81**(Pt 2): 471-479.
- Powers, A. M. and C. H. Logue (2007). "Changing patterns of chikungunya virus: re-emergence of a zoonotic arbovirus." J Gen Virol **88**(Pt 9): 2363-2377.

- Pushko, P., M. Parker, et al. (1997). "Replicon-helper systems from attenuated Venezuelan equine encephalitis virus: expression of heterologous genes in vitro and immunization against heterologous pathogens in vivo." *Virology* **239**(2): 389-401.
- Queyriaux, B., F. Simon, et al. (2008). "Clinical burden of chikungunya virus infection." *Lancet Infect Dis* **8**(1): 2-3.
- Qureshi, S. T., L. Lariviere, et al. (1999). "Endotoxin-tolerant mice have mutations in Toll-like receptor 4 (Tlr4)." *J Exp Med* **189**(4): 615-625.
- Rai, N. K., K. Tripathi, et al. (2005). "Apoptosis: a basic physiologic process in wound healing." *Int J Low Extrem Wounds* **4**(3): 138-144.
- Raju, R. and H. V. Huang (1991). "Analysis of Sindbis virus promoter recognition in vivo, using novel vectors with two subgenomic mRNA promoters." *J Virol* **65**(5): 2501-2510.
- Ramana, C. V., M. Chatterjee-Kishore, et al. (2000). "Complex roles of Stat1 in regulating gene expression." *Oncogene* **19**(21): 2619-2627.
- Ramful, D., M. Carbonnier, et al. (2007). "Mother-to-child transmission of Chikungunya virus infection." *Pediatr Infect Dis J* **26**(9): 811-815.
- Rampal, M. Sharda, et al. (2007). "Neurological complications in Chikungunya fever." *J Assoc Physicians India* **55**: 765-769.
- Randolph, G. J., S. Beaulieu, et al. (1998). "Differentiation of monocytes into dendritic cells in a model of transendothelial trafficking." *Science* **282**(5388): 480-483.
- Rani, M. R., D. W. Leaman, et al. (1999). "Catalytically active TYK2 is essential for interferon-beta-mediated phosphorylation of STAT3 and interferon-alpha receptor-1 (IFNAR-1) but not for activation of phosphoinositol 3-kinase." *J Biol Chem* **274**(45): 32507-32511.
- Rao, T. R. (1971). "Immunological surveys of arbovirus infections in South-East Asia, with special reference to dengue, chikungunya, and Kyasanur Forest disease." *Bull World Health Organ* **44**(5): 585-591.
- Rao, T. R., D. E. Carey, et al. (1965). "Preliminary isolation and identification of chikungunya virus from cases of dengue-like illness in Madras city." *Indian J Med Res* **53**(8): 689-693.
- Rappolee, D. A., D. Mark, et al. (1988). "Wound macrophages express TGF-alpha and other growth factors in vivo: analysis by mRNA phenotyping." *Science* **241**(4866): 708-712.
- Rassa, J. C., J. L. Meyers, et al. (2002). "Murine retroviruses activate B cells via interaction with toll-like receptor 4." *Proc Natl Acad Sci U S A* **99**(4): 2281-2286.
- Ravi, V. (2006). "Re-emergence of chikungunya virus in India." *Indian J Med Microbiol* **24**(2): 83-84.
- Ray, C. G., E. P. Gall, et al. (1982). "Acute polyarthrititis associated with active Epstein-Barr virus infection." *JAMA* **248**(22): 2990-2993.
- Rebouillat, D. and A. G. Hovanessian (1999). "The human 2',5'-oligoadenylate synthetase family: interferon-induced proteins with unique enzymatic properties." *J Interferon Cytokine Res* **19**(4): 295-308.
- Reed, D. S., T. Larsen, et al. (2005). "Aerosol exposure to western equine encephalitis virus causes fever and encephalitis in cynomolgus macaques." *J Infect Dis* **192**(7): 1173-1182.
- Rehli, M. (2002). "Of mice and men: species variations of Toll-like receptor expression." *Trends Immunol* **23**(8): 375-378.
- Rehwinkel, J., C. P. Tan, et al. (2010). "RIG-I detects viral genomic RNA during negative-strand RNA virus infection." *Cell* **140**(3): 397-408.
- Renault, P., J. L. Solet, et al. (2007). "A major epidemic of chikungunya virus infection on Reunion Island, France, 2005-2006." *Am J Trop Med Hyg* **77**(4): 727-731.
- Rezza, G., L. Nicoletti, et al. (2007). "Infection with chikungunya virus in Italy: an outbreak in a temperate region." *Lancet* **370**(9602): 1840-1846.
- Rikonen, M., J. Peranen, et al. (1992). "Nuclear and nucleolar targeting signals of Semliki Forest virus nonstructural protein nsP2." *Virology* **189**(2): 462-473.

- Rikkonen, M., J. Peranen, et al. (1994). "ATPase and GTPase activities associated with Semliki Forest virus nonstructural protein nsP2." *J Virol* **68**(9): 5804-5810.
- Riyaz, N., A. Riyaz, et al. (2010). "Cutaneous manifestations of chikungunya during a recent epidemic in Calicut, north Kerala, south India." *Indian J Dermatol Venereol Leprol* **76**(6): 671-676.
- Roberts, T. L., A. Idris, et al. (2009). "HIN-200 proteins regulate caspase activation in response to foreign cytoplasmic DNA." *Science* **323**(5917): 1057-1060.
- Roberts, W. K., A. Hovanessian, et al. (1976). "Interferon-mediated protein kinase and low-molecular-weight inhibitor of protein synthesis." *Nature* **264**(5585): 477-480.
- Robin, S., D. Ramful, et al. (2008). "Neurologic manifestations of pediatric chikungunya infection." *J Child Neurol* **23**(9): 1028-1035.
- Robin, S., D. Ramful, et al. (2010). "Severe bullous skin lesions associated with Chikungunya virus infection in small infants." *Eur J Pediatr* **169**(1): 67-72.
- Robinson, M. C. (1955). "An epidemic of virus disease in Southern Province, Tanganyika Territory, in 1952-53. I. Clinical features." *Trans R Soc Trop Med Hyg* **49**(1): 28-32.
- Rojas, R., J. Roman, et al. (1996). "Inhibition of apoptotic cell death in B-CLL by interferon gamma correlates with clinical stage." *Leukemia* **10**(11): 1782-1788.
- Romano, P. R., S. R. Green, et al. (1995). "Structural requirements for double-stranded RNA binding, dimerization, and activation of the human eIF-2 alpha kinase DAI in *Saccharomyces cerevisiae*." *Mol Cell Biol* **15**(1): 365-378.
- Ronco, L. V., A. Y. Karpova, et al. (1998). "Human papillomavirus 16 E6 oncoprotein binds to interferon regulatory factor-3 and inhibits its transcriptional activity." *Genes Dev* **12**(13): 2061-2072.
- Rozenendaal, R. and M. C. Carroll (2006). "Emerging patterns in complement-mediated pathogen recognition." *Cell* **125**(1): 29-32.
- Ross, R., E. W. Raines, et al. (1986). "The biology of platelet-derived growth factor." *Cell* **46**(2): 155-169.
- Ross, R. W. (1956). "The Newala epidemic. III. The virus: isolation, pathogenic properties and relationship to the epidemic." *J Hyg (Lond)* **54**(2): 177-191.
- Roth-Cross, J. K., S. J. Bender, et al. (2008). "Murine coronavirus mouse hepatitis virus is recognized by MDA5 and induces type I interferon in brain macrophages/microglia." *J Virol* **82**(20): 9829-9838.
- Rothenfusser, S., N. Goutagny, et al. (2005). "The RNA helicase Lgp2 inhibits TLR-independent sensing of viral replication by retinoic acid-inducible gene-I." *J Immunol* **175**(8): 5260-5268.
- Roux, L., A. E. Simon, et al. (1991). "Effects of defective interfering viruses on virus replication and pathogenesis in vitro and in vivo." *Adv Virus Res* **40**: 181-211.
- Rudd, B. D., E. Burstein, et al. (2005). "Differential role for TLR3 in respiratory syncytial virus-induced chemokine expression." *J Virol* **79**(6): 3350-3357.
- Rulli, N. E., A. Guglielmotti, et al. (2009). "Amelioration of alphavirus-induced arthritis and myositis in a mouse model by treatment with bindarit, an inhibitor of monocyte chemotactic proteins." *Arthritis Rheum* **60**(8): 2513-2523.
- Rulli, N. E., J. Melton, et al. (2007). "The molecular and cellular aspects of arthritis due to alphavirus infections: lesson learned from Ross River virus." *Ann N Y Acad Sci* **1102**: 96-108.
- Rulli, N. E., A. Suhrbier, et al. (2005). "Ross River virus: molecular and cellular aspects of disease pathogenesis." *Pharmacol Ther* **107**(3): 329-342.
- Rupp, J. C., N. Jundt, et al. (2011). "Requirement for the amino-terminal domain of sindbis virus nsP4 during virus infection." *J Virol* **85**(7): 3449-3460.
- Ryman, K. D., W. B. Klimstra, et al. (2000). "Alpha/beta interferon protects adult mice from fatal Sindbis virus infection and is an important determinant of cell and tissue tropism." *Journal of virology* **74**(7): 3366-3378.

- Rymo, S. F., H. Gerhardt, et al. (2011). "A two-way communication between microglial cells and angiogenic sprouts regulates angiogenesis in aortic ring cultures." PLoS One **6**(1): e15846.
- Sabbah, A., T. H. Chang, et al. (2009). "Activation of innate immune antiviral responses by Nod2." Nat Immunol **10**(10): 1073-1080.
- Sadler, A. J. and B. R. Williams (2007). "Structure and function of the protein kinase R." Curr Top Microbiol Immunol **316**: 253-292.
- Sadler, A. J. and B. R. Williams (2008). "Interferon-inducible antiviral effectors." Nat Rev Immunol **8**(7): 559-568.
- Saha, S. K., E. M. Pietras, et al. (2006). "Regulation of antiviral responses by a direct and specific interaction between TRAF3 and Cardif." EMBO J **25**(14): 3257-3263.
- Saito, T., R. Hirai, et al. (2007). "Regulation of innate antiviral defenses through a shared repressor domain in RIG-I and LGP2." Proc Natl Acad Sci U S A **104**(2): 582-587.
- Saitoh, T., M. Yamamoto, et al. (2005). "A20 is a negative regulator of IFN regulatory factor 3 signaling." J Immunol **174**(3): 1507-1512.
- Sakai, M., K. Eguchi, et al. (1993). "Infection of human synovial cells by human T cell lymphotropic virus type I. Proliferation and granulocyte/macrophage colony-stimulating factor production by synovial cells." J Clin Invest **92**(4): 1957-1966.
- Salazar-Mather, T. P., T. A. Hamilton, et al. (2000). "A chemokine-to-cytokine-to-chemokine cascade critical in antiviral defense." J Clin Invest **105**(7): 985-993.
- Sallusto, F. and A. Lanzavecchia (1994). "Efficient presentation of soluble antigen by cultured human dendritic cells is maintained by granulocyte/macrophage colony-stimulating factor plus interleukin 4 and downregulated by tumor necrosis factor alpha." J Exp Med **179**(4): 1109-1118.
- Sambri, V., F. Cavrini, et al. (2008). "The 2007 epidemic outbreak of Chikungunya virus infection in the Romagna region of Italy: a new perspective for the possible diffusion of tropical diseases in temperate areas?" New Microbiol **31**(3): 303-304.
- Samuel, C. E. (1979). "Mechanism of interferon action: phosphorylation of protein synthesis initiation factor eIF-2 in interferon-treated human cells by a ribosome-associated kinase processing site specificity similar to hemin-regulated rabbit reticulocyte kinase." Proc Natl Acad Sci U S A **76**(2): 600-604.
- Samuel, C. E. (1993). "The eIF-2 alpha protein kinases, regulators of translation in eukaryotes from yeasts to humans." J Biol Chem **268**(11): 7603-7606.
- Samuel, C. E. (2001). "Antiviral actions of interferons." Clin Microbiol Rev **14**(4): 778-809, table of contents.
- Samuel, P. P., R. Krishnamoorthi, et al. (2009). "Entomo-epidemiological investigations on chikungunya outbreak in the Lakshadweep islands, Indian Ocean." Indian J Med Res **129**(4): 442-445.
- Sanders, E. J., E. B. Rwaguma, et al. (1999). "O'nyong-nyong fever in south-central Uganda, 1996-1997: description of the epidemic and results of a household-based seroprevalence survey." J Infect Dis **180**(5): 1436-1443.
- Sang, R. C., O. Ahmed, et al. (2008). "Entomologic investigations of a chikungunya virus epidemic in the Union of the Comoros, 2005." Am J Trop Med Hyg **78**(1): 77-82.
- Santhosh, S. R., P. K. Dash, et al. (2008). "Comparative full genome analysis revealed E1: A226V shift in 2007 Indian Chikungunya virus isolates." Virus Res **135**(1): 36-41.
- Sanz, M. A., V. Madan, et al. (2003). "Interfacial domains in Sindbis virus 6K protein. Detection and functional characterization." J Biol Chem **278**(3): 2051-2057.
- Sanz, M. A., L. Perez, et al. (1994). "Semliki Forest virus 6K protein modifies membrane permeability after inducible expression in Escherichia coli cells." J Biol Chem **269**(16): 12106-12110.

- Sarkar, J. K., S. N. Chatterjee, et al. (1965). "Chikungunya virus infection with haemorrhagic manifestations." *Indian J Med Res* **53**(10): 921-925.
- Sarkar, J. K., S. N. Chatterjee, et al. (1967). "Three-year study of mosquito-borne haemorrhagic fever in Calcutta." *Trans R Soc Trop Med Hyg* **61**(5): 725-735.
- Sarkar, S. N., K. L. Peters, et al. (2004). "Novel roles of TLR3 tyrosine phosphorylation and PI3 kinase in double-stranded RNA signaling." *Nat Struct Mol Biol* **11**(11): 1060-1067.
- Sarkar, S. N. and G. C. Sen (2004). "Novel functions of proteins encoded by viral stress-inducible genes." *Pharmacol Ther* **103**(3): 245-259.
- Sasai, M., M. Shingai, et al. (2006). "NAK-associated protein 1 participates in both the TLR3 and the cytoplasmic pathways in type I IFN induction." *J Immunol* **177**(12): 8676-8683.
- Sato, A., M. M. Linehan, et al. (2006). "Dual recognition of herpes simplex viruses by TLR2 and TLR9 in dendritic cells." *Proc Natl Acad Sci U S A* **103**(46): 17343-17348.
- Sato, M., H. Suemori, et al. (2000). "Distinct and essential roles of transcription factors IRF-3 and IRF-7 in response to viruses for IFN-alpha/beta gene induction." *Immunity* **13**(4): 539-548.
- Sato, S., M. Sugiyama, et al. (2003). "Toll/IL-1 receptor domain-containing adaptor inducing IFN-beta (TRIF) associates with TNF receptor-associated factor 6 and TANK-binding kinase 1, and activates two distinct transcription factors, NF-kappa B and IFN-regulatory factor-3, in the Toll-like receptor signaling." *J Immunol* **171**(8): 4304-4310.
- Sawicki, D. L. and S. G. Sawicki (1994). "Alphavirus positive and negative strand RNA synthesis and the role of polyproteins in formation of viral replication complexes." *Arch Virol Suppl* **9**: 393-405.
- Saxena, S. K., M. Singh, et al. (2006). "Resurgence of chikungunya virus in India: an emerging threat." *Euro Surveill* **11**(8): E060810 060812.
- Scheidel, L. M., R. K. Durbin, et al. (1989). "SVLM21, a Sindbis virus mutant resistant to methionine deprivation, encodes an altered methyltransferase." *Virology* **173**(2): 408-414.
- Schmid, D. and C. Munz (2007). "Innate and adaptive immunity through autophagy." *Immunity* **27**(1): 11-21.
- Schmidt, A., T. Schwerd, et al. (2009). "5'-triphosphate RNA requires base-paired structures to activate antiviral signaling via RIG-I." *Proc Natl Acad Sci U S A* **106**(29): 12067-12072.
- Schromm, A. B., E. Lien, et al. (2001). "Molecular genetic analysis of an endotoxin nonresponder mutant cell line: a point mutation in a conserved region of MD-2 abolishes endotoxin-induced signaling." *J Exp Med* **194**(1): 79-88.
- Schuffenecker, I., I. Itman, et al. (2006). "Genome microevolution of chikungunya viruses causing the Indian Ocean outbreak." *PLoS Med* **3**(7): e263.
- Schulz, O., S. S. Diebold, et al. (2005). "Toll-like receptor 3 promotes cross-priming to virus-infected cells." *Nature* **433**(7028): 887-892.
- Schulz, O., A. Pichlmair, et al. (2010). "Protein kinase R contributes to immunity against specific viruses by regulating interferon mRNA integrity." *Cell Host Microbe* **7**(5): 354-361.
- Schulze-Osthoff, K., D. Ferrari, et al. (1998). "Apoptosis signaling by death receptors." *Eur J Biochem* **254**(3): 439-459.
- Schutze, S., V. Tchikov, et al. (2008). "Regulation of TNFR1 and CD95 signalling by receptor compartmentalization." *Nat Rev Mol Cell Biol* **9**(8): 655-662.
- Schwalbe, R. A., B. Dahlback, et al. (1992). "Pentraxin family of proteins interact specifically with phosphorylcholine and/or phosphorylethanolamine." *Biochemistry* **31**(20): 4907-4915.
- Scott, T. W. and S. C. Weaver (1989). "Eastern equine encephalomyelitis virus: epidemiology and evolution of mosquito transmission." *Adv Virus Res* **37**: 277-328.
- Screaton, G. R., J. Mongkolsapaya, et al. (1997). "TRICK2, a new alternatively spliced receptor that transduces the cytotoxic signal from TRAIL." *Curr Biol* **7**(9): 693-696.

- Scrimgeour, E. M., J. G. Aaskov, et al. (1987). "Ross River virus arthritis in Papua New Guinea." Trans R Soc Trop Med Hyg **81**(5): 833-834.
- Seino, K. and M. Taniguchi (2005). "Functionally distinct NKT cell subsets and subtypes." J Exp Med **202**(12): 1623-1626.
- Selsted, M. E. and A. J. Ouellette (2005). "Mammalian defensins in the antimicrobial immune response." Nat Immunol **6**(6): 551-557.
- Sen, G. C. (2001). "Viruses and interferons." Annu Rev Microbiol **55**: 255-281.
- Sergon, K., A. A. Yahaya, et al. (2007). "Seroprevalence of Chikungunya virus infection on Grande Comore Island, union of the Comoros, 2005." Am J Trop Med Hyg **76**(6): 1189-1193.
- Seth, R. B., L. Sun, et al. (2005). "Identification and characterization of MAVS, a mitochondrial antiviral signaling protein that activates NF-kappaB and IRF 3." Cell **122**(5): 669-682.
- Severson, W. E., C. S. Schmaljohn, et al. (2003). "Ribavirin causes error catastrophe during Hantaan virus replication." J Virol **77**(1): 481-488.
- Sharma, S., B. R. tenOever, et al. (2003). "Triggering the interferon antiviral response through an IKK-related pathway." Science **300**(5622): 1148-1151.
- Shaw, A. S. (2008). "How T cells 'find' the right dendritic cell." Nat Immunol **9**(3): 229-230.
- Shen, Y. and T. E. Shenk (1995). "Viruses and apoptosis." Curr Opin Genet Dev **5**(1): 105-111.
- Shimazu, R., S. Akashi, et al. (1999). "MD-2, a molecule that confers lipopolysaccharide responsiveness on Toll-like receptor 4." J Exp Med **189**(11): 1777-1782.
- Shimizu, Y., S. Yamamoto, et al. (1972). "Effect of chloroquine on the growth of animal viruses." Arch Gesamte Virusforsch **36**(1): 93-104.
- Shirako, Y., E. G. Strauss, et al. (2000). "Suppressor mutations that allow sindbis virus RNA polymerase to function with nonaromatic amino acids at the N-terminus: evidence for interaction between nsP1 and nsP4 in minus-strand RNA synthesis." Virology **276**(1): 148-160.
- Shirako, Y. and J. H. Strauss (1990). "Cleavage between nsP1 and nsP2 initiates the processing pathway of Sindbis virus nonstructural polyprotein P123." Virology **177**(1): 54-64.
- Shirako, Y. and J. H. Strauss (1994). "Regulation of Sindbis virus RNA replication: uncleaved P123 and nsP4 function in minus-strand RNA synthesis, whereas cleaved products from P123 are required for efficient plus-strand RNA synthesis." J Virol **68**(3): 1874-1885.
- Siegel, F. P., N. Kadowaki, et al. (1999). "The nature of the principal type 1 interferon-producing cells in human blood." Science **284**(5421): 1835-1837.
- Siegbahn, A., A. Hammacher, et al. (1990). "Differential effects of the various isoforms of platelet-derived growth factor on chemotaxis of fibroblasts, monocytes, and granulocytes." J Clin Invest **85**(3): 916-920.
- Siegel, R. M., J. K. Frederiksen, et al. (2000). "Fas preassociation required for apoptosis signaling and dominant inhibition by pathogenic mutations." Science **288**(5475): 2354-2357.
- Silva, A. M., M. Whitmore, et al. (2004). "Protein kinase R (PKR) interacts with and activates mitogen-activated protein kinase kinase 6 (MKK6) in response to double-stranded RNA stimulation." J Biol Chem **279**(36): 37670-37676.
- Simon, F., E. Javelle, et al. (2011). "Chikungunya virus infection." Curr Infect Dis Rep **13**(3): 218-228.
- Simon, F., P. Parola, et al. (2007). "Chikungunya infection: an emerging rheumatism among travelers returned from Indian Ocean islands. Report of 47 cases." Medicine (Baltimore) **86**(3): 123-137.
- Simonet, W. S., D. L. Lacey, et al. (1997). "Osteoprotegerin: a novel secreted protein involved in the regulation of bone density." Cell **89**(2): 309-319.
- Simpson, L. and R. B. Emeson (1996). "RNA editing." Annu Rev Neurosci **19**: 27-52.

- Sissoko, D., D. Malvy, et al. (2009). "Post-epidemic Chikungunya disease on Reunion Island: course of rheumatic manifestations and associated factors over a 15-month period." *PLoS Negl Trop Dis* **3**(3): e389.
- Skogh, M. and A. Espmark (1982). "[Ockelby disease--a skin and joint disease probably caused by a mosquito-borne alpha arbovirus]." *Lakartidningen* **79**(24): 2379-2380.
- Smith, A. L. and G. H. Tignor (1980). "Host cell receptors for two strains of Sindbis virus." *Arch Virol* **66**(1): 11-26.
- Smith, C. A., R. E. Petty, et al. (1987). "Rubella virus and arthritis." *Rheum Dis Clin North Am* **13**(2): 265-274.
- Smith, G. L. (1996). "Virus proteins that bind cytokines, chemokines or interferons." *Curr Opin Immunol* **8**(4): 467-471.
- Smith, K. D. and A. Ozinsky (2002). "Toll-like receptor-5 and the innate immune response to bacterial flagellin." *Curr Top Microbiol Immunol* **270**: 93-108.
- Smyth, D. J., J. D. Cooper, et al. (2006). "A genome-wide association study of nonsynonymous SNPs identifies a type 1 diabetes locus in the interferon-induced helicase (IFIH1) region." *Nat Genet* **38**(6): 617-619.
- Soden, M., H. Vasudevan, et al. (2000). "Detection of viral ribonucleic acid and histologic analysis of inflamed synovium in Ross River virus infection." *Arthritis Rheum* **43**(2): 365-369.
- Solignat, M., B. Gay, et al. (2009). "Replication cycle of chikungunya: a re-emerging arbovirus." *Virology* **393**(2): 183-197.
- Solomon, T., N. M. Dung, et al. (2000). "Japanese encephalitis." *J Neurol Neurosurg Psychiatry* **68**(4): 405-415.
- Soria, I., P. Myhre, et al. (2000). "Effect of food on the pharmacokinetics and bioavailability of oral imiquimod relative to a subcutaneous dose." *Int J Clin Pharmacol Ther* **38**(10): 476-481.
- Soumahoro, M. K., P. Gerardin, et al. (2009). "Impact of Chikungunya virus infection on health status and quality of life: a retrospective cohort study." *PLoS One* **4**(11): e7800.
- Soumelis, V., P. A. Reche, et al. (2002). "Human epithelial cells trigger dendritic cell mediated allergic inflammation by producing TSLP." *Nat Immunol* **3**(7): 673-680.
- Sourisseau, M., C. Schilte, et al. (2007). "Characterization of reemerging chikungunya virus." *PLoS Pathog* **3**(6): e89.
- Spann, K. M., K. C. Tran, et al. (2005). "Effects of nonstructural proteins NS1 and NS2 of human respiratory syncytial virus on interferon regulatory factor 3, NF-kappaB, and proinflammatory cytokines." *J Virol* **79**(9): 5353-5362.
- Spence, L. P. and L. Thomas (1959). "Application of haemagglutination and complementfixation techniques to the identification and serological classification of arthropod-borne viruses; studies on Chikungunya and Makonde viruses." *Trans R Soc Trop Med Hyg* **53**(3): 248-255.
- Spriggs, M. K. (1994). "Cytokine and cytokine receptor genes 'captured' by viruses." *Curr Opin Immunol* **6**(4): 526-529.
- Srinivasula, S. M., M. Ahmad, et al. (1996). "Molecular ordering of the Fas-apoptotic pathway: the Fas/APO-1 protease Mch5 is a CrmA-inhibitable protease that activates multiple Ced-3/ICE-like cysteine proteases." *Proc Natl Acad Sci U S A* **93**(25): 14486-14491.
- Srinivasula, S. M., S. Gupta, et al. (2003). "Inhibitor of apoptosis proteins are substrates for the mitochondrial serine protease Omi/HtrA2." *J Biol Chem* **278**(34): 31469-31472.
- Stack, J., I. R. Haga, et al. (2005). "Vaccinia virus protein A46R targets multiple Toll-like-interleukin-1 receptor adaptors and contributes to virulence." *J Exp Med* **201**(6): 1007-1018.
- Staeheli, P., F. Pitossi, et al. (1993). "Mx proteins: GTPases with antiviral activity." *Trends Cell Biol* **3**(8): 268-272.
- Staikowsky, F., F. Talarmin, et al. (2009). "Prospective study of Chikungunya virus acute infection in the Island of La Reunion during the 2005-2006 outbreak." *PLoS One* **4**(10): e7603.



- Stanger, B. Z., P. Leder, et al. (1995). "RIP: a novel protein containing a death domain that interacts with Fas/APO-1 (CD95) in yeast and causes cell death." *Cell* **81**(4): 513-523.
- Stark, G. R., I. M. Kerr, et al. (1998). "How cells respond to interferons." *Annu Rev Biochem* **67**: 227-264.
- Steer, S. A. and J. A. Corbett (2003). "The role and regulation of COX-2 during viral infection." *Viral Immunol* **16**(4): 447-460.
- Stein, M. and S. Keshav (1992). "The versatility of macrophages." *Clin Exp Allergy* **22**(1): 19-27.
- Steinbrink, K., M. Wolf, et al. (1997). "Induction of tolerance by IL-10-treated dendritic cells." *J Immunol* **159**(10): 4772-4780.
- Stetson, D. B. and R. Medzhitov (2006). "Recognition of cytosolic DNA activates an IRF3-dependent innate immune response." *Immunity* **24**(1): 93-103.
- Stoermer, K. A., A. Burrack, et al. (2012). "Genetic ablation of arginase 1 in macrophages and neutrophils enhances clearance of an arthritogenic alphavirus." *J Immunol* **189**(8): 4047-4059.
- Strauss, E. G., R. J. De Groot, et al. (1992). "Identification of the active site residues in the nsP2 proteinase of Sindbis virus." *Virology* **191**(2): 932-940.
- Strauss, E. G., E. M. Lenches, et al. (2002). "Molecular genetic evidence that the hydrophobic anchors of glycoproteins E2 and E1 interact during assembly of alphaviruses." *J Virol* **76**(20): 10188-10194.
- Strauss, E. G., C. M. Rice, et al. (1984). "Complete nucleotide sequence of the genomic RNA of Sindbis virus." *Virology* **133**(1): 92-110.
- Strauss, J. H. and E. G. Strauss (1994). "The alphaviruses: gene expression, replication, and evolution." *Microbiol Rev* **58**(3): 491-562.
- Suhrbier, A., M. C. Jaffar-Bandjee, et al. (2012). "Arthritogenic alphaviruses--an overview." *Nat Rev Rheumatol* **8**(7): 420-429.
- Suhrbier, A. and M. La Linn (2003). "Suppression of antiviral responses by antibody-dependent enhancement of macrophage infection." *Trends Immunol* **24**(4): 165-168.
- Suhrbier, A. and M. La Linn (2004). "Clinical and pathologic aspects of arthritis due to Ross River virus and other alphaviruses." *Curr Opin Rheumatol* **16**(4): 374-379.
- Suhrbier, A. and S. Mahalingam (2009). "The immunobiology of viral arthritides." *Pharmacol Ther* **124**(3): 301-308.
- Sun, Y., D. H. Chung, et al. (2007). "Activity of ribavirin against Hantaan virus correlates with production of ribavirin-5'-triphosphate, not with inhibition of IMP dehydrogenase." *Antimicrob Agents Chemother* **51**(1): 84-88.
- Sunderkotter, C., K. Steinbrink, et al. (1994). "Macrophages and angiogenesis." *J Leukoc Biol* **55**(3): 410-422.
- Susin, S. A., H. K. Lorenzo, et al. (1999). "Molecular characterization of mitochondrial apoptosis-inducing factor." *Nature* **397**(6718): 441-446.
- Sutejo, R., D. S. Yeo, et al. (2012). "Activation of type I and III interferon signalling pathways occurs in lung epithelial cells infected with low pathogenic avian influenza viruses." *PLoS One* **7**(3): e33732.
- Suzuki, H., Y. Kurihara, et al. (1997). "A role for macrophage scavenger receptors in atherosclerosis and susceptibility to infection." *Nature* **386**(6622): 292-296.
- Swain, M. G. (2008). "Hepatic NKT cells: friend or foe?" *Clin Sci (Lond)* **114**(7): 457-466.
- Szekanecz, Z., T. Besenyei, et al. (2009). "Angiogenesis in rheumatoid arthritis." *Autoimmunity* **42**(7): 563-573.
- Szekanecz, Z. and A. E. Koch (2007). "Macrophages and their products in rheumatoid arthritis." *Curr Opin Rheumatol* **19**(3): 289-295.

- Szekanecz, Z. and A. E. Koch (2007). "Mechanisms of Disease: angiogenesis in inflammatory diseases." Nat Clin Pract Rheumatol **3**(11): 635-643.
- Szekanecz, Z. and A. E. Koch (2008). "Vascular involvement in rheumatic diseases: 'vascular rheumatology'." Arthritis Res Ther **10**(5): 224.
- Tabeta, K., P. Georgel, et al. (2004). "Toll-like receptors 9 and 3 as essential components of innate immune defense against mouse cytomegalovirus infection." Proc Natl Acad Sci U S A **101**(10): 3516-3521.
- Tacke, F. and G. J. Randolph (2006). "Migratory fate and differentiation of blood monocyte subsets." Immunobiology **211**(6-8): 609-618.
- Tak, P. P. (2006). "Chemokine inhibition in inflammatory arthritis." Best Pract Res Clin Rheumatol **20**(5): 929-939.
- Takahashi, K., T. Kawai, et al. (2006). "Roles of caspase-8 and caspase-10 in innate immune responses to double-stranded RNA." J Immunol **176**(8): 4520-4524.
- Takahashi, K., M. Yoneyama, et al. (2008). "Nonself RNA-sensing mechanism of RIG-I helicase and activation of antiviral immune responses." Mol Cell **29**(4): 428-440.
- Takaoka, A., Z. Wang, et al. (2007). "DAI (DLM-1/ZBP1) is a cytosolic DNA sensor and an activator of innate immune response." Nature **448**(7152): 501-505.
- Takaoka, A. and H. Yanai (2006). "Interferon signalling network in innate defence." Cell Microbiol **8**(6): 907-922.
- Takeda, K. and S. Akira (2005). "Toll-like receptors in innate immunity." Int Immunol **17**(1): 1-14.
- Takeuchi, M., M. Rothe, et al. (1996). "Anatomy of TRAF2. Distinct domains for nuclear factor-kappaB activation and association with tumor necrosis factor signaling proteins." J Biol Chem **271**(33): 19935-19942.
- Takeuchi, O., K. Hoshino, et al. (1999). "Differential roles of TLR2 and TLR4 in recognition of gram-negative and gram-positive bacterial cell wall components." Immunity **11**(4): 443-451.
- Takeuchi, O., A. Kaufmann, et al. (2000). "Cutting edge: preferentially the R-stereoisomer of the mycoplasmal lipopeptide macrophage-activating lipopeptide-2 activates immune cells through a toll-like receptor 2- and MyD88-dependent signaling pathway." J Immunol **164**(2): 554-557.
- Takeuchi, O., T. Kawai, et al. (2001). "Discrimination of bacterial lipoproteins by Toll-like receptor 6." Int Immunol **13**(7): 933-940.
- Takeuchi, T., T. Kobayashi, et al. (2006). "Negative regulation of protein phosphatase 2Cbeta by ISG15 conjugation." FEBS Lett **580**(18): 4521-4526.
- Takeuchi, T. and H. Yokosawa (2008). "Detection and analysis of protein ISGylation." Methods Mol Biol **446**: 139-149.
- Takkinen, K. (1986). "Complete nucleotide sequence of the nonstructural protein genes of Semliki Forest virus." Nucleic Acids Res **14**(14): 5667-5682.
- Tan, S. L. and M. G. Katze (1999). "The emerging role of the interferon-induced PKR protein kinase as an apoptotic effector: a new face of death?" J Interferon Cytokine Res **19**(6): 543-554.
- Tanaka, N., M. Sato, et al. (1998). "Type I interferons are essential mediators of apoptotic death in virally infected cells." Genes Cells **3**(1): 29-37.
- Taubitz, W., J. P. Cramer, et al. (2007). "Chikungunya fever in travelers: clinical presentation and course." Clin Infect Dis **45**(1): e1-4.
- Taylor, K. R., J. M. Trowbridge, et al. (2004). "Hyaluronan fragments stimulate endothelial recognition of injury through TLR4." J Biol Chem **279**(17): 17079-17084.
- Taylor, R. M., H. S. Hurlbut, et al. (1955). "Sindbis virus: a newly recognized arthropodtransmitted virus." Am J Trop Med Hyg **4**(5): 844-862.
- Tellinghuisen, T. L. and R. J. Kuhn (2000). "Nucleic acid-dependent cross-linking of the nucleocapsid protein of Sindbis virus." J Virol **74**(9): 4302-4309.

- Teng, T. S., S. S. Foo, et al. (2012). "Viperin restricts chikungunya virus replication and pathology." J Clin Invest **122**(12): 4447-4460.
- Teo, T. H., F. M. Lum, et al. (2013). "A Pathogenic Role for CD4+ T Cells during Chikungunya Virus Infection in Mice." J Immunol **190**(1): 259-269.
- Teodoro, J. G. and P. E. Branton (1997). "Regulation of apoptosis by viral gene products." J Virol **71**(3): 1739-1746.
- Teodoro, J. G. and P. E. Branton (1997). "Regulation of p53-dependent apoptosis, transcriptional repression, and cell transformation by phosphorylation of the 55-kilodalton E1B protein of human adenovirus type 5." J Virol **71**(5): 3620-3627.
- Terenzi, F., D. J. Hui, et al. (2006). "Distinct induction patterns and functions of two closely related interferon-inducible human genes, ISG54 and ISG56." J Biol Chem **281**(45): 34064-34071.
- Terenzi, F., C. White, et al. (2007). "Tissue-specific and inducer-specific differential induction of ISG56 and ISG54 in mice." J Virol **81**(16): 8656-8665.
- Tesh, R. B. (1982). "Arthritides caused by mosquito-borne viruses." Annu Rev Med **33**: 31-40.
- Tesh, R. B., D. J. Gubler, et al. (1976). "Variation among geographic strains of *Aedes albopictus* in susceptibility to infection with chikungunya virus." Am J Trop Med Hyg **25**(2): 326-335.
- Tesh, R. B., D. M. Watts, et al. (1999). "Mayaro virus disease: an emerging mosquito-borne zoonosis in tropical South America." Clin Infect Dis **28**(1): 67-73.
- Thaikruea, L., O. Charearnsook, et al. (1997). "Chikungunya in Thailand: a re-emerging disease?" Southeast Asian J Trop Med Public Health **28**(2): 359-364.
- Thakral, K. K., W. H. Goodson, 3rd, et al. (1979). "Stimulation of wound blood vessel growth by wound macrophages." J Surg Res **26**(4): 430-436.
- Thangamani, S., S. Higgs, et al. (2010). "Host immune response to mosquito-transmitted chikungunya virus differs from that elicited by needle inoculated virus." PLoS One **5**(8): e12137.
- Thanos, D. and T. Maniatis (1995). "NF-kappa B: a lesson in family values." Cell **80**(4): 529-532.
- Thaung, U., C. K. Ming, et al. (1975). "Epidemiological features of dengue and chikungunya infections in Burma." Southeast Asian J Trop Med Public Health **6**(2): 276-283.
- Thavara, U., A. Tawatsin, et al. (2009). "Outbreak of chikungunya fever in Thailand and virus detection in field population of vector mosquitoes, *Aedes aegypti* (L.) and *Aedes albopictus* Skuse (Diptera: Culicidae)." Southeast Asian J Trop Med Public Health **40**(5): 951-962.
- Thein, S., M. La Linn, et al. (1992). "Development of a simple indirect enzyme-linked immunosorbent assay for the detection of immunoglobulin M antibody in serum from patients following an outbreak of chikungunya virus infection in Yangon, Myanmar." Trans R Soc Trop Med Hyg **86**(4): 438-442.
- Thiruvengadam, K. V., V. Kalyanasundaram, et al. (1965). "Clinical and pathological studies on chikungunya fever in Madras city." Indian J Med Res **53**(8): 729-744.
- Thomas, C. A., Y. Li, et al. (2000). "Protection from lethal gram-positive infection by macrophage scavenger receptor-dependent phagocytosis." J Exp Med **191**(1): 147-156.
- Thome, M., P. Schneider, et al. (1997). "Viral FLICE-inhibitory proteins (FLIPs) prevent apoptosis induced by death receptors." Nature **386**(6624): 517-521.
- Thon-Hon, V. G., M. Denizot, et al. (2012). "Deciphering the differential response of two human fibroblast cell lines following Chikungunya virus infection." Virology **9**: 213.
- Thonnon, J., A. Spiegel, et al. (1999). "[Chikungunya virus outbreak in Senegal in 1996 and 1997]." Bull Soc Pathol Exot **92**(2): 79-82.
- Thyrell, L., L. Hjortsberg, et al. (2004). "Interferon alpha-induced apoptosis in tumor cells is mediated through the phosphoinositide 3-kinase/mammalian target of rapamycin signaling pathway." J Biol Chem **279**(23): 24152-24162.
- Tian, J., A. M. Avalos, et al. (2007). "Toll-like receptor 9-dependent activation by DNA-containing immune complexes is mediated by HMGB1 and RAGE." Nat Immunol **8**(5): 487-496.

- Toivanen, A. (2008). "Alphaviruses: an emerging cause of arthritis?" Curr Opin Rheumatol **20**(4): 486-490.
- Toivanen, A. and P. Toivanen (2006). "Which viruses should we look for in a recent onset polyarthritis." Acta Reumatol Port **31**(1): 39-47.
- Tollefson, A. E., T. W. Hermiston, et al. (1998). "Forced degradation of Fas inhibits apoptosis in adenovirus-infected cells." Nature **392**(6677): 726-730.
- Tomar, S., R. W. Hardy, et al. (2006). "Catalytic core of alphavirus nonstructural protein nsP4 possesses terminal adenylyltransferase activity." J Virol **80**(20): 9962-9969.
- Toth, A. M., P. Zhang, et al. (2006). "Interferon action and the double-stranded RNA-dependent enzymes ADAR1 adenosine deaminase and PKR protein kinase." Prog Nucleic Acid Res Mol Biol **81**: 369-434.
- Trinchieri, G. (1989). "Biology of natural killer cells." Adv Immunol **47**: 187-376.
- Trinchieri, G. (2003). "Interleukin-12 and the regulation of innate resistance and adaptive immunity." Nat Rev Immunol **3**(2): 133-146.
- Tschopp, J., M. Thome, et al. (1998). "The fight of viruses against apoptosis." Curr Opin Genet Dev **8**(1): 82-87.
- Tsetsarkin, K. A., D. L. Vanlandingham, et al. (2007). "A single mutation in chikungunya virus affects vector specificity and epidemic potential." PLoS Pathog **3**(12): e201.
- Tsujimoto, Y., J. Cossman, et al. (1985). "Involvement of the bcl-2 gene in human follicular lymphoma." Science **228**(4706): 1440-1443.
- Turell, M. J., J. R. Beaman, et al. (1992). "Susceptibility of selected strains of *Aedes aegypti* and *Aedes albopictus* (Diptera: Culicidae) to chikungunya virus." J Med Entomol **29**(1): 49-53.
- Turunen, M., P. Kuusisto, et al. (1998). "Pogosta disease: clinical observations during an outbreak in the province of North Karelia, Finland." Br J Rheumatol **37**(11): 1177-1180.
- Tytell, A. A., G. P. Lamson, et al. (1967). "Inducers of interferon and host resistance. 3. Double-stranded RNA from reovirus type 3 virions (reo 3-RNA)." Proc Natl Acad Sci U S A **58**(4): 1719-1722.
- Uddin, S., L. Yenush, et al. (1995). "Interferon-alpha engages the insulin receptor substrate-1 to associate with the phosphatidylinositol 3'-kinase." J Biol Chem **270**(27): 15938-15941.
- Uematsu, S., S. Sato, et al. (2005). "Interleukin-1 receptor-associated kinase-1 plays an essential role for Toll-like receptor (TLR)7- and TLR9-mediated interferon- $\alpha$  induction." J Exp Med **201**(6): 915-923.
- Ueno, H., E. Klechevsky, et al. (2007). "Dendritic cell subsets in health and disease." Immunol Rev **219**: 118-142.
- Ueno, Y., H. Umadome, et al. (1993). "Human parvovirus B19 and arthritis." Lancet **341**(8855): 1280.
- Ulevitch, R. J. and P. S. Tobias (1995). "Receptor-dependent mechanisms of cell stimulation by bacterial endotoxin." Annu Rev Immunol **13**: 437-457.
- Underhill, D. M., A. Ozinsky, et al. (1999). "The Toll-like receptor 2 is recruited to macrophage phagosomes and discriminates between pathogens." Nature **401**(6755): 811-815.
- Unterholzner, L., S. E. Keating, et al. (2010). "IFI16 is an innate immune sensor for intracellular DNA." Nat Immunol **11**(11): 997-1004.
- Uren, A. G., M. Pakusch, et al. (1996). "Cloning and expression of apoptosis inhibitory protein homologs that function to inhibit apoptosis and/or bind tumor necrosis factor receptor-associated factors." Proc Natl Acad Sci U S A **93**(10): 4974-4978.
- van de Sandt, C. E., J. H. Kreijtz, et al. (2012). "Evasion of influenza A viruses from innate and adaptive immune responses." Viruses **4**(9): 1438-1476.
- van der Blik, A. M. (1999). "Functional diversity in the dynamin family." Trends Cell Biol **9**(3): 96-102.

- Vanarsdall, A. L., T. W. Wisner, et al. (2012). "PDGF receptor-alpha does not promote HCMV entry into epithelial and endothelial cells but increased quantities stimulate entry by an abnormal pathway." *PLoS Pathog* **8**(9): e1002905.
- Vande Walle, L., P. Van Damme, et al. (2007). "Proteome-wide Identification of HtrA2/Omi Substrates." *J Proteome Res* **6**(3): 1006-1015.
- Varjak, M., E. Zusinaite, et al. (2010). "Novel functions of the alphavirus nonstructural protein nsP3 C-terminal region." *J Virol* **84**(5): 2352-2364.
- Vasiljeva, L., A. Merits, et al. (2000). "Identification of a novel function of the alphavirus capping apparatus. RNA 5'-triphosphatase activity of Nsp2." *J Biol Chem* **275**(23): 17281-17287.
- Vasiljeva, L., L. Valmu, et al. (2001). "Site-specific protease activity of the carboxyl-terminal domain of Semliki Forest virus replicase protein nsP2." *J Biol Chem* **276**(33): 30786-30793.
- Vassilopoulos, D. and L. H. Calabrese (2003). "Rheumatic manifestations of hepatitis C infection." *Curr Rheumatol Rep* **5**(3): 200-204.
- Vassilopoulos, D. and L. H. Calabrese (2008). "Virally associated arthritis 2008: clinical, epidemiologic, and pathophysiologic considerations." *Arthritis Res Ther* **10**(5): 215.
- Vazeille, M., S. Moutailler, et al. (2007). "Two Chikungunya isolates from the outbreak of La Reunion (Indian Ocean) exhibit different patterns of infection in the mosquito, *Aedes albopictus*." *PLoS One* **2**(11): e1168.
- Veber, M., G. R. Arroe, et al. (2007). "[Chikungunya fever, "that which bends". Epidemic in Africa and Asia--several cases imported to Denmark]." *Ugeskr Laeger* **169**(24): 2311-2313.
- Venkataraman, T., M. Valdes, et al. (2007). "Loss of DEXD/H box RNA helicase LGP2 manifests disparate antiviral responses." *J Immunol* **178**(10): 6444-6455.
- Verrier, B., R. Le Grand, et al. (2002). "Evaluation in rhesus macaques of Tat and rev-targeted immunization as a preventive vaccine against mucosal challenge with SHIV-BX08." *DNA Cell Biol* **21**(9): 653-658.
- Vershinskii, B. V., K. L'Vov D, et al. (1983). "[Karelian fever--a new nosological form of arbovirus etiology (togaviridae, alphavirus, Sindbis complex)]." *Tr Inst Im Pastera* **60**: 31-35.
- Vierboom, M. P., M. Jonker, et al. (2007). "Preclinical models of arthritic disease in non-human primates." *Drug Discov Today* **12**(7-8): 327-335.
- Vijayakumar, K. P., T. S. Nair Anish, et al. (2011). "Clinical Profile of Chikungunya Patients during the Epidemic of 2007 in Kerala, India." *J Glob Infect Dis* **3**(3): 221-226.
- Vogel, P., W. M. Kell, et al. (2005). "Early events in the pathogenesis of eastern equine encephalitis virus in mice." *Am J Pathol* **166**(1): 159-171.
- Volk, S. M., R. Chen, et al. (2010). "Genome-scale phylogenetic analyses of chikungunya virus reveal independent emergences of recent epidemics and various evolutionary rates." *J Virol* **84**(13): 6497-6504.
- von Bonsdorff, C. H. and S. C. Harrison (1975). "Sindbis virus glycoproteins form a regular icosahedral surface lattice." *J Virol* **16**(1): 141-145.
- von Bonsdorff, C. H. and S. C. Harrison (1978). "Hexagonal glycoprotein arrays from Sindbis virus membranes." *J Virol* **28**(2): 578-583.
- Vrancken, K., P. Vervaeke, et al. (2011). "Viruses as key regulators of angiogenesis." *Rev Med Virol* **21**(3): 181-200.
- Wagner, R. R. (1964). "Inhibition of Interferon Biosynthesis by Actinomycin D." *Nature* **204**: 49-51.
- Wagner, R. W., J. E. Smith, et al. (1989). "A double-stranded RNA unwinding activity introduces structural alterations by means of adenosine to inosine conversions in mammalian cells and *Xenopus* eggs." *Proc Natl Acad Sci U S A* **86**(8): 2647-2651.
- Wajant, H. (2002). "The Fas signaling pathway: more than a paradigm." *Science* **296**(5573): 1635-1636.

- Walczak, H., M. A. Degli-Esposti, et al. (1997). "TRAIL-R2: a novel apoptosis-mediating receptor for TRAIL." *EMBO J* **16**(17): 5386-5397.
- Waldburger, J. M., K. Masternak, et al. (2000). "Lessons from the bare lymphocyte syndrome: molecular mechanisms regulating MHC class II expression." *Immunol Rev* **178**: 148-165.
- Wang, C., L. Deng, et al. (2001). "TAK1 is a ubiquitin-dependent kinase of MKK and IKK." *Nature* **412**(6844): 346-351.
- Wang, E., E. Volkova, et al. (2008). "Chimeric alphavirus vaccine candidates for chikungunya." *Vaccine* **26**(39): 5030-5039.
- Wang, H. L., J. O'Rear, et al. (1996). "Mutagenesis of the Sindbis virus nsP1 protein: effects on methyltransferase activity and viral infectivity." *Virology* **217**(2): 527-531.
- Wang, J., H. J. Chun, et al. (2001). "Caspase-10 is an initiator caspase in death receptor signaling." *Proc Natl Acad Sci U S A* **98**(24): 13884-13888.
- Wang, J. P., E. A. Kurt-Jones, et al. (2005). "Varicella-zoster virus activates inflammatory cytokines in human monocytes and macrophages via Toll-like receptor 2." *J Virol* **79**(20): 12658-12666.
- Wang, K., D. Scheel-Toellner, et al. (2003). "Inhibition of neutrophil apoptosis by type 1 IFN depends on cross-talk between phosphoinositol 3-kinase, protein kinase C-delta, and NF-kappa B signaling pathways." *J Immunol* **171**(2): 1035-1041.
- Wang, K. S., R. J. Kuhn, et al. (1992). "High-affinity laminin receptor is a receptor for Sindbis virus in mammalian cells." *J Virol* **66**(8): 4992-5001.
- Wang, Q. and G. G. Carmichael (2004). "Effects of length and location on the cellular response to double-stranded RNA." *Microbiol Mol Biol Rev* **68**(3): 432-452, table of contents.
- Wang, T., T. Town, et al. (2004). "Toll-like receptor 3 mediates West Nile virus entry into the brain causing lethal encephalitis." *Nat Med* **10**(12): 1366-1373.
- Wang, Y. F., S. G. Sawicki, et al. (1991). "Sindbis virus nsP1 functions in negative-strand RNA synthesis." *J Virol* **65**(2): 985-988.
- Wang, Y. F., S. G. Sawicki, et al. (1994). "Alphavirus nsP3 functions to form replication complexes transcribing negative-strand RNA." *J Virol* **68**(10): 6466-6475.
- Wang, Y. Y., L. Li, et al. (2004). "A20 is a potent inhibitor of TLR3- and Sendai virus-induced activation of NF-kappaB and ISRE and IFN-beta promoter." *FEBS Lett* **576**(1-2): 86-90.
- Waterston, R. H., K. Lindblad-Toh, et al. (2002). "Initial sequencing and comparative analysis of the mouse genome." *Nature* **420**(6915): 520-562.
- Wauquier, N., P. Becquart, et al. (2011). "The acute phase of Chikungunya virus infection in humans is associated with strong innate immunity and T CD8 cell activation." *J Infect Dis* **204**(1): 115-123.
- Way, S. J., B. A. Lidbury, et al. (2002). "Persistent Ross River virus infection of murine macrophages: an in vitro model for the study of viral relapse and immune modulation during long-term infection." *Virology* **301**(2): 281-292.
- Weaver, S. C. and A. D. Barrett (2004). "Transmission cycles, host range, evolution and emergence of arboviral disease." *Nat Rev Microbiol* **2**(10): 789-801.
- Weaver, S. C., C. Ferro, et al. (2004). "Venezuelan equine encephalitis." *Annu Rev Entomol* **49**: 141-174.
- Weaver, S. C., A. M. Powers, et al. (1999). "Molecular epidemiological studies of veterinary arboviral encephalitides." *Vet J* **157**(2): 123-138.
- Weihua, X., S. Ramanujam, et al. (1998). "The polyoma virus T antigen interferes with interferon-inducible gene expression." *Proc Natl Acad Sci U S A* **95**(3): 1085-1090.
- Weiss, B., H. Nitschko, et al. (1989). "Evidence for specificity in the encapsidation of Sindbis virus RNAs." *J Virol* **63**(12): 5310-5318.
- Werneke, S. W., C. Schilte, et al. (2011). "ISG15 is critical in the control of Chikungunya virus infection independent of UbE1L mediated conjugation." *PLoS Pathog* **7**(10): e1002322.

- Werts, C., R. I. Tapping, et al. (2001). "Leptospiral lipopolysaccharide activates cells through a TLR2-dependent mechanism." *Nat Immunol* **2**(4): 346-352.
- Wesselingh, S. L., B. Levine, et al. (1994). "Intracerebral cytokine mRNA expression during fatal and nonfatal alphavirus encephalitis suggests a predominant type 2 T cell response." *J Immunol* **152**(3): 1289-1297.
- White, E. (1996). "Life, death, and the pursuit of apoptosis." *Genes Dev* **10**(1): 1-15.
- White, L. K., T. Sali, et al. (2011). "Chikungunya virus induces IPS-1-dependent innate immune activation and protein kinase R-independent translational shutoff." *J Virol* **85**(1): 606-620.
- Whitten, T. M., A. T. Quets, et al. (1991). "Identification of the hepatitis B virus factor that inhibits expression of the beta interferon gene." *J Virol* **65**(9): 4699-4704.
- Wielanek, A. C., J. D. Monredon, et al. (2007). "Guillain-Barre syndrome complicating a Chikungunya virus infection." *Neurology* **69**(22): 2105-2107.
- Wilkerson, M. J., W. C. Davis, et al. (1995). "Immunopathology of chronic lentivirus-induced arthritis." *Am J Pathol* **146**(6): 1433-1443.
- Wreschner, D. H., J. W. McCauley, et al. (1981). "Interferon action--sequence specificity of the ppp(A2'p)nA-dependent ribonuclease." *Nature* **289**(5796): 414-417.
- Wu, D., H. D. Wallen, et al. (1997). "Interaction and regulation of the *Caenorhabditis elegans* death protease CED-3 by CED-4 and CED-9." *J Biol Chem* **272**(34): 21449-21454.
- Xu, G. and Y. Shi (2007). "Apoptosis signaling pathways and lymphocyte homeostasis." *Cell Res* **17**(9): 759-771.
- Xu, L. G., Y. Y. Wang, et al. (2005). "VISA is an adapter protein required for virus-triggered IFN-beta signaling." *Mol Cell* **19**(6): 727-740.
- Xu, X. N., G. R. Screaton, et al. (2001). "Virus infections: escape, resistance, and counterattack." *Immunity* **15**(6): 867-870.
- Yamamoto, M., S. Sato, et al. (2003). "Role of adaptor TRIF in the MyD88-independent toll-like receptor signaling pathway." *Science* **301**(5633): 640-643.
- Yamashiro, S., H. Kamohara, et al. (2001). "Phenotypic and functional change of cytokine-activated neutrophils: inflammatory neutrophils are heterogeneous and enhance adaptive immune responses." *J Leukoc Biol* **69**(5): 698-704.
- Yang, J., Y. Lin, et al. (2001). "The essential role of MEKK3 in TNF-induced NF-kappaB activation." *Nat Immunol* **2**(7): 620-624.
- Yang, Q. H., R. Church-Hajduk, et al. (2003). "Omi/HtrA2 catalytic cleavage of inhibitor of apoptosis (IAP) irreversibly inactivates IAPs and facilitates caspase activity in apoptosis." *Genes Dev* **17**(12): 1487-1496.
- Yang, Y. L., L. F. Reis, et al. (1995). "Deficient signaling in mice devoid of double-stranded RNA-dependent protein kinase." *EMBO J* **14**(24): 6095-6106.
- Yap, G., K. Y. Pok, et al. (2010). "Evaluation of Chikungunya diagnostic assays: differences in sensitivity of serology assays in two independent outbreaks." *PLoS Negl Trop Dis* **4**(7): e753.
- Yarovinsky, F., D. Zhang, et al. (2005). "TLR11 activation of dendritic cells by a protozoan profilin-like protein." *Science* **308**(5728): 1626-1629.
- Yates, R. M. and D. G. Russell (2005). "Phagosome maturation proceeds independently of stimulation of toll-like receptors 2 and 4." *Immunity* **23**(4): 409-417.
- Yergolkar, P. N., B. V. Tandale, et al. (2006). "Chikungunya outbreaks caused by African genotype, India." *Emerg Infect Dis* **12**(10): 1580-1583.
- Yeung, M. C. and A. S. Lau (1998). "Tumor suppressor p53 as a component of the tumor necrosis factor-induced, protein kinase PKR-mediated apoptotic pathway in human promonocytic U937 cells." *J Biol Chem* **273**(39): 25198-25202.
- Yewdell, J. W. and J. R. Bennink (1999). "Mechanisms of viral interference with MHC class I antigen processing and presentation." *Annu Rev Cell Dev Biol* **15**: 579-606.

- Yin, W., T. Hasunuma, et al. (2000). "Synovial hyperplasia in HTLV-I associated arthropathy is induced by tumor necrosis factor-alpha produced by HTLV-I infected CD68+ cells." *J Rheumatol* **27**(4): 874-881.
- Yin, X. M., K. Wang, et al. (1999). "Bid-deficient mice are resistant to Fas-induced hepatocellular apoptosis." *Nature* **400**(6747): 886-891.
- Yoneyama, M. and T. Fujita (2009). "RNA recognition and signal transduction by RIG-I-like receptors." *Immunol Rev* **227**(1): 54-65.
- Yoneyama, M., M. Kikuchi, et al. (2005). "Shared and unique functions of the DExD/H-box helicases RIG-I, MDA5, and LGP2 in antiviral innate immunity." *J Immunol* **175**(5): 2851-2858.
- Yoosuf, A. A., I. Shiham, et al. (2009). "First report of chikungunya from the Maldives." *Trans R Soc Trop Med Hyg* **103**(2): 192-196.
- York, I. A. and K. L. Rock (1996). "Antigen processing and presentation by the class I major histocompatibility complex." *Annu Rev Immunol* **14**: 369-396.
- Young, N. S. and K. E. Brown (2004). "Parvovirus B19." *N Engl J Med* **350**(6): 586-597.
- Zacks, M. A. and S. Paessler (2010). "Encephalitic alphaviruses." *Vet Microbiol* **140**(3-4): 281-286.
- Zamanian-Daryoush, M., T. H. Mogensen, et al. (2000). "NF-kappaB activation by double-stranded-RNA-activated protein kinase (PKR) is mediated through NF-kappaB-inducing kinase and IkappaB kinase." *Mol Cell Biol* **20**(4): 1278-1290.
- Zanetti, M. (2004). "Cathelicidins, multifunctional peptides of the innate immunity." *J Leukoc Biol* **75**(1): 39-48.
- Zhang, D., G. Zhang, et al. (2004). "A toll-like receptor that prevents infection by uropathogenic bacteria." *Science* **303**(5663): 1522-1526.
- Zhang, M., X. Wu, et al. (2008). "Regulation of IkappaB kinase-related kinases and antiviral responses by tumor suppressor CYLD." *J Biol Chem* **283**(27): 18621-18626.
- Zhang, W., S. Mukhopadhyay, et al. (2002). "Placement of the structural proteins in Sindbis virus." *J Virol* **76**(22): 11645-11658.
- Zhao, C., C. Denison, et al. (2005). "Human ISG15 conjugation targets both IFN-induced and constitutively expressed proteins functioning in diverse cellular pathways." *Proc Natl Acad Sci U S A* **102**(29): 10200-10205.
- Zhao, T., L. Yang, et al. (2007). "The NEMO adaptor bridges the nuclear factor-kappaB and interferon regulatory factor signaling pathways." *Nat Immunol* **8**(6): 592-600.
- Zhao, Y., D. B. Conze, et al. (2007). "Tumor necrosis factor receptor 2 signaling induces selective c-IAP1-dependent ASK1 ubiquitination and terminates mitogen-activated protein kinase signaling." *J Biol Chem* **282**(11): 7777-7782.
- Zhou, A., J. Paranjape, et al. (1997). "Interferon action and apoptosis are defective in mice devoid of 2',5'-oligoadenylate-dependent RNase L." *EMBO J* **16**(21): 6355-6363.
- Zhou, S., E. A. Kurt-Jones, et al. (2005). "MyD88 is critical for the development of innate and adaptive immunity during acute lymphocytic choriomeningitis virus infection." *Eur J Immunol* **35**(3): 822-830.
- Zhou, Y. (2008). "Regulatory T cells and viral infections." *Front Biosci* **13**: 1152-1170.
- Zhu, J. (1996). "Ultraviolet B irradiation and cytomegalovirus infection synergize to induce the cell surface expression of 52-kD/Ro antigen." *Clin Exp Immunol* **103**(1): 47-53.
- Zhu, J., J. Martinez, et al. (2007). "Innate immunity against vaccinia virus is mediated by TLR2 and requires TLR-independent production of IFN-beta." *Blood* **109**(2): 619-625.
- Zhu, W. Y., Y. L. Yang, et al. (2009). "Substitutions of 169Lys and 173Thr in nonstructural protein 1 influence the infectivity and pathogenicity of XJ-160 virus." *Arch Virol* **154**(2): 245-253.
- Ziegler-Heitbrock, H. W., G. Fingerle, et al. (1993). "The novel subset of CD14+/CD16+ blood monocytes exhibits features of tissue macrophages." *Eur J Immunol* **23**(9): 2053-2058.



- Ziegler-Heitbrock, L., P. Ancuta, et al. (2010). "Nomenclature of monocytes and dendritic cells in blood." Blood **116**(16): e74-80.
- Ziegler, S. A., L. Lu, et al. (2008). "An animal model for studying the pathogenesis of chikungunya virus infection." Am J Trop Med Hyg **79**(1): 133-139.
- Zipris, D., E. Lien, et al. (2005). "TLR activation synergizes with Kilham rat virus infection to induce diabetes in BBDR rats." J Immunol **174**(1): 131-142.
- Zou, H., W. J. Henzel, et al. (1997). "Apaf-1, a human protein homologous to C. elegans CED-4, participates in cytochrome c-dependent activation of caspase-3." Cell **90**(3): 405-413.
- Zou, H., Y. Li, et al. (1999). "An APAF-1.cytochrome c multimeric complex is a functional apoptosome that activates procaspase-9." J Biol Chem **274**(17): 11549-11556.
- Zuniga, E. I., L. Y. Liou, et al. (2008). "Persistent virus infection inhibits type I interferon production by plasmacytoid dendritic cells to facilitate opportunistic infections." Cell Host Microbe **4**(4): 374-386.

## **X. Annexes**

## Review 1

### **Virus-induced encephalitis and innate immune responses – A focus on emerging or re-emerging viruses**

Denizot M., Thon-Hon VG, **Kumar S**, Neal J.W. and Gasque P. Non Flavivirus encephalitis.

Edited by S Tkachev, *Intech.*, 2011

**Aim of the review:** A wide variety of emerging or re-emerging virus contributes to CNS infection related to neurological disease. Massive outbreaks in the recent past have shown the divergent of the few viruses from non- neurovirulence to neurovirulence such as WNV, CHIKV and enterovirus 71. Herein we discussed the pathological mechanisms as well as the innate immune mechanism engaged during encephalitis with emphasis on chikungunya.

Pathological and immune mechanisms induced by viruses were highlighted in this review:

- Clinical manifestation of the virus; Clinical acute viral encephalitis includes fever, headache and altered level of consciousness. Neurons are the primary target of many viruses.
- Mechanism of virus entry into CNS: virus use different mechanisms to gain access to the CNS such as by infecting micro-vascular endothelial cells, crossing the blood brain barrier (BBB) within virally infected leukocytes, by taking the advantage of incomplete closure of the BBB and/or finally through peripheral neuronal route.
- Infection and replication of the virus in the brain; virus use different receptor to infect the cells like nectin-1 and nectin-2 for HSV, CD46 for HHV6, Ephrins for Hendra virus, scavenger receptor class B membrane 2 and EV71, CD4 for HIV. Apart from these receptors viruses also uses some secondary receptors like CXCR4 and CCR5 for

HIV. Apart from receptors mediated entry viruses also use apoptotic blebs and can spread from cells to cells, while being protected from the antiviral immune response.

- Innate immune responses: CNS infected cells use different PRRs to detect the virus such as TLRs, RLRs. These PRRs once activated lead to the expression of antiviral response through IFN and IFN induced ISGs.
- Apoptosis and autophagy; infected apoptotic cells can be engulf and degraded whereas, cytoplasmic proteins and organelles(including viruses) can be degraded by autophagy.

**General conclusion:** Altogether, this review describes the cross-talk between viruses and the cells and mechanisms implicated in the CNS anti-viral protection.

**My Contribution to this review:** In this review, I personally address the different pathways of virus entry into the CNS.

# Chapter Number

## Virus-Induced Encephalitis and Innate Immune Responses - A Focus on Emerging or Re-Emerging Viruses

Melanie Denizot<sup>1</sup>, Vincent G. Thon-Hon<sup>1</sup>,  
Shiril Kumar<sup>1</sup>, Jim W Neal<sup>2</sup> and Philippe Gasque<sup>1</sup>.

<sup>1</sup>GRI/IRG, Immunopathology and Infectious disease Research Grouping (IRG, GRI),  
EA4517, University, CHR Felix Guyon and CYROI of La Reunion

<sup>2</sup>Neuropathology Laboratory, Dept of Histopathology,  
Cardiff University Medical School., CF14 4XN

<sup>1</sup>France

<sup>2</sup>UK

### 1. Introduction

A wide variety of emerging and re-emerging viruses (e.g. arboviruses, 'arthropod-borne viruses') contributes to neurological diseases. Infections can be associated with new viral variants that are more efficiently transmitted and leading to massive outbreak and increased reports of complicated cases involving the CNS (Tsetsarkin et al., 2007; Vazeille et al., 2007). It is also possible that viruses may have acquired increased neurovirulence by a previously non-neurotropic virus. Viruses that appear to have recently become more neurovirulent include for example the West Nile flavivirus (WNV), Chikungunya alphavirus (CHIKV) and the enterovirus 71 (ENV71) (Griffin, 2010). In addition to these newer challenges, Japanese encephalitis flavivirus (JEV), rabies, polio, measles virus (MV), human immunodeficiency virus (HIV) and human herpes virus (HHV) remain important causes of neurologic diseases. Focusing on CHIKV, this is an alphavirus of the *Togaviridae* family transmitted by mosquitoes of the *Aedes (Ae)* genus. The alphavirus group comprises 29 viruses, six of which of the 'Old World, ie Africa' can cause human joint disorders (arthralgia evolving to arthritis), namely CHIKV, o'nyong-nyong virus (ONNV), Semliki forest virus (SFV), Ross River (RRV), Sindbis virus (SINV), Mayaro virus (MAYV) while the so-called 'New World' such as Eastern equine encephalitis virus (EEEV) and Venezuelan equine encephalitis virus (VEEV) can cause severe brain damage (Das et al., 2010; Jaffar-Bandjee et al., 2009). Interestingly, CHIKV-associated neuropathology was first described in the 1960s but it is the unprecedented incidence rate in the Indian Ocean with efficient clinical facilities that allowed a better description of cases with severe encephalitis, meningoencephalitis, peripheral neuropathies and deaths among newborns (mother-to-child infection), infants and elderly patients (Das et al., 2010; Jaffar-Bandjee et al., 2009). The follow-up of the neonates contaminated by CHIKV clearly indicates poor outcomes and neurodevelopment defects (Jaffar-Bandjee et al., 2011). Neurological manifestations described in adults requiring hospitalization involved cases of encephalopathy frequently associated with the

1 presence of IgM anti-CHIKV in the CSF, encephalitis, Guillain-Barre,  
2 encephalomyeloradiculitis and rare deaths (Economopoulou et al., 2009; Lemant et al., 2008).  
3 In recent histopathological studies, CHIKV infection in adults was associated with bilateral  
4 frontoparietal white matter lesions with restricted diffusion, which is described as an early  
5 sign of viral encephalitis (Ganesan et al., 2008). Focal perivascular lymphocytic infiltrates  
6 were also present in area of active demyelination and some degree of microglial activation  
7 was also noted in the gray matter which may contribute to bystander neuronal loss  
8 (Ganesan et al., 2008). Although data are still scarce, the number of cases with CNS  
9 involvement appears to support the neurotropic/neuroinfectious activity of CHIKV. This  
10 unique CNS infection illustrated by subventricular white matter lesions and  
11 intraparenchymal haemorrhages have been confirmed experimentally. CHIKV diseases can  
12 be reproduced in several animal models and the virus was shown to infect mouse/macaque  
13 brains and to replicate in cultures of glial and neuronal cells (Gardner et al., 2010; Labadie et  
14 al., 2010; Solignat et al., 2009; Wang et al., 2008; Ziegler et al., 2008). The incidence of  
15 neuroinfection is dramatically increased following either the injection of high viral titers, the  
16 route of injection (intranasal > intraperitoneal), in young animals (less than two week-old)  
17 or in mice failing to mount a robust interferon response (i.e. IFNAR knockout animals).  
18 Thus, experimental infections where mice were inoculated subcutaneously showed rapid  
19 and robust replication ( $10^6$ - $10^7$  PFU/ml) of CHIKV in the brain particularly of newborn  
20 mice. Interestingly, infected mice showed signs of illness suggestive of human clinical  
21 pathology such as loss of balance, difficulty of walking, dragging of the hind limbs, skin  
22 lesions but with rare mortality. CHIKV neuroinfection is particularly severe in IFNAR -/-  
23 mice and targeting the leptomeninges, the choroid plexus and ependymal cells lining the  
24 subventricular zone (SVZ) also known as one of the neural stem cell niche in adult brains.  
25 The nature of the receptor(s) mediating cell attachment and infection remains to be  
26 characterized but the role of apoptotic blebs carrying the virus from cell to cell has recently  
27 been established as in a Trojan-horse paradigm (see below). On the one hand, the local  
28 innate immune response is key to the control of viral infection but could also, on the other,  
29 contribute to neuronal loss through the uncontrolled release of cytotoxic inflammatory  
30 cytokines, complement proteins or proapoptotic molecules (TNF- $\alpha$ , FasL, granzymes)  
31 (Hauwel et al., 2005). We will review herein the pathological mechanisms as well as the  
32 innate immune mechanisms engaged during encephalitis and with special emphasis on  
33 chikungunya.

## 34 **2. Encephalitis and clinical manifestations**

35 The clinical hallmark of acute viral encephalitis includes classically fever, headache, and  
36 altered level of consciousness. Other associated clinical observations are disorientation,  
37 behavioral and speech disturbances and seizures. These clinical signs distinguish a patient  
38 with encephalitis from one with viral meningitis, who can have headache, nuchal rigidity,  
39 and fever (Whitley and Gnann, 2002). Clinical findings reflect disease progression and the  
40 specific areas of CNS involvement, which is determined by the tropism of different viruses  
41 for different cell types expressing different viral receptors. Neurons are most likely to be  
42 targeted by several viruses such as polioviruses which preferentially infect motor neurons  
43 and rabies which selectively infects neurons of the limbic system (Griffin, 2010).  
44 Oligodendrocytes, the myelin-forming cells can also be infected (e.g. HHV6, SFV) and  
45 leading to direct or indirect demyelination (Fazakerley et al., 2006; Mock et al., 1999). Other

1 cells within the CNS can also be the site of viral replication and for instance with mumps  
2 virus which can infect epithelial cells of the choroid plexus. The involvement of ependymal  
3 cells of the SVZ can result in hydranencephaly following infection for instance by  
4 adenoviruses or coxsackie viruses.

5 Viruses vary greatly in their capacity to induce encephalitis. For some viruses (e.g. mumps),  
6 neuroinfection is a common but a relatively benign part of the syndrome.

7 For others (flaviviruses such as JEV or WNV), although the infection is highly  
8 asymptomatic, CNS infection when it occurs is the most prominent clinical feature. A third  
9 group of viruses are those which commonly cause infection, but only rarely cause  
10 encephalitis (herpes simplex virus, HSV or CHIKV). In this group, newborns and elderly  
11 patients are at risk because they either have a poor or inappropriate immune response  
12 against the infectious challenge (Hoarau et al., 2010).

13 A paramyxovirus isolated from a Malaysian patient with encephalitis showed *in vitro*  
14 characteristics similar to Hendra virus (HeV), a new morbillivirus previously isolated from  
15 horses and human in 1995. Subsequent virological studies have shown that the Malaysian  
16 pathogen, now named Nipah virus (NiV), is closely related to, but distinct from HeV and  
17 that the two belong to a new genus within the family paramyxoviridae capable of causing  
18 major outbreaks of encephalitis. Patients present with fever, headache, dizziness, vomiting,  
19 and altered mental state.

20 Finally, there are viruses for which human infection inevitably and exclusively results in  
21 CNS disease (e.g. rabies). In addition to acute pathology, other viruses (e.g. measles) can  
22 cause syndromes of post-infectious encephalopathy with the capacity of the virus to hide  
23 into tissue sanctuaries. The capacity of these viruses to reactivate the viral cycle is poorly  
24 understood and may be the results of immune escape mechanisms.

### 25 **3. Molecular and cellular mechanisms for virus entry into the CNS**

26 The clinical manifestations of many virus infections are dependent on whether or not virus  
27 gains access to susceptible cells within the CNS. Therefore, the mechanisms by which  
28 viruses penetrate the CNS are of prime importance in understanding the pathogenesis of the  
29 disease. To understand the invasion process it is necessary to describe one of the  
30 defensive structures that prevent microbial invasion. The CNS is enclosed completely by  
31 three different but connected blood-brain interfaces (Abbott et al., 2010).

32 A blood-brain barrier (BBB) composed of brain micro-vascular endothelial cells (BMEC)  
33 with intercellular tight junctions and supported by astrocytes, pericytes and the basement  
34 membrane. The second interface is highly vascularized and fenestrated barrier localized at  
35 the choroid plexus between blood and cerebrospinal fluid (CSF), which also allows passage  
36 of some blood components and, thirdly, an interface provided by avascular arachnoid  
37 epithelium, underlying the dura, and completely enclosing the CNS (Abbott et al., 2010;  
38 Weiss et al., 2009).

39 There are at least four different mechanisms by which viruses can gain access into the  
40 CNS. First, viruses may gain access by infecting the BMEC or may be transported across  
41 the BMEC (Jarvis and Nelson, 2002). Infection of the BMEC may provide a portal for viral  
42 entry into the CNS and disrupting the BBB function. A number of viruses such as  
43 cytomegalovirus (CMV) (Jarvis and Nelson, 2002), HIV (Moses et al., 1993) and  
44 arboviruses (Dropulic and Masters, 1990) are able to infect the BMEC at least *in vitro*. In  
45 acute viral encephalitis, capillary and endothelial inflammation of cortical vessels is a

1 striking pathological finding, occurring primarily in the grey matter or grey white junction  
2 and this observation may facilitate virus entry. For example, HIV may gain access to CNS *in*  
3 *vivo* by this paracellular route as a result of endothelium activation by TNF $\alpha$  and other  
4 proinflammatory cytokines (Fiala et al., 1997).

5 Second, viruses may transmigrate across the BBB within virally infected leukocytes. For  
6 HIV, several studies suggest that virus shedding from infected CD4+ T cells, macrophages,  
7 and monocytes during migration through the BBB can instigate CNS replication into the  
8 parenchyma (Nottet et al., 1996; Persidsky et al., 1997; Schmidtmayerova et al., 1996). CMV  
9 can also be transferred to CNS by virus infected mononuclear phagocytes and bi-directional  
10 cell to cell transmission between infected monocytes and endothelial cells (Drevets and  
11 Leenen, 2000).

12 Third, viruses can also penetrate the CNS by taking advantage of incomplete closure of  
13 the BBB. Despite the intercellular tight junctions between the capillary endothelial cells  
14 in most regions of the BBB, certain areas of the CNS such as the choroid plexus,  
15 posterior pituitary, and circumventricular organs are not completely protected by the  
16 BBB due to a fenestrated endothelial cell layer and sparse basement membrane (Zhang  
17 and Tuomanen, 1999). A number of blood-borne viruses including mumps (Herndon et  
18 al., 1974), HIV (Bagasra et al., 1996) and CHIKV (Couderc et al., 2008) have been suggested  
19 to penetrate across the choroid plexus micro- vessels and infect the epithelium. In the  
20 CSF space, viruses can subsequently infect the ependymal cells and the surrounding brain  
21 tissue.

22 Finally, viruses can spread to the CNS through peripheral neuronal routes, like  
23 the motor neurons of the spinal cord, olfactory neurons, retinal neurons, oculomotor  
24 neurons and trigeminal nerves, which are directly connected to the CNS, thus providing  
25 a convenient route for neurotropic viruses (Mori et al., 2005; Tirabassi et al., 1998). Viruses  
26 including HSV (Barnett et al., 1993), rabies virus (Jackson, 2003) and VEEV (Charles et al.,  
27 1995) are able to replicate within peripheral nerves and are transported into the CNS  
28 through the axonal transport system of neurons. Certain enteroviruses can also spread to  
29 the CNS by infecting enteric neurons (Morrison and Fields, 1991). Virus spread within the  
30 CNS by retrograde, anterograde or cell to cell diffusion mechanisms.

## 31 **4. Infection and replication of viruses in brain cells**

### 32 **4.1 Primary receptors used by viruses to infect CNS cells**

33 The presence of cell membrane proteins that act as virus receptors determines whether a cell  
34 can be invaded by a virus or not. Dependent on the receptor(s) chosen, some viruses may  
35 infect nearly all mammalian cell types or only a small subset of cells from certain species.  
36 We herein have chosen to highlight only some of the receptors used by a few emerging or  
37 re-emerging viruses to infect specific cell types in the brain and to cause encephalitis.  
38 Several comprehensive reviews have discussed the role of different receptors for rabies  
39 (Acetylcholine nicotinic receptors, NCAM CD56 as well as the P75 neurotrophin receptor,  
40 NTR) (Lafon, 2005) and, hence, this aspect will not be discussed herein.

#### 41 **4.1.1 Nectin-1 and 2 are cellular receptors for HSV**

42 Nectins are immunoglobulin (Ig)-like Cell Adhesion Molecules (CAMs) involved in the  
43 formation of various intercellular junctions and the establishment of apical-basal polarity at  
44 cell-cell adhesion sites (Takai et al., 2008). The nectin family which comprises 4 members,



1 nectin-1 or poliovirus receptor related 1 (PRR1 also called HveC, CD111, HlgR), nectin-2  
 2 (also termed PRR2, HveB, CD112), nectin-3 and nectin-4. Each of them contains an  
 3 extracellular region with three Ig-like domains, a single transmembrane region, and a  
 4 cytoplasmic tail region. Nectin-1, -2 and -3 are expressed ubiquitously in multiple cell types  
 5 such as epithelia, fibroblasts and neurons, whereas nectin-4 is mainly expressed in the  
 6 human placenta. Nectin-1 and -2 have been identified as HSV entry mediators (Hve) (see  
 7 Table I). Nectin-1 can serve as entry receptors for both HSV-1 and HSV-2 (Geraghty et al.,  
 8 1998). In contrast, nectin-2 has more limited entry activity. Indeed, human nectin-2 is only a  
 9

Name	HSV	Rabies	HIV	Polio	WNV	CHIKV
<b>Virus family</b>	Alpha herpesvirus	Rhabdovirus	Retrovirus	Picorna virus	Flavivirus	Alphavirus
<b>Genome</b>	(+)DNA double stranded linear	(-)RNA single stranded linear	(+)RNA single stranded linear	(+)RNA single stranded linear	(+)RNA single stranded linear	(+)RNA Single stranded linear
<b>Envelope</b>	yes	yes	yes	No	yes	yes
<b>Route of brain entry</b>	Trigeminal Nerve Olfactory nerve	Retrograde axonal	Cell mediated BBB crossing	Retrograde Axonal + BBB crossing	Direct BBB crossing	Blood- CSF crossing
<b>Receptors</b>	Nectin-1, Nectin-2, HSPG	NCAM (CD56) AChR P75 NTR	CD4, CCR5, CXCR4	Nectin-1(PRR1), Nectin-2(PRR2)	DC-SIGN (myeloid cells)	Apoptotic bleb-mediated cell entry
<b>Targets (CNS)</b>	Neurons	Neurons	Myeloid cells microglia	Neurons	Myeloid cells Microglia	Epithelial cells Ependymal cells Neurons Glia
<b>Clinics</b>	Encephalitis Herpetic neuralgia Meningitis Myelitis	Guillain Barre like syndrome Progressive encephalitis paralysis	Dementia Encephalitis Myelitis Neuropathy	Paralysis Respiratory arrest	Encephalitis Meningitis Myopathy	Encephalopathy Encephalitis Guillain Barre
<b>Geographic distribution</b>	Worldwide	Europe Asia Africa Americas	Worldwide	India Africa	Europe Americas Africa	Africa Asia India (Europe) (Reunion)

10 (See text for abbreviation)

11 Table I. Encephalitis due to emerging and re-emerging viruses

12 weak entry receptor for HSV-2 and certain strains of HSV-1 carrying out mutations in the  
 13 glycoprotein D (Lopez et al., 2000). A more recent study also assessed the roles of the two  
 14 known entry receptors, HVEM and nectin-1, in neuronal infection in the CNS and the  
 15 development of encephalitis on a mouse model (Kopp et al., 2009). Intracranial injection of  
 16 HSV was performed directly into the hippocampus of Wild-type (WT), HVEM KO, nectin-1

1 KO and double KO mice. The results indicated that nectin-1 deficient mice showed no signs  
2 of disease after intracranial inoculation, and no HSV antigens were detectable in the brain  
3 parenchyma. However, HSV antigens were detected in non-parenchymal cells lining the  
4 ventricles. In the double KO mice, the results showed an absence of disease and no  
5 detectable expression of viral antigens even in non-parenchymal cells, indicating that  
6 infection of these cells in the nectin-1 KO mice was dependent on the expression of HveM.

#### 7 **4.1.2 CD46 is a cellular receptor for HHV6 and measles**

8 CD46 also designated as membrane cofactor protein (MCP) is a member of a family of  
9 glycoproteins acting as regulators of complement activation, but has subsequently been  
10 shown to link innate immunity to adaptative immunity (Seya et al., 1986). CD46 mediates  
11 the inactivation of its natural complement ligands C3b and C4b and acts as a cofactor for  
12 serine protease factor I (Lublin et al., 1988). CD46 thus protect host cells from homologous  
13 complement attack which could result in extensive cytolysis and widespread tissue damage.  
14 Another function of CD46 is to promote T cell differentiation from a helper Th1 to a  
15 regulatory Tr1 phenotype, depending on IL-2 concentrations (Cardone et al., 2010). Human  
16 CD46 is alternatively spliced into several isoforms, resulting in a varying number of  
17 extracellular domains and two different cytoplasmic tails, Cyt1 and Cyt2 (Seya et al., 1999).  
18 CD46 seems to be constitutively recycled from the cell surface via clathrin-coated pits and  
19 transported to perinuclear multivesicular bodies (Crimeen-Irwin et al., 2003). The  
20 importance of CD46 in the homeostasis of the organism is highlighted by its ubiquitous  
21 expression on the surface of all nucleated human cells (Liszewski et al., 1991).  
22 Human CD46 is a cellular receptor for Human Herpesvirus 6 (HHV-6) (Santoro et al., 1999)  
23 and MV (Dorig et al., 1993). The authors demonstrated that both acute infection and cell to  
24 cell fusion mediated by HHV-6 were specifically inhibited by a monoclonal antibody to  
25 CD46; fusion was also blocked by soluble CD46. Interestingly, they showed that nonhuman  
26 cells resistant to HHV-6 fusion and entry became susceptible upon expression of  
27 recombinant human CD46. Concerning the study of MV infection in the CNS, a murine  
28 model of MV-induced pathology was developed from several lines of transgenic mice  
29 expressing human CD46 molecule with Cyt1 or Cyt2 (Evlashev et al., 2000). The results of  
30 their experiments showed that all transgenic mice expressing CD46 protein in the brain  
31 were highly sensitive to intracerebral infection by the MV Edmonston strain, in comparison  
32 to nontransgenic controls. In addition, the two isoforms of CD46, Cyt1 and 2, are  
33 functionally similar in mediating MV entry into the brain.

#### 34 **4.1.3 Ephrins are cellular receptors for Hendra virus (HeV) and Nipah virus (Niv)**

35 The Eph (erythropoietin-producing hepatocellular) receptors are the largest family of  
36 tyrosine kinase receptors (TRKs). They interact with cell surface bound ligands, the ephrins  
37 (Eph receptor interacting proteins) that are a highly conserved class of proteins with many  
38 homologous members. Based on structural differences, two classes of ephrins can be  
39 classified: ephrins-A (A1 to A6) are attached to the plasma membrane via glycosphosphatidyl  
40 inositol (GPI) moiety and ephrins B (B1 to B3) crossing the plasma membrane and  
41 possessing a short cytoplasmic tail. Eph receptors have diverse functions, such as  
42 widespread effects on the actin cytoskeleton, cell-substrate adhesion, intercellular junctions,  
43 cell shape, and cell movement (Egea and Klein, 2007; Himanen et al., 2007; Pasquale, 2005;  
44 Pasquale, 2008).

1 Two independent studies identified EFNB2 as the receptor for HeV and NiV, which are  
2 emergent paramyxovirus. Of the ten potential receptor-encoding plasmids they used to  
3 transfect non-permissive HeLa cells, only the human EFNB2 plasmid confers HeV fusion  
4 permissiveness. They further demonstrated that soluble EFNB2 blocks both viruses fusion in  
5 human EFNB2-transfected HeLa cells. They also showed that both HeV and NiV glycoprotein  
6 G and EFNB2 soluble protein could be specifically and reciprocally captured by ELISA. In  
7 addition, both viruses glycoprotein G were efficiently coprecipitated by EFNB2/Fc.  
8 Another study identified EFNB2 as an entry receptor for NiV (Negrete et al., 2005). The  
9 authors also reported that EFNB2 binds to the NiV glycoprotein G. They observed that  
10 soluble Fc-fusion proteins of EFNB2 effectively blocked NiV fusion and entry into  
11 permissive cell types. Moreover, transfection of EFNB2 into non-permissive cells renders  
12 them permissive for NiV fusion and entry. Interestingly they found that soluble EFNB2  
13 inhibited NiV-envelope-mediated infection of microvascular endothelial cells and primary  
14 cortical rat neurons. EFNB3 was later discovered as an additional receptor for NiV using the  
15 Chinese hamster ovary cell line (CHO-pgsA745) that does not express ephrins  
16 endogenously (Negrete et al., 2006). Interestingly, the authors characterized the important  
17 conserved Leu-Trp residues in the G-H loop of EFNB2 and B3 that are critical for their  
18 binding with NiV glycoprotein G.

#### 19 **4.1.4 Scavenger receptor class B member 2 (SCARB2) and EV71**

20 The concept of scavenger receptors (SCAR) was first described by their ability to bind  
21 modified low-density lipoproteins (Goldstein et al., 1979). SCAR can bind a variety of  
22 natural/endogenous, modified host, microbial (bacterial, viral, fungal, and parasitic),  
23 environmental, soluble or particulates ligands by endocytosis and phagocytosis (reviewed  
24 in (Mukhopadhyay and Gordon, 2004)). SCARB2 (also known as lysosomal integral  
25 membrane protein II or CD36b like-2) belongs to the scavenger receptor class B subfamily,  
26 which also includes SCARB1 and CD36 (Calvo et al., 1995; Eskelinen et al., 2003). SCARB2  
27 is a type III double-transmembrane protein with N- as well as C-terminal cytoplasmic tails  
28 and is located primarily in lysosomes and endosomes. SCARB2 participates in membrane  
29 transportation and the reorganization of the endosomal-lysosomal compartment (Kuronita  
30 et al., 2002). Deficiency of SCARB2 in mice causes ureteric pelvic junction obstruction,  
31 deafness and peripheral neuropathy (Gamp et al., 2003). SCARB2 is widely expressed in  
32 lysosomes and late endosomes (reviewed in (Eskelinen et al., 2003)).

33 Since its identification in California in 1969 (Schmidt et al., 1974), enterovirus 71 (EV71) has  
34 been recognized as a frequent cause of epidemics of hand-foot-and-mouth disease (HFMD)  
35 associated with severe neurological sequelae in some cases (Blomberg et al., 1974). EV71  
36 infections can progress to aseptic meningitis, acute flaccid paralysis and fatal encephalitis  
37 (McMinn, 2002). A recent paper demonstrated that SCARB2 is a receptor for EV71  
38 (Yamayoshi et al., 2009). The authors showed that EV71 binds soluble SCARB2 or cells  
39 expressing SCARB2, and the binding is inhibited by an antibody to SCARB2. Furthermore,  
40 expression of human SCARB2 enables normally unsusceptible cell lines to support EV71  
41 propagation and develop cytopathic effects. Yet, the detail of the interaction between EV71  
42 and SCARB2 at the cellular level, resulting in CNS infection has not been identified.

#### 43 **4.1.5 CD4 as the primary receptor for HIV**

44 Human CD4 exhibits a poly-Ig-like domain structure which is homologous to an  
45 increasingly large number of recognition molecules, and consists in four tandem variable-

1 joining (VJ)-like domains (Maddon et al., 1987). The Ig-like domains of CD4 are anchored to  
2 the membrane by a hydrophobic segment, and followed by a short cytoplasmic region. CD4  
3 is expressed on the surface of T lymphocytes, monocytes, macrophages, and brain microglia  
4 (resident macrophages) (Wyatt and Sodroski, 1998).  
5 HIV invades the CNS early following viral infection but provokes brain disease only years  
6 later. During the periods of progressive immunosuppression, neurological disease occurs in  
7 15 to 20% of infected individuals which develop cognitive and motor impairments referred  
8 to as the HIV type 1 (HIV-1)-associated dementia complex also termed as HIV-associated  
9 dementia or HIV encephalopathy (Janssen et al., 1991; Price et al., 1988). Neurological  
10 disease is often associated with a marked depletion of CD4+ T lymphocytes (Navia et al.,  
11 1986). It is now known that HIV encephalitis is a common pathological manifestation  
12 characterized by monocyte infiltration into brain, the formation of macrophage-derived  
13 multinucleated giant cells, microglial nodules, and demyelination (Sharer et al., 1985).  
14 Considerable amount of data identified CD4 as the main entry receptor for HIV. Previous  
15 studies on the two AIDS retroviruses, human T-lymphotropic virus type III (HTLV-III) and  
16 lymphadenopathy-associated virus (LAV) helped to characterize the primary cellular  
17 receptor involved in HIV infection (Dalgleish et al., 1984; Klatzmann et al., 1984). Dalgleish  
18 and colleagues identified receptor-positive cells by assessing induction of multinucleated  
19 syncytia and by testing the susceptibility of various cell types to pseudotypes of vesicular  
20 stomatitis virus (VSV) carrying envelope antigens of HTLV strains. Their results showed  
21 that both VSV (HTLV-I) and VSV (HTLV-II) pseudotypes plated on a variety of cell types  
22 whereas the VSV (HTLV-III) was more specific to the two human T-cell lines (JM and CEM)  
23 tested. In addition, only cells expressing the CD4 antigen were sensitive to syncytium  
24 induction by HTLV-III and infection by VSV (HTLV-III) pseudotypes. After the screening of  
25 155 monoclonal antibodies to T-cell surface antigens for their ability to inhibit the syncytia  
26 formation induced by HTLV-III, they demonstrated that pre-incubation of cells with all anti-  
27 CD4 antibodies blocked the cell fusion induced by HTLV-III. In another paper published  
28 the same year, Klatzman *et al.* (Klatzmann et al., 1984) investigated the relationship between  
29 the CD4+ tropism of LAV and the presence of CD4 on T lymphocytes. Similarly to the  
30 previous paper on HTLV-III, they reported that pre-incubation of CD4+ T lymphocytes with  
31 three monoclonal antibodies directed against the CD4 glycoprotein specifically blocked cell  
32 infection by LAV.  
33 It is well documented that efficient entry of HIV-1 into target cells is dependent upon  
34 binding of the viral exterior envelope glycoprotein, gp120, to the CD4-amino-terminal  
35 domain (McDougal et al., 1986). After the virus binding, the HIV-1 envelope glycoproteins  
36 mediate the fusion of viral and host cell membranes to complete the fusion process. The  
37 formation of syncytia results in the membrane fusion directed by HIV-1 envelope  
38 glycoproteins expressed on the infected cell surface with uninfected CD4-positive cells.  
39 Although CD4 expression on a target cell seems to be sufficient for HIV attachment, the  
40 fusion process appeared to be more complex.

#### 41 **4.2 Secondary receptors of virus entry**

##### 42 **4.2.1 Chemokine receptors CXCR4 and CCR5 as HIV infection coreceptors**

43 Chemokine receptors are part of the serpentine GTP-binding protein (G protein)-coupled  
44 receptors superfamily that include receptors for hormones, neurotransmitters, paracrine  
45 substance, inflammatory mediators, certain proteinases, taste and odorant molecules. All  
46 known human chemokines fit within four classes based on the cysteine motifs near the N-

1 terminus. The two major classes are the CXC chemokines (CXCR1 to CXCR5) in which the  
2 first two cysteines are separated by a single residue, and the CC chemokines (CCR1 to  
3 CCR9) in which the first two cysteines are adjacent. CXCR4 (also termed fusin, HUMSTR,  
4 LESTR, HM89, LCRI, NPYR, D2S201E) and CCR5 (also known as CKR5, CC CKR5,  
5 ChemR13, CMKBR5) are membrane-bound co-receptors for HIV entry. CXCR4 is expressed  
6 on neutrophils, myeloid cells (as well as microglia), and particularly on T lymphocytes  
7 (Loetscher et al., 1994). CCR5 mRNA expression was detected in lymphoid organs such as  
8 the thymus and spleen, and in peripheral T lymphocytes and macrophages (Raport et al.,  
9 1996). The first HIV-1 co-receptor was identified with the use of a recombinant vaccinia  
10 virus-based construct in which fusion between the HIV gp120 envelope glycoprotein (Env)-  
11 expressing cells and CD4-expressing cells would lead to the activation of a reporter gene  
12 *Escherichia coli* LacZ (Feng et al., 1996). The screening of a HeLa cDNA plasmid library and  
13 subsequent sequence analysis of the insert revealed that the protein was a member of the G  
14 protein-coupled receptor superfamily and was designated "fusin". In addition, loss-of-  
15 function experiments showed that anti-fusin antibodies blocked cell fusion and infection of  
16 primary human CD4+ T lymphocytes. Interestingly, both experiments stressed that fusin  
17 functioned preferentially for T cell line (TCL)-tropic rather than for macrophage (M)-tropic  
18 HIV-1 isolates. The discovery of fusin provided an impetus for the identification of the M-  
19 tropic HIV isolates coreceptor. Several independent reports demonstrated that CCR5 is the  
20 major coreceptor for M-tropic HIV-1 strains (Alkhatib et al., 1996; Choe et al., 1996; Deng et  
21 al., 1996; Doranz et al., 1996; Dragic et al., 1996). The evidence was based on both gain-of-  
22 function studies using recombinant CCR5, and loss-of-function studies with CCR5  
23 chemokines ligands (MCP-1, MIP-1 $\alpha$ , MIP-1 $\beta$  and RANTES) as blocking agents. After the  
24 discovery of CCR5, it was demonstrated that fusin is a chemokine receptor that specifically  
25 recognize the CXC chemokines ligands SDF-1 $\alpha$  and SDF-1 $\beta$  (Bleul et al., 1996; Oberlin et al.,  
26 1996); fusin was thus renamed CXCR4.

#### 27 **4.2.2 Phosphatidylserine (PS), apoptotic blebs and CHIKV spreading from cells to** 28 **cells**

29 PS is a phospholipid located on the inner leaflet of the plasma membrane (Williamson and  
30 Schlegel, 1994; Zwaal and Schroit, 1997). Its internal positioning is maintained by  
31 translocases that catalyze aminophospholipid transport from the external to the internal  
32 leaflet of the plasma membrane. The loss of PS asymmetry can occur during several cellular  
33 events including cell injury, cell activation or apoptosis (Balasubramanian and Schroit,  
34 2003).

35 Two apoptotic pathways can be identified; (i) the extrinsic apoptotic pathway is initiated by  
36 members of the Tumour necrosis factor (TNF) family of death ligands that bind to TNFR  
37 death receptor family members, Tumour Necrosis Factor Receptor -related apoptosis  
38 inducing signal ligand (TRAIL) and Fas ligand (FASL). This results in the formation of the  
39 Death Inducing Signal Complex DISC at the cell membrane. DISC subsequently interacts  
40 with Fas-associated death domain protein (FADD) in caspase 8, pro caspase 3 and this  
41 activates caspase 3, resulting in host cell death (Wilson et al., 2009); (ii) The intrinsic  
42 apoptosis pathway is dependent upon the activation of host proteins such as tumour  
43 suppressor protein P53 by virus infection. This in turn activates BH-3 domain only members  
44 of the B cell lymphoma 2 (Bcl-2) family, e.g the pro-apoptotic proteins Bax and Bak. The  
45 activation of these two proteins produces pores in the outer membrane of mitochondria

1 with the release of cytochrome C activating caspase 9 and cell death (Danial and Korsmeyer,  
2 2004; Kroemer et al., 2007).  
3 Apoptosis following viral infection is a robust line defence mechanism, since the cell auto  
4 destruction appears one of the best ways to limit virus production and spreading (Griffin  
5 and Hardwick, 1997). Unequivocally, the expected purpose of this cell suicide in response to  
6 infection is to short-circuit the viral expansion and to promote the clearance of dead infected  
7 cells by professional phagocytes (Fujimoto et al., 2000; Hashimoto et al., 2007). However,  
8 most viruses deal with this defensive reaction and have evolved strategies to evade or delay  
9 apoptosis (Teodoro and Branton, 1997).  
10 Under normal cellular conditions, exposure PS serves as a recognition signal for  
11 internalization of apoptotic cells or debris. PS-mediated apoptotic clearance is a highly  
12 conserved mechanism, occurring in both professional and nonprofessional phagocytes  
13 (Henson et al., 2001). Importantly, this process does not elicit an inflammatory response  
14 (Savill et al., 2002). "Apoptotic mimicry" or the exposure of PS on the surface of a pathogen  
15 provides a signal for virus uptake and may represent a mechanism for viruses to stunt the  
16 host inflammatory response and evade immune recognition. Some viruses like CMV or  
17 HSV-1 and HSV-2, which acquire their envelopes from intracellular organelles, have  
18 externalized PS (Prydzial and Wright, 1994; Sutherland et al., 1997). A previous study  
19 investigated the early apoptotic events in real time in intact live ND7 neuron-like cells  
20 following HSV-1 infection (Gautier et al., 2003). The authors demonstrated that infection of  
21 differentiated ND7 cells by HSV-1 triggers detectable alterations including PS exposure  
22 indicative of physiological changes associated with early stages of apoptosis.  
23 Furthermore, control of the apoptotic process by the viruses is key, either to establish a  
24 permanent infection when they are able to block apoptosis, or to facilitate their  
25 dissemination and prevent inflammatory and immune response when they are able to  
26 control and activate the late phase of apoptosis (Chen et al., 2006). Dissemination of viral  
27 particles through the production of apoptotic blebs from host cells could confer protection  
28 from the immune system (Chen et al., 2006; Everett and McFadden, 1999). Conversely, it has  
29 been proposed that phagocytosis of these pathogen (Sindbis for example) -enriched  
30 apoptotic blebs by antigen presenting cells (e.g. dendritic cells) could contribute to a robust  
31 and uncontrolled adaptive immune response leading to autoimmunity against self-antigens  
32 contained within the blebs (Rosen et al., 1995). In the case of CHIKV, it has recently been  
33 evidenced that completion of the apoptotic process is an important element for efficient  
34 virus propagation (Krejbich-Trotot et al., 2011). Indeed, CHIKV was revealed to exploit,  
35 may be in parallel to classical ways of entry and cell exit, an ingenious way of camouflage in  
36 apoptotic blebs to enhance viral spreading to neighbouring cells while being shielded from  
37 the immune system.

#### 38 **4.2.3 The C-type lectin receptors and WNV cell entry**

39 The superfamily of proteins containing lectin-like domains is a large group of extracellular  
40 metazoan proteins with diverse functions (Zelensky and Gready, 2005). The main function  
41 of the calcium-dependent 'C'-type lectins is to interact with pathogen-associated molecular  
42 patterns (PAMPs) which are well conserved and expressed by various microorganisms and  
43 to internalize these pathogens for processing and antigen presentation (Drickamer, 1995).  
44 For instance, C-type lectins contain Carbohydrate Recognition Domains (CRDs) capable of  
45 binding to conserved oligosaccharides that are commonly found on the surface  
46 glycoproteins of viruses (Cambi et al., 2005). C-type lectins are secreted as soluble proteins

1 or produced as transmembrane proteins. The Mannan Binding Lectin (MBL), present in the  
2 plasma, is a member of the collectin family and is an example of soluble protein. MBL is  
3 expressed by monocytes/microglia and possesses a globular carboxy terminal sequence that  
4 binds to virus proteins containing mannose molecules. The transmembrane lectins include  
5 the Mannose Membrane Receptor (MMR also known as CD206) and the Dendritic Cell-  
6 Specific ICAM-3 Grabbing Non-integrin (DC-SIGN also known as CD209) receptor that  
7 recognizes "self" intercellular adhesion molecule 2 (ICAM2) and ICAM3 (van Kooyk and  
8 Geijtenbeek, 2003). MMR contains eight CRD (Weis et al., 1998). DC-SIGN is a type II  
9 transmembrane protein which possesses a single globular-structured CRD. DC-SIGN's CRD  
10 is separated from the transmembrane region by a neck domain involved in oligomerization  
11 and which regulates carbohydrate specificity. Finally, a cytoplasmic tail is present, which  
12 includes internalization motifs and an incomplete immunoreceptor tyrosine-based  
13 activation motif (ITAM). Microglia, perivascular macrophages and dendritic cells express  
14 MMR and DC-SIGN (Burudi et al., 1999; Linehan et al., 1999; Mukhtar et al., 2002; Sallusto et  
15 al., 1995; Schwartz et al., 2002). The expression of DC-SIGN on brain microvascular  
16 endothelial cells could be advantageous for viral entry into the CNS (Mukhtar et al., 2002).  
17 Two major lineages of WNV, L1 and L2, have been identified after the phylogenetic analyses  
18 of glycoprotein E (Lanciotti et al., 1999). L1 strains have a large distribution and have been  
19 found in Africa, Europe, the Middle-East, North and Central America whereas the L2 strain is  
20 mainly localized in Africa and Madagascar. WNV human infection is usually asymptomatic,  
21 however life-threatening neurological disease, including encephalitis or meningitis, generally  
22 occurs in older or immunocompromised individuals (Campbell et al., 2002; Granwehr et al.,  
23 2004). A recent study investigated the relative contribution of DC-SIGN in infection by  
24 glycosylated L1 and non-glycosylated L1 and L2 strains (Martina et al., 2008). The authors  
25 showed that in contrast to a non-glycosylated L1 strain, the glycosylated L1 strains use DC-  
26 SIGN as an attachment receptor on dendritic cells, leading to enhanced infection.

#### 27 **4.2.4 Heparan sulfate proteoglycans (HSPGs) and HSV**

28 Heparan sulfate proteoglycans (HSPGs) are secreted and membrane associated proteins  
29 covalently attached to unbranched glycosaminoglycan heparan sulfate (HS) molecules  
30 which are composed of linear polysaccharide chains (Esko and Selleck, 2002). HS molecules  
31 are synthesized on a variety of cell surface proteins but are found consistently on members  
32 of two major families of membrane-bound proteoglycans: the transmembrane core proteins  
33 syndecans and the GPI-linked glypicans (Bernfield et al., 1999). HS can influence cell-  
34 environment interactions by binding to a heterogeneous group of growth factors, matrix  
35 ligands, and cell surface molecules. The possibility that HS could serve as an entry receptor  
36 for HSV type 1 and 2 was assessed on HEp-2 cells (WuDunn and Spear, 1989). They found  
37 that heparin blocked both virus adsorption. Different adsorption inhibitory agents  
38 including, heparin and poly-L-lysine (both bind to anions on the surface of virions and cells)  
39 and platelet factor 4 (which has a high affinity for heparin and heparan sulfate) was tested.  
40 After the incubation of these agents with HEp-2 cells either immediately before or during  
41 exposure with HSV-1 or HSV-2, an inhibition of virions adsorption by heparin was  
42 observed. Same results for poly-L-lysine and platelet factor 4 were obtained. A further study  
43 investigated the role of cell surface heparan sulfate in HSV infection using heparan sulfate-  
44 deficient mutants CHO cells (Shieh et al., 1992). They demonstrated that CHO mutants with  
45 defect in heparan sulfate biosynthesis are resistant to HSV infection and have reduced  
46 numbers of receptor for HSV.

## 1 5. Innate immune responses against viral infection in the CNS

2 The active and highly regulated control of immune responses in the brain is referred to as  
3 "immune privilege". The BBB, which prevents viruses, constituents of the adaptive immune  
4 system and antigen presenting cells, gaining accesses to the brain (for a review, see (Savarin  
5 and Bergmann, 2008)), is considered to be responsive for this privileged environment of the  
6 CNS. The CNS, therefore relies upon glia perivascular and meningeal cells to provide the  
7 innate immune response against virus attack (Hauwel et al., 2005). Microglia, astrocytes,  
8 ependymal cells, oligodendrocytes and neurons express Pattern Recognition Receptors  
9 (PRR)s (Suh et al., 2009) including the highly conserved Toll like receptors TLRs and the  
10 Retinoic inducible gene like RIG-1 receptors (RLRs) (Fujita et al., 2007) that detect the  
11 presence of " non self "as represented by viral nucleic acids.

### 12 5.1 TLRs

13 The TLRs are PRRs that have unique and essential function in animal immunity. TLRs  
14 comprise a family of type I transmembrane receptors, which are characterized by an  
15 extracellular leucine-rich repeat (LRR) domain and an intracellular Toll-interleukin-1  
16 receptor (TIR) domain. LRR domains are found in a diverse set of proteins and mediate the  
17 recognition of components of foreign pathogens referred to as pathogen-associated  
18 molecular patterns (PAMPs) (for a review, see (Alexopoulou et al., 2001)). The cytoplasmic  
19 TIR domain of Toll proteins is a conserved protein-protein interaction module that is  
20 required for downstream signal transduction. So far, 10 and 12 functional TLRs have been  
21 identified in humans and mice, respectively, with TLR1-9 being conserved in both species  
22 (Takahashi et al., 2006). Microglia are the resident macrophages in the CNS and also express  
23 a wide range of TLRs (TLR1-9). Astrocytes express TLR1, 2, 3, 4, 5 and 9 whereas neurons  
24 mainly express TLR3 (Carty and Bowie, 2010). TLRs are located on the cell surface and are  
25 also distributed in the endosome so they are strategically placed to detect cytoplasmic viral  
26 RNA. TLR9 is activated by DNA rich in CpG motifs, whereas TLR7 and TLR8 recognize  
27 RNA viruses and ssRNA. TLR3 is activated by dsRNA formed during replication of viruses.  
28 TLRs signal through the adaptor molecules, myeloid differentiation primary response gene  
29 88 (MyD88) and Trif, to initiate intracellular signaling by transcription factors such as NFκ-B  
30 and the IFN regulatory factors (IRFs) (Alexopoulou et al., 2001). These IRFs are translocated  
31 to the host cell nucleus where they regulate inflammatory cytokine synthesis and stimulate  
32 type I interferon synthesis (IFNα-β expression) to produce a protective response (anti-viral  
33 state) in adjacent uninfected cells (Paul et al., 2007). A further anti-viral property of the IRF  
34 is through its binding to the pro-apoptotic protein Bax and translocation to the mitochondria  
35 with activation of the mitochondrial apoptotic pathway, terminating virus replication  
36 (Chattopadhyay et al., 2010). Viruses can activate more than one TLR and it is known for  
37 example that TLR9 as well as TLR2 in dendritic cells and neuronal cells can respond  
38 to HSV to drive a protective IFN-α antiviral response (Berezky-Veress et al., 2010; Sato et  
39 al., 2006). RNA viruses such as HIV, Rabies and WNV are more likely to be recognized by  
40 TLR3 and/or TLR7 or 8 expressed by microglia and neuronal cells (Prehaud et al., 2005;  
41 Szretter et al., 2010; Wang et al., 2004). The absence of TLR3 enhances WNV mortality in  
42 mice and increases viral burden in the brain (Daffis et al., 2008). Compared to wild-type  
43 controls, TLR3 -/- mice showed relatively little changes in peripheral viral loads.  
44 Interestingly, deficiency of TLR3 was associated with enhanced viral replication in primary  
45 cortical neuron cultures and greater WNV infection in neurons after intracranial inoculation



1 while no significant differences were noted in viral growth kinetics or IFN-alpha/beta  
2 induction between wild-type and TLR3 KO fibroblasts, macrophages, and dendritic cells.

### 3 **5.2 The RIG-I-like receptors (RLRs)**

4 After the discovery of TLRs, several classes of PRRs, including the RLRs were identified.  
5 The RLR family consists of the three RNA helicases members: retinoic inducible gene-I (RIG-  
6 I), the melanoma differentiation-associated factor 5 (MDA5 also known as helicard or IFIH1)  
7 and the laboratory of genetics and physiology 2 (LGP2) that detect RNA viruses (Yoneyama  
8 and Fujita, 2009). RIG-I and MDA5 contain a C-terminal DExD/H box RNA helicase domain  
9 that is a characteristic amino acid signature motif of many RNA binding proteins, as well as  
10 two N-terminal caspase activation and recruitment domain (CARDs). LGP2 lacks CARD  
11 domains and has been proposed to function as a regulator of RIG-I/MDA5 signaling  
12 (Nakhaei et al., 2009). RIG-1 and MDA-5 are expressed by microglia and astrocytes, and  
13 located mainly in the cytosol and detect both short and long ds and ssRNA respectively  
14 (Furr et al., 2008; Hoarau et al., 2011). This interaction activates a series of intracellular  
15 signaling pathways using the adaptor molecules such as Interferon promoter stimulator  
16 (IPS-1) resulting in the transcription of IFN $\alpha\beta$  interleukins and a range of anti-viral proteins.  
17 IPS-1 is key in the control of cell infection by several alphaviruses and flaviviruses including  
18 CHIKV and WNV, respectively. IPS-1<sup>-/-</sup> mice was recently shown to exhibit increased  
19 susceptibility to WNV infection marked by enhanced viral replication and dissemination  
20 with early viral entry into the CNS (Suthar et al., 2010). Moreover, infection of dendritic cells  
21 macrophages and primary cortical neurons showed that the IPS-1-dependent RLR signaling  
22 was essential for triggering IFN response (Suthar et al., 2010). Unexpectedly, infected KO  
23 mice also displayed uncontrolled inflammation that included elevated systemic type I IFN,  
24 proinflammatory cytokine and chemokine responses, increased numbers of inflammatory  
25 cells, enhanced humoral responses marked by complete loss of virus neutralization activity,  
26 and increased numbers of virus-specific CD8<sup>+</sup> T cells and non-specific immune cell  
27 proliferation in the periphery and in the CNS. This uncontrolled inflammatory response was  
28 associated with a lack of regulatory T cell expansion that normally occurs during acute  
29 WNV infection. Thus, the enhanced inflammatory response in the absence of IPS-1 was  
30 coupled with a failure to protect against WNV infection. This is an important finding which  
31 stresses that IPS-1-dependent RLR signaling is equally important in the innate/adaptive  
32 immune responses but also in the balance of the immune response to WNV infection. With  
33 regards to CHIKV, it has recently been shown that IPS-1 is important at least in the  
34 periphery to drive a robust anti-viral response (Schilte et al., 2010).

### 35 **5.3 CNS Innate immune system; Interferon type 1 and 2 responses stimulate an anti- 36 viral response**

37 Mice deficient for the type I IFN receptor (IFNAR) has proved the fundamental importance  
38 of the type I IFN in the control of virus replication (Couderc et al., 2008; Muller et al., 1994).  
39 Indeed, CNS virus infections are more lethal in mice deficient in IFNAR than the wild type  
40 equivalent, emphasizing the importance of IFN $\alpha\beta$ /IFNAR pathway for anti-viral defense  
41 (Griffin, 2003; Paul et al., 2007). The type 1 interferon response is made by most CNS cells  
42 and results in a non-apoptotic anti-viral response by the host cell reducing infection by a  
43 replicating RNA virus (Katze et al., 2002). The IFN anti-viral response involves IFN binding  
44 to IFNAR on the host cell leading to the activation of Janus kinases (JAK) with  
45 phosphorylation of the activators of transcription factors (STAT1 and STAT2). These two

1 proteins enter the nucleus to drive the expression of interferon stimulated genes (ISGs)  
2 (Goodbourn et al., 2000). Host CNS cells in response to IFN stimulation produces a range of  
3 anti-viral ISGs, including oligoadenylate synthetase (OAS) and IFN-inducible ds RNA –  
4 dependent protein kinase (PKR) that both modulate virus replication; RNase L and Mx that  
5 inhibit viral transcription together with the RNA deaminases (ADAR-1 and APOBEC3G)  
6 producing mutations in viral genomes (Goodbourn et al., 2000) (George et al., 2009) (Toth et  
7 al., 2009). Host interferon regulatory factors (IRFs) IRF-7, IRF-9, and ISG54 are all increased  
8 following CNS virus infection and one IRF, ISG15, has been found to be significantly  
9 increased in astrocytes following their infection with RNA virus (Paul et al., 2007). Type 2  
10 interferon response is due to the interferon  $\gamma$  again a glycoprotein expressed by activated T  
11 cells when TCR binds to their cognate antigen (Goodbourn et al., 2000). Many of the  
12 emerging viruses disable the host anti-viral response by targeting the pathways responsible  
13 for regulating IFN and anti-viral proteins.

#### 14 **5.4 Phagocytosis and removal of infected cells**

15 The particularity of the CNS is that it is composed by a majority of cells that are non-  
16 renewable. Hence, it is fundamental to rapidly clear the infected cells and limiting bystander  
17 effects and to reduce massive neuronal loss. Apoptotic cells must be rapidly cleared from  
18 the CNS because they contain neurotoxic proteins and viruses capable of increasing host  
19 tissue infection (Griffiths et al., 2009). Apoptotic cells express a range of non-self-molecules  
20 termed Apoptotic cell- associated molecular patterns (ACAMPs) on their surface and these  
21 molecules include sugars, nucleic acids, ribonucleoproteins and oxidized low density  
22 proteins. The best characterized ACAMP is the phosphatidylserine molecule (PS) (Fadok et  
23 al., 1998) (Savill et al., 2002). Glia and macrophages express a range of receptors including  
24 the phosphatidylserine receptor (PSR), CD14 and the Scavenger receptors (SR) divided into  
25 SRA ( SRA-I, SRA-II ) and SR B including CD36 all expressed by microglia (Areschoug and  
26 Gordon, 2009; Husemann et al., 2002; Savill et al., 2002) which are all involved in the  
27 selective recognition and clearance of apoptotic cells. It should be stressed that these  
28 receptors may also contribute in turn to the infection of phagocytic cells.

#### 29 **5.5 Autophagy and control of viral infection**

30 Autophagy is a fundamental homeostatic process that leads to the degradation and  
31 recycling of long-lived cytoplasmic proteins and organelles (Klionsky, 2007) (Yoshimori,  
32 2004). The hallmark of autophagy is the formation of double or multiple membrane-bound  
33 vesicles called autophagosomes, which sequester a portion of the cytoplasm and fuse, after  
34 maturation, with lysosomes to digest their contents. In the same way, autophagy can also  
35 act directly, as an innate immune actor, to engulf and degrade pathogens. There is now  
36 some evidence for an antiviral role of autophagy related to viruses that specifically target  
37 neurons. The prototype virus studied was SINV, which is a positive-stranded RNA virus in  
38 the alphavirus genus. In mice, SINV produces fatal encephalitis that can be prevented by the  
39 cellular Bcl-2, an inhibitor of apoptosis (Levine et al., 1993). In a search to understand the  
40 mechanism by which Bcl-2 regulates Sindbis virus pathogenesis, a yeast two-hybrid  
41 screening was performed of a mouse brain library using Bcl-2 as bait, leading to the  
42 identification of a novel Bcl-2-interacting coiled-coil protein, Beclin 1. Beclin 1 is the  
43 mammalian homologue of yeast Atg6 and the first identified mammalian autophagy  
44 protein. Enforced neuronal expression of Beclin 1 was found to protect mice against fatal  
45 SINV encephalitis. In addition, Beclin reduces CNS SINV replication and viral-induced

1 neuronal apoptosis (Liang et al., 1998). The ability of enforced neuronal expression of Beclin  
 2 1 to protect against lethal SINV encephalitis suggests a protective role for autophagy in host  
 3 defence against an emerging neurotropic infection.

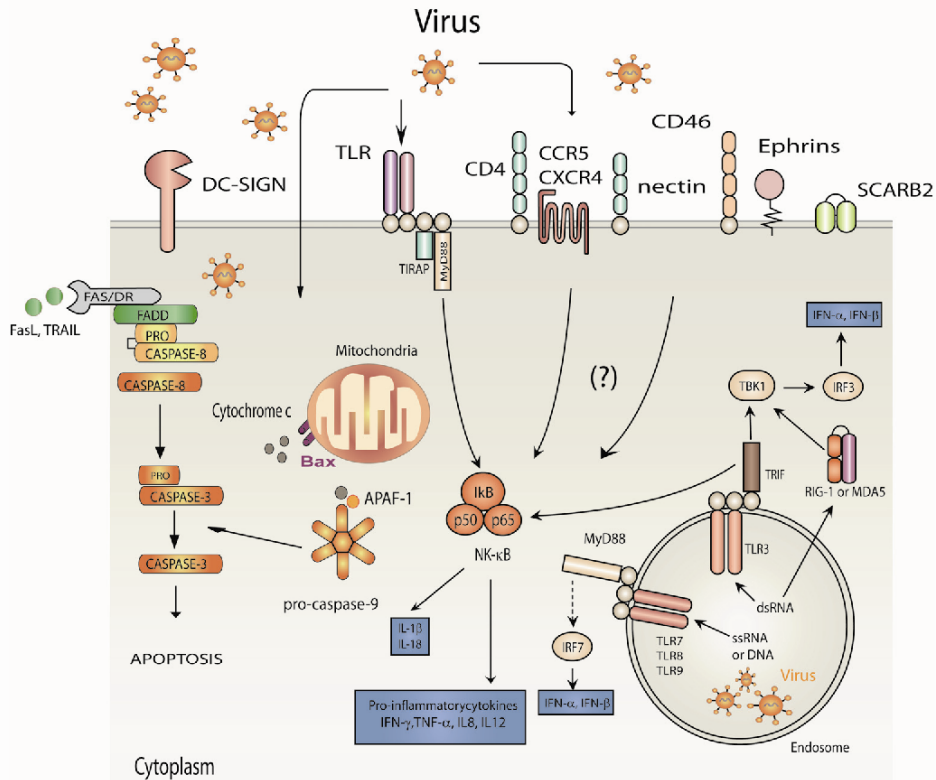

4  
 5 **Fig. 1. Interactions between viruses and host cell receptors:** Several receptors are known to  
 6 interact with viruses and controlling subsequent encephalitis. Some are receptors (e.g. CD4,  
 7 CD46) involved in cell entry and signaling although the pathways which are engaged  
 8 remain poorly characterized. Others are innate immune receptors such as RIG-I MDA5 and  
 9 TLR which are expressed by neurons and glial cells (microglia and astrocyte) to initiate well-  
 10 described signaling pathways that converge at the activation of the transcription factors  
 11 (IRF3/7 and/or nuclear factor-κB (NFκB)). These key events lead to the expression of type-I  
 12 interferons (IFN-α/β). The innate immune signaling pathways are intimately linked to  
 13 apoptosis. The intrinsic apoptosis pathway is initiated by the release of cytochrome C from  
 14 the mitochondria which promotes the formation of the apoptosome, including APAF-1  
 15 (apoptotic protease activating factor) and caspase 9 which in turn activates the effector  
 16 caspase 3. The extrinsic pathway mobilized notably by TNF-α, TRAIL or FASL involves  
 17 death-receptor signaling pathways linked to FADD and caspase 8. Some viruses can escape  
 18 apoptosis by inducing the expression of anti-apoptotic proteins such as Bcl2.

## 1 **6. Conclusion**

2 Despite the vast genetic diversity among viruses, these pathogens face similar obstacles on  
3 the way into the CNS with the dual role of a physical and molecular barriers of the innate  
4 immune system to restrict and protect from infection. However, upon entry whether they  
5 are hidden in leukocytes or in apoptotic blebs, they will be free to interact with neurons in a  
6 rather 'immunoprivileged' environment allowing viral persistence. However, this  
7 paradigm has been reconsidered with the observation that resident cells possess several of  
8 the key innate immune receptors involved in the recognition of the intruders and to engage  
9 a salutary antiviral response (IFN). It is now clear that other molecular interactions between  
10 the viruses and these host cells expressing primary and secondary signaling receptors will  
11 determine the outcome of the infection. Some receptors may control apoptosis or cell  
12 differentiation which in turn may have an impact on the capacity to resist viral infection and  
13 spreading. Our understanding of the molecular mechanisms of CNS diseases is still in its  
14 infancy. Increasingly, identification of virulence factors and host receptors will provide  
15 solutions for this complex puzzle. Understanding these interactions will increase our ability  
16 to control neuroinvasion and encephalitis. Moreover, it will also teach how to use these  
17 entry routes for therapeutic benefit, for example, for gene delivery of therapy of cancer and  
18 neurodegeneration.

## 19 **7. Acknowledgement**

20 The authors thanks the University of la Réunion (Fellowship to GVTH), the CPER/FEDER  
21 funds (GRII Phase I-III), the ANR, INSERM (Fellowship to PG) the Regional council  
22 (Fellowship to SK), the CRVOI for funds and continuous support. We express our thanks to  
23 other members of the laboratory (EA4517) for constructive criticisms and helps.  
24

## 25 **8. References**

- 26 Abbott, N.J., A.A. Patabendige, D.E. Dolman, S.R. Yusof, and D.J. Begley. 2010. Structure  
27 and function of the blood-brain barrier. *Neurobiol Dis.* 37:13-25.
- 28 Alexopoulou, L., A.C. Holt, R. Medzhitov, and R.A. Flavell. 2001. Recognition of double-  
29 stranded RNA and activation of NF-kappaB by Toll-like receptor 3. *Nature.*  
30 413:732-738.
- 31 Alkhatib, G., C. Combadiere, C.C. Broder, Y. Feng, P.E. Kennedy, P.M. Murphy, and E.A.  
32 Berger. 1996. CC CKR5: a RANTES, MIP-1alpha, MIP-1beta receptor as a fusion  
33 cofactor for macrophage-tropic HIV-1. *Science.* 272:1955-1958.
- 34 Areschoug, T., and S. Gordon. 2009. Scavenger receptors: role in innate immunity and  
35 microbial pathogenesis. *Cell Microbiol.* 11:1160-1169.
- 36 Bagasra, O., E. Lavi, L. Bobroski, K. Khalili, J.P. Pestaner, R. Tawadros, and R.J. Pomerantz.  
37 1996. Cellular reservoirs of HIV-1 in the central nervous system of infected  
38 individuals: identification by the combination of in situ polymerase chain reaction  
39 and immunohistochemistry. *AIDS.* 10:573-585.
- 40 Balasubramanian, K., and A.J. Schroit. 2003. Aminophospholipid asymmetry: A matter of  
41 life and death. *Annu Rev Physiol.* 65:701-734.

- 1 Barnett, E.M., M.D. Cassell, and S. Perlman. 1993. Two neurotropic viruses, herpes simplex  
2 virus type 1 and mouse hepatitis virus, spread along different neural pathways  
3 from the main olfactory bulb. *Neuroscience*. 57:1007-1025.
- 4 Berezcky-Veress, B., N. Abdelmagid, F. Piehl, T. Bergstrom, T. Olsson, B. Skoldenberg, and  
5 M. Diez. 2010. Influence of perineurial cells and Toll-like receptors 2 and 9 on  
6 Herpes simplex type 1 entry to the central nervous system in rat encephalitis. *PLoS*  
7 *One*. 5:e12350.
- 8 Bernfield, M., M. Gotte, P.W. Park, O. Reizes, M.L. Fitzgerald, J. Lincecum, and M. Zako.  
9 1999. Functions of cell surface heparan sulfate proteoglycans. *Annu Rev Biochem*.  
10 68:729-777.
- 11 Blomberg, J., E. Lycke, K. Ahlfors, T. Johnsson, S. Wolontis, and G. von Zeipel. 1974. Letter:  
12 New enterovirus type associated with epidemic of aseptic meningitis and-or hand,  
13 foot, and mouth disease. *Lancet*. 2:112.
- 14 Burudi, E.M., S. Riese, P.D. Stahl, and A. Regnier-Vigouroux. 1999. Identification and  
15 functional characterization of the mannose receptor in astrocytes. *Glia*. 25:44-55.
- 16 Calvo, D., J. Dopazo, and M.A. Vega. 1995. The CD36, CLA-1 (CD36L1), and LIMPII  
17 (CD36L2) gene family: cellular distribution, chromosomal location, and genetic  
18 evolution. *Genomics*. 25:100-106.
- 19 Cambi, A., M. Koopman, and C.G. Figdor. 2005. How C-type lectins detect pathogens. *Cell*  
20 *Microbiol*. 7:481-488.
- 21 Campbell, G.L., A.A. Marfin, R.S. Lanciotti, and D.J. Gubler. 2002. West Nile virus. *Lancet*  
22 *Infect Dis*. 2:519-529.
- 23 Cardone, J., G. Le Friec, P. Vantourout, A. Roberts, A. Fuchs, I. Jackson, T. Suddason, G.  
24 Lord, J.P. Atkinson, A. Cope, A. Hayday, and C. Kemper. 2010. Complement  
25 regulator CD46 temporally regulates cytokine production by conventional and  
26 unconventional T cells. *Nat Immunol*. 11:862-871.
- 27 Carty, M., and A.G. Bowie. 2010. Recent insights into the role of Toll-like receptors in viral  
28 infection. *Clin Exp Immunol*. 161:397-406.
- 29 Catanese, M.T., H. Ansuini, R. Graziani, T. Huby, M. Moreau, J.K. Ball, G. Paonessa, C.M.  
30 Rice, R. Cortese, A. Vitelli, and A. Nicosia. 2010. Role of scavenger receptor class B  
31 type I in hepatitis C virus entry: kinetics and molecular determinants. *J Virol*. 84:34-  
32 43.
- 33 Charles, P.C., E. Walters, F. Margolis, and R.E. Johnston. 1995. Mechanism of neuroinvasion  
34 of Venezuelan equine encephalitis virus in the mouse. *Virology*. 208:662-671.
- 35 Chattopadhyay, S., J.T. Marques, M. Yamashita, K.L. Peters, K. Smith, A. Desai, B.R.  
36 Williams, and G.C. Sen. 2010. Viral apoptosis is induced by IRF-3-mediated  
37 activation of Bax. *EMBO J*. 29:1762-1773.
- 38 Chen, Y.B., S.Y. Seo, D.G. Kirsch, T.T. Sheu, W.C. Cheng, and J.M. Hardwick. 2006. Alternate  
39 functions of viral regulators of cell death. *Cell Death Differ*. 13:1318-1324.
- 40 Choe, H., M. Farzan, Y. Sun, N. Sullivan, B. Rollins, P.D. Ponath, L. Wu, C.R. Mackay, G.  
41 LaRosa, W. Newman, N. Gerard, C. Gerard, and J. Sodroski. 1996. The beta-  
42 chemokine receptors CCR3 and CCR5 facilitate infection by primary HIV-1 isolates.  
43 *Cell*. 85:1135-1148.
- 44 Couderc, T., F. Chretien, C. Schilte, O. Disson, M. Brigitte, F. Guivel-Benhassine, Y. Touret,  
45 G. Barau, N. Cayet, I. Schuffenecker, P. Despres, F. Arenzana-Seisdedos, A.  
46 Michault, M.L. Albert, and M. Lecuit. 2008. A mouse model for Chikungunya

- 1 young age and inefficient type-I interferon signaling are risk factors for severe  
2 disease. *PLoS Pathog.* 4:e29.
- 3 Crimeen-Irwin, B., S. Ellis, D. Christiansen, M.J. Ludford-Menting, J. Milland, M. Lanteri,  
4 B.E. Loveland, D. Gerlier, and S.M. Russell. 2003. Ligand binding determines  
5 whether CD46 is internalized by clathrin-coated pits or macropinocytosis. *J Biol*  
6 *Chem.* 278:46927-46937.
- 7 Daffis, S., M.A. Samuel, M.S. Suthar, M. Gale, Jr., and M.S. Diamond. 2008. Toll-like receptor  
8 3 has a protective role against West Nile virus infection. *J Virol.* 82:10349-10358.
- 9 Dalgleish, A.G., P.C. Beverley, P.R. Clapham, D.H. Crawford, M.F. Greaves, and R.A. Weiss.  
10 1984. The CD4 (T4) antigen is an essential component of the receptor for the AIDS  
11 retrovirus. *Nature.* 312:763-767.
- 12 Danial, N.N., and S.J. Korsmeyer. 2004. Cell death: critical control points. *Cell.* 116:205-219.
- 13 Das, T., M.C. Jaffar-Bandjee, J.J. Hoarau, P. Krejbich Trotot, M. Denizot, G. Lee-Pat-Yuen, R.  
14 Sahoo, P. Guiraud, D. Ramful, S. Robin, J.L. Alessandri, B.A. Gauzere, and P.  
15 Gasque. 2010. Chikungunya fever: CNS infection and pathologies of a re-emerging  
16 arbovirus. *Prog Neurobiol.* 91:121-129.
- 17 Deng, H., R. Liu, W. Ellmeier, S. Choe, D. Unutmaz, M. Burkhart, P. Di Marzio, S. Marmon,  
18 R.E. Sutton, C.M. Hill, C.B. Davis, S.C. Peiper, T.J. Schall, D.R. Littman, and N.R.  
19 Landau. 1996. Identification of a major co-receptor for primary isolates of HIV-1.  
20 *Nature.* 381:661-666.
- 21 Doranz, B.J., J. Rucker, Y. Yi, R.J. Smyth, M. Samson, S.C. Peiper, M. Parmentier, R.G.  
22 Collman, and R.W. Doms. 1996. A dual-tropic primary HIV-1 isolate that uses fusin  
23 and the beta-chemokine receptors CKR-5, CKR-3, and CKR-2b as fusion cofactors.  
24 *Cell.* 85:1149-1158.
- 25 Dorig, R.E., A. Marciel, A. Chopra, and C.D. Richardson. 1993. The human CD46 molecule is  
26 a receptor for measles virus (Edmonston strain). *Cell.* 75:295-305.
- 27 Dragic, T., V. Litwin, G.P. Allaway, S.R. Martin, Y. Huang, K.A. Nagashima, C. Cayanan,  
28 P.J. Maddon, R.A. Koup, J.P. Moore, and W.A. Paxton. 1996. HIV-1 entry into CD4+  
29 cells is mediated by the chemokine receptor CC-CKR-5. *Nature.* 381:667-673.
- 30 Drevets, D.A., and P.J. Leenen. 2000. Leukocyte-facilitated entry of intracellular pathogens  
31 into the central nervous system. *Microbes Infect.* 2:1609-1618.
- 32 Drickamer, K. 1995. Increasing diversity of animal lectin structures. *Curr Opin Struct Biol.*  
33 5:612-616.
- 34 Dropulic, B., and C.L. Masters. 1990. Entry of neurotropic arboviruses into the central  
35 nervous system: an in vitro study using mouse brain endothelium. *J Infect Dis.*  
36 161:685-691.
- 37 Economopoulou, A., M. Dominguez, B. Helynck, D. Sissoko, O. Wichmann, P. Quenel, P.  
38 Germonneau, and I. Quatresous. 2009. Atypical Chikungunya virus infections:  
39 clinical manifestations, mortality and risk factors for severe disease during the  
40 2005-2006 outbreak on Reunion. *Epidemiol Infect.* 137:534-541.
- 41 Egea, J., and R. Klein. 2007. Bidirectional Eph-ephrin signaling during axon guidance.  
42 *Trends Cell Biol.* 17:230-238.
- 43 Eskelinen, E.L., Y. Tanaka, and P. Saftig. 2003. At the acidic edge: emerging functions for  
44 lysosomal membrane proteins. *Trends Cell Biol.* 13:137-145.
- 45 Esko, J.D., and S.B. Selleck. 2002. Order out of chaos: assembly of ligand binding sites in  
46 heparan sulfate. *Annu Rev Biochem.* 71:435-471.

- 1 Everett, H., and G. McFadden. 1999. Apoptosis: an innate immune response to virus  
 2 infection. *Trends Microbiol.* 7:160-165.
- 3 Evlashev, A., E. Moyses, H. Valentin, O. Azocar, M.C. Trescol-Biemont, J.C. Marie, C.  
 4 Rabourdin-Combe, and B. Horvat. 2000. Productive measles virus brain infection  
 5 and apoptosis in CD46 transgenic mice. *J Virol.* 74:1373-1382.
- 6 Fadok, V.A., M.L. Warner, D.L. Bratton, and P.M. Henson. 1998. CD36 is required for  
 7 phagocytosis of apoptotic cells by human macrophages that use either a  
 8 phosphatidylserine receptor or the vitronectin receptor (alpha v beta 3). *J Immunol.*  
 9 161:6250-6257.
- 10 Fazakerley, J.K., C.L. Cotterill, G. Lee, and A. Graham. 2006. Virus tropism, distribution,  
 11 persistence and pathology in the corpus callosum of the Semliki Forest virus-  
 12 infected mouse brain: a novel system to study virus-oligodendrocyte interactions.  
 13 *Neuropathol Appl Neurobiol.* 32:397-409.
- 14 Feng, Y., C.C. Broder, P.E. Kennedy, and E.A. Berger. 1996. HIV-1 entry cofactor: functional  
 15 cDNA cloning of a seven-transmembrane, G protein-coupled receptor. *Science.*  
 16 272:872-877.
- 17 Fiala, M., D.J. Looney, M. Stins, D.D. Way, L. Zhang, X. Gan, F. Chiappelli, E.S. Schweitzer,  
 18 P. Shapshak, M. Weinand, M.C. Graves, M. Witte, and K.S. Kim. 1997. TNF-alpha  
 19 opens a paracellular route for HIV-1 invasion across the blood-brain barrier. *Mol*  
 20 *Med.* 3:553-564.
- 21 Fujimoto, I., J. Pan, T. Takizawa, and Y. Nakanishi. 2000. Virus clearance through apoptosis-  
 22 dependent phagocytosis of influenza A virus-infected cells by macrophages. *J*  
 23 *Virol.* 74:3399-3403.
- 24 Fujita, T., K. Onoguchi, K. Onomoto, R. Hirai, and M. Yoneyama. 2007. Triggering antiviral  
 25 response by RIG-I-related RNA helicases. *Biochimie.* 89:754-760.
- 26 Furr, S.R., V.S. Chauhan, D. Sterka, Jr., V. Grdzlishvili, and I. Marriott. 2008.  
 27 Characterization of retinoic acid-inducible gene-I expression in primary murine  
 28 glia following exposure to vesicular stomatitis virus. *J Neurovirol.* 1-11.
- 29 Gamp, A.C., Y. Tanaka, R. Lullmann-Rauch, D. Wittke, R. D'Hooge, P.P. De Deyn, T. Moser,  
 30 H. Maier, D. Hartmann, K. Reiss, A.L. Illert, K. von Figura, and P. Saftig. 2003.  
 31 LIMP-2/LGP85 deficiency causes ureteric pelvic junction obstruction, deafness and  
 32 peripheral neuropathy in mice. *Hum Mol Genet.* 12:631-646.
- 33 Ganesan, K., A. Diwan, S.K. Shankar, S.B. Desai, G.S. Sainani, and S.M. Katrak. 2008.  
 34 Chikungunya encephalomyeloradiculitis: report of 2 cases with neuroimaging and  
 35 1 case with autopsy findings. *AJNR Am J Neuroradiol.* 29:1636-1637.
- 36 Gardner, J., I. Anraku, T.T. Le, T. Larcher, L. Major, P. Roques, W.A. Schroder, S. Higgs, and  
 37 A. Suhrbier. 2010. Chikungunya virus arthritis in adult wild-type mice. *J Virol.*  
 38 84:8021-8032.
- 39 Gautier, I., J. Coppey, and C. Durieux. 2003. Early apoptosis-related changes triggered by  
 40 HSV-1 in individual neuronlike cells. *Exp Cell Res.* 289:174-183.
- 41 George, C.X., Z. Li, K.M. Okonski, A.M. Toth, Y. Wang, and C.E. Samuel. 2009. Tipping the  
 42 balance: antagonism of PKR kinase and ADAR1 deaminase functions by virus gene  
 43 products. *J Interferon Cytokine Res.* 29:477-487.
- 44 Geraghty, R.J., C. Krummenacher, G.H. Cohen, R.J. Eisenberg, and P.G. Spear. 1998. Entry of  
 45 alphaherpesviruses mediated by poliovirus receptor-related protein 1 and  
 46 poliovirus receptor. *Science.* 280:1618-1620.

- 1 Goldstein, J.L., Y.K. Ho, S.K. Basu, and M.S. Brown. 1979. Binding site on macrophages that  
2 mediates uptake and degradation of acetylated low density lipoprotein, producing  
3 massive cholesterol deposition. *Proc Natl Acad Sci U S A.* 76:333-337.
- 4 Goodbourn, S., L. Didcock, and R.E. Randall. 2000. Interferons: cell signalling, immune  
5 modulation, antiviral response and virus countermeasures. *J Gen Virol.* 81:2341-  
6 2364.
- 7 Granwehr, B.P., K.M. Lillibridge, S. Higgs, P.W. Mason, J.F. Aronson, G.A. Campbell, and  
8 A.D. Barrett. 2004. West Nile virus: where are we now? *Lancet Infect Dis.* 4:547-556.
- 9 Griffin, D.E. 2003. Immune responses to RNA-virus infections of the CNS. *Nat Rev*  
10 *Immunol.* 3:493-502.
- 11 Griffin, D.E. 2010. Emergence and re-emergence of viral diseases of the central nervous  
12 system. *Prog Neurobiol.* 91:95-101.
- 13 Griffin, D.E., and J.M. Hardwick. 1997. Regulators of apoptosis on the road to persistent  
14 alphavirus infection. *Annu Rev Microbiol.* 51:565-592.
- 15 Griffiths, M.R., P. Gasque, and J.W. Neal. 2009. The multiple roles of the innate immune  
16 system in the regulation of apoptosis and inflammation in the brain. *J Neuropathol*  
17 *Exp Neurol.* 68:217-226.
- 18 Hashimoto, Y., T. Moki, T. Takizawa, A. Shiratsuchi, and Y. Nakanishi. 2007. Evidence for  
19 phagocytosis of influenza virus-infected, apoptotic cells by neutrophils and  
20 macrophages in mice. *J Immunol.* 178:2448-2457.
- 21 Hauwel, M., E. Furon, C. Canova, M. Griffiths, J. Neal, and P. Gasque. 2005. Innate  
22 (inherent) control of brain infection, brain inflammation and brain repair: the role  
23 of microglia, astrocytes, "protective" glial stem cells and stromal ependymal cells.  
24 *Brain Res Brain Res Rev.* 48:220-233.
- 25 Henson, P.M., D.L. Bratton, and V.A. Fadok. 2001. Apoptotic cell removal. *Curr Biol.*  
26 11:R795-805.
- 27 Herndon, R.M., R.T. Johnson, L.E. Davis, and L.R. Descalzi. 1974. Ependymitis in mumps  
28 virus meningitis. Electron microscopical studies of cerebrospinal fluid. *Arch*  
29 *Neurol.* 30:475-479.
- 30 Himanen, J.P., N. Saha, and D.B. Nikolov. 2007. Cell-cell signaling via Eph receptors and  
31 ephrins. *Curr Opin Cell Biol.* 19:534-542.
- 32 Hoarau, J.J., M.C. Jaffar Bandjee, P. Krejbich Trotot, T. Das, G. Li-Pat-Yuen, B. Dassa, M.  
33 Denizot, E. Guichard, A. Ribera, T. Henni, F. Tallet, M.P. Moiton, B.A. Gauzere, S.  
34 Bruniquet, Z. Jaffar Bandjee, P. Morbidelli, G. Martigny, M. Jolivet, F. Gay, M.  
35 Grandadam, H. Tolou, V. Vieillard, P. Debre, B. Autran, and P. Gasque. 2010.  
36 Persistent chronic inflammation and infection by Chikungunya arthritogenic  
37 alphavirus in spite of a robust host immune response. *J Immunol.* 184:5914-5927.
- 38 Hoarau, J.J., P. Krejbich-Trotot, M.C. Jaffar-Bandjee, T. Das, G.V. Thon-Hon, S. Kumar, J.W.  
39 Neal, and P. Gasque. 2011. Activation and control of CNS innate immune  
40 responses in health and diseases: a balancing act finely tuned by neuroimmune  
41 regulators (NIReg). *CNS Neurol Disord Drug Targets.* 10:25-43.
- 42 Husemann, J., J.D. Loike, R. Anankov, M. Febbraio, and S.C. Silverstein. 2002. Scavenger  
43 receptors in neurobiology and neuropathology: their role on microglia and other  
44 cells of the nervous system. *Glia.* 40:195-205.
- 45 Jackson, A.C. 2003. Rabies virus infection: an update. *J Neurovirol.* 9:253-258.



- 1 Jaffar-Bandjee, M.C., T. Das, J.J. Hoarau, P. Krejbich Trotot, M. Denizot, A. Ribera, P.  
2 Roques, and P. Gasque. 2009. Chikungunya virus takes centre stage in virally  
3 induced arthritis: possible cellular and molecular mechanisms to pathogenesis.  
4 *Microbes Infect.* 11:1206-1218.
- 5 Jaffar-Bandjee, M.C., D. Ramful, B.A. Gauzere, J.J. Hoarau, P. Krejbich-Trotot, S. Robin, A.  
6 Ribera, J. Selambarom, and P. Gasque. 2011. Emergence and clinical insights into  
7 the pathology of Chikungunya virus infection. *Expert Rev Anti Infect Ther.* 8:987-  
8 996.
- 9 Janssen, R.S., D.R. Cornblath, L.G. Epstein, R.P. Foa, J.C. McArthur, R.W. Price, A.K.K.  
10 Asbury, A. Beckett, D.F. Benson, T.P. Bridge, C.M. Leventhal, P. Satz, A.J. Saykin,  
11 J.J. Sidtis, and S. Tross. 1991. Nomenclature and research case definitions for  
12 neurological manifestations of human immunodeficiency virus type 1 (HIV-1)  
13 infection. *Neurology.* 41:778-785.
- 14 Jarvis, M.A., and J.A. Nelson. 2002. Human cytomegalovirus persistence and latency in  
15 endothelial cells and macrophages. *Curr Opin Microbiol.* 5:403-407.
- 16 Katze, M.G., Y. He, and M. Gale, Jr. 2002. Viruses and interferon: a fight for supremacy. *Nat*  
17 *Rev Immunol.* 2:675-687.
- 18 Klatzmann, D., E. Champagne, S. Chamaret, J. Gruest, D. Guetard, T. Hercend, J.C.  
19 Gluckman, and L. Montagnier. 1984. T-lymphocyte T4 molecule behaves as the  
20 receptor for human retrovirus LAV. *Nature.* 312:767-768.
- 21 Klionsky, D.J. 2007. Autophagy: from phenomenology to molecular understanding in less  
22 than a decade. *Nat Rev Mol Cell Biol.* 8:931-937.
- 23 Kopp, S.J., G. Banisadr, K. Glajch, U.E. Maurer, K. Grunewald, R.J. Miller, P. Osten, and P.G.  
24 Spear. 2009. Infection of neurons and encephalitis after intracranial inoculation of  
25 herpes simplex virus requires the entry receptor nectin-1. *Proc Natl Acad Sci U S A.*  
26 106:17916-17920.
- 27 Krejbich-Trotot, P., M. Denizot, J.J. Hoarau, M.C. Jaffar-Bandjee, T. Das, and P. Gasque. 2011.  
28 Chikungunya virus mobilizes the apoptotic machinery to invade host cell defenses.  
29 *FASEB J.* 25:314-325.
- 30 Kroemer, G., L. Galluzzi, and C. Brenner. 2007. Mitochondrial membrane permeabilization  
31 in cell death. *Physiol Rev.* 87:99-163.
- 32 Kuronita, T., E.L. Eskelinen, H. Fujita, P. Saftig, M. Himeno, and Y. Tanaka. 2002. A role for  
33 the lysosomal membrane protein LGP85 in the biogenesis and maintenance of  
34 endosomal and lysosomal morphology. *J Cell Sci.* 115:4117-4131.
- 35 Labadie, K., T. Larcher, C. Joubert, A. Mannioui, B. Delache, P. Brochard, L. Guigand, L.  
36 Dubreil, P. Lebon, B. Verrier, X. de Lamballerie, A. Suhrbier, Y. Cherel, R. Le  
37 Grand, and P. Roques. 2010. Chikungunya disease in nonhuman primates involves  
38 long-term viral persistence in macrophages. *J Clin Invest.* 120:894-906.
- 39 Lafon, M. 2005. Rabies virus receptors. *J Neurovirol.* 11:82-87.
- 40 Lanciotti, R.S., J.T. Roehrig, V. Deubel, J. Smith, M. Parker, K. Steele, B. Crise, K.E. Volpe,  
41 M.B. Crabtree, J.H. Scherret, R.A. Hall, J.S. MacKenzie, C.B. Cropp, B. Panigrahy, E.  
42 Ostlund, B. Schmitt, M. Malkinson, C. Banet, J. Weissman, N. Komar, H.M. Savage,  
43 W. Stone, T. McNamara, and D.J. Gubler. 1999. Origin of the West Nile virus  
44 responsible for an outbreak of encephalitis in the northeastern United States.  
45 *Science.* 286:2333-2337.

- 1 Lemant, J., V. Boisson, A. Winer, L. Thibault, H. Andre, F. Tixier, M. Lemercier, E. Antok,  
2 M.P. Cresta, P. Grivard, M. Besnard, O. Rollot, F. Favier, M. Huerre, J.L. Campinos,  
3 and A. Michault. 2008. Serious acute chikungunya virus infection requiring  
4 intensive care during the Reunion Island outbreak in 2005-2006. *Crit Care Med.*  
5 36:2536-2541.
- 6 Levine, B., Q. Huang, J.T. Isaacs, J.C. Reed, D.E. Griffin, and J.M. Hardwick. 1993.  
7 Conversion of lytic to persistent alphavirus infection by the bcl-2 cellular oncogene.  
8 *Nature.* 361:739-742.
- 9 Liang, X.H., L.K. Kleeman, H.H. Jiang, G. Gordon, J.E. Goldman, G. Berry, B. Herman, and  
10 B. Levine. 1998. Protection against fatal Sindbis virus encephalitis by beclin, a novel  
11 Bcl-2-interacting protein. *J Virol.* 72:8586-8596.
- 12 Linehan, S.A., L. Martinez-Pomares, P.D. Stahl, and S. Gordon. 1999. Mannose receptor and  
13 its putative ligands in normal murine lymphoid and nonlymphoid organs: In situ  
14 expression of mannose receptor by selected macrophages, endothelial cells,  
15 perivascular microglia, and mesangial cells, but not dendritic cells. *J Exp Med.*  
16 189:1961-1972.
- 17 Liszewski, M.K., T.W. Post, and J.P. Atkinson. 1991. Membrane cofactor protein (MCP or  
18 CD46): newest member of the regulators of complement activation gene cluster.  
19 *Annu Rev Immunol.* 9:431-455.
- 20 Loetscher, M., T. Geiser, T. O'Reilly, R. Zwahlen, M. Baggiolini, and B. Moser. 1994. Cloning  
21 of a human seven-transmembrane domain receptor, LESTR, that is highly  
22 expressed in leukocytes. *J Biol Chem.* 269:232-237.
- 23 Lopez, M., F. Cocchi, L. Menotti, E. Avitabile, P. Dubreuil, and G. Campadelli-Fiume. 2000.  
24 Nectin2alpha (PRR2alpha or HveB) and nectin2delta are low-efficiency mediators  
25 for entry of herpes simplex virus mutants carrying the Leu25Pro substitution in  
26 glycoprotein D. *J Virol.* 74:1267-1274.
- 27 Lublin, D.M., M.K. Liszewski, T.W. Post, M.A. Arce, M.M. Le Beau, M.B. Rebentisch, L.S.  
28 Lemons, T. Seya, and J.P. Atkinson. 1988. Molecular cloning and chromosomal  
29 localization of human membrane cofactor protein (MCP). Evidence for inclusion in  
30 the multigene family of complement-regulatory proteins. *J Exp Med.* 168:181-194.
- 31 Maddon, P.J., S.M. Molineaux, D.E. Maddon, K.A. Zimmerman, M. Godfrey, F.W. Alt, L.  
32 Chess, and R. Axel. 1987. Structure and expression of the human and mouse T4  
33 genes. *Proc Natl Acad Sci U S A.* 84:9155-9159.
- 34 Martina, B.E., P. Koraka, P. van den Doel, G.F. Rimmelzwaan, B.L. Haagmans, and A.D.  
35 Osterhaus. 2008. DC-SIGN enhances infection of cells with glycosylated West Nile  
36 virus in vitro and virus replication in human dendritic cells induces production of  
37 IFN-alpha and TNF-alpha. *Virus Res.* 135:64-71.
- 38 McDougal, J.S., M.S. Kennedy, J.M. Sligh, S.P. Cort, A. Mawle, and J.K. Nicholson. 1986.  
39 Binding of HTLV-III/LAV to T4+ T cells by a complex of the 110K viral protein and  
40 the T4 molecule. *Science.* 231:382-385.
- 41 McMinn, P.C. 2002. An overview of the evolution of enterovirus 71 and its clinical and  
42 public health significance. *FEMS Microbiol Rev.* 26:91-107.
- 43 Mock, D.J., J.M. Powers, A.D. Goodman, S.R. Blumenthal, N. Ergin, J.V. Baker, D.H.  
44 Mattson, J.G. Assouline, E.J. Bergey, B. Chen, L.G. Epstein, and B.M. Blumberg.  
45 1999. Association of human herpesvirus 6 with the demyelinating lesions of  
46 progressive multifocal leukoencephalopathy. *J Neurovirol.* 5:363-373.

- 1 Mori, I., Y. Nishiyama, T. Yokochi, and Y. Kimura. 2005. Olfactory transmission of  
 2 neurotropic viruses. *J Neurovirol.* 11:129-137.
- 3 Morrison, L.A., and B.N. Fields. 1991. Parallel mechanisms in neuropathogenesis of enteric  
 4 virus infections. *J Virol.* 65:2767-2772.
- 5 Moses, A.V., F.E. Bloom, C.D. Pauza, and J.A. Nelson. 1993. Human immunodeficiency  
 6 virus infection of human brain capillary endothelial cells occurs via a  
 7 CD4/galactosylceramide-independent mechanism. *Proc Natl Acad Sci U S A.*  
 8 90:10474-10478.
- 9 Mukhopadhyay, S., and S. Gordon. 2004. The role of scavenger receptors in pathogen  
 10 recognition and innate immunity. *Immunobiology.* 209:39-49.
- 11 Mukhtar, M., S. Harley, P. Chen, M. BouHamdan, C. Patel, E. Acheampong, and R.J.  
 12 Pomerantz. 2002. Primary isolated human brain microvascular endothelial cells  
 13 express diverse HIV/SIV-associated chemokine coreceptors and DC-SIGN and L-  
 14 SIGN. *Virology.* 297:78-88.
- 15 Muller, U., U. Steinhoff, L.F. Reis, S. Hemmi, J. Pavlovic, R.M. Zinkernagel, and M. Aguet.  
 16 1994. Functional role of type I and type II interferons in antiviral defense. *Science.*  
 17 264:1918-1921.
- 18 Nakhaei, P., P. Genin, A. Civas, and J. Hiscott. 2009. RIG-I-like receptors: sensing and  
 19 responding to RNA virus infection. *Semin Immunol.* 21:215-222.
- 20 Navia, B.A., B.D. Jordan, and R.W. Price. 1986. The AIDS dementia complex: I. Clinical  
 21 features. *Ann Neurol.* 19:517-524.
- 22 Negrete, O.A., E.L. Levrony, H.C. Aguilar, A. Bertolotti-Ciarlet, R. Nazarian, S. Tajyar, and  
 23 B. Lee. 2005. EphrinB2 is the entry receptor for Nipah virus, an emergent deadly  
 24 paramyxovirus. *Nature.* 436:401-405.
- 25 Negrete, O.A., M.C. Wolf, H.C. Aguilar, S. Enterlein, W. Wang, E. Muhlberger, S.V. Su, A.  
 26 Bertolotti-Ciarlet, R. Flick, and B. Lee. 2006. Two key residues in ephrinB3 are  
 27 critical for its use as an alternative receptor for Nipah virus. *PLoS Pathog.* 2:e7.
- 28 Nottet, H.S., Y. Persidsky, V.G. Sasseville, A.N. Nukuna, P. Bock, Q.H. Zhai, L.R. Sharer,  
 29 R.D. McComb, S. Swindells, C. Soderland, and H.E. Gendelman. 1996. Mechanisms  
 30 for the transendothelial migration of HIV-1-infected monocytes into brain. *J*  
 31 *Immunol.* 156:1284-1295.
- 32 Pasquale, E.B. 2005. Eph receptor signalling casts a wide net on cell behaviour. *Nat Rev Mol*  
 33 *Cell Biol.* 6:462-475.
- 34 Pasquale, E.B. 2008. Eph-ephrin bidirectional signaling in physiology and disease. *Cell.*  
 35 133:38-52.
- 36 Paul, S., C. Ricour, C. Sommereyns, F. Sorgeloos, and T. Michiels. 2007. Type I interferon  
 37 response in the central nervous system. *Biochimie.* 89:770-778.
- 38 Persidsky, Y., M. Stins, D. Way, M.H. Witte, M. Weinand, K.S. Kim, P. Bock, H.E.  
 39 Gendelman, and M. Fiala. 1997. A model for monocyte migration through the  
 40 blood-brain barrier during HIV-1 encephalitis. *J Immunol.* 158:3499-3510.
- 41 Prehaud, C., F. Megret, M. Lafage, and M. Lafon. 2005. Virus infection switches TLR-3-  
 42 positive human neurons to become strong producers of beta interferon. *J Virol.*  
 43 79:12893-12904.
- 44 Price, R.W., B. Brew, J. Sidtis, M. Rosenblum, A.C. Scheck, and P. Cleary. 1988. The brain in  
 45 AIDS: central nervous system HIV-1 infection and AIDS dementia complex.  
 46 *Science.* 239:586-592.

- 1 Pryzdial, E.L., and J.F. Wright. 1994. Prothrombinase assembly on an enveloped virus:  
2 evidence that the cytomegalovirus surface contains procoagulant phospholipid.  
3 *Blood*. 84:3749-3757.
- 4 Raport, C.J., J. Gosling, V.L. Schweickart, P.W. Gray, and I.F. Charo. 1996. Molecular cloning  
5 and functional characterization of a novel human CC chemokine receptor (CCR5)  
6 for RANTES, MIP-1beta, and MIP-1alpha. *J Biol Chem*. 271:17161-17166.
- 7 Rosen, A., L. Casciola-Rosen, and J. Ahearn. 1995. Novel packages of viral and self-antigens  
8 are generated during apoptosis. *J Exp Med*. 181:1557-1561.
- 9 Sallusto, F., M. Cella, C. Danieli, and A. Lanzavecchia. 1995. Dendritic cells use  
10 macropinocytosis and the mannose receptor to concentrate macromolecules in the  
11 major histocompatibility complex class II compartment: downregulation by  
12 cytokines and bacterial products. *J Exp Med*. 182:389-400.
- 13 Santoro, F., P.E. Kennedy, G. Locatelli, M.S. Malnati, E.A. Berger, and P. Lusso. 1999. CD46  
14 is a cellular receptor for human herpesvirus 6. *Cell*. 99:817-827.
- 15 Sato, A., M.M. Linehan, and A. Iwasaki. 2006. Dual recognition of herpes simplex viruses by  
16 TLR2 and TLR9 in dendritic cells. *Proc Natl Acad Sci U S A*. 103:17343-17348.
- 17 Savarin, C., and C.C. Bergmann. 2008. Neuroimmunology of central nervous system viral  
18 infections: the cells, molecules and mechanisms involved. *Curr Opin Pharmacol*.  
19 8:472-479.
- 20 Savill, J., I. Dransfield, C. Gregory, and C. Haslett. 2002. A blast from the past: clearance of  
21 apoptotic cells regulates immune responses. *Nat Rev Immunol*. 2:965-975.
- 22 Schilte, C., T. Couderc, F. Chretien, M. Sourisseau, N. Gangneux, F. Guivel-Benhassine, A.  
23 Kraxner, J. Tschopp, S. Higgs, A. Michault, F. Arenzana-Seisdedos, M. Colonna, L.  
24 Peduto, O. Schwartz, M. Lecuit, and M.L. Albert. 2010. Type I IFN controls  
25 chikungunya virus via its action on nonhematopoietic cells. *J Exp Med*. 207:429-  
26 442.
- 27 Schmidt, N.J., E.H. Lennette, and H.H. Ho. 1974. An apparently new enterovirus isolated  
28 from patients with disease of the central nervous system. *J Infect Dis*. 129:304-309.
- 29 Schmidtmayerova, H., H.S. Nottet, G. Nuovo, T. Raabe, C.R. Flanagan, L. Dubrovsky, H.E.  
30 Gendelman, A. Cerami, M. Bukrinsky, and B. Sherry. 1996. Human  
31 immunodeficiency virus type 1 infection alters chemokine beta peptide expression  
32 in human monocytes: implications for recruitment of leukocytes into brain and  
33 lymph nodes. *Proc Natl Acad Sci U S A*. 93:700-704.
- 34 Schwartz, A.J., X. Alvarez, and A.A. Lackner. 2002. Distribution and immunophenotype of  
35 DC-SIGN-expressing cells in SIV-infected and uninfected macaques. *AIDS Res*  
36 *Hum Retroviruses*. 18:1021-1029.
- 37 Seya, T., A. Hirano, M. Matsumoto, M. Nomura, and S. Ueda. 1999. Human membrane  
38 cofactor protein (MCP, CD46): multiple isoforms and functions. *Int J Biochem Cell*  
39 *Biol*. 31:1255-1260.
- 40 Seya, T., J.R. Turner, and J.P. Atkinson. 1986. Purification and characterization of a  
41 membrane protein (gp45-70) that is a cofactor for cleavage of C3b and C4b. *J Exp*  
42 *Med*. 163:837-855.
- 43 Sharer, L.R., E.S. Cho, and L.G. Epstein. 1985. Multinucleated giant cells and HTLV-III in  
44 AIDS encephalopathy. *Hum Pathol*. 16:760.

- 1 Shieh, M.T., D. WuDunn, R.I. Montgomery, J.D. Esko, and P.G. Spear. 1992. Cell surface
- 2 receptors for herpes simplex virus are heparan sulfate proteoglycans. *J Cell Biol.*
- 3 116:1273-1281.
- 4 Solignat, M., B. Gay, S. Higgs, L. Briant, and C. Devaux. 2009. Replication cycle of
- 5 chikungunya: a re-emerging arbovirus. *Virology.* 393:183-197.
- 6 Suh, H.S., C.F. Brosnan, and S.C. Lee. 2009. Toll-like receptors in CNS viral infections. *Curr*
- 7 *Top Microbiol Immunol.* 336:63-81.
- 8 Suthar, M.S., D.Y. Ma, S. Thomas, J.M. Lund, N. Zhang, S. Daffis, A.Y. Rudensky, M.J.
- 9 Bevan, E.A. Clark, M.K. Kaja, M.S. Diamond, and M. Gale, Jr. 2010. IPS-1 is
- 10 essential for the control of West Nile virus infection and immunity. *PLoS Pathog.*
- 11 6:e1000757.
- 12 Sutherland, M.R., C.M. Raynor, H. Leenknecht, J.F. Wright, and E.L. Pryzdial. 1997.
- 13 Coagulation initiated on herpesviruses. *Proc Natl Acad Sci U S A.* 94:13510-13514.
- 14 Szretter, K.J., S. Daffis, J. Patel, M.S. Suthar, R.S. Klein, M. Gale, Jr., and M.S. Diamond. 2010.
- 15 The innate immune adaptor molecule MyD88 restricts West Nile virus replication
- 16 and spread in neurons of the central nervous system. *J Virol.* 84:12125-12138.
- 17 Takahashi, K., T. Kawai, H. Kumar, S. Sato, S. Yonehara, and S. Akira. 2006. Roles of
- 18 caspase-8 and caspase-10 in innate immune responses to double-stranded RNA. *J*
- 19 *Immunol.* 176:4520-4524.
- 20 Takai, Y., J. Miyoshi, W. Ikeda, and H. Ogita. 2008. Nectins and nectin-like molecules: roles
- 21 in contact inhibition of cell movement and proliferation. *Nat Rev Mol Cell Biol.*
- 22 9:603-615.
- 23 Teodoro, J.G., and P.E. Branton. 1997. Regulation of apoptosis by viral gene products. *J*
- 24 *Virol.* 71:1739-1746.
- 25 Tirabassi, R.S., R.A. Townley, M.G. Eldridge, and L.W. Enquist. 1998. Molecular
- 26 mechanisms of neurotropic herpesvirus invasion and spread in the CNS. *Neurosci*
- 27 *Biobehav Rev.* 22:709-720.
- 28 Toth, A.M., Z. Li, R. Cattaneo, and C.E. Samuel. 2009. RNA-specific adenosine deaminase
- 29 ADAR1 suppresses measles virus-induced apoptosis and activation of protein
- 30 kinase PKR. *J Biol Chem.* 284:29350-29356.
- 31 Tsetsarkin, K.A., D.L. Vanlandingham, C.E. McGee, and S. Higgs. 2007. A single mutation in
- 32 chikungunya virus affects vector specificity and epidemic potential. *PLoS Pathog.*
- 33 3:e201.
- 34 Van Gorp, H., P.L. Delputte, and H.J. Nauwynck. 2010. Scavenger receptor CD163, a Jack-of-
- 35 all-trades and potential target for cell-directed therapy. *Mol Immunol.* 47:1650-
- 36 1660.
- 37 van Kooyk, Y., and T.B. Geijtenbeek. 2003. DC-SIGN: escape mechanism for pathogens. *Nat*
- 38 *Rev Immunol.* 3:697-709.
- 39 Vazeille, M., S. Moutailler, D. Coudrier, C. Rousseaux, H. Khun, M. Huerre, J. Thiria, J.S.
- 40 Dehecq, D. Fontenille, I. Schuffenecker, P. Despres, and A.B. Failloux. 2007. Two
- 41 Chikungunya isolates from the outbreak of La Reunion (Indian Ocean) exhibit
- 42 different patterns of infection in the mosquito, *Aedes albopictus*. *PLoS One.*
- 43 2:e1168.
- 44 Wang, E., E. Volkova, A.P. Adams, N. Forrester, S.Y. Xiao, I. Frolov, and S.C. Weaver. 2008.
- 45 Chimeric alphavirus vaccine candidates for chikungunya. *Vaccine.* 26:5030-5039.

- 1 Wang, T., T. Town, L. Alexopoulou, J.F. Anderson, E. Fikrig, and R.A. Flavell. 2004. Toll-like  
2 receptor 3 mediates West Nile virus entry into the brain causing lethal encephalitis.  
3 *Nat Med.* 10:1366-1373.
- 4 Weis, W.I., M.E. Taylor, and K. Drickamer. 1998. The C-type lectin superfamily in the  
5 immune system. *Immunol Rev.* 163:19-34.
- 6 Weiss, N., F. Miller, S. Cazaubon, and P.O. Couraud. 2009. The blood-brain barrier in brain  
7 homeostasis and neurological diseases. *Biochim Biophys Acta.* 1788:842-857.
- 8 Whitley, R.J., and J.W. Gnann. 2002. Viral encephalitis: familiar infections and emerging  
9 pathogens. *Lancet.* 359:507-513.
- 10 Williamson, P., and R.A. Schlegel. 1994. Back and forth: the regulation and function of  
11 transbilayer phospholipid movement in eukaryotic cells. *Mol Membr Biol.* 11:199-  
12 216.
- 13 Wilson, N.S., V. Dixit, and A. Ashkenazi. 2009. Death receptor signal transducers: nodes of  
14 coordination in immune signaling networks. *Nat Immunol.* 10:348-355.
- 15 WuDunn, D., and P.G. Spear. 1989. Initial interaction of herpes simplex virus with cells is  
16 binding to heparan sulfate. *J Virol.* 63:52-58.
- 17 Wyatt, R., and J. Sodroski. 1998. The HIV-1 envelope glycoproteins: fusogens, antigens, and  
18 immunogens. *Science.* 280:1884-1888.
- 19 Yamayoshi, S., Y. Yamashita, J. Li, N. Hanagata, T. Minowa, T. Takemura, and S. Koike.  
20 2009. Scavenger receptor B2 is a cellular receptor for enterovirus 71. *Nat Med.*  
21 15:798-801.
- 22 Yoneyama, M., and T. Fujita. 2009. RNA recognition and signal transduction by RIG-I-like  
23 receptors. *Immunol Rev.* 227:54-65.
- 24 Yoshimori, T. 2004. Autophagy: a regulated bulk degradation process inside cells. *Biochem*  
25 *Biophys Res Commun.* 313:453-458.
- 26 Zelensky, A.N., and J.E. Gready. 2005. The C-type lectin-like domain superfamily. *FEBS J.*  
27 272:6179-6217.
- 28 Zhang, J.R., and E. Tuomanen. 1999. Molecular and cellular mechanisms for microbial entry  
29 into the CNS. *J Neurovirol.* 5:591-603.
- 30 Ziegler, S.A., L. Lu, A.P. da Rosa, S.Y. Xiao, and R.B. Tesh. 2008. An animal model for  
31 studying the pathogenesis of chikungunya virus infection. *Am J Trop Med Hyg.*  
32 79:133-139.
- 33 Zwaal, R.F., and A.J. Schroit. 1997. Pathophysiologic implications of membrane  
34 phospholipid asymmetry in blood cells. *Blood.* 89:1121-1132.

## Review 2

### **Neurological Chikungunya: lessons from recent epidemics, animal models and other alphavirus family members.**

Thon-Hon G.V., **Kumar S.**, Ramful D., Robin S., Jaffar-Bandjee M.C. and Gasque P.

Book Chapter in 'Neurological infection; CRC press, Taylor and Francis Group. Dr Sunit K Singh and Dr Daniel Ruzek (Eds). Dec 2011:

**Context and Aim of the review:** CHIKV is known to cause not only arthritis, a clinical hallmark of 'old world' alphavirus, but also CNS infection through largely ill characterized mechanism. The recent outbreak of 2005-2006 in Reunion shows severe neuropathology such as encephalitis, meningoencephalitis, mother to child infection and deaths among neonates. In this review we addressed to understand the physiopathology of alphaviruses (CHIKV and SINV) in context of neurological complications.

In this review we highlighted on different observation of CHIKV infection to CNS:

- 1) Around 50% of the neonates were infected from mother with intrapartum viremia. Pediatric patients with neurological manifestations associated with CHIKV infection have symptoms of febrile seizures, acute encephalopathy, meningeal syndrome, and encephalitis. Whereas in adults the neurological symptoms were Guillain-Barre syndrome, encephalitis, seizures, with elevated level of CRP and IgM anti CHIKV in CSF.
- 2) Virus can induce neurological injuries by direct cytolytic action on neurons and glial cells by apoptosis and through the effects of neuroinflammatory cytokines.

**General conclusion:** With this review, an update of clinical manifestation related to neuroadaptive virus like CHIKV and SINV was established in comparison to well known neurological virus like WEEV, VEEV and EEEV; increasing our understanding of these neuro-viral induced pathologies.

**My Contribution to review:** my contribution was to review the different aspects of neurological symptoms observed in adults, pediatric patients and neonates, including deaths due to CHIKV infection.



---

# 2 Neurological Chikungunya: Lessons from Recent Epidemics, Animal Models, and Other Alphavirus Family Members

Vincent G. Thon-Hon, Shiril Kumar,  
Duksha Ramful, Stephanie Robin,  
Marie Christine Jaffar-Bandjee, and Philippe Gasque

## CONTENTS

2.1 Introduction: Chikungunya, a Paradigm Shift From “Old” to “New” World Alphavirus? .....	21
2.2 Neurological Chikungunya in Human Neonates.....	24
2.3 Neurological Manifestations in Pediatric Patients .....	25
2.4 Neurological Chikungunya in Adults .....	26
2.5 Neurological Chikungunya: Routes to CNS Infection and Tissue Injury .....	26
2.6 Neuroinfection by “Old World” Sindbis Virus .....	30
2.7 Neuroinfection by New World Alphaviruses: EEEV, VEEV, WEEV.....	30
2.8 Conclusion .....	32
References.....	33

## 2.1 INTRODUCTION: CHIKUNGUNYA, A PARADIGM SHIFT FROM “OLD” TO “NEW” WORLD ALPHAVIRUS?

Infections of the central nervous system (CNS) by viruses are relatively uncommon yet virtually devastating (Bruzzone et al. 2010). Viral invasion and successful infection of the CNS is an important step in the life cycle of many neurotropic viruses such as poliovirus, rabies, and measles (Griffin 2003). Viruses that invade the brain (and peripheral nerve tissues) have been postulated to cause diseases but through very diverse mechanisms with a unique mechanism of entry, replication, defense

against the immune system, and dissemination to preferred target cells, and developmental stages of infection (van den Pol 2006). Each of these aspects needs to be carefully addressed to understand the pathophysiology of a given virus with neurological complications.

Chikungunya virus (CHIKV) is an alphavirus of the *Togaviridae* family transmitted by mosquitoes of the *Aedes* (*Ae*) genus (Pialoux et al. 2007; Weaver and Barrett 2004). CHIKV was first isolated in 1952 in Tanganyika now Tanzania (Robinson 1955). Recurrent epidemics have been reported primarily in Africa and Asia (Powers and Logue 2007). The largest epidemic of CHIKV disease ever recorded took place in 2004–2011 and was associated with the emergence of CHIKV that were efficiently transmitted by *Ae. albopictus* a vector that has seen a dramatic global expansion in its geographic distribution (Charrel et al. 2007). The epidemic began in Kenya, spread across the Indian Ocean Islands to India (with an estimated 1.4–6.5 million cases) and South East Asia (Ng and Hapuarachchi 2010). Remarkably, CHIKV has accumulated key mutations (such as E1-A226V and E2-I211T) that probably contributed to the recently changed epidemiology and with possible clinical impacts, yet to be fully ascertained (Schuffenecker et al. 2006). The first autochthonous infections in Europe occurred in Italy in 2007 (less than 250 cases) and few reported cases in France in 2010 (Grandadam et al. 2011; Jaffar-Bandjee et al. 2010; Schwartz and Albert 2010). With increased and faster human transportation in the shrinking world, viruses can potentially move into new geographical locations and expand their geographical range. Thus, imported CHIKV cases have now been reported in nearly 40 countries including the United States, Japan, and several European countries (Powers 2011).

The alphavirus group comprises 29 viruses, six of which are called Old World alphaviruses, and they can cause human joint disorders (arthralgia evolving to arthritis). This is the case for CHIKV, o'nyong-nyong virus (ONNV), Semliki forest virus (SFV), Ross River (RRV), Sindbis virus (SINV), and Mayaro virus (MAYV). The acute phase of the disease with Old World alphaviruses is highly symptomatic (>90%) and is characterized mostly by fever, generalized myalgia, and arthralgia (Borgherini et al. 2008, 2007). Arthralgia and crippling arthritis are symptoms that can persist for years (Simon et al. 2011; Sissoko et al. 2009).

In contrast, the so-called New World alphaviruses such as the eastern equine encephalitis virus (EEEV) and Venezuelan equine encephalitis virus (VEEV) are mostly known for their profound neuropathological activities. These alphaviruses were isolated from diseased horses in California, Virginia, and New Jersey and from humans in Venezuela. Since then, these viruses have been isolated from infected mosquitoes (*Culex*), horses, humans, and other vertebrate species, predominantly birds and rodents.

Due to their worldwide emergence/reemergence as well as potential agents of bioterrorism, EEEV, VEEV, and CHIKV have been declared high priority pathogens by the National Institutes of Health.

Remarkably, it has long been known that CHIKV can contribute to neuropathology but by mechanisms largely ill-characterized (Carey et al. 1969; Chastel 1963; Chatterjee et al. 1965; Hammon et al. 1960; Jadhav et al. 1965; Nimmannitya et al. 1969; Thiruvengadam et al. 1965). The attack rate for CHIKV disease can be

**TABLE 2.1**  
**Neurological Chikungunya in Human and Animal Model**

Symptoms	Species	Neonate/		References
		Adult	Infant	
Headache	Human	Yes	–	(Lemant et al. 2008; Lewthwaite et al. 2009; Robin et al. 2008)
Reduced consciousness	Human	Yes	–	(Rampal et al. 2007; Robin et al. 2008)
Febrile seizures	Human	Yes	Yes	(Lewthwaite et al. 2009; Ramful et al. 2007; Robin et al. 2008)
Flaccid paralysis	Human/mouse	Yes	–	(Singh et al. 2008)
Meningeal syndrome	Human	Yes	Yes	(Robin et al. 2008)
Guillain-Barré syndrome	Human	Yes	–	(Economopoulou et al. 2009; Robin et al. 2008; Wielanek et al. 2007)
Epileptic seizures	Human	Yes	Yes	(Economopoulou et al. 2009; Ramful et al. 2007)
Acute encephalopathy	Human	Yes	Yes	(Gerardin et al. 2008; Lemant et al. 2008; Robin et al. 2008)
Neuropathy	Human	Yes	–	(Chandak et al. 2009)
Myeloneuropathy	Human	Yes	–	(Chandak et al. 2009; Kashyap et al. 2010)
Myelomeningoencephalitis	Human	Yes	–	(Economopoulou et al. 2009)
Encephalomyeloradiculitis	Human	Yes	–	(Ganesan et al. 2008)
Meningoencephalitis	Human/monkey	Yes	–	(Economopoulou et al. 2009; Robin et al. 2008)
Optic neuritis	Human	Yes	–	(Rampal et al. 2007)
Encephalomyelitis	Human	Yes	–	(Rampal et al. 2007)
Meningitis	Human	Yes	–	(Lewthwaite et al. 2009)
Encephalitis	Human	Yes	Yes	(Casolari et al. 2008; Chandak et al. 2009; Economopoulou et al. 2009; Kashyap et al. 2010; Rampal et al. 2007; Robin et al. 2008)
Encephalitis	Mouse		Yes	(Wang et al. 2008)

very high; a survey on Grande Comoros Island in 2005 suggested an attack rate of about 50% (Sergon et al. 2007), and in Reunion Island, 266,000 cases were reported (38% of the population) during 2005–2006. Hence, it is certainly the unprecedented incidence rate in the Indian Ocean with efficient clinical facilities that allowed a better description of CHIKV cases with severe encephalitis, meningoencephalitis,

peripheral neuropathies, and deaths among neonates (mother-to-child infection), infants as well as in elderly patients (Economopoulou et al. 2009; Gerardin et al. 2008; Lemant et al. 2008; Lewthwaite et al. 2009; Ramful et al. 2007; Robin et al. 2008; Tandale et al. 2009) (see Table 2.1).

## 2.2 NEUROLOGICAL CHIKUNGUNYA IN HUMAN NEONATES

Mother-to-child transmission of CHIKV with an estimated prevalence rate of 0.25% was first reported during the 2005–2006 outbreak in La Réunion Island, and this novel mode of transmission occurring during the peripartum maternal infection was responsible for a high rate of neurological morbidity (Gerardin et al. 2008; Ramful et al. 2007). Almost 50% of the neonates were infected from mother with intrapartum viremia. In a population-based series of 47 cases of perinatal mother-to-child CHIKV infection in La Réunion island, neonates developed illness as from day 2 to day 10 (mean, 4 days) after birth and 16 (34%) presented severe complications including encephalopathy with seizures in 9 cases in the acute phase of the disease.

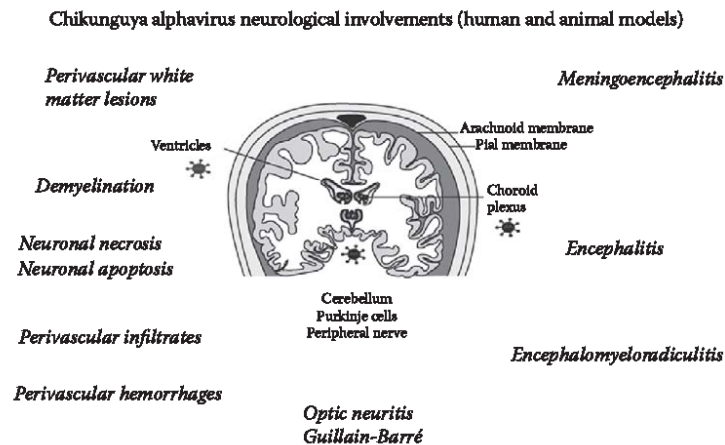

**FIGURE 2.1** Chikungunya neuropathology. CHIKV is not classically considered as a true neurotropic virus, but there is substantial recent evidence from neonates and elderly severe CNS cases and together with data from experimental infections (mice and macaque) using different CHIKV strains. CHIKV can infect neurons and cause apoptosis together with mild gliosis (astrocytes and microglia). Activated glial cells may contribute to the inflammatory response potentially contributing to reported demyelination and perivascular white matter lesions. Cells of the adaptive immune response (T and B cells) recruited at the site of injury may have a double-edged sword activity to either protect from infection or promote further neurotoxicity and demyelination. Of critical note, CHIKV and several other alphaviruses can infect the epithelial cells of the choroid plexus and the ependymal cells of the brain ventricles next to the stem cell niche. Peripheral neuropathies have also been reported in acute CHIKV infection in humans.

Mechanical ventilation was needed in 25% of patients due to apneic spells, status epilepticus, or hemodynamic instability, and one neonate died because of necrotizing enterocolitis. Pathological brain MRI was noted in 17 of 30 patients with brain swelling, scattered white matter lesions in the supratentorial regions, including the corpus callosum and the periventricular and subcortical areas, parenchymal hemorrhages (hematomas and petechias), and early cytotoxic edema on diffusion-weighted sequences evolving towards vasogenic edema in the subsequent course of the disease (Gerardin et al. 2008; Samperiz et al. 2007). Head ultrasound was unspecific with sometimes lenticulothalamostriatal vasculitis. CHIKV RNA was detected in spinal fluid even in apparently uncomplicated cases (23 of the 26 patients tested) even if biochemical and cellular characteristics of the cerebrospinal fluid (CSF) were often unremarkable. Preliminary data concerning long-term clinical follow-up of the infected neonates confirm poor outcome with a mean developmental quotient of 86 (51% of the cases <85) compared with 100 in the control group ( $p < 0.001$ ) at 2 years old (D. Ramful, personal communication). Gerardin et al. (2008) described persistent disabilities, with cerebral palsy, behavioral deficiencies, epilepsy, and language delay in 4 patients (of 9 with neonatal encephalopathy), where long-term sequelae in imaging studies sometimes included parenchymal cavitations secondary to hematomas and cerebral subcortical atrophy. Conversely, in maternal infection occurring far from delivery, there was no propensity to prematurity, growth restriction, fetal deaths, stillbirths, or congenital anomalies, and newborns seemed to be healthy at birth with no detectable IgM antibody at birth (Fritel et al. 2010) (Figure 2.1).

Figure 2.1's citation was placed here. OK?

### 2.3 NEUROLOGICAL MANIFESTATIONS IN PEDIATRIC PATIENTS

CHIKV fever is usually benign in children and neurological manifestations are rare. However, the two deaths reported in La Réunion Island in children (excluding the neonate mentioned before) were associated with severe neurological presentation of the disease including a case of acute disseminated encephalomyelitis and one case of coma associated with an acute hemorrhagic shock syndrome (Robin et al. 2008). In a hospital-based study in La Réunion Island, Robin et al. (2008) described a case series of 30 pediatric patients with neurological manifestations associated with CHIKV infection ranging from simple ( $n = 4$ ) and complex febrile seizures ( $n = 6$ ) to meningeal syndrome ( $n = 4$ ), acute encephalopathy ( $n = 4$ ), diplopia, acute disseminated encephalomyelitis ( $n = 1$ ), and encephalitis ( $n = 11$ ) with often unremarkable CSF findings and unspecific electroencephalography. Cerebrospinal fluid pleocytosis was found in only 4% of examined cases, although CSF RT-PCR was positive in 61%. Similar findings were subsequently described in infants in India and Mayotte Island (Le Bomin et al. 2008; Lewthwaite et al. 2009).

Risk factors for residual neurological deficit (20% of the patients) in the La Réunion cohort included young age (neonatal infection), severe initial clinical presentation (encephalitis), and initial pathological MRI findings. Neurological clinical manifestations of CHIKV infection in the pediatric population added growing evidence to the potential neurovirulence of this arboviral disease with an age-dependent condition (neonatal infection) and consistent laboratory (CHIKV RNA in CSF of patients) and imaging features (pathological MRI). These findings are consistent

with below mentioned mouse models, where young age is a risk factor for severe disease involving the CNS.

## 2.4 NEUROLOGICAL CHIKUNGUNYA IN ADULTS

CHIKV is highly symptomatic (arthralgia, myalgia) over a period of days to weeks, and most patients will recover. However, neurological manifestations described in adults requiring hospitalization involved cases of encephalopathy frequently associated with lymphopenia, thrombocytopenia, elevated CRP, and the presence of IgM anti-CHIKV in the CSF (Lemant et al. 2008). It was evident that these patients had severe comorbidities (e.g., diabetes, renal impairment) and with a mortality of almost 50% probably not directly related to CHIKV (Lemant et al. 2008). Similar neurological complications and fatalities were reported by several groups looking at severe hospitalized CHIKV cases from India (Chandak et al. 2009; Rampal et al. 2007; Tandale et al. 2009). Other neurological complications associated with CHIKV were seizures, encephalitis, Guillain-Barré, encephalomyeloradiculitis, and rare deaths (Chandak et al. 2009; Economopoulou et al. 2009; Ganesan et al. 2008; Lebrun et al. 2009; Lemant et al. 2008; Tournebize et al. 2009; Wielanek et al. 2007). Febrile seizures was found to be associated with both adults and neonates (simple febrile seizures) (Lewthwaite et al. 2009; Ramful et al. 2007; Robin et al. 2008), whereas epileptic seizures was observed in 12 of 610 patients (Economopoulou et al. 2009). Three cases of Guillain-Barré syndrome with associated symptoms of facial palsy and weakness in the hand, feet, or both was observed in La Réunion (Wielanek et al. 2007). Encephalomyeloradiculitis was observed after CHIKV infection by neuroimaging data in two patients and brain autopsy in one patient. In both cases, the symptoms were associated with neck rigidity, drowsiness, and extensor plantar response (Ganesan et al. 2008). Of critical note, these reports should not be generalized, given that they are hospital-based studies and were obtained from sick patients with high proportions of complications.

CHIKV infection in adults was also associated to bilateral frontoparietal white matter lesions with restricted diffusion, which are described as an early sign of viral encephalitis (Ganesan et al. 2008). Focal perivascular lymphocytic infiltrates were also present in area of active demyelination, and some degree of microglial activation was also noted in the gray matter, which may contribute to bystander neuronal loss. Regrettably, this is one of the rare histopathological studies substantiating the contribution of CHIKV to brain damage and most of the evidence comes from in vitro studies and animal models (in mice and macaques).

## 2.5 NEUROLOGICAL CHIKUNGUNYA: ROUTES TO CNS INFECTION AND TISSUE INJURY

Viruses can instigate neurological injuries not only by direct cytolytic actions on neurons or glia (oligodendrocytes, astrocytes) but also by inducing apoptosis, disrupting of the protective blood–brain barrier (BBB), polarizing resident innate immune cells (microglia) to produce proinflammatory cytokines, initiating (auto)



immune attack on specific cells, expressing viral genes and inhibiting cellular genes, altering neuronal migration, attenuating neural progenitor replication, and blocking CSF generation and flow. The multiple mechanisms of viral induction of CNS neuroinfection and dysfunction further complicate our understanding of viral agents in brain disease.

Although data are still scarce, the number of recent human cases with CNS involvement appears to support the neurotropic/neuroinfectious activity of CHIKV (Ganesan et al. 2008; Gerardin et al. 2008; Ramful et al. 2007). This unique CNS infection illustrated by subventricular white matter lesions, and intraparenchymal hemorrhages have been described experimentally and in clinical settings for other alphaviruses such as SFV, RRV, EEEV, and SINV (Deresiewicz et al. 1997; Fazakerley et al. 2006; Jackson et al. 1987; Mims et al. 1973) (see Table 2.2).

CHIKV was shown to infect mouse brain and to replicate in primary culture of neurons and glial cells (Chatterjee and Sarkar 1965; Das et al. 2010; Precious et al. 1974). CHIKV can also replicate in a human neuroblastoma cell line, SH-SY5Y, and cause cytopathic activities (Dhanwani et al. 2011; Solignat et al. 2009). Further evidence comes from experimental infections where mice were inoculated with CHIKV (clinical isolates and genetic clones). Interestingly, CNS infection is particularly described in young mice (outbred CD1, ICR) and recapitulating the human clinical disease (Ziegler et al. 2008). Interestingly, infected mice showed signs of illness suggestive of human clinical pathology such as loss of balance, difficulty of walking, dragging of the hind limbs, skin lesions but with rare mortality. No definite histological evidence of tropism to neurons was reported in these two mouse models, and the CNS infection seemed to be tightly controlled by ill-characterized antiviral mechanisms given that the viral titer was reduced to basal levels at day 10 postinfection. BALB/c mice infected intranasally developed neuronal infection and tissue necrosis in the anterior olfactory lobe (Powers and Logue 2007). Weaver and colleagues also used intranasal injection of CHIKV but the Ross strain selected because of its excessive mouse passage history and which may have increased its neurovirulence (Wang et al. 2008). The 5-week-old *C57BL/6* mice developed encephalitis 7 days postinfection with severe multifocal infection and liquefactive necrosis in the cerebral cortex. Immunohistochemistry techniques revealed that neurons were infected and induced to apoptosis while a prominent microgliosis and perivascular cuffs were distributed throughout the parenchyma. Moreover, the authors reported neuronal degeneration in the hippocampus and multifocal lymphocytic leptomeningitis. In mice deficient in the IFN- $\alpha$  signaling pathway (KO for the IFNA receptor), CHIKV neuroinfection was particularly severe and targets the leptomeninges, the choroid plexus, and ependymal cells lining the subventricular zone (SVZ) also known as the neural stem cell niche (Hauwel et al. 2005a,b). Of critical note, RRV was also shown to infect ependymal cells and lead to cortical thinning and hydrocephalus (Mims et al. 1973). To what extent CHIKV infection could affect the SVZ niche and subsequently the stem cells is currently unknown. This is also little evidence about the cellular and molecular mechanisms of brain tissue injury, which can be direct (neurotoxicity) or indirect through the mobilization of glial cells. To promote host survival, infected cells may undergo apoptosis, which can be qualified as an "altruistic" suicide in response to viral infections; however, neurons have limited capacity for regeneration.

**TABLE 2.2**  
**Cellular Targets, Immune Response, and Long-Term Consequences Following CNS Alphavirus Infection**

<b>Alphavirus</b>	<b>CNS Target Cell</b>	<b>CNS Immune Response</b>	<b>Long-Term Consequences</b>
SINV (mice)	<p><i>Neurons</i> (Griffin and Johnson 1977; Johnson 1965)</p> <p><i>Purkinje cells</i> (Johnson 1965)</p> <p><i>Meningeal cells</i> (Johnson 1965)</p> <p><i>Ependymal cells</i> (Jackson et al. 1987; Jackson et al. 1988; Johnson 1965)</p>	<p><i>Production of IL-1<math>\beta</math>, IL-4, IL-6, IL-10, TNF-<math>\alpha</math>, LIF, and TGF-<math>\beta</math></i> (Wesselingh et al. 1994)</p> <p><i>Production IFN-<math>\gamma</math> by CD4<sup>+</sup> and CD8<sup>+</sup></i> (Binder and Griffin 2001)</p> <p><i>Apoptosis of infected neurons</i> (Levine et al. 1993; Nava et al. 1998)</p> <p><i>Bcl-2 reduces fatality</i> (Levine et al. 1996)</p>	<p><i>Hind limb paralysis, death</i> (Griffin and Johnson 1977; Jackson et al. 1987)</p> <p><i>Acute encephalomyelitis</i> (Jackson et al. 1987), <i>Kyphoscoliosis</i> (Jackson et al. 1988)</p> <p><i>Swelling of lumbar and thoracic neurons</i> (Jackson et al. 1988)</p> <p><i>Death</i> (Griffin and Johnson 1977; Jackson et al. 1987)</p>
EEEV (mouse and human)	<p><i>Neurons</i> (mouse model and human) (Deresiewicz et al. 1997; Griffin 2003)</p>	<p><b>Pleocytosis</b> (Deresiewicz et al. 1997)</p> <p><b>In the CSF</b> (Deresiewicz et al. 1997):</p> <ul style="list-style-type: none"> <li>- <b>Elevated protein concentrations</b></li> <li>- <b>Elevated red blood cell counts</b></li> </ul> <p><b>Leukocytosis</b> (Deresiewicz et al. 1997)</p> <p><b>Hyponatremia</b> (Deresiewicz et al. 1997)</p>	<p><b>Large spectrum of general neurological complications (confusion, somnolence, focal weakness, epileptiform discharges, seizures, stupor, altered mental status, paresthesia accompanying paresis, hemiparesis)</b> (Deresiewicz et al. 1997); <b>lesions of the basal ganglia and cortex, encephalomalacia, focal intraparenchymal perivascular hemorrhage in the caudate nucleus and putamen, microglial nodules, meningeal enhancement, leptomingeal vascular congestion, brain hemorrhage, neuronal destruction, neuronophagia, cranial nerve palsies, focal necrosis, spotty demyelination</b> (Deresiewicz et al. 1997); <b>coma and death</b> (Deresiewicz et al. 1997)</p>

(continued)



**TABLE 2.2 (Continued)**  
**Cellular Targets, Immune Response, and Long-Term Consequences Following CNS Alphavirus Infection**

Alphavirus	CNS Target Cell	CNS Immune Response	Long-Term Consequences
VEEV (human)	<i>Neurons</i> (Griffin 2003)	<b>Meningeal infiltrates composed of lymphocytes, mononuclear cells, and neutrophils</b> (Steele and Twenhafel 2010)	<b>General neurological diseases (somnolence, confusion, disorientation, mental depression, convulsions, seizures, ataxia, paralysis)</b> (Steele and Twenhafel 2010); <b>predominant CNS pathologies (edema, congestion, hemorrhages, vasculitis, meningitis, encephalitis)</b> (Zacks and Paessler 2010); <b>common neurological sequelae</b> (Zacks and Paessler 2010); <b>coma and death</b> (Steele and Twenhafel 2010)
WEEV* (macaque and human)	<i>In the brain</i> (Reed et al. 2005) - <i>Microglia</i> - <i>Purkinje cells</i> <i>In the spinal cord</i> (Reed et al. 2005) - <i>α-motor neurons</i>	<i>Monocytic inflammation in the CNS expanding perivascular spaces</i> (Reed et al. 2005) <b>Occasional infiltrates of lymphocytes, plasma cells, PMN leukocytes surrounding arterioles in the cerebral cortex</b> (Anderson 1984)	<i>Demyelination and myelitis in white matter areas</i> (Reed et al. 2005) <b>General neurological diseases (partial left seizures, deep consciousness depression, hyperreflexia, bilateral Babinski sign)</b> (Delfraro et al. 2011) <b>Severe CNS disorders (multifocal necrosis in the deep gray matter, dilation of the temporal ventricles and compression of the peritroncal and sylvian cisterns)</b> (Anderson 1984; Delfraro et al. 2011) <b>Coma and death</b> (Delfraro et al. 2011)

\* Italicized, NHP model; boldface, human studies.

CHIKV can cause programmed cell death through extrinsic apoptosis (death receptor/caspase 8 pathway), intrinsic apoptosis (cytochrome C/caspase 9 pathway) or autophagy of many cell types including neuroblastoma cells (Krejebich-Trotot et al. 2011) and unpublished observations. This will need to be confirmed using primary cultures, but it should be stressed that this is also salutary to the CNS tissue to limit virus spreading.

Astrogliosis and microgliosis have been reported in human and animal models of CHIKV neuroinfection, and these responses may be essential to ward off the infectious challenge through the production of interferon and interferon-stimulated gene (for a review, see Ryman and Klimstra 2008). The immune response to CNS infection has double-edged sword activity, which protects from infections, on the one hand, and promotes further tissue injury if uncontrolled, on the other (Hauwel et al. 2005a). It is essential to have a better understanding of the plausible role of innate immune effectors such as cytokines and complement proteins produced at the site of injury. This is largely unknown in the case of CHIKV neuroinfection, and important information should be obtained from other alphaviruses affecting brain cells and functions.

## 2.6 NEUROINFECTION BY “OLD WORLD” SINDBIS VIRUS

SINV was named after its first isolation in Sindbis health district near Cairo (Egypt) from a pool of *Culex pipiens* and *Cx univittatus* mosquitoes (Taylor et al. 1955). Other synonyms or subtypes of SINV have been described in Sweden (Ockelbo disease), Finland (Pogosta disease), and Russia (Karelian fever) in the early 1980s, according to the region involved (Brummer-Korvenkontio and Kuusisto 1981; Lvov et al. 1982; Skogh and Espmark 1982). SINV can cause fever, rash, and arthralgia in humans (Turunen et al. 1998) and encephalomyelitis in mice (Jackson et al. 1987). Neuroadapted SINV (NSINV) is a neurovirulent strain that have been developed by serial passage of the original isolate AR339 of SINV from mouse brain (Griffin and Johnson 1977). Infection of weanling mice with NSINV induced an acute encephalomyelitis with high mortality rate, and animals can develop kyphoscoliosis, which is an abnormal curvature of the spine, and hind-limb paralysis (Jackson et al. 1987, 1988). Swelling of lumbar and thoracic neurons has also been documented in NSINV infection (Jackson et al. 1988). SINV is known to infect the Purkinje cells of the cerebellum and meningeal and ependymal cells in mouse (Griffin and Johnson 1977; Jackson et al. 1987, 1988; Johnson 1965). The maturity of infected neurons determines their susceptibility to SINV. Immature neurons replicate SINV to high titers and undergo apoptosis, whereas mature neurons are more resistant to SINV replication and survive viral infection (Binder and Griffin 2001; Burdeinick-Kerr and Griffin 2005). It was shown that infection of neonatal mice with a SINV chimera expressing bcl-2, an anti-apoptotic gene, induced a lower mortality rate (7.5%) (Levine et al. 1996). Hence, controlling neuronal apoptosis protects mice against fatal SINV encephalitis. After intracerebral inoculation of SINV in mice, transcripts of IL-1 $\beta$ , IL-4, IL-6, IL-10, TNF- $\alpha$ , leukemia inhibitory factor (LIF), and TGF- $\beta$  were produced by brain cells in response to infection and may contribute to neuronal loss (Wesselingh et al. 1994).

## 2.7 NEUROINFECTION BY NEW WORLD ALPHAVIRUSES: EEEV, VEEV, WEEV

EEEV, VEEV, and WEEV are New World alphaviruses whose symptoms can be similar to those described for SINV, but as their names suggest, they can frequently

cause severe encephalitis in humans and horses (Zacks and Paessler 2010). They are naturally maintained through enzootic cycles involving arthropods as vectors with ensuing amplification in small mammals or birds, and epizootic cycles between bridging mosquitoes vectors and large mammals such as horses and humans, which are dead-end hosts, as they are not viremic enough to infect mosquitoes and propagate the cycle. Among the three, EEEV seems to be the most virulent in humans, causing mortality in approximately 40% of symptomatic cases (Deresiewicz et al. 1997). In survivors, permanent neurological sequelae can occur, and some with severe impairment die within a few days.

EEEV was first isolated in Virginia and New Jersey from infected horses in 1933 (Giltner and Shahan 1933; TenBroeck and Merrill 1933) and was first recognized to infect humans in 1938 after an outbreak in Massachusetts (Feemster 1938). Three children died and two had encephalitis. An interesting coincidence was that those five cases occurred in essentially the same area as the equine disease. The eastern strain of the equine encephalomyelitis virus had next been isolated from human brain tissue of the first case (Feemster 1938). Enzootic transmission cycle of EEEV involves ornithophilic mosquitoes (mainly *Culiseta melanura*) and passerine birds (Komar and Spielman 1994; Scott and Weaver 1989). EEE usually begins abruptly and rapidly instigate fever, chills, myalgia, and arthralgia; after a few days, neurological signs may appear. EEEV has not been as well studied in animals as VEEV; nonetheless, a variety of animal models have been described, such as mice, hamsters, guinea pigs, and nonhuman primates (NHP), which are the best studied (Zacks and Paessler 2010). In mice and human, EEEV is known to infect neurons (Deresiewicz et al. 1997; Griffin 2003).

VEEV was first isolated in Venezuela from the brain of an encephalitic horse in 1938 (Kubes and Rios 1939) and first recognized to infect humans in 1943 (Casals et al. 1943). VEEV is efficiently amplified during a cycle involving equids and mosquitoes that occurs in an agricultural area (Aguilar et al. 2011). In human, VEEV is usually an acute and often mild systemic disease. Clinical signs can be characterized by fever, chills, generalized malaise, severe headache, photophobia, and myalgia mainly localized in the legs and lumbosacral region. Very young or elderly patients are more likely to develop severe infections. In adults, cases of encephalitis and fatality are scarce (Zacks and Paessler 2010). In mice, neurons are cellular targets for VEEV (Griffin 2003). CNS infection by VEEV has been shown to induce the infiltration of lymphocytes, mononuclear cells, and neutrophils in the meninges. In a minority of cases, these inflammatory cells extended into the Virchow-Robin spaces, which are tiny fluid-filled canal surrounding arteries and veins in brain parenchyma (Steele and Twenhafel 2010). In humans, VEEV-induced fatality occurs in <1% of cases. Nevertheless, neurological diseases including disorientation, ataxia, mental depression, and convulsions can reach 14% of cases, mainly in children. The severity of neurological complications can range from somnolence and mild confusion to seizure, ataxia, paralysis, and coma (Steele and Twenhafel 2010). The predominant CNS pathological findings in deadly VEEV human cases comprise edema, congestion, hemorrhages, vasculitis, meningitis, and encephalitis (Zacks and Paessler 2010).

WEEV was first isolated in California from the brain of horses suffering from encephalitis in 1930 (Meyer et al. 1931). In 1938, the virus has been recovered for

the first time from the brain of a 20-month-old boy in California (Howitt 1938). WEEV is maintained in an enzootic cycle between passerine birds, which are its natural host and culicine mosquitoes, with a variety of mammals as incidental hosts. WEE is usually asymptomatic and much milder than EEE. The disease generally appears abruptly and potentially includes fever, chills, headache, nausea, vomiting, anorexia, malaise, and occasional respiratory signs. WEEV appears to be a recombinant virus originated from a recombination between an EEEV-like and an SINV-like ancestor giving rise to a new virus with encephalogenic properties of EEEV and the antigenic specificity of SINV (Hahn et al. 1988). After aerosol exposure to WEEV in the NHP model, abundant microglia and neurons in the cerebral cortex were WEEV-positive. In addition, a low amount of cerebellar Purkinje cells and alpha-motor neurons in the spinal cord gray matter showed WEEV antigens (Reed et al. 2005). From clinical and radiographic data of 38 patients infected by EEEV, Deresiewicz et al. (1997) found biological abnormalities including pleocytosis (97% of cases), elevated protein concentrations and red blood cell counts in CSF (94% and 77%, respectively), leukocytosis (69%), and hyponatremia (60%). They reported a wide spectrum of neurological complications such as confusion, somnolence, focal weakness, epileptiform discharges, seizures, stupor, altered mental status, paresthesia accompanying paresis, and hemiparesis. Lesions of the basal ganglia and cortex were observed in a 14-year-old boy who died from EEE and whom autopsy revealed a diffuse encephalomalacia, marked perivascular chronic inflammatory changes, and focal intraparenchymal perivascular hemorrhage in the caudate nucleus and putamen. Several microglial nodules were noticed. Deresiewicz et al. (1997) also reported meningeal enhancement, leptomenigeal vascular congestion, brain hemorrhage, neuronal destruction, neuronophagia, cranial nerve palsies, focal necrosis, spotty demyelination, encephalomalacia, coma, and death.

After aerosol exposure to WEEV of NHP, Reed et al. (2005) demonstrated a pronounced encephalitis characterized by monocytic inflammation expanding in perivascular spaces and infiltrating into the surrounding neutrophils. They found that infection of WEEV in the CNS of NHP resulted in multifocal areas of demyelination in the white matter of the brain and spinal cord, occasionally associated with inflammation. In human, Anderson (1984) reported a fatal case in a 75-year-old woman infected with WEEV and presenting perivascular infiltrates and multifocal necrosis in the deep gray matter. Recently, a fatal human case was reported in which the 14-year-old boy experienced from partial left seizures, consciousness depression, hyperreflexia, and bilateral Babinski sign (Delfraro et al. 2011). Depression of consciousness progressed at a deeper level, and the brain showed dilatation of the temporal ventricles and compression of the peritroncal and sylvian cisterns. The level of coma progressed until the patient died (Delfraro et al. 2011).

Please check  
spelling:  
peritroncal.

## 2.8 CONCLUSION

As highlighted throughout this review, our understanding of neurological and potentially encephalitic alphavirus is still in its infancy. CHIKV in addition to its profound arthritogenic activity has also encephalitic potential particularly in newborns and elderly patients with severe comorbidities. Moreover, CHIKV is known

to persist in tissue sanctuaries (not in the brain as far as we know) and contributes to chronic diseases. Some CHIKV elderly patients can experience rheumatism 5 years postinfection and with long-term brain development defects in neonates. Although cell permissiveness and reactivity has been studied in great depth, the mechanisms of CHIKV persistence and associated tissue injuries remains largely ill-characterized. Therefore, with a proven potential to spread globally, it is now critical to devise strategies to circumvent infection of populations at risk and new epidemics. In the absence of a specific antiviral therapy, treatment remains supportive. Recently, the development of polyvalent immunoglobulins, purified from human plasma samples of convalescent patients that exhibited in vitro and in vivo neutralizing activities could be of benefit to neonates born from viremic mothers at delivery and to encephalitic patients at the initial stage of the disease (Couderc et al. 2009). Moreover, protection against mosquito bites remains essential in CHIKV prevention. Parental training about prevention of mosquito bites during the perinatal period and distribution of impregnated mosquito nets should be carried out during outbreaks. DEET (*N,N*-diethyl-*m*-toluamide, now called *N,N*-diethyl-3-methylbenzamide) is considered as the most effective insect repellent for personal protection but is not recommended for young children, pregnant, and lactating women due to potential neurotoxic effects.

## REFERENCES

- Aguilar, P.V., Estrada-Franco, J.G., Navarro-Lopez, R., Ferro, C., Haddow, A.D., Weaver, S.C. 2011. Endemic Venezuelan equine encephalitis in the Americas: hidden under the dengue umbrella. *Future Virol* 6, 721–740.
- Anderson, B.A. 1984. Focal neurologic signs in western equine encephalitis. *Can Med Assoc J* 130, 1019–1021.
- Binder, G.K., Griffin, D.E. 2001. Interferon-gamma-mediated site-specific clearance of alpha-virus from CNS neurons. *Science* 293, 303–306.
- Borgherini, G., Poubeau, P., Jossaume, A., Gouix, A., Cotte, L., Michault, A., Arvin-Berod, C., Paganin, F. 2008. Persistent arthralgia associated with chikungunya virus: a study of 88 adult patients on reunion island. *Clin Infect Dis* 47, 469–475.
- Borgherini, G., Poubeau, P., Staikowsky, F., Lory, M., Le Moullec, N., Becquart, J.P., Wengling, C., Michault, A., Paganin, F. 2007. Outbreak of chikungunya on Reunion Island: early clinical and laboratory features in 157 adult patients. *Clin Infect Dis* 44, 1401–1407.
- Brummer-Korvenkontio, M., Kuusisto, P. 1981. Onko Suomen länsiosa säästynyt 'Pogosta'? (Has western Finland been spared the 'Pogosta'). *Suom Lääkäril* 32, 2606–2607.
- Bruzzone, R., Dubois-Dalq, M., Kristensson, K. 2010. Neurobiology of infectious diseases: bringing them out of neglect. *Prog Neurobiol* 91, 91–94.
- Burdeinick-Kerr, R., Griffin, D.E. 2005. Gamma interferon-dependent, noncytolytic clearance of Sindbis virus infection from neurons in vitro. *J Virol* 79, 5374–5385.
- Carey, D.E., Myers, R.M., DeRanitz, C.M., Jadhav, M., Reuben, R. 1969. The 1964 chikungunya epidemic at Vellore, South India, including observations on concurrent dengue. *Trans R Soc Trop Med Hyg* 63, 434–445.
- Casals, J., Curnen, E.C., Thomas, L. 1943. Venezuelan equine encephalomyelitis in man. *J Exp Med* 77, 521–530.
- Casolari, S., Briganti, E., Zanotti, M., Zauli, T., Nicoletti, L., Magurano, F., Fortuna, C., Fiorentini, C., Grazia Ciufolini, M., Rezza, G. 2008. A fatal case of encephalitis associated with Chikungunya virus infection. *Scand J Infect Dis* 40, 995–996.

- Chandak, N.H., Kashyap, R.S., Kabra, D., Karandikar, P., Saha, S.S., Morey, S.H., Purohit, H.J., Taori, G.M., Dagainawala, H.F. 2009a. Neurological complications of Chikungunya virus infection. *Neurol India* 57, 177–180.
- Charrel, R.N., de Lamballerie, X., Raoult, D. 2007. Chikungunya outbreaks—the globalization of vectorborne diseases. *N Engl J Med* 356, 769–771.
- Chastel, C. 1963. Human infections in Cambodia by the Chikungunya virus or an apparently closely related agent. II. Experimental pathological anatomy. *Bull Soc Pathol Exot Filiales* 56, 915–924.
- Chatterjee, S.N., Chakravarti, S.K., Mitra, A.C., Sarkar, J.K. 1965. Virological investigation of cases with neurological complications during the outbreak of haemorrhagic fever in Calcutta. *J Indian Med Assoc* 45, 314–316.
- Chatterjee, S.N., Sarkar, J.K. 1965. Electron microscopic studies of suckling mouse brain cells infected with Chikungunya virus. *Indian J Exp Biol* 3, 227–234.
- Couderc, T., Khandoudi, N., Grandadam, M., Visse, C., Gangneux, N., Bagot, S., Prost, J.F., Lecuit, M. 2009. Prophylaxis and therapy for Chikungunya virus infection. *J Infect Dis* 200, 516–523.
- Das, T., Jaffar-Bandjee, M.C., Hoarau, J.J., Krejbich Trotot, P., Denizot, M., Lee-Pat-Yuen, G., Sahoo, R., Guiraud, P., Ramful, D., Robin, S., Alessandri, J.L., Gauzere, B.A., Gasque, P. 2010. Chikungunya fever: CNS infection and pathologies of a re-emerging arbovirus. *Prog Neurobiol* 91, 121–129.
- Delfraro, A., Burgueno, A., Morel, N., Gonzalez, G., Garcia, A., Morelli, J., Perez, W., Chiparelli, H., Arbiza, J. 2011. Fatal human case of Western equine encephalitis, Uruguay. *Emerg Infect Dis* 17, 952–954.
- Deresiewicz, R.L., Thaler, S.J., Hsu, L., Zamani, A.A. 1997. Clinical and neuroradiographic manifestations of eastern equine encephalitis. *N Engl J Med* 336, 1867–1874.
- Dhanwani, R., Khan, M., Alam, S.I., Rao, P.V., Parida, M. 2011. Differential proteome analysis of Chikungunya virus-infected new-born mice tissues reveal implication of stress, inflammatory and apoptotic pathways in disease pathogenesis. *Proteomics* 11, 1936–1951.
- Economopoulou, A., Dominguez, M., Helynck, B., Sissoko, D., Wichmann, O., Quenel, P., Germonneau, P., Quatresous, I. 2009. Atypical Chikungunya virus infections: clinical manifestations, mortality and risk factors for severe disease during the 2005–2006 outbreak on Reunion. *Epidemiol Infect* 137, 534–541.
- Fazakerley, J.K., Cotterill, C.L., Lee, G., Graham, A. 2006. Virus tropism, distribution, persistence and pathology in the corpus callosum of the Semliki Forest virus-infected mouse brain: a novel system to study virus-oligodendrocyte interactions. *Neuropathol Appl Neurobiol* 32, 397–409.
- Feemster, R.F. 1938. Outbreak of encephalitis in man due to the eastern virus of equine encephalomyelitis. *Am J Public Health Nations Health* 28, 1403–1410.
- Fritel, X., Rollot, O., Gerardin, P., Gauzere, B.A., Bideault, J., Lagarde, L., Dhuime, B., Orvain, E., Cuillier, F., Ramful, D., Samperiz, S., Jaffar-Bandjee, M.C., Michault, A., Cotte, L., Kaminski, M., Fourmaintraux, A. 2010. Chikungunya virus infection during pregnancy, Reunion, France, 2006. *Emerg Infect Dis* 16, 418–425.
- Ganesan, K., Diwan, A., Shankar, S.K., Desai, S.B., Sainani, G.S., Katrak, S.M. 2008. Chikungunya encephalomyelorradiculitis: report of 2 cases with neuroimaging and 1 case with autopsy findings. *AJNR Am J Neuroradiol* 29, 1636–1637.
- Gerardin, P., Barau, G., Michault, A., Bintner, M., Randrianaivo, H., Choker, G., Lenglet, Y., Touret, Y., Bouveret, A., Grivard, P., Le Roux, K., Blanc, S., Schuffenecker, I., Couderc, T., Arenzana-Seisdedos, F., Lecuit, M., Robillard, P.Y. 2008. Multidisciplinary prospective study of mother-to-child chikungunya virus infections on the island of La Reunion. *PLoS Med* 5, e60.



- Giltner, L.T., Shahan, M.S. 1933. The 1933 outbreak of infectious equine encephalomyelitis in the eastern states. *North Am Vet* 14, 25–27.
- Grandadam, M., Caro, V., Plumet, S., Thiberge, J.M., Souares, Y., Failloux, A.B., Tolou, H.J., Budelot, M., Cosserrat, D., Leparac-Goffart, I., Despres, P. 2011. Chikungunya virus, southeastern France. *Emerg Infect Dis* 17, 910–913.
- Griffin, D.E. 2003. Immune responses to RNA-virus infections of the CNS. *Nat Rev Immunol* 3, 493–502.
- Griffin, D.E., Johnson, R.T. 1977. Role of the immune response in recovery from Sindbis virus encephalitis in mice. *J Immunol* 118, 1070–1075.
- Hahn, C.S., Lustig, S., Strauss, E.G., Strauss, J.H. 1988. Western equine encephalitis virus is a recombinant virus. *Proc Natl Acad Sci USA* 85, 5997–6001.
- Hammon, W.M., Rudnick, A., Sather, G.E. 1960. Viruses associated with epidemic hemorrhagic fevers of the Philippines and Thailand. *Science* 131, 1102–1103.
- Hauwel, M., Furon, E., Canova, C., Griffiths, M., Neal, J., Gasque, P. 2005a. Innate (inherent) control of brain infection, brain inflammation and brain repair: the role of microglia, astrocytes, “protective” glial stem cells and stromal ependymal cells. *Brain Res Brain Res Rev* 48, 220–233.
- Hauwel, M., Furon, E., Gasque, P. 2005b. Molecular and cellular insights into the coxsackie-adenovirus receptor: role in cellular interactions in the stem cell niche. *Brain Res Brain Res Rev* 48, 265–272.
- Howitt, B. 1938. Recovery of the virus of equine encephalomyelitis from the brain of a child. *Science* 88, 455–456.
- Jackson, A.C., Moench, T.R., Griffin, D.E., Johnson, R.T. 1987. The pathogenesis of spinal cord involvement in the encephalomyelitis of mice caused by neuroadapted Sindbis virus infection. *Lab Invest* 56, 418–423.
- Jackson, A.C., Moench, T.R., Trapp, B.D., Griffin, D.E. 1988. Basis of neurovirulence in Sindbis virus encephalomyelitis of mice. *Lab Invest* 58, 503–509.
- Jadhav, M., Namboodripad, M., Carman, R.H., Carey, D.E., Myers, R.M. 1965. Chikungunya disease in infants and children in Vellore: a report of clinical and haematological features of virologically proved cases. *Indian J Med Res* 53, 764–776.
- Jaffar-Bandjee, M.C., Ramful, D., Gauzere, B.A., Hoarau, J.J., Krejbich-Trotot, P., Robin, S., Ribera, A., Selambarom, J., Gasque, P. 2010. Emergence and clinical insights into the pathology of Chikungunya virus infection. *Expert Rev Anti Infect Ther* 8, 987–996.
- Johnson, R.T. 1965. Virus invasion of the central nervous system: a study of Sindbis virus infection in the mouse using fluorescent antibody. *Am J Pathol* 46, 929–943.
- Kashyap, R.S., Morey, S.H., Chandak, N.H., Purohit, H.J., Taori, G.M., Dagainawala, H.F. 2010. Detection of viral antigen, IgM and IgG antibodies in cerebrospinal fluid of Chikungunya patients with neurological complications. *Cerebrospinal Fluid Res* 7, 12.
- Komar, N., Spielman, A. 1994. Emergence of eastern encephalitis in Massachusetts. *Ann NY Acad Sci* 740, 157–168.
- Krejbich-Trotot, P., Denizot, M., Hoarau, J.J., Jaffar-Bandjee, M.C., Das, T., Gasque, P. 2011. Chikungunya virus mobilizes the apoptotic machinery to invade host cell defenses. *FASEB J* 25, 314–325.
- Kubes, V., Rios, F.A. 1939. The causative agent of infectious equine encephalomyelitis in Venezuela. *Science* 90, 20–21.
- Le Bomin, A., Hebert, J.C., Marty, P., Delaunay, P. 2008. Confirmed chikungunya in children in Mayotte. Description of 50 patients hospitalized from February to June 2006. *Med Trop (Mars)* 68, 491–495.
- Lebrun, G., Chadda, K., Reboux, A.H., Martinet, O., Gauzere, B.A. 2009. Guillain-Barre syndrome after chikungunya infection. *Emerg Infect Dis* 15, 495–496.

- Lemant, J., Boisson, V., Winer, A., Thibault, L., Andre, H., Tixier, F., Lemercier, M., Antok, E., Cresta, M.P., Grivard, P., Besnard, M., Rollot, O., Favier, F., Huerre, M., Campinos, J.L., Michault, A. 2008. Serious acute chikungunya virus infection requiring intensive care during the Reunion Island outbreak in 2005–2006. *Crit Care Med* 36, 2536–2541.
- Levine, B., Goldman, J.E., Jiang, H.H., Griffin, D.E., Hardwick, J.M. 1996. Bcl-2 protects mice against fatal alphavirus encephalitis. *Proc Natl Acad Sci USA* 93, 4810–4815.
- Levine, B., Huang, Q., Isaacs, J.T., Reed, J.C., Griffin, D.E., Hardwick, J.M. 1993. Conversion of lytic to persistent alphavirus infection by the bcl-2 cellular oncogene. *Nature* 361, 739–742.
- Lewthwaite, P., Vasanthapuram, R., Osborne, J.C., Begum, A., Plank, J.L., Shankar, M.V., Hewson, R., Desai, A., Beeching, N.J., Ravikumar, R., Solomon, T. 2009. Chikungunya virus and central nervous system infections in children, India. *Emerg Infect Dis* 15, 329–331.
- Lvov, D.K., Skvortsova, T.M., Kondrashina, N.G., Vershinsky, B.V., Lesnikov, A.L., Derevyansky, V.S. 1982. Etiology of Karelian fever, a new arbovirus infection. *Vopr Virusol* 6, 690–692.
- Meyer, K.F., Haring, C.M., Howitt, B. 1931. The etiology of epizootic encephalomyelitis of horses in the San Joaquin Valley, 1930. *Science* 74, 227–228.
- Mims, C.A., Murphy, F.A., Taylor, W.P., Marshall, I.D. 1973. Pathogenesis of Ross River virus infection in mice. I. Ependymal infection, cortical thinning, and hydrocephalus. *J Infect Dis* 127, 121–128.
- Nava, V.E., Rosen, A., Veluona, M.A., Clem, R.J., Levine, B., Hardwick, J.M. 1998. Sindbis virus induces apoptosis through a caspase-dependent, CrmA-sensitive pathway. *J Virol* 72, 452–459.
- Ng, L.C., Hapuarachchi, H.C. 2010. Tracing the path of Chikungunya virus—evolution and adaptation. *Infect Genet Evol* 10, 876–885.
- Nimmannitya, S., Halstead, S.B., Cohen, S.N., Margiotta, M.R. 1969. Dengue and chikungunya virus infection in man in Thailand, 1962–1964. I. Observations on hospitalized patients with hemorrhagic fever. *Am J Trop Med Hyg* 18, 954–971.
- Pialoux, G., Gauzere, B.A., Jaureguiberry, S., Strobel, M. 2007. Chikungunya, an epidemic arbovirolosis. *Lancet Infect Dis* 7, 319–327.
- Powers, A.M. 2011. Genomic evolution and phenotypic distinctions of Chikungunya viruses causing the Indian Ocean outbreak. *Exp Biol Med (Maywood)* 236, 909–914.
- Powers, A.M., Logue, C.H. 2007. Changing patterns of chikungunya virus: re-emergence of a zoonotic arbovirus. *J Gen Virol* 88, 2363–2377.
- Precious, S.W., Webb, H.E., Bowen, E.T. 1974. Isolation and persistence of Chikungunya virus in cultures of mouse brain cells. *J Gen Virol* 23, 271–279.
- Ramful, D., Carbonnier, M., Pasquet, M., Bouhmani, B., Ghazouani, J., Noormahomed, T., Beullier, G., Attali, T., Samperiz, S., Fourmaintraux, A., Alessandri, J.L. 2007. Mother-to-child transmission of Chikungunya virus infection. *Pediatr Infect Dis J* 26, 811–815.
- Rampal, Sharda, M., Meena, H. 2007. Neurological complications in Chikungunya fever. *J Assoc Physicians India* 55, 765–769.
- Reed, D.S., Larsen, T., Sullivan, L.J., Lind, C.M., Lackemeyer, M.G., Pratt, W.D., Parker, M.D. 2005. Aerosol exposure to western equine encephalitis virus causes fever and encephalitis in cynomolgus macaques. *J Infect Dis* 192, 1173–1182.
- Robin, S., Ramful, D., Le Seach, F., Jaffar-Bandjee, M.C., Rigou, G., Alessandri, J.L. 2008. Neurologic manifestations of pediatric chikungunya infection. *J Child Neurol* 23, 1028–1035.
- Robinson, M.C. 1955. An epidemic of virus disease in Southern Province, Tanganyika Territory, in 1952–53. I. Clinical features. *Trans R Soc Trop Med Hyg* 49, 28–32.
- Ryman, K.D., Klimstra, W.B. 2008. Host responses to alphavirus infection. *Immunol Rev* 225, 27–45.



- Samperiz, E., Gerardin, P., Noormahomed, T., Beullir, G., Boya, I. 2007. Transmission perinatale du virus chikungunya, à propos de 47 cas à l'île de la Réunion. *Bull Soc Pathol Exot Filiales* 100, 355.
- Schuffenecker, I., Iteman, I., Michault, A., Murri, S., Frangeul, L., Vaney, M.C., Lavenir, R., Pardigon, N., Reynes, J.M., Pettinelli, F., Biscomet, L., Diancourt, L., Michel, S., Duquerroy, S., Guigon, G., Frenkiel, M.P., Brehin, A.C., Cubito, N., Despres, P., Kunst, F., Rey, F.A., Zeller, H., Brisse, S. 2006. Genome microevolution of chikungunya viruses causing the Indian Ocean outbreak. *PLoS Med* 3, e263.
- Schwartz, O., Albert, M.L. 2010. Biology and pathogenesis of chikungunya virus. *Nature Rev Microbiol* 8, 491–500.
- Scott, T.W., Weaver, S.C. 1989. Eastern equine encephalomyelitis virus: epidemiology and evolution of mosquito transmission. *Adv Virus Res* 37, 277–328.
- Sergon, K., Yahaya, A.A., Brown, J., Bedja, S.A., Mlindasse, M., Agata, N., Allaranger, Y., Ball, M.D., Powers, A.M., Ofula, V., Onyango, C., Konongoi, L.S., Sang, R., Njenga, M.K., Breiman, R.F. 2007. Seroprevalence of Chikungunya virus infection on Grande Comore Island, union of the Comoros, 2005. *Am J Trop Med Hyg* 76, 1189–1193.
- Simon, F., Javelle, E., Oliver, M., Leparc-Goffart, I., Marimoutou, C. 2011. Chikungunya virus infection. *Curr Infect Dis Rep* 13, 218–228.
- Singh, S.S., Manimunda, S.P., Sugunan, A.P., Sahina, Vijayachari, P. 2008. Four cases of acute flaccid paralysis associated with chikungunya virus infection. *Epidemiol Infect* 136, 1277–1280.
- Sissoko, D., Malvy, D., Ezzedine, K., Renault, P., Moschetti, F., Ledrans, M., Pierre, V. 2009. Post-epidemic Chikungunya disease on Reunion Island: course of rheumatic manifestations and associated factors over a 15-month period. *PLoS Neglect Trop Dis* 3, e389.
- Skogh, M., Espmark, A. 1982. Ockelbo-sjukan-ett hud- och ledsyndrom troligen orsakat av myggburet al.fa-arbovirus. *Läkartid* 79, 2379–2380.
- Solignat, M., Gay, B., Higgs, S., Briant, L., Devaux, C. 2009. Replication cycle of chikungunya: a re-emerging arbovirus. *Virology* 393, 183–197.
- Steele, K.E., Twenhafel, N.A. 2010. Review paper: pathology of animal models of alphavirus encephalitis. *Vet Pathol* 47, 790–805.
- Tandale, B.V., Sathe, P.S., Arankalle, V.A., Wadia, R.S., Kulkarni, R., Shah, S.V., Shah, S.K., Sheth, J.K., Sudeep, A.B., Tripathy, A.S., Mishra, A.C. 2009. Systemic involvements and fatalities during Chikungunya epidemic in India, 2006. *J Clin Virol* 2009 46, 145–149.
- Taylor, R.M., Hurlbut, H.S., Work, T.H., Kingston, J.R., Frothingham, T.E. 1955. Sindbis virus: a newly recognized arthropodtransmitted virus. *Am J Trop Med Hyg* 4, 844–862.
- TenBroeck, C., Merrill, M.H. 1933. A serological difference between eastern and western equine encephalomyelitis virus. *Proc Soc Exp Biol Med* 31, 217–220.
- Thiruvengadam, K.V., Kalyanasundaram, V., Rajgopal, J. 1965. Clinical and pathological studies on chikungunya fever in Madras city. *Indian J Med Res* 53, 729–744.
- Tournebise, P., Charlin, C., Lagrange, M. 2009. Neurological manifestations in Chikungunya: about 23 cases collected in Reunion Island. *Rev Neurol (Paris)* 165, 48–51.
- Turunen, M., Kuusisto, P., Uggeldahl, P.E., Toivanen, A. 1998. Pogosta disease: clinical observations during an outbreak in the province of North Karelia, Finland. *Br J Rheumatol* 37, 1177–1180.
- van den Pol, A.N. 2006. Viral infections in the developing and mature brain. *Trends Neurosci* 29, 398–406.
- Wang, E., Volkova, E., Adams, A.P., Forrester, N., Xiao, S.Y., Frolov, I., Weaver, S.C. 2008. Chimeric alphavirus vaccine candidates for chikungunya. *Vaccine* 26, 5030–5039.
- Weaver, S.C., Barrett, A.D. 2004. Transmission cycles, host range, evolution and emergence of arboviral disease. *Nat Rev Microbiol* 2, 789–801.

- Wesselingh, S.L., Levine, B., Fox, R.J., Choi, S., Griffin, D.E. 1994. Intracerebral cytokine mRNA expression during fatal and nonfatal alphavirus encephalitis suggests a predominant type 2 T cell response. *J Immunol* 152, 1289–1297.
- Wielanek, A.C., Monredon, J.D., Amrani, M.E., Roger, J.C., Serveaux, J.P. 2007. Guillain-Barre syndrome complicating a Chikungunya virus infection. *Neurology* 69, 2105–2107.
- Zacks, M.A., Paessler, S. 2010. Encephalitic alphaviruses. *Vet Microbiol* 140, 281–286.
- Ziegler, S.A., Lu, L., da Rosa, A.P., Xiao, S.Y., Tesh, R.B. 2008. An animal model for studying the pathogenesis of chikungunya virus infection. *Am J Trop Med Hyg* 79, 133–139.

## Summary

**Background:** Chikungunya virus (CHIKV) is a member of *Alphavirus* genus of the *Togaviridae* family transmitted by *Aedes* genus mosquitoes. Infection with CHIKV is known to cause human joint disorders like arthralgia or arthritis which can persist for years. During the 2005-2006 outbreaks, CHIKV was seen to be able to persist in synovial macrophages for several months or even years. Macrophages are innate immune cells that play an essential role during inflammation processes but also in other pathologic activities like angiogenesis. In the same time, CNS infections were evidenced, showing a paradigm shift of this virus from the group of arthritogenic ‘old world alphaviruses’ to the encephalitic ‘new world alphaviruses’ group. **Hypothesis:** Our hypothesis is that the persistently CHIKV-infected macrophages can be polarized towards a chronic inflammatory response that may be harmful to neighboring cells of the connective tissue and contributing to arthritis. **Approach:** To decipher the engaged mechanisms, we developed a mouse macrophage cell line model (RAW264.7) of CHIKV infection and analyzed the virus replication and innate immune response engaged (cytokine, proangiogenic factor expression and programmed cell death). We also perform a comparative study with Sindbis virus (SINV), another member of the *Alphavirus* genus. **Findings:** *In-vitro* experiments revealed that less than 5% of RAW264.7 cells were infected, with a stable and constant production of intracellular virus particles, during the time course of infection (8-48hr). The capacity of the virus to replicate in macrophages was confirmed by the presence of positive and negative strands of the virus RNA (RT-qPCR) and dsRNA (immunofluorescence using the J2 antibody). However, no infective viral particles were release from the cells. Surprisingly, the infection did not translate into a robust type I IFN innate immune response (IFN- $\alpha/\beta$  and ISG56). TNF- $\alpha$ , GM-CSF and IL-6 expression were upregulated while IFN- $\gamma$ , IL-1 $\alpha$ , IL-2, IL-4, IL-5, IL-10 or IL-17 expression could not be evidenced after CHIKV exposure (ELISA, FACS array). Also and in contrast to CLTT astrocyte cells (positive control), RAW264.7 infected-cells failed to mobilize apoptosis in order to control CHIKV infection. By comparison to RAW264.7 cells, SINV infection of macrophages clearly showed significant increase in PRRs like TLR-3, RIG-I and MDA5 as well as type I IFN innate immune molecules (IFN $\alpha$ 4, PKR, ISG15/54/56) as well as signs of apoptosis. In addition, high expression of pro-angiogenic factors such as PDGFB was observed in CHIKV infected cells. **Conclusion:** These data clearly show that CHIKV can infect RAW macrophages which, in turn, failed to mount a protective interferon innate immune and apoptosis responses. These observations argue for the capacity of CHIKV to persist in macrophages. Moreover, the robust induced pro-inflammatory TNF- $\alpha$  and pro-angiogenic factors PDGFB may contribute to arthritis. We also showed that RAW macrophages responded differently to different virus of the same genus (CHIKV and SINV). **Perspectives:** The RAW264.7 mouse macrophage cell line model of CHIKV infection developed herein constitutes a new and validated tool to study the mechanism of viral/cell host interaction which could offer a better understanding of chronic pathologies associated with post-CHIKV infections.

## Résumé

**Contexte:** Le virus Chikungunya (CHIKV) est un membre du genre *Alphavirus* de la famille des *Togaviridae*, transmis par les moustiques du genre *Aedes*. L'infection par le CHIKV provoque des troubles articulaires comme l'arthrite ou des arthralgies qui peuvent persister durant des années. Au cours des épidémies de 2005-2006, il a été démontré que le CHIKV pouvait persister dans les macrophages synoviaux pendant plusieurs mois voire des années. Les macrophages sont des cellules du système immunitaire inné qui jouent un rôle essentiel dans les processus inflammatoires, mais aussi dans d'autres activités pathologiques tels que l'angiogenèse. Des infections du système nerveux central par le CHIKV ont également été mises en évidence, démontrant une extension des caractères arthritogéniques de ce virus du groupe des « *alphavirus* de l'ancien monde » à celui des « *alphavirus* du nouveau monde » causant des encéphalites. **Hypothèse:** Notre hypothèse de travail est que les macrophages infectés, de façon persistante par le CHIKV, sont polarisés vers une réponse inflammatoire chronique qui peut être néfaste envers les autres cellules du tissu conjonctif. **Approche expérimentale :** Pour élucider les mécanismes mis en jeu, nous avons développé un modèle d'infection par le CHIKV d'une lignée cellulaire de macrophage murin (RAW264.7) et analysé la réplication du virus et la réponse immunitaire innée engagée (production/libération de cytokines, facteurs de l'angiogenèse et mort cellulaire programmée). Une étude comparative avec un autre alphavirus (virus Sindbis, SINV), a également été réalisée. **Conclusions:** Les expériences menées *in-vitro* ont révélé que moins de 5% des cellules RAW264.7 sont infectées avec une production stable et constante de particules virales au cours du temps de l'infection (8-48h). La capacité du virus à se répliquer dans les macrophages a été confirmée par la présence des brins d'ARN viraux positifs et négatifs (RT-qPCR) ainsi que des ARN doubles brins (immunofluorescence avec l'anticorps J2). Cependant, aucune particule virale infectieuse ne semble être libérée par les cellules infectées. Étonnamment, l'infection ne se traduit pas par une réponse marquée IFN (IFN- $\alpha/\beta$  et ISG56). Une expression accrue de TNF- $\alpha$ , de GM-CSF et d'IL-6 a été mise en évidence tandis que l'IFN- $\gamma$ , l'IL-1 $\alpha$ , l'IL-2, l'IL-4, l'IL-5, l'IL-10 ou encore l'IL-17 ne subissent aucune modulation de leur expression suite à l'exposition des macrophages au CHIKV (ELISA, FACS large). En outre, et contrairement aux cellules astrocytaires CLTT (contrôle positif), les cellules RAW264.7 infectées ne mobilisent pas les mécanismes de l'apoptose afin de contrôler l'infection par le CHIKV. En comparaison avec les cellules RAW264.7, l'infection des macrophages par le virus SINV révèle une augmentation significative de l'expression des PRRs tels que TLR-3, RIG-I et MDA5, de l'IFN de type I (IFN $\alpha$ 4, PKR, ISG15/54/56) ainsi que l'activation de l'apoptose. En outre, l'expression élevée de facteurs pro-angiogéniques tels que PDGFB a été observée dans les cellules infectées par le CHIKV. **Conclusion:** Ces données montrent clairement que le CHIKV peut infecter les macrophages qui n'engagent néanmoins pas, en retour, de réponse IFN ou les mécanismes de l'apoptose à même de contrôler l'infection et pouvant de ce fait contribuer à la persistance du virus. Cependant, la robuste réponse pro-inflammatoire induite par le TNF- $\alpha$  et la production de facteurs pro-angiogéniques tels que le PDGFB peuvent contribuer à l'arthrite. Nous avons également mis en évidence que les macrophages RAW peuvent réagir différemment aux virus du même genre (CHIKV et SINV). **Perspectives:** Le modèle d'infection cellulaire de la lignée murine macrophagique RAW264.7 qui a été développé constitue un nouvel outil pour l'étude de l'interaction hôte/virus qui doit permettre d'une meilleure compréhension de certains mécanismes pathologiques associées aux infections chroniques post-CHIKV/*Alphavirus*.